

PRICE 10 CENTS

IN THIS ISSUE

Our Reconstructed Battleships
How the White House Keeps in Touch with Taft

POPULAR ELECTRICITY

Trade Mark

IN PLAIN ENGLISH

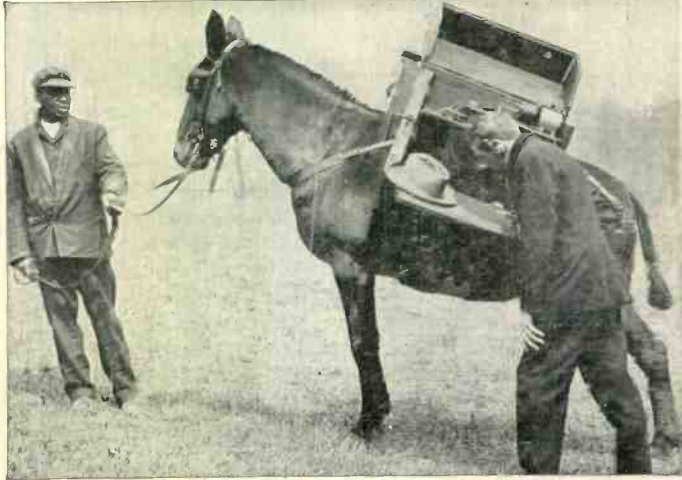

PORTABLE MILITARY WIRELESS STATION

Vol. II.

NOVEMBER 1909

No. 7

2 Years for \$1.50

YOU

AND
You Get

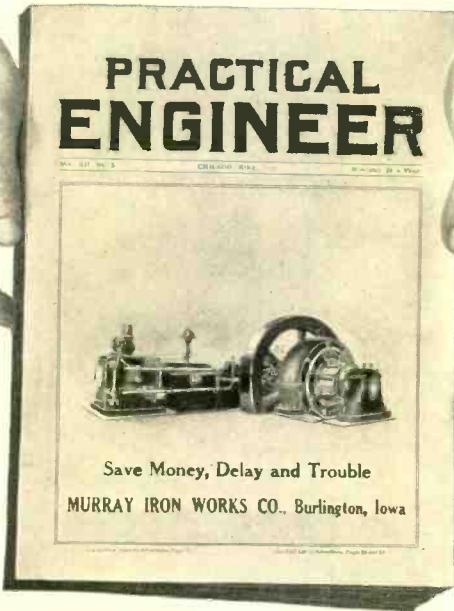

“Questions
and
Answers”
FREE

ought to have Practical Engineer come postpaid to you each month. You'll like it. You'll find things in every number worth many times its cost—new, fresh, up-to-date and mighty interesting information on steam and electrical subjects—live, engineering data, helpful editorials, experiences of engineers; and hundreds of successful engineering methods are described in a way that you'll appreciate and enjoy. All phases of the operation, installation and maintenance of machinery in Central Stations, Electric Lighting Plants and Isolated Power Houses are covered. In addition to this “practical letters” from active engineers are published and from no other single source can you get so many valuable hints and pointers about new ways of doing things, new kinks and new developments in the steam-electric field. These facts are worth knowing for they mean a saving of your time, avoidance of waste effort and greater earning ability. You'd better take this big fine journal for two years. It will help you. It will make your work easier, enable you to do it better, and point the way to quicker results. It contains nothing but good, sound, definite, reliable suggestions for higher efficiency—the kind you want. So start Practical Engineer coming your way today. \$1.50—that's all it costs for two whole years—24 big fat numbers and you get Questions and Answers free.

QUESTIONS and ANSWERS about Electrical Apparatus

by Clayton & Craig, is one of the most helpful and useful books written about electrical machinery and appliances. It is all good. It contains full, clear and absolutely accurate answers to hundreds of important questions—answers which you must positively know if you make good in electrical work. Such subjects as Direct-Current Motors, Induction Motors, Constant Potential Transmission, Mercury Arc Reflectors, Incandescent Lamps, Arc Lamps, Meters, Instruments, Steam Turbo-Generators and many others are fully covered in this book. You really ought to have it to refer to constantly—and you can have it free with two years subscription to Practical Engineering. Well bound in neat, flexible leather binding, Gold Stamped and is pocket size. Sent prepaid to anyone on receipt of price, \$1.00, or sent free on your acceptance of this Special Offer.

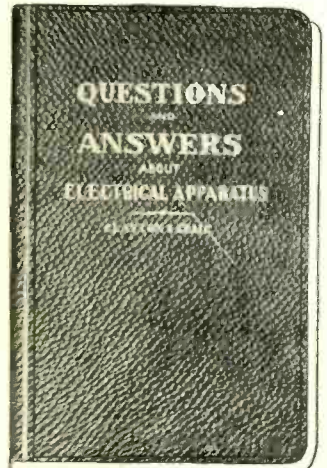

Nov.

Practical Engineer
359 Dearborn St.,
CHICAGO, ILL.

For the enclosed \$1.50, send me Practical Engineer for two years and include without cost, Questions and Answers about Electrical Apparatus, as illustrated here, which I understand will be sent by return mail with a current copy of the paper. I understand that my money will be cheerfully refunded if I'm not thoroughly satisfied with my bargain.

Name.....
Address.....
City..... State.....
Occupation.....

PRACTICAL ENGINEER

359 Dearborn St.
Chicago, Ill.

Cut out along this dotted line and mail today

We Install Power Plants Let Us Figure —

on all your Electrical Work. Some of the largest contracts on Electrical work in the country have been performed by us.

WE INSTALL

Power and Light Plants. Generators and Motors, Electric Light and Power Wiring for Factories, Churches, Schools, Colleges, Theatres, Office, Store and Residence Buildings.

Estimates cheerfully furnished for this class of work in any part of the U. S.

WE MANUFACTURE

Switchboards, Panelboards, Steel Cutout Cabinets, Junction Boxes, Service Switch Boxes, Theatre Stage Plugs, Experimental Switchboards and Appliances for High Schools and Colleges. Newgard receptacles and other electrical specialties.

All Electrical work at the Chicago Electrical Show installed by us.

Manufacturers of the Famous "Newgard" Waterproof Receptacle and Globe.

Henry Newgard & Co. CHICAGO, ILL.

Star Bolts Hold HERE



Where others give first!

The essentials of a good expansion bolt are: reliability, ease in using, strength, smallest hole required for the insertion of the anchor, being able to use the expansion parts with all regular bolts and screws.

These features are embodied in all

**STAR EXPANSION BOLTS
TO USE:**

Drill a hole in your wall, whether brick, stone, tiling, concrete, marble, slate or granite, and insert Anchor. Place fixture to fasten up, and run screw through, into anchor and tighten. The anchor expands in the wall! The fixture stays up until taken down!

Circulars and samples await your name and address at any of our offices.



Star Expansion Bolt Company
147-149 Cedar Street
NEW YORK CITY

1023 Maison Blanche Bldg., New Orleans, La
1010 Howard Street, San Francisco, Cal.
142 Lake Street, Chicago, Ill.

WIRELESS BOOKS You Should Read

The Latest on Wireless Telegraphy
By Newton Harrison, E. E.

Tells how to make and use inexpensive wireless outfits for sending and receiving up to 100 miles. Full details and drawings. 12mo. Cloth. Price, 50 cents

Wireless Telegraphy for Amateurs
By R. P. Howgrave-Graham

Gives full explanation of the construction and working of apparatus for short distance transmission. 160 pages. 51 illustrations. 12mo. Cloth. Price, \$1.00

Mailed postpaid on receipt of price

SPON & CHAMBERLAIN
123 E. Liberty St., New York

**TRY
IT
TEN
DAYS
FREE**
at my
Expense
Write Today



**I
WILL
Prepay
the
Express
Charge**
To Prove
Its Merit
Write at once

CURE YOURSELF BY ELECTRICITY

IF YOU SUFFER

from Rheumatism, Neuralgia, Constipation, Nervousness, Headache, Stomach Trouble or any other disease, I will send you a battery on ten days' trial.

MY VALUABLE NEW BOOK FREE
to all who write. Explains how my wonderful inexpensive batteries cure you in your own home. Tells how Electricity treats disease by striking the root. How it removes the cause, then cures the disease to stay cured. How it builds up and nourishes wasted tissue. It tells how I send a battery without a cent in advance and allow ten days free trial. Write today for this valuable book, I will send it free.

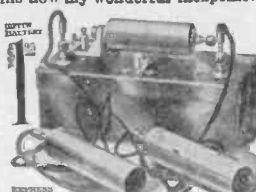

DETROIT MEDICAL BATTERY CO., E. C. Harkness, Gen'l Manager
1195 Majestic Building Detroit, Michigan

BUILDING MATERIAL BARGAINS



Through our policy of buying entire factory lots of merchandise and the purchase of a great deal of material at forced sales we come into possession of immense quantities of high-grade building material and machinery. Note the various items and prices on this page. These and many others in OUR NEW CATALOG (just off the press), offer an unusual opportunity to you to purchase guaranteed material at low cost. Act now and save money.

OUR GUARANTEE The keynote of our business is every article represented to be exactly as represented and to prove satisfactory to the purchaser. Any material not entirely satisfactory can be returned for an exchange or refund of money at our freight expense both ways.

Ready Roofings! Metal Roofings! Roofing Pitch and Roof Coatings!

Steel Roofing
Only \$1.50 per sq. ft.

These are good second-hand sheets of heavy weight, free from nail holes, painted on both sides. Price per 100 sq. ft., flat sheets \$1.50. Corrugated sheets \$1.75. Highest grade, Brand New galvanized roofing made of open hearth process, box annealed, the very best process of making metal roofing. Price per 100 sq. ft., flat sheets \$2.85. Price per 100 sq. ft., corrugated sheets \$3.10.

Coal Tar Roofing Pitch

Genuine Straight Run American Coal Tar Roofing Pitch. Best grade obtainable, not only for repairing leaks in any kind of shingles or built-up roof, but the finest thing for dipping fence posts. Sold only in full barrels of from 300 to 400 pounds. Price per 100 lbs. 53c.

Deadening Felt and Tarred Sheathing

Our catalog gives the price of all the different grades. Special Bargain No. 2275 Red Rosin Sixed Sheathing per roll of 500 square feet, 35c.

"Best Yet" Galvo Rubber Roofing is a very high-grade wool felt roofing thoroughly saturated with Gilsonite asphalt and coated with a secret rubber coat on both sides. Nothing better of this class manufactured. Each roll complete with nails and cement. Price: One-ply \$1.20 per sq., two-ply \$1.75 per sq., three-ply \$2.40 per sq. We offer our Central Brand Flint Surfaced Asphalt Roofing, the highest grade of its kind, each roll complete with nails and cement. One-ply \$1.20 per sq., two-ply \$1.45 per sq., three-ply \$1.80 per sq. We offer Roofing Mill Ends of either the rubber surfaced or flint coated roofing at only 75c per sq., two-ply \$1.40 per sq., three-ply \$1.40 per sq. Samples free—charges prepaid.

A Fortunate Purchase! We have just purchased 2500 rolls of the highest grade roofing made by one of the leading manufacturers. It is thickly coated with crushed grit. The body of the roofing is a very heavy felt, heavier than the ordinary three-ply, and it is thoroughly saturated with Gilsonite asphalt and coated with the secret rubber coating. The roofing has rubber surfaced back and grit coat on top, and weighs about 80 lbs. to the sq. One of the biggest mail order houses is advertising a roofing similar to this as their celebrated "Marble Coat Roofing." Their roofing weighs about 50 lbs. to the sq. Our roofing weighs about 80 lbs. to the sq. Note how much heavier and stronger. Their price is \$2.25 per sq. Our special price on this roofing while it lasts, \$2.00 per sq. It is strictly perfect stock, not mill ends and is complete, with nails and cement. Samples sent free—charges prepaid.

Diamond C Brand Roof Coating Will preserve any kind of roof, whether of metal, composition felt, or shingles. Price per 5 gal. can \$1.95, per barrel of 50 gallons \$12.50.

Hot Water or Steam Heating Plants
Bath Room Outfits and all Plumbing Fixtures and Pipe sold direct to you at Wholesale Prices.

Don't Be Held Up!
Don't pay an exorbitant price in order to have plumbing and heating conveniences in your home. Even though you live in the country they will cost you little. We sell all the material, give you blue prints and specifications that enable you to easily install outfits.

\$300 for hot water heating plant for this 12-room house including all material needed.

\$247 for all the material for a hot water heating plant for this 11-room house.

\$180. A first class hot water heating plant for this 8-room house for \$180.

\$135 is all it cost for a hot water heating plant for this 6-room cottage.

\$39 Buys this complete high grade guaranteed Bath Room Outfit

Bath tub 5 feet long, white porcelain enameled, trimmed complete with full nickel trimmings. Lavatory white porcelain enameled, complete with nickel trimmings. The closet is a high-grade modern sanitary outfit, with polished oak copper lined tank and seat and cover to match. Other bath room outfits from \$24.50 to \$105.00.

You can have a modern hot water heating plant in your home, even though you live away from a city. The cost is low. Fuel bills reduced one-half. Install it yourself. It's easy. Now is the time to prepare for next Winter. We will furnish an estimate free. You will save 50% by dealing with us. Write for information blank now. You take no chances. Our contract plainly states that the plant will furnish the temperatures required in every room. We will supply free of charge all the material should any be required to bring the plant up to our guarantee. Each plant is sold on a year's trial. If not satisfactory we will refund the entire purchase price. Complete working drawings free. We loan complete tool outfits to do the work. You can install the plant at odd times and have it ready for cold weather. Better heating plants cannot be bought at twice our price.

Lavatories—Like illustration, complete with full nickel trimmings at \$10.00. Lavatories without trimmings down to \$2.35.

Glazed porcelain Basin Bowls—We carry all kinds of basin bowls for marble lavatories. 14-inch round patent overflow rubber plug like cut each 75c. All other sizes in our catalog.

Bath Tubs—Cast iron white porcelain enameled, high-grade and with nickel trimmings at \$33.95. A number of slightly defective bath tubs without trimmings at \$5.00 each.

Hot Water Heater
Hot water heat combined with your furnace. Our cast iron heaters in all sizes, can be fitted in your furnace so that you can put hot water radiators in those cool rooms and make a perfect heating plant out of your present poor furnace. Prices the lowest.

Galvanized Ranko Boilers tested to 200 lbs. pressure, 30 gallon boiler, only \$4.90. Complete with stand tube and couplings, \$5.90.

Contractor's Ditch Pumps
and a diaphragm sewer pump will handle any kind of muddy or gritty water or sewage. Can't stop up. Capacity 1,800 gallons per hour. Price \$11.50.

Water Closets
Complete high grade high tank closet like cut—\$11.75. Low tank closets at \$11.25.

Band Saws
Twenty inch combined foot and belt power band saw, the best band saw for carpenters and contractors on the market. Has ratchet pulley foot treadle and it is impossible to cut on a dead centre. Every downward stroke of the treadle moves saw blade about eight feet. Unlimited power and speed can be obtained. Machine, all complete, with two blades. Price \$48.25.

Low Priced Gasoline Engines
Our Waterloo Gasoline Engines are the most simple and perfect operating small engine on the market. You just start the engine and it runs automatically. 2 H.P. water cooled or open jacket. Frost proof, only \$47.50.

Our Free Catalog No. 123 shows plain net prices on every article. Write for it today. We also handle light and heavy machinery, gasoline engines, windmills, etc.

White Enamelled Iron Sinks 18x24 for \$1.85

White Enamelled Kitchen Sinks, size 18x24, at \$1.50. Sink backs rolled rim, white porcelain enameled, 24 inch, at \$1.50, 30 inch at \$1.80.

First grade rolled rim Kitchen Sinks with long back and drain board and nicked faucets like illustration, size 18x30, \$15.75; 20x30 \$20.

Our Free Catalog No. 123 shows plain net prices on every article. Write for it today. We also handle light and heavy machinery, gasoline engines, windmills, etc.

We Guarantee Our Goods

Central Machinery & Supply Co. 2593 Archer Avenue CHICAGO, ILL.

POPULAR ELECTRICITY

IN PLAIN ENGLISH

HENRY WALTER YOUNG, Editor

Vol. II

NOVEMBER, 1909

No. 7

CONTENTS

	Page		Page
Alexander Volta.....	415	Wireless Receiving Set.....	458
ELEMENTARY ELECTRICITY. CHAPTER		Wehnelt Interrupter on 110 Volts A. C.....	458
19. By Prof. Edwin J. Houston.....	416	Wireless Parts and How to Connect Them.....	459
ELECTRICITY ON OUR RECONSTRUCTED		Five Mile Equipment.....	459
BATTLESHIPS	420	Condenser; Lightning Arrestor; Sending Helix;	
Tungsten Sign Lamp.....	424	Anchor Gap.....	459
Convenient Bracket Light.....	425	Tallest Single Stick Aerial.....	459
Show Window Light with Flaming Arcs.....	426	ELECTRICITY IN THE HOUSEHOLD	460-465
LIGHT THERAPEUTICS	427	BEAUTIFUL DISPLAY OF ELECTRICAL	
American Telephone in Pekin.....	428	FIXTURES	460
New Discoveries of Radium.....	428	Christmas Suggestions.....	462
SOME ELECTRIC EXPERIMENTAL APPARA-		ELECTRICITY THE BUSIEST WORKER	462
TUS	429	Electric Hair Drier.....	464
An Example of Economy.....	430	Don't Fear Electricity.....	464
MAGNETS FOR LIFTING STEEL RAILS	431	Shaving Mirror.....	465
Methods of Reviving Dry Cells.....	431	Electrical Home To Be.....	465
Welding Tungsten Lamp Filaments.....	432	JUNIOR SECTION	466-472
The "Great White Way" of Superior.....	433	SOME SIMPLE TELEGRAPH CIRCUITS	466
Attractive Window Display.....	433	One of Faraday's Original Experiments.....	467
HOW THE WHITE HOUSE KEEPS IN TOUCH		TRANSFORMED LIGHTING CURRENT	
WITH TAFT. By Waldon Fawcett.....	434	FOR SMALL MOTORS. By Louis H. Roller.....	468
OZONE GENERATOR IN THE CHICAGO		HOW TO MAKE A SMALL DIRECT CUR-	
PUBLIC LIBRARY	438	RENT DYNAMO. By C. S. Newcomb.....	470
Electric Horn.....	440	Does Lightning Strike Twice in the Same	
An Object Lesson.....	440	Place?.....	472
UNUSUAL APPLICATIONS OF ELECTRIC		QUESTIONS AND ANSWERS	473-478
HEAT	442	Direct Current Generator as Alternating Cur-	
TALKS WITH THE JUDGE	444	rent Motor.....	473
THE MOUNT WEATHER OBSERVATORY	445	High Frequency Current in Therapeutics.....	473
An Ingenious Alarm Clock.....	446	Generators in Series.....	473
NIGHT SCENES AT HUDSON-FULTON		Hydrogen Generator for Lead Burning.....	474
CELEBRATION	447	Recharging Dry Batteries; Current Con-	
The Magnetic Pole not the North Pole.....	448	sumption of Battery Tungsten Lamps;	
Dallas on the Safe Side.....	448	Pocket Storage Battery.....	475
HOW TO MAKE AN AUTO CONDENSATION		Shunt and Compound Wound Generator.....	475
PAD OR COUCH. By Noble M. Eberhart.....	449	Making a Voltmeter; Formula for Voltage;	
Wind Power Electric Plant.....	451	Lines of Force.....	475
A Church on Wheels.....	452	Annunciator Circuit.....	476
Miniature Saw Mill.....	452	500 Volt Motor and Engine; Switchboard to	
Record in Cable Repairing.....	452	Pass Inspection.....	476
Mighty Boiler for Electric Plant.....	452	Operation of a Manual Fire Alarm System.....	477
POPULAR ELECTRICITY WIRELESS CLUB		Small Motor; Hydrometer.....	478
Silicon Receiver.....	453-459	Three Way Switches; Equalizers.....	478
THEORY AND PRACTICE OF THE		NEW ELECTRICAL INVENTIONS	479-480
RADIO SYSTEM. By Frank C. Perkins.....	454	Electric Water Gauge.....	479
ENAMELED WIRE AND TUNING COIL		Unique Incubator.....	479
By A. B. Cole.....	456	Trolley Wheel.....	479
Wireless Association in New Orleans.....	457	Trolley Pole Guide.....	480
Potentiometer and Tuning Coil.....	457	Electric Heater.....	480
Relation of One to Twenty-Five Mile Equip-		Automobiles (Book Review).....	480
ment.....	457	NOTES ON PATENT INFRINGEMENT. By	
Auto-Spontaneous Repeating System.....	458	Obed C. Billman.....	481
Aerial Construction.....	458	SHORT CIRCUITS	482-483
Battery and Condenser for Six Inch Spark Coil	458	ELECTRICAL DEFINITIONS	484

RENEWALS. When your subscription expires, you will find a renewal blank enclosed here. You should fill out and return same with remittance at once, to avoid missing a number. Positively no copies will be mailed on any subscription after same expires unless renewed, and we cannot agree to begin subscriptions with back numbers. The date on wrapper of your magazine shows the issue with which your subscription ends.

CHANGE OF ADDRESS. Notify us promptly of any change in your address, giving both the old and new location. Since each issue is printed a month before the date it bears, we should be notified at least four weeks in advance, in order to make the necessary change in our records.

ISSUED MONTHLY BY POPULAR ELECTRICITY PUBLISHING CO., Monadnock Block, Chicago, Ill.
 YEARLY SUBSCRIPTION, \$1.00; CANADIAN, \$1.35; FOREIGN, \$1.50; SINGLE COPY, 10 CENTS

No additional copies will be sent after expiration of subscription except upon renewal.

Entered as Second Class Matter April 14, 1908, at the Post Office at Chicago. Under Act of March 3, 1879.

Copyright 1909 by Popular Electricity Publishing Co.

BUY the BOY a TOY

TRANSFORMER A Handsome Christmas Gift

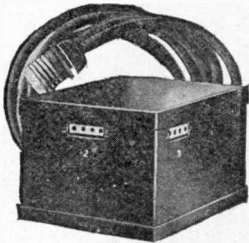

INDESTRUCTIBLE

Something worth while. Instructive as well as Amusing.

It is arranged to connect to any Alternating Current Lamp Socket, reducing the current to low voltages, for operating Electric Trains, Engines, Motors, Miniature Lamps, Etc., Etc.

Purchase Now

FOR SALE BY ALL LEADING ELECTRICAL JOBBERS

THORDARSON ELECTRIC MFG. CO.

220 Jefferson Street - - - - - CHICAGO, ILL.

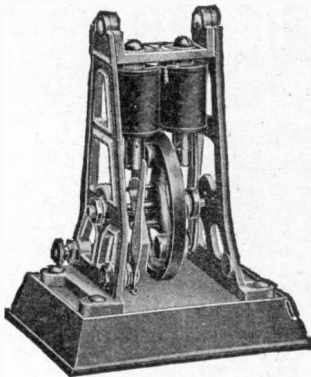

And this is another H.-K. Electric Toy Engine

Style E

Retails for \$1.00

Send for Catalog

Our Toys are covered by Patents granted and Pending.

C We make seven styles of Engines, also Aerial Swings, Merry-Go-Rounds, Ferris Wheels, etc!

The H.-K. Electric Toy Company

INDIANAPOLIS, IND.

Business Opportunity

The Independent Telephone field embraces over 15,000 Companies, operating 20,000 exchanges and employing 200,000 men.



It expends \$50,000,000 a year for apparatus and supplies, while its employes use a like amount for personal requirements, and as much more for their families and homes.



Any article which appeals to a prosperous, buying class is bound to win, and win handsomely, in the telephone field.



Every desirable reader throughout this important industry can be effectively reached through its one representative medium—

Telephony

THE AMERICAN TELEPHONE JOURNAL

Here is a real opportunity for wide-awake sales managers, or merchants who desire additional trade. Sample copies, rates and full descriptive matter promptly furnished on request.

TELEPHONY PUBLISHING CO.

Monadnock Block - - - - - CHICAGO, ILL.

Shelby
Lamps

In a Nut-Shell



1.—Shelby *Tungsten* Filament Lamps.

The lamps that have sent up the quality and knocked down the expense of electric lighting to a point such that it is now within the means of practically **EVERYBODY**.

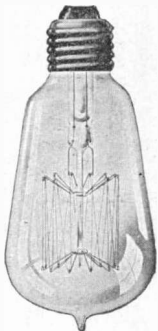

2.—Shelby *Tantalum* Filament Lamps.

Ideal for all direct current service, including **STREET RAILWAYS** and Private Lighting Plants.



3.—Shelby *Gem* Filament Lamps.

More efficient than the ordinary Carbon lamp by **25%**,—with an equal useful life.



4.—Shelby *Useful Light Carbon* Filament Lamps.

They send the light rays **downward** and outward, where they have the greatest effect. "It's All in the Coils,—They're Flat."



The Shelby Electric Company

Main Office and Works: Shelby, Ohio

BRANCHES EVERYWHERE

ONLY 25c

FOR THESE

PRACTICAL BOOKS

IN PLAIN ENGLISH

Splendid for beginners and amateurs. Full of helpful hints for advanced students and working electricians.

The Study of Electricity for Beginners

By Norman H. Schneider

Comprising the Elements of Electricity and Magnetism as applied to Dynamos, Motors, Wiring and to all Branches of Everyday, Practical Electrical work. Gives a good working knowledge of the subject and enables the reader to readily understand more advanced works. 88 pages, with 54 Original Illustrations and six tables. Paper covers. Price 25c.

Dry Batteries

How to Make and Use Them

By a Dry Battery Expert

Carefully revised with additional notes by Norman H. Schneider

Giving full detailed instructions for making Dry Cells of any shape and size, especially adapted for Automobile, Launch and Gas Engine work, Medical Coils, Burglar Alarms and for all purposes requiring a first-class Battery. 59 pages, with 30 Original Illustrations. Paper covers. Price 25c.

USE THE COUPON

Draw a line through title not desired, if you do not want both books.

Popular Electricity Publishing Co.,
Monadnock Block, Chicago, Ill.

Gentlemen:—Enclosed find _____ cents, for which send me **Study of Electricity for Beginners—Dry Batteries, How to Make and Use Them—** as advertised in **Popular Electricity.**

Name _____

Address _____

Town _____

State _____

Grand Land Opening in South Texas

AT ORANGE HILL

This superb orange, fig and vegetable colony land tract will be officially opened for purchase and settlement on November 18.

The land is surveyed into farms from five acres up, and much of it has been sold and settlement has begun. There is only room for about 200 families more. This \$100.00 land has been sold, and can now be reserved, at the extremely low price of \$40.00 an acre, on terms of \$1.00 an acre down and \$1.00 an acre per month. Liberal discount for cash.

NO INTEREST—NO TAXES

And insurance protection against loss in case of death or disability. Ninety days' extension of time in case of sickness or loss of employment. Immediate possession on receipt of first payment if desired.

An orange orchard will come to bearing in 3 years and yield \$150.00 an acre. A 10-year-old orchard will yield \$1,000.00 an acre and sell from \$2,500.00 to \$3,000.00 an acre. The average income from an orange grove 10 years old, for the first ten years, should easily be \$500.00 an acre net. Total earnings for the first ten years for one acre, \$5,000.00.

Magnolia figs come to bearing in 2 years and yield \$100.00 an acre. In 5 years the yield should be \$500 an acre and the orchard worth from \$1,000.00 to \$2,500.00 an acre. The average net yearly earnings of a 10-year-old fig orchard, for the first 10 years, should be \$300.00 an acre, or \$3,000.00 for the 10 years.

Vegetables can be raised between orchard rows and made to yield \$100.00 to \$500.00 an acre. Onions, potatoes, melons, cucumbers, cabbage, strawberries for the earliest and latest markets. Two and three crops a year. No irrigation, 40 inches of rainfall annually.

No clearing, every acre ready for the plow. Unexcelled climate, for health, profit and happiness.

A good truck farmer who knows how to intensify can make more money on 10 acres of this land than on 100 of Northern land, and at the same time be growing orchards for permanent income.

If you are a non-resident arrangements can be made to improve your land for you.

ORANGE HILL TOWN is near center of colony, railroad and best of market facilities. Near Houston and in the center of the greatest development in South Texas.

Send for reservation blank to fill out and reserve 10 or 20 acres of this fine garden land. In this way you will be sure to get in on something at the opening. Those who reserve land get the "first call" and will have the best chances to get near town.

A big thing for the speculator, investor or home builder.

I want you to write me and give me a chance to prove every statement I have made. My guarantee is "**Money back if not as represented.**" Reserve your land before the 18th and get in right.

The title to this land is absolute. Title papers have been deposited with the St. Louis Union Trust Co., which is trustee for purchasers and custodian of funds and will deliver your deed when land is paid for.

Write for maps, plats and full particulars today.

D. D. LANCASTER, General Manager,

The Orange Hill Land Company

Suite 229, Lincoln Trust Bldg., St. Louis, Mo.

Don't Be a Wage Slave

**Make \$3,000.00 to \$5,000.00 a Year
Be a Doctor of Mechano-Therapy**



Are you tired of working for wages which barely keep body and soul together? Have you the ambition to enjoy the profits of your own labor? To gain social prominence and financial independence? To go forth among your fellow men with your head up—an honored and respected citizen of your locality? Have you thought of going into business for yourself?

THEN SEND FOR OUR FREE BOOK

Entitled "How to Become a Mechano-Therapist." It tells how every man and woman, with an ordinary common school education, can acquire a profession within a few months which will insure financial independence for life. **GET OUR BOOK**—it costs you nothing.

WHAT IS MECHANO-THERAPY?

Mechano-Therapy is the art, or science, of treating disease without drugs. It is similar to Osteopathy, but far superior; being the latest, up-to-date method of treating disease by the Natural Method. It heals as Nature heals—in accordance with Nature's laws. The Mechano-Therapist is a drugless physician. His medicines are not drugs, but scientific combinations of food, circumstance, idea, water and motion. He is skilled in compelling the body **TO DO ITS OWN HEALING** with its own force, rather than with poisonous drugs of the old school practitioner.

CAN I LEARN IT?

Have you asked yourself this question? We answer unhesitatingly, **YES.**

If you have so much as an ordinary, common school education you can learn.

You learn if you have the ambition to better your condition.

We can teach you in a very short time, so you may enter this profession—when you do, you begin to make money. We supply all lessons and necessary text books free of cost to you. No apparatus is used. You do not even need a place to work. All you require is your two hands. Certainly you can learn. The free book tells all.

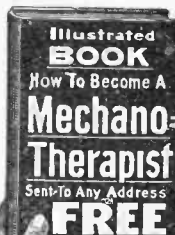

SEND FOR THIS BOOK TODAY, IT IS FREE

We Teach You in Your Own Home

We can teach you an honorable and profitable profession in a few months, which will insure your financial independence for life, making it possible to have an income of \$3,000 to \$5,000 a year. We teach you by mail, in your own home, without interfering with your present duties. No matter how old you are. Any person—man or woman—with just an ordinary school education, can learn Mechano-Therapy. It is easy to learn and results certain. We have taken hundreds of men and women who were formerly clerks—farmers—stenographers—telegraph operators—insurance agents—railway employees—in fact, of nearly every known occupation—old men of 70 years who felt hopeless—youthful men of 20 years, without a day's business experience—salaried men, who could see nothing in the future but to become Oesterized, and laboring men, who never realized that they had within themselves the ability to better their conditions. Write for our **FREE** book, which explains all—today.

AMERICAN COLLEGE OF MECHANO-THERAPY, Dept. 798, 120-122 Randolph Street, Chicago, Ill.

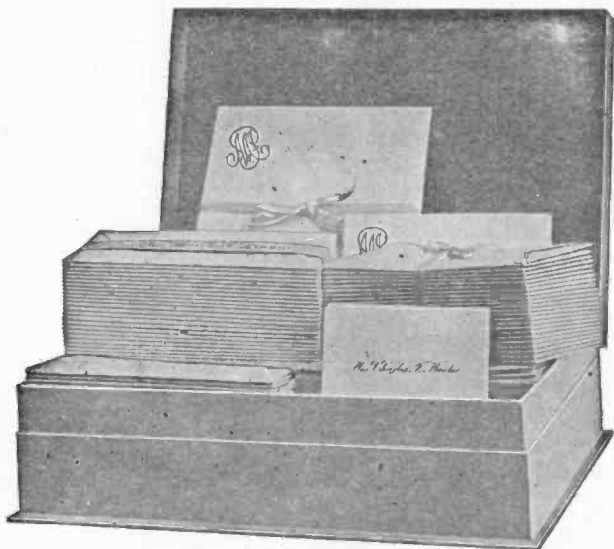

THIS box of HURD'S best Stationery, including two sizes of writing paper, *steel die stamped* with a specially made to order die of two initials, and two sizes of envelopes, also script name plate and 50 cards, price \$3.75, cash with order.

**Makes a Fine
Xmas Gift**

Schaum Engraving & Printing Co.

ENGRAVERS BY ALL PROCESSES

MILWAUKEE,    WISCONSIN

For our Mutual Advantage mention Popular Electricity when writing to Advertisers.

Send for **FREE** Samples and our **Great Clothing Offer**



Write today, just send your name and address for the most complete book of Clothing Styles and Samples ever published.

Sent free and post-paid, if you write at once. A startling, overwhelming revelation of the most stupendous values in **Men's Ready-Made** and **Tailor-Made** clothing ever offered. Values—and in *highest* quality—such as you never head of before. Don't think—don't even consider buying your Fall and Winter suit or Overcoat elsewhere until you have secured the details on this **staggering clothing offer.**

A Tailor-Made or a Ready-Made Suit

just as you prefer. Every single garment designed by the very finest clothing designers in the country, perfectly made up by the most expert workmen it is possible to obtain. No local clothier or tailor can possibly offer you such magnificent styles and quality. Fit, quality and **value** positively guaranteed.

Sent on approval — no money down. Don't send us a single cent until you have actually tried the suit on right in your own home. Satisfy yourself that you have an opportunity to secure far and away the most stupendous clothing bargain you ever heard of **before you even decide to buy.** Examine every detail carefully. Then if you are not absolutely satisfied in every possible way, ship the suit right back to us **at our expense.**

Rock-Bottom Prices Positively the lowest prices ever offered, on highest quality. Local tailors and dealers completely outclassed. You can dress better than you have ever been able to before, and on a mere fraction of what you are now paying.

Get the Truth About Clothing

We want you to read this valuable book carefully. Every secret of the clothing trade exposed. You learn how to tell clothing values in the same way as experts, how to tell wool goods from cotton or from cotton mixtures; how to detect shoddy, how to pick out a piece of goods that will wear, hold its shape, that will not fade, etc. Besides, this free book contains the most complete and startling exposure of clothing frauds that was ever issued. And the magnificent samples which we send you must—surely—delight you. Now write.

BABSON BROS., Dept. 1408 19th & California Ave., Chicago

Send for the Free Book

NOW Don't wait a minute. Use the coupon, or a postal or letter, and write at once. Remember, free examination—no money down—rock-bottom prices. Even if you do not need a suit right away, you should get the Free Samples and this Great Offer. **Send the Coupon NOW!**

BABSON BROS., Dept 1408 19th and California Ave., CHICAGO
Please send me free without any obligations your free clothing samples and full particulars of your great offer.

Name _____

Address _____

An Interesting Proposition

You Can Have Your Choice

As adopted by the fire underwriters of the United States. Contains the National Electric Code explained with numerous illustrations, with the necessary tables and formulae for outside and inside wiring and construction for all systems. Over 150,000 Copies Sold.

Up-to-date and most complete book on "Wireless" yet published. Full directions for constructing experimental sets, and various apparatus winding spark coils of all sizes and dimensions, tuning of wireless stations, etc. Includes Naval Station rules, with codes, etc. and several chapters on wireless telephony. All in simple language. 200 pages, fully illustrated, with 6 additional half-

full page tones showing installation of "Wireless" in the U. S. War Ships and Ocean liners.

Three volumes in one. In this Concise and Practical book you will find everything explained simply and clearly. For the beginner this book is what you want. Over 280 pages fully illustrated.

One of the latest and most valuable works on electricity for the amateur or practical electrician published. Tells you in easily understood language everything you should know about various electrical instruments and apparatus of all kinds, with instructions for conducting interesting experiments with inexpensive materials and tools easily obtained. 206 pages, fully illustrated.

Remember—we cannot give you these books with your own Subscription

of these Practical Books on Electricity—the best of their kind—with a Handy Electrical Dictionary (see small cut) containing over 4800 electrical terms and phrases with 7 pages of diagrams—if you will send us

One Paid Yearly
SUBSCRIPTION
To Popular Electricity



AT ONE DOLLAR
(Canada \$1.35, Foreign \$1.50)

And 25c additional to cover packing and shipping charges on the books.

The subscription must be for some one not already a subscriber to POPULAR ELECTRICITY and your own subscription will not do. We give you the books for getting us a new subscriber—not for subscribing yourself.

POPULAR ELECTRICITY appeals to all classes of readers—has something of interest for everybody. Your friend—neighbor—business associate—fellow employe—any one of the people with whom you come in contact—only needs to have you call attention to our magazine to become interested and give you a subscription.

A few minutes work will win you the books. Many of our readers have already taken advantage of this offer. Why not you?

Don't let this chance slip. Select the book you want, send in the subscription with remittance (including the 25c for charges) and we will forward book and dictionary at once.

POPULAR ELECTRICITY PUB. CO.
Monadnock Block, Chicago, Ill.

Gentlemen: Enclosed find \$..... for which send POPULAR ELECTRICITY to (subscriber's name and address here Not your own.)

Name..... Town.....

St. & No..... State.....

Send me HANDY ELECTRICAL DICTIONARY and (name of book wanted) as per your special offer. (P. E. 10-'09) Write your name and address plainly on space below.

Name..... Town.....

St. & No..... State.....

For our Mutual Advantage mention Popular Electricity when writing to Advertisers.

Vibrate Your Body And Make it Well

You have no *right* to be sick. Pain, suffering and disease are unnatural, they are *wrong*. It is your *duty* to be well. Don't try to *stand* pain—*CURE IT*. No matter what ails you—even if others have told you that your case was incurable—*DON'T GIVE UP HOPE*. The great natural forces, *Vibration and Electricity*, are curing more people today than all the drugs and doctors in the world put together.

THE WHITE CROSS ELECTRIC VIBRATOR

combines both of these great natural curative agents. It gives you your choice of Vibration, Faradic and Galvanic Electricity, either separately or in combination, just as you wish. It relieves pain *instantly*, and its cures are permanent.

The White Cross Electric Vibrator cures the cause of disease. It sends the rich, red blood leaping and coursing through your veins and arteries straight to where the disease begins. It tones up your nerves and muscles and every vital organ. It makes you *fairly singe with the joy of living*. Don't neglect the *FIRST* symptoms. If you feel "run down," "out of condition," if you just feel "out of sorts" generally, something is wrong. The most serious diseases creep upon you unawares. The White Cross Electric Vibrator fills your body so full of vigorous, robust health that pain and disease cannot find a foothold.



Curing Stomach Trouble with Vibration.

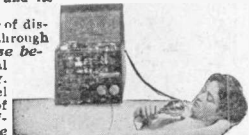

Combined Electric Bath and Vibratory Treatment.



Making the Hair Beautiful with Vibration.



VIBRATION FOR THE RACKING BACKACHE OF WOMEN

FREE BOOK "Health and Beauty"

SEND TODAY for the magnificent free book, "Health and Beauty." This valuable work tells you all about the human body in health and disease in terms so plain, so clear, that anyone can understand. It tells you how you can get well and keep well, no matter what your trouble is. This book was not written for surgeons and physicians, but for you. Every page, every line, is thrillingly interesting. Besides, this book tells you all about the wonderful White Cross Electric Vibrator—what it has done for thousands of others and what it will do for you. It tells you about a very special offer which we are making, for just a short time, on this wonder-working instrument, and how you can get a White Cross Electric Vibrator on a genuine free trial. Your name and address brings this intensely interesting book by return mail. Sign the coupon and mail it to us at once.

CURE THESE DISEASES AND MANY OTHERS

- | | |
|-------------|------------------|
| Hedache | Nervous Debility |
| Catarrh | Bright's Disease |
| Insomnia | Heart Trouble |
| Toothache | Deafness |
| Indigestion | Stomach Trouble |
| Rheumatism | Scalp Disease |
| Neuralgia | Constipation |
| Earache | Lumbago |

All these and dozens of other chronic and acute diseases instantly relieved and permanently cured by Vibration and Electricity. Get our wonderful free book, "Health and Beauty." THEN you will know.

Vibrating Chair Free

With the White Cross Electric Vibrator, you can transform any ordinary household chair into a Vibrating Chair, equal in every respect to those used in the big hospitals and sanitariums. You can give yourself the same treatments, including the famous Swedish Movement treatments, that specialists and sanitariums charge \$2.00 to \$3.00 apiece for. This is only one of the many marvelous things that can be done with the White Cross Electric Vibrator exclusively.

Send Coupon Today For Free Book

DON'T DELAY A MINUTE. Whether you are sick or well, you should send for this book *anyway*. You cannot tell when you may need it and need it badly. When you do there will be no time to send for it. Learn *today* what vibration will do for you—for all your loved ones. Learn all about its wonderful health-giving powers. Learn how you can save all doctor bills and cure yourself right at home without expense.

SEND NO MONEY, just your name and address on the coupon. But write today.

LINDSTROM, SMITH CO.
253 LaSalle Street
Dep't 1408 CHICAGO



SIGN AND MAIL THE COUPON TODAY

LINDSTROM,
SMITH CO.,
253 LaSalle St.,
Dep't 1408 CHICAGO

Without obligations on me, please send free, prepaid, your book "Health and Beauty," on treatment of disease by Vibration and Electricity. Also free trial offer.

Name

Address

.....



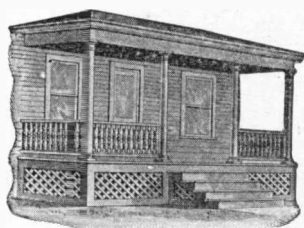

Millwork for this Porch, \$23.38.

We Sell Millwork for all styles of Porches at Cut Prices.

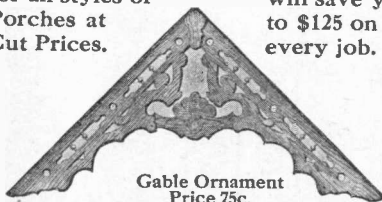

Gable Ornament Price 75c.

Our Stair Department will save you from \$60 to \$125 on every job.



Oak Stairs, Complete, \$28.59.

Old Houses Made New at Small Cost!

Write for Grand Free Millwork Catalog 5000 Bargains in Doors, Windows, Mouldings, All Material for Stairs, Porches, Vestibules, Grilles, &c.

Quality and Safe Delivery Guaranteed Anywhere

Send for handsomely illustrated Free Millwork Catalog showing all kinds of material for building or remodeling. Everything in the latest styles approved by best architects. Each of the 5000 items offered at a bargain price. You can buy, direct from the world's largest building material plant, whatever you require for modernizing both exterior and interior of your home. All styles of doors, from plain pine to finest Art Front Doors of polished hardwood. Prices 80 cents up. Windows in every size and style, from plain windows at 63 cents to magnificent Venetian Art Glass Windows in beautiful color effects. Material for complete flight of stairs, only \$24.73—an actual saving of \$60 to \$125. You will be surprised at the small cost of Hardwood Flooring, Plate Rail, Beamed Ceilings, artistic Mantels, beautiful Grilles and Colonnades, Sleeping Porches and other up-to-date improvements that any carpenter can put in.

We Undersell Everybody on Building Material

We do a business of over a million dollars a year. We carry immense stocks of guaranteed building material in our own warehouses and lumber yards. No other concern can duplicate our prices. All our material is guaranteed up to the Official Grades of the Sash & Door Manufacturers' Association. We sell for cash and ship everywhere under an absolute guarantee of safe delivery and satisfaction or money back.

If you are going to build, remodel or repair a house, barn or any other building, we can save you from 50 to 75 per cent of the usual cost. Don't fail to send for the Free Catalog of Millwork and Building Material.

Gordon-Van Tine's Famous Book of Plans FREE!
44 Complete Houses, Bungalows, Cottages, Barns

The most popular collection of plans for beautiful, practical homes. Up-to-the-minute in style. Correct in every detail. Designed by licensed architects. Don't build until you see these handsome homes. The complete Book of Plans mailed free on receipt of 10 cents to cover cost of packing and postage.

Gordon-Van Tine Company

World's Largest Building Material Plant

1847 Case Street

Davenport, Iowa

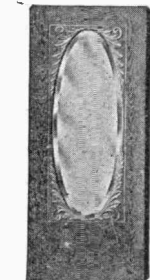

"Graceland" Door with Plate Glass \$11.25

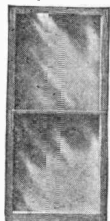

Windows, 63c.

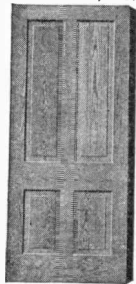

Pine Door, 77c.



500 Sq. Feet Best Bldg. Paper, 37c.

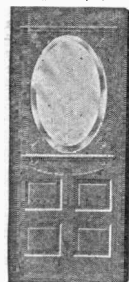

"Claremont." Door, with Clear Glass, \$4.50

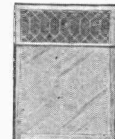

Art Window, \$3.75.

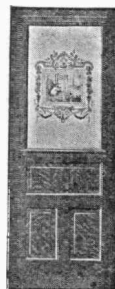

"Manhattan." Door, Etched Glass, \$3.16.



Stair Newels.

Price, \$2.86.

Price, \$2.83.



Combination Oak Plate Rail and Picture Moulding, per Foot, 7c.

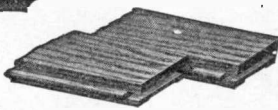

100 Lineal Feet Oak Flooring, 80c.

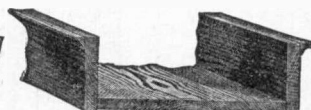

Oak Beamed Ceiling, Lineal Foot, 13c.

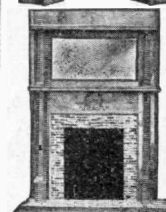

Classic Mantel, \$24.75.

Webster's New \$8.50 Encyclopedic Dictionary FREE with every order!

LATEST—GREATEST—CHEAPEST
Magnificent 1909 Edition—Fresh from the Press—of the

New Americanized Encyclopedia

The most comprehensive, authoritative, up to date Encyclopedia in the world.

TREMENDOUS PRICE REDUCTION—AN OVERWHELMING BARGAIN



Extraordinary
half price
offer.

You save 50%
by ordering
NOW.

The
highest possible
value.

The
lowest possible
price.

\$1.00 SECURES THE SET. Sent FREE for Examination

The Most Stupendous Free Trial Offer Ever Known in the World of Books

Other books may be DESIRABLE—the Encyclopedia is INDISPENSABLE. It solves all problems; answers all questions; settles all disputes. Other books trace one arc of the great circle of knowledge; the Encyclopedia sweeps the whole circumference. These fifteen massive volumes, with their 10,000 double column pages, their superb maps, their hundreds of illustrations, form in themselves a colossal library. It represents the perfection of critical scholarship, the cream of the world's literatures, the sum and essence of human thought and endeavor. It includes every phase of discovery, invention, experience and belief. It describes the countless wonders of the earth, the teeming myriads of the sea, the star-sown spaces of the sky. It covers all epochs of literature, all forms of government, all systems of religion. It reveals all that the world has suffered and dreamed of and hoped and DONE from the beginning of time. All gallant deeds and stirring scenes, all victories of brain or brawn, all marvels of science and invention, all the glorious achievements that have made history luminous and civilization possible are found in the 10,000 pages of these splendid volumes. Can YOU afford to do without it?

Its Matchless Authority. The most brilliant thinkers of the century are enrolled as its contributors. Its writers include such men of world-wide fame as Mathew Arnold, James Bryce, John Morley, Andrew Lang, St. George Mivart, Cañon Farrar, Edmund Gosse, John Stuart Blackie, Leslie Stephen, Edward Freeman, Lord Kelvin, Robertson Smith, Sir Norman Lockyer, Thorold Rogers, Saintsbury, Swinburne, Simon Newcomb, John Fiske, Cardinal Gibbons, John Bach McMaster, Admiral Melville, Thomas B. Reed, Carroll Wright; and these with hundreds of others equally famous give it an authority so overwhelming that it reigns without a rival in the realms of scholarship.

Incomparably Up To Date. Our 1909 Edition is fresh from the press and contains events as recent as the election of President Taft, the latest airship flights of the Wrights and Zeppelin, the return of the United States Fleet from its momentous world-voyage and the great Italian earthquake.

Special Half-Price Offer. To emphasize the issue of the 1909 Edition of this magnificent work we are making for a limited time only a special introductory offer at just ONE-HALF the regular price. The cloth set we price at \$37, the half-morocco at \$46. Moreover, with every order we will send absolutely FREE Webster's Huge New Encyclopedic Dictionary, retailing regularly at \$8.50. It is bound in Full Sheep, marbled edges, gold stamped and indexed. This combination of the world's most famous Encyclopedia and equally famous Dictionary gives you a magnificent reference library of enormous extent and unmatchable value at an expense, for a limited time, of only SEVEN CENTS PER DAY!

Send No Money Now. Sign and mail the attached coupon and we will ship you a complete set for five days' FREE examination. You can return them AT OUR EXPENSE if they fail to give you entire satisfaction. We pay all transportation charges. Should you desire to purchase, then send us \$1.00 as first payment and pay the balance at the rate of \$2.00 per month for the cloth and \$2.50 per month for the half morocco.

Do Not Delay. At these phenomenal prices the introductory sets will vanish like magic. It is the opportunity of a lifetime. Enrich your mind, adorn your library, delight your family with this stupendous work. Write TO-DAY. Remember, No risk! No obligation! You purchase only if satisfied!

THE BOOKLOVERS' SOCIETY

156 Fifth Ave., New York City

P. E.
Nov. '09

COUPON

The
Booklovers'
Society
156 Fifth Ave.
New York

FREE EXAMINATION COUPON

Please send me for examination prepaid a complete set of the **New Americanized Encyclopedia** in half morocco binding at your **SPECIAL HALF-PRICE** offer of \$46.00. If the set is satisfactory, I agree to pay upon the purchase price the sum of \$1.00 in cash within 5 days after receipt of goods and \$2.50 each month thereafter for eighteen months. If the books are not satisfactory, I am to notify you promptly and hold them subject to your order.

Also send me Webster's New Encyclopedic Dictionary, which I am to receive absolutely FREE should I retain the set.

Name

Address

If you prefer the cloth edition, alter \$46.00 to \$37.00, and \$2.50 each month to \$2.00.

For our Mutual Advantage mention Popular Electricity when writing to Advertisers.

POPULAR ELECTRICITY

The light of noonday through
fleecy clouds — The light of

Banner Tungsten Lamps

in frosted bulbs — You can
not tell the difference.

Unequaled
Economy

For Multiple
Burning

A. C. or D. C.
Circuits

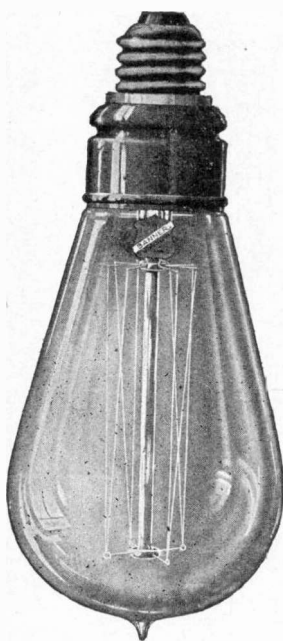

25 Watts

40 Watts

60 Watts

100 Watts

150 Watts

250 Watts

Ask for our Bulletins

Buy Banner Betterness

THE BANNER ELECTRIC CO.

YOUNGSTOWN, OHIO

For our Mutual Advantage mention Popular Electricity when writing to Advertisers.

*You should send your
Name and Address
at once for a Free
Working Sample of
JOHNSON'S UNDER-LAC*



Did you ever get hold of a varnish that would dry *hard* in half an hour—and wouldn't show scratches or heel prints?

Did you ever see a shellac that wouldn't lap, pull or crawl before you could get it spread?

Try Under-Lac

You can use it wherever you would use shellac or varnish. Over stain, dye, filler or on bare wood. To brighten up old varnished, oiled or shellacked surfaces. To preserve and beautify linoleum, oil cloth, etc.

It is applied easily and quickly. Dries hard in a half-hour's time. Will not lap, pull or crawl. Gives a brilliant, lasting finish with all the fine effect of "hand-rubbed" work. More artistic—more satisfactory to both you and your customers—better in every way than shallac or varnish—and *costs less*. Gallon cans, each \$2.50.

Under-Lac is made of pure gum and spirits.

Owing to the recent removal of the Revenue Tax, we are able to use Denatured Alcohol that formerly sold for \$2.60 per gallon—can now be bought for 45c.

One test will convince you that Under-Lac hasn't an equal in the world for its purpose.

Prove It At Our Expense

Send this coupon for a free sample of Under-Lac, and try it yourself. We put it up to your judgment. If you can go back to ordinary shellac or varnish—or to anything else of the kind—after once using Under-Lac, then we've nothing more to say. But we *do* ask you to try it. And we make you this free-test offer because we know what Under-Lac will do. Here's the coupon. A minute's time and a 2c stamp are all that's needed. Why not get it into tonight's mail?

**S. C. Johnson & Son
Racine, Wis.**

"The Wood Finishing
Authorities."

S. C. Johnson & Son, Racine, Wis.
I accept your offer of a sample of Johnson's Under-Lac, better than varnish or shellac. Also, book edition of "E.L.I." agree to test the sample and report results to my paint dealer.

Name.....
Address.....

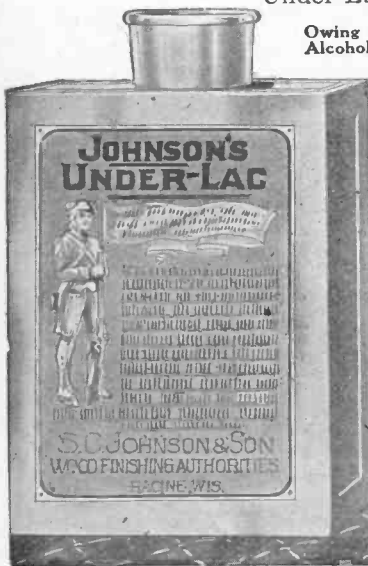

For our Mutual Advantage mention Popular Electricity when writing to Advertisers.



CHIEF DRAFTSMAN

Will INSTRUCT PERSONALLY a limited number selected, ambitious men in

Practical Drafting, Detailing, Designing

Draftsmen Drawing \$125-\$150 Monthly

Are NOT MADE in Schoolrooms,
Are NOT MADE by Reading Books,
Are NOT MADE by making Copies,
Are NOT MADE at home drawing pictures
from printed book lesson.

LET ME TELL YOU:

It requires actual, practical, up-to-date
DRAFTING-ROOM WORK to train YOU to
gain the PRACTICAL EXPERIENCE that your
employer will demand of you.

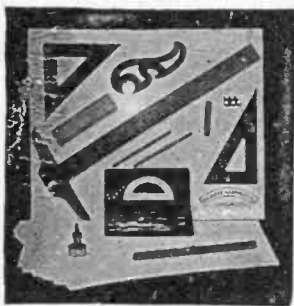

FREE

This \$13.85
DRAWING OUTFIT
and Free Position

As Chief Draftsman of Engineering firm I know exactly the Quality and Quantity of PRACTICAL training, knowledge and actual up-to-date experience (not school knowledge) you must have, in order to obtain a good position and advance to highest salary.

I give INSTRUCTIONS UNTIL COMPETENT and
PLACED in POSITION at above Salary

DON'T waste TIME and MONEY trying to learn from books or printed "STUFF" you can only learn on PRACTICAL WORK which I furnish you.

Address **CHIEF DRAFTSMAN**

Div. 10. Eng's Equip't Co. (Inc.), Chicago

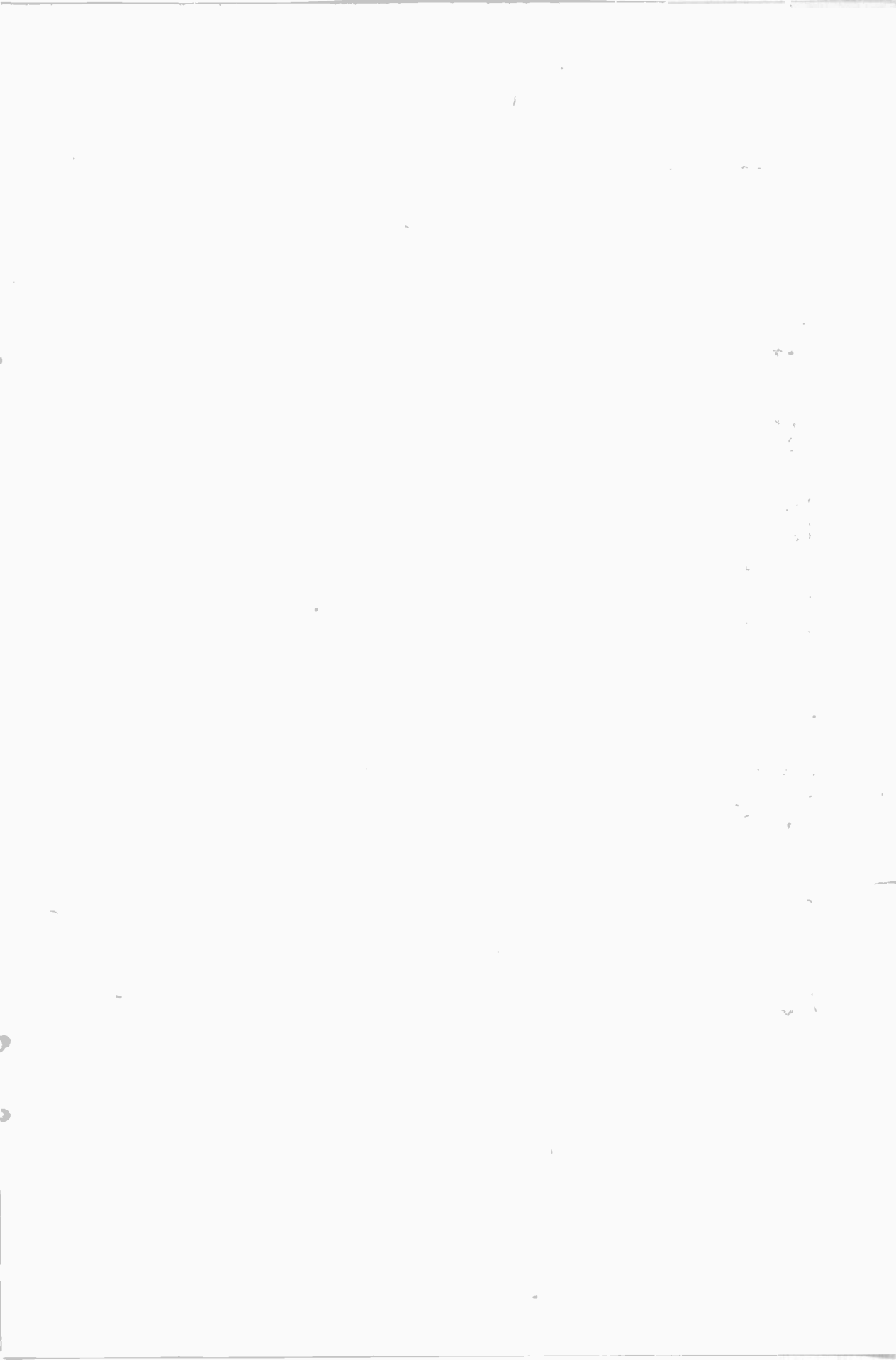



ALEXANDER VOLTA

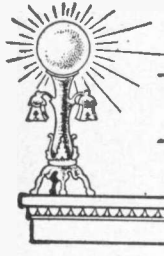

POPULAR ELECTRICITY

IN PLAIN ENGLISH



VOL. II

NOVEMBER 1909

No. 7

ALEXANDER VOLTA

The word "volt" is probably the most familiar of all words in electrical phraseology. It means, of course, the unit of electrical pressure or potential. The name volt was given to this unit in honor of Alexander Volta who lived more than a century ago and was one of the early experimenters who began to arouse the interest of the world in electricity and its possibilities.

Volta's early experiments had to do principally with contact electricity, but by far his greatest achievement was the discovery of the production of electric current through the agency of chemical action, leading to the discovery of the voltaic pile. Galvani had made his famous frog leg experiments and noticed the peculiar muscular contractions when the legs of a newly killed frog were brought in contact with iron. He assumed that this was caused by a vital fluid flowing out of the nerves of the frog and through the iron. Volta at first believed this to be true, but subsequent experiments convinced him that the true cause was a new form of electric current, produced by chemical action. He then built up an electric generator known after him as the voltaic pile, which consisted of a series of two sets of dissimilar metals arranged alternately one above the other with a liquid capable of conducting electricity between. The pile or battery so made was capable of producing a constant flow of current.

Results of his experiments then led Volta to classify electric conductors into two groups: (1) Conductors like carbon and metals which receive electric charges by contact; (2) conductors composed of liquids (which we now would term electrolytes). Current is then produced by arranging two different conductors of the first class with a conductor of the second class between them. This was the forerunner of the battery, which, before the invention of the dynamo, was the only means of producing current in any considerable quantities.

Alexander Volta was born in Como, Italy, in 1745. In 1774 he was appointed Professor of Physics in the Gymnasium of Como. In 1779 he was given the chair of physics at Pavia and in 1791 received the Copley Medal of the Royal Society. In 1801 Napoleon called him to Paris to show his experiments on contact electricity and a medal was struck in his honor. In 1815 the Emperor of Austria made him Director of Philosophy of Padua. He died in the year 1827.

Elementary Electricity

By PROF. EDWIN J. HOUSTON, Ph. D. (Princeton)

CHAPTER XIX—THERMO-ELECTRIC CELLS

In the year 1821, an experiment made by Seebeck, of Berlin, resulted in the invention of another electric source, the thermo-electric cell, that produces electricity by differences of temperature. In the frictional electric machine mechanical energy is converted into electric energy; in the voltaic cell, chemical energy is converted into electric energy, while in Seebeck's thermo-electric cell, it is heat energy that is so converted.

Seebeck's experiment was as follows: He bent a copper rod twice at right angles so as to form the three sides of a rectangle, and then as represented in Fig. 126, completed the fourth side by a bar of bismuth soldered at each end to the copper. When he heated one of these junctions, an electric current was produced that flowed in the direction indicated by the arrow, through the copper, from the hot to the cold junction.

In order to show the presence of this current as well as the direction in which it flows, Seebeck placed a magnetic needle inside the rectangle so that its upper and lower sides were parallel with the direction in which the needle came to rest under the influence of the earth's magnetism. This device practically formed a galvanometer by the use of which it was possible not only to tell when the current was flowing, but also the direction of its flow; for, as soon as one junction was heated and a thermo-current flowed through the circuit the needle was moved in a certain direction to an extent that depended on the amount of electricity flowing, and its direction depending on the direction of the current. Seebeck showed that when the junction instead of being heated by a spirit lamp was cooled by a lump of ice, the needle moved in the opposite direction, thus showing that the current was now flowing in the opposite direction.

Extended observations made by Seebeck and others showed that pairs or couples of practically all metals when formed into circuits similar to the above are capable of

producing currents of electricity when one junction is heated or cooled more than the other.

In the following table a number of metals are arranged in such an order that the current produced by heating a junction of any two of these metals produces a current that flows from the metal first in the list to the other metal. Such a series is known as a thermo-electric series.

Bismuth	Silver
Platinum	Zinc }
Lead	Iron }
Tin	Antimony
Copper	

If, for example, bismuth and antimony were employed, on the heating of one of the junctions the current would flow from the bismuth to the antimony.

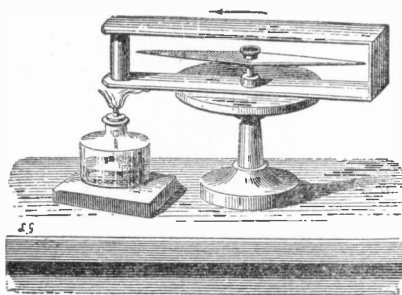

FIG. 126. SEEBECK'S THERMO-ELECTRIC EXPERIMENTS

It can be shown that, generally speaking, the electromotive force produced, and consequently the strength of the current, increases with the difference of temperature.

Electric currents produced by thermo-electric cells were formerly known as thermo-electric currents and the E. M. F.'s so produced as thermo-electromotive forces. These names were employed under the belief that there were different kinds of electricity produced by different electric sources. For example, frictional electric machines, that as we have seen produce powerful electric charges, or electricity at rest, were sup-

posed to produce a peculiar variety of electricity known as static electricity; voltaic cells were supposed to produce what was known as voltaic electricity. It is now known, however, that electricity, no matter how produced, is one and the same; the only differences are in the strength, constancy and direction of the E. M. F.'s, that cause the electricity to flow, or in the steadiness with which the electricity flows; as well as to whether it continues to flow in the same direction or is constantly changing its direction. The terms thermo-electricity, static electricity, and voltaic electricity, however, are still employed, though only as a convenience for indicating the nature of the electric source by which they were produced.

A pair of metals so joined as to be capable of producing electricity when their junctions are unequally heated, is called a thermo-couple, and the combination itself is called a thermo-electric cell.

By the electric power of a metal is meant the E. M. F. it is capable of producing when employed as a thermo-couple with lead, for a difference of temperature of 1° C. These E. M. F.'s, are so small that their values are generally given in microvolts, or millionths of a volt. The following table of thermo-electric powers is taken from Sylvanus P. Thompson. The metals from bismuth to iron are positive and from antimony to selenium negative.

+ Bismuth	89 to 97
+ Nickel	22
+ German silver	11.75
+ Lead	0
+ Platinum	- 0.9
+ Copper	- 1.36
+ Zinc	- 2.3
+ Iron	- 17.5
- Antimony	- 22.6 to - 26.4
- Tellurium	502
- Selenium	800

The E. M. F. produced by a single copper-iron couple, when the junction is raised 1° C. above the other junctions, is -16.14 microvolts. This, as will be seen, is obtained by subtracting -1.36 from -17.5 .

It can be shown that it is not only couples formed of different metals that are capable of producing thermo-electric currents, but that the same kind of metal, when in different physical conditions, is capable of forming a voltaic couple. Sturgeon obtained electric currents from a thermo-electric couple of hammered iron and annealed iron. Becquerel has shown that if a piece of platinum wire coiled at one part of its

length, as shown in Fig. 127, when heated near the coil by a spirit lamp produces a current that can be detected by a delicate galvanometer.

When subjected at its junctions to a difference of temperature of the freezing and boiling point of water, a bismuth-

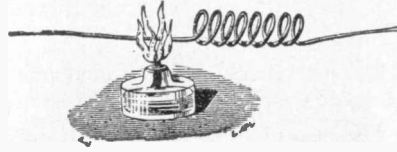

FIG. 127. CURRENT WITH ONE METAL

antimony couple produces an E. M. F. of 0.0115 volts. Consequently, in order to produce currents suitable for ordinary use it is necessary to connect a number of thermo-couples in series. Such a connection forms what is known as a thermo-electric battery.

As in the case of any electric source, such, for example, as the thermo-cell, in order to connect a number of such cells in series, the positive pole of one couple must be connected with the negative pole

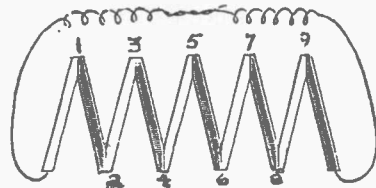

FIG. 128. THERMO-ELECTRIC COUPLES

of the next couple, the positive pole of the couple with the negative pole of the next couple, and so on throughout the series. This is only another way of saying that in a series connected battery of thermo-couples, the alternate junctions must be alternately heated and cooled. In order that this may be readily done the alternate bars of antimony and bismuth that form the successive couples are placed as shown in Fig. 128, where the light and shaded bars represent respectively bars of bismuth and antimony so placed that the successive junctions come at the bottom and the top, forming the junctions at (1), (2), (3), (4), (5), (6), (7), (8) and (9), as shown.

An inspection of this figure will show that all the odd junctions (1), (3), (5), (7) and (9) come at one end of the thermo-pile and all the even junctions, (2), (4), (6)

and (8), at the other end. If, therefore, either end is heated or cooled to a different extent from the other, it will be the odd or the even junctions that are so affected, and thermo-electric currents will be generated.

Since in a thermo-electric battery a great number of couples must be connected in series, in order to be able to pack these couples in a small space, the successive couples are placed parallel to one another

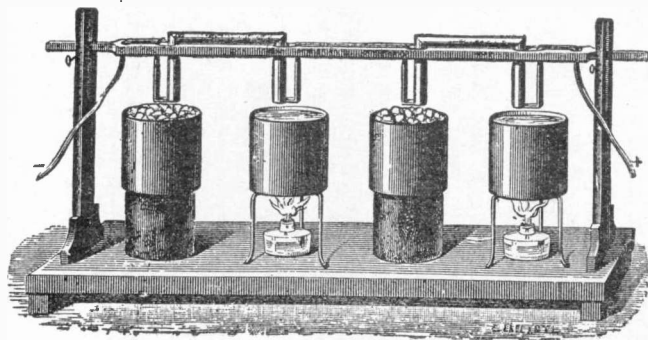

FIG. 129. THERMO-ELECTRIC BATTERY

as shown in Fig. 129, where a series of five couples is seen. In this series the bismuth (-) of one series is soldered to the antimony (+) of another series, and so on for four vertical series placed on top of one another as shown in Fig. 130. In this arrangement, the couples separated from one another by strips of paper covered with varnish are then placed in a copper frame (P). Two binding screws (m) and (n), connected respectively to the antimony of the first pile and the bismuth of the last pile, constitute the positive and the negative poles respectively. This arrangement, as will be seen, brings all the even junctions at one end or face of the thermo-pile, and all the odd junctions at the other end or face.

Nobilli has employed Melloni's thermo-pile in connection with a galvanometer for the measurement of small differences of temperatures. This combination is shown in Fig. 42, where the terminals of a Nobilli pile are connected with a galvanometer by the wires as shown.

As we have already seen, the odd and the even junctions of the pile are exposed at its opposite faces. If, therefore, one of these faces be exposed to a source of heat, and the other face covered by a brass plate so as to protect it from the heat, as shown in the

figure, the needle of the galvanometer will be deflected. Since the amount of the deflection depends on the strength of current produced and this in its turn on the difference of temperature between the odd and the even junctions, it is evident that the heat produced by different sources at different differences can be readily measured.

Moreover, since the direction in which the needle of the galvanometer moves determines the direction of the current it is possible, by exposing both faces of the pile to different sources of heat, so that one source heats the even junctions, and the other source the uneven junctions, to determine which of the two sources is hotter even when a very small difference of temperature exists between them; for, if the sources are equally hot, the failure of the needle of the galvanometer to move shows that neither junction has been heated above the other.

The slightest movement in any direction shows that their temperatures are unequal, and by observing the direction of the motion it is easy to tell which source has the higher temperature.

Melloni, Tyndall, and other investigators, have successfully employed a thermo-pile and galvanometer for studying the pheno-

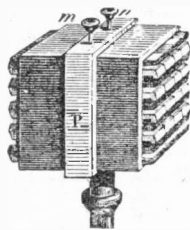

FIG. 130. THERMO-PILE

mena of radiant heat. Far more sensitive methods, however, have recently been employed for measuring small differences of temperature.

In 1881, Langley invented an instrument called a bolometer that was far more sensitive for the measurement of small differences of temperature than the device of Melloni. The bolometer consisted of two strips of platinum wire that were made the two sides of Wheatstone's electric bridge

or balance. As long as these wires are equally heated, the arms of the balance remain in equilibrium, and no movement occurs in [the needle of the galvanometer connected with them. As soon, however, as either arm is exposed to a source of radiation, the other arm being protected against it, a change occurs in the electric resistance of the strip that throws the bridge or balance out of equilibrium, thus permitting the needle of the galvanometer to be deflected. In this way it is possible to measure very small differences of temperature. Langley in speaking of his bolometer, says:

"With the instrument I am now using, a change of temperature of about 0.00001° C. in the strips is detected, a change of $.0001$ of a degree being noted instantly. As these strips are extremely minute, this implies a power of recognizing amounts of radiant heat smaller than those for which the thermo-pile is commonly employed. How small it is difficult to comprehend clearly, but it may be stated, in illustration both of the feebleness of radiant energy in some parts of the diffraction spectrum, and of the delicacy of the instrument, that the heat in certain ultra-violet rays can be detected by it in rather less than ten seconds, though the same radiation is so weak that falling uninterruptedly for over 1,000 years on a kilogramme of ice at 0° C., it would not wholly melt it."

A device has also been produced called the radio-micrometer, in which a wire is suspended by means of a delicate quartz fibre between the poles of a powerful magnet. The circuit of this wire is closed at its lower end by an antimony-bismuth couple. An exceedingly small increase of temperature in this coil, a difference less than one millionth of a degree Centigrade, produces a thermo-electric current that causes a appreciable deflection of the coil. This apparatus renders it possible to detect the heat emitted by a candle flame at a distance of two miles.

The thermo-electric pile of Melloni is only capable of producing very small electric currents. Many efforts have been made

to construct thermo-piles of sufficient strength to produce currents powerful enough to permit this source to take the place of voltaic batteries or even dynamo-electric machines. So far, however, these efforts have been unsuccessful, for, although such thermo batteries are capable of producing fairly large currents when first constructed, yet they soon fail owing probably to physical changes in the character of the junctions possibly due to their continued expansions and contractions.

One of the largest of these early forms of thermo-piles was devised by Edmond Becquerel. Its couples consisted of native sulphide of copper and German silver. This battery which contained 50 couples in two series of 25, was capable of furnishing a current that when first set up could be employed successfully in the operation of the telegraph at considerable distances.

A curious fact, the converse of that described by Seebeck, is known as the Peltier effect, from Peltier, who first observed it in the year 1834. When an electric current is passed across the junctions of a thermo-electric couple, heat or cold are produced according to the direction in which the current passes. If, for example, electric current is passed across a junction of bismuth and antimony, from the bismuth to the antimony, heat is absorbed, so that the junction is cooled. If, however, the current is passed in the opposite direction, or from the antimony to the bismuth, the junction is heated. This phenomenon is known as the Peltier effect in order to distinguish it from the effects produced in a circuit owing to the resistance it offers and known as the Joule effect. It should be observed that the Peltier effect is reversible, since the current produces heat when passed in one direction, and cold when passed in the opposite direction. In the Joule effect, however, heat is produced no matter in what direction the current passes. Moreover, in the Peltier effect the heat produced is proportional to the current strength, while in the Joule effect the heat produced is proportional to the square of the current strength.

(To be Continued.)



Electricity on Our Reconstructed Battleships

Following their return from the memorable cruise around the world the battleships of the record breaking American fleet were sent to the various navy yards on the Atlantic Coast for the most extensive reconstruction

worthy of unqualified endorsement. It is this new invention, distinctly an American conception and unique among the ships of the world, that has lately been installed on our battleships. Some of the ships have

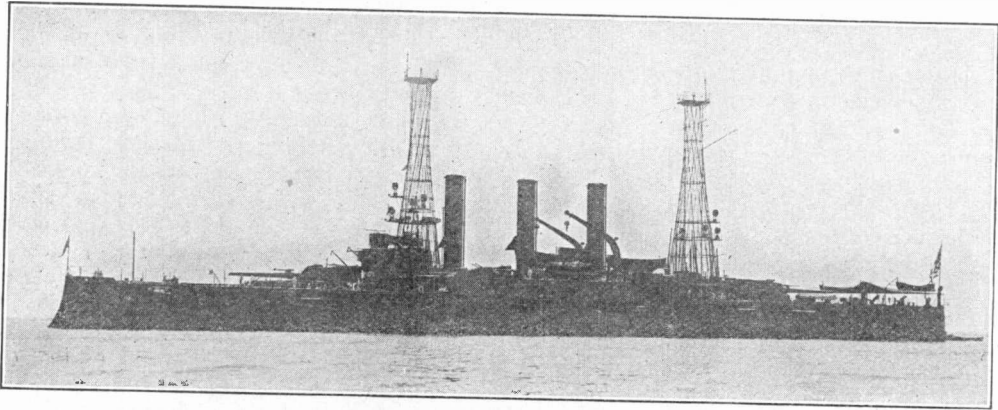

U. S. S. LOUISIANA FITTED WITH NEW MASTS

in the history of the United States Navy. This program of alteration and improvement which is now practically completed and which involved the expenditure in the aggregate of hundreds of thousands of dollars, resulted not only in the radical reconstruction in many respects of our first class battleships but also involved a complete transformation in the appearance of these floating fortresses. Among the most important features of this modernizing of our heavy weight sea fighters has been the notable extension of the electrical activities on shipboard. This, it may be added, is but in accord with the fixed general policy of the U. S. Navy. Every year sees added dependence upon the magic current for the performance of all imaginable forms of service aboard Uncle Sam's fighting craft.

The factor most largely responsible for the altered appearance of the transformed battleships lies in the introduction of the new style mast or fire control tower. This innovation has been introduced primarily to safeguard the electrical utilities in time of battle. It has been realized for some time that the tapering steel tubes, commonly known as the military masts of our battleships in their old guise were by no means ideal for the functions they had to perform, but it was only after months of experiment and tests that there was devised a substitute

each been provided with two of the new masts, whereas others, owing to the limited time available for the repair work, have taken their places in the battleship fleet with only one new tower apiece, the second tower to be supplied in the case of each vessel as soon as opportunity offers.

The new style mast which has been not inappropriately dubbed the "peach basket" is in most marked contrast to its predecessor. The old form of mast, for all that it was of steel, was, save for the gun and searchlight platforms, very suggestive in outline of the traditional masts of the old time sailing ships. The new substitute, on the other hand requires a considerable stretch of the imagination to be construed as a mast, at all. Rather it is a tower as per the official designation—an observatory tower wherein are located many of the most important electrical nerves of the warship.

The secret of the displacement of the old-style mast by this unconventional Twentieth Century creation rests in the comparative immunity of the latter from destruction by gunfire. This was demonstrated some time ago by an intensely practical test in the course of which full service charges from thirteen inch guns at comparatively close range were fired at a steel tower of the new type which had been erected on one of the monitors. It was demonstrated by this and

other tests that, in time of battle an enemy could shoot away fully 75 per cent of the steel latticework comprising one of these cylindrical towers without seriously impairing the electrical arteries within the skeleton structure.

It is difficult to overestimate the importance of this vehicle for safeguarding the interior communicative system of a battleship. The protection that the new style tower affords is quite as essential as is the latter day practice of protecting by heavier armor the vitals of the ship in the form of her engines and boilers. In these days of long-range fighting it is imperative to have lofty, well-nigh indestructible, observation stations for range-finding and fire control. The new style tower supplies this need and

The recent revision of the electrical features of our battleships included improvement of the electrical turret turning machinery and elaboration in other spheres but, in the main, this means merely an extension of activities in fields where electrical energy had already been in use. Indeed, for several years past, the uses of electricity in the Navy have been so many and diversified that it would be difficult to discover openings for progress. It is significant that in almost no branch of naval work where electricity has once been introduced has it been abandoned for economic or other reasons. Perhaps the sole exception is furnished by electric launches which were introduced as tenders for the battleships but were abandoned because they were found to be too heavy.



TYPICAL GROUP OF ELECTRICIANS ON THE FIRST CLASS BATTLESHIP MINNESOTA

incidentally it affords superior positions for the powerful searchlights which now play so conspicuous a part in naval warfare.

Finally the new invention, which will still stand though riddled with shot, is worth its cost merely as insurance for the wireless telegraphy system of a battleship. Wireless communication has become very much of a necessity in the sea service and no battleship captain would like to risk having his wireless telegraph system put out of commission by a single shell from an enemy's rifle as might be the case were the aerial supported by one of the old style masts.

To measure the present advance of electricity in the United States Navy it is but necessary to cite that in 1871 the electrical energy supplied to a ship was limited to one or two small series dynamos, the armature of which was revolved by a hand crank and the output of which did not exceed 100 or 150 watts, an amount of energy that is nowadays required for two or three 16 candle power lamps. The Iowa, one of the first battleships built for Uncle Sam's steel navy (and no longer in commission) was a marvel in her day because she had an electrical output of 96,000 watts or about 125

horsepower. Then came the cruiser Brooklyn in the year 1896 with electrical plant of 150,000 watts. Just after the Spanish-American war the battleship Kearsarge was added to our navy with 350,000 watts of electrical energy and latterly has come the U. S. S. Connecticut—flagship of our present great battleship fleet—with a total of 400,000 watts at 33 per cent overload.

ton battleships Arkansas and Wyoming, the heaviest and most powerful battleships yet planned for the U. S. Navy. Among the proposals submitted was a unique one from the Fore River Ship Building Company of Quincy, Mass.,—a suggestion which carries all the more significance from the fact that the directing genius of the Fore River plant, Mr. Francis Bowles, was for years the Chief

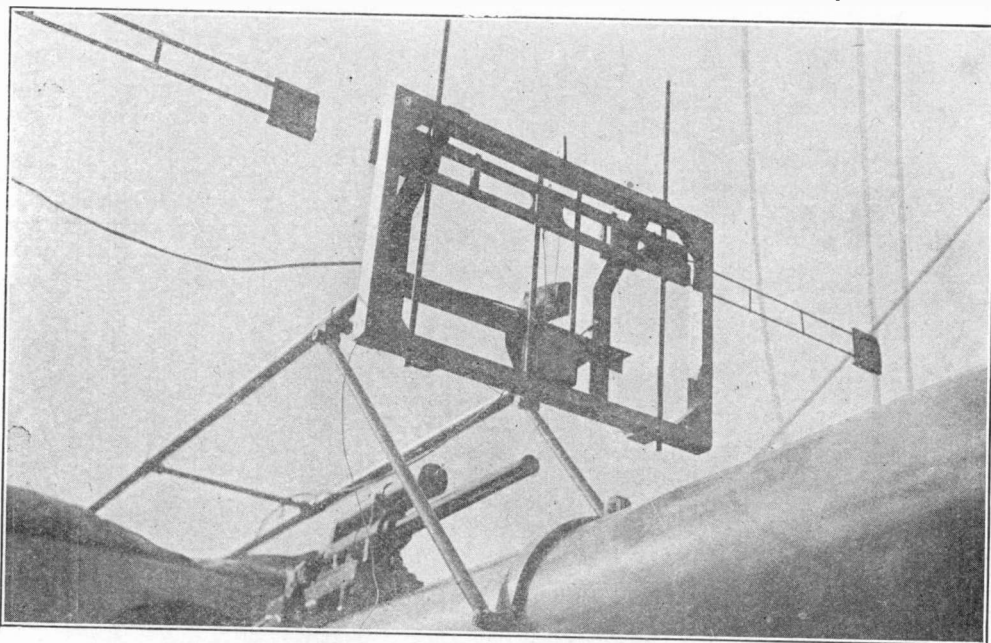

ELECTRICALLY OPERATED SIGHTING APPARATUS FITTED TO A 13-INCH GUN

The tremendous expansion has been due largely to the rapidly increasing demands for electrical drive, which latter consumes fully four-fifths of the total power allotted in the generators of a warship. Indeed, the efficiency and economy of electric drive as compared with all other systems, and its flexible adaptability to power use in general have caused the adoption of electricity as the actuating agent for practically all power purposes on warships outside of the engine and fire rooms and their immediate connections. In these compartments steam drive is still in general use but there is no telling how soon such monopoly will be ended.

The authorities at the U. S. Navy Department were, only a few weeks ago, brought by rather startling means to a realization of the trend of modern development upon the occasion of the opening of the competitive bids for the construction of the new 26,000-

Constructor of the United States Navy and has always been regarded as one of the most progressive of naval experts. The suggestion that came from his firm in the case of the new battleships was to set aside the engineering specifications prepared by the Navy Department and to allow the substitution of a scheme of power generating provided by a combination of reciprocating engines and generators and electric motors. While this daring innovation was not adopted it has set naval experts to thinking and some naval engineers have already declared themselves as frankly in favor of it.

When one takes into consideration the limitations and exigencies of warship operation is it easy to understand the popularity of electric leads (easily maintained and repaired) over long lines of steam piping with their objectionable heat; hydraulic apparatus with its annoying leaks; and pneumatic machines with their inconvenient bulk and

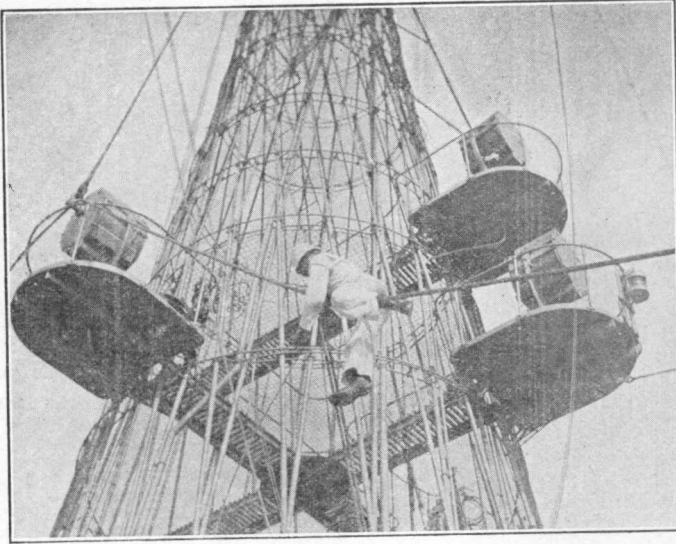

ELECTRICAL WORK ALOFT UNDER THE NEW CONDITIONS

weight. There is yet another factor that might not suggest itself to the average reader. In time of battle the men on board a warship are divided into groups, as, for instance, the gun crews, and each squad is in effect imprisoned in a closed, armor-clad compartment. With steam or the other enumerated forces employed, an accident that involved the cutting of a pipe line would have an injurious and distracting effect upon the men in the compartment or compartments affected, whereas with electricity there is, even in case of accident, no danger of panic. There has been a gradual extension of the use of electricity for operating warship auxiliaries until now only the steering engine and the capstan or windlass remain in the class of steam driven machines, though even in this sphere electrical means of handling the valves are sometimes employed.

One of our latest modern battleships as, for instance, the Connecticut, has a bewildering number and variety of direct current motors. There are motors of from 15 to 35 horse power each for turning the turrets—the steel cheese-boxes in which the big guns are enclosed; motors of from five to eight horse power each for elevating the guns; motors of from three to 10 horse power for gun ramming; and motors of from three to 55 horse power each for hoisting and conveying the ammunition for the huge rifles. Then there is a 50 horse power motor for

lifting out of the water and depositing on the deck of the battleship, the power launches that act as tenders of the warship. There are likewise motors for operating doors and hatches and deck winches, to say nothing of the motors for the wireless telegraph, telephone, and for interior communication.

For ventilating purposes there are on ship-board no less than 106 motors, ranging in power all the way from one-twelfth of one horse power to 12 horse power each. In the workshop on board there are self-contained motors of from one-fourth to seven horse power for operating machine tools. There are two 80-horse power motors for operating the torpedo air compressors and four motors of two or three horse power each for operating fresh water and sanitary pumps. There is a motor in the laundry and in the galleys or kitchens are several motors for operating the dough mixers, dish washers, meat choppers and potato peelers. Indeed the preparation of the food for 900 officers and men on a battleship is done largely by electrical power.

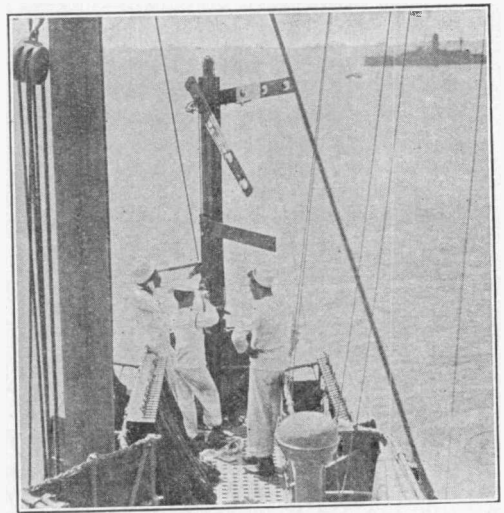

SEMAPHORE SIGNALING ON A BATTLESHIP

Electric lighting is universal in the navy. In addition to the regular 16 and 32 candle power lamps there are employed such novelties as a 150 candlepower diving lamp and a six candlepower torpedo lamp. This torpedo lamp is mounted on the end of a rod for examining the interior of automobile torpedos and is made long and narrow so that it can be inserted in the small orifices in the side of the torpedo. The 16 candlepower lamp is the working lamp for general lighting throughout a battleship, the 32 candlepower lamp being used for signals, running lights, truck lights, etc., and in the dimly lighted magazines and shell rooms where the ammunition is stored deep in the bowels of the ship.

A type of five candlepower instrument lamp is employed for illuminating the indications of "lamp indicating instruments" such as the helm angle indicator, helm telegraph, engine telegraph, etc., and for lighting binnacles and the mechanical telegraphs that flash orders simultaneously to all parts of the big ship. A number of searchlights have place on every battleship. The sizes most in use, rated by diameter of mirror, are 13-inch, 18-inch, 24-inch and 30-inch. Two 36-inch searchlights have been in use and one 60-inch has been installed on one of the ships.

Night signaling is one of the most important spheres in which use is made of electricity in our navy. The object of this class of apparatus is to rapidly and accurately transmit from one station on shipboard to another distant station, by means of lights, a pre-arranged code of signals when darkness prevents other means of visual signaling. The system is most frequently employed in signaling from one vessel to another; for squadron or fleet maneuvers; and for communication between warships and co-operating military commands on shore. The signalling is done by means of double lanterns, the upper half of which is red, and the lower half, white. The connections for individual signals are made by means of a keyboard which has thirty lamp indications and 56 interpretations. The blinker light is a device used as an auxiliary means of signalling by wigwag code, employing a flashing light for the purpose. Then on the bridge of the battleship is a two-arm semaphore. The two arms are used as shape signals in the daytime but they are also fitted with three lamps each for night use.

The arms are operated independently by means of cranks and sprockets and at the top is a fixed red light which serves as a mark for fixing the attention of observers when awaiting signals. The light is screened for all directions save that in which the signal is to be sent.

Tungsten Sign Lamp

Tungsten lamps for electric signs are expected to offer great opportunities for the display of artistic taste and the designers' skill. The light is much whiter and more brilliant than that of the carbon filament lamp and a more striking and attractive effect may be obtained.

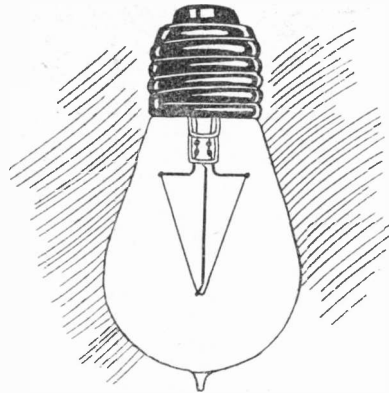

TUNGSTEN SIGN LAMP

The tungsten sign lamps have V shaped filaments, as shown in the sketch, which are strong and durable, being well anchored and supported. They are made in the five watt size giving four candlepower, and are used on 10 to 12 volts. Their life is about 2000 hours.

There are two ways of using these 10 volt lamps on ordinary 110 volt lighting circuits; either by connecting a number of them (10 to 12) across the circuit in series, or else by using special transformers or compensators as they are called, which are made for the purpose.

Nitrogen Fertilizers from the Air

Several representatives from European concerns interested in the manufacture of nitrogenous fertilizer from the air are in this country looking for options on good water power for hydro-electric development in connection with the fertilizing industry.

Convenient Bracket Light

A bracket electric light fixture particularly adaptable to the use of surgeons, dentists, draftsmen, etc., is shown in the sketches. This bracket is so designed that it may be

spiral may be described with the end of the bracket, starting with a circle not more than two inches in diameter and, when the bracket is fully extended, ending with a circle twelve feet in diameter. There is sufficient friction in this joint so that the bracket will

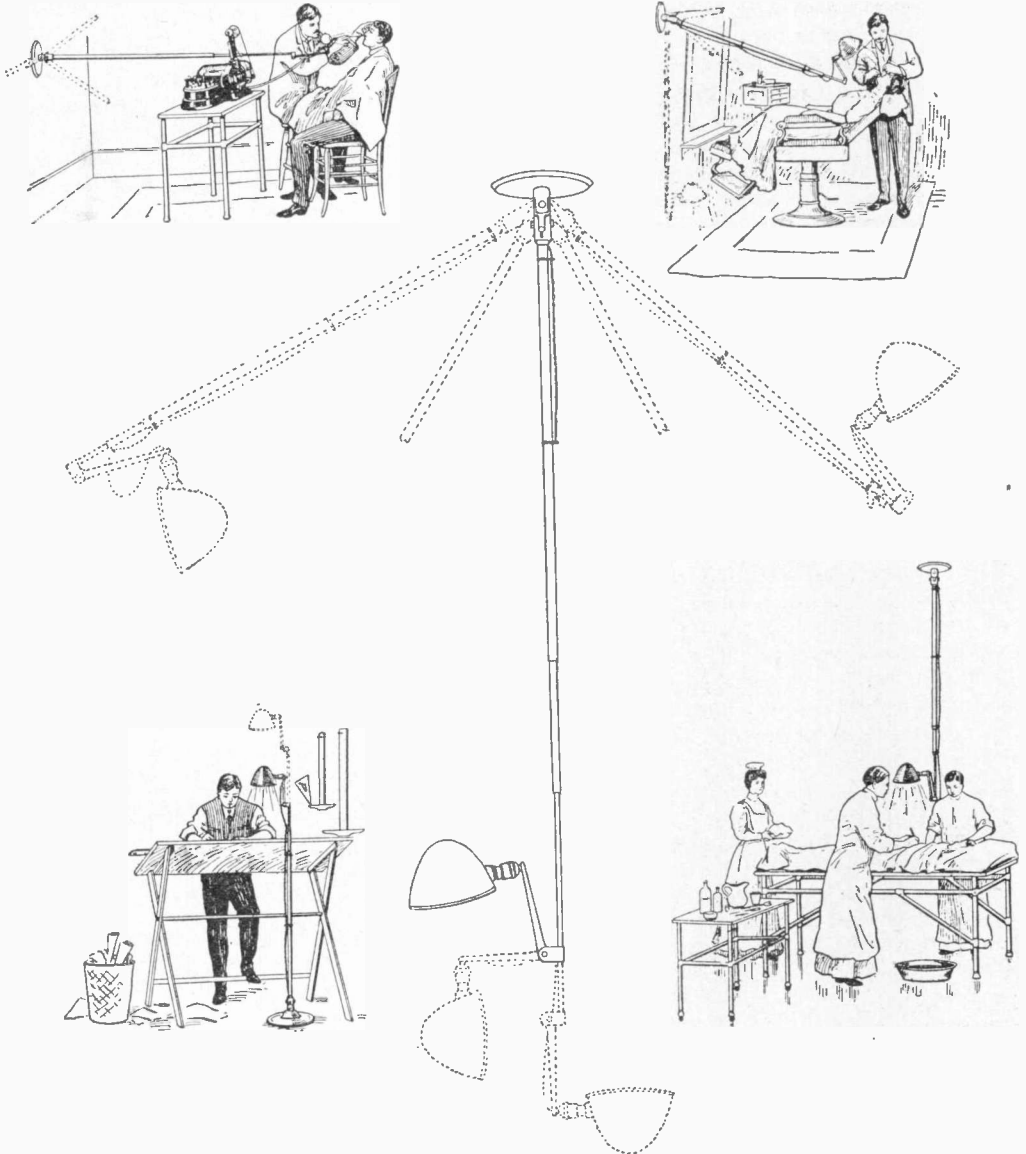

CONVENIENT BRACKET LIGHT FIXTURE

fastened to either wall or ceiling at any convenient point desired, and being provided with a universal joint near its base, it can be swung or moved to any angle. The construction of the joint is such that a perfect

remain in any position in which it is placed. The bracket may be telescoped until it extends outward not more than three feet, or may be extended to a distance of almost nine feet. In addition to this the terminal

arm which holds the lamp proper is hinged and swiveled so that it is independently adjustable to any desired position. By means of a special device the bracket is made to retain its rigidity even when extended to its greatest length, and although the sections telescope smoothly one within the other, provision is made so that all lost motion is automatically taken up.

Show Window Lighted With Flaming Arcs

Merchants realize more and more the strong attractive power which plentiful illumination in their store windows exerts. Flaming arc lamps are among the most attractive illuminants that can be used; they are the kind you so often see in front of theaters, etc., giving the intensely brilliant yellow or orange colored light.

Hitherto it has not been possible to use these lamps in the store windows for two reasons; one being the fact that the peculiar light would not show the color values of the

fabrics in their true relation, the other being that the flaming arcs are more apt to drop sparks than the ordinary arcs and the Board of Fire Underwriters would not sanction their use for window lighting.

These objections have, however, been overcome by a new type of flaming arc and a new method of installation. The new lamp is known as the "Trucolor" and gives 2500 candle power of true white light, showing the fabrics in their true color values and enabling the colors to be distinguished almost as readily as in the daytime.

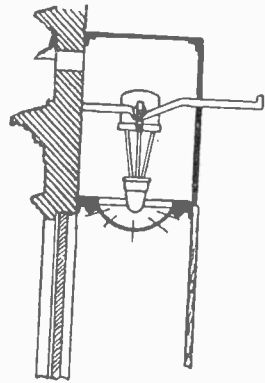

MOUNTING OF FLAMING ARC IN SHOW WINDOW

The method of installation employed, and which has been approved by the Underwriters, is shown in the sketch. The lamp is in a compartment shut off from the lower part of the window containing the inflammable fabrics. Immediately below the lamp in the ceiling of the window is a Holophane glass hemisphere which throws a beautifully diffused light in every part of the window and at the same time prevents any sparks from falling upon the goods displayed.

In the halftone illustration is seen one of Milwaukee's newest stores, which uses this system. On the poles in front are two Aurola flaming arcs, giving the characteristic flaming arc color. These attract the attention of the people from a considerable distance. In the window itself are visible the Holophane hemispheres of the Trucolor lamps installed as described above.

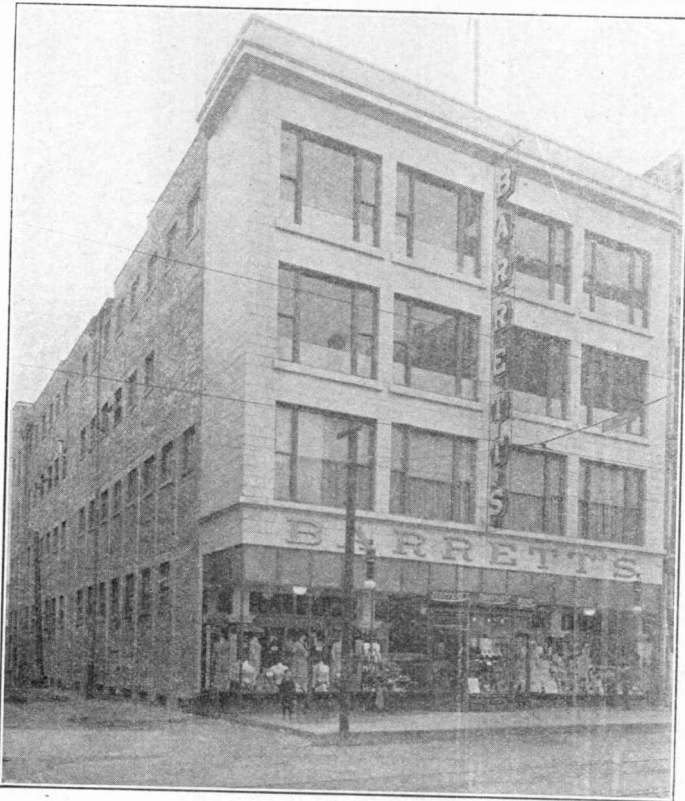

SHOW WINDOW LIGHTED WITH FLAMING ARCS

Light Therapeutics

Physicians today look upon light and also static electricity as auxiliary agents helpful in many cases, in conjunction with certain well defined methods of treatment, in bringing about the desired end. About a decade ago, or perhaps a little more, static electric machines were just coming into use and we also began to hear a great deal about light baths and light cures. There was at first a general rush to adopt these methods and many physicians were inclined to over esti-

widely varying effects on animal organisms, thus the ultra violet rays have perhaps ten times the bacteriacidal power of the red, yellow and green rays, although there is indisputable evidence that these latter rays are by no means devoid of germicidal power.

It is Prof. Finsen's theory that the curative value of light was greatest at the ultra violet end of the spectrum, although he did not ignore the undoubted beneficial effect of the remaining rays in certain indications, and

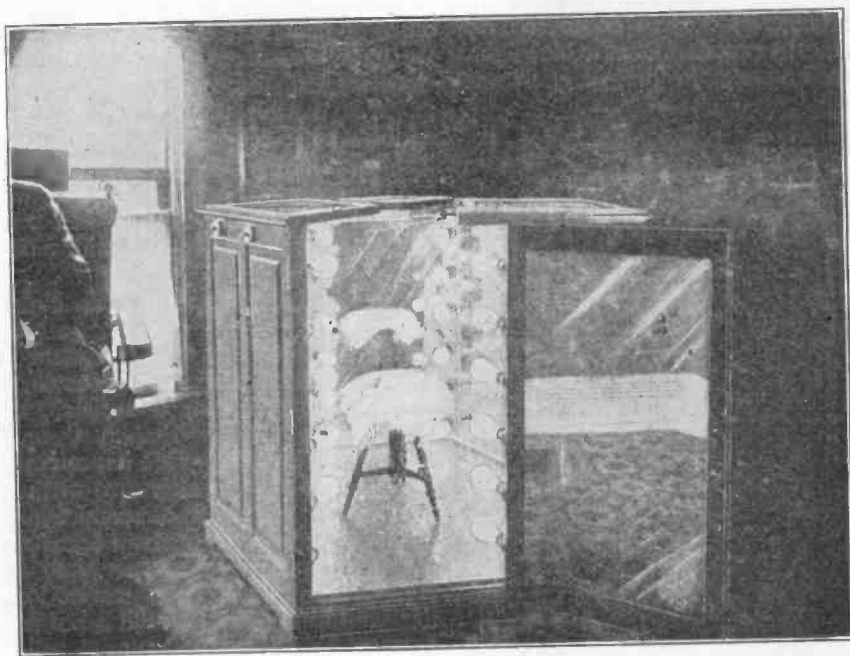

ELECTRIC LIGHT BATH

mate their value and look upon them more or less as cure-alls. A reaction then took place and the static machine and light bath got a severe bump. They have now, however, found their place in legitimate practice as efficient aids in many cases and as such they are used.

Light therapeutics, especially, is rapidly making a place in medical practice. When using light as a unity the nearer it approaches the quality of solar light, the better the results. When decomposed the different rays of the spectrum differing as they do as to wave length and rate of vibration, produce

the Finsen apparatus for light treatment was and is designed with a view of producing light with the greatest possible number of ultra violet rays and the elimination largely of the remainder of the spectrum, and there is no question but that lamp outfits of the Finsen type possess greater germicidal power than those of any other pattern. The usefulness, however, of the ultra violet rays is greatly restricted because of their lack of penetrating power; a thin layer of blood will absorb a very large percentage of these rays and, but a comparatively small per cent will penetrate the tissues to any great depth.

although it has been shown that a few of these rays will filter through to the underlying tissues, and modern technique has devised means for increasing their penetration by forcing the blood out of the intervening tissues by pressure and other means.

It is now claimed that other portions of the spectrum possess an equal, if not greater amount of curative value than the ultra violet. Physiological processes are rapid in light red, slightly slower in green, and considerably slower in violet. Experiment has shown that the same patient will feel perfectly comfortable in the red or orange light; not so well in the green, and a general faintness, and desire for sleep, in the violet.

Prof. Schlager in Vienna endeavored to quiet maniacs by exposing them to blue light, and in some instances the desired effect was

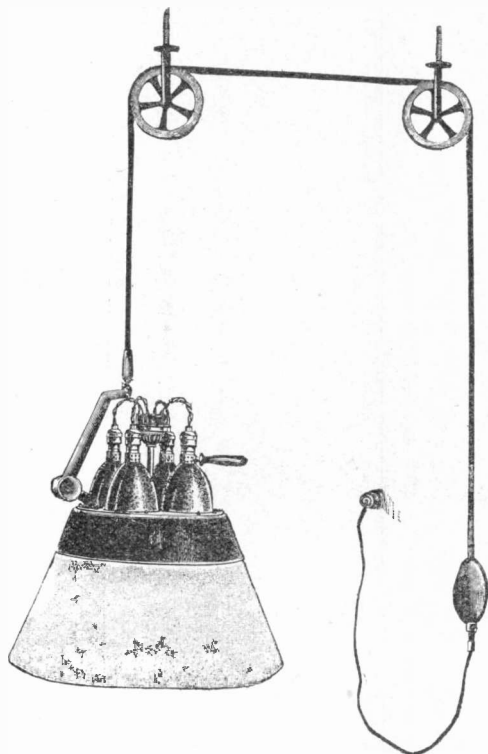

THERAPEUTIC LAMP

obtained by removing them to a room which had windows of blue glass, when all other measures to quiet them had failed.

As opposed to the lack of penetrating power of the ultra violet the blue rays possess the power of penetrability to a marked degree, red and ultra red to a still greater de-

gree. It is the red rays that carry with them the greatest portion of the heat so useful in treating the deep parts of the organism.

To sum up; violet and ultra violet rays are bacteriacidal, antiseptic; blue rays and the central portion of the spectrum, tonic, sedative, penetrative; red and ultra red, stimulative, slightly irritant, deeply penetrative, and thermal.

Moist heat tends rather to promote suppuration while heat administered in light treatments aborts pus formation and suppuration, and it is owing to this fact that concentrated light and heat seems to be the ideal treatment for all suppurative diseases.

In order that all of the therapeutic properties of light may become available when the light is used as a unity it is absolutely essential first, that the light be produced in great volume, that it be of the proper quality and concentrated as greatly as the tolerance of the patient will permit. This is accomplished by various devices such as electric bath cabinets and portable incandescent lamps provided with reflectors.

American Telephones in Peking

An American telephone system, with American instruments, switchboards, cable and appliances, is soon to serve the city of Peking. The Chinese Empire, though absolutely lacking in any such improvement up to today, has at last awakened to the need of a modern system of communication.

The order amounts to about \$1,500,000, and covers a complete telephone plant of the most modern type, including several hundred thousand feet of lead covered aerial and underground cable. The contract called for complete delivery at Tien-Tsin by February 2, 1910, allowing only six months from the time the order was received for making and delivering to the Chinese government

New Discoveries of Radium

Valuable deposits of radium-bearing pitchblende are said to have been discovered on the McCloud river in California. Similar discoveries are also reported in the Cripple Creek district in Colorado. Pitchblende is a rock, tons and tons of which must be ground up, treated chemically, washed, precipitated and filtered, over and over again to obtain a few grains of the precious radium-bearing salts.

Some Interesting Experimental Apparatus

When alternating current is flowing in a wire it will induce in another wire brought near it a current of like character, even though the two wires do not touch. This is the principle of the ordinary transformer. By employing the principle in various ways many interesting experiments may be performed, which are very mystifying to the

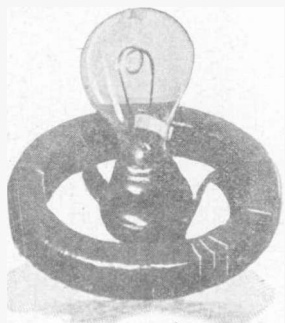

FIG. 1. LAMP COIL

uninitiated, since there is no physical connection between the apparatus and the inducing current. Some simple devices for performing experiments with induced current are shown below.

Fig. 1 is known as a lamp coil. This is a well insulated coil which may be immersed in water, with inside terminals for attaching

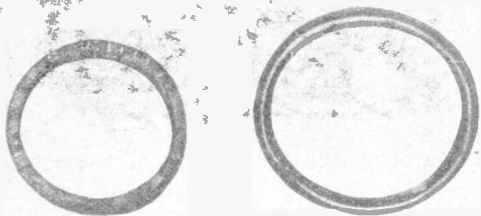

FIG. 2. HAND COIL

FIG. 3. COPPER RING

a lamp socket. The coil is proportioned so that its specific gravity is slightly greater than that of water, when the lamp is inserted, consequently the coil will sink to the bottom when immersed in water. When placed over an alternating current magnet pole the induced current in the coil will illuminate the lamp under water and the magnetic repulsion of the current in the coil will also raise the lamp and coil in the water and balance them at a certain distance above

the magnet pole where the magnetic repulsion is exactly equal to the addition of weight of the lamp and coil over the water they dis-

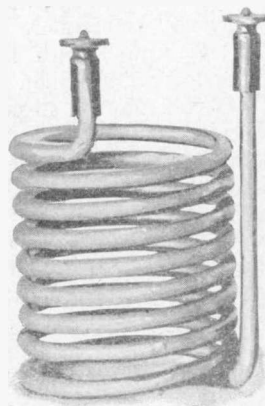

FIG. 4. ALUMINUM SPIRAL

place. It is also useful for showing the presence of the magnetic field around an alternating current magnet pole—its direction, shape and density.

A "hand coil" is shown in Fig. 2, and consists of a coil wound with very fine wire

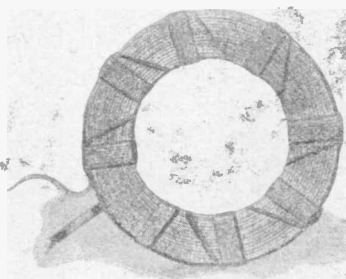

FIG. 5. FLAT COPPER SPIRAL

used for illustrating or explaining the magnetic field. With it a sufficiently high potential is obtained to give a strong shocking sensation if held in the uncovered hand and brought into the alternating magnetic field.

Fig. 3 is a solid copper ring five inches in diameter. This may be used for illustrating electromagnetic repulsion of an alternating current field. When held in an alternating field it will heat rapidly, although its sectional diameter is $\frac{1}{2}$ inch. By spreading steel filings on a plate glass, placing them on alternating magnetic pole and using this copper ring, several instructive experiments can be illustrated.

The aluminum spiral shown in Fig. 4 is made of $\frac{1}{4}$ inch aluminum rod with termi-

nals for attaching a low potential lamp or piece of wire. When brought into a strong alternating current field the lamp can be lighted or the wire melted in what seems to be a very mysterious manner.

A spiral coil wound with flat, cotton-insulated copper wire or ribbon is shown in Fig. 5. This coil may be suspended from balance arm to illustrate electromagnetic attraction and repulsion. The ends are connected together and suspended from the balance arm over the magnet. While the coil is in this position pass the current through the magnet. This will cause the coil to be repelled. When the current is stopped it will be strongly attracted, and if ordinary alternating current is used in the primary coils, the spiral coil will be repelled.

An Example of Economy

A striking example of the economy that can be effected by substituting electric power for hand labor is shown by the application of a 20 horse power alternating current motor

push, and only one attendant to operate the motor. Hence the decrease in cost for labor amounted to the sum paid for one man's service for 24 hours a day, or two on shifts of twelve hours, or three on eight hours. These men were paid 15 cents an hour or \$3.60 a day or \$1314 per year of 365 days. The cost for electrical power was but \$96.00 in the year and there was no repair or maintenance cost. Hence the net saving was \$1218 a year.

The total cost of installing the electrical equipment including wiring, construction of donkey, cost of motor, etc., was in round numbers \$1500, so that the saving almost paid for the equipment in the first year, or looked on as an investment it was paying practically 80 percent dividends.

The saving in time effected by the use of the motor is perhaps more important than the actual cash economy, since the motor-operated turntable can handle several times as many locomotives in a given time. This is of great importance in relieving congestion of traffic near the turntable especially at

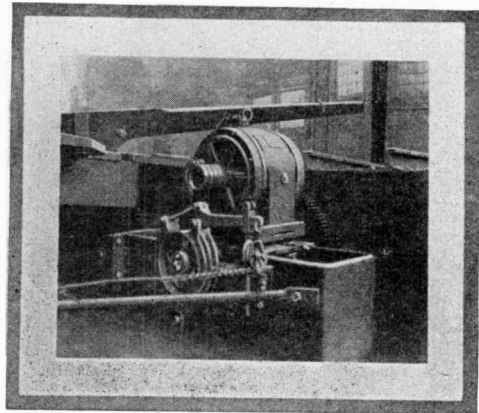
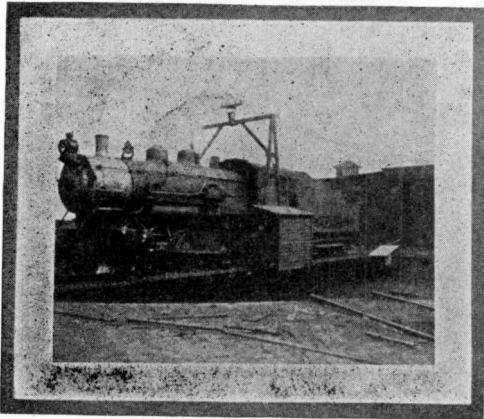

ELECTRICALLY OPERATED TURN TABLE AND EQUIPMENT

to a turntable on one of the railroads in New York State. This turntable had previously been turned by men employed regularly at other duties, but called on every time a locomotive was to be turned. These two squads of men, by pushing on the handle, could accomplish the purpose but slowly, and hence their time at their regular work was of necessity materially shortened. In fact the average time lost by the men amounted to at least the continuous service of two men for twenty-four hours a day. But with the motor no men were needed to

terminals where many locomotives often come in at the same time. It is difficult to reduce rapid movement of equipment and freedom from delay in the movement of traffic to cash value, but the importance of the maintenance of the schedule is so great that railroad officials are warranted in heavy expenses for equipment that helps to this end. The motor may be applied and the current transmitted to it in several different ways, but the method very frequently used is shown in the illustrations.

S. ADAMS.

Magnets for Lifting Steel Rails

In the great steel plant at Gary, Ind., one of the most remarkable applications of electricity is presented by the massive lifting magnets, which, working in pairs, lift 10 tons of steel rails at a load and deposit them, all snugly arranged, on the waiting flat car.

The magnets which accomplish this task are known as electromagnets. They are built somewhat on the principle of huge horse shoe magnets but do not depend for their lifting power upon permanent magnetism, as in the case of the latter. They

up bodily and laid on the car. Then the current is switched off and the magnets let go their hold and are ready for another load.

In this way 3000 tons of rails can be loaded by a single pair of magnets in 20 hours. The rails, moreover, are not bent in the process of handling and loss on this score is eliminated.

Methods of Reviving Dry Cells

The term "dry cell" as applied to the small batteries which are so widely used for various purposes is a misnomer, since

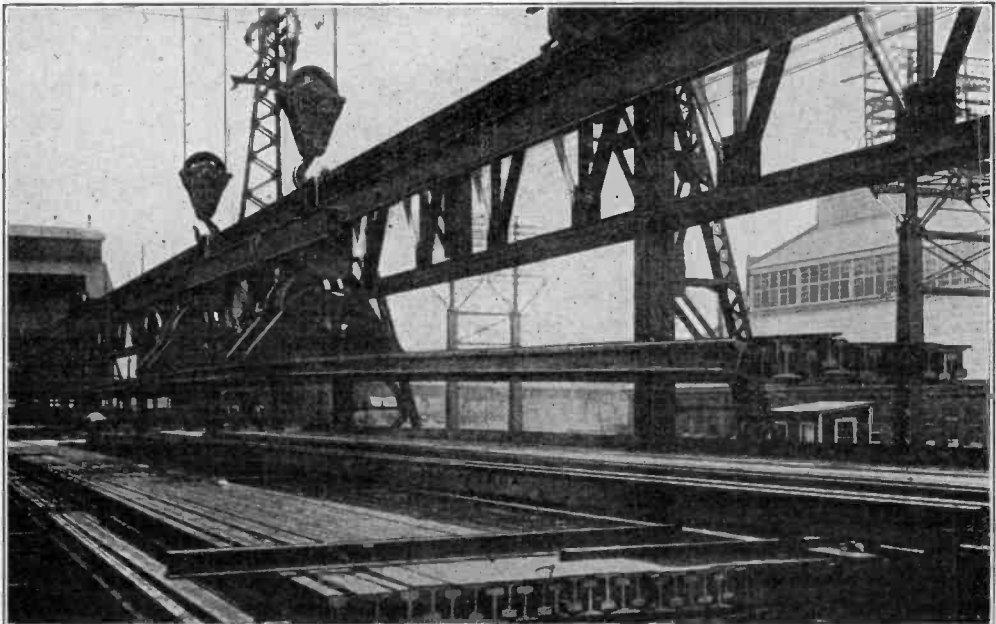

ELECTROMAGNET LIFTING STEEL RAILS

are wound in the middle with great coils of insulated wire, in the same manner that the fields of a dynamo are wound, and their lifting strength, when current is passed through the coils, then increases in direct proportion to the number of turns of wire in the coils and the strength of the current passing therein.

The pole pieces of the magnets are perfectly straight along the bottom and wide enough to rest across several rails at a time as shown in the picture. The magnets are lowered by powerful cranes until they rest on the rails, then the current is turned into the coils and the rails are gripped with an almost irresistible force and are picked

these batteries are really not dry inside but contain liquid absorbed in sawdust, plaster of paris, gelatine, etc. The liquid is generally a solution of sal ammoniac and water. The zinc and carbon elements of the cell are in contact with this "paste," and should the latter become dried out, as is pretty sure to be the case with cells several months old, they lose their efficiency and frequently become practically useless although they may never have been called upon to furnish current.

Once a battery has been dried out in this way it is never possible to make it as good as new or cause it to develop its full voltage for any considerable length of time.

but there are ways in which it may be revived to a certain extent and made better than none at all. Some of the readers of Popular Electricity have sent in descriptions of methods they have used in reviving cells, which are given below and which will answer the inquiries of many who have asked for information on this subject.

Method 1.—Remove the cover from the cell and scrape the outer surface of the zinc fairly clean. Next take a nail and punch quarter inch holes about three-quarters of an inch apart all over the surface. This completes the zinc and carbon elements of the cell. Next procure a quart wine bottle and remove the neck so as to leave a jar about six inches in height. The easiest way to do this is to take a piece of cotton string dampened with kerosene and tie it around the bottle at the proper place, light it, and after it has burned out, plunge the bottle neck downwards into a bucket of cold water.

Set the cell in the center of the jar and fill the remaining space with common salt to within one inch of the top, and pour in water until the salt is thoroughly wet, leaving a little to cover the surface so as to make up for evaporation. Let the cell stand for a few hours until the brine has had time to soak in through the holes in the zinc. Then it will be ready for use.

The above makes a very good cell for any kind of open circuit work such as working electric bells, etc. It is a very cheap cell to make as old dry cells can be procured for a very small sum of money at automobile shops.

Method 2.—Take a 60-penny spike and make about 25 or 30 holes through the zinc cover of the cell. These holes should start near the bottom and extend about one-half or two-thirds of the way up. Get a glass jar that is about an inch larger in diameter than the cell and put half an inch of coarse sawdust in the bottom. Now set the cell in the jar, leaving an equal space all around. Fill the space between the cell and jar with coarse sawdust and pour on a solution of sal ammoniac to thoroughly soak the sawdust. The cell will then be found to deliver a fairly strong current once more. Be careful not to tamp the sawdust too hard or you will crack the glass jar.

Method 3.—The old pitch plug is broken out of the battery, and the pieces saved to be remelted. Pour out and save the sand

or sawdust, which comes next to the pitch. Lift up the crimped paper which comes next, until the contents of the battery are exposed. Then take a large spike nail, and drive holes in the black composition that makes up the battery, sprinkle some powdered sal ammoniac over the holes, and fill them nearly to the top with water. Allow the battery to set until the water has thoroughly soaked into the composition, then pour back the sand. Next remelt the pitch which you saved and pour it back over the top; this thoroughly seals the battery and prevents evaporation. By this method the cells may be renewed until the zinc is eaten away.

Welding Tungsten Lamp Filaments

The chief drawback to the tungsten incandescent lamp now so extensively used is its liability to breakage. This is more liable to happen while the filament is cold, for the material from which it is made is more brittle than while lighted and in a state of incandescence. It frequently happens that a jar or heavy vibration parts the filament at one point, leaving two ends separated from each other by the springiness of the filament though not drawn apart endwise. The break puts the lamp out by opening the circuit through the filament. With the old carbon filament lamp this meant a spoiled lamp, no repair of the break being possible. The ordinary user, basing his act on experience with the old type, when he finds his tungsten lamp similarly broken consigns it to the scrap heap with a sigh and a quick mental calculation to see if what he has saved in his monthly bills has paid for the new lamp he must buy.

Many times this replacement could be saved by repairing the broken lamp if the user would make the attempt. Leaving the lamp in the socket with current turned on gently tap the bulb with one finger to make the broken ends vibrate and wave about, the idea being to make them touch one another. If the lamp is on a drop cord or on a portable stand, turn it at various angles while tapping and a little patience will frequently reward the experimenter with gratifying results, for the instant the broken ends come into contact the current flows and the filament heats to incandescence and a weld is effected. The lamp can then be turned off and on as before and may be

considered as a new one although the weld is probably not quite so strong as the rest of the filament.

Care must be taken not to tap the bulb too hard or a second strand may break, and then a weld becomes impossible. Remember the filament you are trying to fix is cold and brittle.

The "Great White Way" of Superior

Tower Avenue is the "Great White Way" of Superior, Wis. Visitors to this enterprising city at the head of the Lakes are immediately impressed with the lighting of this broad thoroughfare, which is at once artistic and fascinating.

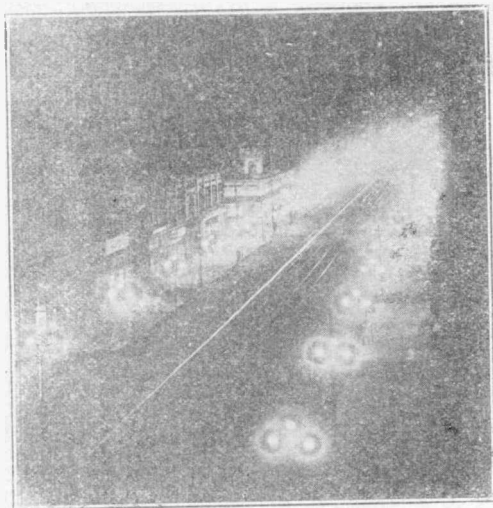

TOWER AVENUE IN SUPERIOR

For a half mile on both sides of the street are located ornamental iron posts, 50 feet apart, making 16 to the block. There are three opalescent globes on each post. The top globe contains one 40 watt tungsten incandescent lamp and the two side lamps are of 100 watts each. The wiring is so arranged that the top lamp may be turned off and the side lamps left burning if so desired.

This unique lighting scheme was planned by the publicity committee of the Superior Commercial Club of which F. E. Spring is chairman, with the co-operation of the Superior Water Light and Power Company of which William H. Winslow is the general manager. The property owners of the city paid for the installation which amounted to about \$80 per post and the merchants with frontage

on the lighted section of the street pay for the current.

Altogether this is one of the most brilliantly lighted thoroughfares to be found in any city and has a marked advertising value.

Attractive Window Display

An attractive window display can be made to draw custom to the electrical supply store. By "attractive," however, is not meant the throwing of a lot of odds and ends into the window; a coil of lamp cord here, a motor there some sockets and plugs in another

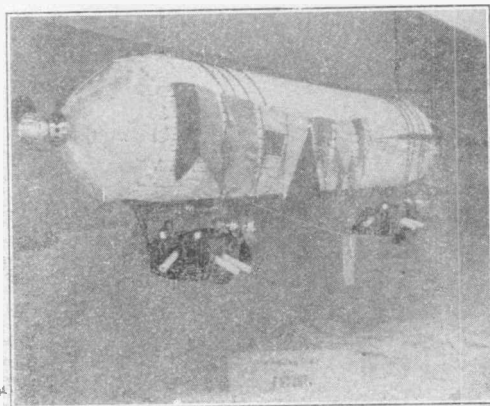

ATTRACTIVE WINDOW DISPLAY

place—which only too often presents the sum and substance of the supply dealers' array.

There is an electrical supply firm in Minneapolis, which makes a hit with its unique and interesting window displays, and the one shown in the picture is not the first of its ideas which has appeared in these pages. In this particular instance the display represents an air ship, copied from a picture of Count Zeppelin's aerial craft. The ship is seen rising from its housing preparatory to its flight across a very realistic appearing lake.

The body of the craft is composed of 600 electrical wiring cleats—the little porcelain clamps which are used to fasten wires to ceilings. The front end consists of a large Holophane shade at the apex of which is an incandescent lamp for a headlight.

Suspended from the body are baskets consisting of outlet boxes used in wiring, and porcelain tubes coming out of the port holes represent guns—for the title of the display is "Fighting Craft of the Future."

Communication Methods on the Taft Tour

By WALDON FAWCETT

One of the most difficult tasks in connection with the carrying out of a Presidential tour and one to the very necessity for which the general public seldom gives a thought is that of maintaining constant interrupted communication between the White House at Washington and the Presi-

at the White House are put to their wits end to forge an elastic communicative chain that will always link the "White House on Wheels" and the executive offices overlooking the Potomac. Not merely the distance is to be considered, although that does constitute a handicap when the Chief Magistrate

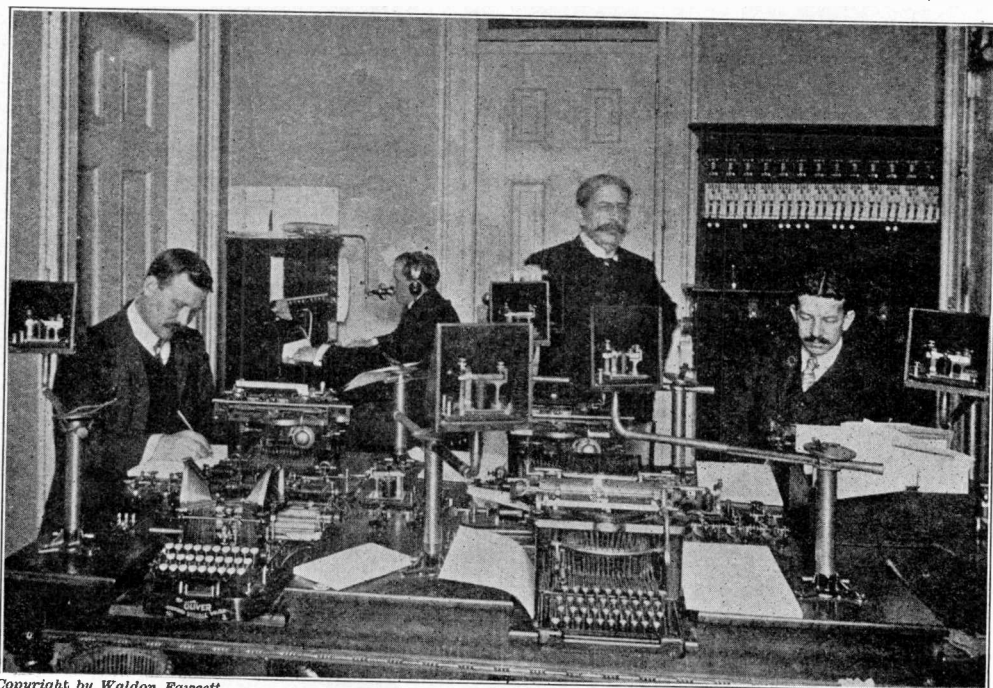

Copyright by Waldon Fawcett

THE TELEGRAPH AND CIPHER BUREAU OF THE EXECUTIVE OFFICES

dent wherever he may be. It is a comparatively simple matter to keep in touch with the President when he is absent from Washington on a journey of only a day or two. This is particularly true, thanks to wireless telegraphy, when he is aboard a Presidential yacht or other government vessel. Similarly the problem is simplified when the President, though absent from the capital is located at a fixed abode—as, for instance, his summer home at Beverly—to which permanent lines of communication may be established.

It is when the President sets out on a prolonged journey, as was the case September 14th when he began his 13,000 mile continental tour, that the "intelligence officers"

is 3000 miles from home. Much more serious is the circumstance that the President is constantly jumping from place to place at the behest of a whirlwind itinerary and has at no time what could be dignified as a "permanent address." Finally, in the case of tours such as that of this autumn the fact that the Presidential party spends days now and then in isolated localities further complicates the chore of keeping the Presidential finger on the pulse of the nation.

The desirability of having our foremost wandering statesman ever within call of the "home office" in the District of Columbia is apparent to every citizen, but the actual necessity for it can be appreciated only by



FRED W. CARPENTER, SECRETARY
TO THE PRESIDENT

those who realize to what an extent Presidential business is transacted through the White House even though the boss be thousands of miles away. When the President is settled at Beverly for the summer many of his correspondents address him there but when he is traveling on limited schedule very few of the letter writers attempt

to catch him on the wing. Even those personal friends and political advisers whose communications, by means of a secret code of signals on the envelopes, pass the secretaries and reach Mr. Taft's hands unopened take the White House route at such times.



WENDELL W. MISCHLER, ASST. SECRETARY
TO THE PRESIDENT



W. WHEELER, U. S. SECRET SERVICE OFFICER, WHO TRAVELS
AHEAD OF THE PRESIDENTIAL "SPECIAL"

They address the White House just as persons who wish to communicate with the officers or men of the Atlantic Fleet address their letters "Care of the Postmaster, New York", even though the fleet be known to be at Provincetown. In other words, the recognized forwarding office constitutes the best, surest and quickest route to the desired destination.

It is because of this vast volume of mail, often numbering a thousand letters a day, which pours into the White House, and by reason of the desirability of having as much of it as possible disposed of at the Executive Offices, that

the President leaves at his base of operations his trusted Secretary, Mr. Fred W. Carpenter, and contents himself for the time being with Assistant Secretary Wendell W. Mischler as his immediate aide aboard the train. Mr. Carpenter, who, during more than six years of the closest association with Taft, has developed into as capable an "un-



TYPICAL GOVERNMENT WIRELESS STATION USED ON THE MISSISSIPPI VOYAGE

derstudy" as such a chief ever had, is at all times able to answer the vast majority of the letters addressed to the President without so much as bothering the busy Chief Executive with a digest of their contents. When the President is undergoing the tension of a prolonged speech-making tour the Secretary redoubles his efforts to dispose of the greatest possible proportion of all letters received for he knows that the head of the house can ill spare the time for such details enroute.

Of course there are some letters that require a personal reply from the President and cannot well await his return to Washington, and these, together with the commissions to be signed and other government documents requiring the President's autograph, are forwarded once a day to the Presidential train. With the system working smoothly the White House each day dispatches a batch of mail to the Presidential train and receives from the train a bundle of communications including the President's dictated instructions as to various matters, commissions and other papers returned with the Presidential signature, etc.

Regardless of the fact that there is this continuous interchange of mail, the main reliance for keeping the President in almost momentary touch with the White House is placed, of course, upon telegraphic and telephonic means. The responsibility for the maintenance of this electrical bond rests with what is known as the Telegraph and

Cipher Bureau of the Executive Mansion—in effect the nerve center of American officialdom. The official in charge of this telephone and telegraph headquarters details one or more of his expert operators to accompany the Presidential train and keep open the communicative system at that end, whereas at the White House the telegraphers, working in "shifts" maintain an ever sensitive receiving station—an institution that is open for business every minute of the twenty-four hours, seven days a week. It is the only institution of the kind under the govern-

ment that is never closed.

The telegraphic and telephonic experts upon whom so much depends at a time such as this begin their preparations long in ad-

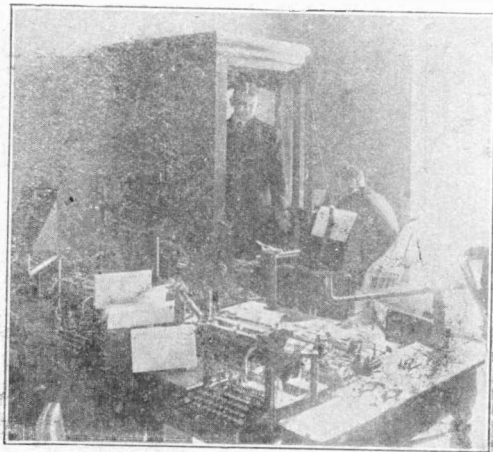

Copyright by Weldon Searcel

TELEGRAPH AND TELEPHONE BUREAU AT THE WHITE HOUSE

vance of the departure of a Presidential party—in fact, just as soon as the itinerary

is completed. The Bureau first makes up its own itinerary with special reference to telegraphic and telephonic conditions in the territory to be visited, and usually a large map is prepared on which every stop of the Presidential party is indicated with its date, hour and duration. By means of this chart, and a thorough system of reports from train dispatchers the exact location of the President's train is always known at the White House and in emergency a message can be placed in the hands of the Chief Executive almost at a moment's notice. For the transmission of the main volume of Presidential business under such conditions efforts are made to handle the accumulated messages at points where the Presidential party tarries for some hours or even days. For the present trip the White House telegraphers arranged in advance to divide the route of the journey into districts in each of which will be available loops direct to Washington.

Some thing like two dozen telegraph wires enter the White House and it is consequently possible to secure a direct wire to any city at any time, reserving it for Presidential business as long as desired.

The President has a private telegraphic cord which he can use while traveling, for the transmission of messages that it is desired shall reach the White House in absolute secrecy. This is seldom resorted to, however. President Taft, unlike his predecessor, is an enthusiast on the convenience of the long-distance telephone and has ever since he entered official life made extensive use of the instantaneous method of communication. Roosevelt, who would not have a telephone on his desk and regarded the invention as in much the same class as the automobile, seldom resorted to the telephone as a means of communication while traveling, but President Taft on the other hand made frequent use of the facilities in his car for talking with Mrs. Taft, or with Secretary Carpenter at the White House. Heretofore the Cabinet officials in Washington have been wont to go to the telephone and telegraph headquarters at the White House whenever they desired to communicate with the President on tour, but if President Taft elects to use the long-distance telephone this may not be necessary inasmuch as the President, if the distance be not too great, can talk from his car to any government department.

The modern Presidential circuit rider depends on the White House to keep him in

touch with the news of the world, or rather that portion of it which might influence executive action. The chronicle of all the happenings of the day pours ceaselessly into the telegraphic hopper at the Presidential mansion and any tidings of importance would be promptly communicated to the distinguished absentee. Should any great national disaster occur or death overtake any of the world's rulers during the Presidential tour the Chief Magistrate would probably get his first news of it via the White House, and would be enabled to take promptly any action that might be necessary.

The one contingency that can upset previous calculations for keeping the White House in touch with a touring President and make necessary a readjustment of communicative lines is when unforeseen circumstances, such as floods, landslides or wrecks make necessary a sudden change in the route of the Presidential "special". Of course, minor changes of route are liable to be made at any time, for the railroad officials very often amend the itinerary after the President has gone to bed, in order that the sleep of the official so sorely in need of rest may not be broken by the sound of clanging bells and shrieking whistles in towns where a small portion of the inhabitants would be awake to extend a noisy welcome to the distinguished visitor, even though he did not propose to tarry within their gates. Such minor digressions do not disrupt things in the communicative chain but any radical change of route temporarily upsets the force at the White House.

An interesting feature of the perpetual "intelligence service" of the present Taft tour grows out of the fact that 1,165 miles of the 12,759 miles embraced in the total journey represents water travel on the Mississippi River. It is the plan to have the Presidential craft equipped with a wireless telegraphy outfit, and most of the United States naval vessels which will be in the river at that time are similarly equipped, so that there should be no difficulty or delay in transmitting Presidential aérograms to shore stations and thence to the White House. Some of the progressive men in charge of the arrangements for the voyage down the Father of Waters have also suggested that a wireless telephone system be installed so that the President may be enabled to communicate en route with the vessels escorting the Presidential craft.

Ozone Generator in Chicago Public Library

A test of importance in the adapting of electric ozone generators to ventilating systems of large buildings is being made in the Chicago Public Library. This demonstration is unique in so far that it is said to be the first actual ozone apparatus installed in a large air duct, used wholly

to convey fresh air to various rooms in a large building.

In selecting the Chicago Public Library building for this test, it was necessary to fulfill the requirement that 10,000 cubic feet of air per minute be ozonized complete, so as to be detected in the most remote part

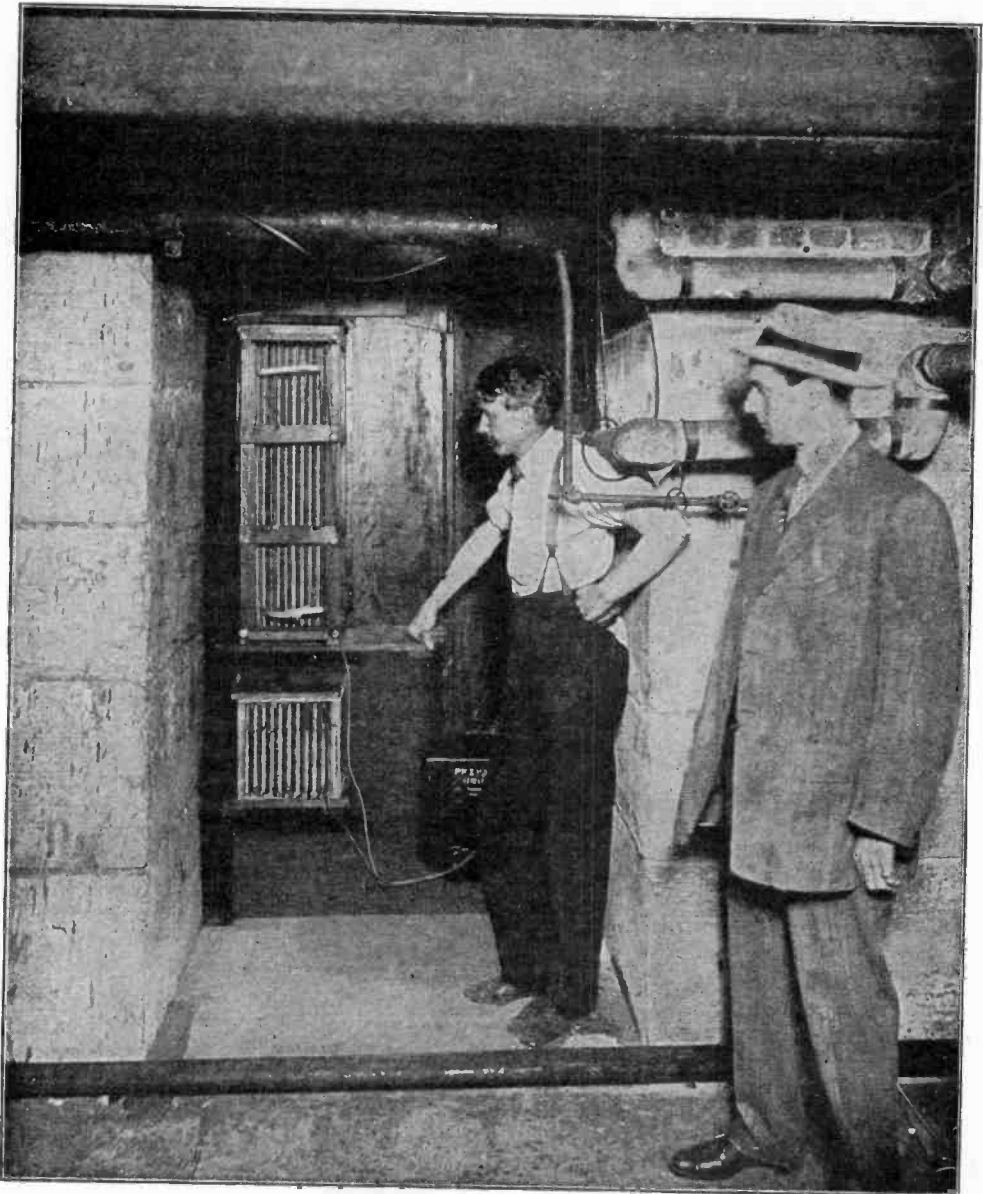

of each room having leaders to it from the main air duct.

The foul air in the Chicago Public Library main reading room has been the source of much adverse comment and discussion for years, and only last March, Dr. W. A. Evans, health commissioner of Chicago, in

which were formerly almost unendurable most of the time on account of the lack of fresh air.

The air ducts of the ventilating system being so complex in the library building, there was afforded at first only the north portion of the building for demonstration.

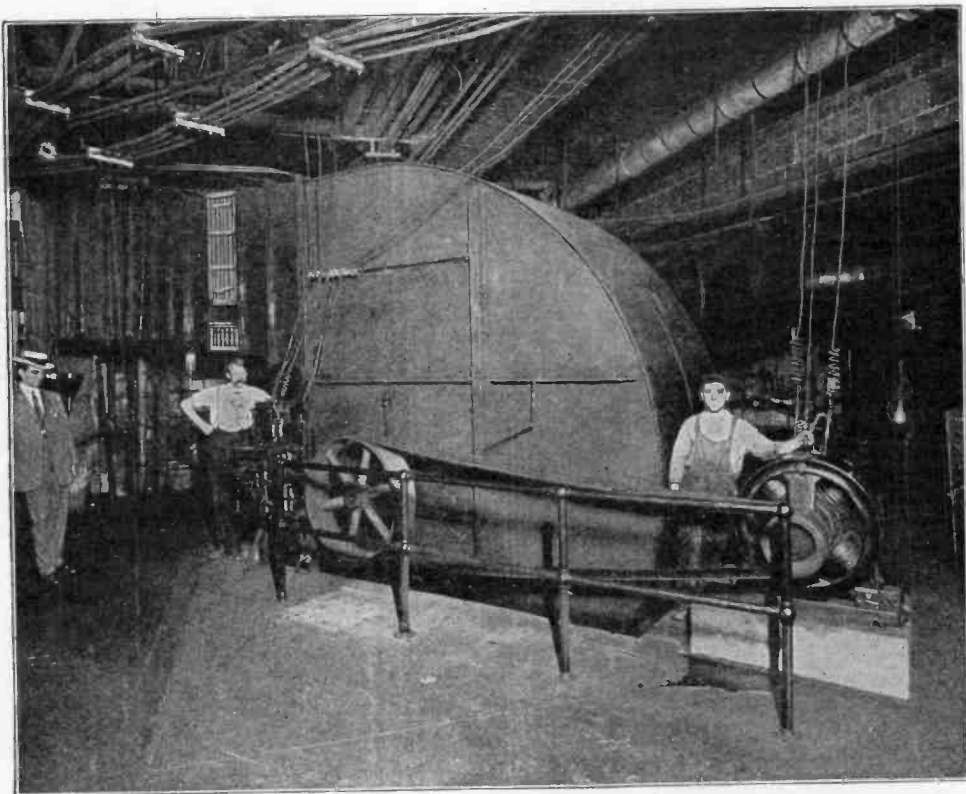

addressing a large audience in the lecture room, stated that the air in the library building was entirely unfit for use.

Results which have been accomplished by the new system are as follows:

Complete deodorizing of the main reading room, freeing from the air odors which have for years so thoroughly permeated all papers, books, furnishings, etc., in this large room.

The injecting of absolutely fresh sterilized air into the room at all times and reducing the humidity in the various rooms during hot and oppressive days of last summer.

The disinfecting of all books, periodicals, etc., on shelves, racks and tables, which are of easy access to the public at all times.

The perfect comfort at all times that is experienced when occasion requires a visit to the large reading room and other rooms

The ozone generator, called the National, was installed in the large air duct in the basement measuring six by nine feet and is the largest unit built for this purpose, consuming about 6.5 amperes of current per hour with a discharge of more than 15,000 cubic feet per hour. It is neatly encased and inserted in the opening of the duct to permit the suction of air to pass through it, thereby becoming completely charged with ozone. By placing the ozone generator between the fan and spray of water used in washing the air greater efficiency was obtained than in placing it in front of the spray and thereby losing a large percentage of ozone which the water would naturally take up.

In describing the generator briefly, it is the result of the work of Mr. S. C. Shaffner

and Mr. S. T. Hutton, electrical engineers of Chicago, who combined their ideas and developed ozone generators to their high state of efficiency. From a feed wire of 110 volts, a connection is made to a step-up transformer which discharges the current at about 7,000 volts, which feeds into the series of electrodes, which are in the form of ordinary hair brushes. A static electrical charge is thus maintained, playing against series of glass plates and forming ozone, which is a form of oxygen (O₃). The ozone so formed has a purity of 97.1 per cent.

When the filtering electrodes become dirty or clogged, they are easily rubbed together and cleaned as one would clean two hair brushes. When placed back in position they are as good as new and will generate their full capacity.

The up-keep amounts to nothing, practically, and the consumption of current required for a certain volume capacity of ozone, as made by different sizes of the machine, is as follows:

25 cubic feet per hour	25 watts
250 " " " "	65 "
500 " " " "	75 "
1000 " " " "	140 "
10000 " " " "	660 "

Electric Horn

Metallic sounds in factories and other noisy places will often absorb the sound of electric bells for signal purposes and make

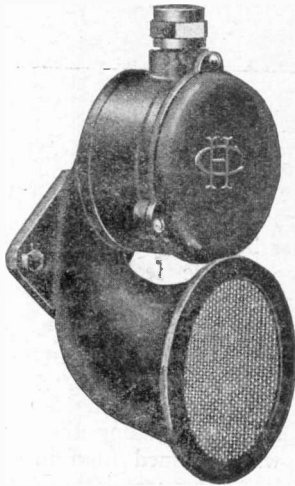

ELECTRIC HORN

them ineffective. In such instances an electric horn may be used to advantage. This horn, which is shown in the picture.

is operated by a vibrator which in turn acts upon a diaphragm in such a manner as to make it give out a peculiar sound readily heard and unmistakable amid the noise. The action of the electric vibrator is somewhat analogous to induction coil mechanism.

The horn measures eight inches from the top to the lower part of the bell-shaped mouth, which is 4 1/8 inches, outside diameter. It is water proof and is made for current of any voltage from 40 to 250, direct or alternating.

An Object Lesson

The days of the old fashioned machine shop, crowded and darkened by hundreds of leather belts from overhead line shafting, are numbered. Not only are most new shops provided with motor driven machine tools but owners are also rapidly finding out that it is possible to change over from belt driven to motor driven machines and save enough in operating expense to more than counterbalance the cost of installation.

Two views are here presented showing a machine room in an old factory, where the method of drive is by belts and shafting, and a similar room in a new factory built by the same company where motor drive is employed. A glance is sufficient to show the advantages derived. In the first place it is much lighter and more airy in the new shop, and the conditions under which the men work are immeasurably better, tending toward greater efficiency and accuracy in turning out the product.

Safety to workmen is another element. With a myriad of whirling belts and the resulting confusion there is greater liability of accident.

Moreover, in a belt-driven shop the line shafts must be kept going all of the time, perhaps on occasions only operating a few machines. This is a useless waste of power. With motor driven machines power is only consumed during the operation of a machine or group of machines. When they are not in use a simple movement cuts off the electric power and waste is avoided.

It is an important fact that in the above example identically the same machines are used in the new plant that were employed in the old plant, as it was found to be a simple matter to equip them with motors and secure just as good speed regulation as could be had by belt drive.

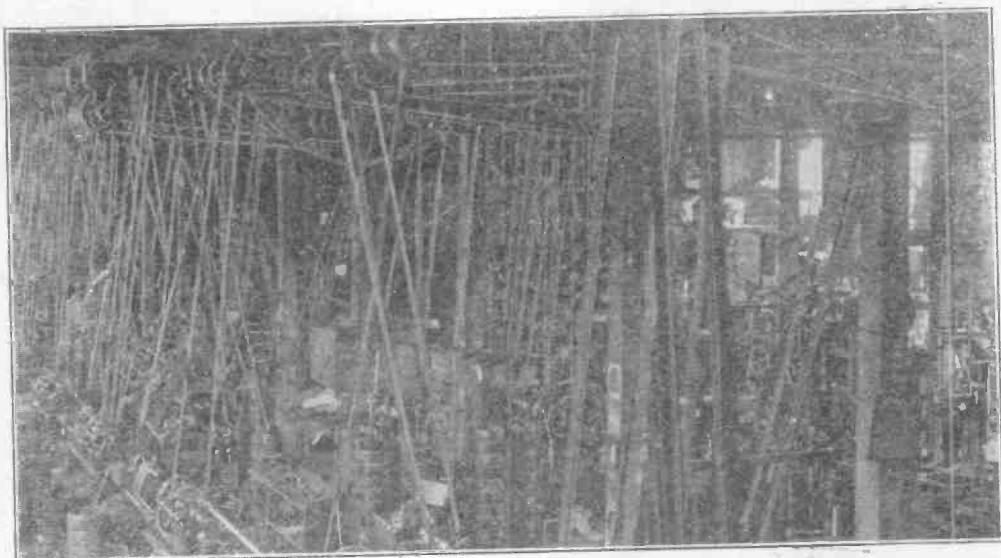

TYPICAL MACHINE SHOP BEFORE THE INSTALLATION OF ELECTRIC DRIVE

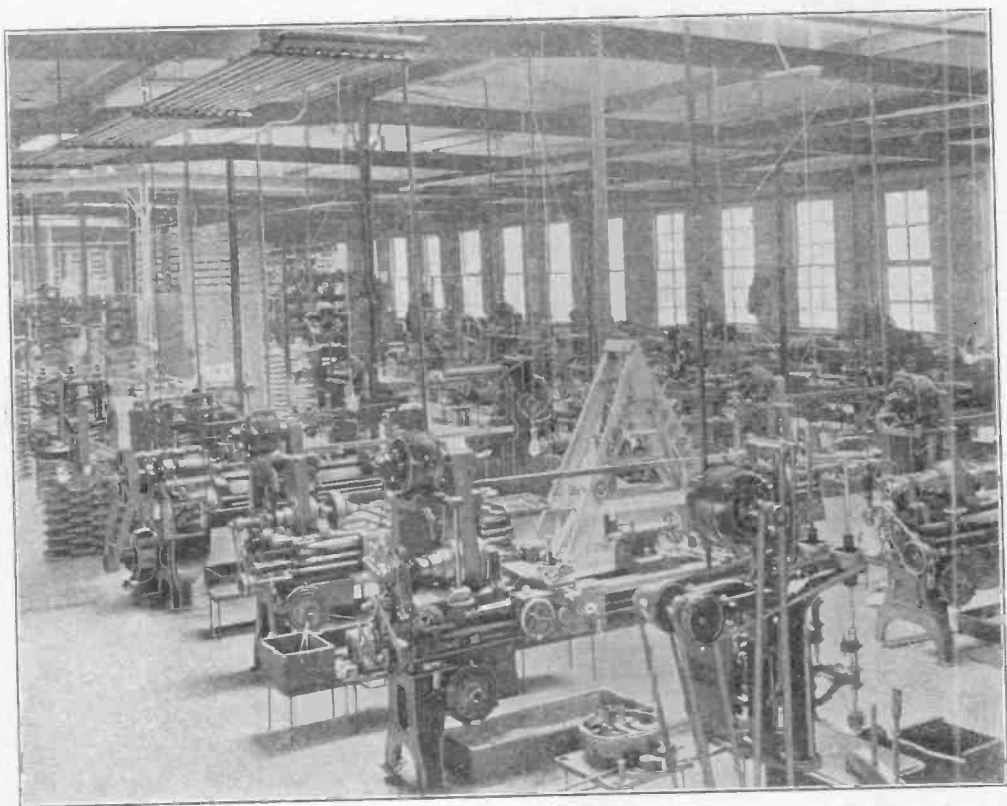

MACHINE SHOP AFTER THE INSTALLATION OF ELECTRIC DRIVE. NOTE ITS LIGHT AND AIRY APPEARANCE

Unusual Applications of Electric Heat

Most of us are familiar with the usual applications of electricity to heating purposes such as flat irons, cooking utensils, soldering irons, etc., but we are not all aware of the

which is the heating element above described. The wires from the lighting circuit pass into the top of the tube and connect with the heating element. When current is turned on the whole spiral is heated to a high temperature and may then be set down into a pail of water to heat the contents. Current must not be left on when the spiral is not immersed in water.

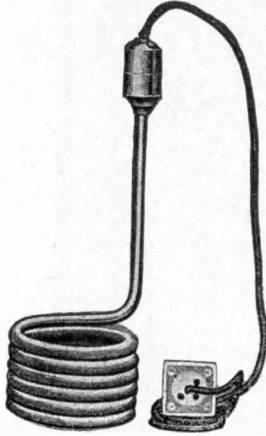

FIG. 1. IMMERSION HEATER



FIG. 3. GLUE POT

extent to which electricity may be applied in heating operations in various industries with which we do not come into daily contact. The object of this article is to illustrate and describe a few of these unique applications. It might be well also to explain

The solder pot shown in Fig. 2 is designed and adapted for melting comparatively small quantities of solder, lead, babbitt metal, and similar metals. The smaller sizes are intended for use on the bench, for tinning,



FIG. 2. SOLDER POT

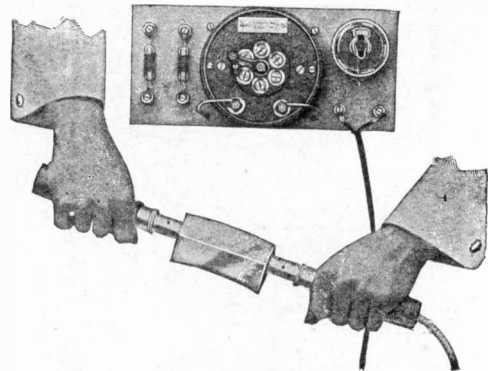

FIG. 4. LEATHER WORKING TOOL AND SWITCHBOARD

that in these utensils heat is produced from the electric current by passing the latter through resistances of fine wire within the utensil. This wire is heated to a high temperature by the passage of the current.

In Fig. 1 is shown a queer device called an immersion heater. It consists of $\frac{1}{8}$ -inch tubing bent in the form of a spiral inside of

dipping, soldering small parts, etc. They are used for a great variety of purposes in various manufacturing establishments. Larger sizes are used for melting metal for bearings, etc.

An electric glue pot, Fig. 3, is ideal for use in a woodworking establishment, paper box factory, in fact any place where glue

pots are used, for the reason that there is absolutely no fire risk. Glue pots are invariably used in places where there are in-

the glue is kept at just the proper consistency.

In the manufacture and repairing of shoes,

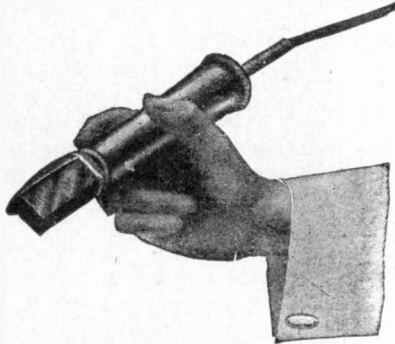

FIG. 5. LEATHER WORKING TOOL

flammable materials, and this single advantage of the electric glue pot is alone sufficient to cause its exclusive use. They are

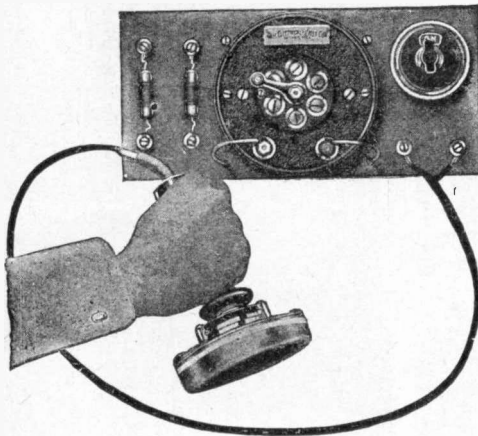

FIG. 6. SHOE IRONING TOOL



FIG. 7. WOOD BENDER

free from dirt, odor, fire or danger. They heat quickly, and by means of the regulating switch it is possible to reduce the heat so that

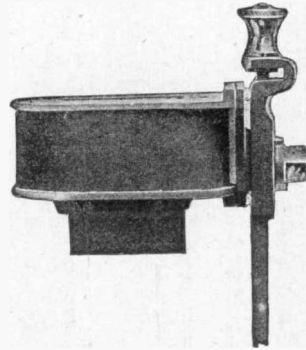

FIG. 8. CIGAR BRANDER

heated tools are employed in the working of the leather—to polish the edges of the soles and heels, to make the little creases across the toe, etc. Figs. 4, 5 and 6 are three types of electrically heated shoe ironing tools which are preferable to those heated over a gas flame. The temperature of the tools is readily regulated and may be kept constantly at the desired value. A small switchboard with fuses, snap switch and regulating rheostat is provided, which makes a perfectly safe and convenient installation.

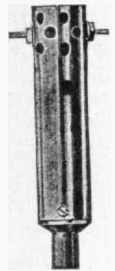

FIG. 9.
CORK
BRANDER

Electricity is also employed in the manufacture of musical instruments, Fig. 7 being an electrically heated wood bender. This

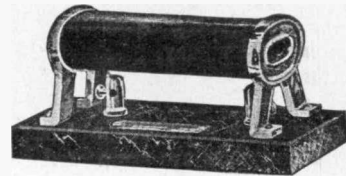

FIG. 10. TOOL HEATER AND ANNEALER

device may also be used by cabinet makers and in pattern shops for bending woods for veneers.

You have, perhaps, wondered how the brands are impressed on certain makes of cigars without crushing the cigar or injuring the wrapper. One way is to use an electric brander such as is shown in Fig. 8. The heater element maintains a constant tem-

perature and the part which does the branding is interchangeable.

On somewhat the same principle is the cork brander shown in Fig. 9.

Fig. 10 is a device designed to heat flat

tools used in melting wax or shellac for filling holes in furniture and similar purposes. It is also designed for use as an annealing furnace to draw the temper out of small steel articles.

Talks With the Judge

"I have noticed so many times when riding on the street cars or elevated trains at night that the lights burn very dim at times, when the car is being started. Sometimes they almost go out entirely and then come on again suddenly. I'd like to know the reason for that?" The Judge was in a question-asking mood.

"Suppose I answer that question by asking another," said I. "Suppose that just above a water faucet you were to drill a small hole in the water pipe; the water would rush out under high pressure.

"Now suppose you open the faucet wide open. The pressure on the pipe at that point and for some distance above will be relieved and the force of the small stream will be greatly diminished—you can see that? Well, exactly the same thing happens on the street car. To start the car requires more current than to run it, and the motors of a street car are so made that they will fairly eat up current in order to get the necessary starting power or torque as it is called. Therefore when the motorman turns on the current to start, especially if the going is hard or it is up grade, the motors consume an enormous amount of current, and this so relieves the pressure or voltage of the system that the lights burn dim until the car is under way.

"Street car systems generally operate on about 550 volts. The lamps on the car consume current at 110 volts in order to burn properly, and they are connected in groups of five in series across this 550 volts. Now if the voltage impressed upon a lamp drops a few volts below the number on which it is designed to operate not enough current will be forced through the filament to cause it to glow, or it may only glow at a dull red heat. So you see when the car starts suddenly under adverse conditions the motors take a great deal of current temporarily. This reduces the pressure to the lamps, as in the case of the water pipe analogy, and causes them to burn dim because of insufficient current."

"I see through that all right enough now," said the Judge; "but it brings to my mind another question. You said something about five 110-volt lamps being burned in series across 550 volts, which don't mean much to me. But I was just wondering if it has anything to do with the fact that when the conductor switches on the lights in the car every turn of the switch turns on five, also if one lamp is burned out there are usually five out; does it?"

"Exactly," I said. "You see electric incandescent lamps are made to burn on certain voltages, maybe on two, four, 50, 110, 220 and so on, the most common kind burning on 110 volts, which is the most common voltage. A lamp of a certain voltage, therefore, when connected to the two terminals of a circuit carrying that voltage will have just enough current forced through its filament to heat it up to incandescence. Increase the voltage and the lamp burns with increased brilliancy or if a high enough point is reached it burns out. Reduce the voltage and it burns dimmer and dimmer until finally it does not glow at all.

Suppose then that you have a 110-volt lamp. connect it across a 110-volt circuit and it will burn all right, but connect it across a 220-volt circuit and it will burn up with a flash. However, if you connect two 110-volt lamps in series (one terminal of one lamp to one of the next and the two free terminals across the circuit) across a 220-volt circuit the resistance of the two filaments will be twice as great as that of one and therefore the same amount of current ($\frac{1}{2}$ ampere) will flow through the two lamps that flowed through the one lamp on the 110-volt current, and the two will then burn properly.

"It is the same with the 550-volt street car circuit. Five 110-volt lamps are connected in series across the 550 volts and enough of these groups of five are used properly to light the car."

The Mount Weather Observatory

Electrical circles, not only in the United States but throughout the world, have every reason to feel the keenest interest in the experiments which are to be conducted at the Mount Weather Observatory—one of the newest and one of the most important scientific institutions founded by the United States government. Not only is electrical energy being employed for much of the

exploration of the upper air is designed primarily as an aid to weather forecasting, but incidentally the studies of the atmosphere will determine the state of its electrification under various conditions, afford data as to its absorption of electric waves, and otherwise contribute new-found technical information that will be of immense significance to students of electricity.

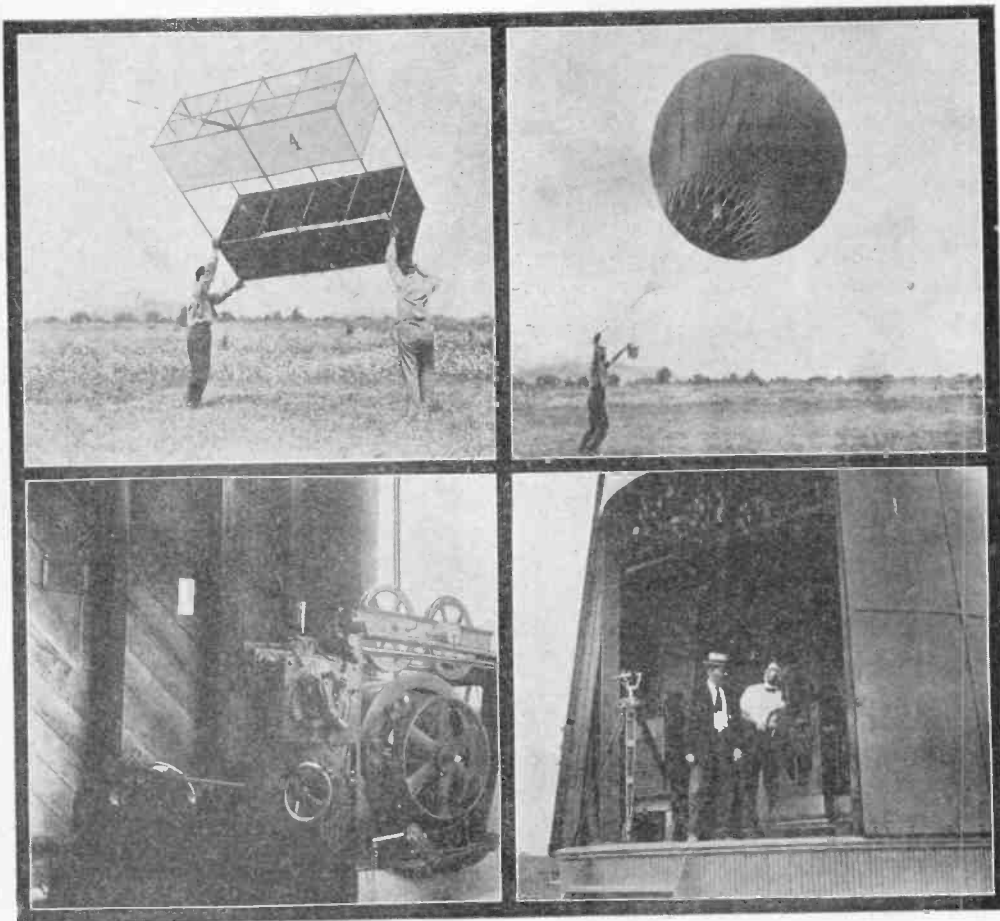

MAKING OBSERVATIONS AT MOUNT WEATHER

original research work at this station above the clouds, but electrical study along new lines is one of the functions of the unique institution. The newly established observatory, it may be explained, is a branch of the United States Weather Bureau and its purpose is upper air exploration. This

Government experts searched the country over ere they found a satisfactory site for this novel experiment station. The requirements were numerous and diverse. The study of the upper air, demanding as it does the daily use of kites and captive balloons, requires a location with a high

average wind velocity. It also calls for a location 10 miles or more away from cities and from electric light wires, since in such localities the loose wires falling as the result of accidents to kites or balloons during a storm would be very troublesome and even a source of danger to transmission lines. The magnetic work which is carried on in connection with the upper air exploration also requires a location remote from trolley lines. All the specifications were fulfilled by the site which was finally chosen—a mountain peak in an isolated part of the Blue Ridge range in Virginia. This mountain top which the government has purchased and christened Mount Weather, is six miles from the nearest railroad and has an altitude of 1,725 feet above sea level.

On the very crest of the mountain have been placed the substantial brick and stone buildings of this scientific outpost. The aerial department has been provided with a power house with engine and dynamo; an electrolytic plant for generating the hydrogen used for the balloons; and a small revolving building which contains the electrically operated kite reel from which the kites and captive balloons are flown. This reel, by the way, is a particularly interesting example of electrically operated apparatus owing to the strains imposed upon it.

The kite reel, carrying the line upon which the kites are flown is driven by a three-horse power motor. The drum is made of forged steel and is capable of carrying nearly 50,000 feet of piano wire line. In the power house of this kite and balloon station is a steam engine and electric generator of 17.5 kilowatts capacity.

Kites are flown whenever there is sufficient wind to carry them aloft. When there is a very light wind the scientists have recourse to small spherical balloons made of varnished cotton cloth and having a capacity of 905 cubic feet each. The upper air data is recorded automatically on self-registering apparatus carried aloft by the kites and balloons. The working principle of these instruments is that of a rotating cylinder upon which the pens connected with their respective elements trace the changing conditions of pressure, temperature, humidity and wind velocity. It is the plan of the officials to ultimately take up wireless telegraphy via kites and other lines of experimental activity for which the conditions at Mount Weather afford exceptional facilities.

An Ingenious Alarm Clock

The object of an alarm clock is, of course, to arouse one from sleep, but it fulfils its function all the better if in some way it can be made to induce us to obey its call. The electric alarm clock shown herewith is of French design and is very neat in appearance. On the dial you will see that there is a third hand like a small crank. This is

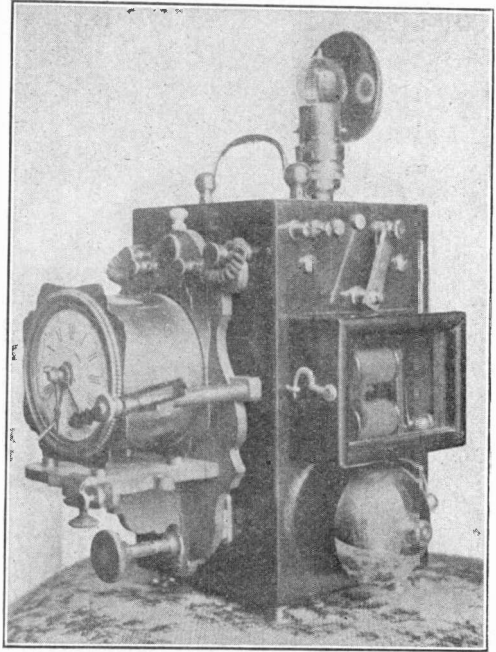

AN INGENIOUS ALARM CLOCK

set to any hour desired and when the hour hand comes in contact with the third hand an electric circuit is closed and an electric bell on the clock is made to ring until you find it necessary to get up and shut the "blamed thing" off. At the same time an electric lamp is turned on.

In case it is not desired to operate the lamp for any length of time for fear of running down the batteries there is ready at hand an exposed portion of the circuit containing a bit of platinum wire which is heated by the passage of the current and at which an alcohol lamp may be lighted.

This device is entirely self contained and the box includes the batteries, so that it may be moved from place to place. It is the invention of René Dubosq, Professor of Philosophy in the High School of Theology of Bayeux, Calvados, France.



BROOKLYN BRIDGE IN FIERY OUTLINE

Night Scenes at the Hudson-Fulton Celebration

Electricity vied with Pyrotechnics to give splendor to the after-dark programme of the Hudson-Fulton Celebration held in New York the last week in September. While the fireworks were particularly effective, they could not take first place over the splendid electrical illuminations which were to be seen

on every hand during the week of the celebration.

The electrically illuminated buildings, bridges and arches in New York and Brooklyn, some of which are here illustrated, presented a scene which even New York will not expect to duplicate for many a day.



CITY HALL ILLUMINATED

Fifth avenue was festooned with incandescent lamps; the "Great White Way" was even whiter, and Brooklyn bridge a line of light from end to end.

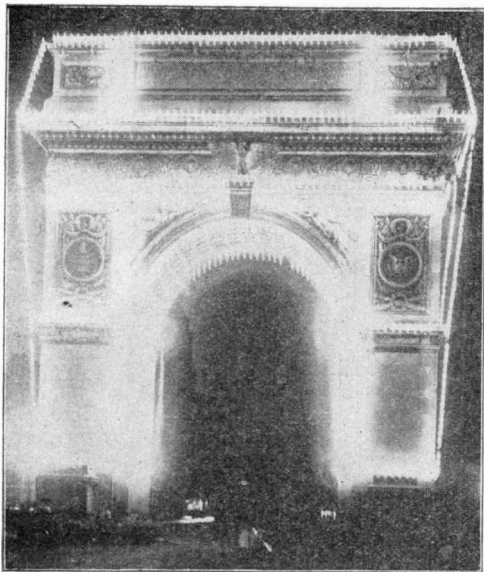

WASHINGTON MEMORIAL ARCH

It is estimated that at least 100,000 horsepower of electrical energy was consumed nightly in producing the special electrical illuminations.

Difference Between the Magnetic Pole and the North Pole

Now that the North Pole has actually been discovered—that fascinating, only spot upon the earth's surface which receives the vertical rays of the pole star—endless have been the discussions as to how one would know when one were there, in what direction a compass needle at the pole would point, etc.

Not everyone understands that the North Pole and the north magnetic pole are two entirely different things. As a matter of fact there are few localities on the earth's surface where the compass points due north. The reason is because the north magnetic pole, or area, lies in the vicinity of King Williams Land just off the Arctic Coast of North America, in Bothia. These are strange lands that we don't hear much about after we have left our school geographies behind.

When this magnetic pole is between us and the North Pole the compass points due

north. As we go either east or west from this line it is easy to see that the compass is "off" to a certain extent. If we were to travel north of the magnetic pole the needle would point south; west of it the needle would point east.

Sir James Ross in 1831 located the north magnetic pole approximately, at a point up in Bothia. But in 1903 Capt. Roald Amundsen, in the good ship *Gjoa* set out on an expedition which lasted till 1906, and during those three years he re-located the magnetic pole and incidentally made the "Northwest Passage," the goal for which mariners have striven since the days of Hendrik Hudson.

Amundsen and his assistants lived for nearly two years at Gjoahavn in King Williams Land, west of the Coast of Greenland. This was about 100 nautical miles from the magnetic pole and is a favorable point for making magnetic observations.

Terrestrial magnetic force is different on every part of the earth's surface and is not always the same at a given point. It is subject to regular daily and yearly changes, and Amundsen wanted to find out about these changes. Evidently the best place would be near the seat of the magnetic power, so there he posted himself, and for 19 months, day and night, his party took readings of their instruments—both inclination and declination.

Amundsen himself also made short excursions right into the very region of the magnetic pole and was able, by the aid of declination observations to prove absolutely that the magnetic north pole does not have a stationary situation but is continually moving. Its general location is, however, in the region mentioned above, and it does very well to steer by.

Dallas on the Safe Side

The city of Dallas, Texas, recently passed an electrical ordinance which it claims is the best in the country. The ordinance requires bonds of every person who handles electrical appliances in any manner, including contractors and the men employed by them, window decorators, stage employees, etc. Before a permit for an installation will be given plans must be submitted showing every connection, and when finished the work will be inspected to see that it corresponds to the plans submitted.

How to Make an Auto-Condensation Pad

By NOBLE M. EBERHART, A. M., M. S., M. D.

Auto-condensation is becoming rapidly popular among physicians as a method of treating diseases where there is an impairment of nutrition or failure in perfect elimination. It is only a question of a few years until it will take the place of other electrical

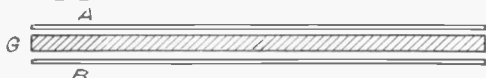

FIG. 1. REPRESENTING THE PLATES OF A CONDENSER

methods for this purpose. The principle involved in auto-condensation is the substitution of the patient's body for one layer of a condenser, and although several other forms for current may be made use of in this way, the term auto-condensation has become re-



FIG. 2. THE PATIENT TAKES THE PLACE OF ONE PLATE

stricted in its meaning to apply to the administration of the high frequency current of D'Arsonval given in this manner: Let (A) in Fig. 1 represent in sectional view, one layer of a plate condenser, (B) the other layer and (G) the glass or di-electric, which separates them. Now, with this form of condenser a positive charge is held on (A) and a negative one on (B) (or vice versa), and they constantly attract one another through the glass (G) which separates them, and although the glass does not prevent this attraction, it does prevent the charges from actually getting through and neutralizing one another. Now if we substitute for (A) the body of a patient (Fig. 2) then when the condenser is charged, the body of the patient is charged just the same as if it were a layer of lead or zinc.

The original auto-condensation couch which is like an elongated Morris-chair, or steamer chair is shown in the accompanying sketch (Fig. 3) together with a coil and a high frequency generator of the D'Arsonval-Oudin type. This couch consists of a frame work underneath the back and seat of which is a layer of zinc, while the cushions are made of rubber and stuffed with rubber waste

(sometimes with silk floss). The zinc plates are attached to one pole of the D'Arsonval apparatus and the other pole connects with metal handles, which the patient takes hold of while sitting on the couch. Thus the patient becomes layer (A) of a condenser as shown in Fig. 2. The rubber cushion takes the place of the glass (G) and the zinc plates represent layer (B) of the condenser. In the operation of this couch the D'Arsonval apparatus produces a rapidly alternating current, so that the patient is first charged, say with a positive current, while the zinc is negative. Then the charges are withdrawn and changed over so that the next instant the patient is negative and the plate positive,

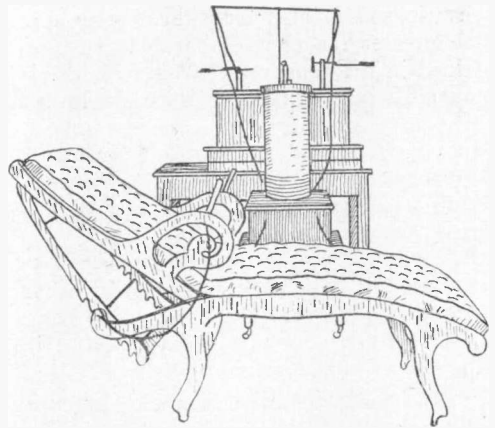

FIG. 3. THE AUTO-CONDENSATION COUCH

etc. It is claimed that with the ordinary apparatus used these alternations take place one million times per second.

Realizing that the arrangement of condenser layers and di-electric was all that was necessary for the obtaining of auto-condensation, I thought of several ways of producing apparatus for this purpose. My first method consisted in making a folding pad as shown in Fig. 4 which consisted of the rubber cushions with the zinc plate on a thin wooden base below. The connection from the patient to the other pole was made with an ordinary hand electrode such as is used with the galvanic or faradic battery. This form of pad is easily constructed by the doctor, by making use of two plates of zinc

with metallic connection, but necessitates the purchase of the rubber cushions and for a home-made apparatus one of the other forms which I shall describe will be found easier to construct.

The next thought that occurred to me was that we have a number of different substances which make good di-electrics, such

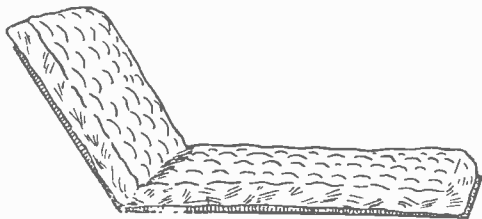

FIG. 4. AUTO-CONDENSATION PAD

as glass, silk, mica, etc. Furthermore there is a well-known law that the thinner the di-electric, so long as it keeps the charges apart, the greater the charge that may be maintained in the condenser. With this in view my most recent pad consists in a layer of condenser together with a sheet of flexible mica covered with leather to resemble the ordinary pad which is used on a physician's office treatment table and this has proved a most satisfactory one.

With these general statements I will suggest two or three ways in which the physician may make a suitable pad for office use.

First, a glass slab, five or six feet in length, 20 inches wide and about one inch thick, such as is used in a glass topped operating table, is fitted in a wooden frame and to the under surface is attached a strip of zinc or of sheet lead, 1-32 of an inch thick. This strip should be about 10 or 12 inches wide so that when placed on the lower surface of the glass it will leave a margin of about four or five inches between the edge of the zinc and the edge of the glass. It should extend lengthwise to within six inches of each end of the glass slab. The zinc or lead plate is connected by an ordinary covered conducting wire (say not smaller than No. 10 or 12), to one pole of the high frequency apparatus and the patient connected by the ordinary metal electrode to the other pole. The patient may be placed directly on the glass, but it is preferable to place him on a thin cushion upon the glass, for the sake of comfort,

Another method is to take a wooden table long enough for the patient to lie on and

place underneath the table top, a layer of plate glass the full size of the top of the table with the strip of lead or zinc attached to the under surface of this glass, always bearing in mind that the essentials of an auto-condensation pad are to have a di-electric with a layer of condenser below it, and the patient attached to the apparatus to form the upper layer. Thus an ordinary Morris-chair or steamer-chair may be used and a layer of lead or zinc fastened underneath the back and seat of the chair, the two strips being fastened together with metallic connections (chain or wire). Underneath the ordinary cushion of the chair, four or five layers of rubber are placed to serve as the di-electric, although the cushions themselves, if they remove the body beyond the sparking distance of the charge on the zinc plate would really make the air space intervening serve as a di-electric. This is not as satisfactory, however, as when the layers of rubber are placed between. The patient then is connected by the ordinary metallic hand electrode and conducting cord, or metallic handles may be fastened on the arms of the chair, the two connected by a bifurcated conducting cord to the one pole; the zinc plates to the other.

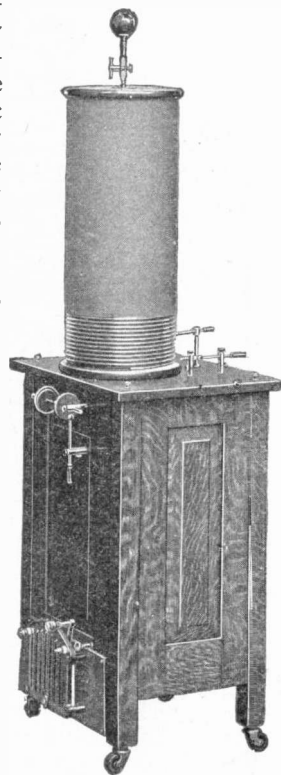
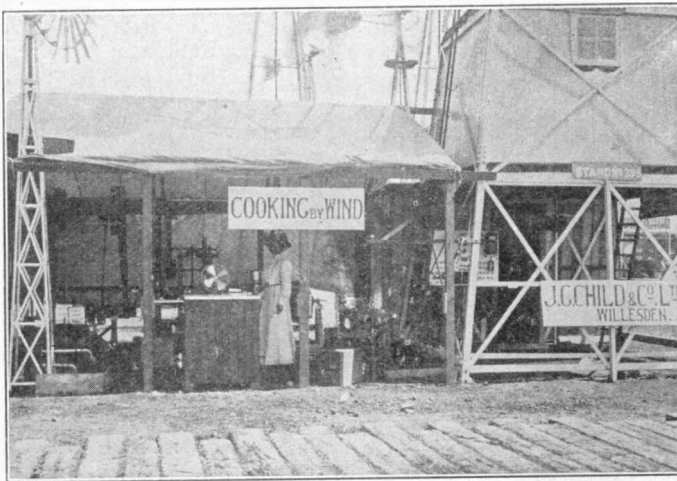

FIG. 5. TESLA-D'ARSONVAL-GEN-
ERATOR

same plan as the one which I have designed, using one or more layers of sheet mica large enough to permit the body of the patient to rest thereon and making use of a layer of condenser (either lead or zinc) underneath the mica, taking care that it does not extend near enough to the edge of the mica to allow

the charge to leak over. On top of the mica, place three or four layers of felt or cover with leather as desired. Should the mica be insufficient to prevent some sparking through, it may be obviated by placing another thin cushion on top of this pad.

Now in the beginning I referred to the fact that auto-condensation was used with the D'Arsonval high frequency current, and to get a sufficient amount of current for auto-condensation we must have generating machines, which will deliver into the pad a charge of not less than 150 milliamperes; the ordinary dose for auto-condensation being



WIND POWER ELECTRIC PLANT AT THE ROYAL SHOW

from 150 to 600 milliamperes. The current can only be measured by a hot-wire meter, the ordinary milliammeter used with galvanic apparatus being entirely useless in measuring high frequency currents. When the D'Arsonval apparatus is charged through an induction coil there is no trouble about getting a sufficient amount of current if not less than a 12-inch coil is employed.

Another method now frequently used is the production of high frequency currents through a Tesla transformer, in which case in order to get sufficient current for auto-condensation there must be a voltage of about 30,000 volts in the primary of the transformer. I have produced one form of apparatus consisting of a combined Tesla-D'Arsonval-Oudin apparatus, shown in Fig. 5, which works perfectly on the alternating current without any intervening apparatus; being attached directly to the lamp socket.

Wind Power Electric Plants

Despite the obstacles presented to the extensive use of wind power for the production of electric current, owing to the uncertainty of the wind and the variability of its velocity when it is blowing, experimenters are continually at work on the problem, especially in England.

At the Royal show at Gloucester there was an electric cooking display by wind power, as shown in one of the accompanying illustrations. A 24-foot wind turbine and complete electric plant was installed capable of generating 3000 kilowatt hours per year with wind averaging eight miles per hour for that period. It is stated that the electric current generated by the wind turbine plant was conducted a distance of 220 yards to the Cottage of the Country Gentlemen's Association, Ltd., for use in lighting and cooking service.

The second illustration shows a plant containing such an equipment for charging electric launches. These plants are supplied by J. D. Childs & Co., Ltd., of Willesten Green, London, and at the factory of the company a wind

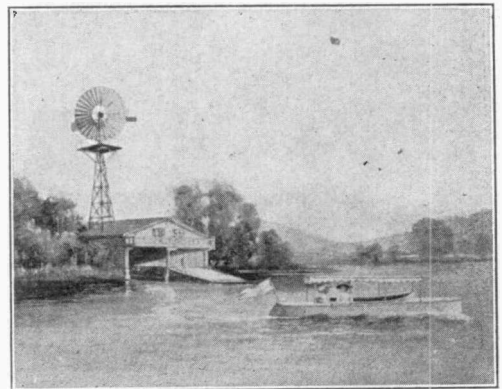

WIND POWER PLANT FOR CHARGING LAUNCH BATTERIES

turbine plant has been in operation for several months with excellent results, supplying current for 150 10-watt lamps.

A Church on Wheels

A church on wheels in the form of an electric Gospel automobile is being used extensively in Cincinnati's slum districts. The queer little church contains a pulpit and seats for 16 persons. It is run by powerful storage batteries which also electrically light the interior.

Three times a week the electric Gospel Auto with a quartet of singers and a minister makes its rounds in the slum districts. The innovation in church work attracts wide attention, and the "electric church" has been successful in its mission. The idea of bringing the church to the people that will not go to church has been so successfully solved with the new Gospel Auto that others like it will be put into service.

Miniature Saw Mill

One of the interesting and unique exhibits at the Alaska-Yukon-Pacific Exposition is a

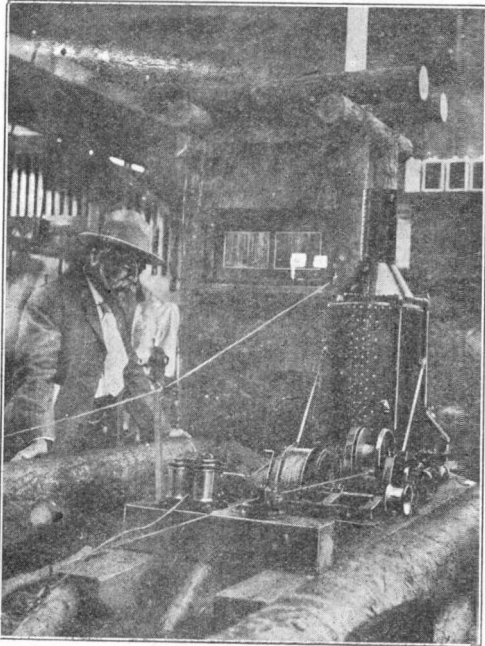

MINIATURE SAW MILL

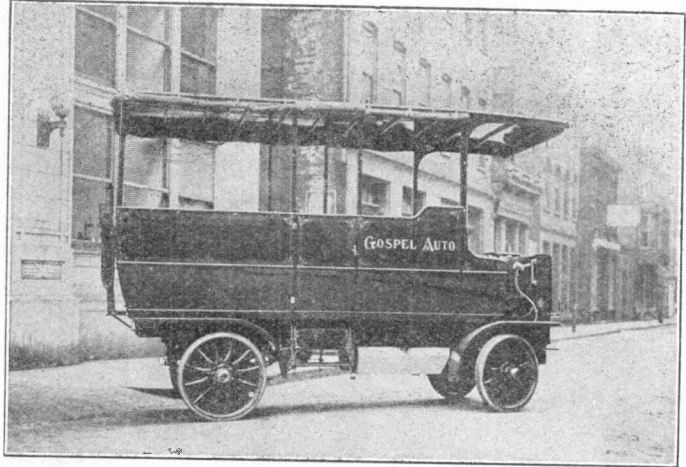

THE GOSPEL AUTO IN CINCINNATI

miniature logging camp, running by its own power and performing before the eyes of the spectator all the operations of making lumber. Ordinarily it is a hard task for man and beast to "snub" the logs or drag them onto the saw carriage. In this miniature plant as in many large mills the "snubbing" is done by means of an electric motor and winch as shown in the picture.

Record in Cable Repairing

A hard record to beat in the quick repairing of a telephone cable was recently made in Nashville, Tenn. A large grain warehouse was destroyed by fire, burning in two a 50 pair cable. The cable department got a record of the damage at 22 minutes after four and at seven o'clock the repairs were entirely completed, in the meantime a section of cable having been strung, tested and spliced, the total length of time occupied by the repairs thus being two hours and 38 minutes.

Mighty Boiler for Electric Plant

A single boiler of unusual capacity has been installed in the new Delray electric power station of the Detroit Edison Company. This mighty boiler has a capacity of 2274 horsepower and has a grate 150 inches wide by 11 feet long. It takes four mechanical stokers to serve its voracious appetite for bituminous coal. As the station grows, more of these units will be added.

POPULAR ELECTRICITY WIRELESS CLUB

Membership in Popular Electricity Wireless Club is made up of readers of this magazine who have constructed or are operating wireless apparatus or systems. Membership blanks will be sent upon request. This department of the magazine is devoted to the interests of the Club, and members are invited to assist in making it as valuable and interesting as possible, by sending in descriptions and photographs of their equipments

The Silicon Detector

The silicon detector is easily made by the amateur, although considerable care must be taken with the adjustment in order to insure sensitive operation. In the beginning it may be stated that the silicon detector operates upon the principle of the thermocouple. The principle of this couple is that when two dissimilar metals are joined together and connected in a closed circuit, a small amount of heat applied to the junction

(E) works through this brass strip and into a threaded eyelet in the base. The thumb screw (F), also of brass, terminates in a sharp point resting against the piece of silicon in the cup (G). This forms the couple. The terminals (B) are connected to (G) and (C) as shown by the dotted lines, the wires being concealed in the base.

The metal cup (G) which holds the silicon is about an inch in diameter and about $\frac{1}{2}$ of an inch deep. Grind down a piece of silicon till it makes a fairly good fit in the cup. Next place some solder in the cup along with some soldering flux. Hold the

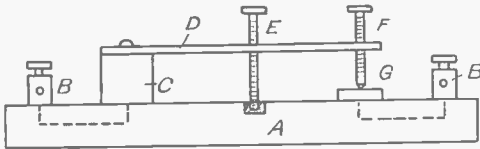

FIG. 1. SILICON DETECTOR

will cause a current of electricity to flow through the circuit. Conversely, if electricity from a battery or other source is sent through the circuit the junction will be heated.

A silicon detector is therefore nothing more than a couple of brass and silicon connected in the aerial circuit and having the telephone receiver bridged around it. The surging waves entering the aerial wire, although representing an extremely small amount of energy, are enough to slightly heat the brass-silicon junction. This causes a tiny current to flow through the telephone and permits the make and break of the incoming waves to be read by the clicks of the receiver.

Fig. 1 is a diagram showing the arrangement of the various parts of a silicon detector. (A) is a base of wood, (C) is a brass block $\frac{1}{2}$ by $\frac{3}{4}$ inches screwed to the base. A brass strip (D), one-sixty-fourth of an inch thick and three inches long by $\frac{1}{2}$ inch wide is screwed to (C). The thumb screw

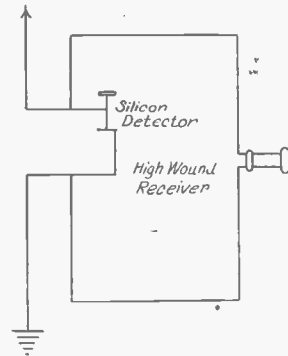

FIG. 2. CONNECTIONS OF SILICON DETECTOR

cup in the flame of an alcohol lamp till the solder is melted then stick in the lump of silicon.

When the parts are set up as shown by Fig. 1 the brass screw (F) may be adjusted to just touch the silicon. With practice you do this adjusting to a nicety.

Connect the detector in the circuit as shown in Fig. 2. Use a high wound receiver.

Theory and Practice of the Radio System

By FRANK C. PERKINS

For field work in military and other service portable wireless telephone and telegraph sets may be utilized to advantage and may be carried on the back of a mule. For short distance service no visible antenna is neces-

This apparatus is supplied with a short antenna and has a range of nearly 100 miles, but for ordinary automobile work a much lighter and less powerful equipment might be employed to advantage.

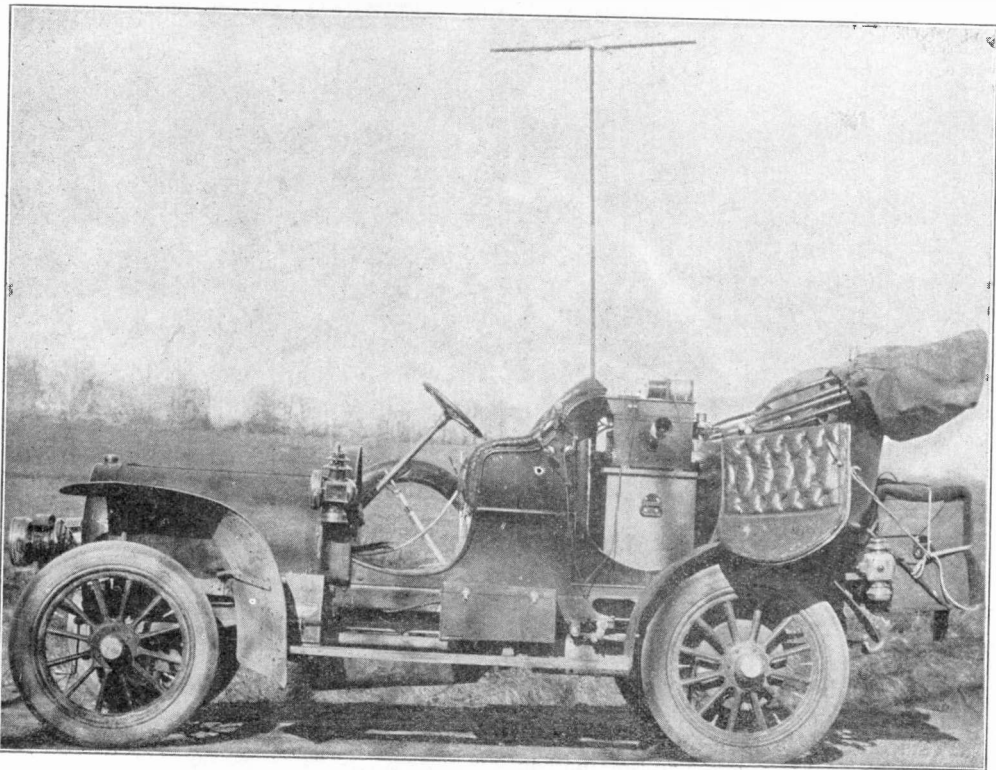

GOVERNMENT AUTO WITH WIRELESS EQUIPMENT

sary, the operator simply using the instrument without removing it from "Maud's" back.

The illustrations show the portable Radio Wireless Telephone and supplementary telegraph for this kind of service. With this instrument it is possible to talk up to 20 miles and telegraph from 80 to 100 miles with a special antenna, although without using a visible antenna is only available for short distance service up to one or two miles.

The complete long distance Radio telephone and sparkless wireless telegraph may also be installed in an automobile to advantage as indicated in one of the pictures

It is interesting to read the following description of the method of operation of the new Radio wireless equipment, as given by the designers of this apparatus, the analogy given greatly simplifying the matter to the mind of the student.

Every school boy knows that if he places several marbles in a row and strikes the marble at one end of the line, the one at the other end will roll away, although all of those intervening remain at rest. The theory of wireless is based to a very great extent upon just this principle. The molecules, ions or whatever you may call them, of the ether, transmit the energy from one

to the next and so on, just as a blow is felt by the end marble, no matter how many intervene.

Picture a man standing upon a bridge with his arm full of bricks. Under the bridge is a second man, to whom the first wishes to communicate an intelligible signal, advising him whether to stay under the bridge or come out. If a brick is dropped into the water below, it sends out a circle of waves which can be noted by the man below. The dropping in of two bricks, one after the other, might be one signal, while the dropping of three bricks at intervals would be another. In this way it would be possible for the two men to devise a code which would represent the alphabet, each signal depending upon the number of bricks dropped within a given time, or the number dropped in succession, followed by a

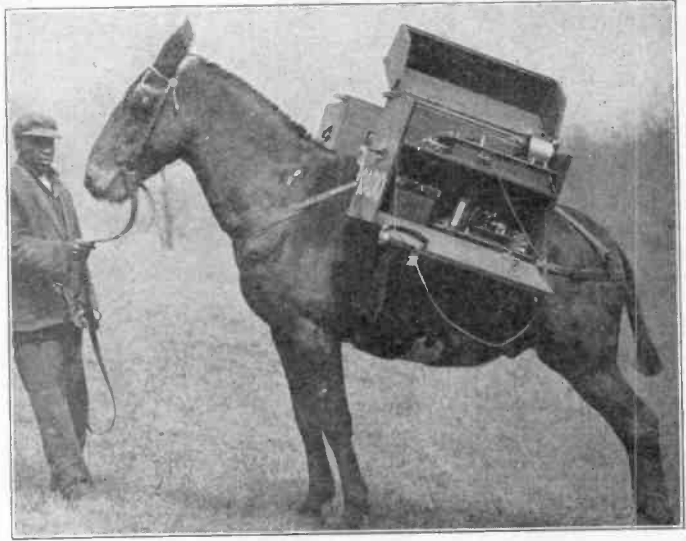

WIRELESS ON MULE BACK

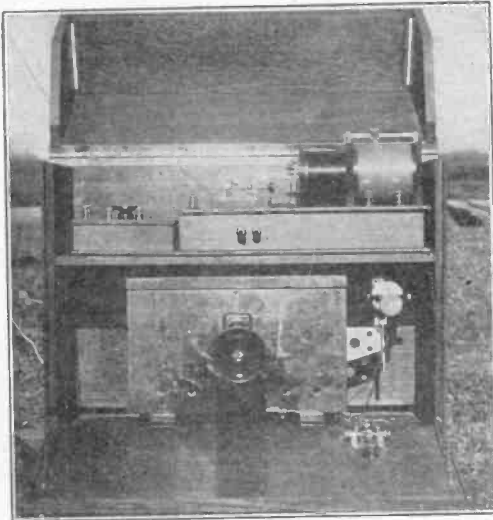

MILITARY PORTABLE SET

pause, and the dropping of more missiles. This represents in a pictorial way the transmission of wireless messages as it was done prior to the invention of the Radio sparkless wireless telegraph.

Now draw a picture of this newest invention in the art of wireless. Supposing

that, instead of an armful of bricks, the man above the bridge has a bag of sand. This sand is permitted to run out in a small stream through a minute hole in the bottom of the sack. As the grains of sand strike the water, there is a very little splash, and the waves that circle out in all directions are ever so much smaller than those caused by the dropping of the brick, but, impelled by the continual stream of sand, these waves go just as far as the others. In order to note these waves, the man beneath the bridge places a small chip upon the surface of the water. While the sand continues to fall from the bag, the chip will be forced up and down by the movement of the water. If the man above places his finger over the hole in the bag and stops the stream of sand, the motion of the chip will cease to be energetic.

The man below would read his signals, not by the waves made by the falling of the sand, but by their interruption for an instant. Thus, instead of dropping a brick, the bridge operator merely places his finger over the hole in the bag to give the signal to the man below.

Briefly, the old system of wireless depends for a signal upon the creation of a wave strong enough to be perceptible at a distance, while the new sparkless telegraph sends out a continuous disturbance whose interruption for an instant causes the transmission of the signal; consequently, only a fraction of the energy is employed in the

latter method with none of the disturbance which is necessary to the operation of the old system.

The inventor, Mr. De Forest, states that this interruption can be made by a machine transmitting system which will do the work of several hundred operators in the same time. Although details of the working of the system have not been made public it

is claimed that with the advent of the new system, close tuning will become possible, and success has already been attained in transmitting several messages at once over the same general apparatus. Thus, multiplex transmission allows several machines, each many times more efficient than the average Morse operator, to operate over a single antenna wire.

Enameled Wire and The Tuning Coil

By A. B. COLE

In making inductance or tuning coils the general practice up to the present has been to use cotton covered wire. A few makers have attempted to use enameled wire, but have found that their coils were not nearly so efficient as those wound in the old way. The reason for this difficulty will be discussed in the present article.

At the start some of our readers will ask, "what is enameled wire," for this wire has

and the total condenser effect, known as "distributive capacity," is in direct proportion to the number of turns of wire in use. Now, the capacity effect acts in such a way as to give a greater wave length per inch of turns than would be had if the wires were spaced at a greater distance; that is, if they were cotton covered. Thus a slight increase in the number of "active" turns makes a comparatively large increase in the wave length, and consequently tuning is far less accurate than with cotton covered wire.

On the other hand the so-called American Black enameled wire has several advantages in other respects over cotton insulated wire where used in the construction of tuning coils. In the first place it gives the instrument a very neat appearance which would be costly to obtain with cotton or other insulation, as this wire is already in a finished state, and needs no further coats of enamel or shellac. Fig. 1 shows a coil wound with this wire, and its appearance needs no further comment.

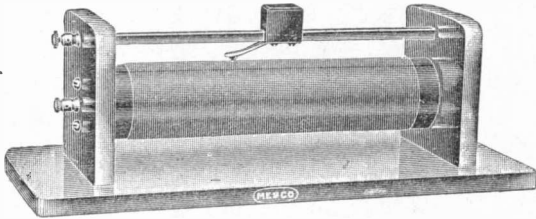

FIG. 1. SINGLE SLIDE COIL

not been on the market long, and is not yet well known. Enameled wire is bare wire with a thick, elastic coat of enamel, which insulates the wire as effectively as a covering of cotton. This wire takes up much less space, however, than the cotton covered, and for this reason many more turns can be had on a core of given length. From this it will be easily seen that the separate turns of wire are much closer together than if cotton insulation were used.

Now we will consider two consecutive turns on a tuning coil. We have here two conducting surfaces (the two turns of wire), separated by an insulating medium (the enamel insulation). This condition constitutes a condenser. Every pair of consecutive wires therefore acts as a condenser.

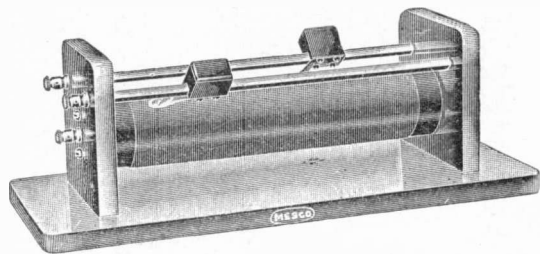

FIG. 2. DOUBLE SLIDE COIL

Where cotton insulation is used a strip must be scraped along the coil so that the slider may make contact with the wire. This operation takes considerable time, and

it is quite difficult to make a good piece of work of it. On the other hand the pressure of the spring of the slider is sufficient to scrape a line of insulation from enameled wire. This advantage will appeal immediately to the amateur and to the manufacturer.

A third advantage of enameled wire is the fact that hard drawn copper is used. Soft copper is generally used with cotton insulation. It will be seen that the slider will not wear enameled wire away so quickly as it will soft copper wire.

From the above facts it would seem that enameled wire is to be preferred if the distributive capacity effect can in some way be overcome.

Since it can be shown that this effect is in direct proportion to the diameter of the coil, the best way to reduce this effect is therefore to reduce the diameter of the coil. Fig. 2 shows a two slider coil designed in this way. The relation of the diameter to the length is well illustrated by the cut. As to the efficiency of a coil designed in this way, it may be stated that with such a coil the writer read a commercial station nearly 500 miles away, with his aerial wire only 60 feet in length. Even under the best of conditions this is a performance out of the ordinary.

Wireless Association of New Orleans

The Wireless Association of New Orleans was organized by Mr. George Seibert and Mr. H. Schluter on August 17. The object of the association is to further the arts of Wireless Telegraphy and Telephony, and to put experimenters on the right footing with the commercial and naval stations in the matter of interference.

The meeting was well attended and the following officers were elected: J. Nadau du Treil, president; George Seibert, first vice-president; H. Schluter, second vice-president; P. Gernsbacher, secretary, and L. Reiss, treasurer.

The meetings will be held at Mr. A. Switzer's laboratory, 1508 St. Charles Ave., on Wednesday, every two weeks, beginning September 1st. The Association invites all to join who own or operate a wireless station in New Orleans. Those who wish to become members of the association may communicate with Mr. Gernsbacher, 2022 State Street.

WIRELESS QUERIES

Answered by Valentine B. Seitz

Potentiometer and Tuning Coil

Questions.—(A) How much No. 28 German silver resistance wire would be required on a potentiometer core $2\frac{1}{2}$ inches in diameter having a thread in between the turns of wire? What would the resistance of this amount of wire be? (B) What is the capacity in meters wave length of a tuning coil having 316 turns of No. 24 bare copper wire wound on a 12-inch core and $2\frac{1}{2}$ inches in diameter with a thread between the turns?—J. S. H., Crestline, Ohio.

Answers.—(A) About 350 feet having a resistance of 400 ohms. As this would make quite a large sized coil, would advise using about No. 30 wire.

(B) With a medium sized aerial it should respond to 2000 meter wave.

Relation of One to Twenty-five Mile Equipment

Questions.—(A) What receiving and transmitting apparatus is required for a station working over a distance of one mile? (B) Would this same outfit work 25 miles if increased in proportion, if not please state how it would differ. (C) How many Leyden jars should be used with a transformer capable of transmitting 25 miles? (B) How far will a six inch coil transmit and what is the approximate cost of constructing it?—H. N., Chicago, Ill.

Answers.—(A) A $\frac{1}{2}$ inch coil for sending, a detector, tuning coil and pair of receivers is all that will be required for a one mile set.

(B) A tuned transmitting set should be used for a 25 mile set. This would include a transformer, condenser, spark-gap and helix. The receiving set should have a receiving transformer in place of the tuning coil, also one stationary and one variable condenser.

(C) A good plate glass condenser having a capacity of about .025 M. F. should be used instead of Leyden jars.

(D) The distance over which a six inch coil could be used, cannot be given with any degree of accuracy, as the results would depend upon the rest of the apparatus and the condition of the territory over which the instruments are to be used. It would cost about \$18.

Auto-Spontaneous Repeating System

Questions.—The article by David Marcus, in the September issue is not altogether clear to me. Will you please explain the following? (A) There is only one wire going to the coils of his repeating relay. To what is the other side connected? (B) Is the choke coil on the same relay

shunted across the other two terminals? (C) Of the four binding posts at the coherer end of the coherer and decoherer diagram which two binding posts are for the coherer and for what are the other two?—J. B. P., West Lafayette, Ind.

Answers.—(A) The other side should be connected to the terminal of the decoherer, to which the wire leading from the contact (C) of the switch (S⁶) is connected. This connection was unfortunately omitted through an oversight by the draftsman.

(B) Yes.

(C) Two perpendicular binding posts carry the coherer tube, while the other two which are in series with the first two are merely used as independent terminals to avoid confusion in wiring. The latter two binding posts may be omitted by connecting the wires from the variable condenser and from the switch (S¹) directly to the perpendicular binding posts carrying the coherer tube.

Aerial Construction

Question.—Please tell me the most reliable method of erecting an aerial consisting of galvanized iron pipe in order to protect it in case of lightning.—O. C. K., Chicago, Ill.

Answer.—The only protection is that of grounding the aerial so as to let static charges that are accumulated pass to the earth. The method of joining your pipe is all right, but would advise insulating the pipe, by mounting on top of the wooden pole.

Battery and Condenser for 6-Inch Spark Coil

Questions.—(A) What is the voltage and amperage required for a 6-inch spark coil and how many dry cells will be needed? (B) How many glass plates and what size will be required for a 6-inch spark coil condenser? The plates are 1-16 inch thick. Please give number of square inches of tinfoil required. This is to bridge across the spark gap.—S. A., Birmingham, Ala.

Answers.—(A) From 10 to 15 volts. Two sets of cells connected in multiple should be used; each set consists of seven batteries connected in series.

(B) This will depend upon the size of glass you wish to use. About 200 square inches of active glass surface should be used. This will take 400 square inches of tinfoil if the plates are not stacked.

Wireless Receiving Set

Question.—Please give diagram of how to connect a double slide tuning coil for use with the auto-coherer, pony telephone receiver and one dry cell and one wet cell battery.—S. K., Denville, N. J.

Answer.—The small permanent condenser (C) must be used with a double slide tuning coil. (See diagram.) A potentiometer must

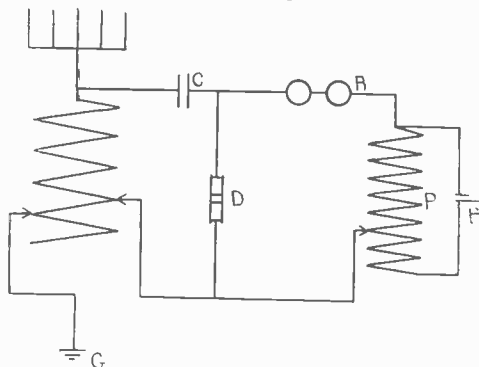

CONNECTION OF DOUBLE SLIDE TUNING COIL

be placed in the circuit when a detector that requires a battery, is used. Would advise using a detector that does not require the use of a battery.

Wehnelt Interrupter on 110 Volts A. C.

Questions.—(A) In the January issue '09 you describe a Wehnelt interrupter. Can this interrupter be used without any resistance on 110 volt alternating current for a two inch coil? (B) Would it not be better to use condensers with the coil? (C) Kindly give diagram of connections.—A. A. B., Seattle, Wash.

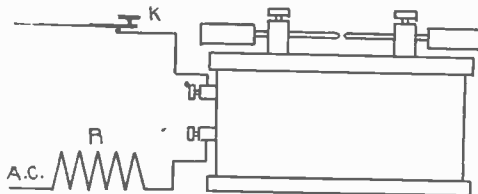

WEHNELT INTERRUPTER ON 110 VOLTS

Answers.—(A) A resistance must be used. Otherwise the coil will take too much current. When used on alternating current, an interrupter of this type should be used in connection with a rectifier.

(B) No.

(C) (See diagram.) The interrupter on the end of the coil should be cut out by connecting the vibrator spring to the adjustable thumb screw or support.

Wireless Parts and How to Connect Them

Questions.—(A) My aerial is 20 feet high, made of four strands of No. 14 aluminum wire one foot apart and 30 feet long. Is this good construction? (B) How far should I receive with a single pole.

75-ohm watch case receiver and potentiometer? How far with 75-ohm double pole receiver? (C) How far can I send with a single unit Splitdorf automobile coil, zinc spark gap and De Forest sending helix (10 turns No. 8 copper wire on 8-inch core)? (D) How can I tell the primary and the secondary terminals of the above coil? (E) Will an Edison cell run the above coil? (F) Will a coherer consisting of two carbon rods end to end with a piece of steel wire between them, and separated from the ends by drops of mercury, work with this equipment? (G) How shall I connect a fusible cut-out?—A. L. M., Rochester, Ind.

Answers.—(A) Your aerial work should all right, but would advise spreading out the wires a little more, if possible, as this will make quite an improvement.

(B) A single pole 75-ohm watch case receiver is not at all adapted to wireless work. A double pole pair of about 1,500 ohms should be used.

(C) Under good conditions using the coil and apparatus mentioned you will be able to send about three miles.

(D) The secondary connection on the coil can be told by the thick hard rubber bushing. The other connection will have to be taken from one of the primary leads, as the secondary is grounded on one end.

(E) It will take at least three Edison cells in series, to run the coil properly.

(F) The coherer will work although it will not be very sensitive.

(G) The fuse would be of no use. To protect the receiving apparatus, shunt a short spark gap across your two leads coming from the aerial switch.

Five-Mile Equipment

Question.—Please advise what instruments are necessary for a complete sending and receiving station operating to a mean distance of about five miles. Also length, size of wire and kind, number of wires and connections of the aerial.—L. M., Minneapolis, Minn.

Answer.—The sending apparatus should consist of a 1-inch coil, batteries and key, while a tuning coil, detector, fixed condenser, and a pair of 1500 ohm receivers will answer for receiving. The aerial should be about 50 feet high and consist of four No. 14 hard drawn copper wires 18 inches apart.

Condenser; Lightning Arrester; Sending Helix; Anchor Gap

Questions.—(A) Please show by diagram how a "fixed condenser" should be used on my receiving

set and what size should it be. (B) What size of leyden jar is necessary across a 2-inch spark gap? If more than one, should they be in series or parallel? (C) Please show by diagram how to use a lightning arrester to protect wireless instruments. Also give a brief description. (D) How should I make a sending helix? (E) What is the "anchor gap" and why is it used?—W. H. B., New York, N. Y.

Answers.—(A) The condenser should have about 40 square inches of active surface when paper is used as the dielectric. (See answer to S. K.)

(B) Three pint jars in parallel.

(C) Place a short safety gap between the aerial and ground.

(D) See answer to L. R., page 324, September issue.

(E) The anchor gap is a short gap placed in the aerial circuit, so that the circuit need not be broken by means of a switch, for receiving.

Tallest Single Stick Aerial

What is said to be the largest stick of timber ever brought into California was raised recently at East San Pedro by the United Wireless Telegraph Co., to serve as an aerial.

This huge piece of timber, which is a selected stick of seasoned Oregon pine, and which was brought to San Pedro on the barkentine James Johnson from the Columbia river three years ago, is 146 feet in length, four feet in diameter at the base and one foot in diameter at the top, and weighs nine tons.

The raising of the mast proved a difficult undertaking, but it was accomplished by hoisting it part way first by means of a gib pole. In attempting to raise the big stick higher, the fall line gave way. Then two lines were run, one to the extreme tip end of the pole and one to the middle, both lines being led through double blocks and tackles to the pile driver standing on the Salt Lake track.

The strain was put first upon the one end, then upon the other, until the mast was in an upright position. Several guy lines were made fast to the pole before it left the ground and were slackened or held taut as the occasion required. The pit in which the mast was set is about twelve feet in depth and will be filled with concrete.



ELECTRICITY IN THE HOUSEHOLD

Beautiful Display of Electrical Fixtures

Beautiful! Exquisite! Splendid! Are a few of the adjectives almost involuntarily used to describe the effects which can now be obtained in scientific and artistic lighting, as exemplified by the magnificent display rooms just completed by one of Chicago's leading electrical supply companies. The black and white of the accompanying halftone pictures gives but a faint idea of the almost palatial splendor of these three rooms, which were fitted out at a very great expense, just to give you a chance to decide upon the particular type of fixture or fixtures which you wish to have installed in your new home.

Did you ever have the experience of selecting at an electrical supply store a portable lamp, wall bracket, or ceiling lamp which seemed to you to be just the thing, and then, when it was in your home finding that it didn't seem to fit in with the general scheme you were trying to carry out—and you were disappointed?

Experiences such as this have come to most of us, and consequently these elaborate rooms were fitted out with the object of enabling the buyer to select intelligently, from a great number of original designs, pieces most desirable for special conditions.

The rooms are three in number, located in the center of a large building and having no windows or other sources of external light. From a small general supply room in front you enter the first of the series, known as the Colonial Room, its finishings conforming in every respect to those in the interior of houses of the Colonial design. All around the walls are bracket lights, a shelf extending clear around supports portable table lamps, and the ceiling is hung with beautiful electroliers.



THE FRENCH ROOM

These lights are all wired and may be turned on and off singly, in groups or all at a time. If you are attracted by any particular design, for instance a beautiful little bracket lamp which you think you would

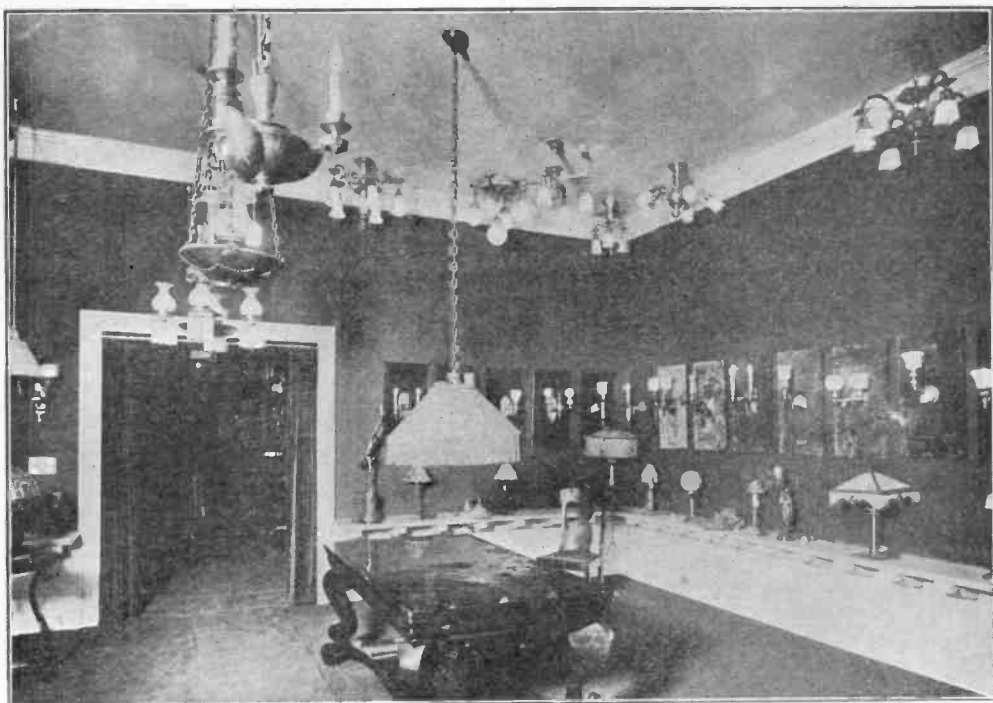

THE COLONIAL ROOM

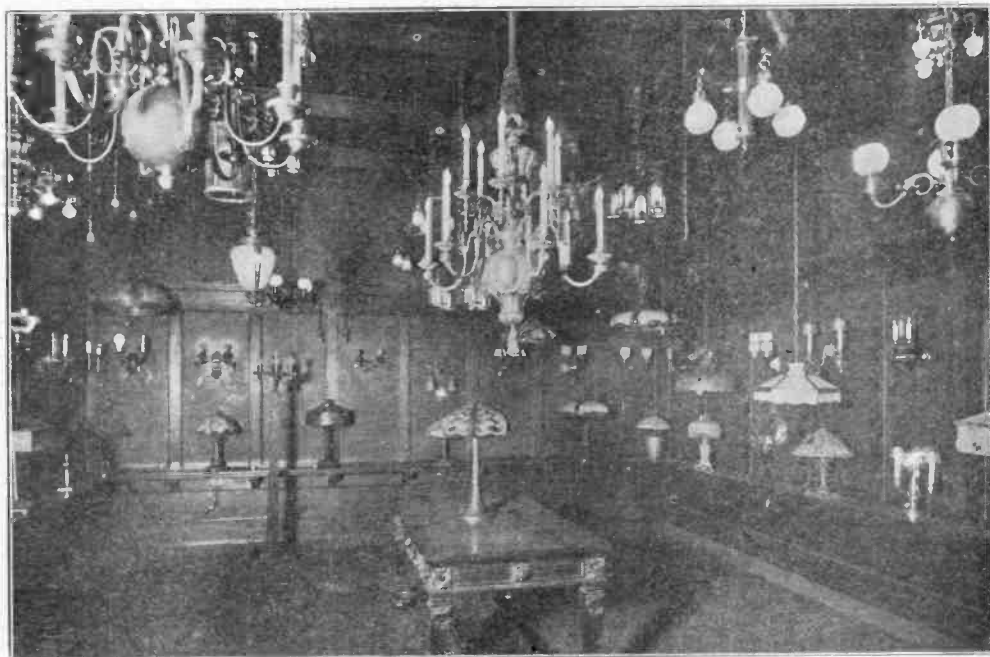

THE ENGLISH ROOM

like to secure for a secluded nook in your home: Presto! All the other lights are turned off, and there it burns just as you would see it in your own apartment without the disturbing influence of other lights. This, in short, is the beauty of the whole scheme. It enables you to select just what you want.

From the Colonial Room we enter the English Room with designs altogether different, to harmonize with that particular style of architecture. In the center of this room is a beautiful electrolier of plated silver, built at a cost of hundreds of dollars. Here as in the first instance, the unit feature has been carried out so that you can see any one of all the lights burning by itself.

Perhaps the finest room of all is the French Room, done off in beautiful brown wood with a finish of satin like fineness. The picture can convey to your mind but a very inadequate conception of the effects there obtained by the skillful arrangement of the electric lights in fixtures of surpassing beauty.

When all of the lights are turned on in all the rooms you wander around in a veritable fairyland.

The designs of fixtures displayed are all of them exclusive, which appeals to the average buyer. You will not find one of them displayed in any other store. If you buy one of the more elaborate pieces you may rest assured that not another one like it will be sold, at least within a radius covered by many states, while if it is one of the smaller pieces no one in your immediate neighborhood can obtain one at any price. There is a certain comfort in this.

Christmas Suggestions

"The twenty-fifth of December isn't so very far away. What are we going to get for Willie?" It isn't a bad idea to give the subject a little serious consideration right now. If the boy is a real live boy—which goes without saying—the chances are ten to one that he takes an interest, and a pretty lively one, in electricity. Likely as not he has been doing a little experimenting on the side, and perhaps you have been out of patience when you were tripped up in a coil of wire or had to sweep up bits of insulation from the floor after he had been at work.

Now why not encourage him if he has an inclination in this direction? It isn't likely that he is a sprouting Edison, but still he may

have the making of a mighty good electrical engineer. So if he wants to telegraph to his chum across the street, or across the city by wireless; if he wants to have motors and batteries and dynamos around, why not get him something of this sort for Christmas?

It is so easy to go to a department store now-a-days and get these very things or select from a dealer's catalogue. There are miniature trains driven by real electric locomotives; electric trolley cars; induction coil outfits which will amuse a half a dozen boys at once; telegraph instruments for amateur lines; wireless telegraph sets, both sending and receiving and complete in all their details; complete experimental outfits containing batteries, small dynamos, motors, wire, miniature lamps and a hundred other things.

These devices are no more expensive than other varieties of toys and are far more amusing and instructive for a boy who is naturally of a scientific turn of mind.

Electricity, the Busiest Worker

If an electrically operated washing machine is possible why not an electric ice-cream freezer, meat chopper, silverware polisher, grindstone, churn; in fact, why cannot all the heavy household tasks be performed in the same manner? Those of you who are not thoroughly posted on what electricity can do in the home would be surprised if you could but know of all the labor saving devices that have come into use even in the last year or two.

"What won't they think of next?" you say, and it does indeed seem that manufacturers are trying to outdo each other to see which can think up and execute the greatest number of new ideas in this line.

One maker of washing machines was early in the field with an electric motor driven machine, the motor being installed under the frame of the machine out of harm's way. Of course that tiresome backache producer—the wringer—by the aid of a little simple gearing was soon made to feel the magic touch of the spirit that lives in the wires, and inspired the proud designer to say that electricity now "does everything but hang out the clothes."

But the designer wasn't content to rest upon this achievement. He saw other things about the house that might just as well be run by electric current and only sought for some plan to apply the power of

the motor already made necessary for the washer. It wasn't long in coming and he called it the universal rod. This simple affair is

they are higher or lower than the shaft of the drive wheel.

In one of the illustrations you may see the washing machine and motor

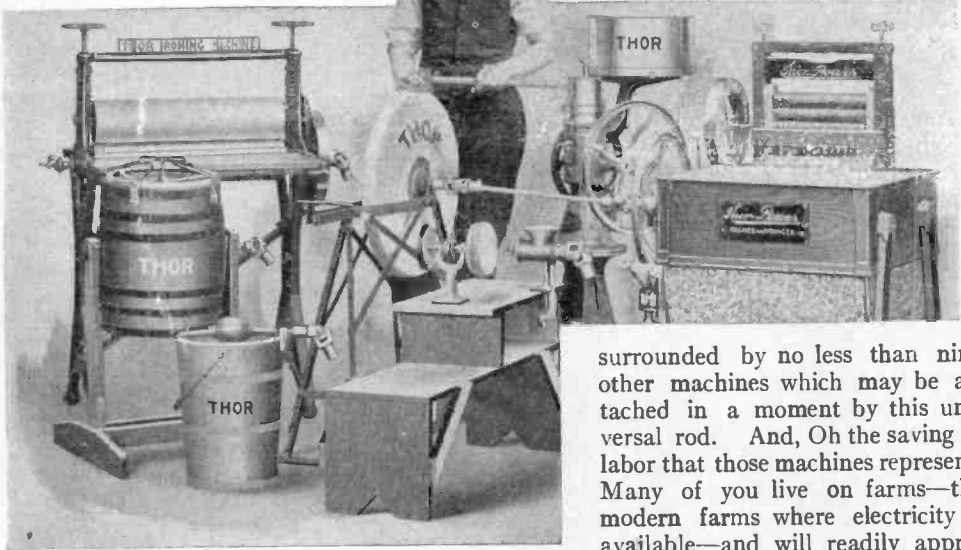

surrounded by no less than nine other machines which may be attached in a moment by this universal rod. And, Oh the saving in labor that those machines represent. Many of you live on farms—the modern farms where electricity is available—and will readily appreciate

nothing more than two “universal joints” and a connecting rod. Now you don't need to know what a “universal joint” is if you don't wish to. Suffice it to say that it permits the drive wheel on the washer to operate other machines even if

the adaptation of electric drive to such tasks as churning, separating cream, grinding tools, etc.

The other illustration is a view in a family laundry equipped with the “Thor” machine as it is called, and which operates, in addi-

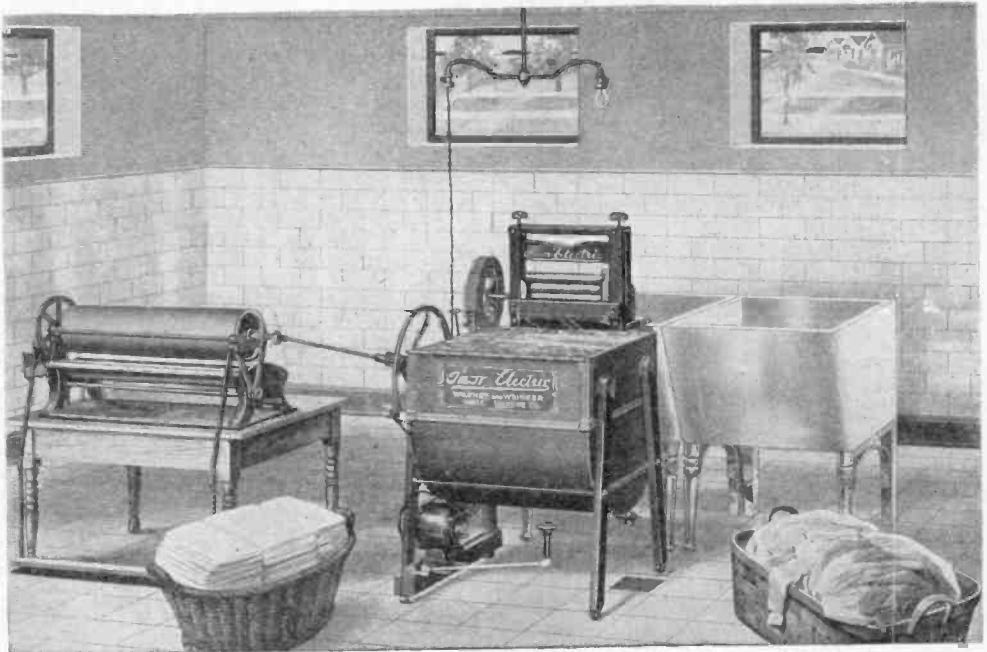

tion to the washer and wringer, an electric ironing machine.

In these cases electricity is the busiest worker in the house, being at once wash-woman, house-maid, laundress and man-of-all-work, all in one.

Electric Hair Drier

And now we have the electric hair drier which is almost a blessing in view of the ease and quickness with which a one-time tedious operation may be performed. No need now to sit in the sun for an hour

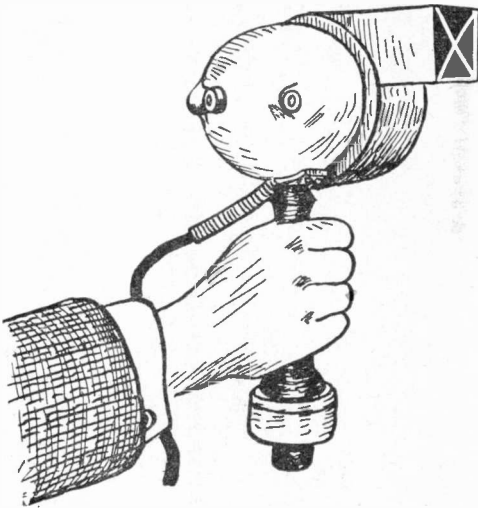

ELECTRIC HAIR DRIER

combing and brushing. This may be a pleasant diversion at times but then again one may be in a hurry, and nothing dries more slowly than the hair when one has no time to waste.

An electric drier is used to drive a current of heated air through the hair. It consists of a small enclosed electric fan, held by a convenient handle in the lower end of which is a snapswitch for turning on and off the electric current. As the fan revolves it draws air in through holes in the casing and throws out a powerful blast from the nozzle-like opening. The air before it leaves the casing is also heated by a small heating coil on the order of the heating units of electric flat irons.

A sketch of one of these fans is shown. The blower case is made of an aluminum casting—light and very neat in appearance. The motor is a high grade machine adapted to operate on either alternating or direct current.

Don't Fear Electricity

To some women the very word "electricity" conjures up visions of a deadly something which lurks in the wires, and contact with which is a constant menace to safety. Fortunately this false notion is rapidly becoming eradicated as people in every walk of life are becoming more familiar with and dependent upon this form of energy. There are still some nervous ones, however, who, though they envy their sisters the comforts and conveniences which only an electrically equipped home can offer are still a little afraid to work around "those dangerous switches and things" as they express it.

Now as a matter of fact electricity in the home is far safer to have around than gas or other forms of fuel. You are in infinitely more danger of injury when you hoist a bucket of coal to the top hopper of a coal stove or touch a match to the jet of a gasolene stove.

The reasons why electricity is safe are two in number—and very good ones. First, it is next to an impossibility to come in contact with it and second, if you did it wouldn't hurt you.

Current which is brought into our homes is at a pressure or potential of 110 volts, which is harmless. There are a very few somewhat hazy records of death resulting from 110 volt current where the victims were in conditions particularly favorable, as in electroplating rooms where the floors and the inmates were soaked in conducting solutions. But even these records are much like the stories of raining frogs—somebody else said so.

The common way for an electrician to test a lamp socket to see whether it is alive is to touch the tip of his finger to the two terminals. While it is not advised that this experiment be performed, as the sensation is somewhat unpleasant, still it shows that there is nothing to be really feared.

But as noted above it is practically impossible to come in contact with "live" parts unless you take something apart in order to do it. Wires from the outside are carefully conducted through the building in iron pipe conduits and are covered with insulation. They are brought to outlets or to lamp sockets. Insulated conductors lead from these outlets or sockets to your cooking utensils, flat irons, vacuum cleaners, etc. The plugs which are on these conductor

cords to connect them with the utensils have rubber handles. The contacts in the switches are carefully enclosed. In fact the same precautions are used as if you were really dealing with something dangerous. Therefore, what have you to fear—not a thing.

Shaving Mirror

Morning or evening is generally the time when the man of the house makes the announcement: "Guess I'll take a shave." All the electric bulbs in the room are turned on and even the gas jets are resorted to, but

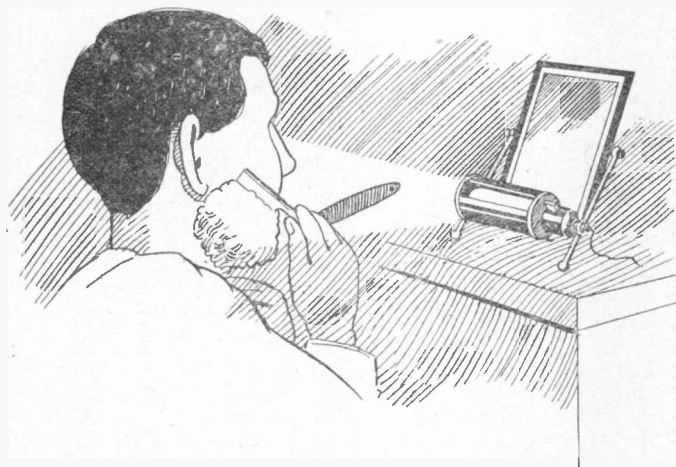

SHAVING MIRROR

the cumulative effect of all these light sources seems only to accentuate the shadow on the side of his face which is away from the light, and bitterly he talks to himself as he scrapes this dark side with trembling hand.

Some say that the new electric mirror makes shaving a pleasure. Perhaps that is a trifle overdrawn but it certainly does make it a safer and more rapid operation. As seen in the sketch this device consists of a portable mirror on the base of which is mounted a long tubular incandescent lamp enclosed in a cylindrical casing which constitutes the reflector. A small section of the casing is open through which the light rays are emitted. The casing can be revolved so that the light from the opening will fall on the lower part of the face and not in the eyes. A lamp cord to the nearest socket completes the apparatus.

But the man needn't think for a minute that he is going to have the exclusive use

of the mirror. It will be found a fair share of the time on his wife's dressing table where its usefulness—for other purposes—will be just as fully appreciated.

The Electrical Home to Be

For electricity there is a vast and wonderful future. Before my mind's eye appears a panoramic view of the human race; its sorrows and its joys controlled by electricity, its pains alleviated, its life prolonged, and the burdens of the workaday world borne by this wonderful and apparently abstract quantity. What we see with the eye is not electricity itself, but effects of which it is the direct cause.

These thoughts found me in an impressive mood. I was visiting the beautiful grounds and buildings of the Alaska-Yukon-Pacific Exposition and I could not but wonder to myself, as I gazed inspired at the beautiful illuminations, if electricity were not some day to become the ruling force in this world of ours.

The kitchen department was naturally to me of particular interest. In passing through it we realize what electricity is doing for the

feminine sex, for despite the fact that women are claiming a place in the commercial and political world, they are still more or less slaves to the kitchen by choice or compulsion.

Let us live and revel in the belief that the time is rapidly approaching when all household requisites shall move to and from us by the mere touching of a button; when we may sit comfortably at the table while the different courses glide noiselessly in and out, controlled by a switchboard attached to our dining table, and discarded plates will remove themselves, and in fact everything will move in perfect harmony. In those days our table conversation will not require to be regulated according to the gossiping capabilities of the dining room girl. It may even be that at some future time our emotions may be lessened or intensified by means of electricity, according to our desires and the resisting power of the will be backed up by so many volts.—MARGARET I. MACDONALD.

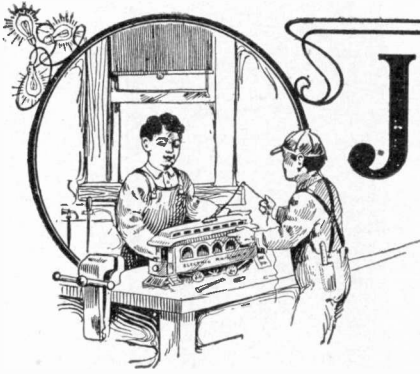

JUNIOR SECTION

Some Simple Telegraph Circuits

From time to time the readers of Popular Electricity who are interested in amateur telegraphy have sent in descriptions and diagrams of the circuits which they use, some of which are printed below for the

benefit of others who are experimenting along this line. sounder connected to the line through a double pole, single throw switch, a battery being also located at each station. The call bell at each station is then connected across the line together with a switch. The push button at each station for ringing the other station is connected around the double pole switch as shown.

The double pole switch is normally left open and the switch in the bell circuit is closed. The line is then in a position for signaling. When operating, the double pole switch is closed and the bell switch opened.

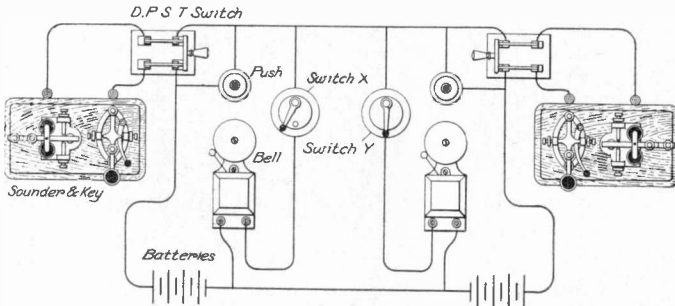

FIG. 1. CIRCUIT WITH CALL BELL SIGNAL

benefit of others who are experimenting along this line.

CALL BELL CIRCUIT

A circuit by which the call signaling is done by electric bells is shown in Fig. 1. At each station is the ordinary key and

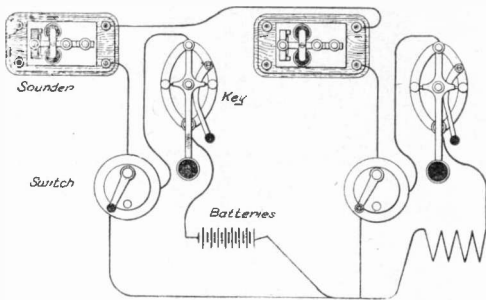

FIG. 2. OPEN CIRCUIT SET

OPEN CIRCUIT LINES

Fig. 2 shows a form of open circuit telegraph line which is very easy to construct. In this case it is imperative that a battery be located at each station as shown. The switch at each station is normally left so

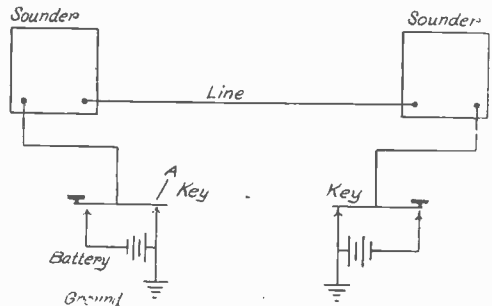

FIG. 3. OPEN CIRCUIT SET

that key and battery are cut out. When one operator wishes to call the other he throws his switch over to the other point, as shown on the diagram, which places his key and battery on the line in series with his

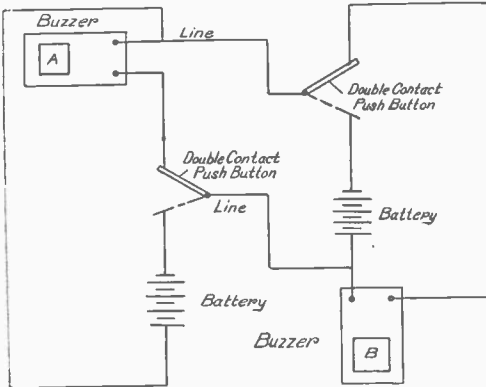

FIG. 4. BUZZER TELEGRAPH

sounder, and he is able to signal the other operator whose sounder is normally in circuit. The other operator in signaling does likewise.

Another type of open circuit telegraph is shown in Fig. 3. For this equipment there is required a regular sounder and key at

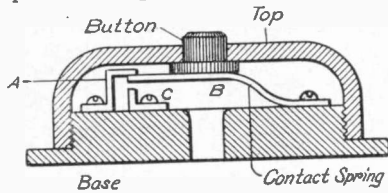

FIG. 5. DOUBLE CONTACT PUSH BUTTON

each station. The sounder should be wound to about 20 ohms resistance for lines over a few hundred feet.

On the back of the key at (A) in the diagram put a strip of brass (insulated from the base) in such a way that the set screw on the lever will touch it when not in use. Connect the strip through the ground in the case of a grounded line, or in the case of an all metallic line, with the second wire.

Connect the binding post or leg which connects with the frame to the binding post of the sounder, as indicated. Run the line wire to the other post of the sounder. Then connect the other post of the key to the battery, and from thence to the ground.

Strictly speaking, this is a closed circuit system, although the battery is not normally on the line.

BUZZER TELEGRAPH

A suggestion for a buzzer telegraph is shown in Fig. 4. It makes use of two line wires and double contact push buttons, a detail of the latter being shown in Fig. 5.

One of Faraday's Original Experiments

In following out the experiments outlined in Popular Electricity, I have noticed that the more classical experiments are for the most part omitted. In the September issue a picture of Michael Faraday brought back to my mind a number of his original

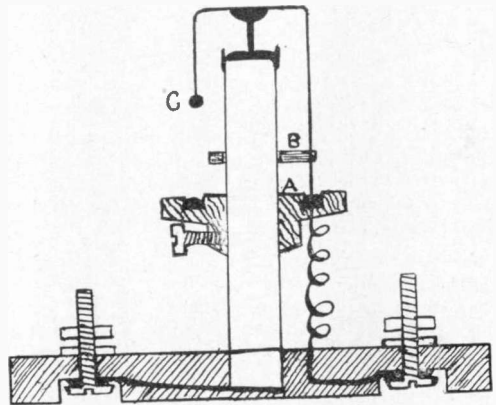

A CRUDE FORM OF MOTOR

experiments. One of his most interesting experiments can be carried out by means of the apparatus described below.

Obtain a bar magnet about six inches long and one quarter of an inch in diameter. Mount the magnet in a hole drilled in a suitable hardwood board. Solder a wire to the lower part of the magnet and connect to an old battery binding post. Around the top of the magnet glue a narrow piece of black paper to form a mercury cup. Turn another cup of the form shown in cross section at (A). This is best made of hard rubber though either vulcanized fiber or a piece of close grained wood will do. Drill a hole through the centre of the cup so that it fits the magnet closely. A set screw may be added which will greatly aid adjustment. Connect the bottom of the cup to a binding post as shown.

The revolving part of this instrument is made out of a piece of hard brass wire. Take a piece of No. 18 wire about six inches long

and two inches from one end solder the point of a needle. Bend the wire as shown and pass through a thin, hard rubber guide ring (B), which fits the magnet rather loosely. A counter-balance (C) will also be needed. Adjust this so that the ring does not touch the magnet.

Fill both mercury cups with pure mercury, first amalgamating all conducting surfaces.

Adjust the large cup till the brass wire just touches the surface of the mercury and then attach a dry battery to the terminals. If the instrument is properly adjusted the wire will revolve with considerable speed. The direction of rotation may be changed by reversing the current. This instrument aptly illustrates the principle of the direct current motor.—Gordon O. Philp.

Transformed Lighting Current for Small Motors

By LOUIS H. ROLLER

Every year there are many boys who get toy motors or miniature electric railways as Christmas gifts, and these are usually operated by dry batteries. The boy soon finds that dry batteries are not to be depended upon for motor work, and naturally seeks some other source of power. If alternating current is used in lighting his home he may transform it to a potential or voltage suitable for his motor, and thus obtain a cheap, steady, convenient, safe and flexible source of power. The small transformers described in the September, 1909, issue (page 331), may be used for this purpose, a potential of twenty volts having been found most satisfactory for railway operation. An equipment for controlling the current to and from the transformer is here described.

are nailed to the inside of the box, just above the transformer, and on these are supported the asbestos covered wood girders, (G) and (G'), to which the ends of the resist-

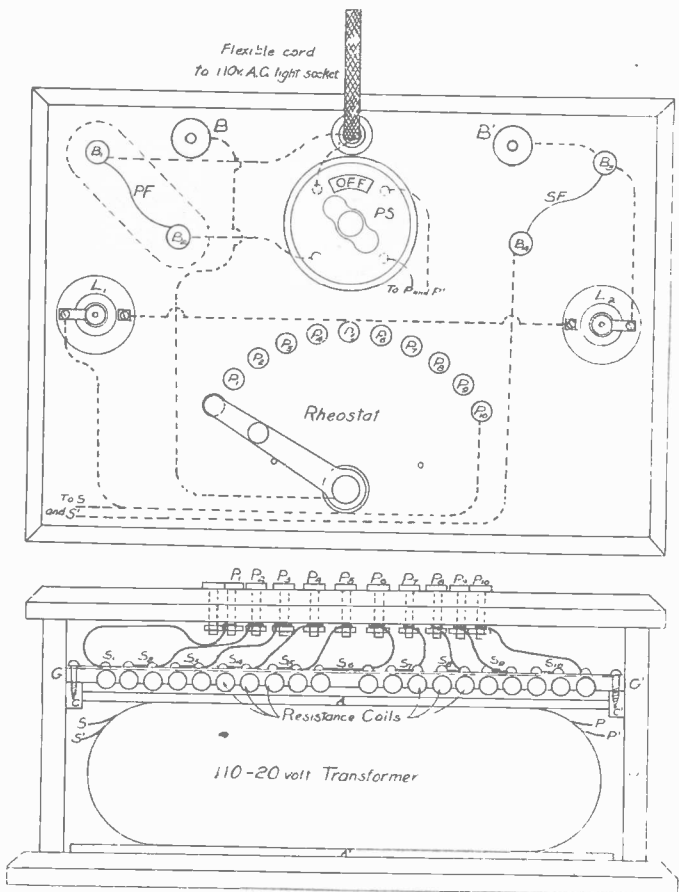

FIG. 1. PLAN AND SIDE VIEW OF CURRENT CONTROLLER

Fig. 1, shows a plan and side elevation of the apparatus. A hardwood box is used as a container, and the transformer is placed in the bottom, with asbestos boards, (A) and (A'), above and below it, and asbestos sheet rammed around it, making it tight in the box. Two cleats, (C) and (C'),

ance coils are then firmly and rigidly screwed.

The cover of the box is used as a switch-board, and contains a double pole snap switch, (PS), four small binding posts, (B₁, B₂, B₃, B₄), two large binding posts, (B) and (B'), two miniature lamp sockets,

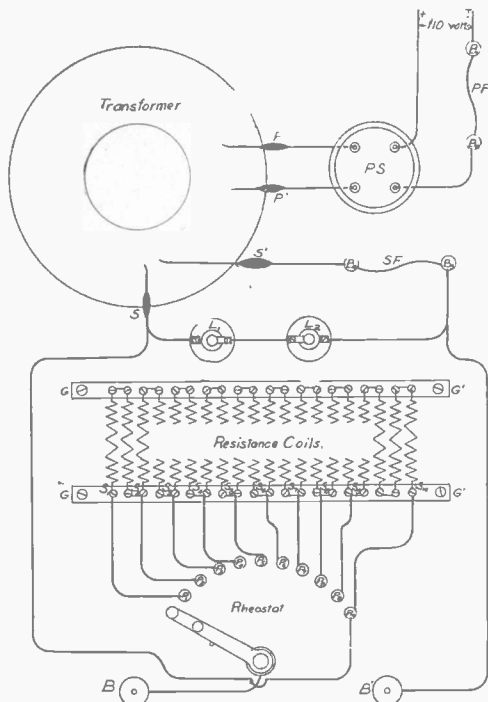

FIG. 2. CONNECTIONS OF CURRENT CONTROLLER

(L₁) and (L₂), and a rheostat with eleven points, (P₁-P₁₀). Fig. 1 is not intended as a detail or working drawing, but is used simply to give the amateur a general idea of what is necessary.

Fig. 2 shows the connections of this apparatus. The master switch, (PS), is used to turn the current to the transformer on or off. (B₁) and (B₂) hold the primary fuse, (PF), which will blow if a short-circuit occurs in the transformer or the switch.

(B₃) and (B₄) hold the secondary fuse, (SF), which protects the rheostat, motor, and wiring from short-circuits or heavy overloads. The girders, (G) (G'), are covered with asbestos sheet to prevent their burning in case the resistance coils get very hot, and the transformer is surrounded with asbestos so that it will not set fire to the box if it should burn out because of some defect in construction. The dotted line around (PF), (Fig. 1), represents a piece of asbestos on the under side of the cover to protect (B₁) and (B₂) from accidental contact with the wires to rheostat. Two 10 volt lamps are put in the sockets, (L₁) and (L₂), and by lighting up, they show that the transformer and fuses are all right, and that a current of 20 volts pressure may be taken from the binding posts (B) and (B'). This current, coming through the rheostat, may be regulated, thus giving various speeds to the motor. The resistance coils may be made of the same wire as that used in the transformer core, namely, soft iron; the length of wire to use cannot be specified here, since it varies with the size of motor and the gauge of wire, and is best determined by experiment.

To give ample protection the primary fuse, (PF), must be two ampere fuse wire, while the secondary fuse wire may be of any capacity from five to ten amperes. If a fuse melts, the current to the box must be shut off, the cause of its melting ascertained, and the trouble remedied before the fuse is replaced. In railway work the secondary fuse may often blow because of accidental "shorts" on the track due to the car jumping off at a switch or crossing.

The cost of current for thus operating a small motor does not exceed a cent or two an hour.

The amateur had best keep in mind that he is now working with *power*, and that loose connections and "shorts" must be carefully avoided; this is best done by soldering and taping all joints, and using well-insulated wires.



How to Make A Direct Current Dynamo

By C. S. NEWCOMB

In the design of this machine it is intended to do away as far as possible with all patterns and molding, but it is assumed that the maker has access to a turning lathe and ordinary machine shop tools.

The field magnet (A) (Fig. 1) is made out of a good piece of soft iron 1 by 2 by 17

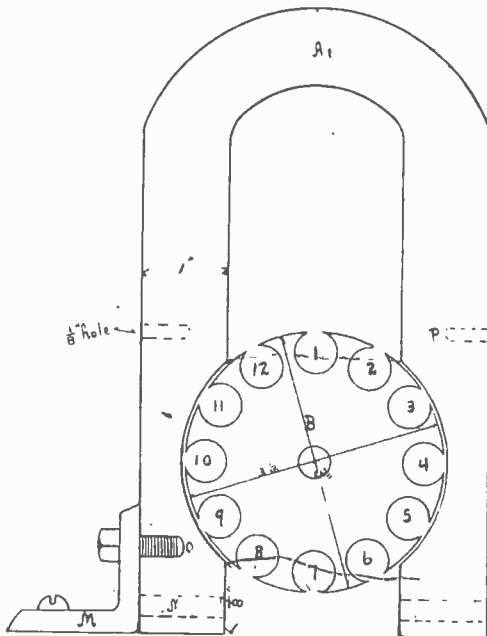

FIG. 1. FIELD MAGNET

inches, bent while red hot in the shape as shown, after which it should be carefully annealed, and then smoothed up clean on a flat emery wheel. Next bore a $\frac{1}{4}$ inch hole in the toe as shown at (N) through both limbs. The hole (O) should be bored and

should be two inches. Finally the field should be cored out on a lathe, leaving the channel exactly $3 \frac{1}{16}$ inches in diameter for the armature to run in. Shaft (D) (Fig. 2) is made out of a piece of $\frac{3}{4}$ inch cold rolled steel, the dimensions being as shown, and a thin nut to go on the threaded part can be made by splitting an ordinary nut with a hacksaw and smoothing it up with a file.

The armature core is known as the laminated type; that is, it is made up of thin sheets of soft iron, three inches in diameter. An end view of the armature core as it rests between the pole pieces is seen in Fig. 1, the slots for the wires being of the shape shown. Now it is not an easy matter to

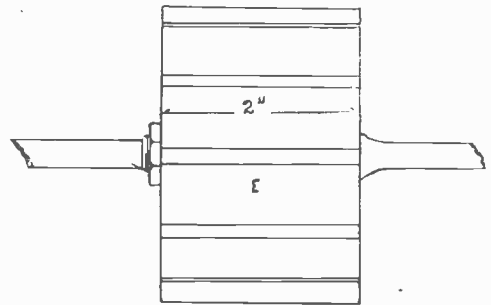

FIG. 3. ARMATURE CORE

cut or stamp out these thin sheets as there are quite a number of them. It is better to buy them outright from a manufacturer.

Whether you buy the armature stampings or make them, they should be given a thin coat of shellac on one side only, before assembling on the armature shaft.

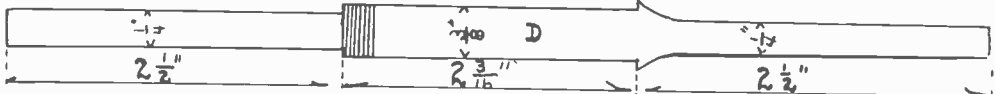

FIG. 2. ARMATURE SHAFT

tapped out $\frac{1}{4}$ inch, this should be done on both sides although in the diagram it is shown on one side only. Also bore the $\frac{1}{8}$ inch holes on each side shown at (P); these holes need not be drilled through but should be drilled deep enough to hold a pin which will be driven in later to hold up the field coils. The distance between the limbs

Assemble the laminations on the shaft as shown in Fig. 3, making the core two inches long; they are held up close together by the nut on the thread portion of the shaft. After this the slots should be covered with a silk dipped in shellac, and the core ends and the shaft carefully covered with the same material and allowed to dry.

The ends of the slots, moreover, should be slightly enlarged and all sharp places in the slots removed before putting on the silk.

The bearings (G) (Fig. 4) are made by cutting a mold out of a $\frac{3}{4}$ inch board, as shown, without the holes. This is then

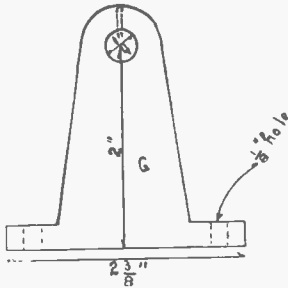

FIG. 4. BEARING

laid on a smooth, flat piece of iron and securely clamped down and run full of babbitt metal, after which the $\frac{1}{4}$ inch hole and the $\frac{1}{8}$ inch holes should be bored. A small oil hole should also be bored in the top.

The commutator (Fig. 5) which is usually the hardest part of the machine to construct, is very simple in principle and is made out of a piece of two inch brass seamless pipe one inch long which should be perfectly round and smooth inside and out. A piece of good hardwood, well seasoned, is then secured. This is made one inch long, with a hole in the center. It is forced upon the

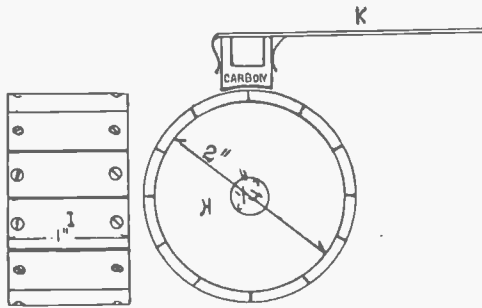

FIG. 5. COMMUTATOR AND BRUSH

shaft and trued up in the lathe until the brass cylinder makes a good snug fit. Then the brass cylinder is fitted on, first giving the wood a coat of shellac. Then inscribe on the surface of the cylinder 12 equidistant lines parallel to the shaft. Drill between the lines small holes as shown in Fig. 5, the outside end holes being countersunk. Small flat headed screws are set in the outer end. The end next to the armature core should

have round headed brass screws. These screws go through into the wood core.

Then the metal along the lines should be cut out with a hack saw, clear through to the wood core, being careful to not leave any material between the cuts. The screws should not under any circumstances touch the shaft in the center of the wood core.

Brush holders (K) may be made out of thin spring brass or phosphor bronze as shown in Fig. 5, with two small holes in the end, and the lips bent to hold the carbon brushes as shown. They should be fastened to the block (C) (Fig. 6) at the ends, and this block is fastened to the base with screws.

The armature is wound with No. 16 B. & S. gauge double cotton covered wire. To

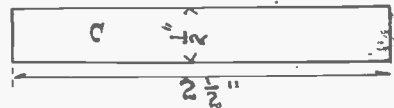

FIG. 6. BRUSH SUPPORT

wind this armature commence in slot No. 1 leaving about three inches of wire projecting out towards the commutator. Wind through slot No. 1 back through slot No. 7 until you have 12 layers in each slot. Then twist up a loop about three inches long and commence in slot No. 2 and back through slot No. 8, and so on. After winding slots Nos. 6 and 12 in this manner there will be 12 layers in each slot. Then continue in the same manner putting 12 layers more in all the slots over the 12 just wound.

To connect to the commutator in each instance the end of the first coil is connected to the beginning of the next throughout and these junctions carried to the corresponding round headed screws on the commutator.

Field coils should be wound with two pounds of No. 22 single silk covered magnet wire wound on a form which should be slightly larger all round than the magnet yoke, and two inches long. This will give about 700 turns or one pound to each coil. It will be well to wind the form with thick paper before commencing to wind the coil and to give each layer a coat of shellac and allow to dry before putting on the next. When the end is reached carefully tape and cover the coil with a layer of paper and then wind on one layer or 20 turns of No. 11 double cotton covered magnet wire for the series coil. When dry remove and tape the coil, slip it onto the magnet and drive in the

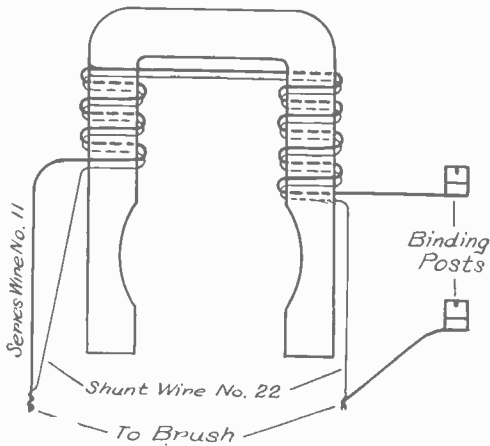

FIG. 7. FIELD WINDINGS

pin in the $\frac{1}{8}$ inch hole, to hold in place. The next coil is wound in the same manner.

Connect the outside end of one of the No. 22 coils to the left hand brush and the inner end

of this coil to the beginning of the other No. 22 coil. The opposite end of the latter coil is then connected to the right hand brush. The No. 11 left hand coil has the beginning end connected to the left hand brush and the other end to the beginning of the second No. 11 coil, the opposite terminal of the latter going direct to the line on the same side; that is, the series coil is in series with brush and one side of the line. This is made clear in Fig. 7.

The machine should be run at least 1500 revolutions per minute, and if the voltage is not enough increase the speed. To get the best voltage control it is recommended that a rheostat be cut in on the shunt wires, when if the power is constant the voltage can be regulated very closely. This machine has a capacity of 10 amperes but loads of 15 would not be safe for a long time as the machine is considerably overloaded at this amperage and would possibly get hot enough to ruin the armature windings.

Does Lightning Strike Twice in the Same Place?



The above question is graphically answered by the two excellent lightning photographs reproduced herewith. The photographs were taken by Charles F. Brooks and Frederick A. Brooks, sons of Morgan Brooks, who is Professor of Electrical Engineering at the University of Illinois.

The scene is on the shores of Lake Minnetonka near Minneapolis, Minn., the distant shore being within the limits of the village of Wayzata. The tree outlines were produced entirely from the brilliant flashes, which are also seen reflected in the water

One of the photographs was taken at about 5 a. m. of August 17th, while the second and more brilliant picture was secured about midnight, five days later. As seen in these pictures the flashes are in exactly the same place relative to the surrounding scenery; that is, as far as can be observed from one point. It is possible, of course, that one flash may have been further away from the camera than the other, but it is altogether more probable that the two flashes struck the same tree, or whatever the prominent point may have been.

QUESTIONS AND ANSWERS

Readers of Popular Electricity are invited to make use of this department. State your questions as clearly and concisely as possible. No consideration will be given to communications which do not contain the full name and address of the writer

Direct Current Generator as Alternating Current Motor

Question.—Could a 4-pole compound wound direct current generator be used as an alternating current 110 volt, 60 cycle motor without rewinding?—N. S. G., Sumpter, Ore.

Answer.—No.

High Frequency Current in Therapeutics

Question.—I am building a 12-inch induction coil and would like to know if the current from this coil can be converted into high frequency so that it may be used as a therapeutic agent. I understand that this can be done by means of a Tesla coil. If this is so, what would be the dimensions of such a coil?—C. L., Minneapolis, Minn.

Answer.—Form a hollow cylinder of dry birchwood 10 inches in diameter and 22 inches long. On one end of this cylinder

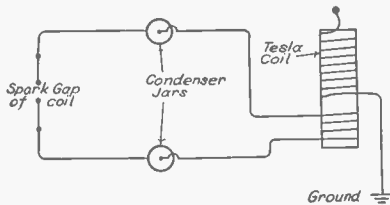

HIGH FREQUENCY APPARATUS

wind the primary, consisting of a single layer of 22 turns of No. 14 rubber-covered single-braid wire, such as is used in wiring. The ends of this wire are connected to two binding posts but not connected to the secondary in any way. The remainder of the cylinder, starting one inch from the primary, is wound with No. 19 rubber covered fixture wire in a single layer. The end of the wire near the primary is the end to be grounded, the other is connected to a terminal on the top of the cylinder, to which the electric appliances are connected. The condenser jars should be 12 inches high and about four inches in diameter, with tinfoil eight inches up from the bottom, inside and out. Connect to the coil as per diagram

Generators in Series

Question.—Please explain how to connect two generators in series, giving additional necessary information.—B. F. A., Nelsonville, Ohio.

Answer.—Generators are used in series on arc circuits and as boosters. To connect machines in series, the positive terminal of one must be connected to the negative

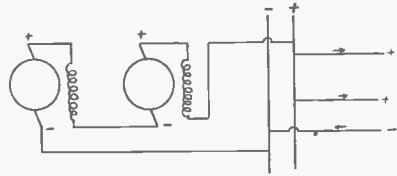

GENERATORS IN SERIES

terminal of the next, as shown in Fig. 1. Each machine must have a current capacity equal to the maximum current on the circuit, but they may differ as to voltage rating; that is, one machine may generate at 50 volts and the other at 450 volts. The voltages of the machines in series are added together, so that the danger to insulation is increased. Series wound dynamos have usually a regulator of some sort. These may not work together. If they do not, connect them so they must. As you do not state winding of your machines we would add that shunt dynamos run well where the field coils are connected to form one shunt across both machines. Again, on compound machines, both shunt coils may be connected so as to be supplied by one armature, the series coils being in the main circuit.

A common return may be used for both generators. In fact it may be connected to the negative bus bar.

Hydrogen Generator for Lead Burning

Question.—Explain the construction and operation of a hydrogen gas generator for lead burning.—W. S., Baltimore, Md.

Answer.—The gas generator used by the largest storage battery manufacturers is

constructed as shown in the accompanying cuts. It is simply two wooden boxes, lead lined, one above the other as shown in Fig. 1, and connected by a lead pipe running from the bottom of the upper box to near the bottom of the lower box. The lower box must be air tight except for the pipe opening

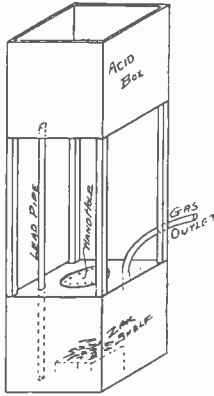

FIG. 1. HYDROGEN GENERATOR

and another pipe connection for the gas; it is also provided with a large hand hole made tight with a rubber gasket for cleaning and renewing. The upper box is open or partly open at the top. The boxes are generally of 3/4-inch wood about 18 inches square,

the top one about three feet above the other. You can make them of any convenient size and if you are not going to use them much you need not line them, but coat them when dry with a few good coats of rubber paint inside and out. Large glass flasks may be used to advantage instead of the boxes, as shown in Fig. 2. Two five gallon water bottles are sufficient. In operation a quantity of zinc is placed on a shelf in the lower box or in the lower bottle. The upper box is filled three-fourths full of sulphuric acid (H_2SO_4) diluted with twelve volumes of water and the stop cock opened to the burner. This allows the acid to run down in contact with the zinc, and hydrogen gas is generated. Care must be taken to get all the air out of the generator before the gas is lighted, or an explosion will follow. When the gas is shut off, the pressure forces the acid back to the upper box away from the zinc and stops the generator. The shelf keeps the zinc away from any little acid that remains below. The burner is clearly shown in Fig. 2 and may be constructed of brass tubing, or can be bought cheaply at any chemical house. You must have an air pressure to operate the burner successfully and this may be obtained from a bellows or similar arrangement, or, get a very large flask and fit up as shown, then allow water to run into it from a faucet and air will be forced out. There are many similar ingenious arrangements. This generator can be used where any pure hot flame is needed and leaving out the air may be used for filling toy ballons and similar devices.

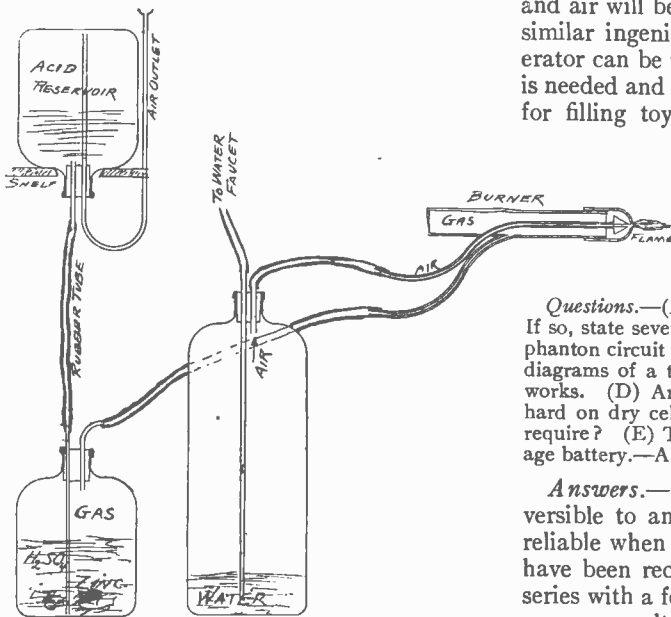

FIG. 2. HYDROGEN GENERATOR MADE FROM GLASS FLASKS

Recharging Dry Cells; Current Consumption of Battery Tungsten Lamps; Pocket Storage Battery

Questions.—(A) Can dry batteries be recharged? If so, state several ways. (B) Show and explain a phantom circuit on a telephone line. (C) Show the diagrams of a telephone pole changer and how it works. (D) Are the new battery tungsten lamps hard on dry cells and how much current do they require? (E) Tell me how to make a pocket storage battery.—A. A. R., Glasgow, Mo.

Answers.—(A) Dry batteries are not reversible to any efficient extent and are not reliable when recharged. "Dead" batteries have been recharged by connecting them in series with a four or eight candle power lamp on a 110-volt direct current for from 15 to 30 minutes, but, although some batteries thus recharged have been kept on heavy

service for a long time, other batteries similarly treated would not hold the charge. Care must be taken to connect the positive pole of the battery (carbon) to the positive wire. The positive wire may be determined by dipping the two wires in acidulated or salt water. The wire which gives off the most bubbles is negative.

(B) and (C) See October issue.

(D) Dry batteries are not designed for constant service and will run down quickly if used steadily on any lamp, but may be used intermittently with good results. The tungsten battery lamps require but $1\frac{1}{2}$ watts per candle. A one C. P. $1\frac{1}{2}$ -volt lamp would require about one ampere and would quickly run down the ordinary dry battery, but the one C. P. 6-volt lamp would require less than $\frac{1}{2}$ ampere, hence it is preferable to use higher voltage lamps. The same size carbon filament would require much more current.

(E) To answer this question would require too much space to be given in this department. An article on this subject is contemplated for a future issue.

Shunt and Compound Wound Generator

Questions.—(A) Assume a shunt-wound generator running under two-thirds load. Suppose the whole load to be suddenly removed without adjusting the rheostat. What would be the result? (B) Kindly answer the same question as to a compound wound machine.—E. D. B., Denver, Colo.

Answers.—(A) In a shunt-wound dynamo the field voltage decreases as the load comes on unless controlled by the rheostat. A sudden removal of the load would cause the voltage to rise, possibly burning out any lamps left on. The voltage rise would not harm the machine if the governor of the engine were properly adjusted.

(B) As the field excitation in a compound wound generator is made up of both a shunt and series winding, opening the external circuit would remove the effect of the series turns and lower the voltage.

Making a Voltmeter; Formula for Voltage; Lines of Force

Questions.—(A) In the September issue is described an ammeter operating on the principle of a solenoid. Can a voltmeter be made depending on the same principle. If so, what change is necessary? (B) Will you give a formula for voltage to be obtained from a dynamo, this formula to depend upon the number of active yards of wire on the armature. (C) How can the number of lines of force in the field of a four

pole dynamo be estimated, not knowing the exact quality of the iron in the poles and armature?—C. F. S., Jr., Brooklyn, N. Y.

Answers.—(A) The pull on the solenoid depends upon the number of ampere-turns in the coil. To use the instrument as a voltmeter it would be necessary, by Ohm's law $C = \frac{E}{R}$, to make the resistance (R) of the coil large enough so that when the terminals were placed across mains having a difference of potential E, that C would be sufficient to give a full scale deflection, where E is the maximum voltage which you wish to measure with the instrument.

(B) The E. M. F. in an armature is expressed by the formula.

$$E = \frac{P B Z S}{M \times 10^8 \times 60}$$

where P = the number of field magnet poles.

O = the total number of lines of force entering or leaving the armature at each pole piece.

Z = number of conductors on the armature.

S = R. P. M. of the armature.

M = number of paths or circuits through the armature.

$\frac{Z}{M}$ = average number of conductors in series on each path or coil.

The formula you ask for would be difficult to state for armatures of various dimensions, while the above rule holds for all armatures.

(C) Solve the above quotation for B after substituting the values of Z, S, M and P.

500-Volt Motor and Engine; Switchboard to Pass Inspection

Questions.—(A) I have a 500-volt, one H. P. A. C. motor. Would it be advisable to rewind the armature or build a transformer, as I desire to run the motor as a dynamo and wish to get 110 volts? (B) Will a $1\frac{1}{4}$ H. P. gasoline engine run the dynamo on an average load? (C) I am making a switchboard for a 110-volt system. Please tell me the rules to observe in order that it may pass inspection.—H. C. G., Haverhill, Mass.

Answers.—(A) We would advise that you build a one kilowatt transformer having a ratio of 5 to 1. The primary of such a transformer connected to your dynamo would carry about two amperes and the secondary slightly over eight. See "Construction of Ring and Core-Type Transformers" in September issue.

(B) Yes, but you may have to adjust the pulleys to get the proper speed on the dynamo.

(C) In answer to W. S. in the May, 1909, issue, connections and devices for a standard switchboard are shown. The panel should preferably be of slate or marble supported by metal brackets from the wall, or by angle iron posts from the floor, supports to be placed so as to give at least eighteen inches between the wall and apparatus on the board. The board should be built so that a space of at least ten or twelve inches is left between the floor and the board, except when the floor about the switchboard is of concrete or other fireproof construction, a space of three feet if possible being also provided between the top of the board and a combustible ceiling. The board should be located in a dry place. A main service switch and fuses equal to the rating of the dynamo must be provided. Provide a metal clad voltmeter and a ground detector, protecting these and pilot lights by standard fuses of not over six amperes capacity. This circuit should be wired with not less than No. 14 B. & S. gauge wire. All wires larger than No. 8. B. & S. gauge must be soldered into lugs for all terminal connections. Switches should be only such as are approved and noted in "List of Electrical Fittings" for use under the rules and requirements of the National Board of Fire Underwriters. Bus-bars of opposite polarity if mounted directly on the board must be spaced $\frac{3}{4}$ of an inch apart and where crossing in air $\frac{1}{2}$ an inch separation is permissible. The National Code urges "that greater distances be adopted wherever conditions will permit." A common error is that of placing grounded bolts of the supporting angle irons too close to live current carrying parts. The last rule quoted applies here also.

Annunciator Circuit

Question—I have a fifteen-drop annunciator. There are eighteen binding posts and two pushes at the bottom. Please give diagram illustrating the connections of same with bells, pushes, and battery. I think the annunciator is of French make.—L. B., W. Somerville, Mass.

Answer—We are not able to answer your question explicitly from information given, but give two diagrams, Figs. 1 and 2 in common use. Fig. 1 shows a battery wire (B) and return wire (R). (B) connects through the bell to the coil of each drop

From the other side of each coil a wire runs to a binding post, through a push button, thence to the return wire (R). Your drops on the annunciator may be arranged to ring the bell after the button is released and until the indicator is placed in position in which case another wire (S) common to one side of each coil would be necessary, the falling of the indicator shunting out the push button as shown in both figures, until the indicator is restored, and requiring an extra binding post. Another binding post may be provided to which bell wire may be connected if the bell is not on the annunciator. These hints may assist in determining the use of each binding post.

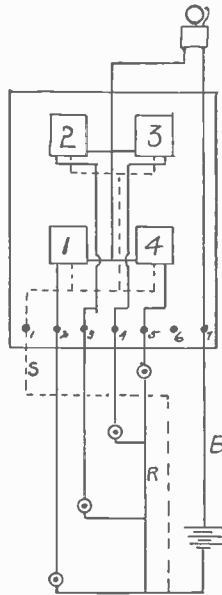

FIG. 1

annunciator. These hints may assist in determining the use of each binding post.

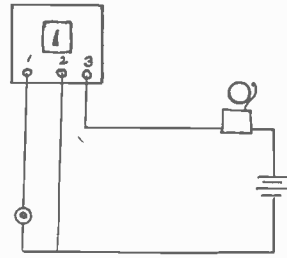

FIG. 2

Operation of a Manual Fire Alarm System

Question.—Please explain the operation of a fire alarm system. Why does the bell ring until the street box is set?—G. C., Denver, Colo.

Answer.—A fire alarm system may be divided into two parts: that inside a building, and consisting of manuals, local batteries, bells, testing apparatus, and an indicator on the outside telling firemen the floor where box is pulled; that outside, made up of the main alarm circuit, street signal boxes, and at the central office of a relay in each circuit, a register for each relay to make note on a tape of the signals, and an automatic signal repeater. One

feature carefully observed regarding city and building boxes is that they shall not be connected electrically, and yet be so arranged that "pulling" the building manual sends in the street box.

Fig. 1 shows the general plan of such an arrangement, (AB) being the fire manual in the building, and (STB) the street box.

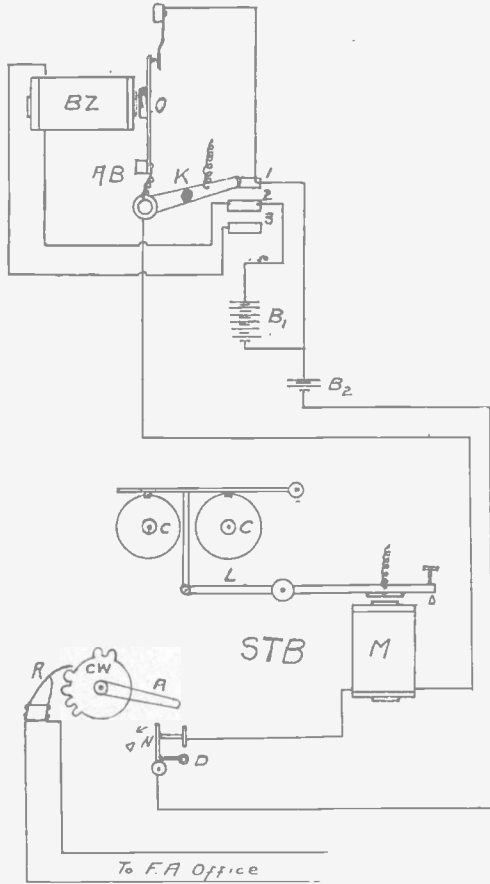

FIG. 1. GENERAL PLAN OF FIRE ALARM

The lever (K) on contact (1) cuts in battery (B₂) through (M), (B₂) not being sufficient to operate lever (L). In case of fire or test, (K) is pulled down to contact (2) which adds (B₁) to battery (B₂). This pulls the armature of (M) down, pushes (L) up and releases clock work (C) which turns contact wheel (CW), registering the number of the box as the circuit is broken and made at (R) by teeth on (CW). Immediately (K) is pulled from (2) to (3). This places battery on (BZ) which causes

armature (O) to be attracted until (A) on (CW) strikes (N) and opens the circuit held closed by counter weight (D). The operation of armature (O) is called the "answer back" signal and indicates that the street box has gone in.

Fig. 2 represents the same equipment as in Fig. 1 with some additions, such as a galvanometer (G), a testing switch (S), fire bell (F), cross relay (C), disturbance bell (D), and trip relay (T). This additional apparatus is usually located in the

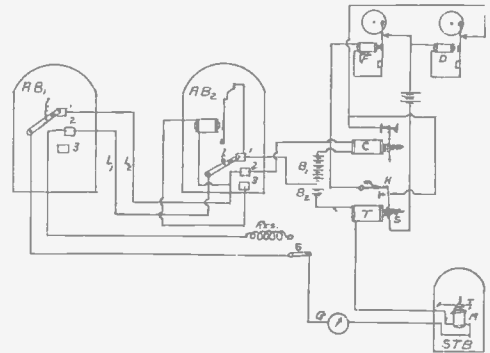

FIG. 2. FIRE ALARM CIRCUIT WITH ACCESSORIES

engine room, except the fire bells, which are placed on each floor. The circuit through the boxes (AB) to the street box (STB) is always closed through the battery (B₂). Now let us note the effect on the magnets of pulling a box. (C) and (T) are magnetized thus putting battery on (F) and (D), ringing the bells. Then the street box is opened at (N), Fig. 1, but armature of (T) has been pulled past the insulated end of spring (H) and locked, keeping (F) ringing, while (D) stops until a knob not shown is pushed, lifting (H) and allowing spring (S) to pull the armature of (T) back; but as the street box is still open, battery (B₂) is not in the circuit of (T) so its armature strikes the back contact and starts (D) again which rings until street box circuit is "set," when (B₂) pulls the armature up to (H).

If (L₁) and (L₂), Fig. 2, get "crossed," relay (C) is attracted and disturbance bell (D) rings. If either (L₁) or (L₂) opens, armature (T) falls back and (D) rings. The reading of (G) shows the general condition of (B₂) and the system. Closing (S) on (Res) tests (B).

Small Motor; Hydrometer

Questions.—(A) How can the motor described in the May, 1909, issue be made into a dynamo giving six volts and four amperes? (B) What is a hydrometer and how made?—F. N., Braintree, Mass.

Answers.—(A) Add a few more turns of wire to the armature coils and run at good speed.

(B) If a body floats in water without being wholly submerged, two forces act upon it—(1) the weight of the body; (2) the buoyancy of the water, which latter is equal to the weight of the water displaced. For example, ice floats in water with 0.918 of its bulk submerged. Water having 0.918 of the volume of a piece of ice weighs the same as the piece of ice; or, if the specific gravity of water be taken as one, the specific gravity of ice is 0.918. In place of a piece of ice, instruments called hydrometers are used to measure the density or gravity of various liquids as compared with water. The diagram shows one of these instruments,

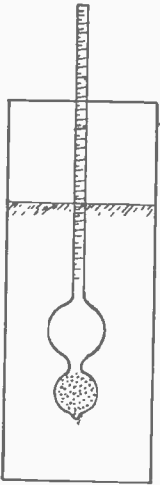

HYDROMETER

consisting of two glass bulbs, the upper terminating in a stem, while the lower bulb before being sealed is filled with shot to cause the instrument to float vertically. Mercury may be used in place of shot. Calibration may be made by placing another standard hydrometer in the liquid with the new one, marking the stem of the latter in accordance with what the standard instrument shows. A second method is to place the new instrument in water marking the point to which it sinks as 1. Place in other liquids of known specific gravity until sufficient points have been marked to give the range desired.

Three-way Switches; Equalizers

Questions.—(A) Please explain three-way switches. (B) Explain a balancing set used in a power house in connection with a three-wire system—a machine that boosts one side or the other according to requirement.—O. E. B., S. Omaha, Nebr.

Answers.—(A) See answer to W. W. H., February, 1909.

(B) In Fig. 1 (A) and (B) are two machines

running on the same shaft. When running as dynamos they generate a voltage of one-half that of the dynamo (D). They are called "equalizers" or compensators." If one side of the system is lightly loaded the machine on that side will run as a motor

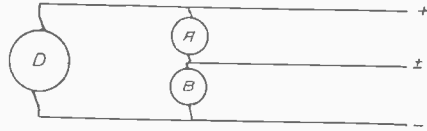

FIG. 1. EQUALIZERS IN CIRCUIT

driving the other as a dynamo. If the two sides are exactly balanced, both machines will run as motors not loaded, taking very little power. They require little attention and are automatic in their control.

Fig. 2 shows the same arrangement with a "booster" (C) added, and on the same shaft. The object of the booster is to raise the pressure in the positive wire to make

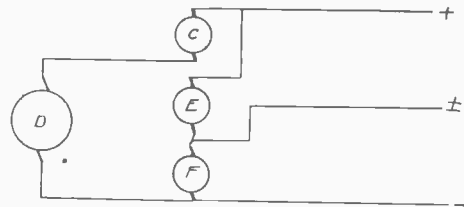

FIG. 2. EQUALIZERS AND BOOSTER IN CIRCUIT

up for some drop as in long transmission. Each of the machines may be excited by shunt windings connected to its own brushes, but a much better arrangement is to excite the field coils of all machines from the feeders coming from dynamo (D), which gives less liability of variation.

Winding a Telephone Generator Armature

Question.—Kindly explain how to wind a telephone generator.—J. B. T., Lincoln, Me.

Answer.—Wind the armature with No. 35 to No. 32 single silk covered wire. Wind the wire in the same direction on both sides of the armature. It will take from 1800 to 2300 turns of wire. Connect the ends of the wire to slip rings or to a single split commutator if pulsating current is desired. It is a good idea to bind the coils with a string to prevent them bulging when turning the generator and to saturate the coils with shellac for better insulation.

NEW ELECTRICAL INVENTIONS

Electric Water Gauge

The water gauge comprises a casing in communication with the boiler, and in the casing is located a float adapted to be raised and lowered by water admitted to the casing

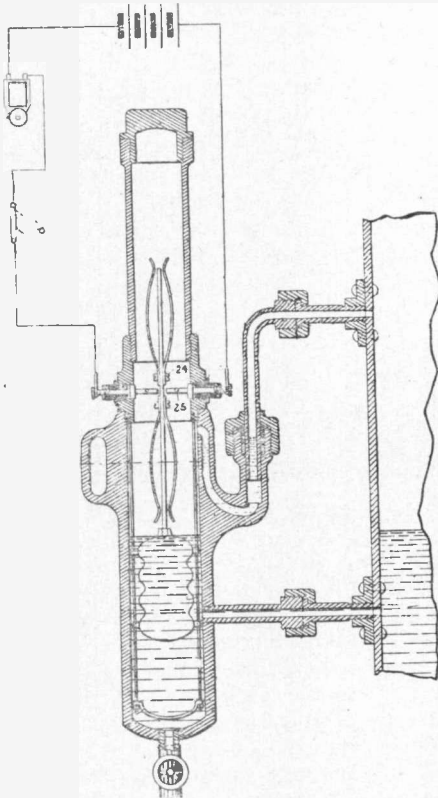

ELECTRIC WATER GAUGE

from the boiler. The casing is provided with electrodes and a circuit is established through electrodes by resilient contacts movable with the float of the gauge. Two alarms are sounded indicating high or low water, and these alarms are adapted to call the matter to the attention of an engineer in order that the supply water to the boiler can be discontinued or increased respectively. The inventor is J. Torok of Renvo, Pa.

Unique Incubator

This incubator is operated from the heat given off by a single incandescent lamp and is designed to be used for exhibit purposes, as the top is composed of a glass dome

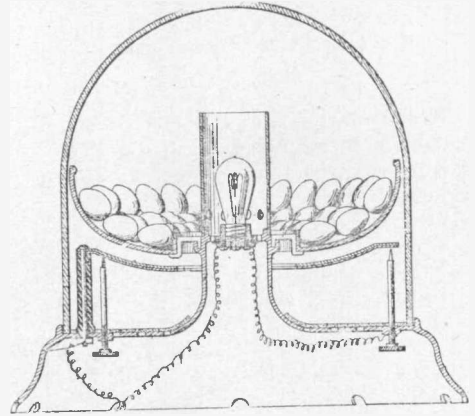

UNIQUE INCUBATOR

through which the eggs and chicks may be watched. It is provided with a thermostat arrangement which keeps the temperature at a constant value. A patent on the device has been granted to Frank C. Perkins and Clarence Z. Davis of Buffalo, N. Y.

Trolley Wheel

Dr. Frederick S. Yoder, a dentist of Eagle City, Pa., has patented a new type of trolley wheel which is to be given a practical test on the traction lines of that city. The device, which is slightly larger than the average wheel in use and has a double flange to provide against a tendency of the wheel to jump the wire against which it travels.

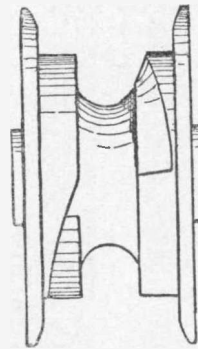

TROLLEY WHEEL

By this construction the tendency of the wheel to remain in contact with the wire is increased and maintained, as each quarter

turn of the wheel will present to the wire one of the tapered walls shown in the illustration.

Under all ordinary circumstances, the central groove will remain in contact with the wire, but should a jar or other cause occasion the wheel to be run in the reverse direction the tendency would be to ride up on the tapered walls, thus presenting the side or surfaces of greater diameter to the wire and holding it by the flange from jumping the cable.

Trolley Pole Guide

It is quite a trick under some conditions for the motorman on an electric car to restore the trolley wheel to the wire in case it accidentally runs off. To assist him to do

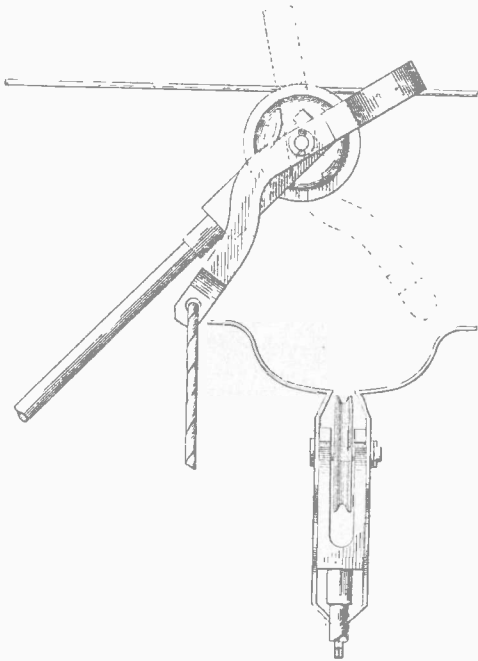

TROLLEY POLE GUIDE

this without delay the trolley pole guide here shown is proposed by James P. Brennan of Centralia, Pa. It consists of a sort of two-pronged fork pivoted on the trolley wheel shaft and manipulated by the cord as indicated in the diagram.

Electric Heater

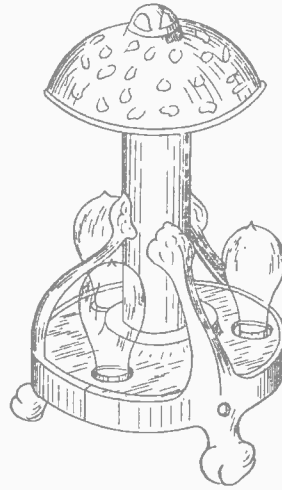

ELECTRIC HEATER

An electric heater of ornamental design is shown in the accompanying cut and is the invention of Frank Kuhn, Detroit, Mich. The heat is derived from incandescent electric lamps mounted in the base as shown. These lamps

are of a low efficiency as far as light is concerned but they give off a great deal of heat. This heat is reflected out in all directions by the polished metal standard and from the base.

BOOK REVIEWS



AUTOMOBILES. By Hugo Diemer, M. E. Chicago: American School of Correspondence. 1909. 186 pages, with 194 illustrations. Price \$1.50.

This book is designed to give to automobile owners or others interested in the science of automobiling, a general, clear idea as to the various parts which go to make up a self-propelled vehicle. It is of exceptional value to prospective chauffeurs or people driving their own cars, in that not only are all of the operating parts described with a view to their practical necessity and utility, but also with regard to the care and attention necessary in their proper use. The author divides the subject into its respective component divisions (the running gear, the power plant, and the body with its accessories) and then treats generally each part and the component elements which unite to form each division. The care and selection of cars occupies sufficient space to give this department its necessary attention. Gasoline and electric power plants are treated in such a way as to bring these subjects within the understanding of the student.

Notes on Patent Infringement

By OBED C. BILLMAN, LL. B., M. P. L.

Definition; Scope of Patent; What Constitutes Infringement

Definition.—In the sense of the patent law an infringement is a wrongful invasion of the exclusive rights secured to a patentee by his letters patent. It is the unauthorized making, or using, or vending to be used, of an invention protected by patent.—Black's Law Dict.; Bouvier's Law Dict.

Scope of Patent.—Claim: (a) Necessity and Purpose.—In the patent the inventor must particularly point out and distinctly claim the part, improvement, or combination which he claims as his invention.—U. S. Rev. Stat. Sec. 4888. The claim is the measure of the patentee's rights, and what is not claimed is not patented.—Pitts vs. Wemple, 1 Biss (U. S.) 87; Corn Planter Patent, 23 Wall (U. S.) 181; Brush Electric Co. 40 Fed. Rep. 834.

(b) Form and General Requisites.—No particular form is required in the claim. All that is necessary is for the inventor to claim specifically his invention in language sufficiently clear and certain to designate it completely and precisely.—Merrill vs. Yeomans 94 U. S. 568. The claim is part of the specification, and is to be inserted at the end just before the signature.—Wilson vs. Coon, 18 Blatchf. (U. S.) 532; 6 Fed. Rep. 611.

What Constitutes Infringement.—Elements and General Principles. (1) Knowledge or Intent of Infringer.—The general rule is that the motive or intent with which an act of infringement is committed is immaterial, and that a person may infringe a patent without even knowing of its existence.—Matthews v. Skates, 1 Fish Pat. Cas. 602, 16 Fed. Cas. No. 9,291.

(2) Use of Things not Claimed by Patent.—When the language of the specification and claim shows what the patentee desires to secure as a monopoly, nothing can be held an infringement that does not fall within the terms which he has thus chosen to express his invention.—Chemical Rubber Co. vs. Raymond Rubber Co., 68 Fed. Rep. 570. But an immaterial change made for the sole purpose of avoiding the exact wording of the claim will not avail to avoid infringement.—Westinghouse vs. Boyden Power Brake Co., 170 U. S., 537.

(3) Use of Part of Patented Invention.—Except where the patent covers merely a particular combination of elements, it is an infringement to use any part of the invention embraced within the patent.—Union Sugar Refinery vs. Mathiesson, 3 Cliff (U. S.) 639, 2 Fish. Pat. Cas. 600, 24 Fed. Cas. No. 14,399. So also when a patent covers several new and independent machines working to a common end, the use of one alone is an infringement.—Wilkins Shoe Button Fastener Co. vs. Webb, 89 Fed. Rep. 982. Although each is capable of independent use.—Wyeth vs. Stone, 1 Story (U. S.) 273.

(4) Application of Patented Invention to New Use.—The unauthorized application of a patented machine or device, or a colorable evasion thereof, to a new use, without varying the principle or means, is an infringement.—Cincinnati Ice Machine Co. vs. Foss-Schneider Brewing Co. 31 Fed. Rep. 469.

(5) Formal Variations. (a) When Form is Immaterial.—The general rule is that when the substance of a patented invention is taken, and the patentee is not limited by his claim, or otherwise, to any particular form of construction, infringement is not avoided by mere change in the form of the infringing device or of the parts thereof, not resulting in the production of any new and useful result, such changes being merely colorable and evasive.—Westinghouse vs. Boyden Power Brake Co., 170 U. S. 537; National Hollow Brake Beam Co. vs. Interchangeable Brake-Beam Co. (C. C. A.) 106 Fed. Rep. 693. This rule applies to differences in appearance, name, shape, proportions, dimensions, and to mere structural differences generally. Union Paper Bag Mach. Co. vs. Murphy, 97 U. S. 120.

(b) When Form is Material.—On the other hand, even a slight change of form will avoid infringement, when form is of the essence of the invention.—Ball, etc., Fastener Co. vs. Ball Glove Fastener Co., (C. C. A.) 60 Fed. Rep. 399, or when the patentee is only entitled to protection for the precise form described in his claim.—Lewis vs. Pennsylvania Steel Co. (C. C. A.) 59 Fed. Rep. 129 rehearing denied (C. C. A.) 60 Fed. Rep. 1005.

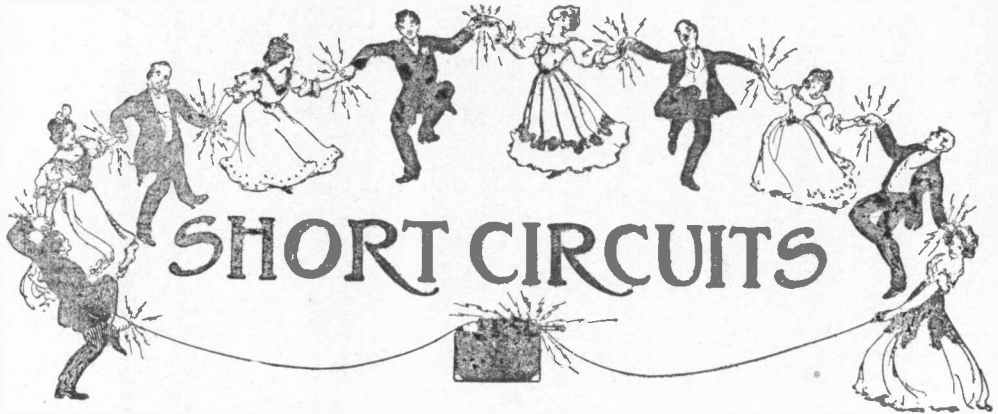

Gossip is putting two and two together and making five.

* * *

Mother—And when he proposed, did you tell him to see me?

Daughter—Yes, mamma; and he said he'd seen you several times, but he wanted to marry me just the same.

* * *

She entered upon her stage life at the age of 15, had attained phenomenal success at 20. Ten years later she toured the states as a star. She was then 22. Eight years after, she left the glare of the footlights, married, got a divorce and returned to her old love at 24. Notwithstanding the fact that her long career upon the boards (25 years), has left its mark on her face, she seems as ambitious and nimble at the head of her own company as she ever did. She is now 28.

* * *

Mr. Brown, looking for his wife, asked the cook: "Bridget, can you tell me of my wife's whereabouts?" Bridget, evidently embarrassed, hesitated before replying, "I think they are in the wash, sorr."

* * *

"Isn't it a shame to keep those poor lions caged?" "Lady," answered the keeper at the Zoo, "they're much happier and safer there than they would be roaming the African jungles."

* * *

"Pa, what do they call a person that reads heads?" "A phrenologist, my boy." "Geel! Then ma must be one of those things. She felt of my head this afternoon and said right away: 'You've been swimming.'"

* * *

A knife-thrower who was performing in an English music-hall had a particularly attractive assistant, whose duty was to lean, with outstretched arms, against a soft pine board. This board was surrounded with electric lights which accentuated her beauty. The knife-thrower would then station himself a few feet distant and hurl knife after knife at the board. These knives would just graze the skin and plunge with a thud in the board and remain quivering. It was a thrilling act, and when the last knife was thrown the young woman would be so closely hemmed in by knives that they had to be drawn out before she could free herself.

One night the pretty assistant was taken ill, and the performer's wife was drafted for the work. She was far from pretty; in fact, she was distinctly homely. She walked out onto the stage and when she reclined against the board the pitiless lights threw into relief her crooked features, unshapely limbs, and general unattractiveness. The knife-thrower took deliberate aim, and a knife flashed across the room and sank into the board by her head. Just as the knife struck, a small boy up in the gallery shouted with a wail, "My Gawd, 'e missed 'er."

"T'other day I asked a waiter ter bring me a chicken dinner—an' he fetched me a handful o' cracked wheat."

* * *

First Man—I called on a couple of ladies last night. His Friend (absently)—So? I'll bet the other fellow held kings.

* * *

On a par with the school boy's definition of a mountain range, which he said was a very large cook stove, may be mentioned that of a student at Sheffield Scientific School who was asked to give the office of the gastric juice. "The office of the gastric juice is the stomach," said the budding scientist.

* * *

The regular ice man was sick and his young son weighed down with responsibility, was driving the ice wagon. He signalled up the dumb waiter to Mrs. Brown that her ice was ready to be drawn up. It was with great difficulty that she succeeded in drawing up the load, but congratulated her-self meanwhile on the fact that the new ice man gave good weight. When the load arrived at the landing, there, perched on the cake of ice, was the ice boy. "What are you doing on that cake of ice," asked the exasperated Mrs. Brown. "Why, I thought I had better come up," said the boy. "I was afraid the ice would be too heavy for you to put into the refrigerator."

* * *

Propos of the queer interpretation frequently placed by children upon remarks made to them, a Western professor related at a recent dinner some examination stories.

"Once, in a Bible lesson," he said, "I repeated the text, 'Arise and take the young child and his mother and flee into Egypt.' Then I showed the children a large picture in bright colors that illustrated the text. The children studied this picture eagerly. Then they all frowned; all looked rather disappointed. Finally a little girl said,

"Teacher, where is the flea?"

* * *

A charming young gentleman about four years of age used to pass a certain lady's house every day on his way to kindergarten. In course of time she made his acquaintance and gave him a penny each morning when they parted.

Eventually his mother requested her not to give him any more money, and the next morning she did not present the usual penny. He did not seem to notice the omission. The succeeding day, when the penny was not given to him, he said nothing. But on the morning of the third day, when the penny was not forthcoming, he sidled up to her and whispered: "Say, what's the matter? Ain't your husband working?"

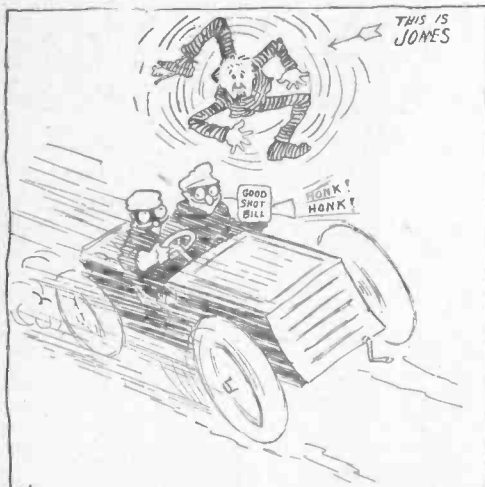

1



2

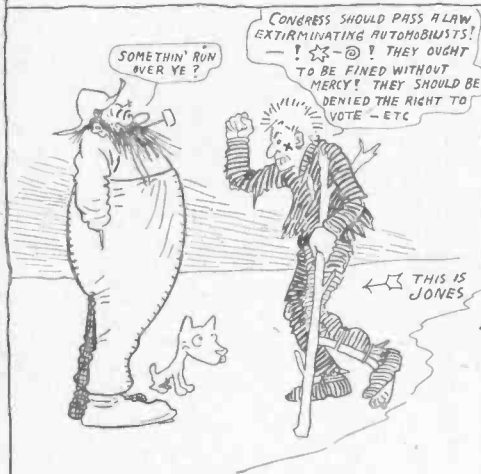

3

THREE DAYS LATER



4

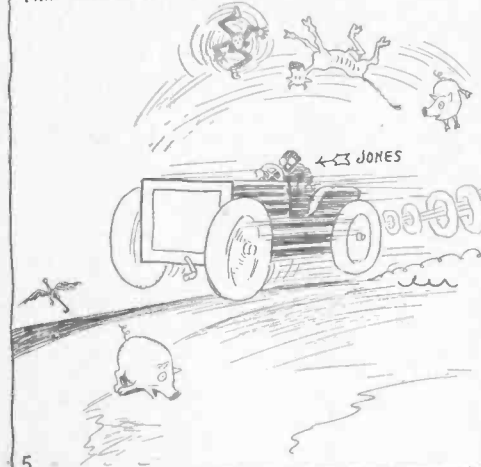

5



6

ELECTRICAL DEFINITIONS

Below are defined a few of the most common electrical terms. They are reprinted from month to month and will be of assistance in understanding the magazine text

- Accumulator.**—See secondary battery.
- Alternating Current.**—That form of electric current the direction of flow of which reverses a given number of times per second.
- Ammeter.**—An instrument for measuring electric current.
- Ampere.**—Unit of current. It is the quantity of electricity which will flow through a resistance of one ohm under a potential of one volt. The international ampere is the current which, under specified conditions, will deposit .001118 grain of silver per second when passed through a solution of nitrate of silver in water.
- Ampere Hour.**—Quantity of electricity passed by a current of one ampere flowing for one hour.
- Anode.**—The positive terminal in a broken metallic circuit; the terminal connected to the carbon plate of a battery.
- Armature.**—That part of a dynamo or motor which carries the wires that are rotated in the magnetic field.
- Brush.**—The collector on a dynamo or motor which slides over the commutator or collector rings.
- Bus Bars.**—The heavy copper bars to which dynamo leads are connected and to which the outgoing lines, measuring instruments, etc., are connected.
- Buzzer.**—An electric alarm similar to an electric bell, except that the vibrating member makes a buzzing sound instead of ringing a bell.
- Candle Power.**—Amount of light given off by a standard candle. The legal English and standard American candle is a sperm candle burning two grains a minute.
- Capacity, Electric.**—Relative ability of a conductor or system to retain an electric charge.
- Charge.**—The quantity of electricity present on the surface of a body or conductor.
- Choking Coil.**—Coil of high self-inductance which retards the flow of alternating current. See self-inductance.
- Circuit.**—Conducting path for electric current.
- Circuit-breaker.**—Apparatus for automatically opening a circuit.
- Collector Rings.**—The copper rings on an alternating current dynamo or motor which are connected to the armature wires and over which the brushes slide.
- Commutator.**—A device on a dynamo shaft for gathering the current from the various coils of the armature and sending it out over the line as direct current. On a motor it takes current from the line and passes it on to the armature coils.
- Condenser.**—Apparatus for storing up electrostatic charges.
- Cut-out.**—Appliance for removing any apparatus from a circuit.
- Cycle.**—Full period of alternation of an alternating current circuit.
- Dielectric.**—A non-conductor.
- Dimmer.**—Resistance device for regulating the intensity of illumination of electric incandescent lamps. Used largely in theaters.
- Direct Current.**—Current flowing continuously in one direction.
- Dry Battery.**—A form of open circuit battery in which the solutions are made practically solid by addition of glue jelly, gelatinous silica, etc.
- Electrode.**—Terminal of an open electric circuit.
- Electromotive Force.**—Potential difference causing current to flow.
- Electrolysis.**—Separation of a chemical compound into its elements by the action of the electric current.
- Electromagnet.**—A mass of iron which is magnetized by passage of current through a coil of wire wound around the mass but insulated therefrom.
- Farad.**—Unit of electric capacity.
- Feeder.**—A copper lead from a central station to some center of distribution.
- Field of Force.**—The space in the neighborhood of an attracting or repelling mass such as a magnet or a wire carrying current.
- Fuse.**—A short piece of conducting material of low melting point which is inserted in a circuit and which will melt and open the circuit when the current reaches a certain value.
- Generator.**—A dynamo.
- Inductance.**—The property of an electric circuit by virtue of which lines of force are developed around it.
- Insulator.**—Any substance impervious to the passage of electricity.
- Kilowatt.**—1,000 watts. (See watt.)
- Kilowatt-hour.**—One thousand watt hours.
- Leyden Jar.**—Form of static condenser which will store up static electricity.
- Lightning Arrester.**—Device which will permit the high-voltage lightning current to pass to earth, but will not allow the low voltage current of the line to escape.
- Motor-dynamo.**—Motor and dynamo on the same shaft, for changing alternating current to direct and vice versa, or changing current of high voltage and low current strength to current of low voltage and high current strength and vice versa.
- Multiple.**—Term expressing the connection of several pieces of electric apparatus in parallel with each other.
- Neutral Wire.**—Central wire in a three-wire distribution system.
- Ohm.**—The unit of resistance. It is arbitrarily taken as the resistance of a column of mercury one square millimeter in cross sectional area and 106 centimeters in height.
- Parallel Circuits.**—Two or more conductors starting at a common point and ending at another common point.
- Polarization.**—The depriving of a voltaic cell of its proper electromotive force.
- Potential.**—Voltage.
- Resistance.**—The quality of an electrical conductor by virtue of which it opposes the passage of an electric current. The unit of resistance is the ohm.
- Rheostat.**—Resistance device for regulating the strength of current.
- Rotary Converter.**—Machine for changing high-potential current to low potential or vice versa.
- Secondary Battery.**—A battery whose positive and negative electrodes are deposited by current from a separate source of electricity.
- Self-inductance.**—Tendency of current flowing in a single wire wound in the form of a spiral to react upon itself and produce a retarding effect similar to inertia in matter.
- Series.**—Arranged in succession, as opposed to parallel or multiple arrangement.
- Series Motor.**—Motor whose field windings are in series with the armature.
- Shunt.**—A by-path in a circuit which is in parallel with the main circuit.
- Shunt Motor.**—Motor whose field windings are in parallel or shunt with the armature.
- Solenoid.**—An electrical conductor wound in a spiral and forming a tube.
- Spark-gap.**—Open space between the two electrodes of a spark coil or resonator.
- Storage Battery.**—See secondary Battery
- Thermostat.**—Instrument which, when heated, closes an electric circuit.
- Transformer.**—A device for stepping-up or stepping-down alternating current from low to high or high to low voltage, respectively.
- Volt.**—Unit of electromotive force or potential. It is the electromotive force which, if steadily applied to a conductor whose resistance is one ohm, will produce a current of one ampere.
- Volt Meter.**—Instrument for measuring voltage.
- Watt.**—Unit representing the rate of work of electrical energy. It is the rate of work of one ampere flowing under a potential of one volt. Seven hundred and forty-six watts represent one electrical horse power.
- Watt-hour.**—Electrical unit of work. Represents work done by one watt expended for one hour.

This Superb World History

Shipped FREE to Your Home

15 Big Volumes
Weight 75 Lbs.

5,000 Pages
700 Illustrations



Publisher Fails!
Splendid De Luxe Edition
Fifteen Large, Beautifully Bound Volumes.

Library of Universal History.

Here is the greatest opportunity ever offered our readers—an opportunity to see with your own eyes these fifteen beautifully bound volumes of the **Library of Universal History**. We send the books themselves, not misleading sample pages. We send the famous complete set because we want you to see and appreciate that this is the most marvelous opportunity ever offered. This handsome edition is bound in Genuine Maroon English Crash Buckram, all printed from large new type, embellished with over 100 double-page maps and plans, 700 full-page illustrations, many of which are in colors, and more than 5,000 solid pages of reading matter. This is the **one reliable, trustworthy history**—the one up-to-date history adopted by educators, schools and colleges. **The history that is in a quarter of a million homes. It is the one history which tells you all, the one history which you should read. And it is shipped FREE—yes, positively free. Send the free coupon.**

The failure of the publishers, the Union Book Co., of Chicago, enables us to make this offer. Absolutely the most sensational offer in the history of the publishing business. An offer without parallel.

We send you the books themselves—not misleading sample pages. You see with your own eyes just what the books are. You examine them in the privacy of your own home. We pay the transportation charges. There is nothing for you to pay. If you don't want the work after the examination is ended, just let us know and we will tell you how to ship them back to us at our expense. We show you these books as willingly as we would show them to you if you came into our store. And we make it easier because we ship the books to your own home. We want you to see these books in your own home. **Keep them for a week.** Begin at the dawn of civilization and tread the paths down to the hour in which you live. And see in passing the men and events as you would have seen them if you in person had lived through all the ages that have gone. The splendid work should be in every home. You should know the sturdy figures

of the past as you know the great men of today. See Caesar, Alexander and Napoleon as you would have seen them had you lived in their own age. Visit battle fields that have moulded the world's destiny and see the armies in conflict. Live in that dim, misty past with the same full understanding you have of the events of today. See Menes build Memphis 5,000 years ago. See Babylon's splendor. See Tyre fall. See it all as if you had lived through the whole 50 centuries. Send the coupon and take advantage of this greatest offer ever made—this biggest opportunity to put a great historical work into your home. **The late Ex-President Cleveland said:** "I am sure this history will find an important place among the publications intended to give wider familiarity with historical literature." **Dr. Frank W. Gunsaulus, President of Amour Institution of Technology,** says: "It is a work of rare genius. Its thought is clear and vigorous, its English pure and elegant." **Send this coupon today.**

This Coupon Brings Books FREE

Just send us the coupon—that is all you need do. Remember, a free examination for a week—books returnable at our expense if you do not want to keep them. If you do wish to keep them, pay only 50 cents after the free examination and then only \$2 a month for 14½ months, a total of only \$29.50, the most sensational forced sale price ever made. (This work has sold for \$60). You should see these books anyway. All must read some history. Why not read the **best?** History fixes ambition. It broadens the mind. It inspires the unworthy to worthiness. It prods the timid to heights of glory. This the one true, late, accurate and readable history. The coupon attached here is NOT an order, merely a request for a free examination—send it NOW.

AMERICAN UNDERWRITERS' CORPORATION
240 Wabash Avenue, Dept. 1408, CHICAGO

Without any expense or obligation to me I will examine the Library of Universal History if sent to my home all charges prepaid. This is positively not an order, but simply a request for an absolutely free examination.

CUT OR TEAR ON THIS LINE 240 Wabash Avenue, CHICAGO, ILL.

Name.....
Address.....
Occupation.....

Do You Want This Home?

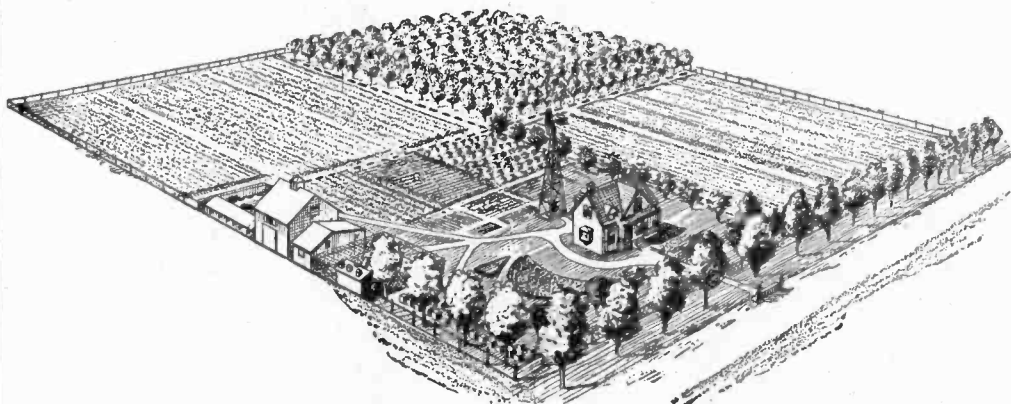

We Must Quickly Build up Population along the W. & C. Railroad in New Reservation just Thrown Open. Send for Our Book. Free Transportation to Investors and Settlers.

We say that a man of average intelligence, even without previous experience can make ten acres of our Washington & Choctaw Railroad lands yield an income of \$5,000 a year.

It is up to us to prove it.

And we are prepared to do so.

In the first place we have the land—nearly 100,000 acres in Alabama's most productive area, in Washington County near Yellow Pine.

Then we have the railroad facilities—the Washington & Choctaw Railroad runs up the middle of the tract, with the Mobile & Ohio on the west and the Tombigbee Valley railroad on the east. Half the land is within $\frac{1}{2}$ miles of railroad.

Ours is the only big crop land now offered that is located near to great markets; Chicago is only 29 hours distant and St. Louis but 21 hours away.

THIS DISTRICT HAS NATIONAL FAME AS A HEALTH RESORT with an altitude of 300 feet above sea level and only 60 miles from the Gulf Coast. The United States Marine Hospital Commission reports this section the only part of the country absolutely free from local diseases.

The rainfall is from 55 to 85 inches, the drainage perfect with no swamps and irrigation never necessary. The summers are exquisitely beautiful and seldom so hot as in the north. The winters are mild and balmy, the government weather reports showing that for 33 years the thermometer has never averaged below 45 degrees in coldest months.

Does this sound good to you?—

—And we are prepared to prove it.

You understand that our relations to the home-seeker and investor are different—more personal and intimate than under ordinary conditions. Here we have a vast tract of land through which the W. & C. Railroad runs that needs development. No railroad can make money without settlers along its line. It is settlers we want—even if we do not make a single dollar of profit on the land.

For almost half a century this elegant land has been dominated by a great lumber company who would not sell and who patrolled the land continually to keep people off. Not even the railroad could buy its right of way. They have now taken off the merchantable timber and only a few weeks ago released the land. It is now thrown open for settlement for the first time.

We are offering the land in any size tract from 10 acres up for almost nothing, only \$17.50 per acre, and on easy payments, as low as \$1.00 a month. We have planned for two new townsites and the early purchasers can get their land right up near these sites.

This is a case where time is more of a factor than money. Be quick to reserve as much of this land as you think you can buy and pay for it on easy monthly installments.

Chances like this are rare—to get good land near railroad, convenient to great markets and in an ideal climate. Fortune awaits you here.

Ask about our "\$500.00 House and Ten Acres."

— GET OUR FREE BOOKLET —

We will mail you a book free that tells all about the land—tells it honestly and sincerely. We're enthusiastic over the vast possibilities offered here to the man of little means but whose ambition is to make money and better his condition.

Write for our Booklet—and we will also send you a free pass over the W. & C. Railroad, whether you buy or not.

Don't buy land anywhere until you investigate this.

Write today and we will send our Booklet.

ADDRESS

WASHINGTON & CHOCTAW LAND CO.
6146 Times Building ST. LOUIS, MO.

The Lamp Bargain of the Year

The "HO-EL" Lamp with Genuine Gold
Iridescent Shade Express
Prepaid - \$8.00

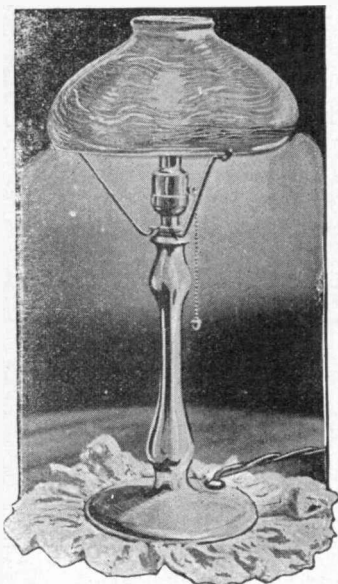

This beautiful electric lamp—rich and elegant in appearance, is offered, for a time, at a remarkably low price. The standard is of pure BELL brass—cast on simple and attractive lines. It has a GENUINE GOLD iridescent shade—the soft opal tones of which make the lamp a thing of wonderful attractiveness. The light operates by means of a convenient pull chain. The true beauty of this lamp cannot be conveyed by pen or picture. Such lamps are being sold today for as high as \$40.00 and, at twice the price we ask, would be a rare bargain indeed. Specially priced by Electric Shop. Complete with frosted lamp and 6-foot silk cord and plug.

**Express
Prepaid . . \$8.00**

The Electric Shop Shaving Mirror

is a remarkable convenience for shaving and massaging. It furnishes perfect light where it is needed on the face in any part of the room at any time of day or night.

It is a combination of mirror, electric light and special reflector. It throws all the light on the face just below the eyes. Both mirror and reflector can be adjusted perfectly—as desired. It has proven the greatest toilet convenience ever offered.

Price complete with tubular lamp and 6 foot silk cord,

**Express
Prepaid . . \$4.25**

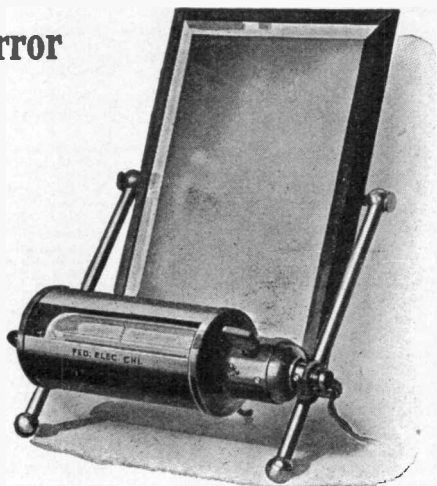

Electric Shop Cor. Michigan and Jackson Boulevards **Chicago, Ill.**

Wireless Men Wanted

TO FILL POSITIONS

Installing and Operating the many Wireless Telephone and Telegraph Stations under course of Construction in the vicinity of the Great Lakes.

The American Wireless Institute

is the ONLY SCHOOL UNIVERSITY-RECOGNIZED by the leading Wireless Companies as being responsible to teach, and our graduates are given preference over other applicants seeking positions. Salaries vary from \$15.00 to \$50.00 per week.

Come! Quick Danger!

Qualify yourself to fill the many available positions in the Wireless field, while the business is young. Descriptive booklet free upon request.

AMERICAN WIRELESS INSTITUTE

71 University Bldg., Detroit, Mich.

A School Within Itself

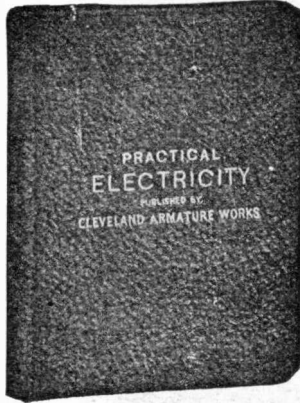

There are XX chapters in all, XIX carrying you from the fundamental principles of electricity on through the various branches to a point where the careful student comprehends the complete designing, care and operation of a dynamo or motor, and I chapter on electric automobiles, outlining their construction, care and operation, and all about storage batteries and how to handle them. Each subject is carefully written and to the point. After a student studies a subject, he is questioned on that subject in such a manner as to bring clearly to his mind the points he needs to know regarding same. A DICTIONARY in back of book will enable him to learn the meaning of any electrical word, term or phrase used in this book, as well as hundreds of others in common use. All required tables necessary in the study are in it.

TABLE OF SUBJECTS:

Chapter

- I—Wiring.
- II—Electric Batteries, Electro Plating.
- III—Magnetism.
- IV—The Magnetic Circuit.
- V—Magnetic Trraction.
- VI—Magnetic Leakage.
- VII—Energy in Electric Circuit.
- VIII—Calculation of Size of Wire for Magnetizing Coils.
- IX—Calculation of EMF's in Electric Machines.
- X—Counter EMF.
- XI—Hysteresis and Eddy Currents.

Chapter

- XII—Armature Reaction.
- XIII—Sparking.
- XIV—Winding of Dynamos and Motors.
- XV—Proper Method of Connecting Dynamos and Motors—Self Excitation.
- XVI—Diseases of Dynamos and Motors, their symptoms and how to Cure Them.
- XVII—Arc and Incandescent Lamps.
- XVIII—Measuring Instruments.
- XIX—Alternating Current.
- XX—Automobiles.

A Dictionary of over 1500 Electrical Words, Terms and Phrases, giving a brief meaning of all which are in common use.

\$2.00 PER COPY—FIFTH EDITION—24,000 COPIES SOLD

The offer we make of refunding money if book is not satisfactory upon examination is AN UNUSUAL ONE in connection with the sale of a book. But we have no fear of its return. Your decision will be what thousands of others have been. Money would not buy it if it could not be duplicated. We could print testimonials by the hundreds. It is best to order and be your own judge of its merits.

CLEVELAND ARMATURE WORKS, Cleveland, Ohio

Armatures and Field Wound, Commutators Filled
AMERICA'S GREATEST REPAIR WORKS

ILLUSTRATING

Law—Pharmacy—Cartooning—Shorthand—Bookkeeping—Nursing—Journalism—Telegraphy—Penmanship

Taught by mail and in our resident schools. Founded 1850. Income increased while learning. Graduates everywhere. Write for our free booklet—tells all. State course desired.

NATIONAL CORRESPONDENCE SCHOOLS 42 N. Penn's St., Indianapolis, U. S. A.

For our Mutual Advantage mention Popular Electricity when writing to Advertisers.



LET US QUOTE YOU PRICES BEFORE BUYING ELSEWHERE

We carry anything in the Electrical Line from the largest to the smallest apparatus
WE CATER TO THE ENGINEER AND THE EXPERIMENTER

Our New 1910 Catalog will be ready soon—make application now



The Red Seal Dry Cell

This Dry Cell is without doubt the most efficient for all kinds of experimental work—Wireless Telegraphy, Telephony, Sparking Purposes, Bells, etc.

Price 25c. each.

Big Discounts on large orders

The American Vibrator



The American Vibrator enjoys an international reputation for

the highest efficiency and most substantial construction of any vibrator on the market to-day at any price, yet sells at a uniform price of \$35.00.

We send the vibrator to responsible physicians on a fifteen days' free trial.

Full particulars on request.

The American Vibrator

is the best portable appliance in existence for administering vibratory treatment. It is put up in an attractive case and is electrically operated—by attachment to the electric light socket. A large number of applicators of different sizes, shapes and materials, specially designed for various uses, are included in the equipment.

- No. 1. Scalp Applicator, price.....75c
- No. 2. Medium Facial Cup, price.....50c
- No. 3. Ball Applicator, price.....60c
- No. 4. Small Facial Cup, price.....50c
- No. 5. Corrugated Disc for Abdominal use, price.....75c

Sent to Physicians on 15 days' Free Trial

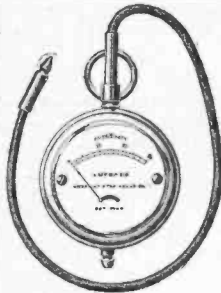

Ever-ready Pocket Meters

Without doubt the smallest, neatest, most accurate, and most reliable Pocket Current Meter made.

Used for testing Dry Cells and small Voltages.

Convenient for Automobile Repairers.

- 0-30 Amperes No. 1002 Ammeter \$3.00
 - 0-30 " 0-14 Volts " 1003 Volt Ammeter 4.00
 - 0-10 Volts " 1005 Volt Meter 3.00
- Each instrument in a Chamois Leather Case.

Christmas Tree Lighting Transformer

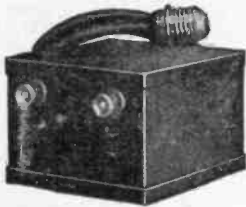

Designed to reduce your regular Electric Light current (110 volts) to 6 or 14 volts for lighting Christmas Tree or other decorative lights.

By using any of our Christmas Tree Lighting Transformers, expensive series wiring is eliminated. The lights are connected in multiple and in case one or more lamps burn out the other lights are not affected.

- Type M—1 to 20 lights, 6 volts \$7.00
- Type N—1 to 20 lights, 14 volts 7.00

Dimensions: Length, 5 inches—width, 4 inches—height, 3½ inches—weight, 8 pounds.

Write at once for our Special Holiday Prices

SOUTHERN ILLINOIS ELECTRIC CO. 508 MISSOURI AVENUE

E. ST. LOUIS, ILL.

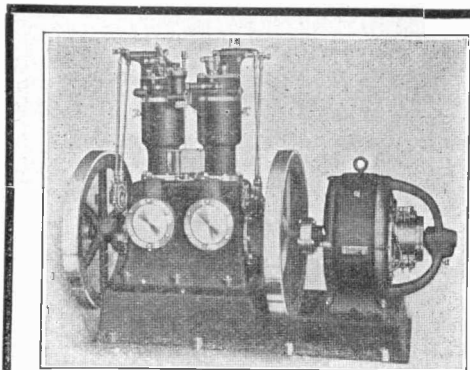

Generator Sets for Electric Light Work

The Bates & Edmonds Generator Sets have proven to be the most efficient for Electric Light Work. Proves up to the most severe tests—and in emergency cases where you have to depend upon its use for lighting purposes has come up to every requirement. Made in capacities from 80 to 350 16 candle power lamps.

Our Generator Sets have become extremely popular in Hotels, Factories, Stores, Country Homes, etc., where it is absolutely necessary to have Electricity always available.

Where Central Station Current is not to be obtained, or where it is not furnished all the time—The Bates & Edmonds Generator Sets are an absolute necessity. Write immediately for our prices on our various kinds of Electric Light Apparatus.

BATES & EDMONDS MOTOR CO.

Gas Engines

LANSING, MICH.

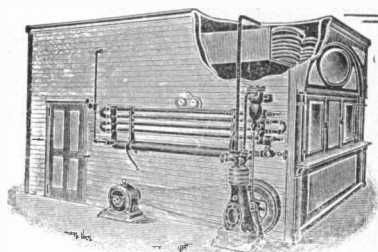

Ice Making and Refrigerating Machinery

Where Electric Current is available you can have your own ICE PLANT. We are the originators of Electrical Ice and Refrigerating Machinery, for all purposes. Hotels, Stores, Buildings, Apartment Houses, etc. Installers of all kinds of Ice Machinery and Refrigerating Machines in any size up to 50 tons daily capacity.

We want to show you how to make your own ice with the Electric Current you have available.

Our years of experience is worth something to you. You can have it free for the asking.

Larsen-Baker Ice Machine Co.

1005 Nicholas Street

OMAHA, NEBR.

Hess Sanitary Bath Locker (Medicine Cabinet)

Something New For Your Home

Made of Solid, Smooth Steel Throughout, and Finished Inside and Out in Finest Everlasting Baked White Enamel—Snow White—with Adjustable Enameled Steel Shelves, Nickel Plated Hinges and Handle.

Better Than Wood and Costs No More

Dust, Germ and Vermin Proof.



No home is complete without a Hess Sanitary Bathroom Locker. It is suitable for the finest bath room. It is dust, germ and vermin proof and easily cleaned with warm water.

Style "A" Locker is made to recess into the wall and projects 1 1/4 inches from the face of wall. It has a beveled plate mirror 16x20 inches and measures 19 1/2 x 23 1/2 inches inside. Below the mirror is an open shelf 19 1/2 x 5 1/2 inches. Style "C" is the same size and finish; made **not to recess** into the wall, but to be suspended on the wall.

Price of Style "A" \$8.00

Price of Style "C" 9.00

Without Mirror deduct \$1.50

Without Open Shelf deduct \$1.00

We will prepay freight charges anywhere east of Missouri and North of Ohio rivers.

The same cabinets with a different arrangement inside, are used in office buildings, clubs and institutions for **Toilet Lockers**.

Send for Illustrated Circular Showing Several Sizes

We are makers of the Hess Steel Furnace. Important booklet, "Modern Furnace Heating" Sent Free.

Hess Warming & Ventilating Co. 912 L. Tacoma Bld. CHICAGO

See That
LOCKER

For our Mutual Advantage mention Popular Electricity when writing to Advertisers,

A Live Wire To Central Stations

Q Don't you sometimes wish your advertising could be made to present your proposition from a different view point? Let some one who knows take up the subject in a different way—appeal on new lines to a new lot of people, as well as the old crowd. We want to convince you that you need this kind of advertising service—what it would mean to you—what it has meant to the largest Central Stations in the country. Then we want to convince you that we can give you this service and do for you what we have done for others. Our proposition will be interesting—your inquiry for it will entail no obligation.

Wm. D. McJunkin
Advertising Agency

167 Dearborn St., Chicago.

Will You Accept This Business Book if We Send it Free?

Sign and mail the coupon below. Send no money! Take no risk!

One hundred and twelve of the world's master business men have written ten books—2,079 pages—1,497 vital business secrets, ideas, methods. In them is the best of all that they know about

- | | | |
|----------------|---------------------|---|
| —Purchasing | —Salesmanship | —Position-Getting |
| —Credits | —Advertising | —Position-Holding |
| —Collections | —Correspondence | —Man-Handling |
| —Accounting | —Selling Plans | —Man-Training |
| —Cost-keeping | —Handling Customers | —Business Generalship |
| —Organization | —Office Systems | —Competition in Fighting |
| —Retailing | —Short Cuts and | and hundreds and hundreds of other vital business subjects. |
| —Wholesaling | Methods for every | |
| —Manufacturing | type and department | |

A 9,059-word booklet has been published describing, explaining, picturing the work. Pages 2 and 3 tell about managing businesses great and small; pages 4 and 5 deal with credits, collections and with rock-bottom purchasing; pages 6 and 7 with handling and training men; pages 7 to 12 with salesmanship; with advertising, with the marketing of goods through salesmen, dealers and by mail; pages 12 to 15 with the great problem of securing the highest market price for your services—no matter what your line; and the last page tells how you may get a complete set—bound in handsome half morocco, contents in colors—far less than your daily smoke or shave, almost as little as your daily newspaper.

*Will you read the book if we send it free?
Send no money. Simply sign the coupon.*

The System Co., 151-153 Wabash Ave., Chicago
If there are, in your books, any new ways to increase my business or my salary, I should like to know them. So send on your 16-page free descriptive booklet. I'll read it. 178-11

Name _____
Address _____
Business _____
Position _____

Credit Tailors

All-Wool
Suits and
Overcoats

\$12.95
to
\$27.50

Sent on
Approval

Your Choice
of 34 Fabrics
Made in the
Latest Styles
Samples Free



Six Months to Pay

The Clement Fall Style Book shows the cleverest clothes made in America. We want to send it to you free. Also 34 samples of cloth. Also a tape line with simple instructions for taking your measurements.

Learn how easy it is to order clothes direct from the maker, saving all middleman's profits. See what a wide choice you get in this way—what stunning metropolitan styles. And see what you save—at least one-third under any tailor's prices.

We sell any suit or overcoat on credit at just the same price as for cash. No other concern will do this. You may have six months to pay—no interest, no security. You don't need to pay for a whole season's clothes in advance.

We send the garments on approval, guaranteeing style, fit, workmanship and price. If not satisfactory in every way the transaction will not cost you a penny.

Every fabric we use is all wool. Every style is up to the moment in fashion. Every garment is made by journeyman tailors in the best manner known to the craft.

Thousands of the best-dressed men in America are buying Clement clothes. They are getting three suits for the usual price of two. And they pay as convenient—a little each month.

Please send for our Style Book and samples and see if you don't want to join them. Simply give us your name and address. Cut out this ad as a reminder, so you won't forget. (4)

THE CLEMENT CO.

479 Franklin Street

CHICAGO, ILL.

Home Study Courses

Over one hundred Home Study Courses under professors in Harvard, Brown, Cornell and leading colleges.

Academic and Preparatory, Agricultural, Commercial, Normal and Civil Service Departments.
Preparation for College, Teachers' and Civil Service Examinations.

250 page catalog free. Write to-day.

THE HOME CORRESPONDENCE SCHOOL
Dept. 100, Springfield, Mass.



Prof. Leung English

For our Mutual Advantage mention Popular Electricity when writing to Advertisers.

POPULAR ELECTRICITY

DON'T USE
TUNGSTEN LAMPS
WITHOUT
"TUNGSTOLIERS"

Our FOLDING LINE of
"TUNGSTOLIERS" all have
ANTI - VIBRATORY SPRINGS
IN THEIR CANOPIES

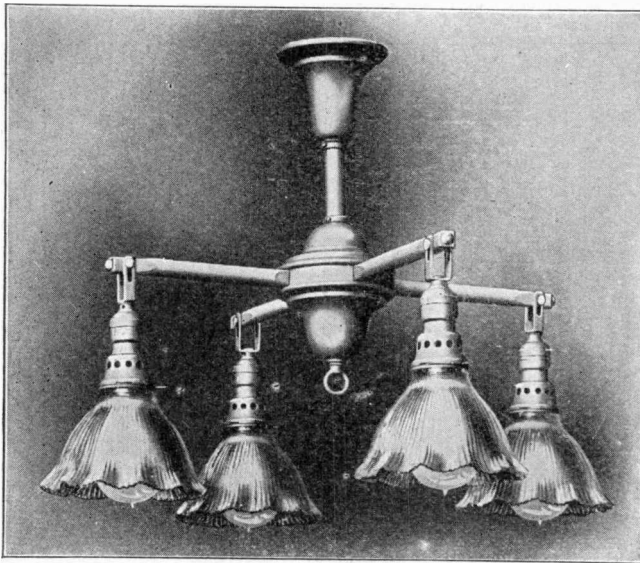

*They will PROLONG THE LIFE
of your TUNGSTEN LAMPS*

THE TUNGSTOLIER CO.
CLEVELAND, OHIO

NEW YORK

MINNEAPOLIS

CHICAGO

TORONTO, CANADA
DALLAS

For our Mutual Advantage mention Popular Electricity when writing to Advertisers.

CLASSIFIED ADVERTISING

Advertisements in the section of Popular Electricity, will cost 40 cents a line, cash with order, and in order to secure proper classification must be in this office the first of the month preceding date of issue

AGENTS

AGENTS MAKE BIG MONEY SELLING OUR new sign letters for office windows, store fronts and glass signs. Any one can put them on. Write today for a free sample and full particulars. Metallic Sign Letter Co., 400 N. Clark St., Chicago, Ill.

WANTED—IMMEDIATELY, AGENTS TO DEMONSTRATE and sell the Lusk Match Safe; exclusive territory; this is a money maker. Call or address Lusk Match Safe Company, Dept. 25, 617-619 Main St., Buffalo, N. Y.

ATTENTION—OUR PROPOSITION OFFERS you best chance you ever had for making easy money and lots of it. Write for our salary plan. Most generous ever presented. Popular Electricity Publishing Co., Monadnock Block, Chicago.

WONDERFUL INVENTION—CANCHESTER Incandescent Kerosene Lamp burns with or without mantle; 10 times brighter than electricity, gas or acetylene, at 1-10 cost. Burner fits all standard lamps; saves 75 per cent oil. No trimming wicks. \$10 daily. Beware of imitations. Outfit FREE. Canchester Light Co., 26 State, Dept. P. E., Chicago.

"PERFUME-GLOSS" IN STARCH—GIVES clothes lasting perfume of Azure Violets; makes them white as snow. Other quick sellers; large profits; agents wanted. Sample 4 cents. Shipman, Lewis Block, Buffalo, N. Y.

AGENTS WANTED—BIG MONEY! NO EXPERIENCE required. Portraits, bromides, photo, pillow tops, 30c. Frames at our factory prices; credit given. Catalogue and samples free. Dept. 9-R, Ritter Art Studio, Van Buren St., Chicago, Ill.

BUSINESS OPPORTUNITIES

1,000 WAYS TO MAKE MONEY—THIS 125-page book, worth dollars, only 20c. prepaid. Satisfaction guaranteed. Goodman & Co., Dept. 19, 2511 N. Humboldt St., Chicago, Ill.

ABSOLUTELY FREE! WITH EVERY ORDER of our \$2 Waterson self-filling fountain pen with safety clasp, will give a \$1.00 acid-proof, 32 faced, 1/4 K Brazilian Diamond set in scarf pin, stud or ring. Both pen and diamond sent postpaid for \$1.00, P. O. order or bill. Wayside Novelty Co., Dept. E., 16 Argyle St., Everett, Mass.

\$21,500 MADE IN 22 MONTHS BY ONE MAN. Another—a new man—has made \$6500 since January 1st. Most are making \$200 to \$400 monthly. Would you like to do the same? Write us. The Oxygenator Co., 232 Pearl St., Buffalo, N. Y.

BUSINESS OPPORTUNITIES

START LEGITIMATE MAIL-ORDER MERCANTILE business of your own; possibilities unlimited; cash orders, good profits; conducted by anyone. We print your catalogs, supply everything; sell you merchandise at wholesale; show you how, on small investment. Write for free booklet and sample catalog. Central Supply Co., Kansas City, Mo.

CHEAP ELECTRICITY—REVOLUTION DYNAMO & MOTOR Co., Richmond, Cal. Second stock offering 5 cents per share. First was oversubscribed.

FREE! FOR SIX MONTHS. KEEPS YOU IN touch with Western progress and mining opportunities. A postal brings it. Write. The Nevada Review, 91 Dearborn St., 4th floor, Chicago.

INCREASE YOUR INCOME. MAKE YOUR spare time pay dividends. Write for our salary proposition. Best chance you ever had to make money quickly and easily. Popular Electricity Publishing Co., Monadnock Block, Chicago.

HUNDREDS BECOME RICH CONDUCTING mail-order business at home evenings. Fifty samples and secret of getting thousands of orders, \$1.10. Circulars free. Self-Culture Society, Novelec, Rogers Park, Ill.

\$500 YEARLY PROFIT FROM TWELVE HENS. Most wonderful, scientific discovery makes this possible. Secrets fully revealed (172 pages), \$2.00. Special introductory price 60c. Particulars gratis. National Institute, 6943 North Clark St., Chicago, Ill.

CONCRETE—LEARN HOW TO HANDLE this material by reading "Concrete," a monthly magazine devoted to the uses of Portland cement. Practical, instructive articles, written in plain English. Sample copy, 10c. Yearly subscription, one dollar. Concrete Pub. Co., 299 Owen Bldg., Detroit, Mich.

START A PAYING BUSINESS AT HOME—Our plan positively successful. My valuable free booklet explains fully. Big opportunity for anyone. Send today without fail. W. E. Foote, Box 155, Muskegon, Mich.

COINS AND STAMPS

STAMPS, 100 FOREIGN, 10 CENTS; 40 U. S., 10 cents. Two Tasmania pictures, 4 cents. F. L. Toupal Co., 1410 Lowe Ave., Chicago Heights, Ill.

OLD COINS—\$5.75 PAID FOR RARE DATE 1853 quarters. \$10 for a cent. Keep all money dated before 1880 and send 10 cents at once for our New Illustrated Coin Value Book. Size 4x7. It may mean your fortune. C. F. Clarke & Co., I. B. 12, LeRoy, N. Y.

POPULAR ELECTRICITY

ELECTRIC MATERIALS

EVERYONE USING DRY BATTERIES SEND 25c. for scientific instructions. Renew exhausted batteries cheaply; last long as new. Fairmount Telephone Co., Leightons Corners, N. H.

MAKE YOUR OWN DRY BATTERIES AND save 50 per cent. Send 25c. for formula. O. B. Eddy & Co., 326 Archer Ave., Peoria, Ill.

FLASHERS

FIREFLY FLASHER—Automatically flashes any lamp on and off 30 times a minute. Flashing socket or standard flasher. Price, \$1.50. Send for booklet. C. O. Schneider & Co., 103 S. State St., Chicago, Ill.

FOR SALE

FOR SALE—MOVING PICTURE FILM, 1c. ft.; machines \$40. H. Davis, Watertown, Wis.

FOR SALE—8 H. P. TRACTION GASOLINE engine, feed cutter and wood saw. Geo. C. Schemmel, Wapakoneta, O.

FOR SALE—13 ENGINE LAHTE, CHUCK and tools, good condition, bargain. John N. O'Brien, South Bend, Ind.

FOR SALE—I. C. S. STEAM ELECTRIC, COST \$100; never used. Will sell or trade for diamond. Full course can be transferred. Arthur Sumner, 103 Vernon St., Rockland, Mass.

FOR SALE—CYCLOPEDIA OF DRAWING, 2 vols., covers the whole field of mechanical drawing and lettering, freehand and perspective drawing, etc. List price, \$9.80; will sell for \$3.00. Henry Ward, 124 East 52nd St.

FOR SALE VERY CHEAP, A 1½ H. P. HIGH grade stationary air-cooled gasoline engine or will exchange for small dynamo or lighting equipment. Sam Diller, 607 East Walnut St., Des Moines, Iowa.

FOR SALE—CYCLOPEDIA OF ARCHITECTURE, Carpentry and Building. 10 vols. In first class condition. Covers subjects of Building Superintendence, Contracts and Specifications, Building Law, Laying Out, Stair Building, Estimating, Strength of Materials, Drawing, Mechanical, Architectural, Free Hand and Perspective; Plastering, Plumbing, etc. etc. Worth \$60.00. My price \$12.00. Address Henry Ward, 124 East 52nd St., Chicago.

FOR SALE—COMPLETE SET OF CASTINGS, with blue prints of 3-4 h. p. gasoline stationary engine; includes governor and timer, screws, etc. \$10. Comet Motor Works, 17 W. Madison St., Chicago, Ill.

FOR SALE—A LARGE QUANTITY OF NO. 34 single silk magnet wire at \$1.50 per pound; any address, prepaid; nothing less than ½ lb. Geo. E. Glasser, Charlotte, N. Y.

LUBRICANTS, ASBESTOS, GRAPHITE AND mica candles for loose pulleys and shaftings; no drip; no dirt; economical. Swain Lubricator Co., 250 E. Lake St., Chicago.

HELP WANTED

CHAUFFEURS—\$5 PER DAY PAID TO COMPETENT automobile drivers; a complete instruction book that will qualify you for these positions will be sent postpaid for 25c. This valuable book tells all about driving and adjusting automobiles; explains all gasoline engine troubles; satisfaction guaranteed or money refunded. George N. Pearson, Bala, Pa., Desk E.

THE UNITED TRADE SCHOOL CONTRACTING Co., conducts a trade school and wants men to learn plumbing, bricklaying or electrical trade. No expense and hundreds have learned in a few months. Steady work guaranteed. Address 120 E. 9, Los Angeles.

THERE ARE ALWAYS GOOD PAYING POSITIONS open for competent young men, who have special training. We supply special books of instructions for forty-four good paying positions; they are arranged especially for home study. Do not buy or enroll for instructions until you have our list, which will be sent for the asking. THE TECHNICAL BOOK & SUPPLY CO., McLeansboro, Ill.

WANTED—RAILWAY MAIL CLERKS, CITY Carriers, Postoffice Clerks. Examinations everywhere November 17th. \$600 to \$1,600 yearly. No "lay-offs." Short hours. Annual vacation. Salary twice monthly. Over 10,000 appointments during 1910. Country and city residents equally eligible. Common education sufficient. Political influence unnecessary. Candidates prepared free. Write immediately for schedule of examinations and free bulletin. Franklin Institute, Dept. L 61, Rochester, N. Y.

MISCELLANEOUS

SHEET MUSIC, 4 COPIES FOR 25c. A POSTAL will bring you our long list of all the popular and latest hits. Semple's Music House, 244 West Ave., Norwalk, Conn.

THE NEW LINCOLN PENNY IN RING, FOR pocket piece and chain, 10c. postpaid. Everybody wants it. Enterprise Co., Dept. B, Woolner Bldg., Peoria, Ill.

THE REX NAPHTHA WASHER—BEST HAND power Clothes Cleaner made. Price \$12. F. W. Pattison, Everett, Wash.

BROTHER—ACCIDENTALLY HAVE DISCOVERED root that will cure both tobacco habit and indigestion. Gladly send particulars. F. F. Stokes, Mohawk, Fla.

PHOTO PILLOW TOPS MADE FROM ANY photograph for 50c. postpaid. Your photograph returned. Photo Pillow Top Studio, Maywood, Ills.

MECHANICAL PROBLEMS SOLVED—MACHINE designing, drafting, specifications, estimates and advice. Unsuccessful patents redesigned and improved. Industrial News Bureau, Ithaca, N. Y.

SAVE MAGAZINE MONEY—SEND ME A list of the magazines you would like, and I will quote you my prices. Catalog free. J. D. Dietrich, 35 Main St., Middleville, Mich.

MISCELLANEOUS

BAND INSTRUMENTS—DISPOSITION OF back stock. Send \$3.00 for one of our second hand cornets. Catalogue 10c. H. H. H. Jordan, San Francisco.

BUILD YOUR OWN CARS—WE CAN FURNISH you with chassis parts, including engine, axles, transmission, frame, etc., at attractive prices. Write us for details. JOHN H. BLACKER & COMPANY, Chillicothe, Ohio.

THREE THOUSAND FORMULAS, MY 368-page volume of recipes and trade secrets, cloth bound, only 40c. prepaid. Worth dollars. Satisfaction guaranteed. **SPECIAL**—Return this ad and I will include 3 months' subscription to Mechanical Digest. Wiley Sanderson, Dept. E., Ypsilanti, Mich.

NATURE'S WAY IN LOVE, COURTSHIP AND Marriage, 10c. or addresses of ten bachelors. August E. Martens, Burlington, Iowa.

ELEGANTLY ENGRAVED COPPER PLATE and 50 finest quality visiting cards for 75c. Money refunded if not satisfied. "Brochon," 271 E. Madison St., Chicago.

THE BOHEMIAN RUBBING STICK WILL make your hands clean and as soft as silk in two minutes; harmless; price, prepaid, 15c. Pavlik Co., Winnetka, Ill.

TEXAS MAP FREE, GIVING CITIES, RAIL-roads, elevations, rainfall, products, etc., with every 25c. subscription to the Texas Realty Journal, a magazine telling all about Texas and her resources and opportunities. Texas Realty Journal, Houston, Texas.

NO NEED TO BE WITHOUT MONEY. OUR new plan gives you a chance to earn lots of money whether you have only a little spare time or wish to devote all of your attention to our interest. Don't wait but write at once for our salary proposition. Popular Electricity Publishing Co., Monadnock Block, Chicago.

LEATHER NECKTIES, MADE FROM THE finest Velvet Sheep Skin, lined throughout with silk. ALL COLORS and novelties. Regular price 75c. Until Dec. 15th the price will be only 42c. Only one to a customer. Money back if not satisfied. Mention this paper when answering and we will enclose, FREE handsome Leather Bookmark. Tracey & Co. Tippencanoe City, Ohio.

"PHONOGRAPH-SYMPHONY"—WONDER-ful improvement for Edison Machines. Write for particulars. Irving Kimball, Inventor & Mfr., 2812 Washington St., Boston, Mass.

BOYS—BOYS—THIS IS FOR YOU, AND those who like boys. "The Boy Electrician," by Prof. Edwin James Houston. A book every boy will enjoy and learn something from. 326 pages—10 full page illustrations. Price \$1.50—or free for only three paid yearly subscribers to Popular Electricity. Popular Electricity Pub. Co., Book Dept., Monadnock Block, Chicago, Ill.

DIES, TOOLS, AND METAL STAMPING made on short notice. Atlas Stamping & Plating Works, 88 W. Jackson Blvd., Chicago, Ill.

MISCELLANEOUS

COMMERCIAL MOTOR VEHICLES—READ the "Power Wagon" for reliable information concerning motor trucks, motor buses, motor cabs, and other machines employed for business purposes. Issued monthly; single copies, 20 cents. \$2 a year. The most valuable paper of its kind published. The Power Wagon, Metropolitan Block, Chicago.

JUST OUT—BEST WORK ON THE SUBJECT ever published. "Operators Wireless Telegraph and Telephone Handbook." by Laughter. A storehouse of up-to-date authentic information. 180 pages. Illustrated. Money back if not all we claim for it. Price \$1.00 postpaid. Free for two paid yearly subscriptions to Popular Electricity. Popular Electricity Book Department Monadnock Block, Chicago.

FIVE TO TEN DOLLARS A DAY—SURE—Until further notice, all orders for Russell's New Confection "DAIRY CREAM CRISP," will receive, free, my up-to-date process for making stale-proof Salted Peanuts, my original Perfection Peanut Butter, and my booklet, "STRAIGHT TALK ON CANDY." Price on application. Address C. E. Russell, 716 Clybourn St., Milwaukee, Wis. P. S.—Over 30 years a candy-maker.

1909 CLINCHER CASES AND TUBES—

Size.	Case.	Tube.	Size.	Case.	Tube.
28x2½ \$ 8.50	\$2.25	34x3½ \$18.40	\$4.00
28x3 10.50	2.75	30x4 19.80	4.20
30x3 11.50	3.00	32x4 21.00	4.50
30x3½ 15.50	3.60	34x4 22.60	4.80
32x3½ 17.00	3.90	34x4½ 28.00	5.50

Also a few guaranteed cases 30x3, \$12.80; 30x3½, \$18.85; 32x3½, \$20.05; single tube tires 26x2½, \$9; 28x2½, \$10; 28x3, \$12. I ship. Pay for tires after examination. Wm Vandernool, Springfield, O.

GUMMED LABELS—3000 FOR \$1.00 POST-paid. Any size up to 1x2. Two colors. All work satisfactory or money back. Trial order convinces. Send for FREE samples. E. Terrance Mfg. Co., Belmar, Pittsburg, Pa.

HOW TO CLEAN CLOTHES—NAPHTHA, steam or dry. Full details by cleaner of 20 years' experience. 50 cents coin or stamps. W. F. Pattison, Everett, Wash.

DOGS, DOGS, DOGS—LOOK HERE! Pointers, English, Irish and Gordon Setters. St. Bernards, Newfoundlands, Terriers of all breeds; and, in fact, if you want a first class dog of any breed, write me. My experience as a Fancier, Exhibitor and Breeder for over 30 years enables me to guarantee my patrons satisfaction in getting good dogs, fair prices and square dealings. Fred B. Kirby, Woodbury, N. J.

ARE YOU INTERESTED IN THE TELE-PHONE BUSINESS? Write for our permium offer. Western Telephone Journal, Vinton, Iowa.

WE MANUFACTURE GLASS PAPER. PLAIN glass windows made to look like real stained glass. Easily applied and beautifies the home. Something new for agents. Two sheets of this glass paper sent as a sample with catalogue in colors and complete instructions on receipt of 10 cents. S. H. Parrish & Co., 216 Clark St., Chicago.

POPULAR ELECTRICITY

PATENTS

SOUTHERN STAMPING & MFG. CO., Manufacturers of special and patented articles. R. A., Nashville, Tenn.

PATENTS—H. W. T. JENNER, PATENT ATTORNEY, and mechanical expert, 608 F. Street, Washington, D. C. Established 1883. I make an investigation and report if patent can be had, and the exact cost. Send for full information. Trade-marks registered.

PATENT—ADVICE AND BOOKS FREE. Highest references. Best results. I procure patents that protect. Watson E. Coleman, Patent Lawyer, 612 F. St., N. W., Washington, D. C.

PATENTS SECURED—INVENTOR'S POCKET Companion free. Send description for free opinion as to patentability. W. N. Roach, Jr., Metzert Bldg., Washington, D. C.

TWO BOOKS FREE—SHEPHERD & CAMPBELL, Patent Attorneys, 2196 McGill Bldg., Washington, D. C.; 246 Canal St., New York; Kimball Bldg., Boston. Prompt service.

PATENTS SOLD FOR 5 PER CENT. WE force sales by constant advertising. Send for plan. Patent Sales Co., Merchantville, N. J.

PICTURES AND POST CARDS

25 BEAUTIFUL POSTCARDS, ALL DIFFERENT, for 25c. Some of them retail at 5c. and 10c. each. Hudson Novelty Co., Port Ewen, N. Y.

ART PICTURES—FIFTY ASSORTED HIGHLY colored postcards and two valuable books, 30c. August E. Martens, Burlington, Iowa.

SCHOOLS

CIVIL SERVICE EMPLOYEES ARE PAID well for easy work; examinations of all kinds soon; booklet 50, describing positions and telling easiest and quickest way to secure them, is free. Write for it now. Washington Civil Service School, Washington, D. C.

PLUMBING, ELECTRICITY, BRICKLAYING or Mechanical Draughting, taught by expert workmen. Short time and small cost. Positions always open. Catalogue free. Write today. Coyne National Trade Schools, 860 N. Ashland Ave., Chicago.

WE SUPPLY SPECIAL BOOKS OF INSTRUCTIONS for forty-four good paying positions; do not buy or enroll for instructions until you have our list, which will be sent for the asking. **THE TECHNICAL BOOK & SUPPLY CO.,** McLeansboro, Ill.

WANTED—LEARN TO WRITE ADVERTISEMENTS; you can positively earn \$25 to \$100 per week; prospectus sent free. Page-Davis Co., 611 Page Bldg., Chicago.

TELEGRAPHY TAUGHT QUICKLY—R. R. wire in school. Living expenses earned. Graduates assisted. Correspondence course if desired. Catalogue free. Dodge's Institute of Telegraphy, 49th St., Valparaiso, Ind. Established 1874.

\$200 TO \$600 MONTHLY EASILY MADE FITTING eye glasses. Short, easy mail course. Reduced tuition. Big demand for opticians. Write today for free "Booklet O.," National Optical College, St. Louis.

MOTORS

ELECTRIC MOTORS AND GENERATORS new and second hand in all sizes; write for quotations; state size, voltage and current supply required. B. Olson-Boettger Mfg. Co., St. Paul, Minn.

HALF, THREE AND FIVE HORSE DIRECT current 220 volt motors. Splendid, very low price. The American Fixture & Mfg. Co., Troy, Ohio.

A MOTOR THAT RUNS EITHER ON BATTERIES or alternating or direct city lighting currents. Blue prints furnished showing connections, also book explaining electrical terms, the principle of electric motors and calculations of their power. Price, shipping charges prepaid, \$1.85. Independent Electric Co., 302-3 Andrus Bldg., Minneapolis, Minn.

TYPEWRITERS

I WANT TO CORRESPOND WITH PERSONS who are about to buy a high-grade typewriter, and object to paying the high prices generally asked by manufacturers and dealers. Any make on approval. L. A. E. Atchison, 4125 West 21st St., Chicago.

WIRELESS

WIRELESS EXPERIMENTERS—JOIN OUR Wireless Club. No fees. Handsome club button free to members. Send for application blank. Secretary Popular Electricity Wireless Club, Monadnock Block, Chicago.

OUR NEW STYLE VARIABLE CONDENSER enclosed in a fine oakwood case consists of II semi-circular plates, \$4.00, guaranteed. Square plates condenser \$2.50; **CAN'T BE BEATEN.** We sell double slide tuning coils 685 meters for commercial use \$3.50. Silicon detector \$1.00, commercial \$2.00. **NONINDUCTIVE POTENTIOMETER, \$1.00.** **A FIXED CONDENSER for your receiving \$1.00, commercial \$1.50.** WRITE, ENCLOSE ONE CENT STAMP for catalogue. **WILLIAMSBURGH WIRELESS CO.,** 105 p Johnson Ave., Brooklyn, N. Y.

WIRELESS MATERIALS, AT BOTTOM prices. Will cheerfully send single and dozen lot prices. John Petri, Dept. A, 329 E. 22d St., Old No., New No., 217 W. 22 St., Chicago, Ill.

WIRELESS SPECIAL FOR OCTOBER—Material for a 2-in. spark coil. Norway iron wire core, 10x1½. No. 14 D. C. C. wire for two layers of primary. One hard rolled fiber insulating tube. 3 lbs. No. 34 S. C. C. wire for secondary. 4000 sq. inches tin foil. Magnetic interrupter with heavy platinum contacts. Brass spark gap with posts, ready to mount. 2 binding posts. Form for winding secondary sections, and complete instructions for winding and assembling. Price \$7.35. Send stamp for catalogue of other wireless supplies. O. S. Dawson, 156 Wabash Ave., Chicago, Ill.

JUST OUT. BEST WORK ON THE SUBJECT ever published. "Operators Wireless Telegraph and Telephone Handbook," by Laughter. A storehouse of up-to-date authentic information. 180 pages. 87 illustrations. Money back if not all we claim for it. Price \$1.00 postpaid. Free for two paid yearly subscriptions to Popular Electricity. Popular Electricity Book Department, Monadnock Block, Chicago



Let This New Electric Invention

Do Your House-Cleaning

¶ This wonderful little machine does absolutely perfect work. We challenge comparison with any of the higher priced Vacuum Cleaners. As far as we are concerned, order ours and any other—send back the one that seems the poorer.

¶ We offer and intend that anyone who buys an Arnold Electric Cleaner, and after a fair trial thinks that any other machine would serve him better—may have his money back for the asking.

The Arnold Electric Cleaner Only \$35.00

Sent Anywhere on Free Trial

¶ This machine is one of the greatest labor savers ever invented.

¶ With an Arnold Electric Cleaner you can thoroughly clean an entire room in a few minutes—a whole house in less than one-third the time heretofore required,

- Cleans it thoroughly.
- Without damaging your carpets and rugs.
- No dust or germs in the air, consequently no dusting necessary.
- It is the only sanitary way.
- Saves time and energy, and, best of all, saves the woman.

¶ It cuts out all the drudgery, and goes far toward solving the servant problem. Makes it unnecessary to ever send your rugs and carpets to the cleaners, where they are generally injured more in one cleaning than they would be by several years of actual use.

¶ The Arnold is easiest to operate because it weighs only 8 pounds. Therefore, can also be easily carried about even by a small child.

¶ The electric motor does all the work. First it loosens up the dirt by operating a patented agitating brush. Then a strong, steady suction, equal to that of any other machine, sucks it into the dust collector bag, from which it can be easily removed. It is the combination of the strong suction together with the patented agitating brush that makes the Arnold quicker and much more efficient than any other machine.

¶ The Arnold Electric Cleaner can be operated from any electric lamp socket, and never costs more than 1 cent per hour to operate anywhere. The machine will work on either direct or alternating current.

Ask Your Electric Light Company

Up-to-date Electrical Dealers and Central Stations all over the country are already carrying a stock of Arnold Electric Cleaners. Ask the manager of your light plant, or inquire at any electrical dealer about the Arnold. If they haven't one on hand, they will be glad to get one for you on our liberal Free Trial Offer. If you prefer, you can write direct to us. Send today for further interesting information of this wonderful little machine, and our exceptional Free Trial Offer.

Exceptional Opportunity For Agents

The Arnold will be the most extensively advertised Electric Cleaner on the market. We want live representatives in every city. Write today for interesting proposition.

STANDARD ELECTRIC WORKS
1220 Washington Avenue
RACINE, WISCONSIN

For our Mutual Advantage mention Popular Electricity when writing to Advertisers.

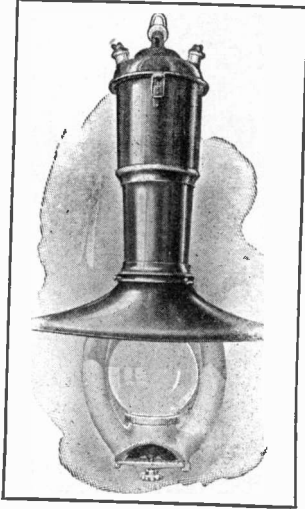

The A-B Regenerative Flame Arc Lamp

The Latest Development in Arc Lighting

Burns 70 Hours on One Trim of Carbons

Simple in Construction.

*Carbon cost 1-3 less than other
Flame Arcs.*

Direct or Alternating Current.

Write for Bulletin and Prices.

THE ADAMS-BAGNALL ELECTRIC CO.
CLEVELAND, O.

CHICAGO OFFICE
303 Dearborn St.

NEW YORK OFFICE
143 Liberty St.

Q Save the Furnace or Steam
Plant on damp and cool days
this Fall by using

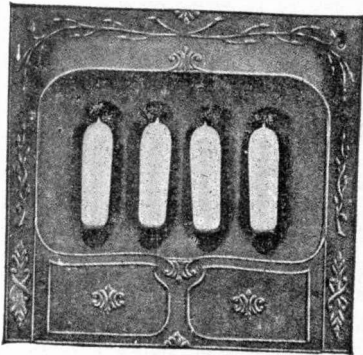

The Electric Open Fireplace

Convenient—Full Heat obtained by simply pushing a button. Safe—No Flame, Gas or Odor. Clean—No Smoke, Dust or Ashes. Beautiful in Design, Perfect in Finish.

All the advantages of the Fuel or Gas Grate without any of the drawbacks, and at less cost.

Send for complete free book and prices to

RATHBONE & PANIGOT CO.

Patentees and Makers

Grand Rapids, Michigan

We
Protect
The
TRADE



Dealers—Send us your name at once,
we want to send you FREE
our Catalog 15.

Write at once.

R. Williamson & Co.

Manufacturers of
Electric and Combination
Fixtures and House
Lighting Supplies

Washington & Jefferson Sts., Chicago

The Best of All Gifts for CHRISTMAS!

Sold on
Credit

\$13.40 Buys this "Lieutenant Landis" 15
Jewel Movement, Gold Filled Case

Value
\$35.00

Open Face
Gold Filled
20 Year
Case

There's nothing equal to a handsome gold watch as a Christmas present! Why not take advantage of our astonishing offer on the celebrated "Lieutenant Landis" Watch!

Watches Sent on Trial—Sold on Credit!

This beautiful watch has 15-JEWEL Movement and Open Face Gold Filled Case, guaranteed for 20 years. It's a stunner! Regular \$35 value—NOW \$13.40 ON CREDIT. We send Watches and Jewelry anywhere for a month's examination. No sale unless you are satisfied and delighted by the quality of goods. Your credit is good here.

Buy Christmas Presents on Credit

From Great Watch and Jewelry Catalog!

Send at once for magnificent Free Catalog of Ladies' and Gentlemen's Watches, Diamonds and Jewelry. Over 1,200 superb specimens of the watchmaker's and jeweler's art. Every thing offered on credit at astounding reductions. You can give away any articles purchased while you are making the small monthly payments.

Big Values—Little Prices!

We give more for the money than any watch and jewelry house in the country. You will be surprised at the small prices—the big values. Credit extended to all! WRITE FOR CATALOG TODAY.

LINCOLN WATCH & JEWELRY CO., 3316 Mospr... Street, CHICAGO, ILL.



\$15.80
Hunting
Case

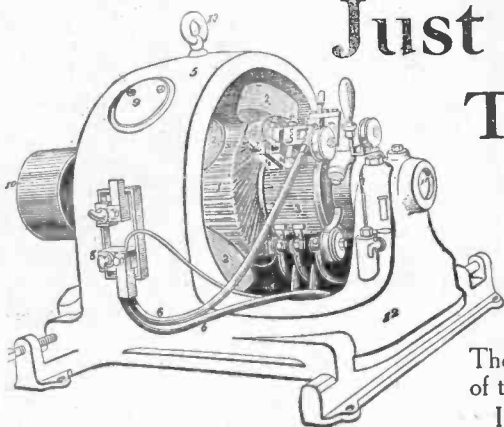

Just Off the Press THE DYNAMO

Its Growth and Construction
Simply Explained

By Joseph G. Branch, B. S., M. E.,
Author of "Conversations on Electricity,"
"Stationary Engineering," etc.

Most unique book of the kind. Nothing like
it ever before published.

The author is one of the best known, practical writers
of the day and this little work is his master-piece.

It is written in the simplest and clearest language,

contains no mathematics and yet is so practical and thorough that it will start you right in your
work as a practical electrician.

Every part of the dynamo is shown in nine full-page, beautifully colored illustrations, each part
being numbered with full explanatory text in connection so that the complete anatomy of the ma-
chine can be seen at a glance.

Strong paper covers—Price—postpaid—Fifty Cents.

FREE for one paid yearly subscription to POPULAR ELECTRICITY.

Subscription must be a new one—and your own will not do.

Popular Electricity Book Department

Monadnock Block

Chicago, Ill.

THE NATIONAL MAGAZINE

Read by the Nation

HAVE YOU HEARD OF

THE NATIONAL MAGAZINE

Read by the Nation

HEART THROBS

HEART SONGS

"HEART THROBS"

the book compiled by 50,000 Americans at a cost to the NATIONAL MAGAZINE of \$10,000: It is a book that you should have, for it contains the selections that you and your friends love so well. It is, indeed, a book lover's gem,—a book for all times and for all seasons, for young and for old, one that will refresh and entertain. It is the popular gift book of today.

For sale at all first class book stores, or direct
Cloth, \$1.50 Morocco, \$3.00

"HEART SONGS"

compiled in the same unique way, as was HEART THROBS to which it is a companion book, HEART SONGS voices with words and music the songs that have endeared themselves to the people of this and other generations. Its charming simplicity, echoing the spontaneous sentiments of 50,000 Americans, will commend it to every musical home.

For sale at all first class book stores, or direct
Cloth, \$4.00 Morocco, \$6.00

THE NATIONAL MAGAZINE

edited by Joe Mitchell Chapple and contributed to by the nation's leaders, is the magazine of all magazines for the American people.

15 cents per copy \$1.50 a year

"THE HAPPY HABIT"

the book in which the readers of The NATIONAL MAGAZINE have preserved to posterity the cheeriest and brightest of Editor Joe Mitchell Chapple's many-sided writings. These selections written in Joe Chapple's characteristic way effervesce with that spirit of optimism and style of intimacy which have endeared him to his many readers. The Happy Habit will dispel the gloom of a dark day; will win over the pessimist to the ranks of the cheerful.

For sale at all first class book stores, or direct
Cloth, \$1.50 Morocco, \$3.00

"The Story of a Great Nation"

the book that will give you a clearer conception of the economic working of the National Government than any book heretofore published. The Story of a Great Nation was written for The NATIONAL MAGAZINE by sixty Government authorities. President Taft dolls for a moment the robes of office; "Uncle Joe" lays aside the speaker's gavel; Chief Wilkie discards the mask of Secret Service—every important factor in our Government, in fact, elucidates in a simple, comprehensive way the manner and institutions of our Government.

For sale at all first class book stores, or direct
Cloth, \$2.00 Morocco, \$4.00

PUBLISHER'S SUBSCRIPTION OFFER

Add the price of any of these books to the price of the National Magazine (\$1.50) and deduct \$1.00

All postage prepaid

THE CHAPPLE PUB. CO. Boston

THE CHAPPLE PUB. CO. Boston

2c a Week Pays Wash Bill!

Electricity or Water-Power Does the Work

Write for
FREE Book

Just a "Twist of the Wrist" Starts or Stops the Machine!

The 1900 Motor Washers are now at work in thousands of homes. They are doing the work formerly done by women, at a cost of 2 cents a week for power! Saving thousands upon thousands of dollars in wash bills. Saving worlds of wash-day troubles. Leaving the women free to do other work while the machines are doing the washing.

The 1900 Motor Washer

Washes a Tubful in Six Minutes!

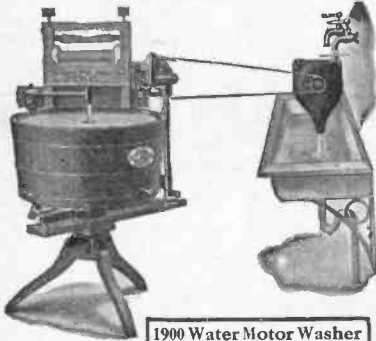

1900 Water Motor Washer
Can be connected with any water tap instantly

Handles heavy blankets or dainty laces.

The outfit consists of the famous 1900 Washer with either Electric Motor or Water Motor. You turn on the power as easily as you turn on the light, and back and forth goes the tub, washing the clothes for dear life. And it's all so simple and easy that overseeing its work is mere child's play.

A Self-Working Wringer Free With Every Washer

The motor runs Washer and Wringer. We guarantee the perfect working of both. No extra charge for wringer, which is one of the finest made. Write for **FREE BOOK** and **30 Days' FREE TRIAL OFFER!** Don't doubt! Don't say it can't be done. The free book proves that it can. But we do not ask you to take our word for it. We offer to send a 1900 Motor Washer on absolute Free Trial for an entire month to any responsible person. Not a cent of security—nor a promise to buy. Just your word that you will give it a test. We even agree to pay the freight, and will take it back if it fails to do all we claim for it. A postal card with your name and address sent to us today will bring you the book free by return mail.

All correspondence should be addressed to **1900 WASHER CO.** 3409 Henry St., Binghamton, N. Y. Or, if you live in Canada, write to the Canadian Washer Co., 355 Yonge St., Toronto, Canada.



1900 Electric Motor Washer
Can be connected with any ordinary Electric Light Fixture

BRANCH HOUSES: We maintain branches at 1947 Broadway, New York City, and 1113 Flatbush Ave., Brooklyn, and in all principal cities. We also make shipments from our warehouses in Kansas City, San Francisco and Seattle.

STIENER'S FAMILY MOTOR

Will run any Washing Machine and Wringer, do all of your other kitchen work. One motor for all purposes—one expense. Will operate any of the articles shown in picture for 1½c. an hour. No experiment—On the market over 2 years.



SAVES YOU \$90.00 A YEAR

HOW? Write for booklet Explaining Fully

STEINER MFG. CO., 2603 North 14th Street ST. LOUIS, MO.

The "IMPERIAL"

A Portable Vacuum Cleaning Machine combining efficiency, practicability and economy. Can be attached to any electric light socket



"The Only High-Grade, Efficient Machine on the Market." Guaranteed

A Dividend Payer for Central Stations

Growing concerns and responsible parties wanted as agents. Exclusive territory given. Send for Catalogue and Particulars.

Price \$100, Complete

EMPIRE VACUUM COMPANY

112 West 30th Street, New York

Deaf Persons Can Now Hear

Wonderful Invention Has Delivered Thousands from the Handicap of Deafness.

Don't think you have to worry along if you can't hear well. Every deaf person is at a hopeless disadvantage, deprived of social pleasure, barred from active business. Any dullness of hearing is a constant mortification.



But now this misery is unnecessary. Every deaf person can hear as well as ever before by simply wearing a pair of

WILSON'S EAR DRUMS

A wonderful little device that fits into the ears without the slightest discomfort. Invisible when inserted—so tiny, so perfect, that you forget you are wearing them. And the effect is magical.

This marvelous invention was perfected by Mr. Geo. H. Wilson, after years of suffering from hopeless deafness. They enabled him to hear perfectly. And this miracle has been repeated for 200,000 persons.

Send today for a book written by Mr. Wilson that tells the whole story—gives hundreds of letters from grateful users. This priceless book is FREE for your name on a postal. Just ask for Mr. Wilson's book. It will come by return mail. Address Wilson Ear Drum Co., 463 Todd Bldg., Louisville, Ky.



Wire, Coils and Cordage

NORWAY IRON WIRE for cores, COTTON, SILK and EMAMELED MAGNET WIRE, heavy and fine sizes for primary or secondary windings, receiver coils or coils of any kind.

COILS wound to your specifications. BELL WIRE and ELECTRICAL CORDS for every purpose.

The above furnished at lowest prices in small quantities for wireless telegraph or experimental purposes, or in large quantities for manufacturers.

Write for prices to Dept. E.

BELDEN MANUFACTURING COMPANY

194 Michigan Street - - CHICAGO, ILL.

RHEUMATISM

I want to send every sufferer who reads this paper a pair of Magic Foot Drafts TO TRY FREE.

SEND ME YOUR ADDRESS TODAY

Write me. I'll send you a \$1.00 Pair of Magic Foot Drafts, the great M'Li-Hon external remedy that is curing thousands, To Try FREE.



FREDERICK DYER, Corresponding Sec'y.

No matter where the pain, whether acute or chronic—muscular, sciatic, lumbago, gout—and however stubborn or severe, you'll get the Drafts by return mail. Then after you get them and try them, if you are fully satisfied with the benefit received, send me One Dollar. If not, keep your money, I take your word.

I make this unequalled offer because I know what remarkable cures the Drafts are performing—cures after 30 and 40 years of suffering—cures after doctors and baths and medicines had utterly failed. Won't you try them? I am sure you'll be glad if you do, and you cannot lose a penny. Address Magic Foot Draft Co., 1140F Oliver Bldg., Jackson, Mich. Send no money. Write today.



TRADE MARK

ONLY
50
CENTS



Boys and Girls, this Real
ELECTRIC MOTOR
is yours for half a dollar

You can have no end of fun with this genuine electric motor. Runs just like a big one. Would cost at least a dollar at any toy store. Well made, lasts forever. Ordinary telephone battery runs it. Will drive toy machinery of any kind. Makes 2,000 revolutions a minute. Five times as big as the picture. Send us half a dollar (10c extra for postage) and we'll send it by return mail. If unsatisfactory we refund your money.

Let us send you free our book for Boys and Girls "ELECTRICAL FUN-MAKERS"

Absolutely FREE. A book every fun-loving boy and girl should have. Tells about all kinds of things that run by electricity. Some of them you can make yourself. We sell all kinds of electrical novelties boys and girls want at manufacturer's prices—about half what toy stores charge. Just write your name on a postal card, with your address, and say "send the book." Do it today. Address

Commercial Electric Co., Dept. 103 Kewanee, Ill.



**TWO COMPLETE TELEPHONES
READY TO INSTALL \$4.25**

Guaranteed satisfactory or money cheerfully refunded.

CENTRAL TELEPHONE & ELECTRIC CO.
2139 Lucas Avenue St. Louis, Mo.



Safety Razor Blades Made Sharper Than New **2 1/2** EA.

Exclusive process; no wearing down; double edge blades a specialty. Send one dozen blades and 30c to buy and save 70c.

KEENEDGE CO., 617 Keenedge Building, CHICAGO

[For our Mutual Advantage mention Popular Electricity when writing to Advertisers.

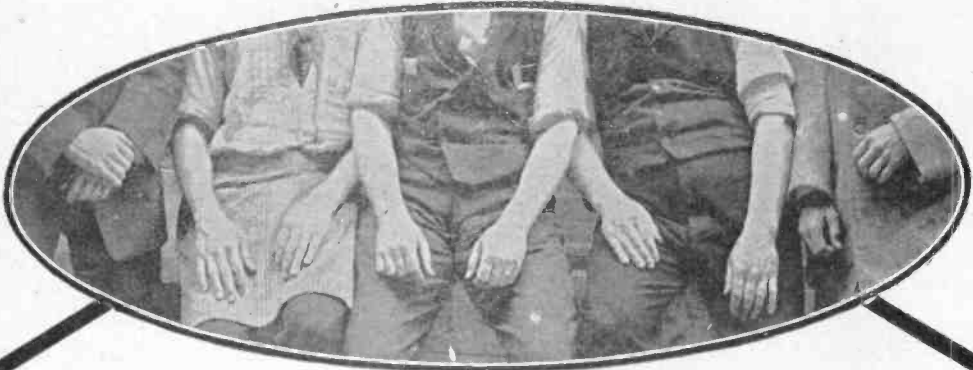

Are YOU One of the "Hands"?

There are two classes of workers—head workers and hand workers. Are you one of the hands? What you get on pay day determines it.

The man who works with his hands does imitative manual labor which thousands of others can do just as well. He is hired at will and may be discharged on a minute's notice. He has no vacations with pay, and if he loses time through sickness or for any other reason, he loses his earnings. He is held down to a life of monotonous routine work, has long hours, and receives low wages.

The ranks of the hand workers are eminently honorable. Such work is the true basis of all success, but the man who stays in these ranks all his life greatly wrongs himself and does injustice to his family or those dependent upon him. He must advance as years go on to the head worker's class.

The man who works with his head is a specially trained man whose place would be hard to fill. He is employed by the month or year, has regular vacations on full pay, does not lose his salary because of sickness, has short hours of work, and receives a good salary.

But it is by no means a difficult thing for the hand worker to become a head worker. The largest institution of its kind in the world has for the last 18 years been helping tens of thousands of handicapped men to get rid of the rule of work-by-the-day jobs and low wages, by training them to hold the high-salaried positions of the head worker. By simply marking and mailing the coupon below, this great institution will take up your individual case, and tell how it can help you to gain a better position, increased earnings, and a successful future. It puts you under no obligation whatever to send us the coupon.

Isn't your future worth this much to you?

International Correspondence Schools
Box 1102, Scranton, Pa.

Please explain, without further obligation on my part, how I can qualify for employment or advancement in the position before which I have marked X.

Bookkeeper	Telephone Eng.
Stenographer	Elec.-Light. Supt.
Ad Writer	Mechanical Eng.
Show-Card Writer	Plumb. and Steam
Window Trimmer	Pitner
Commercial Law	Stationary Eng.
Illustrator	Civil Engineer
Civil Service	Building Con.
Chemist	Architect's Drafts.
Textile-Mill Supt.	Architect
Electrician	Structural Eng.
Electrical Engineer	Banking
Mechanical Drafts.	Mining Engineer

Name _____

St. and No. _____

City _____ State _____

POPULAR ELECTRICITY

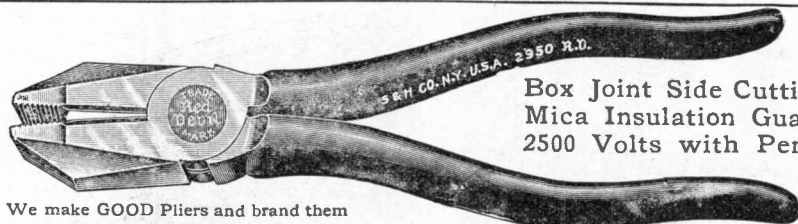

Box Joint Side Cutting Plier. Rubber Mica Insulation Guaranteed to Stand 2500 Volts with Perfect Safety.

We make GOOD Pliers and brand them

"Red Devil"

EACH INDIVIDUAL TOOL IS PURPOSEFULLY CORRECT AND THE BEST THAT MECHANICAL SKILL AND GENIUS, WORKMANSHIP AND MATERIAL CAN PRODUCE.

Order "Red Devil" Pliers from your dealer OR IF HE CANNOT SUPPLY YOU ORDER DIRECT.

SMITH & HEMENWAY CO.

110 Duane Street

New York City

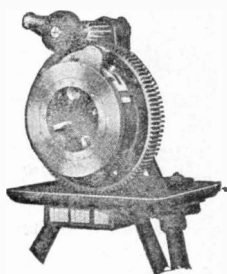

THREADS CUT ON STEEL CONDUIT

This Portable Pipe Cutter is so constructed that it might be called a one-man tool as it can be used either on the work bench or on the floor.

It is a very light weight tool and possesses the very best of workmanship for an astonishingly low price

Write to day for our new catalog.

THE OSTER MFG. CO.
2180 East 61st St., CLEVELAND, O.

2 to 25 h.p.
1 to 4 c.v.
PERFECTION ENGINES
Marine and Stationary
\$29 to \$450

The Marine Sensation of 1909-10

Write at once for information about our new 7 to 8 H. P. Special Heavy Duty Engine. Develops 8 H. P. at 500 revolutions. Crankshaft 1 3/4 inches; propeller shaft 1 1/2 inches; 3-blade bronze propeller; extra long bearings lined with the very best babbit obtainable. A wonder for service, power and durability. Schebler Carbuettor.

The greatest engine ever built for hard work. Find out about it. Write today. CAILLE PERFECTION MOTOR CO., 1315 2nd Ave., Detroit, Mich.

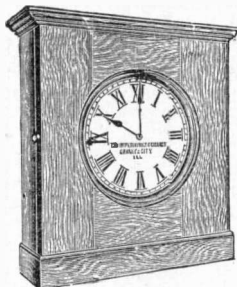
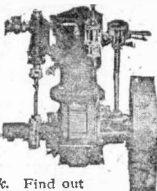

This Electric Clock will run two years without stopping.

Runs from one to two years on 2 cells; cost 40c to 50c for renewal; so simple that it needs no repairs; it is operated by an automatic weight which means accuracy. The cheapest electric clock now on the market. Finished in golden oak or birch mahogany. They are beautiful. Dimensions are 24 inches high, 20 inches wide, 12-inch dial. Ask your jeweler to order you one or write us for prices.

For Buffets, Hotels, Offices, Colleges, Etc.

Ask for our catalogs and prices
THE IMPERIAL ELECTRIC CLOCK CO.
GRANITE CITY, ILLINOIS

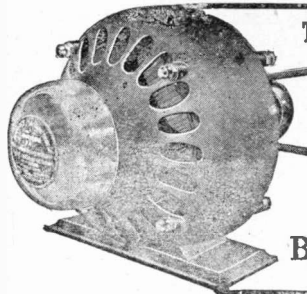

The Barnes Variable Speed Alternating and Direct Current Motor

1-12 and 1-8 H.P.

The only high speed, single phase, alternating motor that absolutely will not heat. Responsible agents wanted.

Barnes Mfg. Co.
Susquehanna, Pa.

GOES LIKE SIXTY
SELLS LIKE SIXTY
SELLS for SIXTY \$60

GILSON Gasoline ENGINE

For Pumping, Cream Separators, Churns, Wash Machines, etc. Free Trial 1 to 25 Horse Power. Ask for Catalog.

GILSON MFG. CO. 600 Park St. Port Washington, Wis.

For our Mutual Advantage mention Popular Electricity when writing to Advertisers.



"LAND"-4¢

I want every man who is interested in securing land, either for a home or as an investment, to send for my book—"Land." It is full of facts you ought to know about. Government land, and land offered for sale in various sections of the country. These facts about climate, crops, rainfall, cost, etc., will help you to intelligently and profitably choose land in Oregon, Washington, California, Idaho, Wyoming, Texas, Florida, Louisiana, and many other states, as well as in Mexico, Cuba, Central America and Canada. Send 4c today to help pay for mailing.
F. E. DOBBINS, Land Commissioner
 809 Finance Bldg., Kansas City, Mo.

Send for this book

Wireless Experimenters Attention

SPECIAL PRICES ON WIRELESS GOODS FOR THIS MONTH ONLY

Sliders, ball-bearing type, 25c. each, 1/4-inch square rods to fit sliders, highly nickel plated, 12-inch long at 30c. each; larger sizes in proportion. Wollaston Wire .00001 per inch, 25c. Parts for all instruments sold separately.

Enclose 2c. stamp for our wireless catalogue, our railway and novelty catalogue will be mailed for a 2c. stamp.

THE I. W. T. WIRELESS

728 Broadway, Brooklyn, N. Y.

New Electrical Novelties

Sent postpaid at Lowest Prices

The new Tungsten Tubular Flashlight with improved battery and lamp sent postpaid for 75c with two extra dry or refillable batteries only \$1.00. Gives 1500 flashes.

Read These Prices!

ALL HIGH GRADE GOODS WITH NEWEST IMPROVEMENTS:

- Electric Cigar Lighters..... 30c up
- " Scarf Pins..... 35c "
- " Flashlights..... 35c "
- Extra Flashlight Batteries..... 6c "
- Miniature Lamps..... 10c "
- Electric Engines..... 45c "

Send stamp for new catalog of complete list.

DEALERS Write for our favorable terms and big discounts on quantity order.

ELECTRIC NOVELTY CO.
 Manufacturers and Importers
 246 Third Avenue, PITTSBURG, PA.



ELECTRIC LIGHTS

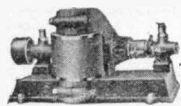

Our outfits are automatic and require no particular attention while running. Made in many sizes. Send for bulletin 104 F

A Complete 8 Light Outfit for \$110

This price includes Dynamo, Storage Battery, Lamps, Wire and Fixtures. Can be installed by any one.

The dynamo can be driven by any convenient power, steady or intermittent. Only one-half H. P. required.

Elbridge Electrical Mfg. Co.
 Elbridge, N. Y. U. S. A.



is the most wonderful and interesting scientific study of the age. Every boy, girl and grown-up should know

about it. Our fascinating 112-page book just makes it easy for you to learn.

We'll send you this new, enlarged catalogue on receipt of 6c. It contains a coupon which entitles you to a rebate of your 6c. on first order of 50c. or over.

Catalogue contains hundreds of illustrations and descriptions of **VOLTAMP ELECTRICAL PRODUCTS**—Wireless Instruments, Motors, Dynamos, Machine Models, Toys, Telegraph Instruments, Batteries, Meters, Coils, Switches, Geissler Tubes, Lamps, Flash-Lights, Telephones, Bells, Miniature Railways, etc.

A boon to the experimenter as well as the practical electrician

VOLTAMP ELECTRIC MFG. CO. Park Bldg., Baltimore, Md.

ELECTRIC GOODS FOR CHRISTMAS.

The World's Headquarters for Dynamos, Motors, Fans, Toys, Batteries, Belts, Bells, Pocket Lamps, Toy Railways, Books, etc. We undersell All. Fortune for Agents. If it's electric we have it. Big Cat. 3 cts.

OHIO ELECTRIC WORKS, CLEVELAND, OHIO

For our Mutual Advantage mention Popular Electricity when writing to Advertisers.

Remarkable Feat for Wireless Boy

"With a wireless station that cost him just \$19, Elmer Lamb, an 18-year-Toledo boy, living on Erie near Galena St., on Friday picked up the U. W. Co.'s 2 K. W. station at Atlantic City, N. J., and a few minutes later picked up the cruiser Oklahoma on the Atlantic coast, and the station at Cape Cod, Mass. The feat is regarded as remarkable here. The boy's instruments complete cost him just \$19. Station is equipped with a 50-foot aerial, Ferron detector, tubular condenser, tuning coil, and 2,000 ohm lead set.

—From Toledo News-Bee of Sept. 18th, '09

The Celebrated Ferron Detector

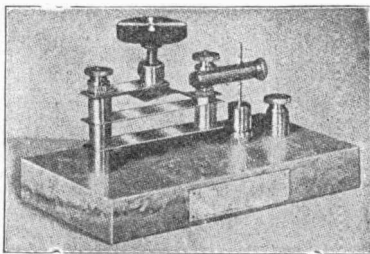

FERRON DETECTOR, PRICE \$8.00

The Ferron Detector is fast becoming the acknowledged detector for high class wireless work. Guaranteed to be accurate by means for sensitivity, and far superior to any detector in existence selling for \$5.00. With our highest grade receiving set, it has a proven range exceeding 2,000 miles. Because of its extreme sensitiveness, no battery or potentiometer is required. It will withstand the strongest signals and remain adjusted for weeks. The users of electrolytic detectors will appreciate this point. The base is of finely polished Italian marble, and the metal parts beautifully nickel plated. The following enthusiastic letter unquestionably proves the Ferron to be much more sensitive than any silicon:

"My profound felicitations; your detector is certainly a bird, and as the president would say, it has all others done to a frazzle. While in Beverly, Mass., I tested it out with a silicon, and I could get P. C. (35 miles) as loud as I could get P. C. (15 miles) on the other."

Receiving set with a proven range of 100 to 300 miles \$12.75
 " " " " " 800 to 1000 " 19.00
 " " " " " 1000 to 1200 " 29.00
 " " " " " 1500 to 2000 " 59.00

Send 3c STAMP for our New Big Catalog of Anything Electrical.
 J. J. DUCK, 428 St. Clair St., Toledo, Ohio



GUDEMAN & COMPANY
Artistic Electrical Decorations

114-118 E. 23rd Street, New York, N. Y.

Electrically lighted Rose Basket—Fruit Trees—Fern
 Dishes—Flower Baskets—Floral Festoons and
 many other designs

MINIATURE AND DECORATIVE LAMPS
 of any description
CHRISTMAS TREE OUTFITS

Our goods on sale at ELECTRIC SHOP, Michigan and Jackson
 Boulevard, Chicago, Ill.

Write for Descriptive Catalogue



Taking the Motosphere Treatment

**MARVELOUS CURES IN INDIGESTION, NERVOUS
 PROSTRATION, INSOMNIA, LA GRIPPE, RHEUMATISM,
 GOUT, SCIATICA, and COMPLAINTS ARISING
 FROM CONGESTION or SLUGGISH CIRCULATION.**

The Motosphere is a new invention that changes electricity back to the original lines of force and concentrates them over the vital organs. Scientific, yet simple—it is vital energy concentrated; the essence of nerve force that revitalizes the blood and enables the system to throw off disease. Does not cost one cent unless it absolutely cures.

Send for booklet of testimonials and particulars.

The Motosphere Mfg. Co.

31 East 27th St., Dept. E, New York City

Price \$12.00 AT FACTORY



SAVE ROOM

Most convenient and practical low-priced Typewriter Stand on the market. Made of selected Oak, fine golden finish, 44 in. long, 24 in. wide; Pedestal 30 in. high; 3 drawers and extension slide; Paper Cabinet with shelves 14x8 1/2 in.; Cabinet has roll curtain front and copy holder. Order from dealer if he has it or will get it; otherwise from us. Do not accept a substitute; no other Typewriter Stand is "just as good."

Ask for Catalog by Number Only.

Quality Excellent

We also make School, Church and Opera Seats, Lodge Furniture.

No. 219—Office Desks, Chairs, Files, Book Cases, etc.

No. 419—Mission Furn Rockers, Davenport, Couches, Settees.

E. H. STAFFORD MFG. CO., 248 Adams St., Chicago, Ill.

DIE WORK MODELS SPECIAL MACHINERY
NATIONAL STAMPING AND ELECTRIC WORKS
 153-159 S. JEFFERSON STREET, CHICAGO, ILL.

AGENTS PORTRAITS 35c. FRAMES 15c.
 Sheet Pictures 1c. Stereoscopes 25c.
 Views 1c. 30 Days' Credit. Samples and Catalog free
 CONSOLIDATED PORTRAIT, Dept. 1408, 1027 W. Adams St., Chicago.

35 POSTCARDS.—Halloween, Thanksgiving, and others; all different. 100 for 25c. A. A. Bradley, 3824 Warron Ave., Chicago. 10c

For our Mutual Advantage mention Popular Electricity when writing to Advertisers.

Electric
Light
is now
cheaper

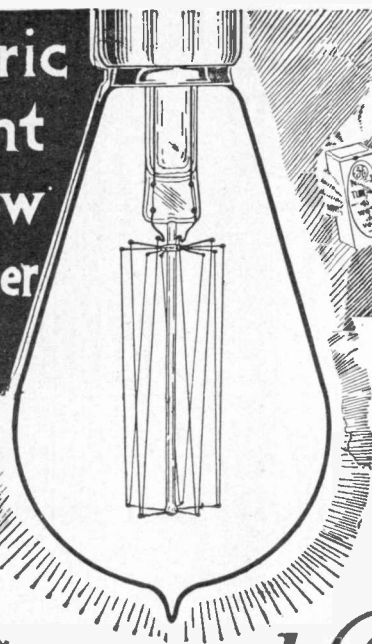

YOU can have a flood of beautiful, healthful Electric Light at 1-2 the old cost by using....

General Electric TUNGSTEN LAMPS

The last argument of gas and oil is gone. They can no longer offer even the claim of economy. With G-E Tungsten lamps electric light becomes at once a greater luxury and also much cheaper. The new filament in this lamp—its distinctive feature—produces a wealth of beautiful clear, white light with less than half the electricity required by old style incandescent lamps of equal candlepower.

An International Achievement

The G-E Tungsten lamp represents the combined achievement of European and American genius.

The General Electric Company secures for users of all its products the best that science and skill can produce by acquiring the rights and processes for the United States of the foremost inventors both in America and Europe.

Recognizing the revolution that the G-E Tungsten lamp would create in lighting, the Company has secured all foreign processes of merit which would improve these lamps

Some Questions Answered

You can use G-E Tungsten lamps in any electric light socket—in any position—at any angle.

The G-E Tungsten lamp has a tough, durable filament and an average life of one year or 800 hours use.

You can identify the genuine G-E Tungsten lamp by the famous G-E monogram on the lamp and on the package.

You can buy G-E Tungsten lamps of any size for any voltage from your electric light company or supply dealer—or write us.

G-E Tungsten Booklet No. 34 (illustrated) tells more about these wonderful lamps and gives some valuable hints on the most effective way to light the home, office, store and factory. Write for it today.

GENERAL ELECTRIC COMPANY, Dept 30, SCHENECTADY, N. Y.
THE LARGEST ELECTRICAL MANUFACTURER IN THE WORLD



LEARN THE
Automobile Trade
WITH
DYKE'S COURSE OF
Automobile Instruction

A NEW METHOD WITH WORKING MODELS

Listen! We have *Testimonial Letters* from each and every customer. Study during spare time—Dyke's Course is now only \$10 and you would never miss the amount. The Automobile and Gasoline Engine profession is the best profession, and there is a big demand for help in this line. **IF YOU OWN** an auto, or launch, or in any way connected or interested in gasoline engines then this course will be of great benefit to you. If you wish to learn the trade this is your opportunity.

DYKE'S COURSE is the only course in the world which can successfully be taught by mail. We use wonderfully clever *Working Models* (made in Europe) of the **Gasoline Engine** and **Magneto** and **Carburettor** that actually work, and they picture the meaning while you study our interesting *Instruction Pamphlets*.



JUST IMAGINE, having in your room an engine cut in half and with each and every part lettered and numbered, also a Carburettor and Magneto lying on your study table while you study our interesting course—that's practically what we give you in our **working models**. You will play with these models like a boy with a toy and the more you play the clearer the subject will be to you.

IN ADDITION we give 24 lessons which are so interesting you will finish them all—they are illustrated with 34 large clear charts.

WE TEACH YOU everything there is to learn about the Automobile and Gasoline Engine such as valve setting, timing ignition, how the cylinders fire, construction of all forms of Magnetos and how to set them, storage batteries and all systems of wiring, and many other important subjects.

ONE CUSTOMER SAYS:

"I've learned more in three weeks study of your Course than during my ten years work around the shop."

Another customer who knew nothing about the Auto or Gasoline Engine says he can now run any car and set valves, etc.

OUR LIBERAL TRIAL OFFER of inspection is proof of our claims, get our fine pamphlet and testimonials.

AUTOMOBILE OWNERS will save the cost the first month. Automobile Engineering is a profitable trade to learn. Our Course qualifies you—write today.

NOTE We are considering the advisability of raising the price on this wonderful Course. Even our students say it is worth a great deal more and it is.

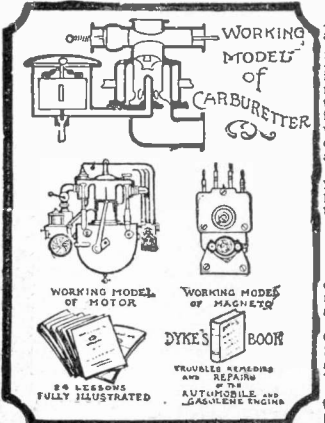

MR. DYKE was the first Auto Supply man in America and built the fifth successful Automobile in this country. His experience is embodied in this course. Mr. Dyke made a special trip to Europe to secure additional matter for this great Course. The working models were designed and are made in Europe by a leading mechanical artist. **NO MATTER** how much you would pay you could not possibly get a course equal to this one.

Here They Are:

The working models of our Gasoline Engine, Magneto and Carburettor—they actually work.

The real feature of our Course, however, are our 24 simple illustrated lessons. We also include a Text book.

It is great—all our customers say so—not one, but all.

FREE THIS AUTO BUTTON AND INSTRUCTIVE PAMPHLET SEND FOR IT TODAY

DYKE'S Corp's School Motoring
1300 Bk. Commerce Bldg., St. Louis

LEARN

Send for Circulars

WIRELESS

TELEGRAPHY

The only official recognized school for the teaching of

Wireless Institute of California, CENTRAL TRUST BUILDING

568 Golden Gate Ave.

SAN FRANCISCO, CAL.

Important Notice to Chicago Subscribers

(By order of the Postmaster, Chicago.)

On September 1, 1909, the renumbering of streets in Chicago will be in effect according to ordinance passed by the Chicago City Council. In order to correct our mailing list and have this publication going through the mail to subscribers in Chicago properly addressed, the publisher asks you to kindly cut out the following form, and after answering the questions appearing thereon, to mail it under cover of envelope sealed, postage prepaid (two cents.)

Popular Electricity Publishing Co.
Monadnock Block, Chicago

(Name of Subscriber)

(New Street and Number)

(Old Street and Number)

For our Mutual Advantage mention Popular Electricity when writing to Advertisers.

ELGIN WATCHES ON CREDIT



P. S. HARRIS,
President Harris-Goar Co.
The House that sells more
Elgin Watches than any
other firm in the world.

BIG SPECIAL This Month
17-JEWEL ELGIN only \$14.50

Let me send you
this High Grade Genuine
17-Jewel ELGIN WATCH in
Hand Engraved Case on

FREE TRIAL

IF IT SUITS YOU
PAY ONLY \$2.00 A Month



You assume no risk whatever in dealing with us, because, before
you buy or pay one cent, we place the watch right in your own hands and let it do its own talking.

We Ask No Security and No Interest—just plain honesty among men. Our Elgin Watches are so
well known and our CREDIT PLAN so easy, that no matter
where you live or how small your wages, **WE WILL TRUST YOU**, so that you and every honest man and woman can own a
High-Grade Elgin Watch in a beautiful Guaranteed 25-year Gold Case and wear it while paying for it in such small payments
that you never miss the money.

Write Today for Our Big Free Watch Catalog

It tells all about our easy credit plan and how we send Elgin 19-Jewel B. W. Raymond and 21 and 23-Jewel Elgin Veritas
everywhere on Free Trial, without security or one cent deposit. Positively Guaranteed to Pass Any Railroad Inspection.

HARRIS-GOAR CO., 1401 Grand Ave., Kansas City, Mo.

ELGIN WATCHES LEAD THE WORLD

Wordy Horn Blower

\$2 Only **\$2**
Two Dollars

Fits
Any
Horn-
Tube

Used
On
Any
Car

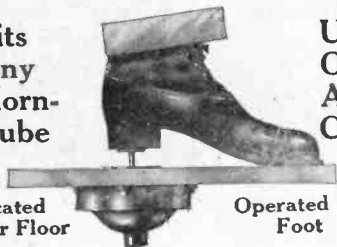

Located
Under Floor

Operated by
Foot

Throw away the rubber bulb and attach a
Wordy Horn Blower. Increases volume of
sound 300 per cent. Lasts a lifetime.

We Guarantee It For 5 Years

No trouble to place on car. Anyone can
do it.

Send for free, illustrated catalog, and learn
all about this wonderful invention.

Sold by auto-supply dealers, or sent, pre-
paid, on receipt of two dollars. Satisfaction
guaranteed or money refunded.

Wordingham Auto Supply Company
Dept. F, Grand Ave., Milwaukee, Wis.

Wool Trousers for Fall \$3.50

MADE TO YOUR MEASURE
NEWEST STYLE

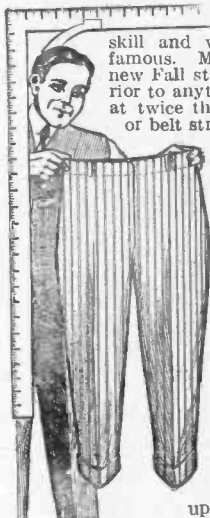

Our master cutters and tailors
will put into these trousers all the
skill and workmanship that have made us
famous. Made exactly to your measure, in
new Fall style by experts; they are far su-
perior to anything your local tailor can produce
at twice the price. No extra charge for cuffs
or belt straps or any of the newest wrinkles.

Why wear ready-made, ill-fitting
garments when you can wear the
best for less money?

**DON'T PAY UNTIL YOU
HAVE THE TROUSERS**
Don't pay us a cent until you
have the trousers and are per-
fectly satisfied in every respect.
No matter where you live, we
can serve you, as we prepay ex-
press everywhere and have cus-
tomers from Main to California.
We take the risk.

FREE Just write us today—
we will send you free a
dozen samples of goods to choose
from, our New Fashion Plates and self-
measurement guide. Select the
goods you want from this elegant
assortment of new wools and send
us your measure and order. Don't
send any money. We will then mail

up the trousers and send them to you.

Express Charges Prepaid Anywhere

When they arrive, inspect them carefully, invite your
friends to look at them, and if pleased, pay only \$3.50.
Unless these goods were far superior to anything ever
shown, we would not dare make this offer. Write today
for free samples and fashion plate. Address

GRAND PANTS COMPANY

12th and Walnut St. Dept. F. Kansas City, Mo.

For our Mutual Advantage mention Popular Electricity when writing to Advertisers.



PITTSBURG, PENN.

Hotel Schenley

Opposite New Half Million Dollar Baseball Park

Surrounded by three acres of lawn and gardens away from the noise and smoke. **Absolutely fireproof.**

Visitors from all over the country are attracted to Pittsburg by that great gift of Andrew Carnegie.

The Carnegie Technical School and Institute

To see that alone is worth a trip to Pittsburg. The Schenley Hotel is opposite this national work of art. Rooms for business meetings furnished free of charge. Wire or write us at once and we will reserve rooms or you. The most attractive hotel in Pennsylvania.

The Schenley is the Waldorf-Astoria of Pittsburg.

Taxicab service ten minutes to all downtown points.
Concerts every evening by Pittsburg Festival Orchestra of 32 piece. Send for booklet.

JAMES RILEY, Proprietor and Manager

TELEPHONE MEN

CUT OUT THIS AD.

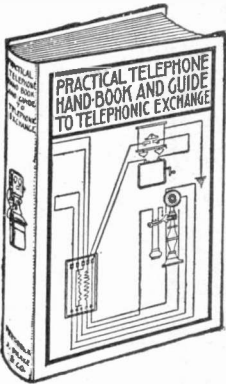

A clear, terse, comprehensive work on the construction, installation, care and management of telephone systems and appliances, including apparatus and methods for testing, locating and clearing of "trouble," with special data on Farm Telephones of great value to builders or promoters of Rural Lines. 179 pages—illustrated. Strong cloth covers.

Send it to us with \$1.50, which will entitle you to a year's subscription (new or renewal) to

Popular Electricity

and your choice of these valuable books on telephony.

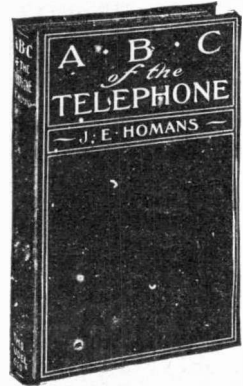

DON'T MISS THIS BIG CHANCE

Both books and 2 years' subscription for \$2.50.

POPULAR ELECTRICITY PUB. CO.
Monadnock Block, Chicago, Ill.

2d and revised edition
A practical and useful treatise for workers and students, in a clear and simple style.
350 pages, with very many illustrations, diagrams, circuits, and tables. Beautifully bound in black cloth, gilt embossed.

You Need One In Your Laundry

The Jewel Electric Washer does it all by electricity—washing and wringing. It is rapid, practically noiseless, and cannot tear or injure the most delicate fabric or break or jerk off buttons. Does in a couple of hours and at an expense of about 4c a week what it would take a laundress two days to do. Anybody can operate the Jewel Electric Washer—it's as simple as switching a light on or off. It will more than pay for itself in laundry saving in a few months. Made on a new washer principle. A saving of time, work and money in any home. Do not confuse it with any other washer—it's built on a new and better principle and costs less to operate.

We Guarantee

The Jewel Electric Washer against any defects in material or workmanship, and further guarantee that if, after 30 days use you find it in any way unsatisfactory, you may return it and your money will be refunded without question.



Small families and flat dwellers are buying Type M—large families, restaurants, small hotels, hospitals, small laundries, cafes, boarding houses, boarding schools are buying Type L.

For farms and country places we make a Jewel to be operated by gas or gasoline engine.

Send for our free booklet, "The Story of A Jewel." It describes the Washer, its application to uses in the home, hotel, laundry, institution, etc. Illustrates sizes and types and convinces you of its time, trouble and money saving features. Profusely illustrated. Ask your furniture or hardware dealer or electric light company to show you the Jewel. If they do not carry it write us direct, giving dealer's name and address.

Dealers

We can make a very interesting proposition to furniture or hardware dealers, dealers in electric appliances and central power stations who take hold of this proposition with us now. Write.

AMERICAN WASHER CO., Licensees

114 Sidney Street, St. Louis, Mo.

Where there are babies or frequent small washes the Jewel is a necessity

"Wireless" demands efficient motor service

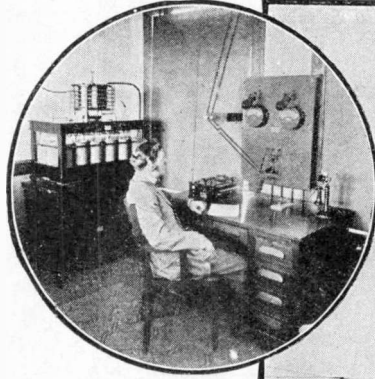

The reliable working of these motor generators saved many lives in the recent marine disasters.

The wireless telegraph on ocean and lake steamers is equipped with Robbins & Myers Motor-Generators. Their reliability is absolute and unquestionable.

This is true of *all* Robbins & Myers Motors.

We make nothing but small direct current motors, $\frac{1}{2}$ to 15 H. P. For printing and engraving machinery, washing-machines, iron and woodworking machinery, adding machines, air compressors, etc.

To Manufacturers:—

We have or will make a motor for every machine in your shop. Have you some problem in regard to power used in your factory, or in the machines you send out? If you have, send the coupon today to our Engineering Department and let us help you.

Where to get them

We carry a complete stock of motors in all sizes at all our branch offices and dealers everywhere have them.

THE ROBBINS & MYERS CO.,

1333-1433 Lagonda Ave. Springfield, Ohio.

Branches in NEW YORK, 145 Chambers St.; PHILADELPHIA, 1109 Arch St.; CHICAGO, 501-515 West Jackson Boulevard; BOSTON, 176 Federal St.; CLEVELAND, 1408 W. 3rd St., N.W.; NEW ORLEANS, 312 Carondelet St.; ST. LOUIS, Locust and 11th Sts.; KANSAS CITY, 120 W. 13th St.

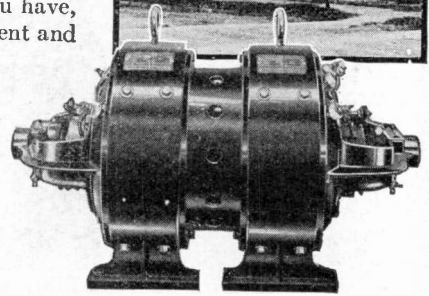
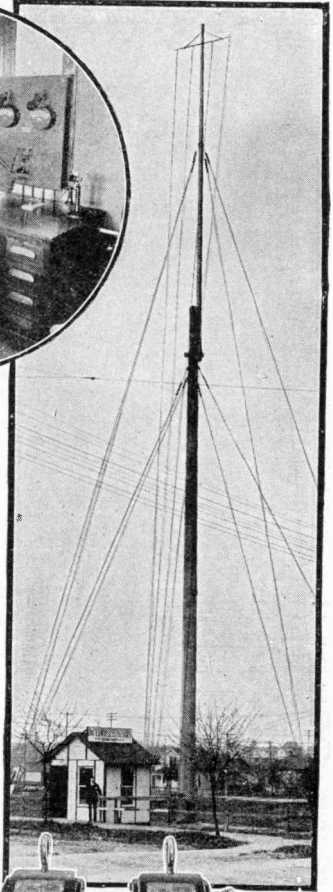

Wireless shore station and Robbins & Myers Motor-Generator.

Robbins & Myers Motors

DIRECT CURRENT "THE STANDARD" 1-30 to 15 H. P. For every machine

THE ROBBINS & MYERS CO.

Springfield, Ohio.

Send me your latest bulletin on Motors. I want a Motor for _____

Name _____

Address _____

COUPON.

For our Mutual Advantage mention Popular Electricity when writing to Advertisers.

DO YOU LIKE TO DRAW?

THAT'S ALL WE WANT TO KNOW



Now, we will not give you any grand prize—or a lot of freestuff if you answer this ad. Nor do we claim to make you rich in a week. But if you are anxious to develop your talent with a successful cartoonist, so you can make money, send a copy of this picture, with 6c in stamps for portfolio of cartoons and sample lesson plate, and let us explain.

The W. L. EVANS SCHOOL OF CARTOONING
325 Kingmoore Bldg., Cleveland, Ohio

LEARN CHIROPRACTIC
The new method of drugless healing
EARN \$50 TO \$100 PER WEEK



Our free book tells how you can learn to detect disease and remove the cause by Howard's method of Spinal Adjustment. Positively the most simple, direct, advanced and scientific method of drugless healing. Based on unerring natural laws. Anyone can understand it; learned in spare time. Improve your social prominence and financial standing. Start now on the road to honor and success. Write for free book and special scholarship offer.

NATIONAL SCHOOL OF CHIROPRACTIC
1732 W. Congress St., Dept. 8 Chicago, Ill.

My BOOK FREE

Memory the Basis of All Knowledge

Stop Forgetting THE KEY TO SUCCESS

HOW TO REMEMBER your memory. Easy, inexpensive. Increases income; gives ready memory for faces, names, business details, studies, conversation; develops WRITE TO-DAY will, public speaking, writing, personality.

Dickson Memory School, 929 Auditorium Bldg., Chicago

Before Designing Your
ELECTRIC MOTORS OR DYNAMOS

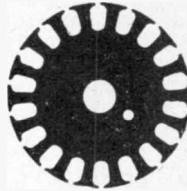

Send for our Circular of castings and parts. Armature discs, commutators, brush holders, etc., for Motors of 1-10 to 2 h. p. Dynamos to 25 light. FINISHED MACHINES AT LOW PRICES.

We always have a few second hand Motors and Gas Engines. If you need anything in a mechanical line write us.

F. E. AVERILL, Mgr. Buffalo, N. Y.
321 7th St.

"How to Construct a Practical Wireless Telegraph"

With illustrations, diagrams, and fine copy of the Codes, 25c. A 2c stamp brings our bulletin of wireless supplies.

CHICAGO WIRELESS SUPPLY CO.
Room 52G, Auditorium Office Bldg. Chicago, Ill.

VENTRILOQUISM

Learned by any Man or Boy at Home. Small cost. Send today 2-cent stamp for particulars and proof.

O. A. SMITH, ROOM 1222—2040 KNOXVILLE AVENUE, PEORIA, ILL.

ANTI-NICOTINE PIPE

"Get the Pleasure Without the Poison" Trade The Pipe They Let You Smoke At Home Mark

Looks and colors like meerschaum. Absorbs the nicotine and keeps on tasting sweet. You never had such an enjoyable smoke.

Order 3 or More Today.
H. MENDES
The Smokers' Friend
312 N. 7th St., St. Louis, Mo.

40c
Three For \$1.00
Sent Prepaid Anywhere
Money Back If Not Satisfactory

THE BEST SPARK PLUG MADE, ONLY 50c



The L. B. is a Standard Plug at a Popular Price. We challenge you to find a "break" idea in its design. Note these features: Porcelain is under no stress as the central electrode is supported at the upper end only. Absolutely no leakage as the expansion and contraction of the metal body is taken up by two McKim copper gaskets, one above and one below the shoulder of the porcelain.

These porcelain plugs were 75c—now 50c. Mica plugs for 75c—were \$1.00.

LEMKE-BRIGGS ELECTRIC CO., Dept. P E MILWAUKEE, WIS.

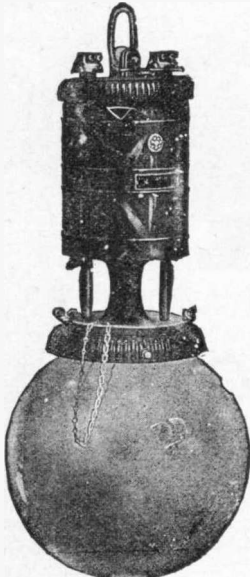

Flaming Arc

Intense Light

Made by a Warner Flaming Arc attracts attention at a distance or close by.

- ☞ Admitted by all to be the strongest light yet produced.
- ☞ Lamp practically indestructible, and made of fireproof material.
- ☞ Made for multiple use on A. C. or D. C. and for Series on High Tension D. C. Series.
- ☞ Vertical Carbon 5-8x12. Only one to trim.
- ☞ First cost less, maintenance less, and service greater than any other lamp made.

Warner Arc Lamp Co.
Muncie, Ind. Wilton, Iowa

Fill in and Mail.
Warner Arc Lamp Co.,
Muncie, Ind. Wilton, Iowa
Mail us catalog of your Flaming Arc

Name _____
Address _____

60 Winter Days

Free Test at Our Risk and Cost

As manufacturers, directly responsible to you for satisfactory results, we will send you a **Hess Steel Furnace** and complete heating outfit, including pipes, registers, fittings and everything needed, made to fit your measurements, with correct plans and instructions for installing, at **\$25 to \$100 less** than you can buy from dealers. We deliver the outfit at your station, freight prepaid. You place the purchase price in the hands of your local banker, who will hold the money 60 days while you test the heater.

In case the test is not satisfactory in every way, you may return the goods at our expense and the banker will refund your money.

Don't Pay an Exorbitant Price for a Heating Outfit

We have manufactured heating outfits for 36 years, and can assure you that there is no necessity for paying the exorbitant prices demanded by others in order to have a modern, high-grade furnace and outfit installed in your building.

Send us a rough sketch of any building you wish to heat. Without any charge or obligation on your part, we will have our expert furnace draftsmen prepare a plan which you can easily understand, showing the best way to heat your building, including every detail of the furnace, pipes, registers, etc., in their proper places, with the exact cost to you of the complete equipment. No charge for this.

Write for our free booklets, "Modern Furnace Heating" and "These Bear Witness." They tell much you should know before ordering your heating equipment. Write now—today.

Installing a Hess Furnace is Easy

By following our simple, clear plans and directions, any man handy with tools can easily install a Hess Furnace and outfit. We furnish all the necessary tools.

Write Today for Booklets and Estimate.

912 Tacoma Bld.

Hess Warming and Ventilating Co., CHICAGO

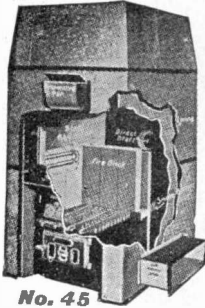

No. 45
"Leader" Hess
Steel Furnace

Price **\$49⁰⁰**

Delivered East of Omaha
and North of Ohio River
Pipes & Reg's Extra

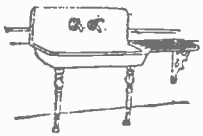
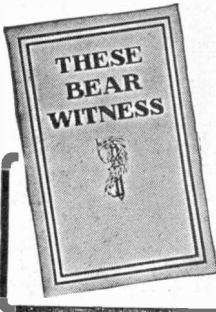

\$8.50 and up
This Magnificent Enamel
One piece sink. Latest design.

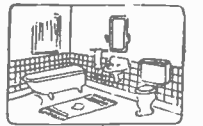

Superb Bath Room Outfit.
None better. at any price
..... \$33.00

Everything in Plumbing and Steam Goods at Cut Rates to Everybody

SAVE YOU 30 TO 45 PER CENT

JOHN HARDIN CO., One-Quarter Century at
4553 Cottage Grove Ave., Chicago

Send for Catalogue A. Dept. 19

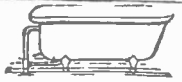

\$10.95 and up

Luxurious Enamel Bath
Tub of guaranteed quality.
Will wear forever.



\$3.00 and up

Laundry Tubs, all styles
and sizes.



HEATING PLANTS

Let us make you an estimate on a heating plant. With instructions from our engineering department, you can install it yourself. Simple and safe as a stove, no expense after once installed. The only beautiful, economic method of heating your home. Plans &c. Tools loaned. Boiler only

\$65.00 and up



Low down and high combination Closets. Guaranteed to be equal to the best in the market. Used in the most palatial homes.

\$11.50

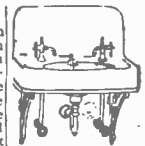

Artistic Lavatories. Various designs. \$7.50 up

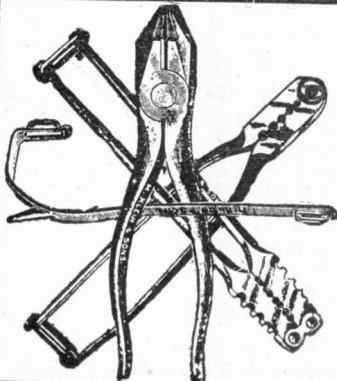

When in Need of Tools
DECIDE ON

"Klein Tools"

They have been the standard for years, they are the standard today, and you get the best there is. Send 3c in stamps for 65 page 7D Catalog, and Discount Sheet, full of interesting tools for Electricians and Linemen.

MATHIAS KLEIN & SONS,
Station U. 3,
CHICAGO, ILL.



Learn Telegraphy

At My Practical School

Only school graduating full-fledged operators. Established 1874. Housed in its own large, modern building. Equipped with R.R. train wire. Endorsed by Railroad and Western Union officials. Exclusive methods. Teachers are practical experts. Living expenses earned. Easy payments. Positions always open. I will help you. Correspondence course if desired, Morse or Wireless. Catalog Free. G.F.O. W. DODD, Pres., Dodge's Institute, 21st St., Valparaiso, Ind.

LEARN TELEGRAPHY

Start right. Get The Telegraph Instructor by C. M. Hoige. Best "Plain English" treatise on the art ever published. For beginners or practical men. 260 pages. Fully illustrated.

Regular price \$1.00. Special 75c prepaid.

POPULAR ELECTRICITY PUBLISHING CO.
Book Department Monadnock Block, Chicago, Ill.

**OUR NEW
ILLUSTRATED
BOOK CATALOG**

Will Interest You

Tells you all about just the books you need to increase your knowledge of Electricity, assists you in your studies and experiments and advance you in Electrical Work. Send 2c. stamp for a copy with particulars regarding our

**SPECIAL OFFER
"An Electrical Library"
FREE!**

Tear Off and Mail Coupon Today

Popular Electricity Publishing Co.
MONADNOCK BLOCK, CHICAGO

Gentlemen:—Enclosed find 2c. stamp. Please send me your Illustrated Book Catalog with full particulars regarding your special offer, "An Electrical Library Free."

Name _____
Address _____
Town _____
State _____

**DO YOU WANT
BETTER LIGHT**

Let us show you our new system of lighting (indirect illumination) for

**Homes, Stores, Hotels
Factories**

all places where light is needed.



Imagine a room evenly illuminated, a mellow radiance from a concealed source flooding it with a light soothing to the nerves, becoming to the complexion and yet *perfect for reading or sewing.*

Those who experience discomfort after a short time under a direct light, suffer no unpleasant effects from an evening's work under the I-COMFORT. Scientists and oculists have long agreed on the perfection of such a system of lighting but heretofore the cost of maintaining and installing has proven prohibitive. The I-COMFORT is simple and inexpensive; under a 60 to 100 Watt Tungsten electric lamp is placed a glass reflector with spiral and vertical corrugations over pure silver, giving the most perfect reflecting surface known to science; the light is thus thrown upon the ceiling and is evenly distributed throughout the room with wonderful efficiency, artistic effect and eye comfort. Thousands already in use in residences, offices, hotels, banks, clubs, art rooms and auditoriums.

Endorsed by the leading architects, oculists, and illuminating engineers.

If your electrical dealer does not handle them address Department F. A. Write at once for our new booklet with illustrations of our Installations.

National X-Ray Reflector Co.
247 Jackson Blvd., Chicago, Ill.

"Exide" Sparking Batteries

For Automobiles

For Motor Boats

A LONG Life Makes the Price LOW

"Exide"

Duplex Sparking Battery.
Contains 2 batteries in one case. The regular

"Exide"

Sparker and the

"Exide"

Emergency.

The Emergency will always get you home from **anywhere** if you overrun the main battery.

Sold separately when desired.



"Exide"

Sparkling Battery.

6-40 List Price,.... **\$20.25**

6-60 List Price,.... **\$25.25**

14 other sizes from **\$7.75**
to **\$46.75.**

"Exide"

Duplex Sparking Battery.

Main 6-40 emergency 6-5
List Price,..... **\$28.50**

Main 6-60 emergency 6-5
List Price,..... **\$33.50**

Do You Know the Use of Storage Batteries?

For 21 years this Company has maintained its leadership as the largest maker because its product has always been the best.

Quantity and Quality are Interdependent

Some of the following applications of Storage Batteries will interest you.

Central Lighting and Power Stations.
Isolated Electric Light Plants.
Street and Interurban Railways.
Alternating Current Regulation.
Electric Vehicle Propulsion.
Vehicle Interior Lighting.
Automobile Lighting.
Railway Car Lighting.
Railway Interlocking Switch and Signal.
Wireless Apparatus.

Telegraphy.
Telephony.
Sparkling Batteries for Stationary Gas
and Gasoline Engines.
Fire Alarm Signals.
Medical and X-Ray Work.
Portable Lighting.
Motor Boat Searchlights.
Laboratory Work.
Small Motor Work.

Used by the great Electric Light Companies, Street Railways, Steam Railroads, The Western Union Telegraph Co., The Postal Telegraph Co., The Bell Telephone Co., The Large Independent Telephone Companies, Automobile Companies, and by over 90% of all the Electric Vehicles manufactured.

BUY WHAT THE EXPERTS BUY

THE ELECTRIC STORAGE BATTERY CO. 1888
1909

PHILADELPHIA, PA.

New York Boston Chicago St. Louis Cleveland Atlanta San Francisco Toronto
And 660 Distributors throughout the United States

For our Mutual Advantage mention Popular Electricity when writing to Advertisers.



Come! Quick! Danger!

Are you prepared for this call—no matter from which department—just think what it would mean to have constantly at your elbow for consultation, an expert on the very problems that puzzle you. That's just what you would have in the

Cyclopedia of Applied Electricity

Six Big Volumes—Bound in Half Morocco—2,896 Pages 7x10 inches—printed on special paper in large, clear type—2,000 full page plates, diagrams, formulas, etc.

Written by thirty expert Electrical Engineers, the biggest men in the profession. It is a working guide for the student or practical electrician, or a ready reference work for the expert.

Examine These Books 5 Days at Our Expense

So confident are we that the books are just what you want, that we will send them to you by prepaid express—you keep the books 5 days—examine them carefully, test them, apply them to your every-day work. If satisfied that the books are the most complete and comprehensive work ever published on electricity, keep them, send \$2.00 within five days and \$2.00 a month until you have paid \$18.80, the special introductory price—the regular list price is \$36.00. If not suited to your needs, notify us. We will send for them at our expense. Fill in and mail the coupon today—the books will be sent you at once.

IMPORTANT SUBJECTS TREATED IN DETAIL

Electric Wiring—Electric Telegraph—Wireless Telegraphy—Telautograph Theory, Calculation, Design and Construction of Generators and Motors—Types of Dynamos and Motors—Elevators—Direct Current Motors—Direct-Driven Machine Shop Tools—Electric Lighting—Electric Railways—Alternating Current Motors—Single Phase Electric Railway—Management of Dynamos and Motors—Power Stations—Central Station Engineering—Storage Batteries—Power Transmission—Alternating Current Machinery—Telephony—Automatic Telephone—Wireless Telephony—Telegraphone, etc.

Special Offer If You Mark and Mail Coupon Promptly

For a short time we will include, as a monthly supplement, absolutely free of charge for one year, the TECHNICAL WORLD MAGAZINE. This is a regular \$1.50 monthly, full of Twentieth Century Scientific facts, written in popular form. Also contains the latest discussions on timely topics in invention, discovery, industry, etc.

AMERICAN SCHOOL OF CORRESPONDENCE
CHICAGO, U. S. A.

FREE OFFER COUPON

Pop. Elec.
11-09
A.S. of C.

Please send me Cyclopedia of Applied Electricity for five days' free examination. Also T. W. for one year. I will send \$2 within five days and \$2 a month until I have paid \$18.80; otherwise I will notify you and hold the books subject to your order. Title not to pass until fully paid.

Name.....
Address.....
Occupation.....
Employer.....

ELECTRICAL TOYS FOR BOYS

SOME CHRISTMAS SUGGESTIONS { Scientific ELECTRICAL Novelties
Practical, Complete, Durable, Harmless

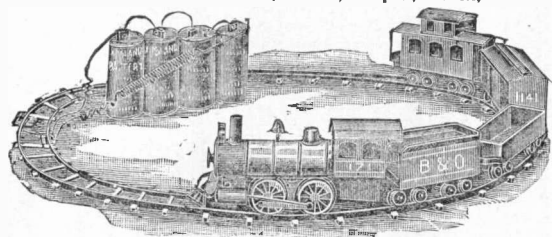

EVERY boy in the country can easily own a railroad. Costs little and pays big dividends in fun. Our Models of Locomotives, Trains, Trolley Cars, Dynamos, Lamps, etc., are practical and durable inventions. Equipped with dry batteries, no acids or liquids used, perfectly safe and harmless. Electrical toys instruct as well as amuse.

Catalog B, fully illustrated, quoting low prices—SENT FREE.

THE CARLISLE & FINCH CO.

264 E. Clinton Ave., Cincinnati, Ohio

Largest Manufacturers Electrical Novelties in the World.

THE
Thurman

Portable
Electric
Vacuum
Cleaner



Excels Them All

You cannot afford to experiment with poorly built or inefficient apparatus; you want

A MACHINE, NOT A TOY

The Thurman can be operated by a child, costs only a few cents per day. Will keep everything in your home clean.

The Thurman is made by the oldest and largest manufacturers of vacuum cleaning machinery in the world—and builders of the "The Thurman III," a hand power vacuum cleaner, that can be

OPERATED BY ONE PERSON

Write for full particulars

GEN'L COMPRESSED AIR & VACUUM MACH'Y CO.

519 No. Taylor Ave., Dept. P. E., St. Louis, U. S. A.

1900

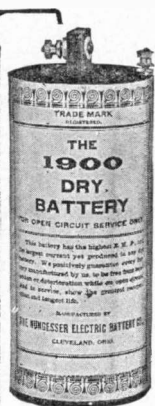

Dry Cells

possess all the features needed to make battery circuits complete and successful in operation.

In all work where batteries are required the 1900 Dry Cell should be used, as its high voltage, long life and efficiency produce results obtained

from no other make and make it the battery of

Known Quality

We especially recommend this battery for operating Wireless Outfits and Gas Engine Ignition.

Write today for our catalogue "E", which gives sizes, full particulars and prices.

The Nungesser Electric Battery Co.

CLEVELAND, OHIO

General Sales Office:

128 West Jackson Boulevard

CHICAGO

QUALITY INSURANCE

Means the elimination of faults in your Product by RIGID TESTS

Shrewd manufacturers do not jeopardize their trade by shipping half-developed goods. Careful purchasers buy subject to specifications and tests.

We are the medium for satisfactory dealings. We make all manner of electrical and photometrical tests and furnish you with exact and dependable data.

Electrical Testing Laboratories

80th St. and East End Ave.

NEW YORK, N. Y.

For our Mutual Advantage mention Popular Electricity when writing to Advertisers.

ELECTRIC TOYS BRING XMAS JOYS

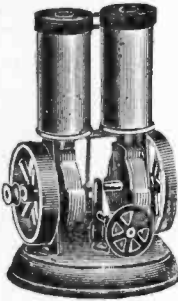
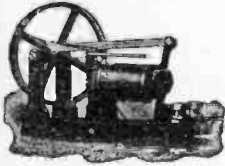

A BUNCH OF RED HOT BARGAINS FOR HOLIDAY TRADE

We Pay The Postage

Electric Engine, like cut	\$0.85
Students Motor, No. 5052
Flash Lights	50c, 95c, 1.10
Miniature Electric Light Outfit98
Ajax Motors	1.35
" Parts only	1.18
Little Hustler Motor97
Marine Engines, like cut	1.22
Electric Shocking Machines	1.10
Gem Telephone (talks 500 feet)65
Telegraph Sets, 5 ohm, \$1.65; 20 ohm	2.05
Pliers, Side Cutting for Boys65
Chemical Outfits, to make Oxygen35
" " Ammonia35
" " Hydrogen35
Alcohol Lamps, used in above sets42

We can Save You Money on all your Electrical Goods and Wireless Sets, Steam Engines, Street Cars, Etc. Send 4c for Catalogs and sample of Burning Wire.
 Above Prices, Special for Holidays. Send in your orders at once.

MEYER'S ELECTRICAL HOUSE

Box 696

EVANSVILLE, WIS.

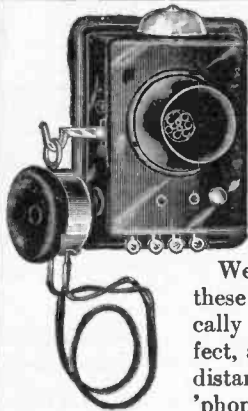

\$1.50 EACH
 or
\$3.00 per pair

The Lowest Priced High Grade 'Phone Made.

We absolutely guarantee these 'phones to be mechanically and electrically perfect, and to work as long a distance as any battery 'phone made.

Instruments are equipped with push button and bell for signaling.

Distance Phones work depends upon size of wire and number of batteries used. Good for 500 feet on 2 Dry Cells per instrument.

C. O. D. orders accepted if one-half of amount accompanies order.

Shipping weight per pair is 5 lbs.

If more than two 'phones are required on a system advise us of your requirements.

EMPIRE ELECTRIC WORKS

1174, Bridgeport, Ct.

A COMPLETE Electrical Workers' Library

By HENRY C. HORSTMANN and VICTOR H. TOUSLEY

Positively up-to-date and written for the men who do the work

We defy any publisher in the world to produce a more practical collection of books for the electrical worker than this series. The immense sale of these popular books since date of publication has been greater than any electrical books ever sold to working electricians.

The Reason?

They are practical and do not confuse the worker. They also have the highest endorsement of the International Brotherhood of Electrical Workers.

To substantiate this claim we offer the sum of One Hundred Dollars to any publisher who will produce a sworn statement showing a greater sale of any similar book or books treating on the subject matter that these do, for the length of time they have been on the market.

As to our reputation for keeping business promises, we will refer you to any bank or business house in Chicago.

For the next ninety days we are making a special introductory offer of the complete set of four volumes, neatly cased (regular price \$6.00).

Our special introductory price to electrical workers \$5.00, prepaid to any address upon receipt of price.

To all persons ordering this set prior to Jan. 1st we will present, free of charge, our Handy Electrical Dictionary for the Vest Pocket, bound in red Russia Leather, gold edges, indexed, 224 pages, illustrated. If the books ordered are not found entirely satisfactory in every way, they may be returned and your money will be cheerfully refunded. To electrical workers already having any of the below enumerated volumes, we will supply single copies of any one or more books at \$1.50 each, postpaid to any address in the world.



Send for descriptive booklet which gives a partial list of contents

Electrical Wiring and Construction Tables	120 pages 70 diagrams
Modern Electrical Construction	340 pages 173 diagrams
Modern Wiring Diagrams and Descriptions	250 pages 200 diagrams
Practical Armature and Magnet Winding	232 pages 128 diagrams

Each volume is substantially bound in full Persian Seal Grain Morocco Leather, stamped on the outside covers in genuine gold leaf, round corners, red edges, pocket size, printed on super-calendered book paper.

Address all orders to the Publishers

Frederick J. Drake & Company

222 Fisher Bldg.,

CHICAGO, U. S. A.

5TH
Annual

**Electrical
Show**

**January
15-29, '10**



**RESERVE
SPACE
NOW**

150,000 PEOPLE
Attended the **ELECTRICAL
SHOW** at Chicago Last Year

THIS throng was made up of people interested in the development of electricity; particularly from the consumer's standpoint.

The development of this marvelous force, together with the great strides made in the manufacture of electrical accessories used in the home, in the office, in the factory and on the farm, has made it vitally important that the manufacturer of electrical accessories, the jobber and the supply house should be interested and support the Electrical Show which takes place in Chicago next year.

It is the general opinion that all who have exhibited at this show have received benefits which they could never have secured in any other way. The public has become interested in the exploitation of their products to the extent that the demand made upon the manufacturer to supply the consumer of electric current has been greater than ever before.

The location of exhibitors in the Coliseum is a vital point in the success of their exhibit. By reserving space considerably ahead of time you will be able to secure your desired position in the hall.

Electrical Trades Exposition Co.
Monadnock Block :: CHICAGO, ILL.

POPULAR ELECTRICITY

A VACUUM CLEANER FOR \$6.00

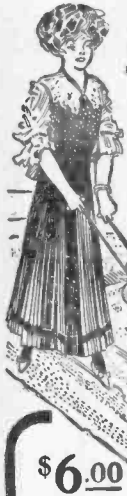

\$6.00

JUST WHAT YOU ARE LOOKING FOR

A Vacuum Cleaner that will do same work as the large expensive machines at a price within reach of every family

Cleans Carpets, Rugs, Matting, etc., on the floor, by the Vacuum Process

THE HOME VACUUM CLEANER WEIGHS ONLY FOUR POUNDS

NOT SOLD IN STORES

Operated by child or weakly woman. Air is drawn through body and fibre of carpet at terrific speed. Carries all dust, dirt, grit, germs, etc., into the Cleaner. No dust in room, it all goes into Cleaner. Supersedes broom, brush, sweeper, dust pan and dust cloth.

Cleans, Sweeps and Dusts in one Operation. Keeps house clean, does away with housecleaning day. Portable, dustless, silent, always ready. Adapted to every home—rich or poor—city, village or country. Does same work as expensive machines. Costs nothing to operate—costs nothing for repairs. Light, neat, well and durably made—should last a lifetime. Saves time, labor, carpets, curtains, furniture. Saves drudgery, **saves health, saves money. Saves taking up and beating carpets.** The Home Cleaner is truly a wonder. Astonishes everybody; customers all delighted and praise it. They wonder how they ever did without it.

Lady had matting too old to take up—Home Cleaner saved it—Cleaned it on floor

Others write: "Would not do without it for many times its cost." Another says: "Ten year old girl keeps everything clean." Another: "Never had house so clean." Another: "Carpets and rugs so clean baby can play without getting dust and germs." Another: "It works so easy; just shove nozzle over carpet, it draws all the dirt into the Cleaner—not a particle of dust raised." So they run, hundreds and thousands of letters praising, without a complaint. To try a Home Cleaner means to want it—then keep it. The size is right—weight is right—price is right. Simple, neat, handsome, durable and easily operated. All put together ready for use when you receive it.

SENT ANYWHERE FOR ONLY \$6.00

Every one tested before shipping—guaranteed as represented or money refunded. Write today; or better, send order, You won't regret it.

FREE SAMPLE TO ACTIVE AGENTS

Agents make money easy, quick, sure. Spare or all-time. Men or women. Experience unnecessary. Woman sold 4 one evening—profit \$12. Agents selling from 3 to 10 a day—profits from \$9 to \$30 a day. Even two sales a day, \$36 profit a week. Lady agents successful. Agent in 5 minutes shows dirt taken from carpet supposed to be clean, and sale is made. Show one in operation. People want it, must have it; when they see it they buy. How they sell! Show ten families, sell 9. Write to-day. Send postal card for full description and agents' plan. Name choice of territory. Act quick.

Address, **R. ARMSTRONG MFG. CO., 52 Alms Bldg., Cincinnati, Ohio**

ELECTRICITY
Practically and Individually
TAUGHT

Our pupils actually handle the tools and machinery.—Instructors stand beside them, directing, criticizing and showing them how to work.
—Day and Evening sessions.—Call and inspect our school and equipment or write for prospectus.

New York Electrical School
49 West 17th Str., New York

DRAWING
as
Taught By
The **ACME**
WAY

ILLUSTRATING
CARTOONING
DESIGNING
MECHANICAL
ARCHITECTURAL
SHEET METAL
PATTERN

You can learn at home in spare time to be a commercial artist or draftsman. We quickly fit you for practical work. Our students earn money and hold positions while studying. Personal criticisms by instructors trained in this country and Europe; and special instruction to develop your individual talent. You submit work as it is done. You pay as you go; no large advance payment required. We guarantee proficiency or return tuition. Write for illustrated catalog and say which you wish to learn: Illustrating, Cartooning, Commercial Designing, Mechanical Drawing, Architectural Drawing, or Sheet Metal Pattern Drafting. If you can attend our Resident School, say so. Estab. 1898.

The Acme School of Drawing. 337 S St., Kalamazoo, Michigan.



Salesmen Wanted

We receive calls for thousands of Salesmen and have assisted thousands of men to secure good positions or better salaries. Hundreds of them who had no former experience and who formerly earned from \$45 to \$75 a month now earn \$100 to \$1000 a month. No matter whether you are a new beginner or an old hand at the game, our eight weeks course in Salesmanship by mail will enable you to increase your earning power from two to ten times what it is at present; and our **FREE EMPLOYMENT BUREAU** will assist you to get a good position. Thousands of good positions will be open for the early spring rush; prepare for one of them now. Salesmanship is the most independent, delightful, well paid profession in the world, and the demand always exceeds the supply. Scores of the wealthiest, most famous men in the U. S., such as Marshall Field, the great dry goods merchant of Chicago, Ex-postmaster General John W. Namaker, the great merchant of New York and Philadelphia; several of Andrew Carnegie's millionaires and scores of others got their start selling goods on the road. Your chance is as good as theirs was. Thousands of Traveling Salesmen earn from \$2500 to \$10,000 and up as high as \$25,000 a year and all expenses. If you are ambitious and want to enter the best paid profession on earth, fill out coupon and send for our free book "A Knight of the Grip" today—it will tell you how to do it. Address Dept. 423 National Salesmen's Training Association, Chicago, New York, Kansas City, Minneapolis, San Francisco, U. S. A.

None P. O. State R. F. D.

For our Mutual Advantage mention Popular Electricity when writing to Advertisers.

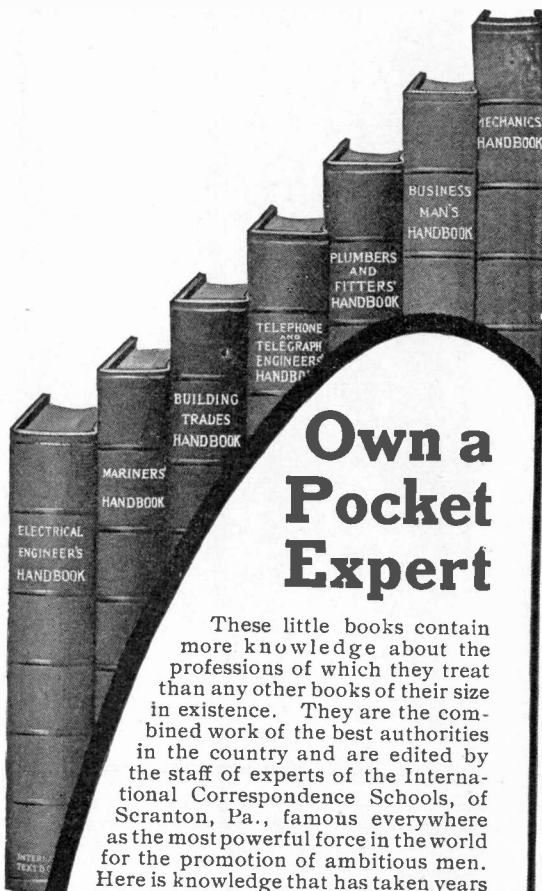

Own a Pocket Expert

These little books contain more knowledge about the professions of which they treat than any other books of their size in existence. They are the combined work of the best authorities in the country and are edited by the staff of experts of the International Correspondence Schools, of Scranton, Pa., famous everywhere as the most powerful force in the world for the promotion of ambitious men. Here is knowledge that has taken years for our best experts to secure, placed at the disposal of every ambitious man—knowledge that is needed in every-day work, that is difficult to carry in the memory, and that cannot easily be found in ordinary books. Just think of getting such a book, cloth bound with gilt titles and tops, printed on good supercalendered paper in clear type, averaging 364 pages and 175 illustrations, for 50 cents! We are using these books to introduce the value of I. C. S. Training, and will send them prepaid, when ordered with coupon below, for the special price for **50c** each handbook of

INTERNATIONAL TEXTBOOK COMPANY

Box 1102-P, Scranton, Pa.

I enclose \$_____ in stamps, for which please send me the books before which I have marked X.

- Tel. & Tel. Handbook Bldg. Trades Handbook
- Plum. & Fit. Handbook Business Man's Handbook
- Mechanics' Handbook Mariners' Handbook
- _____ Electrical Engineer's Handbook

Name _____

St. and No. _____

City _____ State _____

BEWARE OF IMITATIONS
OF THE FASTENERS
MEN SWEAR BY, NOT AT
To be sure you are getting the genuine
WASHBURNE PAT. IMP. FASTENERS
(The Fastener with a Bulldog Grip)



Look carefully for name "Washburne" stamped on every fastener. It is your protection against a poor infringement, the perpetrators of which are being prosecuted.
The genuine Washburne Fasteners are "Little But Never Let Go."
There is Comfort for Men in their use.
They are the greatest little utilities ever invented for men's dress, and are applied to

- Key Chain and Ring, - - - - - 25c
- Scarf Holder, - - - - - 10c
- Bachelor Button, - - - - - 10c
- Cuff Holders, - - - - - 20c
- Drawers Supporters, - - - - - 20c

Catalogue Free. Sold Everywhere. Sent Prepaid.

Look for the Name Washburne.
AMERICAN RING COMPANY
Dept. 5, Waterbury, Conn.

The
Tri-mount Wireless Supply Co
cordially invites you to visit
its exhibit of
High Grade Wireless Apparatus
for experimenters
at the
Boston Electrical Show,
November 15-25, 1909,
and to see and hear the
Special Demonstration
of the
Bishop Wireless Telephone

Cut Your Light Bill

by using a
DIM-A-LITE
TURNS DOWN LIKE A GAS JET



The DIM-A-LITE

is not a lamp but a plug device that will last as long as the socket. Screws into ordinary lamp, and uses any standard Edison bulb.

Reduces current 70% at low position and 20% at medium position.

Price, Gun Metal..... \$1.00
Brush Brass or Oxidized Copper..... \$1.25

Postage Prepaid

FEDERAL ELECTRIC COMPANY
LAKE & DESPLAINES STS., CHICAGO

Save Your Tungsten Lamps

It Saves the Cost
in less than a year

TUNGSTEN LIFE-SAVER
Prolongs the Life of Tungsten Lamps.

Makes it possible to use Tungsten Lamps in Shops, Factories, Etc., where there is vibration.

Are easy to install and require no repair.

TUNGSTEN LIFE-SAVER may be used with any standard fixture or cluster. When installed in stores or offices it may be entirely covered by ceiling canopy. It is a well-made and practical device, and when properly

installed will last for many years, requiring no repairs.

Made in four different strengths, as follows:

No. 5 supports fixture weighing from 4 to 6 lbs.

No. 8 supports fixture weighing from 7 to 9 lbs.

No. 11 supports fixture weighing from 10 to 12 lbs.

No. 14 supports fixture weighing from 13 to 15 lbs.

Weight to include Fixture, Lamps, Shades, Conduit, etc.

Let us send you a sample.

AMERICAN ARC LAMP CO.
Kalamazoo, Mich.

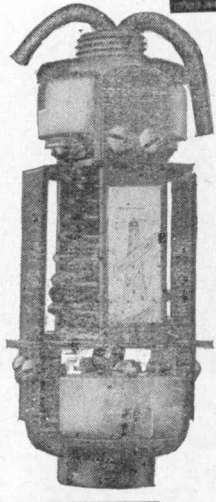

THE BEST LOW PRICE DRY CELL MADE

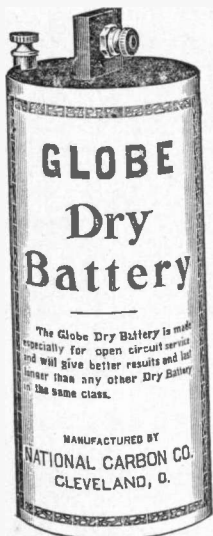

Very extensively used for WIRELESS RECEIVERS, OPERATING SMALL MOTORS, TELEPHONES, CALL BELLS, ANNUNCIATORS, MEDICAL BATTERIES, ETC.

Battery catalogue showing the various types of wet and dry cells we manufacture sent free to all who mention this publication.

In lots of 12 or more

13½c each

No extra charge for
Fahnestock Clips

NATIONAL CARBON COMPANY
CLEVELAND, OHIO

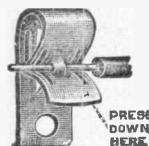

PRESS
DOWN
HERE

1910 YALE MOTORCYCLES NOW READY

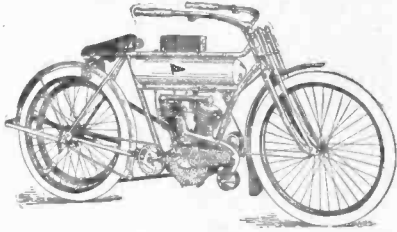

6 1/2 H. P. Twin
S. G. V. Belt. Bosch magneto, \$300.

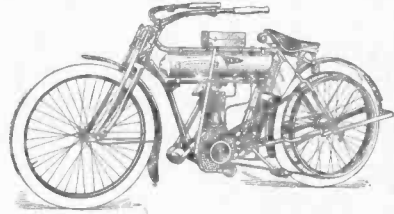

3 1/2 H. P. Single
Flat belt and Idler, Battery ignition, \$200. S. G. V. belt optional. Herz magneto, \$35 extra.

The Yale Motorcycle holds the world's record for endurance, and has made good in every test, no matter how severe.

The Yale Motorcycle is operated at less upkeep expense than any other.

The Yale Motorcycle is ideal for touring and business, because it runs all the time and is free from trouble.

The Yale agency proposition for 1910 is very profitable.

Immediate Deliveries. Write For Information.

THE CONSOLIDATED MFG. CO.

1734 Fernwood Ave.,

Toledo, Ohio

Made in Sizes
to Meet Your
Requirements

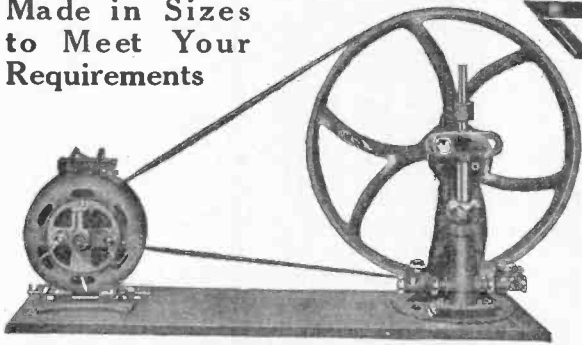

The Jarvis Electric . . . House Pump

will not only pump your water—
but when not in use can be used

to operate your **Washing Machine, Wringer, Sewing Machine, Ice Cream Freezer**, in fact perform numerous other household duties.

The Jarvis Pump is very highly recommended wherever Electricity is available, particularly adaptable for Country Residences, Homes, Factories, Offices, Hotels, Etc. Write today for our new Bulletin No. 101 and obtain our reasonable prices.

We have sold hundreds of these pumps, every one giving satisfaction.

JARVIS 910 River Street,
LANSING, MICH.



PATENTS PATENT ATTORNEYS



PATENTS Secured Promptly and with special regard to the legal protection of the invention
HAND BOOK FOR INVENTORS AND MANUFACTURERS SENT FREE UPON REQUEST

C. L. PARKER, Patent Lawyer

Patents, Caveats, Trade Marks, Copyrights, Reports as to Patentability, Validity and Infringement.
Patent Suits Conducted in all States.

REFERENCES: American Tire Co., Automatic Vending Machine Co., Lippincott Pencil Co., International Ore Treating Machinery Co., Globe Machine and Stamping Co., Metal Manufacturing Co., Builders Iron Foundry, Morgan Machine and Engineering Co., Berkshire Specialty Co., Stewart Window Shade Co., Macon Shear Co., Acme Canopy Co., Oaks Manufacturing Co., Cox Implement Co., Columbus Buggy Co., National Index Co., Handy Box Co., Iron-Ola Co., By-Products Chemical Co., Alabama Brewing Co., National Offset Co., Antiseptic Supply Co., Floor Clean Co., Fat Products Refining Co., Richmond Electric Co., Railway Surface Contact Supplies Co., National Electric Works, Modern Electric Co.

Mr. Parker on November 1 1903, after having been a member of the Examining Corps of the U. S. Patent Office for over five years resigned his position to take up the practice of patent law.

Address 12 MCGILL BUILDING

WASHINGTON, D. C.

Samuel G. McMeen

Kempster B. Miller

McMeen & Miller

Patent Solicitors and Patent Experts

In connection with our telephone engineering practice we make a specialty of securing electrical patents for inventors, and of giving expert advice in patent matters. We also have facilities for marketing meritorious electrical inventions.

1456 Monadnock Block
CHICAGO

333 Grant Ave.
SAN FRANCISCO

PATENTS that PROTECT

Our 3 books for inventors mailed on receipt of 6 cts. stamps.
E. S. & A. B. LACEY, Washington, D. C., Dept. 52 Est. 1869

HAVE YOU AN IDEA?

If so, write for our Books:

"Why Patents Pay," "What to Invent," "100 Mechanical Movements" and a Treatise on Perpetual Motions—50 Illustrations. All mailed free.

F. G. DIETERICH & CO.

PATENT LAWYERS AND EXPERTS

603 OURAY BUILDING, WASHINGTON, D. C.

PATENTS Procured with special regard to the legal protection of the invention. Booklet telling why so many patents are worthless as a protection sent free on request.

Obed C. Billman, Patent Lawyer
Cleveland, Ohio

For our Mutual Advantage mention Popular Electricity when writing to Advertisers.

PATENTS

TRADE MARKS AND COPYRIGHTS
SECURED OR FEE RETURNED

Send model or sketch and description of your invention for free search of the U. S. Patent Office Records.
Our Four Books mailed Free to any address. Send for these books; the finest publications ever issued for free distribution.

HOW TO OBTAIN A PATENT

Our Illustrated 80 page Guide Book is an invaluable book of reference for inventors and contains 100 mechanical movements illustrated and described.

FORTUNES IN PATENTS

Tells how to invent for profit and gives history of successful inventions.

WHAT TO INVENT

Contains a valuable list of inventions wanted and suggestions concerning profitable fields of invention. Also information regarding prizes offered for inventions, among which is a

PRIZE OF ONE MILLION DOLLARS
offered for one invention and \$10,000 for others.

PATENTS THAT PAY

Contains fac-similes of unsolicited letters from our clients who have built up profitable enterprises founded upon patents procured by us. Also endorsements from prominent inventors, manufacturers, Senators, Congressmen, Governors, etc.

WE ADVERTISE OUR CLIENTS' INVENTIONS FREE

in a list of Sunday Newspapers with two million circulation and in the *World's Progress*. Sample Copy Free.

ELECTRICAL CASES A SPECIALTY

We have secured many important electrical patents.

VICTOR J. EVANS & CO.

(Formerly Evans, Wilkens & Co.)

Main Offices, 615 "F" Street, N. W., Washington, D. C.

If You Would Be Always Well BATHE INTERNALLY

A few of the Physicians who use and prescribe the J. B. L. Cascade.

- GEO. H. DAVIS, M. D., Springfield, Mass.
- W. L. SCOFIELD, M. D., Brooklyn, N. Y.
- E. W. GILLIAM, M. D., Baltimore, Md.
- C. W. STOWE, M. D., Salina, Kansas.
- S. P. OWENS, M. D., Ardmore, Kansas.
- D. B. HAND, M. D., Scranton, Pa.

INTERNAL BATHS are more essential to good health than external. Your colon gathers poisons which come in contact with all the blood in your body as it flows through, twice in 24 hours. Flush out this waste and your blood will be pure. The

J. B. L. Cascade

is the one Internal Bath which thousands have been using for years with most effective and satisfactory results. Their experiences and interesting facts about the Internal Bath, its purpose, its operation and results, are contained in a little book, "The What, The Why, The Way," which is sent free on request. It might be well to write for it now while you think of it.

Tyrrell Hygienic Institute, 143k West 65th Street
New York

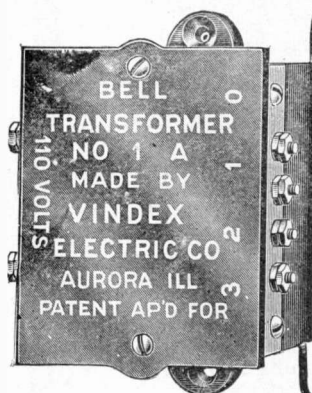

Ring Bells from Light Circuit

No more battery troubles if you use the Vindex Bell Transformer.

This small device is so constructed that it can be connected to any electric light circuit of 110 volts alternating current and reduces the current to the proper voltage for operating door bells, burglar alarms, miniature lamps, small battery motors, and all low voltage electrical apparatus.

Absolutely safe, and can be installed by anyone; never gets out of order and lasts forever, always ready for use and consumes so little current that a meter will not record it.

Write us today for prices and full particulars regarding this most economical and wonderful device. *Agents wanted.*

VINDEK ELECTRIC CO., AURORA, ILL.

LOFTIS SYSTEM DIAMONDS ON CREDIT WATCHES

For Christmas Presents the Loftis System is a great and timely convenience. It enables you to make a beautiful and valuable gift without the outlay of much ready money. A small cash payment and you can give a loved one a fine diamond, watch, or other jewelry. Write for our Christmas catalog, make selections now and let us send them, charges prepaid, for your inspection. If suited, pay one-fifth on delivery; balance in eight equal monthly payments. Our prices lowest. Write today.

LOFTIS Old Reliable, Original, Diamond and Watch Credit House
BROS. & CO. Dept. M885 82 State St., Chicago, Ill. Branches: Pittsburg & St. Louis.

DIAMONDS 20 to 30% DISCOUNT

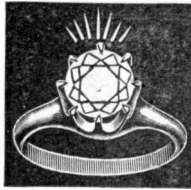

Our new Rhodesian Diamonds from Rhodesia, S. Africa, are mined, cut and polished the same as real diamonds, retain the same beautiful hard brilliancy, and stand all tests of a genuine diamond. Surpass the best imitation stones on the market. Sold loose, or mounted in solid 14K. gold. Also a large assortment of genuine diamonds at wholesale prices. All goods subject to examination and approval, backed by an absolute guarantee to be as represented. Write at once for beautiful illustrated free catalog containing many designs of precious stones and fine watches.

RHODESIAN DIAMOND COMPANY
Dept. A 11., 79 Dearborn Street, CHICAGO

The "Baby" TORCH

Invaluable for Home, Workshop and Repair Kit.



\$1.25
Prepaid

Produces intensely hot flame for soldering, welding, removing paint and 101 odd jobs around the home, repair shop, automobile, motor boat, etc. Powerful, compact, purely automatic, absolutely safe, works without air pressure, lights with match, burns two hours with one filling. Has no objectionable features of other torches. Size of tank 3x2 inches. Used and recommended by Householders, Autoists, Electricians, Jewelers, Dentists and Repair Shops everywhere. Price \$1.25 prepaid. Money back if not satisfactory. Send today.

H. W. HARROLD, VALPARAISO, IND.

For our Mutual Advantage mention Popular Electricity when writing to Advertisers.

Electric Light

**Cheap
Convenient
Reliable
Clean**

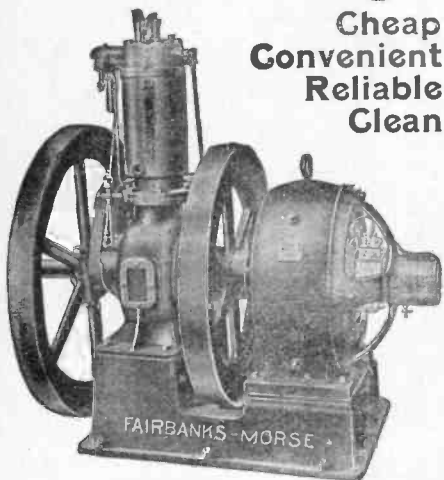

How simple and convenient to just turn a switch and flood your place with bright, cheerful electric light. Then, too, the light is so superior to other lights, in fact, it is nearly as white as sun light when the new economical tungsten lamps are used. Complete outfits, Engine, Dynamo, Storage Battery, and Switch Board from \$500 up, depending on size and equipment; larger plants in proportion. Engine operates on gas, gasoline, kerosene, or distillate. Send for catalog No. 1163 C. B.

FAIRBANKS, MORSE & CO.
481 Wabash Ave. CHICAGO, ILL.

Wireless Instruments

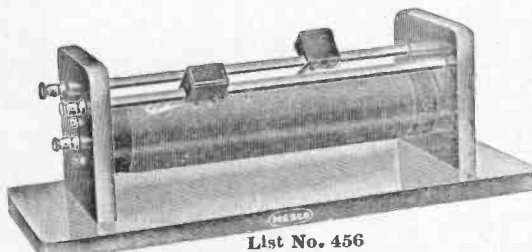

List No. 456

This Receiving Tuning Coil is of the double contact type. It is very selective. Adjustable to wave lengths up to 1500 meters.

List No.	Description	List No.	Price
456	Double Contact Tuning Coil	456	\$ 6.00
450	Wireless Key, Leg Connections	450	3.00
452	Wireless Key, Legless Pattern	452	3.20
454	Crystal Detector Stand	454	3.00
458	Complete Receiving Set	458	13.00
462	One Inch Spark Coil	462	9.00
465	High Efficiency Spark Gap	465	5.00
467	Zinc Spark Gap	467	1.20
455	Single Contact Tuning Coil	455	5.00
457	Variable Condenser	457	6.00
480	Double Leather Covered Headband, with 2-1000 ohm receivers and 6 foot cord	480	13.00
475	Potentiometer	475	3.00
466	High Tension Tubular Condenser	466	6.00

Write for Discounts.

"Something Electrical for Everybody," our catalog 24E mailed on request.

Wireless Folder now ready, ask for one.

MANHATTAN ELECTRICAL SUPPLY CO.
NEW YORK, 17 Park Place CHICAGO, 188 Fifth Avenue
110 W. 42nd St. (Branch) Factories: Jersey City, N. J.
37 W. 125th St. (Branch) Ravenna, Ohio



Don't Blame the Machinist

It's not his fault that your cost of production is too high.

How can you expect him to work to any advantage when he has to stop every few minutes and adjust a lot of belts and pulleys to change the speed of his machine.

No wonder he does not turn out as much work as your competitor's machinist. Why not connect a

Fort Wayne Motor

direct to his machine and increase the quality and quantity of his work?

Also remember that with line shafting and belts you are wasting about 40 per cent of your power in transmission.

Then there is floor space and the ability to locate your machines anywhere regardless of shafting.

Just figure on these points and see how long it would take the motor to pay for itself.

However there are many makes of motors and you would be wise to send for our booklet "Motor Drives" and learn the superior points of ours before you buy.

FORT WAYNE ELECTRIC WORKS

Atlanta 1403 Broadway, Fort Wayne, Ind. Philadelphia
Boston Seattle
Cincinnati Milwaukee New Orleans St. Louis
Chicago New York Pittsburg St. Paul
Grand Rapids San Francisco
Madison Syracuse

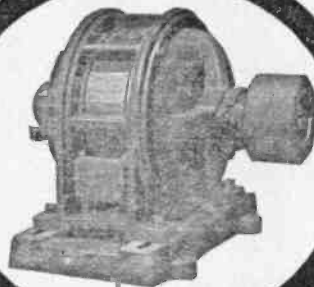

m2

VITAL POWER

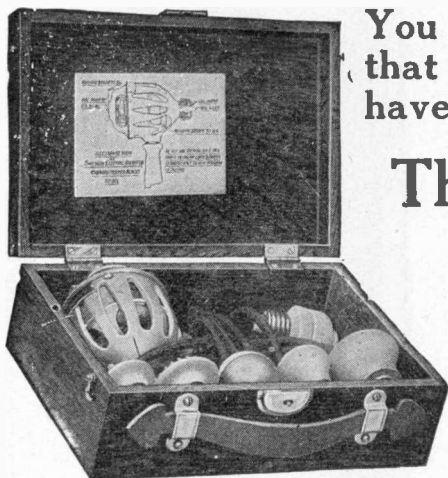

Swedish Electric Vibrator No. 5

Operates on any electric light current, anywhere, direct or alternating.

The only massage Vibrator that gives the **TRUE** Swedish rotary movement, fast, medium or slow. Noiseless in its operation, mechanically perfect and with ordinary care will last a lifetime.

\$25.00

and impure matter that **CLOG UP** the capillaries. These impurities are poisoning and weakening your system and need only to be **RATTLED LOOSE**, combined with blood so that it can and will be **TAKEN OUT OF THE BODY** through the excretory organs.

It takes a big, illustrated book, with charts and diagrams and instructions in **PLAIN ENGLISH** to **SHOW** and **TELL HOW OUR VIBRATOR** will cure any ailment, correct any physical condition. We will send it to you **FREE**. Our Great Expert will write you a special letter of advice on **ANY** male or female disorder, disease, or condition, **FREE** of charge, if you will write us a history of **YOUR** or **YOUR FRIEND'S** case. Don't neglect to write us today.

Our Vibrator runs with batteries or any electric light current; works in the farm home as well as where they have electric lights, comes in an elegant, portable case, including six cells of powerful electric batteries, and all the different applicators. Full and complete instructions accompany each outfit. So simple, a child can safely operate it. Electric shock absolutely impossible. Write now for the big, **FREE** book. We pay all express charges on Vibrators.

You get the enjoyment out of Life that nature intended you should have, if health prevails.

The Swedish Electric Vibrator

will cultivate your system up to the top notch standard; it will **CURE** nearly every ailment; it will give you **VITAL POWER**; it will throb and thrill you into a tireless human engine with **POWER** to think **TWICE AS CLEARLY** and **DO** twice as **MUCH**. When you come in from a hard day's work, it will **SOOTHE**, **REST** and **REVITALIZE** you from head to foot; it will cause your blood to go **LEAPING** and **BOUNDING** through your veins and arteries; cause the flow of nerve fluids to saturate the innermost nerve. You can actually feel disease and weakness being driven from you and **NEW LIFE** and power being generated.

The 50,000 penetrating, revitalizing strokes per minute convey to the flesh a very peculiar vibration, unlike any sensation you ever realized. It **SETS LOOSE** in the blood and lymphatic vessels all stray

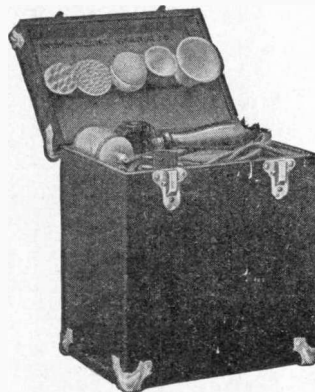

Swedish Electric Vibrator No. 2

Operated by its own powerful dry batteries, equally as effective as the No. 5, but for the use of those not having access to the electric light current.

\$15.00

Swedish Electric Vibrator Company

611-621 Farragut Avenue

CHICAGO, ILL.

NEW HOLIDAY OFFER

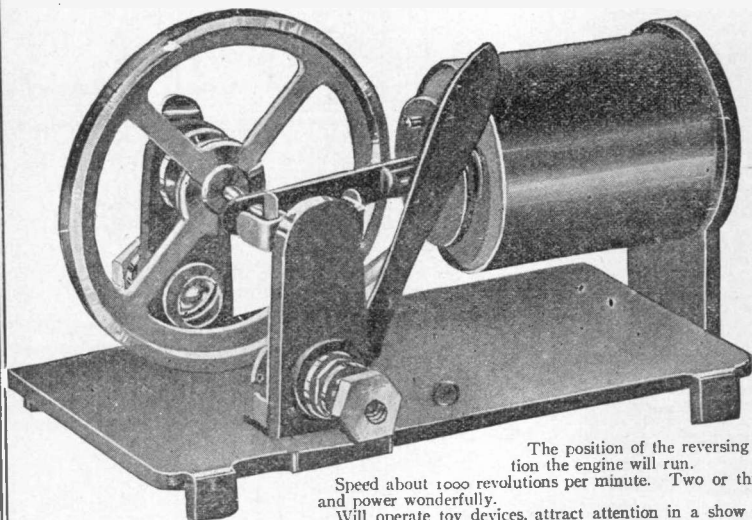

SPECIAL LOW PRICE ON THIS POWERFUL Solenoid Electric Engine

Runs like Lightning.

THIS engine is made to run for a long time on one cell of dry battery. This without doubt the best made electric engine for its size on earth.

The base and frame are made from cold rolled steel;—the coil is hollow, thereby allowing the driving shaft to be operated on the solenoid principle.

The position of the reversing lever controls the speed and direction the engine will run.

Speed about 1000 revolutions per minute. Two or three cells of battery increases speed and power wonderfully.

Will operate toy devices, attract attention in a show window, run a small fan, and is a source of endless amusement and instruction. Batteries can be purchased anywhere for 15 to 20c. each. Finish of frame, fine black enamel, large brass fly wheel is bright dipped cylinder of coil casing in English vermilion red, which makes this also the finest finished and appearing engine.

Every engine comes in an individual box with complete directions for operating. *Delivered, charges prepaid,* to any address in the United States, on receipt of

50 CENTS EACH. CANADA 75 CENTS EACH.

SWEDISH AMERICAN ELECTRIC CO., 1755 Berwyn Ave., Chicago, Ill.

This Complete Electrical Experimental Outfit for \$5.00

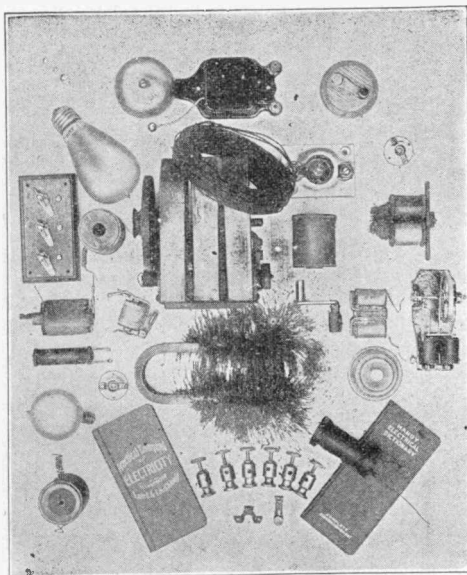

This big offer for short time only

New type Acme Multipolar 100 Watt generator. New and in original boxes. Nickel finish, bronze bearings, oil cups, brass gearing drive, weight of generator alone SIX AND ONE-HALF POUNDS. We have only 2950 in this lot and Reach nearly half a million readers in different magazines. Act Quick. The balance of the outfit consists of:—

4 pair electro-magnets 20, 40, 70 and 100 Ohms, 1 Switch, 1 push button, 1 one-half pound coil of wire, 1 Bell, 2 Miniature Lamps and Sockets, 1 Laboratory test lamp and socket, 6 brass binding posts, 1 Permanent magnet, 1 solenoid magnet with brass core. P. E. **FREE** Send in this coupon with your remittance of \$5.00 before our next Ad appears and we will send you in addition to the outfit a 200 Ohm polarized Relay value \$5.00 (weight 3 lbs.) excellent for wireless. Also a \$2 pair of (enamel covered wire) magnets 30 ohms originally made for Dating Stamps and electric clocks. ACT NOW and be ready for the winter nights.

WESTERN ELECTRIC SALVAGE CO.

New No. 1224 So. Washtenaw Ave.

CHICAGO, ILL.

For our Mutual Advantage mention Popular Electricity when writing to Advertisers.

POPULAR ELECTRICITY

TEN THOUSAND TELEGRAPHERS WANTED

by railroads, commercial companies and Wireless Companies. Only schools in America teaching

WIRELESS TELEGRAPHY

We operate fifteen Wireless Stations. Main Line R. R. Wires in each of our Institutes. Supervised by R. R. Officials. Write for prospectus.

NATIONAL TELEGRAPH INSTITUTE

CINCINNATI, OHIO

PHILADELPHIA, PA.

MEMPHIS, TENN.

DAVENPORT, IOWA

PORTLAND, ORE.

COLUMBIA, S. C.

\$3,000 to \$10,000 A YEAR
IN THE REAL ESTATE BUSINESS



We teach you by mail every branch of the Real Estate, General Brokerage, and Insurance Business, and appoint you **SPECIAL REPRESENTATIVE** of the oldest and largest co-operative real estate and brokerage company in America. Representatives are making \$3,000 to \$10,000 a year without any investment of capital. Excellent opportunities open to YOU. By our system you can begin making money in a few weeks without interfering with your present occupation. Our co-operative department will give you more choice, salable property to handle than any other institution in the world. A Thorough Commercial Law Course FREE to Each Representative. Write for 62-page book free. **THE CROSS COMPANY, 3213 Reaper Block, Chicago**

COPY THIS SKETCH

and let me see what you can do with it. You can earn \$20.00 to \$125.00 or more, per week as illustrator or cartoonist.

My practical system of personal individual lessons by mail will develop your talent. Fifteen years successful work for newspapers and magazines qualifies me to teach you.

Send me your sketch of President Taft with 6c in stamps and I will send you a test lesson plate, also collection of drawings showing possibilities for you.

THE LANDON SCHOOL of Illustrating and Cartooning
1451 Schofield Bldg., Cleveland, O.



Finest Violins on 30 DAYS' TRIAL

We sell direct from our Chicago and European shops. Your choice from the finest collection of both old and new stringed instruments in America. Everything the violinist needs. Violins from \$3.00 to \$100.00 and upwards.

30 DAYS' TRIAL before you decide to purchase. Write today for free catalog & Violinist's Handbook.

Wm. E. LEWIS & SON (Est. 1869) Makers and Importers
250 Wabash Avenue, Chicago, Ill.

Our Specialty: Imported wood, varnishes and tools for violin makers.



VARIABLE CONDENSER.
Circuit Type.

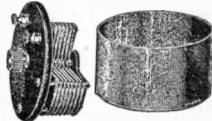

WIRELESS APPARATUS

Our Condenser's range is wide enough for the finest regulation for stations up to 1500 miles. Price \$4.00, positively for this month only. Send 2c stamp for our complete catalogue of Wireless goods.

ETHERIC ELECTRIC CO.

71 Barclay Street

New York, N. Y.

WIRELESS

The Electro-Lytic Detector is the most sensitive responder invented. We can prove this statement by referring to Electrical Magazines and Text Books.

Commercial and Government stations 200 miles away can be heard very distinctly when our detector is connected with a few other instruments costing a mere trifle.

Send 2c stamp for our catalogue.

ETHERIC ELECTRIC CO.

71 Barclay Street New York City

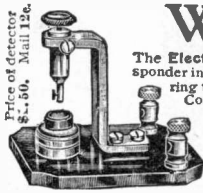

Price of detector \$2.50, Mail 12c.

WIRELESS TELEGRAPHY

SEND today for printed matter fully describing our Wireless Instruments. Prices reasonable and quality the best.

A FEW EXAMPLES: Induction Coils, 2 inch spark, \$7.75, 1 1/2 inch spark, \$5.00. These coils are proving perfectly satisfactory to all purchasers. The Carborundum Detector, \$1.00. After being set up this Detector requires no attention. This feature, combined with the Detector's sensitiveness makes it the most desirable of all popular priced Detectors.

INTERNATIONAL WIRELESS CO., Dept. E, Lima, Ohio

For our Mutual Advantage mention Popular Electricity when writing to Advertisers.

HOW TO TEST

With a Voltmeter

resistances, batteries, coils, etc., and to locate trouble on telephone and other circuits, described in our catalog No. 14. Send for it. It's free and describes also our accurate, compact and inexpensive voltmeters, ammeters and volt-ammeters.



L. M. PIGNOLET, 78 Cortlandt St., NEW YORK

GET ACQUAINTED

with our new course in practical electricity. Issued in three parts, the three books "COMPLETE CONDENSED ELECTRICITY," fully illustrated, included.

For \$4.00 we will send you Part 1, complete with book. We do this to introduce our system which speaks for itself. We know that when you "get acquainted" you will want the full course, price \$12.00. Send a postal anyway and learn more about our proposition.

BARNES MANUFACTURING CO.
16 Belmont Street Susquehanna, Penna.
References: First National Bank; City National Bank.

GOVERNMENT POSITIONS

A Civil Service Manual by Ewart, Field and Morrison prepares for the examinations. Adopted by over 500 Business Colleges, Y. M. C. A.'s, and Public Evening Schools.

Three volumes with maps, \$2.50 postpaid
250 page Home Study catalog free. Write to-day.

THE HOME CORRESPONDENCE SCHOOL
Dept. 129, Springfield, Mass.



Mr. Field

TELEGRAPHY

The Omnigraph Automatic Transmitter combined with standard key and sounder. Sends you telegraph messages at any speed.

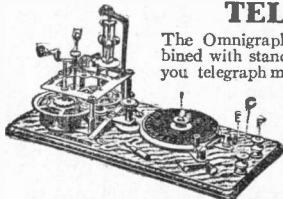

5 Styles, \$2 up. Circular free.

OMNIGRAPH MFG. CO.

39 N. Cortlandt St., New York

Be an Artist

LEARN by mail at home to paint, draw, sketch and decorate china. No experience necessary. All persons who love the beautiful are natural artists. Our wonderful method of personal criticism and individual instruction will bring out your talent. Success assured. Great artists as your instructors. Very profitable and most entrancing work. Write today for our beautiful book, "How to Learn Art." Sent FREE. Write today. Get our great free art book. Omaha, Neb.



Among FINE ARTS INSTITUTE, Studio 1408

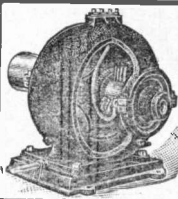

ROTH

ELECTRIC MOTORS
POLISHING LATHES
FORGE BLOWERS
SPECIAL MACHINERY

ROTH BROS. & CO.

419 W. Adams St.

Chicago, Ill.

PARKER

LUCKY CURVE

FOUNTAIN PENS

TRY ONE FREE Select a pen at a dealer's—keep it for ten days—work with it—test it severely, and prove that the Parker is the exception—as it truly is, for the Parker, besides being masterfully efficient, is *cleanly*. Will you give me this chance to prove it?

G. S. Parker
ALL BECAUSE OF THE LUCKY CURVE

Because the ink-feed of the Parker is curved—that's why the Parker is characteristically *cleanly*.

Other pens have straight ink-feeds which retain ink when the pen is returned to your pocket, until air in the reservoir, expanded by heat of your body forces it into the cap, ready to soil your fingers when you remove the cap to write. But the Lucky Curve ink-feed is self-draining, and so Parker pens are *cleanly*. The Parker alone has the Lucky Curve, which is not duplicated in any way in any other fountain pen.

\$1.50 up! Standard, Self-filling, or Safety! The New Jack-Knife Safety can be carried in hand-bag or vest pocket in any position without leaking. You will find one especially designed for your particular work, whatever your work may be.

FREE TRIAL Make a selection at a dealer's. If you can't find a dealer, write me the name of your stationer, jeweler or druggist. I will arrange for you to select from a representative assortment. Beautiful catalog free. See a dealer or write me today.

Dealers— Write for my special 1909 proposition to first 1500 new dealers—a remarkable offer

PARKER PEN COMPANY
 GEO. S. PARKER, Pres.

202 MILL STREET
 JANESVILLE, WIS.

THE
 LUCKY CURVE

THE RADIO

Telephone Holder

is needed by every user of a Desk Telephone

The *Radio* is the most practical and convenient telephone holder ever devised. It is adaptable to any make of desk telephone and can be fastened to either roll or flat top desk. Its adjustable and flexible construction permits the telephone to be used from any angle and any position—sitting or standing—on either side of the desk. It keeps the telephone *up* off of the desk—saves valuable desk space—and positively prevents accidents—overturned ink-wells—telephone falling on the floor, etc.

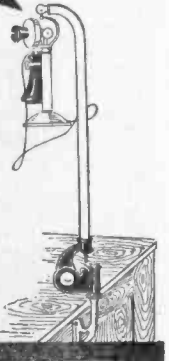

The *Radio* is simple in construction—strong, and has fewer parts than any other holder on the market. And any one can install it in five minutes. No disturbing of telephone cords or wiring necessary. Its suspension joint is ball-bearing, insuring ease of motion. All parts are malleable and non-breakable. Beautifully finished in fine enamel and oxidized copper.

How the Radio works

It is never in the way but always ready for instant service—sitting or standing.

It is adjustable—flexible and ball bearing. It permits you to adjust the telephone to *your* position.

Your caller on the opposite side of desk can use telephone without either of you getting up.

The *Radio* permits one telephone to serve three or more people with remarkable convenience.

The user can tilt the *Radio* in any position to suit his convenience. When released it resumes its normal or vertical position.

Our Satisfaction Guarantee

The price of the *Radio* Telephone Holder is \$3.50—but a small part of its real worth. Mail us this amount *today* and we will send you this *biggest convenience* ever placed upon a desk. Use it ten days and if not more than pleased return it and we will give you your money back. Address "Holder Department".



SWEDISH AMERICAN TELEPHONE COMPANY

Kansas City Branch,
 115 W. Sixth Ave.

CHICAGO,
 1760 E. Ravenswood Park.

Agents Wanted,
 Liberal Profits.

Long Distance, Local, Rural Party Line, Hotel, Portable and Inter-communicating Telephones, Switchboards and Complete Systems. Electrical Supplies of every description. Buy from manufacturer direct and save two or three profits.

For our Mutual Advantage mention Popular Electricity when writing to Advertisers.



The Successful Man

- ☞ There was a time when men just happened to be successful. Opportunity came their way and took them along with it.
- ☞ Times have changed. Now-a-days, success is not an accident; it is a result.
- ☞ Business and Engineering enterprises have become so complex that corporations must have experts to handle them—trained men must be at the head of every department.
- ☞ Are you working towards the head in your chosen occupation? Are you getting the training that will entitle you to the management of your department when the opportunity arrives?
- ☞ The American School, with its thirteen years of experience, with its modern and thorough system of teaching by mail, will qualify you in the higher branches of either business or engineering professions—will give you the training that will enable you to force your way to success.

FREE INFORMATION COUPON

American School of Correspondence:

Please send me your Bulletin, and advise me how I can qualify for position marked "X"

- | | |
|----------------------------|-------------------------|
| ... Book-keeper | ... Draftsman |
| ... Stenographer | ... Architect |
| ... Accountant | ... Civil Engineer |
| ... Cost Accountant | ... Electrical Engineer |
| ... Systematizer | ... Mechanical Engineer |
| ... Certified Public Acc't | ... Sanitary Engineer |
| ... Auditor | ... Steam Engineer |
| ... Business Manager | ... Fire Ins. Engineer |
| ... Commercial Law | ... College Preparatory |

NAME

ADDRESS

OCCUPATION

Popular Electricity, 11-19

Bus.

☞ Don't be an average man at an average salary. Get into the class of successful men.

☞ If you will fill in and mail the coupon, we will tell you how we can realize your ambitions.

☞ The coupon will bring complete information by mail—not an agent. We do not employ representatives or collectors.

WE HELP MEN HELP THEMSELVES

American School of Correspondence
CHICAGO, U. S. A.

\$720

Buy the Material Needed to Build This Home!

Price Includes Blue Prints; Architect's Specifications; Full Details; Working Plans and Itemized List of Material.

OUR HOUSE NO. 130

This is a handsome eight room house, size 25 ft. 10 in. by 29 ft. 6 in., exclusive of porches. First floor contains living room, dining room, pantry, kitchen; front and rear vestibule and reception hall. Second floor contains four good sized bedrooms and bathroom with a spacious closet in each room. It is a design planned so as to be built at a minimum cost of construction, with a maximum return of comfort and modern conveniences. No "ginger bread;" just a solid, sensible, easily constructed, well ventilated and well laid out plan. Easily sold or rented. An ideal house for medium sized family, in either town or country. Write for further information.



We Save You Big Money on Lumber and Building Material!

The Chicago House Wrecking Co. is the largest concern in the world devoted to the sale of Lumber, Plumbing, Heating Apparatus and Building Material direct to the consumer. No one else can make you an offer like the one shown above. We propose to furnish you everything needed for the construction of this building except Plumbing, Heating and Masonry material. Write for exact details of what we furnish. It will be in accordance with our specifications, which are so clear that there will be no possible misunderstanding.

How We Operate:

We purchase at Sheriffs' Sales, Receivers' Sales and Manufacturers' Sales, besides owning outright sawmills and lumber yards. Usually when you purchase your building material for the complete home shown above, elsewhere, it will cost you from 50 to 60 per cent more than we ask for it. By our "direct to you" methods we eliminate several middlemen's profits. We can prove this to you.

What our Stock Consists of:

We have everything needed in Building Material for a building of any sort Lumber, Sash, Doors, Millwork, Structural Iron, Pipe, Valves and Fittings, Steel and Prepared Roofing. We also have Machinery, Hardware, Furniture, Household Goods, Office Fixtures, Wire Fencing—in fact, anything required to build or equip. Everything for the Home, the Office, the Factory or the Field. Send us your carpenter's or contractor's bill for our low estimate. We will prove our ability to save you money. WRITE US TODAY, giving a complete list of everything you need.

Free Book of Plans!

We publish a handsome, illustrated book containing designs of Cottages, Bungalows, Barns, Houses, etc. We can furnish the material complete for any of these designs. This book is mailed free to those who correctly fill in the coupon below. Even if you have no immediate intention of building, we advise that you obtain a copy of our FREE BOOK OF PLANS. It's a valuable book.

Our Guarantee!

This company has a capital stock and surplus of over \$1,000,000.00. We guarantee absolute satisfaction in every detail. If you buy any material from us not as represented, we will take it back at our freight expense and return your money. We recognize the virtue of a satisfied customer. We will in every instance "Make Good." Thousands of satisfied customers prove this. We refer you to any bank or banker anywhere. Look us up in the Mercantile Agencies. Ask any Express Company. Write to the publisher of this publication. Our responsibility is unquestioned.

High Grade Bathroom Outfits!

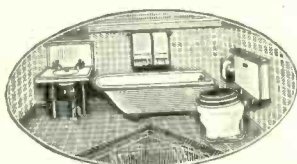

Price of this Bathroom Outfit, \$37.50

This is a positive fact. It's only one of ten other complete outfits that we are offering at prices ranging from \$25.00 to \$100.00. Our catalog describes them in detail. You need the book if you want to keep posted on up-to-date business methods. Get our prices on Pipe and Fittings. Write us today.

Strictly new and as good as anyone sells. We have everything needed in Plumbing Material. Our prices mean a saving to you of 30 to 60 per cent. We can easily prove it if you will give us a chance.

Here is an illustration of a bathroom outfit we are selling at \$37.50. Your plumber would ask you about \$60.00 for this same outfit. It's only one of ten other complete outfits that we are offering at prices ranging from \$25.00 to \$100.00. Our catalog describes them in detail. You need the book if you want to keep posted on up-to-date business methods. Get our prices on Pipe and Fittings. Write us today.

Hot Water Heating Plants!

We furnish new complete hot water heating outfits at half the usual prices. Our proposition includes all necessary plans, specifications, blue prints and detailed instructions; so that any ordinary mechanic handy with the use of tools can easily install it.

You can't go wrong when you deal with us. We stand back of every sale. You send us today a sketch of your building and we will make you a proposition to furnish you a complete steam or hot water heating outfit.

We also have hot air furnaces. Our booklet on heating plants tells every feature of the heating question. We can quote radiators & heaters separately. Whether you buy from us or not it is a valuable book for you to own. Write us today.

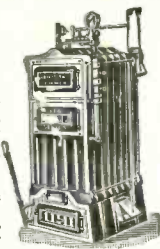

Send Us This Coupon

Chicago House Wrecking Co.:

I saw this ad. in Popular Electricity.

I am interested in _____

Name _____

Town _____

Co. _____

State _____

Free Publications!

Fill in the coupon to the left and we will send you such literature as best suits your needs. We publish a 500 page mammoth catalog fully illustrated, giving our business history and showing all the vast lines of merchandise that we have for sale. We buy our goods at Sheriffs', Receivers' and Manufacturers' Sales. Ask for Catalog No. 891 Our Book on Plumbing and Heating Apparatus contains 150 pages of useful information. Our free "Book of Plans" is described elsewhere in this advertisement.

Chicago House Wrecking Co., 35th & Iron Sts., Chicago.

Water Supply Outfits!

Modern Air Pressure Water Supply Systems at prices ranging from \$48.00 to \$200.00. They are strictly new, first-class and complete in every detail. It makes no difference whether you live in the country, you can enjoy every city comfort at little expense. Why not investigate this! We are ready to furnish you with all facts free of charge. All material fully guaranteed. We also have a complete stock of Pipe, Valves and Fittings at 40 to 60 per cent saving. Gasoline Engines at low prices.

Thor-Electric

Makes The HARDEST WORK About The House
The EASIEST

For One-third your Present Wash Day Cost

Water is heated in and by the washer. Putting clothes into the revolving drum and turning on the power is all you need to do. Not even necessary to interrupt other household duties. Feeding clothes through the reversible automatic wringer into blueing water and back again is the last operation before hanging out.

The clothes in the drum are carried on a cleat or shelf, then dropped. The action is simply the gentle one of **LIFT AND DROP**—lift and drop. While the hot suds pour through and through the clothes, until every particle of dirt is loosened. There are no paddles to strain them. Nothing that can possibly wear the clothes in any way. As the clothes are constantly changing their position they **CANNOT BECOME PACKED IN A WAD**—an exclusive thor-

electric feature. The saving in clothes and the cheapness of operation will pay for a Thor-Electric Washing Machine in a few months.

By attaching the **UNIVERSAL ROD** (sold only with the Thor) the Thor-Electric can be made to perform by electricity countless daily household tasks now done by the housewife, housemaid, washwomen, butler or man-of-all-work. Such as:

Washing the Clothes
Wringing the Clothes
Working the Ironing Machine
Working the Food Chopper
Sharpening Knives

Churning the Butter
Turning the Grindstone
Freezing the Ice Cream and
Doing Scores of
Other Household Duties

Sent on 30 Days' Free Trial

*Write us for free illustrated booklet, No. 49, showing all styles, sizes and capacities.
Ask for our new easy payment plan.*

HURLEY MACHINE CO.

27 S. Clinton St.
CHICAGO

71 First St.
SAN FRANCISCO, CAL.

2609 Flatiron Bldg.
NEW YORK

