

Price 10 Cents

IN THIS ISSUE

ELECTRICITY AND THE POOL ROOMS
R. R. ACCIDENTS AND THEIR PREVENTION

POPULAR ELECTRICITY

Trade Mark
IN PLAIN ENGLISH



SINGER TOWER ILLUMINATED

Vol. 1.

APRIL 1909

No. 12.

Disease Can Be Cured

without the use of medicine

HEALTH AND STRENGTH



This cut shows how the Magnetic waves from our Vest envelop the entire trunk of the body, and saturate the patient with powerful Magnetic vibrations. We make Shields for every part of the body, all described in our new book, "A PLAIN ROAD TO HEALTH," by C. I. Thatcher, M. D. Send for it today. Free to all.

come from a good circulation full of
magnetic life

WE PROVE IT TO YOU

**We Prove Every Statement We Make.
We Do Not Ask You To Take Our
Word As Final Evidence.**

When we say that disease can be cured without the use of medicine, we mean every word we say; every word of it is true. We know it to be true, because in the past quarter of a century we have proven it to our own satisfaction and to the joyful satisfaction of thousands of others. We are constantly on the lookout for other diseases to prove it on. We prove it to anybody; in fact, we want to prove it to everybody.

We do not care what the disease is, nor how severe it is, nor how many other diseases are complicated with it, we can show you parallel cases that have been cured by the Famous Thatcher Magnetic Shields, and these cases are sound and well to-day, as living monuments to the grand revitalizing power of Magnetism. Patients are often told that they have incurable diseases. We want to tell you right here that nearly all of these cases can be cured, and we can prove it to you. More than seventy-five per cent. of all the patients we have cured, were first given up as beyond hope of cure, and they were made sound and well by applying Magnetism according to scientific instructions.

We will point you to cases of Paralysis, Consumption, Diabetes, Bright's Disease, Locomotor Ataxia, Dyspepsia, Rheumatism, Tumors, Nervous Prostration, Obesity, and a hundred-and-one other diseases that are called incurable. We can show you the most incontestable proof that we have cured them. We have cured them after they had been given up to die.

Read the following letters from grateful patients:

THESE POSITIVE POWERFUL STATEMENTS ARE INDISPUTABLE

Serious Complication of Lung, Stomach and Kidney Trouble—A Marvelous Chicago Recovery.

Dr. Thatcher: Dear Sir:—It gives me great pleasure to testify to the perfect cure I have gained by using your wonderful Shields. After suffering 15 years with stomach troubles, although doctoring the greater part of the time, I kept getting worse, until I was the victim of a severe complication of stomach and kidney trouble, which a year and a half ago all seemed to go to my lungs. Had dreadful pains, lost my appetite, could not sleep, became so very weak that I could hardly walk across the floor, and not able to do my work. At times when my pains were not so severe I would try to read, but could not for more than five minutes at a time, as I was very nervous. My family and friends thought I would not live another month. I was getting tired of taking medicine. Nothing helped me. I happened to see your advertisement in the paper, which read "Magnetism Cures Without Medicine." I thought "While there is life there is hope." So just one year ago today I put on your wonderful Magnetic Vest, Leggings and Insoles. The result was a miracle, for in two days I felt relieved; in a week, very much better; in three weeks, entirely cured.

Words cannot express how thankful I am to you for your kind advice; also for the treatment to which I owe my life. May you live long for suffering humanity's sake. May your great and sure cure be known a great deal better than it is today. Yours respectfully, MRS. O. RAY, 654 Hirsch St., Chicago, Ill.

We have thousands of just such letters, stating that the patients had been cured of diseases that had been considered incurable. Do not be discouraged. Do not give up hope, even if you have been told your trouble could not be completely described of your case, and let us prove to you that we can cure you.

We will send you FREE OF CHARGE our new book "A PLAIN ROAD TO HEALTH," by C. I. Thatcher, M. D., and will advise you just what application of Magnetism will be required to cure your case. Write us fully to-day, and we will take the same careful pains to advise you, as if you would call at the office and see us in person.

WARM FEET—A pair of FOOT BATTERIES, the very smallest shields we make, worn in the shoes, will convince the most doubting skeptic of the curative value of MAGNETISM. \$1.00 a pair or three pairs for \$2.00. Send size of shoe when ordering FOOT BATTERIES.

THACHER MAGNETIC SHIELD CO., INC., Suite 277, 169 Wabash Avenue, CHICAGO, ILL.

"The Shields Have Saved My Life"—Extreme Case of Paralysis Speedily Cured.

Dear Dr. Thatcher:—I feel as though I must give my testimonial in hopes that it may induce some poor suffering one afflicted with paralysis to get the shields and be cured, who otherwise would give up in despair and die, for the shields have saved my life, which I believe nothing else could ever have done, for, as you said when I came into your office eleven years ago, a poor, wreck of myself, so that I had to be half carried and could not help myself, and you were afraid it was too late, but advised that if I was covered up with the shields, that I might yet be saved. You did nearly cover me with the shields, and they did their work. They started the deadened blood and saved my life, which must otherwise have been of very short duration, for my bowels and stomach had stopped working entirely for nearly a week. They were the same as dead. I had the second stroke. The root of the tongue was also totally paralyzed and the eyes were set; could not move them and the brain was so far gone it felt just like a big basket on my shoulders, and I had to be held up while the shields were being put on, for my whole strength had given out and I think you had little hopes of saving me, but you said you would try, and only for your timely efforts I would not have stayed long. I began to feel better and improved with every hour after I put them on, and in eight weeks I was out traveling on the road. I was then past 50 years of age. I am now very much alive, smart and active, and I advise no one to hesitate trying the shields after they know what they have done for me, and I will be glad to answer any letter of inquiry that may come to me from any person suffering with paralysis or similar form of disease.

MRS. M. C. SCHWAGER, 646 W. 41st St., Chicago, Ill.

I N D E X

Volume I.

Popular Electricity

(May, 1908, to April, 1909)

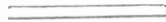

POPULAR ELECTRICITY PUBLISHING CO.
CHICAGO, ILL.

A		Page	B		Page
A B C of The Telephone (Book Review)...		256	Back Yard Electric Lighting Connections...		770
A B C Wireless Receiver.....		635	Baking by Electricity.....		703
A Little Stratagem.....		298	Ballet, Electricity in the.....		26
Acheson, Edward Goodrich.....		308	Barber Chairs, Telephones on.....		49
Accidents and Their Prevention, Railroad.....		754	Bascul Bridge, An 800-Ton Motor Operated.....		423
Accidents, How to Avoid.....		14	Base Ball Returns by Telephone.....		540
Adaptability of the Tungsten Lamp.....		500	Batteries, Applications of Small Storage.....		695
Adding Machine, Improved.....		621	Batteries, Charging Secondary From Pri- mary.....		322
Adjustable Interrupter.....		777	Batteries, Reviving Old Dry.....		658
Adjustable Machine Lamp.....		631	Batteries, Storage.....		261
Advantage of Practical Training.....		689	Battery Box, A Neat.....		338
Advantages of an Electrical Engineering Education.....		45	Battery Charging, Storage.....		659
Advantages of Flameless Cooking.....		715	Battery, Construction of a Small Storage.....		655
Advertising Automaton.....		730	Battery, Crowfoot or Gravity.....		794
Advertising, Unique Central Station.....		760	Battery, Gravity.....		729
Advertisement, An Efficient.....		211	Battery Holder, Wireless.....		495
Aeolus, A Modern.....		712	Battery, Home Made.....		118, 587
Aerial Elevation.....		710	Battery, Making a Storage.....		727
Aerial Systems.....		774	Battery Motor, Operating from Lighting Circuit.....		718
Aerial, Wireless System Without.....		707	Battery Motor Operated from 110 Volt Al- ternating Current.....		453
Aerial Wires.....		229	Battery Motors.....		658
Aerials and Transformers.....		641	Battery Resistance, Measuring.....		792
Afternoon Tea With Mrs. Van Syckle.....		177	Beauties of the Automobile Parade.....		24
Aid in Case of Electric Shock, First.....		28	Bell Ringer That Does Not Use Batteries.....		533
Airship, Wireless From.....		778	Bell Wiring.....		659
Alarm Clock, Electric.....		121, 800	Bells, How to Install Electric.....		255
Alarm Clock, How to Make An Electric.....		787	Bells Operated from Trolley Current, Street Car Signal.....		538
Alarm, Electric Lights An Effective Burglar.....		513	Belts, Static Electricity from.....		480
Alarm, Simple Electric.....		390	Berlin Long Distance Telephone Exchange.....		276
Alarms, Electric Bedroom.....		388	Bernard E. Sunny.....		779
Alden Wireless Telephone.....		79	Beyond the Spectrum.....		460
Alps, Telephone Line Over the.....		474	Bion J. Arnold.....		109
Alternating Current Corrector.....		40	Blanket, Electric Sweating.....		541
Aluminum and Copper.....		628	Bleaching of Flour, Electric.....		232
Aluminum Solder.....		731	Block Signals, Electric.....		754
Amateur's Electrical Laboratory.....		318	Blower for Furnaces, Electric.....		354
Amateur's Wireless Outfit.....		637	Blue Prints, Electric Fan Dries.....		90
American Institute of Electrical Engineers.....		622	Boiler, An Electric Steam.....		373
Ammeter or Voltmeter, To Make An.....		797	Boiler Tube Cleaner, Motor Driven.....		96
Ammeter Shunt.....		794	Boilers, Steam.....		631
Ampere Memorial Tablet.....		629	Bone Surgery, Electric Motors in.....		484
Annealing & Tempering by Electric Fur- nace.....		684	Booth, The Electric.....		575
Annunciator for Electric Bells.....		650	Boy Electrician, The (Book Review).....		49
Another Thunder & Lightning Theory.....		522	Boys' Telegraph Line.....		515
Ants, Electrocuting An Army of.....		613	Branly's Tele-Mechanic.....		47
Antenna, Wireless Telegraph.....		122	Breakfast Prepared on the Dining Room Table.....		50
Apparatus for Cooling Rooms.....		661	Breaking the Ice at a Party.....		507
Applications of Small Storage Batteries.....		695	Bridges, Electric Transporter.....		161
Arc Furnace.....		796	Bridging Telephone, Connection of.....		585
Arc Lamp Crater.....		228	Brief Guide to Vibratory Technique (Book Review).....		256
Arc Lamp, Joerin Singing.....		87	Brusio-Campocologna Power Plant, Switzer- land.....		598
Arc Light, A Simple.....		184	Buffer, Motor Driven.....		565
Arc Rectifier, Mercury.....		624	Bug Trap, Unique Electric.....		335
Arguments for Electrocutation.....		488	Bulletin Board, Following a Ball Game by the Electric.....		349
Arches for Street Lighting, Electric.....		30	Bulletin Squad in a Telephone Exchange.....		540
Armature, Ring Wound.....		797	Burglar Alarm, Electric Lights An Effective.....		513
Armature, Small Dynamo.....		723	Burns, X-Ray.....		211
Armature, Winding a 12-Slot.....		723	Butchers' Electrically Operated Saw.....		731
Arnold, Bion J.....		109	Butter Made by Electricity.....		688
Arrangement of Dining Room Lights.....		251	Buzzer Telephone.....		653
Arrester, Telephone Lightning.....		519			
Art of Electric Welding.....		552			
Artesian Power, Electricity From.....		223			
Artistic Street Lamp Design.....		67			
Arthur Besey Smith.....		573			
As to the Cause of Thunder and Lightning.....		326			
At the Telephone.....		761			
Atlanta, Electric Power for.....		563			
Atlantic Cable, Golden Jubilee of the.....		209			
Atmospheric Electricity, Collecting.....		799			
Aurophone.....		504			
Automatic Electric Time Table.....		469			
Automatic Heat Control System.....		395			
Automatic Lamp Flasher.....		764			
Automatic Lift, Electric.....		474			
Auto-Telegraph Car.....		156			
Automatic Telephone Light.....		517			
Automatic Telephone and Its Operation.....		496			
Automatic Cloth Scouring Machine.....		769			
Automatic Transportation System, New.....		340			
Automaton, Advertising.....		730			
Automobile, An Electric Company's Emer- gency Fire.....		443			
Automobile Emergency Electric Light Plant.....		623			
Automobile Parade, Beauties of the.....		24			
Automobile, Present Status of the Electric.....		482			
Automobile Timing Device.....		739			
Automobiles, New Power Transmission for Electric.....		551			
Awning Operator, Electric.....		458			
			Cable Hauling on the New Manhattan Bridge.....		420
			Cable Laying An Enticing Profession.....		269
			Cable Laying, German Submarine.....		168
			Cables, Simple Method of Testing.....		365
			Cables, Splicing Lead-Covered Telephone.....		302
			Cables, Terminal for Electric.....		396
			Cake, Electric Lighted Birthday.....		506
			Camera, Electrically Operated.....		339
			Camera for Submarine Photography, Elec- trically Operated.....		591
			Camera Shutter.....		521
			Can a Baseball Take Up Lines of Force?.....		259
			Canal, Electric Power from the Chicago Drainage.....		377
			Candy Wrapper, Electrically Operated.....		566
			Cannon, An Electric.....		795
			Cannon, A Novel.....		618
			Car Fenders & Wheel Guards, Testing Street.....		548
			Carbon, Moulding.....		793
			Carr Transportation System.....		340

	Page		Page
Catching the Speeding Motorist.....	739	Construction of a Small Storage Battery....	655
Cathode Rays	740	Construction of a Small Switchboard.....	185
Cause and Effect of Lightning Discharges..	292	Construction of a Two Mile Wireless Outfit.	418
Cause of Poor Light.....	643	Construction of Wireless Equipment.....	709
Cause of Thunder & Lightning.....	183, 261	Construction of Wireless Apparatus.....	455
Causing Sleep by Electricity.....	166	Controller for Toy Motors, Simple.....	654
Cells, Construction of Selenium.....	561	Convention, Oklahoma Electrical.....	23
Cement Industry, Electric Motors in the... 97		Conversations of Electricity (Book Review).	107
Central Station Advertising, Unique.....	760	Cooking by Electricity, Cost of.....	52
Central Station in Chicago.....	595	Cooking Utensils, New Development in....	785
Central Station on Wrecked Ship.....	275	Cooling Furnace Men with Electric Fans... 492	
Centrifugal Machines, Electrical Operation of	239	Copying Machines, Electrically Operated... 431	
Centrifuge	675	Copper and Aluminum.....	628
Cerium Filament Lamp.....	495	Copper Tube Lightning Rod.....	49
Charging Leyden Jars.....	454	Corn Popper, Electric.....	507
Charging Secondary Batteries From Primary Batteries	322	Cornell X-Ray Tube.....	131
Charging Storage Battery.....	659, 695, 793	Corrector, Alternating Current.....	40
Charles Proteus Steinmetz.....	711	Cost of Electricity.....	197
Changing Windings of Fan Motor.....	516	Cost of Cooking by Electricity.....	52
Chemical Effects of Electrical Discharges..	525, 600	Cotton Mills, Motors in.....	562
Chemical Rectifier	692	Cow Milking Machine.....	488
Chewing Gum, Electric Masticator for Manufacture of	550	Cow Milkers Needed in Italy, Electric..... 243	
Chicago, Electric Service in.....	595	Cranes For Stone Quarries, Electric..... 269	
Chicago, Electrical Show.....	632, 665	Crater, The Arc Lamp.....	228
Children, Electric Shocks for Perverse	547	Cross Examination, Electrical.....	627
Chicken Thief, How to Catch a.....	450	Crowfoot of Gravity Battery.....	793
Chickens Hatched in a Stock Ticker.....	254	Current Corrector, Alternating.....	40
Chinese Telephone Exchange.....	175	Curling Iron, Electric.....	314
Chocolate Warmer	553	Current Detector for Relays.....	254
Choke Coil	455	Current Detector for Wireless Work, Simple	252
Cigar Factories, Tungsten Lamps in.....	532	Current Indicator	681
Cigar Moistener, An Electric.....	307	"Current" Topics, Talks on.....	578, 644
Circuit Breaker	657	Cut Glass Telephone.....	41
Circuit, Single Wire Signaling.....	796	Cutting Telephone Poles in Michigan.....	36
Circuits, A Deal in.....	788		
Circuits, House System Telephone.....	793	D	
Circuits, Multiple-Series and Series-Multiple Circuits, Varieties of Electric.....	68	Deaf, Aurophone for the.....	504
City Electrical	77	Deal in Circuits.....	788
City of Lights, Denver.....	300	Death of Dr. S. D. Cushman.....	48
Clamp, A New Test.....	495	Decorations, Electric Table.....	506, 579
Cleaning Outfit, Vacuum.....	179	Definitions, Electrical	60,
Clock, How to Make an Electric Alarm.....	787	126, 196, 264, 328, 400, 462, 524, 594, 664, 734, 804	
Clock, Electric Alarm.....	121, 80	Demagnetizer, Watch	587
Clocks, Regulating by Wireless.....	547	Dental Appliances, Electric.....	75
Closed Core Transformers.....	709	Dentists' Electric Furnace and Pyrometer... 426	
Cloth Scouring Machine, Automatic.....	769	Dentistry, Some Applications of Electricity to	370
Clothing, Electric Iron in the Manufacture of	437	Denver, Electricity in.....	686
Coal Cutting Machines.....	477	Denver, The City of Lights.....	300
Coal Mining, Electricity in, Parts 1, 2, 3... 336, 424, 477		Denver, "Welcome" in.....	246
Code, National Electrical.....	728	Department Store, Telephones in a.....	439
Code, The Japanese Telegraph.....	338	Depositing Metal on Insects.....	187
Codes, Wireless	710	Desert Power Plant.....	416
Coffee Mill, Electric.....	299	Design of a Small Wireless Set.....	589
Coffee Urn, Electric.....	646	Design of a Solenoid.....	194
Coherer, Elastic.....	708	Desk Fan, An Individual.....	307
Coherers, Short Circuiting of.....	457	Detector for Wireless Telegraphy.....	557
Coil to Explode Powder.....	728	Detector for Wireless Work, Simple Current	252
Collecting Atmospheric Electricity.....	799	Detector, Silicon	640
Cooling Rooms, Apparatus for.....	661	Detector Solution	642
Coke Ovens, Electricity in the Charging of. 164		Detector, Wireless	708
Colombia, First Electric Road for.....	24	Development of the Electric Launch.....	39
Coloring Incandescent Lamps, Process of. 627		Development of the Grinding Machine..... 442	
Comfort in the Home, More.....	110	Dictaphone	532
Commonwealth Edison Co.'s Electric Shop. 780		Diffuser, The Extension.....	615
Communication, Marvels of Electrical..... 701		Dimalite	578
Commutator Sparking.....	617	Dining Room Lights, Arrangement of..... 251	
Commutator Trouble.....	655	Dion System of Channel Illumination..... 44	
Complete Wireless Receiving Set for Amateurs	635	Direct Current Motor on Alternating Current	726
Complicated Complaint	278	Divers' Telephone	787
Compound Dynamos	792	Door Bell, Operated by 110 Volt Current... 444	
Compressor, Small Motor Driven Air.....	373	Drainage Canal, Electric Power from the Chicago	377
Concealed Window Lighting.....	735	Draughtsmen, Motor Driven Eraser for... 89	
Concrete Telephone Pole.....	92	Dredge, German Electric.....	243
Condenser, High Frequency.....	542	Dredges for Gold Placer Mining, Electric... 359	
Condenser, Movable Plate.....	709	Drill Holder, Electrician's.....	361
Condenser Phenomenom, Peculiar.....	516	Drill, Motor Driven.....	565
Condensers	455, 640, 642, 709	Drill, Portable Electric Breast.....	765
Connection of Bridging Telephones.....	585	Drop a Penny—Get a Shine.....	629
Connection of a Magneto Telephone.....	585	Drop in Voltage.....	657
Connector for Electrical Circuits.....	768	Drum, Winding a Twelve-Slot.....	723
Construction of a Leyden Jar.....	727	Drunkenness, Electricity to Cure.....	79
Construction of Selenium Cells.....	561	Dry Batteries, Reviving Old.....	658
Construction of a Simple Microphone.....	584	Drying Clothes, Electric Fan for.....	53
Construction of a Simple Wireless Telegraph Set	32	Dugald C. Jackson.....	634
Construction of Small Generator.....	660	Dyeing, Electric	165
		Dynamo Armature, Small.....	723
		Dynamo Construction of a Small.....	660
		Dynamo Design.....	660

	Page		Page
Dynamo Equipment, Man Power.....	221	Electric Fire Boats, First in the World.....	693
Dynamo, A Freak.....	201	Electric Fire Engines.....	208
Dynamo Will not Run.....	797	Electric Fire-Place.....	800
Dynamo, Winding a 75-Watt.....	795	Electric Flat Iron.....	268
Dynamos, Compound.....	792	Electric Floriculture.....	509
Dynamos, Spark Coil Operated from.....	793	Electric Floriculture in England.....	27
E			
Early History of the Telegraph.....	215	Electric Foot Warmer.....	113
Easy Lamp Changer.....	493	Electric Forges in Transvaal Mine.....	47
Eel and His Battery, The Electric.....	291	Electric Frost Foreteller.....	355
Eels, Electricity Rids Power Plant of.....	235	Electric Fountain Center Piece.....	8
Effect of Electricity on Animals.....	414	Electric Furnace.....	240, 535
Effect of Wind on Wireless Waves.....	707	Electric Furnace and Pyrometer, Dentists'.....	426
Effects of a Bursting Fly Wheel.....	505	Electric Furnace, Annealing and Tempering.....	684
Effects of Electric Discharges.....	202	Electric Gas Lighter.....	647
Effective Interior Illumination.....	571	Electric Hair Drier.....	177, 662
Efficiency of Tungsten Lamps.....	614	Electric Hardening of Steel.....	100
Efficient Advertisement.....	211	Electric Headlight, Physicians'.....	258
Edison, Thomas A..... (Frontispiece May, '08)	31	Electric Heating Pad for Nursery and Sick Room.....	505
Edison, Reminiscences of Thomas A.....	31	Electric Heater, A New.....	258, 519
Edison's Theory of Electricity.....	380	Electric Heating.....	124
Edward Goodrich Acheson.....	308	Electric Heating Pad.....	258
Edwin J. Houston, Ph. D.....	38	Electric Household Conveniences, The Latest.....	382
Eight-Hundred-Ton Motor Operated Bascule Bridge.....	423	Electric Hydroscope.....	423
Elastic Coherer.....	708	Electric Illuminations, Quebec's.....	89
Electric Air Filters.....	301	Electric Instrument Sterilizer.....	557
Electric Air Purifier.....	430	Electric Irons in the Manufacture of Clothing.....	437
Electric Alarm Clock.....	121, 800	Electric Ironing Day.....	176
Electric Alarm Clock, How to Make an.....	787	Electric Kettle.....	122
Electric Alarm, Simple.....	390	Electric Kitchen, Equipment of.....	310
Electric Appliances for the Physician, Practical.....	536	Electric Knife, Surgeon's.....	488
Electric Arches for Street Lighting.....	30	Electric Lamps, The Manufacture of.....	408
Electric Automatic Lift.....	474	Electric Lantern in a City's Upbuilding.....	42
Electric Automobiles, New Power Transmission for.....	551	Electric Launch, Development of the.....	39
Electric Awning Operator.....	458	Electric Laundry Washer.....	115
Electric Bedroom Alarm.....	388	Electric Light Connections, Back Yard.....	770
Electric Bell for Light Circuits.....	730	Electric Light in a City's Upbuilding.....	686
Electric Bells, Annunciator for.....	650	Electric Light, Life Belt With.....	140
Electric Bells, How to Install.....	255	Electric Light Plant, Automobile Emergency.....	623
Electric Bleaching of Flour.....	232	Electric Light the Safest in the Home.....	647
Electric Block Signals.....	754	Electric Light Turned Up or Down.....	578
Electric Blower for Furnaces.....	354	Electric Lights an Effective Burglar Alarm.....	513
Electric Booth.....	575	Electric Lights and Telephones for the Turks.....	483
Electric Breast Drill, Portable.....	765	Electric Lighted Birthday Cake.....	506
Electric Bulletin Board, Following a Ball Game by the.....	349	Electric Malting Process.....	520
Electric Cables, Terminal for.....	396	Electric Magic Box, A Marvelous.....	315
Electric Camera Shutter.....	521	Electric Masticator for the Manufacture of Chewing Gum.....	550
Electric Cannon.....	795	Electric Milk Testing.....	224
Electric Chocolate Warmer.....	553	Electric Motor in Bone Surgery.....	484
Electric Cigar Moistener.....	307	Electric Motor in the Home.....	250
Electric Circuits, Varieties of.....	69	Electric Motors in the Cement Industry.....	97
Electric Coal Cutters.....	477	Electric Neutralizer for Printing Presses.....	75
Electric Coffee Mill.....	299	Electric Office Appliances.....	619
Electric Coffee Urn.....	646	Electric Organ.....	502
Electric Company's Emergency Fire Automobile.....	443	Electric Piano Player.....	521
Electric Corn Popper.....	507	Electric Polisher.....	646
Electric Cow Milkers Needed in Italy.....	243	Electric Power for Atlanta.....	563
Electric Cranes For Stone Quarries.....	269	Electric Power from a Glacier.....	237
Electric Curling Iron.....	314	Electric Power from Peat.....	341
Electric Current Consumption in New York.....	801	Electric Power from the Chicago Drainage Canal.....	377
Electric Current, Things to Know About.....	108	Electric Power from the Sun.....	702
Electric Dental Appliances.....	75	Electric Power Plant, How a Farmer Built His Own.....	432
Electric Discharges, Chemical Effects of.....	525, 600	Electric Power, Unloading Bananas by.....	130
Electric Discharges, Effect of.....	202	Electric Protection Against the Tereedo.....	591
Electric Discharges, How to Photograph.....	388	Electric Punkah.....	539
Electric Discharges, Luminous Effects of.....	401	Electric Radiator.....	647
Electric Discharges, Magnetic Effects of.....	270	Electric Radiator, A Portable.....	448
Electric Discharges, Mechanical Effects of.....	463	Electric Railroad on a Large Scale.....	703
Electric Discharges, Photographs of.....	244	Electric Railway in Norway, First.....	762
Electric Discharges, Physiological Effects of.....	676	Electric Railway on a 200-Year-Old Viaduct.....	181
Electric Discharges to Increase Grain Yield.....	361	Electric Railway, The First.....	226
Electric Discharges, Thermal or Heating Effects of.....	329	Electric Railways of Manila.....	745
Electric Dredge, German.....	243	Electric Railways, Extraordinary Growth of.....	81
Electric Dredges for Gold Placer Mining.....	359	Electric Railways, How a Boy Built One of the First.....	580
Electric Driven Polishing Outfit.....	535	Electric Railways in Japan.....	353
Electric Driven Tools, Portable.....	268	Electric Rail Welding.....	152
Electric Dyeing.....	165	Electric Roads, Refrigerator Cars for.....	348
Electric Eel and His Battery.....	291	Electric Rat Trap.....	731
Electric Elevator, Novel.....	99	Electric Reduction Furnace.....	661
Electric Emanations, Photographing.....	43	Electric Rotary Floor Polisher.....	178
Electric Fan.....	539	Electric Saw for Butchers.....	165
Electric Fan Dries Blue Prints.....	90	Electric Search Light for the Camp.....	54
Electric Fan for Drying Clothes.....	53	Electric Scrubbing Brush.....	485
Electric Fans, Cooling Furnace Men With.....	492	Electric Self-Registering Target.....	66
Electric Fans Revive Firemen.....	414	Electric Service in a Great City.....	595
Electric Fault Finder.....	616		

POPULAR ELECTRICITY

5

	Page		Page
Electric Sewing Machine.....	507	Electrically Operated Copying Machine.....	431
Electric Ship Scrubber.....	547	Electrically Operated Saw, Butchers'.....	731
Electric Shock, First Aid in Case of.....	28	Electricity Applied to Horticulture.....	766
Electric Shock, What to Do for.....	149	Electricity and Fog.....	235
Electric Shocks for Perverse Children.....	547	Electricity and Submarine Mines.....	279
Electric Shoe Shiner.....	629	Electricity and the Poolroom.....	746
"Electric Shop," the Wonders of.....	780	Electricity as a Resurrection Force.....	155
Electric Sign, A Remarkable.....	201	Electricity a Protection Against Tere-do Worms.....	426
Electric Signal for Mail Boxes.....	27	Electricity, Baking by.....	703
Electric Signal Light for Street Cars.....	379	Electricity Book for Boys, Harper's (Book Review).....	592
Electric Signs, Flashing.....	362	Electricity Beats Eggs.....	324
Electric Silver Polisher.....	646	Electricity, Butter Made by.....	683
Electric Sleep.....	166	Electricity, Collecting Atmospheric.....	799
Electric Spark, Gas Engine Ignition by.....	611	Electricity Cooks for the King.....	295
Electric "Specials".....	494	Electricity Cures Lockjaw.....	494
Electric Sprinkling Car.....	225	Electricity Does the Drudgery.....	644
Electric Static Machine.....	518	Electricity for Medicinal Purposes.....	536
Electric Steam Boiler.....	373	Electricity, Milking Cows by.....	488
Electric Suction Sweeper.....	178	Electricity for the Southern Pacific.....	130
Electric Sweating Blanket.....	541	Electricity from Artesian Power.....	223
Electric Table Decorations.....	579	Electricity from Belts, Static.....	480
Electric Tailor's Goose.....	221	Electricity from Peat.....	169
Electric Talking Siren, French.....	65	Electricity from Small Water Powers.....	208
Electric Time Table, Automatic.....	469	Electricity Generated by Sea Waves.....	620
Electric Tire Vulcanizer.....	561	Electricity in Coal Mining, Parts 1, 2, 3.....	336, 454, 477
Electric Toaster.....	647	Electricity in Agriculture.....	590
Electric Torpedo Fish.....	398	Electricity in Dentistry.....	370
Electric Traction, Railless.....	529	Electricity in Denver.....	686
Electric Transporter Bridges.....	161	Electricity in Its Infancy.....	98
Electric Truck, Wireless.....	142	Electricity in the Himalayas.....	67
Electric "Tubes" of Light.....	86	Electricity in Mohammed's Tomb.....	502
Electric Vacuum Cleaner.....	712	Electricity in the Ballet.....	26
Electric Waffle Iron.....	646	Electricity in the Charging of Coke Ovens.....	164
Electric Warming Pad.....	545	Electricity in Medicine, By Dr. Otto Jeutt- ner (Parts 1 to 6).....	18, 102, 144, 212, 250, 344
Electric Washing Machine.....	577, 644	Electricity on the Farm, 79, 216, 432, 559, 606.....	766
Electric Water Heater.....	459	Electricity On Shipboard.....	290
Electric Water Heater, Novel.....	509	Electricity Opens Safe.....	143
Electric Water Heaters Not Dangerous.....	179	Electricity, Playing a Piano by.....	534
Electric Water Level Indicator.....	422	Electricity, Poaching by.....	475
Electric Water Still.....	633	Electricity, Progress of.....	470
Electric Welding, Art of.....	552	Electricity, Raising Tomatoes by.....	500
Electrical Cable, Largest.....	171	Electricity, Regulator for Static.....	517
Electrical Circuit Connector.....	768	Electricity, Respect But Do Not Fear.....	626
Electrical Contracting (Book Review).....	438	Electricity Rids Power Plant of Eels.....	235
Electrical Cross Examination.....	627	Electricity, Running a Ranch by.....	559
Electrical Definitions.....	60, 126, 196, 264, 328, 400, 462, 524, 594, 664, 734,	Electricity, Sanitation by.....	447
Electrical Engineer, How I Became An.....	56	Electricity, Static Applied to Wireless Tel- egraphy.....	581
Electrical Engineering Education, Advan- tages of.....	45	Electricity, Testing Raw Material by.....	565
Electrical Features of the German Ship Building Exposition.....	55	Electricity, The Cost of.....	197
Electrical Game, New.....	54	Electricity, The Future of.....	429
Electrical Home Decorations.....	576	Electricity the Life Principle.....	253, 398
Electrical Illumination of Niagara Falls.....	80	Electricity the Life of Vegetables.....	349
Electrical Illumination, The Mercurv Vapor System of.....	556	Electricity vs. The Smoke Nuisance.....	220
Electrical Installations of the United States Navy (Book Review).....	49	Electricity, Through the Cascade Tunnel by.....	621
Electrical Laboratory, Amateur's.....	318	Electricity to Cure Drunkenness.....	79
Electrical Massage.....	643	Electricity, Woman's Field Broadened by.....	249
Electrical Method of Administering Medi- cine.....	438	Electricity, Women to Grow Flowers by.....	509
Electrical News.....	48	Electrician, Information for the Practical.....	194
Electrical Operation of Centrifugal Ma- chines.....	239	Electrician's Drill Holder.....	361
Electrical Phenomena of the Grand Plateau.....	551	Electricians in Demand, Naval.....	150
Electrical Production of Iron & Steel.....	240	Electricians, Uncle Sam's Naval.....	57
Electrical School, The Navy.....	758	Electrocute Flies, A Way to.....	55
Electrical School Programme Transmitter.....	9	Electrocuting an Army of Ants.....	613
Electrical Show.....	665	Electrocution, Arguments for.....	488
Electrical Show, A Visit to the.....	665	Electrocution of Animals.....	476
Electrical Show, New York.....	486	Electrocution vs. Hanging.....	171
Electrical Show, Omaha.....	155	Electrohen.....	187
Electrical Show, The Chicago.....	632	Electrolytic Interrupter.....	586, 660
Electrical Society, A Great.....	622	Electrolysis, Extracting Metals by.....	122
Electrical Splendors of Riverview.....	265	Electrification of the Chicago, Milwaukee & St. Paul.....	703
Electrical Terms Simplified.....	719	Electrification of the St. Clair Tunnel.....	562
Electrical Toys, Holiday.....	510	Electrification of Steam Railroads.....	493
Electrical Training, Advantage of Practical.....	689	Electromagnet.....	658
Electrical Vacation.....	247	Electromagnetic Engines.....	660, 723
Electrical Veins of a City.....	605	Electromagnetic Lamp Socket.....	414
Electrical Wants.....	124	Electromagnet Operation.....	17
Electrical "Wizards" of the Past.....	222	Electromagnetic Torpedo.....	396
Electrically Driven Swing Saw.....	425	Electromagnetic Toy Engine.....	119
Electrically Driven Telescope.....	568	Electromagnet Winding.....	797
Electrically Fired Cannon.....	518	Electroplating.....	795
Electrically Heated Fabrics.....	106	Electroplating on Glass.....	590
Electrically Heated Glue Pot.....	164	Electroplating Without Immersion.....	685
Electrically Heated Steering Wheel.....	618	Electrophone for the Deaf.....	23
Electrically Operated Candy Wrapper.....	565	Electrostatic Machine.....	456, 457, 651
Electrically Operated Camera.....	389	Electrostatic Machine, A Simple.....	186
Electrically Operated Camera for Sub- marine Photography.....	591	Electrotherapeutic Appliance, German.....	476
		Electrotherapeutic Heating Device.....	191
		Elevator, Novel Electric.....	99

	Page		Page
Elevators, Loud Speaking Telephone for...	368	Fulgurites	703
Elementary Electricity (Parts 1 to 12).....	2, 68, 132, 202, 270, 329, 401, 463, 525, 600, 676,	Furnace, Arc	796
Elithu Thomson	381	Furnace, Electric	535
Emergency Electric Light Plant, Automob- ile	623	Furnace, Electric Reduction.....	661
Emergency Street Railway Light.....	90	Furnace, How to Make an Electric.....	648
Engine, Electromagnetic Toy.....	119	Furnace Men, Cooling with Electric Fans..	492
Engineers' Charts (Book Review).....	255	Furnaces, Niagara's Electric.....	285
Engineer, The Illuminating.....	614	Furnaces, Electric Blower for.....	354
Equipment, Construction of Wireless.....	709	Fuse, When it Blows Out.....	770
Equipment of an Electric Kitchen.....	310	Future of Electricity.....	429
Eraser for Draughtsmen, Motor Driven....	89		
Exhibit, A Unique Lamp.....	541	G	
Exposition, Electrical Features of the Ger- man Ship Building	558	Galleries, Illumination of Picture.....	360
Exposition, Southern Electrical and Indus- trial	771	Gas Engine Ignition by Electric Spark....	611
Extension Diffuser	615	Gas Lighter, Electric.....	323
Extracting Gold from Sand.....	76	Gas Lighters, Spark Coil for.....	518
Extracting Metals by Electrolysis.....	122	Gathering Locomotives	424
Extraordinary Growth of Electric Railways.	81	Generating Electricity by Sea Waves.....	620
Extraordinary Lightning Stroke.....	137	Generating Plant, Portable Electric.....	167
Eye Magnet	323	Generator, Construction of a Small.....	660
Eye Magnets	428	Generator, Magneto	660, 794
		George Westinghouse	503
F		German Electric Dredge.....	243
Fabrics, Electrically Heated	106	German Electrotherapeutic Appliances....	476
Factory Economy, Good Light is.....	631	German Magnetic Separator.....	131
Failure of Motor "Leads"	675	German Ship Building Exposition, Electrical Features	558
Falls of the Zambesi to Produce Electricity	40	German Submarine Cable Laying.....	168
Fan, An Individual Desk.....	307	German Telephones	167
Fan Motor, Changing Windings of.....	516	Getting a Light	697
Fan Motor, Rewinding	725, 586	Glacier, Electric Power from.....	237
Fan Motor, Rewinding an Induction.....	517	Glass Telephone, Cut.....	41
Fans, Cooling Furnace Men with Electric..	492	Glass Telephone Mouthpiece.....	627
Farm, Electricity on the.....	79, 216	Glass Telegraph Poles.....	339
Fault Finder, Electric	616	Glue Pot, Electrically Heated.....	164
Favorite Marks for Thunderbolts.....	342	Gold Placer Mining, Electric Dredges for..	359
Ferguson, Louis A.	182	Golden Jubilee of the Atlantic Cable.....	209
Fessenden System, Wireless Telephony by the	638	Good Ground Connection.....	584
Festoons, Electrical	576	Good Light is Factory Economy.....	631
Filters, Electric Air.....	301	Good Start	635
Fire Alarms Over Telephone Wires.....	380	Graduated Street Lighting.....	626
Fire Automobile, An Electric Company's Emergency	443	Grands, Liters and Meters.....	622
Fire Boats, First Electric	693	Grand Plateau, Electrical Phenomena of..	551
Fire Engines, Electric	208	Gravity Battery	729
Fire-fly Flasher	764	Gravity Battery, Crowfoot or.....	793
Fire Hose Telephone	431	Great Electrical Society.....	622
Fire-Place, An Electric	800	Great Lakes, Wireless on the.....	170, 640
Firemen, Electric Fans Revive	414	Grinder, Motor Driven.....	565
First Aid in Case of Electric Shock.....	28	Grinding Machine, Development of the....	442
First Electric Fire Boats in the World....	693	Ground Connection, A Good.....	584
First Electric Railway	226	Gunnison Irrigating Tunnel.....	633
First Electric Railway in Norway.....	762	Guns, Sighting Big.....	798
First Electric Road for Colombia.....	24		
Fish Street Central Station	595	H	
Fish, Telephone to Detect the Presence of..	564	Hair Drier, Electric.....	177, 662
Fixtures, Some New Lamp	688	Hair, Instrument for Removing Superfluous	656
Flameless Cooking, Advantages of.....	715	Handling 75,000 Volt Current.....	88
Flasher, Automatic Lamp	764	Handy Magnet	757
Flashing Electric Signs.....	362	Handy Wireman's Screw Driver.....	440
Flat Iron, Electric.....	268	Hanging vs. Electrocuting.....	171
Floor Polisher, Electric Rotary.....	178	Hardening of Steel, Electric.....	100
Floriculture, Electric	509	Harper's Electricity Book for Boys (Book Review)	592
Floriculture in England, Electric.....	27	Head Lamps Protect the Street Sweeper..	628
Flour, Electric Bleaching of.....	232	Headlight, Physicians Electric.....	258
Flower Boxes, Lamp Posts with.....	604	Heat Control System, Automatic.....	395
Fly Wheel Explosion.....	505	Heater, Electric Water.....	459
Fog and Electricity.....	235	Heater, New Electric.....	258, 519
Following a Ball Game by the Electric Bul- letin Board	349	Heating Device, Electrotherapeutic.....	191
Following a Telephone Call, Parts 1 and 2	61, 127	Heating, Electric	124
Foot Warmer, Electric.....	113	Heating Pad	545
Forges in Transvaal Mine, Electric.....	47	Heating Pad, Electric.....	258
Formula, Power Factor.....	659, 516	Heating Pad for Nursery and Sick Room, Electric	505
Formulas for Electricians to Know.....	210	Hellon Lamp	207
Founders' Day Parade in Philadelphia.....	470	Henry, Original Manuscripts of Joseph....	495
Fountain Center Piece, Electric.....	8	High Frequency Apparatus.....	516, 726
Four Inch Jump Spark Coil.....	588	High Frequency Apparatus and Induction Coils	724
Four Year Old Telegram.....	149	High Frequency Apparatus, How to Make a High Frequency Current Experiments....	630
Freak Dynamo	201	High Frequency Current, Simple Explana- tion of	198
Freak Lightning Stroke.....	353	High-Speed Monorail Car, The Kearney... High Temperature, Measurement of.....	306 690
Freight Tunnels Under the Streets of Chi- cago	352	High Tension Current, Transmitting and Transforming	350
French Electric Talking Siren.....	65	High Tension Transmission Line, Insulat- ing A	549
French Hydro-Electric Plant.....	356	High-Tension Wires, Smoke Rings and....	604
From Trains to Stockings.....	701	High Voltage Transmission, Record in....	417
Frost Foreteller, Electric	355	High Voltage Wires, Underground.....	680
Fruit Jar, Leyden Jar made from a.....	452		

	Page		Page
Himalayas, Electricity in the.....	67	Insulator for Telephone Wires.....	800
Historical Memorials, Lamp Posts as.....	598	Instrument for Removing Superfluous Hair.....	656
History of an Art.....	163	Instrument Sterilizer, Electric.....	557
Holy City of Medinah and Tomb of Mohammed Invaded by Electricity.....	502	Interesting Telegraphic Statistics.....	369
Holiday Electrical Toys.....	510	Interior Illumination, Effective.....	571
Home Made Battery.....	118, 587	Interrupter, Adjustable.....	777
Home Made Static Machine.....	651	Interrupter, Electrolytic.....	E86, 660
Home Made Telegraph Sounder.....	612	Inventions, Steps Necessary in Patenting.....	277
Home Made Voltage Regulator.....	501	Iron and Steel, Electrical Production of.....	240
Home, More Comfort in the.....	110	Ironing Day, An Electric.....	176
Horse-Shoe Magnets.....	588	Irrigating Tunnel, Gunnison.....	638
Horticulture, Electricity Applied to.....	766	Is Absolute Etheric Vacuum Obtainable?.....	260
Hosemen, Power Wires not Dangerous to.....	425	Italian Electric Power Plant.....	228
Hotel Signal System.....	623	Italian Railway, Picturesque.....	236
House Telephone, How to Connect a.....	657		
House Cleaning Simplified.....	53	J	
House System Telephone Circuits.....	793	Japanese Telegraph Code.....	338
House Without a Chimney.....	17	Joerin Singing Arc Lamp.....	87
Household Conveniences, the Latest Electric.....	382	Jump Spark Coil, Four Inch.....	588
Household Refrigeration Plant.....	446	Joseph Henry, Original Manuscripts of.....	495
Houston, Edwin J.....	38	"Just Pull" Switch.....	765
How A Boy Built One of the First Electric Railways.....	580		
How a Farmer Built his own Electric Power Plant.....	432	K	
How an Electromagnet Operates.....	173	Kearney High-Speed Monorail Car.....	304
How Electric Power for Atlanta is Developed.....	563	Kempster B. Miller.....	445
How I Became an Electrical Engineer.....	56	Kilowatt Hour Equivalents.....	25
How it Might Happen.....	610, 682	Kilowatt Made Easy.....	89
How Ralph Photographed the Thief.....	116	Kitchen, Equipment of an Electric.....	310
How the Time Ball is Dropped.....	14	Kite Elevated Aerial.....	642
How to Build a Wattmeter.....	124	Kite Telephone.....	108
How to Catch a Chicken Thief.....	450	Kettle, Electric.....	122
How to Connect a House Telephone.....	657	Knife, Surgeons Electric.....	488
How to Construct a Shocking Coil.....	119		
How to Install Electric Bells.....	255	L	
How to Make a High Frequency Apparatus.....	542	Labor Saving in Office Work.....	619
How to Make a Magnetic Snake.....	55	Laboratory, Amateur's Electrical.....	318
How to Make a Polarized Relay.....	188	Lamp, Adjustability of the Tungsten.....	500
How to Make a Tuning Coil.....	706	Lamp, Adjustable Machine.....	631
How to Make an Electric Alarm Clock.....	787	Lamp, Cerium Filament.....	495
How to Make an Electric Furnace.....	648	Lamp Changer, Easy.....	493
How to Make an Induction Coil.....	725	Lamp Exhibit, A Unique.....	541
How to Photograph Electric Discharges.....	388	Lamp Fixtures, Some New.....	688
How to Wire a Telephone Set.....	260	Lamp Flasher, Automatic.....	764
Hydro-Electric Plant in France.....	356	Lamp, Miner's.....	520
Hydroscope, The Electric.....	423	Lamp, Modern Aladdin's.....	761
		Lamp Posts as Historical Memorials.....	598
I		Lamp Posts with Flower Boxes.....	604
Ice Plants, Recorder for.....	521	Lamp Testing Watt Indicator.....	354
Ignition by Electric Spark, Gas Engine.....	611	Lamp Rheostat for 110 Volts.....	252
Illuminating Engineer.....	614	Lamp Socket, Electromagnetic.....	414
Illumination, Effective Interior.....	571	Lamp Switch.....	765
Illumination, Latest Method of Indirect.....	490	Lamp, The Hellon.....	207
Illumination of Niagara Falls, Electrical.....	80	Lamp, The Nernst.....	530
Illumination of Picture Galleries.....	360	Lamp, The Quartz.....	501
Illumination of Singer Tower.....	738	Lamp, The New Vapor.....	556
Illumination, Quebec's Electric.....	89	Lamps for Automobiles, Tungsten.....	765
Illumination, The Mercury Vapor System of Electrical.....	556	Lamps for the Street Sweeper.....	628
Illumination, Unique Library.....	113	Lamps, Process of Coloring Incandescent.....	627
Illuminations A Quarter of a Century Ago.....	172	Lamps, the Manufacture of Electric.....	408
Illuminations at San Francisco.....	225	Lamps, Wattmeter for Testing Incandescent.....	539
Improved Adding Machine.....	621	Lamps Withstand Lightning, Tungsten.....	618
Incandescent Lamp Collection.....	163	Large Dam Contemplated.....	76
Incandescent Lamps, Process of Coloring.....	627	Largest Electrical Cable.....	171
Incandescent Lamps, Wattmeter for Testing in Case of Short Circuit.....	628	Largest Meat Cutter in the World.....	681
Incubator, Temperature Regulator for.....	190	Largest Transformer Ever Built.....	749
Indicator, Electric Water Level.....	422	Latest Method of Indirect Illumination.....	490
Indicator, Lamp Testing Watt.....	354	Latest Electric Household Conveniences.....	382
Indicator, Rotation.....	159	Laundry Washer, Electric.....	115
Indirect Illumination, Latest Method of.....	490	Lead-Covered Telephone Cables, Splicing.....	302
Individual Desk Fan.....	307	Leyden Jar, Charging.....	454
Induction Coil.....	586, 709, 642	Leyden Jar, Construction of a.....	727
Induction Coil Data.....	725	Leyden Jar Made from a Fruit Jar.....	452
Induction Coil, How to Make a.....	725	Library Illumination, Unique.....	113
Induction Coil Questions.....	658	Life Belt with Electric Light.....	140
Induction Coil, Small.....	729	Life Principle, Electricity the.....	398
Induction Coils and High Frequency Apparatus.....	724	Lift, Automatic Electric.....	474
Induction Fan Motor, Rewinding an.....	517	Lifting Magnet.....	94, 757
Induction Motor, A Simple.....	58	Lifting Tons by a Magnet.....	94
Induction Motor Operation.....	656	Light, Automatic Telephone.....	517
Inductive Resistance.....	656	Light, Cause of Poor.....	643
Information for the Practical Electrician.....	192	Light Circuits, Electric Bell for.....	780
Inland Empire, Power Generation for the.....	612	Light, Electric "Tubes" of.....	86
Insects, Depositing Metal on.....	187	Light, Emergency Street Railway.....	90
Insulating a High Tension Transmission Line.....	549	Light Enough to Encircle the Globe.....	91
Insulation, Locomotive Discharges and.....	613	Light, Method of Measuring.....	257
		Lights, Arrangement of Dining Room.....	252
		Lighting Circuit for Telephone Booths.....	242
		Lighting Circuit Operating Battery Motor From.....	718
		Lighting Current Not Dangerous.....	448
		Lighting, Graduated Street.....	626

	Page		Page
Remarkable Electric Sign	201	Skyscraper of 1950.....	233
Reminiscences of Thomas A. Edison.....	21	Small Dynamo Armature	723
Repeaters, Telephone	729	Small Induction Coil	729
Resistance, Inductive	656	Small Motor-Driven Air Compressor.....	373
Resistance, Measuring Battery	792	Small Motor Construction	651
Respect but do not Fear Electricity.....	626	Small Wireless Telegraph Outfit.....	427
Resurrection Force, Electricity as a.....	155	Smith, Arthur Bessey	573
Rewinding an Induction Fan Motor.....	517	Smoke Inspector, Telephone Aids.....	9
Rewinding Fan Motor	586, 725	Smoke Nuisance, Electricity vs.....	220
Reverser for Motor Driven Planers.....	555	Smoke Rings and High-Tension Wires.....	604
Revelation, A	113	Snap Switch, A Push Bar.....	358
Revolving Old Dry Batteries	658	Socket, Electromagnet Lamp.....	414
Rheostat for Small Motors.....	317	Soil Treatment by Wireless Waves.....	590
Ring Wound Armature	797	Solder, Aluminum	731
Riverview, Electrical Splendors of.....	265	Solenoid, Design of a.....	194
Rotary Floor Polisher, Electric.....	178	Solution, Detector	642
Rotation Indicator	259	Some Applications of Electricity to Dentistry	370
Running a Ranch by Electricity.....	559	Some Unique Motor Applications.....	700
S			
S. D. Cushman, Death of	48	Some New Lamp Fixtures.....	688
Salutatory	1	Sounders, Operation of 20-Ohm.....	586
San Francisco's Welcome to the Fleet.....	225	Southern Electrical & Industrial Exposition.	771
Sanitary Refrigeration for the Home.....	446	Southern Pacific, Electricity for the.....	130
Sanitation by Electricity	447	Spark Coil	589, 641, 710
Saw, Butchers' Electrically Operated.....	731	Spark Coil Condenser	641
Saw for Butchers, Electric.....	165	Spark Coil Design	778
Sawing Through Steel	64	Spark Coil Dimensions	589
Scheme for Show Window Lighting.....	492	Spark Coil for Gas Lighters.....	518
Schillens Power Plant	356	Spark Coil for 110 Volts A. C. 2-Inch.....	708
School, The Navy Electrical.....	758	Spark Coil for Wireless.....	454
School Programme Transmitter, Electrical.	9	Spark Coil, 4-Inch Jump	588
Screw Driver, Handy Wireman's	440	Spark Coil Operated From Dynamos.....	793
Scrubber, Electric Ship	547	Spark Plug Coil and Wiring	729
Scrubbing Brush, Electric	485	Spark Coil, Primary Winding of.....	456
Search Light for the Camp, Electric.....	54	Spark Coil, Secondary of.....	588
Searchlight, Refinements of the Modern.....	94	Spark Coils	709
Secondary Batteries, Charging From Pri-	322	Spark Coils, Sending Distance of.....	454
mary Batteries	588	Sparkling, Commutator	617
Secondary of Spark Coil.....	459	Sparkling Apparatus, Peculiarities In.....	710
Secret Telephone	154	Specifications for Thirty-Inch Spark X-Ray	724
Seismograph	561	Coil	460
Selenium Cells, Construction of.....	592	Spectrum, Beyond The	302
Self-Propelled Vehicles (Book Review).....	66	Splicing Lead-Covered Telephone Cables.....	612
Self-Registering Target, Electric.....	454	Spokane and Inland Power Plant.....	309
Sending Distance of Spark Coil.....	455	Spong Fishing by Submarine Boat.....	225
Sending End, Wireless	100	Sprinkling Car, Electric	562
Sending Pictures by Electricity.....	132	St. Clair Tunnel, Electrification of the.....	631
Series Multiple and Multiple Series, Circuits	114	Steam Boilers	581
Servant Girl, The New.....	507	Static Electricity and Its Application to a	480
Sewing is Easy the Electric Way.....	115	Simple Wireless Telegraph System.....	517
Sewing Machine, a Motor for the	547	Static Electricity From Belts.....	457, 518
Ship Scrubber, Electric.....	290	Static Machine, A Home-Made.....	651
Shipboard, Electricity On.....	547	Static Machines	456
Shocks for Perverse Children.....	119	Stationary Engineering (Book Reviews).....	256
Shocking Coil, How to Construct a.....	629	Steel, Electric Hardening of.....	100
Shoe Shining by Electricity.....	628	Steel, Sawing Through	64
Short-Circuit, In Case of.....	457	Steering Wheel, Electrically Heated.....	618
Short Circuiting of Coherers	780	Steinmetz, Charles Proteus.....	711
Show Room of Commonwealth Edison Co.....	492	Steps Necessary in Patenting Inventions.....	683
Show Window Lighting, Scheme for.....	735	Still, Electric Water.....	254
Show Windows, Lighting of	794	Stock Ticker, Chickens Hatched in a.....	335
Shunt, Ammeter	505	Stone Telegraph Poles	267
Sick Room, Electric Heating Pad for.....	606	Stomach, Photographing the.....	659, 695, 793
"Sierra Casa," The Home Electrical.....	201	Storage Battery Charging.....	655
Sign, A Remarkable Electric.....	362	Storage Battery, Construction of a Small.....	727
Signs, Flashing Electric	538	Storage Battery, Making a.....	261
Signal Bells, Operated from Trolley Current	379	Storage Batteries	695
Signal Light for Street Cars, Electric.....	623	Storage Batteries, Applications of Small.....	439
Signal System, Hotel.....	796	Store, Telephones in a Department.....	682
Signaling Circuit, Single Wire.....	798	Street Car Accidents, How to Prevent.....	379
Sighting Big Guns.....	640	Street Cars, Electric Signal Light for.....	548
Silicon Detector.....	184	Street Car Fenders and Wheel Guards, Test-	299
Simple Arc Light	654	ing	538
Simple Controller for Toy Motors.....	252	Street Cars, Nickel-In-Slot Device for.....	67
Simple Current Detector for Wireless Work	390	Street Car Signal Bells Operated From Trol-	30
Simple Electric Alarm	186	ley Current	626
Simple Electrostatic Machine	198	Street Railway Light, Emergency.....	90
Simple Explanation of High Frequency Cur-	58	Street Sweepers, Head Lamps for the Pro-	628
rent	649	tection of	339
Simple Induction Motor	365	Stringing Double Trolley Wire.....	309
Simple Magnet Motor	725	Submarine Boat, Sponge Fishing By.....	168
Simple Method of Testing Cables.....	450	Submarine Cable Laying, German.....	591
Simple Telephone Circuit	738	Submarine Photography, Electrically Ope-	787
Simple Transformer	762	rated Camera for	98
Singer Tower At Night.....	796	Submarine Telephone	367
Single Phase Railway	87	Submarine, Uncle Sam's	178
Single Wire Signaling Circuit.....	599	Sub-Station, A Portable.....	702
Singing Arc Lamp, Joerin.....	65	Suction Sweeper, Electric	779
Single-Phase Railroad and Telephone.....	356	Sun Power Plant	779
Siren, French Electric Talking.....	356	Sunny, Bernard E.....	779
Sixteen Thousand Horsepower From a	356		779
Mountain Stream	356		779

POPULAR ELECTRICITY

II

	Page		Page
Surgeon's Electric Knife.....	488	Telephones, Connection of Bridging.....	585
Surgery, Electric Motor in Bone.....	484	Telephones, German.....	167
Sweating Blanket, Electric.....	541	Telephones on Barber Chairs.....	49
Sweeper, An Electric Suction.....	178	Telephones, Single-Phase Railroad and.....	599
Swing Saw, Electrically Driven.....	425	Telephony, Wireless.....	392, 588
Switch, A Push-Bar Snap.....	358	Telescope, Electrically Driven.....	568
Switch, Magnet Operated Track.....	324	Tell of Your Experiments.....	194
Switch, The "Just Pull".....	765	Temperature Regulator for Incubators.....	190
Switch, Three Way.....	659	Temperatures, Measurement of High.....	690
Switchboard, Construction of a Small.....	185	Tempered Steel.....	100
Switzerland, The White Coal of.....	698	Tempering and Annealing by Electric Furnace.....	681
T			
Table Decorations, Electric.....	506, 573	Ten Thousand Horsepower Turbines at Niagara Falls.....	46
Tablet, Ampere Memorial.....	629	Teredo, Electric Protection Against the.....	591
Tailor's Goose, Electric.....	221	Teredo Worms, Electricity a Protection Against.....	426
Talking Over a Sunbeam.....	173	Terminal for Electric Cables.....	396
Talking Siren, French Electric.....	65	Test Clamp, A New.....	495
Talks on "Current" Topics.....	578, 644	Testing Cables, Simple Method of.....	365
Target, Electric Self-Registering.....	66	Testing, Electric Milk.....	224
Telegram, A Four-Year-Old.....	149	Testing Raw Materials by Electricity.....	565
Telegram Went Too Fast.....	500	Testing Street Car Fenders and Wheel Guards.....	548
Telegraph, An Open Circuit.....	722	Tesla Coil.....	198, 542
Telegraph at the U. S. Capitol, Printing.....	92	Textile Plant, Motors in a.....	562
Telegraph, Automatic.....	496	Thermal or Heating Effects of Electric Discharges.....	329
Telegraph Code, The Japanese.....	338	Thomas A. Edison (Frontispiece May, '08).....	381
Telegraph, Early History of the.....	215	Theory of Lightning.....	619
Telegraph Line, A Boys'.....	515	Theory of Vibratory Energy.....	325
Telegraph Poles, Glass.....	339	Therapeutic Appliances.....	476
Telegraph Poles of Stone.....	335	Things to Know About Electric Current.....	108
Telegraph, Quadruplex.....	518	Thirty-Inch Spark X-Ray Coil, Specifications for.....	724
Telegraph Sounder, Home-Made.....	512	Three-Way Switch.....	659
Telegraph System, Open Circuit.....	795	Through the Cascade Tunnel by Electricity.....	621
Telegraph That Prints.....	91	Thunder and Lightning, Cause of.....	326
Telegraph, Wig-Wagging Before.....	200	Thunder and Lightning, Cause of.....	183, 261
Telegraph, Wireless.....	319	Thunder and Lightning, More on.....	397
Telegraphing, Record in.....	369	Thunder and Lightning Theory.....	460, 522
Telegraphing Statistics, Interesting.....	369	Thunderbolts, Favorite Marks for.....	342
Telegraphing and Telephoning Over One Line.....	288	Time Ball, How Dropped.....	14
Telegraphone.....	141	Timing Automobiles.....	739
Tele-Mechanic, Branly's.....	47	Tire Vulcanizer, Electric.....	561
Telephone, A Buzzer.....	653	Titubator, Motor Driven.....	675
Telephone Exchange, Berlin Long Distance.....	276	To Ascertain Polarity.....	738
Telephone, A Secret.....	459	To Determine the Kind of Current.....	681
Telephone Aids Orchestra.....	17	To Make an Ammeter or Voltmeter.....	797
Telephone Aids Smoke Inspector.....	9	Toaster, Electric.....	647
Telephone, At the.....	761	Toaster, The Radiant.....	786
Telephone Booth, Lighting Circuit for.....	242	Tomatoes, Raising by Electricity.....	500
Telephone Call, Following a (Parts 1 and 2).....	61-127	Torpedo Boat Electrically Propelled and Steered.....	458
Telephone Calls, Register for.....	315	Toy Electric Train, Operation of.....	322
Telephone Circuit, Simple.....	725	Torpedo, Electromagnetic.....	396
Telephone Circuits, House System.....	793	Torpedo Fish, Electric.....	308
Telephone, Connection of a Magneto.....	585	Toy Monorail Car.....	385
Telephone, Cut Glass.....	41	Toy Monorail System.....	658
Telephone Does Detective Work.....	453	Toy Motors, Simple Controller for.....	654
Telephone Exchange, A Chinese.....	175	Toys, Holiday Electrical.....	510
Telephone Exchange, Bulletin Squad in a.....	540	Trackless Trolley.....	522, 529
Telephone, Fire Hose.....	431	Track Switch, Magnet Operated.....	324
Telephone for Elevators, Loud Speaking.....	368	Traction, Railless Electric.....	529
Telephone, How to Connect a House.....	657	Train, Operation of a Toy Electric.....	322
Telephones in a Department Store.....	439	Train Signaling.....	190
Telephone in Newspaper Work.....	57	Transformer.....	793
Telephone, Kite.....	108	Transformer, Closed Core.....	709
Telephone Light, Automatic.....	517	Transformer Design.....	586, 660
Telephone Lightning Arrester.....	519	Transformer for Door Bells.....	533
Telephone Line.....	454	Transformer, High Frequency.....	542
Telephone Line Over the Alps.....	474	Transformer, Largest Ever Built.....	749
Telephone Magneto.....	729	Transformer Operation.....	393
Telephone Mouthpiece of Glass.....	627	Transformer, Two Hundred and Fifty-Watt.....	724
Telephone News Service.....	763	Transforming and Transmitting High Tension Current.....	350
Telephone Pole Changer, Trouble With a.....	391	Transformers and Aerials.....	641
Telephone Pole, Concrete.....	92	Transmission, A Record in High Voltage.....	417
Telephone Poles in Michigan, Cutting.....	36	Transmission Line, Insulating a High Tension.....	549
Telephone Receivers, Wireless.....	704	Transmission of Niagara's Power.....	10
Telephone Repeaters.....	729	Transmitter, Telephone.....	726
Telephone Rules.....	485	Transmitting and Transforming High Tension Current.....	250
Telephone Set, How to Wire a.....	260	Transmitters, Wireless Telegraph.....	82
Telephone, The Nickel.....	796	Transportation System, New Automatic.....	340
Telephone to Detect the Presence of Fish.....	564	Trap, Unique Electric Bug.....	385
Telephone Transmitter.....	726	Traveling by Vortices.....	397, 522
Telephone Under Water.....	787	Trees, Lightning Protector for.....	123
Telephone, Unique.....	165	Tremendous Heat Developed by Lightning.....	339
Telephone, When Using a Neighbor's.....	485	Trolley Car as a Moving Van.....	150
Telephone, Wireless.....	588	Trolley Current for Signal Bells.....	538
Telephone Wires, Fire Alarms Over.....	380	Trolley Guard for Railroad Crossings.....	77
Telephone Wires, Insulator for.....	800		
Telephoning and Telegraphing Over One Line.....	288		
Telephoning to Trains While in Motion.....	190		
Telephoning, Wire Fences Used for.....	58		
Telephones and Electric Lights for the Turks.....	483		

	Page		Page
Trolley Wire, Stringing Double.....	339	"Welcome" in Denver.....	246
Trouble Wagon, An Up-To-Date.....	481	Welding, The Art of Electric.....	552
Trouble With a Telephone Pole Changer.....	391	Westinghouse, George.....	503
Trough Window Lighting.....	735	What a Kilowatt Hour of Electricity Will Do	23
Truck, Wireless Electric.....	142	What to Do for Electric Shock.....	149
"Tubes" of Light, Electric.....	86	Wheatstone Bridge and Varley Loop Test.....	392
Tungsten Lamp.....	761	Wheel Guards, Testing Street Car Fenders	548
Tungsten Lamp, Adaptability of the.....	590	and.....	698
Tungsten Lamp Is Efficient, Why the.....	614	White Coal of Switzerland.....	124
Tungsten Lamps for Automobiles.....	765	When Is a Cell Polarized.....	645
Tungsten Lamps in Cigar Factories.....	632	When Duties Become Pleasures.....	770
Tungsten Lamps Withstand Lightning.....	618	When the Fuse Blows Out.....	485
Tungsten Production.....	558	When Using a Neighbor's Telephone.....	614
Tuning Coil.....	455, 710	Why the Tungsten Lamp Is Efficient.....	209
Tuning Coil, How to Make a.....	621	Wig-Wagging Before the Telegraph.....	179
Tunnel, Electrically Operated Cascade.....	562	Will Electricity Retard Old Age.....	457
Tunnel, Electrification of the St. Clair.....	44	Wimshurst Machine.....	795
Tunnel Illumination, Dion System of.....	633	Winding a 75-Watt Dynamo.....	723
Tunnel, The Gunnison Irrigating.....	352	Winding a Twelve-Slot Drum.....	422
Tunnels Under the Streets of Chicago,	46	Window Display, Unique.....	492
Freight.....	46	Window Lighting, Scheme for Show.....	58
Turbines at Niagara Falls, Ten Thousand	483	Wire Fences Used for Telephoning.....	707
Horse Power at.....	642	Wireless, A New Triumph for.....	455
Turkey, Telephones and Electric Lights in	724	Wireless Apparatus, Construction of.....	495
Twenty-Mile Wireless System.....	708	Wireless Battery Holder.....	635
Two Hundred and Fifty Watt Transformer	418	Wireless Club, Popular Electricity.....	710
Two-inch Spark Coil for 110-Volt A. C.....	143	Wireless Codes.....	508
Two-Mile Wireless Outfit, Construction of a	772	Wireless Detector.....	142
Typesetting By Wireless.....	772	Wireless Electric Truck.....	778
Typewriter and Typography, Wireless.....	57	Wireless From Airship.....	443
U		Wireless From the Washington Monument.....	581
Uncle Sam's Naval Electricians.....	98	Wireless, Ground Connection For.....	636
Uncle Sam's New Submarine.....	680	Wireless in a New Sphere, Wonders of.....	640
Underground High Voltage Wires.....	760	Wireless on the Great Lakes.....	637
Unique Central Station Advertising.....	335	Wireless Outfit, Amateur's.....	418
Unique Electric Bug Trap.....	541	Wireless Outfit, Construction of a Two-Mile	567
Unique Lamp Exhibit.....	113	Wireless Picture Telegraphy.....	642
Unique Library Illumination.....	165	Wireless, Playing Chess by.....	158, 642
Unique Telephone.....	572	Wireless Receiving Ends.....	440
Unique Water Power Plant.....	422	Wireman's Screw Driver, Handy.....	455
Unique Window Display.....	758	Wireless Sending End.....	456
United States Naval School.....	92	Wireless Set.....	589
United States Capitol, Printing Telegraph	130	Wireless Set, Design of a Small.....	641
at the.....		Wireless Spark Coil For.....	642
Unloading Bananas by Electric Power.....	247	Wireless System.....	707
V		Wireless System, Twenty-Mile.....	319
Vacation, The Electrical.....	712	Wireless System Without Aerial.....	122
Vacuum Cleaning Apparatus, The Electric	645	Wireless Telegraph.....	455
Vacuum Cleaning Device.....	508	Wireless Telegraph Antenna.....	557
Vacuum Cleaning (Numaticon).....	179	Wireless Telegraphy.....	32, 82, 158, 227, 296
Vacuum Cleaning Outfit.....	260	Wireless Telegraphy, Detector For.....	772
Vacuum, Is Absolute Etheric Obtainable.....	443	Wireless Telegraphy Made Simple (Parts 1	427
Valves, Motor Operated.....	624	to 5).....	32
Vapor Rectifier, Mercury.....	441	Wireless Telegraph on the High Seas.....	427
Variable Speed Motors, New.....	68	Wireless Telegraph Outfit, A Small.....	32
Varieties of Electric Circuits.....	392	Wireless Telegraph Set, Construction of a	581
Varley Loop Test, Wheatstone Bridge and	389	Simple.....	82
Very Shocking Push Button.....	502	Wireless Telegraph System, Static Electric-	588
Vibration in Motors, Overcoming Noise and	325	ity Applied to.....	138, 588
Vibratory Energy, Theory of.....	665	Wireless Telegraph Transmitters.....	254
Visit to the Electrical Show.....	657	Wireless Telephone, Novel.....	704
Voltage, Drop in.....	501	Wireless Telephone, Receivers.....	79
Voltage Regulator, A Home-made.....	797	Wireless Telephone, The Alden.....	173, 392, 588
Voltmeter, To Make an Ammeter or.....	261	Wireless Telephony.....	638
Volts and Watts, Questions of.....	522	Wireless Telephony by the Fessenden Sys-	143
Vortices, Traveling by.....	397, 561	tem.....	772
Vulcanizer, Electric Tire.....	446	Wireless Typewriter and Typography.....	707
W		Wireless Waves, Effect of Wind on.....	590
Waffle Iron.....	580	Wireless Waves, Soil Treatment by.....	260
Walkins Electric Railway.....	545	Wiring a Telephone Set.....	393
Warming Pad, Electric.....	577	Wiring, and Motor and Transformer Opera-	506
Wash Day Loses Its Terrors.....	644	tion.....	222
Washing Machine, Electric.....	447	With Our Women Readers.....	592
Washing Machine, Motor Power for the.....	443	Wizards of the Past, Electrical.....	780
Washington Monument, Wireless From the	587	Wonder Book of Magnetism, (Book Review)	249
Watch Demagnetizer.....	117	Wonders of "Electric Shop".....	509
Watch Dog, Motorman's.....	459	Wonders of Wireless in a New Sphere.....	13
Water Heater, Electric.....	208	Woman's Field Broadened by Electricity.....	183
Water Powers, Electricity From Small.....	179	Women to Grow Flowers by Electricity.....	13
Water Heaters Not Dangerous, Electric.....	509	Word of Warning.....	183
Water Heater, Novel Electric.....	422	Worlds Within Worlds.....	211
Water Level Indicator, Electric.....	574	X	
Water Purifier for the Home, Ozone.....	360	X-Ray Burns.....	153
Water Purification by Ozone.....	572	X-Ray, Photographing Elephant By.....	131
Water Power Plant, Unique.....	683	X-Ray Tube, Cornell.....	753
Water Still, Electric.....	354	Y	
Watt Indicator, Lamp Testing.....	539	Yacht, Non-magnetic.....	351
Wattmeter for Testing Incandescent Lamps	124	Z	
Wattmeter, How to Build a.....	366	Zambesi Power Plant Assured.....	40
Wattmeter, Reading the.....	260, 55	Zambesi Produces Electricity.....	40
Way to Electrocute Flies.....	620		
Wave Motor.....	620		

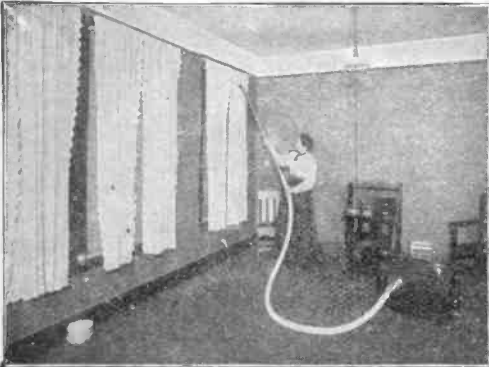

**The "LITTLE GIANT"
ELECTRIC PORTABLE SUCTION CLEANER**

For Cleaning Carpets, Rugs, Mattresses, and Curtains.

Removes every particle of dust from Books, Pictures, Shelves, Draperies, Portieres, etc.

Costs less per hour to operate.

Price, complete, \$85.00

SEND FOR LITERATURE

PACIFIC SUCTION CLEANER CO.

322 POST ST., SAN FRANCISCO, CAL.

Don't Take Chances

with so-called electric washing machines still in the experimental stage.

We have been making an excellent line of Cylinder Washing Machines ever since 1903. If you buy the

**SANITARY PARAGON
Electric Washer and Wringer**

(Made of Metal Throughout)

you are certain of a reliable machine which embodies all the essential features of durability, efficiency and service. The Paragon is conceded by laundry experts and leading engineers to be the Acme of Perfection and mechanical ingenuity.



1909 Model

Before buying any washer do not fail to send for our illustrated Catalog A14.

PARAGON MFG. CO.

3619-23 Ashland Ave.
CHICAGO



Fig. 1.



Fig. 2.



Fig. 3.

**Here's Something New
Designed For YOU!**

Very often you have "Things To Fasten" to brick, stone, concrete, marble, tile, etc. This shows how such fastenings may be made quickly, cleanly and securely with

STAR SCREW ANCHORS

Drill hole. Insert Anchor (Fig. 2). Put screw (Fig. 1) thru material to be fastened into inserted Anchor (Fig. 2) and fasten tight. You then have a positive inner end expansion—**which will hold.**

STAR SCREW ANCHORS are made in one piece of soft lead composition. ANY SIZE to fit all screws.

SEND FOR CATALOGUE AND SAMPLES

**Star Expansion Bolt Co.,
Bayonne, N. J.**

**THE
"National"**

**A
PORTABLE
VACUUM
CLEANING
MACHINE**

combining efficiency, practicability and economy. Can be attached to any electric light socket.

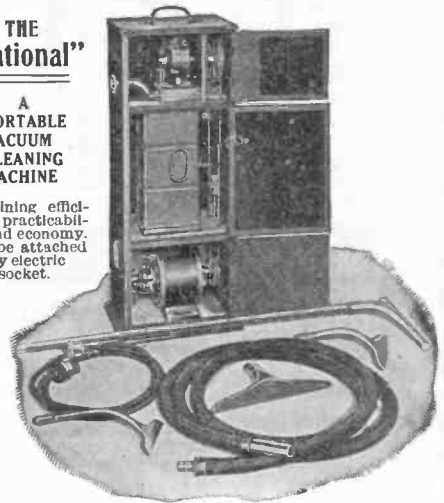

EFFICIENT Because it thoroughly accomplishes its purpose.
PRACTICAL Because of its simplicity and compactness.
ECONOMICAL Because of its minimum cost of maintenance and operation.

Growing concerns and responsible parties wanted for agents. (Exclusive territory given. Price Complete \$100.00. Send for Catalogue and Particulars

NATIONAL VACUUM COMPANY
20 Broad Street, :: :: NEW YORK

POPULAR ELECTRICITY



Thousands of valuable libraries are started every year by students, the foundation being a few books and two or three Globe-Wernicke "Elastic" Bookcase Sections.

Write for beautifully illustrated catalogue giving full descriptions of various sizes to fit any scientific book published.

The Globe-Wernicke Co.
CINCINNATI

\$1.00 FOR THIS SET OF INSTRUMENTS

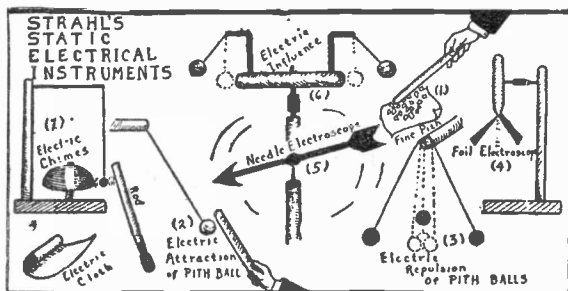

20 EXPERIMENTS
and how to operate them

For the boy and student of Wireless Telegraphy it is the most interesting, instructive and educational experiment that can be secured.

Everyone interested in Electricity should take advantage of this offer. Cannot be bought elsewhere under \$10.00.

Pith for Pith Balls 10 Cents a Box
\$1.00 Secures the Complete Outfit

WILLIAM STRAHL
250 Broadway, NEW YORK CITY, N. Y.

FREE

A Testing SAMPLE



SUPERIOR BELT DRESSING
The 21 ounce and metal end bar.

Give it trial on your Dynamo and Motor Belts. Sure cure for Slipping. Will help you out on "Peak Load."

SAVES POWER. TRY IT.

Sold by Mill Supply Dealers.

Superior Chemical Mfg. Co.
GRAND RAPIDS, MICH.

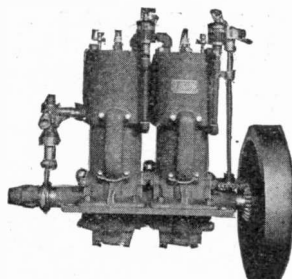

Automobile and Marine Gasoline Engines

From 1 to 15 Horse Power.



Sterling Engine Company

29 South Clinton Street
CHICAGO, ILL.

THE PEACEMAKER

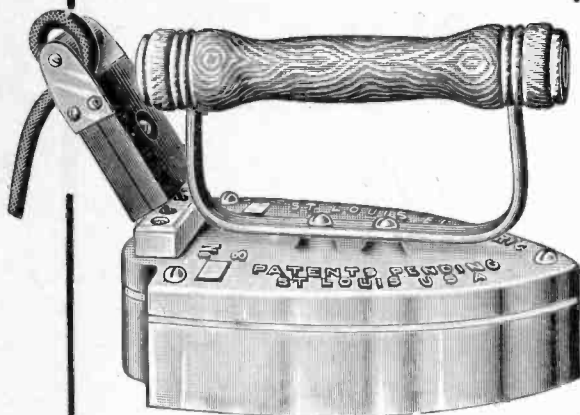

AN ELECTRIC IRON
 COMBINING
 PERFECT HEAT DISTRIBUTION
 THE HIGHEST CHARACTER OF
 WORKMANSHIP
 PRACTICAL INDESTRUCTIBILITY
 THE HANDSOMEST FINISH

☞ Covering all the points of the perfect iron, and of such simple construction that the highest electrical and iron value is delivered for the least money.

☞ On ordinary work it can be used with the current turned off half the time, yet the iron is so built that the grip is always cool.

☞ Made in all weights from 4 pounds to 27 pounds.

☞ Continuously used in every place where an Electric Iron can be used, rendering the highest service to the user, and a clean satisfaction to the dealer.

☞ You will not be satisfied until you have a

"PEACEMAKER"

☞ Possibly your Electric Light Plant or Dealer may not have them. If not write us direct.

SPECIAL INTRODUCTORY PRICE

Central Station Managers and Dealers it will pay you to know our Special Introductory Proposition.

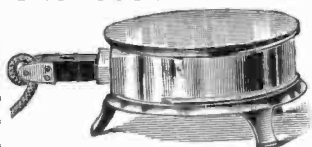

ST. LOUIS ELECTRIC HEATING CO.
 ST. LOUIS, MO.

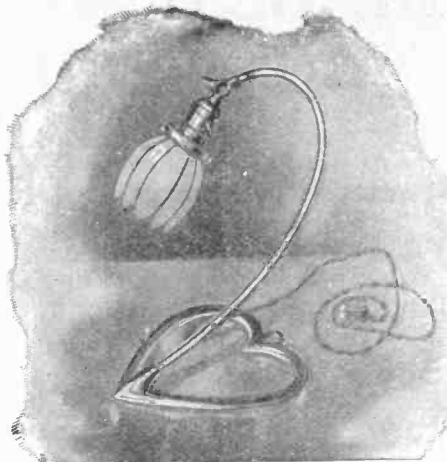

Old Vienna Art Lamp

Some lamps are beautiful, but not useful; others are useful but not beautiful. The Old Vienna Portable is both beautiful and useful. Its graceful design, brush brass finish and art glass shade make it an ornament for any home. Equally serviceable as a library, hall, bedroom or desk lamp, or as a wall light. Complete with cord and plug, shipped anywhere, only

\$3.75

Express Prepaid

FEDERAL ELECTRIC COMPANY
 128 W. Lake Street, CHICAGO

THE BEST TELEPHONE BOOKS AT LOWEST PUBLISHER'S PRICES POSTAGE PREPAID

ORDER OF

Telephony

THE AMERICAN TELEPHONE JOURNAL

MONADNOCK BLOCK.

CHICAGO, ILL.

ABC OF THE TELEPHONE.

BY J. E. HOMANS.

Chapter I—The Telephone Apparatus and its Operation. Chapter II—A Brief Survey of the Theory of Sound. Necessary to an Understanding of the Telephone. Chapter III—A Brief Survey of the Principles of Electricity. Chapter IV—Electrical Quantities. Chapter V—History of the Speaking Telephone. Chapter VI—Later Modifications of the Magnet Telephone. Chapter VII—The Carbon Microphone Transmitter. Chapter VIII—The Circuits of a Telephone Apparatus. Chapter IX—The Switch Hook and Its Function in the Telephone Apparatus. Chapter X—The Switchboard and the Appliances of the Central Station. Chapter XI—The Operator's Switch Keys and Telephone Set. Chapter XII—Improved Switchboard Attachments. Chapter XIII—Switchboard Lamp Signals and Circuits. Chapter XIV—The Multiple Switchboard. Chapter XV—Locally Interconnected or Multiple Transfer Switchboard. Chapter XVI—Exchange Battery Systems. Chapter XVII—Party Lines and Selective Signals. Chapter XVIII—Private Telephone Lines and Inter-communicating Systems; Common Return Circuits. Chapter XIX—Private Telephone Lines and Inter-communicating Systems; Full Metallic Circuits. Chapter XX—Large Private Systems and Automatic Exchanges. Chapter XXI—Devices for Protecting Telephone Apparatus from Electrical Disturbances. Chapter XXII—The General Conditions of Telephone Line Construction. Chapter XXIII—Telephone Pole Lines. Chapter XXIV—Wire Transpositions on a Pole Line. Chapter XXV—Telephone Cables and Their Use in Underground and Pole Lines. Chapter XXVI—Circuit Balancing Devices. Chapter XXVII—The Microtelephone. Chapter XXVIII—Wireless Telephony. Chapter XXIX—Useful Definitions and Hints on Telephone Management.

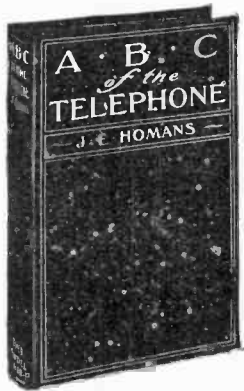

375 pages, 268 illustrations and diagrams, black velum cloth. Price, \$1.00.

TELEPHONE PRINCIPLES AND PRACTICE.

BY GEORGE WALKER WILDER, Ph. D.

This is one of the most valuable treatises on telephony.

CONTENTS.

Chapter I—Magnetic Action. Chapter II—The Centimeter—Gram—Second System. Chapter III—The Electric Current and Magnetism. Chapter IV—The Solenoid. Chapter V—The Production of an Electrical Pressure. Chapter VI—Sound. Chapter VII—Early Forms of Telephony. Chapter VIII—The Telephone Receiver. Chapter IX—The Transmitter. Chapter X—Induction. Chapter XI—The Induction Coll. Chapter XII—The Magneto Generator. Chapter XIII—Ringers. Chapter XIV—The Generator Shunt. Chapter XV—The Hookswitch. Chapter XVI—Instruments and Instrument Circuits. Chapter XVII—Party Lines. Chapter XVIII—Exchange Systems. Chapter XIX—Switchboards and Circuits. Chapter XX—Switchboard Details. Chapter XXI—Complete Switchboards. Chapter XXII—Capacity. Chapter XXIII—Common Battery Systems. Chapter XXIV—Selective Party Lines. Chapter XXV—Location of Exchanges and Pole Lines. Chapter XXVI—Poles. Chapter XXVII—Wire. Chapter XXVIII—Construction of the wire plant. Chapter XXIX—Cables. Chapter XXX—Lightning Protection. Chapter XXXI—Line Disturbances. Chapter XXXII—Electrical Testing.



450 pages, 375 illustrations. Price \$2.00. Postpaid.

OTHER GOOD TELEPHONE BOOKS

- A. B. C. of the Telephone, J. E. Homan \$1.00
- American Telephone Practice, K. B. Miller \$4.00
- Electrical Instruments and Testing, N. H. Schneider . . . \$1.00
- Handy Electrical Dictionary 25c
- Modern Electrical Construction, Horstman & Tousey, . . . \$1.50

- Modern Wiring Diagrams, Horstman & Tousey, \$1.50
- Telephone Construction, Installation, Wiring, Operation and Maintenance, W. H. Radcliffe and H. C. Cushing, Jr. \$1.00
- Telephone Construction, Methods and Cost, C. Mayer \$3.00
- Telephony, A. V. Abbott, 6Vois \$6.00
- Telephony, W. C. Boyer \$3.00
- And Paul Lätzke's great telephone story, "A Fight, with an Octopus" 25c

TELEPHONY
PUB. CO.
Monadnock Block,
Chicago, Ill.

Gentlemen—In accordance with your advertisement in Popular Electricity, I enclose \$_____ for which you may send me

ARE YOU READING "TELEPHONY" THE GREAT WEEKLY TELEPHONE JOURNAL?

A \$3.00 a year paper for \$2.00 to those who use coupon attached.
SAMPLE COPY FREE.

Name

Address

For our Mutual Advantage mention Popular Electricity when writing to Advertisers

**You Can Sell
More Electric Current**

There are reasons why every householder should use electric current for light, cooking, ironing, and operating many household utensils. There are reasons why every user of power, little or much, should buy it from Central Station.

By Advertising

these reasons and proving them with forceful arguments, any Central Station can greatly increase its sale of current. For years we have prepared and placed such advertising for the largest Central Stations in the country. We will be glad to confer with you.

WM. D. McJUNKIN

Advertising Agency

Business Builders

167 Dearborn Street

Chicago

Do You Want to Be WELL?

Do you lack that vigor and strength that comes with abundant health? Need of vitality causes most disease. ELECTRICITY will give you better blood and splendid regular circulation—fresh energy—NEW LIFE. Don't depend on drugs.

THE NEW



Wireless Battery

(Electricity in Tablet Form)



is the new invention that physicians use and prescribe because it is compact, simple, safe and DEPENDABLE. A Pocket Battery in a polished metal case—no wires, cords, plugs or liquids—just fits the hand. Small but potent; lasts a lifetime and cannot get out of order.

INVALUABLE FOR RHEUMATISM, NEURALGIA, ASTHMA, INSOMNIA and all nervous troubles and diseases caused by sluggish circulation.

BEAUTY MASSAGE and ELECTRIC BATHS administered by means of the WIZARD WIRELESS are effective, pleasant and enjoyable. The finest natural complexion beautifier ever discovered. Healthy, active skin is necessary to both health and beauty.

FOR HAIR AND SCALP a special electric brush goes with every Wizard Wireless. Better than gallons of tonics—clean, quick and easy to use.

Will You Try One Free?

We have a special offer to make responsible people. WRITE TODAY for our free approval plan and our new booklet on Home Treatment.

The Genesee Electric Mfg. Co.

106 Sterner Bldg., FLINT, Mich.

**Will You Accept This
Business Book if We
Send it Free?**

Sign and mail the coupon below. Send no money! Take no risk!

One hundred and twelve of the world's master business men have written ten books—2,079 pages—1,497 vital business secrets, ideas, methods. In them is the best of all that they know about

- Purchasing
- Credits
- Collections
- Accounting
- Cost-keeping
- Organization
- Retailing
- Wholesaling
- Manufacturing
- Salesmanship
- Advertising
- Correspondence
- Selling Plans
- Handling Customers
- Office Systems
- Short-cuts and Methods for every line and department
- Position-Getting
- Position-Holding
- Man-Handling
- Man-Training
- Business Generalship
- Competition Fighting and hundreds and hundreds of other vital business subjects.

A 9,059-word booklet has been published describing, explaining, picturing the work. Pages 2 and 3 tell about managing businesses great and small; pages 4 and 5 deal with credits, collections and with rock-bottom purchasing; pages 6 and 7 with handling and training men; pages 7 to 12 with salesmanship, with advertising, with the marketing of goods through salesmen, dealers and by mail; pages 12 to 15 with the great problem of securing the highest market price for your services—no matter what your line; and the last page tells how you may get a complete set—bound in handsome half morocco, contents in colors—for less than your daily smoke or shave, almost as little as your daily newspaper.

Will you read the book if we send it free? Send no money. Simply sign the coupon.

The System Co., 151-153 Wabash Ave., Chicago

If there are, in your books, any new ways to increase my business at my salary, I should like to know them. So send on your 16-page descriptive booklet. I'll read it. 178-3

Name _____
 Address _____
 Business _____
 Position _____

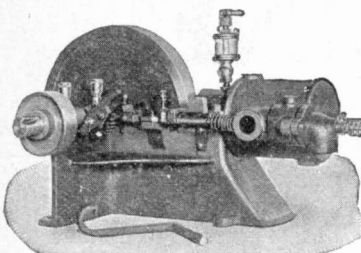

The
Plunket
Junior

A HIGH GRADE HIGH DUTY
ONE HALF HORSE POWER

GAS ENGINE

weight 68 lbs. Water Jacketed 4 Cycle.

FOR LABORATORY, SHOP OR HOME
Efficient, Durable, Simple.

**Cheaper to Operate than Electric Motor
ALSO MORE ELASTIC.**

Governed so that speed may be increased or reduced as desired.

**SEND FOR CATALOGUE
AND PRICES**

J. E. PLUNKET, 47-49 S. Jefferson St. CHICAGO

Agents Wanted.

Everything for Furnace Work



On Free Trial At Our Expense
Until Jan. 1st, 1910

Our story is quickly told. We will send you a Hess Steel Furnace and complete heating outfit, including pipes, registers, fittings and everything needed, for from \$25 to \$100 less than you can buy from dealers, and deliver it at your station, freight prepaid. You may place the purchase price in the hands of your local banker who will hold the money until Jan., 1st, 1910, while you test the heater.

These Important Heating Books FREE



If the test is not satisfactory to you in every way, you may return the goods at our expense and have your money back, we to pay cost of removal and freight charges both ways. Ask us more about it. There's money in it for you. Our great co-operative plan makes you a partner in our success. We explain this with every estimate. This offer also applies to heating equipments for all buildings. We manufacture and sell from our factory direct to you.

No 45
"Leader" Steel Furnace
Price \$49 Pipes and Registers Extra
Delivered any station east of Omaha and north of the Ohio River

Heating Plans Free! Write for Booklets!

Send us a rough sketch of any building that you wish to heat and—without any charge or obligation on your part, we will have our experts prepare a simple, clear plan, which you can easily understand, showing every detail of the furnace, pipes, registers, etc., in their proper places, with the exact cost to you of the complete equipment.

The Hess Furnace will burn any fuel. Besides any kind of coal, or wood,—chips, twisted straw, corn cobs or any other waste fuel can be utilized and money saved.

Our free booklets, "Modern Furnace Heating" and "These Bear Witness," give valuable information about heating any building perfectly and economically. Write today for these booklets.

Hess Warming & Ventilating Co.,
912 Tacoma Bldg., Chicago

ORANGEINE

(POWDERS)

"The Only Ethical Proprietary"

The Best Indorsed Remedy in the World. Widely Tested Since 1892
The Surest "Self-Help" Over Hard Places

There is nothing secret about Orangeine. Its formula is published on every package, and shows a perfect balance of remedial agencies, skilfully selected, to reach the cause of pain and many ailments, with no reactive or drug effect.

Especially prompt and accurate for Colds, Grip, Headache, Neuralgia, "out of sorts feeling."

WHAT ORANGEINE DOES

Dispels Pain	Regulates Digestion	Prevents Sickness
Checks Indisposition	Increases Nutrition	Offsets Wear and Tear
Assures Energy When Most Needed	Makes Better Blood and More of It	
Perfectly Adjusts the Nervous System		

25c Package Free for Honest Test

Orangeine is mailed anywhere on receipt of price. 10c package (2 powders), 25c package (6 powders), 50c package (15 powders), \$1.00 package (35 powders). We will mail free, one 25c package, on receipt of request, with assurance of honest test, under suggestion of our directions.

The Orangeine Chemical Co., 15 Michigan Ave., Chicago

POPULAR ELECTRICITY

IN PLAIN ENGLISH

HENRY WALTER YOUNG, Editor

Vol. 1.

APRIL 1909.

No. 12.

CONTENTS

	Page	Page
Singer Tower Illuminated.....(Front Cover)		
Show Window with Interior Illuminated Glass Pillars.....(Frontispiece)		
LIGHTING OF SHOW WINDOWS. By William Kelly	735	
Singer Tower at Night.....	738	
To Ascertain Polarity.....	738	
Catching the Speeding Motorist.....	739	
ELEMENTARY ELECTRICITY CHAPTER 12. By Prof. Edwin J. Houston.....	740	
Electric Railways of Manila.....	745	
ELECTRICITY AND THE POOLROOMS. By A. A. Weiss.....	746	
Directions for Reviving Dry Cells.....	748	
Largest Transformer Ever Built.....	749	
PROTECTION FROM LIGHTNING. By Albert Walton	750	
RAILROAD ACCIDENTS AND THEIR PREVENTION. By Lewis E. Walkins.....	754	
A HANDY MAGNET.....	757	
THE NAVAL ELECTRICAL SCHOOL. By Lieut. Com. Phillip Williams.....	758	
Unique Central Station Advertising.....	760	
At the Telephone.....	761	
The Modern Aladdin's Lamp.....	761	
FIRST ELECTRIC RAILWAY IN NORWAY. By Dr. Alfred Gradenwitz.....	762	
Telephone News Service.....	763	
Automatic Lamp Flasher.....	764	
Tungsten Lamps for Automobiles.....	765	
The "Just Pull" Switch.....	765	
Portable Electric Breast Drill.....	765	
ELECTRICITY APPLIED TO HORTICULTURE. By Frank C. Perkins.....	766	
Connector for Electrical Circuits.....	768	
Machine for Washing and Drying Blue Prints	768	
Automatic Cloth Scouring Machine.....	769	
A Portable Ozone Producer.....	769	
BACK-YARD ELECTRIC LIGHT CONNECTIONS	770	
When the Fuse Blows Out.....	770	
Southern Electrical and Industrial Exposition	771	
POPULAR ELECTRICITY WIRELESS CLUB	772-778	
WIRELESS TYPEWRITING AND TYPOGRAPHY	772	
Wireless Telephone On the High Seas.....	773	
AERIAL SYSTEMS. By Alfred P. Morgan	774	
An Adjustable Interrupter.....	777	
Wireless From Air-Ship.....	778	
Make-and-break Interrupter.....	778	
ELECTRICAL MEN OF THE TIMES. Bernard E. Sunny.....	779	
ELECTRICITY IN THE HOUSEHOLD.....	780-786	
THE WONDERS OF "ELECTRIC SHOP"	780	
NEW DEVELOPMENT IN COOKING UTENSILS	785	
The Radiant Toaster.....	786	
JUNIOR SECTION	787-792	
How to Make An Electric Alarm Clock.....	787	
Telephoning Under Water	787	
A DEAL IN CIRCUITS. By Paul H. Woodruff	788	
QUESTIONS AND ANSWERS.....	792-797	
Compound Dynamos; Measuring Battery Resistance	792	
House System Telephone Circuits.....	793	
Transformer; Storage Battery Charging.....	793	
Spark Coil Operated From Dynamo.....	793	
Molding Carbon	793	
Crowfoot Or Gravity Battery.....	794	
Winding Small A. C. Armature.....	794	
Dry Battery Construction	794	
Open Circuit Telegraph System.....	795	
Winding a 75 Watt Dynamo.....	795	
Electroplating	795	
An Electric Cannon.....	796	
The Nickel Telephone	796	
Single Wire Signaling Circuit.....	796	
To Make An Ammeter or Voltmeter.....	797	
Dynamo Will Not Run.....	797	
Electro-magnet Winding.....	797	
Ring Wound Armature	797	
NEW ELECTRICAL INVENTIONS.....	798-800	
SIGHTING BIG GUNS.....	798	
COLLECTING ATMOSPHERIC ELECTRICITY	799	
An Electric Fire-Place.....	800	
Insulator for Telephone Wires.....	800	
Electric Alarm Clock.....	800	
SHORT CIRCUITS	801	
ELECTRICAL DEFINITIONS	802	

ISSUED MONTHLY BY POPULAR ELECTRICITY PUBLISHING CO., Monadnock Block, Chicago, Ill.
YEARLY SUBSCRIPTION, \$1.00 CANADIAN AND FOREIGN, \$1.50; SINGLE COPY, 10 CENTS.

No additional copies will be sent after expiration of subscription except upon renewal.

Entered as Second Class Matter April 14, 1908, at the Post Office at Chicago. Under the Act of March 3, 1879.

Copyright 1909 by Popular Electricity Publishing Co., Chicago, Ill.

Watch this Page.

ATTRACTIVE RENEWAL OFFER

We offer you with your renewal the choice of some of the best electrical books published FREE with \$1.00, Canada \$1.35, Foreign \$1.50, for your renewal.

When your subscription expires, you will find a renewal blank enclosed here. You should fill out and return same with remittance at once to avoid missing a number. Positively no copies mailed on any subscription after same expires unless renewed, and we cannot agree to begin subscriptions with back numbers.

No matter when your subscription expires, it will pay you to avail yourself now of this

Special Offer For Renewal Subscribers Only

HANDY ELECTRICAL DICTIONARY.

By W. L. Weber.

Complete, concise, convenient. Designed to meet the needs of the beginner or student in electricity, and at the same time to furnish a compact, reliable reference, in an easily accessible form, for the electric worker and expert. 224 pages—"Plain English"—definitions of over 4,800 electrical terms and phrases. Seven pages of diagrams. Margin indexed. Handsomely bound in red leather.

DYNAMOS AND ELECTRIC MOTORS AND ALL ABOUT THEM.

By Edward Trevert.

Explains, simply, the different types of dynamos and electric motors with instructions and working drawings for constructing a dynamo and building an electric motor; also how to make an electric battery for running motors. Fully illustrated.

WIRELESS TELEGRAPHY.

By Fred. Collins.

Practical instructions covering the history, principles, methods and apparatus used in wireless telegraph work, including a special article on the telautograph, with a list of examination questions.

PRIVATE HOUSE ELECTRIC LIGHTING.

By F. H. Taylor.

A popular hand book of modern methods in wiring and fitting as applied to private houses, including a chapter on small generating plants. 132 pages; 66 illustrations.

TELEGRAPHY AND HOW TO LEARN IT.

By Wilson F. Frederich.

A complete treatise in Elementary Electricity and Practical Telegraphy, which together form the "Science and Art of Telegraphy." Its scope and treatment is within the comprehension of all students who will find it extremely practical. Handsomely illustrated.

HOW TO MAKE ELECTRIC BATTERIES AT HOME.

By Edward Trevert.

As its title indicates, this handy little volume shows how to make simple yet substantial and practical electric batteries, both closed and open circuit, which can be used for experimental work or for operating telegraph lines, ringing door bells, running small motors, incandescent lamps, etc. Illustrated.

Popular Electricity is growing at a tremendous rate, it's reading pages improving each issue. You'll be renewing sometime. Why not now, and get a valuable book **Free**

ADDRESS CIRCULATION DEPARTMENT

Popular Electricity Publishing Co.

Monadnock Block, Chicago.

PUBLISHER'S PAGE

No Longer in the "Infant Class"

With this issue Popular Electricity completes one year of its existence. In another month it may take its place among the sedate and turn compassionate eye upon those that are still laboring mightily under the appellation—"Vol. 1." The first year in the life of any publication has a very important bearing on its future, and in many cases those twelve months actually determine whether it shall live or die. During this period the wants of the reading public must be determined, in the particular field which the publication covers, that it may be so shaped as to meet the requirements of the greatest number. . During this same period the "dear readers" are also making a little investigation on their own account—and they are most discriminating. In the final analysis, upon their decision hinges the fate of the "infant."

We are not going to boast, but we do feel that the results of the first year's work warrant some elation on our part. The reception of Popular Electricity has been flattering. Its circulation has been increased beyond expectations, and this circulation among a class of intelligent and earnest readers has brought to us and enables us to retain a rapidly growing clientele of satisfied advertisers. For this generous support we wish to express our sincere thanks, and to promise increased efforts to make Popular Electricity more worthy of its continuation.

WHAT THE NEWSDEALERS ARE DOING

Newsdealers have found in Popular Electricity a "live wire" and many of them are making special efforts to "push a good thing along." They realize that this is the age of electricity and are not slow to see the significance of a magazine, not a technical publication, that they can hand out to the general reader who comes along with the query "Got anything on Electricity?" The enthusiastic support which many of them are giving the magazine is exemplified by the attractive display shown herewith, which is but one among hundreds.

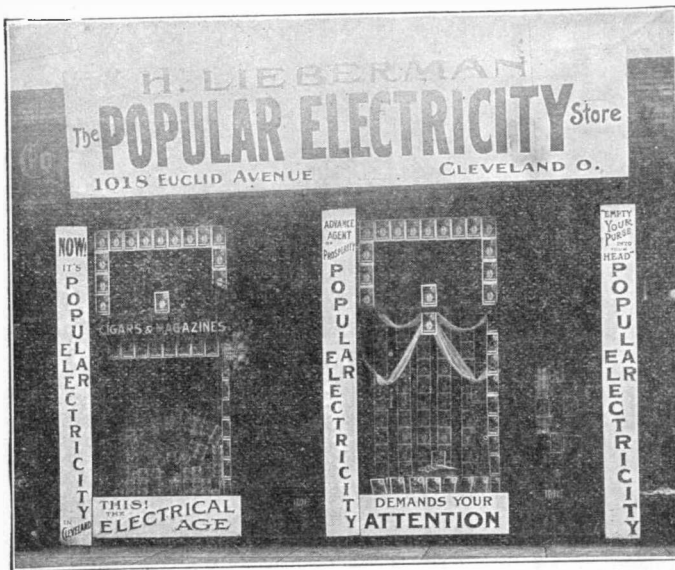

RENEWALS: The date on the wrapper of your magazine shows the issue with which your subscription expires. No additional copies will be mailed after the expiration of a subscription, except upon renewal. Since each issue is printed a month before the date which it bears, renewals should be sent in at least four weeks in advance, in order that no copies be missed.

For our Mutual Advantage mention Popular Electricity when writing to Advertisers.

ELECTRICAL WORKERS

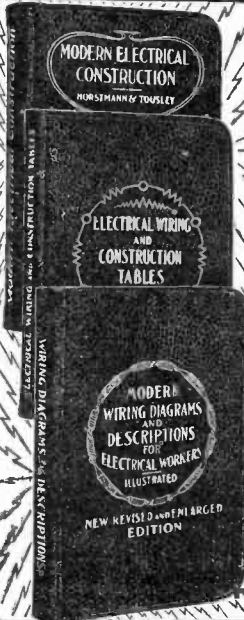

A Complete Electrical Workers' Library Positively Up-to-Date and Written for THE MEN WHO DO THE WORK

There is little that is theoretical, nothing historical, but everything useful and practical. Just what is needed to be known and nothing to confuse. The authors are men who are brought in daily contact with electrical workers and who, therefore, are conversant with their needs and with the best methods of presenting the various subjects.

MODERN WIRING, DIAGRAMS AND DESCRIPTIONS

Describes everything used in general practice; bells, burglar alarms, batteries, dynamos and motors, meters, automobiles, arc and incandescent wiring, telephones, testing, trouble, etc. Fits the owner for any kind of electrical work. Each diagram and explanation complete in itself, not requiring any previous knowledge of the subject to be able to understand it.

A complete collection of diagrams covering every class of construction with which the electrical worker will be brought in contact. A book that can be carried on the job. Settle disputes and arguments.

ELECTRICAL WIRING AND CONSTRUCTION TABLES

This book contains the only practical alternating current wiring table published. Here is the old formula for drop in voltage:

$$\sqrt{[(E. X. P. F.) + (I. X. R.)]^2 + [(E. X. I. F.) + L]^2} = E'$$

To do intelligent work you must use this formula to find the size of wire needed or use the tables in this book. In the past most people have guessed.

This book gives tables by which the proper size wire may be found without the use of mathematics. The tables do all the figuring.

Trigonometry, algebra and the extraction of the square root are not necessary with these tables. Over 100 pages of tables. Single, two and three phase; any distance, any loss, any power factor, any voltage, any efficiency, 25, 60 and 125 cycles.

All that are needed; none that are not needed. Will save, in time saved, their cost many times over. The tables showing the proper size wire to use according to the Underwriters' table of carrying capacity minimize the possibility of costly errors.

MODERN ELECTRICAL CONSTRUCTION

The practical workman's handbook. Written by men in daily touch with the best class of work and the latest wrinkles. For those who desire to pass civil service examinations, gain admittance to the unions, become first-class wiremen, know all the tricks of the trade. Detail information on all construction work. Every page full of practical information; nothing else. Strictly up-to-date. Per set of three volumes, bound in full Persian Morocco leather, red edges, round corners, \$4.00. Single volumes, each, \$1.50. Sent to any address, all charges paid, upon receipt of price. FREDERICK J. DRAKE & CO., 216 Fisher Building, Chicago, U. S. A.

25c BOOKS

Our 25c Electrical Books are immensely popular

Here are some of the Titles

- Electricity
- Dry Batteries.
- Electrical Circuits and Diagrams, (Part 1) Direct Current.
- Electrical Circuits and Diagrams, (Part 2) Alternating Current.
- Electric Bells and Alarms.
- Modern Primary Batteries.
- Experimenting with Induction Coils.
- Induction Coils. How to Make and Use Them.
- Simple Experiments in Static Electricity.
- The Wimshurst Machine.
- Alternating Currents, Simply-Explained.
- Small Accumulators.
- Small Electrical Measuring Instruments.

All Fully Illustrated

Mailed postpaid upon receipt of price

Send for full List of over 60 Titles **FREE**

SPON & CHAMBERLAIN
123 E. Liberty St. NEW YORK

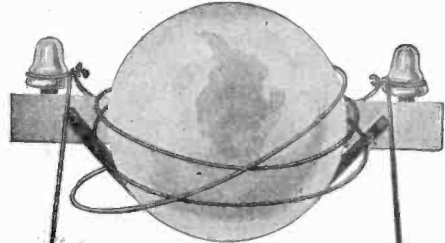

No More Interesting or Better Paid Profession Exists Than

Electricity

Our Students Learn by Doing the Work Themselves under the guidance of skilled instructors, in the largest and best equipped Electrical School in the world.

Write or Call for Prospectus.

New York Electrical Trade School
36 West 17th Street, New York



My Boy! Here's Your Chance

It's more than a chance — you can make it a certainty because it depends entirely upon yourself. It's your opportunity to rise to one of the countless positions open to the trained man and obtain a trained man's salary.

The man who sits in his private office and "hires and fires" and lays out your work, was no more qualified to fill that position a few years ago than you are today. He saw HIS CHANCE and made the most of it. He obtained his training and knowledge by study. You can do the same — the American School will help you.

You don't want to remain in the "time-clock and dinner-pail" class all your life — don't be satisfied with just a common job at small pay. Show the boys at the shop that you have it in you to advance — you owe it to yourself and your family.

Don't be afraid to mail the coupon, you won't be bothered by agents or collectors. Like all strictly educational institutions, the American School depends, for growth, upon reputation and the success of its students.

Don't let a little thing like filling in and mailing a coupon stand between you and success, congenial work and more pay. *Accept your chance to-day.*

WE HELP MEN HELP THEMSELVES

**American School of Correspondence
CHICAGO, U. S. A.**

For our Mutual Advantage mention Popular Electricity when writing to Advertisers.

FREE INFORMATION COUPON

American School of Correspondence:

Please send me your free Bulletin of engineering information and advise me how I can qualify for position marked "X."

- | | |
|--------------------------|-----------------------------------|
| Electrical Engineer | Telephone Engineer |
| Draftsman | Heating and Ventilat'g Engr. |
| Civil Engineer | Plumber |
| Mechanical Eng'r | Architect |
| Stationary Eng'r | Hydraulic Engineer |
| Structural Engineer | Textile Boss |
| Municipal Eng'r | Sheet Metal Pattern Drafts'n |
| Railroad Engineer | College Preparatory Course |
| Structural Drafts'n | Sanitary Engineer |

NAME

ADDRESS

OCCUPATION Pop. Elect. 4-09

POPULAR ELECTRICITY

The Del Electric Curling Iron



¶ A new and practical electrically heated device for curling the hair. The only electric curling iron that will produce marcel and pompadour effects. ¶ This iron is self contained—requiring no separate device for heating, thereby insuring absolute cleanliness. ¶ Attaches to any lamp socket by means of cord and plug. ¶ When the iron is sufficiently hot, turn off the current, the cord may be detached, and the iron will remain hot for some time. This leaves you free to act without chance of the cord getting in your way. Will be found most convenient when traveling.

Price, \$3.75 complete.

SOLD BY ALL FIRST-CLASS
DEALERS

Del Sales Company, ⁹⁸ Jackson Blvd. Chicago

EXCELSIOR AUTO-CYCLE

FOR 1909

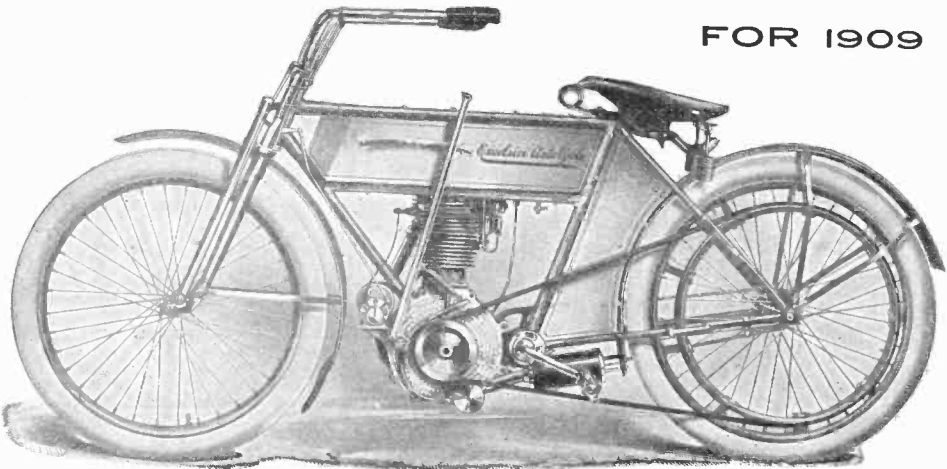

Not Rebuilt and Reconstructed—It Was Right at the Beginning

But embodying every new feature found to be a real improvement of practical value.

We were the first advocates of a low saddle position. Watch others follow.

Our positive sight feed oiling system positively eliminates lubricating troubles.

High tension magneto or battery ignition.

Straight line frame that gives the maximum strength at minimum weight.

These are but a few of the many points that make the **EXCELSIOR AUTO-CYCLE** the one that is always on the job.

Our new illustrated circular, M. C. 129, gives full details. Write for it today.

EXCELSIOR SUPPLY CO.

233-237 Randolph Street, Chicago, Ill.

Established 1876.

For our Mutual Advantage mention Popular Electricity when writing to Advertisers.

Refinish a Piece of YOUR Furniture at OUR Expense

Let us send the
Materials Free



WE WANT a sample of wood finishing done with our preparations in your home. We will send the materials to do the work. Here they are:

A bottle of Johnson's Electric Solvo to quickly remove the old finish—

A bottle of Johnson's Wood Dye (you to choose the color from our 14 different shades) to color the wood—

A sample of Johnson's Prepared Wax to give that beautiful "hand-rubbed" effect—

And our illustrated guide book for home beautifying which includes complete color card and tells how to finish and refinish wood.

No doubt you have some piece of furniture that you prize highly, yet do not use on account of the worn condition of its finish, or because it does not harmonize with other furniture or decorations.

Use this outfit, which we want to send you free, for refinishing it, and you will be surprised to learn how easily the work is done and the beauty of the result.

May we send you these three packages, and the valuable six-color book, free at once? Learn from the test the beautiful effect obtained from the use of

Johnson's Wood Dye

It is not a mere stain. It is a deep seated dye—sinking into the pores of the wood and bringing out the beauty of the grain. When finished with Johnson's Prepared Wax you have a permanent finish of real beauty and most artistic effect. We want to give you these three packages at once. Send ten cents to partially pay cost of packing and postage—using coupon below for your convenience.

Johnson's Wood Dye comes in 14 Standard shades:

- | | |
|------------------------|-----------------------------|
| No. 126 Light Oak | No. 130 Weathered Oak |
| No. 123 Dark Oak | No. 131 Brown Weathered Oak |
| No. 125 Mission Oak | No. 132 Green Weathered Oak |
| No. 140 Manilla Oak | No. 121 Moss Green |
| No. 110 Bog Oak | No. 122 Forest Green |
| No. 128 Light Mahogany | No. 172 Flemish Oak |
| No. 129 Dark Mahogany | No. 178 Brown Flemish Oak |

Half-pints 30c; pints 50c. Johnson's Prepared Wax 10c and 25c packages. Also sold in large sizes. For sale by all leading paint dealers. Send coupon today to

S. C. Johnson & Son, Racine, Wis.

"The Wood Finishing Authorities"

Please Use This FREE COUPON

I accept your offer and enclose 10 cents to partially pay postage and packing on Free Booklet, Edition P. E. 4, one sample bottle of Johnson's Wood Dye, shade No. 126, and one sample bottle of Johnson's Electric Solvo and a sample of Johnson's Prepared Wax.

Name.....
Address.....
Name..... I usually buy my paint at store of.....
Address.....

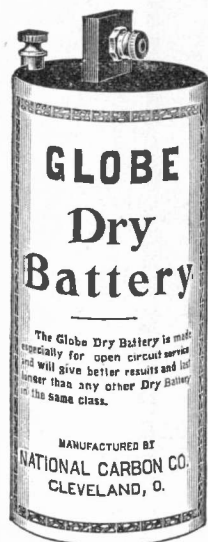

A POPULAR BATTERY

AT A POPULAR PRICE

Very extensively used for CALL BELLS, BURGLAR ALARMS, ANNUNCIATORS, TELEPHONES, MEDICAL BATTERIES, SMALL MOTORS, Etc.

In all comparative tests made of the various makes of low price dry cells on the market the GLOBE proved its superiority in length of life, efficiency and recuperative powers.

Price in lots of 12 or more 13½c each.

NATIONAL CARBON CO., CLEVELAND, O.

Let Us
Send You a

Monarch Vibrator

Guaranteed to be the most powerful, durable and practical vibrator of its size made.

ON APPROVAL

These vibrators contain complete, perfect Electric Motors, and are made to run on their own dry cells or to attach to electric light socket like a lamp. Fully adapted to professional requirements, yet the most economical and satisfactory for home use. Light, compact, noiseless; motionless handle. To prove our strong claims for the Monarch, we send it prepaid

TO TRY FREE

Don't buy a vibrator without careful consideration of every one of the above points, including scope of guaranty.

For Beauty

Helps to restore to nature's intended perfections. Removes wrinkles and facial blemishes. If too thin, it brings the blood and develops fullness of the neck, arms or deficient parts, by building new flesh. If too stout, it brings the blood to wash away adipose tissues. Splendid for the scalp, for the complexion and after shaving. Prevents dandruff, irritation, falling hair, baldness.

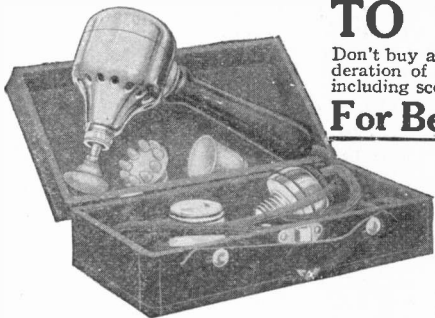

For Health

Furnishes passive exercise to parts which suffer from congestion, the cause of all disease, bringing the rich, purifying blood in quick response to its swift pulsations, and restoring normal functions. Soothes excited nerves and brings sweet, refreshing sleep.

Let us send you a vibrator, prepaid, without a cent in advance, so that you may know for yourself the wonderful benefits of vibration when given by a high grade machine. Liberal allowance for old machines in exchange. Our new Book, "Health and Beauty Without Medicine," with illustrations from life, FREE Write today. Address

MONARCH VIBRATOR CO., 444 Security Building CHICAGO, ILLINOIS

Death in the Phone! She Doesn't Know

YOU TELL HER that if she presses her lips against the mouthpiece of an uninfected Phone she takes chances of becoming infected with loathsome and incurable diseases.



SCIENTIFIC TESTS PROVE

that the mouthpiece of every uninfected Phone swarms with malignant Germs, which she may inhale and thus contract Tuberculosis, Diphtheria, Typhoid, Pneumonia, or even a more revolting disease! The diaphragm of the Phone, upon which the breath of the user condenses in large drops, forms an ideal incubator for GERMS; Guinea pigs inoculated with such drops developed Tuberculosis of the lungs.

Even the healthy mouth harbors Germs of dread disease which might prove fatal if transmitted to a person susceptible to disease! Scores use your Private Phone; it may infect you even though your lips do not touch it—for you cannot use it without inhaling the exhalations of others. See the drops on the diaphragm; smell it. Ask your Physician or any Bacteriologist! Write us for convincing proof. Take no chances; equip your Phone with a

DIOZO PHONE DISINFECTOR

& Deodorizer. It KILLS Germs—Destroys odors. Keeps the mouth-piece constantly DISINFECTED. Applied in less than a minute! Guaranteed for 1 year. No care, trouble or recharging. It does not interfere with the operation of the Phone. Attractive in appearance; made entirely of metal, aluminum finish and filled with solid DIOZO—no LIQUID. We mail one to any part of the world, postpaid, for 50c.

PARKER CHEMICAL CO., 233 Market St., CHICAGO

ELECTRICITY

Did you ever stop to think just how much has been accomplished with this "something of which we know so little."

It is only lately that public attention has been directed to its value as a curative agent especially in such diseases as

RHEUMATISM LUMBAGO NEURALGIA SCIATICA

and the results that have been accomplished have astonished even the most sanguine.

As a result of the study and investigation which this Company has been making under the direction of Expert Electro-therapists, we have been able to place on the market

ELECTRO-ROL

a perfect combination of Faradic electricity and Vibration or massage.

The Electro-Rol is so simple that a child can use it without danger, so effective that Physicians and Masseuse have adopted it in their practice, and the price is so reasonable that it is within the reach of every family.

We want to send YOU our booklet and Body chart so you will know more about the Electro-Rol and what it will do for you in pain or sickness. A postal will bring our reply.

OLIVER MFG. CO. Inc. 1021 Walnut St., PHILADELPHIA, PA.

We Want a Representative In Your Shop

- ¶ We have a plan by which farming can be done on a large scale and pay small investors very large returns.
- ¶ We farm in TEXAS the land of opportunities, where you can harvest some crop every month in the year.
- ¶ It will pay every one to investigate and secure an interest with us. Full particulars free.
- ¶ You can make \$100 a week representing us without leaving your present occupation. Try it.

National Farm & Land Co.

Dept. A. ST. LOUIS, MO.

LET US FIGURE

on all your Electrical Work. Some of the largest contracts on Electrical work in the country have been performed by us.

WE INSTALL

Power and Light Plants. Generators and Motors, Electric Light and Power Wiring for Factories, Churches, Schools, Colleges, Theatres, Office, Store and Residence Buildings.

Estimates cheerfully furnished for this class of work in any part of the U. S.

WE MANUFACTURE

Switchboards, Panelboards, Steel Cutout Cabinets, Junction Boxes, Service Switch Boxes, Theater Stage Plugs, Experimental Switchboards and Appliances for High Schools and Colleges. Newgard receptacles and other electrical specialties.

All Electrical work at the Chicago Electrical Show installed by us.

Manufacturers of the Famous "Newgard" Waterproof Receptacle and Globe.

HENRY NEWGARD & CO.

30-32 West Monroe St., Chicago, Ill.



2 H.P. Detroit Engine \$29⁵⁰

3-5-7-10-12 14 and 40 H. P. at proportionate prices.

Starts without cranking; no cams, valves, springs or sprockets. Only three moving parts. Uses alcohol, gasoline, naphtha, distillate, kerosene, coal oil, etc. All bearings babbitted. Cylinders and pistons ground. Crank shaft forged steel. For your Row Boat, Sall Boat, Launch. 10,000 in use. All sizes ready to ship. Send for testimonials and free catalog.

DETROIT ENGINE WORKS, 1310 Jefferson Ave., Detroit, Mich.

LEARN TO DRAW



Artists and draftsmen make \$20 to \$100 a week. Pleasant, refined, fascinating work for men, women boys and girls. We guarantee proficiency or will refund tuition.

Quality At Home in Spare Time

Illustrating, Cartooning, Commercial Designing taught by artists trained in American and European Schools. Instruction adapted to each student's needs. Advisory Board of world's best artists approves lessons. Test Work Sent FREE to ascertain individual talents and needs. State course wanted. You assume no obligation. Mechanical, Architectural and Sheet Metal Pattern Drafting also taught successfully. ACME School of Drawing, 237 South St. Kalamazoo, Mich. If interested, ask about the ACME RESIDENCE SCHOOL IN KALAMAZOO



FRY DRAUGHTING TABLES

For years Fry Patent Draughting Tables have been the standard. There are none better at any price. Style B shown in the illustration is very complete, with foot rest, swing instrument drawer and sketch box. Has adjustment for attaching to either side. The top can be raised without raising frame. Suitable for sketch, perspective and careful work. When not in use folds up and can be set in small space. Made durably from best material; iron standards adjustable to desired height. Write to-day for descriptive matter our entire line of draughting-room furniture. The quality and price is right.

FRITZ MFG. CO., 93 Alabama St., Grand Rapids, Mich.



COLUMBIAN ENGRAVING CO.

HALF TONE
ZINC ETCHING
& ILLUSTRATING

331-335 DEARBORN ST.
CHICAGO

PHONE HARRISON 3978

ELDRIDGE ELECTRIC MFG. CO.

MANUFACTURERS OF

ELECTRICAL MEASURING INSTRUMENTS & SPECIALTIES

26 P. O. Square,
SPRINGFIELD, MASS., U. S. A.

4-IN-1 VOLT-AMMETER



measures high and low volts, amperes and resistances. It's compact, accurate and inexpensive. Send for complete catalog No. 14, of portable and switchboard voltmeters and ammeters.

L. M. PIGNOLET
78 Cortlandt St. - New York

MAKE MIRRORS AT HOME

Big profits, with little outlay. One 18x36 in. mirror costs \$2.00 to \$5.00. You can silver a glass this size for 20c. Send 50c in stamps or money order and we will send you explicit directions how to do it; also how to emboss, grind, foil, gold leaf, frostchip and make imitation stained glass. How to transfer photos on glass, bore holes in glass and cut skylights.

GEORGE L. PATTERSON & CO.
2214 Monticello Avenue MORGAN PARK, ILL.

"Don't Cuss The Telephone"

Because your line is noisy. Buy a "Wasatch Induction Killer," and be happy. Made for all kinds of noisy lines.

"IT STOPS THE BUZZ"

Sent by mail postpaid for \$1.50. Every telephone user needs one. "Agents Wanted." "Patent Pending."

WASATCH ELECTRIC SERVICE CO., (Inc)
46 Post-Office Place, Salt Lake City, Utah.

THE BEST LIGHT



2¢ A WEEK

MAKES and burns its own gas. Produces 100 candle power light—brighter than electricity or acetylene—cheaper than kerosene. No dirt. No grease. No odor. Over 200 styles. Every lamp warranted. Agents wanted. Write for catalog. Do not delay.

THE BEST LIGHT CO.
380 E. 5th St., Canton, Ohio

DO YOU LIKE TO DRAW?

THAT'S ALL WE WANT TO KNOW

Now, we will not give you any grand prize—or a lot of free stuff if you answer this ad. Nor do we claim to make you rich in a week. But if you are anxious to develop your talent with a successful cartoonist, so you can make money, send a copy of this picture, with 6c in stamps for portfolio of cartoons and sample lesson plate, and let us explain.

The W. L. EVANS SCHOOL OF CARTOONING
833 Kingmoore Bldg., Cleveland, Ohio.



Webster's New \$8.50 Encyclopedic Dictionary FREE with each of the First Hundred Orders!

MAGNIFICENT 1909 EDITION OF THE
New Americanized Encyclopedia

First in Wealth of Learning, First in Weight of Authority, Latest in Date of Publication
 Fifteen massive volumes, sumptuous binding; 10,000 double-column pages, 100 superb maps, 37,000 biographical references, hundreds of illustrations, colored plates of the rarest beauty



"An intellectual ocean whose waves touch every shore of thought."

\$1.00 Secures the Set.
 Sent Free for Examination

A Home University
 A College Education
 A Huge Library

The King of All Encyclopedias, at Prices Never Before Approached

You have always meant to get an encyclopedia—every intelligent man does. NOW IS THE TIME. The possession of this latest and greatest of all ENCYCLOPEDIAS puts you ten years ahead of your less enterprising neighbor. Other books tell you about ONE thing; this tells you about EVERYTHING. It covers every phase of human knowledge, discovery, experience, and belief. All gallant deeds and stirring scenes, all victories of brain or brawn, all marvels of science and invention, all the glorious achievements that have made history luminous and civilization possible are found in the 10,000 teeming pages of these splendid volumes. Can YOU afford to do without it?

Its Matchless Authority. The most brilliant thinkers of the century are enrolled as its contributors. Its writers include such men of world-wide fame as Matthew Arnold, James Bryce, John Morley, Andrew Lang, St. George Mivart, Canon Farrar, Edmund Gosse, John Stuart Blackie, Leslie Stephen, Edward Freeman, Lord Kelvin, Robertson Smith, Sir Norman Lockyer, Thorold Rogers, Saintsbury, Swinburne, Simon Newcomb, John Fiske, Cardinal Gibbons, John Bach McMaster, Admiral Melville, Thomas B. Reed, Carroll Wright; and these, with hundreds of others equally famous, give it an authority so overwhelming, so incomparable, that it reigns without a rival in the realm of scholarship.

Special Half Price Offer. To emphasize the issue of the 1909 edition of this magnificent work, we are making, for a limited time only, a special introductory offer at just ONE-HALF the regular price. The cloth set we price at \$37.00, the half morocco at \$46.00. Moreover, with each of the first hundred orders to reach us we will send absolutely FREE Webster's Huge New Encyclopedic Dictionary, retailing regularly at \$8.50. It is bound in full sheep, marbled edges, gold stamped and indexed. This combination of the world's most famous Encyclopedia and equally famous Dictionary gives you a magnificent reference library of enormous extent and unmatched value.

Send No Money Now. Sign and mail the attached coupon and we will ship you a complete set for five days free examination. You can return them AT OUR EXPENSE if they fail to give you entire satisfaction. We pay all transportation charges. Should you decide to purchase them, then send us \$1.00 as first payment and pay the balance at the rate of \$2.00 per month for the cloth and \$2.50 per month for the half morocco.

Do Not Delay. At these phenomenal prices the introductory sets will vanish like magic. It is the opportunity of a lifetime. Enrich your mind, adorn your library, delight your family with this stupendous work.

WRITE TODAY. Remember. No risk! No obligation!
 You purchase only if satisfied.

The Booklovers' Society

156 Fifth Ave.
 New York City

P. E.
 Apr. '09

THE
 BOOKLOVERS'
 SOCIETY
 156 Fifth Avenue,
 New York

Please send me for examination prepaid a complete set of the New Americanized Encyclopedia in half morocco binding at your SPECIAL HALF PRICE offer of \$46.00. If the set is satisfactory, I agree to pay upon the purchase price the sum of \$1.00 in cash within 5 days after receipt of goods and \$2.50 each month thereafter for eighteen months. Title to remain in The Booklovers' Society until full purchase price has been paid. If the books are not satisfactory, I am to notify you promptly and hold them subject to your order. Also send me Webster's New Encyclopedic Dictionary, which I am to receive absolutely FREE should I retain the set.

NAME

ADDRESS

If you prefer the cloth edition, alter \$46.00 to \$37.00 and \$2.50 each month to \$2.00.

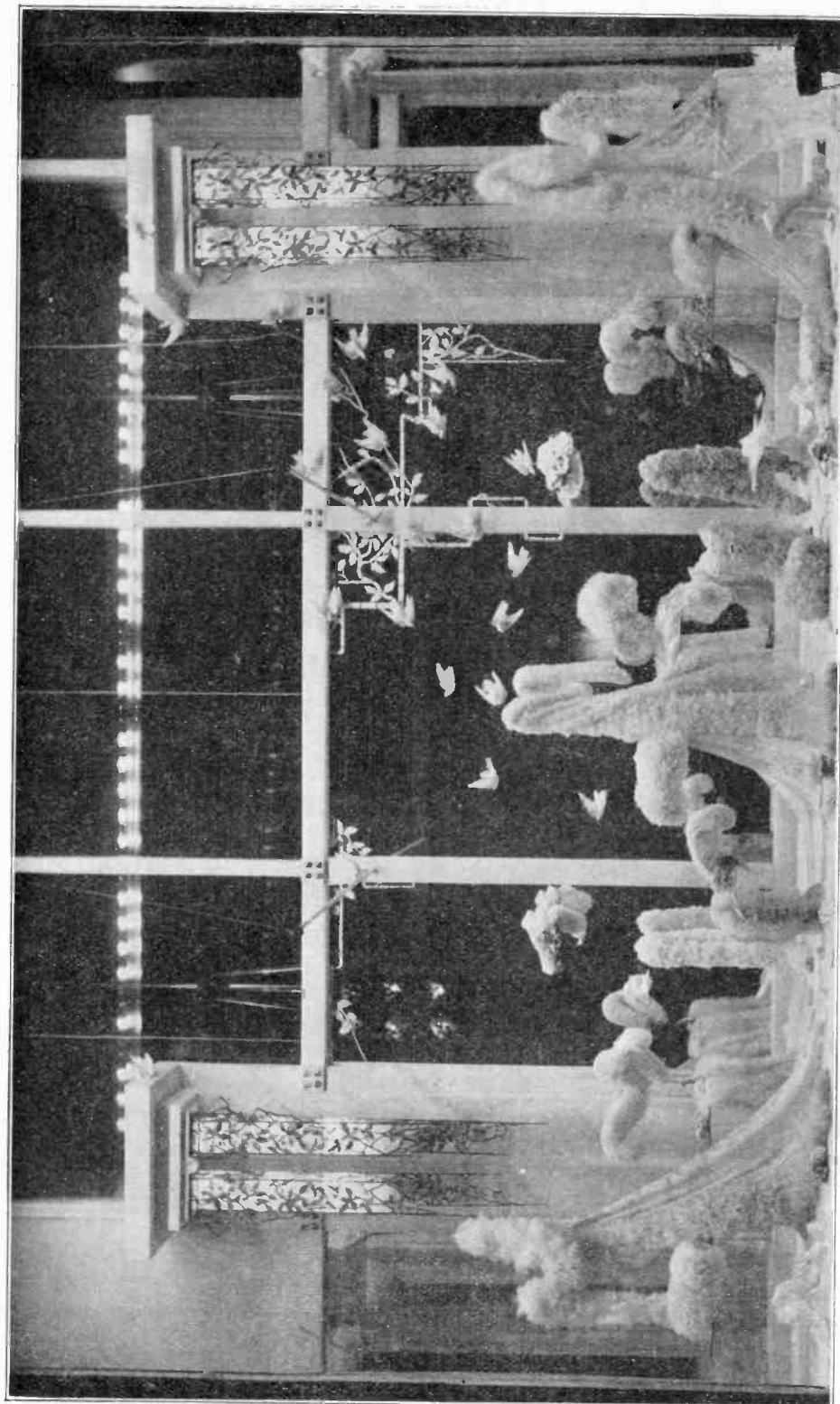

SHOW WINDOW WITH INTERIOR ILLUMINATED GLASS PILLARS. SMALL LAMPS APPARENTLY SHOWING ARE REFLECTIONS FROM CONCEALED TROUGH LIGHTS.

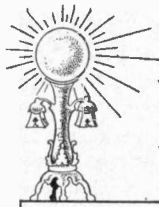

POPULAR ELECTRICITY

IN PLAIN ENGLISH



VOL. I

APRIL 1909

No. 12

THE LIGHTING OF SHOW WINDOWS.

BY WILLIAM KEILY.

When the lighting of the show windows of stores is spoken of, it is of course assumed that electric lighting is meant, for this is certainly one branch of illumination where the advantages of electricity must be universally conceded. One has but to imagine the sorry figure that the store fronts in any of our American cities would present to our twentieth-century eyes, after dusk, if any other illuminant were used, to realize that it is a case of "Eclipse first; the rest now here."

But while all up-to-date show windows are lighted electrically, there are about as many methods of accomplishing the result as there are window-trimmers or designers, to say nothing of the illuminating engineers, who have ideas of their own on the subject. As might be expected, the engineers and the designers of window displays do not always agree. The engineer is a man whose shibboleth is "efficiency"; he is to do with one dollar what any fool can do with two. He wants to get the greatest amount of useful light in that window at the least cost. Very likely he will favor the tungsten lamp, with its high efficiency and its beautiful white light, directed where needed by reflectors designed with mathematical accuracy.

On the other hand, the high-class window trimmer is an artist. He aims to produce beautiful effects by combinations of color and form. He has in mind the apparent changes in form when viewed under different colors—a subject but little understood. He has his designs, his backgrounds, his comple-

mentary colors, his tones and tints. "Softly, softly," he may say to the engineer; "we do not want a white light; we want a yellow with some red in it—a warm, friendly flesh tint, not a glare

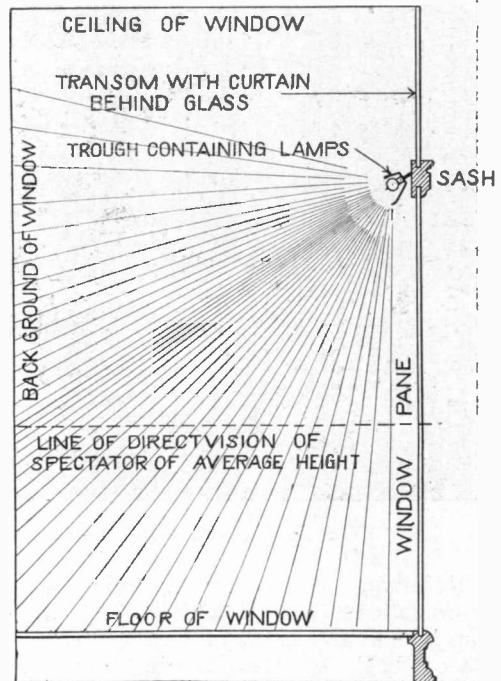

ARRANGEMENT OF CONCEALED TROUGH LIGHTS, SHOWING ANGLE OF GREATEST ILLUMINATION.

of white; white is harsh." And he will probably have his way.

The present article is accompanied by some photographs, taken about midnight or 2 o'clock in the morning, when the sidewalks are comparatively clear,

showing the beautiful window displays and window lighting of the famous retail store of Marshall Field & Co. in Chicago. Such effects as these are only obtained by the highest degree of artistic skill backed by lavish expenditure; but it is to be remembered that the lighting effects, which are excellent, are obtained by very simple means; they can be duplicated at small expense in windows much less pretentious.

tric lamps of 16 candlepower each and spaced about six inches apart. These lamps have the ordinary carbon filaments and produce the familiar yellowish light. They are invisible to the spectator unless he twists his neck around and makes a particular effort to look at them. The idea is to show the merchandise, not the lights. Each lamp carries its own reflector; that is, the upper half of the round bulb is silvered

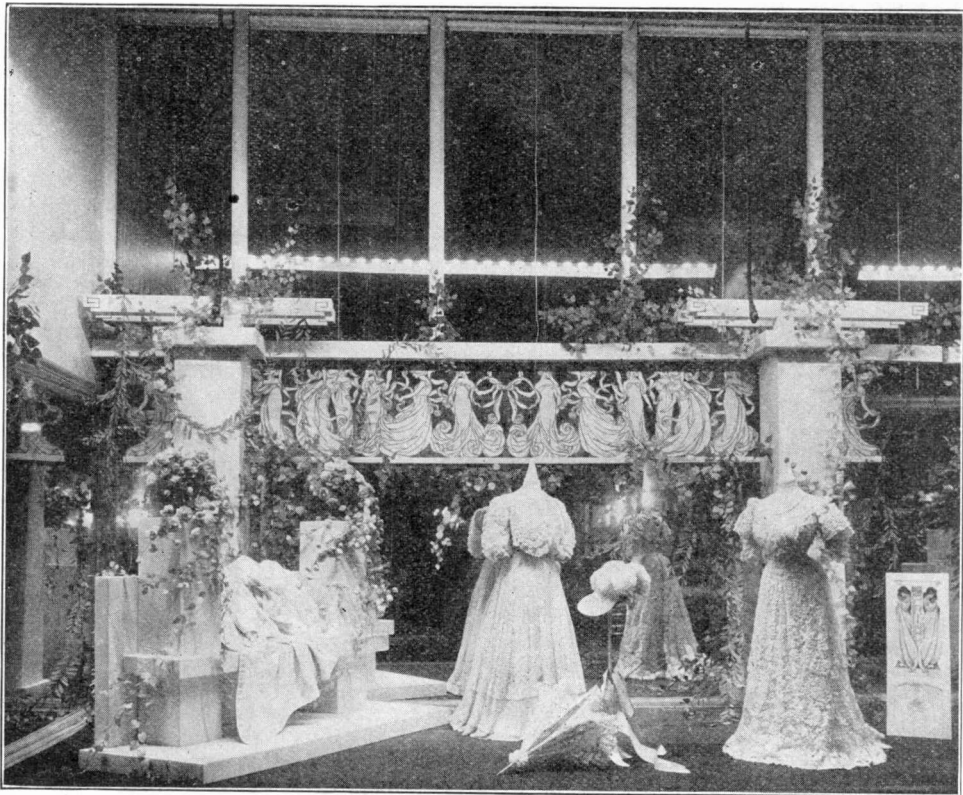

IN THIS VIEW THE ANGLE OF LIGHT IS PLAINLY SHOWN AT THE LEFT.

Referring to the accompanying diagrammatic sketch, it will be seen that the lamps are contained in a trough placed back of the framing or sash which separates the main part of the window pane (which is a single sheet of glass about 12 feet high and 17 feet wide) from the upper part or transom, behind which is a draped curtain. This trough is of wood, painted white on the inside and shaped as shown in the sketch. Inside it, at an angle of about 35 degrees, are round incandescent elec-

like a mirror. When the reflecting power becomes lessened the lamp or lamps may be replaced easily.

As shown in the diagram the lamps are so placed that the greatest amount of light comes where it is most wanted, and that is on the plane extending from the eyes of a spectator of average height. The upper part of the window does not need much light and does not get it. In some of the pictures the angle of light is clearly shown. In two of them rows of lights can be seen appar-



ILLUMINATION OF OBJECTS OF ART.

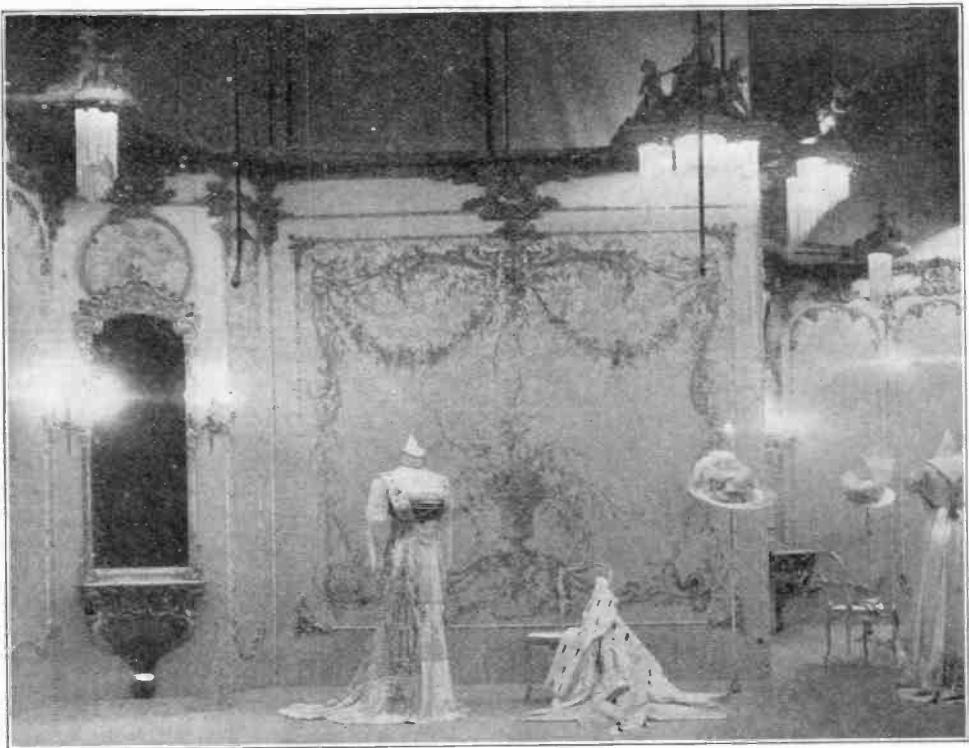

SHOW WINDOW LIGHTING. OVERHEAD FIXTURES WITH GLASS TUBING PENDANTS.

ently, but these are reflections of lights in glass partitions; the lamps themselves are invisible.

While the source of general illumination is carefully concealed, it is sometimes desirable to show a few decorative lamps in the window setting. One of the pictures reveals some beautiful overhead fixtures, in which 16-candle-power lamps are concealed in circular fringes of glass tubing. The average length of these glass tubes is 18 inches. In the same photograph are to be seen some modern bracket fixtures arranged to look like candles. The frontispiece shows the pretty effect obtained by vines climbing on hollow pillars of glass with lights within.

Window decorating is an art by itself. In some respects it is like stage setting. For instance, in the retail store of Marshall Field & Co. there are 40 show windows facing the sidewalk. Each of these window spaces is 17 feet high, 22 feet wide and 9½ feet deep. Here is a room of considerable size, for which, on a grand occasion, a design, a setting, a picture, must be provided. At the opening of the new store in 1907 a force of 300 people was employed for six months making window decorations. The head window trimmer gets a larger salary than any other man in his profession in the United States.

But, unlike the stage, there is no illusion. Everything displayed is genuine and is shown both by daylight and artificial light. Imagine a stage setting in broad, garish day! In window dressing in the great retail stores the richest of satins, silks, damasks and gold embroidery are used. Sometimes the decoration, irrespective of the objects displayed, costs a thousand dollars for a single window.

Show window lighting is one of the most attractive features of city streets. It may be simple or elaborate, direct or indirect, with white light or colored, from any of a variety of lamps, arranged in one of a myriad of forms; there is no hard-and-fast rule to follow. Every merchant must adapt his means to his end, but one thing is certain, if he is to get the best value out of his windows, he must light them attractively by electricity.

THE SINGER TOWER AT NIGHT

Viewed at night from Brooklyn Bridge, or from any point on North River, East River, or the Bay, the lofty tower of the Singer Building in New York looms up above the shadowy outlines of the city as the brightest object in all the range of vision. The front cover picture in this issue is a striking view of this remarkable example of electrical illumination which was planned throughout by Mr. W. D'A. Ryan, illuminating engineer of the General Electric Company.

The dome of the building, which begins at the forty-fifth floor, is outlined with incandescent lamps, but the main body of the tower is thrown into bold relief by 30-inch searchlights, thirty in number. The east, south and west sides are lighted from the eighteenth to the thirty-fourth floor by searchlights on the fourteenth floor level, which is the point at which the tower proper begins. The north side is lighted from the twenty-fifth to the thirty-fourth floor, the lights being located on the roof of the City Investing Building, which conceals the lower portion of the face. The searchlights are provided with special lenses to insure an even distribution of light over the faces of the tower. The flag, which waves at a point 625 feet above the curb, is illuminated by a special 36-inch projector in addition to those provided for the tower lighting.

TO ASCERTAIN POLARITY.

A reader of Popular Electricity offers the following method of ascertaining the polarity of a circuit. Dip blotting paper in a solution of potassium iodide (it can be used any time by moistening with water). Place the two electrodes near together on the paper. The paper at the positive terminal will turn a deep violet.

At a recent 25-mile test in the crowded streets of New York an electric delivery wagon defeated a gasoline wagon of the same capacity by 12 minutes. The route lay through a very busy section where quick maneuvering and frequent stops were necessary.

CATCHING THE SPEEDING MOTORIST.

In the day time the constables who amuse themselves by timing motorists and arresting those who exceed the speed limits have it all their own way. The night time has been the motorists' time for turning the tables. It is difficult to catch a man's speed at night and counsel for the defense never had much trouble in tripping the local timer and witness for the prosecution.

"How do you know he was going at the speed you state?" asks counsel for the defense in thundering tones.

"I timed him by my watch," answers the witness.

"Oh, you did, did you," comes back the counsel with the cross examiner's tinge of sarcasm. "Well, how did you make out the time on your watch, considering the night on which you say you timed him was pitch dark and there was no lamp in your vicinity?"

This always reduces the witness to confusion or the necessity for inventing unconvincing tales of matches struck on a dark and windy night or of a positive recollection of the time as caught by the light of the whirling lamps of the victim's own machine.

In Europe they have tried all kinds of ideas to overcome the difficulty of accurately timing the speed of a motorist and doing it in a way that will be convincing in court. The police of England have resorted to signaling from roofs, an uncomfortable and unreliable method of timing the speeders. They have sworn to the time as caught from sun dials and have proved learned and positive concerning timing done by a watch without a second hand.

The ease with which an astute lawyer has made these witnesses appear ridiculous in court has at last prompted a scientific inventor to come to the rescue with a simple little contrivance that is proving the undoing of "scorchers" who exceed the speed limits at night, thinking they can do it with impunity on account of the friendly darkness.

The device, as used on the road from London (Eng.) to Portsmouth, is a small electric flash lamp that is used with a timing clock. The little apparatus is so small that it can easily be carried in a policeman's pocket. When he has reason to believe that an approaching auto-

mobile is going faster than the law allows he reaches for his pocket clock, holds this in one hand and with the other has in readiness the electric button that flashes a lamp on the face of the clock at the moment the motorist is passing. Down the line another policeman waits with his flash lamp ready and the time is taken at the given distance. There is no possibility of confusing a witness as to his



ELECTRIC TIMING DEVICE FOR POLICEMEN.

method of timing when one of these little electric flash lamps is used. The light is there and the pressing of the button at the time of the passing of the automobile is so obviously a mechanical way of ensuring the absolute accuracy of the timing of the motor's passing that there is little to be done except pay the fine and be more careful in future.

ELEMENTARY ELECTRICITY.

BY PROF. EDWIN J. HOUSTON, PH. D. (PRINCETON).

CHAPTER XII.—CATHODE RAYS.

Besides the effects produced by the passage of electricity through ordinary matter, there are additional effects that are observed only when the path of the discharge is through the residual atmospheres of very high vacua.

When a disruptive discharge is passed through a closed vessel containing air, as long as the pressure is the same as that of the outer atmosphere, no unusual phenomena are observed. If, however, the air is gradually removed, the sparks begin to widen, and when the vacuum reaches a certain, but not very high point, they occupy the entire space inside the vessel, filling it with a pale glow of a bluish or purplish light that is separated from the cathode, or negative electrode, by a narrow dark space, while a small bright point, or star of light, appears at the anode or positive electrode.

When a higher vacuum is reached, the light breaks up into numerous striæ or alternate light and dark bands. At a still higher vacuum the dark space occupies the entire vessel, all the light disappearing except a greenish light that appears at the wall of the tube that receives a bombardment from the cathode.

The following facts have been discovered concerning these discharges, namely:

(1.) Something is thrown with great velocity from the surface of the cathode. At one time these were believed to be the molecules of the residual gaseous atmosphere, but are now known to consist of minute particles torn from the atoms of the residual gas at the cathode.

(2.) During the discharge, the temperature of the cathode is higher than that of the anode.

(3.) The light produced is especially rich in rays capable of exciting fluorescence and phosphorescence.

(4.) The particles thrown off from the cathode move in straight lines in parallel paths until they strike portions of the wall of the tube directly opposite the cathode.

(5.) When the vacuum reaches a certain high point the dark space sur-

rounding the cathode gradually increases in width until at last it occupies the entire tube. All light then disappears except that produced at the portions of the wall against which the particles strike.

(6.) The moving streams are deflected by the approach of a magnet, and, therefore, must consist of electrified particles, since they practically form the circuits of electric currents, and, like all movable electric circuits, are deflected by magnets.

The above principles were discovered

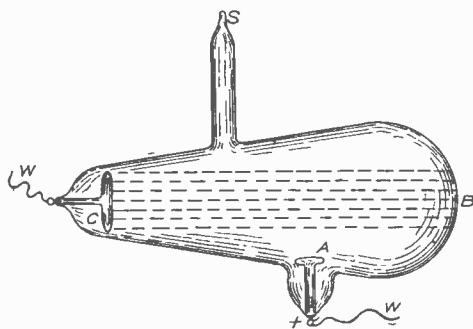

FIG. 77. CROOKES' TUBE.

by investigations made by a number of physicists as the results of researches extending from 1839 to the present time.

A glass tube containing a vacuum capable of exhibiting the above effects on the passage of a high-pressure electric discharge is known as a Crookes' tube. Such a tube is represented in Fig. 77. The leading-in platinum wires (W W) are provided with concave disk-like enlargements at (C) and (A). The connections are such that (C) is made the —, or negative terminal or cathode, and (A) the +, or positive terminal or anode. A small branch tube (S) is provided for connecting the tube to the mercury pump while exhausting. When the necessary vacuum has been reached the tube is sealed off by a blow-pipe flame and thus disconnected from the pump.

When an electric discharge from a Ruhmkorff coil, or other high-pressure

source, is passed through the tube the particles thrown off from the cathode do not pass to the positive to the negative terminal, as is believed to be the direction in which ordinary electric currents pass, but move off from it in straight lines until they strike the opposite walls of the tube. These streams thus thrown off from the cathode, constitute what are called the cathode rays.

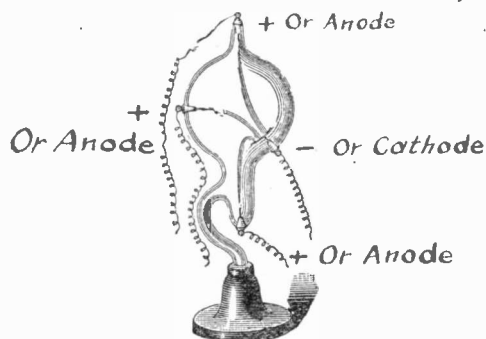

FIG. 78. PATH OF CATHODE RAYS IN LOW VACUUM.

When the vacuum is low, as represented in Fig. 78, the luminous streams pass from the cathode to the three different anodes connected as shown to the three positive terminals. When, how-

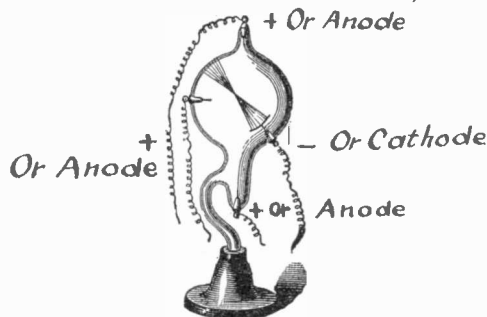

FIG. 79. PATH OF CATHODE RAYS IN HIGH VACUUM.

ever, as shown in Fig. 79, the vacuum is high the discharge from the cathode proceeds directly in straight lines until it strikes the opposite walls of the tube in streams that are entirely independent of the positions of the anodes. Since the cathode rays are thrown off from the surface of a concave mirror, in order to proceed in straight lines they are first collected at a single point or focus from which they pass in straight paths to the wall of the tube as shown.

The cathode rays not only possess exceedingly curious and interesting peculiarities but are capable of throwing considerable light on many phenomena. We will, therefore, carefully study some of their peculiarities.

As early as 1859, Plücker, while passing high pressure electric discharges through the, vacuous atmospheres of glass tubes, observed a greenish phosphorescent light on the inside of the tube in the neighborhood of the cathode. He correctly attributed it to something thrown off from the cathode.

In 1869, Hittorf observed that when a solid or liquid substance was placed between the cathode and the opposite wall of the tube, it cast a well-defined shadow on this wall whether it was an electric conductor or a non-conductor. Since this shadow was surrounded by phosphorescent light, he concluded that something thrown off from the cathode spread uniformly through the tube like rays of light and regarded it as probably a species of wave motion.

In 1876, Goldstein repeated Hittorf's experiment and found that a pointed cathode produced well defined shadows, but when the cathode was large the shadows produced were less sharp. It was Goldstein who first employed the name cathode rays. Like Hittorf he regarded them as peculiar waves in the universal ether.

A careful study by Crookes of electric discharges in high vacua resulted, in 1879, in the production of the radiometer or light mill. In this device a wheel, whose vanes are made of thin sheets of mica covered on one side with silver and on the opposite side with lamp black, supported on an axis so as to move with as little friction as possible, was placed inside a glass tube containing a very high vacuum. When exposed to the light of the sun, or to any artificial light such as that of a candle, or a burning match, the wheel is set into a rapid rotation in a direction away from or against the blackened sides. This is only another way of saying that the particles shot off from both sides of the mica vanes move with a greater velocity from the hotter sides, or the sides covered with lamp black, for those sides absorb the heat, and, therefore, become

hotter than the silvered sides which throw it off.

Crookes obtained higher vacua than any of the physicists who preceded him. He demonstrated that when the vacuum became sufficiently high to cause the black space surrounding the cathode to fill the entire tube, the streamings forming the cathode rays consisted of matter in a new state or condition. He called this matter ultra-gaseous or radiant matter. As is now known, he was actually dealing with a new kind of matter, rather than a new state or a condition of matter, but this was a subsequent discovery.

In this investigation, which as we have seen resulted in the production of the radiometer, Crookes thought that it was the molecules of the residual gaseous atmosphere that were thrown off at right angles from the surface of the cathode.

It was not difficult to explain why a dark space surrounded the cathode, nor why, as the vacuum became higher, the width of this space increased until it finally occupied the entire inside of the tube. As the vacuum became higher, and the number of residual molecules in the tube decreased, the distance any molecule could move without colliding with a neighboring molecule was increased. Since the light in the tube is produced by the collisions of the molecules, the distance any molecule could move outward from the cathode without colliding against other molecules would necessarily increase until, when the vacuum became sufficiently high to permit the molecules to pass through the entire distance between the cathode and the opposite walls, no collisions could occur, and consequently, no light could be produced.

That the particles thrown off from the cathode in a vacuous tube move in straight lines from the cathode was proved by Crookes as follows. A Maltese cross (b), formed of a thin sheet of mica, is placed opposite the cathode of the Crookes tube represented in Fig. 80. When the terminals are so connected that (P) and (N) form respectively the anode and the cathode, the walls of the tube at (c), opposite the cathode, show a dark shadow of the cross, surrounded by a phosphorescent light.

If the cross is so supported that after the shadow has continued for a fairly long time, it can be shaken down, thus exposing all the wall opposite the cathode to the rays, a curious phenomenon is observed. A pattern of the cross is

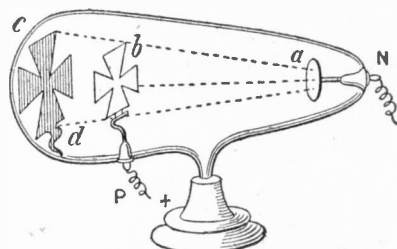

FIG. 80. SHADOW FORM IN CROOKES' TUBE.

still seen on the glass, but now the places formerly occupied by the shadow are brighter instead of darker than the adjacent parts, just as if the portions of the glass walls outside the shadow of the pattern had become fatigued by their long phosphorescence and were therefore less able to respond to the bombardment than the remaining portions. But what is still more curious this tired condition of the glass continued even after the glass of the tube had been fused and re-blown.

The color of the phosphorescent light produced by cathode rays varies with the kind of substance against which the rays strike. In the case of ordinary soda glass, the color is a greenish-yellow; in the case of lead glass the color is blue.

The phosphorescent effects produced by cathode rays are often of exceeding beauty. By employing different substances practically all the colors of the solar spectrum can be obtained. This is especially the case with chemical substances that consist of two different salts simultaneously thrown down from a solution so that the quantity of one is greatly in excess of the other. A marked difference exists both in the intensity and color of the light emitted by a pure salt and a salt that is mixed with a small quantity of another salt. For example, pure sulphate of lime, when exposed to the cathode rays, exhibits a faint orange phosphorescence, but when mixed with a small quantity of sulphate of manganese, fluoresces with a bright green light. Pure sulphate of strontium does not phosphoresce at all, but the

presence of a small quantity of sulphate of manganese causes it to emit a bright red light. Pure zinc sulphate produces a white phosphorescence, but the presence of one per cent of sulphate of manganese produces an intense red. Sulphate of sodium fluoresces with a bluish light while the presence of one-half per cent of sulphate of manganese changes the color of the fluorescence to an intense brownish-yellow.

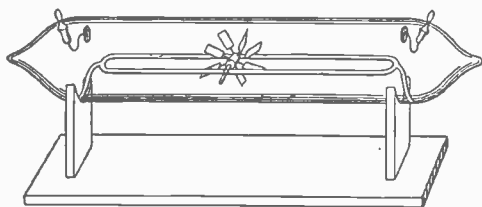

FIG. 81. MECHANICAL EFFECT PRODUCED BY CATHODE RAYS.

When exposed to the cathode rays certain bodies acquire the property of becoming luminous when their temperature is raised to a point far below that at which they ordinarily become luminous. This property is called thermoluminescence. Such bodies retain their property for weeks, and even for months after the cathode rays have fallen on them.

That the cathode rays are able to produce mechanical effects can be shown by a wheel, the vanes of which are made

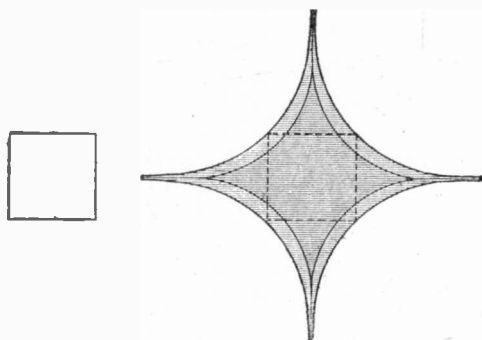

FIG. 82. CATHODE RAY PATTERNS AT HIGH AND LOW EXHAUSTION.

of sheets of thin mica, when placed as shown in Fig. 81, on glass rails, opposite electrodes at the top of a Crookes' tube. On the passage of an electric discharge the cathode rays strike the upper vanes and drive the wheel from the negative to the positive end of the tube.

When it has reached this end a reversal of the polarity causes it to be driven in the opposite direction.

As has already been mentioned, the cathode rays are able to raise refractory bodies like platinum to intense incandescence, when permitted to strike against them. As would be expected, since the streams that form the cathode rays carry minute charges of negative electricity, and therefore act as movable conductors, adjacent cathode streams repel one another. This has been demonstrated by Goldstein in various ways, one of the simplest of which is to produce phosphorescent patterns by employing differently shaped cathodes, and noting the shapes of the phosphorescent figures produced on the walls of the tube that receive the bombardment from their particles. By employing differently shaped cathodes, cut from portions of the surface of a sphere, Goldstein found that when the vacuum was high the particles were thrown off from the surface of the cathode at right angles, so that the phosphorescent patterns had the same size and shape as the cathode except that they were inverted. When, however, the

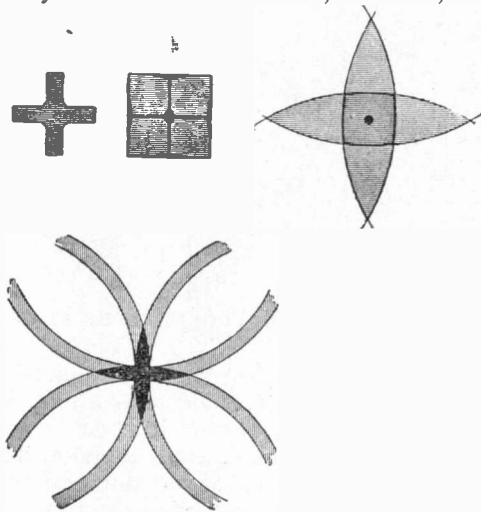

FIG. 83. PATTERNS PRODUCED BY CURVED CATHODE.

pressures were low, this was not even approximately the case.

When, for example, as in Fig. 82, the boundary of the curved cathode was a square, at high exhaustions the phosphorescent pattern is the same size and shape as indicated by the dotted lines.

At low pressures, however, the patterns as shown are entirely different.

When the cathode is a curved, rectangular cross, as shown in Fig. 83, the patterns formed as the pressure is gradually decreased exhibit the changes of shape indicated.

When the cathode has the shape of a plane, rectangular cross, as shown in Fig. 84, then the shapes assumed by the phosphorescent patterns are as shown in the figure.

The cathode rays possess the power of discharging bodies that are either negatively or positively electrified, when suitably insulated and surrounded by dry air or other non-conducting gas. As we shall shortly see this property is also possessed by the X-rays or Röntgen rays, as well as by the rays thrown off from radio-active substances.

J. J. Thomson in his "Discharge of Electricity Through Gases," writes as follows concerning the cathode rays:

"Let us trace the consequence of supposing that the atoms of the elements are aggregations of very small particles, all similar to each other. We shall call

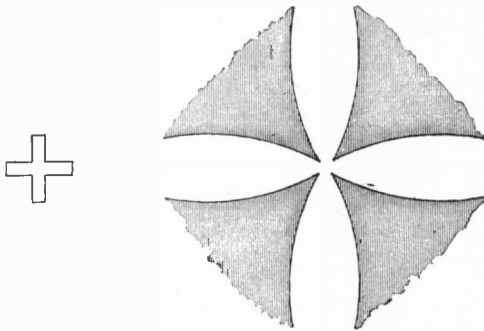

FIG. 84. PATTERNS PRODUCED BY PLANE CATHODE.

these small particles corpuscles, so that the atoms of ordinary elements are made up of corpuscles and holes, the holes being predominant. Let us suppose that at the cathode some of the atoms of the gas get split up into these corpuscles, and that these, moving at high velocities and charged with negative electricity, form the cathode rays. The distance these rays would travel before losing a given fraction of their momentum would be proportional to the mean free path of the corpuscles. Now the things these small corpuscles strike against are other corpuscles and not the molecule consid-

ered as a whole; they are supposed to be able to thread their way through the interstices in the molecule."

As will be described in the next chapter, the cathode rays led to the discovery of the X-rays. Before this was done, however, an intermediate step was taken by Lenard. This consisted in providing that portion of the Crookes' tube against which the cathode rays were projected with a thin sheet of aluminum of a

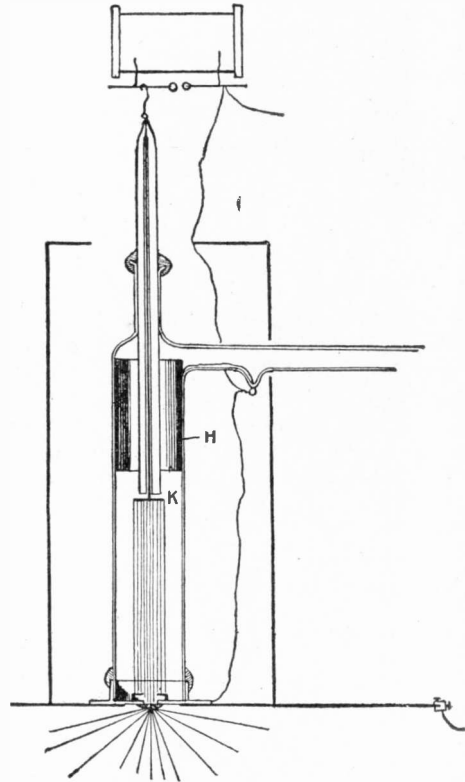

FIG. 85. LEONARD'S APPARATUS.

thickness of but .00265 mm., placed on that part of the walls of the tube that received the bombardment as shown in Fig. 85. When the vacuum in such a tube was so high that the dark space around the cathode occupied the entire tube a diffused light was seen in a dark room spreading from the window into the air outside the tube. This light was brightest in the immediate neighborhood of the window, and possessed like the cathode rays powers of producing phosphorescence, and was known as the Lenard rays.

(To be continued.)

ELECTRIC RAILWAYS OF MANILA.

To those who have not visited far-away Manila, in the Philippines, the name is likely to bring up a mind-picture of a city built in the past, though living in the present—a city in which

an up-to-date street car service, and wherever electricity is called to the service of the public, there also will be found enterprise and Twentieth Century ideals of living.

Manila's electric railway system is

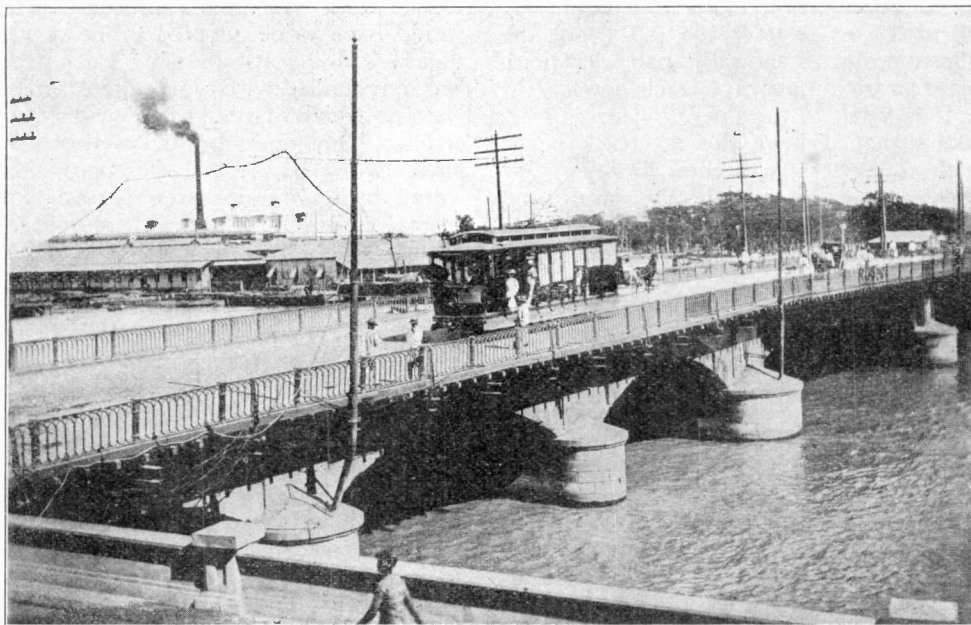

ELECTRIC RAILWAY ON "THE BRIDGE OF SPAIN".

modern conveniences are lacking. Such is not the case, however, for Manila is a city with electric lights, telephones and

adequate for its needs. It had its beginning, of course, with horse cars, but now the electric trolley has superseded antiquated methods. One of the views shows a street scene in what might be called the "congested" part of the city. It shows the Escolta—Manila's Broadway. The line is double-tracked, the cars are commodious and even the motorman is a model of the spic-and-span type and would be a credit to the service in any of our own cities.

The second view shows a trolley car on the Bridge of Spain, which, by the way, was the only bridge found by our soldiers upon the capitulation of Manila.

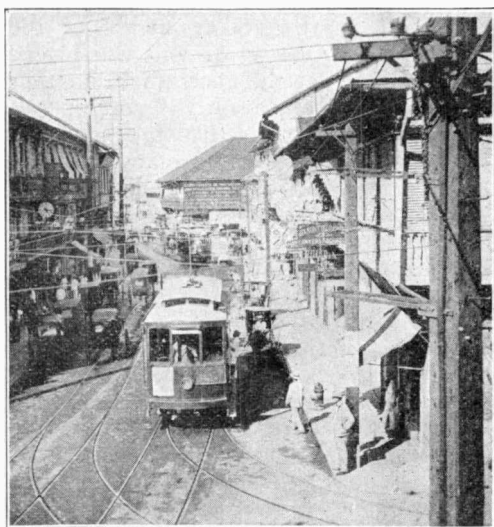

THE ESCOLTA—MANILA'S BROADWAY.

One of the most novel uses for the electric motor is reported from Nevada, Iowa. A man who is extensively engaged in the poultry business has rigged up a revolving brush driven by a small electric motor for washing the feet of newly killed fowls before shipment.

ELECTRICITY AND THE POOLROOMS.

BY A. A. WEISS.

In this description of a phase of metropolitan life of which little is known, although its ramifications permeate all classes of society, it is not my intention to consider the morals of the question, but to show the part electricity plays in obtaining race track news.

It is vital, to the operation of a poolroom, that it have the racetrack news, such as starters, scratches, jockeys, winners, etc., at practically the same time the track bettor has it. Some years ago this end was accomplished by having a man stationed at the track, who telegraphed this news to New York headquarters, where it was redistributed all over the country. But owing to pressure being brought to bear, by conflicting interests, the racetrack management divorced itself from all poolroom connections. The telegraph company refused to allow the matter to pass over its wires and the telephone company wires, then used, were tampered with to such an extent, that something had to be done to save the business from ruin.

I was wire chief of the Coney Island telephone office, at the time, and had previously met these people in routine business transactions. They came to me in their extremity and an arrangement was effected by which I was to help them out. The Pinkerton detectives, engaged by the track people, were now active in preventing this news from reaching New York, although there were no difficulties in sending it out from the city.

The first plan of the telephone company to stop the transmission of news from the track was simply to put the line from that place out of commission, in the central office, during the racing hours. This was easily avoided by connecting the outside line to another number in the office. In this way they were using their own line, but it appeared in the office as another wire. Arrangements had been made with another subscriber to use his number for this purpose. So it was really his line that was put out of commission. This worked well for a few days, but the Pinkerton agents in New York found the news

coming in as usual. They then adopted different tactics. They cut the outside lines.

We now saw that different tactics would have to be adopted. The opposition was doing its utmost. Each track was surrounded with high canvas screens and the whole district patrolled by Pinkertons. Our operators were then supplied with powerful telescopes, that would bring six or seven persons into focus, life size, at a mile. "Long Tom," one of the telescopes, was about nine feet long. Rooms were rented where a view could be had of the grandstand, and the screens then offered no difficulties whatever. The transmission line now had to be looked to. The rooms were always engaged where telephone service was available in or near the house. We then used a set of "retardation" coils, which are nothing more than an iron core about $\frac{1}{4}$ by $3\frac{1}{2}$ inches, rubber heads at each end, and wound with No. 36 wire to about 500 ohms resistance. These were connected as in Fig. 1. The coils will allow a current of slow fluctuation, such as a telegraph current to pass, but are a closed faucet to a high-frequency current such as a telephone talking current. This apparatus enabled us to telegraph over a telephone line, even though it were in use, without the conversing parties being aware of the telegraphing. One set of coils was placed in the house, at the race track, another in the central office, on the corresponding line. A tap was then taken off between the coils in the office and connected to a dead wire, in a cable running from Coney Island to Flatbush (a section of Brooklyn), where it was run into a house having a Flatbush telephone. This was far enough away to bar suspicion.

The operation was simple, the man in Flatbush, overlooking the races, would call New York on his telephone, then place the mouthpiece over the telegraph sounder; the Coney Island man would then telegraph over the line through the cable. The Flatbush man would have the telephone receiver to his ear. If he was advised that New York was not getting it all he would break in on Coney

Island and have him repeat. This worked like a charm for over a year. The Pinkertons would often talk over the very telephone line our operator was sending his Morse on.

In one case the "scope" man was located in a house where there were no telephone facilities. We ran a wire under sod for a short distance, then connected it to a fence, made of chicken wire. This fence abutted against a house where a telephone was located. The fence was then connected between the

tery office equipment now in general use, as at that time, but not in these particular offices.

It was now a simple matter to place the coils on the Bath Beach line and on the Coney Island line and connect the telegraph again. The Coney Island man would then call Bath Beach and engage him in ordinary conversation while the Morse operator would at the same time send the real news over the same wire by telegraph.

At one time we had to modify this

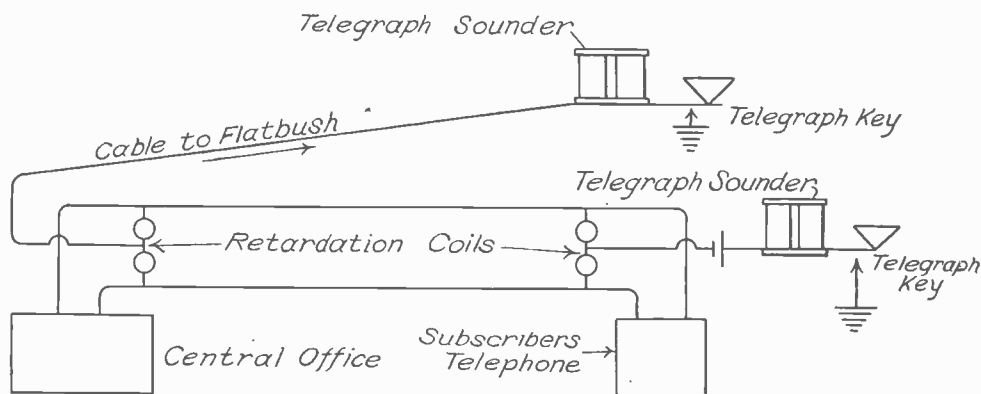

FIG. 1. ARRANGEMENT FOR SIGNALING THROUGH FLATBUSH CABLE.

coils, the outside coil running to terminals to the telephone line, and we had a very successful Morse line in operation. At times the Pinkertons would have from sixty to a hundred lines out of service in a vain endeavor to catch the proper one. They did this by short-circuiting each line. This of course put the telephone lines out of commission, but the Morse line was not affected. Had they grounded the wires properly we also would have been at sea.

The line, however, was eventually discovered, and then we hit upon a new scheme. Instead of using the dead cable line, to Flatbush we let the exchange operator "put up" the connection herself. We engaged a room at Bath Beach, about three miles from Coney Island. There was a telephone office located at Bath Beach which had direct trunk connection with Coney Island, and as both offices were at that time of the magneto type, the trunk, when in operation, was simply a link between the two telephones without any apparatus whatever, differing in this respect from the common bat-

plan, as the proprietor of the house we had in Coney Island would not let us use his telephone for calls, so we hired another one whose line run on the same poles as the original line, and connected the two lines through a condenser placed on a pole, which enabled us to talk between the two houses without calling central. The connection was then completed to Bath Beach as before.

These conditions had existed for two years and the Pinkertons of course had not been idle. The last success we had was at the Sheepshead Bay track. We had arranged for a private wire running through Sheepshead Bay to New York. This was a grounded telephone line and was constantly under suspicion. We connected to it, through induction coils, apparatus which sent out weak impulses similar to wireless signals, which would not excite suspicion, owing to all lines in the vicinity being at all times more or less subject to such interference from the Marconi and DeForest stations, located at Coney Island.

We accomplished these results by

much forethought and close attention to details. Considerable experimenting had been done with wireless apparatus and we purposed giving it a trial. A large apparatus had been installed, engine, dynamo, and complete sending and receiving set. We strung an antenna in the garret and set up our transformer, sending helix, condensers and key, together with a small tuned detector. In

had chances for so-called inside information, but I never knew them to bet.

DIRECTIONS FOR REVIVING DRY CELLS.

The ordinary dry cell battery is not "dry" in the strict sense of the word for there is moisture in it although of course, the cell is tightly sealed up and there is no inconvenience from stopping

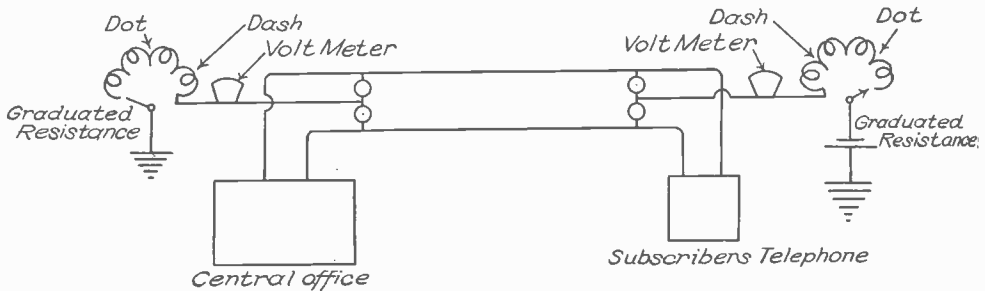

FIG. 2. PROPOSED VOLTMETER SIGNALING APPARATUS.

testing out, the engine, which was an old French automobile affair, made such a noise and smoked so much that the attention of our friends, the Pinkertons, was attracted. That settled the wireless. The apparatus was confiscated on a trumped up charge together with the telescopes. It was later released, but not in time for further use.

Various other methods were considered to outwit our opponents in their little game of "find the operator." I remember one I proposed as shown in Fig. 2, which I think would have been more successful than the telegraph for the purpose and conditions. It consisted of a voltmeter whose needle was swung to 10 volts for a dot and 20 for a dash through a gradual step-down resistance. This if properly designed would not affect a telephone receiver as the current was negligible.

My connection with this business now ceased. It was for me a most interesting battle of wits while it lasted. I am no more in touch with the situation, but if there is any possible way of getting the news through, it is very probably being done on similar lines. The amount paid for this service by the various poolrooms of the country must be enormous, and of course the bettor pays for it all. The people I was associated with knew the game, were acquainted with jockeys and

liquids. But the cells are never so tightly sealed that the moisture cannot slowly evaporate, and for this reason the cells will eventually become useless if kept for a long time, even if they are not used. They may be revived to a certain extent by the addition of various solutions, though they can never be made as good as "fresh" cells. One way of doing this is suggested by a reader of Popular Electricity and is as follows:

By means of a machine drill make about 15 holes in the circumference of the zinc shell of the battery. These holes should go clear through, or about one inch. The diameter of the hole should not be more than 1/8 or 3/16 inch. In an earthenware tank dissolve one pound of chloride of zinc in three pounds of water or equal proportions. Bring this solution to boiling. Place the batteries in this solution and leave them in it for about 30 minutes. When the batteries are taken out and dried they will be ready for use.

Two electric interurban sleeping cars have been operated for 18 months by the Illinois Traction Company with such success that more cars have been added. The cars are without motors or air pumps and are run as trailers to ordinary interurban electrics.

LARGEST TRANSFORMER EVER BUILT.

The accompanying picture shows the largest transformer ever built. It is about 20 feet in height and weighs com-

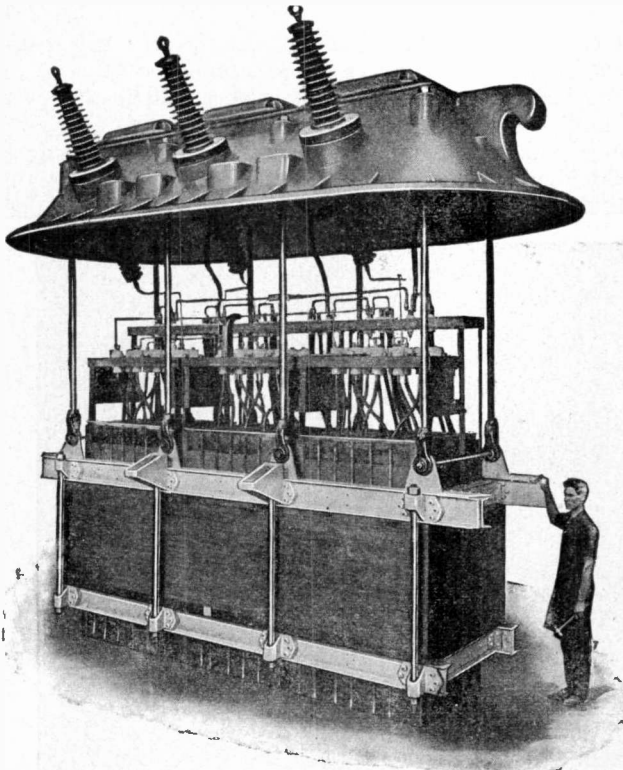

LARGEST TRANSFORMER EVER BUILT.

plete, with the outer casing in place, 120,000 pounds. This weight does not include the water which is kept circulating in the casing to cool the interior parts.

Some will no doubt ask what such a transformer is for. The question may be answered by saying that a transformer is necessary in order to boost or step the voltage (pressure) of the electric current generated by the dynamos up to a value sufficient to force the current through a long transmission line, perhaps one or two hundred miles, to the locality in which it is to be utilized. Copper or aluminum wire being expensive, as small a size as possible must be used in the transmission line. The smaller the wire the greater the resistance to the flow of current, consequently the transformer is employed to furnish sufficient voltage to overcome this resistance.

A transformer is a comparatively sim-

ple piece of apparatus, with no moving parts. When two coils of wire are placed one over the other and alternating current is passed through one of them, an

alternating current is set up in the other, although the two coils are entirely separated and insulated from each other. This is caused by an electrical phenomenon known as induction. This effect is increased if a mass of iron be placed within the coils. If the primary coil, or the coil receiving current from the source, has, say 100 turns, and the secondary coil has 1 000 turns, the voltage delivered by the secondary will be 10 times as high as that impressed upon the primary, although the current, measured in amperes, will be only one-tenth that delivered to the primary.

The above, in brief, is the principle of the step-up transformer. The one shown in the picture takes current from the dynamos at 11,000 volts and transforms it to current at 100,000 volts. Ten thousand kilowatts or 13,400 horse-power of electrical energy pass through its coils when it is operated at full load. Considerable heat is generated in the coils which are kept cool by water in the casing. Approximately 10 miles of wire is used in the secondary winding.

Man has much greater power of electrical resistance, or much less susceptibility, than many other animals. A leech placed upon a copper plate which rests upon a larger plate of zinc is unable to crawl off on account of the feeble electric action excited by the contact of the metals. Horses are troubled by slight differences of potential. An ox treated for rheumatism with electricity succumbed to a current absolutely inoffensive to man.

PROTECTION FROM LIGHTNING.

BY ALBERT WALTON.

Since good old Ben Franklin astonished scientists and the world in general by identifying lightning with electricity the world has seen and heard many thunder storms and suffered much from lightning, and yet we have added but little to the bare facts that Franklin brought out by the famous "Philadelphia Experiments." It is a very difficult sub-

Following out these trains of reasoning it has been possible to form theories that seem to be very satisfactory and truly to explain a large number of the strange things lightning does and in a measure to define what it probably is.

Up to very recent times lightning has been a matter of wonder and dread only. Since before history was written light-

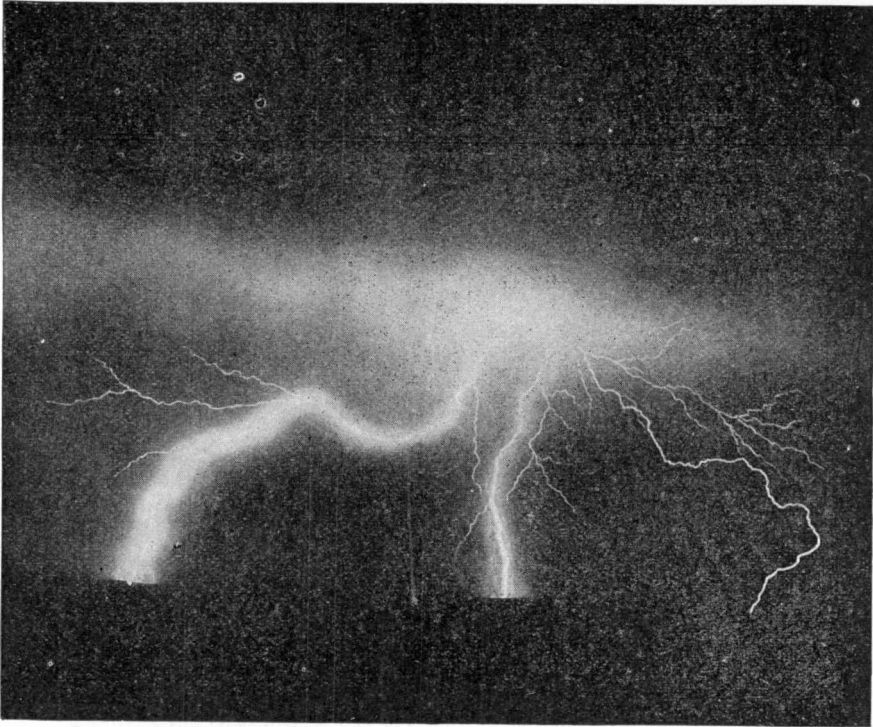

THE BEST MADE LIGHTNING ARRESTERS ARE NOT PROOF AGAINST A DIRECT DISCHARGE.

ject for study at best. It will not submit to be measured and gauged, nor will it be controlled or regulated. Its very violence makes it all but impossible to get at its exact nature. The best that can be done is to observe the effects of its dread work and then reason back from these to the probable causes.

Scientific observation of the results of the workings of electricity of the milder sort, the electricity of commerce and the laboratory, has accumulated a great fund of facts and laws which have a strong relation to the problem of explaining the operations of the awful "shafts of Jove."

ning has been held in awe and reverence predominated by a fear unspeakable. It has held the place of an instrument of the gods to punish and to warn mankind. The modern engineer, however, is a man of practical mind and, devoting his mind to practical things, is concerned with lightning chiefly with a view to preventing, if possible, its destruction of life and of the works of man. Until recent years this has meant the protection of buildings of various sorts, and Franklin, himself, was one of those who early pointed out that, though it was not possible to prevent the lightning discharge,

it was very possible to so guide its path to the earth that it would do no damage in its passage.

To this end lightning rods have been employed with good effect for many years. They form an attractive and easy path from the highly charged atmosphere to the earth and the lightning passes down them where otherwise it would expend its force through a path of bricks or timber, down chimneys or through roofs and walls, tearing and burning on its way. Often the discharge is so great that even the heavy lightning rods themselves have been burned in two from the heat.

One often hears people wondering why the great sky scrapers of our big cities are not frequently struck by lightning. Many people have a great fear of being caught in one of these huge steel buildings in a thunder-storm. As a matter of fact they are the very safest places one could wish for, as the whole building is one immense lightning-rod capable of carrying off the worst shock without the slightest damage. They are probably struck frequently in every heavy storm that sweeps over the city where they are and no one is the wiser. The principle of diverting the lightning through a path which will lead it to earth without damage is here brought into play without any extra precautions or visible devices, and as it is an invisible protection it is one that few people realize exists.

This principle, indeed, is at the bottom of all the vast number of ingenious devices that have been invented to protect the immensely more valuable property of the present day. Greater importance has become attached to lightning protection today, not only because the buildings are larger and more expensive, but mainly because of the extensive development of the practical use of electricity itself. It is not strange that the apparatus that is designed to make and to carry electricity for commercial purposes should be very sensitive to the effects of lightning. The network of wires that cover the land from end to end has, by its very omnipresence, been a source of continual and enormous losses from strokes of lightning.

Such is the nature of one of these fearful electric discharges that it is not even necessary that the wire itself be struck to produce damage. If a tree, or a house, or even the earth itself be struck in the vicinity of a wire a tremendous disturbance is caused in the wires which is almost as violent in effect as though the wire had received the full force of the stroke. The difficulty would not be so great were it only for the destruction of the wires, but it must be remembered that each wire leads to some electrical machine or other, and usually these are extremely expensive. The tremendous force of the lightning's effect in the wire finds an outlet in these machines, unless they are properly pro-

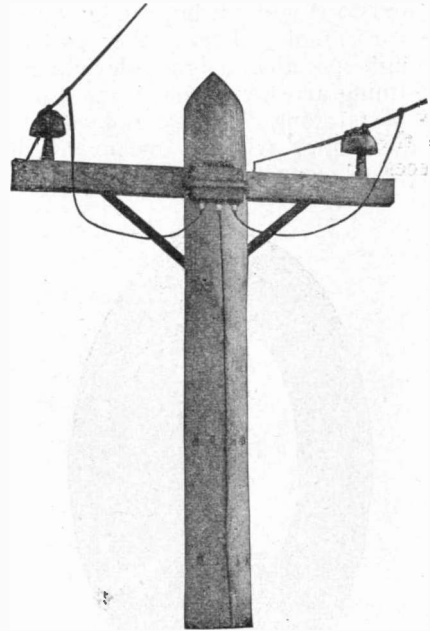

THE LITTLE IRON BOX IS THE LIGHTNING ARRESTER.

tected, with the result that they are often totally destroyed, with an enormous loss in money and a great danger to the lives of those working around them.

In order to minimize these losses and to prevent the disastrous interruptions to the service of telegraph, telephone, street car and lighting companies, great ingenuity has been shown in the development of devices to divert the force of the discharge into the earth instead of through the electrical machines.

Many a panic has been caused in our

city street cars by the flash of a slight lightning stroke that has come along the trolley wire and followed down the trolley pole to the motors and through them to the rails. It is always a needless panic, however, for the passengers on the seats are as safe as the people in a house well protected by lightning rods, for the trolley pole and the wires of the car form a very effective lightning rod in themselves, conducting the lightning from wire to ground without danger to those inside the car. Such a discharge, though not dangerous to the passengers, is expensive to the company, since it damages the machinery in the car and makes expensive repairs necessary. To render these strokes harmless other ways are provided for the lightning to get to the ground so it will not have to go through the cars at all. These other paths are through specially designed devices called "lightning arresters," which are hung on the posts along the way and connected to the trolley wire by means of short pieces of copper wire. You may see

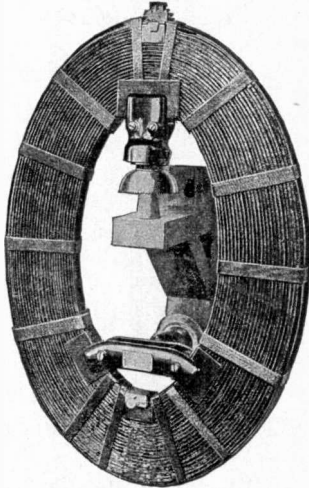

THE "CHOKER" COIL.

these little iron boxes if you look sharply. They will be seen on perhaps every hundredth pole from which the trolley wire is suspended. They are up near the top of the pole. A wire runs from one side of them out to the trolley wire and another wire runs from the other side down the pole to the ground. They are usually little round iron boxes somewhat bigger than a common alarm

clock, though sometimes they are square and are about the size of a pound candy box. When the lightning hits the wire or comes near it most of the force of the bolt jumps through these little boxes and goes down the wire to the ground without doing any damage. Or if the stroke

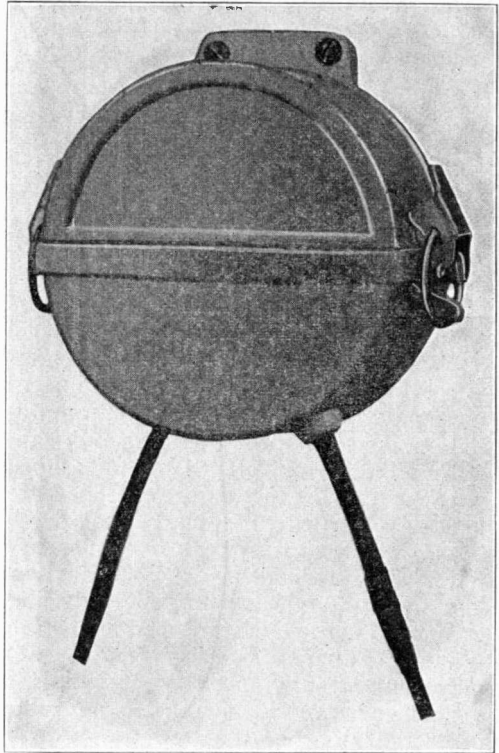

ROUND TYPE OF LIGHTNING ARRESTER.

is so severe as to injure them they are so much less expensive than the motors of a car that the company has saved money by letting them take the force of the stroke.

Long ago it was realized that lightning had an aversion to turning a corner or to deviating from a straight path, and this peculiarity has been taken advantage of in practically all of the inventions for protective purposes. It acts as though it were traveling with such tremendous force and rapidity that when it comes to a curve or bend in its course it prefers to leave that path and strike out straight through the air till it reaches some more easy and direct path to the earth. On the other hand, fortunately,

the ordinary "working" electricity does not object to following a course of many bends and kinks, and for this reason it is possible to make use of the peculiar tendency of lightning to follow the straightest path, for the protection of electrical apparatus.

It has become the custom to place on the wall of an electric station a combination of devices for this purpose. The wire entering the station from the outside, where it is exposed to lightning, is brought to what is called a "choke coil." This is a copper ribbon wound up as a spiral. The electricity from the dynamos that has come in over the wires or is to pass out over them has also to pass around all those turns of the coil. These coils, in fact, form a part of the system of wiring from the machines to the outside lines of wiring, and the dynamo currents passing along this system find little or no resistance in going through the coils. When, however, a lightning disturbance comes in over the wires the coils offer such an obstruction to the discharge that it will find another path rather than go through them, even though it must go through several feet of air space to jump to some easier path. This, however, it is not permitted to do, for a wire is joined to the outside wires at a point just before they reach the choke coils and this wire runs in a straight line to a "lightning arrester," which consists generally of a series of little brass knobs mounted on a piece of marble. The knobs are separated so there is a slight space between them, although the general line of the posts is straight to the ground. From the last knob another wire is run down into the earth. The usual electric current in the main wires can run down the wire that leads from them to the knobs, but cannot get across the air gaps, so none is lost. A stroke of lightning, however, comes in over these same wires, finds the choke coil in its path, and, with its irresistible power, finds no difficulty in instantly jumping from knob to knob and from the last one to the earth through the wire provided for that purpose. Thus all the machinery beyond the choke coil is saved the blow and the force of the discharge is led to earth without the slightest damage. And furthermore, the

device is instantly ready for another one should it chance to "strike twice in the same place" which, by the way, it does very often, the adage to the contrary notwithstanding.

It is very exciting to be in a power station whose wires cover a country for miles around while a lightning storm is in progress. Knobs are constantly joined by little angry snapping sparks, for there is always some part of the network outside of the station that is at least a little affected by the flashes that are playing over the country round about. It is very fascinating to watch, for one realizes that it represents a tremendous force that has travelled miles to find a way to escape. And while one is watching these little crackling sparks there comes the real stroke, and for an instant one would think that the knobs and the marble and the wall on which they were hung had all been destroyed together. A sharp report and a flash, that is dazzling for the instant, occurs and blots out the power of sight for a space, and then after the first second's astonishment one realizes that somewhere out on the line a real stroke has come to earth near the wire and that this is its effect for which he has been watching. It is worth waiting for, but like many such things, once is usually sufficient to satisfy the curiosity especially when the observer is told that during the last storm the line itself was struck and the whole device was destroyed in endeavoring to relieve the line and save the machines, for no "lightning arrester" has as yet been invented that will stand the direct stroke, which, however, is fortunately a comparatively rare occurrence.

NON-MAGNETIC YACHT.

A non-magnetic yacht will be built for the Carnegie Institute for making magnetic surveys over certain parts of the ocean where the earth's magnetic data have not yet been accurately determined. The only metal used, outside of the crank shaft, will be bronze and manganese alloy, so that there will be no iron to disturb the action of the delicate magnetic instruments.

RAILROAD ACCIDENTS AND THEIR PREVENTION.

BY LOUIS E. WALKINS.

Whenever a passenger train is wrecked and a number killed and many injured, as the result of a misplaced switch, a head-on, or rear-end collision, failure of an engineer to see a signal as he rushes towards it, or failure of a tower signal operator or station agent to set the proper signal for the engineer, there is at once a great hue and cry by the public and the press against the officials of the railroad company because of the apparent inefficiency of the signal and train control system employed by the railroad, or the apparent criminal carelessness of the employes held responsible for the accident. Then comes the shifting of the apparent error by these employes, one upon the other: "I saw no signal for me to stop," says the engineer; "I set the signal to danger," says the tower operator, or station agent.

To satisfy the constant clamor of the traveling public for the running of trains on schedule time, and for more rapid transit, the officials of our railroads have no easy problem on their hands to keep the service of the passenger traffic on time and run the trains with safety. They must rely upon the fidelity and judgment of those in charge of the trains, the safety appliances, and the telegraph. Those that hold these highly responsible positions of trust should be schooled to the positions they are to hold, and only the best of their class selected to fill the positions of trust. They should have sufficient salary so that they will value their positions so well they will render their best efforts in order to retain them.

But sometimes the best human mind will err in all vocations of life. Consequently human ingenuity and skill have ever been directed with marvelous results to produce apparatus or devices, not only to remind men of their duty, or error, but, should they fail, to register the error, thus fixing the responsibility. And for many important purposes these devices automatically of themselves may perform the duty and prevent what might have happened.

There is a long gruesome list of railroad wrecks that have resulted through the sleeping telegraph operator in a way

station or signal tower. Why should not an operator, no matter where he is located on a line of railroad, have, above all men of responsibility, a detector registering more often than any other his service to duty? The ordinary business man employing a watchman to watch over his premises during the hours of night has such a device to keep that watchman attentive to his duty looking after possible thieves or for fire, on his premises.

To my mind the whole trouble with the railroad signal and train control situation in our country is that there are too many signals; too much complicated apparatus used and intricate working details; too much dependence upon poorly paid human responsibility in its control. There should be but one standard of railroad signal and train control; a system uniform throughout the railroad systems of the country. It should be a simple system thoroughly tested and then its adoption should be compelled by the Government. It should be regularly inspected and kept in thorough repair under the supervision of government inspectors. A matter of first cost should not be considered in a matter of so vital interest to all our people.

A locomotive traveling at a high rate of speed, say 45 miles an hour, passes a stretch of track of 1,000 feet in but a few seconds of time. The engineer may be approaching a way signal at this particular time. A current of air suddenly created through a suction current may drive a volume of smoke or steam to his side of the locomotive, obscuring from his vision the signal toward which he is rushing, and he passes without seeing it. It will be said that it is his duty to stop his train as quickly as possible, call for a brakeman to be sent back as per the rules of his company to provide a means of warning any following passenger or other train to stop, so he may back with safety to a point to see the signal. This he does we will say and finds it at safety. Then he recalls the brakeman sent back, waits for him, and then goes ahead again. All this takes time. And there is a delay, and a situation to be explained,

and there is only the word of the engineer.

Visible railroad signals should be of only one class. Danger signals; one color by day, and the same by night. They should be of such size and distinctive color as easily to be discernible over the whole stretch of the railway within the signal giving zone. Such a signal should have as an auxiliary apparatus means of

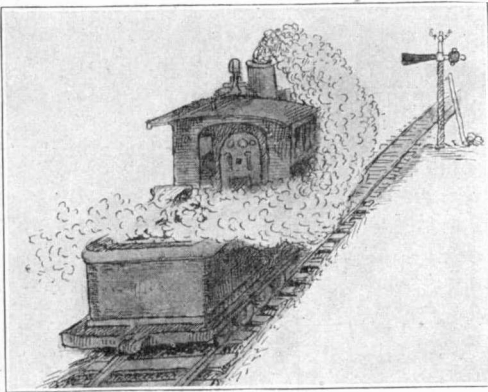

PERHAPS THIS HAPPENS WHEN PASSING A SIGNAL.

giving a loud audible alarm upon the locomotive, or to operate a locomotive engine stop when the signal is at danger. And right here the manager of a railroad will tell you, and with great truth, no apparatus of such character has as yet been produced for that purpose which is reliable in its operation.

No system of audible locomotive signal, or engine stop, can be operated with success except under the most favorable conditions; unless the service way conductor is always in connection with the locomotive so as to give, in sufficient block lengths of the rapidly moving locomotive, the electric power time to perform its highly important functions.

There is another problem where steam railroads are operated in conjunction with electric traction on the same right of way. At a discussion early last year at an Institute meeting in New York City the following statement was made by a member and agreed upon by the members present, while considering the installation of the under-running protected third-rail as in use on the West Shore and New York Central railroads, as follows: "The signal field also, is one in

which there is room for improvement in reducing the cost of installation so as to make the use of electricity feasible from a financial standpoint. The use of electricity at the present day requires the throwing away of old type signal and interlocking systems, and the installation of an entirely new system at a vast cost, due to the necessity of using the track rails for the return current. On one of the branches of the New York Central railroad the substitution of electricity for steam has been indefinitely postponed, because of the attendant great cost of making a change in the block signals and interlocking, but one of the electrical companies now gives hope that a new method has been devised which will do away with the necessity for more expensive portions of the apparatus, and so far reduce the cost of the change of signaling as to make feasible the electrification of the branch line."

The safe operation of railroad trains was a problem of years after the advent of this means of transportation, and the problem has not by any means been fully solved as yet. The first great advance was the achievement of Mr. George Westinghouse—the invention of the air brake. The foundation of this great invention was the placing in direct connection with the locomotive boiler an automatically operated air pump equipment. The power that drew the train operated the air pump that furnished the air power to stop the train when it was necessary. Then came the vacuum, produced in the same way. The reliable block signal and train control system of the future must have its prime operative from the same source.

The power that moves the steam train, unlike the electric traction system which latter derives its power from conductors located upon the way, is from a steam prime mover which generates its energy while standing or moving. Therefore, for steam traction, the signal and train control must derive its power to perform its functions in the most simple and reliable way, from the locomotive boiler through an auxiliary equipment such as an electric power generating unit, similar to the Westinghouse air brake pump.

To such a system I have given much thought. As a result I suggest the fol-

lowing system, whose foundation is based on standard apparatus and equipment in combination.

Time and constant use, with the improvements up to date have proven the reliability of the over-head trolley conductor. For the purpose I am about to describe, I have selected what is called the loop trolley as so extensively used in Europe on all electric high speed rail-

ground this three or five mile section of over-head wire to stop any locomotive entering or running in that block.

Instead of the over-head trolley, the inverted, or under-running third-rail of a much lighter construction than that so extensively in use for electric traction purposes could be used.

To perfect the present situation (the use of the present block signaling and

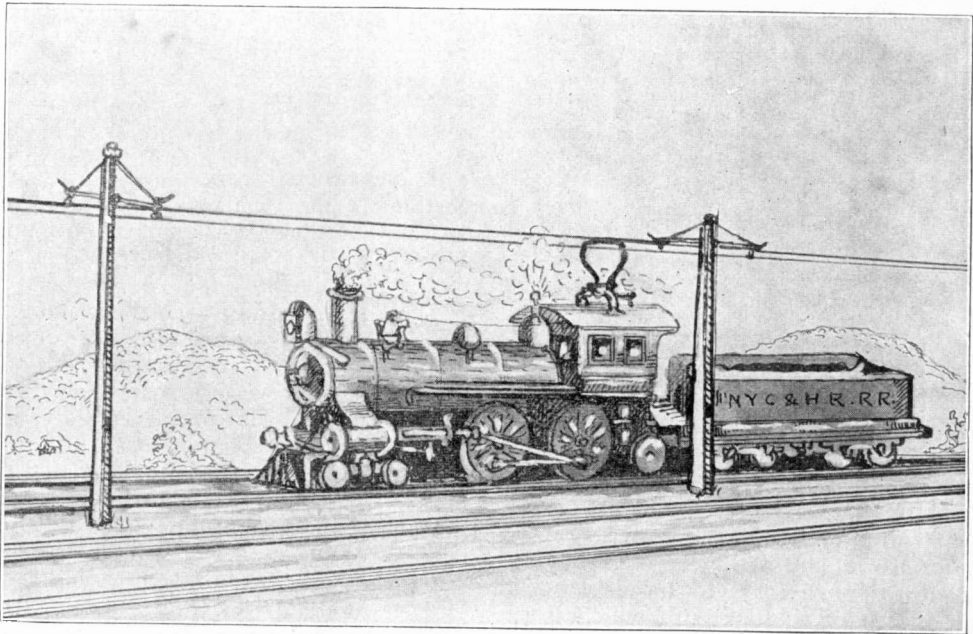

PROPOSED TROLLEY SIGNAL-OPERATING SYSTEM.

ways. I propose that all steam locomotives on the line of railroad be equipped with one of these trolleys on top of the cab, and in connection with it and a ground that there be an automatically operated electric power generating unit, taking up no more room upon the locomotive than the air pump for the air brakes. An over-head conductor should be installed, sectioned off by insulated joints every three to five miles. Two locomotives within each block, the two power generating units combining, would thus complete a powerful electric circuit sufficient to operate any valve of standard make, and of a size sufficient to blow a very loud whistle upon each locomotive, and operate a locomotive engine stop. A tower switch operating lever has only to

train-control systems), I would recommend the use of a sealed automatic time registering device for the purpose of keeping an exact record of the movement of any visible railroad signal, the minute and second of each hour of the whole day, showing when the signal went to "danger" and the time it was in such a position. There should also be a duty register for every telegraph and signal operator, requiring them to register once so often each hour of the whole day. This would lay the blame, should an accident occur, where it belongs.

The first alarm of fire by an electric telegraph system was given at 8:30 p. m., April 29, 1852, in Boston.

A HANDY MAGNET.

Did you ever try to remove chips and borings from the almost inaccessible nooks in a machine tool or to fish a bolt or boring tool out of the bed of a lathe without leaving part of your knuckles behind? If you ever did you will appreciate the handy magnet. In shops where

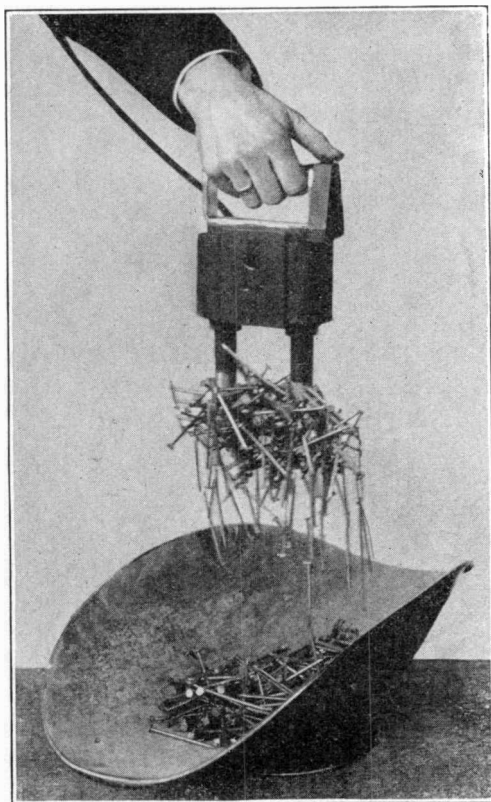

HANDLING NAILS WITH A MAGNET.

brass and iron filings accumulate it is necessary to separate the two metals before selling or melting them. Here again the handy magnet is especially useful, for it will attract only the iron or steel, making separation easy by simply passing the magnet through the mixed metals.

The new device is a hand magnet weighing only about seven pounds, but capable of lifting castings of from 10 to 15 times its own weight. It is designed for operation on 110-volt, direct current circuits and is furnished with drop cord and attachment plug so that it may be readily attached to any ordinary lamp

socket. The push button mounted on top of the magnet and operated by the thumb closes the circuit to the coils and makes the magnet operative. On releasing the button the poles become demagnetized and the load is released.

In foundries the magnet may be used to pick up hot or awkwardly shaped castings; smooth plates, which are sometimes difficult to secure a hold on when laying on a flat surface.

Suspended with its two poles immersed in the liquid, the magnet will attract to itself any particles of iron or steel, which it may be desired to remove from the tubs in which paints, glazes, chemicals, etc., are mixed.

One user who has several automobile trucks in his business, put the magnet to a novel use. He was paving an alley in the rear of his store with ashes and finding that many nails from packing boxes, burned under the boilers, were

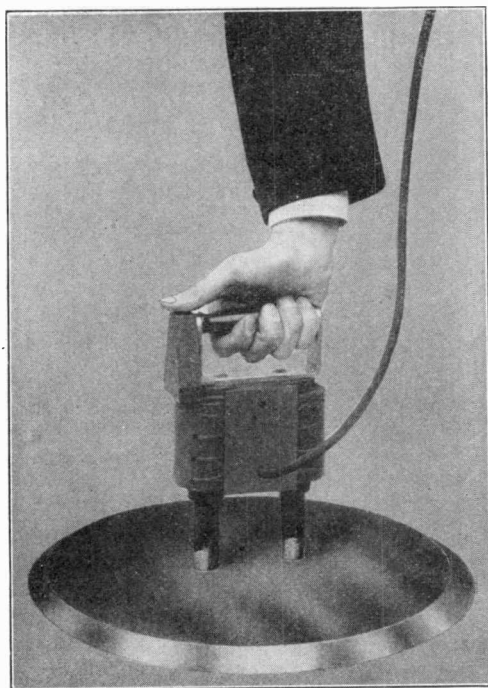

AN OBJECT THAT WOULD BE AWKWARD TO HANDLE WITHOUT THE MAGNET.

mixed with the ashes, he guarded against punctured tires by employing a magnet to remove nails from the ashes before strewing them in the alley.

THE NAVY ELECTRICAL SCHOOL.

BY LIEUT. COM. PHILLIP WILLIAMS.

Very few citizens in this large country of ours are aware of the fact that a technical school of high order for the specific purpose of teaching electricity is maintained by the United States government at New York. There is an increasing demand for electricians in the navy just as there is for them in civil life, and the government, realizing the importance of this great branch of sci-

igation. They must be American citizens, sound in mind and body, and be able to pass a rigid physical examination; must have some knowledge of electricity, and be able to solve problems in arithmetic through fractions and decimals. Those between the ages of 21 and 35 with a fair knowledge of electricity and electric machinery enter the school as electricians third class, and are

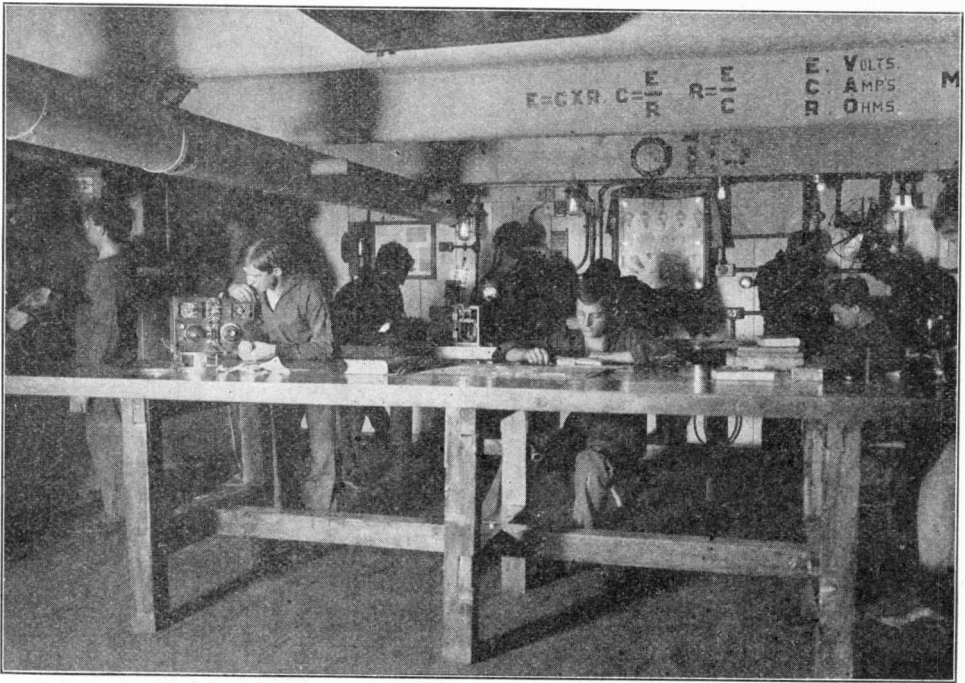

STUDYING LINE WORK AND WIRING APPLIANCES.

ence, is willing to educate those men who are eventually to handle the large power plants now necessary on modern battleships, a battleship of the type of the "Connecticut" requiring some 30 expert electricians on board to care for the electrical machinery and appliances.

All men upon entering the electrical branch of the Navy are sent to the Naval Electrical School before detailed to ships for sea duty. The men who attend this school are from all parts of the country, and must meet the qualifications required by the Bureau of Nav-

paid \$30 per month; those between the ages of 18 and 25, with little knowledge of electricity but a good high school education, enter the school as Landsmen for Electricians and are paid \$16 per month.

The men at the school are all regularly enlisted in the United States Naval Service for four years and have all the privileges and allowances of enlisted men. When they join the service they are given an outfit of clothing to the value of \$60. Their home is on board the U. S. S. Hancock at the Navy Yard,

New York, and they are there furnished board, lodging and medical attendance.

The course at the school is unique. There are no classes; instruction is individual.

with simple electrical experiments.

The remainder of the course is entirely practical, the men going from the theory section to duty in the dynamo room of the U. S. S. Hancock where



LABORATORY WORK IS COMBINED WITH THEORY.

The course covers 21 weeks altogether. Upon entering the school men are first assigned to the theory section where four weeks is devoted to the study of the principles of electricity, magnet-

ism and electromagnetism. The men are made familiar with electrical units, the theory of dynamos and motors, the handling of electrical instruments and

they become familiar with the ship's electrical plant and its routine and where they are taught its care and manipulation under the supervision of trained electricians.

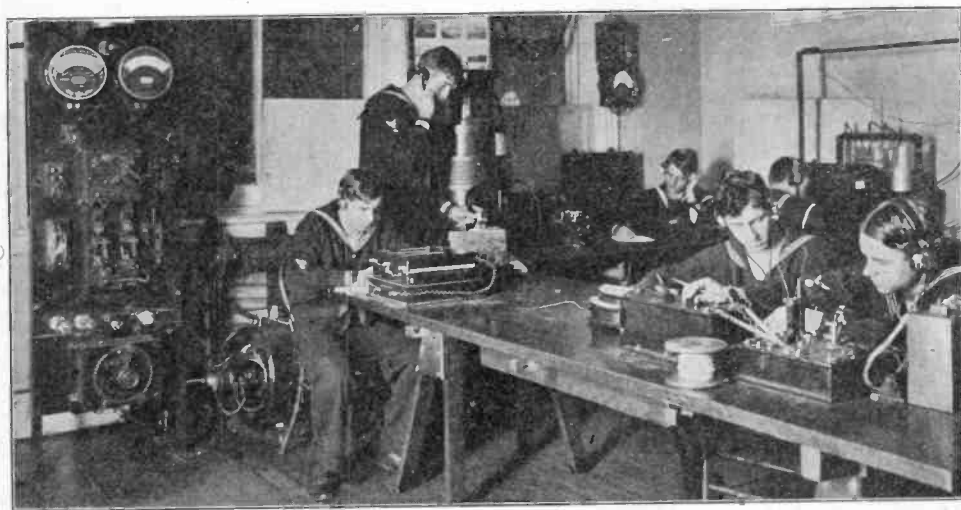

TUNING AND ADJUSTING WIRELESS TELEGRAPH APPARATUS.

ism and electromagnetism. The men are made familiar with electrical units, the theory of dynamos and motors, the handling of electrical instruments and

In order to satisfy the demands of the electrician on board ship the men must also be "ready men" with the lathe, tools, and at all repair work.

Entering the practical electricity section, the men have the handling, the actual assembling and taking apart, the adjusting and the manipulating of practically all the electrical machinery, appliances and instruments found on board ship.

After the work in practical electricity all the men are given a thorough course in wireless telegraphy. They are taught its principles, the arrangements of the different types, how to send and receive messages; each one actually doing the sending and receiving. They are de-

tailed from time to time for duty at the Navy Yard Station, which is almost constantly in communication with other stations and with ships at sea, and which is one of the most important wireless stations in this country. They are taught the care and handling of instruments, and the routine of wireless telegraph stations.

After the course in this section, the men are well equipped for their duty as electricians in the navy, and are, by orders from the Navy Department, Washington, D. C., sent to various ships.

UNIQUE CENTRAL STATION ADVERTISING.

Window displays made by electric lighting companies are a form of advertising which has done much to popularize the use of electric current, especially for household purposes. A striking display of this character is shown in the picture and was fitted up by the Dayton (Ohio) Lighting Company.

A live pig was allowed to roam around the window and the advertising signs that would tend to help the electric light and power business along.

light and power business along.

well as the electric milk warmer at the top.

The intended effect was to bring out the fact that you could roast a small pig in an electric oven, which appears on the right of the photograph.

The company changes its "New Business" department windows every week, and keeps them up-to-date and "alive," taking advantage of all the local happen-

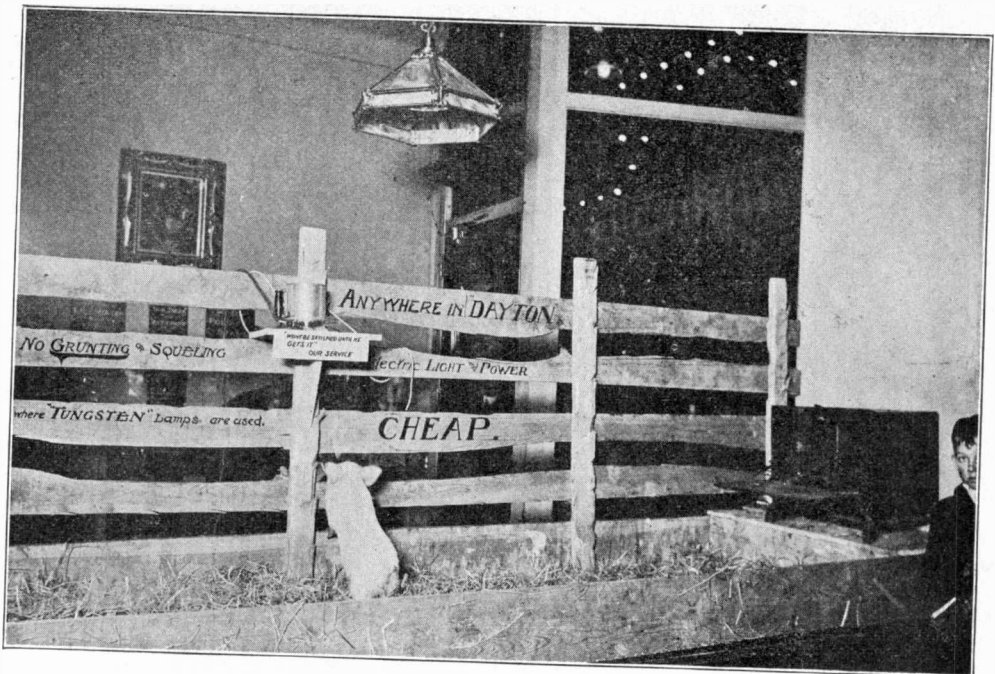

UNIQUE CENTRAL STATION SHOW WINDOW.



By Courtesy of the Chicago Tribune.

AT THE TELEPHONE.

The daily newspaper cartoon, reproduced herewith, is a drawing that arrests attention. It is the work of John T. McCutcheon, and was published in the Chicago Daily Tribune. A temporary crib used in the work of building a tunnel for water supply beneath the bed of Lake Michigan, and located perhaps three-quarters of a mile from the shore, off Chicago, was burned on January 20, 1909. The alarm was given by telephone, as the picture depicts with such terrible intensity, although the man who gave it was never able to finish the message. The great value of the telephone is not fully realized until some great emergency arises.

THE MODERN'S ALADDIN'S LAMP.

Scarcely less marvelous than the magic power of the lamp of Aladdin in the good old eastern tale is the rapidity with which the tungsten electric incandescent lamp has come into use in the United States. In 1907 there were 48,000 of these lamps made in the United States; in 1908 the number was 3,500,000. The tungsten lamp has been "commercial" in this country for about two years. The reason for its extraordinary popularity is the fact that it gives about $2\frac{1}{2}$ times the light of the ordinary carbon filament lamp, for the same consumption of electricity. It has been said to be the greatest development in electric lighting in the last 20 years.

The tungsten lamp was developed abroad, especially in Germany (although it is said that the first patent, but not practicable, was taken out in the United States in 1876), but it has received its greatest recognition and improvement in this country. On the electric lighting cir-

cuits ordinarily in use it is not available in small sizes, the "25-watt" lamp, of about 20 candlepower, being the smallest. But for "low-voltage" circuits, say for automobiles, train lighting, etc., the smallest sizes are made.

Tungsten is a metal, of course, but it has the characteristic that it cannot be drawn into a wire for the lamp filament by any practicable process now known. In the shape of a powder it is made into a paste with a binding material. It is then squirted under pressure through a small die, producing the unfinished filament. Next it is dried, cut into shape, and purified by the passage of an electric current. This must be done without oxidation, and it is said that the success of the lamp depends upon the purification process. When completed, owing to its crystalline structure, the filament is rather fragile, and consequently the larger lamps, with their long filaments, cannot be used where there is much vibration.

FIRST ELECTRIC RAILWAY IN NORWAY.

BY DR. ALFRED GRADENWITZ.

Until recently Norway had never had an electric railway. This was natural, for the larger cities were provided with steam railroad facilities and the outlying districts were too sparsely settled to give promise of profitable operation. One locality was found, however, which could better be served by an electric line than by any other means, and this was the picturesque valley of the River Orkla. Here an electric railway connects Thamshavn and Lokken mines, and runs along Orkedals Fjord, about 20 miles west of Trondhjem, with which

lighting the town and the villages situated along the railway as well as for operating the Lokken mining machinery.

Solbu, a typical wayside station, is shown in one of the pictures. The station buildings, made of logs, are quaint in design, though substantial and exactly suited to the locality. The sod roofs of the buildings are in marked contrast to the very modern "catenary" trolley construction and the electric lights.

The railway is operated on what is known as the alternating current, single

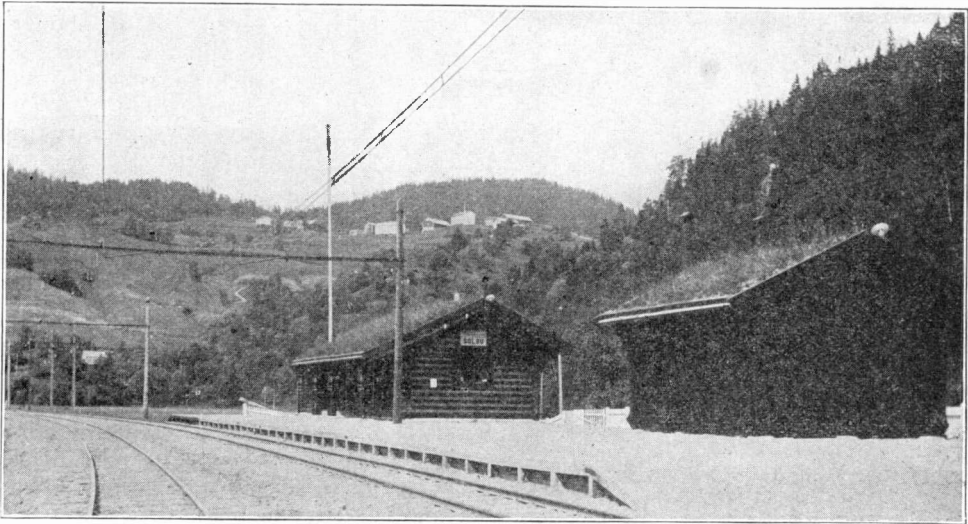

QUAINT NORWEGIAN RAILWAY STATION.

town a regular steamer service has been established in connection with the railway.

The main line is about 16 miles long, and the freight line and sidings add another three miles. At the terminal station of Thamshavn is situated one of the largest Norwegian timber factories in which the well known wooden houses are made on a large scale.

Energy for operating the railway is derived from a large hydroelectric power house installed to the west of Thamshavn in another valley, near the Skjenald Falls, which yield a good flow of water throughout the year. The same power house also supplies current for

phase system. This system is the latest development in electric railroading, and is coming into quite extensive use in this country. In our ordinary city railways and in most interurban lines direct current is used (current flowing continually in one direction) at about 500 to 600 volts pressure. To obtain it the current is first generated in the power plant as alternating current at high pressure or voltage. It is then transmitted to substations along the lines. The pressure is then reduced by a transformer. Then by a special machine the alternating current is changed to direct-current and fed into the trolley wires at frequent intervals. This all takes costly

machinery and numerous attendants. With the single phase system, however, current at high voltage is transmitted directly to the trolley wires, and there are specially made motors on the cars to utilize it. This results in a considerable saving in apparatus and line losses, and the system is now widely advocated by engineers for interurban roads.

The second illustration shows one of the 20-ton electric locomotives used in drawing the cars on the Thamshavn

\$7.31 a year the subscriber is entitled to two receivers and the full service of news, music, etc., the subscriber to pay the expenses of installation and removal, generally about \$8.50. The service begins at 8.55 a. m., when a buzzing noise loud enough to be heard across a large room and lasting for 15 seconds, announces the correct time. At 9:30 the day's program of important events is announced; that is to say, the ceremonies, lectures, plays, races, etc. At 10 and 11

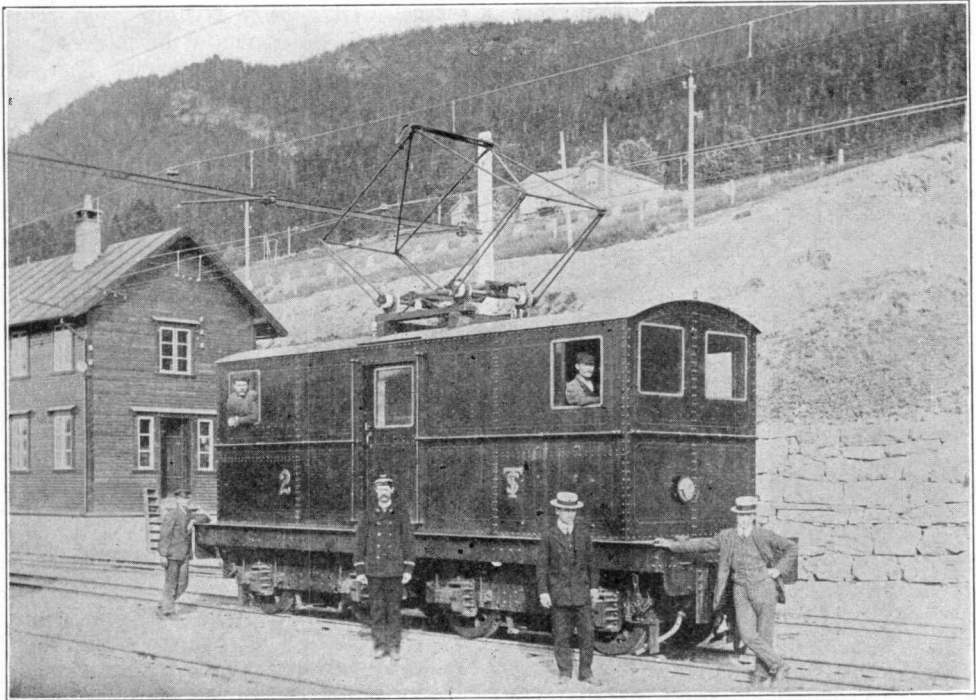

ELECTRIC LOCOMOTIVE ON NORWEGIAN RAILWAY.

line. Instead of the usual trolley pole and wheel a "pantagraph" trolley is used which slides along under the wires, springing up and down with any irregularities in the contour of the line.

TELEPHONE NEWS SERVICE.

Private enterprise has established a unique telephone news service in Budapest, the capital of Hungary. The telephones which give this service are entirely distinct from the regular telephone system which is owned by the government.

For an annual subscription price of

o'clock stock quotations and general news items are given.

At noon comes a second announcement of the correct time, followed by parliamentary news and general items of interest. At 12:45 stock quotations from the local, Vienna and Berlin exchanges and general news. At 2 p. m. more parliamentary and general news, and at 3 p. m. the closing prices of stocks, meteorological forecast, local personals and small items, and in winter the condition of the various skating places. At 4 p. m. court and miscellaneous news. From 4:30 to 6:30 military music from one of the great cafes or

gardens. In the evening the subscriber may choose between the Royal Opera and one of the theatres, and later music by one of the orchestras.

This program is sufficiently varied to satisfy the desires of all classes of subscribers, and in general the service seems to give the utmost satisfaction.

AUTOMATIC LAMP FLASHER.

The "Firefly" thermostatic flasher, the basic principle of which was invented by Dr. C. O. Schneider of Chicago, is a very interesting little device to automatically open and close the circuit, to flash one or more electric lamps with which it is connected in series.

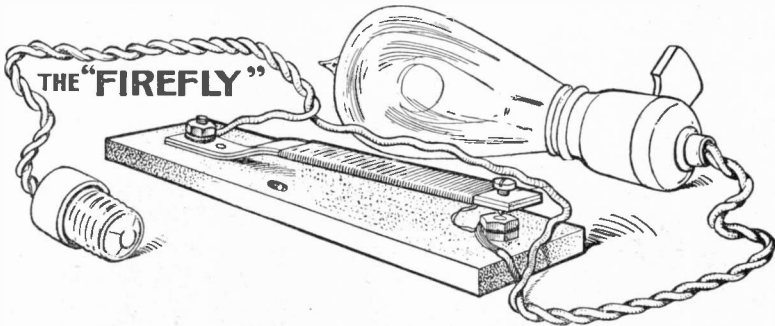

THE AUTOMATIC LAMP FLASHER.

It is a well understood fact that a like change in temperature will produce a greater or less amount of expansion or contraction in one kind of metal than in another. Brass when subjected to the same rise in temperature will expand considerably more than iron.

In this instrument two parallel bars of metal are used, the upper one being brass and the lower one iron, and they are riveted together in several places. This composite bar is then fastened tight to the porcelain base at one end, and the other end is free to move up or down when effected by a change in temperature.

Around this composite bar is a winding of extremely fine insulated wire of high resistance. This winding is connected to the bar at that end which is fastened to the base and the other end of the wire is not in contact with the bar, but is connected to the binding post below. In the free end of the bar beyond the winding is a screw with a piece of iridio-platinum in the end, and imme-

diately below this, but separated by an air space of about 1-64 of an inch, is a disk also of iridio-platinum mounted in the tip of the binding post which is below. These form the contacts between which the current is made and broken. The flasher is connected with the lamp in series, as is shown in the picture.

Now when the current is turned on, the circuit through the lamp is completed only after the electricity has traversed the fine wire winding of high resistance, and this so impedes the current that only a very trifling amount can pass, and consequently the lamp remains dark. The little electricity that does pass, however, is enough to raise the

temperature of the composite bar of iron and brass, and due to this heat, the upper or brass piece expands most, and consequently the free end of the bar moves down until the platinum contacts come together, thus cutting out the resistance of the winding by closing the circuit so the current will take the path

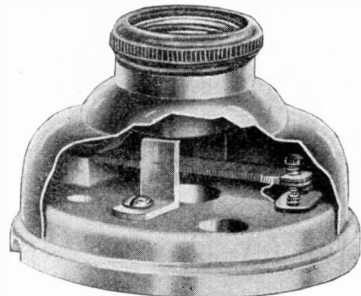

LAMP FLASHER INSTALLED IN BASE OF SOCKET.

of comparatively no resistance through the composite bar itself, and consequently the lamp is lighted. Now as there is no more current passing through the winding, the bar soon cools and con-

tracts so that the contact is again broken and the light goes out. Thus the lamp automatically flashes on and off 20 or 30 times a minute for an indefinitely long time.

TUNGSTEN LAMPS FOR AUTOMOBILES.

The new tungsten lamp, the economical features of which have revolutionized electric lighting, has been successfully applied to automobiles to take the place of the oil signal lamps or for instrument illumination.

The tungsten lamps are made in miniature sizes which can be run by low voltages from the ignition battery at such a high efficiency as to necessitate only one-third of the battery capacity required for carbon lamps.

It is very probable that electric lights will soon take the place of the acetylene headlights on automobiles used for city purposes. There is even some talk of passing ordinances in several cities against the use of these glaring headlights which blind pedestrians and other drivers. Oil headlights have been tried but they give too little light and the experiments recently conducted with the new tungsten electric lights warrant the statement that they make better headlights than gas for city machines.

THE "JUST PULL" SWITCH.

Are you short? Perhaps you are only just below medium height. But at any

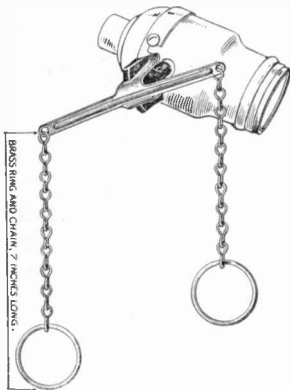

THE "JUST PULL" SWITCH.

rate you would rejoice to have all out-of-reach electric light buttons brought down to where you could reach them without

standing on tip-toes. Here is a device that does this very thing. It is so simple that we wonder why some one did not think of it long ago. It consists of a little metal arm with a short chain on each end. In the middle is a spring jaw which snaps on over the button. Then, pull one chain and the lamp is turned on; pull the other and it is off.

PORTABLE ELECTRIC BREAST DRILL.

A portable drill for iron and steel work, operated by electricity, forms a very convenient addition to the machinist's kit. It is not too heavy to carry around and will do the work of a hand drill much more quickly and with a minimum amount of labor. The sketch

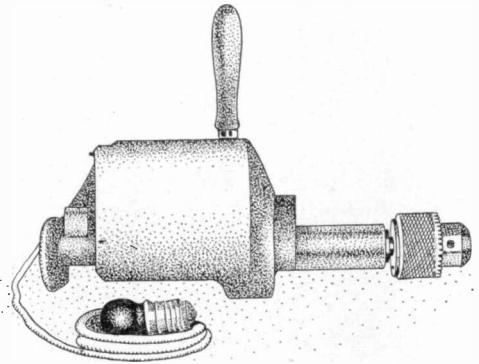

PORTABLE ELECTRIC BREAST DRILL.

shows a type of electric breast drill which operates on direct current. No electrical knowledge is required on the part of the operator, it only being necessary to screw the plug into a convenient lamp-socket and turn a snap-switch located on the frame of the machine. The end of the frame is provided with a breast-plate and the handle on the side, for steadying the drill while in operation, may be unscrewed when ready to pack up.

By simply removing two nuts the entire machine may be taken apart for inspection without in any way affecting the electrical connections. The running parts are enclosed by the frame, but suitable air-ducts provide for cooling of the armature. The machine is built in four sizes which will take drills up to $\frac{1}{4}$, $\frac{3}{8}$, $\frac{1}{2}$, and $\frac{3}{4}$ inches in diameter, respectively.

ELECTRICITY APPLIED TO HORTICULTURE

BY FRANK C. PERKINS.

If a discharge of high potential, static electricity will have a stimulating effect on animal life, why will it not also have a similar effect on plant life? So reasoned Sir Oliver Lodge, the noted English scientist, and he put his reasoning into effect with results which have been widely discussed, and which many believe will mark another step in modern agricultural methods.

The method employed in the application of electricity to horticulture and agriculture consists in stretching over the field to be treated a number of wires on poles just high enough for loaded wagons and ordinary farming opera-

be maintained for some hours each day, but be shut off at night; it is probably only necessary to supply it during the early morning hours in summer time, and in spring time or in cold cloudy weather for the whole day. In bright sunshine it seems unnecessary or even harmful. But at what stages of the growth of a plant the stimulus is most effective has still to be ascertained. Probably the earlier the better; and since in the case of wheat, both the ear and the straw is valuable, the electrification should be applied for a time each day during the whole period of growth until stooling begins.

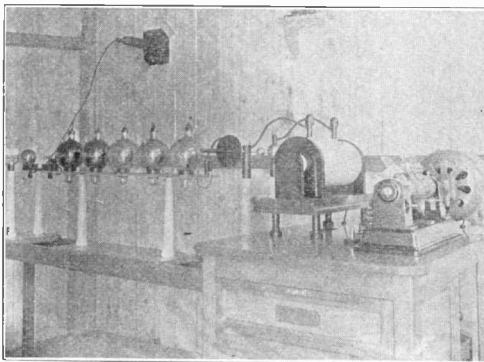

FIG. 1. HIGH TENSION APPARATUS USED IN HORTICULTURE.

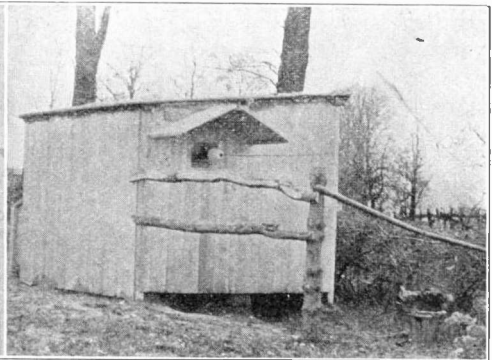

FIG. 2. THE APPARATUS IS INSTALLED IN SMALL QUARTERS.

tions to go on without difficulty below the wires. The wires are quite small and are supported by a few posts in long parallel spans, these being about 30 feet apart. At one post the electric current supply of high-potential static electricity, similar to that produced by a friction machine, is connected to the system of conductors, with power for maintaining a constant supply.

It is said that leakage immediately begins, and the charge fizzes off from the wires with a sound which is sometimes audible, and with a glow just visible in the dark. Persons walking about below the wires can sometimes feel the effect on the hair of the head, as of a cobweb on the face. They are then feeling the stimulating action of the electrification.

It is held that the electrification should

Power required to generate the electricity is very small, for although the potential is high the quantity is insignificant, and the energy is accordingly comparatively trivial.

Experiments carried out at the Bevington Hall estate near Evesham, England, by Sir Oliver Lodge, under the direct supervision of Electrical Engineer J. E. Newman, were performed on about 40 acres of land. The very high tension current was produced by an induction coil and a system of valve rectifiers as shown in Fig. 1. The current was thus supplied to the field wires at a tension of 100,000 volts.

The apparatus was all inclosed in a little shed shown in Fig. 2.

Some remarkable results were obtained, especially in growing wheat.

Fig. 3 shows two wheat stalks grown on good soil and each six weeks old. The one at the right was grown under the influence of the electric discharges while the one at the left was not. A much stronger and more luxuriant growth is noticeable in the former.

In discussing electricity in agriculture, Sir Oliver Lodge gave some interesting historical data as follows:

"Some thirty years ago a Swedish professor named Lemström sought to elucidate the Aurora Borealis by trying to imitate its appearance by electrical experiments. For this purpose he produced high-tension discharges of various kinds, and sent them through vacuum tubes until he got an appearance very like that of the Northern Lights. Some of these experiments he conducted in his greenhouse, and he noticed incidentally that the plants seemed to thrive under the treatment, and that the electrification thus produced in their neighborhood appeared to do them good. He also noticed, as remarkable, the flourishing development of plants in Arctic regions, where the sunlight was very weak; and he attributed part of this growth to the influence of electric discharges.

He says that when the plants in the north of Norway, Spitzbergen and Finnish Lapland, have resisted the frequently destructive night frosts they show a degree of development which greatly surpasses that of plants in more southern regions, where the climatic conditions are more advantageous. The rich development appears principally in the fresh and clear colors of the flowers, in their strong perfume, in the rapid development of the leaves on the trees, and their scent, but particularly in the rich harvest which different seeds—such as rye, oats and barley—will produce, when as before stated they are not destroyed by the frosts. From a bushel of rye sown they will often produce 40 bushels, and from barley 20 bushels and so forth. It is the same with grass. These results are attained, although the people cultivate their soil very imperfectly, using only ploughs and harrows of wood.

"He pursued the matter by careful observation, taking test plants in pairs

or groups, electrifying one group—that is to say, discharging some electricity into the air above it—and keeping a similar group away from the electricity in order to compare them. Then he photographed the two groups side by side, and found in nearly all cases a marked improvement as the result of the electrical treatment. He concluded that the needle like shape of the leaves in fir trees, and the beard on the ears of most cereals, have the discharge of electricity,



FIG. 3. WHEAT STOCK AT RIGHT WAS GROWN UNDER ELECTRICAL INFLUENCE.

as their function, and finds that they do act in this way.

"This observation and these experiments of Professor Lemström were not, indeed, the beginning of the application of electricity to plant growth, because pioneer attempts had been made long before, as will be mentioned directly, but it was the beginning of a thorough and scientific treatment of the problem. Attempts of a different kind had also been made. Plates had been sunk in the ground, and a current passed between them among the roots of plants; but whatever effect is thus caused is of a totally different kind to that excited by high tension electricity supplied to the air above them. There are natural earth currents, and these must flow

among the roots of plants, though whether they produce an appreciable effect may be doubted.

"There is a natural atmospheric electrification, and this must be playing an important part in many phenomena. Atmospheric electrification is responsible for the formation of rain and hail. During fine weather the electricity in the air is usually of one sign; mainly positive. When wet weather sets in, the electricity in the air usually changes sign, becoming negative. The whole subject is a large one; a great deal is known about it, and vastly more remains to be known, but meanwhile it can hardly be doubted that the electrification of the air has some effect on growing plants. For it is found that, under the influence of sunshine, electrified plants can give off electricity from the leaves, and the fact that the air is naturally electrified relatively to the soil causes all plants to be electrified too, so that in all probability they are in a constant state of slow electrical discharge, which becomes more rapid when the sun is up. In what way this discharge of electricity from the growing tips is produced is not known, but it is natural to suppose that it cannot be without influence, and it is reasonable to think that the influence may be beneficial—a hypothesis which direct experiment confirms."

CONNECTOR FOR ELECTRICAL CIRCUITS.

In motor, transformer and other installations it is sometimes necessary to replace a broken piece of apparatus quickly. The process of unsoldering the old joints and soldering new ones is a slow one, and in case of emergency the time lost may represent a serious expense. A simple and ingenious device for making quick connections is known as the segment pin connector, made for circuits carrying 90 to 200 amperes. This connector is of brass, in two parts. One part is permanently soldered to the motor or transformer terminal, the other part to the lead. The two parts of the connector may be joined in a moment's time by turning them at right angles, inserting the segment shaped lug of one into the hole of the other and then

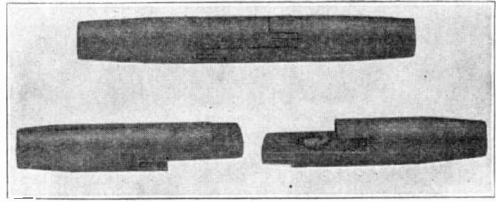

ELECTRICAL CONNECTOR.

bringing the two parts around into alignment. They may be disconnected with equal ease by reversing the process. These connectors are universal; that is, either part of one connector will fit either part of any other.

MACHINE FOR WASHING AND DRYING BLUEPRINTS.

An automatic electric machine of German design and construction performs the washing, drying and rolling of blueprints, delivering them complete. It is operated by an electric motor driving the rolling mechanism from the top of the machine by a chain and gearing. The printing is done by three arc lamps each consuming 1,300 watts of current.

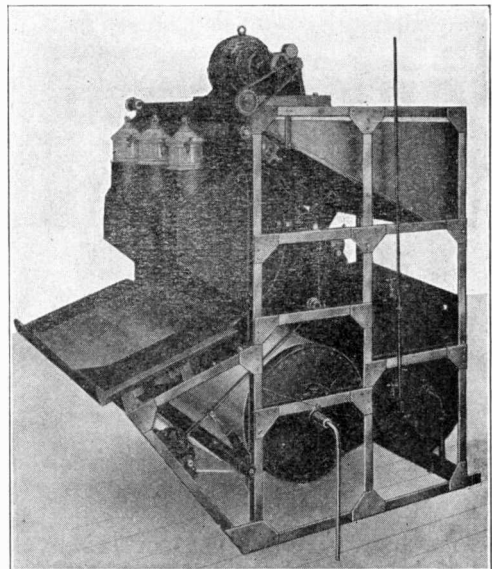

MACHINE FOR WASHING AND DRYING BLUEPRINTS.

The tops of these three lamps show in the picture.

This machine is said to have a capacity for 1,600 feet of blueprints in a sin-

gle day of 10 hours. By a continuous operation the tracing cloth is fed through the machine, passing in front of the lamps along with the sensitized blueprint paper fed from another roll. The completed blueprint is then delivered washed and dried.

AUTOMATIC CLOTH SCOURING MACHINE.

One man and a helper can do with this machine work that would require six men to do by hand, in the scouring of cloth in dyeing and cleaning establishments. Again it is the electric motor that has made this possible.

The water and other ingredients used in the scouring process are stored in the tank under the machine (completely out

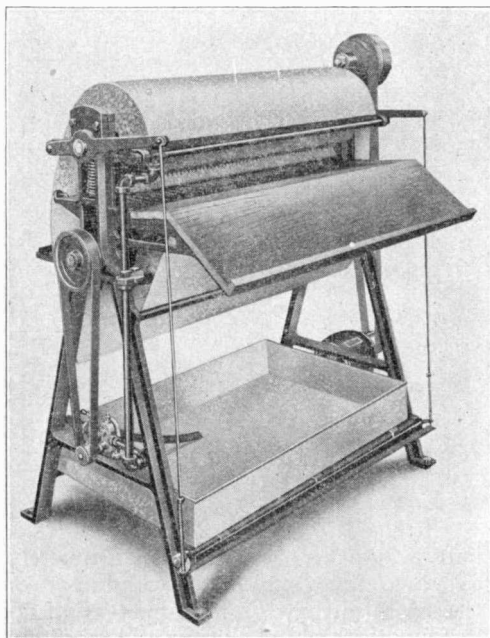

CLOTH SCOURING MACHINE.

of the way) and are supplied to the goods being scoured through a perforated pipe, that distributes evenly over the surface of contact with the brushes.

The water is raised from the tank by a pump that starts and stops automatically as the machine is started or stopped.

The motor drives both pump and scouring brushes and is started and stopped by a pedal arrangement so that the operator has both hands free.

A PORTABLE OZONE PRODUCER.

Ozone is a peculiar form of oxygen which is formed by the chemical union of three atoms of oxygen with each other to form a tri-atomic molecule of oxygen, as it is called. It is the gas which gives off the peculiar odor that is noticed

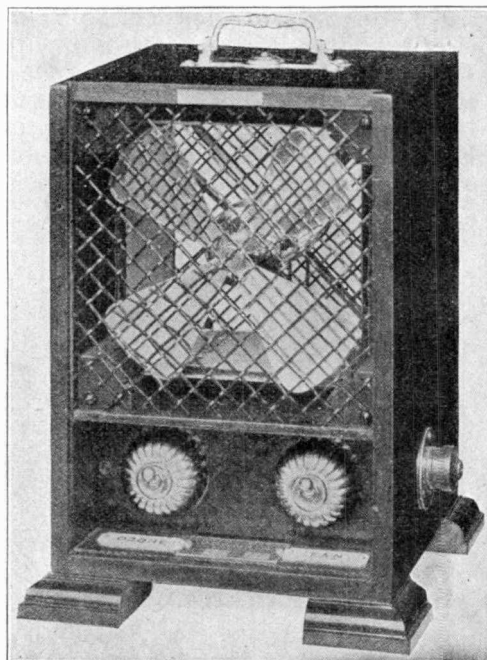

PORTABLE OZONE PRODUCER.

when heavy discharges or sparks of electricity pass through the air. Ozone is a powerful disinfectant and germicide and consequently is beneficial for purifying air in houses, hotels, hospitals, etc.

A portable apparatus for making ozone is shown in the picture. The screen shown in front forms one electrode of a high voltage circuit, the other electrode is in the interior of the casing. The high voltage is produced by a transformer contained in the apparatus. The primary or low voltage winding of the transformer is connected by a cord and plug with any lamp socket in a 110-volt alternating current light circuit.

In operation, the high voltage impressed upon the two electrodes causes a "silent discharge" of electricity to take place between the electrodes. This discharge is very minute and can hardly be seen or heard, but it brings about a chemical union in the oxygen atoms in

cutting out the current which would otherwise damage the motors. On street cars this wire usually melts with an explosion and a puff of smoke, harmless in itself but sufficient to startle nervous passengers.

But instead of being indicative of danger the fuse is devised to prevent accidents. Electric machinery differs from all other machinery in that it will work itself to death, so to speak. Overloaded engines will stop; but an overloaded motor will work right on until it burns up. To protect it fuses or circuit breakers are inserted in the circuit.

The fact that passengers have been so frightened when the fuse blew out as to jump off the moving car or even out of the windows necessitated the invention of the automatic circuit breaker. The circuit breakers are operated by an electric magnet whose core it attached so as to trip a release or trigger and allow a heavy spring to throw open a switch. This device does away with the explosion and the smoke.

SOUTHERN ELECTRICAL AND INDUSTRIAL EXPOSITION.

From the Southern Exposition to the Southern Electrical and Industrial Exposition is a long step. It is, long in respect to years and it is long in respect to developments, both electrically and industrially. The Southern Exposition was held in Louisville, Ky., 26 years ago. The Southern Electrical and Industrial Exposition, to be held April 12th to 24th, will show a development in electricity never dreamed of a quarter of a century ago.

One of the chief purposes served by the exposition was the introduction of the application of electricity to lighting and motive force. For the first time in Louisville there was installed at that exposition the electric arc lamp. It was a very crude affair compared to the present day lighting facilities, but it brought to the attention of those who saw it the possibilities which underlie the uses of electricity. At that time the city streets were lighted with primitive gas lamps. Several years later, these unsightly lamp posts or gas lamps gave place to the electric arc light, now awaiting removal to give place to artistically designed poles bearing high candle-power lights.

Another and greater service was that rendered by the introduction of the application of electricity to motive power in street railway service. What is now Central Park was at the time of the old exposition the "front yard" of Mr. A. V. DuPont, Louisville's pioneer street car magnate. Encircling this large plot of ground was a narrow gauge railway track on which were operated electrically propelled cars, among the first used in the United States. The cars were what operated on what is known as the third rail system, the trolley being then a discovery for the future. The cars were small and the service was anything but satisfactory. However, it was the fore runner of the line which seven years later was installed on Green street and which was the third electric line installed in the United States. Electric railway service in 1883, however, was a different proposition from what it is today. Then it meant a short ride and long walk in many instances, for there were many halts and frequently complete suspension. But, a visit to the exposition at that time was not complete without a ride on the "new wrinkle."

In contrast to the old exposition, the exposition to be held in April will be very distinct. Whereas there was shown at the old exposition the beginning of the application of electricity, there will be shown at this one the very latest developments, and there are many developments with which the people of Louisville and the people of the south are not at all familiar.

The Southern Electrical and Industrial Exposition will be held in the armory. An interesting feature will be the display of a giant painting showing the river front of Louisville from the Indiana shore. This painting will be 40 by 60 feet and will be one of the most perfect sketches ever made of this beautiful prospect. In it the artist, Guy M. Leber, expects to produce his masterpiece.

At the south end of the armory will be hung a giant swinging electric clock, which will indicate the time by means of shafts of vari-colored lights. There will also be an immense electric tower which will rise 80 feet from the main floor and lose itself in a blaze of light in the lofty dome of the armory.

POPULAR ELECTRICITY WIRELESS CLUB.

Membership in Popular Electricity Wireless Club is made up of readers of this magazine who have constructed or are operating wireless apparatus or systems. Membership blanks will be sent upon request. This department of the magazine is devoted to the interests of the Club and members are invited to assist in making it as valuable and interesting as possible, by sending in descriptions and photographs of their equipments.

WIRELESS TYPEWRITING AND TYPOGRAPHY.

The principle underlying the design of all wireless telegraph systems has been recently extended in a very promising manner to the operation of distant mechanisms. It has thus been possible to demonstrate the practicability of long-distance steering of balloons and vessels, launching of torpedoes and controlling of all sorts of mechanisms connected by no material link with the operator.

The latest development in that field is a wireless apparatus adapted to the operation of typewriting and typesetting machines. This apparatus which has been designed by Mr. H. Knudsen (the inventor of an ingenious system of transmitting pictures by wireless telegraphy) can be connected to and worked in combination with any typewriting or linotype machine, or in fact, with any machine of a similar construction. By means of one sending apparatus, it allows a message to be received simultaneously on any number of typewriting or typesetting machines, situated at any distance from the sender.

One or more steamships having a wireless installation on board may by this system receive the electric impulses sent by a central transmitter, any number of receiving machines reproducing the message, typewritten or set in type. It is also possible so to tune and arrange the machines, that no foreign messages or signals can interfere with, or be received by them.

The transmitting and receiving machines, as represented in the Figs. 1 and 2 respectively, are practically identical in construction and in their simplest form consist of the following parts: The transmitting typewriter connected with an electric motor operating two pulleys, over which an endless belt with two contacts is wound. This belt travels in a constant direction, and the contacts,

which are fastened at equal distances to its inside, come to a full stop at each half of a revolution, in fact, every time one of the contacts has passed over the alphabetic contacts connected to the levers of the transmitting typewriter.

In order to operate the machine, the contacts corresponding to each letter of the message are raised by pressing down the levers of the transmitting typewriter

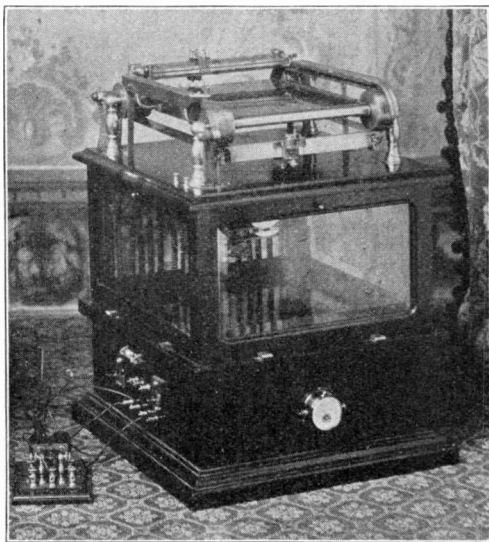

FIG. 1. WIRELESS TYPEWRITER TRANSMITTER.

keyboard. Those contacts then remain in a raised position until the starting key or lever has been pressed. This lever starts the belt of the transmitting machine, and at the same time sends cut an electrical impulse which is received by the typewriter installed at the remote end, thus starting this typewriter. The belts of the transmitting and receiving machines accordingly travel at the same speed over their respective contacts. The transmitting machine obvious-

ly makes contact only with such types as have been previously raised, and on touching the raised pin the contact on the endless metallic belt, depresses this, thus sending an electric impulse out to the receiving station, where it completes a circuit through a coherer and relay.

The metallic contact fixed to the traveling belt thus completes a current through a magnet located above the corresponding key or lever of a typewriter or linotype machine, actuating the lever in exactly the same manner as an operator would do when handling the machine in the usual way. It is essential that

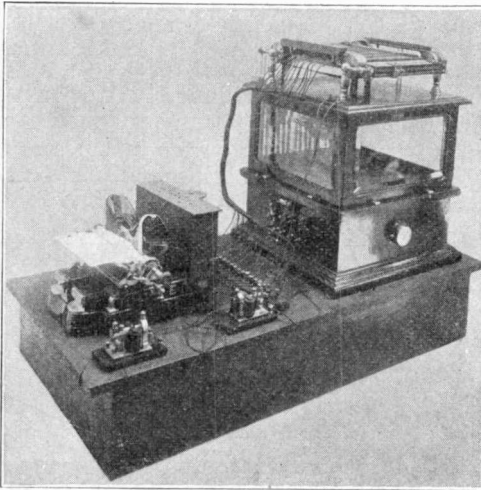

FIG. 2. WIRELESS TYPEWRITER RECEIVER.

both machines and metallic belts should come to a full stop after passing over their contacts, being held in this position until the first electric spark has been sent out from the transmitting machine.

The construction of Mr. Knudson's machine, while very simple, is of extreme accuracy. All the machines are of the same size and made from the same patterns.

As any number of typesetting machines may be operated in different parts of the country or in different countries simultaneously, all reproducing the same message, it is possible for one operator to type or set type on any number of receiving machines on land or sea, in fact, wherever anyone of these receivers,

tuned to the transmitter, may be installed in connection with any wireless telegraph systems.

As everybody knows of what enormous value any saving of time is to a newspaper proprietor, it will be readily understood that this most direct and rapid transmission of news, directly from the sub-editor or correspondent to a number of typewriting or typesetting machines, will be universally appreciated and found very profitable by enterprising publishers.

When this ingenious system will have come into general use and, for instance, have been adapted to a trans-Atlantic station, a newspaper correspondent, comfortably seated in London, will be able to set type in the New York printing room at the very moment he dictates his message to his typist. It is hard to realize what a revolution this system which obviously makes the newspaper man independent of space and time, may produce in journalistic practice.

WIRELESS TELEGRAPHY ON THE HIGH SEAS.

The fact steamer Vilano has for a long time received messages from the main German station at Nauen, as far off as the island of Teneriffe. The latest German record has, however, just been made by communication between two vessels equipped with long-distance wireless apparatus. The steamer Frio, which was south of Cape Finistere, exchanged messages with the steamers Roca and Arcona at the remarkable distance of 925 to 1,000 English miles. The Roca was at the time of this exchange of messages south of Lisbon, Portugal, while the Arcona was in the North Sea in the latitude of Scheveningen, Holland.

Conversation between the two vessels was hardly ended when the North German Lloyd steamer Grosser Kurfurst, on board of which was King Friedrich August of Saxony, was announced by the English apparatus. Both vessels were in sight of each other. The Grosser Kurfurst vainly endeavored to forward a message from Scheveningen or some other continental port to the King of Saxony. Failing in this, the Frio was

spoken, and requested to send the message further. The Frio took the message and sent it without further loss of time to the wireless station of the Holland government at Scheveningen; the distance being 1,440 kilometers or 895 English miles. Scheveningen accepted the message, and remarked that the signals from the Frio were unusually legible. The Frio took advantage of the opportunity to send a greeting to the King of Saxony on board the Grosser Kurfurst—which message the King answered the next day.

The majority of the English wireless

stations on the German fast steamers had up to that time refused to communicate with stations working with other systems, and especially with those having German instruments. The "emergency" created by the presence of the King on board the Grosser Kurfurst compelled the English stations, however, to break the rule. It was necessary to call in the assistance of the stronger and further-reaching stations. The technical papers remark in this connection that the Frio apparatus is a small and comparatively weak one, calling for only two horse-power.

AERIAL SYSTEMS.

ALFRED P. MORGAN.

Many amateurs are under the erroneous impression that almost anything in the shape of wires run up into the air will serve for an aerial and consequently in traveling around the country one sees a queer assortment of wires, such as

be of the same size and length so as to permit of accurate tuning. If the owner cannot afford stranded phosphor bronze wire, copper wire not smaller than No. 16 B. & S. gauge is best. Aluminum wire is not to be desired for

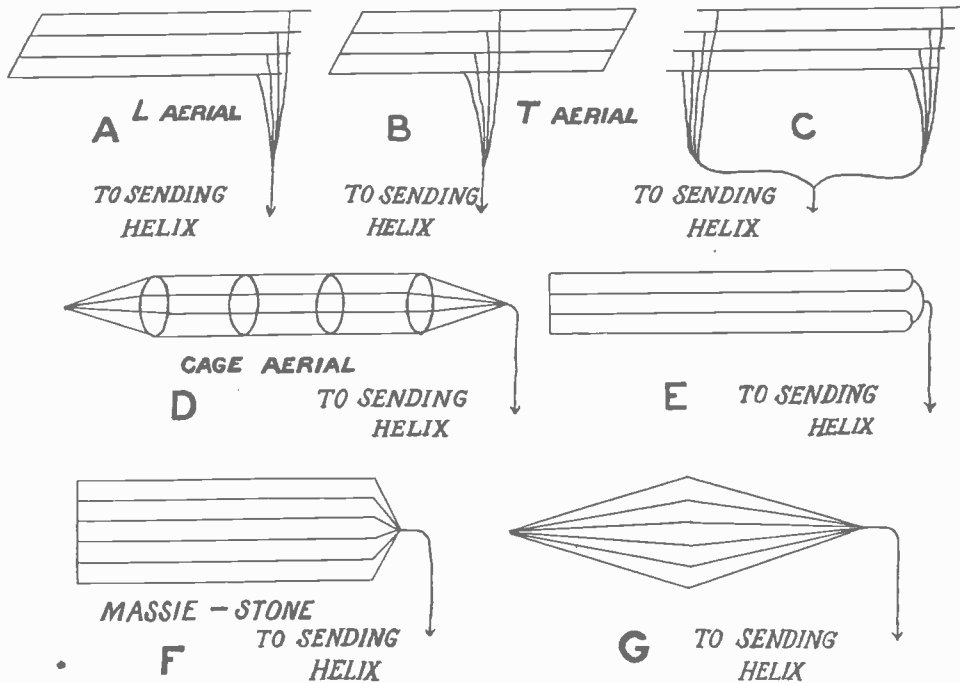

FIG. 1. MOST COMMON TYPES OF AERIALS.

poultry netting and sheet iron, above the roofs of houses.

In fitting up a station the aerial should receive first attention. The wires should

other than experimental purposes, for a short time, as the acid fumes in the air from smoke, etc., quickly attack and coat it. Connections made in aluminum

wire are very liable to become badly oxidized unless great care is exercised in soldering them.

It is needless to say that an aerial should be as high above neighboring objects and as well insulated as possible.

tion of energy when the transmitter is in operation.

Fig. 1 shows the most common types of aerials in use and the proper place for connecting the leading-in wires. (A), (B) and (C) are horizontal aeri-

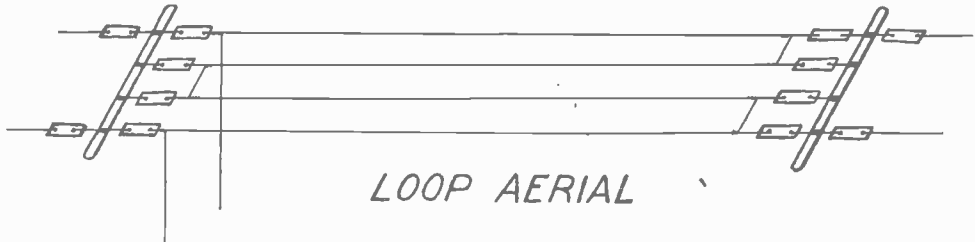

FIG. 2. LOOP AERIAL.

For small light aerials, strings of two or three glazed porcelain cleats make excellent insulators. Large heavy aerials, where the strain is great, require a special ebonite or composition insulator.

als having the opposite ends at the same height. (D), (E), (F) and (G) are vertical aerials having the end opposite the leading-in wires the highest.

Fig. 2 shows the "loop" type of aerial

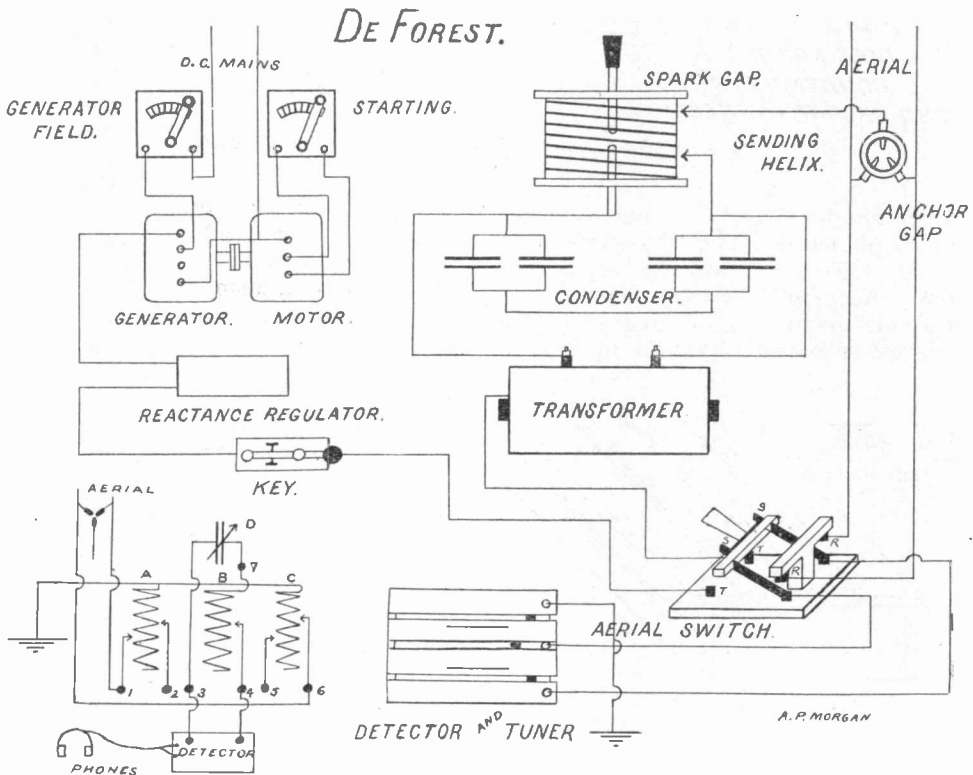

FIG. 3. COMPLETE SYSTEM AS WIRED ON THE DE FOREST PRINCIPLE.

Ropes make the best guys for holding a pole unless the wire guys are properly wrapped with iron wire so as to produce a choking effect and prevent the absorp-

tion of energy when the transmitter is in operation. This type of aerial gives an increased signaling range and permits of very nice tuning. In towns where

alternating current is used for power and lighting purposes, amateurs are greatly annoyed by a humming in the telephone receivers due to the induction of neighboring lines. This humming

key while the switch is in position for receiving. Any double pole knife switch may be easily adapted to this type by moving the contacts (T T) forward so that they come beyond the insulating

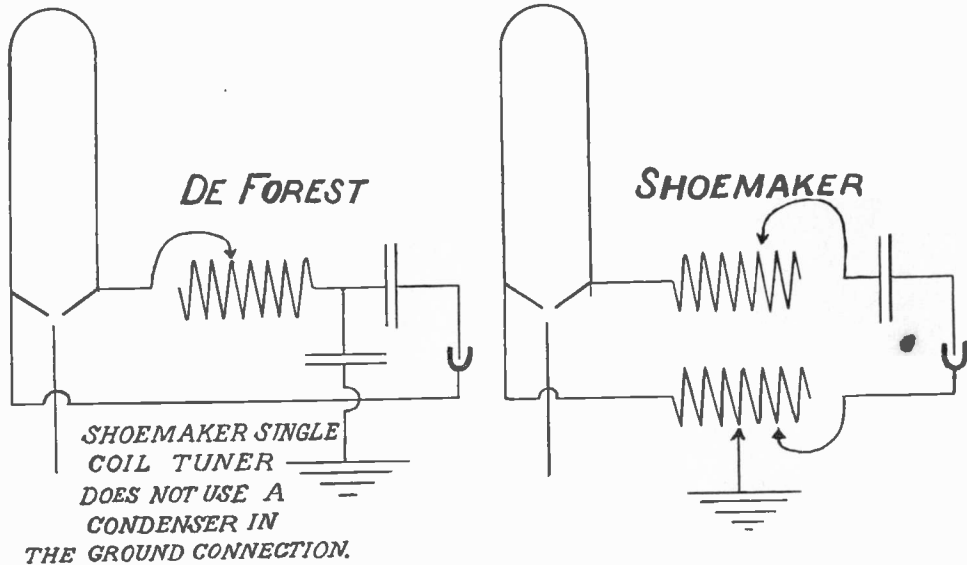

FIG. 4. CONNECTION OF TUNING COIL TO AERIAL.

may be almost entirely cut out by using the "loop" aerial. The two wires must be led separately into the operating room. A complete circuit of a "loop" aerial installation as wired on the DeForest principle is shown in Fig. 3.

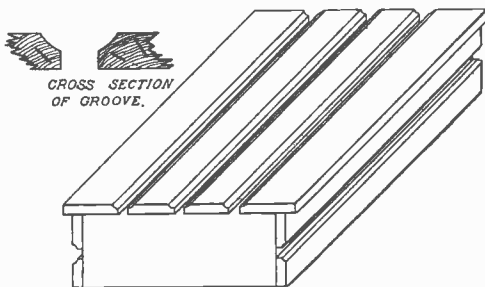

FIG. 5.

In most amateur stations an induction coil and batteries will replace the transformer and motor generator.

A special form of aerial switch as shown in perspective in Fig. 3 is used to prevent damage to the receptor through an accidental touch of the transmitter

bar. A yoke of copper or brass is fastened on the insulating bar so as to touch the contacts (T T) and complete the primary transmitting circuit when the switch is down. A T-shape piece of hard rubber or fibre is provided with contacts (R R) and mounted on the base so that the knives strike the contacts and connect the aerial to the receptor when the switch is up.

The anchor gap is a small hard rubber or fibre ring about two inches in diameter having three small $\frac{1}{8}$ -inch zinc or brass rods around the circumference at equal distances apart. The sparking distances between them should be equal and never greater than 1-16 of an inch.

Either one, two or three tuning coils may be used with this type of aerial. The DeForest system usually contains three. These are mounted in a case about 12 by 15 by 4 inches. The proper circuits are shown in Figs. 3 and 4. The two outside tuning coils (A) and (C) have each two contacts arranged 90° apart to prevent interference and allow closer adjustment. Handles of hard rub-

ber project through the grooves which are shaped as in Fig. 5 so as to make room for the finger tips and permit a firm grip to be had without the handles being made to project too far. It is a wise plan to mount only the tuning coils in the case and provide it with binding posts so that connections may be made to the proper condensers, and different detectors as carborundum, silicon or the electrolytic may be used. The condenser (D) should be made adjustable if good results are desired. The wire commonly used for the coils is No. 25 B & S gauge enameled or cotton covered. Adjustable condensers are sometimes shunted across binding posts (3) and (4) and (6) and (7).

The top of the transmitting helix is connected to the adjustable electrode of the spark gap which has a rubber handle.

AN ADJUSTABLE INTERRUPTER.

The interrupter here illustrated has the great advantage of being adjustable. As this is an important feature the writer undertook the designing of one with the following result.

After selecting the jar, which is straight sided, six inches in diameter, by eight inches tall, a cover is cut which overlaps the edges $\frac{3}{4}$ of an inch all around. In the center cut a hole $1\frac{1}{4}$ inches in diameter. Then procure a glass tube of one inch inside diameter and walls $\frac{1}{8}$ inch thick; this must be six inches long. One end must be flared by heating and forcing a hardwood stick into the opening; the other end is drawn out to a point $\frac{3}{4}$ inch long. When cold the tip is broken off, leaving a hole $\frac{3}{16}$ inch in diameter. This hole must be smoothed with a small round file wet with turpentine.

The glass rod (C) is of $\frac{3}{8}$ inch stock, one end drawn to a long tapering point, the other end left square. A brass rod (D) $\frac{3}{8}$ inch in diameter is cut three inches long and threaded for two inches. The unthreaded end is placed against the square end of the glass rod and a piece of brass $\frac{1}{2}$ inch wide and long enough to be bent around the two rods and the ends fastened with a small bolt (see cut). A great deal of care must be used

in this joining, so that the resulting rod is perfectly straight.

The brass support (E) is bent to shape, a hole drilled and tapped for the rod, which is now screwed in. A knurled nut is permanently fastened to the end of the rod and the bracket screwed down to the cover.

Two lead plates are cut, one for the large jar and the other for the glass tube. These plates are the electrodes and are connected to the binding posts mounted on top.

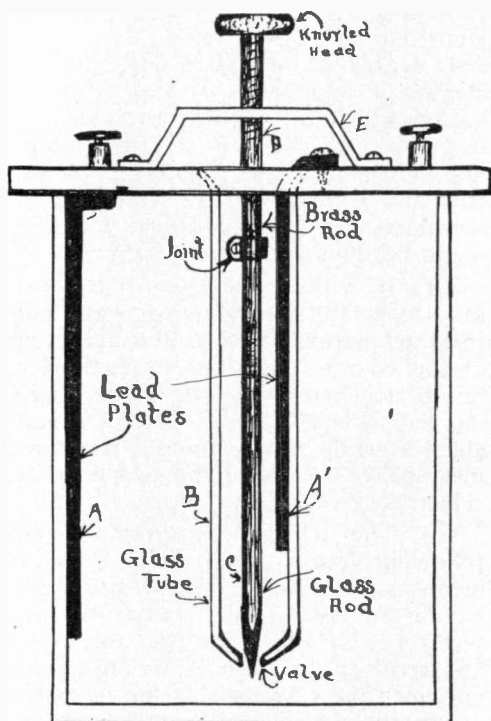

AN ADJUSTABLE INTERRUPTER.

Partly fill the jar with an electrolyte of water 10 parts, and sulphuric acid one part. Connect to the source of current and screw the rod into the opening. The resulting valve motion gives the desired adjustment.

GRADY B. MEDEARIS.

To give some idea of the extent of the incandescent lamp industry in this country it is noted that during the year 1907 a single electrical manufacturing company disposed of 32,000,000 lamps.

WIRELESS QUERIES.

ANSWERED BY V. H. LAUGHTER.

WIRELESS FROM AIR SHIP.

Questions.—(A) Can a wireless system be worked without being connected to the ground? I am going to build a flying machine and intend to send messages to the earth while sailing. (B) Are the instruments for wireless telephony much different from those of wireless telegraphy? (C) What are the principles of a common telephone?—E. L. F., Fort Worth, Tex.

Answers.—(A) We understand that experiments in communicating from balloons, etc., have been carried out with a fair degree of success. The common method is to suspend a wire from the balloon which is supposed to answer as the aerial radiating wire. At the receiving end the aerial wire picks up the signals and conducts to the receiving instruments. As an experiment it will no doubt be interesting.

(B) In wireless telephony it is necessary to set up a continuous wave current and impress thereon the inflections of the voice. The wave is changed to this period and picked up at the receiving end where it flows through a suitable detecting device and is translated into spoken words in the telephone receiver.

(C) The telephone consists of the following parts: Signalling arrangements, switch hook to throw from signalling to talking set, transmitter and receiver. Of the above the transmitter and receiver are the essential parts and on which the principals of the telephone are based. For a simple explanation we can take the transmitter connected in series with the battery and the telephone receiver. The transmitter consists of a metal cup full of carbon granules. In the front of the cup is placed a metal electrode resting against the carbon granules but insulated from the cup, the electrode being fastened to a diaphragm in the front.

The receiver is a coil of small magnet wire placed over a bar magnet near the end with a ferrotypic diaphragm resting in close proximity to this but held from the magnet by means of the receiver case.

The current from the battery circu-

lates through the transmitter and the coil of wire over the magnet. When the diaphragm of the transmitter is spoken against the electrode in the cup takes up the vibration and gives the same motion to the mass of carbon granules. As the current flows through the carbon granules, and this mass is varied in its resistance and conductivity by the vibrations of the electrode, the current is changed to the same proportion, and the fluctuations of this current therefore correspond to the sound fluctuations of the voice. The current flows through the winding of wire of the bar magnet and increases and decreases the magnetic pull against the ferrotypic plate in proportion to the current, thereby resulting in a vibration of the ferrotypic plate which corresponds to the form of the words as spoken at the transmitter. The telephones used at the present time combine several features not given above but the working theory is the same.

MAKE-AND-BREAK INTERRUPTER.

Question.—Please give drawing showing how to make a make-and-break interrupter.—J. D. M., San Francisco, Cal.

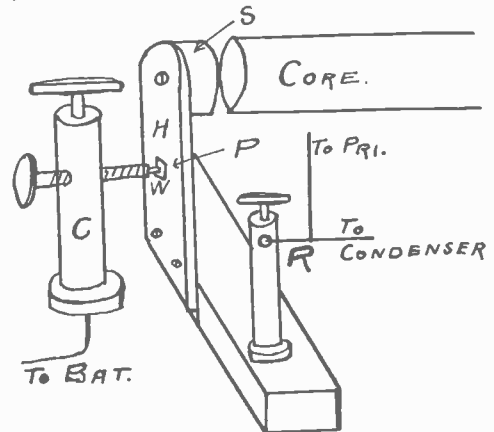

MAKE-AND-BREAK INTERRUPTER.

Answer.—See diagram. (C) bell contact screw pillar with platinum point (W). Brass spring (H) soldered or screwed at lower end to brass base upon which is soldered terminal (R). (S) is a soft iron cylinder screwed to (H). Connections are shown.

The first alarm of fire by an electric telegraph system was given at 8:30 p. m., April 29, 1852, in Boston.

ELECTRICAL MEN OF THE TIMES.

BERNARD E. SUNNY.

Nearly all men of prominence in the electrical industry have made their own way from the bottom of the ladder, and not a few, like Edison, began as telegraph operators. To this class belongs Mr. Bernard E. Sunny, president of the Chicago Telephone Company, who, from a position at a telegrapher's key in Brooklyn, has made himself, by native ability, untiring but intelligent application and very unusual gifts of persuasion and tact, one of the most conspicuous electrical men of affairs in the Central West and a leader in the civic advancement of the city of Chicago and the state of Illinois.

It is a very good test of a man's character to get the real opinions of those who work under him and are closely associated with him when he is in undress, as it were, in the rush and strain of daily life. Mr. Sunny, calm, fair-minded, considerate in all emergencies, has an enthusiastic admirer and eulogist in every man who ever worked for him, and only a just man, of strength and power but of good intent, could have made the impression he has made on so many other men.

Mr. Sunny's advancement has been rapid, and can only be sketched in the barest outline on this page. He was born in Brooklyn in 1856, and after attending the public schools in that city, became an operator for the Atlantic and Pacific Telegraph Co. In 1875, when hardly more than a boy, he came to Chicago as manager for the company named. Three years later he was married to Ellen Clifton Rhue, of Brooklyn, and the same year he became superintendent of the Bell Telephone Company

of Chicago. In 1882 he was made superintendent of the Chicago Telephone Company, a consolidation of the Bell and Western Union telephone interests in Chicago. Twenty-six years later he returned to the company, grown mightily in the meantime, as its president. In the interval he became prominent in the electric light and power industry. He



was president of the Chicago Arc Light and Power Company in 1888, and the year following found him western manager for the Thompson-Houston Electric Company. The General Electric Company succeeded this company in 1892, and Mr. Sunny was made western manager of this also, with a territory embracing thirteen states. In 1907 the great value of his services was recognized by his promotion to the vice-presidency of the General Electric Company, of which he is still one

of the directors. Last year he became vice-president of the American Telephone and Telegraph Company and very soon after president of the Chicago Telephone Company.

Mr. Sunny is president of the board of trustees of the Illinois Eastern Hospital for the Insane at Kankakee, the largest institution of its kind in the world. He is president of the Grover Cleveland Memorial Association. Under his supervision, when president of the Civic Federation in 1902, an amendment to the state constitution was adopted, after a strenuous campaign, by which the "justice shops" of Chicago were abolished. This was a great advance. Mr. Sunny has held many other public positions.



ELECTRICITY IN THE HOUSEHOLD

THE WONDERS OF "ELECTRIC SHOP."

Electricity in the home makes for luxury, convenience or practical utility, according to one's taste and purse. All three of these characteristics are exemplified in a very striking degree in the new "Electric Shop" in Chicago, which has been opened at the corner of Michigan and Jackson boulevards to demonstrate the beauty and variety and usefulness of applications of electricity in the household.

tasteful elegance, one must see it. There is nothing else like it anywhere.

Located in the imposing Railway Exchange building on the corner where the North, South and West Side boulevards meet, or will meet, the Shop could not have been better placed. Its principal feature is a large, imposing apartment on the corner, on the ground floor, architecturally treated as one room, but divided by a richly carved screen into two sections. There are two street entrances

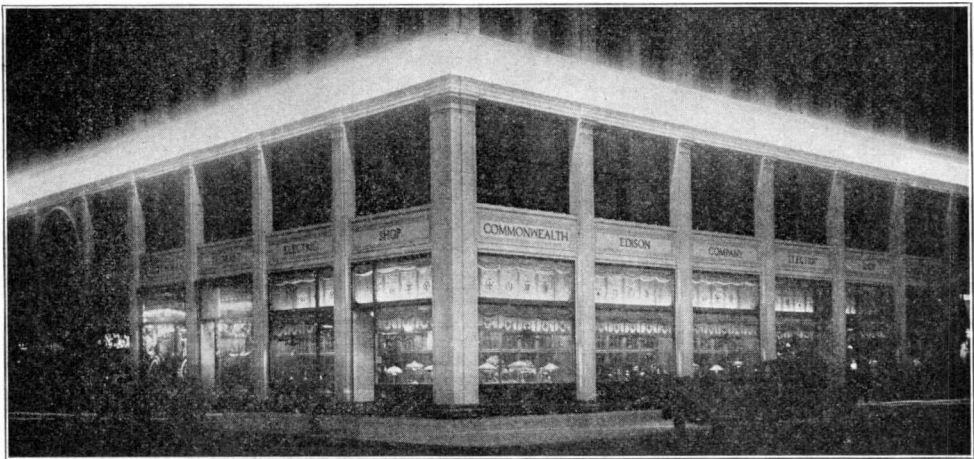

"ELECTRIC SHOP" IS A GLARE OF LIGHT.

The Shop has been fitted up in the most beautiful and lavish manner by the Commonwealth Edison Company and it is rapidly becoming one of the show places of Chicago—a really sumptuous demonstration of the wonders of electricity as applied to make life better worth living in the home. The illustrations give some idea of it, but to appreciate fully its rich,

into the Shop, one from each street, and it has seven show windows. Some 750 tungsten lamps arranged in a line running entirely around the street fronts of the building, just above the second story, make the structure conspicuous and also make the sidewalks beneath almost "as light as day" at night, for the Shop is open in the evening.



MAIN ROOM IN "ELECTRIC SHOP".

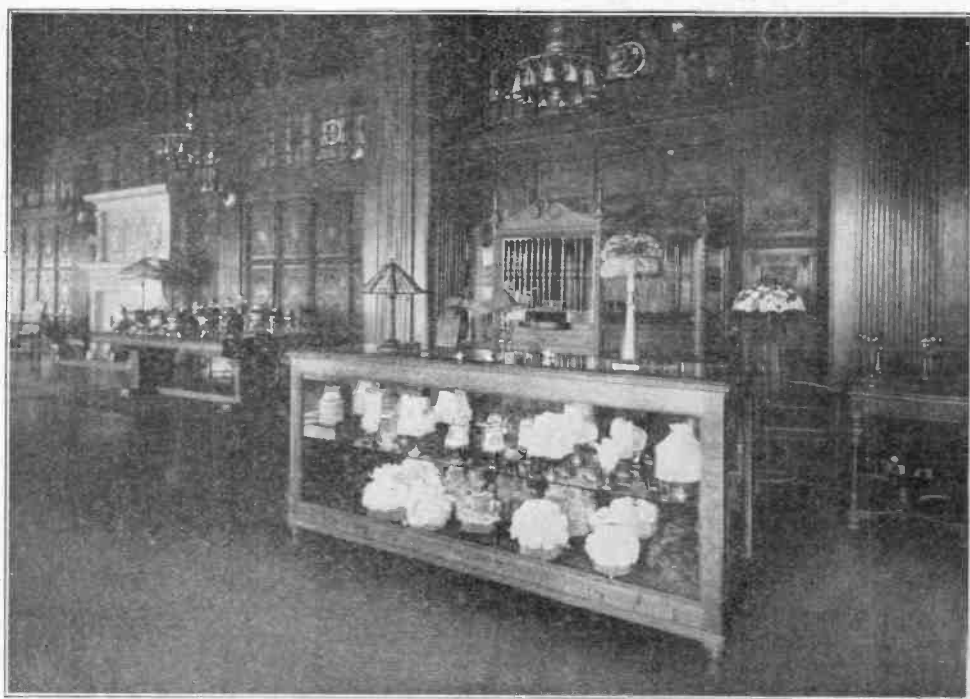

SALES ROOM IN "ELECTRIC SHOP".

The display windows themselves merit an extended description, did space permit. They show some of the beautiful and useful objects to be seen within and are lighted by tungsten lamps with Holophane shades placed in the ceilings of the windows and arranged between screens of art glass so as not to be themselves visible. There are handsome curtains especially designed, with lace borders matching the style of the room. Each window bears the crest of Electric Shop in colors.

The main entrance is on Jackson boulevard and leads into the reception room, as the southern part of the main



CORNER BY THE "ELECTRIC WOOD WIRE".

room is called. The general effect of the decorations is as though one stepped into a fine old room in a mansion. The architectural treatment, carefully and well worked out, is Elizabethan, with richly carved wainscot and beamed ceiling. The woodwork is oak in antique gray finish, and the panels of the wainscot are richly carved. These panels are also doors, behind which are concealed shelves for goods, or, in one case, a beautifully finished switchboard, from which the vari-

ous electric circuits are governed on the "remote-control" principle.

Above the wainscot is a frieze of rich art glass running entirely around the room and made up of panels representing the old coats-of-arms in use in early English times. Behind the frieze are placed electric lights carefully planned to bring out the deep, warm colors of the designs in the glass to best advantage. When these are turned on there is a luminous band, softly but richly colored, running entirely around the room.

The floor is of interlocking rubber tile, dark green in color, while the beams of the ceiling are richly decorated with gold and the strong primary colors. The ceiling between the beams is treated in a deep old gold. Large and handsome Oriental rugs are scattered about the floor, and the furniture is of carved oak, especially designed for the Shop in the Elizabethan style and in finish the same as the wainscot walls. There is an imposing fireplace of white Bedford stone richly carved in the same style as the wainscot. In it, supported by andirons especially designed, a wood fire is burning—apparently. But this is an electric wood fire imported from Germany; it is a remarkably clever imitation, without dirt or ashes, and is greatly admired.

Besides the frieze lighting there are ceiling and wall fixtures for general illumination. They are notably handsome. Further, the portable and floor lamps displayed for sale, and which are such a conspicuous feature of the reception room, are all arranged to be "connected," so that they also may furnish light. These lamps are many of them very beautiful—real works of art. Various styles and periods are shown, as Viking, Greek, Roman, Renaissance, Louis XVI., Colonial, Modern Floral, and many others. In the reception room are also shown, on tables, a variety of highly finished utensils for dainty electric cooking, as chafing dishes, coffee percolators, tea kettles and the like, in silver, copper, bronze or nickel. Many have handles of ebony or other rare woods.

The sales room is the northern portion of the large room. It has a direct entrance from Michigan boulevard. Here are the cashier's desk and show-cases containing many electrical novelties.

Among these articles are vibrators, fancy silk shades, flashlights for the pocket, various kinds of sockets, adapters for candlesticks, gas or oil lamps, electric heating pads, hair dryers, curling irons, cigar lighters and numerous small specialties. Here also are to be found vacuum cleaning outfits, luminous and non-luminous heaters, electric stoves and all kinds of electric heating and cooking utensils as well as the less expensive portable electric lamps. In one wall-case are samples of the beautiful Quezal iridescent shades for lights and more silk shades in lovely colors.

Extending westward from the sales

This room illustrates four distinct methods of lighting—cover or trough lighting, side lighting, direct lighting from a central fixture suspended over the table, and indirect or “eye-comfort” lighting in which light from lamps concealed in fixtures suspended from the ceiling is first thrown on the ceiling and thus reflected throughout the room. The serving tables are connected most ingeniously for electric cooking conveniences and there is an electric “wood fire” in the fireplace.

Adjoining the dining room on the south are the kitchen and pantry and beyond the latter is a lavatory for women.

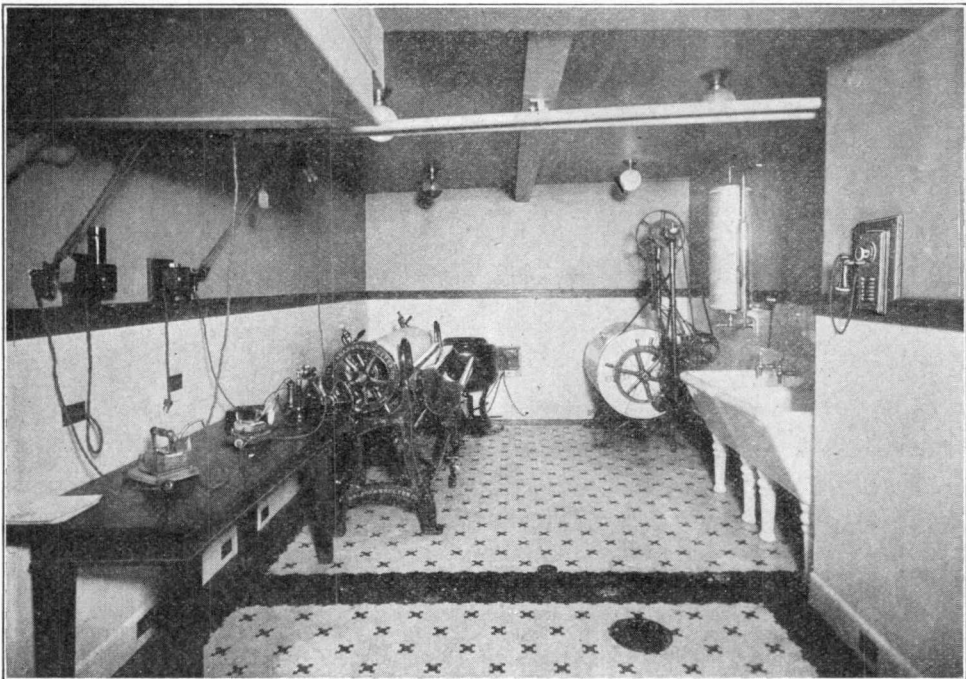

LAUNDRY IN "ELECTRIC SHOP".

room, and with an entrance also from the lobby of the building, is the dining room of Electric Shop. This is designed in the style of the early English Renaissance, with wainscot of fumed oak and a vaulted ceiling ornamented in low-relief panels treated in gold and colors. The fireplace is of old English tile, and there are a sideboard and two serving tables as well as the dining table and chairs. The hangings are of silk brocade after a design of the period which the room represents.

The kitchen is designed to be a model one in every respect. All the fittings are of the most up-to-date character, nickel-plated or white-enamelled where possible. The porcelain sink is said to be the finest in Chicago. There is an electric cooking range with a metal hood and provided with an oven, a grid, a frying pan, coffee percolator, cereal cookers, broiler and tea-kettle. A big white electric refrigerator, an electric dish-washing machine with a glass front and a kitchen table where all sorts of practical demonstra-

tions are carried out, complete the equipment of this interesting room.

In the pantry are a German-silver sink and a china closet. Here are an "instantaneous" electric water heater and an electric food warmer. The hangings at the doors in the kitchen and pantry, which are finished alike in maple, are of

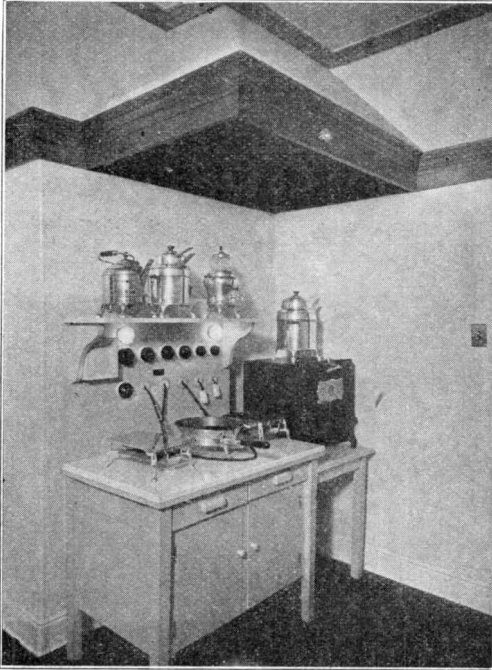

A CORNER IN THE ELECTRIC KITCHEN.

quaint design in white and yellow which recalls the work on the old English samplers.

A private automatic electric elevator, very handsomely finished, is used to convey visitors to the basement. It is of the type designed for household use, in which no operator is required. All that is necessary is to press the proper button, either in the car or at the entrance to it, and if the coast is clear and all is safe, the machine does the rest. The elevator will not operate if any door leading to the shaft is open. It meets with the unbounded approval of visitors.

In the basement are to be found the many ingenious labor-saving devices by which electric power is nowadays displacing manual labor in the home, to the great relief of the women of the household. The elevator, for instance, saves stair climbing. There are electrically driv-

en sewing machines, coffee grinders, knife sharpeners and buffers for cleaning silver. One ingenious outfit, mounted on a circular table, consists of an egg beater, a small churn, a fruit-juice extractor, an ice-cream freezer, a meat chopper, a cake stirrer, a coffee grinder and a potato peeler. Surrounded by these little machines is one central electric motor, so arranged that it may be connected to any one of them and provided with two speeds.

All the laundry appliances are shown here—several washing machines, a centrifugal extractor to separate the water

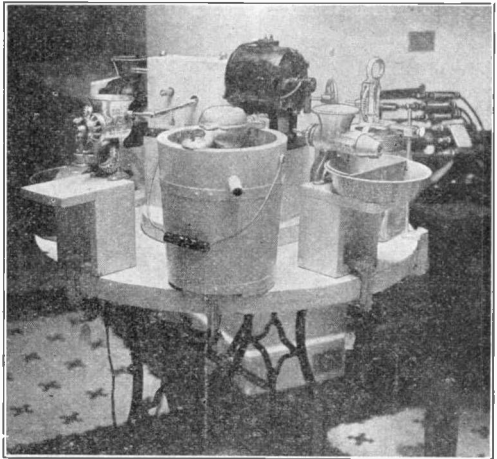

ONE MOTOR OPERATES EIGHT UTENSILS.

from the clothes and so dry them, an electrically heated and turned mangle, the indispensable electric flatiron and ironing-table fixtures. There is also an electric water heater for the laundry. A very complete demonstration is also made of the system of cleaning houses and buildings by the vacuum process which is now attracting so much attention.

A "mercury arc rectifier" shows how electricity in the form of alternating current can be changed or "rectified" so as to be suitable to charge the storage batteries for the electric automobile in the garage. A "low-voltage transformer" demonstrates how bells may be rung by electricity supplied by the ordinary electric-lighting circuits in the house, if of the alternating current kind, doing away with batteries. The ammonia plant for operating the refrigerator in the kitchen is in the basement and is shown in opera-

tion. There is also an electric machine for making ice for table use.

In another basement room are displayed fixtures of all kinds for electric lighting. Here also is a demonstration of color effects under various forms of light. The inside working of the customer's electric meter is made clear in this room by a working demonstration. Indeed, it is characteristic of Electric Shop that everything is or can be shown in operation. By this means the display is not only of great interest as an exhibition but is of real educational value, for it is open every secular day and visitors are made welcome.

NEW DEVELOPMENT IN COOKING UTENSILS.

Almost every day something new in the line of electric cooking devices is brought out. Higher efficiency is being sought continually in order to reduce the cost of electric current for household

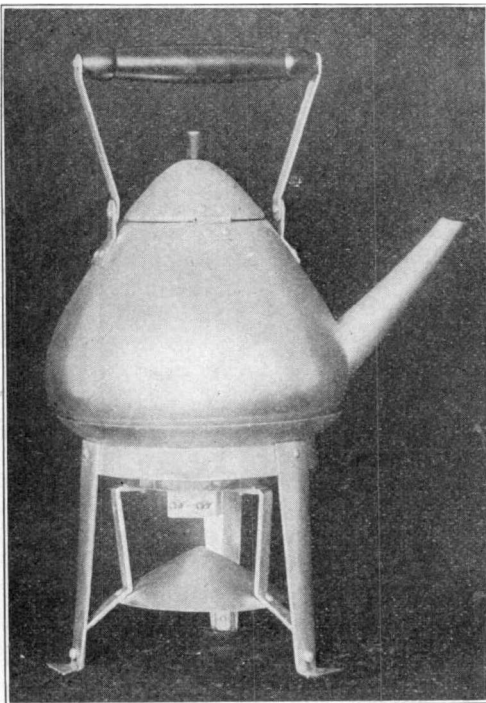

SOMETHING NEW IN TEA KETTLES

purposes and hasten the approach of the era of fireless, smokeless cooking. Among recent developments is the application of a new type of heating ele-

ment to a line of unusually attractive utensils, some examples of which are here illustrated. This heating element consists in reality of a little flat top disk,



ARTISTIC COFFEE PERCOLATER.

or stove, which, by means of a special clamping device, similar to the cover of a fruit jar, is held firmly up against the bottom of the vessel to be heated. The only part of the heating element exposed to view is the projection which carries the terminals for attachment to the plug and cord, but the arrangement is such that the parts may be removed and washed.

The disk of the heating element is made of a special metal alloy which conducts heat very readily, and which will not rust. The resistance ribbons of metal, which are connected to the electric circuit, are situated very close to the under side of the disk, and as the current flows through them they are heated

so quickly that in five seconds the hand cannot be held to the disk. Beneath the ribbons is a dead air space which effectually prevents radiation, so that all the heat generated by the current, for which you are paying out your money, goes into the materials which are being cooked. None is radiated out into the

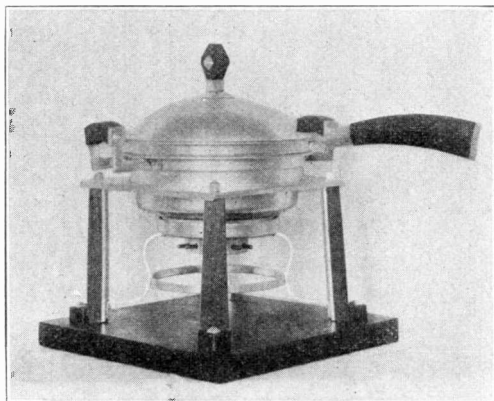

CHAFING DISH WITH NEW TYPE OF HEATER.

room as a waste and as an actual discomfort during warm weather.

The chafing dish shown in one of the pictures is equipped with one of these heaters, having two sets of terminals as shown, giving two different heats. This heating element is known as a 500 watt unit; that is, it consumes current equal to that required for ten ordinary incandescent lamps. At ordinary rates for current this would not mean over five cents an hour for operation at full heat. With this device many appetizing dishes may be cooked which will constitute the principle item on the bill of fare and a substantial meal may be prepared at the cost of but a few cents for heat.

THE RADIANT TOASTER.

The proper making of toast involves the conversion of the starch in the bread into dextrine in the toast. In order to do this most thoroughly the heat should be given time to penetrate to the center of the slice before the outside has begun to change color. This ideal condition is most nearly realized when bread is toasted entirely by radiant heat. By subjecting bread to the heated air currents of a stove top it is quickly browned on the surface and easily burned. Thus the

necessary chemical changes are not permitted to take place. Toast that is clammy in the middle and blackened on the outside is less nutritious than untoasted bread, and much harder to digest.

With the Radiant toaster browning is evenly distributed over the entire surface of both sides of the bread by means of radiant heat in about three and one-half minutes from the time current is turned on. Subsequent toasts may be made in three minutes or less.

The toaster comprises a solid porcelain base upon which is mounted a nickel wire grid inclosing a radiant heating element. This heating element consists of little vertical coils of resistance wire which become red hot almost the instant

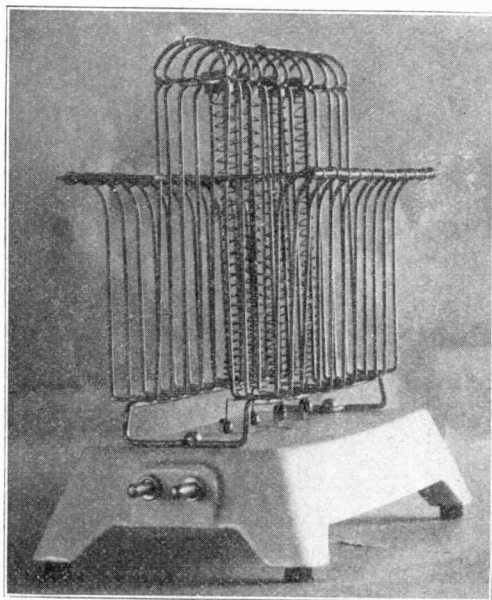

THE RADIANT TOASTER.

the current is turned on. The slices of bread are then placed in the grid with their surfaces almost in contact with the heating element and are promptly toasted entirely through and given a delicate brown on the outside.

Four slices may be toasted at one time, two on each side. The device may be used on the breakfast table as rubber feet are provided for the base which prevent injury to the table top. The two terminals at the end of the base enter a plug attached to the insulated wires which reach to the nearest lamp socket.

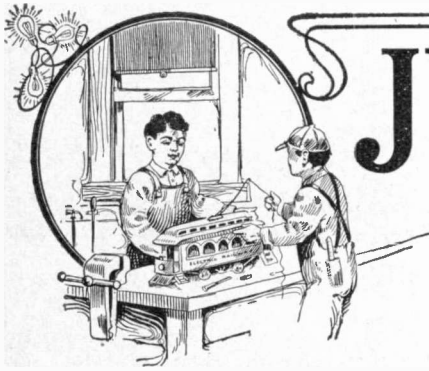

JUNIOR SECTION

HOW TO MAKE AN ELECTRIC ALARM CLOCK.

There are many kinds of mechanical alarm clocks, but here is an electrical one that anyone can make. All the materials needed are two dry batteries, about 20 feet of bell wire, a switch and some common pins.

Fasten one end of a wire to the works of the clock so as not to interfere with its mechanism. (See diagram.) Stick pins into the face about where every

hour is marked and fasten all of these to the end of another wire.

The other wire, which is attached to the works, fasten to the switch and next to the batteries.

When the wire on the hour hand comes in contact with the pin to which the wire is attached a contact will have been made, and the bell will ring until the wire has passed by the pin or the switch is turned off.

TELEPHONING UNDER WATER.

A Belgian named Debbaudt is reported from Antwerp to have introduced successfully a new system of telephonic communication between a diver at the bottom of the harbor and his mates in the boat or on land. The diving costume which he wears differs but little in outward appearance from the usual type, but in the helmet there is a telephone transmitter and receiver, in communication with the usual apparatus employed in telephony, above the water, by means of a wire passing through the air-supply tube. A Holland journalist on land was able to carry on conversation with a diver so equipped, without the slightest inconvenience resulting from indistinctness. The great advantage of this invention is that in future the diver who has any communication to make to those above will not either be limited to a code consisting of a few jerks of the life-line, or have to ascend to the surface every time he has anything to say. Those above will be able to communicate their directions to the workers on the bottom with accuracy and dispatch. Of course the saving of time will be an important feature, but safety to the diver is the first point to be considered.

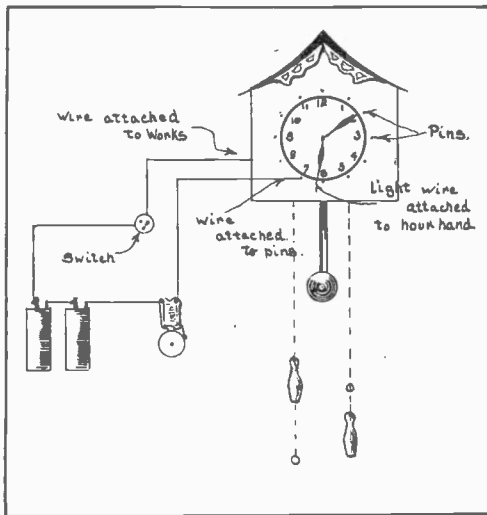

ELECTRIC ALARM CLOCK.

hour is marked and fasten all of these to the end of another wire.

Wind around the hour hand a very fine uninsulated wire, so that one end will project far enough to strike the pins, and the other end will make a connection with the wire attached to the works.

Fasten the other end of the wire,

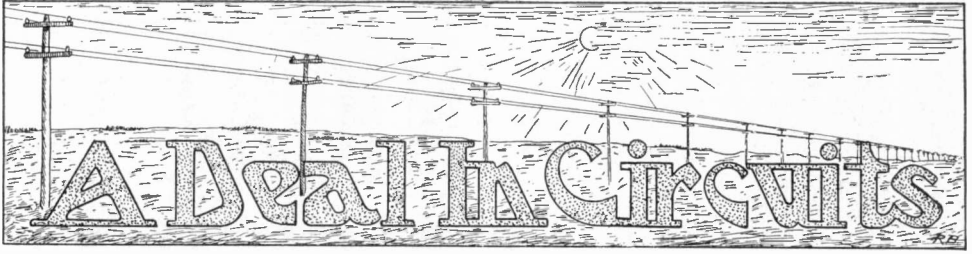

BY PAUL H. WOODRUFF.

Dan Gilmore stood in front of the office of the Marengo Telephone Company and looked himself over. His glance had travelled from a pair of dilapidated shoes to the very baggy knees of his trousers, when he decided that further inspection would probably weaken his self-confidence, and so spoil his appeal for a job. He hastily entered the telephone office.

"Please tell the manager that Mr. Gilmore would like to see him," he said boldly to the only person in sight.

"About what?" queried the young lady, coldly.

"Why—er—work!" he announced, rather less confidently.

"Second door to the right." She was already at work on the books again, and Gilmore passed through the door he thought she had indicated.

The second door to the right was closed. He opened it slightly, with the caution of a man not sure he is right, and glanced in. Seated about a long table were five or six men, listening to another who stood at the head of the table, and spoke in rapid; vehement tones.

"In other words, gentlemen," he was saying, "twenty-five thousand dollars' worth of stock must be sold if we are to continue in business. The eastern market is flat—dead. And if that amount is thrown on the local market you know the result. The situation is critical."

Gilmore softly closed the door and tiptoed away.

"Wrong door; directors' meeting," he muttered. "No place to look for a line-man's job, though, that's plain."

He walked out of the building and surveyed it with some interest. Then he strolled along the main business street to the western edge of the town. As far

as he could see was the desert; and overhead, glistening brightly in the sun, stretched four taut copper wires, whose supporting poles vanished at the horizon. Gilmore eyed the construction with approval.

"That's the long distance line to Reno," he commented. "A valuable property, or I'm no judge of telephone work. And the company owning it is up in the air!"

The best street corner in town was occupied by an assay office. Over it a gold-lettered window indicated the place of business of the Transplanetary Space Telephone Company; visitors welcome.

Gilmore stared at this inscription for fully a minute. Then he started up the stairs. As his eyes attained the level of the second floor his glance, directed through an open door, fell upon a large man seated at a splendid mahogany desk. The large man was smoking a large cigar and gazing into vacancy; and his thoughts were pleasant, judging by the smile which flickered across his not too refined features. Gilmore stopped abruptly, ducked his head, and for the second time crept noiselessly out again into the street.

"Whew!" he whispered. "Old Colonel Powers! Good thing I saw him first. I don't want to meet him; that is, until I find out what his game is."

He put his hand in his pocket and surveyed what came forth with interest.

"Two dollars and seventy cents," he announced to himself. "Good chance for another bankruptcy soon."

He entered the Palace Hotel and walked to a public telephone booth. There he consulted the directory, called a number and dropped a five-cent piece in the slot with something of a grimace.

"Hello!" he called presently. "Is this

the office of the Transplanetary Space Telephone Company? I am considering an investment, but want some information before taking time to call on you. You have a wireless system, I presume?"

"We have the only wireless system, my friend," came the reply, in a powerful voice fairly bubbling with enthusiasm. "A system that will revolutionize all existing methods of communication; a system that—"

"Can you demonstrate?" cut in Gilmore.

"Our system is open to you at any time you care to make an investigation. Our experimental receiving station is at Reno, and any party you name at that point will be put in connection with you. When do you desire a trial, Mr.—er—"

"This afternoon at three. Goodby," said Gilmore shortly.

Another call and another five cents gave him connection with the offices of the Marengo Telephone Company.

"What can you tell me about the Transplanetary Space Telephone Company?" he asked.

"Absolutely nothing," was the somewhat crisp response. "We are an operating company, with actual business to handle, and have no time to investigate promoters' schemes."

"But," protested Gilmore, "they claim wireless connections with Reno."

"Perhaps they have such connections."

"I believe," went on the inquisitive Gilmore, "that you have the only two lines to Reno, about two hundred miles. Do the Transplanetary people ever use those lines?"

"They never have and never will, sir! Good-day!" The receiver clicked, and Gilmore replaced it on its hook.

"Perhaps," he murmured, "you would profit by taking a little time to investigate promoters' schemes, especially when the particular promoter is Colonel Everard Powers. I wonder if his offer of a connection to Reno is a bluff?"

For a while he pondered the idea of calling on the Colonel in disguise, and putting his offer to the test. But another inspection of his pocket rather discouraged the thought.

"Two-sixty now," he mused; "I'll have to get busy if I'm going to eat tomorrow."

A luncheon reduced his hoard to two dollars and forty cents; but during its consumption he decided on his course. A few minutes later he was slowly following the line of poles of the Reno leads out into the desert.

"Lightning arrester and ground wire on every pole," he commented. He had carefully inspected eleven poles, without pausing, when a bright, silvery spot on one of the wires overhead caught his eye.

"Newly soldered connection," he muttered; "may be suspicious—may not."

He stared at the spot for a minute, then suddenly squatted at the base of the pole and closely examined the ground wire where it was connected to the ground rod. Something about the latter looked queer to him and as he tapped it with his knife, instead of the chink of metal it gave forth a dead, wooden sort of sound. He seized the ground wire and pulled vigorously. Another pull, and the cap came off the ground rod suddenly, revealing a pipe through which the wire continued down into the earth. Both the pipe and its cap were made, not of iron or copper, but of black fiber.

Gilmore was beginning to get interested. A ground rod made of insulating material seemed peculiar, to say the least. He stooped, and with a powerful effort drew it up out of the sand, rather to his own surprise. It was barely two feet long.

"H'm!" he panted. "I think there is a treasure chest buried here, waiting for me!"

Using his hands and the bit of fiber tube, he began digging. The loose, parched dust of the desert got in his eyes and nose, and ran back into the hole nearly as fast as he removed it, but in half an hour he felt something hard beneath his fingers. A few minutes later he opened a stout oak box about a foot square, and roughly tore from its inside two large, ironclad coils of insulated wire. Their removal revealed the end of an iron pipe that projected into the box from the side toward town. From the pipe protruded two wires.

"There's another of these machines about twelve poles out of Reno; but I think this one will settle the Colonel," he

said, as he triumphantly surveyed the dismantled apparatus.

He walked back to town with the confiscated coils, and hunted up the office of the *Marengo Mercury*. The evening edition was just going to press, but the advertisement clerk promised to insert a "personal" notice reading:

"Investors in Transplanetary Space Telephone stock will learn something of great importance by calling in person on Mr. Gilmore, Hotel Palace, at 9 this evening."

"Exactly!" said Dan, cheerily. "Up to your old tricks, eh, Colonel?"

Colonel Everard Powers straightened up suddenly.

"See here!" he said huskily. "I've got a good thing here. You spoil it and I'll—but hold on a minute. You're a telephone man, Dan. Come in with me, and you will have ten thousand in a week."

Dan smiled.

"I'm afraid the game is spoiled now, Colonel, even if I did want to become



HE UNEARTHED SOME IRON-CLAD COILS.

Then Dan Gilmore walked up the stairs over the assay office and entered the door of the Transplanetary Space Telephone Company without a hint of his former diffidence.

"Well, well, Colonel! I'm really glad to see you here!" he exclaimed heartily.

But the Colonel did not seem to share in the enthusiasm. His great body seemed to have shrunk down into his chair, and even his cigar hung limp and dejected from his half-open mouth.

"Dan Gilmore!" he gasped feebly.

your partner in crime," and he tapped the coils significantly.

The Colonel's face turned a livid purple, and he leaped from his chair.

"Sit down, Colonel, sit down!" said Dan coolly. "Ever since that little affair of yours in Chicago I have carried a gun handy, in case I should meet you. I have an item in the evening paper that will expose your whole scheme, and tomorrow you will be behind the bars."

The Colonel was speechless and seemed in danger of apoplexy.

"On second thought, though," said Dan, still smiling, "I ought to feel grateful to you. I came here looking for an honest job. Through you, I think I will get one. How much actual money have you taken in?"

"Not a cent; not a cent!" protested Powers, finding his voice suddenly. "If you think you can—"

"But you have subscriptions for stock," said Gilmore.

"Twenty-five thousand dollars," groaned the Colonel.

"All good?"

"As gold!"

"Now, Colonel, I'm going to be good to you. Pack your personal effects in a hurry, and vanish before the papers are out. No—stay a minute! You beat me out of the only thousand dollars I ever accumulated about a year ago. Pay me back a hundred and I'll call it square."

"I haven't but eighty dollars," said the Colonel.

Dan reflected.

"You will need a little," he said, "because I want you to get as far away from this town as possible, for the simple reason that I like the town, and think I will settle down here as one of its influential citizens. Give me fifty, and get out. I appoint myself receiver for the Transplanetary Space Telephone Company. Now get!"

At a quarter to nine that evening the clerk of the Palace Hotel began to receive inquiries for Mr. Gilmore. A bell-boy piloted the visitors up to the biggest room in the house, where Dan Gilmore, attired in a well-fitting, new business suit, met them. At nine o'clock he had to send for more chairs. By nine-thirty the room was filled with the business men of the town, who met each other with some surprise.

"Gentlemen," said Dan Gilmore, "I am a telephone man of long experience, and first I want to congratulate you upon the excellent system with which your town is provided. The Marengo Telephone Company owns a property that for efficiency and excellence of construction I have seldom seen equalled. I predict that its stockholders will soon begin to reap very large rewards.

"In your other institution, the Transplanetary Space Telephone Company, I

have today unearthed fraud and deception of large dimensions. I am prepared to prove that the demonstration circuit of the company to Reno, claimed to be wireless, was stolen from the Marengo Telephone Company through the surreptitious use of its splendid long-distance lines.

"As receiver for the wireless concern, gentlemen, I hold your stock subscriptions for twenty-five thousand dollars. This money I have saved to you from absolute loss. You have but to say the word, gentlemen, and these stock subscriptions will be returned to you. But you intended this money for investment. You were promised perhaps fifty per cent, without any proof. I offer you ten per cent, at par value, in an institution that is yours, and that you ought to be proud to have a part in. Tomorrow I will call upon each of you with your shares of stock in the Marengo Telephone Company, which thus becomes the strongest telephone company in this part of the country. Gentlemen, I thank you."

When the excitement and the questioning subsided, Gilmore found that he had sold twenty thousand dollars' worth of stock. To the few dissenters who made up the other five thousand he returned their subscriptions. Then he went to bed and slept the sleep that follows a good day's work.

The next morning, shaven, brushed and polished until he looked "fresh from New York" as the clerk remarked, he entered the offices of the Marengo Telephone Company. As he passed the newspaper office he thanked his stars that the *Mercury* did not get out a morning edition.

Mr. Daniel Gilmore of Chicago, capitalist, created quite a sensation in the telephone office. And when he announced that he was so well pleased with the plant that he intended to invest twenty thousand dollars in stock of the company at seventy dollars a share, one might almost have imagined tears in the eyes of those excellent people.

"And by the way," said Mr. Gilmore, "as I intend to remain here, some minor connection with the actual work of the company, enough to keep me occupied, would be acceptable, if convenient to you. I am an old telephone man."

The officers looked at each other.

"Would you care to accept the position of manager?" asked the president tentatively. "We intend to install a third long distance line to Reno soon, as the traffic is too heavy for the two we have; and we really need a man like yourself to see that everything is properly taken care of."

"Why don't you install a phantom circuit on the two you have at present?" asked Gilmore. "Your present lines are first-class, and in that way you will secure your three circuits without any new construction work."

The officers shook their several heads.

"We tried that only a month ago, Mr. Gilmore," said the secretary, "but the phantom apparatus would not work. Do you know of any case where such a circuit has operated successfully?"

Gilmore grinned.

"The last bit of telephone work I did was to inspect a very successful phantom circuit, over the same length of line as yours," he replied. "As to its working—I have a couple of phantom coils at the hotel that I will donate in honor of my new position with you; and I'll guarantee they will work!"

QUESTIONS AND ANSWERS.

Readers of Popular Electricity are invited to make free use of this department. Knowledge on any subject is gained by asking questions, and nearly every one has some question he would like to ask concerning electricity. These questions and answers will be of interest and benefit to many besides the one directly concerned. No consideration will be given to communications that do not contain the full name and address of the writer.

COMPOUND DYNAMOS; MEASURING BATTERY RESISTANCE.

Questions.—(A) What is the difference between an over compounded and an under compound dynamo? (B) What are the uses of each? (C) How can the internal resistance of a battery be measured?—N. G. B., Marlboro, Mass.

Answers.—(A) In a compound wound machine each field magnet is wound with two separate coils, one of a few turns of heavy wire in series with the armature; the other, a shunt, consists of many turns of fine wire connected across the brushes. The shunt winding is proportioned to bring the voltage up to normal with no load. Then as the load comes on, the increasing current through the series winding and out to the line increases the field excitation in proportion as the load comes on and maintains the pressure constant across the brushes. Such a machine is compound wound. If this series winding is of enough turns to raise the voltage above the normal as the load comes on, such a machine is over compounded. If, on the other hand, the series turns are not sufficient to keep up the normal voltage as the load increases, the machine is under compounded.

(B) Compound dynamos are used in isolated plants and small central stations where automatic regulation is required, and are generally employed in electric

railway houses where voltage fluctuation is considerable owing to changing load. Over-compound dynamos are used where it is necessary to generate somewhat above the normal voltage in order to deliver normal voltage at some distant point.

(C) The internal resistance of a cell is difficult to measure. The voltmeter—

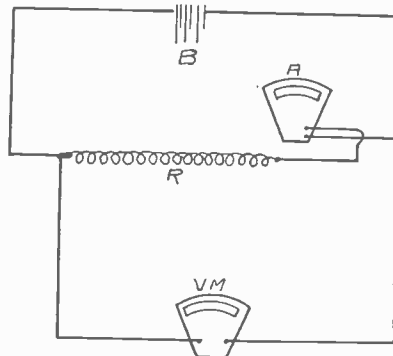

METHOD OF MEASURING BATTERY RESISTANCE.

ammeter method shown in the diagram is considered good, letting the battery replace (R). The voltmeter reading will be the drop over the ammeter and (R). The resistance of the ammeter must be known, then by Ohm's law, (C) times resistance of the ammeter equals the drop over the resistance of the ammeter where

(C) is the ammeter reading. Hence to be correct $R = \frac{E - (C \times \text{Am. res.})}{C}$. The

drop over the ammeter is small and in every day work this correction may be neglected; then $R = \frac{E}{C}$.

HOUSE SYSTEM TELEPHONE CIRCUITS.

Question.—I have started to put telephones in our mill—one in the office and five in different parts of the mill. I wish to arrange so that the office can call any one of the five by using a switch, and also so that any one of

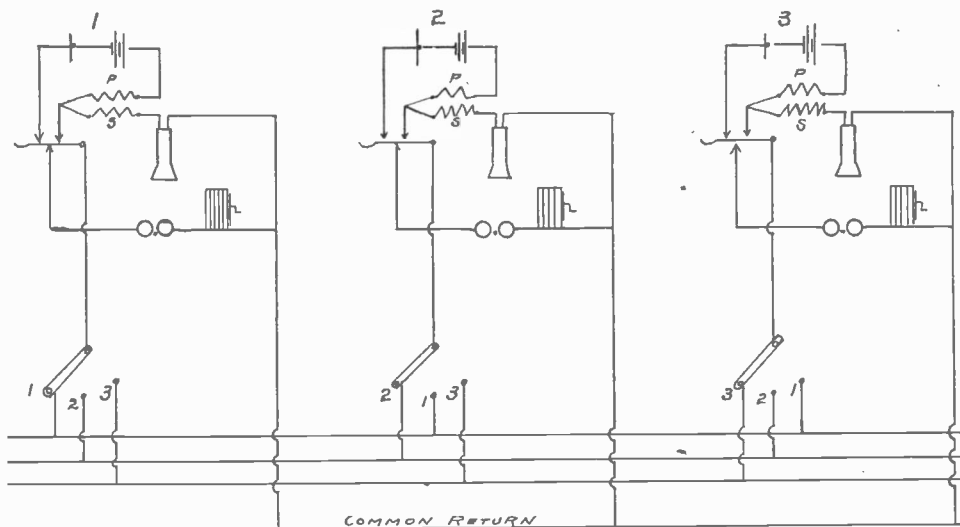

HOUSE SYSTEM TELEPHONE CIRCUITS.

the five can call the office without interfering with the other four.—R. K., Haledon, N. J.

Answer—Arrange circuits as shown in diagram except that you should provide six separate wires, preferably in cable form, and a common return. With this arrangement and a six-point switch any telephone may call any other without interfering with the others, but care must be taken, when through talking, to place the switch on the home button for a future call.

TRANSFORMER; STORAGE BATTERY CHARGING.

Questions.—(A) How can a transformer be made that will step six volts direct current up to 10 or 12 volts. (B) can dry batteries be used for charging the storage battery de-

scribed in the February issue, 1909.—R. L. N., Tilton, N. H.

Answers.—(A) Transformers can be used on alternating current only.

(B) They could be used but the process would be very costly.

SPARK COIL OPERATED FROM DYNAMOS.

Questions.—(A) Would a dynamo having two field coils, a six segment commutator and a twelve slot armature run a spark coil? (B) Would an eight segment commutator and eight slot armature do the work? (C) Could I use a magneto to operate a spark coil having a vibrator?—W. O., Grand Park, N. Y.

Answers—(A) and (B). Yes, though the current would be somewhat unsteady.

(C) No. The ordinary magneto generator is wound to give alternating current at high voltage and little current.

MOLDING CARBON.

Question.—Can powdered carbon be molded into sticks or cylinders, and if so how?—W. C., Rochester, Ill.

Answer.—Briefly, coke is crushed to the size of coarse gravel in a mill for this purpose. It is then placed in retorts, heated 30 to 40 hours to a white heat, then cooled. The solid so formed when cool is ground and bolted like corn meal so as to separate the coarse from the fine. Next, coal tar pitch is ground fine like the coke. These two are carefully

mixed (in which process lies the secret) in a revolving barrel kept at 300° F. The mixture left to cool for 12 hours becomes so solid that it is again pulverized. Into hot molds the pulverized material is poured, heated again for a short time to 300° F., then the molds are subjected to great pressure. The molds are then opened and carbons attached to each other by "fins" are taken out, placed in fine sand in a furnace and heated for 96 hours. The cooling requires 48 hours. The carbons are now uncovered, sorted and sent to the plating room to receive the copper coating that you see on arc lamp carbons.

carbon and manganese to act as conductors? (C) Does the saline solution act chemically on the manganese? (D) Is not the electricity produced by the corrosion of the zinc by the solution, and not by action on the manganese? (E) Sand and sawdust on top must become damp; do they not tend to short circuit to some extent?—J. M. McM., Port Townsend, Wash.

Answers—(A) Authorities agree in the use of battery solution for moistening except that some manufacturers use trade secret binding substances. The powdered carbon and manganese are moistened and stirred until no longer dusty.

(B) The carbon acts as a conductor

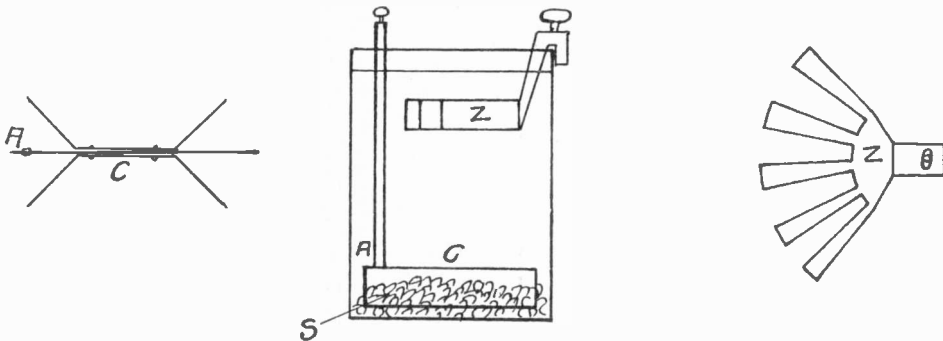

CROWFOOT OR GRAVITY BATTERY.

CROWFOOT OR GRAVITY BATTERY.

Question.—Please give directions for making a crowfoot or gravity battery.—H. H., Kansas City, Mo.

Answer.—See sketch. The copper (C) is made of thin leaves of the metal riveted together as shown, having an insulated wire attached at (A). The zinc (Z) may be of any shape but is usually as shown. For a jar six inches in diameter and eight inches high use a three-pound zinc and three pounds of copper sulphate (S). Fill the jar with water. This cell should always be left working on a small resistance. When not in good condition the blue solution will rise and copper will be deposited on the zinc. The voltage is 1.07 and the current one-half ampere.

DRY BATTERY CONSTRUCTION.

Questions.—(A) Are not all dry cells packed solid with powdered carbon and manganese dioxide, to which is added a small amount of material other than moistening with the battery solution? (B) Is it not the function of

and electrode, and the manganese is a depolarizer.

(C) No.

(D) The chemical action in the cell is as follows: When the circuit is closed the zinc (Zn) displaces ammonium (NH_4) in the solution forming zinc chloride ($ZnCl$). The ammonium breaks up into ammonia gas (NH_3) which either unites with water or escapes, and frees hydrogen (H) which is liberated at the surface of the carbon. Without the manganese the hydrogen would soon collect on the carbon, but with the manganese rich in oxygen the hydrogen takes up oxygen and forms water (H_2O).

(E) Some moisture as an electrolyte is essential to the operation of the cell.

WINDING SMALL A. C. ARMATURE.

Question.—How may I wind a one-eighth horse-power motor armature for operation on alternating current?—P. C., Newkirk, Okla.

Answer.—See answer to question (B) of F. E. B., Mendota, Wis., and also to M. B., Superior, Wis. March issue, 1909.

OPEN CIRCUIT TELEGRAPH SYSTEM.

Question.—How should I connect a telegraph line consisting of three instruments on an open circuit with only one main wire? L. R. D., St. Johnsbury, Vermont.

gauge double cotton covered wire on armature and four pounds of No. 20 B. and S. gauge on field magnets. Wind as in diagram.

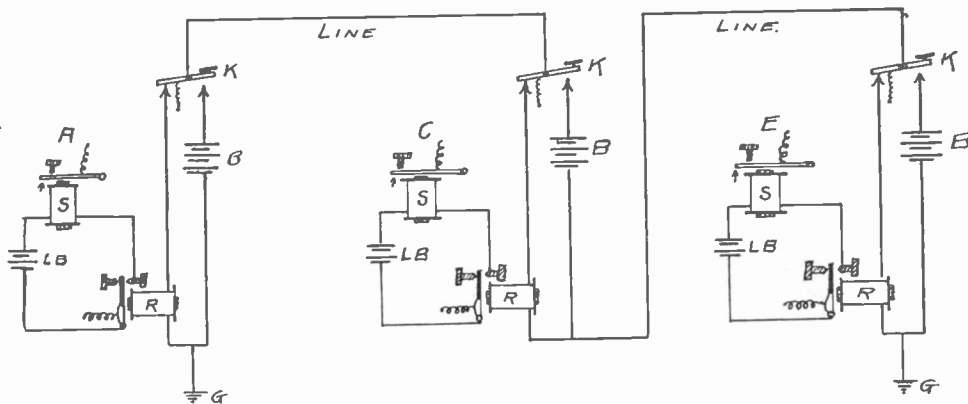

OPEN CIRCUIT TELEGRAPH.

Answer.—The diagram shows three stations (A, C, E), keys (K), sounders (S), relays (R), local batteries (LB), main line batteries (B), and grounds (G). When not in operation all batteries are on open circuit.

WINDING A 75-WATT DYNAMO.

Question.—Please tell me how to wind a drum armature of a small 75-watt dynamo.—T. F., So. Whitely, Ind.

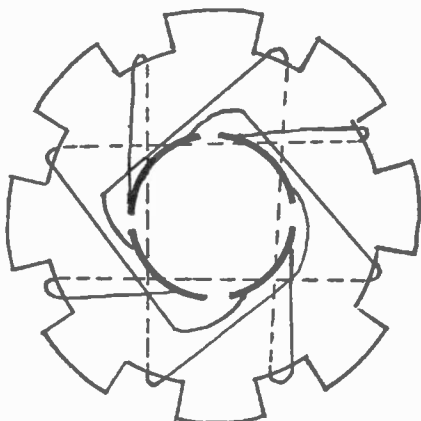

DYNAMO WINDING.

Answer.—We assume two field magnet coils in shunt, diameter of armature two-thirds of the length, and eight slots. Use eight ounces of No. 20 B. & S.

ELECTROPLATING.

Questions.—(A) What capacity dynamos would it take to operate a 64 gallon copper solution to deposit on one-half dozen plates 18 by 25 inches? (B) What are the ingredients and quantities in the above bath?—D. W., Reading, Pa.

Answers.—(A) Current of 15 to 18 amperes per square foot at six volts or less works most satisfactorily for copper.

(B) Fourteen per cent copper solution, two or three per cent sulphuric acid, and distilled water or filtered rain water.

A cyanide solution much used on iron, brass, and steel is made as follows: Pure potassium cyanide, ten ounces; potassium carbonate, two ounces; copper carbonate, five ounces. For each gallon of water use quantities above noted, dissolving nearly all of the potassium cyanide in part of the water, then adding copper carbonate which has been dissolved in the water. Now dissolve the potassium carbonate in water and add to the above solution while stirring. Use copper anodes and a weak current with this solution.

AN ELECTRIC CANNON.

Question.—How can I fire a small muzzle loading cannon by electricity?—R. W. Y., St. Joseph, Mo.

Answer.—See answer to C. D. in March issue. A modification of this arrangement to suit your cannon, with wire tips at or in the touchhole of the gun will fire it.

THE NICKEL TELEPHONE.

Question.—Would you give diagram of connections used in Chicago five-cent telephones?—W. H. S., Chicago, Ill.

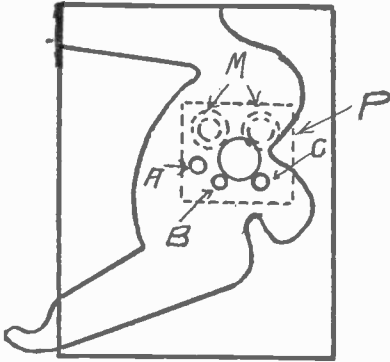

NICKEL IN THE SLOT MECHANISM.

Answer.—Referring to both diagrams, the coin when deposited strikes projection (A) and drops between projections (B) and (C). This places a ground on the line through magnets

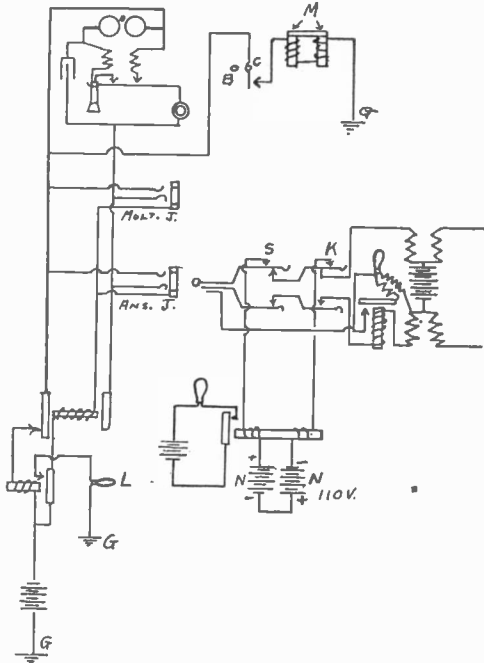

CONNECTIONS OF A NICKEL TELEPHONE.

(M) and lights lamps (L). This current is so small that magnets (M) will not operate. The operator answers by inserting answering plug, cutting off signal lamp (L) and talks to subscriber. If party called answers, the operator

presses key (K) sending 110 volts through magnets (M) and (C) is drawn back and coin falls into box. (B) and (C) are fastened to a flat plate in front of (M). If party does not answer, key (S) is pressed, sending 110 volts in the opposite direction through (M) withdrawing (B) and allowing coin to fall out of box. In case a coin is dropped into box while another is still in place it rolls over coin and (A) and returns to party calling.

SINGLE WIRE SIGNALING CIRCUIT.

Question.—Is it possible to have a single-wire signaling system between two points consisting of a push button switch, bell, and battery at each end so arranged that when circuit is closed at (K'), bell will ring at (C) only, and if switch is closed at (K) bell will ring at (A) only.—F. C. L., Cleveland, Ohio.

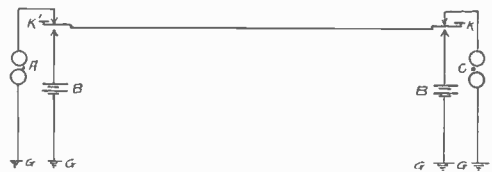

SINGLE WIRE SIGNAL CIRCUIT.

Answer.—See self-explanatory diagram.

ARC FURNACE.

Questions.—In an arc furnace I use lamps for resistance. These are too expensive and short lived. My current is 115 volts, 60 cycles and I wish to draw six or eight amperes. (A) I should like to use iron or steel wire. (B) In furnace shown in the February number is there any way to empty the crucible while hot, because in taking it up with forceps the lower carbon comes out, leaving a hole in the bottom.—W. M., Salt Lake City.

Answers.—(A) The resistance of one 32-candlepower lamp is 108 ohms. You are using eight in parallel placed in one lead to arc. The total resistance is then 13.5 ohms. No. 14 B. & S. gauge iron wire might be used but 725 feet would be necessary to give 13.5 ohms resistance. A high resistance wire such as German silver, or ferro-nickel, would be better. See answer to J. B., February issue.

(B) No, unless the lower carbon is not fastened to base and is attached to an insulated flexible conductor.

TO MAKE AN AMMETER OR VOLTMETER.

Question.—Please tell me how to make a simple ammeter.

Answer.—Secure a piece of brass wire $\frac{1}{8}$ inch thick and $1\frac{3}{8}$ inches long. In

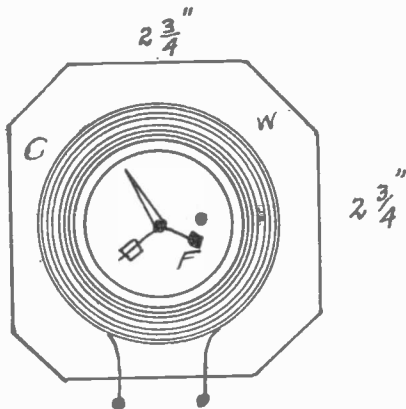
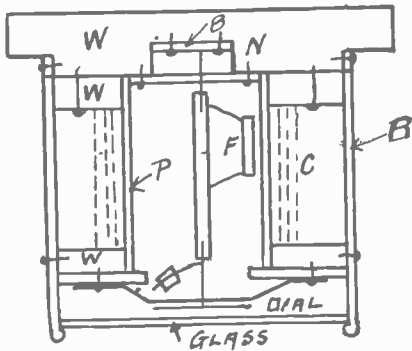

AMMETER OR VOLTMETER.

each end make a hole $\frac{3}{16}$ inch deep with a needle drill. Cut the heads off two pins and solder in each end, these pins to act as pivots. Referring to drawings, make a bobbin of paper $\frac{1}{16}$ inch thick (P), $1\frac{5}{16}$ inches in diameter and $1\frac{3}{8}$ inches long. Parts marked (B) are brass, and those marked (W) are wood. To the brass shaft solder a piece of soft iron (F). In the base (N) and through the brass plate drive an iron nail. For a voltmeter, wind on No. 36 cotton covered wire until bobbin is nearly full. For an ammeter try 12 turns of No. 14 wire and vary until a full scale deflection is obtained. As a voltmeter the instrument will read 20 volts. As an ammeter full scale deflection is made by four amperes. When

current is passed through the coil the nail and soft iron bar repel each other as both are magnetized.

DYNAMO WILL NOT RUN.

Questions.—I have made a dynamo with field magnets of the Edison type. The armature is laminated with 12 round slots. The armature is wound in diametrically opposite slots until they are full. (A) Is the winding correct? (B) Why will the dynamo not generate or run as a motor?—V. F., Watseka, Ill.

Answers.—(A) The winding is correct.

(B) This is a most difficult question to answer and requires a noting of numerous possible causes. We suggest that you look up the following: Wrong winding of field magnets; residual magnetism of the field magnets may be of wrong polarity; in small dynamos the average resistance is very easily computed too low, or a mistake made in gauge of wire; mistake in connecting armature winding to commutator; too wide an air gap; break in field or armature coils; a shunt dynamo will not "build up" with a low resistance in the outside circuit.

ELECTRO MAGNET WINDING.

Questions.—(A) I wish to make an electromagnet using a core three inches in diameter by four inches in length. What size and quantity of wire should I use to get the strongest magnet from the use of 20 cells of dry battery? (B) Can I use this magnet on a lighting circuit of 110 volts by reducing to 39 or 40 volts?—F. B., Excelsior Springs, Mo.

Answers.—Use ten layers of No. 20 B. and S. gauge double cotton covered wire.

(B) Yes.

RING WOUND ARMATURE.

Question.—Will you tell me how much and what size wire to wind on a dynamo armature three inches in diameter and one and three-quarter inches long?—M. C., Louisville, Ky.

Answer.—Assuming from dimensions that your armature is of the ring type, allow the field winding to remain, and use at least nine ounces of No. 20 wire. Ring armatures should not be wound more than three layers deep.

NEW ELECTRICAL INVENTIONS.

SIGHTING BIG GUNS.

In sighting practice with the big turret guns on battleships, without actually firing the guns, it is customary to provide miniature targets which are suspended in front of the guns and moved up and down. A small gun is attached to the large gun, so that the bullet from the former will strike the target at the point aimed at by the large gun. The gun captains obtain practice in sighting and aiming the guns by aiming the large gun at the moving target and then fir-

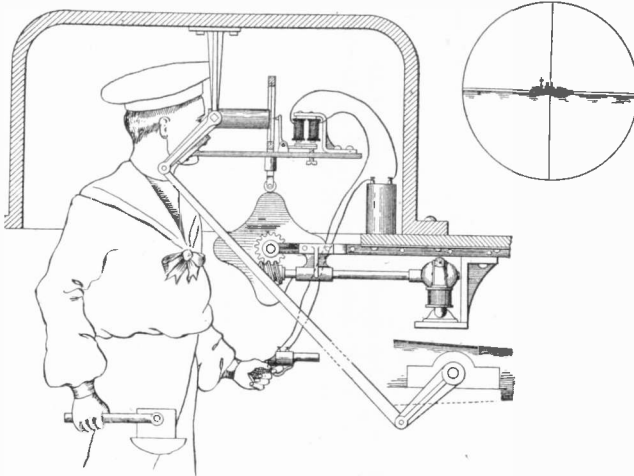

SIGHTING APPARATUS FOR BIG GUNS.

ing the small gun when the sight bears on the desired point, the bullet mark in the target indicating the accuracy of the aim.

In other devices, called "dotters," an electromagnetic marking device is arranged when actuated to make a dot on the target, and the gun captain is provided with a firing-pistol, which closes the electric circuit by which the electromagnetic marking device is actuated. Devices of this kind are very valuable in instructing men to fire correctly and to follow a moving target, but they require several men to work them. A further objection is that they cannot well be used in windy weather.

By employing a system recently pat-

ented by Bradley A. Fiske, of the United States Navy, it is said a gunner can practice sighting and firing by himself without requiring the assistance of others, and the use of the apparatus is not dependent upon the condition of the weather or the steadiness of the ship.

In accordance with his plan a sighting tube is arranged to be moved in the movement of the gun, and a target picture, seen edgewise in the cut, is placed in close proximity to the front of the sighting tube, this picture being independently movable. An electromagnetic marking device, the circuit of which is closed by the pistol-like device in the gunner's hand, is arranged to mark the target at the point aimed at by the sighting tube, the electromagnets pulling up one end of a right-angle lever on the other end of which is a sharp point which punctures the picture.

The picture is seen in the sighting tube which is provided with cross-hairs whose junction mark any spot aimed at by the tube. The picture is also mounted so that it may be moved

up and down with a wave-like motion to make it more difficult for the gunner to bring the junction of the cross-hairs on any particular spot on the picture.

In the gunner's right hand is shown, diagrammatically, the lever for controlling the motions of the gun.

The operation is simple. The gunner looks through the tube and marks some point on the pictured battleship he wishes to pierce. He then moves the gun controlling lever, elevating and depressing the gun, which also moves the sighting tube correspondingly, until the cross-hairs fall upon the point selected, then he pulls the trigger puncturing the picture at the point where the cross-hairs bisect. If his aim be good the puncture will be at

the point on the picture at which he aimed. At the same time he has gone through the actual movements of manipulating the gun.

COLLECTING ATMOSPHERIC ELECTRICITY.

It has been the dream of many inventors to devise some means by which the electricity in the atmosphere might be collected and utilized in the service of man. It is the opinion of many that vast quantities of electricity are present in the high altitudes or even in the regions of infinite space beyond the earth's atmosphere. Among the latest methods proposed is one patented by Walter I. Pennock of Philadelphia. In the words of the inventor the scheme relates to "a method of collecting electricity from a strata laden with electricity at high altitudes in the atmosphere, through the medium of a wire cable suspended from one or more balloons and in conveying this electricity to the earth's surface."

According to this inventor's theory the passage of the electrical current to the earth under ordinary conditions is prevented by an obstruction afforded by the dense lower strata of the atmosphere, which is a bad conductor of electricity, as shown by the electrodes of an ordinary static machine. When the electrodes are placed close together, the atmosphere is seen to carry the current across from one electrode to another, but if placed far apart the current is obstructed by the intervening air. The dense lower strata of the atmosphere affords one of the best non-conductors of electricity, as shown in the conduction of the electric current by telegraph, or trolley wires on the earth's surface, where only a small quantity of the electric current escapes through the atmosphere; while rarefied atmosphere affords a good conducting medium, as shown by the vacuum tube. The upper strata of the atmosphere being rare in proportion to the attitude, and being a good conductor of electricity while the lower strata of the atmosphere being dense and affording a non-conducting medium for the electric current, thus causes an obstruction to the electric current, or power in its passage to the earth's surface from

the electric strata of the atmosphere under ordinary conditions.

When, however, the clouds of a thunder storm pass over the surface of the earth, these clouds being of very great height, the moisture in the clouds forms a better conductor of electricity than does the dry air, with the result

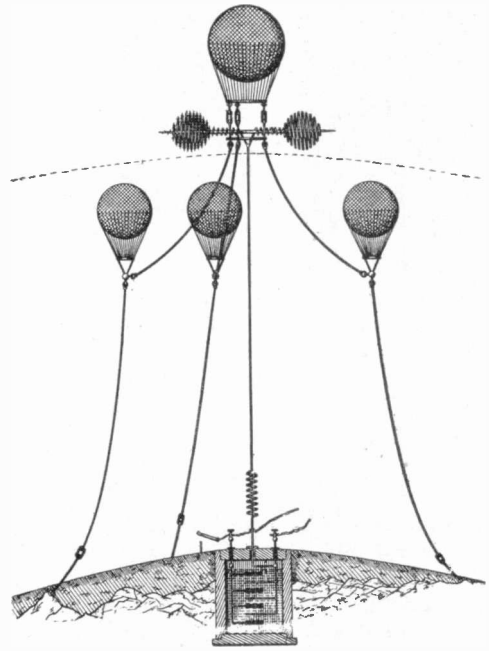

PROPOSED PLAN FOR COLLECTING ATMOSPHERIC ELECTRICITY.

that the electricity in the upper strata of the atmosphere breaks through the cloud as a streak of lightning and in that form reaches even to the earth's surface, while the thin or shallow strata of clouds, observed in the so-called "settled rain" storm, do not extend upward to a sufficient height to form a conducting medium for the electricity from the electric strata to the earth's surface. For this reason there is usually no lightning during the latter variety of rain storm.

The principle of the proposed electricity collector consists in elevating high up in the rarefied atmosphere, by anchored balloons, a sort of spiral collector with many sharp points. From this a wire passes down to earth and charges an electric accumulator.

AN ELECTRIC FIREPLACE.

This device consists of a frame or panel adapted to fit into an ordinary fireplace or grate. This frame is of metal and is provided with several polished concave recesses or reflectors. In front of these are placed long tube-like incandescent lamps of special design, not shown in the cut, which are adapted to

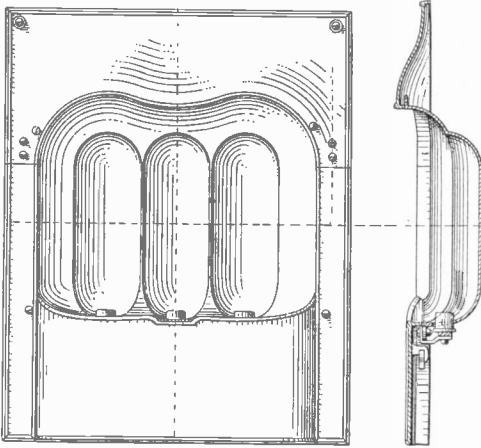

ELECTRIC FIREPLACE.

radiate a large amount of heat. The lamps are screwed into receptacles in the base and when they are burning will heat a good-sized room and at the same time give out a soft, pleasant light. The inventor of the device is Alfred D. Rathbone of Grand Rapids, Mich.

INSULATOR FOR TELEPHONE WIRES.

For attaching telephone and telegraph wires to walls, posts, trees, etc., the insulator shown in the diagram possesses

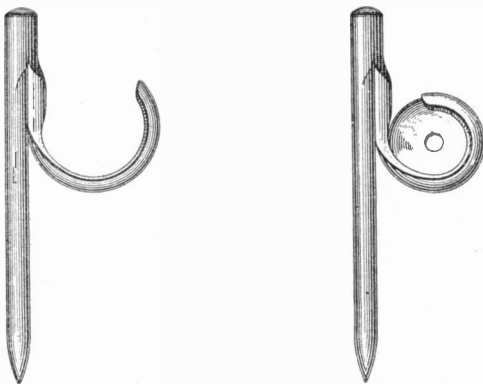

INSULATOR FOR TELEPHONE WIRES.

some desirable features. The insulator comprises a spike adapted to be driven by a hammer into the mortar between bricks in a brick wall or into trees or into frame structures, and on one side of this spike there is formed a clip adapted to embrace and hold an insulating button or washer. The button, which is pierced in the center to hold the wire, is placed in the clip, which is then bent around it. The device is the invention of George B. Marshall, Shannon, Tex.

ELECTRIC ALARM CLOCK.

A new type of alarm clock is shown in the diagram. It is fitted with an electric lamp so placed as to illuminate the dial. This lamp is controlled by a push button on the end of a cord, which may be long enough to extend to the bed, so that the time may be ascertained without getting up. At the right of the clock is the usual alarm bell which may be set

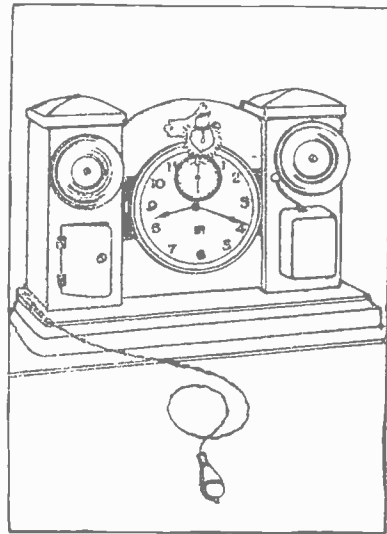

ELECTRIC ALARM CLOCK.

to go off at any predetermined time. At the left is a bank for valuables which is so arranged that if it is tampered with the alarm will ring.

Competent engineers estimate that there is 2,000,000 horse-power which could be easily developed from water-power in this country. This would save annually 225,000,000 tons of coal.

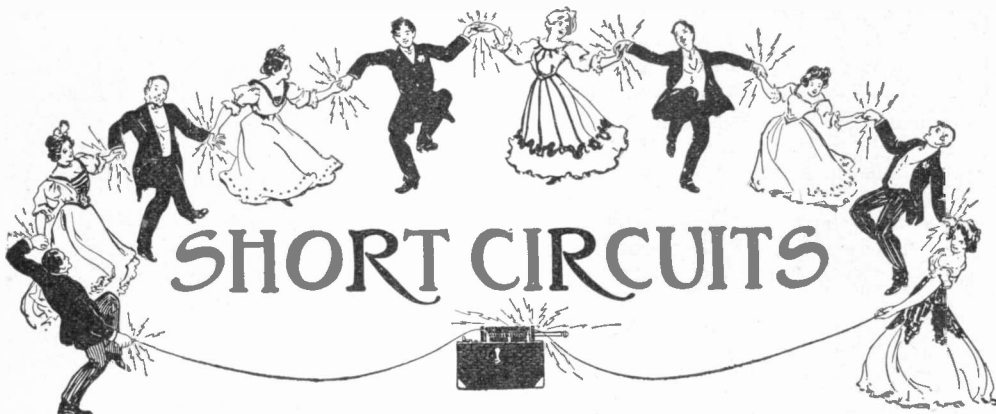

Heard at the lunch counter: "Hey, waiter! I thought I ordered pork and beans. Where is the pork?"

"Excuse me, sir, but there it is, just behind one of the beans."

Wearry (dejectedly): "Dey'se always inventin' useless tings, like de horseless wagon and de wireless telegraph. Why don't dey do sompin' for us poor hoboos. Give us a toothless bulldog."

Her waist begins just below her neck. Her hips have been planed off even with the rest of her body. She is usually buttoned up the back, and around her neck she wears a section of barbed wire, covered with lace. She wears on her head a blonde haystack of hair, and on top of this a central dome with rings about the same size as those of Saturn. She is swathed in her gown like an Indian papoose, and on the ends of her feet are dabs of patent leather. She walks on stilt-like heels with the expertness of a tight-rope dancer. The pores of her skin are full of fine white powder.

This is a Woman.

"Porter."

Thus the passenger for London hailed a railway servant at a small Scottish station. "Yessir?" The man instinctively held out his hand.

"Do you think this parcel well enough tied to trust going in the van?"

"Weel, I'll see," answered the porter, dropping the parcel with a bang. "She'll get that here, and she'll get that at the junction."—giving it another drop—"and she'll get THAT at Perth!"—banging it so lustily that all the contents scattered over the pavement. "Weel, sir, if she be goin' farther than Perth, she'll nae do whatever!"

The telephone engineer was approached by a friend not posted in the science of telephony who asked: "Say, Bill, what are these sound waves I hear about?"

Without the least hesitation the engineer answered: "If you were familiar with the definition of the two words you would not ask such a foolish question, and I want you to remember every word so if anyone asks you the question you can answer it.

"As you perhaps know, silence in action is sound in motion. Sound and silence, then, belong to the order of dual substance in unity. This phonic unity is an independent, imponderable, phonic, chrystoplastic, suisysmoris which cannot be divided or destroyed. It resides in all non-metallic atoms, which are not only part with it, but transmit, reverberate and absorb it, and—" but the friend had gone.

Now, Mr. Editor, what I want to know is this: Was the definition of the first word correct?—Stephen Huckelheimer, Podunk, Mo.

Poeticus—"I wish to publish my poems, but have so many irons in the fire that I haven't been able to do it."

Cynicus—"Why not put them in where your irons are?"

"The members of the Women's Rights Society held their semi-annual meeting in the town hall yesterday, and during the president's address it was so quiet you could have heard a coupling-pin drop."

The cross-eyed man was watching the activity of Niagara. "What a big waste!" he remarked to his friend.

The very stout lady standing near-by looked at him angrily. "Mind your own business"

Goldstein and Abrahams with their wives were in a railroad wreck. Goldstein got \$1,000 damages and Abrahams \$2,000.

"Abrahams, how did you get two thousand dollars vile I got only von?"

"Dot is simple," said Goldstein, "I had de presence of mind to kick mine wife in de face."

A waiter on a B. & A. buffet car told me confidentially that the chef couldn't fry my eggs, "cause, suh, de road am dat rough, dem eggs 'd scramble 'fo' you know'd it."

An eastern college graduate applied for work in a Michigan lumber camp. He was told to get busy on one end of a cross-saw, the other end being in charge of an old and experienced lumberman. At first all went well, but at the end of the second day the young man's strength began to wane. Suddenly the old man stopped the saw and spat.

"Sonny," he said, not unkindly, "I don't mind yer ridin' on this saw, but if it's jest the same to you I wish you'd keep yer feet off the ground."

"I tell you I won't have this room," protested the old lady to the bell boy who was conducting her. "I ain't a-goin' to pay my good money for a pigsty with a measly little foldin' bed in it. If you think that jest because I'm from the country—"

Profoundly disgusted, the boy cut her short. "Get in, mum. Get in," he ordered. "This ain't yer room. This is the elevator."

The junior partner of the Wall street firm was slightly indisposed and the senior partner was calling him up every three minutes.

"Why do you telephone so often?" inquired a friend.

"Well, his temperature fluctuates considerably and some of my customers are speculating on the fluctuations."

ELECTRICAL DEFINITIONS.

Accumulator.—Storage battery.

Alternating Current.—That form of electric current the direction of flow of which reverses a given number of times per second.

Ammeter.—An instrument for measuring electric current.

Ampere.—Unit of current. It is the quantity of electricity which will flow through a resistance of one ohm under a potential of one volt.

Ampere Hour.—Quantity of electricity passed by a current of one ampere flowing for one hour.

Anode.—The positive terminal in a broken metallic circuit; the terminal connected to the carbon plate of a battery.

Armature.—That part of a dynamo or motor which carries the wires that are rotated in the magnetic field.

Branch Conductor.—A parallel or shunt conductor.

Brush.—The collector on a dynamo or motor which slides over the commutator or collector rings.

Bus Bars.—The heavy copper bars to which dynamo leads are connected and to which the out-going lines, measuring instruments, etc., are connected.

Buzzer.—An electric alarm similar to an electric bell, except that the vibrating member makes a buzzing sound instead of ringing a bell.

Candle Power.—Amount of light given off by a standard candle. The legal English and standard American candle is a sperm candle burning two grains a minute.

Capacity, Electric.—Relative ability of a conductor or system to retain an electric charge.

Charge.—The quantity of electricity present on the surface of a body or conductor.

Choking Coll.—Coil of high self-inductance.

Circuit.—Conducting path for electric current.

Circuit-breaker.—Apparatus for automatically opening a circuit.

Collector Rings.—The copper rings on an alternating current dynamo or motor which are connected to the armature wires and over which the brushes slide.

Commutator.—A device for changing the direction of electric currents.

Condenser.—Apparatus for storing up electrostatic charges.

Cut-out.—Appliance for removing any apparatus from a circuit.

Cycle.—Full period of alternation of an alternating current circuit.

Diamagnetic.—Having a magnetic permeability inferior to that of air.

Dielectric.—A non-conductor.

Dimmer.—Resistance device for regulating the intensity of illumination of electric incandescent lamps. Used largely in theaters.

Direct Current.—Current flowing continuously in one direction.

Dry Battery.—A form of open circuit battery in which the solutions are made practically solid by addition of glue jelly, gelatinous silica, etc.

Electrode.—Terminal of an open electric circuit.

Electromotive Force.—Potential difference causing current to flow.

Electrolysis.—Separation of a chemical compound into its elements by the action of the electric current.

Electromagnet.—A mass of iron which is magnetized by passage of current through a coil of wire wound around the mass but insulated therefrom.

Electroscope.—Instrument for detecting the presence of an electric charge.

Farad.—Unit of electric capacity.

Feeder.—A copper lead from a central station to some center of distribution.

Field of Force.—The space in the neighborhood of an attracting or repelling mass or system.

Fuse.—A short piece of conducting material of low melting point which is inserted in a circuit and which will melt and open the circuit when the current reaches a certain value.

Galvanometer.—Instrument for measuring current strength.

Generator.—A dynamo.

Inductance.—The property of an electric circuit by virtue of which lines of force are developed around it.

Insulator.—Any substance impervious to the passage of electricity.

Kilowatt.—1,000 watts. (See watt.)

Kilowatt-hour.—One thousand watt hours.

Leyden Jar.—Form of static condenser which will store up static electricity.

Lightning Arrester.—Device which will permit the high-voltage lightning current to pass to earth, but will not allow the low voltage current of the line to escape.

Motor-dynamo.—Motor and dynamo on the same shaft, for changing alternating current to direct and vice versa or changing current of high voltage and low current strength to current of low voltage and high current strength and vice versa.

Multiple.—Term expressing the connection of several pieces of electric apparatus in parallel with each other.

Multiple Circuits.—See parallel circuits.

Neutral Wire.—Central wire in a three-wire distribution system.

Ohm.—The unit of resistance. It is arbitrarily taken as the resistance of a column of mercury one square millimeter in cross sectional area and 106 centimeters in height.

Parallel Circuits.—Two or more conductors starting at a common point and ending at another common point.

Polarization.—The depriving of a voltaic cell of its proper electromotive force.

Potential.—Voltage.

Resistance.—The quality of an electrical conductor by virtue of which it opposes the passage of an electric current. The unit of resistance is the ohm.

Rheostat.—Resistance device for regulating the strength of current.

Rotary Converter.—Machine for changing high-potential current to low potential or vice versa.

Secondary Battery.—A battery whose positive and negative electrodes are deposited by current from a separate source of electricity.

Self-inductance.—Tendency of current flowing in a single wire wound in the form of a spiral to react upon itself and produce a retarding effect similar to inertia in matter.

Series.—Arranged in succession, as opposed to parallel or multiple arrangement.

Series Motor.—Motor whose field windings are in series with the armature.

Shunt.—A by-path in a circuit which is in parallel with the main circuit.

Shunt Motor.—Motor whose field windings are in parallel or shunt with the armature.

Solenoid.—An electrical conductor wound in a spiral and forming a tube.

Spark-gap.—Space between the two electrodes of an electric resonator.

Storage Battery.—See secondary battery.

Thermostat.—Instrument which, when heated, closes an electric circuit.

Transformer.—A device for stepping-up or stepping-down alternating current from low to high or high to low voltage, respectively.

Volt.—Unit of electromotive force or potential. It is the electromotive force which, if steadily applied to a conductor whose resistance is one ohm, will produce a current of one ampere.

Voltage.—Potential difference or electromotive force.

Volt Meter.—Instrument for measuring voltage.

Watt.—Unit representing the rate of work of electrical energy. It is the rate of work of one ampere flowing under a potential of one volt. Seven hundred and forty-six watts represent one electrical horse power.

Watt-hour.—Electrical unit of work. Represents work done by one watt expended for one hour.

CLASSIFIED ADVERTISING

Rates, 40 cents per agate line, cash with order, nothing less than 3 lines.
Advertisements should be in our office on or before the 2d preceding date of issue.

Help Wanted.

WE EXPECT to have positions for a number of men as automobile car drivers, and interurban railways; only sober and reliable men need apply; experience unnecessary; send four-cent stamp for applications. The Western Transportation Company, American Nat. Bank Bldg., St. Paul, Minn.

WANTED—Railway mail clerks, clerks at Washington, customs clerks. Yearly salary \$800 to \$1,600. Short hours. Annual vacation. No "layoffs." Salary absolutely certain twice each month. Examinations everywhere, May 15th. Over 2,000 appointments to be made during 1909. Everyone over 18 eligible. Country residents eligible. Common education sufficient. Candidates prepared free. Write immediately for schedule. Franklin Institute, Dept. D 66, Rochester, N. Y.

WANTED—Responsible men and strong boys at Los Angeles. Fair pay while mastering trade of plumbing, bricklaying or electricity in months instead of years. No expense for instruction. Write quick. United Trade School Contracting Co., Los Angeles.

Patents.

PATENTS. H. W. T. Jenner, patent attorney and mechanical expert, 608 F Street, Washington, D. C. Established 1883. I make an investigation and report if patent can be had, and the exact cost. Send for full information. Trade-marks registered.

PATENTS—Advice and books free. Highest references. Best results. I procure patents that protect. Watson E. Coleman, Patent Lawyer, Washington, D. C.

Agents Wanted.

WANTED—One hustler in every concern employing any number of men to represent Popular Electricity. Here is your chance to double your income without interfering with your regular work. Others are making \$2.00 to \$5.00 a day and there is no reason you cannot do what others are doing. Give name of your company and number of employes, name of your superintendent or foreman and we will send free, samples and outfit. Address Circulation Mgr., Popular Electricity, 1262 Monadnock Block, Chicago.

AGENTS. Our \$2 adding machine is making a tremendous hit, good territory unoccupied. Smith Supply Co., B.-6, Los Angeles, Cal.

Inventions.

EXPERT AND SUCCESSFUL inventor will develop ideas and inventions, build models, make drawings and give general advice in perfecting and marketing inventions. Long experience. Circular free. L. Casper, 688 No.

Schools.

\$200 TO \$600 MONTHLY EASILY MADE fitting eye glasses. Short, easy mail course. Reduced tuition. Big demand for opticians. Write to-day for free "Booklet O." National Optical College, St. Louis

WANTED—Responsible men and strong boys at Los Angeles. Fair pay while mastering trade of plumbing, bricklaying or electricity in months instead of years. No expense for instruction. Write quick. United Trade School Contracting Co., Los Angeles.

WANTED—Railway mail clerks, clerks at Washington, customs clerks. Yearly salary \$800 to \$1,600. Short hours. Annual vacation. No "layoffs." Salary absolutely certain twice each month. Examinations everywhere May 15th. Over 2,000 appointments to be made during 1909. Everyone over 18 eligible. Country residents eligible. Common education sufficient. Candidates prepared free. Write immediately for schedule. Franklin Institute, Dept. D 66, Rochester, N. Y.

For Sale.

FOR SALE—Complete set of castings, with blue prints of $\frac{3}{4}$ h. p. gasoline stationary engine; includes governor and timer, screws, etc. \$10. Comet Motor Works, 17 W. Madison St., Chicago, Ill.

THOUSANDS OF PRACTICAL FORMULAS, 15c each. We can tell you how to make or mend anything. Consulting Chemists, Box 217, Redlands, Cal.

THREE THOUSAND FORMULAS. My 368-page volume of recipes and trade secrets, cloth bound, only 40 cents, prepaid. Worth dollars. Satisfaction guaranteed. Wiley Sanderson, Dept. E, Ypsilanti, Mich.

SNOW scenes. Views from one of Maine's most picturesque places. 5 ft. snow. 6 actual photo-cards, highly polished, 50c. Suitable for framing. C. Stanley, L. B. No. 5, Dixfield, Me.

AMATEURS READ THIS. 200 WATT DY-NAMO—Rough castings, \$4; blue prints, 50 cents. If castings are ordered within thirty days after prints, price of prints refunded. LEE, HARRIS & CO., Box 414, Jamestown, N. Y. Photo for 2-cent stamp.

Business Opportunities.

INVESTORS' NOTICE—Invest \$5.00 or more and become an original organizer of the South Bend Mining and Milling Company, who hold options on grand "Tungsten properties;" an investment of each \$5.00 secures 100 shares of stock. Invest to-day. For further information address South Bend Mining and Milling Company, Neitzel Block, South Bend, Ind.

BIG MONEY—Start a dyeing, cleaning and pressing establishment, unlimited field, enormous profits, no capital needed. We teach you the secrets by mail. Particulars free. Ben-Vonde Co., Dept. R, Staunton, Va.

CLASSIFIED ADVERTISING.

(CONTINUED.)

Busintss Opportunities.

WANTED—To sell any size of Louisiana red cypress cross arms, bored to pattern. Louisiana Red Cypress Company, New Orleans, La.

MAKE MIRRORS AT HOME. Big profits with little outlay. One 18x36-in. mirror costs \$2.00 to \$5.00. You can silver a glass this size for 20c. Send 50c in stamps or money order and we will send you **EXPLICIT DIRECTIONS** how to do it; also how to emboss, grind, foil, gold leaf, frost chip and make imitation stained glass. How to transfer photos on glass, bore holes in glass and cut skylights. George L. Patterson & Co., 2214 Monticello Ave., Morgan Park, Ill.

Wireless.

WIRELESS TELEGRAPHY. Make your own apparatus. Send 25c (coin) for complete instructions with diagrams for making all instruments necessary for a complete sending and receiving station, including one-inch spark coil and two different types of receivers. Box 519, Lima, Ohio.

WIRELESS EXPERIMENTERS. 1200 OHM receivers, each \$3.00. Wound with copper wire and very sensitive. First 25 sold will be fitted with nickel plated headband. W. C. Getz, 345 N. Charles St., Baltimore, Md.

Miscellaneous.

ALL SAFETY RAZOR BLADES 2½c each. Double edged blades a specialty. We sterilize, sharpen and return your own blades better than new. Send address for convenient mailing package. Keenedge Co., 87 Keenedge Bldg. Chicago.

MEDICAL AND SPARK COILS repaired. Send stamp for full detail drawings on a medical or spark coil. Price 50c. Address J. Lockie, R. 1718, Marquette Bldg., Chicago.

MAGIC POCKET TRICK FREE. Catalogue included, send 4c in stamps. Magic, Dept. 17, 270 W. 39th St., New York.

MAKE MIRRORS AT HOME. Big profits, with little outlay. One 18x36-in. mirror costs \$2.00 to \$5.00. You can silver a glass this size for 20c. Send 50c in stamps or money order and we will send you **EXPLICIT DIRECTIONS** how to do it; also how to emboss, grind, foil, gold leaf, frost chip and make imitation stained glass. How to transfer photos on glass, bore holes in glass and cut skylights. George L. Patterson & Co., 2214 Monticello Ave., Morgan Park, Ill.

THREE THOUSAND FORMULAS. My 368-page volume of recipes and trade secrets, cloth bound, only 40 cents, prepaid. Worth dollars. Satisfaction guaranteed. Wiley Sanderson, Dept. E, Ypsilanti, Mich.

SNOW scenes. Views from one of Maine's most picturesque places. 5 ft. snow. 6 actual photo-cards, highly polished. 50c. Suitable for framing. C. Stanley, L. B. No. 5, Dixfield, Me.

AMATEURS READ THIS. 200 WATT DYNAMO—Rough castings, \$4; blue prints, 50 cents. If castings are ordered within thirty days after prints, price of prints refunded. LEE, HARRIS & CO., Box 41, Jamestown, N. Y. Photo for 2-cent stamp.

THE DYNAMO

**Its Growth and Construction
Simply Explained**

By JOSEPH G. BRANCH, B. S., M. E.

**Author of "Conversations on Electricity,"
"Stationary Engineering," etc.**

The author is one of the best known practical writers of the day and this little work is his masterpiece.

It is written in the simplest and clearest language, contains no mathematics and yet is so *practical* and *thorough* that it will start you right in your work as a *practical electrician*.

Every part of a dynamo is shown in nine full-page beautifully colored illustrations, each part being numbered with full explanatory text in connection, so that the *complete anatomy* of the machine can be seen at a glance.

Prices—Postpaid

Fifty cents in strong paper covers—or given **FREE** with one year's subscription to **POPULAR ELECTRICITY** at \$1.00 (Canadian \$1.35, foreign \$1.50).

Seventy-five cents—**Handsomely** bound in cloth—or given **FREE** with eighteen months' subscription to **POPULAR ELECTRICITY** for \$1.50 (Canadian \$2.00, foreign \$2.25).

Act Quick—Don't Miss This

Popular Electricity Publishing Company
1252 Monadnock Block, CHICAGO



If you want a good piano we save you from \$100 to \$300 by our direct factory-to-purchaser system.

WING PIANOS

are made by us, in our own factory. They are sold direct from our factory and in no other way. Every unnecessary cost is eliminated. Every dollar spent with us is piano value through and through—the best that 40 years of study and experience can produce. The lowest, factory-price consistent with an artistically and musically perfect instrument

THE WING TONE is so sweet and deep it is in a class of its own. Thousands of customers yearly write and tell us so. "Pure and sweet; every note clear and musical; responsive to the lightest touch, yet possessing great volume and power, without a trace of harshness"—this describes the tone of the WING PIANO.

—THE WING WAY—

We will place a WING PIANO in any home in the United States on trial entirely at our expense, without any advance payment or deposit. If, after 20 days' trial in your own home, it is not satisfactory, we take it back. Nothing to be paid by you before it is sent, when it is received, or when it is returned. You are under no more obligation to keep the piano than if you were examining it at our factory. Every expense and all risk is ours, absolutely. Easy installment payments, if you desire them.

When you buy a piano at retail you pay the retail dealer's store rent and other expenses; you pay his profit and you pay the commission or salary of the agents or salesmen he employs. We make the WING PIANO and sell it ourselves. We employ no agents or salesmen. When you buy the WING PIANO you pay the actual cost of construction plus only our small wholesale profit. This profit is small because we sell thousands of pianos yearly. Most retail stores sell no more than 12 to 20 pianos yearly and must charge from \$100 to \$300 profit on each. You can calculate this yourself. These dealers get as much profit on their cheap pianos as on the standard high grade ones. As the cheap pianos cost less than half, they "talk up" and push the cheap piano—but often call them high grade.

Pioneers of the direct plan of piano selling, our unparalleled success has brought forth many imitators, but no competitors, either as to the excellence of our product or the integrity and economy of our methods. Forty years of daily increasing business and 45,000 satisfied and enthusiastic buyers testify to this.

Ask a Wing customer what he thinks of Wing Pianos and Wing methods. We will send you names in your locality for the asking.

Our commercial standing and references will guarantee you that our word is good and contract gilt-edged. The publishers of any prominent magazine will also tell you this.

The WING PIANO is broadly guaranteed in writing for 12 years.

FREE EVEN IF YOU ARE NOT READY TO BUY
WRITE OR SEND THE COUPON TO-DAY

WING
& SON

370-391
W. 13th St.,
New York

Send to the name and address written below, your Free Books without any cost or obligation on my part.

"The Book of Complete Information
About Pianos."

A copyrighted book of 152 pages with many illustrations. A complete reference book on the piano subject. History of the piano, descriptions of every part, how to judge good and bad materials, workmanship, etc. Teaches you how to buy intelligently. You need this book.

Free for the asking from
the old house of

WING & SON 370-391 W. 13th St.,
New York

THE MARVELOUS INSTRUMENTAL ATTACHMENT

If you choose, and without extra cost, your piano can have this wonderful addition. Imitates perfectly the mandolin, guitar, harp, zither, and banjo. Music written for these instruments, can be played just as perfectly by a single player on the piano as though rendered by an orchestra. It is an integral part of the instrument; does not take in any way from its tone or value as a piano and prolongs the life of the strings and action.

YOUR NAME IN GOLD

J.E. MILLER
FINISH

SHARP-WELL Strops

give your razor that "just right" edge that means the difference between a quick, easy shave and a painful ordeal.

- ☞ Made by a **RUSSIAN PROCESS** by a Russian expert.
- ☞ Beginning with the skin and ending with the finished product, every step is taken to secure **Highest Strop Excellence.**
- ☞ Double leather, prepared for sharpening and finishing—one side with Sharp-Well treatment; 2½ x 25 inches; rubberoid military swivel; double stitched handle.

YOUR NAME PRINTED IN GOLD—Mail us \$2.00 and receive the strop. Your money back in 90 days if not perfectly satisfied.

ILLINOIS RAZOR STROP COMPANY
60 Wabash Avenue, Chicago



"CURE YOURSELF BY ELECTRICITY"

New Book—Illustrated from Life—Sent FREE to all who write.

Write to-day for our new **Free Book**—"Cure Yourself by Electricity"—illustrated with photos from life. Shows how the **New Home Batteries** cure **Rheumatism, Neuralgia, Lumbago, Headache, Insomnia, Constipation** and all nerve affections and diseases arising from sluggish circulation; also how they afford electric baths and beauty massage without cost at home.

THIS BATTERY

\$1.95

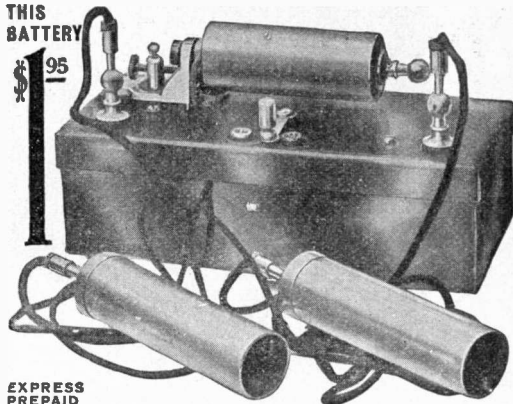

EXPRESS PREPAID

Every Home Should Have a Home Battery.

We send our batteries Prepaid without a cent in advance (prices \$1.95 and up) and allow 10 DAYS' FREE TRIAL. Write for our Book.

DETROIT MEDICAL BATTERY CO.,
195 Majestic Bldg., Detroit, Mich.

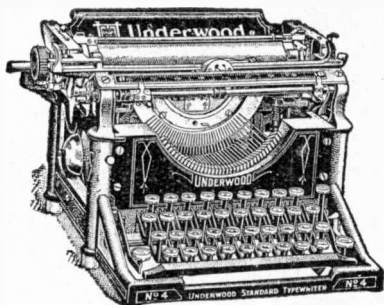

The Operator

With Mind on the Work

does his best without waste of time or energy. The operator on the

UNDERWOOD STANDARD Typewriter

need think only of the work in hand—not of the machine. The moving of the paper and of the carriage is automatic—accomplished at one time by the lever on the left which is operated by perfectly natural sidewise movement of the hand. It is not lifted—no conscious effort is required.

Ease of operation, visible writing and the other nearly automatic features which enable the Underwood to almost take care of itself will save 25% of time in your office without the operator being required to increase speed of fingers—at the keyboard. You'll see for yourself if you'll come to look, at any time convenient to you.

UNDERWOOD TYPEWRITER COMPANY, Inc., 133 Wabash Avenue, CHICAGO ANYWHERE

Murdock's Wireless Operators' Head Receivers

Style—"AM"—Double Amateur.

200—Ohms	-	-	\$4.50
1000—Ohms	-	-	5.50
1500—Ohms	-	-	6.50
2000—Ohms	-	-	7.50
3000—Ohms	-	-	8.50

With German Silver split head band. Hard rubber composition receivers. 5 foot green cord and connecting block.

Style—"Pro"—Double Professional

2000—Ohms	-	-	\$11.00
3000—Ohms	-	-	12.00
4000—Ohms	-	-	13.00
5000—Ohms	-	-	14.00
6000—Ohms	-	-	15.00

With nickel plated split head band. Genuine hard rubber receivers. Ball and socket and adjustment on band. 7 foot silk cord. Silk covered copper wire windings.

Send for Complete Price Lists.

"The Receiver Specialists"

WM. J. MURDOCK & CO.

45 Carter Street, CHELSEA, MASS.

THE KIMBLE VARIABLE SPEED SINGLE PHASE A. C. MOTORS

Send for Catalogue R

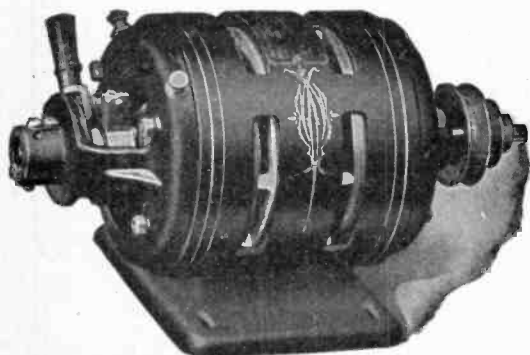

1/2 H.P., 110 Vts., 60 Cycle.....	\$27.00
1/2 H.P., 110 Vts., 60 Cycle.....	50.00
1/2 H.P., 110 Vts., 60 Cycle.....	60.00

All Motors Guaranteed 2 Years.

KIMBLE ELECTRIC CO.

617 West Adams Street
CHICAGO

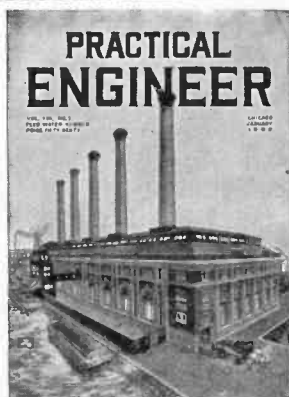

SIZE
9 X 12
INCHES
PUBLISHED
MONTHLY

214
PAGES
REGULAR
PRICE
\$1 A YEAR

Yours 2 Years FOR - - \$1.50

Including the January 214-Page
SPECIAL FEED WATER NUMBER

AND A VALUABLE TOOL FREE

PRACTICAL ENGINEER is a big up-to-date monthly paper for Steam and Electrical Engineers. Each issue is brimful and overrunning with interesting illustrated articles, crisp editorials, experiences of engineers and the latest and most useful facts regarding Steam-Electric Power Plants. It gives plain, practical instruction and information, adapted to the needs of the man-on-the-job and everything is to the point, presented in clear, forcible down-on-the-earth-style, easily understood by every engineer.

It is the paper you need. It will make your work easier and help you to do it better by pointing the way to better methods and quicker results. Don't miss this special offer. Take advantage of it today, now, while you think of it, and receive in return for your \$1.50 a copy of the Big Feed Water Number—23 other big fat numbers, and a polished Steel Combination Square thrown in free.

The January Feed Water Number of **PRACTICAL ENGINEER** contains 214 pages and is a text book on the subject. It is the most complete and practical treatise ever printed and no engineer should be without it. The price of a single copy is 50 cents, but we'll include it without extra charge with your two years' subscription if received before the supply on hand is exhausted, but the supply is limited, so send in your order at once.



You'll find this 6-inch Combination Square one of the most useful and valuable tools you ever had. It takes the place of a whole set of try squares and you will use it constantly. You can adjust it to any point within its length and it combines in one compact tool a square, miter, depth gauge, level and a handy little scratch awl on the bottom. And it is yours free with 2 years' subscription to **PRACTICAL ENGINEER**.

This
Steel
Combination
Adjustable
Square sent
FREE

This is your chance to get a high class engineering paper at a mighty low price, including the Special Feed Water Number and a valuable tool free.

Send in \$1.50 today and the Big Special Number and Square will be sent you by return mail. If, after receiving them you are not pleased, return them, and your money will be refunded at once.

Canadian readers send \$1.00 extra for Postage

PRACTICAL ENGINEER

359 Dearborn Street, CHICAGO, ILLINOIS

Would you like to be our Agent in your
locality? :: Our terms are liberal.

POPULAR ELECTRICITY

THE LIGHT THAT NEVER FAILED



**ORDER
THE
BEST**

**THE
LIGHT
DE LUX**

**Immediate
Delivery**

**Prices
Right**

THE "QUALITY OF LIGHT" OF
G-I TUNGSTEN LAMPS

IS TRUE AS THAT OF THE SUN

The General Incandescent Lamp Company
CLEVELAND, OHIO

SAN FRANCISCO, 403 Atlas Bldg.

SEATTLE, 223 Colman Bldg.

For our Mutual Advantage mention Popular Electricity when writing to Advertisers.

2c a Week Pays Wash Bill!

Electricity or Water-Power Does the Work

Write for
FREE Book

Just a "Twist of the Wrist" Starts or Stops the Machine!

The 1900 Motor Washers are now at work in thousands of homes. They are doing the work formerly done by women, at a cost of 2 cents a week for power! Saving thousands upon thousands of dollars in wash bills. Saving worlds of wash-day troubles. Leaving the women free to do other work while the machines are doing the washing.

The 1900 Motor Washer

Washes a Tubful in Six Minutes!

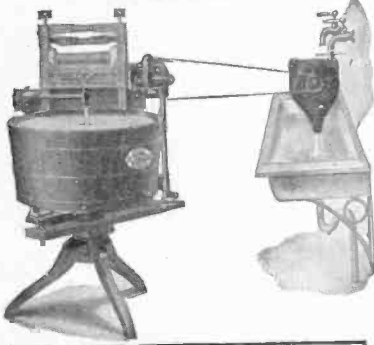

Handles heavy blankets or dainty laces.

The outfit consists of the famous 1900 Washer with either Electric Motor or Water Motor. You turn on the power as easily as you turn on the light, and back and forth goes the tub, washing the clothes for dear life. And it's all so simple and easy that overseeing its work is mere child's play.

A Self-Working Wringer Free With Every Washer

The motor runs Washer and Wringer. We guarantee the perfect working of both. No extra charge for Wringer, which is one of the finest made.

Write for FREE BOOK and 30 Days' FREE TRIAL OFFER!

Don't doubt! Don't say it can't be done! The free book proves that it can. But we do not ask you to take our word for it. We offer to send a 1900 Motor Washer on absolute Free Trial for an entire month to any responsible person. Not a cent of security—nor a promise to buy. Just your word that you will give it a test. We even agree to pay the freight, and will take it back if it fails to do all we claim for it. A postal card with your name and address sent to us ~~to-day~~ will bring you the book free by return mail. Address, The 1900 Washer Co., 3324 Henry St., Binghamton, N. Y. Or, if you live in Canada, write to the Canadian 1900 Washer Co., 355 Yonge St., Toronto, Canada.

1900 Electric Motor Washer
Can be connected with any ordinary
Electric Light Fixture

1900 Water Motor Washer
Can be connected with any water tap instantly

READ THESE LETTERS

Thos. O. Land, General Manager Conway Telephone Co., Pawnee, Okla.: "I have read the book and consider it one of the best books published. It is worth more than its weight in gold. I would like to see every young man read this book. I can certainly recommend it."

O. A. Jackson, Mason City, Iowa: "It is a great and good book."

James T. Castle, Manager Buckeye Engine Co., Pittsburg, Pa.: "Have read 'The Law of Financial Success' and find it of so much interest I want you to send me one-half dozen copies, as I would like to distribute same among my friends."

Harry A. Fries, Newark, N. J.: "Book is O. K.; worth twice the money with \$10.00 added to it."

W. L. Wagner, of the Pros Gas Engine Co., Webb City, Mo.: "I cannot tell you in words just how well pleased I am with the book."

John G. Gretzinger, Fullerton, Cal.: "It is worth its weight in gold to me, far better than I expected."

Many others on file. None solicited.

JUST WRITE YOUR NAME AND ADDRESS RIGHT HERE:

Name

Address

Tear out this advertisement, wrap a dime or stamps in it, enclose in envelope and mail to

THE FIDUCIARY CO., 963 Tacoma Bldg.
CHICAGO, ILL.

and **DO IT NOW**

The book will be promptly mailed, postpaid. Whenever you wish to part with it, return it and the 10 cents will be instantly refunded.

THE LAW OF Financial SUCCESS



TELLS YOU IN PLAIN ENGLISH

- HOW** to make money safely and judiciously.
- HOW** to judge investments properly and realize financial success.
- HOW** to acquire the faith necessary for success.
- HOW** to analyze, develop and utilize your dormant abilities essential to success.
- HOW** to guide your ambition, concentrate upon your aim and persist until you achieve it, etc., etc.

SPECIAL PAPER - BOUND EDITION
104 Pages - 10 CENTS - 16 Chapters
100,000 Copies Sold

MAKING MONEY

is not difficult for the man or woman who follows the instructions contained in the sixteen chapters of this most successful book of the year. The tremendous editions enable the publishers to sell the book at 10c, a price at which no man can afford to be without a copy any more than he can afford to refuse payment for his work or services. **Fill out the coupon now.**

POPULAR ELECTRICITY

200,000 PEOPLE WILL SEE THIS SHOW

SOUTHERN ELECTRICAL and INDUSTRIAL EXPOSITION

LOUISVILLE APRIL 12 TO 24 1909

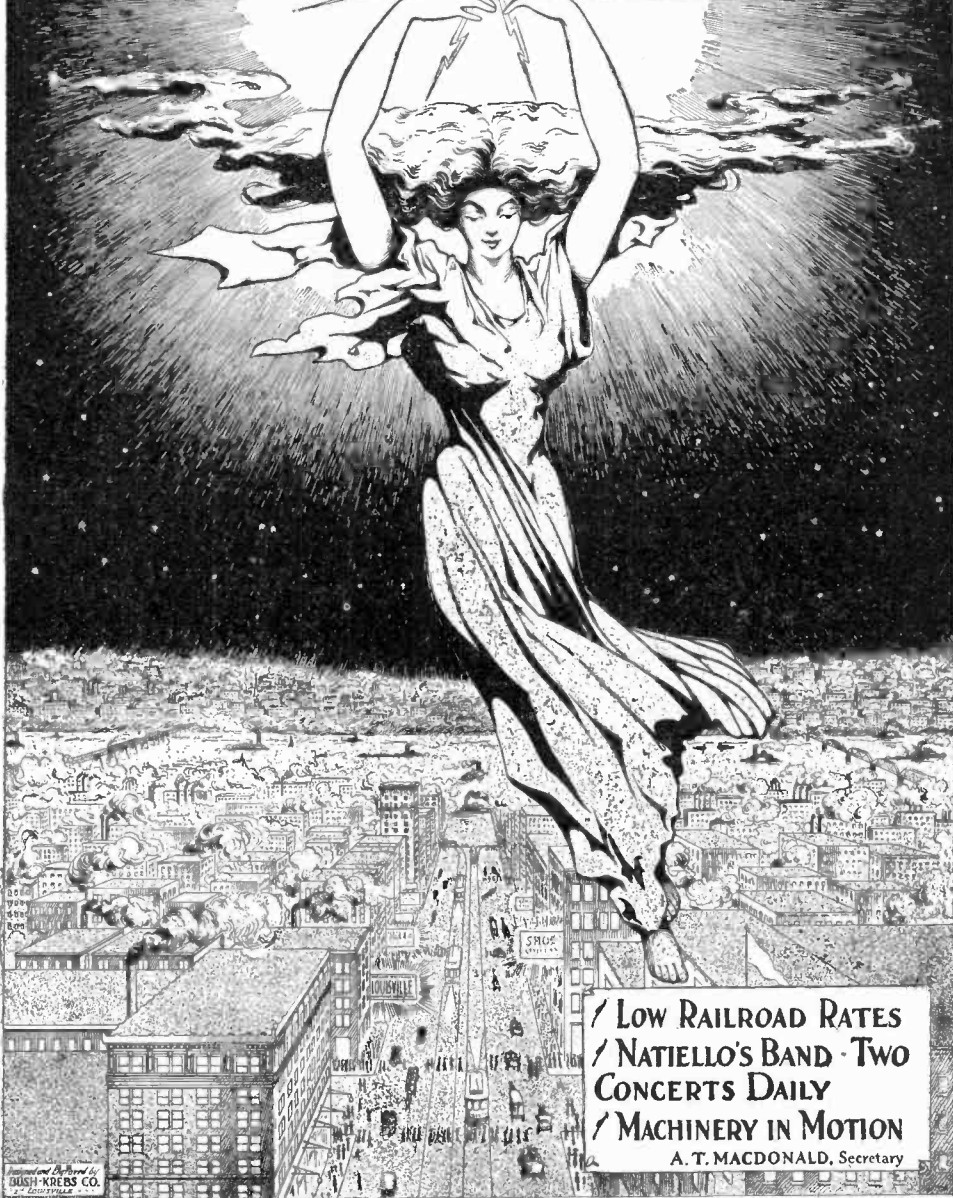

/ LOW RAILROAD RATES
/ NATIELLO'S BAND - TWO
CONCERTS DAILY
/ MACHINERY IN MOTION
A. T. MACDONALD, Secretary

Printed and Published by
DUSH-KREBS CO.
CINCINNATI, O.

AN EPOCH MAKING EVENT BACKED BY THE BUSINESS MEN OF LOUISVILLE

For our Mutual Advantage mention Popular Electricity when writing to Advertisers.

WALKINS LABORATORY AND PATENTS COMPANY

☐ Mechanical and Electrical Engineers. Processes of Manufacture Worked Out. Special Apparatus and Equipment Designed for Any General or Special Purpose.

☐ Manufacturers of the Walkins Mercury Vapor Electric Light. Apparatus for Sub-Marine or Aerial Photography.

☐ Advise of your wants Mechanical or Electrical and we will submit you a proposition.

☐ Correspondence invited.

LABORATORY,
140 Belmont St., BROCKTON, MASS.

It Pays for Itself

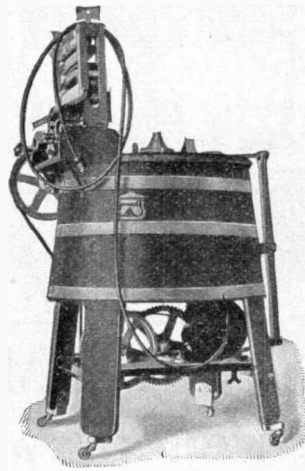

The Automatic Electric Washer will save you in money many times its cost in a short time. Does away with all the disagreeable features around the house that occurs when washing is necessary. *Write for our booklet before you buy elsewhere.*

Automatic Electric Washer Co.
NEWTON, IOWA

ROBERT P. MURPHY, Prop.

HOTEL ALBANY

41st Street and Broadway, New York

Remodeled, Handsomely Furnished New Throughout



Absolutely Fireproof. In the heart of the City. **500 Rooms. 300 Bath Rooms.** European Plan. Cuisine Unexcelled. Gentlemen's Cafe, Ladies' Restaurant and Moorish Rooms. Popular Prices. Plenty of life—but Homelike.

\$1.00 PER DAY AND UP
SEND FOR BOOKLET.

Meet me at the College Inn, under the Albany, New York's Leading Rathskeller, a place to eat, drink and be merry. Music.

"1900" Dry Cells

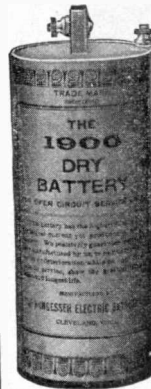

ARE the Batteries of Merit. Eighteen years of successful operation make them of

Known Quality

Manufactured by

The Nungesser Electric Battery Co.
CLEVELAND, OHIO

General Sales Office:
128 West Jackson Boulevard
CHICAGO

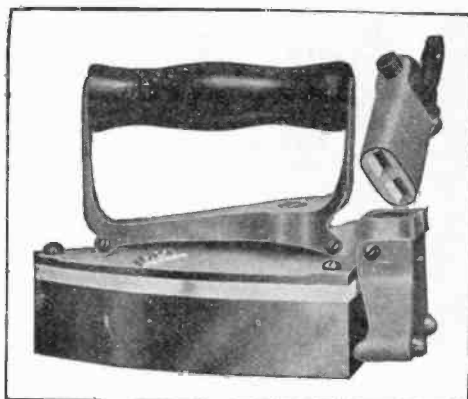
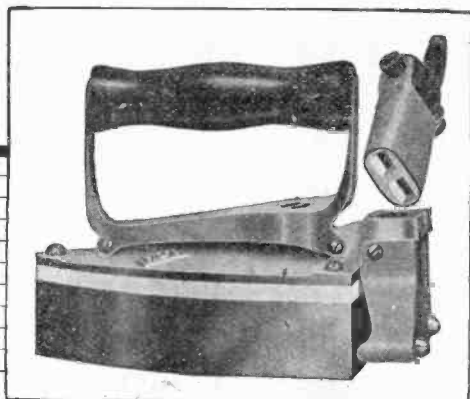

Two Models for 1909 the well-known Pacific Electric Iron

Standard Type with improvements—Same with Automatic Cut-Out applied

OUR 1909 MODEL STANDARD HOT POINT IRON is the same as the iron we sold with great success during 1908, with a number of decided improvements.

This iron is extremely economical because it has such great heat-storing capacity. When heated up the switch plug can be pulled out and the iron used fully half the time on light work without the current.

In one city where 1100 irons were sold in 1907 and 1950 irons were sold in 1908, the number of burn-outs was so small that the company wrote us that it was not worth keeping track of. This means that the iron has long life and can be used for years.

The heating elements are easily removable. Only a screw driver needed to put in a new pair of heating elements.

Every Hot Point Iron is guaranteed to the lighting company or dealer for twelve months. Should the user have any trouble with it the lighting company or dealer stands ready to make it good.

Pacific Electric Irons are on sale in many cities all over the country. Inquire first of your Lighting Company. If they do not handle it they can probably direct you to a Dealer who does.

If neither lighting company nor dealer have Pacific Electric Irons, **write to us for our special introductory price.**

OUR 1909 AUTOMATIC HOT POINT IRON is exactly the same as our "Standard" model, but with our new automatic cut-off device applied.

This automatic device throws the switch out when the iron exceeds working temperature so that it is impossible to injure the heating elements of the iron or to do any damage.

This does away with all risks of fire, which has been the only real objection against electric flat irons.

The automatic device is positive in action. When the iron has passed a certain temperature the switch plug is thrown out and the iron immediately begins to cool off.

It operates on an entirely new principle and is not a thermostat. There is no other electric iron with an automatic control.

An electric iron saves time and work. It makes ironing a pleasure instead of drudgery. It is economical, costing only 4 to 7 cents for an hour's ironing. And so handy—simply put in the plug and begin to iron.

This Automatic Model of the Hot Point Iron is just being introduced. It is the first automatic iron placed on the market and possibly your Lighting Company or Dealer will not have a sample. But ask them first. If they can not show it to you, **write us for our special introductory price.**



Central Station Managers and dealers should write for our special sample proposition. This allows ample time to test the iron and if not satisfied you can return it at our expense. Order a sample now.

PACIFIC ELECTRIC HEATING CO.

FACTORIES AT

ONTARIO, CALIFORNIA

63-65 W. Washington St., CHICAGO

POPULAR ELECTRICITY



TUNGSTEN



The New Electric Lamp

Gives three times as much light
as the old Edison lamp and costs
no more for electric current

For twenty years Edison incandescent lamps have been standard for electric lighting. The General Electric Company makes millions annually. They are to be seen wherever electric light is used.

The GE Tungsten lamp differs from the GE Edison lamp only in the light-giving filament inside the glass bulb which is made of the rare metal tungsten instead of carbon, as in the Edison.

Tungsten will not melt at temperatures ruinous to carbon filaments. The process used by the General

Electric Company in producing tungsten filaments makes such good use of that quality that GE Tungsten lamps give three times the light obtainable from carbon filament lamps.

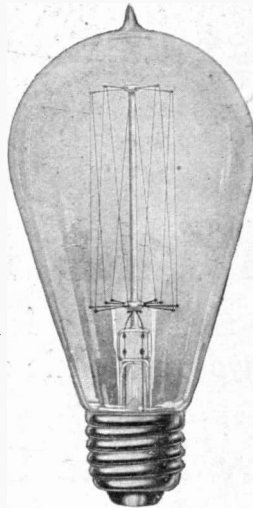

The new lamp is made in six sizes—25, 40, 60, 80, 100 and 250 watts. The smaller sizes are suitable for household use—the larger sizes for store and public use.

All sizes give four candle light for every five watts used—an efficiency of $1\frac{1}{4}$ watts per candle.

*You will know it
in the glass stem*



*by the monogram
inside the bulb*

You can get these lamps from electric lighting companies everywhere or from electrical supply dealers. More details on request.

Sales Offices
in all large
cities in U. S.

General Electric Company

Main Lamp
Sales Office:
Harrison, N. J.

2077

For our Mutual Advantage mention Popular Electricity when writing to Advertisers.

POPULAR ELECTRICITY

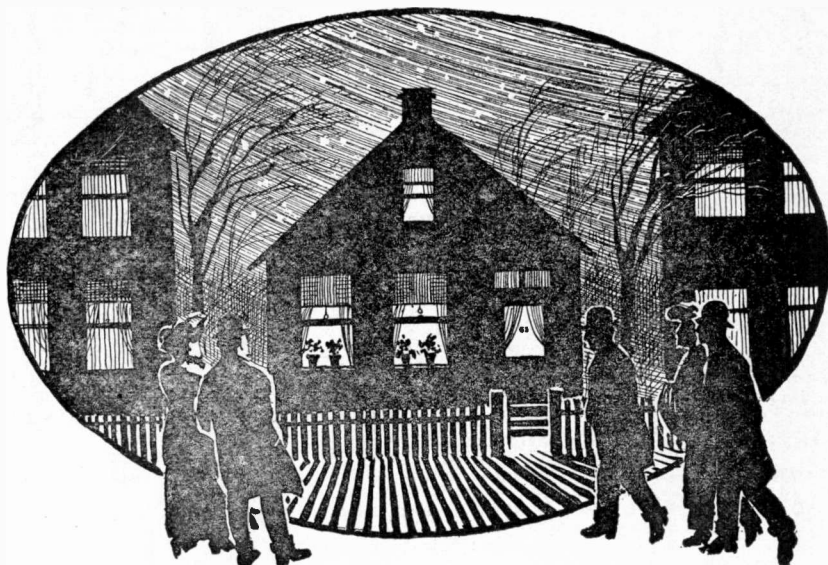

Hundreds of Small Houses Like This One

are being wired by us for electric light at cost—payable a little each month for two years.

**Any House Owner
Can Now Afford**

to install this modern convenience from cellar to garret. Electric light costs no more than any other. Call Randolph 1280.

Visitors are at all times welcome at Electric Shop, the Commonwealth Edison Co.'s Show Rooms, devoted to the demonstration and sale of electrical equipment and devices for use in the home. Cor. Michigan and Jackson Boulevards.

Commonwealth Edison Company

139 Adams Street

CHICAGO, ILL.

POPULAR ELECTRICITY

Be Your Own Plumber

There is no mystery about plumbing work. You can be your own plumber if you only make up your mind to do it.

Our perfect ALL IRON PIPE system of plumbing will enable any handy mechanic to install the material on farm or in city. Send us a list of your needs. All we ask is an opportunity to figure on your wants. We carry everything necessary for installing this class of work. Soil Pipe, lead and water pipe and fittings of all kinds, etc. If you cannot tell what you need, get our free catalogue, showing all grades of plumbing Fixtures, and send us plans of your house and we will figure up everything required for the work, and quote you lowest wholesale prices. We sell plumbing and heating material direct to the consumer at factory prices, and we will furnish our customers working drawings and instructions free.

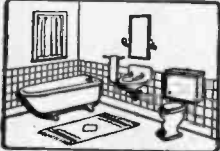

COMPLETE BATHROOM OUTFITS, from \$24.50 to \$125.00.

HEATING PLANTS

Don't think you cannot afford a modern Hot Water or Steam Heating Plant till you get our figures. Special price for first plant in each locality. Plans free. Tools loaned.



We send FREE detailed estimate on receipt of rough sketch or plan of the building to be heated. Prompt attention. We will refund purchase price if plant is not satisfactory.

MACHINERY

We are headquarters for machinery of all kinds. Heavy engines and large power boilers, as well as small. Below we list a few items. Everything at bargain prices.

- 2 Speed Laths.
- 1 10x4 Sebastian Lathee.
- 1 9x28 Barnes Lathee. 1 10x14 Chucking Lathee.
- 1 12 inch Drill Press. 1 16 inch Drill Press.
- 1 No. 2 Klemmsmith Miller.
- 1 24 inch Shaper. 1 14 inch Pipe Machine.
- 3 4 inch Forbes Hand Pipe Machines.
- 1 2 H. P. 220 Volt Motor.
- 2 1 H. P. 220 Volt Motors.
- 2 50 Light Dynamos.
- 30 Other Motors and Generators.
- 10 Assorted Emery Grinders.

Tools of all kinds at Wholesale Prices

Machinery List No. 123a lists a lot of splendid bargains. Write for it and ask us regarding anything in the line of Machinery or Electrical Equipment

Write today for new enlarged Catalogue No. 123 covering Home Builders Supplies. YOUR MONEY REFUNDED IF NOT SATISFIED.

Central Machinery & Supply Co. 2593 Archer Ave. CHICAGO

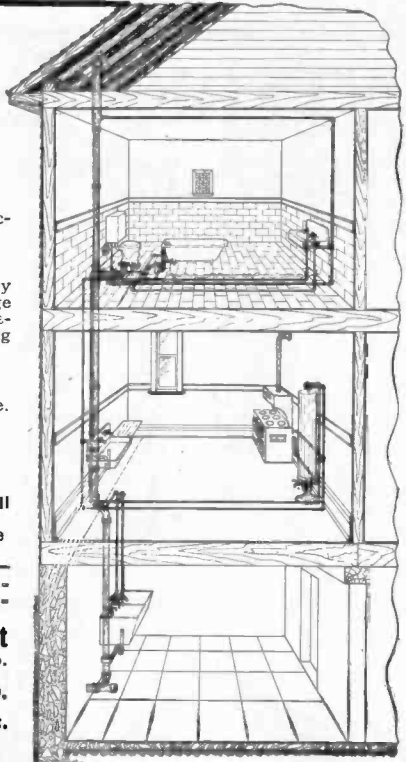

A SCHOOL WITHIN ITSELF

the careful student comprehends the complete designing, care and operation of a dynamo or motor, and I chapter on electric automobiles, outlining their construction, care and operation, and all about storage batteries and how to handle them. Each subject is carefully written and to the point. After a student studies a subject, he is questioned on that subject in such a manner as to bring clearly to his mind the points he needs to know regarding same. A Dictionary in

back of book will enable him to learn the meaning of any electrical word, term or phrase used in this book, as well as hundreds of others in common use. All required tables necessary in the study are in it.

TABLE OF SUBJECTS:

<p>Chapter</p> <p>I—Wiring.</p> <p>II—Electric Batteries, Electric Plating.</p> <p>III—Magnetism.</p> <p>IV—The Magnetic Circuit.</p> <p>V—Magnetic Traction.</p> <p>VI—Magnetic Leakage.</p> <p>VII—Energy in Electric Circuit.</p> <p>VIII—Calculation of Size of Wire for Magnetizing Coils.</p> <p>IX—Calculation of EMF's in Electric Machines.</p> <p>X—Counter EMF.</p> <p>XI—Hysteresis and Eddy Currents.</p>	<p>Chapter</p> <p>XII—Armature Reaction.</p> <p>XIII—Sparking.</p> <p>XIV—Winding of Dynamos and Motors.</p> <p>XV—Proper Method of Connecting Dynamos and Motors—Self Excitation.</p> <p>XVI—Diseases of Dynamos and Motors, their Symptoms and How to Cure Them.</p> <p>XVII—Arc and Incandescent Lamps.</p> <p>XVIII—Measuring Instruments.</p> <p>XIX—Alternating Current.</p> <p>XX—Automobiles.</p>
--	---

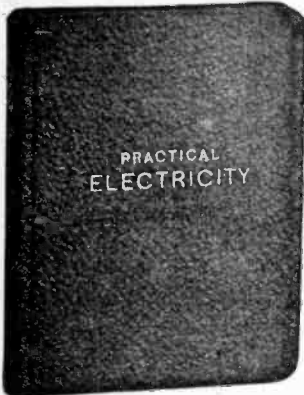

A Dictionary of over 1,500 Electrical Words, Terms and Phrases, giving a brief meaning of all which are in common use.

\$2.00 PER COPY — FOURTH EDITION — 20,000 COPIES SOLD.

The offer we make of refunding money if book is not satisfactory upon examination is AN UNUSUAL ONE in connection with the sale of a book. But we have no fear of its return. Your decision will be what thousands of others have been. Money would not buy it if it could not be duplicated. We could print testimonials by the hundreds. It is best to order now and be your own judge of its merits.

THE MORTIMER BOOK CO., 160 Washington St., Chicago, Ill.

For our Mutual Advantage mention Popular Electricity when writing to Advertisers.

INTERESTING NOVELTIES

"Just Pull" TRADE MARK Electric Light Attachment

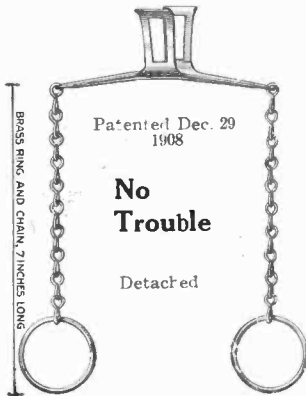

For turning light on or off, used on stationary fixtures. Cannot get out of order. Why stretch and strain to reach your lights? "JUST PULL" brings every one within easy reach.

To Attach—Slip over electric button and clamp with pair of pincers. That's all.

Agents wanted. Price 25c. Sample doz. \$1.75 postpaid.

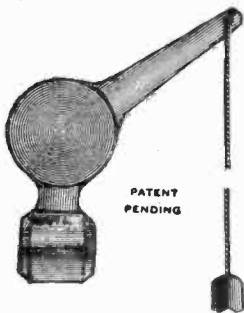
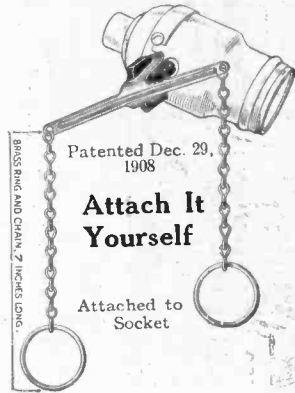

Rittenhouse Socket Pull

Easily attached to an ordinary key socket. Contains a ratchet so that only one pull is necessary.

Has no springs, etc., to get out of order, gravity being the only means used.

Furnished in Polished Brass, Old Brass, Nickel and Oxidized Copper.

Standard length of pull, 9 inches.

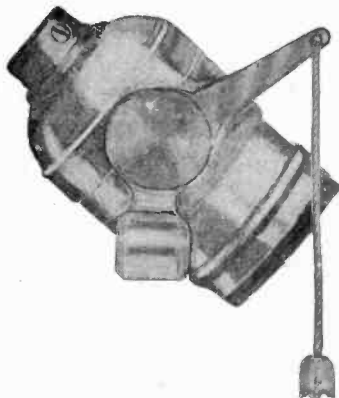

Rittenhouse Socket Pull

Attached to An Ordinary Key Socket

Our socket pull simply slides on the socket key and is particularly applicable to sockets already installed. It is just the thing for the man who wants a Pull Socket but doesn't wish to discard his Key Socket.

Alternate pulls turn lights on and off.

It works equally well with socket at any angle.

Lists at 25c. Can be retailed for less.

Send \$1.75 for trial dozen, postpaid.

Write us for DEALERS prices on above articles, also Our Proposition to AGENTS.

COMMERCIAL ELECTRICAL COMPANY

KEWANEE, ILLINOIS.

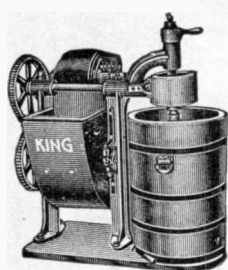

**The New
20th Century
Ice Cream
Freezer and
Crusher**

A complete ice cream plant in one machine—electrically driven. No belts or pulleys. Requires small space. Why not make your own ice cream and save money? The ideal freezer for confectioners and druggists. Made in 2 sizes—20 and 40 quart. Write for catalogue and prices.

R. A. Dewsberry, Chicago, Ill.
46 N. Morgan Street



Excel Electric Laundry Irons,

Electric Universal Coffee Percolators, Chafing Dishes, Tea Pots, Tea Kettles, Nursery Food Warmers, Cereal Cookers, and many other useful Electric Appliances, described in our attractive catalogue "H"
The next mail will bring it if you write us.

All "Excel" Appliances
GUARANTEED

"Excel" in durability, attractiveness and efficiency.
Lowest in price.
We desire to quote discounts to leading Electrical Houses.

EXCEL ELECTRIC HEATING CO.
237 Broadway, New York City, N. Y.

**THORDARSON'S
"JUNIOR"
BELL RINGER.**

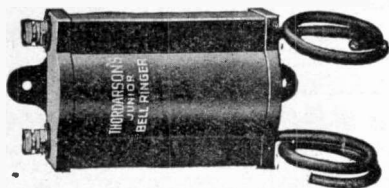

CONSUMES NO CURRENT

A LOW PRICE EFFICIENT TRANSFORMER FOR RINGING DOOR BELLS, BUZZERS AND ALL CLASSES OF LIGHT SIGNAL WORK, WHEN INSTALLED PROPERLY WILL LAST A LIFE TIME.

FOR ALTERNATING CURRENT ONLY.

PRICE \$3.00

FOR SALE BY ALL LEADING ELECTRICAL JOBBERS.

THORDARSON ELECTRIC MFG CO.
151-157 S. JEFFERSON ST.
CHICAGO, ILL.

Send No Money

JUST YOUR ADDRESS



In order to prove that Rheumatism, Indigestion, Constipation, Neuralgia, Deafness, Nervousness, Paralysis and Insomnia, in fact any ailment or pain due to congestion or poor circulation can be promptly relieved in your own home without drugs or medicines, we want to send you a **Vibro-Life**

Vibrator Free

Express Prepaid

YOU decide whether to buy it or return it, and it costs you not one cent unless you keep it. Fully guaranteed. Try it ten days, then if you are fully satisfied with the benefit received, buy it; otherwise return it and we will pay the express charge. **Send no money now**—Just fill in and mail the coupon. This offer and special price is for a limited time only, so write at once.



EUREKA VIBRATOR CO.,

Suite 552 D No. 1269 Broadway, New York City.
Or Box 682, Brantford, Ontario, Canada.

I am interested in your Free Trial Offer, also free booklet on Health and Beauty.

NAME.....

ST. AND NO.....

CITY.....

POPULAR ELECTRICITY

AROUND THE WORLD BUT NEVER OUT OF INK

You feel safe when writing a Cheque with



Are ink tight in pocket. Others leak through at back end.

NOTE—Blair's are the Only Practical Ink Pencils. Take no chances on a substitute. Owing to U. S. and British patents they cannot be imitated. For Correspondence, Manifold, Ruling and Stenography. Having no leaky air tube, they fill easier. Hold 50 per cent. more ink, and permit the use of Blair's Safety Ink-making Cartridges. 10c. extra. Saving cost of cheque punch, 5c. Point will last for years. Soon saves cost. PRICES: Plain, \$1.00; Chased, \$1.25; Chased and Gold Mounted, \$1.50; Red Cases, 3/4 in., \$1.25; large barrel, 4 in. or 4 1/2 in., \$1.50, 3/4 in. Silver Filling, \$2.50; by insured mail, 8c more. Ordinary Ink can be used. Blair's Fountain Pen Co., 6 John Street, Suite 279, New York; 15 Bishopsgate St., Without, London, E. C. Get Agency.

THREADS CUT ON STEEL CONDUIT

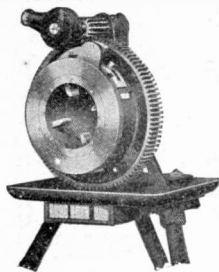

Portable Pipe Cutter.
A one-man tool for the bench or floor.
Light weight and cheap.
Send for new catalog.

THE OSTER MFG. CO.
2180 East 61st Street
CLEVELAND, OHIO

ANYTHING ELECTRICAL

A 2c STAMP SECURES

Our Latest Catalogue—100 Pages of Electricity—Flashlights, Motors, Dynamos, Electric Heating Devices, Wireless Outfits, etc. Also Great German Toys.

J. J. DUCK, 428 St. Clair St., TOLEDO, OHIO

KLEIN'S

Now Electrician's
Pocket Tool Kit

This tool-kit contains a selection of Klein tools such as have been found indispensable to the practical telephone man.

It is of convenient pocket-book style, with a firm metallic clasp. Send 3c in stamps for 65 page catalogue. Special prices quoted on request. Write for new catalogue.

Mathias Klein & Sons
Sta. U. 3, Chicago, Ill.

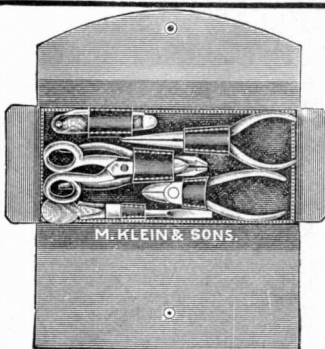

No. 403 K

WIRELESS TELEGRAPHY

Have you heard of our "Five Mile Outfit"? which is the most efficient, durable, and compact short distance outfit on the market. The sending station was designed to work 5 miles under all conditions, but under more favorable circumstances it will work farther. The receiving station requires no battery, adjustment, nor attention. The range of the receiving station is limited only by the strength of the transmitting spark. Price, complete with 1-4 inch coil, \$9.15. Receiving station only, \$2.25. The detector used in these outfits is the only guaranteed detector on the market. Are you not interested in a detector that will work perfectly under the severest conditions? Our circulars describe it fully. Price, \$1.00. 1000 ohm telephone receiver, with a fine cord and thin diaphragm, \$2.75. 1-4 inch coil, \$5.00. 2 inch coil, \$7.75. Send stamp for circulars. INTERNATIONAL WIRELESS CO. DEPARTMENT E. LIMA, OHIO

For our Mutual Advantage mention Popular Electricity when writing to Advertisers.

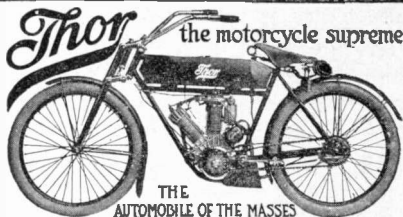

THE
AUTOMOBILE OF THE MASSES

Speed 5 to 60 miles an hour. Fast enough for the most daring; slow enough for the most cautious. Governed and controlled entirely with the handle grips—mechanism concealed and protected. Easily mastered by a novice. Practical for pleasure or business. Can outdistance fastest automobiles and all rival motor cycles. Takes any mountainous road at slow or high speed. The *Thor*, without any repairs, was the only one of 9 contestants to complete the 1,116-mile cross country endurance test of Chicago Motor Cycle Club.

Models—\$150 to \$300. Motors—2 1/2 H. P. to 6 H. P.

Agents Wanted in Every City and Town.

Largest Motor Cycle Plant in America. Over 10,000 *Thor* motors in use. Features not on any other motor cycle. Catalogue with our liberal proposition free.

AURORA AUTOMATIC MACHINERY COMPANY,
Dept. C. Aurora, Illinois, U. S. A.

HANDY IN EVERY HOME

Everybody who sees this useful and pretty little novelty wants one of the

Excelsior Combination Tweezers and Magnifying Glass

No toy, but a practically useful article that is indispensable in every household. A powerful magnifying glass enlarges the object the tweezers are to work on, rendering it easy to extract splinters or hairs. Nickel plated and highly polished. Also useful for mill workers, jewelers, botanists, physicians, etc.

By mail 15, 35 and 50c., 3 sizes.

ASHER KLEINMAN, Sole Mfrgr., 250 Eighth Ave., New York, N. Y.

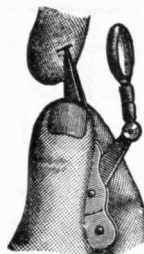

Make \$30 to \$60 a Week

and more in your spare time. Install a few of our "Trade Stimulator" Machines with your home merchants. Increase business for them and make big profits for yourself. Everybody wants to use them in Cigar Stores, Drug Stores, Billiard Halls, Resorts, etc. New Catalogue and full particulars of our plan free. Write today.

PURITAN MACHINE CO., 78 Brush St., Detroit, Mich.



The **READY** is the handiest instrument ever invented for drawing purposes. Compass, Protractor, Rule, Scale, Square, etc., all in one piece. You can carry it in your vest pocket and be ready to make any kind of drawing. A practical tool in every way. Graduations in 10ths, 20ths, 16ths, and 32nds or Metric Units.

Prepaid with directions for \$1.00.

Dept. D.

READY MFG. CO., Rochester, N. Y.

AGENTS' PORTRAITS 35c, FRAMES 15c,
sheet pictures 1c, stereoscopes 25c,
views 1c. 80 days credit. Samples and Catalog Free.
Consolidated Portrait Co., 290, 110 W. Adams St., Chicago.

Good For \$1.00

Sign and mail this coupon to Magic Foot Draft Co., Dept. 440 F, Jackson, Mich.

Name

Address

By return mail you'll get a \$1 pair of Magic Drafts To Try Free, as explained below.

**IF YOU HAVE
RHEUMATISM**

write your name and address plainly on the above coupon and mail to us. Return post will bring you, prepaid, a regular \$1 pair of Magic Foot Drafts, the great Michigan External Cure for Rheumatism of every kind—chronic or acute—muscular, sciatic, lumbago or gout. Then after you try them, if you are fully satisfied with the benefit received, send us One Dollar. If not, they cost you nothing. You decide and we take your word.



FREDERICK DYER, Corresponding Secretary.

Magic Foot Drafts are curing old chronic cases of 30 and 40 years standing, after every thing else had failed, as well as all the milder stages. We have the evidence to prove all our claims. It must be plain that we couldn't send the Drafts out everywhere as we do on approval if they didn't cure. We want every sufferer to try them, so send us your full address on the coupon today. Our valuable illustrated Book on Rheumatism comes free with the trial Drafts. Send no money—only the coupon.



TYPEWRITERS
All Makes, \$10 Up. CASH OR TIME.
Rented Anywhere—Rental Applied.
SENT ON TRIAL—FREE.
Tell us what you want and what you expect to pay and we will ship you one for trial and examination. All fully guaranteed.
Economy Typewriter Exchange, 74 Washington St., CHICAGO, ILL.

**Send for one of these
32-Page Books To-Day**

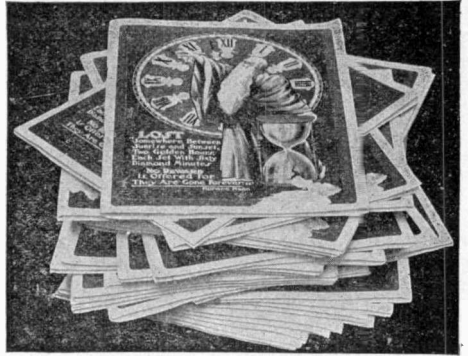

Our Booklet No. 80 contains valuable information for every person interested in Inter-communicating Telephones and Private Branch Exchange Systems for use in—
HOME—OFFICE—FACTORY
BANK—HOSPITAL—HOTEL

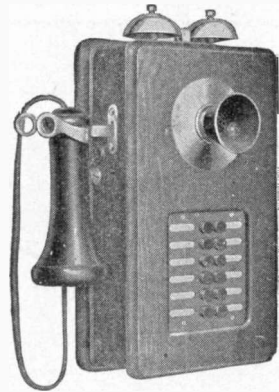

"QUALITY APPARATUS"

We make the greatest variety of Telephones for any kind of service and Switchboards for any size system. Consult us regarding any telephone requirements.

Ask for Booklet No. 80—Second Edition
Sent free upon application to either office.

**STROMBERG-CARLSON
TELEPHONE MFG. CO.**
ROCHESTER, N. Y.

CHICAGO, ILL.

KANSAS CITY, MO.

There are over 1,100,000 "S-C" Telephones in use



Room 12x14 feet, beautifully illuminated with a one-unit fixture containing one 60 watt Tungsten lamp—consuming current about equal to one 16 c. p. carbon filament lamp.

WRITE — OR CALL — TODAY

The "I-Comfort" System

is an efficient practical method of

INDIRECT ILLUMINATION

For Residences, Halls, Offices, Assembly Rooms, Etc.
THE LONG LOOKED FOR COM-FORTABLE METHOD.

This System is the greatest modern advancement marking an epoch in interior illumination. Endorsed and recommended by leading oculists and medical authorities.

A SOFT, EVEN LIGHT ALL OVER THE ROOM—NO SHADOWS.

The lamps are concealed by specially designed inverted reflectors, set in neat brass receptacles, so that the brilliant lights are out of line of vision.

One 60-Watt Tungsten Lamp

is ample for the room illustrated here. The current consumption is no greater than for the direct lighting systems formerly used, and is oftentimes much less.

New Catalog contains full information, prices and details.

PATENTS APPLIED FOR.

National X-Ray Reflector Co.

247 E. Jackson Boulevard... Chicago, Ill.

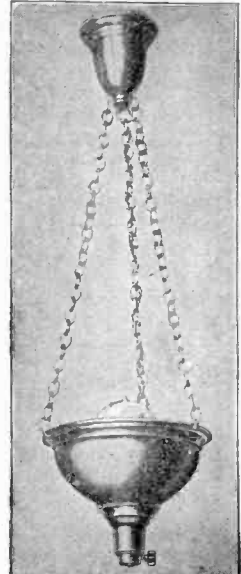

E 401 Wired Complete.

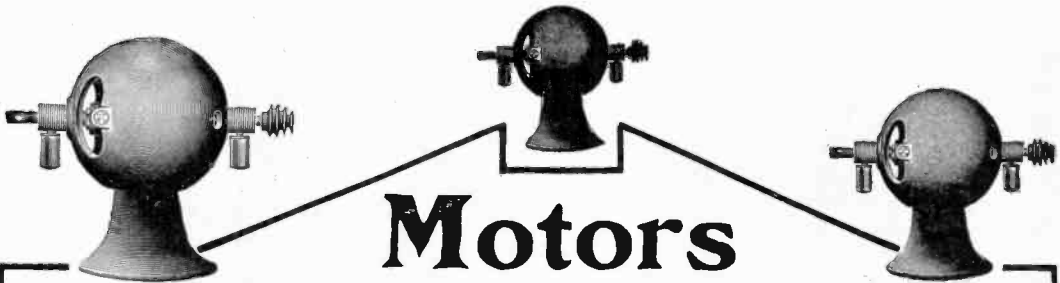

Motors

We have the most complete line of Alternating and Direct Motors ever manufactured for Laboratory or Mechanical Use.

Alternating—100 to 110 Volt, 60 Cycle

Direct—100 to 110 Volts

Work on Either Current.

All our goods are guaranteed to be high grade, durable and efficient for commercial use.

Write at once for price list and catalogue P of our complete line.

Shaft

1/40- 8 3/4" diameter Tool Steel Armature.

1/20-10 7/8" diameter Shaft.

1/10-15 7/8" diameter Commutators 3/8 watt, 3/8" diameter.

Journal Bronz Self Oiling.

Birtman, English, Edwards Co.

92 East Lake Street, Chicago

The WORLD Is YOURS For \$3.00

TECHNICAL WORLD MAGAZINE } BOTH FOR
and the } \$3.00
NEW PEERLESS 12-INCH GLOBE }

The regular price of THE TECHNICAL WORLD MAGAZINE is \$1.50 a year, but it's worth far more. You could not duplicate the Peerless Globe for \$6.00. We have, however, purchased many thousands in order to bring this great bargain opportunity within the reach of our patrons and friends.

New Peerless 12-inch Globe



Height 20
Inches.

—the latest globe on the market, lithographed in ten permanent oil colors. The stand which is made of oak, weathered finish, is more up-to-date and far superior to the old-style iron base. The ball, or globe proper, is finished with high-grade varnish and is, therefore, impervious to water. It can be kept bright by an occasional wiping with a damp cloth.

TIME DISC—By means of a time disc at the north pole, time at any point in the world may be instantly approximated by noting the time at the point where observation is made.

ISOTHERMAL LINES—The isothermal lines are represented by red and blue lines for January and July and at various intervals the mean temperature for three months is noted.

The **ANALEMMA**—Just west of Mexico is the Analemma representing a figure eight. This is divided into months and the months, in turn, into days, and shows just where the direct rays of the sun strike the earth for every day in the year.

NOTE. The globe weighs eight pounds when packed ready for shipment. The subscriber must pay the freight or express charges when delivery is made.

Technical World Magazine
Chicago, U. S. A.

Pop.
Elect.
4-09
ORDER
BLANK

Technical
World Magazine
Chicago, U. S. A.
For the \$3.00 enclosed please send me The
Technical World Magazine
for one year, and the 12-inch
Peerless Globe, as advertised.

Name.....
St. Address.....
City.....State.....

DEAF PEOPLE NOW HEAR WHISPERS

Listening Machines Invented
by a Kentuckian.

Invisible, When Worn, but Act
Like Eye-Glasses.

Ever see a pair of Listening Machines?
They make the Deaf hear distinctly.
They are so soft in the ears one can't tell they are wearing them.

And, no one else can tell, either, because they are out of sight when worn. Wilson's Ear Drums are to weak hearing what spectacles are to weak sight. Because, they are sound-magnifiers, just as glasses are sight-magnifiers.

They rest the Ear Nerves by taking the strain off them—the strain of trying to hear dim sounds. They can be put into the ears, or taken out, in a minute, just as comfortably as spectacles can be put on and off.

And, they can be worn for weeks at a time, because they are ventilated, and so soft in the ear holes they are not felt even when the head rests on the pillow. They also protect any raw inner parts of the ear from wind, cold or dust, or sudden and piercing sounds.

These little telephones make it easy for a Deaf person to hear weak sounds as spectacles make it easy to read fine print. And, the longer one wears them the better his hearing grows, because they rest up, and strengthen, the ear nerves. To rest a weak ear from straining is like resting a strained wrist from working.

Wilson's Ear Drums rest the Ear Nerves by making the sounds louder, so it is easy to understand without trying and straining. They make deaf people cheerful and comfortable, because such people can talk with their friends without the friends having to shout back at them. They can hear without straining. It is the straining that puts such a queer, anxious look on the face of a deaf person.

Wilson's Ear Drums make all the sound strike hard on the center of the human ear drum, instead of spreading it weakly all over the surface. It thus makes the center of the human ear drum vibrate ten times as much as if the same sound struck the whole drum head. It is this vibration of the ear drum that carries the sound to the hearing Nerves. When we make the drum vibrate ten times as much, we make the sound ten times as loud and ten times as easy to understand. This is why people who had not in years heard a clock strike can now hear that same clock tick anywhere in the room, while wearing Wilson's Ear Drums.

Deafness, from any cause, earache, buzzing noises in the head, raw and running ears, broken ear drums, and other ear troubles, are relieved and cured (even after ear doctors have given up the cases) by the use of these comfortable little ear-resters and sound magnifiers.

A sensible book, about Deafness, tells how they are made, and has printed in it letters from hundreds of people who are using them. Clergymen, Lawyers, Physicians, Telegraph Operators, Trainmen, Workers in Boiler Shops and Foundries—four hundred people of all ranks who were Deaf, tell their experience in this free book. They tell how their hearing was brought back to them almost instantly, by the proper use of Wilson's Ear Drums. Some of these very people may live near you, and be well known to you. What they have to say is mighty strong proof.

This book has been the means of making 326,000 Deaf people hear again. It will be mailed free to you if you merely write a post card for it today. Don't put off getting back your hearing. Write now, while you think of it. Get the free book of proof. Write for it today to the Wilson Ear Drum Co., 386 Todd Building, Louisville, Ky.

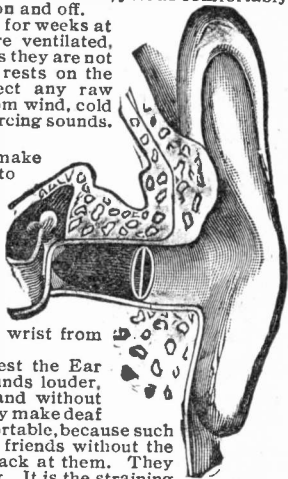

Perfect Health Without
Medicine, Scientific Discovery

OXYDONOR

Destined to Revolutionize
the Art of Healing.



Its record of cures is so astonishing as to be almost unbelievable. It has cured the most obstinate ailments and weaknesses. The nature of the disease makes no difference. No matter how severe your affliction, no matter how long standing, no matter how many other treatments you may have tried, you have no right to believe your case hopeless before you have tried OXYDONOR, a self home treatment, without drugs. Most convincing proofs in our descriptive booklet, sent free to all.

DR. H. SANCHE CO.

67 Wabash Ave., Room 266. CHICAGO, ILL.

A Battery Bargain

A 6 Volt, 60 Ampere Storage Battery
GUARANTEED 1 YEAR

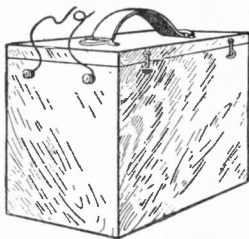

\$9.75

Selling regularly
at \$22.50

S. BREAKSTONE

900 Fisher Building
CHICAGO, ILL.

Electric Motor Watch Charm



A genuine Electric Motor, inclosed multipolar type. Runs 2000 revolutions per minute. Highly polished and plated. A powerful "Pocket Battery" with every outfit. Postpaid, \$1.00.

DESPATCH MFG. CO.
112 N. 1st St., Minneapolis, Minn.



Ayes All Steel Vises

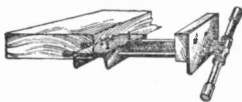

Wood Workers Vise, Durable, Handy, Simple and Cheap. Price \$2.50 weighs 15 lbs., fully guaranteed, returnable if not pleased.

AYES & COMPANY,
59 Ellen St., Chicago.

For our Mutual Advantage mention Popular Electricity when writing to Advertisers.

POPULAR ELECTRICITY

BUSINESS PROMINENCE SOCIAL SUCCESS WEALTH



The Master Key

Stop Forgetting

MEMORY

"You are no greater intellectually than your memory"

My book: **HOW TO REMEMBER**, sent free to readers. It opens the doors of wealth and achievement with the master key that fits all locks.

There is nothing difficult about my method. You can study anywhere, at any time, in spare moments. I have taught more than 40,000 people how to remember. My method teaches you how to remember things you have seen, read and been told about, increases business capacity, income, social standing—also how to remember faces, names, business details, studies—develops will, concentration, personality, self-confidence, conversation, public speaking, writing, etc. Write today for free copy of my interesting book—"How To Remember"—and see how simple my memory training really is. Address

DICKSON MEMORY SCHOOL, 929 Auditorium Building, Chicago

Works By Pulling The Cord



HYLO-ECONOMICAL

The Lamp That Turns Down

There is a little filament in each lamp in addition to the regular one. It gives one-sixteenth the light and consumes one-sixteenth the current.

You can use the little filament by pulling the cord or slightly turning the bulb.

Universally used in Sleeping Rooms, Bath Rooms and Hallways, the light is soft and the cost almost nothing when small filament is used—lasts indefinitely.

Full illumination is obtained instantly when desired.

THE ECONOMICAL ELECTRIC LAMP CO.,
25 West Broadway, NEW YORK, N. Y.

Works By Slightly Turning The Bulb



The Baby Torch

Size of Tank, 3 x 2 inches



Lights with a match.

BURNS without air-pressure: gives intense blue flame. The smallest, most compact and efficient torch made.

For Electricians, Wiremen and Automobile Users.

WRITE FOR PRICES
H. W. HARROLD
Valparaiso, Ind.

Popular Electrical Books in Simple Language

The A B C of WIRELESS TELEGRAPHY

EDWARD TREVERT.

One of the best beginner's books on Wireless. Not theory but practice, and practice of the best kind. Besides some space devoted to the theory and history of wireless, there is an interesting chapter on Hertzian wave signaling, with drawings and directions for making the apparatus; descriptions of wireless stations earlier and later types, and descriptions of various systems of wireless. Price \$1.00

STORAGE BATTERIES,

THEORY, CONSTRUCTION AND USE.

A. E. WATSON.

A new Book describing the construction and the principal features of storage batteries of all the prominent types. A chapter on switchboard arrangements is of special value. The use and care of the batteries is explained, as are the chief faults and troubles for users. Invaluable. Price, \$1.50

For others get our book lists.

E. BUBIER PUBLISHING CO., Lynn, Mass.

GROW MUSHROOMS

FOR BIG AND QUICK PROFITS



Ten years experience enables me to give practical instructions that will add \$5 to \$60 per week to your income without interfering with regular occupation. For full particulars and free book, address

JACKSON MUSHROOM FARM,
3213 N. Western Ave., Chicago, Ill.

FREE FREE FREE

My Latest Catalogue of Self-Educational Books.

Operators' Wireless Telegraph and Telephone Hand Book.....\$1.00

Practical Armature and Magnet Winding.....1.50

The Automobile Hand Book.....1.50

FOR SALE BY

GEORGE C. HARRIS, 44 N. Curtis St., Chicago

For our Mutual Advantage mention Popular Electricity when writing to Advertisers.

**JUST A LITTLE BETTER THAN
THE BEST**

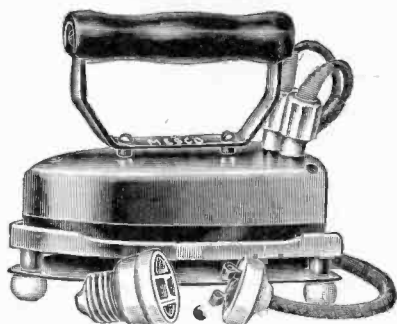

Mesco Electric Irons

Save time, patience and money. No unnecessary heat. Always ready when wanted. Safe and sure. We guarantee the Mesco Iron for one year, against mechanical or electrical defects.

100 TO 120 VOLTS:	
3 lb. 200 watts	\$3.50
6 lb. 400 watts	4.75
200 TO 240 WATTS:	
3 lb. 200 watts	\$3.50
6 lb. 400 watts	4.75

Manhattan Electrical Supply Co.

188 FIFTH AVE., - CHICAGO
17 PARK PLACE, NEW YORK

RING WITHOUT BATTERIES

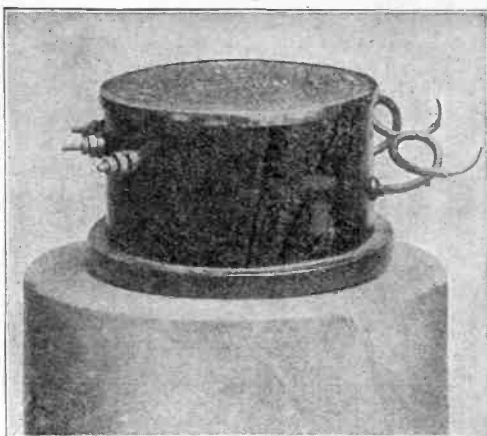

The Rollinson Bell Ringer

will operate buzzers, door bells, hotel calls, elevator calls, automatic gas lighters, etc., from an ordinary 110-volt lighting circuit, without the use of batteries.

The bell ringer is made in three sizes, all three taking 100 to 130 volts from the line and changing it to 6-13-19 and 8-16-24 volts respectively for supplying the bell circuit. Using alternating current, the device may be said to operate without cost for current.

MOHAWK ELECTRIC CO., Albany, N. Y.

DIAMONDS on CREDIT

20% DOWN—10% PER MONTH

Why wait for your Diamond until you have saved the price? Why not have the use and pleasure of same immediately and pay for it by the Lyon Method? Lyon's prices are fully 20% lower than any others. Lyon's Diamonds are guaranteed perfect blue-white, imported in the rough, cut and polished here to save import duties and middlemen's profits. A written guarantee accompanies each Diamond. You have the option for exchange at any time at full purchase price. All goods sent prepaid for inspection. Send now—today—for our Catalogue No. 2, splendidly illustrated. *Established 1843.*



**J·M·LYON & CO. · 71·73 NASSAU ST·
NEW YORK**

Make More Money

Increase your personal earnings or those of your business by learning the modern method of business promotion. If you are handicapped by the small salary of a narrow, crowded line of work, prepare for one of the varied well-paid positions in the great profession of advertising. If you are a business man and want to increase the volume and profits of your business

Learn Advertising

We provide expert, practical instruction in writing, planning and managing retail, mail-order, trade-paper or ask-the-dealer advertising, agency work and soliciting. To prove the superiority of our instruction we offer the mail course on

30 DAYS FREE TRIAL

or an evening FREE in New York. Write for particulars. National advertisers should ask for Business Analysis Blank for planning campaigns.

GEORGE FRANK LORD, INC., 333B 4TH AVE., NEW YORK

For our Mutual Advantage mention Popular Electricity when writing to Advertisers.

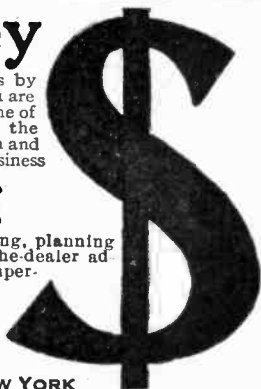

POPULAR ELECTRICITY

Pilley's Combination Flue Brush and Scraper

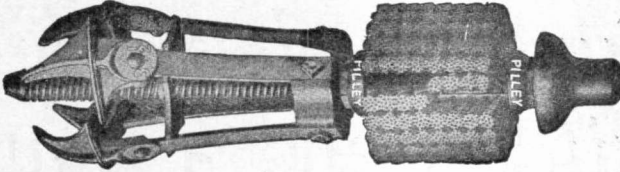

is made of the very best steel wire and in the very best and strongest manner. Every brush is guaranteed, so that if it is not just what we represent, you lose nothing.

WRITE FOR CATALOG

Pilley Packing & Flue Brush Mfg. Co., 612 S. 3d St., St. Louis, Mo.

Instructions in Wireless Telegraphy

SEND 25c for the best wireless instruction book ever published. Tells you how to construct your own spark coils, relays, coherers and tapping keys, etc. Non-technical; everybody can understand it. Complete instructions.

We also manufacture and deal in all kinds of electrical apparatus at low prices, and are the only manufacturers of the famous Joerin Third Relay, with which many marvelous experiments can be performed. Send 5 cents in stamps for catalogue.

ELECTRICAL EXPERIMENTERS SUPPLY COMPANY

Successors to Joerin Electric Novelty Co.

Room 500, 622 Wells Street, Chicago, Ill.



Especially adapted to electrical work

Installed or removed in a moment.

A SURE GRIP

Pierce Expansion bolts never slip. They hold like grim death in masonry, marble, tile or slate.

Pierce Specialty Co.

Elkhart, Ind.

QUALITY INSURANCE

Means the elimination of faults in your Product by RIGID TESTS.

Shrewd manufacturers do not jeopardize their trade by shipping half-developed goods. Careful purchasers buy subject to specifications and tests.

We are the medium for satisfactory dealings. We make all manner of electrical and photometrical tests and furnish you with exact and dependable data.

Electrical Testing Laboratories

80th St. and East End Ave.,

NEW YORK, N. Y.

For our Mutual Advantage mention Popular Electricity when writing to Advertisers.

The Swedish-Electric vibrator is a *gymnasium*, a *physician*, a *beauty builder*, and a *youth restorer*, all in one.

IT gets right down to the centers of *stimulation*—it *reaches* the *nerve* bases—*spurs* the *circulation* out of *sluggishness*—*hardens* the *muscles* quicker than *pulleys* and *dumb-bells*—*soothes* tired limbs *better* than *hand massage*—brings the blood into the *skin*—fills out the “*sunken-in*” spots in the *face* and the *arms* and *neck*—turns *flabby*, drooping furrows of *fat* into firm, *healthy*, beautiful *flesh*. It draws the *blood* into the *scalp* and *loosens* the *scruff* and *dandruff*—*replaces* the *deadened* skin with *healthy* tissue in which the *hairs* take a *firmer hold* and get *sufficient nutrition* from *their cells* to thicken and endure. If you have a *headache*, a few *touches* of the vibrator will *stop* it—if you are a *rheumatic*, it will *instantly relieve* the *twinges* and *soothe* the *effected parts* eventually effecting a *gradual* but permanent *cure*. Throw away *drugs* for *constipation*—the *vibrator* will *reach* the *seat* of the trouble and *un-clog* the *bowels* within *two minutes*. If you can't *sleep*, the vibrator will touch the *morphic nerves* and accomplish *more* than a *narcotic* without making a possible *victim* of the *drug habit*. It takes a *book* of many pages to tell *all* the wonderful things that the vibrator *can* and *does* do.—It will bring *back* your youth if you are *old* and keep you *young* if you are youthful—it will give *worn women* the *color* and *vitality* of a *mountain girl*. It will *recharge* a *fagged* business man into an *alert*, *eager*, *tireless*, *engine* with the *power* to think *twice as clearly* and to *do* twice as *much*.

The Swedish Electrical Vibrator used ten minutes each day will *prolong* your *life* by at least *twenty* years. You'll ward off enough illness to make it the biggest economy that you have ever effected. Send for *FREE* book *today* and you'll *order* the *vibrator* the *next* day. When writing be sure to state whether you have *Electric current* in your home or office.

The Swedish Electric Vibrator Co.

604-620 Farragut Ave.,
CHICAGO, ILL.



The
Best
Battery
Vibrators
on Earth

\$15.00 VIBRATOR

is contained in same kind of case as
\$12.50 outfit.



\$12.50 VIBRATOR

Case, Applicators and Batteries.



The Best
Electric Light Current Motor
Vibrator on Earth

**\$25.00 ELECTRIC LIGHT CURRENT
MOTOR VIBRATOR**

D. C. or A. C., 110 or 120 Volts.



Case containing the \$25.00 Electric
Light Current Vibrator.

Swedish-Electric Vibrator Co.,

602-642 Farragut Ave.,
CHICAGO, ILL.

For our Mutual Advantage mention Popular Electricity when writing to Advertisers.

POPULAR ELECTRICITY

Be A Salesman

Traveling Salesmen are the best paid men in the commercial world, earning from \$1,000 to \$10,000 a year. We will teach you to be one, by mail, in eight weeks and through our **Free Employment Bureau** assist you to secure a position with a reliable firm. No experience required. Hundreds of calls for our graduates. If you want to increase your earnings and enter the most independent and best paid profession in the world, our **Free Book "A Knight of the Grip"** will show you how. Write nearest office for it today.

Dept. 158 Nat'l Salesman's Training Assn.
New York, Chicago, Kansas City, Minneapolis, San Francisco.

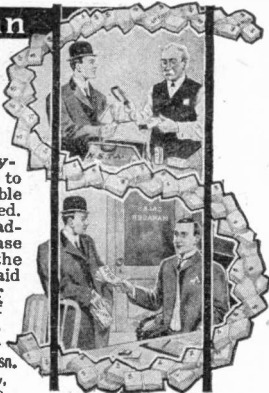

HOTEL EMPIRE



WE OFFER YOU THE MOST DELIGHTFUL

HOTEL ACCOMMODATION AT MODERATE COST

BROADWAY, (LINCOLN SQUARE) AND 63D ST. **NEW YORK CITY**

All surface cars pass or transfer to door Subway and "I." stations, one minute
ALL MODERN IMPROVEMENTS
Rooms, with detached bath, \$1.50 per day up
Rooms, with private bath, 2.00 " "
Suites, with private bath, 3.50 " "
W. JOHNSON QUINN, Proprietor,



FLASH LIKE GENUINE

Day or night. You can own a diamond equal in brilliancy to any genuine stone at one-thirtieth the cost.

Baroda Diamonds in Solid Gold Rings stand acid test and expert examination. We guarantee them. See them first; then buy. Catalogue Free. Patent Ring Measure included for FIVE two-cent stamps.

THE BARODA CO.
Dept. 40, 230 N. State Street, Chicago

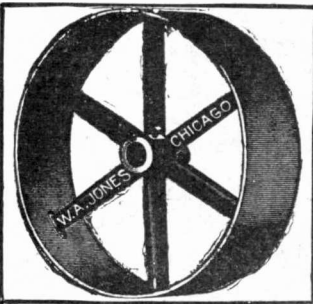

Do You Lose Power?

We are experts in answering that question. That is our business. Write us your troubles. Ten chances to one we can be of service.

CATALOGUE A17

WE ARE EXTENSIVE MANUFACTURERS OF

Pulleys, Shafting, Hangers, Gears, Friction Clutches, Sprocket Wheels, Bearings, Belting and Mill Supplies.

Our Patent Leather Faced Pulleys are what you need for Motors and Generators.

W. A. JONES FOUNDRY & MACHINE CO., 148 West North Ave., Chicago

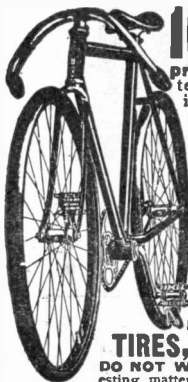

10 DAYS FREE TRIAL

We will ship you a "RANGER" BICYCLE prepaid to any place in the United States without a cent deposit in advance, and allow ten days free trial from the day you receive it. If it does not suit you in every way and is not all or more than we claim for it and a better bicycle than you can get anywhere else regardless of price, or if for any reason whatever you do not wish to keep it, ship it back to us at our expense for freight and you will not be out one cent.

LOW FACTORY PRICES We sell the highest grade bicycles direct from factory to rider at lower prices than any other house. We save you \$10 to \$25 middlemen's profit on every bicycle—highest grade models with Puncture-Proof tires, Imported Roller chains, pedals, etc., at prices no higher than cheap mail order bicycles; also reliable medium grade models at unheard of low prices.

RIDER AGENTS WANTED 1909 Ranger Bicycle furnished by us. You will be astonished at the wonderfully low prices and the liberal propositions and special offers we will give on the first 1909 sample going to your town. Write at once for our special offer.

DO NOT BUY a bicycle or a pair of tires from anyone at any price until you receive our catalogue and learn our low prices and liberal terms. **BICYCLE DEALERS:** you can sell our bicycles under your own name plate at double our prices. Orders filled the day received.

SECOND HAND BICYCLES—a limited number taken in trade by our Chicago retail stores will be closed out at once, at \$3 to \$8 each. Descriptive bargain list mailed free.

TIRES, COASTER BRAKES, single wheels, inner tubes, lamps, cyclometers, parts, repairs and **DO NOT WAIT** but write today for our Large Catalog beautifully illustrated and containing a great fund of interesting matter and useful information. It only costs a postal to get everything. Write it now.

MEAD CYCLE COMPANY, Dept. P-251 CHICAGO, ILL.

For our Mutual Advantage mention Popular Electricity when writing to Advertisers.

Sweep With Electricity With This Little Machine on Free Trial



THIS LITTLE MACHINE will take up all the dust and dirt from carpets, furniture and portieres more perfectly than any of the big vacuum cleaners, for the work of which you pay \$35 to \$50. We send it on free trial.

At a cost of **less than one cent**, you can thoroughly clean any room. Simply attach the wire to an electric light socket, turn on the current and run it over the carpet. A rapidly revolving brush loosens the dust, which is sucked back into the dirt bag.

There are attachments for cleaning curtains, portieres and pictures, without removing them from the walls. Nothing need be disturbed. Anyone can operate it. You can do all your spring house-cleaning with this little machine without taking up your carpets and rugs.

This machine is substantially made—will last a lifetime. Repairs and adjustments are never necessary.

Try this machine on trial. It will cost you nothing. We pay all express charges. If, after you have used the Hoover Electric Suction Sweeper for a fair trial, you are not satisfied that it is worth the price we ask, return it to us at once at our expense.

Orders for machines to be sent on trial will be filled in the order received. Do not delay. Write today for full information about their free trial plan and booklet, "Modern Sweeping by Electricity."

Electric Suction Sweeper Co., Dept. 15, New Berlin, O.

• THE ...
Positive Electric Vacuum Cleaner

is the Acme of perfection vacuum cleaning appliances. The exploitation at this time is after the firm decision on the part of the manufacturers that they have overcome the defects and eliminated the faults of electrically applied vacuum cleaners that are now on the market.

The ambition of the manufacturer has been realized in offering today a vacuum cleaner that will perform the functions that vacuum cleaners were intended for, that is to clean more thoroughly and with less labor on the part of the operator than any method that has been employed in the past. Every performance of the machine has resulted in a sale.

ELECTRIC CLEANER CO.

Monadnock Block

∴

CHICAGO, ILL.

Murdock's Circuit Detector

PAT. APP. FOR

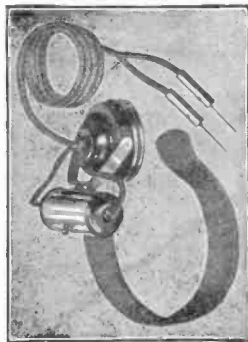

Don't Use a Magneto For Testing. Use Our Detector.

Neat and compact — can be carried in pocket.

Invaluable for Testing—Enclosed Fuses—Bell and Light Wiring—Lamps, Motors and Dynamos—

Switchboards and Instruments—Insulated Wire and Cables, and Conductive Material.

SPECIAL OFFER

On receipt of \$2.50 and mentioning this paper, we will send prepaid to any part of the U. S. or Canada one of these Detectors complete with cord and battery, \$2.50.

MANUFACTURED ONLY BY

WM. J. MURDOCK & CO.
 CHELSEA, MASS.

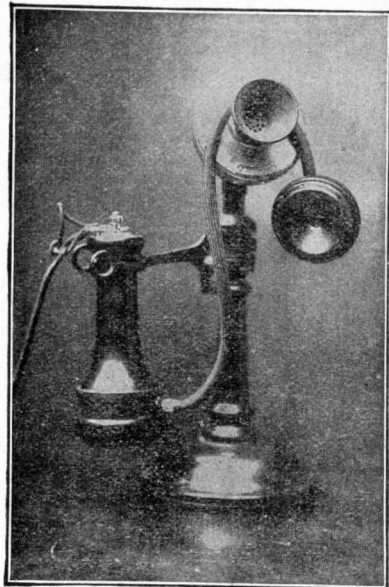

HELP-A-PHONE

How often do you have important conversations over your phone?

How often have you failed to hear distinctly?

The Help-a-Phone is just what you need where the noise of the typewriter, the buzz of conversation or the rattle of machinery interferes with the accurate and satisfactory hearing of messages.

Makes telephoning possible under any condition. Makes whispered conversations possible on local lines.

Offices, homes and shops where it has been in use report that it is invaluable. Money cheerfully refunded if you are not satisfied. State in ordering whether it is to fit a Bell or other instrument. Sent on receipt of price \$3.50.

If you are not interested as a telephone user send to us for a few facts and figures on the Help-a-Phone as an agency proposition. We have men and women who are coining money.

Western Help-a-Phone Company, 568 5th Ave., Chicago, Ill.

CHAS. E. GREGORY, Pres.

ELECTRICIAN @ MECHANIC

is a magazine which will help you. It is a practical monthly for every one who wants to learn about electricity, or who uses tools. Its articles tell you how to make dynamos, engines, wireless telegraph apparatus, furniture, models, etc. It is the only magazine of its kind in the world.

EDITORS

FRANK ROY FRAPRIE, M.Sc.Chem. Prof. A. E. WATSON, E.E., Ph.D.
M. O. SAMPSON

REGULAR FEATURES

Electricity. Practical and simple articles on electrical science, new applications and history, all illustrated. How to make dynamos, motors, batteries, all kinds of electrical apparatus. How to wire for bells and electric lights, install telephones, etc.

Mechanical Articles. How to use lathes and machine tools. How to use tools of all kinds. Forging, metal working, soldering, brazing, plating, etc. How to build gas engines, steam engines and other machines. All about gas engines and flying machines. Illustrated articles on everything new in mechanical progress.

Woodworking and Manual Training. How to build mission furniture. Wood finishing, staining, polishing, etc. Woodwork joints and cabinet making. How to make useful and handy articles of wood. Mechanical drawing, etc.

Wireless Telegraphy and Telephony. Full information of all that is new in wireless. Any one can build a wireless station from our descriptions. Our Wireless Club has nearly a thousand members in America and even beyond the seas.

All articles written in simple language for everybody to read. \$1.00 a year. Three months' trial, 20c.

SPECIAL THIRTY DAY OFFER

For **Thirty Days Only**, or until our stock of back numbers is exhausted, we offer twelve back numbers and a full year's subscription for **\$1.35**. Money orders only; no stamps accepted.

Sampson Publishing Company, 1140 Beacon Building BOSTON, MASS.

For our Mutual Advantage mention Popular Electricity when writing to Advertisers.

OUT THIS MONTH

ILLUMINATION has made its appearance. It is full of good things for every man connected in any way with the lighting industry. Following is a partial contents of the March Number, and the men who have made it.

- E. G. COWDERY, General Manager of the Peoples Gas Light & Coke Company, Chicago, writes on "Gas as an Illuminant."
- WALDON FAWCETT, tells for the first time in an illustrated story of a newly discovered means of lighting being experimented with by the government.
- LEM F. PARTON, who has made an extensive tour of South America, points advantages in this country for the erection of electric light plants and tells of markets for supplies in a very interesting article.
- FRANK C. PERKINS tells of the progress of illumination in European countries and shows what is being done in installing modern lighting systems abroad. This article is fully illustrated and is of especial interest to electrical engineers.
- A. CRESSEY MORRISON takes up the subject of acetylene and treats it from the standpoint of a man who has made it a study for years and who is an accepted authority on the subject.

These are only a FEW of the many interesting and valuable features of this magazine, and a special offer was made to readers of Popular Electricity last month which is repeated this month, as many wrote in asking the privilege of taking advantage of it after the March issue was out.

To those who will fill out the coupon on this page and mail it in, the publishers will give a three years' subscription for \$1.00. Single copies are 10c each, and this offer permits readers of this magazine to subscribe for it at a price so low that by sending in one dollar now thirty-six copies will be sent during the next three years for what it would cost to buy it over the news-stand for less than a third that time. The publishers do not want news-stand sales, they want actual subscribers and for that reason the special offer is being made.

Fill out the coupon now while you think of it. Mail it to us immediately. If you do not care to enclose your dollar with the blank, send in the coupon properly filled out anyhow, and we will mail you a bill for the amount which you may pay when you receive the first number, but to save time and annoyance at both ends, enclose the dollar right away.

Illumination Publishing Company
 324 Dearborn Street,
 CHICAGO, U. S. A.

P. E.
 ILLUMINATION,
 Chicago

Please send me your magazine to the address below for three years, for which I agree to pay you \$1.

Name.....

Street No.....

Town.....

State.....

Firm.....

Position.....

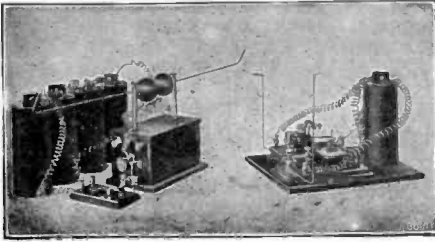

A Complete Wireless Outfit, \$12.25

You will be astonished at the remarkable results to be obtained with it.

We are World's Leaders in Electrical Supplies. Everything for boy or student at cut prices.

Send 4 cents for catalogues and sample burning wire.

B. M. MEYERS ELECTRICAL HOUSE, Evansville, Wis.

SHORTHAND IN 30 DAYS

WE absolutely guarantee to teach shorthand complete in thirty days. You can learn in spare time in your own home, no matter where you live. No need to spend months as with old systems. Boyd's Syllabic System is different in principle from all other systems. The first radical improvement in shorthand since 1839. It is easy to learn—easy to write—easy to read. Simple. Practical. Speedy. Sure. No ruled lines—no positions—no shading, as in other systems. No long list of word signs to confuse. Only nine characters to learn and you have the entire English language at your absolute command. The best system for stenographers, private secretaries, newspaper reporters. Lawyers, ministers, teachers, physicians, literary folk and business men may now learn shorthand for their own use. Thousands of business and professional men and women find their shorthand a great advantage. The Boyd System is the only system suited to home study. Our graduates hold lucrative, high-grade positions everywhere. Send today for free booklets, testimonials, guarantee offer, and full description of this new Syllabic shorthand system.

Address **CHICAGO CORRESPONDENCE SCHOOLS, 966 Chicago Opera House Bldg., Chicago, Ill.**

"Vesta"

Pocket Electric Lantern

DRY STORAGE BATTERY
TUNGSTEN BULB

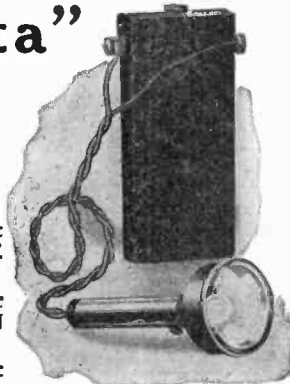

This is not a toy but is a practical portable lantern designed in response to an increasing demand for a safe powerful light where the use of gasoline oil or a candle is dangerous.

The battery is so made that it can be carried in the hip pocket without inconvenience and will give an exceptionally clear, white light from 12 to 15 hours on one charge.

Recharging can be done at small cost and the batteries will last for many months if properly cared for.

Write for further information.

Price \$5.00

VESTA ACCUMULATOR CO.

1338 Michigan Ave., Chicago, Ill.

HOTEL CUMBERLAND

NEW YORK

S. W. Cor. Broadway at 54th Street

Near 50th St. Subway and 53d St. Elevated and accessible to all surface lines.

Ideal Location Near Theatres, Shops and Central Park.

New and Fireproof

Strictly First-Class Rates Reasonable
All Hardwood Floors and Oriental Rugs

TRANSIENT RATES:

\$2.50 with bath and up.

Ten Minutes' Walk to Twenty Theatres.

Send for Booklet

Harry P. Stimson

R. J. Bingham

Formerly with Hotel Imperial

Formerly with Hotel W. podward

POPULAR ELECTRICITY

Vibrate Your Body And Make it Well



VIBRATION FOR THE RACKING
BACKACHE OF WOMEN

You have no *right* to be sick. Pain, suffering and disease are unnatural, they are *wrong*. It is your *duty* to be well. They are *stand* pain—**CURE IT**. No matter what ails you—even if others have told you that your case was incurable—**DON'T GIVE UP HOPE**. The great natural forces, *Vibration and Electricity*, are curing more people today than all the *drugs and doctors* in the world put together.

THE WHITE CROSS ELECTRIC VIBRATOR

combines *both* of these great natural curative agents. It gives you your choice of Vibration, Faradic and Galvanic Electricity, either separately or in combination, just as you wish. It relieves pain *instantly*, and its *cures are permanent*.

The *White Cross Electric Vibrator* cures the *cause* of disease. It sends the rich, red blood leaping and coursing through your veins and arteries *straight to where the disease begins*. It tones up your nerves and muscles and every vital organ. It makes you *fairly tingle with the joy of living*.

Don't neglect the FIRST symptoms. If you feel "run down," "out of condition," "if you just feel" "out of sorts" generally, *something is wrong*. The *most serious* diseases creep upon you unawares. The *White Cross Electric Vibrator* fills your body *so full of vigorous, robust health* that pain and disease cannot find a foothold.



Curing Stomach Trouble
with Vibration.

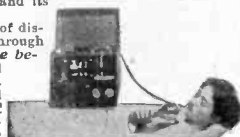

Combined Electric Bath and
Vibratory Treatment.

FREE BOOK "Health and Beauty"

SEND TODAY for the magnificent free book, "Health and Beauty." This valuable work tells you all about the human body in health and disease in *terms so plain, so clear*, that anyone can *understand*. It tells you how you can get well and *keep* well, no matter *what* your trouble is. This book was not written for surgeons and physicians, but for *you*. Every page, every line, is thrillingly interesting.

Besides, this book tells you all about the wonderful *White Cross Electric Vibrator*—what it has done for thousands of others and what it will do for you. It tells you about the *very special offers* which we are making, *for just a short time*, on this wonder-working instrument, and how you can get a *White Cross Electric Vibrator* on a *genuine free trial*. Your name and address brings this intensely interesting book by return mail. Sign the coupon and mail it to us at once.



Making the Hair Beautiful
with Vibration.



CURES THESE DISEASES AND MANY OTHERS

Headache	Nervous Debility
Catarrh	Bright's Disease
Insomnia	Heart Trouble
Toothache	Deafness
Indigestion	Stomach Trouble
Rheumatism	Scalp Disease
Neuralgia	Constipation
Earache	Lumbago

All these and dozens of other chronic and acute diseases instantly relieved and permanently cured by Vibration and Electricity. Get our wonderful free book, "Health and Beauty." THEN you will know.

Vibrating Chair Free

With the *White Cross Electric Vibrator*, you can transform any ordinary household chair into a Vibrating Chair, equal in *every respect* to those used in the big hospitals and sanitariums. You can give yourself the same treatments, including the *famous Swedish Movement* treatments, that specialists and sanitariums charge \$2.00 to \$3.00 apiece for. This is only one of the many marvelous things that can be done with the *White Cross Electric Vibrator* exclusively.

Send Coupon Today For Free Book

DON'T DELAY A MINUTE. Whether you are sick or well, you should send for this book *anyway*. You cannot tell when you *may* need it and need it *badly*. When you do there will be no time to send for it. Learn *today* what vibration will do for you—for all your loved ones. Learn all about its wonderful health-giving powers. Learn how you can save all doctor bills and cure yourself right at home without expense.

SEND NO MONEY, just your name and address on the coupon. *But write today.*

LINDSTROM, SMITH CO.
253 LaSalle Street
Dept 1154 CHICAGO



LINDSTROM, SMITH CO.,
253 LaSalle St.,
Dept. 1154 CHICAGO
Without obligations on me, please send free, prepaid, your book "Health and Beauty," on treatment of disease by Vibration and Electricity. Also free trial offer.

Name

Address

SIGN AND MAIL THE COUPON TODAY



For our Mutual Advantage mention Popular Electricity when writing to Advertisers.

POPULAR ELECTRICITY



I WANT TO TEACH YOU TELEGRAPHY

either through my private correspondence course at your home or at my residence school. Telegraphy offers more opportunities for steady, profitable, fascinating employment and advancement to the highest salaried positions than almost any other occupation. There is a good demand today for competent telegraphers, and now is the time to learn telegraphy.

MY AUTOMATIC SELF-TEACHER will teach you at your home during your spare hours. It is to telegraphy what the phonograph is to foreign language study. I furnish a complete set of records with each machine, a 264 page cloth bound book

"THE TELEGRAPH INSTRUCTOR," written by myself and in fact everything required to learn telegraphy at home.

MY RESIDENCE SCHOOL IS THE LARGEST IN AMERICA, and expenses are lower than anywhere else. Now, if you are at all interested in the study of telegraphy, let us become acquainted.

WRITE ME TODAY for catalog containing information of both courses. **IT IS A FIELD YOU OUGHT TO ENTER.**

G. M. DODGE,

Foster Street, VALPARAISO, INDIANA

For the
B.P.O.E.
Best Pipe on Earth

IRVING'S WIZARD PIPE

The Best for the Office

For the
B.P.O.E.
Best People on Earth

Represents the first novel and valuable idea in pipe construction in years. To fill, turn pipe upside down and swing briar bowl out from rubber stem. Light the tobacco, close pipe and invert it. You can then smoke in clean comfort.

No Spilling of Ashes on Books, Desk or Clothes.

In case of unexpected visitors, put pipe in your pocket—lighted—and continue smoking when they leave. Cut shows complete separation of tobacco from saliva and nicotine which are absorbed by renewable Antiseptic Wick in cartridge shell. Air feed from below ensures burning all the tobacco—no waste as in ordinary pipes.

Style X, straight or curved stem, \$1.00, Style XX, straight or curved stem, sterling silver mounted, in leather case, \$2.00. Both have genuine French Briar bowls and Best Vulcanized Rubber stem. Either sent postpaid with 1 doz. antiseptic cartridges on receipt of price.

Wizard Patent Developing Co., Inc., Dept. 8, 128, West 31st Street, New York, N. Y.



DEALERS
WANTED



AN INSPIRATION!

To refit your office with "Andrews Quality" Office Furniture is a good one. Improves your business, nerves and bank account.

Try it!

A. H. Andrews Co.

174 Wabash Avenue, CHICAGO

**BIG
PAY**

**PLUMBERS, BRICKLAYERS and ELECTRICIANS
EARN \$5.00 A DAY AND OVER.**

We can teach you any of these trades in from 2 to 3 months by Practical and Individual Instruction and enable you to secure a well-paying position upon graduation. Write today for free catalog.

COYNE 253 Tenth Ave., NEW YORK
NATIONAL TRADE SCHOOLS 825 N. Ashland Ave., CHICAGO

**SHORT
HOURS**

For our Mutual Advantage mention Popular Electricity when writing to Advertisers.

A SHINE FOR A GENT



If you have a little capital and want to establish yourself in a profitable, permanent and substantial business, write us at once about our

Electric Automatic Shoe Polisher

A practical, effective coin operating shoe cleaner and polisher. Can be installed in stores, depots, public places, in factory where. Unsurpassed money-maker. Draws trade wherever installed.

COST OF OPERATING, 1c PER 100 SHINES

Not a cheap penny slot machine, but a practical necessity in a class by itself.

ORGANIZERS & AGENTS WANTED with some capital for local operation. **BIG PROFITS.**

ACT QUICKLY: WRITE US TO-DAY

ELECTRIC SHOE POLISHER CO.
1314 Great Northern Building, Chicago

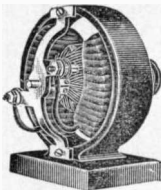

DYNAMO - MOTOR \$3.85

(A Dynamo and Motor in One)

As a dynamo it will light 40 candle power, operate induction coils; charge storage batteries; decompose water; electroplate, etc. As a motor, will operate swing machine, jeweler's lathe, emery wheel, circular saw, advertising devices, and other useful appliances. Send stamp for catalog. Nos. 11 and 12 of new things electrical.

ARROW ELECTRIC CO.
103 South Canal Street, Chicago, Ill.

Do You Hear Well?

The Stolz Electrophone—A New, Electrical, Scientific and Practical Invention for those who are Deaf or Partially Deaf—

MAY NOW BE TESTED IN YOUR OWN HOME.

Deaf or partially deaf people may now make a month's trial of the Stolz Electrophone at home. This personal practical test serves to prove that the device satisfies with ease, every requirement of a perfect hearing device. Write for particulars at once, before the offer is withdrawn, for by this personal test plan the final selection of the one completely satisfactory hearing aid is made easy and inexpensive for every one.

This new invention, the Stolz Electrophone (U.S. Patent No. 763,676) renders unnecessary such clumsy, unsightly and frequently harmful devices as trumpets, horns, tubes, ear drums, fans, etc.

It is a tiny electric telephone that fits on the ear and which, the instant it is applied, magnifies the sound waves in such manner as to cause an astonishing increase in the clearness of all sounds. It overcomes the buzzing and roaring ear noises and, also, so constantly and electrically exercises the vital parts of the ear that, usually, the natural unaided hearing itself is gradually restored.

What Three Business Men Say:

The Electrophone is very satisfactory. Being small in size and great

In hearing qualities makes it preferable to any I have tried and I believe, I have tried all of them. M.

W. HOYT, Wholesale Grocer, Michigan Ave. and River St., Chicago.

The Stolz Electrophone Co., Chicago, Ill. Gentlemen—I have used your Electrophone since July

1908. It enables me to hear speakers over 50 feet away. Without it I could not hear their voices. It has improved my natural hearing at least 50%, and has stopped the head noises which were so annoying. Refer to me at any time. Yours truly, E. P. ROGERS, Suite 908-159 LaSalle St., Chicago, Ill.

I have now used your Electrophone over a year, and know that it is a first-class, scientific hearing device. Without it people have to shout directly in my ear to make me hear. With it, I can hear distinctly when spoken to in an ordinary tone. Best of all, it has stopped my head noises, which were a terrible aggravation. LEWIS W. MAY, Cashier, 100 Washington St., Chicago.

Write to or call (call if you can) at our Chicago offices for particulars of our personal test offer and list of other prominent endorsers who will answer inquiries. Physicians cordially invited to investigate aurists' opinions.

Stolz Electrophone Co., 1775 Stewart Bldg., 7th floor, Chicago.

Branch Offices: Philadelphia, Cincinnati, Seattle, Los Angeles, Pittsburgh, Louisville, Indianapolis, Des Moines, Toronto.

Foreign Office: 82-85 Fleet St., London, Eng.

Mrs. C. Lidecka, 238 12th Ave., Maywood, Ill., wears an Electrophone

Less conspicuous than eyeglasses

ers over 50 feet away. Without it I could not hear their voices. It has improved my natural hearing at least 50%, and has stopped the head noises which were so annoying. Refer to me at any time. Yours truly, E. P. ROGERS, Suite 908-159 LaSalle St., Chicago, Ill.

I have now used your Electrophone over a year, and know that it is a first-class, scientific hearing device. Without it people have to shout directly in my ear to make me hear. With it, I can hear distinctly when spoken to in an ordinary tone. Best of all, it has stopped my head noises, which were a terrible aggravation. LEWIS W. MAY, Cashier, 100 Washington St., Chicago.

Write to or call (call if you can) at our Chicago offices for particulars of our personal test offer and list of other prominent endorsers who will answer inquiries. Physicians cordially invited to investigate aurists' opinions.

Stolz Electrophone Co., 1775 Stewart Bldg., 7th floor, Chicago. Branch Offices: Philadelphia, Cincinnati, Seattle, Los Angeles, Pittsburgh, Louisville, Indianapolis, Des Moines, Toronto. Foreign Office: 82-85 Fleet St., London, Eng.

Be the Master



Only the man who is "The Master"—master of himself—master of his trade or profession, wins great success.

It's Knowledge, not strength that gives this mastery to man. The educated, trained, thinking workman is in demand.

You can educate yourself—you can prepare for advancement by using a portion of our Great Specialized Engineering Library:

Cyclopedia of Engineering

A practical, genuine reference work on steam boilers, steam, gas and oil engines, marine and locomotive work, mechanical drawing, management of dynamos and motors, electric lighting and wiring, etc.

These six volumes contain 3,200 pages, size, 7x10 inches and over 2,000 full page plates, drawings, diagrams, formulas, tables, etc. Also contains a series of practical test questions with solutions, and is carefully indexed for ready reference

IT COSTS NOTHING TO LOOK

Upon receipt of coupon we will send you a set of this great Cyclopedia, by prepaid express, without deposit or guarantee of any kind. Keep the books five days, examine them carefully, give them every possible test. We want you to be the judge—you are under no obligations.

If you decide the books are not what you want, advise us and we will have them returned at our expense. If you keep the books send us \$2.00 within five days, then \$2.00 a month until you have paid the special price of \$18.60. The regular list price is \$36.00.

This special offer is good until May 1st.

IMPORTANT SUBJECTS COVERED

Calorimeters—Pumps—Elevators—Indicators—Valve Gears—Turbines—Compression and Absorption Refrigeration—Gaseous and Liquid Fuel—Condensers—Navigation Air Brakes—Machine Shop Work—Ventilation—Heating—Air Compressors—Principles and Management of Direct Current Dynamos and Motors—Storage Batteries—Automobiles, etc.

FREE! Order at once and we will include for one year, as a monthly supplement, the TECHNICAL WORLD MAGAZINE

A regular \$1.50 monthly, presenting twentieth century facts in plain English. Latest discussions on timely topics in science, invention, discovery, industry, etc. The strongest serial of the season, "WHO OWNS THE EARTH," appears in the February issue. JUST MAIL THE COUPON.

American School of Correspondence, Chicago, U. S. A.

FREE OFFER COUPON

American School of Correspondence: Please send set Cyclopedia of Engineering for five days' free examination. Also T. W. for one year. I will send \$2 within 5 days and \$2 a month until I have paid \$18.60; otherwise I will notify you and hold the books subject to your order. Title not to pass until fully paid.

NAME.....

ADDRESS.....

OCCUPATION.....

EMPLOYER.....

Don't Be a Wage Slave

**Make \$3,000.00 to \$5,000.00 a Year
Be a Doctor of Mechano-Therapy**

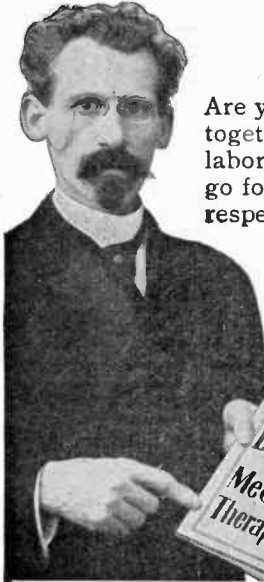

Are you tired of working for wages which barely keep body and soul together? Have you the ambition to enjoy the profits of your own labor? To gain social prominence and financial independence? To go forth among your fellow men with your head up—an honored and respected citizen of your locality?

THEN SEND FOR OUR FREE BOOK

Entitled "How to Become a Mechano-Therapist." It tells how every man and woman, with an ordinary, common school education, can acquire a profession within a few months which will insure financial independence for life. **GET OUR BOOK**—it costs you nothing.



What is Mechano-Therapy?

Mechano-Therapy is the art, or science, of treating disease without drugs. It is similar to Osteopathy, but far superior, being the latest, up-to-date method of treating disease by the Natural Method. It heals as Nature heals—in accordance with Nature's laws.

The Mechano-Therapist is a drugless physician and a bloodless surgeon. His medicines are not drugs, but scientific combinations of food, circumstance, idea, water and motion.

The Mechano-Therapist is skilled in compelling the body to DO ITS OWN HEALING with its own force, rather than with poisonous drugs of the old school practitioner.

CAN I LEARN IT?

Have you asked yourself this question? We answer, unhesitatingly, YES.

If you have so much as an ordinary, common school education, you can learn. If you have the ambition to better your condition—to earn more money—to have more leisure—you can learn.

Nor does this require years of patient study to learn Mechano-Therapy—we can teach you in a very short time, so that you may enter this profession—and when you do, you begin to make money. No text books are required, beyond those furnished by us. We supply all lessons and necessary text books free of cost to you. No apparatus is used. You do not even need a place to work. All you require is your two hands.

Read What Our Graduates Say

The statements of a few of our graduates below verify every claim we make. Read them carefully, and remember that what these men and women have done, you may do. The success they have made, you may make. We do not give the address of the people whose testimonials we print. Our graduates are meeting with remarkable financial success, and shrink from having their prosperity published broadcast. If you wish to communicate with any whose names are given below, write us and we will supply you with the address.

Treating Physician for Diabetes

Dr. Ellsworth says: I have all I can do, and at very good fees, and am at present treating an M. D. for Diabetes. It is impossible for me to speak in fitting terms of the wonderful success of Mechano-Therapy in the treatment of disease.

Considers Mechano-Therapy Better Than Osteopathy

Dr. B. E. French says: I consider Mechano-Therapy greatly superior to Osteopathy, and as it is a profession so very interesting and one so easily learned, I am surprised that more do not take it up, especially as the course in your college is so inexpensive.

An Enthusiastic Graduate Says Best Paying Profession

Dr. Stagle says: Mechano-Therapy is one of the cleanest, best paying, up-to-date professions. One that is remunerative from the start—one that is practical in every way—one that is not built on theory—one that is progressive—one that will make you prosperous while you are making others well and happy.

A Personal Word

From the President of the College.

Have you ever thought of going into business for yourself?

Then send for my FREE book. It will tell you how others are enjoying a life of luxury, while putting money away in the bank. How YOU can not only gain independence, but be a benefit to humanity and a highly respected citizen with an income of \$3,000 to \$5,000 a year.

All I ask is that you send me the coupon below for my FREE book. You can then decide, in the privacy of your own home whether you wish to embrace the opportunity which I offer you, or whether you will continue to plod along the balance of your days slaving for others.

We Teach You in Your Own Home

We can teach you an honorable and profitable profession in a few months, which will insure your financial independence for life. We can make you master of your own time—to come and go as you will—an honored and respected citizen, with an income of \$3,000 to \$5,000 a year. We teach you this pleasant, profitable profession by mail, right in your own home, at your own convenience, and without interfering with your present duties. It makes no difference how old you are, any person—man or woman—with just an ordinary common school education, can learn Mechano-Therapy. It is easy to learn and results are sure.

It is simply drugless healing. A common-sense method of treating human ills without dosing the system with poisonous drugs—that's all. We have taught hundreds of men and women who were formerly clerks—farmers—stenographers—telegraph operators—insurance agents—railway employees—in fact, of nearly every known occupation—old men of 70 years who felt discouraged and hopeless—young men of 20 years, who never had a day's business experience—salaried men, who could see nothing in the future but to become Oserized—laboring men, who never realized that they had within themselves the ability to better their conditions. Write for our FREE book, which explains all—today.

Cut Out This Coupon and Mail It Today

AMERICAN COLLEGE OF MECHANO-THERAPY,
Dept. 722, 120-122 Randolph Street, Chicago, Ill.

GENTLEMEN:—Please send your book, "How to become a Mechano-Therapist," free of cost to me.

My Name.....

My Post Office.....

R. F. D. or St. No.....State.....
(Write name, town and state very plain)



FREE BOOK

Try to realize what this opportunity means TO YOU. If you are contented, and willing to drudge for others all your life for a mere pittance, our proposition may not interest you. But if you have a spark of manhood or womanhood left—any ambition whatsoever to improve your condition socially and financially, learn this pleasant profession. It will make you independent for life. It is so easy—so VERY easy—to get all the details—without trouble or expense. Simply sign and send us the coupon now.

AMERICAN COLLEGE OF MECHANO-THERAPY
Dept. 722, 120-122 Randolph St., Chicago, Ill.

SIMPLY SEND THE COUPON FOR THIS

Illustrated
BOOK
How To Become A
Mechano-Therapist
Sent To Any Address
FREE



Send for this Book Today, it is FREE

PATENTS = PATENT ATTORNEYS

**U. S. or
CANADIAN
PATENTS**

\$25.00

We pay all expenses and disbursements except Government fees

ASSOCIATES throughout Continental Europe, Great Britain, the Colonies, South America and Canada enable us to investigate and prosecute foreign interests with dispatch.

Our Pamphlet No. B for the asking.

THE INDUSTRIAL LAW LEAGUE, Inc.
170 Broadway, NEW YORK CITY, N. Y.

Samuel G. McMeen

Kempster B. Miller

McMeen & Miller

Patent Solicitors and Patent Experts

In connection with our telephone engineering practice we make a specialty of securing electrical patents for inventors, and of giving expert advice in patent matters. We also have facilities for marketing meritorious electrical inventions.

1456 Monadnock Block,
CHICAGO

787 Market Street,
SAN FRANCISCO

PATENTS that PROTECT

Our 3 books for Inventors mailed on receipt of 6cts. in stamps
Rooms 41-51 Pacific Bldg.
R. S. & A. B. LACEY, Washington, D. C. Established 1869.

THE INVENTOR'S UNIVERSAL EDUCATOR
TELLS ALL ABOUT PATENTS,
HOW TO SECURE THEM. HAS

600 MECHANICAL MOVEMENTS
also 50 PERPETUAL MOTIONS

Every inventor should have a copy. Price \$1.00 by mail.
Address

F. G. DIETERICH, Uray Bldg., Washington, D. C.

PATENTS SECURED. Inventor's Pocket Companion free. Send description for free opinion as to patentability. W. N. Roach, Jr., Metzerott Building, Washington, D. C.

PATENTS

TRADE MARKS AND COPYRIGHTS

SECURED OR FEE RETURNED

Send model or sketch and description of your invention for free search of the U. S. Patent Office Records.

Our Four Books mailed Free to any address. Send for these books; the finest publications ever issued for free distribution.

HOW TO OBTAIN A PATENT

Our Illustrated 80 page Guide Book is an invaluable book of reference for inventors and contains 100 mechanical movements illustrated and described.

FORTUNES IN PATENTS

Tells how to invent for profit and gives history of successful inventions.

WHAT TO INVENT

Contains a valuable list of inventions wanted and suggestions concerning profitable fields of invention. Also information regarding prizes offered for inventions, among which is a

PRIZE OF ONE MILLION DOLLARS

offered for one invention and \$10,000 for others

PATENTS THAT PAY

Contains fac-similes of unsolicited letters from our clients who have built up profitable enterprises founded upon patents procured by us. Also endorsements from prominent inventors, manufacturers, Senators, Congressmen, Governors, etc.

WE ADVERTISE OUR CLIENTS' INVENTIONS FREE in a list of Sunday Newspapers with two million circulation and in the *World's Progress*. Sample Copy Free.

VICTOR J. EVANS & CO.

(Formerly Evans, Wilkens & Co.)

Main Offices, 615 "F" Street, N. W., Washington, D. C.

Readers of Popular Electricity who have Inventions to Patent can refer to Advertisers appearing on this page with the assurance that their interests will be absolutely protected to the smallest detail.

For our Mutual Advantage mention Popular Electricity when writing to Advertisers.

POPULAR ELECTRICITY

Direct-Connected Slow-Speed Rotary Electric Pump

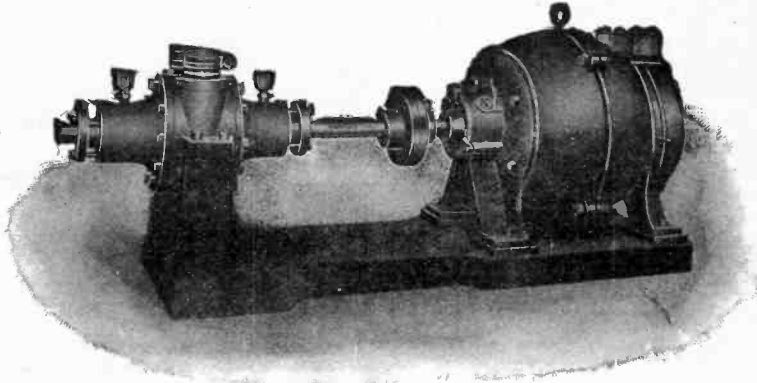

Automatic, silent, primes itself, has positive action on the water. Will pump any liquid that is free from grit. Arranged with tank switch to control operation, starting when tank is two-thirds empty and stopping when water is at proper level.
A most durable pump, all wear being easily taken up.

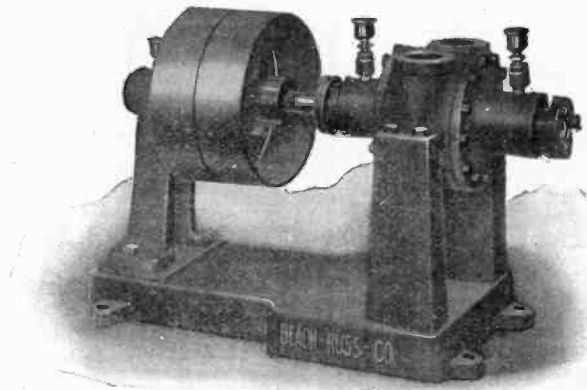

Smallest size No. 1— 600 gallons per hour
No. 2—1200 “ “ “ “
No. 1 uses $\frac{1}{2}$ H. P.—No. 2 uses 1 H. P.

Tank switch controls operation of pumps.

Built on Turbine Water Wheel principles—not on Centrifugal principles.

For use in Tanneries, Laundries, Dyers, Hotels, Institutions and Private Houses.

Let us quote you on Rotary Pumps for all purposes, Vacuum Pumps, Pressure Blowers, Blower Burners, Flat Irons.

BEACH-RUSS CO. 214 FIFTH AVENUE
CHICAGO

For our Mutual Advantage mention Popular Electricity when writing to Advertisers.



LEARN To DRAW

You can become a newspaper magazine illustrator by learning at home—learn the illustrating business from the biggest and most substantial school of its kind in the world—the institution that is the one school endorsed by all leading artists of the country. If you are ambitious and energetic we can teach you thoroughly by mail. Send for our beautiful prospectus—it's free.

SCHOOL OF ILLUSTRATION

Founded by F. Holme
Dept. 278, 88 Wabash Avenue, Chicago



Be a Card Sign Writer

and earn from \$18.00 to \$20.00 per week. If you want a pleasant, profitable position in a big, substantial house where opportunities for advancing always exist, let us

make you a competent *Show Card Writer*. We can teach you thoroughly by mail in five to six months, qualifying you to do every kind of card writing from plain price cards to artistic posters. The work is clean, refining and free from the wear and tear of a commercial life, and card writers are always in demand.

If you are a clerk, window trimmer or advertising man in any wholesale or retail firm can quickly increase your salary and make your position more secure by learning to write card signs.

Send for free and full information from the most successful Card Writing School in the world. Address:

THE SIGN WRITING SCHOOL,

Dept. 278, 90 Wabash Avenue, Chicago, Ill.



LEARN TO WRITE ADVERTISEMENTS

EARN \$25 TO \$100 A WEEK

We will teach you by correspondence the most fascinating and profitable profession in the world. Send for our beautiful prospectus. It's FREE.

PAGE-DAVIS SCHOOL
Dept. 278, 90 Wabash Ave., Chicago
Dept. 278, 150 Nassau St., New York

Address either office.

LEARN JEWELERS ENGRAVING

"The Engraving School that Graduates Experts" A fascinating, high-salaried and easily learned trade, taught thoroughly and practically by correspondence. We will teach the beginner better engraving by correspondence than he can gain in years of rigid apprenticeship. We will improve the skill of any engraver one hundred per cent and make him master of the trade. The demand for competent engravers far exceeds the supply. Send for handsome illustrated prospectus, 90 Wabash Ave., Chicago.

THIS HANDSOME DRAWING OUTFIT FREE

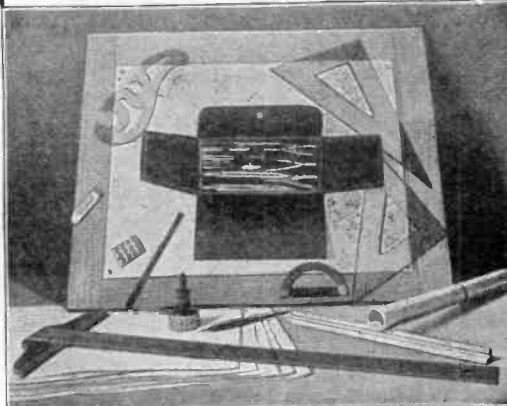

TO EVERY STUDENT IN DRAFTING AND ARCHITECTURE

Learn to use these tools because with them you can earn from \$30.00 to \$70.00 every week of the year.

LOOK HERE! THE "FREEPORT IDEA" means that ordinary men can become Draftsmen, Designers—Trained Men—in the drafting and design of Machinery. Sheet Metal Work, Piano cases, Interior and Office Fixtures; in Architecture and the Design of all forms of Buildings.

The "FREEPORT IDEA" is a wonderful improvement in Correspondence School Training. You will get Technical training by doing actual work. We use common English and teach both the **THEORY** and **FRAC-TICE**.

Ask us about it. Use the following **COUPON**.

FREEPORT CORRESPONDENCE SCHOOLS

903 Rice Bldg., Freeport, Ill.

I would like the position before which I have marked a cross (X). Please explain, without cost to me, how I can get such a position and be sure to hold it.

- | | |
|-------------------------|------------------------|
| Mechanical Draftsman | Manual Training Instr. |
| Sheet Metal Draftsman | Bookkeeper |
| Architect | Advertiser |
| Architectural Draftsman | Stenographer |
| Architectural Designer | Steam Engineer |
| Carpenter and Joiner | Locomotive Firemen |

NAME.....AGE.....
CITY.....STATE.....
ST. or R. F. D.....OCCUPATION.....

For our Mutual Advantage mention Popular Electricity when writing to Advertisers.



Back to His Old Job

**Promoted—Couldn't "Make Good"—Put Back at his Old Job—
Humiliated—Confidence Gone—Opportunity Killed.**

Suppose *you* were advanced—as indeed you hope to be—would you be prepared for your new duties—or would you make a "hit or miss" effort and end in dismal failure through *lack of training*?

The element of "failure" need never enter into your career if you have the special training such as the International Correspondence Schools of Scranton can impart to you in your spare time. Success will be doubly sure because I. C. S. training makes you an expert *at your chosen occupation*. Keeps you moving up. *Raises your salary*. Helps you to get both hands on a better position—where before you merely viewed it from a distance. *Makes you a Success!* By marking the attached coupon you will learn how you can be helped. Mark it now. Doing so costs you only the postage. Marking the coupon is in no way binding.

How You Can Compel Success:

You can quickly and easily put yourself in a position to earn more through I. C. S. help without leaving home or giving up your position. *There are no books to buy*. So long as you can read and write the I. C. S. has a way to make you successful.

About 300 students every month **VOLUNTARILY** report salaries raised through I. C. S. help. During January the number was 287

A postage stamp brings you the very information you need to break away from Failure and win Success. Is your future worth it? Does your ambition justify it? Then, by all means mark and mail the coupon **NOW**—before you forget it.

SALARY-RAISING COUPON

INTERNATIONAL CORRESPONDENCE SCHOOLS
Box 1102, Scranton, Pa.

Please explain, without further obligation on my part, how I can qualify for employment or advancement in the position before which I have marked X

Bookkeeper	Mechan. Draughtsman
Stenographer	Telephone Engineer
Advertisement Writer	Elec. Lighting Supt.
Show Card Writer	Mech. Engineer
Window Trimmer	Plumber & Steam Fitter
Commercial Law	Stationary Engineer
Illustrator	Civil Engineer
Civil Service	Building Contractor
Chemist	Architect/Draughtsman
Textile Mill Supt.	Architect
Electrician	Structural Engineer
Elec. Engineer	Banking
	Mining Engineer

Name _____
Street and No. _____
City _____ State _____

NEW BOOKS FOR BOYS

A book that the boy will eagerly devour. Shows him what he can do with his own

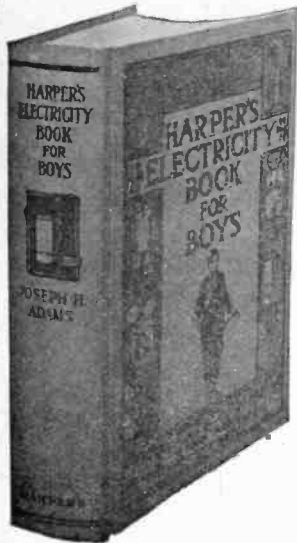

hands, and accomplish results with inexpensive materials. Tells how to make simple batteries, induction coils, telephones, wireless telegraph apparatus, and hundreds of other interesting and instructive articles.

Explains briefly and in simple language the workings of electricity in its daily application and has an appendix of electrical terms and phrases. Every boy should have this book. 407

pages with 274 illustrations. Price, \$1.75. Given free for three paid subscriptions to

Popular Electricity

Presents the subject in a way that makes it both interesting and instructive and easily understood by young people. Describes vividly the invisible wonders of the mysterious world of magnetism.

Fascinating as a fairy tale. Delights both young and old. 325 pages, 77 illustrations. Price \$1.50. Given free for three paid subscriptions to

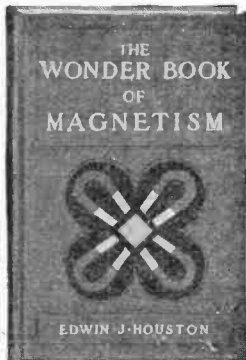

POPULAR ELECTRICITY

Enclosed find..... please send

..... (Name book.)

Name

Address

City

State



ANY ONE

Can Own this Wonderful Moving Picture Show

You have seen and been spellbound at the thrilling moving picture shows in the big theatre. Of course, every one has.

Now, you can have the same source of wonderful entertainment and enjoyment, the same flashing throbbing life-like pictures, right in your own home.

In the past it has been out of the question to own the great machines used in the theatres. These machines have cost hundreds of dollars and require the most expert operator. Now, however, thanks to the most wonderful inventor of the age, a real practical moving picture machine, not a toy, not only at a sum so ridiculously low that any family can afford it, but by our WONDERFUL OFFER, you can own the machine, fully as good, remember, as the big ones in the theatre, and

Pay on the Easiest Payments.

We mean exactly what we say. Never was such an offer made. It gives every family the opportunity to own a real moving picture machine which, like a wizard, brings the whole world of excitement and amusement into your own home.

YOU RISK NOTHING. You don't pay a cent unless you want the Ikonograph. **THEN YOU PAY ON YOUR OWN TERMS.**

You select terms to suit yourself. Take all the time you need. You will never notice the small payments. The money you spend in chewing gum, candy and little things that don't last will easily pay for this marvel of modern times. You can do as many have done.

Pay From Profits

made giving moving picture shows to your friends and towns people. If you want, you can go to other towns too and make big money giving moving picture shows. Fortunes are made this way. One moving picture theatre in Chicago made

\$100,000 in One Year.

The Ikonograph gives you the start, but whether you want a moving picture machine to make money or to amuse yourself at home, our Ikonograph is the greatest offer ever made. Any boy or girl can run it and it is non-explosive, and we exchange films, so you have new things to see all the time. Remember it costs nothing to find out all about our wonderful Ikonograph offer. Simply write like this:

PLEASE SEND ME FULL PARTICULARS OF YOUR GREAT IKONOGRAPH OFFER AND 1909 BOOK POSTPAID.

We will send you full particulars right away. Do it now. Write today.

Home Merchandise Co.

920 McClurg Bldg.

CHICAGO, ILL.

POPULAR ELECTRICITY



The Big Three in Electricity

Franklin Discovered It—Edison Developed It—The Cyclopedia Applies It
CYCLOPEDIA of APPLIED ELECTRICITY

is a practical guide for every man who wants information regarding electrical appliances. This work presents in compact, practical form and in simple, non-technical language, the results of the best work of the best men in the electrical profession; it lays the foundation of electrical progress for years to come.

This Cyclopedia covers the whole electrical field more completely than any other group of volumes. It comprises 2,896 pages of up-to-date, authoritative information; it treats of 23 general subjects; its detailed index includes over 4,000 different topics. It contains hundreds of special photographs, diagrams, sections, etc., besides condensed tables and formulas, containing information that it would require years of time and a fortune to collect. The pages are 7x10 inches in size, printed on special paper, in large, clear type, carefully bound in half morocco.

THE YOUNG MAN who has not yet chosen his life's work, will find it a valuable guide to one of the greatest money making professions of the present and future age. The development of this vast science has just begun. There is plenty of room at the top for inventive genius and new discoveries that will bring fame and fortune.

THE ELECTRICAL WORKER whether "trouble shooter" or expert, will find this Cyclopedia especially valuable as an index to what he knows and a ready reference to what he has forgotten.

THE BUSINESS MAN AND HOUSE OWNER can gain from it a knowledge of electricity that will save him many a dollar.

FREE FOR EXAMINATION: Fill in and mail the coupon. We will send you a set of these practical books for 5 days' FREE examination. Examine the books carefully.

If satisfactory send \$2.00 within 5 days and \$2.00 per month until you have paid the special \$18.60 price. The regular list price is \$36.00. If you don't keep the books, advise us and we will send for them.

REMEMBER! you can examine the books without expense or obligation—we pay all charges.

IMPORTANT SUBJECTS TREATED

Electric Wiring—Electric Telegraph—Wireless Telegraphy—Telautograph—Theory, Calculation, Design and Construction of Generators and Motors—Types of Dynamos and Motors—Elevators—Direct Current Motors—Direct-Driven Machine Shop Tools—Electric Lighting—Electric Railways—Alternating Current Motors, etc.—Single Phase Electric Railway—Management of Dynamos and Motors—Power Stations—Central Station Engineering—Storage Batteries—Power Transmission—Alternating Current Machinery—Telephony—Automatic Telephone—Wireless Telephony—Telegraph, etc.

FREE! IF YOU ORDER PROMPTLY

With all orders received before May 1st, we will include for one year, as a monthly supplement, the

TECHNICAL WORLD MAGAZINE

An ideal American family monthly—regular price \$1.50. Clean, instructive, helpful and true—with the whole round world as its field. Present day, scientific facts and inventions are treated in a manner so clear and comprehensive that any one can understand and every one can learn.

AMERICAN SCHOOL of CORRESPONDENCE
 CHICAGO, U. S. A

FREE OFFER COUPON

Pop. Elect. 4-09. A. S. of C.
 Please send me Cyclopedia of Applied Electricity for five days' free examination. Also T. W. for one year. I will send \$2 within 5 days and \$2 a month until I have paid \$18.60; otherwise I will notify you and hold the books subject to your order. Title not to pass until fully paid.

NAME

ADDRESS

OCCUPATION

EMPLOYER

\$410.00 BUYS ALL THE MATERIAL IN THIS BARN

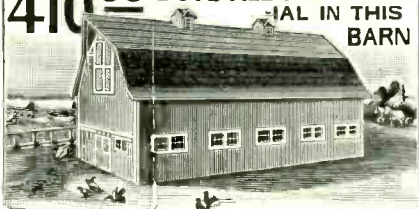

An Illustration from our "Book of Plans"

A modern up-to-date barn, one of many illustrated and fully described in our free "Book of Plans." It can be readily constructed by an ordinary mechanic with the aid of our simple plans & specifications, furnished free of charge. In referring to this design mention "J F1."

Building Material Greatest Offer EVER PUBLISHED!

FREE BUILDING HOUSE AND BARN PLANS!

The Chicago House Wrecking Co. is the most wonderful institution in the world. We offer you an opportunity to make an enormous saving in the purchase of building material and supplies of every kind. Read our new 1909 offer carefully. It is something that every man with an immediate or prospective building idea must carefully consider. We say that, quality considered, we can undersell any concern in existence on any lumber or building material needed for construction of any house or building.

100,000,000 Feet of New Lumber at Wrecking Prices!

We purchased direct from the Mills, at various Forced Sales, thousands of carloads of high-grade, first-class, brand new Lumber. We bought it at sacrifice prices and we are offering it for sale at a reasonable margin of profit. This is an opportunity of a lifetime to buy the very best Lumber manufactured at prices less than the dealer or jobber can ordinarily buy it for.

As to quality, rest assured nothing better is manufactured. Don't listen to what unscrupulous dealers may tell you. Our material is guaranteed to be clean, new, fresh lumber — not wrecked material in any sense of the word — just as good as you can buy anywhere and it is sold under a positive, binding guarantee that protects you absolutely.

We don't ask for money in advance. You can buy it without sending one cent of money with your order. All we require is a guarantee as to your responsibility. Money refunded if material is contrary to our representation. We have a capital stock and surplus of over \$1,000,000.00. We refer you to any bank or banker anywhere. Or you can write direct to the Great Stock Yards Bank, The Drovers Deposit National Bank of Chicago.

\$650 Buys all the Material to Build This House!



THIS IS AN EXACT PHOTOGRAPH OF OUR WONDERFUL \$650 HOME. That means we will furnish you all the Lumber and Building Material needed to construct it. Write for our "Book of Plans," which gives details showing exactly which material is furnished. Mention Design "J F6." This is only one of many other designs shown in our grand "Book of Plans."

NOTE THE PRICES!

Red Cedar Shingles	\$3.00
White Pine L'th	
No. 1—32-in..	1.75
Roof Sheathing	14.50
2x6—12 ft.....	15.50
4-in. White Pine	
Lap Siding....	16.50
4-in. Flooring..	16.00
Pt. Sh'th'g L'th	16.00
Fencing, 6-in..	18.00
2x6—22 ft.....	19.00
Ceiling, 3/4x4-in	14.50
2x8—18 ft.....	19.00
Drop Siding....	16.00
2x10—12 ft.....	18.00
2x12—20 ft.....	19.50
Barn Boards....	19.50
C'r 1/2 S. Flo'r'g	30.00
Ye'l'w P'pr Sid.	15.00

¶ Prices are, per thousand, in carload shipments only, F. O. B. Chicago, for 30 days only. All material guaranteed new.

Send Us Your Lumber Bill for Our Estimate!

¶ We urge you to send us your carpenter's bill for our estimate. Have him make up a list of every single item you will need and send it to us. We guarantee to go over it carefully and itemize it fully and to send you a clear concise statement of just what we will furnish and the prices will be so low as to secure your order. You can include in your list of material everything needed; that means even plumbing and heating material, furniture, rugs, etc.

FREIGHT PREPAID OFFER

¶ We make our quotations Freight Prepaid. That means delivered free of all charges to your railroad shipping point. No trouble with the Railroad Companies for you. We assume every possible risk. We guarantee safe, sound and prompt delivery and if any material reaches destination damaged, we make good at once and assume all your claims against the Railroad Co.

NOTE THE PRICES!

Barn Sash.....	\$ 0.36
Storm Sash.....	.70
Stall Sash.....	.21
Hot Bed Sash..	1.55
Windows.....	.50
Panel Doors....	.80
Window Frames	1.25
Door Frames....	.50
Base Angles....	.02
Corner Blocks..	.02
Base Blocks....	.03 1/2
Stair Rails.....	.07
Porch Balusters	.05
Porch Rail.....	.03
Cottage Wind's.	3.52
Porch Columns.	.65
Blinds.....	.66
Porch Brackets	5.00
H'd'w'd Mantels	5.00

¶ Prices are subject to quick acceptance, and all material guaranteed brand new, standard grade and quality.

Send for Our Free Catalog No. 891

We publish a book of some 500 pages, containing a general record of our goods and showing millions of dollars worth of merchandise secured by us at Sheriff's Sales, Receivers Sales and Manufacturers' Sales. It lists Building Material and Supplies, Machinery, Roofing and Wire, Structural Material, Hardware of all kinds, Furniture and Office Fixtures, Belting and Rubber Hose, Plumbing and Heating Apparatus, Pipe, Valves and Fittings, Wire and Manila Rope, Electrical Apparatus, Safes and Vault Doors, Tanks, etc., etc.

In addition to this General Catalog we publish a "Book of Plans." It shows illustrations of modern houses and barns; gives illustrations from life as well as floor plans; it explains our unique offer to furnish all material needed to construct any buildings shown in our book. You can get a complete set of plans, specifications and bill of material for \$2.00, Or, furnished free with your order. We also publish a Furniture Catalog showing handsome designs in Household Goods, Furniture and Office Supplies. Write us your wants. We can save you big money. We illustrate rugs, carpets and linoleum in exact colors. Ask for Catalog No. 891. We have an immense stock of Imported Oriental Rugs. Write for prices.

CHICAGO HOUSE WRECKING CO., 35th & Iron Streets, CHICAGO

CHICAGO HOUSE WRECKING CO., CHICAGO

Send me free of all cost your Wonderful Catalog and Building Offer, as advertised, I saw your advertisement in Pop. Electricity

Name.....

Town.....

County.....State.....

R. F. D. No. 539

The Machine That Makes Electricity Adaptable to Many New Household Uses

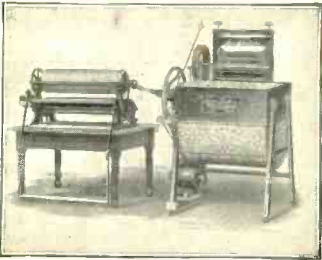

THOR Running Ironing Machine

The Thor Electric Washer and Wringer **does everything but hang out the clothes**, and is beyond question the greatest labor-saving household invention ever devised. The **Universal Rod**, attachable only to the Thor, harnesses electricity for many new household uses never performed by power before.

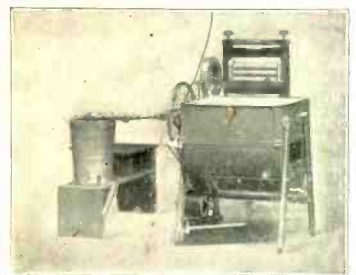

THOR Running Ice Cream Freezer

THOR Electric



The "THOR" Washing Clothes

Washer AND Wringer

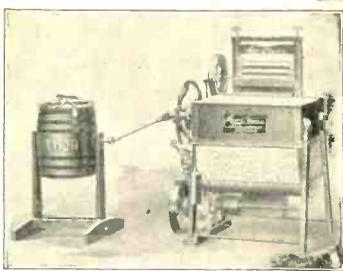

THOR Running Churn

We cannot describe here what these wonderful inventions will do, nor how they do it—this is all clearly and interestingly set forth in our new illustrated book, "The Easy Way Wash Day," sent free on request. You'll want to know about them so write for the book today.



THOR Running Grindstone

EXCLUSIVE AGENTS WANTED

High grade dealers (one in each town) can secure territory now open. Liberal discounts and unusual co-operation in extensive advertising, etc., will be given every dealer. Our policy is to arrange with first responsible dealer or agent, who solicits territory. Much of our territory is now covered, so write promptly for the territory you want.

Sold to Purchasers on Free Trial—Easy Terms—Freight Prepaid.

1202, 153 S. Jefferson St.,
CHICAGO

HURLEY MACHINE CO.

2502 Flatiron Building,
NEW YORK