

29365

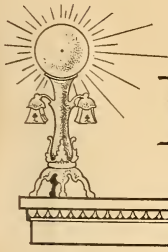

# POPULAR ELECTRICITY

IN PLAIN ENGLISH

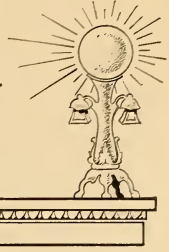

VOL. I

MAY 1908

No. 1



## SALUTATORY



"Electricity, carrier of light and power,  
Devourer of time and space,  
Bearer of human speech o'er land and sea,  
Greatest servant of man, itself unknown."

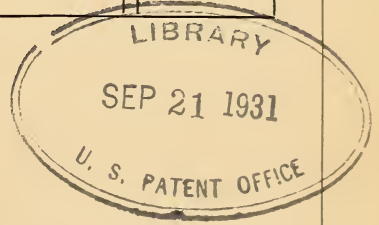

POPULAR ELECTRICITY Magazine is designed to present the wonders of Electricity "plain English." It will contain much to interest even the greatest experts in the art. The magazine is intended especially for the people, and will be written and edited by experts, but in a popular form. It will be strictly non-technical, and will be so plain that all may understand. In short, it will be the first medium ever published to bring the general public in familiar touch with the most wonderful force the world has ever known.

The primary object of the magazine is to present the interesting side of applied electricity—and every side of applied electricity is interesting. The secondary object is to bring electricity into more general use. If it were but better understood, electric power would be used in the home and business life even more freely than it is now. It does so many things, and does them so well and so cheaply, that only a more general knowledge on the part of the public is required to bring this wonderful power into more familiar use in daily life.

New developments in the art are constant. And the editors will draw on the entire world for contributions. It will be the special mission of this magazine to bring first knowledge of these developments and present them in a simple and fascinating form.

Neither pains nor expense will be spared in this work, and it is the belief of the publishers that the public will give eager support to POPULAR ELECTRICITY.

# ELEMENTARY ELECTRICITY.

BY EDWIN J. HOUSTON, PH. D. (PRINCETON.)

## CHAPTER I.—THE ELECTRIC CIRCUIT.

THE rapidity and certainty with which electricity can be caused to light up the multitude of incandescent lamps scattered through the rooms and corridors of a huge office building or skyscraper, such as shown in Fig. 1, seldom fail to excite admiration. If it happens that this operation is seen for the first time, there is an added feeling of wonder and bewilderment. But a moment before there was darkness throughout the great building. Suddenly, as switch after switch is rapidly closed, the lamps flash out and pour through room after room in the great buildings a flood of soft mellow light like that of the sun, that literally turns night into day. There is certainly something mysterious, and even uncanny, that the electricity should be able to find its way so unerringly through the vast network of wires that connect the separate lamps with the source of current in the street or sub-basement below. To the uninitiated it seems strange that the current has been able, among the many different paths apparently open to it, to pick out the particular path in which are located the lamps that are to be illumined, deliberately passing by other paths. Is there not, the tyro almost unconsciously inquires, some species of intelligence that permits the electricity thus to select the particular route it has been desired to take? Unable, satisfactorily, to answer this, as well as many other queries that suggest themselves to his bewildered mind, it is not surprising if he reaches the conclusion that the mysterious force of electricity is of far too complex a nature to permit it to be thoroughly comprehended by any but the highly gifted and educated.

Similar thoughts arise, when, toward evening, the arc lamps are lighted in the streets of a great city. Through street after street the lamps almost instantly flash out at points situated probably a mile or more from the great dynamos or generators that are producing the exciting current.

But even more astonishing is the certainty with which telephonic currents are able to find their way not only through the overhead wires that connect different cities, but through the tens of thousands of wires in the underground conduits that extend below the level of the street without straying or getting lost. It seems doubly incomprehensible that these currents do not lose the complex and delicate variations in strength by means of which, when passed through the coils of a telephonic receiver, they are not only able correctly to reproduce the conversation, but even in most cases to transmit the peculiar characteristics of the voice of the speaker.

This seems strange enough when, while sitting in one's office, a telephonic message is received from one or another of the many thousands of subscribers connected with the central exchange. It appears almost incredible that, in the twinkling of an eye, this strange electric force has been able to find its way into the particular building and correctly reproduce the spoken message.

If, with the hope of solving this problem, one visits the telephone exchange with which his telephone is connected, and obtains permission to take a peep back of the great switchboard through which all the circuits coming into that exchange pass, and from whence they are distributed, his bewilderment instead of being removed, is only increased. The multitude of wires he sees seems at first almost incredible. If the exchange is in a large city, and the time of his visit is at the busy hour of the day, conversations are being carried on by different voices through a large portion of those wires, and the currents reproducing these conversations are passing with that wonderful velocity that characterizes electricity. Surely the electric currents might be excused, if occasionally they take a wrong path, especially when, as will afterwards be pointed out, it is learned that the currents do not flow through the mass of the conductor, but



through the region or space outside them. And yet a particular current unerringly finds its way to the particular circuit with which it is connected. Is it then at all surprising that, perhaps, a large proportion of mankind should reach the conclusion that it is utterly hopeless for them to attempt to master even the elements of this highly complex and mysterious force?

And yet it is not because people do not wish to familiarize themselves with the principles of electricity that this conclusion is reached. It is reached most



FIG. 1. MODERN SKYSCRAPER WHERE ELECTRICITY IS A WONDER WORKER.

reluctantly. Did it not seem so hopeless, every one would master at least the principles of this great science. But what can he do? Again and again he has probably tried, by the reading of text books, and scientific periodicals, to master the difficulties of this occult force. Perhaps in too many cases he has been driven away by the highly technical, although thoroughly correct, language employed, or by the intricate mathematical formulas employed.

It is my object in this series of articles on elementary electricity to prove that it is by no means true that it is impossible for anyone to obtain clear and correct ideas concerning this great branch of applied science. Although this great and mysterious force appears

at first sight to be hopelessly complex, yet there is in reality nothing about its general principles and the laws that govern it that should prevent anyone from thoroughly grasping it. In order to explain this matter at somewhat greater length, I invite you to take a short stroll with me along some street or thoroughfare in which great quantities of electricity are employed both day and night for illumination, for the driving of cars and motors, or for any other work that electricity is capable of performing.

There can probably be found no better thoroughfare for this purpose than that part of Broadway in New York City, which extends between 23d and 46th Streets. This thoroughfare has appropriately been called "The Great White Way." It is, I believe, a region that can properly claim to employ a greater amount of electric current for the purposes above enumerated than any other part of the world. In the comparatively short distance of but twenty-three blocks there are several great department stores, one of which is among the largest in the world, and others so large that at least one of them might properly claim second rank as regards size. Besides numerous smaller stores, there are some seventeen large hotels and an equal number of theatres. In the same district are to be found the printing establishments of two large daily newspapers, most of the machinery of which is electrically driven.

The night is drawing on as we begin our stroll, and soon a flood of light is poured into the street from lamps suspended from the tops of tall poles, or from clusters of lamps supported on pedestals about the height of the old form of the lamp posts for gaslights. The effect of this illumination is admirably shown in Fig. 2. Some of these are of the well known form of arc lamps that produce a white light closely resembling that of sunlight, while others are of the newer form, the flaming arc, that produce the characteristic yellow light. As we pass along we see many electric signs formed by the groupings of clusters of incandescent lamps, displayed on the fronts of stores, or on the sides of tall buildings. They either glow steadily with different colored

lights, or mysteriously appear and disappear at regular intervals, as the current is automatically cut off from or connected with the lamps by the opening and closing of switches. This current, as a rule, is taken from the electricity that flows into the stores from mains connected with the nearest lighting station.

We pass great stores brilliantly lighted. The goods in their windows are well illumined, and can distinctly be seen in all their details of structure and natural colors. The lamps, however, from which the goods receive their light are skillfully concealed from sight, pref-

We pass several theatres that between the hours of 8 and 11 p. m. employ great quantities of light in the auditorium, but especially on the stage, or in the wings, after the rising of the curtain.

As we continue our stroll, entering, possibly, one of the large hotels, it will be seen that here too the lamps employed are placed above the line of vision, since it is the objects in the corridors and rooms, the food on the table in the dining room, and the people, that it is desired shall be seen. To a certain extent, however, handsome electroliers or groups of bracket lamps, or circles of lamps around the pillars, or artistic



FIG. 2. BEGINNING OF THE "GREAT WHITE WAY."

erably in the upper part of the window back of a suitably arranged curtain. This is a sensible arrangement. In order to see an illumined object distinctly the light from that object should be the only light that enters the eye of the observer. If the luminous sources are in view, so as to be able to throw their light directly into the observer's eyes, the intense images they produce will make the goods in the window almost invisible.

As it is yet early, the stores are seen to be brilliantly illumined by clusters of lamps located above the goods either in the ceiling or on the sides of columns near the ceiling.

groups of lamps on the newel posts of the staircases, serve the double purpose of illumination and adornment.

But it is not necessary that you should walk through the "Great White Way" in New York City. There are similarly brilliantly illumined thoroughfares in all the other great cities of the United States, as well as in other parts of the world, where you can see similar things.

No matter how thoroughly you have been impressed by the great complexity of the force of electricity, which is thus able to produce such mysterious results, I trust you will not permit yourself to come to the conclusion that electricity is a subject that is hopelessly beyond



your ability to comprehend. I am sure this is not true. It is by no means true that such matters can be made intelligible only to the highly educated. On the contrary, so far from a high school education, or the still higher education afforded by a college or university being necessary, if you possess but average intelligence, practically all the general principles of electricity can be made plain to you. Moreover, if you only possess a knowledge of the four fundamental rules of arithmetic—addition, subtraction, multiplication and division—you can even make some of the simpler calculations for determining the quantity of electricity that will flow under different conditions through any path or circuit.

In order to prove this let us take up some of the cases referred to in which electric currents, flowing from underground mains, pass into a building, and are able to reach arc or incandescent electric lamps or any other piece of electric apparatus. To do this intelligently, we will first discuss some of the peculiarities of what may be termed a simple electric circuit.

A circuit of this character consists of the following essential parts:

(1). An electric source, or device for producing electricity, and causing it to flow through wires properly connected with it.

(2). An electro-receptive device connected with the circuit for producing some of the many different effects that electricity is able to produce. There are a variety of electro-receptive devices such as arc or incandescent lamps, electro-magnets, electric heaters, etc.

(3). Conducting wires so connecting the electric source with the electro-receptive device as to carry the current out from the positive pole of the source to the electro-receptive device, and, after it has passed through it and produced its peculiar effects, to lead it back again to the south pole of the source which it enters.

(4). A switching device provided for opening or closing the circuit at any convenient point.

In order to simplify this idea, we may correctly regard any electric circuit or series of circuits, no matter how com-

plicated, as a single circuit consisting of an electric source or generator (G), Fig. 3, an arc lamp (L), conductors (C C'), and a switch (S).

It should be mentioned here that a practical system of electric arc lighting would never employ a single generator (G) to feed or supply the current to a single lamp (L). In actual practice from 60 to 120 arc lights, more or less, would be fed by a single dynamo. Nor is it to be understood that a series of separate conductors, corresponding to (C C'), must connect each lamp with the generator. We have shown the connection of a single lamp to the circuit merely for the purpose of illustrating one of the ways in which a path or circuit may be provided for an electric generator and a single receptive device.

Supposing now that in the above diagram (+) represents the positive

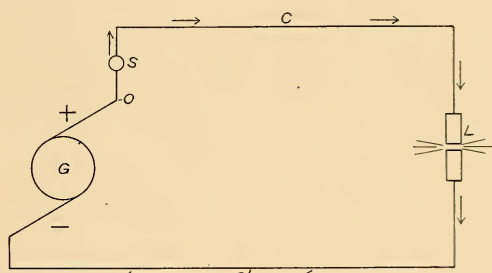

FIG. 3. A SIMPLE ELECTRIC CIRCUIT.

pole of the electric source or generator, that is, the pole or terminal at which the electricity leaves the generator on its way to the electro-receptive device, and that (—) represents the negative pole or terminal, through which the current is led back to the source after it has passed through the electro-receptive device. Then the path or circuit traversed by the current when the switch (S) is closed, will, as indicated by the arrows, be as follows: Leaving the generator (G) at (+) the current flows through the conductor (C) to the upper carbon of the arc lamp, thence through the space occupied by the carbon arc or luminous portion of the lamp, through the lower carbon, and thence through the conductor (C') to the negative pole, where it again enters the generator.

The object of producing electricity is to cause it to pass through electro-

receptive devices so as to obtain from them some desired effect, such as light, in the case of an incandescent or arc lamp; magnetism, in the case of an electro-magnet; heat, in the case of an electric heater; mechanical motion, in the case of a motor or an electric bell; etc. When, therefore, one familiarizes himself with the elements of the simple electric circuit that is represented in Fig. 3, he has covered an important part of electricity at actual work. Already, therefore, the bewildering complexity of electricity as it appeared to the mind of the reader, as in imagination he took a stroll with me along "The Great White Way," or elsewhere, should be decreasing. In order that any of the effects then witnessed shall have been produced it is only necessary to provide an electric source for generating electricity, and starting it out on its way through a conducting path or circuit, thence through an electro-receptive device and back again to the source. While it is true that in many cases the circuits are necessarily of great complexity, owing to the great number of receptive devices connected with the source, or owing to other causes, yet no matter how complex, such a circuit can readily be divided into a number of separate circuits, each of which is correctly represented by the simple electric circuit of the preceding figure, and the same thing is true of the far more highly complex circuits that lead into and out of a central telephonic exchange.

A difficulty may possibly exist in the minds of some of my readers as to the exact meaning of the word circuit. Some may think that the word circuit necessarily implies the idea of a circular path, and that the current on leaving the generator passes through the wires connecting it with the receptive device, and returns to the source in the path represented in Fig. 4, where, as before, (G) represents the generator, (S) the switch, (L) the arc lamp, and (C) and (C') the circuit wires.

Now, in point of fact, while, in the case of electro-magnets, the electric circuit actually takes true circular paths through the successive loops of the magnetizing coils, yet in nearly all other practical circuits the path taken differs

markedly from that of a circle. Sometimes, as in Fig. 5, this path is exceedingly irregular, the conducting wire abruptly changing its direction at a number of points.

Generally speaking, there is no reason for such an irregular circuit, except in cases where a number of separate arc lamps, call bells, telegraphic sounders, etc., are placed in a single circuit. Here the shape of the circuit is necessarily dependent on the position of the separate receptive devices.

At other times the simple circuit takes the form shown in Fig. 6, where two straight wires are parallel to each other with an electro-receptive device placed as shown.

But no matter what the shape of the circuits above mentioned, for, from an electric standpoint they form the same kind of circuits, it is a comparatively easy matter to calculate the amount of current that would flow through them.

When, by the action of a switch, or

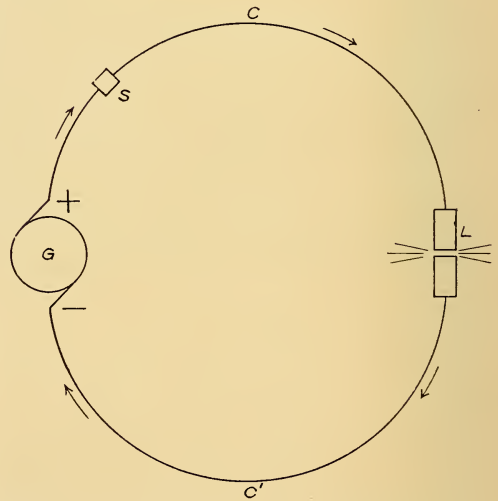

FIG. 4. A CIRCUIT IS NOT NECESSARILY ROUND LIKE THIS.

in any other way, an electric circuit is opened at any point, so that a conducting path is no longer provided for the current, the circuit is said to be open, broken or disconnected. When the break is closed or bridged over, the circuit is said to be made, completed or closed. Various devices are provided for opening and closing electric cir-



cuts. Such devices are generally called switches.

Electricity is capable of passing through conducting paths with such almost inconceivable velocity, that when a circuit is closed, the electricity almost instantly appears in all parts of the circuit, even though it be hundreds or thousands of miles in length. In the same way, on the opening or breaking of a circuit, the electricity almost immediately ceases to flow. As is well

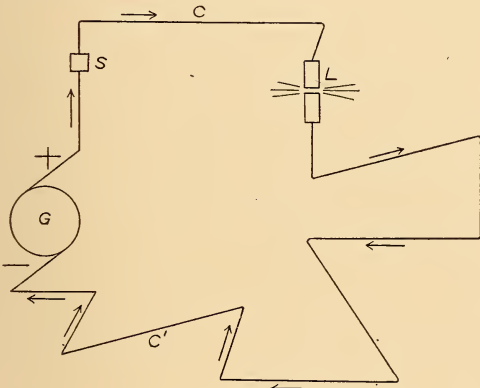

FIG. 5. CIRCUITS ARE SOMETIMES IRREGULAR LIKE THIS.

known, it is on this peculiarity of electricity that the operation of the telegraph, the telephone, call bells, annunciators and burglar and fire alarms, is dependent.

Having thus briefly described a simple electric circuit, let us now inquire as to the conditions that determine the strength of the current, or the amount or quantity of electricity that flows through it in a given time, such as one second.

While the rules for determining the current flow in any circuit are sometimes complex, and give no little trouble to students, yet, generally speaking, they are quite simple, as I hope to be able to prove. The quantity of electricity that flows through any circuit under given conditions is generally determined by what is known as Ohm's law. This law simply stated is as follows:

The quantity of electricity passing in a given time through any circuit depends on the pressure or force that causes the electricity to flow, and the

resistance the circuit offers to its passage or flow. The greater the pressure of the electric source, and the less the resistance of the circuit, the greater is the quantity of electricity that will pass.

The pressure that causes electric currents to pass through a circuit is called the electromotive force, or the force which sets electricity in motion. Electromotive force is generally represented by the letters E. M. F., or simply by the letter E.

Whatever resists or opposes the flow of electricity is known as the electric resistance.

Ohm's law, therefore, may be represented in simple arithmetic as follows:

$$\text{Electric current} = \frac{\text{electromotive force}}{\text{electric resistance}}$$

This simply means that in order to increase the quantity of electricity flowing through any circuit when the same source is employed, the resistance of the circuit must be decreased, or, if the resistance is to remain the same, the electromotive force of the source must be increased.

Therefore, in order to cause twice the current strength to pass through a given circuit, it is only necessary to employ a source producing twice the electromotive force, or to so arrange the circuit as to halve its resistance.

The electromotive force of a dynamo can generally be increased by driving the

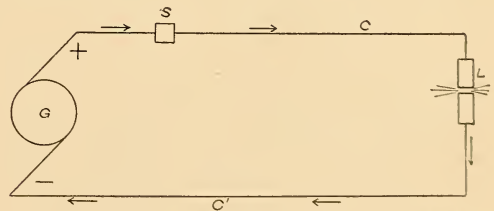

FIG. 6. A FORM ELECTRIC CIRCUITS OFTEN TAKE.

machine at a greater speed. In the case of a voltaic battery, it can be increased by employing a greater number of battery cells connected in a certain manner. In the case of the conducting wires, the resistance may be decreased by employing shorter, thicker wires, or, in the case of an iron telegraph circuit, by employing a copper wire instead. It is possible, therefore, in the case of any electric

circuit to greatly vary the current of electricity that can be sent through it.

In some respects the flow of electricity through a wire closely resembles the flow of water or gas through a pipe. Indeed, the distribution of water or gas through the pipes of a great city is in many respects similar to the distribution of electricity. In the case of the distribution of water, a pump, or other means, supplies water to a reservoir at a higher level than that of the pipes connected to it. The difference of level between the surface of the water in the reservoir, and that of the outlet pipe, produces a pressure that may be called a "water-motive" force, that is, a force that tends to set water in motion through a pipe, just as the electromotive force is the force that tends to set electricity in motion through a wire. It is, of course, self-evident that the greater the value of the water-motive force, or the water pressure, the greater will be the quantity of water that can be forced through a pipe.

There are evidently two other conditions that will affect the total quantity of water passing, that is, the number of gallons per minute or the number of cubic feet per minute. The larger the pipe that is connected with the reservoir, the greater will be the flow of water through it, since evidently a circular pipe, one foot in diameter, will be able to carry a much greater quantity of water per second than a circular pipe, one inch in diameter.

Moreover, the quantity of water passing through a pipe is affected by the resistance the pipe offers to its flow. Generally speaking, a straight pipe, twice as long as another straight pipe, will offer twice as much resistance to the passage of water. Then, too, sudden changes in the direction of the pipe will also greatly affect the quantity of water passing.

What has here been said concerning the passage of water through a pipe is also true of the passage of gas through a pipe. The pressure causing the motion of the gas, which may be called the gas-motive force, is generally produced by the weight of the gas holder or the vessel in which the gas is stored. The quantity of gas which flows through the

pipe is determined by the size of the pipe, by its length, and by the character and number of its bends.

Now in the case of an electric circuit, there are similar conditions that affect the quantity of electricity that passes. Where the same material is employed, the thickness of the conductor corresponds to the diameter of the pipe, and the length of the conductor to the length of the pipe. It is generally a simple matter to determine the value of the electric resistance offered by a circuit, and it is also easy to measure by a suitable instrument such as a voltmeter, the electromotive force of the source. When these two quantities are known, it is only necessary to divide the electromotive force of the source by the electric resistance of the circuit, to determine the quantity of electricity that passes.

(To Be Continued.)

## ELECTRIC FOUNTAIN CENTER PIECE.

Electric fountain center pieces for banquet tables make a very effective and artistic form of decoration. The electric fountain shown herewith is self-con-

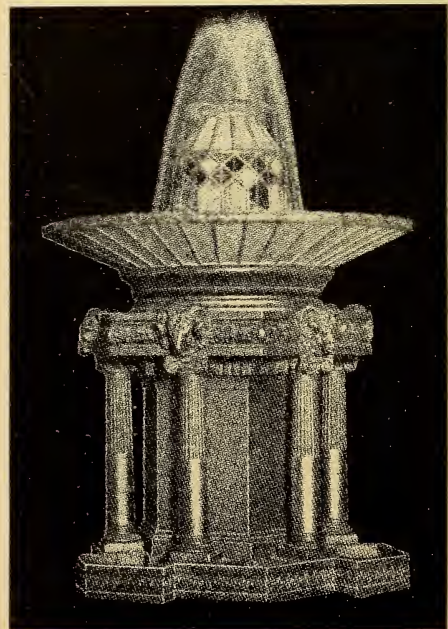

ELECTRIC FOUNTAIN CENTER PIECE.



tained and does not need to be connected to any source of water supply, as the water necessary for its operation is contained in the fountain itself and is used over and over again.

There is a small electric lamp in the upper glass portion which illuminates that part of the fountain and also the water jets which are continually playing. Inside the glass portion there is a horizontal jet of water which causes the glass to revolve on a pivoted base. This produces a very pleasing moving effect and variety of colors, which are the chief beauties of the fountain.

The water is kept in movement by a small motor-driven centrifugal pump in the base of the fountain. Very little expense is connected with the operation. The motor is simply attached to an electric light fixture or other outlet by a flexible cord, and the current consumption is no more than that of two ordinary incandescent lamps.

## ELECTRICAL SCHOOL PROGRAMME TRANSMITTER

A valuable accessory for indicating and controlling the daily routine of a school is the Stamford clock program transmitter. This device will ring automatically all clock signals and corridor and outside gongs from day to day. The arrangement of the program is shifted automatically on the proper days, and all signals may be silenced on Saturday and Sunday, thus saving battery power. When arranged for factory use, the signals may also be silenced on Sunday only.

Various signals are controlled by this device through the agency of a perforated band of paper, which travels continuously over a set of pulleys controlled by clock work, as shown in Fig. 1. As the paper strip passes over the pulleys the metallic pointers shown at the top in Fig. 1, travel over its surface, and whenever a perforation on the strip moves under one of the pointers the latter passes through the strip and makes electrical contact, thereby closing an electrical circuit which rings the proper gong or alarm at the proper time.

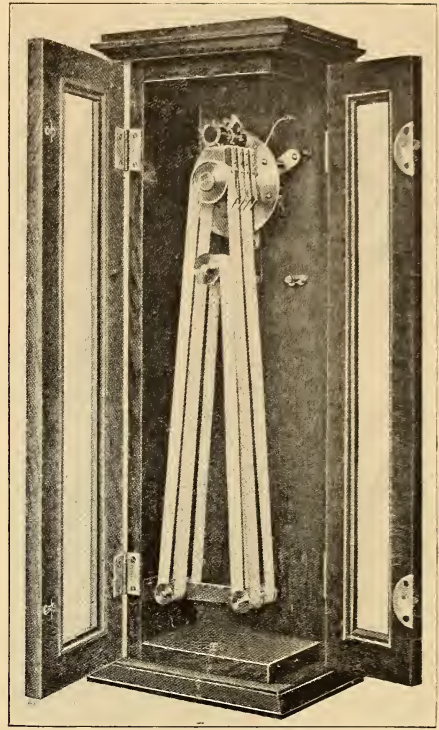

FIG. 1. ELECTRICAL PROGRAMME TRANSMITTER.

The perforations are made in the strip at intervals by a hand punch, and there



FIG. 2. PROGRAMME TAPE.

is no limit to the number of signals that can be made with one strip. Fig. 2 shows a section of the programme tape.

## TELEPHONE AIDS SMOKE INSPECTOR.

Paul P. Bird, chief smoke inspector of Chicago, has planned several conning towers equipped with telephones and located on a number of high buildings in the Loop as an aid to the abatement of smoke nuisance. If a chimney is seen smoking, says the Western Electrician, the lookout calls up the engineer of the building and tells him to remedy the fault at once. Formerly offenders were notified by mail, but this was not so effective as the telephone plan.

## TRANSMISSION OF NIAGARA'S POWER.

**D**EVELOPMENT of the power of Niagara Falls is a subject which has held the attention of engineers the world over since the beginning of the first plant. Much of this power is now utilized on the spot, in the various industries that have sprung up like magic on both the American and Canadian sides. It was early recognized, however, that to obtain the full

limits of practical transmission. This led to the organization of the Niagara, Lockport and Ontario Power Company, a company which buys the power from the generating plants, transmits it over transmission lines of great length and sells it again to consumers located along these lines. The work which this company has undertaken is intensely interesting, and the features of the great



FIG. 1. ELECTRIC CABLES ACROSS NIAGARA RIVER.

benefit of this almost unlimited source of energy it would be necessary to provide means for the transmission of the electrical power far and wide to the numerous cities which are within the

transmission lines, over which 180,000 horsepower will eventually be carried are of interest even to those outside of the engineering profession.

Mr. Ralph D. Merston, chief engineer



of the Niagara, Lockport and Ontario Power Company, presented a paper on June 26, 1907, before the American Institute of Electrical Engineers, which gives in detail the features of this remarkable undertaking and from which the following facts were taken.

At present the Niagara, Lockport and Ontario company owns a private right of way varying from 75 to 300 feet wide, reaching from Niagara Falls to Syracuse, N. Y., and taking in the cities of Lockport, Mortimer, Rochester

absolutely certain that no discontinuance of service shall come about through failure of a line.

Power is brought across the Niagara River by means of aerial cables spanning the river, as shown in Fig. 1, and delivery of the power is taken by the transmission company at the international boundary line. The cables are brought across the river in three spans, one span from steel cantilevers at the top of the cliff on the Canadian side to steel towers at the water's edge on the



FIG. 2. TRIPOD TOWERS FOR TRANSMISSION LINES.

and Fairport. There is also a line extending to Buffalo.

The transmission lines will all be in duplicate, as fast as completed, making

Canadian side; another span from the water-edge towers on the Canadian side to the corresponding towers on the American side; and a third span from

the steel water-edge towers on the American side to steel cantilevers at the top of the cliff on the American side.

The steel cantilevers and the river

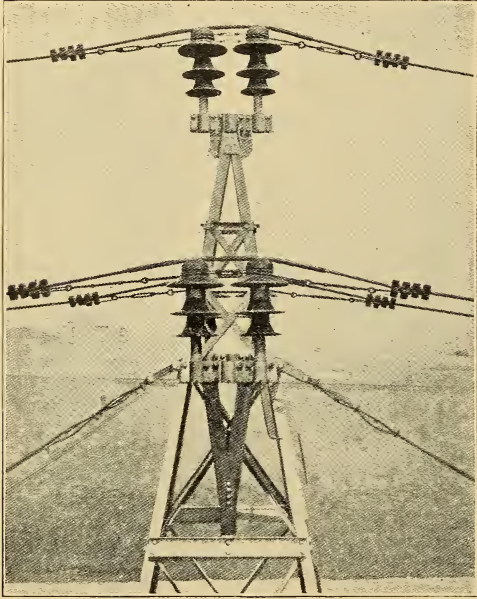

FIG. 3. TOP OF TOWER, SHOWING INSULATORS.

edge towers are all designed to withstand the most extreme conditions of sleet and wind that will probably ever exist. The requisite mechanical strength of the insulation at the points where the cables are attached to the steel structures is obtained by using a sufficient number of line insulators, and the proper distribution amongst these insulators of the forces which will come upon them is effected by means of malleable cast-iron caps cemented to the tops of the insulators and to which the cables are fastened.

The transmission lines throughout are of the most substantial construction. The first towers installed were of the steel tripod type as shown in Fig. 2, made of lap-welded pipe. The latest form the tower employed is of structural steel as shown in Fig. 3. This view also shows the method of mounting the great porcelain petticoat insulators, each of which is nearly two feet in height. The cables which these insulators support carry electrical current

of 60,000 volts pressure, and they must consequently be exceptionally strong from an electrical as well as a mechanical standpoint.

The steel towers, which are 75 feet high, are mounted on foundations of reinforced concrete and are capable of withstanding the transverse forces which would be brought upon them were the wires covered with a layer of ice half an inch thick and with a cross wind blowing at the rate of 75 miles an hour.

In a number of places on the main line it was necessary to cross the Montezuma Marsh. Where this marsh was crossed with steel tower construction, the concrete foundations for the steel towers were built by first excavating the swamp through the soft mud until the soft marl, forming the sub-stratum of the swamp, was reached. On the marl was laid a platform of two layers of corduroy, and on this platform was built the concrete foundations, the weight of which was made sufficient to take care of any uplift which will come upon the towers.

There are three wires carried by each tower, constituting what is known as a three phase line. The cables of this line are made of aluminum strands, the largest sizes containing 19 strands and



FIG. 4. RAISING A TOWER.

having a cross sectional area of 642,800 circular mils, a circular mil being the area of a circle whose diameter is one one-thousandth of an inch.

The construction of this line was a difficult piece of work. The towers were transported in parts to the points



where they were to be erected. Here they were assembled and then raised in the same manner that a wind mill tower is raised. Fig. 4 shows the raising of a tower.

Fig. 5 is a view showing how a joint is made in the big aluminum cable. The ends of the cable are slipped into two parallel tubes and then tubes and cable are twisted until a perfect electrical and mechanical joint is made.



FIG. 5. SPLICING THE ALUMINUM CABLE.

A long transmission line of this character needs careful attention owing to the fact, that, though located 75 feet in the air, it has its vulnerable points, not the least of which are the porcelain insulators which offer such enticing marks to the small boy with a rifle. On a considerable portion of the company's right of way is a wagon road for use in patrolling the line and delivering materials for construction or repair. At certain points along the line are patrol houses for storing material, for taking care of horses and for comfortably housing the patrolmen. Each house has its sleeping room, kitchen and sitting room.

On all of the transmission lines, the company maintains a private telephone line on a separate set of wooden poles. Taps from this line are brought into all the patrol houses, and in addition the patrolmen are provided with portable telephone sets which may be connected to the telephone line at any point. They

are in this way kept in constant communication with headquarters.

## A WORD OF WARNING.

Temptation to alight backwards from a street car while it is still moving, seems almost too strong to overcome, in spite of the many warnings that have been given. Street car companies find that a very large percentage of accidents result from this one form of carelessness.

The Milwaukee Electric Railway and Light Company has devoted one page of its time table to this subject, and the page is reproduced herewith, to emphasize the warning that has so often been given but which is so often disregarded.

## Avoid Accidents



**SAFE**

**UNSAFE**

**Do Not Board or Leave Car While It is In Motion.**

When alighting from car, grasp hand hold with left hand and face in direction car is headed. Where the doors on the left side of car are open, grasp hand hold with right hand and alight, facing forward.

In boarding, grasp hand hold toward front of car before stepping up.

Before alighting, see that no vehicle is passing, to collide with or run into you.

Before passing around rear of car see that no car is approaching from opposite direction.

**Destroy All Previous Time Tables.**

## HOW THE TIME BALL IS DROPPED.

FEW people realize the extent of the time service which the government now furnishes, with the co-operation of the telegraph companies, to all parts of the United States as well as to Havana and Panama. Among the interesting features of this service is the dropping of nineteen time balls at the principal seaports and ports on the Great Lakes. Precisely at the hour of noon these balls are dropped in plain sight of vessels off these ports, and the mariner is thereby enabled to correct

those who have noted this occurrence may not be aware that the dropping of the ball is controlled by apparatus located in the Federal Building some blocks away, which in turn is controlled over the telegraph lines from Washington, D. C. Yet this is the case, and the ball drops every day at noon and within a very small fraction of a second of variation.

The work in Chicago is under the supervision of Lieutenant W. J. Wilson of the Hydrographic Bureau.

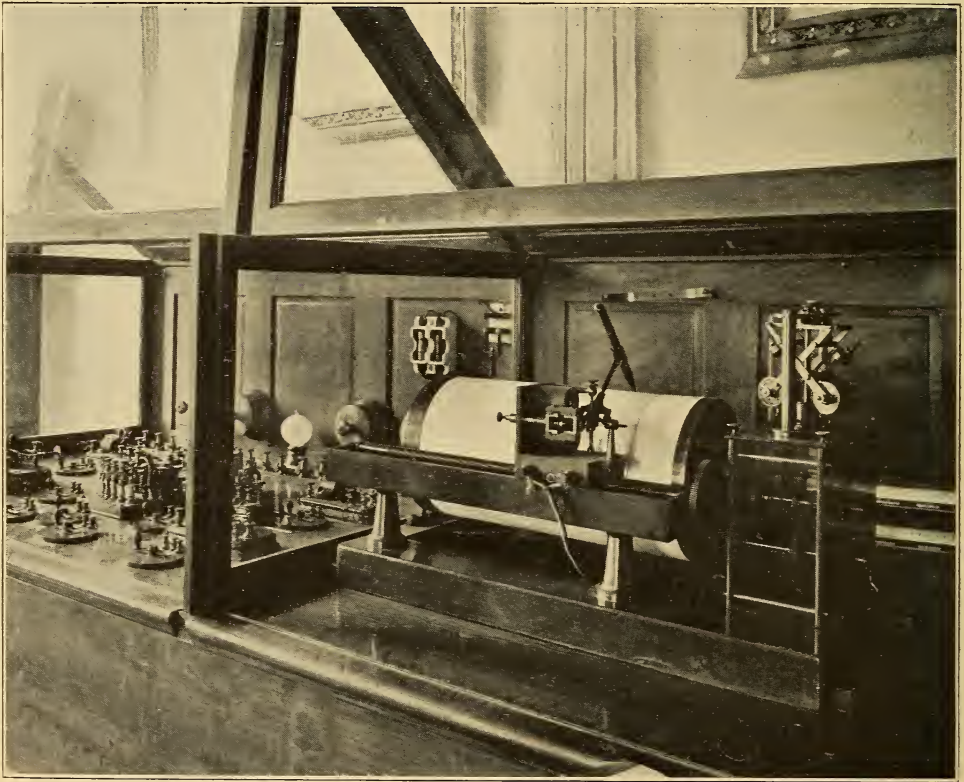

TIME RECORDING PEN IN OPERATION.

his chronometer with absolute accuracy whenever he is in one of the ports where this service is given.

Of the thousands who throng State street in Chicago at the hour of noon, probably not one per cent have ever happened to cast their eyes up at the roof of the Masonic Temple at just the right instant to see the great ball on the flagstaff drop from sight. Many of

The method by which the ball is dropped is a very interesting one. Five minutes before noon, Washington time, all telegraph circuits are cleared, not only for the time ball service but for transmission of the correct time to thousands of points all over the country. Then what is known as the master clock at Washington is connected to the telegraph lines.



The master clock is for correcting the clocks at the various stations where the time service is given. The Washington clock beats off seconds, which beats are transmitted over the wires the same as the dots of a message in the Morse code. As the master clock ticks off the seconds of the last five minutes before noon the twenty-ninth beat of each minute is omitted, the last five beats of each of the first four minutes and the last ten beats of the fifth minute. The beats as they are transmitted over the wire are registered at the Chicago station and other stations in the service by a pen on a moving strip of paper much as the first telegraph messages were recorded before it became common practice to read them by ear. The pen moves over the strip of paper, which is actuated by clockwork. As the beat comes over the wire it actuates an electromagnet, which gives the pen a pull and makes a sharp jog in the line every second except when the beats are omitted as stated above. Here then is a complete record of the 300 seconds before noon as beat off by the master clock.

At the receiving station there is the local clock, which is also made to tick off the seconds in the same manner as the master clock and register them on the same strip of paper in the same manner. The marks made by the local clock are, however, of a different shape from those made by the master clock, so by comparing the two records on the paper strip it may be seen at a glance whether the local clock is a half, a quarter, a fifth or any other fraction of a second off—the ends of the minutes as recorded by the master clock being readily noticeable on the record by the failure of the five beats and consequent failure to record on the strip.

In the above manner it is therefore possible absolutely to check the local clock. As it is only 11 o'clock in Chicago when it is noon in Washington there is ample time after checking the local clock to get ready for dropping the ball at noon. Anywhere within the bounds of eastern time, however, the signals from the master clock would come in just before noon, and it would be necessary to throw the circuit for dropping the ball in upon the time cir-

cuit during the ten-second interval in the beats that occur at the end of the last minute.

The time ball on the roof of the Masonic Temple is 4 feet 10 inches in diameter and weighs 150 pounds. It is hollow and slides up and down on a 32-foot steel pole. When raised to its highest position the ball is 342 feet above the level of Lake Michigan. The ball is raised by a rope and drum operated by

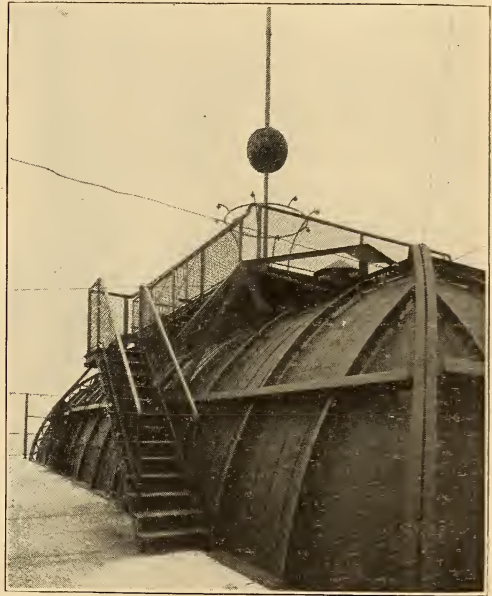

TIME BALL ON MASONIC TEMPLE.

a motor. It is then held by a catch, which is in turn controlled by an electromagnet in circuit with the local clock in the Federal Building, which clock has been checked an hour previous as described. This local clock ticks off the seconds before noon as in the case of the master clock at Washington. During the ten-second pause before noon, Chicago time, the ball is hoisted and then the last second before 12 the clock gives a final tick, the impulse is transmitted over the wire, the electromagnet is released and the ball drops. Every captain of a lake steamer within sight of the ball then knows that the hour of noon has been indicated as accurately as is within the power of science and human ingenuity, and he sets his chronometer accordingly.



MANUFACTURED BY  
THE CHICAGO ELECTRICAL CO.  
CHICAGO, ILL., U.S.A.

ILLUMINATIONS AT THE CHICAGO ELECTRICAL SHOW HELD AT THE COLISEUM, JAN. 13TH TO 25TH.



## HOUSE WITHOUT A CHIMNEY

A house without a chimney, in other words, a fireless, smokeless house, is entirely in sympathy with twentieth century ideas. Such a house has been erected in Carrollton, Ill., by Mr. F. M. Sinsabaugh, manager of the Carrollton Heat, Light and Power Company. In this unique residence there will not be a stove, furnace or flue of any description. Heating will be done by steam, piped from the lighting company's plant, which is located at no great distance. Cooking will be done exclusively by electricity, and of course electric lights will be used.

The residence is 34 by 30 feet, with two stories, attic and basement. The architecture is of the plain substantial mis-

seven switches. The cost of current for cooking for a family of five persons is estimated at \$4.50 a month, the prevailing rate for electric current at Carrollton being five cents per kilowatt-hour.

Mr. Sinsabaugh has expressed in a practical way, his faith in the ability of the plant to keep his household comfortable and cook his meals. To build a chimneyless house is the strongest possible expression of this confidence.

### TELEPHONE AIDS ORCHESTRA.

A new use has been discovered for the telephone, which is the maintenance of pitch and rhythm between an orchestra and trumpeters located behind the stage.



HOUSE WITHOUT A CHIMNEY.

sion style and the construction material cement blocks.

In the kitchen no range is visible, its place is taken by a compact electric cooking cabinet. This is fitted with two electric lights, a two-quart cereal cooker, four-quart teakettle, coffee percolater, ten-inch frying pan, broiler, griddle and four-quart vegetable cooker, all of aluminum ware. There is also an electrically heated oven for baking. Current for heating these utensils is controlled by

The telephone was used in this manner recently when the Boston Symphony Orchestra was giving a concert in New York. A telephone was placed in the trumpeters' quarters in the rear of the stage, the receiver being fitted with a large megaphone. In the same manner a megaphone was placed over the transmitter of another telephone located near the main orchestra, to collect the sounds. By this arrangement perfect pitch and rhythm were secured.

# ELECTRICITY IN MEDICINE.

BY OTTO JUETTNER, M. D., PH. D.

## PART I.

THE last few decades have witnessed the wonderful development of electricity. From the mere plaything of hardly more than fifty years ago that subtle form of physical energy has developed and grown into an agent of still increasing power and usefulness in almost every line of human activity. It has invaded the domain of medical practice and has unfolded to the investigating eye and mind of the physician new and wonderful possibilities in the interests of human health. The announcement of the discovery of a hitherto unsuspected form of energy emanating from vacuum-tubes of special construction (X-ray or Roentgen-ray) a few years ago gave a tremendous impetus to the study of electricity in its relation to medicine, until we finally have reached a point where electricity is a necessary and indispensable part of the modern physician's work.

The doctor of to-day uses various forms of electrical energy in the study, treatment and cure of disease. Much has already been accomplished in the elaboration of this subject, and yet the promises of the future seem even greater than the achievements of the recent past. In presenting this series of articles on "Electricity in Medicine" my object is to give a practical resume of our knowledge of the subject and enable the reader to form an intelligent opinion concerning the uses and particularly the abuses of electricity in the treatment of disease; to point out to the mind of the conscientious physician the landmarks of the subject as revealed by the researches and experience of masters in electro-therapeutic art, and to educate the lay mind in the proper estimation of the legitimate electro-therapeutic work of the physician as distinct from the absurd claims of the charlatan.

We shall begin our studies with the discussion of the rudiments and principles of electricity, as far as they concern the practice of "electro-therapy" (electricity in the treatment of disease).

Sir Oliver Lodge in his excellent book

entitled "Modern Views of Electricity" recognizes four distinct forms or varieties of electrical energy, to-wit:

1. Static Electricity or electricity at rest. This form of electricity is found, for instance, in gas-fixtures under certain favorable atmospheric conditions when it is possible to extract it in the form of a spark by pointing a finger close to the fixture. The hair of some people is charged with electricity of this kind. The crackling noise which is distinctly heard when such a person combs his or her hair is due to the liberation or discharge of the electrical force. The word "static" is of Greek origin and means "standing still" (electricity at rest).

2. Current Electricity or electricity in motion. The word "current" is of Latin origin and means "running," "moving" or "flowing." It refers to the supposed motion of the electrical force through or along a conductor. The old physicists, including our own Benjamin Franklin, compared the "motion" of electricity to the motion or flow of water and applied to it the term "current." It refers to the kind of electricity that is carried by wires which are, therefore, known as conductors. A conductor is any substance capable of carrying or conducting electricity. There are good conductors, like all metallic substances; moderately good conductors, like the tissues of the human body, and poor conductors, like silk, dry air and glass. Substances that do not conduct electricity are known as non-conductors or insulators.

3. Electro-magnetism is a peculiar form of electrical energy and is sometimes called electricity in rotation. The ancients were familiar with the fact that amber, when rubbed, became possessed of a peculiar property of attracting other bodies. From the Greek word *electron*, meaning amber, the word electricity is derived. It originally meant "a force possessed by amber." Dr. Gilbert, a physician who lived about 200 years ago, showed that many other substances, in



fact nearly all substances, if rubbed in a certain manner, possessed this force. We know now that if two substances are rubbed together both are electrified but not in the same manner. One becomes positively electrified while the other is negatively electrified. Substances that carry similar charges (i. e. both positive or both negative) repel each other while opposite charges attract. The old Grecians called this peculiar manifestation "magnetism," from the name of the Greek province Magnesia, whose iron ores were found to possess this peculiar property. Electricity and magnetism bear a close relation to each other, in fact they are only different manifestations of one and the same force. The mutual, close relation of the two kinds of manifestation are well illustrated by the familiar little induction-coil of every Faradic battery of which we shall speak later on. In this little coil the electrical current produces magnetism in the iron core.

4. Electro-radiation is the phenomenon which explains the various forms of electrical conduction or transmission without conductors other than the space intervening between the generator and the receiver of the energy. Professor Hertz was the first physicist who studied these invisible, conductorless, wireless forms of electrical manifestation. They are named in his honor Hertzian waves. The X-rays belong under this head and also the radiations from certain substances like radium that constantly emit energy and are, therefore, said to be radio-active. The subject of radio-activity is of the greatest importance nowadays. Just as radium possesses and constantly emits certain forms of energy, it is thought that the human body in its nerve cells possess a certain kind of radiating energy that is constantly given forth and constitutes what, in its visible manifestations, we recognize as the life of the body. Exhaustion of radio-activity means death. It is plain that this life-energy, brain- or nerve-force is closely related to electricity in some form or other. Many of the effects of electricity on the human body can be explained in this way.

Sir Oliver Lodge did not add a fifth variety of electrical energy to his classi-

fication which really ought to be included, namely:

Inductive Electricity. It is not a different kind of electrical energy but it differs from the four varieties mentioned in the manner of its production and is dependent upon the existence of an electrical charge or current in any conductor. The latter is surrounded by a sphere of influence whose diameter depends on the character of the charge or current carried by the conductor. This sphere of influence is called the magnetic field or the electro-magnetic field of the conductor. If a substance capable of carrying electrical energy is brought near a conductor actually carrying electricity, without, however, touching this conductor but close enough to invade its electro-magnetic field, the substance will receive an electrical charge. There is no contact, no direct conduction. We call this mode of generating electricity induction, and the energy produced, induced electricity. In attempting to explain the phenomenon of induction Benjamin Franklin took it for granted that all bodies in nature contained electrical energy. If there was an excess of the latter, he considered the excessively charged bodies to be positively electrified. By bringing an insufficiently (or negatively) charged body near the positively electrified body, the latter would incite an additional charge in the former and the induced charge would be the result. Symmer, another physicist, assumed that the electrical force is present in all substances and reacts upon irritation, e. g. friction, by breaking up into two forces of opposite character, positive and negative. If another substance is brought near a conductor, the predominant element, positive or negative, in the latter will attract the opposite element in the substance brought near the conductor. Thus an electrical manifestation of opposite character is incited, i. e. an induced charge or current opposite in character to the charge or current in the conductor. Thus the substance acted upon becomes a conductor of an induced charge or current. It is known as the secondary conductor while the original conductor is the primary. The charge or current carried by a primary con-

ductor is known as a primary charge or current, while an induced charge or current is always called a secondary charge or current. Two familiar examples of induction will help to make the subject clear. If the inside of a Leyden jar is charged positively, the outside will receive a negative charge by induction and vice versa. The outer or secondary winding of a Faradic coil receives its energy from the inner or primary winding by induction. Both examples will be fully discussed later on. For the sake of completeness let me add that the positive element is often called the anode while the negative is known as the cathode.

Definition and explanation of a few elementary electrical terms will serve to elucidate some of the fundamental principles upon which the science of electricity rests.

The electroscope is a simple device for the purpose of determining whether a body is electrified. In its simplest form it consists of two strips of gold-leaf suspended together from the same wire. The whole arrangement is protected by a glass jar. When the instrument is brought near an electrified body, the two strips of gold-leaf become charged and violently diverge. It simply indicates that electrification has taken place but does not suggest the kind of electrical energy present, its amount or its potential force. There are ways and means of determining the quantity and the force of the electrical energy. Before discussing them it will be necessary to get a clear idea of electrical quantity and force.

We have stated previously that electricity is in reality a dual form of energy possessing a negative and a positive character. It is lying dormant throughout the whole creation. The two elements, positive and negative, are in a condition of perfect mutual equipoise. When, under given favorable conditions, this perfect equipoise is disturbed and the hitherto dormant force becomes an active electrical force we express this phenomenon by saying that the potential of one element has become different from the potential of the other. The active flow or tendency is from the higher potential to the lower one. This

is the direction of the current. We call the element possessing the higher potential the positive pole. The element possessing the lower potential is the negative pole. Thus the electrical energy or current tends from the positive towards the negative element. That which disturbs dormant electricity and changes it into active electrification is called the electromotive force. The relative intensity of this force is expressed by the voltage. By the voltage of a current, therefore, we mean the degree of electromotive force which disturbed the perfect potential equipoise of dormant electricity. Let us illustrate this point by a pertinent example.

If we connect two vessels of equal size and containing an equal amount of water, by means of a pipe, the water will flow through the pipe if one vessel is higher than the other. If the two vessels are on the same level, the pressure is the same and no water will flow. If we lower one vessel, the water from the higher vessel will drain into it. The water, obeying the law of gravitation, will seek the lower level. Let us apply this principle to the subject of electricity. The two vessels on the same level represent the perfect equipoise of the two electrical elements. Raising one vessel corresponds to disturbing the equipoise of the electrical elements and raising the potential of one element. This element with the higher potential we call the positive element. Water flows from the higher vessel to the lower one through the tube. Analogously, electricity tends from the positive side towards the negative through a suitable conductor. The degree of lowering of the one vessel determines the force with which the water will gravitate and flow toward the lower level. This corresponds to the relative degree of electromotive force or voltage with which the electrical energy will manifest itself. A unit of electromotive force is called a volt.

Returning to the example quoted we can readily understand that the water does not necessarily always drain in the same quantity and at the same rate. It may drain in a thick or in a thin stream. The idea of quantity is also applicable to electricity. The quantity of current flowing is called amperage, one unit of



which is known as an ampere. There may be obstacles in the way of the water flowing, e. g. a narrowing of the caliber of the tube. Applied to electricity these obstacles suggest what is meant by resistance, one unit of which is called an ohm.

The units of voltage, amperage and resistance have been definitely determined. Go to any electrical supply-house or laboratory and ask to be shown a Daniell's cell. It consists of copper in contact with a sulphate of copper solution. Separated by a porous partition is a zinc plate in a solution of sulphate of zinc and sulphuric acid. The electromotive force produced by a cell of this kind is a trifle more than one volt.

The exact meaning of resistance was determined by the International Congress of Electricians at Paris in 1884. A unit of resistance (ohm) is the resistance of a column of pure mercury, 106 centimeters long, 1 square millimeter thick, weighing 14.4521 grammes, at a temperature of zero degrees Centigrade. This amount of resistance is approximately equal to the resistance of a copper wire 1/20 inch thick and 250 feet long.

The amount of current which will flow through a resistance of one ohm with an electromotive force of one volt is called one ampere. The thousandth part of an ampere is a milli-ampere and is the unit of quantity used in medical electricity.

The terms volt, ohm and ampere immortalize the names of the three great scientists Volta, Ohm and Ampere, who were among the early investigators of electricity.

Dr. Ohm recognized the close relationship and interdependence of electromotive force, current-strength, and resistance. He formulated this relationship by the law of resistance which is known as Ohm's Law, to-wit: the current strength (amperage) is always equal to the electromotive force (voltage) divided by the resistance. Transposing the factors of this equation we may say that the voltage is equal to the amperage multiplied by the resistance or again, that the resistance is equal to the amperage divided by the voltage. Let C stand for current-strength (amperage), E for electromotive force (voltage)

and R for resistance (ohms), the formula in its triple form would read thus:

$$C = \frac{E}{R}, \text{ or } E = C \times R, \text{ or } R = \frac{E}{C}$$

The law of Ohm enables us to figure out the amount of the current-strength, resistance or electromotive force if the other two factors are known. Instruments for the measurement of amperage and voltage are called, respectively, ammeter and voltmeter. An instrument for the measurement of milli-amperes is known as a milli-ampere-meter, this instrument being of great service in the practice of medical electricity.

We have seen that electrical energy becomes manifest the moment the equipoise of dormant electricity is disturbed by some agent or other. The immediate effect of such disturbance is the production of electromotive force or voltage. There are two ways in which voltage may be produced, to-wit: by chemical action (cells, etc.) and by mechanical energy (friction machines, dynamos, etc.). We shall consider the construction of these generators and their physical effects in our next lesson.

An electric circuit is the path of an electric current from the positive (anodal) to the negative (cathodal) side of the generating source. The circuit is said to be closed as long as the current flows, and is said to be open when a break occurs in the path. It is a grounded circuit if the earth is used as a part of the circuit. If the two sides of a circuit are connected before the current has a chance to flow through the full extent of the conductors, this closure is called a short circuit.

Let us suppose that the current is produced by more than one generating source, e. g. five, ten or more cells. These cells may be wired together by combining all the positive elements and gathering the energy produced by them. The wires from the positive elements are twisted into one common wire or conductor. The same is done with all the negative elements. Thus we have two wires, one representing the combined positive energy, the other the combined negative energy of the generating

sources. This way of wiring is known as wiring in multiple or wiring in parallel. These terms apply to any electrical apparatus that is wired in the manner indicated. Thus, if we connect a dozen receptacles for incandescent lamps with two supply or feed wires, each receptacle being attached to both wires, we would say that the lamps are wired in multiple or in parallel. If one of these lamps should burn out, it would not affect the others. If one of the five, ten or more cells which we have wired in multiple should be exhausted or become disconnected, it would simply mean the loss of the energy of one cell. In no other way would the sum total of energy from the cells wired in multiple be affected. If twelve lights are wired in multiple and one burns out, the other eleven would still continue to burn. They draw from the same source but independently of each other. This is the meaning of multiple or parallel wiring.

There is still another way in which cells and other electrical apparatus may be wired. If we wire twelve cells by connecting the positive element of one with the negative element of the next, and so on until the elements of all the cells are connected, we finally get two wires, one from the first cell and the other from the last, that represent the combined energy of the twelve cells. Let one cell become exhausted and the circuit would at once be broken. Likewise, if we place twelve lights on one of two feed wires, not on both, they would be dependent on each other. Let one lamp burn out and the circuit will be broken. The other eleven lamps would not light up. This is what is known as wiring in series. Electrical devices that are wired in series draw their energy from the same source and are dependent on each other.

How many different kinds of currents are there and which are used in electro-therapy?

We have seen that a current is pushed by its electromotive force from the higher level (positive, anode) to the lower (negative, cathode). As long as the position of the two levels relatively to each other remains undisturbed the current will flow in this one direction. This is what we mean by a constant current.

It is also called a direct current. It is the same kind of a current that was formerly called a galvanic current, the term suggesting the name of the great physicist Galvani. The word "galvanic" has become practically obsolete. We speak of a direct current in common electrical parlance or of a constant current in electro-therapy.

Let us suppose that the relative position of the two poles were continually changing. The current would still be flowing from positive to negative, but, owing to the change in the relative position of the two poles, would be changing its actual direction continuously. Let a man be walking toward a certain point, say a stone placed fifty feet away. If some one were to throw this stone above the man's head to a place fifty feet behind the man's back the man would have to reverse his direction in order to walk towards the stone. He is walking in the opposite direction but still towards the stone. This is to illustrate the change in the direction of a current while the latter necessarily flows from positive to negative. A changing current like this is called an alternating current. The electromotive force of an alternating current begins at the zero mark and rises to its full height then drops to the zero mark (neutral level) and below it to a depth corresponding to the previous rise or height. It returns to the neutral level and begins again to rise. The rise above the neutral level and the subsequent drop or fall beneath it are the alternations of the current. Each curve is an alternation. Two alternations following each other constitute a cycle. The time consumed in the completion of a cycle is a period. The number of alternations occurring in one second indicates the frequency of the current. There may be a thousand, ten thousand, one hundred thousand, a million and more alternations in one second. Thus we get the term high frequency current to indicate an alternating current characterized by many alternations per second. Currents of high frequency have become of greatest interest and importance in the practice of electro-therapy, as we shall see later on.

(To be continued.)



## ELECTROPHONE FOR THE DEAF.

The fact that electricity used in the telephone enables people to converse with one another when over 1,000 miles apart suggested the idea of the electrophone, which materially aids those who are partially deaf to hear. The makers of the Stolz electrophone claim no efficacy for this instrument in cases where the auditory nerve has been paralyzed and there is absolute deafness.

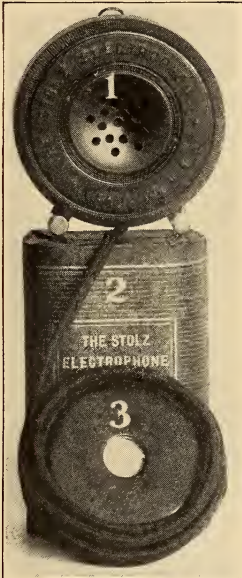

FIG. 1. ELECTROPHONE.

In such cases there is no hope for aid in hearing. In cases, however, where there is only partial deafness the electrophone has demonstrated its usefulness in a practical manner.

Fig. 1 shows a view of the electrophone, which consists of a miniature telephone set, (1) being the transmitter, (2) the battery and (3) the receiver. The transmitter and battery case are in one piece and are compact and light enough to be carried in the vest pocket or tucked out of sight in a ladies waist. A cord carrying two conducting wires leads from the transmitter to the receiver ear piece. This ear piece may be either held to the ear with the hand or it may be fastened to the head by a head band. Most of the working parts of the electrophone are therefore hidden, and the ear piece and small cord

running to it are not unsightly, as will be noted in Fig. 2.

Sound waves which impinge on the diaphragm of the transmitter are greatly multiplied in volume and are transmitted through the cord to the receiver which is held to the ear. Deaf persons are therefore able to hear with the electrophone more easily than with an ear trumpet, and are not annoyed by its unsightliness.

The transmitter being covered by the clothing does not impair its efficiency in



FIG. 2. USING THE ELECTROPHONE.

the least. The weight of the outfit complete is but 11 ounces, so that it is not inconvenient to carry about. The battery cells will last about six weeks and may be renewed at a cost of a few cents.

### OKLAHOMA ELECTRICAL CONVENTION.

Enthusiastic preparations are being made for the coming convention of the Oklahoma Electric Light, Railway and Gas Association which will be held in Guthrie, Okla., May 25th to 27th. This is one of the younger of the many state electrical associations which have come into existence during the last few years, and which are of such efficient aid in the furtherance of the use of electricity. At the Guthrie convention one of the interesting features will be a very complete exhibit of electrical devices for the household.

## BEAUTIES OF THE AUTOMOBILE PARADE.

Formal opening of the automobile season on "Automobile Row," in Chicago, was this year marked by a week's carnival, the initial demonstration being a parade in which gayly decorated cars to the number of 100 or more participated. The parade was held on the evening of March 28, and was one of the most beautiful exhibitions of its kind ever held in the city. In spite of the cold weather it was estimated that 50,000 people saw the pageant.

Nearly all of the cars were decorated with floral designs and several were illuminated with festoons of electric

lights. The second illustration is shown one of the electrically lighted cars. The lights were furnished with current from storage batteries and were artistically festooned over the car.

### FIRST ELECTRIC ROAD FOR COLOMBIA.

On the steamer Prince Eitel Fredrich, which sailed recently from New York, was shipped the equipment of the first electric street car road to be built in the republic of Colombia, S. A., says the Electrical World. The road will be constructed in Bogota, the cap-



lights, which added greatly to the brilliance and beauty of the scene. In all there were 23 prizes given. The electric vehicle shown herewith was one of the prize winners. Every possible point on the car was covered with flowers and as an additional ornamentation, several white doves were mounted on flexible steel rods projecting from the car, and as the rods vibrated the doves appeared to float and flutter in the air. In the sec-

ond illustration, and will replace the mule car lines now in use. The steamer will discharge at the port of Cartagena, and from there the steam railroad will transport the equipment for 15 miles, when the journey will be continued by water for 400 miles. A trip of 100 miles on mule back, followed by a water trip and another mule-back journey, will finally bring the equipment to its destination. The cars used will be run by two 25



horsepower motors each and current will be generated in a power house belonging to the city. The road is not more than six miles in length and eight or nine cars will be used, but eventually the system will be much enlarged.

#### WHAT A KILOWATT HOUR OF ELECTRICITY WILL DO.

Calculated by an electrical engineer of the municipal lighting plant of Loughborough, England.

1. Saw 300 feet of lumber (deal).
2. Clean 5,000 knives.
3. Keep your feet warm for five hours.
4. Clip five horses.
5. Warm your curling iron every day in the year for three minutes and twice

12. Fill and cork 250 dozen pint bottles.

13. Supply all the air required by an ordinary church organ for one service.

14. Run a plate polishing machine for 21 hours.

15. Give you three Turkish baths.

16. Keep four domestic irons in use for an hour.

17. Keep you warm in bed for 32 hours.

18. Give you a fire in your bedroom for an hour while you are dressing or undressing.

19. Boil nine kettles of water, each holding a pint.

20. Cook 15 chops in 15 minutes.

21. Run a small ventilating fan for 21 hours.

22. Run a large ventilating fan for

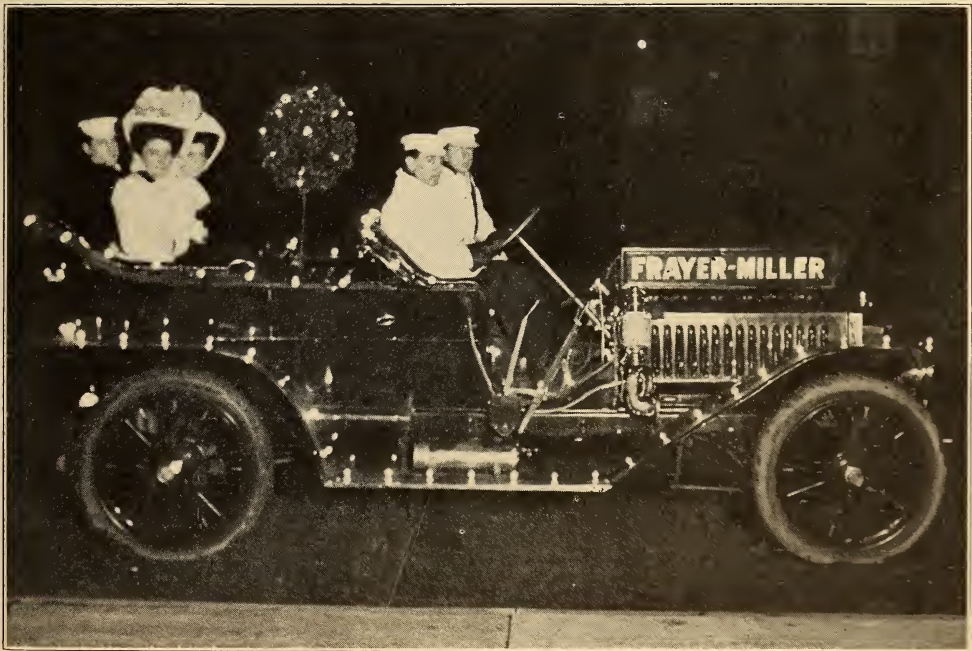

on Sundays.

6. Warm your shaving water every morning for a month.

7. Give you 1,250 impressions on a Brenner royal printing machine.

8. Run a mechanical sieve for two hours.

9. Run an electric clock for 100 years.

10. Light 3,000 cigars.

11. Knead eight sacks of flour into dough.

six hours.

23. Keep your breakfast warm for five hours.

24. Run a sewing machine for 21 hours.

25. Carry your dinner upstairs every day for a week.

26. Keep your coffee pot warm at the breakfast table every day for a week.

27. Carry you three miles in an electric brougham.

## ELECTRICITY IN THE BALLET.

Novel use of electric lights in the costuming of the chorus of "Honeymoon Trail" at the La Salle Theatre, Chicago, has attracted favorable comment. In this production there are 460 lights on the stage at one time. These are not carried by an amplified chorus, either, but by ten girls who assist Miss Florence Holbrook in a song number entitled "Whose Little Girl Are You?".

The girls wear stunning red and black dresses, with immense picture hats, and green and red muffs. When the gowns were made an electrical expert was called in to help the costumer, and the creations were wired so that 46 bulbs were sewed

from the back of the stage, by insulated wires, and the attachment is made by 10 male escorts of the girls who connect the wires. There is an independent connection for each dress and, for safety, a fuse for each girl. The girls control the lights themselves, through switches carried in the muffs. A transformer on the stage reduces the current of 110 volts to one of six volts. The lights are one-half candle power each.

The audience apparently is mystified by the manner in which current is carried to the lights, because the choristers are seemingly free from bungling batteries, the gowns being snug and form-



into each dress. The task was so ingeniously done that the spectators can notice nothing unusual in the make-up of the garments, and the lighting of the lamps comes as a distinct surprise, particularly as the ballet engages in a lively dance on a full-lighted stage just a second before.

The bulbs are concealed in roses which form a border around the bottom of the skirt, in the bodice and in the brim of the hat. Some are red and some white. The current is conveyed to each girl

fitting. After each verse the stage lights are turned up and through hasty manipulation of the wires by the male members of the chorus the girls appear free and without the impediment of wires, which the audience seems to think ought to run through the floor.

Preliminary to the staging of the feature, the La Salle Theatre electrician gave the chorus girls and their male assistants a course of instruction which eliminated any fear they may have had about managing the 460 lights.



## ELECTRICALLY EQUIPPED DRY DOCK.

The new dry dock of the San Francisco Dry Dock Company now being built at Hunters Point near that city, will be the largest in the world, and what is more it is practically an electric dry dock, for the pumps that will remove the water will be electrically driven. Up to the present time the largest dry dock in the world was at Belfast, Ireland, but this new American dock far surpasses it in all particulars. It will be 1,050 feet long, 144 feet wide and  $34\frac{1}{2}$  feet deep.

The pumping plant will consist of four 54-inch centrifugal, double suction pumps, with a joint capacity of 200,000 gallons of water a minute. Each pump will be driven by a 500-horsepower, three-phase electric motor, operating at 440 volts. These pumps will be placed in the bottom of the pump pit and can be started from the gallery at the floor level, the intention being to use the high tension current of a nearby central station at about 10,000 volts and transform it to the required voltage.

With the above electrical installation it will be possible to pump 24,000,000 gallons of water in two hours, which will be sufficient to empty the great dock. A record made possible by the use of electricity.

## ELECTRIC FLORICULTURE IN ENGLAND.

Electric floriculture has been developed to a considerable extent in England. In one adaptation of this method the electric light was made to take the place of the sun in this way: Along the whole length of two green-houses, tomato plants, fuchsias, chrysanthemums, geraniums and ferns were arrayed. One house was left as usual, the other fitted up with an electric light. The plants at the start were all of the same height on the first morning, but after three days a notable difference was apparent between those left alone and those grown at night under the large arc lights.

In the house with the large arc light the lamp was moved by a motor car over an overhead railway, the journey back and forth taking exactly an hour. Thus in three hours it traveled up and down the house three times. The result after

three nights and four days showed that the tomato plants in the house which had been electrically lighted at night had grown an average of four inches taller than those in the house without light.

## ELECTRIC SIGNAL FOR MAIL BOXES.

People living on rural free delivery mail routes will be interested in a new type of mail box which is the invention of Mr. Norman L. Cheney, of Batavia, Ill. In the country, the mail boxes are often located at a considerable distance from the farm house, and sometimes out of sight of the occupants. Many steps may therefore be saved if some effective means of signaling be employed to indicate when mail has been deposited in the box.

Mr. Cheney's device consists of a sim-

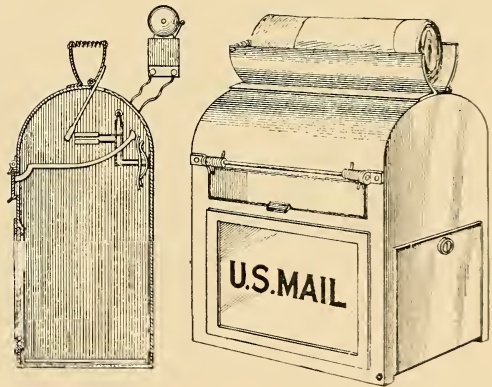

ple mail box so arranged that an electric alarm is sounded when small pieces of mail are dropped inside and more bulky packages placed in a special receptacle on top of the box. The hinged door through which letters are dropped into the box is normally held closed by a spring. When the door is opened, however, the movement closes the circuit to an electric bell located in the house, which sounds an alarm as long as the mail carrier has the door open. In a similar manner a package deposited in the receptacle at the top of the box will close the same circuit and ring the alarm.

Batteries are used to furnish the current necessary and the connections are simple and easily made.

## FIRST AID IN CASE OF ELECTRIC SHOCK.

**E**FFORTS toward resuscitation after electric shock should be persisted in as earnestly as in case of drowning, and even after life is apparently extinct there have been cases where the victim has been revived. The United Gas Improvement Company of Philadelphia originated a very efficient system of first aid which is described in the following paragraphs, and which if followed closely will in many cases result in the saving of a life.

A kit containing the following materials should be kept in readiness: A bottle of aromatic spirits of ammonia; a bottle of ordinary ammonia, with sponge attachment; a package of bicarbonate of soda (ordinary baking soda); a tin cup; a pair of tongue pliers; a towel; a package of antiseptic cotton; a roll of adhesive tape.

The first thing to do is to send for a doctor, in the meantime acting as follows: Carry the patient immediately into fresh air. Place him on his back on a flat surface, with a coat rolled (not folded) under the shoulders and neck, in such a way as to allow the head to fall backward enough to straighten the wind-pipe, as shown in Fig. 1; at the same time open the patient's shirt wide at neck and loosen the trousers and drawers at waist, and have an assistant rub his legs hard.

Open his mouth, forcing the jaw if necessary. If the jaw is rigid it can be forced open by placing the forefinger back of the bend of the lower jawbone and the thumbs of both hands on the chin, pulling forward with fingers and

pressing jaw open with thumbs.

Place something (a piece of wood) between the teeth to keep the jaws open and to prevent the patient biting his tongue, using something large enough to prevent any danger of his swallowing it accidentally; grasp the tongue with the tongue pliers as shown in Fig. 1, having an assistant hold it out while you are helping the patient to breathe, as described below. In the absence of tongue pliers, the tongue may be grasped between the index and second fingers, after they have been covered with a handkerchief.



FIG. 1.

After the clothing has been loosened, the jaw forced open, the froth cleared from the mouth and the tongue grasped, begin artificial breathing at once as follows:

Kneel far enough behind the head of the patient to prevent interference with the man holding the tongue. Bend the patient's arms so that the hands meet on the

chest; grasp the patient's forearms firmly, as close as possible to the bent elbows, then firmly press the patient's elbows against the sides of his body so as to drive the air out of the lungs, as shown in Fig. 2, raising the arms slowly with a sweeping motion until the patient's hands meet above (or behind) the patient's head, as shown in Fig. 3. Then while you have the patient's arms stretched out in line with his body, give them a slow, strong pull, until you have expanded or raised his chest as high as it will go. Then bring the arms, with bent elbows, down against the sides, and press them firmly as before.





FIG. 2.

This action should be continued about 15 times a minute until the patient begins to breathe. You must guard against a tendency to make these motions too fast; they must be made slowly. A good plan is to count four slowly—"one," as the pressure is given on the sides; "two," as the arms are being extended above the head; "three," as the strong pull is given, and "four," when the arms are again being bent and returned to the sides.

Do not let your hands on the forearms slip away from the elbows. The best result comes from grasping close to the elbows.

The operator must appreciate the fact



FIG. 4.

that this manipulation must be executed with methodical deliberation, just as described, and never hurriedly or half-heartedly. To grasp the arms and move them rapidly up and down like a pump-handle is both absurd and absolutely useless.

Each time the arms are pulled above the head and the chest expanded, the assistant who is holding the tongue should pull the tongue out and downward, and another assistant should, from time to time, slap the chest with a



FIG. 3.

towel or cloth wet with cold water.

When the patient is breathing by himself, the process of artificial breathing can be stopped, but the process of pressing the sides every other time he breathes out, should be started as follows:

Do not press vertically, but press on the patient's side (palms of hands over lower ribs) as shown in Fig. 4, in such a manner as to force as much air out of the lungs as possible. You can carry

out this pressing action most successfully, if, on beginning, you move your hands in and out with every breath, pressing very lightly, until you have established a rhythmical motion of your hands in unison with the patient's breathing; then you can begin to press hard at every other outgoing breath. The object of doing this is to strengthen his breathing. By making the pressure every other time he breathes out, you give him an opportunity to take a breath himself, and this natural effort to breathe is in itself strengthening to the action of the lungs.

Continue this pressing action until the man is conscious and breathing well by himself.

### ELECTRIC ARCHES FOR STREET LIGHTING

An attractive and very efficient method of street lighting is shown by the ac-

also serves as an effective means of advertising the city.

Current for the lamps is furnished by the Mansfield Railway and Light Co.

#### QUESTIONS AND ANSWERS.

The object of Popular Electricity is not only to interest its readers and keep them in touch with things electrical, but more than that, to be of real benefit to those who are seeking to increase their knowledge of the theory and application of electricity. To this end a "Question and Answer Department" will be embodied in the magazine. If there is some question or problem in electricity that is puzzling you, send it in. The question will be printed together with the answer, and this information will interest hundreds of others in whose minds the same question has arisen. Because your query may be of a very elementary nature do not hesitate to submit it on that account. Thousands of people in the various walks

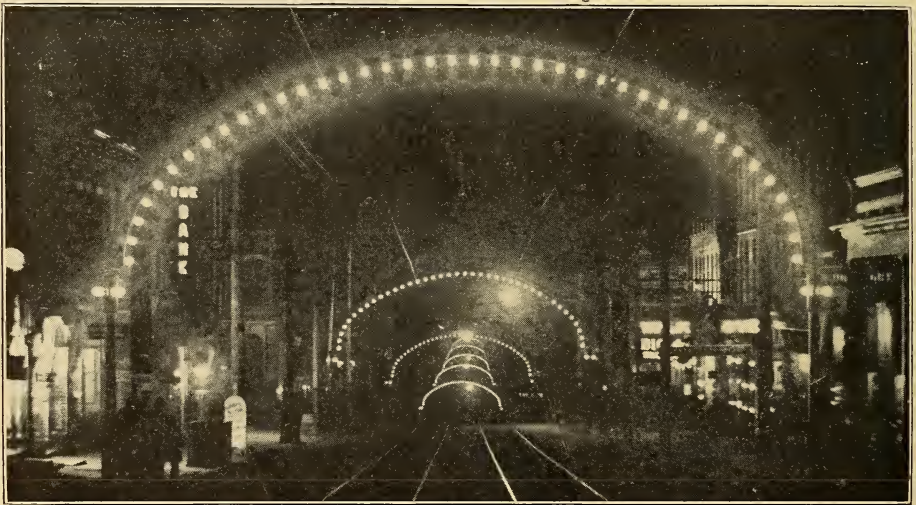

ELECTRIC ARCHES IN MANSFIELD, OHIO.

companying illustration, which is an excellent night view of Main Street, Mansfield, O.

Steel lattice work arches, supported by steel pillars, span the street at each intersection, for a distance of over half a mile, and the effect of the 40 incandescent lamps carried by each arch is highly ornamental. This method of lighting is confined to the business district and has been found entirely satisfactory. It

of life are interested in electricity, although they may have very little knowledge of how this great force accomplishes the wonderful results seen on every hand. Your question and its answer will benefit them, and the department may be made a clearing house for this general knowledge. Questions of a more technical nature will also be answered for the benefit of those who are trained in the electrical art.



## REMINISCENCES OF THOMAS A. EDISON.

Mr. James Walsh, a well-known resident of Chicago and also well known all over the country as a railway man, and who has now retired from active business life, gives some interesting reminiscences of Thomas A. Edison. Mr. Walsh, when a telegraph operator at Ridgeway, Mich., knew Edison as a boy, and the story of some incidents in his early life is therefore best told in Mr. Walsh's own words.

"I was an operator at Beebe's Corner, later Ridgeway and now Lennox, when I first met young Edison; he was then about 13 years of age. Beebe's Corner was a station between Detroit and Port Huron, and the boy carried newspapers on the train between Detroit and Port Huron. He left Detroit about 7 o'clock in the morning returning about the same time in the evening. His parents at that time resided at Port Huron. This was in 1860.

"We called him 'little Al,' and bright and well liked he was, both by train men and passengers. People have sometimes spoken of him in later life as not being a good business man—let me say that he began as one and has been one ever since. When he was newsboy on the train, he had a little font of type in the baggage car and used to print a little paper of his own, giving the news of his route as he went along between the stations, which he used to sell with the Detroit papers. This was enterprise indeed, and with it he had business sagacity, for he telegraphed the headlines of the city papers ahead to all the operators on the line, and in this way excited interest in his papers at the different stations along the line. The telegraph operators, who were all his friends, used to bulletin the head lines for him, and as it was about the opening of the war, there was always an eager waiting throng to whom he quickly disposed of his papers. He was a most lovable little fellow and a prime favorite with everybody. We all called him 'Little Al.'

"I saw him every day during six or seven months and then was transferred to St. Mary's. Meantime the lad Edison

had learned telegraphy in the Detroit and Port Huron offices of the Grand Trunk. When next I heard of him he had become night operator at Stratford.

"A funny incident happened there which was told to me by the superintendent of telegraph lines just as it occurred. Edison had, as night operator, to report every half hour to the chief dispatcher at Toronto. One night the circuit was found to be open somewhere between Toronto and Stratford. It happened as luck would have it that the superintendent of telegraph lines was on the night train leaving Toronto, and he tested all the offices along the line to find the break. When he reached the Stratford office he found the trouble was right there, and on examining the connections he found that young Edison was the cause of it by reason of an electric alarm clock he had invented to wake him up at the half hour periods, so that he might hear the call if he drowsed off, as night operators sometimes do. The alarm did not waken him on that particular night and the result was that Edison got the 'sack' there and then.

"Next day he went to Buffalo, the terminus of the Stratford line, and obtained employment in the Western Union Company's office. The manager there thought he had a greenhorn to try out, and put him on the Associated Press wire the first night, giving word to New York to rush business for the benefit of the new man. But the new man took the business all right, swift though it came, to the intense surprise of the local manager and the sender in New York. Thus was Edison's reputation as a crack operator established at once. It was born in him.

"The next I heard of him was after his success in inventing the stock ticker. This instrument is substantially the same to-day as when he first invented it. With part of the proceeds of that invention he purchased the street railway line between Fort Gratiot and Port Huron for his father and brother and set them up in business. Afterwards his reputation became world wide.

"I have always been proud of my early acquaintance with 'Little Al,' and proud too of his grand success."

# WIRELESS TELEGRAPHY MADE SIMPLE.

BY V. H. LAUGHTER.

## PART I.

### CONSTRUCTION OF A SIMPLE WIRELESS TELEGRAPH SET.

**W**IRELESS telegraphy is coming into quite general use as means of communication between ships at sea, city to city overland, army service, etc. It has only been a matter of a few weeks since the Marconi wireless company has established communication across the ocean. While this does not signify that the cable companies will be forced out of business, yet it shows the wonderful developments and improvements that have been accomplished along this line in a comparatively short time. From the above and other well-known feats it may readily be understood that this new art will sometime occupy a position as important as the telephone and telegraph of to-day. The field is also unlimited for the invention of new and useful improvements, which need not be given here but can be readily understood after we have become familiar enough with the various systems in use to understand their defects.

The following description of a short distance wireless outfit will not only be useful to those who wish to experiment in this field, but it will also serve to make clear the elementary principles upon which wireless telegraphy is based. Such a set is very easy to construct and will be found to give good results for distances of one-fourth to one-half mile over land, while over water the same set would probably work twice this distance. The knowledge gained will also prove of great benefit should an attempt be made to construct larger sets.

Before taking up the construction it will be well to give a general review of the parts needed which are as follows: Spark coil capable of giving a one-inch spark; two brass balls one-half or one inch in diameter; telegraph key; 150-ohm relay; coherer; common four-ohm electric bell. As it is very important that an exact idea be obtained of each working part and its operation, each will be described here in detail.

The spark coil is a transformer, so

made that it will "step up" a current of low voltage to several thousand volts. The coil consists of a bundle of soft iron wires around which is wound two layers of No. 16 or 18 cotton covered magnet wire. Over this winding and well insulated from it is wound several hundred layers of No. 36 silk-covered magnet wire. The first winding is known as the primary, while the second winding of small wire is known as the secondary.

If the current from a number of batteries is now sent through the primary winding, although any other source of current will do, the core will become magnetized, and invisible magnetic lines of force will be set up beginning at the end of the core and extending through

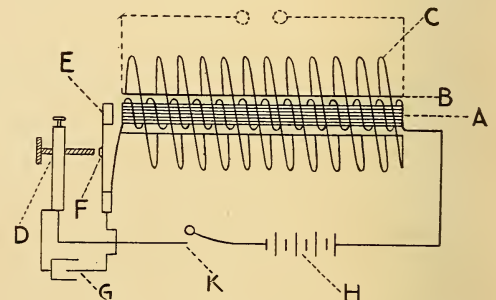

FIG. 1. VIBRATOR FOR WIRELESS TELEGRAPH.

the large number of secondary turns. If this primary current is now quickly broken a second current of high voltage will be induced in the secondary, due to the large difference in number between the adjacent turns of the two coils of wire, which produces a high voltage action.

From the above it is readily understood that some means for rapidly "making and breaking" the primary circuit is necessary. In fact the efficiency of small size coils depends to a large extent on this current "breaker" or vibrator as it is usually termed. The action of a vibrator is shown in the sectional view of the spark coil, Fig. 1. The vibrator consists of the soft iron disk (E) screwed to the spring strip



(F). In the center of this brass spring strip is placed platinum foil, which the contact of the screw (D) touches, the contact of this screw also being platinum pointed.

By pressing the telegraph key (K), the battery circuit is closed and current flows through the contacts (F) and (D) and through the primary winding around the core (A), saturating it with magnetism and thereby attracting the soft iron disk (E). The attraction of the disk now breaks the battery circuit, and magnetism immediately ceases to exist, which allows the soft iron disk to fly back to its original position, due to the action of the spring, only to repeat the operation over again. At each "make and break" of the vibrator the secondary current is induced in the secondary winding as explained before.

A condenser (C) which is made by building up alternate layers of tin foil and paper is connected to the two vibrator contacts (D) and (F). The condenser serves to prevent sparking at the vibrator contacts as well as to strengthen the current by making a dis-

charge around the primary winding at each swing of the vibrator.

brass rods about six inches in length and large enough to make a perfect fit in the balls. The rods with balls are now mounted on the top of the coil, one terminal of the outside or secondary being connected to one ball and the other terminal to the other ball. The telegraph key (K) is also connected in series with the batteries (H) and the primary connections of the coil.

Attention is next directed to the aerial and ground. The aerial, which may consist of No. 14 bare copper wire, is run to the top of a pole 50 or 60 feet in height and suspended by means of a swing made by tying two knobs on a well-oiled seagrass rope, so that they rest about one foot apart. One of the knobs is fastened to the top of the aerial while to the bottom one is tied the No. 14 bare copper wire. The aerial should be led

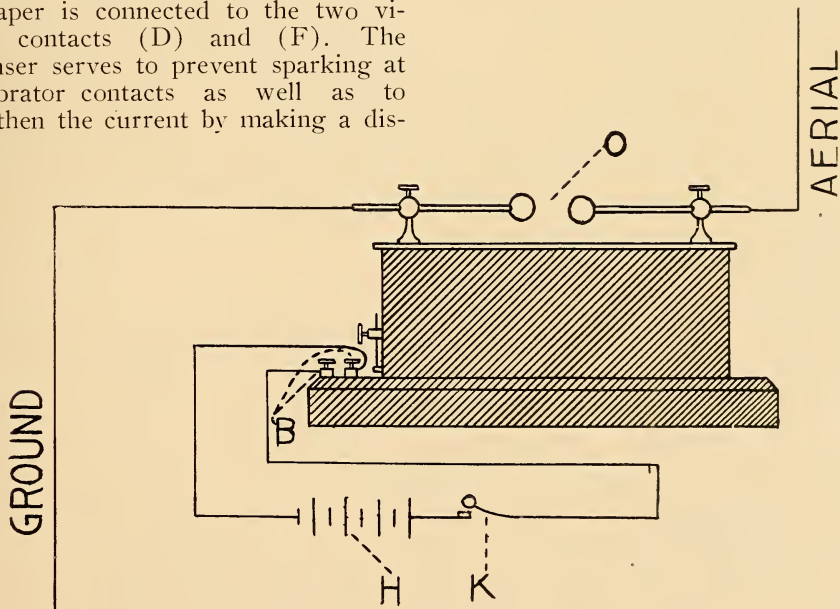

FIG. 2. WIRELESS TRANSMITTING APPARATUS COMPLETE.

charge around the primary winding at each swing of the vibrator.

To arrange the coil as a wireless transmitter two brass balls should be secured about one-half or one inch in diameter. The balls should be perfectly round and highly polished. A  $\frac{1}{8}$ -inch hole is drilled in each to the depth of  $\frac{1}{4}$ -inch. The balls are now fitted on

in through a hole drilled in a pane of glass, or if this is not possible, wrap the aerial to several times its diameter with tape and place in a porcelain tube, the tube being placed in a hole drilled through the wall for this purpose. The aerial is now soldered to one of the brass rods which supports one of the brass balls. The ground should con-

sist of a metal plate buried to a depth of six feet with insulated wire soldered to it. This ground wire is now led up and soldered to the rod opposite the one to which the aerial was soldered.

The sending end is now complete as shown in Fig. 2. The adjustments and working will be taken up later on.

One of the most important parts of the receiving set is the coherer. To

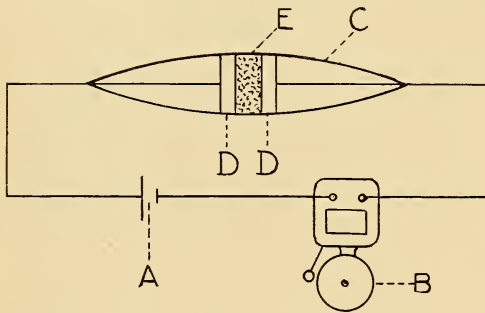

FIG. 3. BRANLY'S COHERER.

Branly is given the credit for first discovering that a loose mass of iron filings, when brought in close proximity to the discharge of a leyden jar or other high frequency discharge, will cling together, or cohere, and thereby lower the resistance of the mass as a whole, allowing the current from a battery to more easily flow through the mass when the particles are in coherence than when they are not. The filings may be placed in a tube and form part of a circuit to an electric bell or other indicating device. Branly's original plan is shown in Fig. 3, in which (A) is the battery, (B) the bell, (C) a glass tube, (D-D) silver pole pieces with metal filings (E) between. In order to stop the bell from ringing it was necessary to tap the tube with a pencil which would "decohere" the filings, and this would increase the resistance so that enough current would not flow through to actuate the bell.

This is the identical coherer used by Marconi in his original experiments, with the exception of a few improvements, the main improvement consisting of an automatic tapping device as explained farther on. The coherer in construction is extremely simple. In

Fig. 4 is shown a type that will answer perfectly well for experimental purposes and is fairly sensitive.

The coherer consists of two double lead binding posts (BB), two brass silver-plated rods (CC) large enough in diameter to make a snug fit in the binding post and about two inches in length, a glass tube (D) and filings. The binding posts should be mounted on a wood base one-half inch in thickness polished or varnished to suit the taste, and two inches apart. The silver-plated rods are mounted end to end with a space of about one-sixteenth inch separating the two ends. In the space between the ends of the rods are placed the filings, being held in place by the glass tube slipped over the ends of the rods as shown in Fig. 4 at (E). The filings should be prepared by sawing a nickel block with a hack saw. The filings should be sifted through a fairly thin mesh cheese cloth, the dust which goes through being thrown away while the larger pieces are retained and placed in the space at (E). It is also well to heat the filings after preparation, so as to drive away moisture which will prove detrimental to the working of the instrument.

The coherer is first connected up with

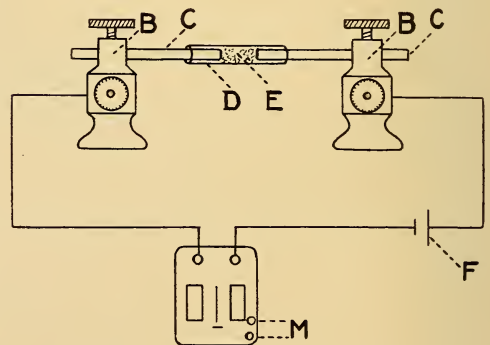

FIG. 4. COHERER IN CIRCUIT.

relay (B) and battery as shown in Fig. 5. As some will not understand the action of a relay it may be briefly described as two magnet coils with connecting posts. The magnet coils are connected in series with the battery and coherer. In front of the coils is pivoted an armature which is attracted by the



flow of even a very small amount of current around the magnet coils, due to the fact that the coils have in the center a soft iron core which becomes magnetic and attracts the armature. The armature in its forward pull closes a second circuit which comprises the battery (C) and an electric bell.

The tapper of the electric bell serves to de-cohere the filings as well as to give the audible signals. It should be mounted on the baseboard in such a manner that the hammer will tap the glass tube when in action.

If all connections have been properly made the apparatus is ready to be adjusted. The brass rods of the coherer should be pushed against the mass of filings until the armature of the relay is

ground wires have been erected the same as at the sending end, the connections being as shown in Fig. 5.

At the sending end the two spark balls are brought up until only one-eighth of an inch separates them. This is done in order that a heavy wave will be sent out which is capable of being detected at much greater distances than were a longer gap used.

By pressing the telegraph key at the sending station the battery circuit is closed which allows the current to flow around the primary winding, energizing the core and starting the vibrator in operation. At each swing of the vibrator the high frequency current is induced in the secondary, which flows out at the terminals to the spark gap (O), Fig. 2. In breaking down the high resistance interposed by the air in the spark gap a wave motion is set up which oscillates up

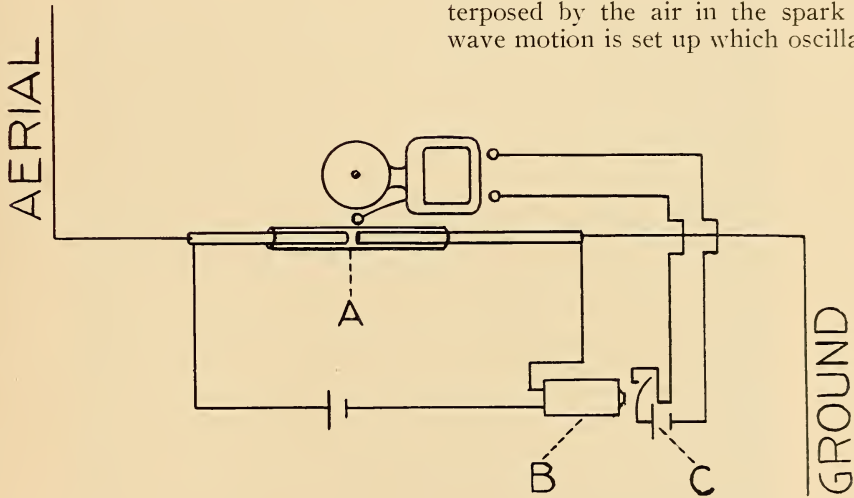

FIG. 5. RECEIVING APPARATUS COMPLETE.

thrown and the electric bell starts ringing.

The arms are now gradually withdrawn until the bell barely stops ringing. The next adjustment is that of the relay. A spring should be provided to control the tension of the armature, and this should be unwound until the relay armature closes the connection and rings the bell. The tension is now slightly increased until the point is reached where the circuit is barely open. In fact the distance which separates the relay contacts is hardly visible to the naked eye. The set is now ready to be put in operation, considering that the aerial and

and down the aerial and ground wire, also setting up a similar wave motion in the ground and the air, or rather in the ether which is supposed to exist in the ground as well as the air. This wave motion goes out equally in all directions, and at the receiving station a certain portion is caught by the aerial and ground wire, which small portion flows through the coherer and coheres the loose mass of filings, lowering the resistance as before stated and allowing the current from the battery to flow through and actuate the relay. This closes the second circuit which starts the bell in operation. The bell continues to

decohere the filings as long as the wave continues to come in. In this manner the dots and dashes of the code are sent, as the bell will continue to ring as long as the key at the sending station is pressed. In adjusting the apparatus it is

best to place the sending and receiving ends about ten feet apart without aerial or ground wires. Then continue to adjust and widen the distance until the limit is reached.

(To Be Continued.)

## CUTTING TELEPHONE POLES IN MICHIGAN.

**B**OARD a train at Menominee, Mich., on the shore of Green Bay and ride to Marquette on the shore of Lake Superior, across the northern peninsula of Michigan. A view from the car window will be a revelation to the uninitiated. Twenty-five years ago this was an almost unbroken forest of pine.

Proceeding from Menominee, the

bermen in low and swampy spots. These trees may stand to-day, but a few months hence they may support a telephone line in Texas.

Here on rising ground close to a running stream the cedar pole cutter builds his shanty, unless he is fortunate enough to find one abandoned in years past by the pine logger.

By December the whole swamp is



CONCENTRATING YARD.

farms gradually become poorer and more scattered until finally they are left behind and a desolate region begins. This whole land in all accessible localities was lumbered over years ago. Since then woodland fires have swept over the region and made ruin complete. The spectre like skeleton stubs of once giant pines pierce their way upward from the undergrowth, here and there over the flat country as far as the eye can reach.

In the interior regions of this wilderness, however, there are still small patches of virgin forest left by the lum-

frozen solid, footing is good and horses are brought in to drag the poles out of the tangle of tops and branches to the roads that have been cut. When the snow falls the sleds are loaded and hauling begins. The small operators depend almost wholly upon the snow to make roads for hauling, but where a considerable amount of cedar is being cut or where other logging is being done in connection with the cedar cutting, the whole operation will bear the expense of making ice roads, which make sled hauling almost independent of snow.



With the advent of spring the woodsman's task is done and the dealer's work commences. At hundreds of small stations and sidetracks on railroads traversing the cedar producing territory, the result of the winter's work is piled in lots of from 300 to 5,000 poles, all sizes from 16 to 70 feet long usually mixed together without regard to size. The small lots of under 2,000 are usually loaded on cars and shipped to central concentrating points, where in large yards the poles are sorted and piled, each size separately. When sufficiently dry they are then ready for distribution to the trade throughout the country. The larger lots are usually partially sorted at

#### EDISON LIGHT ON WILLIAMSBURG BRIDGE.

The city of New York has been experimenting with an electric power plant for lighting the Williamsburg bridge, garbage being used as fuel. This municipal undertaking has, however, not been a success. After being humored and pampered for more than two years, and fed everything in the fuel line from garbage to kerosene, it had to be abandoned.

While garbage burned, it was found that it was not as good a steam producer as some older forms of fuel. A few tons of coal judiciously mixed with the refuse helped out to some extent, and an occasional dash of kerosene aided materially in raising the indicator on the steam

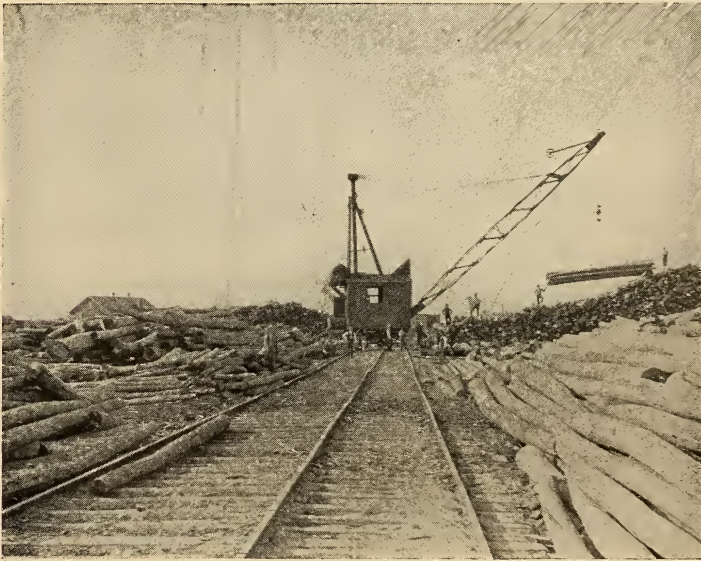

PILING TELEPHONE POLES WITH A CRANE.

the producing point. Direct shipments are made until the assortment is broken up, then the balance is loaded and shipped to the concentrating yard, where the sorting is done.

The larger firms in the business handle from 100,000 up to as high as 200,000 poles annually, equivalent to from 800 to 1,600 carloads, the railroad ties, fence posts and cedar logs produced with the poles amounting to twice as much more. A yard which will accommodate all the standard sizes of poles and posts must provide a pile frontage of not less than 1,800 feet, with depth varying from 50 to 150 feet.

gauge. But at best it was expensive, so the old Edison lighting contract has been renewed.

#### NEW YORK SUBWAY POWER.

All of the underground railways in New York are operated on the third-rail system and the power plant in use for this purpose is said to be equal to the strength of 83,000 horses and 200 of the mogul style of locomotives which are hauling the 18-hour trains between New York and Chicago. The plant is now being increased to a capacity of 125,000 horsepower in order to supply the tunnels.

# ELECTRICAL MEN OF THE TIMES.

## EDWIN J. HOUSTON, PH. D.

The most popular "boy" in Philadelphia is Edwin J. Houston—scientist, electrical engineer, teacher, inventor and author. Although now nearly 64 years of age, Dr. Houston is a "boy" in the sense that he is looked upon as a personal friend by thousands of boys all over the country, both through intimate acquaintance and through the influence of the many books which he has written, and which have thrilled the hearts of boys the world over. From this Dr. Houston derives more satisfaction than from the honors he has so justly earned in the field of science.

Edwin J. Houston was born in Alexandria, Va., July 9, 1844. His education was completed at Princeton, where he received the degree of Doctor of Philosophy. Early in his career he became interested in the study of electricity as one of the branches of natural science, and he was one of the inventors of the Thomson-Houston system of arc lighting. This achievement alone has made his name familiar to every student of electricity, for it was of a pioneer character and one of the first real developments in the field of electric lighting. This interest in electricity was uppermost in his mind throughout his long career, and he added much to electrical progress by numerous inventions and improvements in electrical apparatus.

He was for many years professor of geography and natural sciences at Central High School, Philadelphia, and of physics at Franklin Institute, finding time also to act in a consulting capacity on many electrical projects and to as-

sume the duties of president of the American Institute of Electrical Engineers for two terms.

As an author Dr. Houston is an authority on many subjects. It would be impossible here to enumerate all of the many works from his pen, as he has written no less than 80 on scientific subjects, but a few will serve to indicate the great variety of his writings. Among

them are the following: Elements of Natural Philosophy; Elements of Chemistry; Dictionary of Electrical Words, Terms and Phrases; Electrical Transmission of Energy; Alternating Currents; Arc Lighting; Electro - Therapeutics; Telephony, and last, but not least, his books for boys, of which he has written nine thus far, prominent among these being *The Boy Electrician* and *The Wonder Book of Volcanos and Earthquakes*. His literary work is by no

means completed, however, and he still continues to write, one of his latest undertakings being a series of articles for this magazine.

Although Philadelphia has been his home for nearly all his life, Dr. Houston has traveled extensively, and during his travels he has secured a fund of information, from which he has drawn liberally in the preparation of his various books.

Such a man then is Dr. Houston. Well versed in almost every department of science, but never a dabbler. A man of practical ideas, the influence of whose work has been a potent factor in electrical development. And last, but not least, a "boy."



EDWIN J. HOUSTON.



## DEVELOPMENT OF THE ELECTRIC LAUNCH

Where electric current is available for charging purposes the electric launch is an ideal craft for pleasure purposes. It is simple to operate, there is no steam boiler or engine to care for and no gasoline engine, consequently no inflammable fluid need be carried. By reason of the ease of operation the owner or his wife may be the pilot.

Electric launches are now built in a great variety of sizes, from the small fishing boat up to launches over 40 feet in length, which will safely carry 70 passengers.

One objection which has hitherto been held against the electric launch has been the fact that the storage batteries can not be charged by alternating current. A storage battery can only be charged by direct current, which is forced through the cell in the same direction continuously. Alternating current reverses its direction of flow many times per second, and each reversal of current destroys the charging effect.

In many localities only alternating current is available, and a converter of the mechanical type to change the alter-

the disposal of the launch owner a cheap and simple instrument for charging his batteries. By means of this exceedingly simple device the alternating current is converted into direct current, and the



GLIMPSE IN THE CABIN OF AN ELECTRIC LAUNCH.

necessity of a costly charging plant or rotary converter of the mechanical type is obviated.

The mercury-arc rectifier is a form of



FISHING FROM AN ELECTRIC LAUNCH.

nating current to direct current is expensive and adds materially to the cost of the launch outfit. Recently, however, the mercury-arc rectifier has made its appearance, and as pointed out by the Electric Launch Company, it places at

electric lamp, and consists of a vacuum tube of glass, into which the two terminals of the charging circuit are introduced through sealed openings. This tube contains a small amount of mercury and by shaking the tube slightly, some of

the mercury is vaporized. This vapor of mercury is a conductor of electricity, and current immediately begins to flow from one terminal to the other through the vapor in the tube. By a curious phenomenon the vapor of mercury has been found to admit of a flow of electric current in one direction only. That is, the electric impulses of an alternating current, which are in one direction, pass through the vapor, while those in the other direction are dampened out. If a mercury-arc rectifier, therefore, be inserted in an alternating current circuit, the alternating current entering at one terminal of the rectifier comes out at the other terminal as direct current, or current flowing in one direction only. It may then be passed on into the batteries to charge them.

### ALTERNATING CURRENT CORRECTOR.

**A**LTERNATING electric current cannot be used for the charging of storage batteries owing to the fact that each reversal of the current destroys the charging effect of the preceding impulse. Direct current can therefore only be used for this purpose. In localities where alternating current, only, is available some method must be employed to change the alternating form to direct for the charging of automobile batteries, sparking batteries and the like. This is accomplished in various ways as by the mercury-arc rectifier, rotary converters, motor-generators, etc.

The Ruprecht corrector is a novel device for changing alternating to direct current. It is based upon the principle that certain metals and solutions have the property of acting as a valve when a current of alternating character is allowed to flow through them. This valve action permits current impulses in one direction to flow through the solution, while those in the opposite direction are dampened out. The Ruprecht corrector is made up of several cells composed of these metallic solutions, and alternating current passed in at one terminal of the corrector comes out of the other terminal as direct current.

Several sizes are made. One size is

of about two amperes capacity. A larger size, which is shown in the accompanying illustration, has a capacity of five to ten amperes and will charge batteries and operate direct current motors of considerable size from an alternating current circuit.

There are numerous applications which may be made of this corrector in a building where only alternating cur-



ALTERNATING CURRENT CORRECTOR.

rent is to be had. For instance, it may be used for charging storage batteries, to operate small direct current motors, to do electroplating and to produce direct current for physicians and dentists.

### FALLS OF THE ZAMBESI TO PRODUCE ELECTRICITY.

Victoria Falls of the Zambesi River, in Africa, are  $2\frac{1}{2}$  times as high as Niagara Falls and are capable of developing nearly 300,000 horse power. A company has been formed known as the Victoria Falls Power Company, to develop the water power of these falls and to transmit the electrical energy produced, to Johannesburg, 700 miles away. This project, if fulfilled, will mean the construction of one of the longest transmission lines ever attempted.



## A CUT GLASS TELEPHONE.

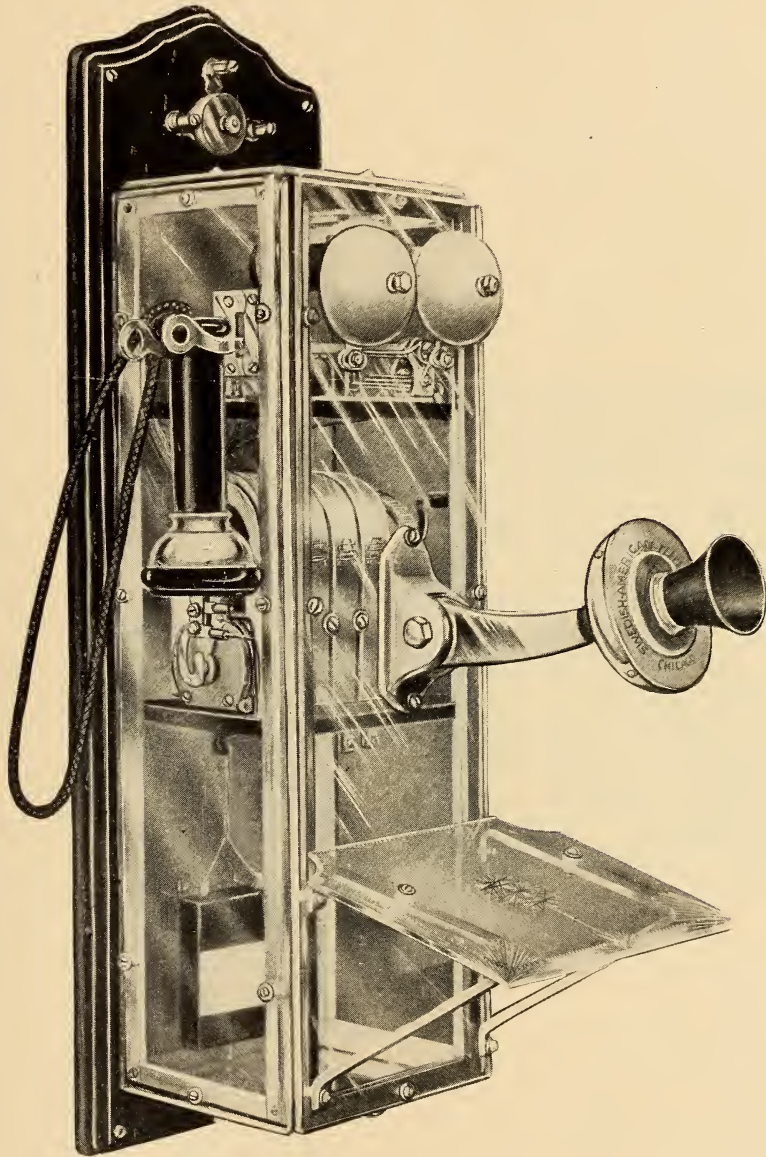

J. M. Plaister, general manager of the Fort Dodge (Iowa) Telephone Company, enjoys the distinction of having the most unique telephone ever made. The accompanying illustration shows the telephone, the case of which is made of plate and cut glass.

It has not been an unusual thing to see telephones made of rare woods, such as mahogany, ebony, birdseye maple, etc., but the production of a glass telephone was something unthought of except by

the originator, a prominent telephone concern in Chicago.

This instrument was constructed not only from a point of beauty, but for the purpose of showing the skill of the workmen, and to show the methods of installing parts and demonstrate the simplicity of construction and accessibility of parts of the instrument. It will be observed by referring to the illustration that all parts are plainly visible without opening the case. The sides and front

of the cabinet are made of beveled French plate glass, fastened by means of machine screws to the nickel-plated frame work. The desk or shelf is also made of plate glass and has a beautiful design cut upon it.

### PHOTOGRAPHY SUPPLEMENTED BY THE ELECTRIC LANTERN

Enthusiastic followers of amateur photography will find their work more interesting and more instructive by taking



WILD ROSE.

advantage of the highly perfected electric lanterns which are now obtainable for projecting their work upon a screen. With the advent of the high power incandescent electric light have come excellent projecting lanterns which may be purchased at exceedingly low prices within the reach of any amateur photographer.

At the end of a season's work a very interesting collection of slides may be made of one's work, and delightful, instructive and entertaining exhibitions may be given in any home where electric current is available. The same lantern may also be used as an enlarging camera, using the ordinary lantern slide negatives for making enlargements upon developing paper up to 18 by 22 inches in size. By using an electric light in making enlargements, it is possible to

obtain a much more even illumination.

It is well for the amateur photographer to lay his plans for the season's work along some special line, for instance, boats and boating, horses, dogs, the flight of birds, etc. Perhaps one of the most interesting and instructive plans of work is that which Mr. C. F. Poppelbaum of Chicago has been following for the last three years, commencing the season's work before the snow is off the ground. Three years ago Mr. Poppelbaum began to collect and make photographs of the wild flowers of Illinois, and thus far has 173 different kinds which he has secured within a 15-mile radius of Chicago, and there are hundreds of others which he hopes to add to his collection this year. Some of the flowers are so tiny and delicate that it was impossible for him to carry them home for the purpose of photographing, and the photographs were made in the woods under the most trying circumstances.

The flower photographs from which the illustrations of this article were reproduced, were made by Mr. Poppel-



BLACK EYED SUSAN.

baum on plates  $3\frac{1}{4} \times 4\frac{1}{4}$ , from which, by contact, lantern slides were made. Where it was possible to do so, the slides were colored while the flowers were still fresh, thereby giving their true color value. These slides are in demand by public schools and colleges



for use in their botanical classes. Most schools are equipped with electricity and by simply attaching wires from the lantern to any lamp socket the pictures may be projected upon the screen at a moment's notice without the danger always present with oil, acetylene or oxy-hydrogen.

In flower photography no special form



TRILLIUM.

of camera is required, any form of focussing camera being suitable. A rising front is essential, but there will be little use for a swing-back. It should be possible to insert the plate holder and withdraw its slide without risk of moving the camera, so care must be taken that this part of the apparatus works easily and smoothly. Isochromatic plates undoubtedly should be employed for flower work, as ordinary plates give incorrect renderings of the color values of flowers. Green foliage and red and yellow flowers come out too dark, while blues are too light. The yellow centers of dog daisies appear as black patches, while the crimson-edged corona of the narcissus is often quite indistinguishable when these flowers are photographed on an ordinary plate. Great improvement in all flower pictures is obtained by using a screen or filter which increases the exposure from four to eight times. Even with white flowers there is a certain blueness in the shadows which is much more satisfactorily rendered by the use of a filter.

## PHOTOGRAPHING

### ELECTRIC EMANATIONS.

Is it possible to take photographs of the invisible and to a certain extent the unknown? The answer of the average man would be in the negative, but Professor Frederick Hovenden says it is not only possible, but is prepared to prove that the invisible not only can be photographed, but that the results can be reproduced by means of the cinematograph.

Professor Hovenden, who is a well known man of science, works upon the following assumptions: Electricity, heat and ether are the same thing, and consist of a "fluid," which, if properly illuminated, will be visible to the naked eye; that it, is possible to make cinematograph or moving pictures of the invisible; that the ordinary human being exhales electricity or ether through the pores of the skin at the tips of the fingers, and that photographs of this electricity can be taken and reproduced by the cinematograph, the electricity being invisible unless specially illuminated.

Most people have rubbed their feet on the carpet and then placing their fingers up to the chandelier and heard and seen the sparks of electricity. But how about the invisible forms of electricity? This is how Professor Hovenden makes photographs of them. He first fills a square glass box, which is technically known as an "analyzer," full of ordinary tobacco smoke from a cigarette, and this is carefully mixed with the air. He then places his finger through a hole in the bottom of the "analyzer," and when the light from a powerful electric arc lamp is turned on, it is said to be quite possible to see the ether—or electricity—issuing from the finger. Prof. Hovenden explains that this electricity comes through minute holes in the top of those ridges of the skin by which identification by finger print impressions is carried out. These minute holes are at times visible to the naked eye when the finger is carefully examined. It is said that the electricity can be seen escaping from the finger even when the latter is covered by a tight fitting india rubber cap.

## DION SYSTEM OF CHANNEL ILLUMINATION.

**O**F all the systems ever devised for marking navigable channels the Dion system of electrical channel illumination is perhaps the most unique.

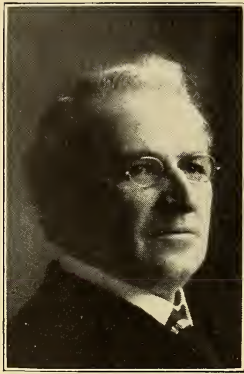

LEON DION.

By its use ships will be able to thread their course through tortuous routes literally through paths of light. Reversing the usual order of things, the light will come up from below and will show as bright spots on the surface of the water. The inventor of this scheme is Mr. Léon Dion of Wilkes-Barre, Pa., and it is said that the patent which he has obtained on

cable or cables laid along the channel, preferably two cables, with one on each side of the course. These cables are of the submarine type and each contains two wires which are connected with a dynamo on the shore. At intervals along the cables wires are tapped in for connection to incandescent lamps. These lamps send their light upward and cast a bright spot on the surface, clearly outlining the channel. One of the illustrations herewith shows the method of arranging the cable and lights at the bottom of the channel. It will be seen that they are at sufficient depth not to offer an obstruction to the passage of smaller craft which do not find it necessary to confine their course to the channel followed by the larger ships.

In the smaller illustration the arrangement of the incandescent lamp is shown. The lamp is enclosed in a water-tight tube which is fitted with a

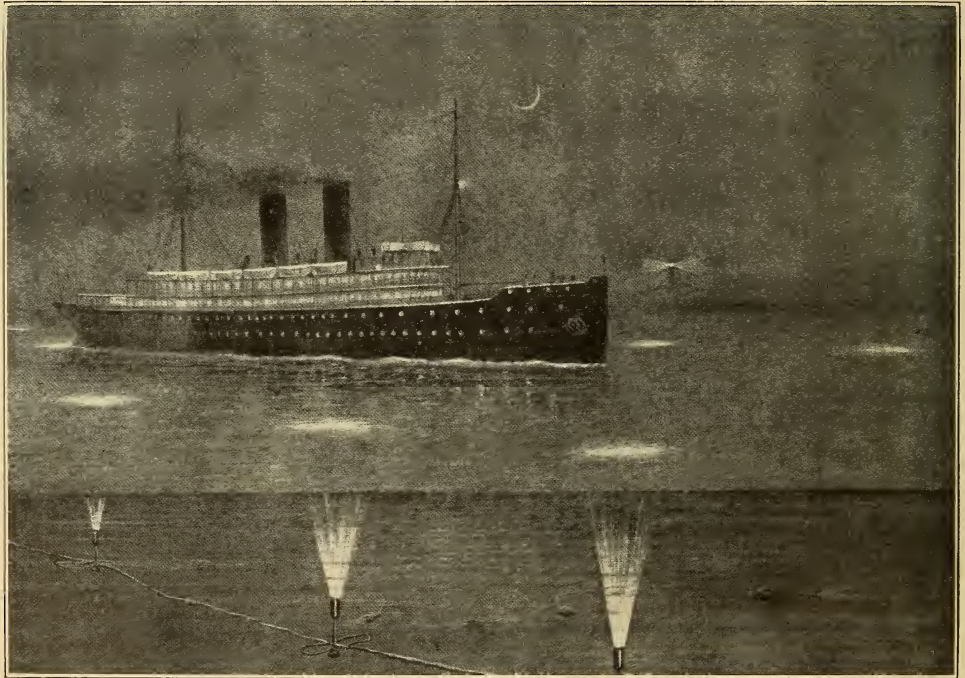

STEAMER GUIDED BY DION LIGHTS.

this system is one of the few absolutely fundamental patents.

The new system consists of an electric

lens in the upper end, the tube acting as a reflector to concentrate the rays over a small area on the surface of the water.



The tube is weighted just enough to overcome its natural buoyancy. These lamps are placed at greater frequency than ordinary buoys, although on a perfectly straight course three to the mile are sufficient.

When replacing burned out globes the cable may be lifted to the surface with a grapple, or else the lamps may be connected to the main cable with connec-

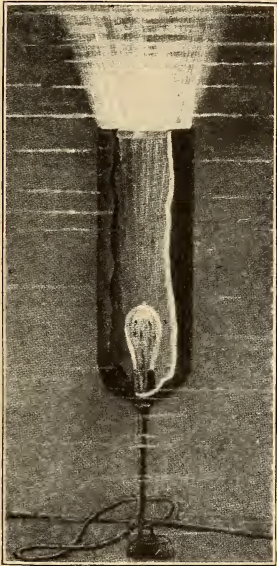

DION LAMP AND REFLECTOR.

tions long enough to enable each tube and lamp to be lifted to the surface without in any way disturbing the main cable.

Besides the advantages of this system which have been outlined above there are several others which may be mentioned. It is not disturbed by the waves on the surface, as the water a few feet below the surface is always practically still.

The lights are also easily distinguished in foggy weather for the reason that the beam of light continues on from the surface of the water through the fog, forming a pillar of light through which ships are guided as were the Israelites of old. This beam is not dispelled by wind, as wind and fog almost never occur at the same time.

Submerged lights would also be of

advantage in the navigation of submarine boats when maneuvering in a harbor. In time of war the lights could be turned off under normal conditions, but could be switched on to admit a friendly craft.

#### ADVANTAGES OF AN ELECTRICAL ENGINEERING EDUCATION.

Charles P. Steinmetz, the noted electrical engineer, recently presented a paper before the American Institute of Electrical Engineers upon the subject of an electrical engineering education, its advantages and the facilities for securing such an education in this country as compared with other countries. In introducing the subject Mr. Steinmetz said:

"In general, the conditions for a good electrical engineering education in the United States are far more favorable than anywhere else; for an electrical engineering industry developed to a higher degree and to a greater magnitude than in any other country offers a very large field of application to the graduate engineer, thus supplying an incentive to enter this profession. Unlike other countries, where some opposition to the college-trained man, as unpractical, still lingers, the electrical industries here prefer, and in many instances demand, a technical college training for their engineering staffs. There is a tendency now to demand this training even for administrative and commercial positions. This leads to a close co-operation between the electrical industry and the engineering college. The leaders of the industry take a close and active interest in technical educational work, while teachers of engineering consider it as their foremost duty closely to follow and keep informed of the advances of the electrical industries, sometimes even are actively engaged in industrial work.

As early as possible the students are introduced to the industry, by visits to factories, inspection trips, etc., which become more and more an important part of the college education. This is as it should be, and probably constitutes the strongest features of American engineering education."

## TEN THOUSAND HORSEPOWER TURBINES AT NIAGARA FALLS.

Among the great power development undertakings which have been completed at Niagara Falls, that of the Niagara Falls Hydraulic Power and Manufacturing Company furnishes an interesting example. In this plant are located four powerful hydraulic turbines of the Samson type which are rated at 10,000 horsepower each, and which work under a head of 220 feet of water. These turbines are each direct connected to two

power house, and from that point it falls vertically through the great steel pipe shown in the picture to the turbines 220 feet below. Each turbine is entirely encased in steel. The water enters from the under side and strikes upon the buckets of the wheel within the case. The bucket wheel is divided into two sections, the water being divided by guides equally between the two sections. The water after leaving the buckets is

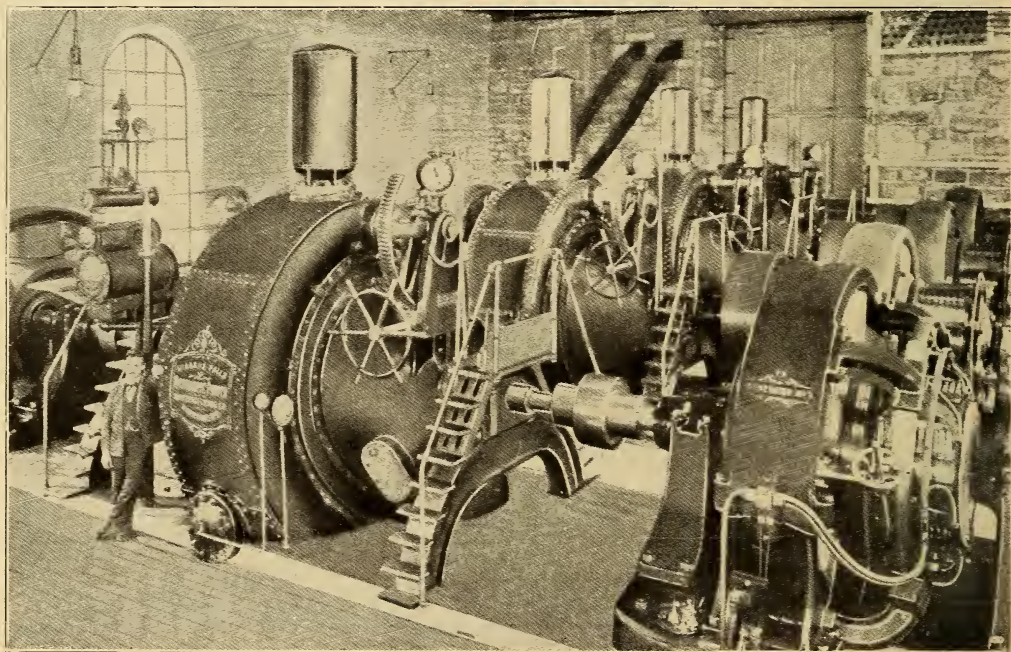

FIG. 1. NIAGARA PLANT THAT DELIVERS 40,000 HORSEPOWER.

electric generators as shown in Fig. 1. The first of the four generator groups furnishes current for two suburban trolley car lines, while the three in the background drive the machinery in the aluminum works of the Pittsburg Reduction Company. Three other turbines of the same type operated by the Hydraulic Power and Manufacturing Company are located in a separate building.

Fig. 2 shows an exterior view of the two plants, the main one being the building on the left at the foot of the cliff. Water is brought from the river above the falls to the top of the cliff above the

finally discharged through a discharge tube in the side of the casing.

The shaft to which the bucket wheel of the turbine is attached extends out horizontally through the casing on both sides, and the two generator shafts are attached to it by means of couplings as shown in Fig. 1. The generators are therefore driven at the same speed as the turbine. As the speed of the generators must be maintained as nearly constant as possible, whether they are heavily or lightly loaded, the turbine is provided with a balanced gate which may be operated by the hand wheel shown in Fig.



1. to increase or decrease the flow of water to the turbine. In this way the speed may be kept practically constant at all loads.

It is interesting to those not familiar with the various designs of hydraulic turbines, to know that in the type above described, power is derived from the water by virtue of its weight, rather than by the force of its impact against the blades. The pipe leading from the water supply at the top of the cliff, and its connection to the casing of the turbine, are water tight, so that the entire weight of the water column 220 feet high bears upon the buckets of the turbine wheel.

incompetent smiths. So electric forges have been devised for use in the mines, which will save much in labor and tools. The electric forges give an even easily regulated heat, and the drills are sharpened right at the point where they are needed.

#### BRANLY'S TELE-MECHANIC.

An apparatus which is of considerable interest has been devised by Dr. Edouard Branly, of Paris, which he calls the "Tele-mechanic." By means of electric waves sent from an operating post he is able to act upon devices which are located at a distant point, and thus has com-

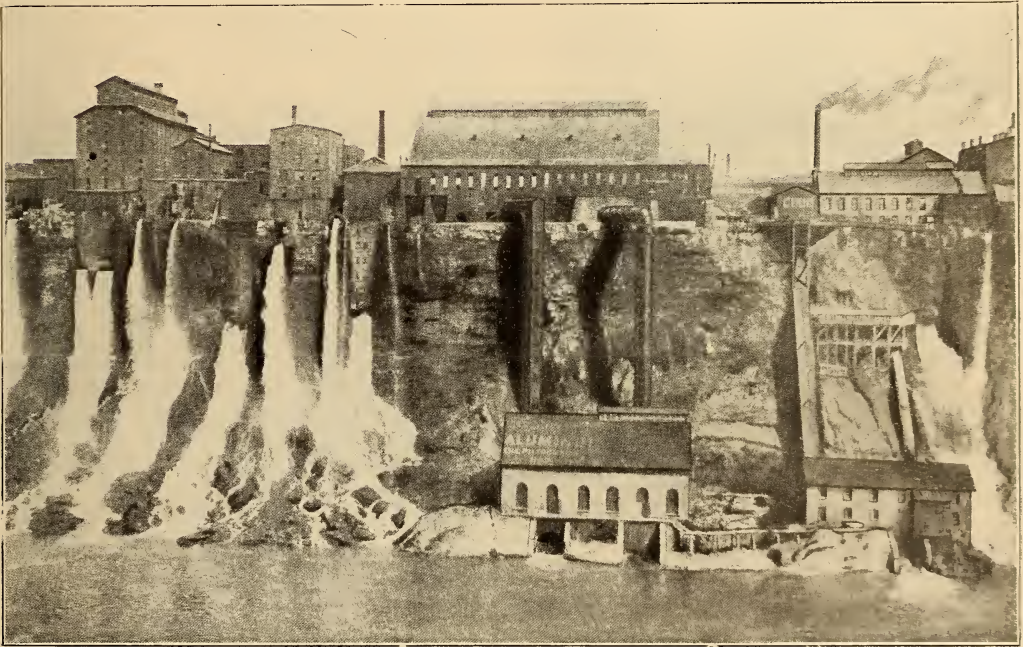

TURBINE PLANTS WORKING UNDER 220 FOOT HEAD.

The pressure exerted by a column of water of this height is nearly 100 pounds per square inch, so it may be readily seen that an enormous turning force is imparted to the bucket wheel.

#### ELECTRIC FORGES IN TRANSVAAL MINE.

Away down in the Village Deep Mine in the Transvaal, S. A., electric forges are daily in operation. It has been found that the best drills, which constantly require sharpening, have been injured by sending them above ground to the tender mercies of more or less

plete control over the latter. In this way he was able to carry out torpedo steering at a distance, and tests which he made in the Mediterranean with this idea were very successful. Among the actions which can be carried out at a distance are the lighting of lamps, starting of motors, firing of mines, and the working of any kind of electromagnetic apparatus. Different kinds of machines can be set in movement to accomplish any desired operation. Thus it will be seen that the apparatus has a practical value.

## DEATH OF DR. S. D. CUSHMAN.

Dr. Sylvanus D. Cushman died at his home in Minneapolis, Minn., on March 1, 1908, at the age of 89 years. His death marks the end of a career which is closely connected with events in the history of telephone development, for Dr. Cushman believed up to the time of his death that he was the rightful inventor of the telephone, and proofs which he presented were so strong that time after time court proceedings were



resorted to, although he was unsuccessful in his efforts to substantiate his claims against the Bell company.

The story of Dr. Cushman's discovery, which is said to have been made twenty years before that of Bell, is very interesting. In 1851 he was engaged in building a telegraph line out of Racine, Wis. While carrying out this work he constructed a device to be used as a lightning arrester. The device was simple, consisting of a box containing two electromagnets connected with the ground and with the telegraph line, a thin sheet of iron being placed near the poles in a position similar to that occupied by the diaphragm of a telephone transmitter and immediately under a hole in the box. Two of these arresters were connected to two different points

on the line, and while examining one of them during a thunderstorm Dr. Cushman was surprised to hear the croak of a frog apparently coming from the box. He immediately went to the other arrester located near a marsh and there sure enough was a large bullfrog which had taken up its quarters near the arrester box. Next day two parties were formed, one at each box, and telegraphic signals were exchanged from one party to the other. Then suddenly someone spoke into one of the boxes and his voice was heard emanating from the other.

Such is the story of Dr. Cushman's "talking box" as he called it. It is said that for many years he used the device only for social entertainments. Then Bell patented his telephone and secured control of the field.

Since that time the matter of the invention of the telephone has been under litigation at intervals almost to the present time, Dr. Cushman endeavoring with the energy and determination which were characteristic of his nature to secure the rights which he believed were his. Many believed with him that he was the true inventor of the telephone.

Dr. Cushman was an intimate friend and associate of S. F. B. Morse, inventor of the telegraph. Although a graduate of two medical colleges he gave up the practice of medicine early in life to follow his inclinations, which were in the line of electrical experiment. He devised a fire alarm and telegraph system, and also devised the cable type of lightning rod.

---

### ELECTRICAL NEWS.

Popular Electricity desires the active co-operation of its readers in securing news regarding things electrical—old things done new ways, new things done old ways—but always electrical. Good prices will be paid for original articles that can be used. Let them be interesting, but short, with good photographs or diagrams. New discoveries and inventions, new installations, handy devices and methods for electrical workers—all these things are interesting. We want electrical news but it must be fresh and to the point.



## BOOK REVIEWS.

**ELECTRICAL INSTALLATIONS OF THE UNITED STATES NAVY.** By Burns T. Walling and Julius Martin. Annapolis: The United States Naval Institute. 1907. 648 pages, with 300 illustrations. Price \$6.00.

This book is a complete manual of the latest approved electrical material as used by the United States navy, including data as to its use, operation, inspection, care and management, and the methods of installation on board ship. As is well known to those who have had to do with navy installations, the rules and requirements relative to the character, methods of installation and operation of electrical apparatus for naval vessels are very strict, and apparatus which will meet these requirements is considered to be the highest of its class. The book under consideration is an excellent manual not only for manufacturers who contemplate bidding on naval specifications but for those connected with the navy in an operating capacity. Some of the subjects taken up by various chapters in the book are as follows: Incandescent lamps; generating sets; inspection of generating sets and motors; interior and exterior communication; wiring appliances, etc., which serve to show the scope of the book. In all there are 15 chapters, each containing information and data which is valuable to any one having to do with the operation of electrical machinery.

**THE BOY ELECTRICIAN.** By Edwin J. Houston, Ph. D. New York: J. B. Lippincott Company. 1907. 326 pages, with 11 illustrations. Price \$1.50.

Any boy that can read this book and not become absorbed in its contents must lack those peculiar elements which go into the make-up of a real live boy. The book is written by a man who, in addition to the multitudinous duties of an active career in the fields of science, invention and teaching, has found time to make a careful study of boy character and at the same time to make thousands of them his intimate friends. "The Boy Electrician" is writ-

ten in a style to arouse the deepest sympathies in a boy's nature and at the same time to create in him a desire to know more of the wonders of electricity. It treats of the adventures of two Philadelphia Grammar School boys, who, in addition to a fondness for baseball, swimming and other athletic exercises, are possessed of a marked liking for the natural sciences. The story is full of fun and adventure and contains descriptions of experiments which may be performed with simple electrical apparatus and intensely interesting applications of electricity which a boy may make in his games and pastimes.

**COPPER TUBE LIGHTNING ROD**

Experts of the Weather Bureau, United States Department of Agriculture, have discovered that lightning prefers to follow a straight conductor rather than a curved or spiral path. Many no doubt will remember the old fashioned lightning rod, which was made of iron and the surface of which was grooved spirally, like an auger. Hollow copper rods have been found to constitute the best path for lightning discharges, even better than solid copper.



A section of the "Ohio" lightning rod shown herewith is a good example of the modern idea. The rod is practically two hollow tubes of copper joined by a web. The sections are made to telescope into each other so that any desired length may be built up. This rod can readily be bent or twisted so as to pass around chimneys, ventilators, etc.

**TELEPHONES ON BARBER CHAIRS.**

Telephones on barber chairs are among the late innovations, the first shop so equipped being in Paterson, N. J. Through the use of the telephone, it is possible for a business man, while being shaved, to hold constant communication with his office. The barber in charge states that he put in the telephones as an experiment, and he has been congratulated by several of his customers, who are unanimous in their opinion that, while the plan is a novel one, it is soon to become popular in other places.



# ELECTRICITY IN THE HOUSEHOLD

## BREAKFAST PREPARED ON THE DINING ROOM TABLE

BY NAN R. MARTIN.

**C**LEANLINESS, safety and ease of control make electricity the ideal medium for cooking. It is instantly available by the simple turning of a switch and almost no heat is radiated from the cooking utensils. Those who began its use as a luxury, possibly, now look upon it as a necessity and would never be reconciled again to coal, gas or oil with their attendant smoke, odor, and soot.

Electric cooking utensils are perfectly safe in every way and are practically indestructible. They are made without solder, and there is no danger of leakage. The heat is derived from heating units or coils which are a part of each piece of apparatus. These heating units are remarkably long-lived, but should necessity require they may readily be replaced at slight expense.

All electric cooking devices are so constructed that the heat is generated directly at the point of application, and is there absorbed by the materials to be cooked. Just enough heat is generated to do the work and no more, and it is for this reason that cooking by electricity does not perceptibly increase the temperature of the room, even on the warmest days of summer.

Electric cooking utensils may be handled like ordinary kitchen utensils. They are designed for practical every-day use and are not injured by overheating. They are made of non-tarnishing polished

aluminum, nickle or silver plate and are ornamental as well as practical for kitchen use.

One of the advantages of an electrical cooking equipment which will appeal to the housewife is the possibility of preparing a dainty breakfast right in the dining room, the utensils used being an electric coffee percolator, chafing dish and bread toaster. These may be placed on the table. Each article is furnished with eight feet of flexible cord, a detachable connector and an attaching plug, which will fit any ordinary lamp socket and is always ready for immediate use. All that is necessary is to take out a lamp and insert the plug, and heat is then immediately available. Five cups of coffee may be made in fifteen minutes, using cold water to start.

The delicious flavor and fragrant aroma of really good coffee depends as much upon the making as on the coffee itself. Many believe that to have good coffee one must buy the most expensive brand. This is not a fact, as a cheaper grade may be used with satisfactory results, owing to the scientific principle upon which the percolator is constructed. Steam generates under a bell valve in the percolator and water and steam are forced up through a tube into a glass globe, which contains the coffee. The lower metal portion of the percolator which fits into the base of the globe is perforated, and the water falls in a fine



spray on the coffee and percolates back into the lower part. By this circulating process the entire strength of the coffee is extracted in the most economical manner, without the harmful ingredients, and a beverage of delicious flavor, and of any desired strength, is produced.

Another good feature of the electric coffee percolator is the fact that it is not necessary to use anything to clear the coffee.

The percolators are made with the

without the inconvenience of gas or alcohol. There are no soldered seams. The inside is sheet copper tinned, and the outside polished sheet aluminum. They are also made in copper, nickel or silver plate, and may be obtained with the stove separate, to which the chafing dish may be clamped by a simple, quick working device which insures perfect heating contact. They may also be used as a double boiler, or single boiler for vegetables, or as a frying pan. In some types a regulat-



heating unit inside the article. The urn and stove are separate, but a clamping device secures them in perfect heating contact.

Possibilities of the chafing dish were never fully realized until electricity was used as a source of heat. These dishes are made with the heating unit inside the article. They develop two degrees of heat, one high and one comparatively low, and consist of a food pan and a blazer. They can be used for preparing many dainty breakfast dishes, as well as luncheons and after-theater suppers,

ing switch beneath the stove gives three degrees of heat, each one steady, even and dependable, an important consideration in good cooking. There are six inch electrical stoves made which fit either chafing dish or percolator, and the stove can be used at any time to keep food warm on the table.

As an auxiliary to the dining room furniture a chafing dish table is very desirable. It makes a convenient stand for the chafing dish, percolator and toaster, and is provided with suitable connections.

One of the most important utensils for the preparation of a breakfast in the dining room is the electrical toaster. It can be used by any member of the family and may be placed on the dining room table in front of the person using it. The toaster may be used for a great variety of purposes such as making toast, warming shredded wheat biscuits, toasting water crackers, etc. These may be eaten while hot, without the necessity of running back and forth from the kitchen.

Following are two dainty dishes which may be prepared with a chafing dish and which, together with toast and coffee, make a very acceptable breakfast.

#### SCRAMBLED EGGS WITH TOMATO.

5 eggs.  
1 cupful of tomatoes.  
Salt and pepper.

Beat the eggs in a bowl long enough to blend the whites and yolks. Add tomatoes drained and chopped quite fine. Salt and pepper. Serve on hot toast and hot plates.

Chopped oysters or ham and bacon in place of tomatoes make an appetizing dish.

#### BLANQUETTE OF CHICKEN.

1 pint cold chicken cut in small squares.  
1 tablespoon butter.  
1 heaping tablespoon flour.  
½ cup white stock.  
Yolks of two eggs.  
½ cup cream.

Parsley, salt, pepper and lemon.

Stir butter into flour before it browns. Add stock, a little lemon juice, white pepper, salt, then cream. Boil at once and add chicken.

Use low heat and simmer eight minutes, then add the eggs, well beaten. Stir in chopped parsley and serve on hot toast.

#### A NOVEL ENTERTAINMENT.

A small company of women can be amused by a cooking contest. Provide enough chafing dishes for half the number present, a "cook" and "helper" being assigned to each one. Each couple brings the material for a dish which can be cooked in fifteen minutes. These dishes are passed around and tried, and to the maker of the best concoction is voted a chafing dish as prize. A club could purchase this by contribution—a second prize being awarded the most efficient "helper." The chafing dishes can be borrowed for the contest. Where electricity is available in the house, electric chafing dishes should be brought, as results may be obtained much more expeditiously.

## COST OF COOKING BY ELECTRICITY.

A determination of the cost to the average family of cooking by electricity is difficult to make because of the scarcity of authentic figures and the varying conditions in different cities and families. The following letter published by the Portland (Oregon) Railway Light and Power Company from one of its customers gives some data on the subject.

The outfit on which the figures were based consisted of the following devices: One oven; one broiler; one eight inch disk stove; one seven inch frying pan; one coffee percolator, 300-watt size; one five inch frying pan; two two-quart combination cookers; one chafing dish; one one-quart water heater.

The average amount of current consumed per day during the test was 2.76 kilowatt-hours, which at five cents per kilowatt-hour amounts to 13.8 cents per day, or \$3.87 for the 28 days of the test.

The first two weeks of the above record there were two in the family. The last two weeks there were three. The cooking was done on the electric outfit exclusively. The cost per person per day was 5½ cents.

In comparing this with gas it was found that the gas bill used to run, for the same service, from \$2 to \$3.50 per month, depending on the time of the year.

The advantages of the electric outfit which would offset the difference in charge, are the cleanliness of the utensils; also the absolute lack of offensive odor during the operation of cooking. The latter reason is one of the strongest points in favor of the use of electricity. Many became nearly nauseated from the offensive odor of the gas and are practically unable to eat after cooking the meal.

An incandescent lamp in its green shade will, when turned upward toward the ceiling, spread a soft and pleasantly diffused light plenty strong enough for a room where no reading is to be done. When the lamp is used in this way no shadows are cast.



## HOUSE CLEANING SIMPLIFIED.

The thoroughness with which electric renovators do their work assures the housekeeper that the dust and dirt will be kept down to a minimum, not only immediately after a spasmodic old-fash-



ioned spring house cleaning, but every day in the year, or whenever the machine is used. In this way, the home is always thoroughly cleaned, and sanitary conditions more fully observed.

The Invincible electric renovator, as described in *The Electric City*, is a machine operated by electricity for nearly all kinds of house cleaning purposes and can be easily handled, deriving its electricity from the nearest electric lighting fixture.

The machine is made in two sizes—one known as the domestic size, and the other as the commercial size. The former is for use in private residences, and the latter better adapted to the requirements of hotels, large apartment buildings, etc.

The commercial machine contains a brush in the carpet sweeping attachment, which is revolved rapidly by the electric motor, which also operates a double fan. The position of the brush is adjusted ac-

ording to the kind of material across which it is to be moved. An important advantage of this machine is the fact that it will take care of paper, matches, cigar stubs, and similar small articles which may be on the floor, depositing them the same as it does the dust and fine dirt in the separator, which is easily removed at any time and the contents disposed of.

As will be seen from the illustrations, the machine has a flexible hose connection, providing for the use of special cleaning tools with which delicate curtains, portieres and tapestries, clothing and similar articles, and upholstered furniture, may be quickly and thoroughly cleansed. By the use of these attachments, out-of-the-way places beyond or-



dinary reach or under and behind heavy furniture, radiators, etc., are easily reached.

### ELECTRIC FAN FOR DRYING CLOTHES.

Those who have electric fans will find them useful in winter as well as in summer. A fan placed near a stove will quickly dry clothes placed in front by blowing a strong current of warm, dry air on them.

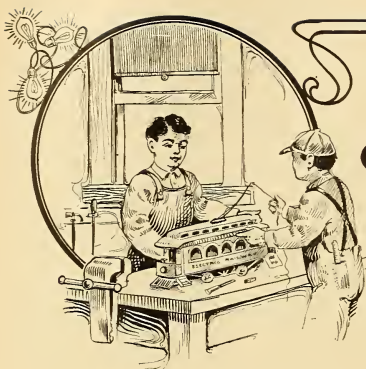

# JUNIOR SECTION

## NEW ELECTRICAL GAME.

No end of fun can be obtained from the Knapp electric questioner, which is the latest electrical game. Each questioner consists of a neat case containing a battery and a small induction coil and buzzer, with circuits connected to a number of metal pins arranged in the body of the case, as shown in the picture. Each outfit includes 12 sets of cards with perforations to fit over the metal pins. There are two sets of 24 pins each, one

and tap the pins which are located over the answers on the right hand side of the card. When the key touches the pin over the correct answer the buzzer sounds a signal and the answer may then be read off.

## ELECTRIC SEARCHLIGHT FOR THE CAMP.

Plans will soon be in order for the summer camping trip and it is a good idea to begin to make a list right now of the little things which help to make camp life pleasant. One of the most useful little electric devices is the pocket searchlight. Most boys have probably owned one of these searchlights at some time or other. But did you ever take one along on a camping trip? Perhaps you are returning to camp through the woods after dark. The searchlight will save you many bruised shins. If you wish to enter the tent quietly without disturbing the other occupants you can do so without stepping on your comrades and bringing down on yourself a storm of shoes, sticks, etc., which always seem to be ready at hand on such occasions.

These searchlights may be obtained at most novelty stores. For a very reasonable price you may secure a very serviceable one with metal case covered with a soft leatherette outer covering. All of the exposed metal parts are heavily nickel-plated. The lamp is actually of two candlepower, but the special reflector and lens make the light a powerful one. The battery will illuminate a light of this kind many thousand times.

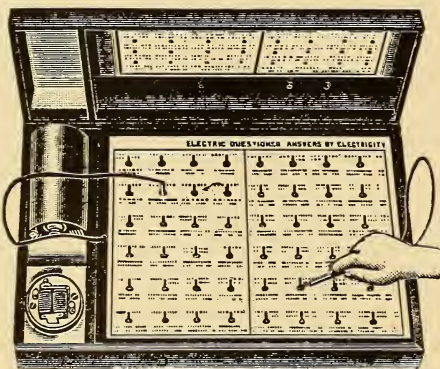

ELECTRIC QUESTIONER.

set on the left side of the box and one set on the right side. The cards as they are fitted over the pins contain 24 questions on the left half and the 24 answers on the right half of the case. It is impossible, however, to know which answer fits which question without the use of the electric battery and buzzer. To operate the questioner proceed as follows: Place the key attached to the left flexible cord on the pin over any question desired. Next take the key attached to the flexible cord on the right



## HOW TO MAKE A MAGNETIC SNAKE.

Very little material is necessary to make a magnetic snake, and a great deal of amusement may be had from this simple device.

First, cut several circles out of heavy cardboard, about three inches in diameter, and glue them firmly together. This will make a disk (A) of sufficient weight for the body of a top. The stem of the top (B) should be made of heavy steel wire, the stem being passed through the center of the circle, which should be reinforced by a small disk in the middle as shown.

The stem should first be magnetized, however, and this may be done as follows: Draw the wire across the marked end of a horseshoe magnet in the direction of its length. Lift the wire from the pole of the magnet several inches and then bring it down again on the same pole, and draw it across as

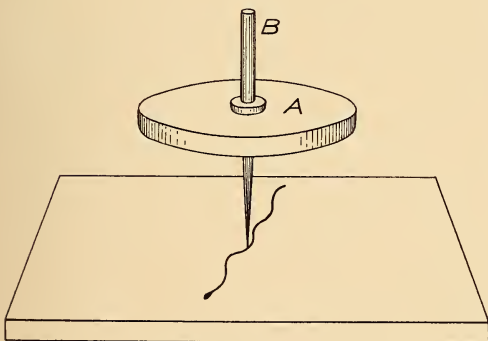

MAGNETIC SNAKE.

before. Repeat this several times and the steel wire will be found to be magnetized. Do not rub the wire back and forth across the magnet.

Having now made the wire a magnet push it through a hole in the center of the disk and the top is complete, ready to be spun with the fingers.

Use a soft iron wire for the snake, bent as shown in the cut. Spin the top in a dent made in a smooth board, and place the snake against the revolving stem. The magnetism in the stem will cause the snake to move about in a peculiar manner.

## ELECTRIC DANCERS.

Take the bottom of a round tin box, making it quite shallow, and in the bottom place several small pieces of carbon, secured by burning a match to a coal

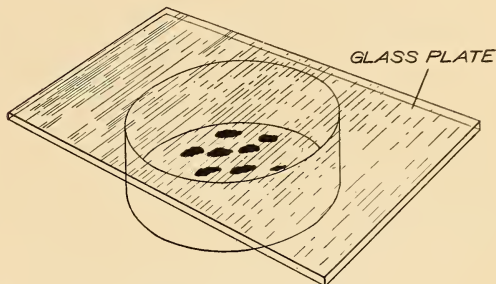

ELECTRIC DANCERS.

and breaking off small pieces of the charred wood.

Over the tin box place a sheet of glass, and rub the glass briskly with a flannel cloth. This rubbing of the glass with wool generates what is known as static electricity, and as soon as the pieces of carbon feel the effects of this electricity they begin to dance a lively jig.

The glass should be thoroughly warmed to remove all moisture from the surface, and the flannel should also be warmed in damp weather.

## A WAY TO ELECTROCUTE FLIES.

A screen for electrocuting flies is easily made and offers a source of much amusement. A device of this description was made by a Chicago man and was found to work admirably. The screen was made with the wires running in one direction connected to one terminal of a small dynamo and the cross wires connected to the other terminal. The two sets of wires were insulated from each other.

When Mr. Fly comes along and lights airily on the screen the fun begins. No sooner does the fly touch the screen and rest with his legs touching the two sets of wires than he stiffens out and is done for. The electrocution is accomplished without pain to the fly, judging from the quickness with which he doubles up. The fly, moreover,

never comes to life after sitting on this improvised electric chair.

Current strong enough to electrocute flies may be barely perceptible to the human touch, and is entirely harmless.

The current from a small toy dynamo would be amply sufficient. These screens might be made up in squares and hung in different parts of a room, and thereby made to serve a useful purpose.

## HOW I BECAME AN ELECTRICAL ENGINEER.

BY AN ELECTRICAL ENGINEER.

WHEN I was a boy living in a town in southern Pennsylvania, the thought came into my head that I would like to know something about the wonderful agent, electricity. There was an old power house in our town, which supplied light to the streets and stores. People in those days did not use electricity in their homes. It was too expensive and they were afraid of it.

Oftentimes I would go to the power house and watch the dynamos grind out the "juice." I would stand and watch and watch those old armatures revolve at a terrific speed. About this time my parents moved to a smaller town some sixty miles distant, and here was a much older station with one boiler, one engine and one dynamo. At this place I secured employment without compensation, and my experience began.

The plant ran from dusk until ten o'clock on Sunday night, twelve o'clock on Saturday night and eleven o'clock every other evening during the week. This was a strange schedule and quite frequently the plant shut down when light was most needed. Something would go wrong. Probably the fireman had fallen asleep and let the steam go down, or perhaps there had been no oil put in the bearings and they had heated. In this instance the engine was shut down and a water hose turned on the heated bearing. When it had cooled we would start the engine again. I remember well, at one time, a small bolt on the governor of the engine struck my elbow while I was oiling the eccentric. The engineer shut down the plant and ran for a doctor, who put four stitches in the wound and placed my arm in a sling. After the operation the plant was again started. Always before the plant was shut down we would blow a whistle, and just before starting the whistle would be blown again, this was to give warning to the

people that something had gone wrong.

I became tired of this irregular work and secured a position out in Ohio in an electrical manufacturing works. My wages were fifteen cents per hour, ten hours per day. Here I was put to dipping armature leads in a pot of hot solder, first the leads were dipped in an acid solution, then in the solder. It was summer time and the intense heat of the solder combined with the heated temperature of the shop was almost beyond endurance. I worked with sleeves rolled up and often with nothing but an undershirt for protection against the heat. However, the acid and heat soon poisoned my hands, face and body. I could not endure this kind of work longer, so was put to dipping armature disks and coils in black insulating paint. Then I was allowed to wind armature and field coils, assemble machines and test them out. On one test I was housed in twenty-four hours without a bite to eat and was as hungry as a bear. Then the shop superintendent came in with one ham sandwich for me. I felt like throwing it in his face and telling him to eat it himself. However, I got "even" with him a few days afterward. We were soldering some armature taps. I started the gasoline torch and "squirting" the gasoline in his eye. He was very angry, cursed me and kicked me out of the shop. I thought surely he would "fire" me, but he didn't.

After spending about a year in this place the thought came to me that I would like to have a technical education, thinking that it would be a help in securing a better position. So I entered an eastern technical school in New York state, where I went through the regular course of study in electrical engineering and graduated with a good standing in my class. While at college I helped myself financially by waiting on tables



in a boarding house and doing other odd jobs wherever I could pick them up. During vacations I was employed as draftsman with various concerns.

After graduation I secured a position as electrical inspector in New York City, this work brought me in contact with all classes of people. Having spent a little over a year in this work it was my good fortune to secure the position of constructing superintendent of an electric light and power plant (water power) in a town of five thousand inhabitants out in Ohio. It was in the spring of the year when I undertook this work. I had plenty of ambition and a stock of "hustleness." Within three months I had the system in complete working order. When the street lighting circuits were put into operation it was a great blessing to me to hear the people cheer and shout. I was retained as manager of the company and have made the business a paying one from the beginning.

My advise to any young man desiring a knowledge of electrical engineering is to first get some experience, then when you enter a good technical school you will find this experience of much benefit. You cannot expect to make a success if you are addicted to intoxicants and other immoral pursuits. Do not expect too much salary after graduation, take fifty dollars a month if it is offered to you. Eventually, by application and thoroughness in your work, you will earn more. At all times be a gentleman.

#### THE TELEPHONE IN NEWSPAPER WORK.

On some of the daily papers in the large cities there are reporters of the regular staff who do not see the office for weeks, or even months, at a time. Their salaries are sent to them by messengers. They receive their assignments by telephone, and after getting their stories they telephone the facts to the office. If the story is a particular "rush" affair the reporter dictates into the receiver to the man in the office, who raps it off on a typewriter. Such a reporter's tolls may amount as high as forty or fifty "calls" a day. Some of the papers have a rule that every reporter must call up the office once every half hour, whether there is any news to be given or not. Thus a city editor may keep

constantly in touch with fifteen or twenty men who are "on assignments" and is able to take a man from a comparatively unimportant assignment and send him "on the jump" to the scene of a "big story."

The telephone is, furthermore, invaluable in a newspaper office in obtaining long-distance news in a hurry. It often beats the telegraph.

---

#### UNCLE SAM'S NAVAL ELECTRICIANS.

Young men who have electrical experience and who love the sea, or young men who are seamen and have electrical inclinations, will find abundant opportunity to follow their inclination by entering the naval electrical school maintained at the New York Navy Yard. The entrance examination is not hard and there are plenty of opportunities ahead. While the boys are studying they will receive full pay and allowances—kit, board, books and material—without cost. They may, too, if they are favorably passed upon, be entered as landsmen. That is to say, they will when competent be placed in charge of, or stationed at, one of the numerous land electrical plants connected with the Navy, be it wireless or otherwise.

If the young sea electrician goes through the full course he will be engaged for twenty-one weeks, learning all about electric whistles, wireless telegraphy, electric searchlights, signaling, electric dinkey engines, machinery for hoisting and operating the big guns and many an unusual thing.

Naval electricians are divided into three classes. When finally passed through the schools in the ordinary way the naval electrician enters the third class and draws \$30 a month with the usual allowances. While a student he gets \$16 a month. As a chief electrician he will draw \$60 a month at the start and the usual allowances with good food and opportunities for a fine experience. Uncle Sam takes good care of his electricians, as there is need of them all the time, and each year this need becomes more and more imperative. The use of electricity on warships is becoming more general, for it is the electrical age in the Navy as elsewhere.

## WIRE FENCES USED FOR TELEPHONING.

W. D. Hornaday describes in the *Western Electrician* a method by which fence wires are extensively used in the West and Southwest by the United States Army Signal Corps. In some localities the fence wires are converted into regular telephone lines from 10 to 30 miles long.

In the military maneuvers that take place in the ranch region, the Signal Corps plays an important part in directing the movement of the troops by these improvised telephones. In some localities, where the country is rough or heavily wooded, it is impossible to

this fence riders are constantly employed.

The equipment consists of a grounding piece and a transmitter and receiver. It is easily carried from place to place, and mounted on horses the Signal Corps is able to rush from place to place, changing the telephone attachment from one fence to another as the necessity of communication demands.

## A SIMPLE INDUCTION MOTOR

The very simplest form of induction motor is constructed as shown in the accompanying illustration. It probably doesn't have more than one fly power, but it is an induction motor for all that.

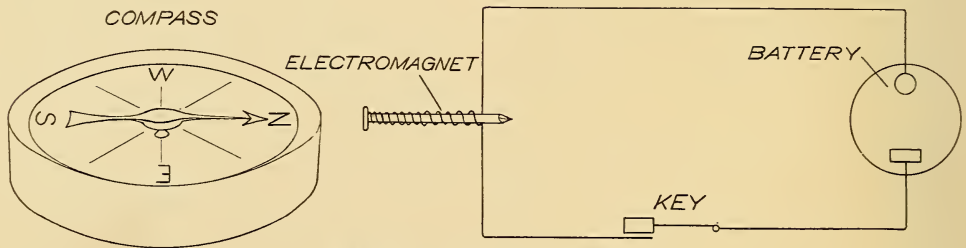

SIMPLE INDUCTION MOTOR.

convey the signals from one point to another by the usual method of flags or other visual signals. It is then that the telephone is brought into play. Each detachment of Signal Corps men is equipped with a field telephone attachment. It requires the work of but a minute or two to connect this attachment with a fence wire and to get in direct communication with headquarters.

The use of the fence wires for telephone communication obviates the necessity of constructing temporary field telephone lines by the Signal Corps. It sometimes happens that a little difficulty is obtained in using the wires on account of some poor connection or break, but it usually does not take long to discover and remove the cause of the trouble. On some of the big ranches straight lines of wire fences 50 to 75 miles long are frequently found, and these afford excellent opportunity for good military field-telephone service. As a matter of necessity, all ranch fences must be kept in good repair. To do

It shows that magnetism has the power to act through space in a very remarkable manner. The materials required are a small compass, a few feet of insulated copper wire, a dry battery, and a wire nail.

Wind a few turns of the insulated wire around the wire nail as shown, taking care not to wind the wire on double, but to simply wind one strand around the nail, allowing the coil thus formed to cover up the other strand. This forms what is known as an electromagnet. Connect one end of the wire to one terminal of the battery and the other end to a simple key. Next run a wire from the key to the other side of the battery. The key is simply a little switch to open and close the circuit suddenly.

Next place the compass at such a distance from the end of the electromagnet that it is barely attracted. Then open and close the circuit regularly by means of the key and the needle will be made to revolve rapidly.



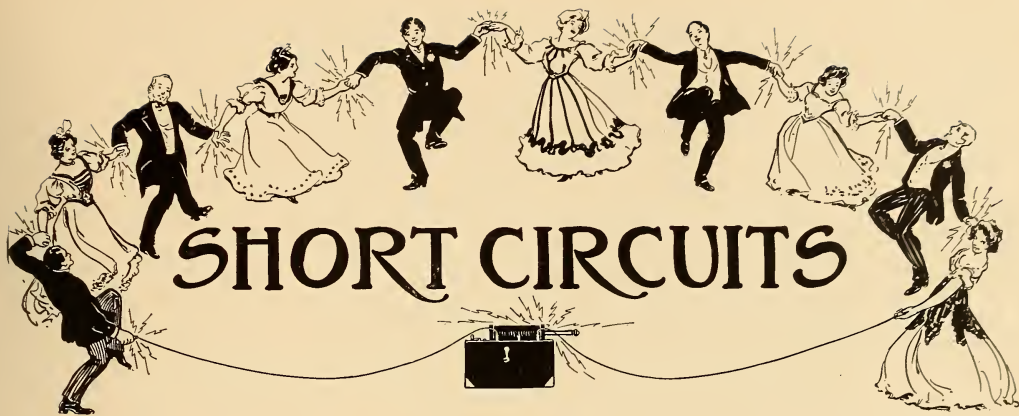

Jakey—Fadder, a shentlemans haf fallen troo de coal-hole!

Isaac—Clap de cover ofer him, ker-vick, mein sohn, vile I runs for a police-mans. Ve must arrest him for tryin' to steal te coals, or he'll sue us for tamages.

Of all the funny sights to be seen on a street car the most interesting is the shopper—the woman, of course. She gets on the car; opens her satchel, takes out a purse, closes the satchel, opens the purse and takes out a dime, closes the purse, open the satchel, puts in the purse, and closes the satchel. The conductor comes along, the lady hands him the dime and receives a nickel in change. She opens the satchel, takes out the purse, closes the satchel, opens the purse, puts the nickel in, closes the purse, opens the satchel, puts the purse in, and then closes the satchel and proceeds to look dignified.—Star Monthly.

Ding, dong, bell,  
Pussy's in the well,  
Who put her in?  
Little Johnny Green.  
Who pulled her out?

The sanitary commission the follow-  
ing summer.

Slow Waiter—Have I ever been in the country, sir? No, sir. Why do you ask?

Tired Customer—I was just thinking how thrilling you'd find it to sit on the fence and watch the tortoises whiz by.—Tit-Bits.

A New York man is about to patent an invention which he expects will make him rich and famous. By pressing an electric button a large sign appears in the kitchen indicator, saying, "You are discharged." In this way the mistress of a home can dismiss her cook and stay quietly locked in her bedroom until that lady has departed.

"Have you movable or immovable property?"

"It's hard to tell."

"How is that?"

"Why, I own an auto."

"Yes," said the Suffragist on the platform, "women have been wronged for ages. They have suffered in a thousand ways."

"There is one way in which they never suffered," said a meek-looking man, standing up in the rear of the hall.

"What way is that?" demanded the Suffragist.

"They have never suffered in silence."

Manager of gas company questioning applicant for meter inspector: "Please understand that this company will not tolerate drinking."

Applicant: "No, sir. I can't drink, sir. One drink always makes me see double."

Manager: "Well—er—you might take just one drink before you start to inspect meters."

## ELECTRICAL DEFINITIONS.

Alternating Current.—That form of electric current the direction of flow of which reverses a given number of times per second.

Ampere.—Unit of current. It is the quantity of electricity which will flow through a resistance of one ohm under a potential of one volt.

Anode.—The positive terminal in a broken metallic circuit; the terminal connected to the carbon plate of a battery.

Armature.—That part of a dynamo or motor which carries the wires that are rotated in the magnetic field.

Circuit.—Conducting path for electric current.

Circuit-breaker.—Apparatus for automatically opening a circuit.

Commutator.—A device for changing the direction of electric currents.

Condenser.—Apparatus for storing up electrostatic charges.

Direct Current.—Current flowing continuously in one direction.

Efficiency.—Relation of work done by a machine to energy absorbed.

Electrode.—Terminal of an open electric circuit.

Electrolysis.—Separation of a chemical compound into its elements by the action of the electric current.

Electromagnet.—A mass of iron which is magnetized by passage of current through a coil of wire wound around the mass but insulated therefrom.

Field of Force.—The space in the neighborhood of an attracting or repelling mass or system.

Fuse.—A short piece of conducting material of low melting point which is inserted in a circuit and which will melt and open the circuit when the current reaches a certain value.

Galvanometer.—Instrument for measuring current strength.

Inductance.—The property of an electric circuit by virtue of which lines of force are developed around it.

Insulator.—Any substance impervious to the passage of electricity.

Kilowatt.—1,000 watts. (See watt.)

Kilowatt-hour.—One thousand watt hours.

Leyden Jar.—Form of static condenser which will store up static electricity.

Motor-generator.—Combined motor and generator for changing alternating to direct current or vice versa.

Multiple.—Term expressing the connection of several pieces of electric apparatus in parallel with each other.

Ohm.—The unit of resistance. It is arbitrarily taken as the resistance of a column of mercury one square millimeter in cross sectional area and 106 centimeters in length.

Poles.—Terminals of an open electric circuit.

Potential.—Voltage.

Relay.—Instrument for opening or closing a local circuit, which is operated by impulses from the main circuit.

Resistance.—The quality of an electrical conductor by virtue of which it opposes the passage of an electric current. The unit of resistance is the ohm.

Series.—Arranged in succession, as opposed to parallel or multiple arrangement.

Shunt.—A by-path in a circuit which is in parallel with the main circuit.

Solenoid.—An electrical conductor wound in a spiral and forming a tube.

Spark-gap.—Space between the two ends of an electrical resonator.

Switch.—Device for opening and closing an electric circuit.

Transformer.—A device for stepping-up or stepping-down alternating current from low to high or high to low voltage, respectively.

Volt.—Unit of electromotive force or potential. It is the electromotive force which, if steadily applied to a conductor whose resistance is one ohm, will produce a current of one ampere.

Voltage.—Potential difference or electromotive force.

Watt.—Unit representing the rate of work of electrical energy. It is the rate of work of one ampere flowing under a potential of one volt. Seven hundred and forty-six watts represent one electrical horse power.

Watt-hour.—Electrical unit of work. Represents work done by one watt expended for one hour.





**O**ld King Cole was a merry Old Soul  
With a cellar list from Beer to Hock  
Yet he chose to think the very best drink  
Was a bottle of cold *White Rock*

Funniest book of the year, "Richard's Poor Almanack," bound and illustrated, sent for 10c. Address, White Rock, Flatiron Building, N. Y.



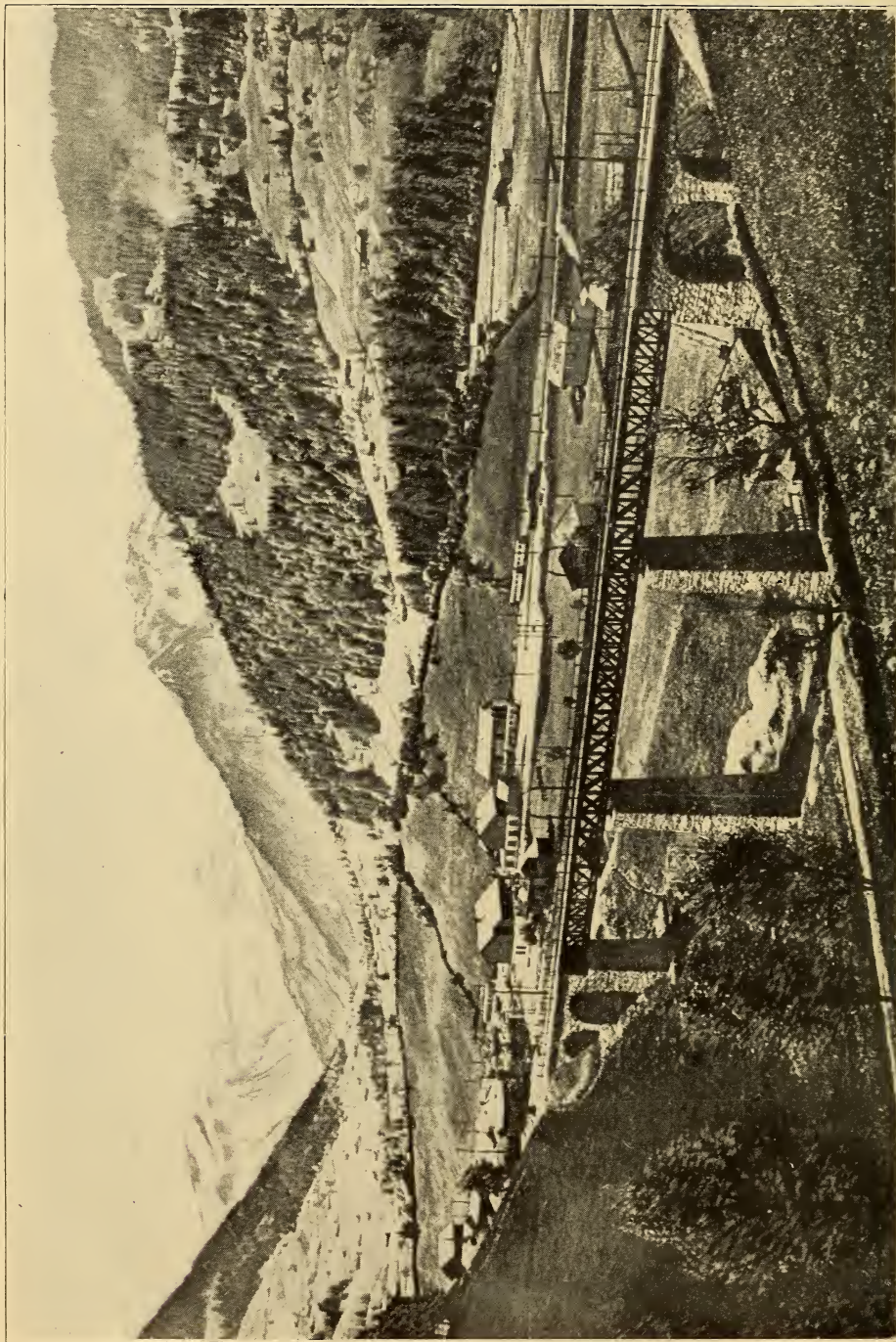

ELECTRIC RAILWAY IN THE SWISS ALPS.