

# POPULAR COMMUNICATIONS

FEBRUARY 1990 \$2.50

\$3.50 CANADA

Incorporating SCAN Magazine The Official Publication of the Scanner Association of North America

## Visit To A Secret Government Radio Station

### Also in this issue:

- Liberia's Radio War
- Monitoring the British Royal Navy
- Skip Scanning Central America
- Making The Best of a Mobile Tuner
- Special Section: World Band Tuning Guide

TRANSMITTER FACILITY  
 REGIONAL COMMUNICATIONS ACTIVITY  
 NATIONAL COMMUNICATIONS SYSTEM

ones, Ham, Nostalgia,  
 ore!

\*\*\*\*\*4\*\*\*\*\*-DIET 07003  
 02 00866331 9005 8202 ADW  
 MICHAEL CLARSON  
 23 BOKAD TERRACE  
 ELOOMFIELD NJ 07003







# YOU EXPECT THE WORLD FROM ICOM RECEIVERS

ICOM's IC-R71A and IC-R7000 are the professional's choice for receiving international broadcasts, aircraft, marine, business, emergency services, television, and government bands. These people demand the finest in communications and so do you. ICOM puts the world at your fingertips with the IC-R7000 25-2000MHz\* and IC-R71A 0.1-30MHz commercial quality scanning receivers.

## Incomparable Frequency Control.

Both the IC-R71A and IC-R7000 feature direct frequency access via their front keypad, main tuning dial, optional infrared remote control and/or computer interface adapter. **Incredible Flexibility!**

## Full Coverage, Maximum Performance.

The superb IC-R71A is your key to worldwide SSB, CW, RTTY, AM and FM (optional) communications plus foreign broadcasts in the 100kHz to 30MHz range. It features IF Notch, low noise mixer circuits and a 100db dynamic range. The pacesetter **IC-R7000** receives today's hot areas of interest, including aircraft, marine, public services, amateur, and satellite transmissions in the 25MHz

to 2000MHz\* range. It includes **all mode operation** low noise circuits plus outstanding sensitivity and selectivity. The IC-R71A/R7000 combination is your window to the world!



The IC-R71A is a shortwave listener's delight. Its **32 tunable memories** store frequency and mode information, and they are single-button reprogrammable **independent of VFO A or VFO B's operations!** Dual width, an adjustable noise blanker, panel selectable RF preamp, and selectable AGC combined with **four scan modes** and all-mode squelch further enhance the IC-R71A's HF reception!

The IC-R7000 features 99 tunable memories and **six scanning modes**. It even scans a band and loads memories 80 to 99 with active frequencies without

operator assistance! Additional features include selectable scan speed pause delays, wide/narrow FM reception and high frequency stability.

**Options.** IC-R7000: RC-12 remote control, EX-310 voice synthesizer, CK-70 DC adapter, MB-12 mobile bracket. IC-R71A: RC-11 remote control, EX-310 voice synthesizer, CK-70 DC adapter, MB-12 mobile bracket, FL-32A 500Hz, FL-63A 250Hz and FL-44A filters.

**See these quality ICOM receivers at your local authorized ICOM dealer today.**

\*Specifications of the IC-R7000 guaranteed from 25-1000MHz and 1260-1300MHz. No coverage from 1000-1025MHz.

ICOM America, Inc., 2380-116th Ave. N.E., Bellevue, WA 98004  
**Customer Service Hotline (206) 454-7619**  
 3150 Premier Drive, Suite 126, Irving, TX 75063 /  
 1777 Phoenix Parkway, Suite 201, Atlanta, GA 30349  
 ICOM CANADA, A Division of ICOM America, Inc.,  
 3071 - #5 Road, Unit 9, Richmond, B.C. V6X 2T4 Canada

All stated specifications are subject to change without notice or obligation. All ICOM radios significantly exceed FCC regulations limiting spurious emissions. Receivers 89

**ICOM**  
 First in Communications

# OPTOELECTRONICS



## You Have Counted on Us for 15 Years

You have counted on OPTOELECTRONICS Hand Held Frequency Counters to be the best quality, to be affordable and reliable. We have been there for you with Frequency Counters that are compact and ultra sensitive.

And more and more of you are counting on us, technicians, engineers, law enforcement officers, private investigators, two-way radio operators, scanner hobbyists, and amateur radio operators, just to name a few.

### Hand Held Series Frequency Counters and Instruments

MODEL	2210	1300H/A	2400H	CCA	CCB
RANGE: FROM TO	10 Hz 2.2 GHz	1 MHz 1.3 GHz	10 MHz 2.4 GHz	10 MHz 550 MHz	10 MHz 1.8 GHz
APPLICATIONS	General Purpose Audio-Microwave	RF	Microwave	Security	Security
PRICE	\$219	\$169	\$189	\$299	\$99
SENSITIVITY					
1 KHz	< 5 mv	NA	NA	NA	NA
100 MHz	< 3 mv	< 1 mv	< 3 mv	< .5 mv	< 5 mv
450 MHz	< 3 mv	< 5 mv	< 3 mv	< 1 mv	< 5 mv
850 MHz	< 3 mv	< 20 mv	< 5 mv	NA	< 5 mv
1.3 GHz	< 7 mv	< 100 mv	< 7 mv	NA	< 10 mv
2.2 GHz	< 30 mv	NA	< 30 mv	NA	< 30 mv

ACCURACY ALL HAVE +/- 1 PPM TCXO TIME BASE.

All counters have 8 digit red .28" LED displays. Aluminum cabinet is 3.9" H x 3.5" x 1". Internal Ni-Cad batteries provide 2-5 hour portable operation with continuous operation from AC line charger/power supply supplied. Model CCB uses a 9 volt alkaline battery. One year parts and labor guarantee. A full line of probes, antennas, and accessories is available. Orders to U.S. and Canada add 5% to total (\$2 min, \$10 max). Florida residents, add 6% sales tax. COD fee \$3. Foreign orders add 15%. MasterCard and VISA accepted.

Orders to U.S. and Canada add 5% to total (\$2 min, \$10 max). Florida residents, add 6% sales tax. COD fee \$3. Foreign orders add 15%. MasterCard and VISA accepted.

### OPTOELECTRONICS INC.

5821 N.E. 14th Avenue • Fort Lauderdale, Florida 33334  
 1-800-327-5912 FL (305) 771-2050 FAX (305) 771-2052



# POPULAR COMMUNICATIONS

FEBRUARY 1990

VOLUME 8, NUMBER 6

Incorporating **SCAN** Magazine

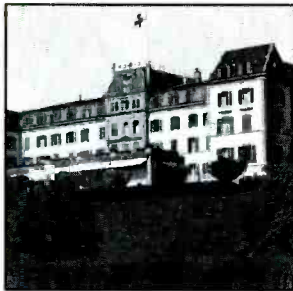

34



53



68



10

## FEATURES

- Scanning Today** 8  
The World Of SCAN. *By Chuck Gysi*
- Liberia's Radio War** 10  
The Liberian Rural Communications Network  
*By Gerry Dexter*
- Scanning Central America** 14  
Shadowy Communications From The Southern Hemisphere Herald Tomorrow's Headlines.  
*By Chuck Robertson*
- Radio's Yesteryear** 16  
Leafing Through The Pages Of History *By Alice Brannigan*
- KKN39: A Magical Mystery Tour** 20  
Not Quite As Resolved As Claimed—We Sent Our Own Investigative Team! *By Havana Moon*
- Books You'll Like** 24  
World Band Radio, Air-Scan and Early Broadcasting  
*By R. L. Slattery*
- The British Royal Navy** 28  
DX'ing This Far-Flung Military Force! *By Patrick O'Connor*
- SCAN Communications** 31  
*By Pete Hanson*
- Making The Best Of A Mobile SWL Antenna** 32  
*By Peter O'Dell*
- Red Cross Broadcasts** 34  
Here's How To Tune Them In. *By Gerry Dexter*

## COLUMNS

- CB Scene . . . . . 36
- You Should Know . . . . . 39
- Satellite View . . . . . 44
- Pirates Den . . . . . 47
- Emergency . . . . . 48
- RTTY . . . . . 50
- Listening Post . . . . . 53
- How I Got Started . . . . . 59
- Clandestine Communications . . . . . 60
- Broadcast DX'ing . . . . . 62
- Ham Column . . . . . 65
- Telephones Enroute . . . . . 66
- Communications Confidential . . . . . 68
- Washington Pulse . . . . . 72

## DEPARTMENTS

- Beaming In . . . . . 4
- Mailbag . . . . . 6
- New Products . . . . . 23
- Shortwave Listings . . . . . 40
- Communications Shop . . . . . 76

*This month's cover: U.S. Army transmitter site, Miami, FL. Photo by Larry Mulvehill.*

## EDITORIAL STAFF

**Tom Kneitel, K2AES / KNY2AB**, Editor  
**George Doobinin**, Associate Editor

## CONTRIBUTING EDITORS

**Gerry L. Dexter**, Shortwave Broadcast  
**Robert Margolis**, RTTY Monitoring  
**Gordon West, WB6NOA**, Emergency  
**Don Schimmel**, Utility Communications  
**Edward Teach**, Alternative Radio  
**Harold A. Ort, Jr.**, Military Consultant  
**Janice Lee**, Radar Detectors  
**Chuck Gysi, N2DUP**, Scanners  
**Havana Moon**, Clandestine Consultant  
**Roger Sterckx**, AM/FM Broadcasts  
**Ed Noll, W3FQJ**, Thoughts and Ideas  
**Donald Dickerson, N9CUE**, Satellites  
**Kirk Kleinschmidt, NT0Z**, Amateur Radio

## BUSINESS STAFF

**Richard A. Ross, K2MGA**, Publisher  
**Donald R. Allen, N9ALK**, Advertising Mgr.  
**Emily Kreutz**, Sales Assistant  
**Dorothy Kehrwieder**, General Manager  
**Frank V. Fuzia**, Controller  
**Catherine Ross**, Circulation Director  
**Melissa Kehrwieder**, Data Processing  
**Kathleen Bell**, Customer Service

## PRODUCTION STAFF

**Elizabeth Ryan**, Art Director  
**Barbara Terzo**, Artist  
**Dorothy Kehrwieder**, Production Manager  
**Emily Kreutz**, Production  
**Pat Le Blanc**, Phototypographer  
**Florence V. Martin**, Phototypographer  
**Hal Keith**, Technical Illustrator  
**Larry Mulvehill, WB2ZPI**, Photographer

A publication of



CQ Communications, Inc.  
76 North Broadway  
Hicksville, NY 11801-2953 USA.

Offices: 76 North Broadway, Hicksville, NY 11801. Telephone 516 681-2922. FAX (516) 681-2926. Popular Communications (ISSN 0733-3315) is published monthly by CQ Communications, Inc. Second class postage paid at Hicksville, NY and additional offices. Subscription prices: Domestic—one year \$18.00, two years \$35.00, three years \$52.00. Canada/Mexico—one year \$20.00, two years \$39.00, three years \$58.00. Foreign—one year \$22.00, two years \$43.00, three years \$64.00. Foreign Air Mail—one year \$75.00, two years \$149.00, three years \$223.00. Entire contents copyright ©1990 by CQ Communications, Inc. Popular Communications assumes no responsibility for unsolicited manuscripts, photographs, or drawings. Allow six weeks for change of address or delivery of first issue. Printed in the United States of America.  
Postmaster: Please send change of address to Popular Communications, 76 North Broadway, Hicksville, NY 11801.

# UNIVERSAL SHORTWAVE

Monitor More With Advanced Equipment From Universal!

## COMMUNICATIONS RECEIVERS

### □ Japan Radio NRD-525



For the communications connoisseur. Covers .1-34 MHz. Incredible performance and features. In stock. \$1179.95 (+\$12 UPS)

### □ Kenwood R-5000

A powerful receiver for the serious DXer. An exceptional value. \$849.95 (+\$11 UPS)

### □ Kenwood R-2000

Many features: mems., scan, sweep, FM mode, 24 hr. clock etc. \$649.95 (+\$10 UPS)

### □ Icom R-71A

A well-respected time-tested performer. Notch, 2 VFOs, keypad. \$849.95 (+\$9 UPS)

### □ Yaesu FRG-8800

Beautiful LCD display, keypad, memories and more. \$689.95 (+\$9 UPS)

## PORTABLE RECEIVERS

### □ Sangean ATS-803A



Keypad, memories, BFO, clock, RF gain, etc. A strong performer and unbeatable value. \$189.95 (+\$5 UPS)

### □ Sony ICF-2010

Super high performance and features. VHF air too. \$359.95 (+\$5 UPS)

### □ Magnavox D2935

A highly rated low cost fully loaded portable for every budget. \$189.95 (+\$5 UPS)

### □ Grundig Satellit 500

Hi-tech with beautiful fidelity and style. Synchronous tuning. \$499.00 (+\$5 UPS)

Note: Radios listed above are all LW-MW-SW-FM digital. Contact us for other models

## SPECIAL RECEIVERS

### □ Icom R-9000



Solid all-mode coverage from .1 to 1999.8 MHz. Multi-function CRT with spectrum analyzer. The ultimate receiver! \$4795.00 (+\$28 UPS)

### □ Sony CRF-V21



This LW/MW/SW/FM visual receiver has an LCD screen for spectrum analysis, memory and data display. Built-in decoder-printer for FAX and RTTY reception. \$4795.00 (+\$15 UPS)

## MULTI-MODE CONVERTERS

### □ Universal M-7000



The Universal M-7000 will permit you to intercept and decode Morse code, various forms of RTTY, FDM and FAX. Simple connections to your receiver and video monitor will enable you to monitor with the most sophisticated surveillance decoder available. No computer is required. See the world of shortwave excitement you have been missing. Requires 115/230 AC 50/60 Hz. Starting at \$999.00. Please write for full details.

- ◆ Morse Code (CW)
- ◆ Regular Baudot RTTY
- ◆ Variable Speed Baudot
- ◆ Bit Inverted Baudot
- ◆ ASCII Low & High Speed
- ◆ Sitor Mode A (ARQ)
- ◆ Sitor Mode B (FEC)
- ◆ ARQ 2&4 chan. (TDM)
- ◆ ARQ-E and ARQ-E3
- ◆ VFT Modes (FDM)
- ◆ Russian 3rd Shift Cyrillic
- ◆ Facsimile (FAX) AM/FM
- ◆ Packet 300 & 1200 AX.25
- ◆ Remote Terminal
- ◆ Literal & Databit Modes
- ◆ Variable & Standard Shift
- ◆ Automatic Tuning
- ◆ Diversity Reception

## MULTI-MODE CONVERTERS

### □ Universal M-900



Here is a compact, easy to use decoder that copies all the most important shortwave transmission modes. The M-900 covers Morse code for monitoring hams, ships and coastal stations. Baudot RTTY is included for decoding weather and international press broadcasts. Both Sitor A and Sitor B are supported for monitoring the extensive maritime and diplomatic traffic. Facsimile (to the printer only) lets you receive maps and pictures from around the world. Requires 12 VDC @.8A Text output to video monitor. \$499.95 (+\$8)

- ◆ Morse Code (CW)
- ◆ Regular Baudot RTTY
- ◆ Sitor Mode A (ARQ)
- ◆ Sitor Mode B (FEC)
- ◆ Facsimile (FAX) FM
- ◆ Variable & Standard Shift

M-900 System Components  
A complete M-900 system would require:

- ▶ Universal M-900
  - ▶ 12 VDC Power Supply
  - ▶ Your SW Receiver
  - ▶ Video Monitor
  - ▶ Parallel Printer
  - ▶ Cables for above
- Please write to Universal for full information on the M-900 and the above optional items. Full system prices are available.

## COMMUNICATIONS BOOKS

□ **Passport To Worldband Radio 1990 Ed.**  
By L. Magne. Graphic presentation of all SWBC stations. Reviews too. New! ..... \$14.95

□ **Shortwave Receivers Past & Present**  
By F. Osterman. Your guide to 200 receivers with new-used value, specs, features. .... \$6.95

□ **Aeronautical Communications Handbook**  
By R. Evans. A mammoth book on all aspects of shortwave aero listening. 266 pages. ... \$19.95

□ **Complete SWL's Handbook Third Edition**  
By Bennett, Helms, Hardy. Nearly 300 pages on all aspects of SWL'ing. .... \$16.95

□ **Guide To Facsimile Stations**  
By J. Klingenfuss. The complete guide to FAX with freqs., schedules and addresses. ... \$17.95

□ **Shortwave Listening With The Experts**  
By G. Dexter. Over 500 pages and 25 chapters of in-depth info. on all aspects of DXing. \$19.95

□ **Soviet Maritime RTTY Dictionary**  
By G. Gorka & F. Osterman. Find, decode and understand Russian radioteletype. .... \$11.95  
✓ Please add \$1 per title for shipping.

## SHORTWAVE LISTENER CATALOG

Universal offers a huge 52 page shortwave catalog covering all types of monitoring equipment including receivers, antennas plus RTTY and FAX equipment. All major brands are represented including Kenwood, Icom, Yaesu, JRC, AEA, MFJ, Sony, Grundig, Sangean and Magnavox. Plus an unbeatable selection of books, parts and accessories. Big 8½" by 11" format.

★ Available for \$1 postpaid ★

## STORE HOURS

Monday - Friday 10:00-5:30  
Except Thursday 10:00-8:00  
Saturday 10:00-3:00

• We ship worldwide  
• Visa, MC, Discover  
• Prices & specs. are  
subject to change.

• In business since 1942!  
• Used equip.  
list available

## Universal Shortwave Radio

1280 Aida Drive Dept. PC  
Reynoldsburg, Ohio 43068 U.S.A.  
Ohio: 614 866-4267 Toll Free: 800 431-3939



## *E.T. — Leave Your Message At The Tone!*

For many years it seemed that UFO's were mainly interested in dropping in on the United States. Hollywood's epics going back to the 1950's *War of the Worlds*, *Day The Earth Stood Still*, *This Island Earth*, *Invaders From Mars* and many others seemed to reinforce this notion. With few exceptions, the U.S. has remained their primary landing zone for decades. By 1977's *Close Encounters Of The Third Kind*, the tricky aliens had shown up so often that they figured out how to gain admission to a National Monument without paying the admission fee.

It was therefore a welcome change to learn from British press reports that mysterious circular marks were showing up all over the landscape there, and that popular opinion was that they had been caused by UFO landings. Not to be outdone by the British, the UFO's landed in daylight in a Soviet park. Large aliens then emerged, took a stroll, fired off a couple of disintegrating beams at local residents, and then departed.

Strangely, the renewed interest in UFO's caused POP'COMM to begin receiving phone calls, letters, and FAX messages in a steady stream that still continues. Lots of people are apparently quite certain that I'll be able to give them at least several frequencies they can tune to monitor the communications from the reported alien space vehicles. As if I could look it up in *Passport To World Band Radio*, *WRTVH*, or somewhere and rattle off a string of frequencies.

Let's assume that the British ground markings weren't caused by environmental, or other natural factors, and that the Soviet reports aren't the result of someone at Pravda losing it. Maybe there really are current visitations from space aliens, and maybe the rumors are true that our own government has hidden away the wreckage of a UFO that crashed in the 1940's. I've got an open mind on the topic, but some questions relating to the possible communications aspects still bug me the most.

If science fiction is actually science fact, I wonder why we are so utterly confident that any of the communications systems in use are compatible with our receivers and scanners. If UFO's exist and are interstellar visitors, it's obvious that the principles of space travel, flight, and knowledge of physics and metallurgy are radically different than and far exceed any concepts even remotely comprehended by our civilization. Communications systems used are just as likely to be wholly different and far more advanced.

They could be based upon principles of natural magnetism, gravity, X-rays, gamma rays, cosmic rays, or are in some spectrum or dimension we haven't yet discovered.

Fact is, our own civilization is using the communications spectrum all the way past 500 GHz and, despite all the reported visual sightings of UFO's, it's odd that nobody (including the most zealous UFO buffs) has reported hearing any radio communications from the craft, nor has suggested any frequencies in use. Neither have we heard any encouraging words from radio astronomers who are assiduously checking a myriad of frequencies for possible signals from other civilizations. You'd certainly think that if such communications were taking place right here under our noses, somebody would have picked up *something*. But not a peep's been heard from any of the alien vehicles that might be operating from here, nor from their home bases that might be beaming signals towards their space ships on missions to Earth.

To think that such craft actually exist, and have communications that nobody has ever reported could lead you to the conclusion that we aren't tuned to the right frequencies, or in the right mode, or we don't recognize what we're hearing as alien communications, or else there are other types of spectrums or anti-spectrums that we don't even know about.

It would seem that there are probably millions of intelligent civilizations elsewhere in the universe. A reasonable percentage of them would have to be far older and more advanced than ours. It doesn't surprise me that we don't have radio receivers that can monitor their communications. Some say that their spacecraft have been visiting this planet since ancient times, yet our own technology for listening has been evolving from scratch for less than one hundred years.

We see how far our technology has come in only the last fifty years. Consider the possibilities that during this period, we might have been visited by several different civilizations. Every one of them may have regarded our communications methods as being so obscure, crude, and primitive that they study us as humans ponder the sounds made by porpoises, whales, elephants, and baboons.

Mail from the more esoteric branch of the readership is convinced that alien communications are probably more along what we would regard as telepathic lines rather than being high-tech contrivances. There is, of

course, some debate in the world of science as to the existence of telepathy, and whether it can be deliberately sent or received (by humans) with or without external aids.

In August of 1984, we ran a story about a telepathic transmitter called the *God Box* that someone was selling. Supposedly it put you in contact with Heavenly authorities. In April of 1985, we told you about the Hieonymous Machine (U.S. Patent 2,482,773) that sent out psychic power even when it was turned off. In another issue we told you about the *Spiricam* and other communications equipment claimed to enable two-way communications with persons formerly alive.

Then, in July of 1987, we told you about *Timothy Green Beckley's Book of Space Contacts*, which stated flat out that alien space visitors had been contacted numerous times by means of a *Teslascope*. Although the book didn't give any frequencies, it did provide plans for building a *Teslascope*. The device is apparently a telepathic communicator supposedly designed by Nikola Tesla (whom the author claimed was actually a visitor from Venus).

Obviously, there's a lot to be heard in the psychic band, if only we could figure out where it was. Thanks to one of our intrepid authors, this question may have been resolved. The other day, Chuck Robertson passed along a copy of an ad from some "new age" type of publication. It seems to confirm that this is still a valid approach, and that a piece of modern hardware is known as the *E.L.F. generator*, which a company in Dayton is selling for \$285.

Robertson describes it as "outlandish," although the manufacturer claims it will "electronically amplify your telepathic communications." My interpretation of that description is that it's a linear amplifier for your cranium. *But wait!* The manufacturer advises it's for "serious psychics only," then cautions that it's "for experimental use only." They don't spell out the trouble one can get into with this machine if it's misused, but you can use your own imagination as to the ghastly results.

Whatever it is or does, the kernel of valuable information they let slip out in the ad was the operating frequency—so get set to copy it down for future reference and to settle any barroom bets that might arise. They reveal that the unit operates in "the PROVEN psychic brain frequency range of 7.83 to

*(Continued on page 78)*





# EEB THE NATION'S #1 SWL SUPPLIER

## ORDERS 800-368-3270



**NEW**

### ICOM R9000 THE ULTIMATE RECEIVER

- 100 kHz to 2000 MHz
- CRT Multi-Function Display
- Spectrum Slope  $\pm 100$  kHz
- 1000 Memories-10 Banks of 100
- 4 Antenna Inputs
- Watch ICOM Ads for Detailed Specifications
- Suggested List \$5495 Call for Quote



CRIS Compatible

**NEW**

#### PANASONIC RFB 65-SSB



\$259.95

Top of the Line Portable Now with CW/SSB • 155-30 MHz  
• 36 Memories • Keyboard Entry  
RFB40 \$189.95 RFB20 \$119.95  
RFB10 \$89.95

**NEW**

#### SANGEAN ATS-808



PLL-All Band LW-MW-SW-FM  
• 45 Memory Keyboard Entry  
• Compact Size FM Stereo with Headset

Introductory Priced \$229.95

**NEW**

#### SONY ICF SW20



Compact AM-FM 7 SW Bands  
• Shirt Pocket Size (Replaces ILF4920)  
Price \$99.95 + \$5 UPS

**NEW**

#### GRUNDIG 500



• Synchro Detection • All Band All Mode • Superb Audio  
• Keyboard Entry  
Introductory Priced \$499.00 + \$5 UPS

**FREE**

**1989 Catalog.**  
**Get All The Details.**  
**36 Pages.**  
**FREE in USA.**  
**Canada \$1.00.**  
**All Others \$3.00.**

### ICOM

R71A-This is our best seller. ICOM R71A has all the features one expects in a world class receiver. All mode AM, SSB, CW, RTTY, FM (OPT). Complete coverage. 1 to 30 MHz. 3 Filter positions, direct keyboard entry. 32 memory channels, PLL tuning in 10 Hz steps for exact frequency. Many ICOM options plus EEB high performance package. (CALL)  
CRIS Compatible ICR71A \$849.00 + \$12 UPS



R7000-There is nothing to compare with the R7000 under \$12,000. This is the most sophisticated V/UHF receiver ever offered to the public. No wonder it's our best selling V/UHF receiver. All mode AM, SSB, CW, FM, FMN-25 to 2000 MHz (20 kHz to 2 GHz w/NOVEX FC7100), direct keyboard entry. 99 memory channels, many ICOM options plus EEB options and high performance package deal. (CALL)  
CRIS Compatible ICR7000 \$1019.00 + \$12 UPS

### JRC-NRD525

A high-class, general coverage receiver with expandability looking to the future. The NRD-525 will change your shack into a new universe! 0.09 MHz to 34 MHz. Pass band shift. 200 memories. Direct keyboard entry. AM, FM, CW, SSB, RTTY, SSB. Notch filter. V/UHF converter option. Filter options.  
CRIS Compatible NRD525 \$1179.00 + \$12 UPS



### KENWOOD

The KENWOOD R5000 is the new high performance receiver from the leader in communications technology. 150 kHz to 30 MHz. 100 memories. Keyboard entry. AM, FM, USB/LSB, CW, FSK. VHF 108-174 Opt VC20.  
\$849.95 + \$10 UPS



The KENWOOD R2000 150 kHz to 30 MHz. 10 memories. AM, FM, SSB, CW. VHF 118-174 MHz opt VC10.  
R2000 \$649.95 + \$10 UPS

### YAESU

FRG800 offers functionality and operating convenience for the serious shortwave listener. 150 kHz to 29.999 MHz. Direct keyboard entry. Dual Clocks/Timers. Wide/Narrow Filter. 12 Memories. AM, SSB, CW, FM. VHF 118-174 MHz option \$119.95. FRG800 \$699.95 + \$10 UPS



FRG900 VHF/UHF General Coverage Receiver. 60-905 MHz 100 Memories. FRG900 \$559.95 + \$6 UPS

### GRUNDIG

The Satellit 650 International is the ultimate in German crafted portable radios. Excellent audio. 510 kHz to 29.999 MHz. 24 hour clock/calendar. 3 Bandwidths. 60 Memories. AM, FM, SSB, CW. Keyboard Entry. PLL Control. Nicad Battery Option.  
New Low Price \$849.00 + \$12 UPS



The Satellit 400, with its rounded corners and smooth lines is the obvious "style leader" in personal portables, covers all shortwave bands plus MW and FM. 24 Memories. Keyboard Entry.  
New Low Price \$319.95

### SANGEAN

ATS803A. So much HITECH in one package, a super value. Covers all SW Bands. Tunes. 150-30 MHz + FM 88-108. 9 Memories Auto Scan. Keyboard Entry. Stereo w/Headset or Line output. AC Adapter Included.  
ATS803A \$199.95 + \$4 UPS



SG789. Slightly larger than SONY ICF 4920 same coverage plus stereo w/headset. SG789 \$89.95 + \$4 UPS

MS101. All new mini set similar to Panasonic RFB10. 9 Band, AM, FM, 7SW, stereo w/headset MS101 \$79.95 + \$4 UPS

MS103. Same as MS101, 9 SW Bands. MS103 \$99.95 + \$4 UPS

### CLOSE-CUT

JIL SX 400 Close Out Save \$300. 26-500 MHz (.1-1300 MHz w/opt. call) Digital keyboard - Readout memory scan 13.8 VDC. Much More Call. SX400 List \$695 while they last \$399 - \$6 UPS

### SONY-THE ONE AND ONLY

ICF2010 is the market leader of portables, our best selling portable. Full coverage. 15 to 30 MHz, FM 76-108 MHz, Air Band 116-136 MHz. AM, FM, CW, SSB. Sync Detection. 32 Memories. Keyboard Entry. Many Features.  
ICF2010 \$369.95 + \$6 UPS



ICFSW1S. The newest in miniaturization only 2 3/4" x 4 3/4". Tests show it as best of sub-compact case, active antenna, world AC Power Pack, Phone, SWL Book, Travel with the "SYSTEM" or just the Radio, Complete coverage to 30 MHz FM 88-108. Keyboard Entry. LCD Readout/Clock.  
ICFSW1S \$319.95 + \$4 UPS

ICF2003 delivers most performance of all portables in the mid-size class. 15-30 MHz. AM, CW, SSB 76-108 MHz FM. 10 Memories. Keyboard Entry. Paperback book size. Optional AC Adapter.  
ICF2003 \$279.95 + \$4 UPS

PRO80 locks like a scanner • Covers 15-108 MHz + 115-223 MHz with supplied converter • Multi-Mode AM-FM-CW-SSB • 10 Memories • 4AA Power Opt Nicad EAC Adapter.  
PRO80 \$399.95 + \$4 UPS

### MAGNAVOX

D2999. 146-30 MHz FM 88-108. Keyboard entry. 16 Memories. Multi-mode AM, CW, SSB, FM, Scan. 12/24 Hour clock.  
D2999 \$299.95 + \$6 UPS



D2935 ..... Discontinued

D1875 ..... \$79.95 + \$6 UPS

### ANTENNAS

DATONG AD370 HF. 1-30 MHz outdoor active, rated #1 by IBS. AD370 \$149.95 + \$4 UPS

SONY AN1. HF. 1-30 MHz outdoor active. Our #1 seller for 3 years. AN1 \$84.95 + \$6 UPS

EAVESDROPPER. Outdoor passive trapped dipole. 9 SW Bands. 43 ft. long. 100 ft. lead. Everything you need. Best Seller SWL \$59.95 + \$4 UPS

ALPHA DELTA SLOPER DXSWL \$89.95 + \$5 UPS

### NOVEX NEW PRODUCTS

CRIS8000. Computer Radio Interface System. The ultimate HITECH computer (IBM PC) system for control, logging, scanning, spectrum analysis. Using most current radios. Free CRIS Newsletter (CALL).  
CRIS6000. \$749.00 + \$8 UPS

RACKMOUNT. Novex RM Series Rackmount hardware for most popular radios ICOM, KENWOOD, YAESU receivers and transceivers.  
Prices from \$79.95 + \$5 UPS



ELECTRONIC EQUIPMENT BANK  
516A MILL STREET NE  
VIENNA, VA 22180

ORDERS: 800-368-3270  
LOCAL TECH: 703-938-3350  
FAX: 703-938-6911

- PRICES SUBJECT TO CHANGE
- PRICES DO NOT INCLUDE FREIGHT
- SORRY, NO CODs
- RETURNS SUBJECT TO 15% RESTOCK FEE



# MAILBAG

## LETTERS TO THE EDITOR

Each month we select representative reader letters for our Mailbag column. We reserve the right to condense lengthy letters for space reasons. All letters submitted for consideration must be signed and show a return address. Upon request, we will withhold sender's name should the letter be used in Mailbag. Address letters to Tom Kneitel, Editor, Popular Communications Magazine, 76 North Broadway, Hicksville, NY 11801.

### Radio's Role Acknowledged

Coach Paul "Bear" Bryant's favorite saying was "When the going gets tough, the tough get going!"

AM Clear Channel Radio and ham and shortwave really showed their necessity when Hurricane Hugo came calling on the south eastern seaboard. In the absence of electricity and adequate telecommunications links and no cable TV, high power, Clear Channel AM Radio, also, Ham links and networks was a source of vital, life-saving information, and great comfort to millions of citizens scared and displaced by this killer storm.

Strong high power AM stations such as WSB, Atlanta, WSM, WLAC, Nashville, WPDQ, Jacksonville, WWL, New Orleans, WLS, WGN, WMAQ, Chicago, KDKA Pittsburg, WABC, New York, WLW, Cincinnati, WBT, Charlotte, WHO, Des Moines, WJR, Detroit, KMOX, Saint Louis, and many others joined in. This impressive cadre of stations emanating from outside the affected area forged a vital emergency communications link between the outside world with remaining victims, evacuated residents, and distant loved ones by broadcasting from the scene phone reports, and fast breaking national hurricane center information of the storms progress. This live drama included actual eyewitness reports of roofs blowing off, flying boats and cars, and chilling live broadcasts of the powerful wind noise of Hugo himself. Transmitted at the speed of light direct to millions of concerned listeners around the country.

This demonstration under duress shows AM radio at her "highest and best use," serving the public by interlocking wide coverage areas with battery radio equipped listeners, all pulled together with a common bond of surviving the ravages of a natural disaster.

All of the radio stations, and dedicated broadcasters, Hams, and interactive listeners, that participated in this mass communications effort deserve a "Gold Commendation" and should be recognized as true "COMMUNICATIONS HEROES."

AM Radio, LW, MW, SW, shows her public necessity every day in every city on earth! FM Radio can only dream of such ubiquitous utilitarian purpose . . .

H. Dickson Norman,  
NDXE GLOBAL RADIO  
Opelika, Alabama

### His Just Deserts

An area radio station has morning sports-trivia call-in games daily. It's run several times a day, with the questions being asked by the traffic reporter in his helicopter. About five minutes before each contest, the studio calls the traffic reporter on the UHF two-way radio and feeds him the question and the correct answer. The first listener to call in with the answer to each question is awarded a free dinner at a local diner. I've been wrestling with my conscience as to the ethics of calling in the answers that I've heard on the two-way, especially when it doesn't appear that anybody has guessed the answer. What do you think?

H. R. Willson,  
New York

*If the guilt doesn't get you first, then certainly a few of those free blue plate specials will show you the error of your ways. — Editor*

### A Question Of Frequency

A nearby store that sells mostly outdoor activity supplies recently began displaying 2-watt handheld transceivers for \$280 a pair. The salesman told me that the units are available for one of three different channels, have a range of up to three miles, and that no FCC license is required for their operation. He said that they're ideal for campers, hunters, hikers, and other people whose activities take them into wilderness areas. What I want to know is, what frequencies would such non-licensed equipment use? Can I pick these frequencies up on my scanner?

Ted Bertieux,  
Westbrook, ME

*Your description and pricing information leads me to believe that these aren't units that operate in the 49 MHz "no license" band. My guess is that they're probably the same units that an RV store in my own area is offering with the same general features and for about the same price. The three operating frequencies involved are 151.625, 154.57, and 154.60 MHz, and you certainly can pick them up on your scanner. You do need an FCC license to operate on any of these Business Radio Service frequencies, but I wouldn't take bets on the percentage of campers, hikers, or hunters who bother with that little formality. Nevertheless, packed in the carton with each transceiver is an FCC li-*

*cense form and instructions for using same. Why the FCC requires licenses for these flea-powered communications devices is a mystery. The chances of anybody operating one and then getting caught and hassled seems practically nil, which is why the salesman gave out the misinformation about not needing a license. Obtaining the license is so simple, it's just as easy to apply for the license as it is not to. Renewing it at the end of the license term, however, is a nuisance. — Editor*

### Not As Risky As 5 Card Stud

POP'COMM frequently makes reference to QSL's, which I have come to understand are cards that one receives from broadcasters and some other stations in return for sending a reception report. Bear with me, for I'm still rather new to the listening hobby, but I haven't fully grasped the point of gathering these QSL's, although it may be tied in with being able to tell other listeners how many different stations or countries you have heard. You could do that without the QSL's, couldn't you? If I told you that I monitored 175 countries, would it be necessary for me to display these QSL's in order to be believed. If not, then couldn't I just say any number of stations or nations?

Buck DeLorenzo,  
Pawtucket, RI

*You're delving into sacred territory here, Buck, and many heavy traditions are involved. Although books about the why's and wherefore's of QSL's and QSL'ing have been written, you've probably given it an interesting summation from the point of view of someone who's gathered a few facts but isn't familiar with most of the traditions and finer points of the QSL art. Some clubs issue awards based upon monitoring achievements as provable by the QSL's the applicant has presented, or has claimed and would be willing to present upon demand. Most listeners, however, simply seek QSL's for the sheer enjoyment of collecting them and for no other reason. I suppose that a person could falsely claim DX achievements to others and few would think to challenge the claims, unless they seemed totally outrageous. But, what would be the point? I might add that over the years there have been a few well known DX'ers who got caught falsifying reception reports in order to obtain rare QSL's from obscure stations. When news of such events circulated through the hobby grapevine, it served only to get these people ostracized. Cheating at the QSL game may not be as serious as cheating at poker, but it's definitely worse than lying about the giant fish that fell off the hook just as you were reeling it in. — Editor*

PC





# The Know-It-All Radio

## Affordable Realistic Desktop Scanner

This easy-to-use know-it-all lets you hear what's happening around town: police and fire calls, ambulances, trains, Ham radio, weather service and more. Realistic PRO-57 is a compact 10-channel scanner that gives you keyboard access to over 22,000 frequencies—and you never have to buy crystals.

The PRO-57 has scan delay to prevent missed replies and lockouts so you can temporarily bypass unwanted channels. Frequency coverage is 30-54, 138-174 and 380-512 MHz.

A detachable indoor antenna is included and there's a jack for adding an external antenna. PRO-57 offers high sensitivity and outstanding audio quality in a fit-anywhere 2 x 8 x 7" package. Only \$139.95

## World-Class Quality, First-Class Service

PRO-57 is backed by our 1-Year Limited Warranty. The optional Tandy® Service Plan extends warranty coverage to five years for \$39.95—just pennies a month!

Try out this value-packed scanner now at one of the 7000 Radio Shack locations.

Price applies at participating Radio Shack stores and dealers

**REALISTIC**® Exclusively at **Radio Shack**®  
The Technology Store<sup>SM</sup>

A DIVISION OF TANDY CORPORATION

CIRCLE 130 ON READER SERVICE CARD

One of the most frequent questions we get in the mail here at SCAN is how do I find out what frequency such-and-such company uses or how do I find out where to find frequencies used by a certain type of user (park rangers, for instance). It doesn't take a whole lot to become a frequency sleuth if you have the proper materials available at your monitoring post to tune in those elusive signals across the bands.

First of all, you need to have an understanding that radio frequencies are divided up and assigned by types of users and are known as radio services. For instance, cab companies generally operate in the taxi radio service. Likewise, police usually operate in the police radio service. Take note that I've said "usually" in these two examples; we'll get into this a bit later here.

In the taxi radio service, frequencies are available in the 152, 157, 452 and 457 MHz ranges. However, there's an even more definitive breakdown in that base stations only operate in the 152 and 452 MHz bands while only mobiles can operate on the 157 and 457 MHz bands. Presumably, the Federal Communications Commission made this stipulation many years ago in setting up the taxicab radio service to prohibit car drivers from talking back and forth over their radios. Only the dispatcher can hear the cabs and the cabs can only hear the dispatcher in this type of set-up.

While the taxicab radio service has its own frequencies set aside for radio usage, there are other places a cab company may pop up in the frequency spectrum. In the nation's top metropolitan areas, there are additional cab frequencies in what is called T-band, 470-512 MHz. Cabs also can operate in the 800 MHz band, and even are eligible to set up their own paging operations in the 929 MHz band. But as you may well know, that's not the only place cabs may show up on the air.

While most types of commercial or non-commercial services may qualify to be licensed in the radio service that best identifies its type of operation, they also may be qualified to operate in other radio services as well. For instance, while a cab company would be eligible to license itself in the taxicab radio service, it also would be able to license itself in the business radio service because it would be able to prove it is a for-profit type of operation. So when searching out a local cab company's unknown frequency, the scanner operator must keep in mind that in addition to searching the taxicab radio service frequencies, he or she also might want to check all available business radio service frequencies as well.

Some other instances of users being eligible for licensing in more than one radio service include for-profit ambulance services that can license themselves on special emergency radio service frequencies as well as business radio service frequencies; police departments that can license themselves on police frequencies or the catch-all local government radio service (which can support any governmental function except on the federal level); newspapers operating in either the relay press radio service or business band; and school buses operating either in the special emergency radio service or business band. In fact, in some rare instances, a town or county will take out a local government license in its name and allow a local school district to use it for its functions. However, FCC rules do not allow school districts to license themselves in the local government radio services.

What places can you come up with accurate lists of what frequencies can be used by who? The one listing most scanner operators use is in the back of *Police Call*, which is available at all Radio Shack stores. The guide gives a listing in the back by frequency telling what radio service is allocated to what frequency. For instance, if you look up 154.515, the listing will tell you that the frequency is used for business. Likewise, a look at 155.265 will tell you that special emergency radio service eligibles can use that frequency. However, if you want a more detailed look at who can use what frequency, under what circumstances and what limitations are placed on a frequency, there is no better source than the FCC rules.

In most cities, the federal government operates government book stores under the auspices of the Government Printing Office. If you live in a metropolitan area, check the federal government listings for the nearest big city for the office nearest you. In these bookstores, FCC rules can be purchased. They usually are referred to as CFR—or Code of Federal Regulations. The federal rules governing the FCC are found under Title 47. It is under this title that you'll find several volumes regarding FCC regulations. However, the one of most interest to the scanner hobbyist is Part 90 of Title 47. Part 90 deals with the private land mobile services, or the two-way radio services that one would normally tune in on a scanner.

In these rules, you'll find not only lists of frequencies, but also what makes one eligible to apply in a given radio service. For instance, to apply in the automobile emergency radio service, an applicant basically must operate a service either on a private or public basis to assist disabled vehicles. If you read further in the rules, you find out that certain frequencies are reserved for use by auto clubs and cannot be used by for-profit tow trucks. In another radio service, the special emergency radio service, you'll learn in the rules that the following types of operations may apply for licenses: medical services, rescue organizations, physically handicapped individuals, veterinarians, disaster-relief organizations, school buses, beach patrols, communications for isolated areas, communications standby facilities and emergency repair of public communications facilities. That's a real mouthful! However, by reading the rules, you'll learn about the various types of allowable operations. And I'll bet you didn't know physically handicapped persons could license themselves on frequencies also used by ambulances, rescue squads, veterinarians and lifeguards.

If you have trouble locating a copy of Title 47's Part 90, you may want to check your local library. Many larger libraries, such as county libraries, will carry a copy of the various CFR's. The library also can advise you how to get in touch with the U.S. Government Printing Office so you can purchase your own copy of the rules. The rules also can be purchased on microfiche and several other organizations, such as frequency coordinators in the various radio services, also make available for sale the FCC rules. One publisher of FCC rule books is the National Association of Business and Educational Radio (NABER), which coordinates frequencies in the business radio service. They can be reached at (703) 739-0300.

### Letters

Howard Katz of South Easton, Massachusetts, asks about using CB or 2-meter amateur mobile antennas for scanner use and whether they'd work as well as specialized broadband scanner antennas. First of all, the best antenna for a scanner is a scanner antenna. Most scanner antennas will cover all the popular bands of VHF low and high bands as well as UHF. Some of the newer mobile scanner antennas also will cover up as high as 1000 MHz. If you're listening to each of the different bands on your mobile scanner, then you probably should use a scanner antenna that will give somewhat equal performance on each band. However, if most of your listening is on VHF low band (30-50 MHz), you might find that a CB antenna, which is tuned for 27 MHz, might give the best performance for the lower frequencies. Likewise, if most of your listening is 150-174 MHz, then a 2-meter amateur mobile antenna, which is designed for 144-148 MHz, would give the best coverage for the one band.

SCAN members are invited to send in their questions about scanning. We also invite your frequency updates to be mentioned in this column, as well as news clippings about how scanners are put to good use in the community. We're also interested in hearing about any proposed laws that might infringe on the rights of scanner listeners. Write to: Chuck Gysi, N2DUP, SCAN Editor, P.O. Box 414, Western Springs, IL 60558-0414.



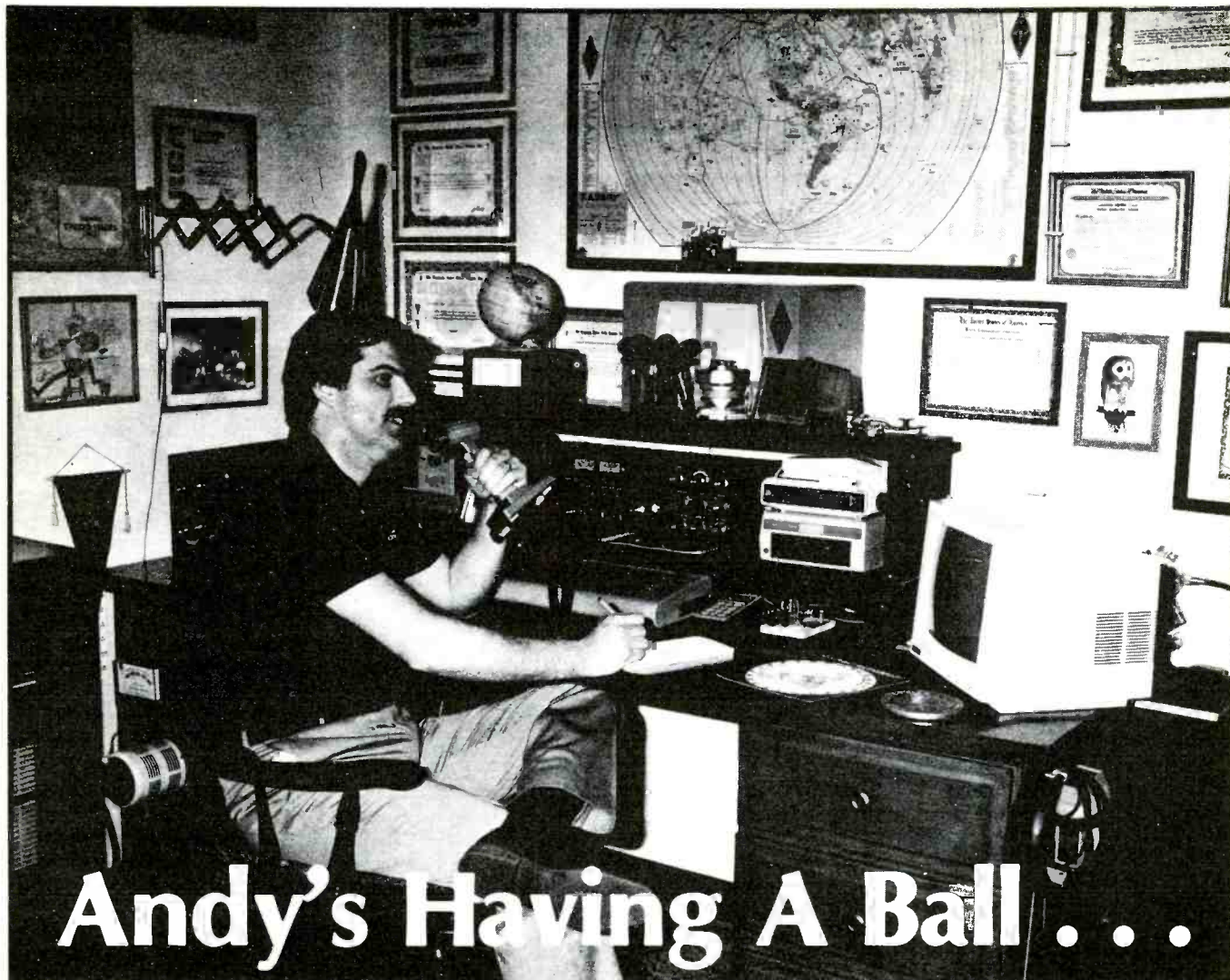

# Andy's Having A Ball . . .

## and you can too!

Andy is a Ham Radio operator and he's having the time of his life talking to new and old friends in this country and around the world.

You can do it too! Join Andy as he communicates with the world. Enjoy the many unique and exclusive amateur bands . . . the millions of frequencies that Hams are allowed to use. Choose the frequency and time of day that are just right to talk to anywhere you wish. Only Amateur Radio operators get this kind of freedom of choice. And if it's friends you're looking to meet and talk

with, Amateur Radio is the hobby for you. The world is waiting for you.

If you'd like to be part of the fun . . . if you'd like to feel the excitement . . . we can help you. We've got all the information you'll need to get your Ham license. Let us help you join more than a million other Hams around the world and here at home. Who are we? We're the American Radio Relay League, a non-profit representative organization of Amateur Radio operators.

For information on becoming a Ham operator  
circle number 11 on the reader service card or write to:

**AMERICAN RADIO RELAY LEAGUE**

Dept CQ, 225 Main Street  
Newington, Conn. 06111.

# Liberia's Radio War

## The Liberian Rural Communications Network

BY WILLIAM E. MACKIE, Ph.D.

(For two years Dr. Mackie headed the team of American advisers attached to LRCN.)

In the pre-dawn hours of November 12, 1985, a small group of soldiers moves quickly toward Liberia's national radio station, ELBC, in the outskirts of Monrovia, the small West African nation's capital city. The group is led by General Thomas Quiwonkpa, a former commander of Liberia's army who fled to the U.S. in 1963 after a failed attempt to unseat Head of State Samuel K. Doe.

Quiwonkpa's army consists of a small group of disgruntled Liberians who have become disillusioned with Doe's leadership and a few mercenaries recruited in neighboring Ivory Coast and Sierra Leone. Each recruit has been promised \$100,000 and schooling in the United States.

Widespread complaints that Doe rigged the long-awaited national election held in October have persuaded Quiwonkpa that the time has come to act. The rebels believe the Liberian people are fed up with Doe's excesses and official corruption and will welcome the coup.

Just after 6:00 a.m. the rebels burst into the ELBC studios and order a startled duty announcer to play a tape proclaiming that the Doe government has been overthrown.

The announcer, fear and anxiety evident in his voice, gives a brief introduction: "Stand by for a . . . urgent message."

"Fellow citizens," the tape begins, "this is General Thomas Q. Quiwonkpa. The patriotic forces under our command have seized power. Our forces have completely surrounded the city. Samuel Doe is in hiding . . . there is no escape for him."

The tape is repeated frequently during the morning, interspersed with martial music. For the benefit of rural Liberians who speak "Liberian English," and ELBC announcer broadcasts a "translation" of the Quiwonkpa message, including a warning to avoid involvement in the conflict.

"Do not go and humbug anybody, that what they say. So, OK, from 6:00 o'clock in the morning to 6:00 o'clock the other day they want everybody to stay home. No trouble . . . we here at the radio station will tell you whatsoever they want for us to tell you that finished taking place."

By noon President Doe takes to the air to counterattack. He hurries to ELWA, a missionary radio station not in rebel hands, to announce that he is still in power. ELWA is located only a few miles from ELBC, which continues broadcasting the rebel's victory message. Puzzled Liberian's tune from station to station, trying to decide which report is correct.

Displaying more optimism than the evidence seems to warrant at this stage, President Doe says, "The situation is well under control. My forces are now going to take over ELBS [the Liberian Broadcasting System of which ELBC is a part] and the rest of the stations in the country."

After fierce fighting, ELBC falls to the government soldiers and Doe is once again in control of the airwaves and the country. Three days later Quiwonkpa is killed at the ELWA Junction, on the road connecting the two radio stations which played so important a part in Liberia's "radio war."

While bullets were flying at the national radio station compound, a group of Liberians and Americans nervously awaited the outcome with special concern. They were the staff and U.S. advisers of the Liberian Rural Communications Network (LRCN), whose new headquarters building, nearing completion and soon to be occupied, was only a few yards from ELBC, the center of a battle zone.

An anxious inspection when the fighting ended revealed only minor damage to the new LRCN building—a ruined air conditioning compressor, some shattered glass bricks in a large hallway window and numerous pock marks from bullets. The battle had taken a toll, but the debut of LRCN would not be seriously delayed. The headquarters building was completed without further incident, three rural stations were built and the network began regular broadcasting in August, 1986.

Some Liberian and U.S. officials were surprised that Doe allowed LRCN to come into existence because of the security risks arising from having radio stations in areas far from the capital. As Doe had just been reminded, broadcasting facilities are a prime target of anyone seeking to gain control of a government. There is also a risk that independently programmed radio stations, such as those operated by LRCN, could be used for private political purposes and subversion.

Why then was Doe willing to let LRCN's three radio stations operate far from the watchful eyes and ears of the central government in Monrovia? He may have thought that the limited range of the stations would make them less attractive to aspiring revolutionaries than the more powerful national radio station in Monrovia. In addition, Doe's political organization is represented by a County Superintendent in each town where the stations are located, which provides a means of monitoring what is being said on LRCN. The stations occasionally have been reprimanded by the Superintendents for



LRCN headquarters in Monrovia, scene of a battle between Government of Liberia and rebel soldiers in a 1985 coup attempt. The antennas on the roof are part of the independent sideband (ISB) studio-transmitter link.





*A producer in one of LRCN's Monrovia studios prepares a tape for relay to the rural stations via the ISB transmitter. The control board and a rack for cartridge tapes is on the left.*



*A LRCN producer edits a program on a custom-built system used for editing, auditioning and dubbing.*

over-zealous reporting of incidents embarrassing to the central government, but by and large, there has been little political interference from the Doe government.

A final reason for the Liberian government's willingness to experiment with local radio may be the sincere belief that potential social and economic benefits for the country's neglected rural dwellers make LRCN worth the risk. In fact, at the network's inauguration ceremony in August 1986, President Doe promised that his government would do "everything possible" to guarantee LRCN's survival.

LRCN, a joint project of the Government of Liberia and the United States Agency for International Development (USAID), was conceived as a means of encouraging development in Liberia's long-neglected rural

areas through the use of local radio. Planning for LRCN began in the late 1970's and continued in spite of the 1980 coup that brought Samuel Doe to power and the serious decline in the country's economy which followed.

LRCN's facilities consists of a headquarters and central production unit in Monrovia and three 10 kW mediumwave stations in the towns of Voinjama (585 kHz), Gbarnga (558 kHz) and Zwedru (1260 kHz). The network recently installed 2.5 kW backup transmitters at each site.

Daytime coverage of the stations is 30-50 miles (.05 mv) but increased dramatically at night. Engineers report that poor ground conductivity limits coverage, particularly at the Zwedru site in southwestern Liberia.

The stations are not connected by two-

way broadcast links, but the Central Production Unit at the Monrovia headquarters of LRCN sends programs for broadcast by the rural stations via a 10 kW independent sideband transmitter (ISB).

The rural stations broadcast in 13 indigenous languages and English and produce most of their own programs locally. While many broadcasts focus on development themes—the stations provide a well-rounded mix of news, information and entertainment. LRCN's operating costs are met by grants from the Liberian government and the sale of air time to public service clients and a few commercial advertisers.

The six-hour broadcast day is divided into morning and evening blocks of approximately three hours each. Producers were recruited from the coverage area of each



*Station ELRG in Gbarnga. Offices, studios and transmitter are housed in a single building. The generator building is on the left.*

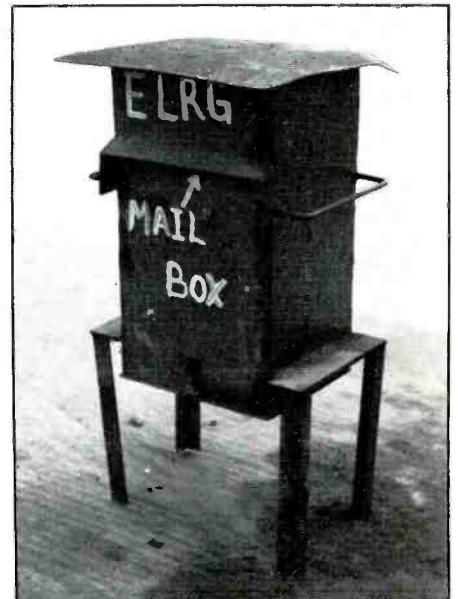

*The stations have placed mailboxes in nearby town so listeners can send letters and music requests. The letters are delivered to the stations by taxi and bus drivers.*

station and were given two years of production training before the network began broadcasting. LRCN's staff totals about ninety.

By all indications, LRCN has made a major impact on rural Liberia. A survey made after the first year of broadcasting revealed very high listenership and substantial gains in knowledge relating to development. The stations are extremely popular with listeners, as demonstrated by audience research as well as the number of people who visit the stations, volunteer their time and write letters to the network.

The Institute for International Research of Arlington, VA, managed the project for USAID until the end of U.S. participation in March 1989. IIR personnel helped plan the network, assisted with training and worked alongside the Liberian staff during the early years of broadcasting. IIR recruited advisers to work in Liberia from educational broadcasting institutions in the U.S. and other countries, radio stations and universities.

A number of short-term consultants advised in special areas such as finance, promotion and fund raising, radio drama, music production, health education and agricultural broadcasting. More than a dozen U.S. Peace Corps volunteers have worked with LRCN since its inception.

The three rural stations are basically identical in design. The production areas are built with double cement block walls for soundproofing. Two control rooms allow si-

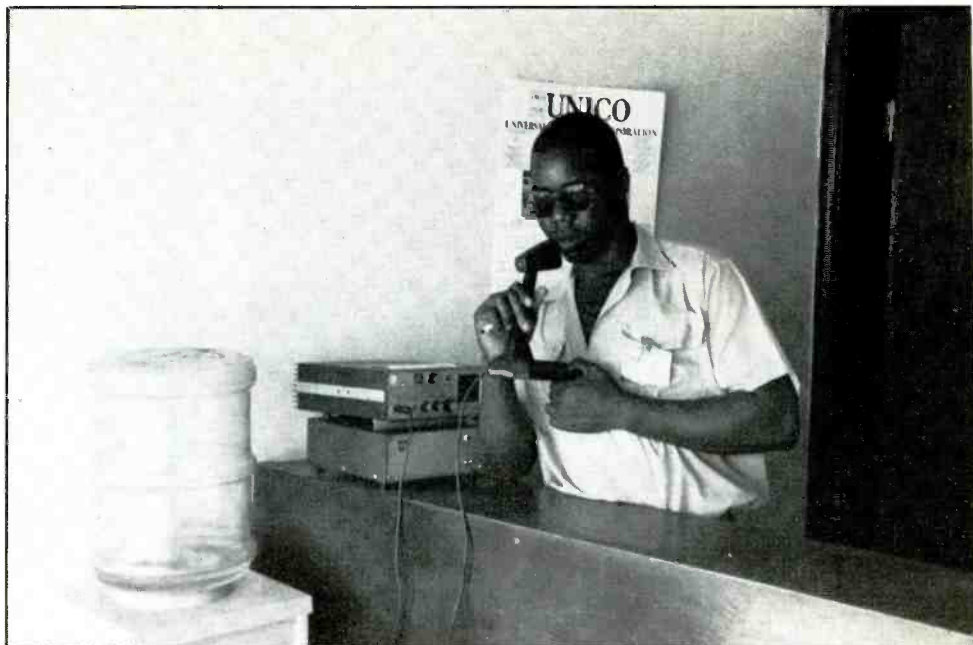

The three rural stations communicate with each other and headquarters via 100 watt SSB transceivers. Telephone service is extremely limited in rural areas.

multaneous broadcasting and production, a necessity since most development programs are prerecorded. Each station has three studios—a large studio for dramatic and musical programs, a smaller studio for interview and talk programs and a small announce booth.

The control rooms are arranged for combo (self-announce) operation. Equipment includes stereo control boards (modified for mono), turntables, cart machines, reel-to-reel tape decks and broadcast—quality cassette units. Marantz cassette recorders are used for field recording. The stations have

## Computer Aided Scanning

a new dimension in communications from Datametrics



Now you can enhance your ICOM communications receiver through a powerful computer controlled system by Datametrics, the leader in Computer Aided Scanning. The system is as significant as the digital scanner was five years ago and is changing the way people think about radio communications.

The Datametrics Communications Manager provides computer control over the ICOM R7000 or R71A receiver. Comprehensive manual includes step by step instructions, screen displays, and reference information.

Powerful menu driven software includes full monitoring display, digital spectrum analyzer and system editor. Extends ICOM capabilities including autolog recording facilities, 1000 channel capacity per file, and much more.

Innovative hardware design requires no internal connections. Overcomes ICOM limitations such as ineffective scan delay.

## Datametrics, Inc

R7000 system \$ 299  
 R71A system \$ 299  
 Manual and demo disk \$15

Requires ICOM receiver and IBM PC with 512K and serial port. The R71A version also requires an ICOM UX-14.

Send check or money order to Datametrics, Inc, 2575 South Bayshore Dr, Suite 8A, Coconut Grove, FL 33133. 30 return privileges apply.

CIRCLE 145 ON READER SERVICE CARD

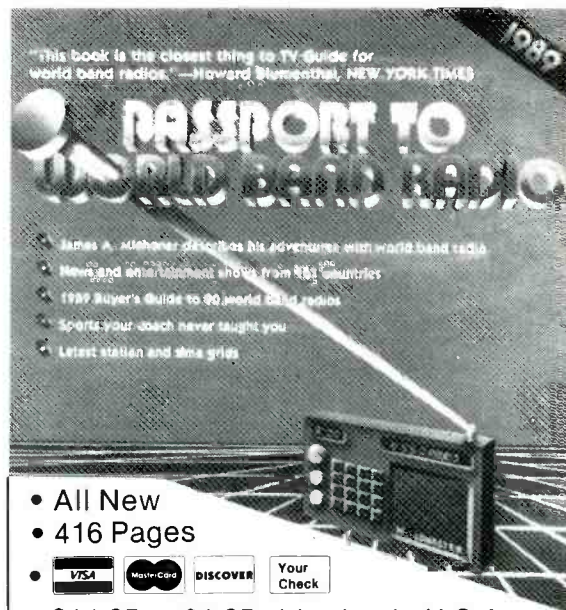

- All New
- 416 Pages

• VISA MasterCard DISCOVER Your Check

- \$14.95 + \$1.95 shipping in U.S.A.
- A Must For Any Level Of SWL
- THE Shortwave Listener's Bible



Orders: 800-368-3270  
 Electronic Equipment Bank

516A Mill St. NE • Vienna, VA 22180 Local and Tech Info  
 (Just minutes from Washington, DC) 703-938-3350

CIRCLE 147 ON READER SERVICE CARD



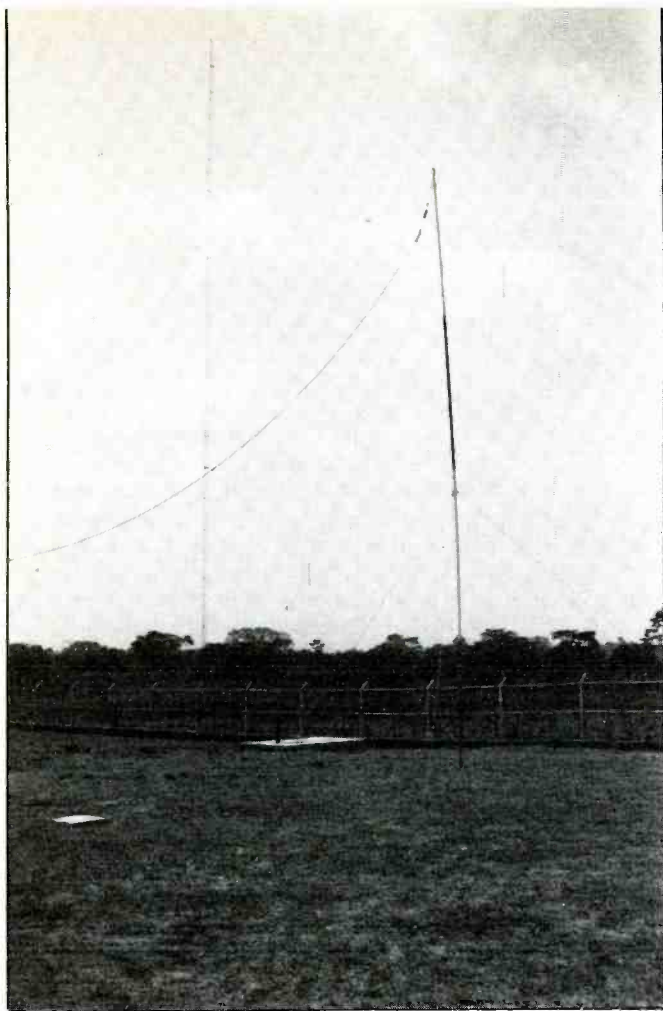

Antenna towers are located behind each of the rural stations. Each site has a 10 kW mediumwave transmitter and a 2.5 kW standby unit. The mast in the foreground supports a SSB antenna and shortwave receiving antenna.

Marti 100 watt transmitters used for the ISB studio to transmitter link — one for upper sideband and one for lower sideband. The ISB can transmit two programs simultaneously.

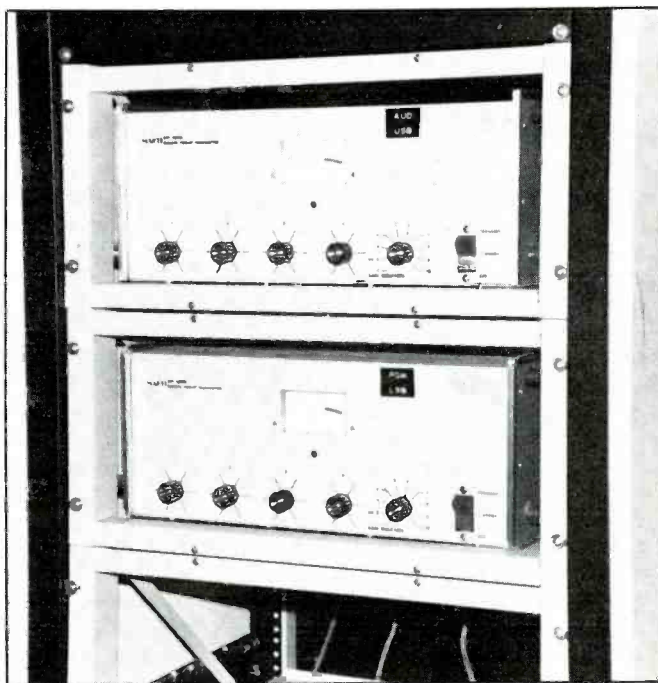

Marti transmitters and antennas on telescoping towers for originating remote broadcasts.

Each station is equipped with two diesel generators, since commercial power is available only occasionally. High fuel and generator maintenance costs have been major problems for LRCN since the beginning of broadcasting.

LRCN's engineers were trained through a combination of in-country study with local instructors using materials designed for correspondence study and short-term training in the U.S. with the Harris Corporation of Quincy, IL, the contractor who supplied and installed the transmitters and studio equipment.

While it is unlikely you will hear LRCN's mediumwave signals in the U.S., a real challenge for DX'ers is the independent sideband transmissions which relay programs from Monrovia to the rural stations. ISB transmissions are currently on 3975 kHz. Several reception reports have been received from the U.S. and other countries. Reports are acknowledged by letter. Write to LRCN at Box 2176, Monrovia, Liberia, West Africa.

The best listening times for ISB transmissions are at 0700-0715 and 1900-1915 UTC when a national news program in English is relayed daily for rebroadcast by LRCN's rural stations. Other programs are fed to the stations several times weekly.

Because there is no dependable telephone service in rural areas, the network uses 100 watt single sideband (SSB) transmitters for routine communications. News reports from the local stations are recorded from the SSB for incorporation into programs produced in Monrovia. Operating frequencies are 6.965, 7.790 and 7.820

MHz. Upper sideband is used exclusively.

Because of LRCN's demonstrated success as a tool for stimulating development, the network hopes to attract further assistance from international donors. Plans call for the construction of more rural stations to, in the words of LRCN's slogan, "Help Liberia Grow With Radio." PC

## Add New Enjoyment To Your SW Receiver with the Portable MICRODEC™ Decoder

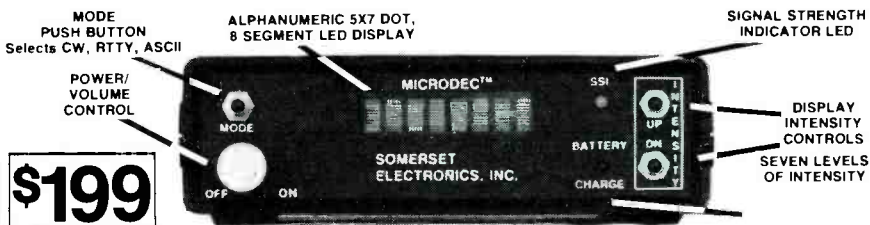

**\$199**

**MICRODEC™ converts MORSE, RTTY, and ASCII to ALPHANUMERIC CHARACTERS**

- Automatically tracks MORSE code speeds from 5 to 70 WPM
- Decodes 60, 67, 75, 100 wpm RTTY and 110, 330 BAUD ASCII.
- Standard ASCII port to interface with your computer.
- Internal practice code oscillator.
- Standard cockpit green display. (red & yellow optional)
- Power switch/Volume control/Internal speaker
- Completely portable with optional NICAD rechargeable batteries mounted internally. — \$29.95
- Ultra compact and lightweight 1.5 H x 5.08 W x 5.25 L (1 pound w/batteries).
- Operates on DC voltages between 9 VDC and 15 VDC (9 VDC adapter provided at no cost).

**SHIPPING AND HANDLING:** Continental United States add \$8.50 for UPS ground. Florida residents add 6% sales tax. Other types of Express shipments and foreign destinations will be quoted on request.

**METHODS OF PAYMENT:** MasterCard, VISA, Money Orders, Certified Checks, and Personal Checks. Please note for personal checks we allow two weeks for checks to clear.

**SOMERSET ELECTRONICS, INC.**

1290 HIGHWAY A1A, SATELLITE BEACH, FL 32937 • ORDER & FAX: (407) 773-8097

CIRCLE 142 ON READER SERVICE CARD

# Scanning Central America

## Shadowy Communications from the Southern Hemisphere Herald Tomorrow's Headlines

BY CHUCK ROBERTSON

The evening TV news confirms that Central America is turning into a political hot spot and land of terrorism and intrigue that most of us used to associate with Southeast Asia or the Middle East. Thanks to the benefits of the sunspot cycle, your scanner brings it right to you while it's happening, giving the situation a much sharper edge than yesterday's news tapes shown to you courtesy the TV networks.

You'll monitor the many military and paramilitary groups operating in Central America. The U.S. military keep a nervous watch on the Panama Canal, while troops in Honduras and El Salvador conduct non-stop war games and training exercises. Meanwhile, local militaries, drug barons, plus a ragtag mix of left and right wing guerillas keep the region on the cutting edge of anarchy, or at least revolution. Yes, when the VHF "low band" is open for skip to Central America, there's never a lack of military macinations and intrigue.

U.S. Government mobiles are monitored tracking a mysterious "target" vehicle that's been tagged with a bumper beeper transmit-

ter. Their comms are observed on 31.75 MHz. *Searcher 110* was tense as he instructed his companions, "Target fading in and out . . . still heading north . . . negative contact at this time . . . last seen 12 kilometers out."

A minute later, *Searcher 230* rebounded, "picked up track about 10 kilometers out." And so it went, but who were these Americans tracking? Were these military units looking for guerillas? Were they DEA agents following a shipment of drugs headed northward to the U.S. via the Mexican corridor?

### You Can Listen, Too!

Last winter at this time, the airwaves were thick with scrambled communications from this region. Low power manpacks, handhelds, as well as mobile units used by local security patrols were heard with Time Domain scrambling. U.S. military units were observed with (DES and MUX) scramblers, too. Frequencies below 40 MHz, scrambled and in the clear, make it northward for all of us to copy without much difficulty.

A peculiar type of digital data burst turned up in the skip. It's like a *boop-beep* type of signalling. They're brief (less than 3 seconds), and are certainly related to military or federal activities. Weapons or telemetry is a possible source. It's been logged on 31.45, 31.86, 32.65 and 32.90 MHz. Even the Nevada Test Site repeater on 36.33 runs these signals. What's going on?

New in the Central American comms scene is equipment with 12.5 kHz channel increments. Local military forces have been spotted on frequencies like 33.525, 34.025 and 34.6825 MHz. Soviet low band radios are known to have 12.5 kHz channel spacing, so perhaps the Sandinistas in Nicaragua have such sets. U.S.-backed forces use radios with 50 kHz and 10 kHz channel spacing.

A voice multiplexing (MUX) trunk with continuous guard tones was found operating week after week on 31.925, 31.95 and 31.975 MHz (NBFM mode). DES scrambling was also monitored on 31.975, which took me by surprise. Occasional clear voice comes through on 31.95, and when it did, it

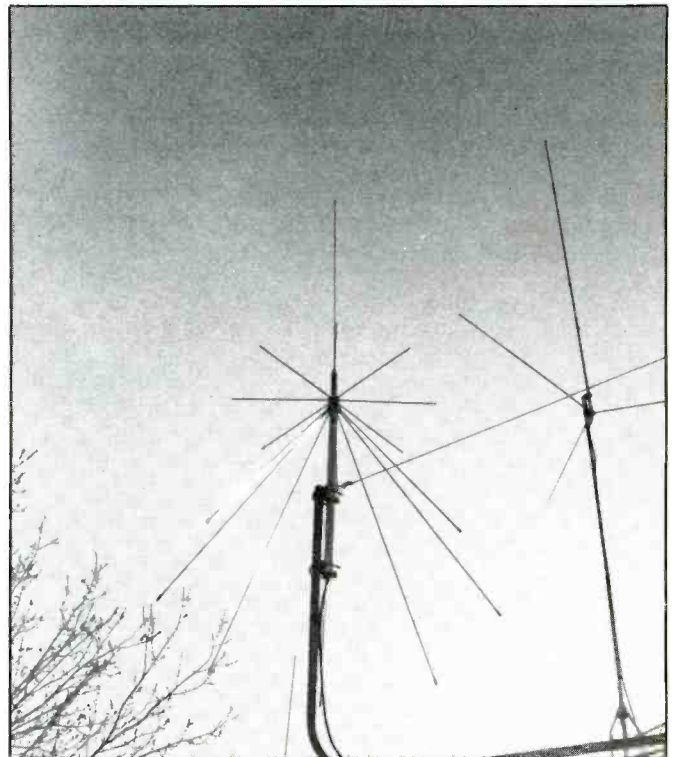



revealed that this unusual net was operated by the U.S. military. For a description of MUX, DES, and TD scrambling techniques, see the September '88 issue of POP'COMM feature, *It's Scanner DX Skip Season!*

## Unusual Aero Comms

On 36.45 MHz, two apparent U.S. aircraft enroute Colombia gave a detailed minute-by-minute description of the ground below as they overflew Panama and the nearby San Blas Islands. "Those are the Cuna Indians there on the beach. They live on the San Blas Islands. They're similar to the Philippine people. This chart shows the area we're now over is uncharted . . . I'm going down for a look at the volcano . . ." This type of guided tour was monitored for about 2 hours beginning at about 1400 UTC one morning last winter.

Maintenance on the Panama Canal and its reservoirs is conducted by the U.S. Army Corps of Engineers, with comms on the Command Net frequency 31.75 MHz. ID's I've logged here include *Coco Solo 23* (mobile); *Guabala Air* and *48-Air* (towers); *Forward Base Camp*; *Fort Sherman*; *Fort Gullick*; *Station 99*; *LSE Site*; *Corps Site*; *Robert 79'er*; *Army 292* (helo); *Madden Lake* and *Gatun Lake* (reservoirs); *Rio Indio* (tributary of Madden Lake); and *Balboa City*.

Also, vessels of Gulf Fleet Marine moving through the canal can be heard on 31.48 MHz. These commercial vessels pass position reports to *Harvey Base*, located in New Orleans, LA.

## Military Stuff

Honduran troops are heard regularly on 32.00 MHz in clear voice Spanish. ID's here include *El Gun* and *Booma*. Locations mentioned are Pito Solo and Campo Palmerola (Palmerola AFB, Honduras). Lively US/Honduran war games on the Coco River (near Tocoa) were tuned on 30.25 and 31.00 MHz. Ground forces had ID's like *Wolf 7*, while helos had ID's like *Dragon 27*.

The language barrier made for problems between the forces. On 35.00 MHz, pilot of a U.S.A. aircraft ID's as *Vulture 23* asked another station, "Is he speaking English. Later *Vulture 23* dryly observed that, "100 infantry managed to dismount before they died." Good thing these were only maneuvers and not the real thing! For more of these frequencies, see our Low Band Skip Log.

## Meddlin' In Medellin

A short crawl through the dense underbrush at the Panamanian border and you're in Colombia. What with dozens of private drug armies terrorizing the countryside and cities, the police dispatchers rack up lots on mike time. A very active one uses NBFM and is heard on 34.50 MHz, with mobile units on the same frequency). This dispatcher seems to be located in Medellin, which is to cocaine what the south of France is to Bordeaux wine.

Last spring the frequency was going wild with comms relating to the attempted escape of drug runners from Bellavista penitentiary. At attack force stormed the bastions in a failed attempt to free some of the drug kingpins there. Approximately 20 men armed with grenades and automatic weapons tried to shoot their way past the guards.

Any time skip comes rolling in from Colombia, try listening on 34.50 MHz, also 36.80 and 45.50 for "Bogota."

We are presenting a Low Band Skip Log that lists some Central American skip reception you can watch for. A few Caribbean, Pacific, and South American loggings are sprinkled in for good measure. Military intercepts are WBFM, everything else is NBFM unless noted otherwise. SS = Spanish; PP = Portuguese; EE = English; BIWI = British West Indies; BI = Business.

### Low Band Skip Log

- 29.625 & 29.655: Whistler RT's in in SS boatlegging in the ham band.
- 29.72, 29.80, & 29.90: US mil exercises in Pacific: "Send report to Battalion," "Uniform-71," "Juliet-71," "November-75." See 30.10 logging.
- 29.80: US mil ID as "Hotel."
- 29.815: SS outbander in NBFM; a beep at end of each xmin.
- 29.935: SS outbander in AM mode. Actually, the range 29.70 to 29.95 is often saturated with SS outbanders.
- 29.97: US mil in Pacific: "Red-3, 0226."
- 29.975: SS agri ops, NBFM.
- 30.00: USN Shore Patrol somewhere.
- 30.03: USAF airfield management.
- 30.05: Joint mil exercises, EE/SS: "Victor-64 at Base Camp."
- 30.10, 30.80, 31.00, 31.10: US mil exercises, Pacific area: "Stop due to weather," "November-74," "Uniform-37."
- 30.25 & 33.85: Joint mil exercises, EE/SS, 2 companies; "Alpha Tank," "Charlie Tank."
- 30.475: Security Service, San Salvador, El Salvador, 24-hr. ops, very active.
- 31.00: Medical svc, Guatemala City, Guatemala.
- 31.70: Mil ops, EE/SS: "Crackerbox Ops."
- 31.80 & 35.20: Petro related BI, many bases in Honduras: Tegucigalpa, Sierra; also a base in Mexico ID's as "Mexico."
- 31.96: BI in San Salvador, El Salvador.
- 31.98: SS phone-in pager; 2 tones then message.
- 32.01: Port ops, maybe El Salvador.
- 32.02: Costa Rican BI.
- 32.05: BIWI: "I'm at Mountain View."
- 32.08: Petro ops in SS, Mexican.
- 32.10: EE/SS military; "Proud Banner" (vessel), "Bubblegum-53."
- 32.20: Guatemalan BI in SS: "Guatemala."
- 32.225: Repeater out, SS BI.
- 32.30: Joint mil ops, EE/SS; convoy.
- 32.31: Joint mil ops, EE/SS; battalion on move.
- 32.35: SS mil: "Saturno."
- 32.46: Managua, Nicaragua: BI
- 32.50: Repeater out; Central American BI.
- 32.68: Honduran BI: Tegucigalpa, Juticalpa, San Antonio.
- 32.65: Mexico military, SS.
- 32.75: US mil: "Peck to Rad-1. Go to covered mode."
- 33.10: US Security patrol, Tegucigalpa, Honduras.
- 33.20: Repeater out (32.78 in); BI with bases in Honduras, El Salvador, & Mexico.
- 33.425-33.825: Many repeater outputs (inputs exactly 6 MHz higher) for Central American BI's.
- 33.48: Tegucigalpa, Honduras: BI in SS.
- 33.50 & 33.60: Mexican military. Primary base freqs. ID as "Militar Mexico."
- 33.85: Military ops; PP.
- 34.06 & 34.66: Honduran BI: Tegucigalpa, Choluteca, San Lorenzo, Taujica.
- 34.30: Base & port ops: Panama Canal. Also EE & SS mil ops: "India-24" & "-34."
- 34.50: USAF: "Engine light is on...must land!" "Buckeye Ops," "Buckeye-196," "Snowman" (a/c) at 1547 UTC.
- 34.60: Police or BI in SS: "Central, Panama 36."
- 34.60: EE/SS mil, range ops: "3-Papa-27" (US) & "Uniform-53" (SS).
- 34.60: Hindi & EE, maybe Trinidad, Suriname, or Guyana: "How's your mother?"
- 34.725: SS BI: AM mode, very active. May be Managua, Nicaragua.
- 34.83: SS BI: Santo Miguel.
- 35.35 & 34.90: EE/SS mil maneuvers, Central Am.
- 35.825: 3-tone telemetry, So. America. Other stas

found from 35.55 to 35.75 in 25 kHz steps, AM mode.

- 35.91: SS BI; Mexico.
- 36.00: French Creole, Haiti, some hollering. Also a repeater out similar to 32.50 MHz.
- 36.24: SS BI: Colon, Panama.
- 36.35: Port ops: Panama.
- 36.50: SS petro BI. Calling for Arco.
- 36.65: USN ships, So. Pacific: "Yellow Bear," "Port-15."
- 36.80: USAF ops: "Switch 344.6 MHz."
- 37.35: BI, Panama.
- 37.60, 37.65, 37.70: SS pager, AM mode, 2-tones then messages.
- 39.34: Repeater out: BI in Honduras.
- 40.45: SS police patrols, NBFM.
- 40.55, 40.64, 40.66, 40.68: Various types of beeping tones. Federal agencies involved in tracking target vehicles sometimes use the 40 MHz band for the transmitter. The 40.66-40.70 MHz sub-band is allocated for sea buoys, wildlife tracking & field disturbance sensors. Freq 40.68 MHz allocated for medical, industrial, scientific devices.
- 40.76: Repeater out, French Creole. Xmsn has odd multiple tone-burst access.
- 40.87: 2-tone digital signalling.
- 41.00: Security patrol in SS/EE may be in Honduras.
- 41.10, 41.28, 41.34, 41.40, 41.52, 41.58, 41.64, 41.70, & 41.80: SS t/c with many phonetics & numbers. San Jose, Costa Rica mentioned.
- 41.425: SS BI, Mexico. Bank deposit numbers.
- 41.82: SS BI with names & places listed: Colon, Panama.
- 42.18: Repeater out: PP from Brazil.
- 42.26: SS BI, La Plata, Argentina.
- 42.275 & 42.975: EL Salvador, BI.
- 42.62: Pager from Argentina: 2 tones followed by voice message sent twice. Also check: 31.35 32.68 32.82 32.96 35.08 35.28 35.32 37.12 37.42 37.62 39.64 & 46.26 for similar.
- 43.00: BIWI: Trinidad?
- 43.65: Fire Dept., Colon, Panama; SS.
- 44.30: Repeater out (44.675 in), an SS BI in clear speech & inversion scrambling. Also a repeater out in SS from a BI in Santiago, Cuba "Santiago-4."
- 46.25: SS BI, Venezuela.
- 47.325: Repeater out, SS BI with tone burst access.
- 48.075: Repeater out, SS BI; San Antonio.
- 48.75: Fire Dept., Trinidad.
- 49.05: Repeater out: BIWI, maybe Bahamas.
- 49.60: Panamanian government ops in Cristobal.

# A New AOR Scanner

100 Channels Low, Air, High, UHF & 800MHz



AR950  
Total Price, Freight Prepaid  
(Express Shipping Optional)  
**\$299.00**

- Perfect for base or mobile. Includes AC and DC power cords, mobile mount hardware and 2 antennas.
- Covers 27-54MHz, 108-174MHz, 406-512MHz and 830-950MHz.
- 5 Scan Banks and 5 Search Banks
- 25 Day Satisfaction Guarantee
- No Frequencies Cut Out.
- Size: 3 1/2" H x 5 5/8" W x 7 7/8" D. Wt.: 2 lb. 10 oz.

**ACE**  
COMMUNICATIONS

10707 E. 106th St. Indpls., IN 46256

Toll Free 800-445-7717

Visa and MasterCard  
(COD slightly higher)

In Indiana 317-849-2570 Collect FAX (317) 849-8794

CIRCLE 140 ON READER SERVICE CARD

# Radio's Yesterday

## Leafing Through The Pages of History

BY ALICE BRANNIGAN

What a month for a cruise! Let's take one on the *S/S Admiral Evans*, courtesy of reader Charles Christian, SSB Network member SSB-32Q, of Santa Rosa, CA. Charles sent us a photo of his dad taken aboard that good ship in 1921 when he was a waiter aboard the *Evans*. This was a 2,393-ton steel steamer, 253 feet in length, that carried 194 passengers and a crew of 45. It was built in 1901 and spent much of its career in Alaskan trade, although it spent a few years in the early 1920's cruising between Portland and San Diego. The ship was torn up for scrap in 1937.

In the photo Charles submitted, his dad is posing on the deck while holding several pieces of radio gear. Written in longhand across the bottom of the photo is the caption, "The first Gibbons hookup." Charles asks is we can put any of this together to shed some light on what the photo's all about.

First, let's note that the *S/S Admiral Evans* didn't turn up (under that name, anyway) in records until the early 1920's. It was first assigned the callsign KICZ on 425, 500, 730, and 1000 kHz. By 1928 the callsign had been changed to WGCB and the authorized frequencies were 123, 143, 375, 425, and 500 kHz—later modified to 143, 150, 157, 375, 425 and 500 kHz. However, what we see being held in the photo isn't wireless gear.

What we see is very early broadcast receiving equipment. The first commercial broadcasting stations were licensed beginning late in 1921, although a number of stations had been operating under experimen-

tal authorizations prior to that. Personally owning a radio receiver in 1921 was a definite status symbol, something worth having a photo while you displayed the equipment.

The reference to the "first Gibbons hookup" is a bit confusing in view of the photo being dated 1921. There was no brand of radio called a Gibbons, and the only significance I could find for that reference would be to Floyd Gibbons. Gibbons was a well known and very colorful reporter for the Chicago Tribune. His WWI military exploits had cost him an eye, and the eyepatch only added to his image and aided in making him somewhat of a national personality. Yes, Gibbons eventually became well known as a newscaster and a sportscaster, and for telling about his wartime adventures. I believe that Gibbons' broadcasting career began over Chicago's WGN, which commenced broadcasting on June 1, 1924 with Gibbons' debut on Christmas Eve of 1925. That was years after this photo was snapped.

It may be that Gibbons had made earlier appearances, and that's what the photo caption means. Or, it could be that a "Gibbons hookup" refers to something totally different, such as the name for a type of homebrewed circuit that Charles' dad had constructed in those days when receivers were so expensive. You may recall that sometimes early circuits were known by the names of their designers—Colpitts, Hartley, DeForest, Armstrong, and so on. Was the reference to the "first Gibbons hookup" intended to recall that, or something else?

We hope some of our readers can offer

some thoughts on this.

By the way, Charles' dad ended his nautical career in the early 1960's as Director of Passenger Service of Matson Lines in San Francisco. He passed away in 1972.

### Experimental Shortwave Relay

From time to time we get a chance to share with you a memory of one of those shortwave relay stations that operated in the late 1930's. In those years the FCC seemed to be considering the idea of permitting mediumwave broadcasters to relay their programs on higher frequencies. The broadcasters were pressing to find new avenues in which to present their services, and there was no pressing need for high frequencies anyway in those years. The FCC responded by issuing Experimental licenses in order to let broadcasters test this new concept and see if they could evolve some kind of wholly new broadcasting service. Many stations took out licenses.

One of those stations was KSTP in St. Paul, MN. They were issued a license with the callsign W9XUP for operation on 25950 kHz with 1 kW. Henry Ward, of Sherbrooke, Quebec, picked up the station's signals in 1938 and was rewarded with a QSL when he sent a reception report. We thank him for permitting us to give you a look at this interesting card.

So far as we can tell, WWII ended this experiment in broadcasting. By the time the war ended in 1945, broadcasters found that



"The first Gibbons hookup," wrote Charles Christian's dad about this photo in 1921. It seems to refer to the two radios he's holding, but the exact meaning is open to speculation.

25,950 KC.	1000 WATTS
ST. PAUL, MINNESOTA, U. S. A.	
<b>W9XUP</b>	
Owned and operated by Radio Station KSTP	
WE TAKE PLEASURE IN VERIFYING YOUR REPORT OF RECEPTION OF OUR TRANSMISSION ON <u>OCT. 30, 1938</u>	
THANK YOU <u>L. H. CARR, CH. ENGINEER</u> Engineering Department	

W9XUP was a shortwave relay operated in the 1930's by medium-wave KSTP. (Courtesy Henry Ward, Sherbrooke, Que.)





WNYF was a 500-watt station that transmitted fire dispatches on 1630 kHz for many years. It had a larger audience than some broadcasters. They sent this QSL card to listeners throughout North America. (Courtesy Tom Kneitel)

FM was on their horizon and so interest in shortwave relays tapered off.

### All Fired Up

Time was when many public safety stations encouraged the general public to tune in on what they are doing. So it was with the New York City Fire Department in the era when many police and fire stations could be monitored on frequencies at the high fre-

quency end of the AM broadcasting band. The NYFD's main dispatching station in the 1930's and 1940's was WNYF, which ran 500 watts into a 165 foot tower. At night, the station could be easily picked up in most areas of the U.S. and Canada. During the day, it had a huge and loyal audience of fire buffs who had discovered that fire calls could be picked up on standard AM broadcast receivers. WNYF used to claim that it heard from many listeners who left their ra-

dios tuned to their station at all times. Between its local and night DX audiences, WNYF always received as much fan mail and QSL requests as a broadcasting station. Each request for a verification was promptly honored with a QSL card showing several fireboats in action, with a complete technical description of the station on the reverse.

When WNYF moved off of 1630 kHz in the early 1950's, there was a loud cry of protest from the station's huge band of steady listeners who were enraged. They wrote a sea of complaint letters to the NYFD and even the mayor. The decision to change frequencies, however, was made by the FCC which shifted police and fire stations to frequencies above 30 MHz.

One of the old WNYF veri cards was received by Tom Kneitel in 1948, and we are happy to give you a look at this unusual card.

### KLX Clicks

Here's a puzzlement. Reader D.M. Gunn, of Oakland, CA sent the column a clipping from the Oakland Tribune dated last September 15th. The story mentioned that in 1921, "Little Jimmy" (a 5 watt transmitter) was first turned on in a studio located in the Hotel Oakland, and thus was born station KLX, which was then operated by The Oakland Tribune. We found it curious because it doesn't show up in 1921 broadcast station records. Checking further, I found that the 1921 date is nevertheless supported by the present owners of the KNEW, which is the station into which KLX has presently evolved. They say that the sta-

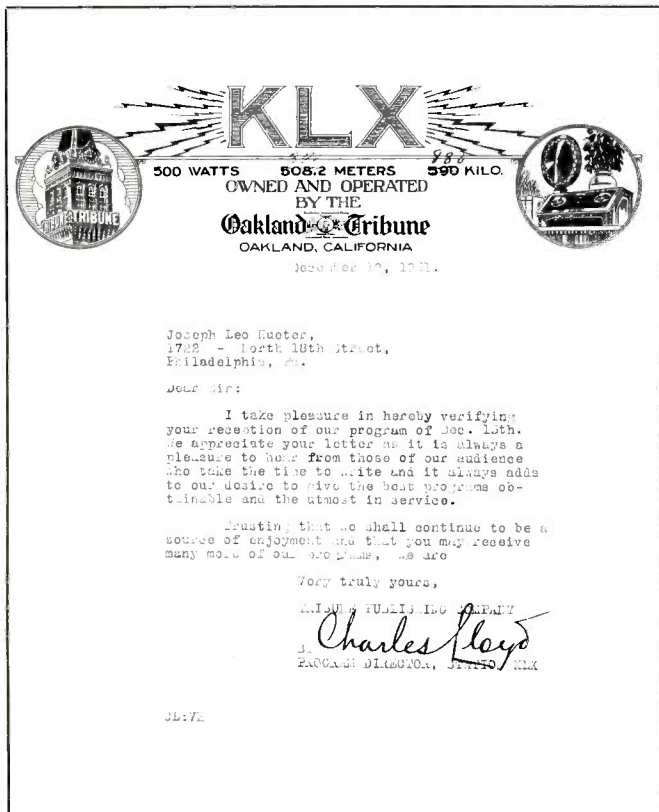

When did KLX first go on the air? The exact date isn't quite certain. (Courtesy Joe Hueter)

The front of the WPAT building in 1979. (Courtesy Marlow Saady)

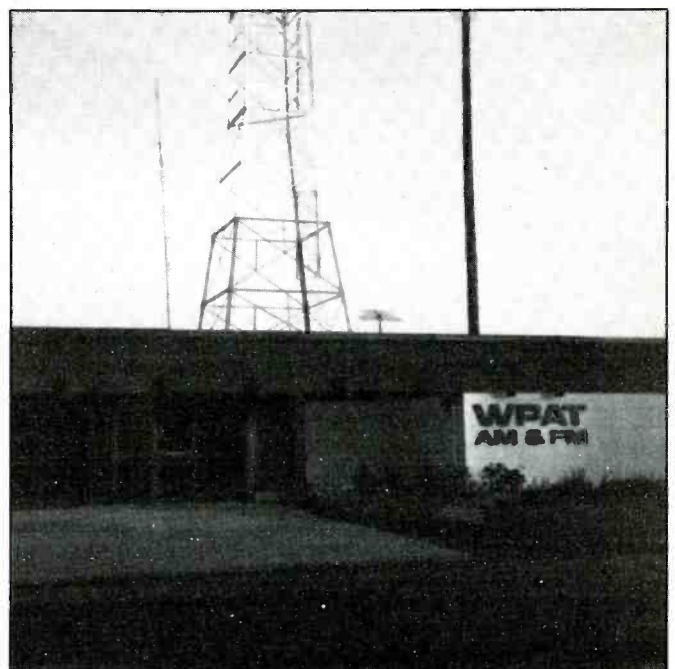



WPAT's 4-tower directional array for AM operation in 1979. (Courtesy Marlow Saady)

The radio shack aboard the old USS Nero as it looked in 1916. (Courtesy Will Jensby, W0EOM/6)



tion began broadcasting on July 2nd, 1921. That date is ten weeks before the government issued the first commercial broadcasting license (to Boston's WBZ), and five months before KDKA (Pittsburgh) received its license.

My suspicion is that the station may well have gone on the air in July of 1921, but under the Experimental license 6XAJ issued to Preston Allen of the Hotel Oakland. The license for KLX wasn't issued until 1922 (which is the start-up date KLX used to claim).

The year 1923 saw KLX on 590 kHz from the Tribune Tower with its new 50 watt rig (known as "Powerful Katrinka," after a character in the *Toonerville Trolley* comic strip). Soon after, the station increased its power to 500 watts, then moved to 1270 kHz, then to 880 kHz.

KLX became an extremely popular station and presented a wide variety of programs ranging from college graduation ceremonies to kiddie programs such as "The Tribune Funnies Man" (Jack Morris), and "Uncle Mel's Kiddie Ranch" (starring Jack Cahill).

By the mid-1930's, KLX had grown to 1 kW, and just prior to WWII it changed over to 910 to coincide with the FCC's new frequency plan. The station was sold in 1959 and the new owners changed its callsign to KEWB. It didn't take very long for KEWB's owners to annoy the FCC. In 1960 the FCC chided them for starting an amoeba scare, and for airing an "outer space voice" type of production the FCC termed "alarming and vulgar." Eventually the station was sold again. You may know it now as country music station KNEW running 5 kW on 910

kHz. Since March of 1988 it's been owned by the Malrite Communications Group.

A veri letter from KLX was received by Philadelphia DX'er Joe Hueter in December of 1931. The fancy letterhead depicts (at the left) the station's location (in The Tribune Tower) sending signals over to a radio receiver at the right. The letterhead must have been old because it was printed with 580 kHz, a frequency that hadn't been used by KLX since November of 1928. Apparently stations changed to new frequencies so often in those days that it hardly paid (during the Great Depression) to ditch it when it became outdated. You did what KLX did, write in the new information by hand and use up what you had in stock before you printed up more; even if you were a publisher!

### Down Pat

We received some photos taken in 1979 by reader Marlow Saady, Jamaica, NY. They show the AM transmitting facilities of WPAT, Paterson, NJ.

This station went on the air on May 3rd, 1941 with 1 kW on 930 kHz from 7 Church Street in Paterson. The transmitter was in Clifton. The station later went to 5 kW, and (in 1957) added an FM outlet on 93.1 MHz. Although WPAT still announces Paterson as its home, its offices are actually at 1396 Broad Street in neighboring Clifton. The AM and FM outlets run the same programming, which is "easy listening" music. In fact, WPAT is enormously successful and was one of the first stations to popularize this type of format.

The photos show a four-tower directional

antenna, with each of the towers topped by a capacitance "hat."

### I Must Go Down To The Sea Again . . . .

A good photo of the wireless apparatus aboard the good ship *USS Nero* (late of Mare Island, CA) was forwarded to us by our friend Will Jensby, W0EOM/6, of Santa Clara, CA. This photo was snapped on 14 November 1916. If the *USS Nero* isn't familiar to you, it bore the official USN designation AC-17 and was a steel steam collier built in England (1895) as the *S/S Whitgift*. It enlisted in the USN three years later in order to serve in the Spanish-American War as a collier and supply ship. *Nero* was given the callsign NEDX, and was in service through WWI. She was decommissioned in 1921 and sold the following year.

Although rather spartan in appearance, and certainly far from spacious, the radio shack aboard the *USS Nero* was neatly arranged and far less haywire looking than the average shipboard radio room of that era. The desk shows the receivers, while the transmitters are at the left. On the deck in front of the transmitters is an official USN brass cuspidor, placed within range of the sparks.

### Early Broadcaster

One of the pioneer equipment manufacturers was Colin B. Kennedy, maker of receivers and other equipment for early tinkers. While his company (The Colin B.



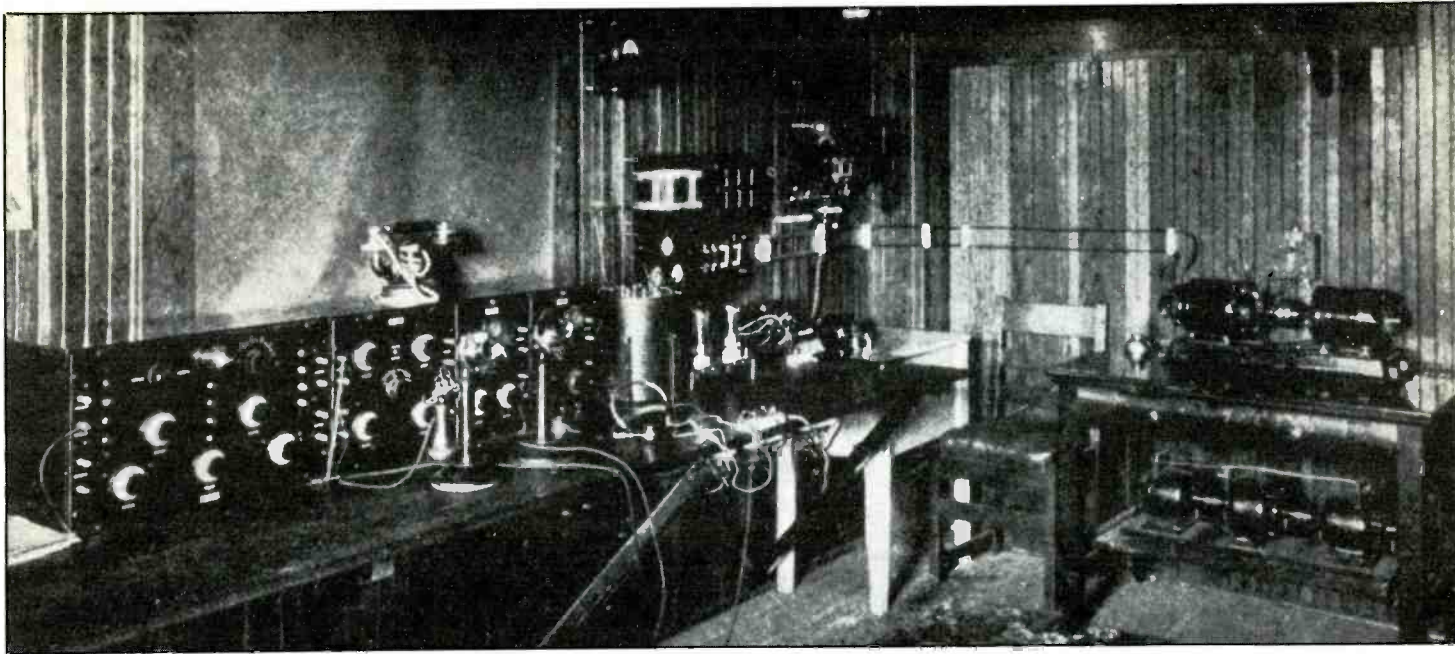

Experimental broadcaster 6XAC in Los Altos, CA evolved into early commercial broadcaster KLP. That gave KLP the dubious honor of being one of the first commercial broadcasters to go off the air.

Kennedy Company) earned quite a respectable reputation, his little venture into broadcasting is obscure and all but forgotten.

October, 1920, saw the Kennedy Company's experimental station go on the air with the callsign 6XAC. This was a 50 watt station that operated on 700 kHz. The station was located on O'Keefe Avenue in Los Altos, CA at the home of Emil A. Portal, a Kennedy executive.

The station broadcast music for an hour on Monday nights, then again on Thursday nights, and also on Saturday afternoons. Reception reports for 6XAC arrived from the entire West Coast from San Diego to British Columbia, and east to Montana and Nevada. In early 1922, 6XAC exchanged its Experimental license for a commercial broadcasting license with the callsign KLP, per government mandate. It seems that the station wasn't as interested in being a commercial broadcaster as it would have been in remaining an experimental entity. After only a few months of operation as KLP, it went dark and became one of early broadcasting's first commercial stations to do so.

The equipment at 6XAC/KLP consisted of a Kennedy 100 low frequency receiver, Type 200 shortwave receiver, Type 300 audio control panel, and a Type 520 two-stage audio amplifier.

The transmitting equipment used two 50-watt Cunningham tubes, one as the modulator and the other as the oscillator. The filaments were powered directly from the 10 volt secondary of a 60 Hz transformer having a neutral point. The plate current came from a 1 kW motor-operated generator. A special design modulation transformer was used to insure good voice and music reproduction. All of this was fed into a 55-ft. cage antenna strung between two 100-ft. masts.

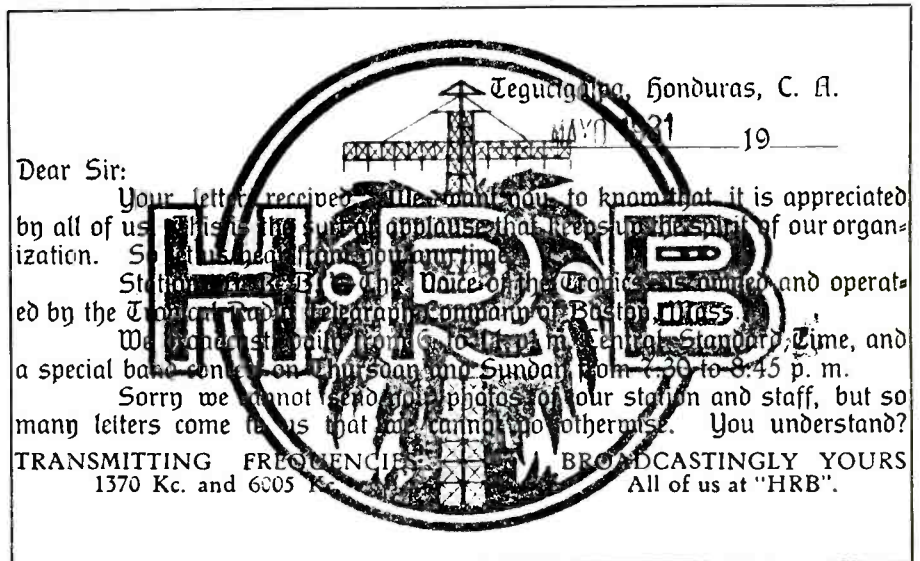

If you weren't listening to your shortwave receiver in 1931 you may have missed hearing HRB, the first broadcaster in Honduras. Here's the QSL you also missed out on. (Courtesy Joe Hueter)

### Who's On First?

Another early but short-lived broadcaster was HRB, Tegucigalpa, Honduras. Known as *The Voice of The Tropics*, HRB operated on mediumwave (1370 kHz) as well as shortwave (6005 kHz) back in 1931. These were the first broadcasting stations to operate in Honduras, and they did it with clout. HRB's mediumwave transmitter rang a sizzling 2.3 kW.

HRB was American owned, being operated by the Tropical Radio Telegraph Company, of Boston. The station was on for five hours per day, but that was back in 1931. For whatever reasons, it appears that HRB

existed for only a very brief period around 1931 and then it went off the air for good.

Most likely very few remember HRB career on shortwave for anywhere else, and undoubtedly very few examples of its QSL card still exist. Luckily for us, Joe Hueter of Philadelphia heard HRB 59 years ago and got one of those cards, which he shared with us.

That's a wrap for February. Thanks to those who furnish these pages with information, old QSL's (even good photocopies will do), photos, news items, old station directories and lists, and anything else related to old-timey wireless, broadcasting, and communications on land, on sea, and in the air.

# KKN39: A Magical Mystery Tour

***Not Quite as Resolved as Claimed – We Sent Our Own Investigative Team!***

BY HAVANA MOON

**T**here's an old adage that goes something like this: "There's nothing new in the world—just lots of things we don't know."

Nothing could be closer to the truth when it comes to the Uzi City (Miami) transmit and receive sites of KKN39 on 4956.5 kHz. As a matter of fact, it would be most appropriate to apply this adage to *all* KKN stations and their frequencies.

Ostensibly operated by the U.S. State Department, their exact purpose as well as their actual operators remain a mystery. It might be assumed that there is some type of NCS (National Communications System), U.S. Army as well as Federal Emergency Management Agency (FEMA) involvement if one is to believe the numerous signs on and around both Miami sites.

To claim the KKN39 mystery is resolved

is too simple. The intent of this article is to pick up where Al Zilman's *Monitoring Times* April '89 brief, but interesting, KKN39/Miami article left off.

Readers will recall that it was *Popular Communications* that first revealed the Miami sites of KKN39. That seemed to set off numerous aftershocks.

## **Sights To Be Seen**

The transmit facility is—without question—roughly 1.5 miles south of U.S. 41, State Road 90, SW Eighth Street, Tamiami Trail on Krome Avenue, State Road 997, SW 177th Street, old State Road 27. A somewhat confusing address to say the least. But confusion is just one of the many games that Miamians have long endured. And since Miami is the CIA and NSA's city

of choice, there will be sinister game after game.

Just locate Krome Avenue and take it from there—OK? No problem locating the Gold Coast railroad Museum or the Zoological Park. To publish a map of this portion of Uzi City would only add to the confusion.

The KKN39 receive facility is just west of the Dade County Zoological Park and Gold Coast railroad Museum. Both are major Miami tourist attractions. In fact, the railroad museum parking lot ends where the barbed-wire topped fence surrounding the receive site begins.

Frenetic activity along with heavy security was clearly evident at the receive site. This was in stark contrast to the "laid back" attitude observed at the transmit site some seven or eight miles distant. The heavily armed



The KKN39 transmitter site from another angle shows some of the antennas used.

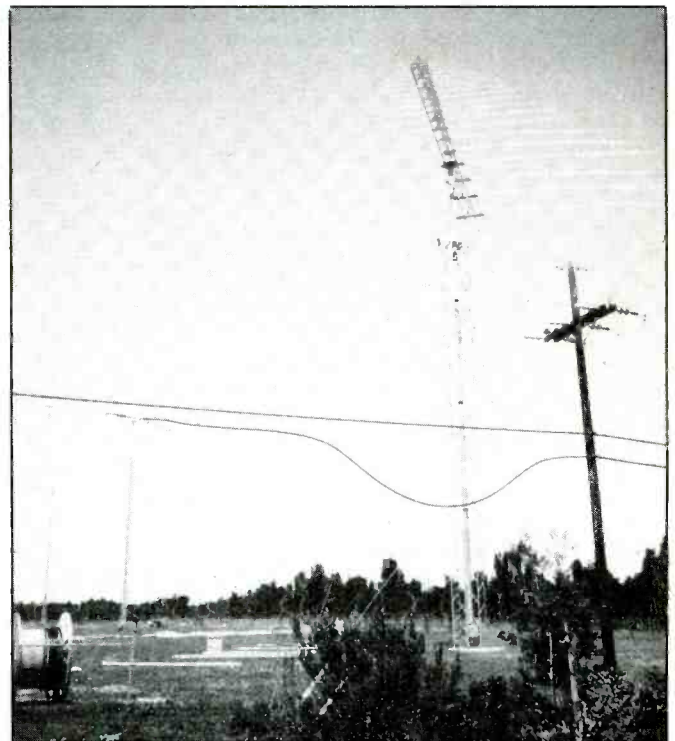

Log periodic antenna at the KKN39 transmit site on Krome Avenue. This is about 15 miles west of downtown Miami.



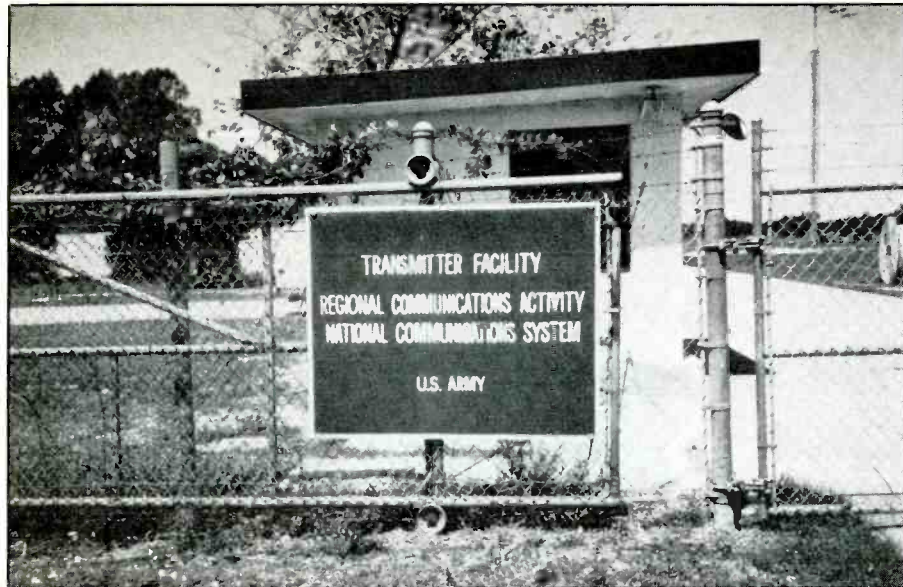

Entrance to the KKN39 transmit site identifies it as an Army component of the National Communications System.

private security guard at the transmit site was somewhat less than awake when John Fulford (WA4VPY) and I arrived early on a Sunday morning recently.

After a minute or two of hesitation, it was decided that we would be allowed to photograph. We were even told that it was not safe to stand under the large "conical antenna" (sometimes referred to as "circular HF") clearly evident in the background. This—according to a somewhat sleepy, confused and grouchy security guard—was due to excessive radiation from the antenna!

While photographing from various locations around the railroad museum, John

and I were continually told by various museum employees to exercise caution. CIA was continually mentioned!

### The Unmarked Chopper Caper

One employee told us of U.S. Coast Guard Helicopters making continual sweeps of the perimeters of the receive site. At no time, however, did we observe any U.S. Coast Guard air presence. Why the U.S. Coast Guard is involved—at this time—is a total unknown.

Another employee told us of a mysterious

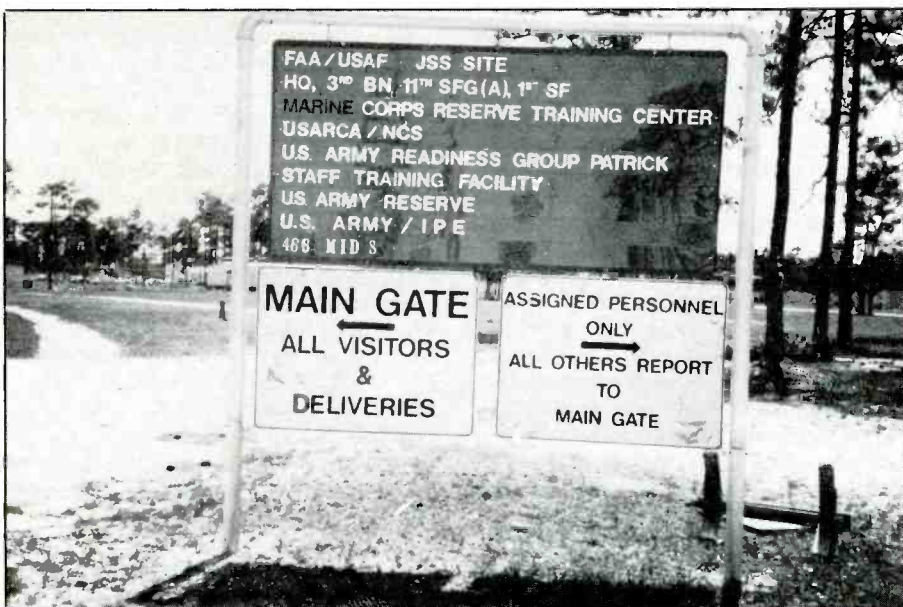

Entrance to the KKN39 receive site shows it is apparently used by many folks. This site used to be the old Richmond Naval Air Station, which was a blimp base during WWII. During the early 1960's, it was home of Zenith Technical Enterprises, a CIA cover.

## Improve Reception !!

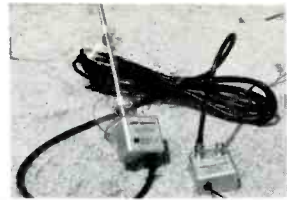

**SUPER VAK-TENNA** Only \$149.<sup>95</sup>

0.5-800MHz ACTIVE RECEIVE ANTENNA

SWL's and Scanners will love the superior reception and wide frequency range of this compact antenna. The SUPER VAK-TENNA includes a low noise 14 db amplifier stage and mounts using convenient SUCTION CUPS! 15' feedline and 110 VAC power std. Mast Mount, DC and Europower versions available.

Only \$29.<sup>95</sup>



**SUCTION CUP MOUNT VAK-TENNA!**

IDEAL FOR APARTMENTS OR OFFICES

Mount to your window for the BEST coverage! VHF/UHF Scanning, HAM 2 meter, FM/TV, Marine users now have a convenient, portable antenna that mounts easily. POWERFUL suction cups hold for weeks! Whips telescope to 79" yet fold to 12". Receives 30-500MHz or transmit 70-230MHz. Supplied with 15' of coax and choice of BNC, PL259 or Motorola connector. (please specify when ordering)

**TAPE SAVER TS-1** \$49.95

Eliminates dead time on your scanner tapes!

Connects between scanner and recorder for "action only" recording. Internal speaker so you can listen while hooked up. 115VAC powered 12VDC & batt avail. Telephone adapter \$10



**SIGNAL INTENSIFIERS**

A HEARING AID FOR YOUR RECEIVER!

These WIDEBAND receive preamps use state-of-the-art MMC chips to make your antenna come to life!

**PREMIUM RFP-40** \$69.95  
1-1300 MHz! 15 DB GAIN!



For all scanners, shortwave revrs., AM-FM-TV and more. 115VAC powered (12VDC add \$4). Choice of BNC, SO239 (PL259 mate) and "F" connectors. Weatherproof, battery powered and remote mounted versions also available. See spec sheet for details!

**CB INTENSIFIER**

Only \$49.<sup>95</sup>

Improve your CB's range! The RFTTR boosts received signals by 13db! Internal T/R relay. 12VDC pwr. (AC pwr add \$10)

SSB Version \$64.95

MARINE-VHF version \$99.95



**WINDOW COUPLER**

Bring the coax from your outside antenna to your inside radio without difficulty! The coupler boxes mount to your window with tape. For Scanners, TV, FM. 60-800 MHz 8db loss. Order WPO-TV \$49.95

**INDOOR ANTENNA WIRE 50' \$8.00**

**SEND FOR FREE SPECIFICATIONS!**

When ordering please add:

Continous US shipping/handling \$4  
AK, HI, PR, Canada shipping/handling \$7  
NY and MI residents add local sales tax  
UPS or US Mail COD \$2.75+(above charges)  
Personal Checks, MO's, COD's accepted!



**ELECTRON PROCESSING, INC.**

P.O. BOX 68

CEDAR, MI 49621

(616) 228-7020

**SAISFACTION GUARANTEED!**

Order any product (except software) from EPI and if not satisfied return it within 15 days for a full refund (less shipping/handling).

CIRCLE 132 ON READER SERVICE CARD

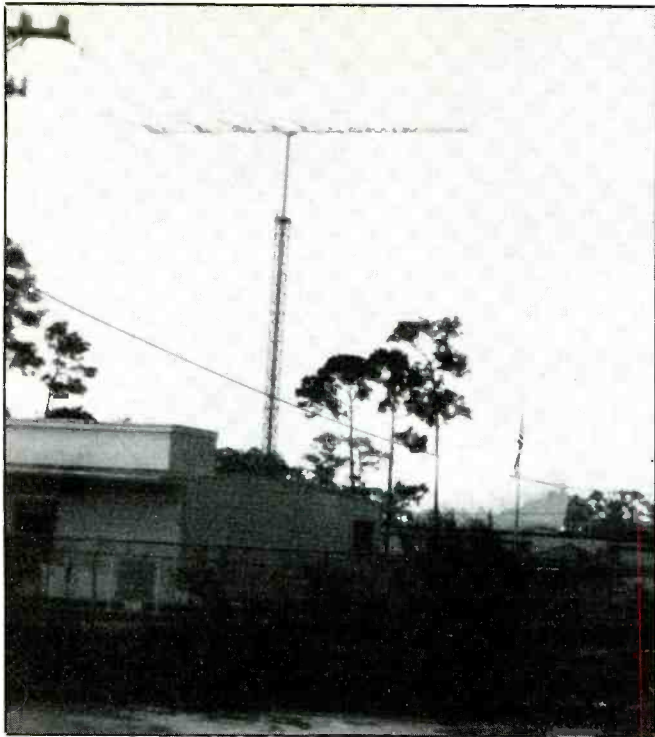

▲ The KKN39 receive site from another angle.

◆ Log periodic antenna at the KKN39 receive site. Notice the radomes in the background.

black and unmarked helicopter that often circled this area at a low altitude.

Seconds later, our ears picked up the unmistakable sounds of a distant helicopter. It took John and I only a few sweeps of the southern sky with our binoculars to locate an apparently black helicopter hovering in the distance! The helicopter was real. But was the color simply our imagination playing tricks on our mind?

Aeronautical sectional maps indicate that this particular area is restricted air space.

Both Miami sites contain a multitude of HF antennas, including log periodics, conicals and dipoles. Additionally, two radar domes were clearly visible at the receive site. Two satellite domes were also in clear view at the receive site.

Well hidden in the dense tropical foliage was a heavily barricaded concrete building simply marked NCS/Building 61! What really lies behind those carefully guarded windows and doors? Perhaps the dark and shadowy world of spookdom?

The entrance signs indicate many possibly unrelated military, as well as other U.S. Government agencies, that maintain facilities on this receive site. Among them are the U.S. Army Readiness Command at Patrick Air Force Base. A phone call to the Public Information Officer (PIO) at Patrick produced no meaningful information.

### **An Educated Guess**

My opinion is that this receive site is also (in addition to other activities) a NSA "intercept site" manned by Army Security Agency and Air Force Securities and Electronics Command personnel. This, mind you, is only an educated guess.

The Naval Security Group Activity (also

under control of NSA) is located some miles to the south off Card Sound Round on Homestead Air Force Base.

The tall structure at the railroad museum sprouts numerous VHF/UHF antennas. Our source told us that these were in no way related to the activities of the KKN39 receive site. All the systems atop this structure belong to various Dade County public safety operations.

The parabolic microwave dish among this melange of antennas might well serve other purposes other than public safety. No meaningful answer was available as to the exact purpose of the "dish."

It was also noted that while visiting both sites, large scale construction activity was in the beginning stages.

I'm in strong disagreement with the oft-heard belief that monitoring of the common five-digit Spanish frequencies in Miami indicated that these signals were not local and were consistent with a Cuban source.

Certainly some of these numbers signals are of Cuban origination, but other signals definitely originate from various areas of South Florida. Our sources suggest that some five-digit transmissions are part of a clandestine DGI (Cuban Intelligence) net operating from various sites in Dade County as well as counties to the north and south. Other sources indicate various exile groups are responsible for some of the more commonly heard numbers transmissions.

Other contacts tell us that DGI "numbers" station operators have an uncanny knack for staying several jumps ahead of NSA/Miami! Could that really be true?

My guess is that where there is a KKN transmit site, you'll find a "numbers" station nearby. Such is the case with KKN50 at

Remington, Virginia, some fifty miles southwest of Washington, DC.

During our visit we noted no activity on the KKN39 frequency of 13387 and 17413.5 kHz. Our frequency meter, however, indicated activity on 141.000 MHz. Our handheld scanner indicated otherwise. This reading was obtained from the parking lot adjacent to the KKN39 receive site.

But this is not the end of our story. West Coast monitors claim—and very loudly—the existence of another 4956.5 kHz KKN39 site somewhere in California! Daytime signal strength in the San Diego and San Jose areas are said to be overly strong.

Of equal importance would be the exact location of KKN44. State Department claims of Monrovia, Liberia are at best questionable. Harry Helms tells me that his San Diego location, KKN44 is heard as late as 0830 UTC on 7652 kHz. Propagation at that time would rule out Monrovia.

I seem to remember that either 7651 or 7652 kHz was once a Voice Of America feeder frequency from Greenville.

On many occasions over the past months I have heard the KKN44 marker "mixing" with a five-digit Spanish transmission on 11467 kHz at 2100 hours. When the five-digit transmission ceases (after carrier shutdown) no more KKN44!

And do keep in mind, that if you gaze into the distance too long, you miss what is under your nose.

The mystery deepens . . . .

Time now for a Tecate and . . . .

Havana Moon y Amigos.

A special thanks to John Fulford (WA4VPY), Dr. John Santosuosso and Harry Helms. A very BIG THANK YOU to J.I. of the San Jose area of California.



# NEW PRODUCTS

## REVIEW OF NEW AND INTERESTING PRODUCTS



### TELEBELL

The United States Telesis Corporation in Oklahoma introduced their Telebell series of communications products for the home, office and industrial market.

The Telebell turns an ordinary push-button telephone into a multi-use communications device.

It features an electronic telephone converter, using advance technology, which is plugged into a 110 volt line and regular RJ11 modular phone jack and is then used to convert Telebell speaker phones at a door entrance and telephones so that if a person is at the door, any phone in the house can be used to speak with them by simply pressing (\*) on the phone.

Telebell is an excellent advice for screening unwanted visitors, paging employees or receiving deliveries, all done from the convenience of a telephone.

All Telebell Telephone Converters feature third party calling. A third person can be brought into the speakerphone conversation by simply dialing his or her number. An employee working late at the office is "Never Alone" with Telebell.

Other Telebell models feature . . . TRANSFER—speakerphone is forwarded to another telephone number; DOOR STRIKE MODULE—operates an electric door or gate from any telephone; LINE INTERFACE MODULE—for use of Telebell with PBX or key system; speakerphone with lighted activator button, as needed for all in one location.

Telebell products are UL approved and come with a one-year limited warranty on all parts and labor.

Telebell retails for \$299.95 each. For more information, contact United Telesis Corporation, 6488 Avondale Drive, Suite 125, Oklahoma City, OK 73116, or circle 102 on our Readers' Service.

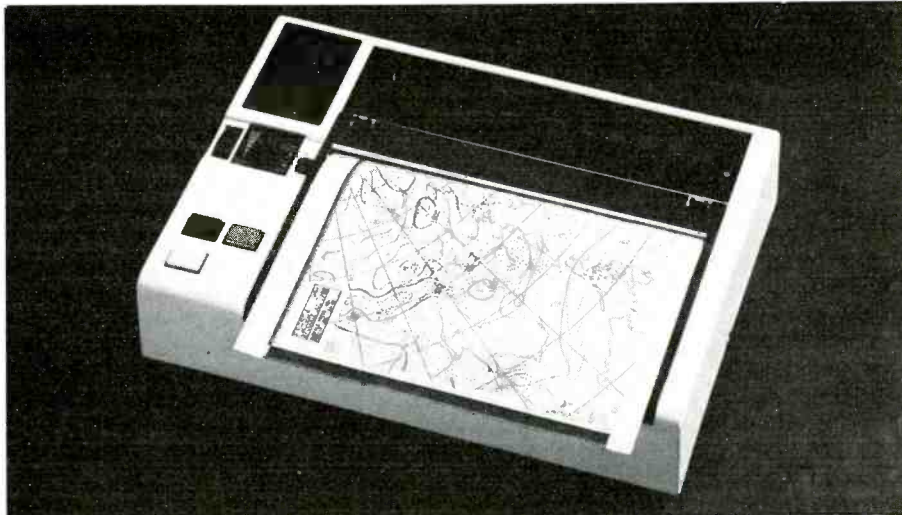

### WX-1000 Radio Facsimile Terminal

ACE Communications, Inc., introduced the WX-1000 stand-alone radio facsimile terminal. The WX-1000 is designed to produce hard copy images from various radio facsimile services including: NOAA weather chart, NFAX, press photo and even satellite weather picture from NOAA, GOES and METEOR, etc. The WX-1000 requires only audio output from a shortwave receiver or

S-band receiver capable of receiving facsimile signals. The built-in high resolution 24 pin thermal printer produces crisp images with high resolution. It is also capable of producing gray scale which is ideal for APT (Automatic Picture Transmission) by weather satellite.

For further information contact ACE Communications, Inc., 22511 Aspan Street, El Toro, CA 92630-6321 or circle 101 on our Readers' Service.

### New From ICOM

ICOM announces the new 440 MHz and 144 MHz dual band mini handheld, the IC-24AT. Demands for compact, lightweight and multi-functional dual band transceivers are increasing. ICOM answers these demands with the IC-24AT, the most compact dual band handheld in the world!

Compact and Sophisticated—The IC-24AT measures only 2.0"W x 5.4"H x 1.4"D and weighs just 12 ounces. The new dual band mini handheld is designed to fit comfortably in your hand and provide you with a variety of the most advanced dual band features.

Five Watt Power Output—The IC-24AT delivers a full five watts of output power at 13.8 volts DC. Reach all those distant repeaters!

Built-in Clock—Be on time for all your scheduled QSO's with the advanced 24-hour clock system with auto power, on-timer and power-off timer functions built-in. The IC-24AT can turn itself on when a pre-programmed time matches actual time and automatically turns itself off which conserves battery life.

Crossband Full Duplex Capability—The IC-24AT's is capable of simultaneously transmitting on the 144 MHz band and receiving on the 440 MHz and vice versa,

acting as a crossband repeater. A convenient feature for telephone-style full duplex QSO's.

Convenient Keyboard and Tuning Control—The IC-24AT easy-to-access keyboard is useful for keying in frequencies, storing a frequency in memory, simplex/duplex selection, scanning activities and many other functions. The top panel tuning control compliments the keyboard aiding in quick switching of memory channels and tuning steps.

DTMF Autodial Memory—The IC-24AT can store and send frequently used telephone numbers (up to 15 digits) at the touch of a button if it is stored in one of the four DTMF code memory channels. No need to push multi-digit phone numbers anymore with the IC-24AT!

The IC-24AT features all this and much more including an external DC power jack, convenient repeater functions, priority watch, plus a variety of scan functions. A kaleidoscope of options are also available for the IC-24AT including the UT-50 CTCSS encoder/decoder unit, and UT-51 CTCSS encoder unit.

For more information, contact ICOM America, Inc., P.O. Box C-90029, Bellevue, WA 98009-9029, or circle 103 on our Readers' Service.

## Here's Your Passport

International broadcasting has never been better. DX conditions are excellent, and lots of stations are crowding the bands begging for your attention. When you combine this with only a fraction of the number frequencies being available for international broadcasters, you can understand why stations are jammed together at 5 kHz intervals instead of the 9 kHz and 10 kHz used on the mediumwave bands. You can appreciate why many frequencies are shared by several stations, sometimes simultaneously. You can also see why a number of international broadcasters have elected to move their operations outside of the edges of the authorized bands and into the relative quiet of bands allocated to non-broadcast services.

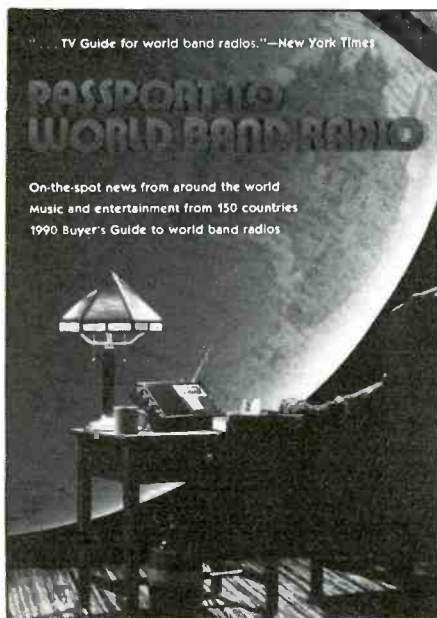

One of the best ways to sort out all of this is with the latest (1990) edition of *Passport To World Band Radio*. This unique book has been issued in a number of previous annual editions, each one reflecting the many changes that have taken place since the previous ones went to press. There have also been various refinements to the methods of presenting the information in order to give it the maximum usefulness and clarity.

Although there are several interesting article features, and also a very thorough and up-to-date buyer's guide to the "world band" radios, in this attractive 384-page book, it is the "blue pages" section that takes up almost half of the volume. This section contains a by-frequency 3310 to 26050 kHz guide to all the channels used by international broadcasters. Each frequency is depicted in a chart form and split into 24 one-

hour grids. You then can quickly look up any frequency and tell which station(s) is/are using it during any given time period, which languages are used, if the frequency is seasonal, if it is jammed, plus other useful information. This is the main reason you'll want to have a copy of the 1990 *Passport To World Band Radio*, and it's well worth having in order to access these frequency-use tables.

*Passport To World Band Radio* is your information source to understanding the activity status of each international broadcast channel. A fine reference book put together by Larry Magne and his staff that has carved itself a yearly niche on the shelves of broadcast listeners.

Published at \$14.95 by International Broadcasting Services, Ltd., Box 300, Penns Park, PA 18943, the book is widely sold by leading shortwave stores and mail order suppliers.

## Early Broadcasting

*The Early Days of Radio Broadcasting*, by George H. Douglas, is a scholarly 256-page hardcover book on precisely how and why radio developed as it did. This book, which contains 30 photos, illustrations, a bibliography, and an index tells its story with depth and considerable authority, the author being a professor at the University of Illinois (Urbana-Champaign).

This history concentrates on the years between 1920 and 1930 in the United States when the medium was rapidly forming and expanding. It covers all important areas in the development of the radio industry: business programming, government regulation, finance, the manufacturing of radio receivers and other equipment, the development of technology, the establishment and rise of networks, and the flowering of radio as a medium of entertainment and news.

Many stories and anecdotes of how radio affected the fortunes of politicians, musicians, actors, educators, sports personalities, advertisers, and how it created its own heroes in the form of sportscasters, announcers, and newscasters; how it boosted the careers of many vaudeville performers and actors, paving the way for the creation of radio characters such as *Amos n Andy*, *The Goldbergs*, *Myrt and Marge*, and many others.

Author Douglas devotes a chapter explaining the "radio craze" of the early 1920's, when the new fad swept across the nation and it was considered "in" to be able to one-up your friends by telling them how much more DX you could pick up at night on your receiver than they could on theirs. He then devotes another chapter to the

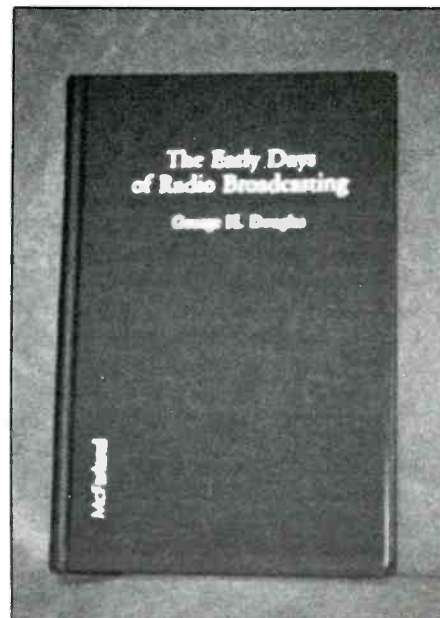

rowdy early early broadcasters themselves and their squabbles over certain prized frequencies and how they defied and fought against the government's early attempts to assign them on frequencies they found to be less than optimum for their operations. There was a lot of in-fighting.

*The Early Days of Radio Broadcasting* is \$25.95 plus \$1.50 shipping/handling from McFarland and Co., Box 611, Jefferson, NC 28640. Residents of NC add \$1.30 sales tax.

Broadcasting's history has, of course, been told many times. Still, Prof. Douglas' brings it into lively and interesting focus and offers a book that makes for good reading for those of us who love the medium.

## Ultimate Aero

There's an all-new 5th Edition of the popular *Air-Scan Guide to Aeronautical Communications* just out. This is a gigantic compilation of aeronautical communications frequency and station information containing about 65,000 listings. It's the largest single source of aeronautical station and frequency data yet assembled and has roughly 60% more listings than the previous edition. In this case, there are now 192 large-size pages of data enclosed in an attractive full-color cover.

This new edition of Tom Kneitel's guide, brings into sharp focus every aspect of HF and VHF aero monitoring, leading off with useful on monitoring the aircraft and ground stations. It then gets into the listings, with state-by-state listing of landing areas (civil, military, private, and even "unlisted" ones) in the 118 to 137 MHz band; control towers,



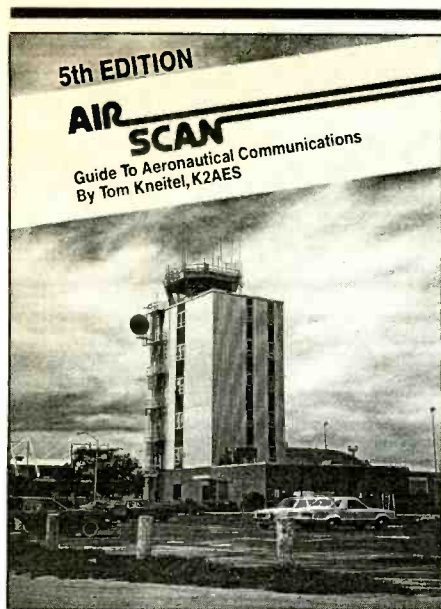

unicoms, approach and departure, ground control, clearance delivery, ATIS, etc. There are also frequencies for aero enroute (airline "company") frequencies, airport security, ground transportation, fire/crash, air cargo, air ambulances, flying schools, agri-air, federal agencies, aircraft repair and ground services, airline ground operations, and many other categories—including those in the 30 to 50, 138 to 174, 406 to 512, and 800 MHz bands in the U.S.

The 5th Edition of *Air Scan* lists all FAA, Canadian, and Mexican Air Route Traffic Control Centers with their remote sites, a glossary of communications terms, "frequency file" listings for VHF/UHF, a special section on frequencies for recreational aviation (gliders, hot air balloons, ultralights, hang gliding, parachuting, etc.), plus other special sections.

In addition to the airports in the USA (including Puerto Rico and the Virgin Islands), all land and seaplane landing areas having radio communications in Canada are also listed (the previous edition carried only selected airports in Canada). Furthermore, additional listings are given for Pacific Territories, Caribbean areas, Mexico, Greenland and other North Atlantic areas.

HF listings for North America show airline operational, military, VOLMET, FAA, blimp, petroleum, CAP, Customs Service, hurricane hunter, ICAO and many other useful frequencies.

Many HF/VHF "unlisted" frequencies are included for various facilities, keeping this the one, essential monitoring guide to HF and VHF aero communications for all monitors throughout North America.

The new 192-page 5th Edition of *Air Scan* is \$14.95, plus \$2 postage to addresses in USA/Canada/APO/FPO. residents of NY State, please include \$1.13 sales tax. It's published by CRB Research Books, Inc., P.O. Box 56, Commack, NY 11725. Your favorite communications dealer may also carry this book.



# Now Available!

The Second Annual



## Amateur Radio 1990 Equipment Buyer's Guide



### The Active Ham's Complete Annual Reference Master

This enlarged and improved master directory and buyer's guide will serve you day in and day out in searching out new gear, comparing new models, locating dealers near you and mail-order retailers around the country. It'll help you buy more wisely with its multi-reference concept to help you wend your way through the buying maze.

### COMPLETE PRODUCT INFORMATION

It's a single-volume source book of the latest Amateur Radio gear all sectionalized by equipment type for easy reference by CQ's seasoned editorial staff:

- Complete product descriptions.
- Technical specifications.
- Retail prices.
- Equipment photographs.

### WHO'S WHO IN THE AMATEUR RADIO BUSINESS

It's a Buyer's Guide filled with the kind of support information you've always needed, but couldn't easily get: Dealer listings state-by-state (including branches), names and calls for key personnel, top lines carried, whether or not trade-ins are accepted or on-site repairs are made . . . and so on.

### BUYING TIPS FROM THE EXPERTS

Great articles on the in's and out's of purchasing Amateur equipment. The experts give you the inside scoop on everything from antennas to transceivers to making your first packet contact . . . and lots more.

### ORDER YOUR BUYER'S GUIDE TODAY!

Don't miss the single most valuable buying guide in the Amateur Radio field. Send only \$4.95 today. Foreign: \$6. U.S. funds. Foreign orders are payable in U.S. funds only by check drawn on a U.S. bank, or by U.S. Postal Service Money Order.

YES, please send my copy of 1990 EQUIPMENT BUYER'S GUIDE for only \$4.95 postage paid.

Date \_\_\_\_\_ Number of Copies \_\_\_\_\_

Name \_\_\_\_\_ Call \_\_\_\_\_

Address \_\_\_\_\_

City \_\_\_\_\_ State \_\_\_\_\_ Zip \_\_\_\_\_

Check  MasterCard  VISA

Card No. \_\_\_\_\_ Expires \_\_\_\_\_

Signature \_\_\_\_\_

(Signature required on all charge orders)

Mail to: CQ Communications, Inc.  
76 North Broadway, Hicksville, NY 11801



HMS BRAZEN (F91), a BROADSWORD class frigate completed in 1982. (Photo courtesy British Royal Navy)

# The British Royal Navy

## *DX'ing this far-flung military force!*

BY PATRICK O'CONNOR

**F**rom the defeat of the Spanish Armada in 1588 to the present, the British Royal Navy (BRN) has stood out as one of the world's finest fighting forces. At the peak of its power, the Royal Navy protected the far-flung British Empire, was instrumental in obtaining victory in two World Wars, and helped develop advanced Naval weapons still in use today.

In recent years, the BRN has undergone a change in mission. With the dismemberment of the Empire, the mission has become one of fitting into the NATO alliance, standing ready to oppose Warsaw Pact aggression. Gone are the big-gun capital ships of the past; in their place floats a leaner, more efficient fighting force dedicated to the preservation of peace.

Despite the smaller size, the BRN is the

third-largest naval force in the world (the Soviet & U.S. Navies are larger), and the last to see major combat action (in the Falklands Islands War).

Combat ships of the BRN fall into three broad categories: submarines (both ballistic-missile and hunter/killer types); anti-submarine warfare ships (destroyers and frigates) and three small aircraft carriers.

As with any military force that operates away from home, the BRN needs an ability to communicate between remote locations and the headquarters back home. These days, most such comms take place either by satellite or encrypted RTTY. Very little message-type CW or SSB is heard on BRN frequencies.

So, you might well ask, how can I manage to log BRN comms? With a little effort,

you should be able to log AND verify both ships and shore stations!

Being away from home for extended periods, the crews of British warships tend to miss their families. To keep up morale, ships often make ship-to-shore radiotelephone contact with Portishead Radio in England to allow these men to talk to their families.

The transmissions are of the normal ship-to-shore variety. They take place on duplex channels, with Portishead on the higher of the paired frequencies (see chart). These comms are 'in the clear' (unscrambled) and in English.

Once initial contact is established, the ship identifies as "Warship . . .", so unless you manage to catch the original contact, you probably won't hear the ships callsign.

On occasion, Portishead may have the



### Portishead Radio, England – Paired Frequencies

Call	Channel	Ship	Shore
GKT22	402	4066.1	4360.5
GKT26	406	4078.5	4372.9
GKT20	410	4090.9	4385.3
GKV26	426	4140.5	4434.9
GKT42	802	8198.1	8722.0
GKU46	816	8241.5	8765.4
GKU49	819	8250.8	8774.7
GKV42	822	8260.1	8784.0
GKV46	826	8272.5	8796.4
GKW41	831	8288.0	8811.9
GKT51	1201	12330.0	13100.8
GKT52	1202	12333.1	13103.9
GKT56	1206	12345.5	13116.3
GKV54	1224	12401.3	13172.1
GKV58	1228	12413.7	13184.5
GKV50	1230	12419.9	13190.7
GKW52	1232	12426.1	13196.9
GKT62	1602	16463.1	17236.0
GKT66	1606	16475.5	17248.4
GKU61	1611	16491.0	17263.9
GKU65	1615	16503.4	17276.3
GKU68	1618	16512.7	17285.6
GKV63	1623	16528.2	17301.1
GKW62	1632	16556.1	17329.0
GKW67	1637	16571.6	17344.5
GKW60	1640	16580.9	17353.8
GKT76	2206	22015.5	22611.5
GKU72	2212	22034.1	22630.1
GKU74	2214	22040.3	22636.3
GKU70	2220	22058.9	22654.9
GKV77	2227	22080.6	22676.6
GKV79	2229	22086.8	22682.8
GKX70	2240	22120.9	22716.9

ship move to a different channel. Portishead channels are identified by the last letter and numbers (See chart); thus GKV54 would be "Victor fifty-four". On rare occasions, Portishead may have the ship move to a frequency outside the normal channels if conditions on the band are crowded and/or very noisy.

Verifying British warships can be done. To simplify matters, there is only one address for any BRN ship:

HMS "... " (Hull #)  
 ATTN: Communications  
 BFPO Ships  
 London  
 ENGLAND

Remember that these conversations are of a personal nature. Follow normal utility reporting guidelines: report only the identifications of the stations in contact, NOT the message content. Be sure to send a PFC (prepared-form card) with your report; these ships don't have their own QSL cards. Also, reply postage in the form of mint British stamps or a couple of IRC's should be included. On occasion, you might get a 'goodie' with your QSL - a ship photo or informational pamphlet, or a letter from the Captain or Communications Officer.

There are a few BRN shore stations that

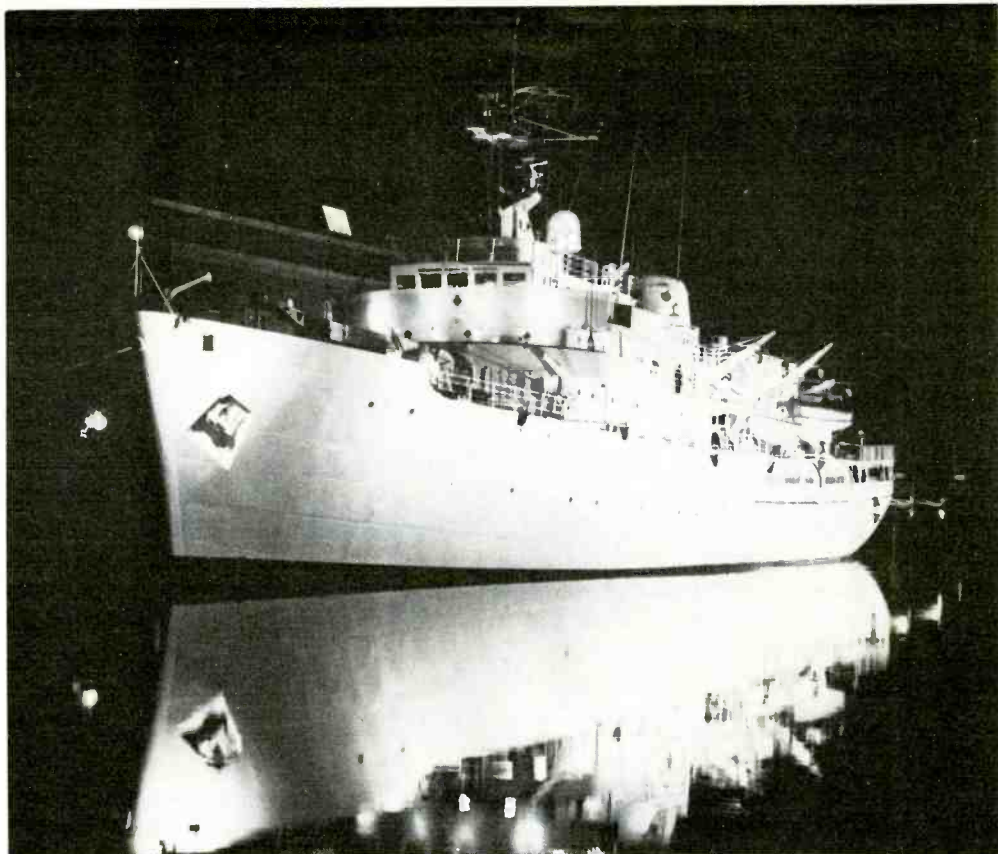

HMS HECLA (A133), one of Britain's small fleet of ocean survey ships. The data collected by these ships is of interest to mariners the world over. (Photo courtesy British Royal Navy)

### List Of British Warships

#### Aircraft Carriers

Ark Royal (R07)  
 Illustrious (R06)  
 Invincible (R05)

#### Destroyers

Birmingham (D86)  
 Cardiff (D108)  
 Edinburgh (D97)  
 Exeter (D89)  
 Glasgow (D88)  
 Gloucester (D96)  
 Liverpool (D92)  
 Manchester (D95)  
 Newcastle (D87)  
 Nottingham (D91)  
 Southampton (D90)  
 York (D98)

#### Assault Ships

Fearless (L10)  
 Intrepid (L11)

#### Seabed Operations Vessel

Challenger (K07)

#### Survey Ships

Beagle (A319)  
 Bulldog (A317)  
 Fawn (A320)  
 Fox (A320)  
 Hecla (A133)  
 Hecate (A137)  
 Herald (A138)  
 Roebuck (A130)

#### Frigates

Achilles (F12)  
 Active (F171)  
 Alacrity (F174)  
 Amazon (F169)  
 Ambuscade (F172)  
 Andromeda (F57)  
 Arethusa (F38)  
 Argonaut (F56)  
 Argyll (F232)  
 Ariande (F72)  
 Arrow (F173)  
 Avenger (F185)  
 Battleaxe (F89)  
 Beaver (F93)  
 Boxer (F92)  
 Brave (F94)

#### Frigates

Brazen (F91)  
 Brilliant (F90)  
 Broadsword (F88)  
 Campbelltown (F86)  
 Charybdis (F75)  
 Chatham (F87)  
 Cleopatra (F28)  
 Cornwall (F99)  
 Coventry (F98)  
 Cumberland (F85)  
 Danae (F47)  
 Euryalus (F15)  
 Hermione (F58)  
 Juno (F52)  
 Jupiter (F60)  
 Lancaster (F233)  
 London (F95)  
 Marlborough (F231)  
 Minerva (F45)  
 Norfolk (F230)  
 Penelope (F127)  
 Phoebe (F42)  
 Plover (F240)  
 Scylla (F71)  
 Sirius (F40)



HMS ANDROMEDA (F57), a missile-armed LEANDER class frigate on patrol in the Persian Gulf; note the large number of radio and radar antennas on board. (Photo courtesy British Royal Navy)



HMS GLOUCESTER (D96), one of the 'Batch three Type 42' destroyers coming off a hard turn; note the extra anchor on the fore-deck below the bridge. (Photo courtesy British Royal Navy)

# Organize and Protect Your Copies of **POPULAR COMMUNICATIONS**

Now there's an easy way to organize and keep copies of your favorite magazine readily available for future reference.

Designed exclusively for PC by Jesse Jones Industries, these custom-made titled cases and binders provide the luxury look that makes them attractive additions to your bookshelf, desk or any location in your home or office.

Whether you choose cases or binders, you'll have a storage system that's durable and well organized to help protect your valuable copies from damage.

Popular Communications  
Jesse Jones Industries, Dept. P-Com  
499 East Erie Avenue, Philadelphia, PA 19134

Please send \_\_\_\_\_ cases; \_\_\_\_\_ binders  
for Popular Communications Magazine.

Enclosed is \$ \_\_\_\_\_.

Charge my: (Minimum \$15)

American Express  Visa  
 MasterCard  Diners Club

Card # \_\_\_\_\_ Exp. Date \_\_\_\_\_

Signature \_\_\_\_\_

Charge Orders: Call TOLL FREE 7 days, 24 hours 1-800-972-5858

Print Name \_\_\_\_\_

Address \_\_\_\_\_  
No P.O. Box Numbers Please

City/State/Zip \_\_\_\_\_

PA residents add 6% sales tax

Quantity	Cases	Binders
One	\$ 7.95	\$ 9.95
Three	\$21.95	\$27.95
Six	\$39.95	\$52.95

**Add \$1 per case/binder postage  
and handling. Outside USA  
\$2.50 per case/binder. (U.S.  
funds only.)**

**SATISFACTION GUARANTEED**

are heard with CW marker signals. These are:

GYA/GYC- London  
GZU- Petersfield  
MTI- Plymouth  
GYU- Gibraltar  
MGJ- Faslane  
MTO- Rosyth, Scotland

Occasionally heard on SSB is GXW, Portland Naval Air Station, usually on 8993 kHz, USB. It should be noted that some of these stations are rarely heard these days, and count as good DX when you do hear them.

As with the ships, there is only one address for the shore stations:

Royal Navy COMMCEN Operations  
Old Admiralty Buildings  
Spring Gardens  
Whitehall  
London SW1A 2BE  
ENGLAND

As with the ships, be sure to enclose a PFC and return postage.

Remember that you are dealing with a military service that has certain security considerations. Thus, be circumspect in the details you ask for. Data such as transmitter power, antenna type or ship location may be classified. On occasion, you might receive a, "Sorry, but we can't honor your request" type letter. If this happens, don't be discouraged. If you happen to hear the ship again at a later date, you can always try again. Missions and security considerations can change with time.

The list of British warships is complete as of July 1988. Changes may occur with the passage of time, with ships being added to or deleted from active service. The letter/number combination after the name is the hull number, painted on the side of the ship to facilitate identification. (Submarines and minor ships aren't included with the list, as neither has ever been noted on HF).



## Communications In The World Of Emergency Services

**D**ave Laurich is the Emergency Medical Service (EMS) co-ordinator for the village of Western Springs, IL. The job of EMS Technicians came into effect after the Vietnam War, when the U.S. Army found it necessary to have doctors in the field. Since the doctor was on the scene within seconds, the patient had immediate first-aid which was vital to the survival of the injured party.

This interview will give you insight as to what an EMT (Emergency Medical Technician) does and what kind of communication products are necessary. SCAN was able to catch up with Dave at the fire department on one of his 7am—7am, twenty four hour shifts.

*SCAN: How did you get interested in being an EMT?*

Dave: hereditary. A family line. My father was a fireman and he rode the ambulance for many years. From the time I can remember I always wanted to be a fireman.

*SCAN: Can you describe for us your duties?*

Dave: My duties here for the Village of Western Springs are that of EMS co-ordinator. I am responsible for all EMS activities; the training and re-training of staff, continuing education, recertification and I also serve, as do all other paramedics, as code enforcers and firefighters. So our job is three-fold. Besides that, each one of our staff is designated a certain responsibility in the the Village. Some are computer experts, others are vehicle maintenance, air-pack maintenance, the repacking of equipment on the fire trucks, and each full-time staff member has a different responsibility when not out on duty.

*SCAN: What kind of communications products do you use?*

Dave: Our communications products.

We'll start with our car systems. In all of the vehicles there are Motorola four frequency radios with fire, NIFERN (Northern Illinois Fire Emergency Radio Network) which is the mutual aide band that allows communications between different fire departments when there is a large disaster, with need for more than one department, mercy—which is used to talk with the doctors at the hospital for advise about medication. We also carry in our units a DPW (Department of Public Works) frequency as a backup to the fire frequency so we can get off and talk without tying up the fire band. Our base station is Motorola. We also have telemetry capabilities and an eight channel Apcore Motorola white box that is used for our paramedic, or telemetry contact with the hospital. When we're on a paramedic run where we do a typical set up, we start iv's, monitor the heart, etc., we talk on the telemetry radio because it is taped at the base station. But if the emergency isn't that serious, we'll use mercy, which isn't taped. One reason we use Telemetry radios is that they are on an ultra-high band that gives us the capability of not having everybody being able to listen in. Obviously, if you have a programmable scanner, you could program it in. But not everybody can listen in on that and also it is a sole frequency, which doesn't allow bus companies to use it for their communications. The fire and NIFERN bands are the same way. We also have cellular phones. Here in the fire department, we have a phone in the Chief's car, and we'll be getting one in our main response ambulance. The cellular phone will act as a backup to our white telemetry radio. Also, they're (the doctors) showing us more of what we are having to do in the field as far as stabilization of a patient goes. One of the things the doctors are going to want us to

perform is a 12 EKG (Electro Cardio Gram) in the field and then transmit that frequency to the hospital. Basically, you're going to need a cellular phone system to do that, so we're anticipating and planning to to equip our ambulances with a phone. All of these communications products in the ambulance will be used as a command post during a large scale disaster.

*SCAN: Do you use scanners and what kind of features do you find helpful?*

Dave: Personally, it's hard for me to use a scanner to listen to the fire band, but I do turn my pager on when I'm at home to listen to the calls. In the firehouse, it's not unusual to see guys walking around with their pagers. We have a Bearcat in the watch office that is almost always on with someone listening. On a slow day, we sit and listen to hear what is going on. To stay in touch with the community, we scan the police department. If we hear there is a car accident, we can get a jump on it just by listening. The feature we find useful is definitely the scan. On our Motorolas in the ambulance, we scan eight frequencies and still if the fire band was to have a communication for us, we can freeze it. As soon as the fire dispatcher presses their button to transmit, the radio automatically locks in on the fire frequency.

As you can tell from what Dave Laurich has told us in the above article, communications plays a major role in the emergency rescue business. But if it were not for Dave going to his follow up classes every month, or if ordinary people were not taking life-saving CPR courses, all the communications products you have just learned about would be of relatively small importance.

Western Springs EMT, Dave Laurich.

The communications center of the Western Springs firehouse.



# Making The Best Of A Mobile SWL Antenna

BY PETER O'DELL, WB2D

**M**y wife says that I'm a homebody, because I really do not enjoy driving or going places. If left alone, I'd stay home and play with my radios and computers. Unfortunately, three or four times a year, I'm roped into making long trips in the car. The only sight that I'm interested in seeing is my destination as quickly as possible.

Years ago, I tried mobile ham radio operation (HF) with a Drake TR4-C, which had tubes and required a separate power supply. It worked okay, but it was bulky, and the tubes produced a lot of heat for a car that wasn't air conditioned. And it only covered the ham bands, so there wasn't much to do if those bands were closed or boring. About a year ago, I acquired a Kenwood TS-680s that has a general coverage receiver built in. It's small, solid-state (very little heat and it operates on 12V) and the receiver covers everything from the AM broadcast band up through 33 MHz.

Well, maybe traveling wouldn't be quite so bad. One of the things that I noticed quickly is that mobile antennas are very narrow—they only work well on frequencies near the one they are tuned for. Outside that range, transmitting becomes impossible, and reception is pretty bad, too.

The solution to the transmitting problem was obvious to me since I'd used it for all sorts of "problem" locations, like apartments where outside antennas were prohibited. I'd always been able to get some sort of signal on the air with an antenna tuner. Properly tuning a tuner requires a transmitted signal, and I hear the FCC takes a dim view of tuning up outside the ham bands. You can tune for received signal strength, but that's real hard to do on the weak ones.

## Bridge Over Troubled Frequencies

Then I noticed that MFJ has an inexpensive antenna bridge (MFJ-204B). It's small and relatively inexpensive (about \$80). Ah, that looked like the solution to my problem, and it was. If you want to use the MFJ-204B to tune an SWL antenna to some frequency other than the resonant one, you'll need to hook it up as shown in Fig. 1. An antenna switch isn't absolutely necessary, but it sure is convenient. Without it, you'll have to swap the coax cable back and forth for each different frequency you want to listen to. If you don't want to bother making up your own jumper cables, you can buy them

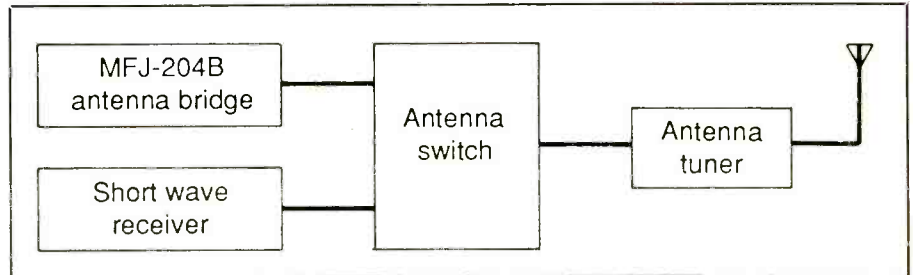

Fig 1. Block diagram for properly connecting the MFJ-204B antenna bridge. The antenna switch is an MFJ-1702 or equivalent, and the tuner is the MFJ-945C or equivalent. Ready-made patch cables are available from Radio Shack (see text).

ready-made from Radio Shack (278-968).

One thing that makes this whole process very simple is that you only have to do it once for each frequency, unless you switch antennas or move the antenna to a different location on the vehicle. Just make up a chart like the one in Fig. 2. As you tune the tuner for each frequency, just mark down the settings. Then when you want to listen there in the future, just use the chart to obtain the proper settings.

Using the MFJ-204B couldn't be simpler. Once it is hooked up to the tuner and antenna or switched to it, set the resistance scale

to 50 ohms. MFJ calibrates each unit before shipping and places a tag on the back that notes the 50-ohm setting. In my case, it was half-way between "C" and "D". Set your receiver on the frequency that you want to listen to. Set the MFJ-204B to the proper band as indicated by the frequency range on the face. Now rotate the "Tune" knob until you hear a real loud carrier on the receiver. Tweak the "Tune" knob for maximum reading on the receiver S-meter.

Now you are ready to tune the tuner. Most tuners like the MFJ-945C shown in the picture have three tuning controls—two ca-

Tuner Setting Chart					
	Frequency	Antenna Used	Transmitter	Inductance	Antenna
1.					
2.					
3.					
4.					
5.					
6.					
7.					
8.					
9.					
10.					

Fig. 2 Tuner setting chart. Use this chart or make up your own. Once you know the proper settings, you can tune the antenna for any frequency in a matter of seconds.



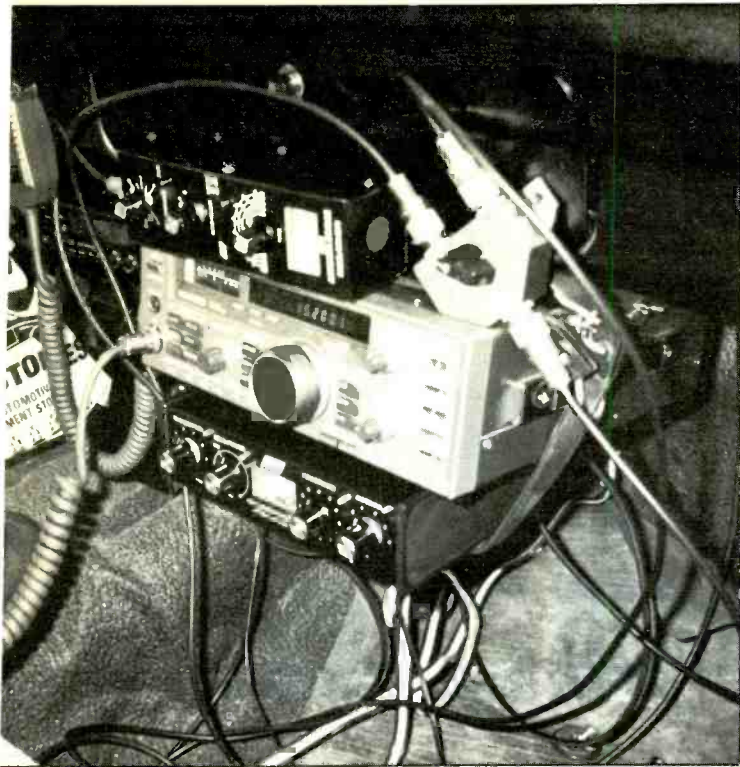

The TS-680s installed in the truck with the MFJ-204B, the switch, and the tuner. After finding and recording the tuner settings for all the frequencies you will be using, the MFJ-204B and the switch can be removed from the set up.

The Kenwood MA-5 installed on the truck bumper. It tilts out and back from the truck body and cap.



capacitors and a coil. (The other knob and switch are for the built-in SWR bridge.) Set the two capacitor controls, which are usually located on the outside edges of the tuner, to mid range. Adjust the inductance knob for a minimum reading on the MFJ-204B (antenna bridge) meter. When you find the setting that produces the lowest meter reading, note it on your chart. Now rotate the two capacitors (marked "Transmitter" and "Antenna" on the MFJ-945C tuner) for the lowest meter reading. These controls may interact somewhat, so tweak them alternately. When no further reduction in meter reading can be obtained, note the control settings on your chart.

You'll probably find that a ham antenna tuned for a frequency near the SWL band that you want to use works best, but they are more expensive than, say, a full-length CB whip. I used the Kenwood MA-5, which consists of wire wound on the outside of a fiberglass whip and covered with heat-shrink tubing. There's a different resonator section for each band. So I used the 20-meter resonator for listening to the 19-meter short wave band, for instance.

That's all there is to it for successful mobile listening. A properly adjusted antenna tun-

er will make time fly, even if you can't, on that next trip.

### CB And Tuners, Too

A couple of months back, I had to make a long trip in my pickup truck. Since I was going to be traveling alone, taking the radio along was a must. I wanted to keep it as simple as possible, so I didn't bother with the tuner at first, figuring that I would stay in the ham bands. Well, the SWR was almost 2:1 at the best spot. After looking at the situation, I figured out what was wrong. The antenna was located too close to the truck body and cap, and that was causing the SWR to be too high.

Most bumper mounts allow some adjustment to the angle of the antenna. Tilting the antenna out and back away from the truck body brought the SWR down to about 1.5:1. When I put the tuner in line, it was easy to drop the SWR down to 1:1.

A few weeks later a good friend of mine was complaining because his new camper didn't have a place for mounting a CB antenna. He'd tried the back bumper, but the radio wouldn't work right. My experience with the truck came to mind immediately.

The first thing we did was to put a whip on the rear bumper. We mounted it right on the very outside edge of the bumper and tilted it back and out. At the top of the camper, the antenna was about 3 feet back from the camper, and it was sticking out about a foot from the side of it. I admit, it did look a little "funny," but what the heck, it worked. It was very unlikely that it would strike anything as my friend drove along. By letting it stick out from the side like that, it made it easier to pick up signals from the forward direction of the camper. After all, that's where Smokey can do the most damage!

We finished the installation off with an antenna tuner. It was easy to get the SWR down to 1:1. A little informal testing showed that it worked better than any of the short antennas that he had tried, and it was less likely to strike anything as he drove along.

Hams have been using antenna tuners for years. They'll work just as well for SWLing or CB. For CB, all you need is an SWR bridge to adjust it for the lowest SWR. For SWL'ing, you may need the MFJ-204B antenna bridge to get the best results. We've been talking about mobile installations, but tuners work just as well in base station applications.

PC

# Red Cross Broadcasts

## Here's How To Tune Them In

BY GERRY DEXTER

**S**pring 1945. Europe is devastated by war and struggling to simply get back on its feet. 700 Frenchmen, liberated by the Allies are on a train, winding their way through Switzerland on an agonizingly slow trek home. Disruptions and chaos surround them. It may be days before these newly-freed men and women get home to their loved ones.

The Geneva-based International Committee of the Red Cross learns of the plight of the 700 French. Officials of the organization ask for and receive air time from what was then Radio Geneva and go on the air to broadcast the names of the people on the train so that their families, who knew nothing of their status, would know they were alive and on their way home.

That historical program was, in a sense, the beginning of the broadcasting service of the International Committee of the Red Cross, a unique radio service even today.

Back in 1945, with the war reaching its end, there were thousands of political prisoners who were tasting freedom for the first time in years. But transport problems and other difficulties meant long delays before their freedom could be enjoyed in their own homes. Families were desperate for news of missing friends and relatives. Radio stations in countries formerly occupied by the Nazis were either destroyed or ill-prepared for handling anything more than they already had. As a result, the broadcasts of the ICRC continued past that first program and in the months and years to follow, the Red Cross broadcasted the names of hundreds of thousands of released political prisoners who were waiting to go home. Swiss Radio, whose facilities were being used for the programs, allowed the ICRC more and more time, until the ICRC was on the air for twelve hours a day, seven days a week. By the end of 1948, when things finally began to settle down, the ICRC had broadcast more than 600,000 names in 17 languages.

But even during the war the ICRC had aired weekly news reports on its activities in all corners of the world. After the war, these programs continued to inform listeners of the many tasks still waiting to be done. Despite its wartime experience with broadcasting, the ICRC didn't really come to terms with the vast potential of radio until it got into the prisoner name game. Once the ICRC became aware of the enormous potential for good that the broadcasts offered, thoughts



*RCBS studios are in the ICRC's headquarters building in Geneva, Switzerland.*



*RCBS producer Nicolas Sommer gets set to do a program.*

were directed towards trying to find a way through which the Committee could broadcast on a more consistent, permanent basis.

We've heard much about the World Administrative Radio Conference meetings held in 1979 and 1984. It was at such a meeting in Mexico City, in 1948, that the mold was formed for the ICRC's continuing radio activity. The Swiss government delegation advanced the case for a frequency assignment for the International Committee of the Red Cross. Approval for the idea was granted and the ICRC remains the only international humanitarian group in the world to have been assigned its own radio frequencies for international broadcasting.

Originally, the idea was that such a service would be needed in the case of another war. The ICRC could envision a repeat of the World War II situation in which information about prisoners of war would have to be broadcast. With that in mind, the ICRC started transmissions in 1951 on a test basis to see how far the broadcasts could be received. No tones or segued music with announcements made up these tests, they were actual programs dealing with the work of the ICRC.

In Switzerland, international broadcasting transmitters are not owned or operated by Swiss Radio International, but rather by the Swiss Posts, Telegraphs and Telecommunications. It was this organization which granted air time in a bi-monthly basis for broadcasting to Europe, the Middle East and the Americas beginning in 1965.

As the ICRC geared up for a more active, more frequent broadcasting effort, studios were built within the large building housing the ICRC in Geneva. More timely reports



*A program is taped in the RCBS studio.*

### **Red Cross Broadcasting Service – English Transmission Schedule**

To Americas:

1st and 4th Tuesdays and Fridays at 0310–0327 UTC on 6135, 9725, 9885 and 12035.

To Australia:

1st and 4th Mondays and Thursdays at 0740–0757 on 9560, 9885, 11695 and 17830.

To Asia:

1st and 4th Mondays and Thursdays at 1040–1057 on 11935, 15570, 15585 and 17830.

To Asia:

1st and 4th Mondays and Thursdays at 1310–1327 on 11955, 15570, 17830, and 21695.

To Europe:

1st and 4th Sundays at 1100–1130 on 7210.

1st and 4th Mondays at 1700–1730 on 7210.



on ICRC's work, activities and goals could now be included in the programs.

The Swiss PTT allowed the initiation of broadcasts directed to Asia and Africa in 1971. That same year the name "Red Cross Broadcasting Service" was adopted. By 1978 the broadcasts had become monthly rather than every other month.

Decisions as to how many hours for broadcasting will be available are made by the Swiss PTT, not by the Committee. At present, the Red Cross is on the air for a total of only 78 hours per year! While the ICRC might like to have more time available for programming, the Committee recognizes that any such additional time does not automatically translate into better programs. The broadcasting staff at the ICRC is very small, studio facilities and budget are limited.

At present, the ICRC broadcasts in English, French, German, Spanish, Arabic and Portuguese. Every effort is made to keep the programs lively and informative. Listeners are encouraged to mail in questions about the Red Cross and its work. Wherever possible, these questions are answered on the air.

As mentioned, the ICRC radio staff is small, amounting to just one producer and studio technician. Other ICRC staffers are called upon to help out and some professional journalists also work on a part time basis. The programs deal with the work of the International Committee, whose principal task is to protect and assist victims of conflict. Coverage is also given to the League of Red Cross Societies, which coordinates relief to victims of natural disasters and to national Red Cross and Red Crescent groups. Interviews, on-the-scene reports, news briefs and answers to listeners questions make up the programming format.

In May 1984, several changes were made in the broadcast line-up. Broadcasts to Africa and Asia were increased to monthly, a monthly broadcast in Spanish to Latin America was added, Arabic to North Africa and the Middle East was moved to Friday and programs for Europe in English, French, German and Spanish were moved to the last Sunday of each month with a re-

peat broadcast the following day.

Transmitter time is provided to the ICRC by the Swiss Posts, Telegraph and Telecommunications at no cost. The transmitter at Schwarzenburg is used for directional broadcasts, the units at Beromunster are used for non-directional broadcasts.

The International Committee of the Red Cross welcomes reception reports at 17 Avenue de la Paix, CH-1211, Geneva,

Switzerland. Correct reports will be confirmed by QSL card.

Knowing its history, its aims and goals, one must come to the conclusion that the last word in the name Red Cross Broadcasting Service must have more meaning to it than that of some other stations who use the word in their names.

Check the RCBS schedule and tune in Red Cross Radio. **PC**



The Red Cross confirms reports with this attractive QSL card.



## The Best\* Just Got Better!

The Eavesdroppers™ now includes our new Zap Trapper™ Electronic Gas Tube Lightning Arrestors. Receive-only design shunts damaging transients to ground at only 1/7th the voltage buildup of the available 200 watt transmit-type arrestors, providing maximum solid state receiver protection.

Protect your investment - combine an excellent shortwave receiving antenna with the best receiver protection money can buy.



- Completely assembled and ready to use
- Only 42" overall length
- 3 trap circuits permit reception on all shortwave bands, 11-90 meters
- All connections soldered and enclosed in ultrasonically-welded, hermetically-sealed trap covers
- Includes 50' of 450 lb. test nylon rope

**Model T** includes 100' twinlead feedline

**Model C** includes weatherproofed center connector for your coax & coax sealant

- Either model \$79.95
- UPS for lower 48 states \$4.00
- COD add \$3.00, IL add 7% sales tax
- Foreign shipping quoted

\* "The best...built like an antenna should be." -Larry Magne in *World Radio TV Handbook*.

"Our best seller." -EEB in their recent ads and catalogs

"Now in use in 45 countries." -Giffler Shortwave in 1983

### Antenna Supermarket

PO. Box 563 Palatine, IL 60078 Tel (708) 359-7092 Fax (708) 359-8161

At your dealer or direct • Visa & Mastercard accepted

Please send all reader inquiries directly.



## 27 MHz COMMUNICATIONS ACTIVITIES

**M**obile users were obviously the people Cobra had in mind when they came up with their new line of *Weather Radio* CB's, including one with a front-mounted speaker.

The new Cobras feature a front-panel switch for selecting three NOAA weather frequencies, which are received via the CB antenna used with the equipment. The marriage of a CB transceiver and a weather radio is certainly one of convenience to the mobile user, especially since (during severe weather) the NOAA broadcasts mention weather-related travel problems.

The Cobra Model 18RV not only has the weather channels, it also is unusual because it's a mobile unit with a front-firing speaker. Mobile rigs traditionally have had speakers mounted in the bottom in order to save space on the front panel and keep it as small as possible. But while bottom-mounted speakers have served one purpose, they also managed to limit the number of ways a mobile rig could be mounted and installed. A front speaker enables easy installation beneath a car or truck seat as well as custom mounting into dashboards or overhead instrument panels in off-road and RV's and in pickups and trucks without the need for accessory speakers or cutting extra speaker openings in order to achieve audio clarity.

The Model 18RV also has an "instant Channel 9" button and a five-segment LED S/RF meter. The MSRP of this unit is \$129.95. Another new weather channel CB in this family of transceivers is the Model 23-PLUS, with electronic tuning, LED channel display, S/RF meter, and Channel Saver features. A Model 41-PLUS weather radio CB (MSRP \$169.95) offers more frills, like Cobra's *Dynamike* gain control, a local/distance switch, and ANL/NB control.

For more information on the Cobra line of weather radio CB's, contact Cobra Electronics Group, Dynascan Corp., 6500 West Cortland Street, Chicago, IL 60635, or circle 108 on our Readers' Service.

### Reader Report

A San Diego reader who uses the CB handle *The Bozo* sent a photo, and also asks a question we have heard before. He says that he's gotten all kinds of advice on the "proper" length to cut coaxial cables for home (and especially) mobile use between transceivers and antennas. At this point, he's heard so many opinions he doesn't know which is the correct length and he hopes we can clear up the situation.

First, let me note that some mobile antennas are designed with the intention of being used with the specific piece of coaxial cable that comes in the package with the whip. In



The new Cobra CB rigs also offer NOAA channel reception.

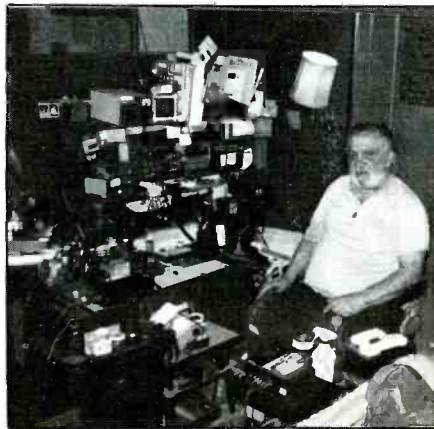

Here's "The Bozo," a CB'er from San Diego, CA.



A small portion of Frank's collection of CB and other radio gear in Danbury, CT.

such instances, the type and length of the cable as supplied by the manufacturer may be critical and shouldn't be changed under any circumstances for fear of completely screwing up the antenna's performance. If the manufacturer specifies your use of a particular hunk of cable he has supplied, please don't try to second guess his design engineers by trying to improve the situation with your own length of cable.

The coax that runs between your transceiver and antenna is normally *not* considered to be a "tuned" element. Usually, it may be any length and still preserve its rating. In the case of RG-58/U cable, commonly used for CB work, the approximate impedance rating is 50 ohms. Whether the cable is cut to 2 feet or 200 feet, this characteristic impedance should remain unchanged. In some few instances, however, the coax you use may respond unfavorably in a particular antenna installation. This reduces the transmitter's ability to feed power into the cable and ultimately to the antenna.

In such instances, one technique for improving things is to use a length of coaxial cable cut to an electrical half-wavelength, or multiple of this dimension. With RG/58U, an electrical half-wavelength occurs when the cable is cut to 11 feet 10 inches. Note that this is physically shorter than a half-wave antenna, which is about 18 feet. The reason is that RF travels more slowly through cable than through air, and the cable must be correspondingly shorter to achieve the same effect.

Thus, some CB'ers have come to the conclusion that it's mandatory for *all* CB installations (mobile or base) to always use coaxial cable cut to 11 feet 10 inches, or any multiple of that length such as 23 feet 8 inches, 35 feet 6 inches, etc.

Still, if there are major deficiencies elsewhere in the antenna system (such as the antenna being grossly detuned, the coax being old or damaged, or the antenna connector being badly soldered), this trick may not give you much relief.





This is Connie, who's been a welcome monitor on Channels 9 and 19 around Spring Lake Park, MN. His handle is the "Ohio Cab Driver."

Personally, I've never been all that concerned with these exact length considerations. I just use a good quality cable with as short a run as necessary to reach between rig and antenna. I then use an antenna matcher to peak the entire system to 1.25:1 VSWR. This has always worked fine for me, although those who wish to use the 11 foot 10 inch formula surely aren't going to do any harm—and it could help in some cases.

### Fed Facts

Brian Cassidy, Registered Monitor KPA3LF, of PA observes that there is supposedly a U.S. Government communications band between the 27.410 and 27.995 MHz, also on frequencies below the CB channels. He wonders if these frequencies are ever actually used by federal stations, or if their supposedly being allocated for government "use" is little more than an excuse to keep CB from expanding there, and to intimidate illegals.

Federal use of these frequencies has actually been observed, with 27.575, 27.585, and 27.625 MHz used by several federal agencies, with 27.785 and 27.980 MHz apparently used by the U.S. Coast Guard in some areas. As for the rest of the band, the amount of actual use by federal agencies is open to some question and we'd like to hear from readers who can offer definite information.

### On The Band

Good to hear from the *Ohio Cab Driver/Trucker Base*, otherwise known as Connie of Spring Lake Park, MN. This station, operated by a CB'er who has put in many years behind the mike, monitors Channels 9 and 19 at all times in order to provide highway information and assistance for truckers and all other drivers on Route 694 in the vicinity of Exit 38. When providing emergency radio services, the station ID's as *Minnesota Emergency Radio Unit 3*.

We heard, too, from *Minnesota Emergency Radio Unit 38*, a/k/a *Gunfitter* (or just plain Steve) of Brooklyn Center, MN. Steve passes along information that some

local Domino's Pizza delivery drivers are CB'ers who are starting a campaign to "key up for the cause" of community safety. Steve is one of the thousands of Domino's drivers and he feels that nobody knows the back streets of their communities better than these drivers. When street crimes are spotted, these drivers instantly use 27 MHz to report the incidents to their local police.

From Frank, of Danbury, CT we received a photo of some of the extensive collection of communications equipment he has acquired. In fact, he sent several photos that show CB gear such as a vintage Browning Golden Eagle Mark III, a Pearce Simpson Bengal, Realistic Navajo TRC-457, CDE Mark 20, plus antique broadcast receivers. Boy, are we envious! Now that we know all of this stuff is highly desired by collectors, it sure makes us feel crummy about having thrown out all of our old and broken CB rigs over the years. We've tossed out everything from Lafayettes to Philmores, from DeWalds to USL's, plus Cadre's, International Crystal rigs, and others. If we could only get even *half* of them back, we'd probably be able to open a museum.

### Mobile Power Sources

There are at least three methods for picking up power for a mobile installation—the cigar-lighter socket, ignition switch, and at the car battery. The first method, using the cigar-lighter outlet, is considered as a temporary hookup. Though it is convenient, it prevents use of the lighter and it leaves a dangling wire at the dashboard. If it is used for any considerable length of time, be aware that many lighter sockets continue to have power even after the ignition key is removed. Thus, if a rig is inadvertently left on for a week or two, it could discharge the battery.

The safest power-pickup point is at the ignition switch. By hooking the power lead to the accessory terminal on the back of the switch, the set may be operated while the engine is on or off. Removal of the key automatically turns off the transceiver. (This is the same method used with most ordinary car radios.) Locating the correct terminal at



Our Overseas CB QSL of The Month is from Jaime, of the Alpha Scorpio DX International Group, Azores Islands. The QSL was submitted to us by Pat Burke, SSB Network member SSB-349A, Fort Wayne, IN.

## MFJ SHORTWAVE ACCESSORIES

### REMOTE ACTIVE ANTENNA

**MFJ-1024** Receive strong clear signals from all over the world with this 54 inch active antenna that rivals long wires hundreds of feet long.

**\$129.95**

"World Radio TV Handbook" rates the MFJ-1024 as "a first rate easy-to-operate active antenna ... Quiet with excellent dynamic range and good gain ... Very low noise factor ... Broad frequency coverage ... the MFJ-1024 is an excellent choice in an active antenna."

Remote unit mounts outdoors away from electrical noise for maximum signal and minimum noise pickup. Mount it anywhere - atop houses, apartments, ships, buildings, balconies.

Covers 50 KHz to 30 MHz. High dynamic range eliminates intermodulation. Control unit has 20 dB attenuator, gain control. Lets you switch

2 receivers and auxiliary or active antenna. On' LED. 6x2x5 inches. Remote has 50 ft. coax and

connector. 3x2x4 in. 12 VDC or 110 VAC with MFJ-1312, \$9.95.



### INDOOR ACTIVE ANTENNA

**MFJ-1020A** Now you'll rival or exceed the reception of outside long wires with this tuned indoor active antenna.

**\$79.95**

"World Radio TV Handbook" says MFJ-1020 is a "fine value ... fair price ... best offering to date ... performs very well indeed."

Its unique tuned circuitry minimizes intermod, improves selectivity, reduces noise outside tuned band. Functions as a preselector with external antenna. 0.3-30 MHz. Telescoping antenna. Controls are Tune, Band, Gain, On-Off/By pass.

6x2x6 in. Use 9 Volt battery 9-18 VDC or 110 VAC with MFJ-1312, \$9.95.



### ANTENNA TUNER/PREAMP



**MFJ-959B** Don't miss rare DX because of signal power loss between your antenna and receiver.

**\$89.95**

The MFJ-959B provides proper impedance matching so you transfer maximum signal from your antenna to your receiver from 1.6 to 30 MHz. You'll be surprised by significant increases in signal strength.

20 dB preamp with gain control boosts weak stations. 20 dB attenuator prevents overload. Select from 2 antennas, 2 receivers. 9x2x6 inches. Use 9-18 VDC or 110 VAC with optional AC adapter, MFJ-1312, \$9.95.

For your nearest dealer or to order:

**800-647-1800**

Order from MFJ and try it. If not satisfied return within 30 days for refund (less s/h). Add \$5.00 s/h. One year unconditional guarantee. Free catalog.

**MFJ ENTERPRISES, INC.**

Box 494, Miss. State, MS 39762  
601-323-5869 Telex: 53-4590 MFJSTKV

MFJ... making quality affordable

CIRCLE 149 ON READER SERVICE CARD

the rear of the ignition switch can be done by putting your hand behind the dashboard and feeling for the longest screw on the rear of the switch. (Since it is designed to receive additional accessory wires, the shaft of the screw is longer than other terminals.) Depending on the particular car, there may be up to four screw terminals on the switch.

Some CB manufacturers recommend that the power lead should run directly to the ungrounded or hot terminal on the car battery. Their reason concerns noise suppression. By making a direct connection to the primary power source, there is less chance that noise voltage impressed on oth-

er power wiring will reach the receiver through the power lead. This can be checked experimentally and the direct battery connection used if there is a significant drop-off in noise. It should be remembered, however, that with the direct hookup, the transceiver is not turned off with the ignition key.

### Proper Use Of A Field-Strength Meter

Most simple field strength meters tend to give exaggerated readings. Even small changes in transmitter tuning can cause the

## SHAGG & TANGIE

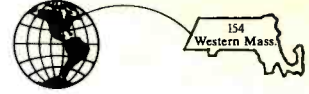

88's Jim & Annette Maciag  
P. O. Box 238 • Ludlow, MA 01056 73's  
— Base & Mobile Stations —

How about sending us your CB card, like this beauty sent in by Shagg and Tangie? They monitor Channel 23, and also swap cards. Their 20 is: Jim and Annette Maciag, P. O. Box 238, Ludlow, MA 01056.

## Feeling Left Out?

Have your favorite communications (Police, Fire, etc) moved to the 800MHz band? Are the scanners available which access this band too expensive? If you are like many scanning enthusiasts, this can be a real dilemma. For those of you who are still in a futile search for 800 MHz coverage on your hand held scanning radio, GRE America, Inc. has a product for you. Introducing the newly developed **Super Converter™ II** which has all of the features that you have come to enjoy in our

**Super Converter™ 8001** (810 - 912 MHz coverage, etc.), and more.

The **Super Converter™ II** has a convenient switch which allows for an instant return to normal scanning frequencies without disconnecting the unit. It is also equipped with BNC connectors for easy adaptability to your handheld scanner.



Introducing the **Super Converter 8001™** from GRE America, Inc. The **Super Converter 8001™** once attached allows any UHF scanning or monitoring receiver to receive the 810 to 912 MHz band.

It has been our experience that most scanning radios suffer from a lack of sensitivity due to antenna and power limitations. Introducing the GRE **Super Amplifier™**. The **Super Amplifier™** is a compact pre-amp designed to work with scanners and it amplifies the reception of the VHF/UHF bands (from 100MHz to 1GHz) as high as 20db.

The **Super Amplifier™** has an adjustable gain which is controlled from the back of the unit and allows amplification level of up to 20db through all frequencies, equipped with a bypass switch to return to normal scanning frequencies. As with all other GRE products, you will find the quality and design of the **Super Amplifier™** to be of the highest standard.

Wide range frequency (up to 1GHz) antenna is exclusively available from GRE America, Inc.

For more information, or a dealer near you (new dealers are welcome), contact GRE America, Inc. at the address below.

## GRE America, Inc.



GRE America, Inc.  
425 Harbor Blvd.  
Belmont, California 94002

Telephone (415) 591-1400  
Outside CA: (800) 233-5973  
Fax: (415) 591-2001

CIRCLE 119 ON READER SERVICE CARD

meter needle to swing way up and give the false impression of high output power. The first precaution in using most meters, therefore, is to consider all readings as simply relative. Numbers which appear on the meter face should not be taken literally. When the needle moves from 2 to 4, for example, it does not indicate a doubling of power, but a much smaller increase. The needle is primarily useful for its relative up or down movement.

Before readings are taken, check to see if nearby objects could affect the CB antenna signal. When checking a mobile rig, for example, all car doors should be closed, windshield wipers placed in the down position, and the trunk lid closed. The car should not be parked next to trees or dense foliage. The immediate surrounding area should be free of overhead power lines and the metal downspouts of a nearby house.

Keep the meter's whip antenna in a perfectly vertical position while taking readings. Important, too, is the distance between meter and antenna; the farther, the better. This prevents the meter from picking up the undesired magnetic field from the antenna. You're interested only in the electrostatic field—that part of the pattern that travels beyond the immediate area. (If the meter has low sensitivity, the type without a transistor amplifier, it usually can be improved by increasing its whip length with additional wire.) A spacing that gives good results is approximately 18 feet between meter and car antenna. Using a meter with poor sensitivity, however, might require a somewhat closer range.

Whatever type of field-strength meter is used, its whip antenna must not be 9 feet in length. This length would cause it to act as a beam element and absorb an undesirable amount of energy from the CB antenna. Then, as the meter whip retransmits this energy, it distorts the true pattern of the CB antenna. The meter whip should be at least one foot longer or shorter than 9 feet.

Finally, the meter should not be handheld, if possible. Placing it on some solid object, such as a chair, will keep the reading steady and easy to view.

This column wants your questions, thoughts, QSL cards, and station photos.



## Output Filters For SWB Reception

A filtering system usually connected between the headset or external speaker output of a SWL receiver and a good comfortable headset can be a boon to more satisfactory listening and better readability, especially in a noisy weak-signal location. Such an arrangement can often be of assistance, too, where signal levels are high. The combination can also be of benefit when connected between an external speaker output of the receiver and an external speaker.

For my listening, I often use a quality stereo headset with right and left sides in parallel to obtain monaural operation. As you well know, a headset provides better program listening and/or DX'ing as compared to a speaker. Concentration and enjoyment are accented. Headset listening and, when needed, filtering, are a good combination.

The three basic types of filters included in such an assembly are low-pass, high-pass and notch, Fig. 1. The low-pass filter passes audio frequencies up to a specific cut-off frequency. Frequencies above this point are attenuated. The rate of attenuation depends on the filter design. The drop off can be gradual, or steep-skirted, as marked in Fig. 1A. Usually the cut-off frequency is designated as that frequency at which the response is down 3 decibels. However, there is no firm rule. Often a curve will be stated to be flat-out to some specific frequency, or some other designation of frequency response.

A low-pass filter passes audio frequencies down to a specific cut-off frequency, as shown in Fig. 1B. It is apparent that a combination of two such filters can control the overall response of an audio amplifier. If you are able to adjust the overall response at each end, it is possible, by using the proper circuits, to attenuate noise and interference components that may be present at one, or both ends. In fact, it is sometimes necessary to chip away at the high-frequency end of the response so much that some of the high frequencies of the desired signal are attenuated in order to obtain a readable and/or less annoying signal to listen to in the presence of noise and/or interference. In addition, one must be aware that you can make an improvement, but sometimes not remove completely very strong interference that may exist. Such a predicament often haunts weak-signal receiving sites.

Another useful filter is the top-notch filter which has a steep-skirted attenuation re-

(Continued on page 42)

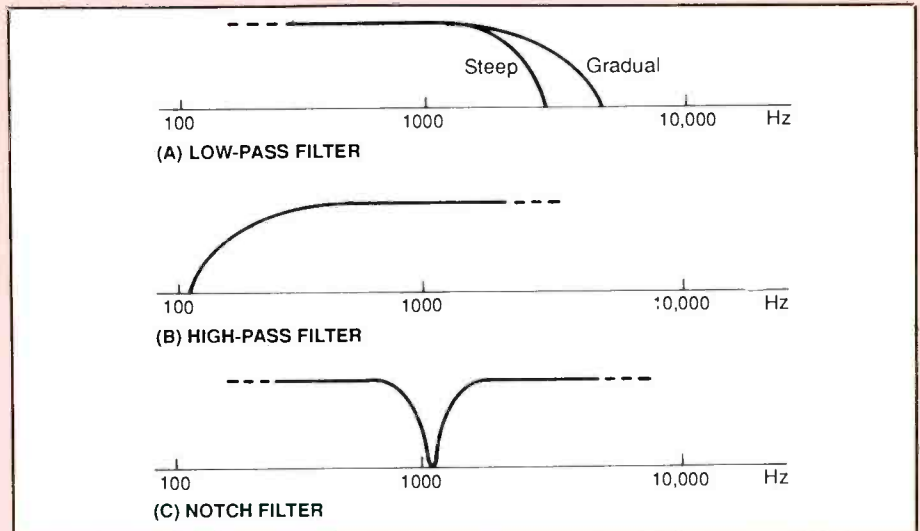

Fig. 1 - Basic filter types.



Fig. 2 - MFJ Optimizer showing easy two- controls operation.

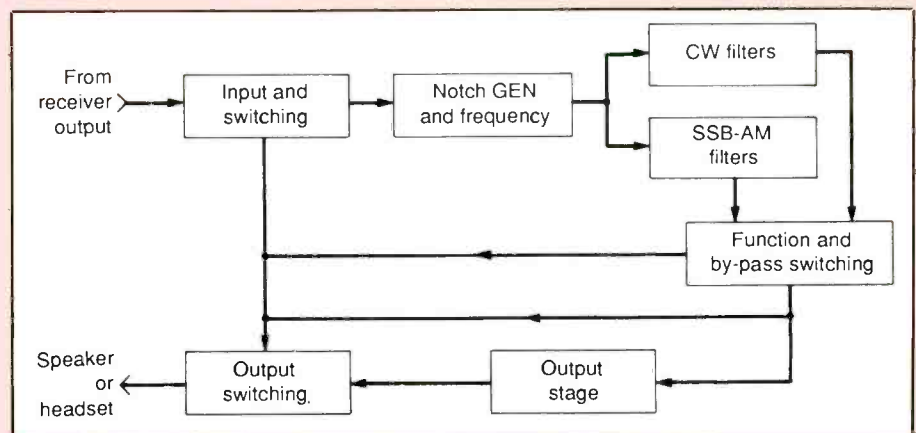

Fig. 3 - Simplified Block plan of Optimizer.

# POP'COMM's World Band Tuning Tips

## February, 1990

This Pop'Comm feature is designed to help you hear more shortwave stations. Each month this handy, pull-out guide will show you when and where to tune to hear a wide variety of local and international broadcasters currently active on the shortwave radio bands.

Note that the languages used will not always be English and that broadcasts may not necessarily be beamed to North America. Keep in mind that stations frequently make changes in broadcast times and frequencies. Changes in propagation conditions may also make certain broadcasts difficult or impossible to receive at times.

All times given are in UTC.

Frequency	Station/Country	UTC	Notes	Frequency	Station/Country	UTC	Notes
3220	HCJB	0945	Quechua	6015	R. Abidjan, Cote d'Ivoire	0000	close. French
3240	TWR Swaziland	0300		6020	R. Netherlands	0030	
3245	Radio Clube Varginha, Brazil	0105	Portuguese	6020	R. Australia	0800	sign on
3335	R. East Sepik, Papua New Guinea	1130	Pidgin	6030	Voice of America	1100	
3335	R. Alvorado, Brazil	0200	Portuguese	6030	R. Santa Maria, Chile	0900	Spanish
3339.5	R. Altura, Peru	0345	Spanish	6040	Voice of America	1130	
3366	GBC Ghana	0530		6050	FRCN, Ibadan, Nigeria	2300	close
4000	R. Bafoussam, Cameroon	0430	French	6050	HCJB, Ecuador	0220	Spanish
4700	R. Riberalta, Bolivia	0145	Spanish	6060	R. Australia	1100	
4755	Caracol Bogota, Colombia	0100	Spanish	6070	CFRX, Canada	0700	
4760	ELWA, Liberia	0605		6090	RTL Luxembourg	2330	
4770	R. Nigeria, Kaduna	0500		6095	Voice of America	1100	Spanish
4790	R. Atlantida, Peru	0345	closing. Spanish	6100	Voice of Nicaragua	0030	
4795	LV de los Caras, Ecuador	0145	Spanish	6100	Deutsche Welle	2330	German
4800	R. Popular, Ecuador	0330	Spanish	6130	CHNX, Canada	0830	
4805	Rdf. Amazonas, Brazil	0210	Portuguese	6135	R. Tahiti	0800	French, Tahitian
4810	R. Orion, So. Africa	0100	English, Afrikaans	6135	R. Univ. Concepcion, Chile	1015	Spanish
4835	R. Tezulutlan, Guatemala	0230	Spanish	6165	R. Netherlands	0040	via Bonaire
4840	R. Valera, Venezuela	0330	Spanish	6185	WRNO, Louisiana	0430	
4840	ORTM, Mali	0000	closing. French	6255	R. Venceremos	0250	clandestine. Spanish
4845	R. Fides, Bolivia	0030	Spanish	6280	V of Hope, Lebanon/Israel	0400	sign on
4851	R. Luz y Vida, Ecuador	0230	Spanish	6340	Turkish Police Radio	0600	Turkish
4870	ORTB Benin	0500	Sign on. French	6576	R. Pyongyang, N. Korea	1130	
4880	R. Five, So. Africa	0430		6590	R. Beijing, China	1200	
4885	Ondas del Meta, Colombia	0330	Spanish	7125	Vatican Radio	0210	closing
4904.5	Rdf. Nat., Chad	0425	sign on. French	7145	R. Polonia, Poland	0100	Polish
4910	ZBC, Zambia	0405	English, vernacular	7165	RFE/RL	0400	various languages
4925	Em. Meridiano 70, Colombia	0145	Spanish	7220	RFE/RL	0500	various languages
4920	ABC, Australia	1000		7240	CRTV Garoua, Cameroon	0430	sign on. French
4935	R. Tropical, Peru	0415	Spanish	7260	R. Vanuatu	0700	French
4940	R. Continental, Venezuela	0345	SS	7260	Radio Canada Intl	0205	sign on, Russian
4945	R. RSA, So. Africa	0300	0400 Afrikaans	7275	Radio Canada Intl	0240	Russian
4950	V of Puijiang, China	1300	Chinese	7290	R. Moscow	0200	E. Coast No. America
4960	R. Federacion, Ecuador	0100	closing	7315	WHRI, Indiana	0030	
4970	R. Rumbos, Ecuador	eves	Spanish	7320	BBC	0445	sign on, Arabic
4975	Ondas del Ortegua, Colombia	eves	Spanish	7325	Voice of America	0600	sign on
4980	Ecos del Torbes, Venezuela	0300	Spanish	7345	R. Prague, Czechoslovakia	eves	
4985	R. Brazil Central, Brazil	0100	Portuguese	7355	KNLS, Alaska	1200-1300	Russian
5004	R. Nacional Bata, Eq. Guinea	0300	Spanish	7355	WRNO, Louisiana	2310	
5025	R. Rebelde, Cuba	eves	Spanish	7380	LV del CID	0200	Spanish (clandestine)
5030	R. Impacto, Costa Rica	eves	Spanish (occ. 5044)	7400	WSHB, S. Carolina	0030	Christian Science Net
5030	R. Los Andes, Peru	1100	Spanish	7475	RTT Tunisia	0340	Arabic
5035	R. Centrafrique, Cent. Af. Rep.	2300	closing. French	7520	WHRI, Indiana	1200	
5057	R. Gjirokaster, Albania	0400	sign on, Albanian	7670	Stolnik, Bulgaria	0315	Bulgarian
5075	Caracol Bogota, Colombia	eves	Spanish	7770	CPBS, China	1300	Chinese
5875	BBC	0445	sign on. Russian	9022	VOIRI, Iran	0215	Spanish
5910	BRT, Belgium	2200		9325	R. Korea	0900	
5930	R. Prague, Czechoslovakia	0100		9350	R. Korea	0900	
5945	R. Austria International	2230		9360	R. Nacional Espana	0300	Spanish
5960	R. Japan	0145	via Sackville	9375	R. Tirana, Albania	2000	
5975	R. Macarena, Colombia	0945	Spanish	9395	V of Greece	1915	Greek
5995	R. Australia	0830		9445	V of Turkey	2200	
6005	BBC	0100	world service	9465	WMLK, Pennsylvania	1920	
6010	R. America, Peru	1015	Spanish	9465	KYOI, Saipan	1210	Christian Science Net
6015	R. Austria International	0530	via Sackville	9475	R. Cairo, Egypt	0200	to N. America



Frequency	Station/Country	UTC	Notes	Frequency	Station/Country	UTC	Notes
9485	TWR, Monaco	0640	sign on	11935	Voice of America	1130	sign off. Spanish
9495	WSHB S. Carolina	1100	Christian Science Net	11950	RTM Morocco	2230	Arabic
9500	R. Tirana, Albania	0530		11950	Deutsche Welle, W. Germany	1950	sign off. Arabic
9510	BBC	0515	sign on. French	11955	BBC	1245	sign off. via Singapore
9515	R. Novas de Paz, Brazil	2350	Portuguese	11960	KVOH, California	0445	
9535	R. Canada Intl	0200		11965	WRNO, Louisiana	1500	
9565	Deutsche Welle, W. Germany	0100	sign on. via Malta	11980	KSDA, Guam	0900	
9570	R. Korea	1400		12010	R. Austria Intl	1930	German
9575	RAI, Italy	0100	to N. America	12015	R. Ulan Bator, Mongolia	1230	Chinese
9580	R. Australia	early mornings		12040	BBC	1420	unidentified language
9580	Africa No. One, Gabon	0500	French	12080	Kol Israel	0115	
9595	Voice of America	1100	to Caribbean	13605	Voice of the UAE, Abu Dhabi	2200	Arabic
9600	R. MEC, Brazil	0300	Portuguese	13650	R. Canada International	2100	Czech
9625	CBC No. Que Sve Canada	0100		13655	R. Jordan	0600	Arabic
9640	Ecos del Torbes, Venezuela	1000	Spanish, //4970	13660	R. Baghdad	2030	to Europe
9670	HCJB, Ecuador	1100	Quechua	13700	R. Netherlands	1930	Arabic
9675	R. Japan	0830	Japanese. via Fr. Guiana	13720	KSDA, Guam	1400	
9695	R. Sweden	2330	Portuguese. //11705	13730	R. Austria Intl	2030	2100 close
9720	SLBC, Sri Lanka	1250		13740	Voice of America	0130	Spanish
9725	Adventist World R., Guatemala	0445	Spanish	13740	RTBF Belgium	0430	French
9730	R. Berlin Intl., E. Germany	2230		13745	ICBS Iceland	1215-1245	Icelandic
9735	Deutsche Welle, W. Germany	1100	via Antigua	13760	WHRI, Indiana	1630	
9735	R. Nacional Paraguay	0030	Spanish	13790	ISBS, Iceland	1410-1440	
9755	R. Canada Intl	2300		14918 USE	R. Kiribati	0620	part English
9755	R. Cairo	0130	Arabic. Holy Quran Serv	15010	V of Vietnam	1100	
9760	R. Tirana	2330		15020	All India Radio	1445	unidentified language
9765	V of the Mediterranean, Malta	0640	via Cyclops, Malta	15084	VOIRI Iran	1730	Farsi
9770	R. Australia	1100		15095	R. Damascus, Syria	2104	close
9790	Radio France Intl	0330	via Fr. Guiana	15105	R. Yugoslavia	2130	
9795	Voice of Turkey	2200-2200	to W. Europe	15105	Deutsche Welle, W. Germany	1150	close. via Sri Lanka
9815	KUSW, Utah	0300		15130	R. Beijing, China	0000	
9820	R. Moscow	2359	closing. Russian	15140	R. Nacional, Chile	2030	Spanish
9825	BBC	0230	Portuguese	15145	R. Liberty	0145	Russian
9835	R. Budapest	0130	to N. America	15180	R. Norway	1100	Norwegian
9840	KNLS, Alaska	0800-0900		15185	R. Moscow	1200	unidentified language
9850	WCSN, Maine	0130	Christian Science Net	15185	R. Finland Intl	0230	English (Sunday)
9855	R. Netherlands	2130	sign on, Dutch	15190	TWR Swaziland	1430	tests
9870	R. Austria International	0000	sign on	15205	Deutsche Welle, W. Germany	1050	Spanish, via Antigua
9870	KTWR, Guam	1415	Chinese	15220	R. Cairo, Egypt	2215	Arabic
9880	R. Moscow	0230	spanish	15225	WSHB, S. Carolina	2000	Christian Science Net
9900	R. Cairo, Egypt	0100	Arabic	15230	Radio Havana Cuba	1800	Spanish
9915	BBC	0130	world service	15260	BBC	2100	world service
9925	BRT, Belgium	2130	Spanish	15265	Voice of America	1100	Spanish
11500	R. Beijing, China	2100	sign on to Europe	15270	Radio Nacional, Ecuador	1730	Spanish, via HCJB
11515	R. Bangladesh	1815	to Europe	15310	R. Norway	0200	Norwegian
11550	VOFC, Taiwan	1300	WYFR via Taiwan	15320	R. Peace & Progress, USSR	1359	close. Russian
11580	WYFR, Florida	0430		15330	R. Sofia, Bulgaria	2145	English
11635	TWR, Monaco	1530	Russian	15335	RFE/RL	1600	
11650	KTWR, Guam	1445	Chinese	15350	R. Japan	0200	sign on. Japanese via Fr. Guiana
11660	RTBF, Belgium	0530	French	15375	KFBS, Saipan	1300	close. Malaysian
11665	KTWR, Guam	1415	Chinese	15380	R. Bucharest, Romania	0200	N. America
11680	KGEI, California	0430	Russian	15410	R. Austria Intl	0400	German
11685	R. Prague, Czechoslovakia	0130	N. America	15435	UAE Radio, Dubai	1600	
11700	R. Peace & Progress, USSR	0000	Spanish	15440	R. Beijing, China	0930	S. Pacific
11705	R. Sweden	0230	N. America	15445	R. Veritas Asia, Philippines	1500	
11710	R. Sofia, Bulgaria	0030	Bulgarian	15470	R. Tashkent, Uzbek SSR	1330	
11715	R. Beijing, China	0300	Bulgarian	15475	Africa No. One, Gabon	2000	French
11715	VOIRI, Iran	1130		15505	R. Kuwait	1815	Arabic
11720	R. Mayak, USSR	1430	Russian	15530	R. Moscow	1250	world service
11720	BBC	0445	Arabic	15540	RTBF, Belgium	2115	French
11725	RFE/RL	0300	various languages	15560	R. Netherlands	1930	French, via Madagascar
11730	R. Canada International	2300	weekends only	15560	R. Peace & Progress	1300	
11735	R. Yugoslavia	2100		15580	KUSW, Utah	0000	
11745	Radiobras, Brazil	0200	N. America	15610	WCSN, Maine	2030	Christian Science Net
11750	BBC	0200	world service	15615	Reshet Bet, Israel	0450	Hebrew
11755	R. Beijing, China	0900	to S. Pacific	15685	Voice of Unity (clandestine)	0145	Pashto/Dari
11765	R. Japan	2300	via Gabon	15700	Voice of the Libyan People (clandestine)	0455	sign on. Arabic
11770	R. Australia	0930	close. English, French	17545	Reshet Bet, Israel	1815	Hebrew
11770	HCJB, Ecuador	0600	sign on. French	17555	WSHB, S. Carolina	1530	Christian Science Net
11785	R. Guaiba, Brazil	0100	Portuguese	17575	R. Netherlands	1930	French
11800	R. Australia	1100		17620	Radio France Intl	1605	
11805	KTWR, Guam	1015		17630	Africa No. One	1500	French
11810	R. Baghdad	0130		17710	Radio Havana Cuba	1915	
11815	R. Liberty	2200	Russian	17730	Radio Moscow Intl	0140	French
11820	Radio Havana Cuba	0200		17795	Radio Canada International	1330	sign on, Russian
11835	SLBC, Sri Lanka	1100		17840	Vatican Radio	1215	sign on
11835	R. Moscow	1130	unidentified language	17855	Radio Beijing, China	1200	
11850	FEBC, Philippines	1230	unidentified language	17865	Voice of America	1300	Hindu
11855	Radio Canada Intl	1330		17880	R. Moscow	0230	No. America
11865	BBC	0958	close. Portuguese	21605	UAE Radio, Dubai	1615	
11885	RFE/RL	2100	various languages	21610	R. Sweden	1430	Swedish. English
11910	R. Budapest, Hungary	2345		21705	R. Norway	1300	Norwegian
11925	R. Bandeirantes, Brazil	0030	Portuguese				
11930	R. Moscow	0015	Russian				

(from page 39)

sponse as shown in C. It can be moved right into the bandpass of the desired audio response to ferret out a narrow-band slice of interference. The notch filter removes heterodynes (whistles) you often hear when listening to a station. Usually the removal of a narrow slice of frequency has no effect on the readability of the signal. In fact, it improves readability by removing or cutting way back on the level of the interfering whistle.

### Complete Filter Assembly

An MFJ filter assembly, called the Optimizer, is shown in Fig. 2. Note the notch control to the left and the low-pass selectivity switch on the right. This switch can also select a single high-pass filter when needed. Also, the complete filter system can be bypassed, except the included amplifier when desired, using this switch. When the unit is turned off, the entire Optimizer is bypassed and the signal goes directly from receiver to headset or external speaker.

The block plan of Fig. 3 shows the general arrangement of the Optimizer. It was designed for ham, SSB and CW use, but works out well for SWB AM reception, too. First, the incoming signal passes through the notch filter and its associated frequency control, which permits the notch to be moved across the entire audio bandpass. When turned to the far right, it is out of the circuit.

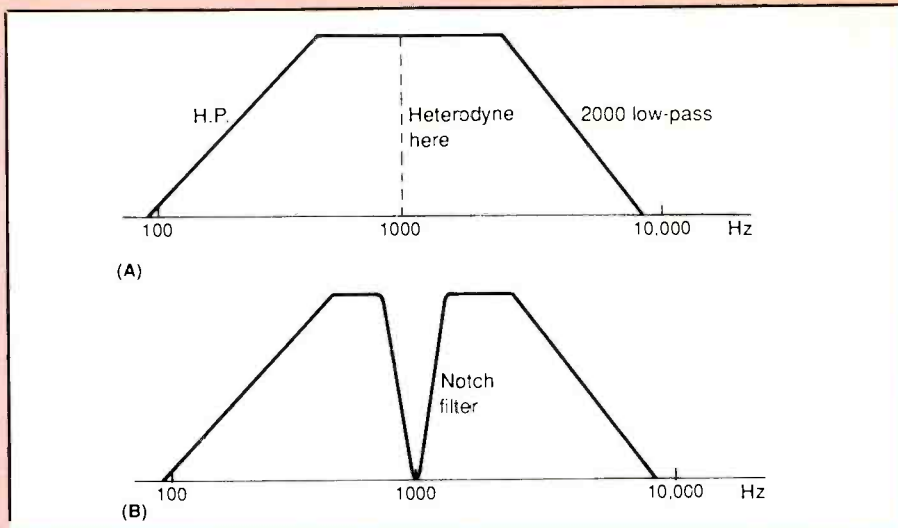

Fig. 4 - Filter responses (A) combines response (B).

Next, there are a pair of filters for ham CW and SSB/AM operations. Cut-off frequencies for the low-pass filter for SSB/AM operations are 1500, 2000 and 2500 Hz. CW cut-off frequencies are 180, 150, 110 and 60 Hz. The high-pass filter, when in the circuit, starts at 375 Hz and drops the low-frequency response at wavelength 12 decibel per octave rate. Thus, 60 and 120 Hz hum and other low-frequency noises can be

removed.

The overall response of the low-pass filter set for 2000 Hz is shown in Fig. 4A. However, a heterodyne is noted at exactly 1000 Hz. To remove it, you vary the notch frequency control until it centers about 1000 Hz and drop it out as shown in Fig. 4B. The control must be adjusted slowly and carefully until you find the exact spot that takes out the heterodyne. Also, at times you can use the notch filter at either end of the bandpass to take out the noise or interference. Its like forming a sharper skirt in the cut-off frequency range.

In checking the unit, it was no problem in removing a heterodyne. An example is the 1000 Hz beat encountered when tuning in Tahiti on 15171 or WYFR on 15170. Heterodynes were removed in the reception of various stations although the source of the whistle is usually not known. Sometimes narrow bands of background noise within the bandpass were taken out using the combination of proper filter and setting of notch position. Remember, the combination of notch and filter can cut out interference more sharply at band edges.

The R-2000 has a wide and narrow switch position. With the Optimizer, I could set the receiver on wideband and obtain some setting in between that was not as severe as the narrow setting of the receiver switch. A good compromise could be obtained for general listening with noise present.

Hum and RTTY were taken out of the received AM signals. In DX'ing, voice readability were improved by bypassing the filter system and only using the built-in Optimizer amplifier. This connection doesn't pass as many lows and the voice is accented. In this case, it seemed to compensate for too many lows brought out by the characteristics of the headset.

PC

**SEE The World For \$499.95<sup>1</sup>**



Now you can explore the world without leaving your living room. The M-900 receives Morse code from ships, coastal stations and hams. It also decodes regular (Baudot) RTTY still used by many international press agencies, weather stations and aeronautical concerns. Both Sitor modes are also included to monitor maritime, diplomatic and Amtor traffic. The M-900 even provides high resolution FAX images (to printer port only), so you can SEE pictures, maps, photos, and marine charts from around the world!  
<sup>1</sup> A complete system will require your receiver, your video monitor, a 12 VDC power supply and cables. A printer is also required for FAX mode only. Please write for full technical details including special system pricing. The M-900 alone is \$499.95 (+\$8 UPS).

**UNIVERSAL RADIO**  
1280 Aida Drive Dept. PC  
Reynoldsburg, OH 43068  
☎ Toll Free: 800 431-3939  
☎ In Ohio: 614 866-4267

**Huge 52 page catalog  
only \$1 postpaid.**

Universal has been serving radio enthusiasts since 1942. We carry all major lines of SWL and HAM equipment.

**USE  
YOUR**

**F  
R  
E  
E**

**I  
N  
F  
O  
R  
M  
A  
T  
I  
O  
N**

**C  
A  
R  
D**



# uniden®

## \$12,000,000 Scanner Sale

Uniden Corporation of America has purchased the consumer products line of Regency Electronics Inc. for \$12,000,000. To celebrate this purchase, we're having our largest scanner sale in history! Use the coupon in this ad for big savings. Hurry...offer ends March 31, 1990.

### ★★★ MONEY SAVING COUPON ★★★

Get special savings on the scanners listed in this coupon. This coupon must be included with your prepaid order. Credit cards, personal checks and quantity discounts are excluded from this offer. Offer valid only on prepaid orders mailed directly to Communications Electronics Inc., P.O. Box 1045 - Dept. UN13, Ann Arbor, Michigan 48106-1045 U.S.A. Coupon expires March 31, 1990. Coupon may not be used in conjunction with any other offer from CEI. Coupon may be photocopied. Add \$12.00 for shipping in the continental U.S.A.

- |                         |          |
|-------------------------|----------|
| Regency TS2-T .....     | \$259.95 |
| Regency R1600-T .....   | \$239.95 |
| Regency R1099-T .....   | \$99.95  |
| Regency RH606B-T .....  | \$419.95 |
| Regency RH256B-T .....  | \$294.95 |
| Bearcat 200XLT-T2 ..... | \$229.95 |
| Bearcat 100XLT-T .....  | \$184.95 |
| Bearcat 800XLT-T2 ..... | \$229.95 |
| Uniden HR2510-T .....   | \$229.95 |
| Uniden HR2600-T .....   | \$274.95 |
| Uniden PRO500D-T2 ..... | \$29.95  |

### ★★★ VALUABLE COUPON ★★★

#### Bearcat® 760XLT-T

List price \$499.95/CE price \$244.95/SPECIAL 12-Band, 100 Channel • Crystalless • AC/DC Frequency range: 29-54, 118-174, 406-512, 806-956 MHz. Excludes 823.9875-849.0125 and 868.9875-894.0125 MHz. The Bearcat 760XLT has 100 programmable channels organized as five channel banks for easy use, and 12 bands of coverage including the 800 MHz band. The Bearcat 760XLT mounts neatly under the dash and connects directly to fuse block or battery. The unit also has an AC adaptor, flip down stand and telescopic antenna for desk top use. 6-5/16" W x 1 1/8" H x 7 3/4" D. Model BC 590XLT-T is a similar version without the 800 MHz. band for only \$194.95. Order your scanner from CEI today.

#### NEW! Regency® Products

- |  |          |
|--|----------|
| R4030-T Regency 200 ch. handheld scanner .....       | \$254.95 |
| R4020-T Regency 100 ch. handheld scanner .....       | \$189.95 |
| R4010-T Regency 10 channel handheld scanner .....    | \$114.95 |
| R1600-T Regency 100 channel mobile scanner .....     | \$244.95 |
| P200-T Regency 40 channel CB Mobile .....            | \$38.95  |
| P210-T Regency 40 channel CB Mobile .....            | \$56.95  |
| P220-T Regency 40 channel CB Mobile .....            | \$79.95  |
| P300-T Regency 40 channel SSB CB Mobile .....        | \$137.95 |
| P400-T Regency 40 channel SSB CB Base .....          | \$174.95 |
| PR110-T Regency "Passport" size radar detector ..... | \$114.95 |
| PR120-T Regency "micro" size radar detector .....    | \$144.95 |
| MP5100XL-T Regency 40 Ch. marine transceiver .....   | \$139.95 |
| MP5100XL-T Regency 60 Ch. marine transceiver .....   | \$159.95 |
| MP6000XL-T Regency 60 Ch. marine transceiver .....   | \$209.95 |
| MP2000XL-T Regency handheld marine trans. ....       | \$189.95 |

#### Regency® RH256B-T

List price \$799.95/CE price \$299.95/SPECIAL 16 Channel • 25 Watt Transceiver • Priority The Regency RH256B is a sixteen-channel VHF land mobile transceiver designed to cover any frequency between 150 to 162 MHz. Since this radio is synthesized, no expensive crystals are needed to store up to 16 frequencies without battery backup. All radios come with CTCSS tone and scanning capabilities. A monitor and night/day switch is also standard. This transceiver even has a priority function. The RH256 makes an ideal radio for any police or fire department volunteer because of its low cost and high performance. A 60 Watt VHF 150-162 MHz. version called the RH606B-T is available for \$429.95. A UHF 15 watt, 16 channel version of this radio called the RU156B-T is also available and covers 450-482 MHz. but the cost is \$454.95.

### ★★★ Uniden CB Radios ★★★

The Uniden line of Citizens Band Radio transceivers is styled to complement other mobile audio equipment. Uniden CB radios are so reliable that they have a two year limited warranty. From the feature packed PRO 810E to the 310E handheld, there is no better Citizens Band radio on the market today.

- |  |          |
|--|----------|
| PRO310E-T Uniden 40 Ch. Portable/Mobile CB ..... | \$83.95  |
| PRO330E-T Uniden 40 Ch. Remote mount CB .....    | \$104.95 |
| PRO500D-T Uniden 40 Channel CB Mobile .....      | \$38.95  |
| KARATE-T Uniden 40 channel rescue radio .....    | \$53.95  |
| GRANT-T Uniden 40 channel SSB CB mobile .....    | \$166.95 |
| MADISON-T Uniden 40 channel SSB CB base .....    | \$244.95 |
| PC122-T Uniden 40 channel SSB CB mobile .....    | \$119.95 |
| PRO510XL-T Uniden 40 channel CB Mobile .....     | \$38.95  |
| PRO520XL-T Uniden 40 channel CB Mobile .....     | \$56.95  |
| PRO530XL-T Uniden 40 channel CB Mobile .....     | \$79.95  |
| PRO540E-T Uniden 40 channel CB Mobile .....      | \$97.95  |
| PRO640E-T Uniden 40 channel SSB CB Mobile .....  | \$137.95 |
| PRO710E-T Uniden 40 channel CB Base .....        | \$119.95 |
| PRO810E-T Uniden 40 channel SSB CB Base .....    | \$174.95 |

### ★★★ Uniden Radar Detectors ★★★

Buy the finest Uniden radar detectors from CEI today. TALKER-T2 Uniden talking radar detector .....

- |   |          |
|---|----------|
| TALKER-T2 Uniden talking radar detector .....     | \$144.95 |
| RD7-T Uniden visor mount radar detector .....     | \$99.95  |
| RD9-T Uniden "Passport" size radar detector ..... | \$114.95 |
| RD9XL-T Uniden "micro" size radar detector .....  | \$144.95 |
| RD25-T Uniden visor mount radar detector .....    | \$54.95  |
| RD500-T Uniden visor mount radar detector .....   | \$74.95  |

#### Bearcat® 200XLT-T2

List price \$509.95/CE price \$239.95/SPECIAL 12-Band, 200 Channel • 800 MHz. Handheld Search • Limit • Hold • Priority • Lockout Frequency range: 29-54, 118-174, 406-512, 806-956 MHz. Excludes 823.9875-849.0125 and 868.9875-894.0125 MHz. The Bearcat 200XLT sets a new standard for handheld scanners in performance and dependability. This full featured unit has 200 programmable channels with 10 scanning banks and 12 band coverage. If you want a very similar model without the 800 MHz. band and 100 channels, order the BC 100XLT-T for only \$189.95. Includes antenna, carrying case with belt loop, ni-cad battery pack, AC adapter and earphone. Order your scanner now.

#### Bearcat® 800XLT-T2

List price \$549.95/CE price \$239.95/SPECIAL 12-Band, 40 Channel • No-crystal scanner Priority control • Search/Scan • AC/DC Bands: 29-54, 118-174, 406-512, 806-956 MHz. Excludes 823.9875-849.0125 and 868.9875-894.0125 MHz. The Uniden 800XLT receives 40 channels in two banks. Scans 15 channels per second. Size 9 1/4" x 4 1/2" x 12 1/2". If you do not need the 800 MHz. band, a similar model called the BC 210XLT-T is available for \$178.95.

#### Bearcat® 145XL-T

List price \$189.95/CE price \$94.95/SPECIAL 10-Band, 16 Channel • No-crystal scanner Priority control • Weather search • AC/DC Bands: 29-54, 136-174, 406-512 MHz. The Bearcat 145XL is a 16 channel, programmable scanner covering ten frequency bands. The unit features a built-in delay function that adds a three second delay on all channels to prevent missed transmissions. A mobile version called the BC560XLT-T featuring priority, weather search, channel lockout and more is available for \$94.95. CEI's package price includes mobile mounting bracket and mobile power cord.

#### President® HR2510-T

List price \$499.95/CE price \$239.95/SPECIAL 10 Meter Mobile Transceiver • Digital VFO Full Band Coverage • All-Mode Operation Backlit liquid crystal display • Auto Squelch RIT • Preprogrammed 10 KHz. Channels Frequency Coverage: 28.0000 MHz. to 29.6999 MHz. The President HR2510 Mobile 10 Meter Transceiver made by Uniden, has everything you need for amateur radio communications. Up to 25 Watt PEP USB/LSB and 25 Watt CW mode. Noise Blanker. PA mode. Digital VFO. Built-in S/R/F/Mod/SWR meter. Channel switch on the microphone, and much more! The HR2510 lets you operate AM, FM, USB, LSB or CW. The digitally synthesized frequency control gives you maximum stability and you may choose either pre-programmed 10 KHz. channel steps, or use the built-in VFO for steps down to 100 Hz. There's also RIT (Receiver Incremental Tuning) to give you perfectly tuned signals. With receive scanning, you can scan 50 channels in any one of four band segments to find out where the action is. Order your HR2510 from CEI today.

#### NEW! President® HR2600-T

List price \$599.95/CE price \$299.95/SPECIAL 10 Meter Mobile Transceiver • New Features The new President HR2600 Mobile 10 Meter Transceiver is similar to the Uniden HR2510 but now has repeater offsets (100 KHz.) and CTCSS encode.



BC760XLT  
800 MHz.  
mobile scanner  
SPECIAL!

### ★★★ Uniden Cordless Telephones ★★★

- |  |         |
|--|---------|
| XE750-T Uniden Cordless Phone with speaker ..... | \$99.95 |
| XE550-T Uniden Cordless Phone .....              | \$79.95 |
| XE300-T Uniden Cordless Phone .....              | \$69.95 |

### ★★★ Extended Service Contract ★★★

If you purchase a scanner, CB, radar detector or cordless phone from any store in the U.S. or Canada within the last 30 days, you can get up to three years of extended service contract from Warrantech. This service extension plan begins after the manufacturer's warranty expires. Warrantech will perform all necessary labor and will not charge for return shipping. Extended service contracts are not refundable and apply only to the original purchaser. A two year extended contract on a mobile or base scanner is \$29.99 and three years is \$39.99. For handheld scanners, 2 years is \$59.99 and 3 years is \$79.99. For radar detectors, two years is \$29.99. For CB radios, 2 years is \$39.99. For cordless phones, 3 years is \$34.99. Order your extended service contract today.

### OTHER RADIOS AND ACCESSORIES

- |  |          |
|--|----------|
| BC55XL-T Bearcat 10 channel scanner .....              | \$114.95 |
| BC70XL-T Bearcat 20 channel scanner .....              | \$159.95 |
| BC175XL-T Bearcat 16 channel scanner .....             | \$156.95 |
| R2066-T Regency 60 channel scanner .....               | \$149.95 |
| R1099-T Regency 45 channel scanner .....               | \$109.95 |
| TS2-T Regency 75 channel scanner .....                 | \$269.95 |
| UC102-T Regency VHF 2 ch. 1 Watt transceiver .....     | \$114.95 |
| BP55-T Regency 16 amp reg. power supply .....          | \$179.95 |
| BP205-T Ni-Cad batt. pack for BC200/BC100XL-T .....    | \$39.95  |
| BB-T 1.2 V AA Ni-Cad batteries (set of eight) .....    | \$17.95  |
| FBE-T Frequency Directory for Eastern U.S.A. ....      | \$14.95  |
| FBW-T Frequency Directory for Western U.S.A. ....      | \$14.95  |
| RFD1-T Great Lakes Frequency Directory .....           | \$14.95  |
| RFD2-T New England Frequency Directory .....           | \$14.95  |
| RFD3-T Mid Atlantic Frequency Directory .....          | \$14.95  |
| RFD4-T Southeast Frequency Directory .....             | \$14.95  |
| RFD5-T N.W. & Northern Plains Frequency Dir. ....      | \$14.95  |
| ASD-T Airplane Scanner Directory .....                 | \$14.95  |
| SRF-T Survival Radio Frequency Directory .....         | \$14.95  |
| TSG-T "Top Secret" Registry of U.S. Govt. Freq. ....   | \$14.95  |
| TTC-T Tune in on telephone calls .....                 | \$14.95  |
| CBH-T Big CB Handbook/AM/FM/Freband .....              | \$14.95  |
| TIC-T Techniques for Intercepting Communications ..... | \$14.95  |
| RRF-T Railroad frequency directory .....               | \$14.95  |
| EEC-T Embassy & Espionage Communications .....         | \$14.95  |
| CIE-T Covert Intelligence, Elect. Eavesdropping .....  | \$14.95  |
| MFF-T Midwest Federal Frequency directory .....        | \$14.95  |
| A60-T Magnet mount mobile scanner antenna .....        | \$35.95  |
| A70-T Base station scanner antenna .....               | \$35.95  |
| A1300-T 25 MHz-1.3 GHz Discone antenna .....           | \$109.95 |
| USAMM-T Mag mount VHF ant. w/ 12' cable .....          | \$39.95  |
| USAK-T 3/4" hole mount VHF ant. w/ 17' cable .....     | \$35.95  |
- Add \$4.00 shipping for all accessories ordered at the same time. Add \$12.00 shipping per radio and \$4.00 per antenna.

### BUY WITH CONFIDENCE

To get the fastest delivery from CEI of any scanner, send or phone your order directly to our Scanner Distribution Center. Michigan residents please add 4% sales tax or supply your tax I.D. number. Written purchase orders are accepted from approved government agencies and most well rated firms at a 10% surcharge for net 10 billing. All sales are subject to availability, acceptance and verification. All sales on accessories are final. Prices, terms and specifications are subject to change without notice. All prices are in U.S. dollars. Out of stock items will be placed on backorder automatically unless CEI is instructed differently. A \$5.00 additional handling fee will be charged for all orders with a merchandise total under \$50.00. Shipments are F.O.B. CEI warehouse in Ann Arbor, Michigan. No COD's. Most items listed have a manufacturer's warranty. Free copies of warranties on these products are available by writing to CEI. Non-certified checks require bank clearance. Not responsible for typographical errors.

Mail orders to: Communications Electronics, Box 1045, Ann Arbor, Michigan 48106 U.S.A. Add \$12.00 per scanner for U.P.S. ground shipping and handling in the continental U.S.A. For Canada, Puerto Rico, Hawaii, Alaska, or APO/FPO delivery, shipping charges are two times continental U.S. rates. If you have a Discover, Visa, American Express or Master Card, you may call and place a credit card order. 5% surcharge for billing to American Express. Order toll-free in the U.S. Dial 800-USA-SCAN. In Canada, dial 800-221-3475. FAX anytime, dial 313-971-6000. If you are outside the U.S. or in Michigan dial 313-973-8888. Order today. Scanner Distribution Center and CEI logos are trademarks of Communications Electronics Inc. Sale dates 10/1/89 - 3/31/90 AD #100189-T Copyright © 1989 Communications Electronics Inc.

For credit card orders call  
**1-800-USA-SCAN**

**COMMUNICATIONS  
ELECTRONICS INC.**

**Consumer Products Division**

P.O. Box 1045 □ Ann Arbor, Michigan 48106-1045 U.S.A.  
For orders call 313-973-8888 or FAX 313-971-6000



### U.S. Space Command (II)

**T**he Air Force has a central part to play in the US Space Command. Even before the Space Command was formed, the Air Force operated a world-wide network of ground stations which controlled our military and spy satellites. In all there are 9 satellite control stations spread around the globe. The Space Commands Master Control Center is located at Sunnyvale, Calif. The station's official name is the Air Force Satellite Test Center, better known as the Big Blue Cube by its inhabitants. In addition to these control stations there are 27 sites world-wide which are space sensors of one type or another. There is an unknown number of military communications centers which have access to these satellites. Space Command also has several automated remote relay stations which relay information from various satellites to ground control stations.

The Air Force supplies most of the personnel that staff these stations. over 14,000 military, civilian and contract personnel work for the Space Command through the Air Force. The staffing of these stations becomes a little more complex than would first appear. Some of the ground stations (often located at large military communication complexes and others in underground vaults) are staffed by single services like the Army's DSCS or GPS sites, while others are manned by multi-service and civilian personnel. Several of these larger multi-service communications centers are controlled by the National Security Agency (NSA). They are the intelligence branch that is responsible for all signal and telemetry intelligence the US gathers. In addition, they generate and handle all the codes used by the intelligence services including number stations, military tactical codes and satellite codes. Though these stations are manned by telecommunications specialist from several branches of the service, the HOT intelligence and codes are usually handled by NSA personnel. Keep in mind that NSA collects 90% of our signal intelligence (SigInt) and other electronic intelligence (ElInt). Photo and imaging satellite intelligence and Human Intelligence is the domain of the CIA. The US Space Command's Joint Space Intelligence Center monitors and analyzes all collected information from our spy satellites and makes risk assessments on all launches and satellites put up by foreign nations, looking for any possible hostile intent.

1st Space Wing of the USAF operates the

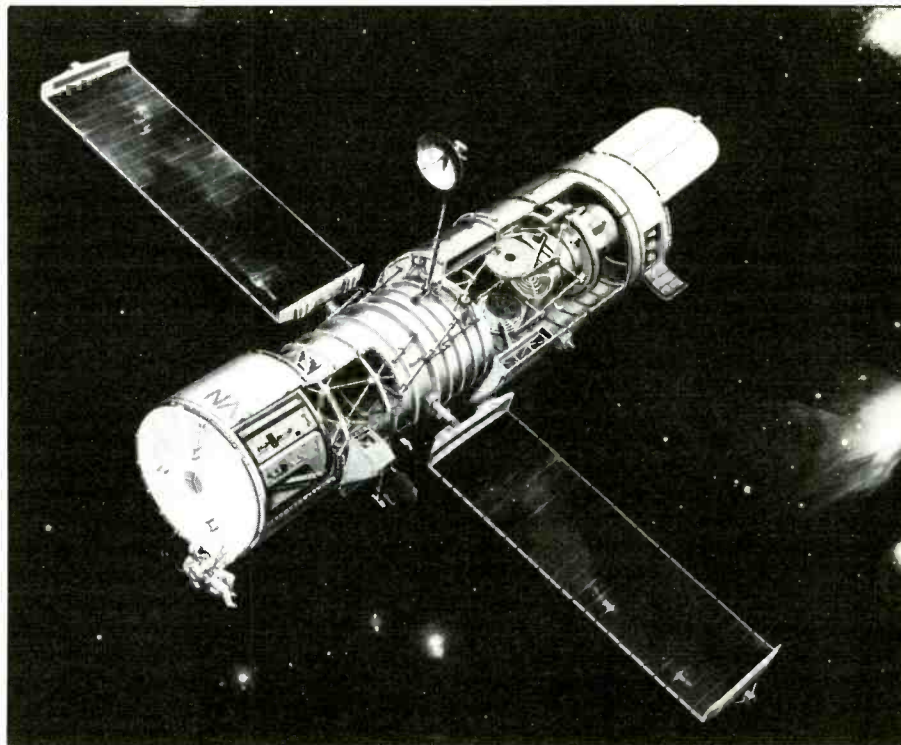

*The new KH-12 spysat is thought to be similar to the Hubble Space Telescope (DOD).*

tactical warning and attack assessment facility. This includes Pave Paws, (Phased Array Radar), and mechanical Ballistic Missile Early Warning Systems (BMEWS). The men of the 2nd Space Wing operate the command and control stations. One, located at Falcon Air Force Station Colorado, 10 miles south of Colorado Springs, will serve as a back-up control facility for Sunnyvale California. It will pick up some of the work load for the Defense Support Program (DSP), Early warning Satellites, The Defense Meteorological Satellite Program, (DMSP) weather satellites and the new Navstar navigation satellites. They also work closely with the manned spaceflight control squadron during DOD shuttle missions. This squadron is located at Johnson Space Center and oversees the launch and control of Top Secret satellite missions and SDI experiments. The training for all the Space Command and NORAD communications personnel is done by the Air Force 1013 Combat Crew Training Squadron.

The communications personnel of the US Space Command operate our spy satellite network and related collection and retransmission facilities for NSA and CIA. Of all our satellite systems the Satellite Data System (SDS) is one of our most important. Those spacecraft are in a molniya (highly elliptical) orbit, and are responsible for collecting and relaying to ground stations a large portion of the intelligence gathered by our spy satellites. They collect information and relay it to ground stations when it is least likely that their signals will be intercepted by Soviet spysats, ships or ground stations. SDS and other spacecraft like the TDRSS (see April 1988 issue) can be crosslinked at high enough frequency to be difficult to intercept especially when the information can be crosslinked to several satellites making the information, if intercepted by the Soviets, difficult to tract to any specific location.

To further protect our space assets and confuse the Soviets we go a step further. Our space systems are usually thought of as



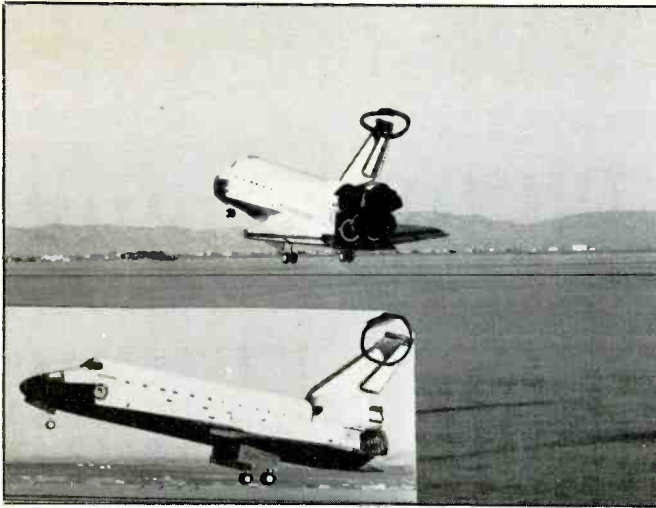

SDI experiment carried in tail section of STS-28.

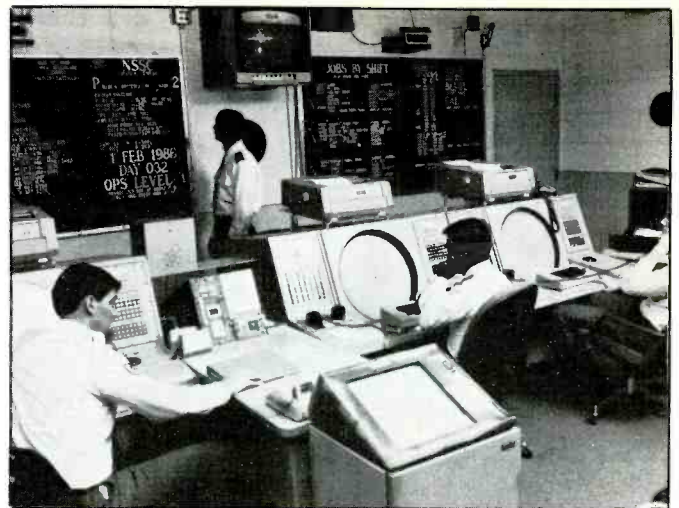

US SPACE COM space surveillance center.

**GEODSS SITES**

White Sands, NM  
 Teagn, S. Korea  
 Maui, Hawaii  
 Portugal  
 Canada  
 Malabar, FL  
 New Zealand  
 Italy  
 California  
 Diego Garcia Is.

**NSA/Military**

**Communications Centers**

England	Pakistan
Spain	China
Greece	Australia
Cyprus	Ethopia
Turkey	Morocco
Okinawa	Seychelles Is.
Japan	E. Africa
Iceland	Italy
S. Korea	W. Germany
Norway	Austria

**Spysat**

Type	Orbit
KH-12 Photo/Elint	Polar/LEO
KH-11 Photo/Elint	Polar/LEO
Teal Ruby IR/Imaging	LEO/Polar
White Cloud ElInt	LEO/Polar
Clipper Bow RadInt	Polar/LEO
SDS Communications	Molniya
DMSP Weather	Polar
DSP Early Warning	Geo
GPS Navigation	LEO/High

SDS-Satellite Data System  
 DMSP-Defense Meterological Satellite Program  
 DSP-Defense Support Program  
 GPS-Global Positioning System  
 LEO-Low Earth Orbit

**Satellite Control Stations**

Sunnyvale, CA  
 Anderson AFB, Guam  
 Kaena Point, Hawaii  
 Mahi, Seychelles Is.  
 New Boston Air Station, NH  
 Thule AFB, Greenland  
 Vandenberg AFB, CA  
 Oakhanger, UK  
 Peterson AFB, CO

**Satellite Data Processing Centers**

NSA/SigInt	Ft. Meade, MD
CIA/PhotoInt	Ft. Belvoir, VA
Early Warning	Buckly Air Base, CO

**Projected Milstar Locations**

Milstar	Location
#14	177.5°E
#11	152° E
#15	150° E
# 7	133° E
# 5	90° E
# 4	55° E
#10	30° E
# 9	19° E
#13	4° E
# 2	9° W
# 8	68° W
# 1	90° W
# 6	120° W
#12	148° W

Milstar Frequency bands  
 250-400 MHz  
 2/20/45 GHz

dedicated systems. For example, we have the DSCS communication satellites, or the Early Warning (DSP) spacecraft systems. Each system consists of several satellites designed for a specific purpose. What you may not realize is that any one of the FltSatcom satellites, for example, may only look like a FltSatcom. It may be designed to look like a FltSat, with the same antenna and solar panels. It will even be in the same orbit as a real FltSat, but it will have an entirely different mission. It may be an infrared Early warning spacecraft, or a SigInt platform in FltSat clothing. Most of the US and Soviet satellite fleets are an odd mixture of satellites. Most of these spy spacecraft (and communications satellites as well) double as spaceborn ASAT systems as they carry enough explosives to destroy the spacecraft on command, to keep it from re-entering earth's atmosphere or falling (no pun intended) into the hands of the opposition.

The National Reconnaissance Office (NRO) is responsible for determining the priority of targets for our spy satellites. NRO is made up of members of the CIA and the Air Force. In the early days of satellite reconnaissance, both agencies sought control of these satellites. The NRO sees to it that no time, energy or resources are wasted on infighting between the two groups.

The Ballistic Missile Defense of the US Space Command include SDI research and development. The Strategic Defense Initiative Office (SDIO) is responsible for deciding what type of weapon research is to be explored. When this has been decided, the Naval Research Laboratory (NRL) takes the lead in designing experiments, weapons and satellite prototypes to test the theory behind the SDIO projects. For example two experimental SDI spacecraft were launched last year by the Air Force. Both were built by the NRL.

They were both launched at the same



NORAD Command Post.

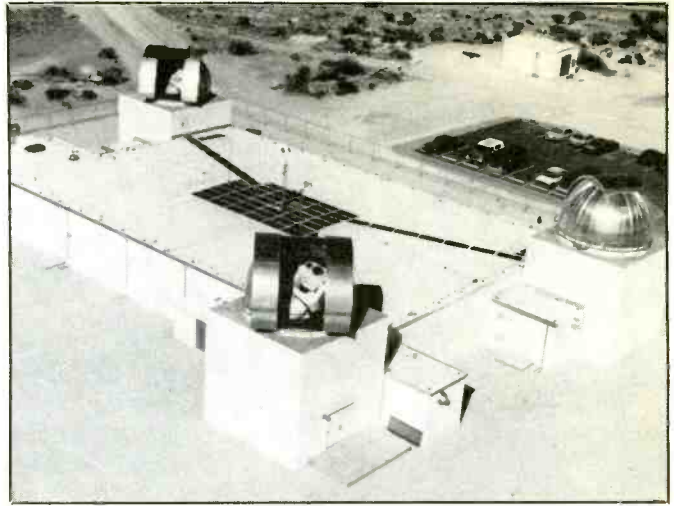

GEODDS site (US Space Com).

time on a Delta launch vehicle. The launch was named Delta Star 183. One spacecraft is a laser target for our ground based lasers at White Sands, N.M. and Hawaii. The problem we now have with lasers is controlling the diameter of the beam. The atmosphere tends to disperse or diffuse the beam into a wide pattern, causing it to be less effective. The second spacecraft will be a relay mirror, which will be used to reflect laser beams from the ground towards targets in space.

The Space Shuttle also conducts SDI experiments. STS-28 carried a KH-11 satellite and several experiments. We know little about these experiments. However, STS-28 does give us some evidence that laser or optical experiments were conducted. The tail section of the shuttle gives us this clue.

Though it could go unnoticed to the casual observer, any photo of the landing of STS-28 will show that an additional piece of equipment has been added to the top of the vertical tail section of the shuttle. There appears to be an opening or a lense facing toward the front of the spacecraft. This additional equipment has not been seen on other shuttle craft. During these classified shuttle missions' crew communications with the ground have been scrambled after the TDRS satellite has been accessed. Unencrypted voice is still used on UHF during the launch phase. Additional security measures have been taken to protect crew communications. Voice communications between the crew members is conducted on infrared frequencies on all classified missions. This

protects the mission from nosey Soviet spy satellites and ground stations, who, naturally have an interest in such missions. Eventually the whole shuttle fleet may be switched to the IR system. Unclassified missions have used RF frequencies for crew communications. This means the crew conversations can be overheard, not only by the Soviets but by SWL's as well. The RF system uses frequencies between 260 and 280 MHz.

The way satellite intelligence is handled is changing. This information has always been highly centralized and tightly controlled. With the deployment of the next generation of spysat and communications satellites, their mission will change from a strictly Strategic roll to a Tactical one. TENCAP is the program and Milstar is the satellite. TENCAP (Technical Exploitation of National Capabilities) will allow field commanders, ship captains and bomber pilots to get real-time (live) photos, data and voice communications from our spy and communications satellites. The Milstar satellites will replace our present military satellite communication system and provide a single uniform communications network for all the services. Satellites will be deployed in geo-stationary, polar and possibly high or molniya orbits. This will give continuing communications and intelligence coverage for all our naval, air and ground forces.

The mission of the men and machines of the US Space Command has been quite clearly outlined by their Commander-in-Chief, General John L. Piotrowski: "Future military space operations must be treated with the same developed-for-war approach that today is applied to operations on land, sea and air. The evolution of space operations away from a solely peacetime orientation to one of stressing war fighting requirements must continue in order to deter aggression and if deterrence fails, succeed on the battlefield."

See you next month.

## Order Back Issues of **POPULAR COMMUNICATIONS**

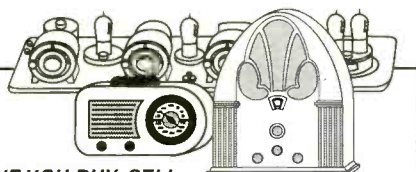

IF YOU BUY, SELL  
OR COLLECT OLD RADIOS, YOU NEED...

### ANTIQUE RADIO CLASSIFIED FREE SAMPLE COPY!

Antique Radio's Largest Monthly Magazine  
Articles - Classifieds - Ads for Parts & Services.  
Also: Early TV, Ham Equip., Books, Telegraph,  
Art Deco, 40's & 50's Radios & more...

Free 20-word ad each month. Don't miss out!  
6-Month: \$11. 1-Year: \$20 (\$30 by 1st Class)  
A.R.C., P.O. Box 802-T5, Carlisle, MA 01741

CIRCLE 143 ON READER SERVICE CARD

### FREE CATALOG! 1-800-648-7938 JERROLD HAMLIN OAK ETC CABLE TV DESCRAMBLERS

- Compare our Low Retail Prices!
- Guaranteed Prices & Warranties!
- Orders Shipped Immediately!

REPUBLIC CABLE PRODUCTS, INC.  
4090 Paradise Rd. #15, Dept. 102  
Las Vegas, NV 89109  
For all other information (702) 362-9026

CIRCLE 144 ON READER SERVICE CARD



# PIRATES DEN

BY EDWARD TEACH

## FOCUS ON FREE RADIO BROADCASTING

A new pirate broadcaster announced plans for a late fall start. **Action Radio** planned to run 250 watts from a mountain-top in West Virginia. The closest thing given to a frequency was "near 41 meters." Programming will consist of light rock and oldies. Requests and dedications can be phoned to (412) 551-7392. "The Front Porch Show" will be the main program aired by the station. The operator says he needs a reliable mail drop.

Mail drops—some of them anyway—are in a change mode, according to information sent by Nick Grace in Massachusetts. Nick says the Beaver Falls address is now defunct but has been replaced by P.O. Box 628, Slanesville, WV 25444. Nick also reports that the operator of the Hilo drop is replacing that one with P.O. Box 452, Wellsville, NY 14895. And, Nick says the Kingston, NY drop is closed. Also, **International Alternative Radio** writes to correct their address—it's 1257 Siskiyou Blvd., Box 132, Ashland, OR 97520. IAR now handles mail for FM pirates KCUF and Radio Free America.

Frank Marauder of **Zodiac Radio** says he's getting QSL requests from a large area—distances of up to 1,900 miles. Marauder says that another station, KCCR, is still on the air on 7405 but only uses 2 watts. KCCR hasn't received any reports.

Joe McCusker sends a new clipping reporting on an FCC burst of **WHOT** back in July, though the FCC didn't release the news for several months. WHOT was located in a Brooklyn apartment.

Again, there are a lot of pirate logs so let's get to them.

**Zodiac Radio** is heard frequently by Don Feldman in California who says the best times to check are Wednesdays through Saturdays between 0300-0500. What frequency, Don? Alan Fedder, also in California, found the station on 7423 at 0433 with "War of the Worlds."

**KNBS Free Radio** was heard by Ben Fuller, Jr., in Massachusetts on 7410 at 1814 with satirical commercials, ID's for "Cannabis Radio" pro-drug announcements and country songs. DJ was Phil Muzik. Nick Grace heard them at 1834-1845 on 7412.

James Geoffrey Malta in New York caught **Jolly Roger Radio**, which claims to be in Europe. He had them on 6229 around 0000 announcing 60 watts and giving QSL address as J.R.R., Box 39, Waterford, Ireland.

Another European, **Weekend Music Radio** in Scotland, was heard by Nick Grace who had them at 0155 on 15043 with mostly bagpipe music. Robert Ross had them from 0119 sign on to 0300. Address

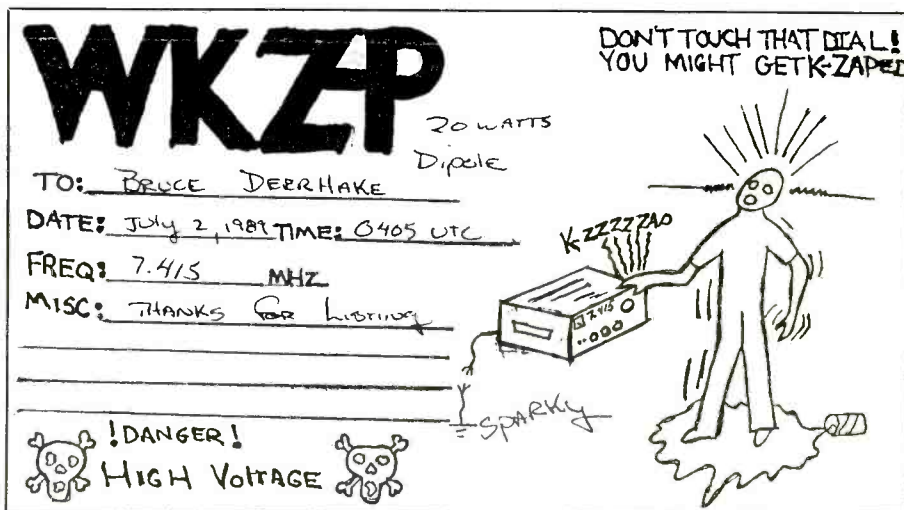

Here's a QSL from WKZP (K-Zap) received by Bruce Deerhake of Dayton, OH.

given as 42 Aaran Close, Cambridge, England.

**Radio Clandestine** was heard by Mark Morgan in Ohio on 7415 at 0100-0230 with usual host R.F. Burns and mentions of the "Motor Vessel Shangri-la" and "somewhere off the coast of North America." Nick Grace caught them at 0301-0342 and noted that the CW station often active in this area moved from 7417 to 7415 while Clandestine was on. Ross in Ontario had them on 7415 and 7420 between 0312 and 0329.

Robert also heard **United World Radio** on 7415.3 at 0024-0029 with ID "This is the international service of United World Radio in the 49 meter band" (despite the 41 meter band frequency, Edward). Also heard by Grace at 0257-0351.

Grace hears RFM (Radio Free Massachusetts) on 7416 at 0023-0051 with music and talk, and says they have a very nice QSL. What's the address, Nick?

Nick also hears **The Voice Of Stench** on 7416 at 2229-2239, but with a weak signal.

Robert Ross heard **Samurai Radio** on two occasions: 0140 on 6275 and then at 0155 with a test on 6200.7. The operator said hello to Radio Clandestine's R.F. Burns and pirate/clandestine writer George Zeller. ID as "Samurai Radio, the Voice of Oriental America, 6275 kHz in the 48 meter band."

**Radio Garbanzo** was heard by Morgan from 0200-0252 on 7413 with rock music and fake commercials. Also logged by Grace on 7412 at 0200.

Grace also had **WART** on 7355 at 0300. This is a member of the Pirate Radio Network, (i.e., it's affiliated with Radio Clandestine) but, says Nick, WART transmits

from a different location.

Nick also had **KRUD** at 0400 on 7415 and WBRI on 7485 and 7491 (times?) and 7489 at 2320. WBRI was giving the Washington address of the FCC for reception reports! *Funneee!*

RADIO USA was heard by Nick at 2211-2237 on 7417. This broadcast was followed by one from **Radio Flatulence** at 2237-2252.

**Radio Dog** was heard by Morgan on 7420 at 0300-0330 when the DJ said he had to sign off because "the antenna was heating up." Gave power as 100 watts.

**CHGO** was logged by Nick Grace at 0325 on 7412. Played jazz and alleged a Chicago area location (hence the call letters). Nick wonders if there's any address for this one. I haven't seen anything yet. Anyone else?

**Radio Kaos** via Radio Clandestine was noted by Ross on 7415 and 7420 between 0343-0435 with R.F. Burns saying it was a special broadcast of Roger Water's Radio Kaos.

Ross also found **Radio Jam** on 7415 at 0244-0251 with ID "You are listening to radio service worldwide, Radio Jam, broadcasting somewhere from Florida."

Robert Ross and Nick Grace also report a number of QSL's. Robert got replies from Free Radio One and Radio Comedy Club International and Nick received QSL's from Radio Clandestine, KNBS, Radio Flatulence and Radio Free Massachusetts.

Thanks to all of you who sent reports and information. Keep them coming—and let's have even more of you joining in! That includes station ops, too; readers appreciate getting the dope on your plans, programming, equipment and such.

PC

### Handheld Position Fixing – Available Now

**J**ust pull out the antenna, press the tiny on-button, wait a few seconds, and your exact position in geographic hours, minutes, and seconds, is displayed on the tiny screen. Push 2 other buttons, and your tiny location receiver will now display numbers corresponding to time delay lines printed on marine charts, or numbers that correspond with grids printed on topographical maps. And push one more button, and your handheld receiver will display your altitude, as well as your speed and direction over water, in the air, or on land.

Are we dreaming? Absolutely not! The equipment is now available, and maybe purchased for as little as \$300 to as high as \$3,000. It all depends what you want for position finding.

**2 POSITIONING SYSTEMS.** Two completely different radio navigation systems are the popular choice today by mariners, aviators, the Coast Guard, and the military. These two systems are called *Loran*, and *GPS*. Oh yes—there are others, such as the old RDF radio beacon system, Omega, VOR Omni, Consolan, Decca, and Transit—but the two most popular systems today, featuring inexpensive handheld receivers available for civilian use, are Loran and GPS. (See *Popular Communications*, January issue, 1989)

**LORAN.** The Loran-C navigation system operates at 100 kHz. Loran stations make up strategically located Loran chains. In the United States, Loran chains are operated by the United States Coast Guard. In other countries, Loran chains are operated by that country's governmental agencies.

Here in the United States, Loran-C navigation has enjoyed popularity among boaters because of the low-cost availability of equipment. The typical cost of a marine Loran receiver is less than \$400, and position accuracy is better than 1/4 mile absolute, and better than 50 feet repeatable. Aircraft owners also enjoy the benefits of Loran, and now with portable equipment, so may the backpacker, camper, or emergency communicator.

Synchronized Loran chains provide excellent 100 kHz Loran coverage throughout most of the land areas of the United States, and almost all ocean areas along our coast line—out to 200 miles. The new Loran-C mid-continent expansion project (MEP), a joint project of the U.S. Coast Guard and Federal Aviation Administration, will add mid-United States Loran coverage not currently serviced by existing Loran-C chains.



Author Gordon West testing, side-by-side, Loran (left) and GPS satellite receivers.



The mid-continent expansion project will require the construction of two new Loran-C chains. The southcentral U.S. chain includes a new station in Boise City, Oklahoma; Las Cruces, New Mexico; and Gillette, Wyoming, to go along with existing stations in Searchlight, Nevada; Raymondville, Texas; and Grangeville, Louisiana.

The new northcentral U.S. Loran chain will include new stations in Gillette and a new station in Havre, Montana, added to existing stations in Minnesota and British Columbia.

When the two new chains are completed by mid-1990's, all of the United States will be covered with Loran-C signals.

It takes a portable (or really, any type) Loran receiver approximately 3 minutes to tune into the synchronized chain's pulses. The sensitive receiver has no speaker—your position simply reads out as latitude and longitude on the display screen. You may also read out time delay lines overprinted on most marine charts. This allows for position fixes within yards of your actual location.

The latest entry in tiny Loran locaters is from Voyager (9610 DeSota Avenue, Chatsworth, California 91311). Their handheld Loran receiver is completely self-contained, and operates over 24 hours on 6 AA alkaline batteries. Just pull the antenna up, turn the set on, and in about 2 minutes, you read out your position. Built-in software compensates for ASF (land mass) correction—giving you the ability to capture signals even in hilly terrain. Push one more button, and you can monitor your speed over water, air, and land, plus determine



A portable Loran receiver priced at \$300.

your magnetic direction, as well as time and distance to predetermined "waypoints."

For emergency communicators, store your command post location in a waypoint, and then take off with your search party and you'll always know how far away from base you are, and the way to get back home. You can store up to 100 waypoints in the Voyager "SportNav" portable Loran receiver.

While Loran is great, there are some drawbacks to the system. 100 kHz Loran frequencies are effected by atmospheric conditions, and also by nighttime skywaves. Fluorescent lights will drive your Loran crazy. You could also use a longer antenna than what is found on most portable Loran receivers, too, for reception in weak signal areas. However, these drawbacks are offset with the extremely low pricing of most Loran receivers from \$200 through \$800. This voyager unit sells for around \$600.





Hand-held portable, \$600 Loran receiver capable of 50 foot return repeatability of your position.

GLOBAL POSITIONING SYSTEM. GPS will eventually replace almost every other aid to radio navigation. This includes Loran, too, but not until the year 2000. You don't need to wait that long to use GPS—GPS signals are on the air now, and a handheld GPS receiver, priced under \$3,000, may track your position down to the yard where you are actually geographically located. In fact, put a GPS receiver in one spot for a day, and it can resolve the position down to a centimeter!

The GPS system receives its signals near 1500 MHz from a constellation of polar-orbiting satellites. This \$10 billion system is well underway to be completed within a few more years. There are now enough Block 1 and Block 2 satellites in orbit to give us 2-dimensional fixes, almost 24 hours a day. And, in just one year from now, there will be enough satellites in orbit to give us a 3-dimensional fix, 24 hours a day.

When ultimately completed, a constellation of 21 satellites, along with 3 spares, will give you instant position fixes, plus altitude, magnetic direction, and velocity, 24 hours a day, almost anywhere in the world. As long as you have a view to the sky, the GPS system will beam down the tiny satellite signals for your receiver to pick up.

A handheld GPS receiver is available today from Magellan Systems (260 E. Huntington Drive, Monrovia, California 91016). The Magellan Model NAV-1000 handheld portable receiver is almost the same size as the Voyager Loran receiver. But it's a world apart in its difference! The Magellan Model 1000 receives at 1500 MHz (as opposed to 100 kHz) and captures incoming signals from the satellite constellation. Through a

complex receiver sequencing scheme, the 2-channel receiver tracks the incoming signals of up to 4 satellites and will read out a new position fix every 45 seconds. And, hey, what's a 45-second wait if your position fix is within a few yards of your actual geographic location! In fact, for land surveys, let this receiver sit at a specific coordinate for about an hour, and it could resolve your position down to just a few feet. A simple push of a button allows the receiver to also read out topographical grids, used by most land maps. Out on the water, or up in the air, the unit would read out latitude and longitude down to the second, and tenths of a second.

Slightly larger GPS receivers will simultaneously track 2 or 3 satellites, giving you not only your exact position, but altitude, and velocity, and magnetic direction. While these sets are a little larger than what you might consider handheld, soon we will be seeing this type of technology in smaller sets.

As an emergency communicator, you could be asked to set up search teams and specific search tracks. These receivers, to include accessory track plotters, are portable, handheld, and are now priced well within the range of search and rescue private organizations.

Look for the global positioning system (GPS) to become the ultimate navigation system for the future, too. **PC**

## New from AOR

2000 Channels  
5MHz to 1500MHz



**AR2515**

- Covers 5MHz to 1500MHz in AM/FM/Wide FM modes. Continuous coverage
- 2000 Channel Memory 1984 Scan Frequencies & 16 Search Groups
- Scan/Search speeds up to 36 channels or increments per second
- Built in RS 232 computer interface
- 25 Day Satisfaction Guarantee. Full Refund if not Satisfied.
- Size 3 1/4" H x 5 3/4" W x 7 1/8" D Wt. 2 lb. 10 oz.
- Supplied with AC & DC power cords. Telescopic antenna

Total Price. Freight Prepaid (Express Shipping Optional)  
\*Upgrades of AR2002's to AR2515 specs Available

**\$695.00**

**ACE**  
COMMUNICATIONS

10707 E. 106th St. Indpls., IN 46256

Toll Free 800-445-7717

VISA and MasterCard  
(COD slightly higher)

In Indiana 317-849-2570 Collect FAX (317) 849-8794



CIRCLE 120 ON READER SERVICE CARD

# HAM RADIO IS FUN!

It's even more fun for beginners now that they can operate voice and link computers just as soon as they obtain their Novice class license. You can talk to hams all over the world when conditions permit, then switch to a repeater for local coverage, perhaps using a transceiver in your car or handheld unit.



Your passport to ham radio adventure is TUNE-IN THE WORLD WITH HAM RADIO. The book tells what you need to know in order to pass your Novice exam. Two cassettes teach the code quickly and easily.

Enclosed is my check or money order for \$19.00 plus \$3.50 for shipping and handling or charge my

( ) VISA ( ) MasterCard ( ) Am. Express

Signature \_\_\_\_\_

Acct. No. \_\_\_\_\_

Good from \_\_\_\_\_ Expires \_\_\_\_\_

Name \_\_\_\_\_

Address \_\_\_\_\_

\_\_\_\_\_

\_\_\_\_\_

City \_\_\_\_\_ State \_\_\_\_\_ Zip \_\_\_\_\_

PC

THE AMERICAN RADIO RELAY LEAGUE  
225 MAIN ST.  
NEWINGTON, CT 06111

CIRCLE 121 ON READER SERVICE CARD

## THE EXCITING WORLD OF RADIOTELETYPE MONITORING

**M**ystery of the month: In a recent RTTY test transmission by NBA, USN, Balboa, Panama, RY's were being sent to CCS. Now as every red-blooded utility station monitoring hobbyist knows, CCS is supposed to be the callsign of Santiago naval Radio. But NBA identified CCS on the test tape as being at Arauco, Chile. This transmission was on 20741 and 21833 kHz about a month before the beginning of IAWG-89, which was to be hosted by Chile's naval war college. NBA was setting up a communications link with Chile in advance of the war games.

Arauco is on the Pacific Coast of Chile at 37.15S, a short distance south of Talcahuano, Chile, the main naval base and headquarters for the Second Naval Zone. I find no callsign listed for Arauco. The callsign for Talcahuano is CCT.

The International Telecommunications Union says CCS is assigned to "Santiago Radionaval." Why NBA says it's Arauco, is a mystery. We would like to hear from anyone who could offer a good explanation.

There's no word yet whether Pan African News Agency, Dakar, Senegal, will drop its HF Radio service, as it was reported that PANA planned to link up with a UNESCO satellite network.

A report in the weekly newsmagazine "Insight" says that PANA's editorial department was to have been fully computerized last November in preparation for the linkage. Italy provided \$1.6 million toward PANA's goal of breaking the monopoly in Africa of the giant world news agencies such as AP, UPI, AFP, and Reuters.

Those of you who have read TASS's English news reports via RTTY may have found the use of the English language to be dry and stilted. Now all that's about to change.

An American graduate student was recently hired by TASS's Moscow office to edit English-language copy for style, according to Editor & Publisher magazine. TASS, which has faced difficulties in the past in selling subscriptions to its news service to the U.S. print and electronic media because of the stuffiness of its English usage, wants the recent college graduate to broaden the agency's appeal to the West's news organizations.

The former student will work for TASS for at least a year, with an option to stay two more years, as the Soviet Government loosens control over many of its agencies that were once financially supported by the Kremlin.

Those who own RTTY modulators with the ability of showing Cyrillic characters on video monitors will soon find that three more letters are being added to the Cyrillic

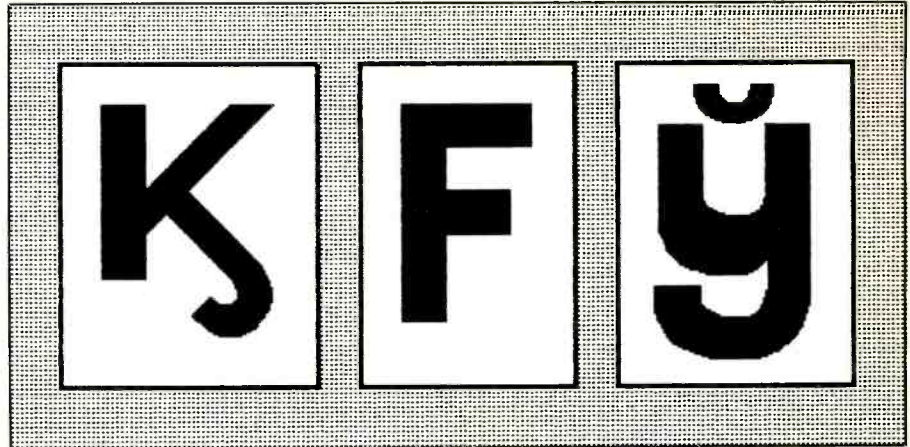

Figure 1. New letters of the Cyrillic alphabet added to approximate sounds of the Arabic language. The letters are pronounced, from left to right, "kH" as a hard, guttural sound, "gh" as a hard, guttural sound, and "wooh". (Source: The New York Times)

alphabet to approximate the sounds of the Arabic language heard in the Tatar SSR, it was reported in The New York Times (see figure 1).

The change will affect all Cyrillic alphabet typewriters as well as third-shift teleprinters and telegraph instruments, which will have to have additional codes devised to handle the additional characters.

For current reports of solar activity, tune in the WWV and WWVH time signal stations at 18 minutes past the hour to hear how calm or violent the storms are. The least amount of activity means better RTTY DX'ing for you.

### RTTY Intercepts

- 4356.5:** UDH, Riga R., Latvian SSR, w/ARQ phase sig & ID in CW at 0200 (Fred Hetherington, FL).
- 5160:** 5UA, ASECNA, Niamey, Niger, w/RYRY, 375/50N at 0100 (Hetherington, FL).
- 5421.5:** NRPX, USCG cutter Buttonwood, w/wx obs via NMG at 0321, 170/75R (Michael Ricks, PA).
- 5815.7:** MKK, RAF, London, England, w/foxes & RYI's at 0305, FDM 325/50R (Dallas Williams, CO).
- 6824:** GHH, Jamestown Meteo, St. Helena, w/RYRY + "Met St Helena transmitting on 9044 kHz." Was 425/50R, 0238-0240 (Ed.).
- 6835:** GFL22, Bracknell Meteo, England, w/coded wx 425/50R at 0244 (Ed.).
- 6902.5:** KAWN, USAF, Elk Horn, NE, w/aero wx, 850/75N at 0330 (Ed.).
- 6979:** CCS, Santiago (or Arauco? See main test—Ed.) Navrad, Chile, w/test xmsn at 0420, 850/100N (J.M., KY).
- 6989:** Un-ID w "ZCZC QJH VRMM" + RYRY, 0005-0026, 850/50R (Williams, CO). This may be Male Aero, Maldives, if we regard VRMM as an ICAO location indicator—Ed.
- 7626:** ASECNA, Bamako, Mali, w/RYRY, 425/50R at 0145 (Hetherington, FL).
- 7711-7713:** MKK, RAF, London, England, w/foxes, counting a RYI's on 6 channels, 170/50N&R (Ed.).
- 7832:** USAF MARS sta AFA1FP wkg AFA2ER, AFA3CT, & AIR, at 1435, 170/45R (Ed.).
- 7887:** 4UZ, UN, Geneva, Switzerland, w/tfc in EE, 425k/75R (Williams, CO). Time?—Ed.
- 7887.8:** Probably Mexican govt w/wx in SS for Central America at 0241, 170/50R, foll by SSB tfc at 0246.

### Abbreviations Used In The RTTY Column

AA	Arabic
ARQ	SITOR mode
BC	Broadcast
EE	English
FEC	Forward Error Connection mode
FF	French
foxes	"Quick brown fox ... "test tape
GG	German
ID	Identification/ied
MFA	Ministry of Foreign Affairs
nx	News
PP	Portuguese
RYRY	"RYRY ... "test tape
SS	Spanish
tfc	Traffic
w/	With
wx	Weather

Same type tfc noted on 12154.3 (Williams, CO). If this is indeed a Mexican sta., there are two possibilities found listed on 7886.5 for SSB fone. They are XB267, Cordoba; and X3BHG, Jasso—Ed.

**7909.3-7911.4:** VDD, Canadian mil., Debort, NS, w/foxes, counting and "Test" w/o ID on 10 channels, FDM 170/75N&R, at 1610 (Ed.).

**8070:** ZRH, Cape Town Navrad, RSA, w/RYRY to NMN at 0035, 850/75R (Williams, CO).

**8145:** EIP, Shannon Aero, Ireland, w/flight plans at 0411, 850/50N (Williams, CO).

**8193:** TAD, MFA, Ankara, Turkey, w/5L grps to Ottawa, ON, at 1403, 850/75R (J.M., KY). FYI, J.M., the words "fm disisleri" indicates that smsn is from Ankara—Ed.

**8229:** UISZ, the Soviet spaceflight tracking ship Akademik Sergei Korolev, w/tfc relay to UVAU & UUYZ, 170/50 at 0325 (Ricks, PA).

**8709.5:** VIS, Sydney R., Australia, w/ARQ phase sig & CW ID at 1000 (Hetherington, FL).

**9044:** GHH, Jamestown Meteo, St. Helena, w/RYRY at 0238, 850/50 (Ricks, PA).

**9070:** 6VA29, Dakar Meteo, Senegal, w/coded wx, 425/50N at 0313 (Ed.).

**10105:** RKA79, TASS, Moscow, USSR, w/YRYR & ID in AA at 1133, foll by nx in AA at 1137, 425/50R (Ed.).

**10389:** 5NL, Lagos Aero, Nigeria, w/RYRY at 0230, 900/50R (Ed.).

**10428:** Guessing USN w/foxes & counting at 0103, 850/75R (J.M., KY).

**10452:** STK, Khartoum Aero, Sudan, w/RYRY at 0108, 425/50R (J.M., KY).



**10551.3:** GFL23, Bracknell Meteo, England, w/ coded wx at 1025, 425/50R (Ed.).

**10674:** NMG, USCG, New Orleans, LA, w/Safety Broadcast msg for NBTC, cutter Aquidneck, at 1254, 170/75R (J.M., KY).

**10835:** CLP1, MFA, Havana, Cuba, w/crypto after ZZZZZ at 0440, 425/50N (J.M., KY).

**11044.4-11046.4:** VER, Canadian mil., Ottawa, ON, w/foxes, counting, RYRY & ID as "RCCACP." Was FDM 170/75N on 7 channels at 1307 (Ed.).

**11422:** FJY5, French mil., Crozet Island, w/RYRY w/o ID at 1130, 425/75N. Then "non protege" tfc that appeared to be a love letter. Ended xmsn at 1132 (Ed.).

**11430:** HMF55, KCNA, Pyongyang, North Korea, w/nx in FF at 2200, 425/50N. Good sig. Found the foll day on 11432 at 0953 w/RYRY into nx in EE at 1000. But a solar storm caused very bad garbling. What a difference 12 hours make! (Ed.).

**11439.5:** 5NK, Kano Aero, Niger, w/RYRY, 600/50R at 2057 (Ed.).

**11442:** 5KM, Bogota Navrad, Colombia, w/RYRY to NBA, 850/75R at 2050 (Hetherington, FL).

**11459:** Y7A49, MFA, Berlin, GDR, w/RYRY at 0500, 425/100R (J.M., KY).

**11549.7:** FJY4, French mil., Amsterdam Island, w/tfc to FJY2, Kerguelen Island, ARQ-E3/96 at 1215. Tfc included a "routine" msg that was encrypted, wx obs from a ship, & coded wx. Off at 1241 (Ed.).

**12223.7:** VOA, Greenville, NC, w/its Near-East file nx in EE at 2326, 425/75N (Ed.).

**13089:** SPB62, Szczecin R., Poland, w/an ARQ msg in Polish at 2000 (Hetherington, FL).

**13092:** Y5M, Ruegen R., GDR, w/ARQ phase sig + ID in CW at 2010 (Hetherington, FL).

**13415:** A North Korean embassy w/tfc in 5F grps & KK, 1000/50N at 1235 (Hetherington, FL).

**13486:** NMG, USCG, New Orleans, LA, w/Safety Broadcast Notices to Mariners relayed from USCG, San Juan, PR, to NRQW, cutter Sweetgum, & NRQW giving QSL's. Notices involved the destruction of ship navigation aids by Hurricane Hugo. Was 170/75R at 1325 (Ed.).

**13526:** DHJ51, Gregel meteo, FRG, w/coded wx at 1430, 425/100N (Ed.).

**13530:** RVW53, Moscow Meteo, USSR, w/coded wx, 900/50R at 1433 (Ed.).

**13542:** RFTJD, French mil., Libreville, Gabon, w/"controle de voie" at 0105, ARQ-E3/48 (Ed.).

**13563:** 3MA22, CNA, Taipei, Taiwan, w/nx in EE at 1444, 850/50N (Ed.).

**13895:** Y2V4y, ADN, Berlin, GDR, w/nx in AA at 1750, 425/50N (Ed.).

**14178:** VOA, Greenville, NC, on ham band w nx in EE & SS, 425/75N at 1626. Strong sig (Ed.).

**14348:** CLN530, PL, Havana, Cuba, w/nx at 1955, 425/50R. Apparently off freq. by 2 MHz since the sta sent an ID as CLN530 16348 kHz and CLN451 14901 kHz. Found 14901 active at the time, but not 16348 (J.M., KY). The actual callsign here is CLN440, and was off freq. by only -6 kHz—Ed.

**14370:** HZJ, Jeddah Aero, Saudi Arabia, w/RYRY at 1933, 425/50N (Ed.).

**14387.9:** AFRTS, Los Angeles, CA, w/UPI's L.A. Area nx summary, FDM 85/50R at 1757. See 16048.5, where schedule for these items was released earlier in the day. Higher freq not in op at this time (Ed.).

**14392:** USAF MARS sta AFA2XO w/relay of telegrams from AGA8CL, 170/75R at 1929 (Ed.).

**14452:** WGY908, FEMA, Denver, CO, and WGY909, FEMA, San Francisco, CA, w/encrypted data at 2045, 850/75N (J.M., KY).

**14523:** Un-ID w/5L grps at 1426, 500/50N. Extremely dirty sig, possibly a spur (Williams, CO).

**14595:** JAL54, Kyodo, Tokyo, Japan, w/nx in EE at 1015-1100, 850/50R. Haven't logged this one here since 1982 (Hetherington, FL).

**14764:** A9M70, GNA, Manama, Bahrain, w/nx in AA, 300/75R at 2056 (Ed.).

**14776:** SUC, Cairo Aero, Egypt, gives ID as "EUCN," at 1441, foll by aero wx at 1446, 850/50N (Ed.).

**14785:** ATP65, MEA, New Delhi, India, w/nx in EE at 1310, 425/50N (Ed.).

**14786.5:** 9PL, Kinshasa Meteo, Zaire, w/RYRY at 2015, 425/50N (Ed.).

**14814.7:** Assuming Egyptian diplos w/ARQ tfc in AA. Brief msgs from "14" to "13" sent at 1746, 1753,

1809 & 1813 (Ed.).

**14838:** VOA "American Republics File" nx in EE & SS, 425/75N at 1935 (Ed.).

**14862.7:** Possibly an Egyptian diplo w/ARQ msgs in AA, 2135-2237 (Ed.).

**14912:** "DFZG," MFA, Belgrade, Yugoslavia, w/nx in SC & EE to embassies worldwide, at 1449, 425/75N (Ed.).

**15520:** Possibly ZRH w/mil tfc. from SANSa re ships/cargo, 850/75R at 1320. Repeated msg sent to NCSO, Walvis Bay (Williams, CO).

**15667:** FDY, French Air Force, Orleans, France, w/le bricks & RYRY, 425/50R at 1326 (Ed.).

**15710:** RED52, TASS, Moscow, USSR, w/nx in FF at 1330, 425/50R. Frequent QRM from "Double Oh" on USB working "Virgin 2," in Hurricane Hugo-related tfc. "Virgin 2" was on St. Thomas, VI (Ed.).

**15710:** RED52, TASS, Moscow, USSR, w/nx in FF at 1330, 425/50R. Frequent QRM from "Double Oh" on USB working "Virgin 2," in Hurricane Hugo-related tfc. "Virgin 2" was on St. Thomas, VI (Ed.).

**15818.2 & 15819.2:** MKD, RAF, Akrotiri, Cyprus, w/foxes, counting & RY's at 1639. Was 170/50R on lower freq and 170/50N on the other (Ed.).

**15845:** SUA289, MENA, Cairo, Egypt, w/nx in AA at 1351, 425/50R (Ed.).

**15988:** ADN, Berlin, GDR, w/nx in SS at 1524,

425/50N (J.M., KY). Callsign here is Y2V57—Ed.

**15992:** 4U2, UN, Geneva, Switzerland, w/telexes at 1747, 425/75R (Ricks, PA).

**16013:** RFVI, French mil., Le Port, Reunion, w/"controle de voie" and tfc in FF to RFQR, TDM-B/96 at 1311 (Ed.).

**16033.8:** CLP1, MFA, Havana, w/tfc to Nigeria, 500/50R at 2135 (Hetherington, FL).

**16037:** CLP1 w/prensaminex nx in SS, at 2059, 425/50N. Ended smsn a minute later (Ed.).

**16045:** CLP1 w/RYRY w/o ID, then "QSV" (4X), more RYRY, and a circular w/only 9 words being sent before abruptly ending xmsn. Was 425/50N at 2118 (Ed.).

**16048.5 & 16048.8:** AFRTS, Los Angeles, CA, wk/UPI schedule of nx events in L.A. area. Was FDM 170/50R at 1329 (Ed.).

**16095:** OMZ, MFA, Prague, Czechoslovakia, w/diplo nx in FF & ss/off in Czech, 425k/75N, 1524-1528. Sent CW 1528-1532 (Ed.).

**16118.5:** Possibly CLP1 w/nx in SS re "narcotraffic," 425/100N at 1630. Went to CW w/VV's at 1637 (Ed.).

**16129:** North Korean Embassy, Havana, Cuba, w/5F msgs & telegrams in KK, 1000/50N, 1247-1340 (Ed.).

**16136:** BZR66, Xinhua, Beijing, China, w/nx in EE at 1320, 425/75R (Ed.).

**World Probe**  
 \$29.<sup>95</sup> World Band Scanner Antenna  
 + SS P & H • Cuts Noise • Improves Reception • Indoors or Out •  
 • Works with all World Band Portables and Scanners •  
 • Sleek 6-ft Probe with Integral 25-ft Low-Loss Shielded Feedline •  
 • Fully Insulated and Weather Sealed • Decorator White Design •

AntennasWest Box 50062-P FREE Storage Pouch  
 801 373 8425 Provo, UT 84605 & Universal Connector Kit

CIRCLE 11 ON READER SERVICE CARD

SHORTWAVE RECEIVERS, HAM RADIOS, BOOKS, ANTENNAS, SCANNERS, Business Radios. ICOM, YAESU, KENWOOD, SONY, PANASONIC, MOTOROLA.  
 ... our 40th Year ... Worldwide shipping.  
 Sales ... Service. Large Showroom. Open 7 days.

**Barry Electronics Corp.**  
 Your one source for all Radio Equipment!

212-925-7000 or Fax 212-925-7001  
 512 Broadway, NYC, NY 10012

**Jo Gunn Enterprises**

— CB Antennas — Mobile Antennas  
 — 10 Meter Antennas — Coax

11 METER "COMBINATION TALKING"  
**JG-4 STAR UPS SHIPPABLE**

10 METER OMNI - DIRECTIONAL  
**JGAR - PISTOL (VERTICAL ANTENNA)**  
 (Frequency Range 26.000-29.500)  
 UPS SHIPPABLE

**Specifications:**  
 Type: Horiz. & Vert.  
 Polarization: Twin Feed  
 Gain: 15.5 DB  
 Front to Back Ratio: 45 DB True  
 Side Rejection: 45-50 DB True  
 Back Rejection: 45 DB True  
 Weight: 34 Pounds  
 Length: 12 Feet  
 SWR: 1:1  
 Horiz. to Vert. Separation: 20-25 DB  
 Wind Survival: 100 MPH  
 Power Multiplication: 50X  
 Audio Gain: 20 DB  
 Wind Load: 3.7

**Specifications:**  
 Gain: 4.75 DB  
 Multiplication Factor: 12X  
 Power Rating: 2000 CW, 4000 PEP  
 Weight: 8.0 Pounds  
 Height: 10 Feet  
 Materials: Anodized 6063T-6 Aircraft Aluminum Tubing

REQUIRES 1 COAXIAL CABLE FOR HOOK-UP

Call or send \$2.00 for Complete Catalog and Pricing of Antennas.  
 ALL CANADIAN INQUIRIES CONTACT:  
 SALES CANADA INC.  
 5035 NORTH SERVICE RD. UNIT D 16  
 BURLINGTON, ONTARIO  
 L7L 5V2  
 Tel: 1-416-332-5944 L7L 5V2 Fax: 1-416-332-5945

Route 1 - Box 32C, Hwy. 82  
 Ethelsville, AL 35461  
 (205) 658-2229  
 Hours: 10 am - 6 pm (CST)  
 Monday - Friday  
 DEALER INQUIRIES, PLEASE CALL

CIRCLE 117 ON READER SERVICE CARD

**FRANKLIN-BELLE PUBLISHERS**  
 The Antenna People Present:

● MAGAZINES ●  
 ● antennex—A monthly magazine all about antennas. Read in 40+ countries.....\$15.97

● BOOKS ●  
 ● Rules of the Antenna Game By Ted Hart, W5QJR.....\$9.95  
 ● Small High Efficiency Antennas By Ted Hart, W5QJR.....\$19.95  
 ● Electronics for the Radio Amateur By James G. Lee, W6VAT.....\$19.95

● SOFTWARE (IBM) ●  
 ● Transmitting Loop Antenna.....\$17.75  
 ● Transmission Line Antenna.....\$17.75  
 ● Antenna Utilities-Series 1.....\$27.75  
 ● Noise Analysis Program.....\$9.75  
 ● Capacitor Design Program.....\$9.75

● OTHER ●  
 ● Wiperless Capacitor Plans.....\$4.95

TO ORDER—Send Check or MO plus \$1.50 S&H per item (except magazine) Texas residents add 7.5% sales tax, TO:

**FRANKLIN-BELLE PUBLISHERS**  
 4639 Corona, Suite 12  
 Corpus Christi, TX 78411  
 (512) 852-0446

CIRCLE 118 ON READER SERVICE CARD

# They're Here!

## MODERN ELECTRONICS

### FUN PROJECT BOOKS

You'll want these two exciting project books, packed with complete plans for building a wide variety of useful electronic devices. The *First and Second Books of Modern Electronics Fun Projects*, both Howard W. Sams publications, are now available.

You'll find all the how-it-works information, schematics, photos, drawings, printed-circuit guides and parts sources to make it a snap to build almost 50 useful, unique electronic devices at modest cost.

Discover how these circuits and modern electronic devices perform their magic. Learn practical electronic technology the painless way and have fun doing it!

All projects are based on material published in *Modern Electronics*, with updates and revisions. They've been built and tested by the original authors. Chapters are divided into Intro To Electronic Projects, Home Electronics, Audio/Video Electronics, Security Electronics, Computers, Test Equipment, and Electronic Designing. There's something for everyone!

#### Look at what you can build & take pride in:

- \*Digital voltmeter accessories—high-frequency ac probe, true-rms adapter, temperature probe
- \*Car projects—anti-theft alarms, engine tachometer
- \*Life-saving detectors—gases & microwave leaks



- \*Computer system power controller
- \*Dual-pulse generator
- \*Surround-sound audio enhancer
- \*Security—telephoned status reporter, alarm control center
- \*Home convenience—selectable phone ringer musical tunes, touch-sensitive light controller.
- ... and so much more.

The Fun Projects are capped by introductory information on building projects and kits (tools needed, parts sources, etc.) and advanced design techniques that illustrate how a designer thinks and plans when putting together a practical end product.

From beginning to end, MODERN ELECTRONICS FUN PROJECT BOOKS are for you! Order them today for a fast start in the world of electronics.

MODERN ELECTRONICS  
76 N. Broadway, Hicksville, NY 11801

Name \_\_\_\_\_  
Address \_\_\_\_\_  
City \_\_\_\_\_  
State \_\_\_\_\_ Zip \_\_\_\_\_  
( ) Check ( ) MasterCard ( ) VISA  
Card No. \_\_\_\_\_  
Expires \_\_\_\_\_  
Signature \_\_\_\_\_

(Signature required on all charge orders)

Order Date: \_\_\_\_\_

QTY	Title	Price	Total
	First Book of Modern Electronics Fun Projects	\$12.95 ea.	
	Second Book of Modern Electronics Fun Projects	\$12.95 ea.	
		<b>Total</b>	
		<b>*Shipping</b>	
		<b>Grand Total</b>	

\*Shipping charges \$2 per order. Orders processed day received, but please allow 30 days for delivery.

- 16145: RWM77, APN, Moscow, USSR, w/nx in EE, 425/100R at 1321 (Ed.).
- 16223: RFTJ, French mil., Libreville, Gabon, w/"controle de voie" at 2003, TDM-B/96 (Ed.).
- 16506.7: Marina Tres (Mexican Navy), w/ARQ tlc in SS at 1447 (Ed.).
- 18042: DFZG, MFA, Belgrade, Yugoslavia, w/nx in SC, 425/75N at 2010 (Hetherington, FL).
- 18050: YZI, Tanjug, Belgrade, Yugoslavia, w/nx in FF, 425/50R at 1351 (Ed.).
- 18055: DFZG w/nx in SC, then crypto after XPXPXP & 3F grps, 425/75N, 1525-1530 (Ed.).
- 18125: RND70, TASS, Moscow, USSR, w/nx in EE, 425/50R at 1355 (Ed.).
- 18207: 9KT345, KUNA, Safat, Kuwait, w/nx in AA, 335/50N at 1130 (Hetherington, FL).
- 18207.5: HBD68, A Swiss Embassy somewhere, w/a 5F grp msg, ARQ at 2040 (Hetherington, FL). Guatemala City is the location—Ed.
- 18362.2 & 18363.5: VOA, Munich, FRG, w/RYRY to Greenville, NC. FDM 85/75N, at 1419 (Ed.).
- 18388.5: 5AF, Tripoli Aero, Libya, w/coded wx at 1633, 350/50N (Ed.).
- 18496: CNM80X11, MAP, Rabat, Morocco, w/nx in AA, 425/50R at 1630 (Ed.).
- 18604.1: VOA, Greenville, NC, w/RYRY to Monrovia, Liberia, FDM 85/75R at 1236 (Ed.).
- 18642.5: VOA, Greenville, NC, w/nx in EE at 2035, 425k/75N (Ed.).
- 18646.7: PCW1, MFA, The Hague, Holland, w/phase sig + CWID at 2034 (Ed.).
- 18700: Y2V44, ADN, Berlin, GDR, w/nx in EE, 425/50N at 1537 (Ed.).
- 19090.3: CLP1 w/a msg to 20 Cuban embassies, 500/50N at 1820 (Hetherington, FL).
- 19210: RCC79, TASS, Moscow, USSR, w/nx in FF beginning at 1400, 850/50R (Ed.).
- 19225: FDY, French Air Force, Orleans, France, w/le bricks & RYRY at 1603, 425/50R (Ed.).
- 19227: DFZG, MFA, Belgrade, Yugoslavia, w/crypt to after ZPZPZP & telexes to the ambassador at Ottawa, ON. Was 425/75N, 1604 to 1608 s/off (Ed.).
- 19954: CLP1, MFA, Havana, Cuba, w/circulars to embassies at 1251, 1000/75R (Ricks, PA).
- 20126: "BZQU" w/RYRY at 1545, 425/75N (J.M., KY).
- 20178: RFFA, French mil., Paris, France, w/"controle de voie," TDM-B/96 at 1802 (Ed.).
- 20240: Un-ID French mil. (Bordeaux?), w/circuit ID of HZE + "de RFFEDHZ" & "cabine RFFEDHZ en alarme." "Cabine" means callbox. Was ARQ-E/48 at 1726 (Ed.).
- 20420: Y2V20, ADN, Berlin, GDR, w/nx in AA, 425/50N at 1334. ADN's logo reads as "BR," in print-out (Ed.).
- 20523.2: Un-ID w/a telex in II, ARQ, 1814-1825 on a Saturday (Ed.).
- 20632: RFV1, Le Port, Reunion, w/"controle de voie," TDM-B/96 at 2000 (Ed.).
- 20655.3: DPA, Hamburg, FRG, w/nx in EE, 425/50N at 1238 (Ed.).
- 20741: NBA, USN, Balboa, Panama, w/tlc to CCS, Santiago Navrad, Chile, 850/75R at 1258. Sez CCS QTH is at Arauco, Chile, in RYRY test. Was //21833 (Ed.).
- 22564: WLO, Mobile R., AL, w/FEC wx BC at 0100 (J.M., KY).
- 22600: HJN2 w/ARQ msgs to ships at 2213. Any-one know the QTH of this Colombian coastal sta? (Ed.).
- 23370: HZN50, Jeddah Meteo, Saudi Arabia, w/coded wx, 170/100N at 1520 (Ed.).
- 23462.5: MKK, RAF, London, England, w/foxes, counting, & RYI's at 1515, FDM 170/50R. Test xmsn ran on other channels, but entire system was shutdown at 1516 before nearby freqs could be determined (Ed.).
- 23972: JMG5, Tokyo Meteo, Japan, w/coded wx at 1645, 850/50R (J.M., KY).
- 25315: RPFN, Lisbon Navrad, Portugal, w/foxes, counting, and RYRY, sent to PWZ33 at 1324, 850/50R (J.M., KY).
- 26207: DFZG, MFA, Belgrade, Yugoslavia, w/nx in SC, 3F grps, & crypto after XYXYXY, 1543-1735, 425/75N (Ed.).
- 26240: RFV1, French mil., Le Port, Reunion, w/"controle de voie," TDM-A/96 at 1705 (Ed.).



# LISTENING POST

BY GERRY L. DEXTER

## WHAT'S HAPPENING: INTERNATIONAL SHORTWAVE BROADCASTING BANDS

**G**abon's Africa Number One continues to expand and now has its fifth 500 kw transmitter on the air. The Moyabi facility is used as a relay site by Radio France International, Swiss Radio International and Radio Japan. Africa Number One's own transmissions are scheduled at 0500-0700 on 9580, 0700-0800 on 9580 and 17630, 0800-1600 on 17630, 1600-2100 on 9580 and 15475 and 2100-2300 on 9580. Broadcasts are almost entirely in French.

The new High Adventure ministries station on Guam was expected to be operational by the end of the 1989 or early this year. The call letters are supposed to be KHBN. No specific frequency or time schedule information was available at this writing. The new station is the third in the High Adventure group, joining KVOH in California and the Voice of Hope in Lebanon/Israel.

Tonga is definitely back on the air. For North American listeners, reception of the Tonga Broadcasting Commission remains one of the toughest of today's DX challenges. Your best bet is around 0700-0800 on 5030, while Radio Impacto is silent. In a year or so of operation on shortwave the station has been heard by only a handful of North American DXers.

The unhappy changes at Radio Denmark were scheduled to have gone into effect by now, meaning that broadcasts from Denmark can no longer be heard direct from that country. Radio Denmark is on the air via the facilities of Radio Norway International.

A new Ecuadorian station is Radio Centro, Ambato, operating on a variable frequency of 3289, and sometimes audible around 1000, as well as in North American evenings. Radio Tayabamba in Peru also operates very close to this spot so careful listening is needed.

Radio MEC in Rio de Janeiro, Brazil has been reactivated on shortwave and is active on both 9600 and 11950 from 1100 and runs through the day and into the evenings. All broadcasts are in Portuguese, of course. Several Brazilian stations once owned by the government are now in private hands. They are: Radio Nacional, Tabatinga; Radio Nacional, Sao Gabriel da Cachoeira; Radio Nacional, Porto Velho; Radio Nacional, Cruzeiro do Sul and Radio Nacional, Manaus. Apparently the change hasn't resulted in new names for the stations, at least not yet.

KY0I in Saipan was off the air for several months while service work was done on the transmitter and a new, second transmitter added. This broadcaster, which is part of the Christian Science (Herald Broadcasting) shortwave network, should be back on by

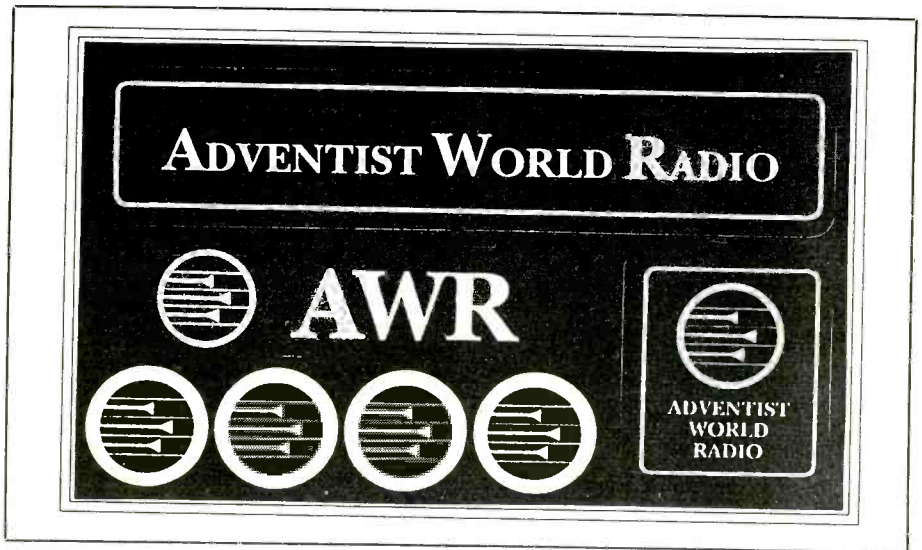

*KSDA's listener-designed QSL is in white and royal blue. The circles are stickers which can be peeled off and placed elsewhere if desired.*

now and perhaps with the new call of KHBI. It will, of course, carry Christian Science network programming.

KSDA, the Adventist World Radio station in Guam is putting a new transmitter on the air. That will make three, with a fourth to be added sometime in the future. Incidentally, KSDA and Adventist World Radio should receive the thanks and appreciation of every SWL for their admirable QSL poli-

cy. They not only answer every correct report but they go "above and beyond" to provide memorable QSL cards. Last year they held a QSL card design competition and gave prizes to half a dozen winners. Our hats are off to KSDA and Adventist World Radio. We can think of any number of shortwave broadcasters we wish would follow your example!

IN THE MAIL there's a nice letter from



*Staff engineer Tim Coucke took this photo of the KNLS control room. The Optomod HF audio processor unit is just to the right of the control board.*



A coconut hair ornament is featured on this Radio Beijing card, one of an always changing collection of designs offered by this station. (Thanks to Bill Walbesser)

Tim Coucke, an engineer at KNLS, who sends along a photo of their control room. A new Optimod-HF audio processor was put into use on March 31, 1989 (Time says KNLS was the first to use this unit fulltime) and, says Tim, has done wonders to make the KNLS signal more intelligible while at the same time enabling the station to cut back on transmitter power. Time says WSHB, the BBC and VOA are using or will be using the Optimod system.

David Olson ("Lonely little me out here in the middle of nowhere") of Watford City, North Dakota says he's using a Realistic DX-66 and a Hallicrafters S-40B with a 20 foot vertical. We used to have an S-40B, David and, actually, wouldn't mind picking one up again, just for the sake of sentiment!

Those AFRTS single sideband broadcasts are brought up again, this time by Ralph J. Mensch of Carteret, New Jersey who hears them on 1645.2 from 1645 to past 2300 and wonders where they're coming from. The transmitter is at a US Air Force base near Barford, England, Ralph. Still looking for a mailing address that works. Perhaps one of our utility DX compadres can help us out?

One of the large variety of Radio Beijing QSL card designs is pictured this month, courtesy of Bill Walbesser of Ravena, New York. Bill says he just renewed his listening hobby, which he first started back in 1964.

John Kershaw of San Diego, California says he's been an avid listener for the past 30 years. He uses a Sony 2003 with a longwire antenna.

**WHERE HAVE ALL THE CAMERAS GONE?** We continue to tear open the mail as it comes in, looking for shack photos. But

finding them has become a rare event! Have we the world's most bashful readers or what? If that's the case, we'll even accept shack photos of your equipment (without you and your smiling face). One way or the other, through, we'd sure like to feature you and/or your shack in these pages one day down the line. How about it?

**SOME REPORTING NOTES.** In addition to the standard request to please send loggings by country and include your last name and state abbreviation after each item, there are a couple of other things you can do to make things go more smoothly on this end. Use the same country names as we use in the column (West Germany not Germany, Fed. Republic of; England, not United Kingdom, etc). Reports are cut into strips for sorting and those written on light-weight tissue-type paper are very difficult to work with. If you can use standard typing paper (or heavier weight) it'll help a lot.

Check to make sure you've noted the language (if not English) and included both time and frequency. We've had to dump a number of items recently due to missing essential information.

Also, please don't send items that date back more than a month before the date you make up your report. The shortwave broadcast bands change rapidly and we want to keep the info as fresh as possible.

Thanks for your cooperation. Please keep the reports, comments, questions, illustration material, schedules and so on coming our way!

Here are this month's logs. All times are in UTC and language is English unless noted otherwise.

Abbreviation Used in Listening Post	
AA	Arabic
BC	Broadcasting
CC	Chinese
EE	English
FF	French
GG	German
ID	Identification
IS	Interval Signal
JJ	Japanese
mx	Music
NA	North America
nx	News
OM	Male
pgm	Program
PP	Portuguese
RR	Russian
rx	Religion/ious
SA	South America/n
SS	Spanish
UTC	Coordinated Universal Time (ex-GMT)
v	Frequency varies
w/	With
WX	Weather
YL	Female
//	Parallel frequencies

**Afghanistan:** Radio Afghanistan, 15510 (via USSR, editor) at 1900. (Giannarellis, Greece)

**Alaska:** KNLS on 11715 at 0810. (Wittmann, WA)

**Albania:** Radio Tirana, 9480 at 2132. (Walbesser, NY) 0430. (Mitchell, HI) 9500 at 0350. (Wittmann, WA)

**Algeria:** RTV Algerienne, 17745 at 1823 in AA. (Gilbert, CA)

**Argentina:** RAE at 0055 in SS on 11710. (Gilbert, CA)

**Ascension island:** BBC Relay on 9600 at 0615. (Johnson, IL)

**Australia:** Radio Australia, 9580 at 0805 with propagation report. (Walbesser, NY) 9655 at 0712. (Gilbert, CA) 11720 at 0828. (Mitchell, HI) 15160 at 0500. (Carson, OK) 15240//15320//17715//17750//17795 at 0535 with Pacific Beat program. (Johnson, IL) 21740 at 0201. Reynolds, MO) 21525 at 1330. (Giannarellis, Greece)

ABC Brisbane, 4920 at 1235. (Duggan, AZ) 15425 at 0910. (Wittmann, WA)

**Austria:** Radio Austria international, via Canada on 6015 at 0525 in German. (Ross, WA) EE at 0532. (Carson, OK) (Changes at 0530, editor) 13730 at 0615. (Johnson, IL) 21490 at 0740. (Giannarellis, Greece)

**Belgium:** BRT, 9925 at 2330 with "Belgium Today". (Miller, GA, Kershaw, CA) 17550 at 1231 with "Brussels Calling". (Reynolds, MO)

**Brazil:** Radio Nacional, Cruzeiro do Sol, 4755 at 0050 in PP. (Davis, WA) 0438 (Ross, WA)

Radio Nacional Porto Velho, 4945 at 0419 in PP with ID, music. (Ross, WA)

Radiobras, 11745 at 0202 and 0230 (Reynolds, MO; Wittmann, WA)

Radio Aparecida, 11855 at 0855 in PP. (Johnson, IL)

Radio Nacional Amazonia, 11780 at 0945 with PP ID. (Johnson, IL)

**Bulgaria:** Radio Sofia, 11660 at 2330. (Walbesser, NY) 17750 at 0300 with IS, ID. (Johnson, IL) 15290 at 0334. (Ross, WA) 15330 at 1429 in unidentified language. (Carson, OK) 17825 at 0630. (Giannarellis, Greece)

**Burkina Faso:** Radio Burkina, 4815 at 0600 sign on in FF. (Johnson, IL; Gilbert, CA)

**Canada:** Radio Japan relay on 5960 at 0138. (Reynolds, MO)

Radio Canada International, 17875 at 2109 to the Caribbean. (Carson, OK) 21675 to Europe at 1830. (Miller, GA)

CFRX Toronto, 6070 at 1920. (Mierzwinski, PA) 1750 with Wayne McClaine Show. (Malta, NJ)

CBC No. Quebec Service, 6195 at 0338. (Ross, WA) 0200 on 9625. (Wittmann, WA)

CFCX Montreal, 6005 at 1936. (Mierzwinski, PA)

**Chile:** Radio Nacional, 15140 in SS at 0100. (Kershaw, CA) 2310. (Johnson, IL) 1800 (Mierzwinski, PA)

**China:** Radio Beijing, 9570 at 1625. (Mitchell, HI) 9690 at 0350. (Wittmann, WA) (via Spain, Editor)

11685 at 0400. 17715 (via Mali, ed) and 17855 at 0000. (Walbesser, NY) 11715 (via Mali) t 0337. (Ross, WA) 11840 (Via Canada) at 0443 and 11855 at 1433, 15129 at 0040. (Carson, OK) 15130 (Via Mali, editor) at 0323. (Ross, WA)

**Colombia:** Caracol Bogota, 5075 in SS at 0310. (Carson, OK) 0445. (Johnson, IL)

La Vo del cinaruco, ARAUCA, 4865 with ID at 0502, then news. (Ross, WA) 0210 with mentions of Bogota and Caracol net. (Mierzwinski, PA) 0340 with news, Cracol IDs. (Carson, OK)

**Costa Rica:** Radio Impacto, 6150 at 0409 in SS. (Gilbert, CA)

Radio For Peace International, 7375 in USB at 0450 with "Common Ground" program. (Johnson, IL) 21565 with Radio Netherland's "European Profile" program at 2208. (Miller, GA)

Faro del Caribe, 5055 at 0405 with SS ID. (Johnson, IL) Here and 6175 at 0505. (Gilbert, CA)

**Cuba:** Radio Havana Cuba, 5965 at 0454. (Mitchell, HI) 6035 at 0527 and 9710 at 0328. (Ross, WA) 11760 at 0401. (Carson, OK) 11825//5965 at 0455 with "DX'ers Unlimited." (Malta, NJ) 11970 at 0445. (Carson, OK)

Radio Rebelde, 5025 at 0215 in SS. (Johnson, IL)

**Czechoslovakia:** Radio Prague, 7345 at 0341. (Ross, WA) 9540 at 0100. (Walbesser, NY) 0400 in SS. (Gilbert, CA) 11990 at 0340. (Wittman, WA) 13715 at 1745. (Mitchell, HI) 0100. (Carson, OK) 21450 at 1725. (Johnson, IL)

**East Germany:** RBI, 6165 in GG at 0550. (Ross, WA) 11785 at 0227 sign off. (Johnson, IL) 11810 at 0510. (Carson, OK)

**Ecuador:** 6230 at 0556. 11775 at 0326. (Ross, WA) 11925 at 0700. (Mitchell, HI) 15155 at 0307. (Reynolds, MO) 17790 at 2130. (Giannarellis, Greece)

Radio Quito, 4920 at 0505 with ID in SS. (Johnson, IL)

**Egypt:** Radio Cairo, 9475 at 0200. (Johnson, IL)

**England:** BBC 5975 (via Antigua, Editor) at 0500. (Wittman, WA) 9615 at 0800, 9640 at 0600, 15280 at 0800, 15360 at 0850. (Mitchell, HI) 11760 via Cyprus?



(listed as via oman, editor) at 0847. (Duggan, AZ) 15260 at 0130 (via Ascension, editor) and 17740 at 0621. (Carson, OK) 21710at 1936. (Olson, ND)

**Ethiopia:** Voice of Ethiopia, 9560 at 1502 with American pop, news by woman, f/by "Introduction Ethiopia." (Gilbert, CA) 9660 at 1800 with news. (Giannarelis, Greece)

**Finland:** Radio Finland International, 11755 at 0236 with "Business Monday" (Gilbert, CA) 0245 on 15185. (Wittman, WA) 21550 at 1303 with "Good Morning North America". Toll-free phone number to get current broadcast schedule is 1-800-221-9539. (Reynolds, MO)

**France:** Radio France International, 5945 at 0045 in FF (Davis, MA) 6150 in SS at 0537. (Ross, WA) 17620 at 1600. (Mitchell, HI) 25820 in FF at 1405. (Johnson, IL)

**French Guiana:** RFI relay, 11670 at 0341. (Ross, WA) 11995 at 0314 (Reynolds, MO)

RFO Guyane, 5055 in FF at 0525. (Duggan, AZ)

**Gabon:** RFI via Africa No. One - 4830 at 0500 in FF (Johnson, IL)

Africa No. One at 1529 on 17630 with African pops. (Carson, OK)

**Ghana:** Ghana Broadcasting Corp. at 0540. (Gilbert, CA) 0600 with ID and drums. (Johnson, IL)

**Greece:** Voice of Greece, 9395 at 0132 with news. (Walbesser, NY) 9420 at 0349 with news. (Ross, WA) 11645 at 0130 with news. (Johnson, IL)

VOA Relay, 9760 at 1517. (Reese, Thailand)

**Guatemala:** Radio Tezulutlan, 3370 at 1135. (Spanish or Indian languages, editor) (Duggan, AZ) 4835 at 0217 in SS. (Gilbert, CA)

Radio Cultura, 3330 at 0630. (Gilbert, CA)

**Honduras:** Sani Radio, HRRI, 4755 at 1220 in SS. (Duggan, AZ)

HRVC La Vo Evangelica, in SS on 4820 at 0402, 0454. (Gilbert, CA; Ross, WA)

**Hungary:** Radio Budapest, 9520 at 0057. (Walbesser, NY) 9835 at 2330, 2348. (Miller, GA; Carson, OK)

**Iceland:** Iceland State Broadcasting Service, 15767 at 1215 with news in Icelandic. (Giannarelis, Greece)

**India:** All India Radio, 9910 at 2200 with news, commentary. music. (Giannarelis, Greece)

**Iran:** VOIRI, 9022 at 0310 in SS. (Johnson, IL) 0235 in Farsi. (Gilbert, CA)

**Iraq:** Radio Baghdad, 9505 at 0159 with mideast music. (Gilbert, CA) 9515 at 0200. (Johnson, IL) 0303. (Walbesser, NY)

**Israel:** Kol Israel, 11605 at 2327. (Olson, ND) 11655 at 0402. (Gilbert, CA) 15615 at 0010. (Wittman, WA) 17630 at 0403. (Ross, WA)

**Italy:** RAI, 9545//9710 at 0135 with IS. (Johnson, IL) 9575//11800 at 0230 in Italian. (Gilbert, CA) 15330 at 0351. (Ross, WA)

**Japan:** Radio Japan, 5960 (via Canada, editor) at 0131. (Carson, OK) 6025 at 0116. (Olson, ND) 6140 at 0534. (Ross, WA) 11800 (via Gabon) at 2120, //15325//15350 (via French Guiana) at 0258 in JJ/FF. (Johnson, IL) 11840 at 0900, 15275 at 0755, 17765 at 2345 and 17810 at 2100. (Mitchell, HI) 17825 at 0316. (Ross, WA)

**Jordan:** Radio Jordan, 11955 at 0406 in AA. (Gilbert, CA) 13655 at 0535 with pops. (Johnson, IL)

**Liberia:** VOA Relay, 15580 at 1743. "Sound of Soul" (Reynolds, MO)

**Libya:** Radio jamahiriya, 15415 at 2254 in AA. (Gilbert, CA)

**Lithuanian SSR:** Radio Vilnius, 11790 at 2209 with news, commentary. (Walbesser, NY) (via Radio Moscow, editor)

**Luxembourg:** Raio Luxembourg, 6090 at 0616-0620 in GG. (Gilbert, CA)

**Madagascar:** Radio netherlands relay, 15560 at 1845 (Johnson, IL) 15570 at 1630. (Giannarelis, Greece)

**Mali:** Radio Beijing relay, 15129 at 2334. (Carson, OK) 17715 at 0000. (Reynolds, MO)

RTV Malienne, 4835 at 0614 with African music. (Gilbert, CA) (Presume in FF, editor)

**Malta:** Voice of the Mediterranean, 9765 at 0600 sign on. (Gilbert, CA)

**Mauritania:** ORTM, 4865 at 0700 in AA. (Gilbert, CA)

**Mexico:** La Voz de Vera Cruz, 6020 at 0550 in SS. (Gilbert, CA)

La Hora Exacta, 9555 at 0614 with ID. SS. (Ross, WA)

**Monaco:** Trans World Radio 9485 at 0700 with reli-

gon. (Johnson, IL) 9650 at 1500 sign on. (Gilbert, CA)

**Morocco:** RTV Morocaine, 15335 at 0021 with local music. FF. (Gilbert, CA)

**Netherlands:** Radio Netherlands, 6020 at 0030. (Davis, MA) 9715 (via madagascar, editor) at 0730 and 17575 at 0835. (Mitchell, HI) 9860 at 2030 and 21520 at 1130. (Giannarelis, Greece) 13700 at 0429 with IS. (Johnson, IL) 15570 (via madagascar, editor) at 1630 and 1830. (Mitchell, HI) 17605 at 1854. (Carson, OK)

**Netherlands Antilles:** Radio Netherlands, Bonaire relay, 6165 at 0029. (Reynolds, MO) 9590 at 0343. (Ross, WA) 15315 at 0032. (Walbesser, NY)

Trans World Radio, Bonaire, 11930 at 0310, 0331, 0337. (Walbesser, NY; Reynolds, MO; Ross, WA)

**New Zealand:** Radio New Zealand, 15485 at 0550. (Johnson, IL) 17705 at 0413. (Gilbert, CA)

**Nicaragua:** Voice of Nicaragua, 6100 at 0409 in SS. (Ross, WA)

**Niger:** La Voix du Sahel, 5020 at 0530 sign on in FF. (Gilbert, CA)

**Nigeria:** Voice of Nigeria, 7255 at 0445 with sign on. (Carson, OK) 0500 with news. (Kershaw, CA) 0530 with news. (Johnson, IL)

**North Korea:** Radio Pyongyang, 7580 in JJ at 0853. (Duggan, AZ) 11830 at 0823. (Mitchell, HI)

**Norway:** Norway International, 17840//21705 at 1600 with Sunday EE program. (Johnson, IL) 21705 at 1400 in NN. (Carson, OK)

**Papua New Guinea:** NBC Port Morseby, 4889 at 0911. (Mitchell, HI)

Radio East New Britain, Rabaul, 3385 at 1040. (Mierzinski, PA)

# Soup up with our Super Amplifier!!

Introducing a brand new product, the **Super Amplifier™** is a compact pre-amp designed to work with scanners and it amplifies the reception of the VHF/UHF bands (from 100MHz to 1GHz) as high as 20db. The **Super Amplifier™** has an adjustable gain which is controlled from the back of the unit and allows amplification level of up to 20db through all frequencies, equipped with a bypass switch to return to normal scanning frequencies. As with all other GRE products, you will find the quality and design of the **Super Amplifier™** to be of the highest standard.

## Specifications and Features

- Frequency Range: 100MHz to 1GHz
- Adjustable Gain: 0 - 20db
- Input: BNC Connector
- Output: BNC Connector
- Power: 9 Volt battery or adapter
- Power Indicator: LED
- Dimensions: 68 MM x 34 MM x 37MM
- Output Impedance Load: 50 Ohms
- Bypass Switch

For more information, or a dealer near you (new dealers are welcome), contact GRE America, Inc. at the address below.



**GRE America, Inc.**

GRE America, Inc.  
425 Harbor Blvd.  
Belmont, California 94002

Telephone (415) 591-1400  
Outside CA: (800) 233-5973  
Fax: (415) 591-2001



**Paraguay:** Radio Nacional, 9735 at 0026 in SS. (Gilbert, CA)

**Peru:** Radio Union, 6115 in SS at 0550. (Gilbert, CA)

**Philippines:** Far East Broadcasting Co. 11850 at 1258 with religious programs. (Reynolds, MO)

VOA Relayk, 15155 and 15425 and 1212 with jazz. (Reynolds, MO)

Radio Veritas Asia, 9525 at 1430 with ID and program schedule. (Gilbert, CA)

**Poland:** Radio Polonia, 6135 at 2230 with news, comment, postbag. (Giannarelis, Greece)

**Portugal:** Radio Portugal, 9680 at 2348 in PP. (Carson, OK) Here and 9705 at 2155 with ID in PP and EE. (Johnson, IL)

**Romania:** Radio Bucharest, 15335 at 1525 sign off, frequency announcement in EE. (Reese, Thailand) 15380 at 0406. (Ross, WA) 17850 at 1320. (Johnson, IL)

**Saudi Arabia:** BSKSA, 15060 with mideast music at 0411. (Gilbert, CA) (Presume in AA, editor)

**Singapore:** SBC Radio One, 5010 at 2300 with news. (Reese, Thailand) BBC Relay, 6195 at 1535. (Reese, Thailand)

**Solomon IS:** SIBC, 5020 at 0800, 9545 at 0730. (Wittmann, WA) 9545 at 0724. (Mitchell, HI)

**South Africa:** Radio RSA, 4810 at 0257 with IS, ID and into Afrikaans. 7270 at 0450 with IS. (Johnson, IL) 9580//9615//11935 at 0200 with news. 21535 at 1900 with news. (Walbesser, NY) 1900 with news. (Mitchell, HI) 21590 at 1430. (Reese, Thailand) 1540. (Mitchell, HI)

Radio Five, 4880 at 0400 with music, ID. (Johnson, IL) 11885 at 0533, 0545. (Carson, OK; Walbesser, NY)

**South Korea:** Radio Korea, 15575 at 1403, 2340. (Reynolds, MO; Wittman, WA)

**Spain:** Spanish National Radio, 9630//15110 at 0033 in SS. (Walbesser, NY)

**Sweden:** Radio Sweden, 9695 at 0030. (Walbesser, NY; Wittman, WA) 11705 at 0316, 0317. (Gilbert, CA; Ross, WA) 21610 at 1545. (Johnson, IL) 21675 at 1530, 1541. (Giannarelis, Greece; Carson, OK)

**Switzerland:** Swiss Radio International, 12035 at 0407. (Ross, WA) 17830 at 1550. (Walbesser, NY)

21630 at 1559. (Mitchell, HI) 21695 at 1334. (Carson, OK)

**Tahiti:** 15171, in Maori and FF with island music at 0405. (Duggan, AZ)

**Taiwan:** 5950 (via WYFR at 0720, 9680 (via WYFR) at 0207. (Wittmann, WA) 15345 (via WYFR) at 2212. (Carson, OK) 17610 (via WYFR) at 2245. (Walbesser, NY)

**Thailand:** Radio Thailand, 9655 at 2308 with songs, tourism and news. (Giannarelis, Greece)

**Tunisia:** RTT Tunis, 7475 at 0530 in AA. (Gilbert, CA) 11550 at 0530 with news in AA. (Johnson, IL)

**Turkey:** Voice of Turkey, 9445 from 2200. (Kershaw, CA) 0310. (Walbesser, NY) 17760 at 0340. (Ross, WA)

**Ukraine SSR:** Radi Kiev, 9610 0200-0300. (Davis, MA) Here at 2357 sign off. Also 0212 on 12000. (Walbesser, NY)

**Unidentified:** 6215 at 1219 in SS. (Probably the contra clandestine Radio Liberacion/Quince de Septiembre, editor) 15572 at 0530 in oriental language. 25900 at 0310 in AA to 0400 close. Back at 1300 to 1600 close. (probably Voice of the UAE, Abu Dhabi, editor) (All Duqan AZ)

**United Arab Emirates:** UAE Radio, Dubai, 11940 at 0347, 15555 at 0349. (Ross, WA) Here and 153400 //15435//17890//21605 at 1600. (Johnson, IL)

Voice of the UAE, Abu Dhabi, 13605 at 2300 in AA. (Kershaw, CA) 2310 in EE. (Carson, OK)

**United States:** Radio Earth program via WHRI at 0350 on 7365. (Carson, OK)

WWCR - 7520, 15690 at 0400. (Malta, NJ)

WMLK, 9465 at 0407, (Carson, OK)

KUSW, 15650 at 1610 with rock. (Malta, NJ)

**USSR:** Radio Moscow feeder, 9145 at 0310. (Johnson, IL) 11675 at 0524, 11900 at 1458, 12050 at 0501 (via Petropavlovsk), 17605 (via Petropavlovsk-Kamchatska?) at 0553 (Carson, OK) 11730 (believe via Shabarovsk) at 0838 in CC. 15435 at 1630. (Duggan, AZ) 15540 at 1417. (Reynolds, MO)

4975 (listed as Dushambe, Tadjikistan - editor) 1241. (Duggan, AZ) (Presume in RR/ Editor)

Radio Peace and Progress, 15545 at 1630. (Giannarelis, Greece)

**Vatican:** Vatican Radio, 6248 in Italian at 0539. (Gilbert, CA) 17730 at 1512 in Amharic (Carson, OK) 21650 in probable Amharic. (Johnson, IL)

**Venezuela:** Radio Tachira, San Cristobal, 4830 at 0050 in SS. (Davis, MA) 0150. (Mierzwinski, PA)

Radio Rumbos, Caracas, 4970 in SS with ID 0357. (Ross, WA) Here with SS ID at 0440, also 2355 on 9660. (Johnson, IL)

Radio Valera, 4840 at 0335 in SS. (Mierzwinski, PA)

**Vietnam:** Voice of Vietnam, 10010 at 1429 in CC. (Gilbert, CA) 1500 at 1800 with news. (Giannarelis, Greece)

**West Germany:** Deutsche Welle, 6160 (via Antiqua) at 0859, 6170 (via Sri Lanka) at 1630, 9545 (via Antigua?) at 0315, 17875 at 0600, 21680 (via Malta) at 1640. (Mitchell, HI) 6075 at 0532, 11810 (via Malta) at 0322. (Ross, WA) 9565 (via Malta) at 0126. (Walbesser, NY) 9700 at 0500, 7765 at 1540. (Walbesser, NY) 11845 at 0546. (Carson, OK) 11865 at 0127. (Duggan, AZ)

**Yugoslavia:** Radio Yugoslavia, 11735 from 0000. (Kershaw, CA) 0032. (Carson, OK) 15105 at 2100. (Johnson, IL) 0005. (Gilbert, CA)

That's the lot, and lots of thanks to the following: James G. Malta, Piscataway, NJ; John Kershaw, San Diego, CA; Jim Ross, Vancouver, WA; Jeremy P. Willmann, Tacoma, WA; Warren Gilbert, Sherman Oaks, CA; William F. Walbesser, Ravena, NY; Tim J. Johnson, Galesburg, IL; Aris Giannarelis, Athens, Greece; John Miller, Thomasville, GA; Frank Mierzwinski, Mt. Penn, PA; John Spencer Carson, Jr., Norman, OK; D.N. Davis, Pittsfield, MA; Cliff Reynolds, Hazelwood, MO; David Olson, Watford City, ND; Frank Duggan, Phoenix, AZ; Randall Reese, Bangkok, Thailand and Bill Mitchell, Kula, HI.

Til next month, good listening!

## Introducing the Super Penetrator Mobile Ultra-Wideband 10 & 11 Meter Antenna

Featuring the widest band pass of any antenna on the market today. Our exclusive "Quad-Angular" helical coil has more surface area for highest possible gain and lowest static build-up resulting in quieter operations.

- Frequency range: 25-30 MHz
- VSWR: 1.3 MHz with a standing wave of 1.5 to or less
- Power Rating: 2.5 KW
- 2 shaft lengths available: 16 or 25 inches
- Mounting: 3/8 x 24 standard "stud" type
- Materials: machined from highest quality solid brass and stainless steel

Send for free catalogue and Smith chart.

Manufactured in Japan by Diamond  
"The technology leader in antenna design"



Exclusively for  
**RF Limited**

P.O. Box 1124  
Issaquah, Washington 98027  
Telephone (206) 392-0399  
Telex 329 473 BURGESS SEA  
Fax (206) 302-8413

## COMPUTERIZE YOUR SHACK

Control up to eight digital radios simultaneously from your MS-DOS microcomputer! We offer a series of software/hardware package that interface with most current synthesized rigs.

ICOM: IC-781, 765, 761, 751A, 735, 725, R71A, R7000, R9000, 271, 471, 1271, 275, 375, 475, 575, CI-V

KENWOOD: TS-940, 440, 140, R-5000, 680, 711, 811

YAESU: FT-767, 757 GXII, 757 GX, 747, 9600, 736

JRC: NRD 525

COLLINS: 651 S1

Datacom couldn't be simpler. Knowledge of MS-DOS is not necessary—the installation program does it all! Datacom allows complete control of your rig from the keyboard.

### A few of its many features:

- Adds scan function to radios that don't allow this from front panel.
- Adds frequency and associated info memory limited only by disk storage.
- Tabular screen display of all the channels stored in memory, along with a full description of each including: mode (LSB, USB, FM, etc.), eight character alphanumeric description, signal bandwidth.
- Full featured logging utility.
- Able to automatically log hits while sweeping.
- Color coded program for ease of use (will run on a monochrome system).
- Menus for amateur, AM-FM broadcast, television broadcast, S/W, aviation, marine, with most popular frequencies stored.

Call or Write today for more information

AVAILABLE FOR IBM PC, XT, AT, 80386 256K RAM 1 SERIAL PORT AND 1 FLOPPY MINIMUM

PROGRAM WITH INITIAL LIBRARIES	129.95
RS-232 TO TTL INTERFACE (NEEDED IF DON'T HAVE MFRS INTERFACE)	
EXTERNAL INTERFACE ALLOWS 4 RADIOS (NOW WITH SQUELCH DETECT CIRCUITRY)	129.95
INTERNAL PC INTERFACE W/1 SERIAL & 1 RADIO PORT	129.95
SPECTRUM ANALYZER MODULE	(CALL FOR PRICE)
COMPLETE SYSTEMS INCL. RADIO, INTERFACE COMPUTER AVAILABLE	(CALL FOR PRICE)

Order direct or from Universal Radio 800-431-3939, Gilfer Shortwave 800-GILFER-1

**DATACOM, INT.**

7678 Venetian St. • Miramar, FL 33023

Orders: (800) 780-9505

Info: (305) 987-9505



# HOW I GOT STARTED

**P**opular Communications invites readers to submit, in not more than 125 words, how they got started in the communications hobby. Each month, we'll select one and run it, and award its sender with a one year's subscription or subscription extension. We'll accept them (preferably) typewritten, or otherwise easily legible. If you have a photo of yourself taken recently, or when you got started, please include it with your story. We can't return or acknowledge material whether we use it or not. You need submit your story only once, we'll keep it on file and consider it for future issues. All submissions become the property of Popular Communications.

Entries will be judged taking into consideration if they tell a story that is especially interesting, amusing, or otherwise unusual. We reserve the right to make any necessary syntax, spelling, or grammatical corrections, or minor wording changes to improve style.

Address all entries to: How I Got Started, Popular Communications, 76 North Broadway, Hicksville, NY 11801.

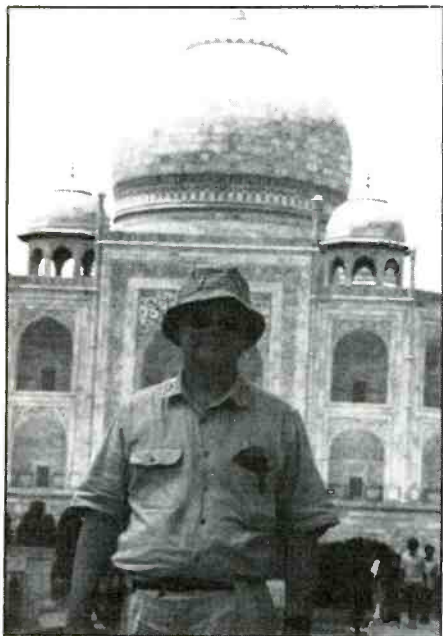

*Richard Weideman at the Taj Mahal.*

## **February, 1990's Winning Entry**

This month we have the story of Richard Weideman, now residing in Grand Rapids, MI. Richard tells about getting started in radio while a long way from home. He told POP\*COMM:

"The Taj Mahal was a total surprise; it de-

fies photography and hyperbole. No matter where one stands in its garden of paradise, no position can diminish its splendor. But the Taj was only one of India's only surprises. Another was my introduction to world band radio. This occurred in the summer of 1988, when I was teaching English at St. Peters, a boy's boarding school in Panchgani, a remote hill station three hours

south of Pune in the spectacular Sahaydri Mountains. The only radio possible there was shortwave. Clive Highland, the congenial chemistry teacher, lent me his radio. It changed my life, turning me into a SWL and sometime DX'er. Thanks to my Sony ICF-2010, I now live in a more interesting world, a world increasingly more surprising. Thank you, Clive. Thank you, India." **PC**

**For 25 years,  
our people have  
endured long hours  
and tough  
working conditions  
for no pay.**



**And 9 out of 10 would  
do it again.**

**TO FIND OUT WHY  
call**

**(316) 263-2100**

**or write**

**REACT INTERNATIONAL, INC.**

**242 Cleveland**

**Wichita, KS 67214**

# CLANDESTINE COMMUNIQUE

WHAT'S NEW WITH THE CLANDESTINES

**E**xiled Panamanian senator Mayin Correa recently replied to a reception report from your editor, covering the anti-Noriega program being aired on *Radio Impacto* in Costa Rica. We had been led to believe by various reports in the shortwave press that Senator Correa was the person doing the broadcasting but she says that the woman's voice heard on the broadcast belongs to someone else. It seems that a woman correspondent in Panama provides the material, which is then read by another woman friend since the correspondent's voice is well known in Panama. Ms. Correa says "I am still their correspondent as I transmit the interviews, but without my voice." The material she sent included a three page copy of what we suspect may have been the talk she gave at the Association of North American Radio Clubs convention in Florida last July. The paper/speech calls for the United States to support an anti-Panama station which would operate on the standard AM band and be staffed by professional Panamanian journalists. The anti-Panama program airs around 0400 over Radio Impacto, 5030 (or 5044) and 6160.

A note in *The Intelligence Newsletter* forwarded to our *Clandestine Confidential Newsletter* by Interests Limited of Maryland says that the FCC's closure of *La Voz de Alpha 66* last may came after the Alpha 66 group was given a warning to cease broadcasting. The warning came very shortly after President Bush took office. Other sources indicate that complaints by the Cuban government to the U.S. State Department precipitated the FCC bust. As we noted in an earlier column Alpha 66 vows to return to the air.

9435 has become a popular spot for certain African clandestines. *The Radio Voice of Ethiopian Unity* is operating on that frequency at 0400-0500 in Amharic. Other times are 1800-1830 in Tigrigna, 1830-1900 in Oromo and 1900-2000 in Arabic. Another anti-Ethiopian station, *The Voice of the Oromo Liberation*, is now using this channel at 1530-1600. There seems little doubt that these stations are broadcasting from the Sudan, using government facilities. Sudan's National Unity Radio was operating on this frequency up until the coup late last June. Now, on some occasions, regular broadcasts of the government's Radio Omdurman are noted on the frequency, sometimes replacing the broadcasts of the two clandestines. One anti-Sudanese broadcaster—the Sudan People's Liberation Movement's Radio SPLA also uses 9435 for its broadcasts at 1300-1330.

*Radio Magallanes*, the anti-Chile program carried on Radio Moscow has this cur-

SOLO EL PUEBLO  
SALVA EL PUEBLO



## Voz Panameña

Órgano divulgativo de noticias, análisis y comentarios sobre la vida panameña.  
Envíanos tus opiniones, ideas y artículos al Aptdo. Nº 14.985, Zona Postal 1011-A, IPOSTEL, La Candelaria, Caracas, VENEZUELA. Telefax 582-574-2364, Tel. 574-4242 (24 horas)

---

Nº 20

Caracas, 17 de Julio de 1989

# Noriega tiene que irse

### Clamor internacional contra dictadura

PANAMA, Agosto 14 (Corresponsal de VP) Guillermo Endara, Presidente-electo de la Republica de Panamá, dijo que su coalición de partidos que ganó por abrumadora mayoría las elecciones del 7 de mayo en Panamá, insiste en la retirada del dictador Noriega del Comando de las FF.DD. y en que se reconozcan los resultados de los comicios.  
Por otro lado el Movimiento Civilista Universitario en un manifiesto a la Nación solicita la remoción del Canciller Cordóvez de la Comisión de la OEA, el respeto a la voluntad popular expresada el 7 de mayo y "la salida inmediata de Manuel Antonio Noriega de la Jefatura de las FF.DD."  
(Continúa en la pág. 7)



Noriega: dos jets y dos Yates

### Transfirió \$50 millones a su esposa y tres hijas

WASHINGTON, Agosto 12 (Corresponsal) La cadena internacional de noticias TELEUNION dijo ayer que la fortuna personal de Noriega supera los 480 millones de dólares en propiedades y dinero depositado en diferentes bancos. Marlene Fernández de Tolomundo (Cable News Network-CNN) reportó que el gobierno de los Estados Unidos ha rastreado casi 157 millones de dólares de la inmensa fortuna del dirigente militar, considerada en su mayoría proveniente del narcotráfico.  
El 6 de septiembre de 1984, Noriega pidió al Bank of Credit & Commerce International (Londres) 5400 mil dólares como la base de pago para un apartamento de 5.3 millones de Francos Franceses en París (US\$797,400 \$).

— Consejo de Seguridad de las NN.UU. —

## Embajador Okun desenmascara al Canciller J. Ritter de Noriega

NUEVA YORK, Agosto 14 (Corresponsal de VP) — Rijiando sin el habitual protocolo al vocero de la dictadura de Noriega, Jorge Ritter, el Embajador de los Estados Unidos en las Naciones Unidas, Herbert S. Okun dijo que "vamos a ponerle fin a esta argucia (incumplimiento de los Tratados) de una vez por todas. Estados Unidos entro en dichos Tratados porque servian a nuestro interés nacional y a los del comercio mundial, están sancionados por nuestra Constitución, son Ley de los Estados Unidos y están consagrados en el Derecho internacional". Okun respondió al representante de Noriega en el Consejo de Seguridad de las Naciones Unidas, el que minutos antes mostró una película de maniobras militares al tiempo que repetía absurdamente el argumento de que los Estados Unidos está tratando de rescindir los "Tratados Torrijos-Carter de 1987". Al respecto dijo el Embajador "El Presidente ha reafirmado repetidamente que Estados Unidos respetará plenamente las obligaciones contraídas en los Tratados".

### Un llamado a la insurgencia

CARACAS, Agosto 7 (Especial VP) — En carta abierta a los panameños y por conducto de los dirigentes Ricardo Arias Calderón y Guillermo Ford, de visita en Caracas, el Coronel Roberto Díaz Herrera, en un remitido público, llama a la insurgencia en Panamá. "No cabe duda-dice Díaz Herrera- el dictador Noriega está acorralado, tambaleante, desprestigiado, y caera".  
La OEA -afirma el ex-jefe del Estado Mayor- con sus profundas contradicciones y limitaciones hizo lo que pudo: denunciar con nom-  
(Ver pág. 7)



Jorge Ritter... la argucia del tratado

QUIERE DISTRAR LA ATENCIÓN.  
También dijo que la crisis de Panamá se concentra en la persona y la conducta de Noriega lo que fué explícitamente reconocido por la  
(Ver pág. 3)

### Panameños Censuran la Actitud del Canciller Londoño de Colombia

(Ver Cartas al Editor - Pág. 2 )

This anti-Noriega newspaper comes out of Venezuela.

rent schedule: 0100-0130 (except Wednesdays and Saturdays) and 0200-0230 on 1186, 11890, 15475, 15510, 15520 and 15585.

Back to Africa—a new station is *Radio SNM*, the Voice of the Somali National Movement which is said to be active at 1500-1700 on 6470 (or 6516). The station reportedly has also identified as *Radio Hargeisa* (the name of a legitimate Somali broadcaster in Hargeisa) and *Radio Halgan*, which was the ID of a former anti-Somali station operated by the Democratic Front for the Salvation of Somalia and the Somali National Movement. Incidentally, the legitimate *Radio Hargeisa* is said to have been destroyed. Unfortunately, the time and frequency of the broadcast make reception in North America unlikely.

*Radio Democracy* is supposed to be a new anti-China clandestine broadcasting in

support of the Democracy movement. However, the modus operandi of this one is very similar to the several anti-Chinese broadcasters active over the past two decades or so, i.e. 5 to 10 minute broadcasts aired irregularly between 0900-1300 or 1400. The frequency in this case is 7125. It's believed, therefore, that *Radio Democracy* is in league with the operators of such stations as the *Voice of the PLA*, *October Storm* and so on and is not a station belonging to the newly formed student opposition group, though this group would like to begin clandestine broadcasts to China.

*The Voice of the Nation's Saving*, a North Korean station beaming to the South has been discontinued by the North Korean government. One of the North's other anti-South clandestines, *Voice of National Salvation*, has filled in the gap. It now operates at 0300-0700 on 3480, 4400, 4450, 4557;

60 / POPULAR COMMUNICATIONS / February 1990

THE MONITORING MAGAZINE





## DX, NEWS AND VIEWS OF AM AND FM BROADCASTING

**W**hen a new AM'er takes to the air, it's worthy of being noticed. So, let's all welcome WADN, 1120 kHz, of West Concord, MA. According to information sent to us by reader Martin Swartz, Manafield, MA, this station is calling itself "Walden 11-20" and is the only commercial broadcaster in the U.S. devoted to acoustic and contemporary folk music. WADN also broadcasts the nightly news from the BBC, plus the CBC's *As It Happens*.

Running 5 kW (1 kW nights), WADN took a full twelve years of planning and paperwork to put into operation by its two founders, Dick Pleasants and Lloyd Simon.

We were also pleased to hear from Mitch Kazel, a Teaching Associate in the Dept. of Journalism of the University of Illinois at Urbana-Champaign that (at the time of his writing) efforts were in progress to purchase the assets of WJTX in Champaign and return it to the air after it had been silent for a year. Plans were for the revitalized station to use the callsign WBCP and be operated under minority ownership. Plans are for the programming to be centered around an urban contemporary format with some easy listening jazz, rock, and blues blended to appeal to an over-30 audience.

WJTX, which operated on 1580 kHz, had been known as WCCR until 1984 and had used various formats before going silent.

For those who like to keep count, at the beginning of last fall the FCC counted a total of 4,965 AM stations; 4234 FM stations (plus another 1,401 educational FM); 547 VHF commercial TV; 535 UHF commercial TV; 342 VHF/UHF educational TV; 1,778 FM translators and boosters; 4,884 VHF/UHF TV translators; and 558 VHF/UHF low power TV stations. They don't list international (shortwave) broadcasters in these stats for reasons unknown.

In reply to those who have asked about the status of 1605 to 1705 kHz, the FCC hopes to start doling out authorizations for those ten new AM channels by this coming summer. The FCC's original plans for these frequencies have included their being used to accommodate networks of "national licenses" running many 250 watt transmitters, or several 1 kW transmitters, or a few 10 kW transmitters. On the other hand, the entire broadcast industry doesn't quite see things in the same light, with many daytime broadcasters hoping that the FCC will permit them to move off their crowded existing channels and reassign them to the newly created frequencies.

The FCC denied Garden State Broadcasting, Limited Partnership, review of a Review Board decision upholding an interlocutory ruling by an Administrative Law

### Applications Filed for AM Facilities Changes

K---	Soquel, CA	1200 kHz	Increase to 50 kW/11.5 kW
KHDL	Opportunity, WA	630 kHz	To 840 kHz, 50 kW/250 W
WCUE	Cuyahoga Falls, OH	1150 kHz	Increase to 5 kW days
WGNN	Lawrenceville, TN	1360 kHz	To 610 kHz, 1.5 kW
WGUL	Dunedin, FL	860 kHz	Reduce to 1.5 kW nites
WSGD	Amsterdam, NY	1570 kHz	Move to Ballston Spa, NY
WSJM	St. Joseph, MO	1400 kHz	To 1310 kHz, 5 kW/500 W
WWES	Hot Springs, VA	1270 kHz	Increase to 5 kW
WXTL	Jacksonville Bch., FL	1010 kHz	Reduce to 25 kW/10 kW
WYNX	Smyrna, GA	1550 kHz	Increase to 1.8 kW nites

### Applications Filed for FM Facilities Changes

KFAY-FM	Huntsville, AR	95.9 MHz	Move to 92.9 MHz
KJLY	Blue Earth, MN	100.9 MHz	Move to 104.5 MHz
KUDA	Pahrump, NV	107.5 MHz	Move to 105.7 MHz
KURA	Ouray, CO	104.9 MHz	Move to 105.7 MHz
WAAZ-FM	Crestview, FL	104.9 MHz	Move to 104.7 MHz
WMLQ	Rogers City, MI	97.7 MHz	Move to 96.7 MHz
WPLH	Tifton, GA	104.7 MHz	Move to 104.9 MHz
WQIC-FM	Marion, MS	103.1 MHz	Move to 95.1 MHz

### Approvals for AM Facilities Changes

KCPK	Rancho Mirage, CA	1200 kHz	Reduce to 2.5 kW/740 W
KHNC	Johnstown, CO	1360 kHz	Add nites with 530 W
KIAM	Nenana, AK	1270 kHz	Reduce nites to 2.2 kW
KINY	Juneau, AK	800 kHz	Increase to 10 kW days
KQXI	Arvada, CO	1550 kHz	Increase to 10 kW nites
KRML	Carmel, CA	1410 kHz	Reduce to 2.5 kW/2 kW
WGRM	Greenwood, MS	1240 kHz	Reduce to 730 W
WJIK	Camp Lejeune, NC	1580 kHz	Power to 10 kW
WMGA	Moultrie, GA	1130 kHz	To 580 kHz, 900 W days, move to Riverside, GA
WSEA	Georgetown, DE	900 kHz	Increase to 1 kW nites
WTCL	Chattahoochie, FL	1580 kHz	Increase to 10 kW/500 W

### Approvals for FM Facilities Changes

Kids	Palmyra, MO	98.3 MHz	To 97.9 MHz
KJEF	Jennings, LA	92.7 MHz	To 92.9 MHz
KJTY	Topeka	88.3 MHz	To 88.1 MHz
KKRC-FM	Sioux Falls, SD	93.5 MHz	To 103.7 MHz
KLGT	Buffalo, WY	94.1 MHz	To 92.9 MHz
KQIA	Clarinda, IA	106.3 MHz	To 106.1 MHz
WEUL	Kingsford, MI	98.9 MHz	To 98.1 MHz

# WGSF

## STEREO 1210



## Seeking Call Letter Changes

Existing	Seeking	
KLTH	KHTK	Florissant, MO
KMGK	KVVL	Glenwood, MN
KTCL	KCSP	Casper, WY
KZZA	WMGK	Thief River Falls, MN
WATD	WNSX	Brockton, MA
WCQT	WHLP-FM	Centerville, TN
WATD	WNSX	Brockton, MA
WCQT	WHLP-FM	Centerville, TN
WDOW-FM	WERQ	Dowigac, MI

## AM Call Letter Changes Approved

New	Old	
KBRL	KSWN	McCook, NE
KCLB	KVIM	Coachella, GA
KOJO	KTEO	San Angelo, TX
KRVC	KBOY	Medford, OR
KUTR	KLZX	Salt Lake City, UT
WAFN	WDLW	Waltham, MA
WBCR	WYOM	Wilkes-Barre, PA
WBLL	WPKO	Bellefontaine, OH
WKJY	WTBP	Parsons, TN
WLVH	WFNS	Manchester, CT
WMOU	WIGW	Berlin, NH
WOEQ	WOOO	Royal Palm Beach, FL
WPBE	WJKF	Jacksonville, FL
WPDQ	WJKF	Jacksonville, FL
WQLL	WSPB	Sarasota, FL
WTMS	WEGP	Preque Isaac, ME
WZRZ	WWAM	N. Ft. Myers, FL

## FM Call Letter Changes Approved

New	Old	
KERN-FM	KQXR	Bakersfield, CA
KFFX	KHUQ	Hugoton, KS
KHFX	KIOV	Honolulu, HI
KKLR	WWOC-FM	Poplar Bluff, MO
KLES	KNRJ	Worthington, MN
KLMK	KINB	Poteau, OK
KNRJ	KKHT	Houston, TX
KSSK-FM	KXPW	Honolulu, HI
KUKI-FM	KUKY	Ukiah, CA
WBCR-FM	WBCR	Beloit, WI
WBQB	WFVA-FM	Fredericksburg, VA
WCTK	WMYS	New Bedford, MA
WCZY-FM	WMMI-FM	Mt. Pleasant, MI
WDZR	WVKS	Etowah, TN
WEBQ-FM	WDRW	Eldorado, IL
WFOS	WNHS	Chesapeake, VA
WHRV	WFOS	Norfolk, VA
WHXT	WKPE	Orleans, MA
WLVH-FM	WLVH	Hartford, CT
WMMV	WMML-FM	Bay Minette, AL
WOOZ-VM	WEBQ-FM	Harrisburg, IL
WVRK	WNKS	Columbus, GA
WXJM-FM	WJCR-FM	Washington, PA
WZAZ-FM	WPDQ	Green Cove Springs, FL
WZOS	WPZX	Oswego, NY
WZPK	WMOU	Berlin, NH

# YOU AIN'T HEARD NOTHIN'...YET!

Since 1967, CRB Research has been the world's leading publisher and supplier of unique hobby and professional books and information including:

- Scanner Frequency Guides
- Shortwave Frequency Guides
- Military/Federal Communications
- Broadcast Station Registries
- Undercover Communications
- Survival Communications
- Covert Operations
- Electronic Espionage
- Surveillance
- Monitoring
- Cryptography & Codes
- Bugging
- Wiretapping
- Communications Antennas
- Electronics & Projects
- Regency Scanner Directories
- Computer Technology
- & Other Related Topics!

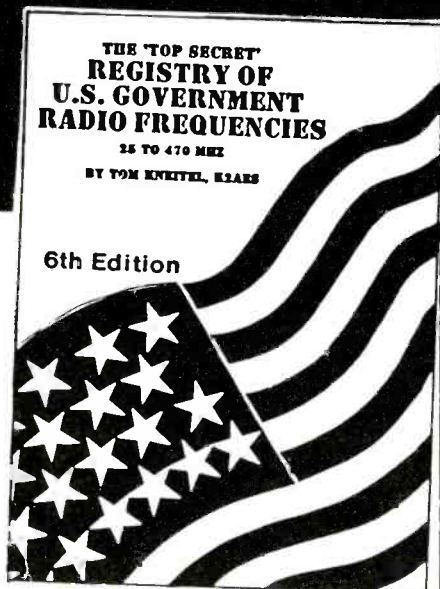

New titles are constantly being added to our exciting catalog. If it's interesting and unusual, we've got it. You'll see! Ask for our latest FREE catalog.

**CRB RESEARCH**  
P.O. Box 56 Commack, NY 11725

**SE** SIGNAL ENGINEERING's  
High Performance CB Antennas

**SUPERHAWK**  
\$114.95

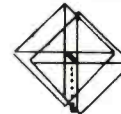

**Goldenrod  
45 Mobile  
Antenna**



**SPYDER A**  
\$35.95

**WHITE LIGHTNING**  
\$199.95



**LIGHTNING 6**  
\$359.95

**THE most POWERFUL  
CB base in the world today!**

All SE PATENTED rotary beams are true quads and OUTPERFORM their counter parts (quad/yagi types). SE's patented SFS matching system makes SE QUADS the most technologically advanced antennas in the world today.

If your dealer doesn't have SIGNAL ENGINEERING, write or call for full specs. DEALER inquiries invited.

**SIGNAL ENGINEERING**

2624 Fayette Drive, Mountain View, CA 94040  
(415) 948-3833

### Applications Filed For New FM Stations

CA	Bakersfield	90.9 MHz
CA	Victorville	88.5 MHz
GA	Dahlonega	104.3 MHz
GA	Pearson	101.7 MHz
ID	Sun Valley	91.9 MHz
ID	Wallace	100.7MHz
IL	Dwight	98.9MHz
LA	Vidalia	104.7MHz
MO	Huntsville	92.5MHz
MO	Osceola	92.3MHz
MO	Warsaw	93.7MHz
NY	Jamestown	90.0MHz
NY	Queensbury	91.7MHz
NY	Watertown	88.5MHz
OH	Montpelier	104.5MHz
SD	Canton	102.5MHz
TN	Columbia	88.7MHz
TN	Henderson	107.7MHz
TN	Woodbury	104.9MHz
TX	Bloomington	106.9MHz
TX	Franklin	98.9MHz
TX	Los Ybanez	107.9MHz
TX	New Ulm	92.3MHz

### Application Filed for New AM Stations

CA	Bakersfield	90.9 MHz
CA	Victorville	88.5 MHz
GA	Dahlonega	104.3 MHz
GA	Pearson	101.7 MHz
ID	Sun Valley	91.9 MHz
ID	Wallace	100.7 MHz
IL	Dwight	98.9 MHz
LA	Vidalia	104.7 MHz
MO	Huntsville	92.5 MHz
MO	Osceola	92.5 MHz
MO	Warsaw	93.7 MHz
NY	Jamestown	90.9 MHz
NY	Queensbury	91.7 MHz
NY	Watertown	88.5 MHz
OH	Montpelier	104.5 MHz
SD	Canton	102.5 MHz
TN	Columbia	88.7 MHz
TN	Henderson	107.7 MHz
TN	Woodbury	104.9 MHz
TX	Bloomington	106.9 MHz
TX	Franklin	98.9 MHz
TX	Los Ybanez	107.9 MHz
TX	New Ulm	92.7 MHz

### Permits Granted For New FM Stations

AL	Oxford	97.9 MHz
AL	Vernon	106.5 MHz
AR	Trumann	106.7 MHz
AZ	Cottonwood	105.7 MHz
CA	Madera	107.3MHz
CA	Randsberg	89.7MHz
FL	Watertown	105.7MHz
GA	Folkston	92.3MHz
GA	Millen	94.9MHz
HI	Kehaha	103.3MHz
KY	Vanclave	99.9MHz
ME	Howland	103.9MHz
ME	Old Town	107.3MHz
MI	Oscoda	100.1MHz
NM	Corrales	95.1MHz
NV	Mesquite	97.5MHz
NY	New Paltz	88.7MHz
NY	Poughkeepsie	88.7MHz
NY	Spencer	105.7MHz
OK	Heavener	92.5MHz
OK	Spencer	105.7MHz
OR	Myrtle Point	94.1MHz
TX	Madisonville	96.1MHz
TX	Mason	97.9MHz
TX	Wichita Falls	90.5MHz
VA	Harrisonburg	88.7MHz
WA	Bellingham	91.3MHz
WI	Peshtigo	96.1MHz

### AM Call Letters Deleted From FCC Records

KJLU	Klamath Falls, OR
KRDE	Pismo Beach, CA
KUIP	Gardnerville, NV
WGNZ	Tuckahoe, VA
WKAO	Hanahan, SC
WKRE	Jamesville, VA

### FM Call Letters Deleted From FCC Records

KCUM-FM	Crookston, MN
WEYS	Institute, WV
WGRF	Rockford, MI
WWMI	Sebawaing, MI

### Application Filed For New AM Station

NV	Boulder City	1030 kHz
----	--------------	----------

### New FM Call Letters Assigned

KIEZ	Brusly, LA
KIXF	Madisonville, TX
KPRV-FM	Heavener, OK
KYOU	Wendover, NV
WACZ	Dansville, NY
WAMW-FM	Washington, IN
WAYB	Graysville, TN
WCII	Spencer, NY
WDNO	Laurel, DE
WGGA-FM	Cleveland, GA
WNUV	Albany, GA
WXVO	Oliver Springs, TN

### Permits Granted For New AM Stations

CA	Yountville	840 kHz
FL	Kendall	1020 kHz
GA	Clarksville	1500 kHz
NM	Santa Fe	1550 kHz

Judge in this proceeding involving the renewal application of WWOR(TV), Secaucus, N.J. and the competing applications of Garden State and Whately Communications for a new station on WWOR's facilities.

In a prehearing discovery ruling, the ALJ had rejected Garden State's work-product claims and required it to produce documents supporting the proposed testimony of its expert witness, Dr. Roger N. Johnson. Garden State argued that this discovery ruling was inappropriate in light of the procedure established for the exchange of the parties' direct written testimony.

The Commission noted, however, that the direct written testimony procedure, to which Garden State voluntarily agreed in this case, was merely one facet of the Commission's efforts to expedite evidentiary hearings. It said Garden State had made no showing either that it was intended to or that it should be used to the exclusion of other prehearing procedures which are also designed to expedite the overall hearing process.

We are always seeking photos of AM or FM broadcasting facilities, bumper stickers, and news clippings relating to broadcasting stations.

PC

## ASSOCIATED RADIO

8012 CONSER BOX 4327  
OVERLAND PARK, KANSAS 66204

CALL 913-381-5900

FAX 913-648-3020

**SHORT WAVE  
AMATEUR  
RADIO**

*New and reconditioned equipment.*  
**BUY—SELL—TRADE—SERVICE**



**CALL FOR  
YOUR  
LISTENING  
NEEDS**

*Send \$3.00 for our current catalog and wholesale sheet.*

Please send all reader inquiries directly



## The Lighter Side Of Ham Radio Nets

**B**ecause Amateur Radio is built upon a foundation of public service and emergency communications, when most people (hams and non-hams) think of radio "nets," they probably think of disaster communications nets—the kind activated during hurricanes and earthquakes. Although these nets play an important and often exclusive role, there's a lighter side to Amateur Radio nets that often goes unnoticed by the public at large—and even many hams. The nets I'm talking about are the non-traffic, wide-coverage "fun" nets that are geared towards hundreds of diverse activities and pursuits.

How would you like to spend a Monday evening talking about shortwave with fellow enthusiasts around the country? You can if you tune to the Great Circle Shortwave Society Net on 3855 kHz every Monday night at 0100 UTC. Or how about checking in with the Rotary Net (14292 kHz, Sundays at 1800 UTC), or the North American Ten Meter Youth Net (28450 kHz, Sundays at 0000 UTC), or the Lateshow Net (21430 kHz, daily at 0400 UTC)?

Checking into these nets is a great way to make friends, discuss interesting topics, engage in unparalleled ragchewing, work rare DX stations, states or counties, or find a source of software for your obsolete or unusual computer. SWL's are welcome, too (even though your conversations are a bit one-sided!).

If you're wondering how to find out when and where these nets meet, look no further. The ARRL publishes *The ARRL Net Directory* every year. It lists time and frequency information for hundreds of nets, including a comprehensive listing of traffic and emergency nets, in addition to the "fun" nets discussed in this month's column. The *Directory* is a real bargain, too. Simply send \$1 to me at the address listed at the end of the column. When your *Directory* arrives, you can start exploring the HF ham nets in earnest. In this month's column, I'll try and give you a brief preview of the kinds of nets you'll run across.

### Awards-Chasing Nets

Awards such as Worked All States, Five-Band Worked All States, and *CQ Magazine's* USA-CA (for working most or all of the 3000+ countries in the US) have many support nets. Probably the most popular WAS-type net is the 3905 Century Club Net which, at last report, meets on 3905 kHz, daily from 0200 to 0600 UTC; and on 7233 kHz, daily from 0100 to 0500 UTC. This net sponsors a wide variety of its own awards, and even has



*Veteran DX'er, Gus Browning, W4BPD, is shown here at the helm of his 1947 "super station." Now 81 years old, Gus's station has dwindled to a set of Drake C-line twins and a vertical antenna. The Orangeburg, South Carolina DX'er, a pioneer of modern-day DX'peditions, hand built each component of his 1947 station—one main receiver with six separate front ends, each with its own VFO, and six matching kW transmitters. The antenna-switching relays are shown at the top of the photo. His antenna farm consisted of 13 rhombic antennas covering some 152 acres. Gus has held W4BPD since first being licensed in 1927. Keep up the good work, Gus!*

its own QSL bureau! This is the place to find those last few states for WAS. See *CQ* for the latest information on USA-CA nets.

### Maritime Service Nets

Amateur Radio is a natural when it comes to providing communications with ships at sea. Try tuning in to the following nets: Caribbean Net, 7158 kHz, daily at 0000 UTC; International Maritime Mobile Net, 14313 kHz, daily at 0000 UTC; Chubasco Net, 7294 kHz, daily at 1530 UTC.

### Ragchew Nets

Those of you who like to "chew the rag" with the best of 'em will find many opportunities listed in the *Net Directory*. Try these nets, just for the fun: Bear Foot Net, 3936 kHz, daily at 0100 UTC; Buffalo Chip Net, 14300 kHz, Sundays at 0300 UTC; Eighty Meter Ragchew Net, 3709 kHz, Tuesdays at 0100 UTC; Nitwits Over The Hill Inspirational Nut Group, 3933 kHz, daily at 1400 UTC. There are many more.

### DX Nets

This popular activity supports a large number of nets. Checking in can quickly

add to your country totals. Certain regional DX stations are often much easier to work—if you can find the right net and check in at the right time. Give these DX nets a try: Afrikana Net, 21355 kHz, daily at 1800 UTC; Connecticut DX Net, 28425 kHz, Mondays at 0100 UTC; Pacific DX Net, 14265 kHz, Tuesdays and Fridays at 0530 UTC. There are many others.

### Computer Nets

There are at least a couple of dozens computer nets around the country. Some are machine-specific, others are more general in nature. Here's a sampling: Amateur Computer Experimenters, 146.55 MHz, daily at 0300 UTC (Northwest Washington); Atari Microcomputer Net, 7230 kHz, Sundays at 1800 UTC; Computer Nut Net, 3939 kHz, Saturdays at 1430 UTC; QZX Net (Timex/Sinclair), 7245 kHz, Wednesdays at 0001 UTC.

### Special-Interest Nets

Special-interest nets are plentiful on the HF ham bands. Just about every possible topic is addressed by some net, somewhere. Here are a few: American Cancer Society Net, 14295 kHz, Thursdays at 1900 UTC; AMSAT Nets, 14282 kHz, Sundays at 1900 UTC; East Coast SPAM Group (Society for the Preservation of Amplitude Modulation), 3895 kHz, Saturdays at 1300 UTC; International Firefighters Net, 21355 kHz, daily at 1500 UTC; International Police Association Radio Club Net, 21410 kHz, Sundays at 1700 UTC; World Peace Net, 14250 kHz, Saturdays at 2355 UTC.

Amateur nets have their own evolutionary cycle, so it's conceivable that some of the nets listed are no longer active. Take it with a grain of salt—the net will probably pop up somewhere, or another one just like it will. Tuning the ham bands in search of new nets can be a lot of fun. You never know what you'll find! If you come across an interesting net, don't be afraid to join in. Nets are generally friendly places. You'll certainly be welcomed, and you may even make a few new friends and become a regular participant.

Keep your photos and letters coming to me in care of ARRL, Department PCN, 225 Main Street, Newington, CT 06111. I'd like to extend a special thanks to Randall Reese, a POP'COMM reader in Bangkok, Thailand who has been sending me lots of interesting stuff on ham radio over there. See you next month.

PC

# TELEPHONES ENROUTE

BY TOM KNEITEL, K2AES

## WHAT'S HAPPENING WITH CELLULAR, MARINE & MOBILE PHONES

Last month we discussed how telephone calls are placed from airliners. This time around we'll get our feet back on the ground by examining telephone calls that can be placed from public telephones aboard passenger trains. Not that telephone service aboard trains is, in itself, new. I recall coming across one of them in the late 1940's on one of the old 35/43 MHz mobile service channel pairs. Then, about fifteen years ago, the Amtrak Metroliners were offering telephone calls in the 416 MHz band. That's all changed now.

Beginning in 1986, the Amtrak Metroliner corridor between New York City and Washington, DC began offering GTE Railfone service. Simultaneously, the Amtrak San Diegan operating between Los Angeles and San Diego, CA instituted similar service. Within the past few months, the new luxury passenger service between Washington, DC and Chicago started up and offered this new service as one of its features.

The Railfone on-board telephone system enables a passenger to place direct dial calls via the standard cellular communications network. The on-board telephones don't accept or contain any money; calls may be charged to most major credit cards (the telephone reads the information off the magnetic strip on the card when it is inserted into

a slot on the instrument). The credit card information is sent out as a data burst to the Railfone system computer which instantly verifies card type and account number.

The cost of a Railfone call to anywhere in the U.S. is \$1.50 per minute plus \$1.50 service charge. International calls are \$4.00 per minute plus the \$1.50 service charge.

In 1987, the first full year of Railfone service, the system handled more than 120,000 calls. The following year, there were about 156,000 calls put through.

The Railfone telephone wall units are located in the Custom Class car and Amcafe car on each San Diegan train. On the Amtrak Metroliner, there are telephone booths in the First Class Club Service Car, the dinette car and one coach of each train. Pictorial instructions provide step-by-step passenger actions (four steps) to place and terminate a call.

If you're familiar with using a cellular phone, you know what a drop out is; it's a dead spot where there is no coverage. Your call abruptly ends and you can't use your cellular again until you get into a location where your signal can hit the cell's antenna with your signal, or vice versa. Once a handshake relationship can resume, you're back in business. This is a problem that isn't unknown to callers from the train. A route

map posted next to the phone depicts the best service areas. The caller is also warned that tunnels and other passing obstructions may cause a drop out, during which times a red Service Interrupt light will come on. When the red light goes out, the caller can dial for an operator and get the call reconnected without an additional service charge. For instance, on the Santa Barbara to San Diego corridor, service interruptions occur at Seacliff, Ventura, and Tunnels, as shown on the route map.

Calls to Information (Directory Assistance) are free, but charges apply to calls placed to "800" numbers.

Railfone is operated by GTE Railfone Incorporated, 2809 Butterfield Road, Oak Brook, IL 60522.

### With The Suppliers

Ameritech Mobile Communications, which serves twenty two midwestern cities with cellular service (began in October of 1983, and was the first cellular system in the U.S.) signed up its 200,000th cellular subscriber last August. Within the Ameritech service areas, new subscribers come through the doors via Sears, as well as consumer electronics stores such as Radio Shack, Highland, ABC, Fretter and others.

Motorola signed a contract for an experi-



◆ GTE Railfone is the system used for placing calls from passenger trains. This provides direct-dial service through cellular base stations.

Steve Vitrano (left) and Jim Roberteillo (right) of NYNEX Mobile Communications recently donated a cellular phone to Detective Michael Boyle, Narcotics Bureau, Linden, (NJ) Police Department. The equipment is used for undercover and surveillance communications.

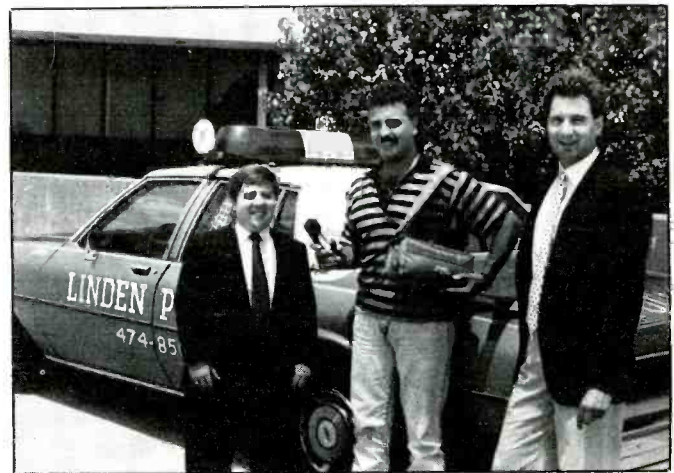





Several of the new Cobra cellular products that are arriving on the market.

mental digital cellular phone system in West Germany. The contract was made with Detecon of the Bundespost and is for the supply of a validation system for the Pan-European Digital Cellular Network (GSM). A trial system will be installed in Bonn.

Last April, Motorola charged Nokia, Inc., with patent infringement covering limited technical details of its mobile phones. Nokia is one of the world's leading manufacturers and distributors of car phones. The U.S. International Trade Commission Administrative Law Judge, however, made a determination that supported Nokia in the dispute.

### Hardware

A new line of Cobra-brand cellular phone accessories will be marketed by Alliance Research Corporation under license. This in-

cludes antennas, antenna mounts, microphones for speakerphone systems, mounting kits for portables and transportables, as well as adapter kits for antenna and power connections.

For more information, contact Cobra Electronics Group/Dynascan Corp., 6500 West Cortland Street, Chicago, IL 60635, or circle 105 on our Reader's Service.

We like the sleek lines as well as the nifty features of the *Diamondtel 90X* handheld (portable) cellular from the Mobile Electronics Division of Mitsubishi. This little dynamo weighs only 18 ounces, which gives it the distinct honor of being 22% lighter and 20% smaller than most other handheld cellulars. But, despite its pint size, it's got 15 hours of standby power stored in its rechargeable batteries, or 90 minutes of continuous talk time. That's 50% more than Mitsubishi's previous portable unit.

It comes with a built-in antenna and self-contained power source, and puts out .6 watt. Optional accessories can hook the unit to your vehicle's electrical system and an external vehicle antenna. Most folks will want

to carry this unit in their pocket, purse, or attache case for on-the-spot use. Its convenience features include a 100-number memory (up to 36-digits per number), last number redial, automatic retry, and the ability to scan memorized numbers automatically from A-to-Z, or in reverse. A built-in user manual provides you with operating instructions right on the unit's LCD screen.

For roamers, there's the ability to register the unit with cellular suppliers in two cities. For folks who fear that unauthorized persons might pick up the unit and try to place calls to South Yemen or Tasmania, there are no less than six different levels of call restriction.

For more information on the *Diamondtel 90X*, contact Mitsubishi Electric Sales America, Inc., Mobile Electronics Division, 800 Bierann Court, Mount Prospect, IL 60056, or circle 106 on our Reader's Service.

We are always seeking your mobile/marine telephone thoughts, ideas, questions, as well as news clippings. We're also interested in hearing from equipment manufacturers as well as cellular suppliers.

PC



## CODE SCANNER ADVANCED MULTI-MODE DECODER Two Line, 32 Character LCD Display



Copies Morse, Baudot and ASCII Codes from your Radiol Automatic Morse Code tracking: 3-70 WPM. Built-in Code practice oscillator for hand key with readout to display. Built-in speaker. Advanced Analog and Digital filtering with AGC. Special practice mode to learn Morse characters. Compact size: 3 1/2" x 5 3/4". Operates from 12 VDC or 120 VAC adapter provided. Easy hook-up to Radio speaker or headphone jack. Made in U.S.A.

Call or write for **FREE** brochure or order Factory Direct.

**CODE SCANNER Model CSCAN ..... \$ 189.00**

Add \$5.00 shipping for continental U.S. Send check, money order, VISA or MasterCard.

*Microcraft*

Corporation Telephone: (414) 241-8144  
P.O. Box 513Q, Thiensville, Wisconsin 53092

CIRCLE 136 ON READER SERVICE CARD

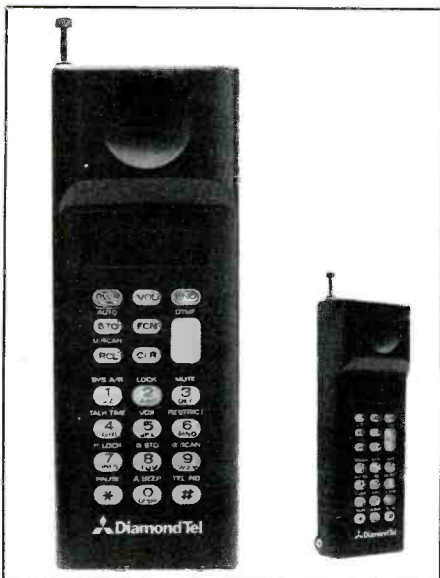

The *Diamondtel 90X* is small in size, but is a full-featured portable cellular telephone.

# WOW!

## Have you seen U.S. Scanner News

The fastest growing all scanner magazine on the market today.

Try it, you'll like it.

Send \$7.50 for a 6 month sample subscription, \$15.00 for a One year subscription, Two years \$29.00, Three years \$43.00. Foreign subscription \$19.50 per year.

Payment must be included with order.

(Washington state residents add 7.6% tax.)

**Bob's Publications**  
**P.O. Box 1103**  
**Vancouver, WA 98666**

CIRCLE 137 ON READER SERVICE CARD

# COMMUNICATIONS CONFIDENTIAL

## YOUR GUIDE TO SHORTWAVE "UTILITY" STATIONS

**M**ore first-time contributors joined our ranks this month. D.A. Judkins, NC uses a Realistic DX-300 receiver, MFJ 1224 TU, AEA CP-1 TU, Commodore 64 computer w/MBAText and HAMTEXT software. His antennas are two dipoles up at 40 feet; one with a north/south polarization and the other facing east/west.

Raphael Galizot, West Berlin has a Kenwood R-5000 connected to an active antenna. He said he discovered POP'COMM during a visit to New York.

A.F. Thomas, BC, Canada monitors with a Emerson ATS-803 and hails from the Williams Lake area where the famous Williams Lake Stampede is held each year.

Ed Jelf, KY enjoys SWL'ing with a Kenwood R-2000 coupled with an AEA PK232 multimore controller connected to a Tandy SX computer. He also has a MFJ antenna tuner/preamp, Radio Shack Diskcone antenna, 6' vertical and a 65' longwire antenna.

And submitting loggings for the first time was Brian R. Webb, CA. Brian didn't indicate what equipment he was using.

Ronnie M. Rome, CA advised he was not able to get copy of CW transmissions with his recent equipment addition of an AEA PK-232 and Commodore 64 computer.

Andy Gordon, CT reports having heard the MARS station aboard the future USS Abraham Lincoln CVN-72, NNN0NAL testing their equipment. Andy says he made his latest loggings from a site at Long Beach Island, NJ.

It was good to hear again from Jeff Hall who has now relocated in Japan. He had previously advised he had lost all his equipment in the move. He now advises "I experiment with several receivers, some of which I bought second-hand and found them rather dismal so I'm now using a Sony 2010 with a 100' longwire." He continued "this is a good place to hear VIP traffic. And if you like shipwrecks there is usually one a week, although it seems to always involve the Koreans and their massive but leaky fishing fleet. Piracy is a constant threat outside of Japanese territorial waters. There are more Russian vessels heard than you might expect but they seem to favor the RT for long arguments over God knows what. Russian is not my forte." Welcome back Jeff, glad to learn you were able to resume your SWL'ng.

From Brazil we received a letter from Roberto Benevolo who listed some additional LPL, General Pacheco Radio frequencies. The station, located in Buenos Aires, Argentina operates on 3805, 4395, 6515, 8720, 13160, 17235, 17285, 22605 and 22700 kHz SSB.



The FAA warns off the potential vandal from its Martinsville, WV site. (Photo by Charlie MaCatee, WV.)

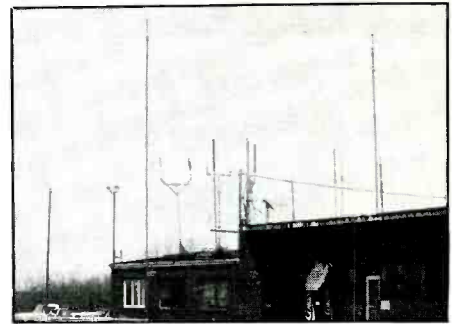

FAA comms station, Martinsburg, WV (Photo by Charlie MaCatee, WV.)



View of several FAA antennas at Martinsburg, WV. (Photo by Charlie MaCatee, WV.)

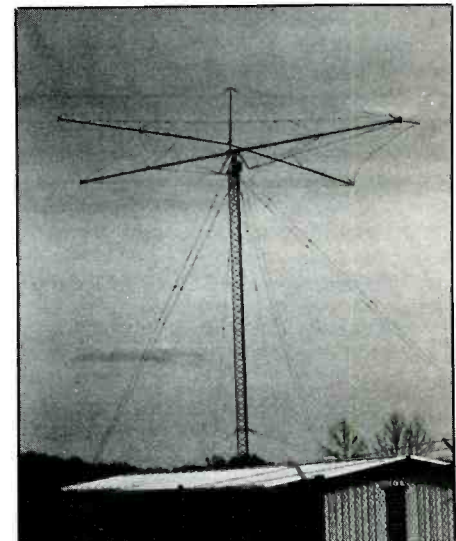

A multi-directional antenna used at the FAA Martinsburg site. (Photo by Charlie MaCatee, WV.)

Michael Willmer, MI wrote "I have been keeping a list of frequencies on which I heard the tone associated with US Customs operations. The same tone that a reader thought might be for a trunked system. So far I have heard the tone on 7475, 8125, 10242, 13907, and 20890 kHz. I have noticed no Customs activity on these frequencies. CFL-7 shows these frequencies to be associated with US Government either military or civilian. I wonder what is really going on here."

With his always interesting commentary, Simon J. Mason, England sent in the following information: "In the July column

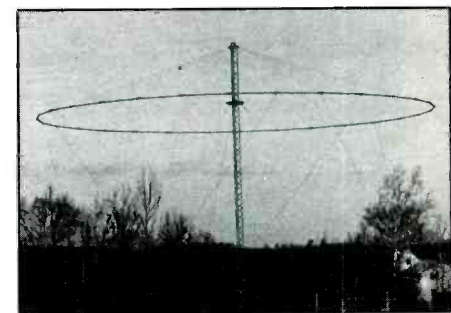

A hula hoop on a stick? No, another interesting FAA antenna at Martinsburg, WV. (Photo by Charlie MaCatee, WV.)



With its 2000W output, the beacon at South Bimini Airport is heard over a wide area. Here is the PFC for that station from Steve McDonald, BC, Canada.

you printed an intercept from myself of a station sending TIU on 5310 using a CW cut numbers systems of TIURQWNO PQ. I have checked this station again and it uses TIURQWEOPY as numbers. When the sequence is rearranged you will note it is QWERTYUIOP, (the typewriter keyboard sequence) which equals 1234567890.

I have been monitoring a few 'X' beacons lately. They all have identical formats and broadcast 24 hours a day. They can be heard on 3180, 6735, and 9325 kHz. They send X for 8 minutes, then four 5F groups separated by one X for 2 minutes. Here is an example:

2122-2130 X  
 2130-2132 35852 14839 57938  
 40065 X (repeated)  
 2132-2140 X  
 2140-2142 02046 12673 92107  
 10010 X (repeated)  
 2142-2150 X (and so on)

Thanks so much Simon for another very informative letter.

An informative rundown was forwarded by Donald R. Brown, MD concerning one of the "Numbers" stations. Here is what he said: "I wanted to help you identify the language used by the YL broadcasting 5F traffic in AM mode that you talked about in the August 1989 issue and give you my background on the activity. By the way, I am a proud charter subscriber—have all issues.

Davie Sabo shares his PFC with readers.

UTC	KHZ	NOTES
1800	3223//4030	1
1900	3023	1 and 3
1930	3223	1 and 3
2000	3223	1
2100	3223	1
2230	4030	2
2330	4030/3223	2

Note 1: Only noted on odd-numbered days.  
 Note 2: Only noted on even-numbered days.  
 Note 3: Five musical notes are repeated over and over for 3 to 15 minutes followed by 5F traffic.

My international marketing job allows me to travel worldwide, and I always carry a pair of trusty Sony receivers. I have heard the YL, with the indicated signal strengths, while I was in Munich (QSA 5), Frankfurt (QSA 4), Belgrade (QSA 4), Rome (QSA 3), London (QSA 3), at my home in Maryland (QSA 2) and Oslo (QSA 1).

The language the YL uses is Serbo-Croatian, and the traffic is always in 5-figure groups.

The first intercepts of the YL were in May 1985, then again in September 1985, September 1987, October 1988, and the last time was June 1989."

Table 1 lists the observed schedules and frequencies.

**202:** Beacon CL, Kisarazu, Honshu, Japan in CW at 1016. (Hall, Japan)

**216:** Beacon XA, Oshima, Honshu, Japan in CW at 1015. (Hall, Japan)

**251:** Beacon YU, Yokosuka, Japan (ex-270) in CW at 1017. (Hall, Japan)

**319:** Beacon CJ, Hachijo Jima, Honshu, Japan in CW at 1300. (Hall, Japan)

**464:** Unid CW stn sending wx in EE at 1221. (Hall, Japan)

**472:** JNX, Kushi, Hokkaido, Japan w/wx in EE and mkr of DE JNX JNX in CW at 1213. (Hall, Japan)

**2582:** Yarmouth CG Radio wkg vessel Lady Hammond re pp to a shore party re locations and repairs of buoys. USB at 0057. (Fernandez, MA)

**2714:** NBSZ, USNS Missisniewa, T-AO-144 (off freq) clg Norfolk Port Control at 0935; NMOM, USS Engage, MSO-433 (off freq) clg Newport Harbor Control at 0845. (Gordon, CT)

**2716:** USS Lake Champlain, CG-57 w/ unsuccessful calls to San Diego Control, then to any stn on net, for rdo check. USB at 0555. (Sabo, CA) NJHS, USS Sides, FFG-14 wkg Long Beach Control 2 at 0930 re permission to enter port; NKIN, USS California, CGN-36 clg Alameda Port Control at 0955; NDIK, USS Miller, F-1091 wkg Newport Port Control Secondary at 1100 re request for tugs, pilot & berth assignment; NAAV, USS Vandergrift, FFG-48 clg Long Beach Control at 1005; NQSJ, USS Grapple, ARS-53 clg Little Creek Port Control at 0955; NJJT, USS Taylor, FFG-50 wkg Charleston Navy Tug Control at 2350 re request from Taylor for arrangements of air transportation from NavSta Charleston for VIP's returning to shore, on Taylor next day; NCAS, USS Clifton Sprague, FFG-16 clg Newport Port Control at 0930; NGHY, USS Peterson, DD-969 clg Canaveral Control at 0910. Note: It is unusual for Navy warship to use their unclassified clasign (ship's name) when clg Canaveral Control. As a matter of fact, Canaveral Control answered as "Port Control" and called Peterson "Inbound Navy Unit" attempting hide ships

name. Peterson however continued to ID as USS Peterson. (Gordon, CT)

**2754.1:** CZDE DE DZCF GR 7 K (This is CKN xmtr, what is he doing??); then DE CZDE 7 BT YEIWA K and then into marker VVV VVV DE CKN C13E etc. He must have been acting as relay for two stns I couldn't hear. CW at 0935. (Ed.)

**2759.3:** Two OM/SS conversing, frequent mention of Havana and fact they unable to make contact. USB at 0944. (Ed.)

**3090.8:** SLHFB "L" in CW with L sent every 3 secs. Hrd at 0325. (Fernandez, MA)

**3170:** Time stn OLB5, Podebrady, Czech. AM w/pips each sec, 1 long pip on each 00 sec mark. No ID on H + 00 mark. Copies this stn next several evenings. Hrd 0335-0400. (Fernandez, MA)

**3377.7:** Automatic CW stn sending grps of 3 L/F mixed. Transmission is sequence of 18 grps and then sequence is repeated. Stn later sent ID at WGY912, VIP Relocation Site, Mt. Weather, VA. Similar activity observed on 4778 kHz. Appears that the sequence is changed on the half-hour. Hrd 0112. (Ed.)

**3413:** OM/EE in USB at 0410 w/wx at European terminals. (Fernandez, MA)

**3429.4:** GVX DE HAK QSA GA GA GA in CW at 0034. Both stns unid. continued clg over and over. (Ed.)

**3484.5:** No calls hrd. 5L grps sent, noted character MW, spanish nyeh. Hrd 0029 in CW. Checked freq again at 0056 and a unid stn was sending 5F grps. (Ed.)

**4066.1:** NKID, USS Kidd, DDG-993 wkg Norfolk ICSB at 2355. Kidd made pp to Norfolk Port Control requesting Navy YTB Tug meet Kidd next day; NNXY, USS Hoel, DDG-13 wkg San Diego CSS1 at 0455 w/personal pp; NNQN, USS Independence, CV-62 wkg San Diego CSS1 at 0515. Several pp's made from COMNAVAIRPAC to Independence's AirWing through CSS1; NPFS, USS Harry W. Hill, DD-986 wkg San Diego CSS1 at 0425 but bad conditions so neither could read other ok. (Gordon, CT)

**4080:** OM/RR at 1840 w/5F grps. (Galizot, Berlin)

**4087:** WJG, Memphis Marine in USB at 2309 wkg Iron Traveler w/posit report. (Symington, OH)

**4090:** Fishing boat/shore party wkg in USB (shore party on 4385 kHz) re tuna fishing ops. (This is channel 410 duplex (Fernandez, MA)

**4112:** Starship Oceanic wkg WOM, Miami (on 4407 kHz) in USB at 0140 w/pp. (Symington, OH)

**4225.9:** CW loop w/call XFM, Manzanillo, Mexico. (Jelf, KY)

**4274.7:** CQ DE HPP, Panama, in CW. (Jelf, KY)

**4419.4:** WIK4545, the Adventurer, w/position report to KNC, Seattle. USB at 0529. (Sabo, CA)

**4560:** Golf 6 Uniform in USB clg other similar calls for rdo checks. No replied. This is MARS freq. Hrd 0341. (Fernandez, MA)

**4562.5:** JWT, Stavanger, Norway in CW at 0224 w/VVV JWT marker. (Ed.)

**4637.5:** Houston wkg Rig 27 in USB at 0604. (Sabo, CA)

**4669:** Mike 5 wkg Mike 6, Mike 7 and Mike 8 at 2326. "Cipher Protect" used repeatedly. Mike 5 also hrd on 2145 kHz USB. (Mcatee, WV)

**4760:** Golf 7 Tango/Mike 5 Quebec in USB at 0412 w/rdo check. Several other stns on net w/similar calls. (Fernandez, MA)

**4926:** YL/GG in AM at 2110 w/5F grps. (Charret, FRG)

**5015:** YL/GG rptng Juliet Uniform in AM 0400-0405, then 5F grps in GG to addrees 271 and 667. (Mason, England)

**5228:** YL/GG in AM at 1902 clg 824, 1-0 count. (Charret, FRG)

**5230:** YL/EE calls Mike India Whiskey 2 at 1816. Possible MOSSAD. (Galizot, Berlin)

**5316:** YL/GG in AM at 2104 w/3 = 2F grps. (Charret, Berlin)

**5320:** USCGC Point Verde in USB at 1049 wkg USCG Group New Orleans w/tfc re "New Horizon." (Symington, OH)

**5413:** YL/EE is SSB at 1912 w/callup of 535 and 1-0 count. (Charret, FRG)

**5416:** At 2130 bells similar to lightship bells (8 tones). At 2135 harsh sounding YL with 5F/2F callup then into 5F grps. Very rare appear here for this regular 3260 kHz station. (Mason, England)

**5667:** YL/Bulgarian at 1914 w/5F grps. (Galizot, Berlin)

**5668:** YL/RR w/mil-style nbrs repeating slowly 'Sednitzer Asem Sest' from 1900-1905 then 'Norma 853 Gruppen 40' then 5F grps. Msg rptd next day on 10180 kHz at 0500. (Mason, England)

**5696:** CG Rescue 1504 in USB at 1447 in contact with Rescue Coordination Center (RCC) New York confirming search pattern and w/Navy P-3 in SAR for man from sloop Anaulis. Women crew member was rescued by research vessel Geronimo after two weeks at sea. Portsmouth contacted Geronimo on 8765.4 kHz re survivors condition. (Willmer, MI); USCG Rescue 1490 wkg USCG CommSta Portsmouth, VA at 0246. Reported airborne at 0246 from Elizabeth City, VA for search of Perquimans River for an overdue crab boat. (McAttee, WV)

**6272.9:** HLG, Coastal stn Seoul, Korea DE HQQA, Corona No. 1 in CW at 1052. (Ed.)

**6462.2:** FUM, Papeete, Tahiti in CW at 0757 w/mkr of VVV DE FUM. (Foss, AK)

**6506:** USCG Guam in USB at 0950 w/wx bcst. (Symington, OH)

**6672.3:** NOAA43 and Miami w/comms re Hurricane Hugo. Aeronautical stn at San Francisco comes up on 6672.6 and asks for signal check. NOAA43 tells Miami that San Fran is clg. They exchange sig reports and each assures other they not causing QRM with each others ops. MOAA43 sends Vortex (phonetic) report to Miami. San Francisco up again wkg commercial flight and quickly has it QSY to another freq. At approx 0319 a/c NOAA43 tells Miami that "West wall of eye is now over the beach." Hugo was hitting Charleston, SC. With origination time of 0325, NOAA43 files last Vortex report and is told to "come on home." NOAA43 asks that an individual buy a case of beer, ice it down, they will pay him for it when they return. Tuned out at 0357. (Ed.)

**6723.2:** Key West called by Keesler Field in USB at 1339 for radio check. (Ed.)

**6734.5:** SLHFB "X" in CW at 0214. X sent every sec. (Ed.)

**6735:** Head Cap 35 in USB at 0148 w/talk of CAP exercise response 89. Said exercise would receive White House review. (Willmer, MI)

**6750:** Britannia 3558 wkg Lajes AB in USB at 055 w/Pirep. (Symington, OH)

**6756:** Andrews AFB & SAM 681 (or 631?) w/pp's. Wx passed to SAM. Hrd 0937-1040. (Thomas, BC, Canada)

**6761:** Real Silk (a/c) in USB at 0430 wkg Ambitious w/freq checks (in coded form). Then Coyotee 66 (a/c) clg Hotcake (gnd sta) with no reply. Then Hotcake w/another gnd station & giving a "JJ WX REPORT" after making a SKYBIRD (air/gnd) call. (Fernandez, MA)

**6780:** YL/Czech in AM at 2006. (Charret, FRG)

**6800.8:** Some type of burst transmission. Was up less than 1 min. Back up at 1323 for 29 secs. Then at 1327 for 22 secs. Dropped at 1328. (Ed.)

**6865:** Test Range w/rdo check in USB at 1310. (J.M., KY)

**6927.8:** KKN50, Remington, VA sending CW mkr. (Jelf, KY)

**6948:** Strange signal. Noisy dots foll by raspy noisy dash. Hrd at 1800. (Crabill, VA) Also hrd 7893 but diff sequence.

**6996:** USAF MARS net in USB at 1324 w/stations from Japan & Korea-AFC8OS, AFC8TA, etc., wkg AFC6RI (Calif.?) for stateside phone calls. (Hall, Japan)

**7330:** SAC station Blackeye w/EAM in USB at 1947. This is SAC Xray freq. (J.M., KY)

**7412:** YL/GG in AM at 0902 w/callup of 221 and 1-0 count. (Charret, FRG)

**7475:** KEM-80, Wash., DC w/KIA-21, Oklahoma City, OK. Wkg in USB at 1415. Went to Channel 11. (Willmer, MI)

**7475:** SAC Station Majority clg Bellhop on Whiskey 104. An EAM hrd here at 1419. (J.M., KY) This freq apparently shared w/FAA. (Ed.)

**7505:** NAR, USN, Key West, FL w/CQ in CW at 0430. (J.M., KY)

**7508.3:** Unid stn in CW (hand sent) at 2343 w/SS texts. Based on location mentioned in text and msg format, this would seem to be Chilean Military t/c. (Ed.)

**7525:** T/c in SS among oprs of "Radio Comunicaciones Serrano" Hqs in Santa Cruz, Bolivia) in SSB at 0127-1040. Stns located in Santa Cruz, Robore, Cochabamba, La Paz, Tarija, Oruro, Quijarro, Potosi and other cities. System used for private telephone comms. Opr in one city will ask another city opr thru the dispatcher, who selects freq to be used. Freq range seems to be

tween 7400-8300 kHz. (Benevolo, Brazil)

**7533.5:** WGY-912, FEMA VIP Relocation Facility wky NNNONAV for pp into Puerto Rico NAV couldn't raise any PR stns on that circuit. Hrd at 1900. (Gordon, CT)

**7535:** NLMW, USS Newport, LST-1179 wkg Norfolk SESEF for equip/transmission checks at 1720. Others also checking their equip were: NCFR, USS Adroit, MSO-509; USS Gunston Hall, LSD-44; NZDN, USS Fairfax County, LST-1193; and NGJS, USS Pharris, FF-1094; NAHM, USS Guam, LPH-9. (Gordon, CT)

**7555:** OM/EE (sound like a fisherman) in LSB at 0048 talking about water depths. (J.M., KY)

**7915:** Stns of Empresa Nacional de Ferrocarriles (ENFE) (Hqs in Santa Cruz, Bolivia) w/comms re train derailment. Station Quijarro wkg Robore. This freq used to transmit train data among ENFE's railroad stns. T/c often sounds like "Spy Number" stns when they are sending msgs w/railroad car weights. (Benevolo, Brazil)

**8045:** FSB, Interpol Hq, Paris, France w/ID in CW at 0442. (J.M., KY)

**8295:** T/c in SS among agencies of Bolivian Dept of Police. Exchanging reports concerning gas price increase. Hrd SSB 2013-2100. (Benevolo, Brazil)

**8310:** T/c in SS among Bolivian banks in SSB 1425-1450. Stns located in Cochabamba, Robore, Potosi, Santa Cruz, Puerto Suarez, Oruro, Tupiza, and Monteagudo. Trinidad tried to enter on this freq but was told to use another channel. (Benevolo, Brazil)

**8330:** Callup in CW of 578 x3 67895/11 96335/33 90630/22 from 2100-2105. Then into 5F grps. Each msg ended with AR and was separated by II. (Mason, England)

**8514:** WLO, Mobile, AL in CW at 1500 w/t/c list & freq into then wx. (Rome, LA)

**8545.7:** GKA, Portishead, England sending character grps than CW mkr. (Jelf, KY)

**8665:** KLC, Galveston, TX w/t/c for M/V Proteus, ELC16. CW at 1950. (Rome, LA)

**8719:** NZPU, USS Papago, ATF-160 wkg NIHI, USS Opportune, ARS-41 at 2055 w/signal check. Papago trying raise COMSUPRON-8; NQJ, USS Grapple, ARS-53 wkg NIID, US Recovery, ARS-43 at 0130. (Gordon, CT)

**8855:** Manaus Aeradio, Brazil in USB at 0244 wkg Maiquetia Aeradio, Venezuela. (O'Connor, NH)

**8921:** Speedbird 175 in USB at 0332 wkg Speedbird London; enroute JFK-Heathrow. (O'Connor, NH)

**8950:** Land installations of Bolivian Air Force in Cochabamba and Robore in SSB 2144-2210 exchanging msgs in SS re personnel recruitment. (Benevolo, Brazil)

**8975:** OM in USB at 1300 w/t/c in EE mixed with Malay. Msg dealt w/death of Marine. Seems be wkg an RAAF type on other end. Prob RAAF Butterworth. (Hall, Japan)

**8979:** Series of Chinese outbander nets here in USB at 1236 w/t/c on 8990, 8989, 8980 as well. TFC consists of OM yelling wildly in CC. Sometimes YL/CC joins in. Poss Taiwanese fishing fleet somewhere in a nightly gabfest. (Hall, Japan)

**8989:** Brook to Raymond 20 in USB at 0240 via pp thru MacClellan re request for crew bunks on arrival. (Rome, LA)

**9042.5:** SLHFB "K" in FSK at 1242. (Hall, Japan)

**9056.5:** SLHFB "U" in FSK at 1243. (Hall, Japan)

**9307:** Canadian oil rig t/c w/XKP854, Cardiff Radio running patches for unid stn CXF59 in USB mode at 0458. (Sabo, CA)

**9330.7:** VBBE clg KL2V (both unid) in CW at 0942. (Foss, AK)

**9450:** YL rptng November Zulu w/electronic tones in AM from 2200-2205 then 5F grps for addrees 202, 649 and 955. (Mason, England)

**9512:** CCS, Santiago Naval Radio, Chile w/JNQY DE CCS in CW at 1400. (J.M., KY)

**10110:** Delegate meeting held via radio by delegates of a Bolivian union in SSB 2037-2109 in SS. They located in Oruro, Cochabamba, Potosi, Sucre, La Paz, Santa Cruz and other cities, using a non-id governmental network. (Benevolo, Brazil)

**10493:** WGY908, FEMA, Denver, CO wkg WGY912, Mt. Weather, VA at 2247 for sig check. (McAttee, WV)

**10495:** Two stns ID'ing as KLJK, Omi Dynamchem, tanker in CW at 1310 wkg KEY, Omi Corp, 280 Park Ave., NY, NY 10017. T/c was coded grps. (J.M., KY)

**10701:** Unid stn in CW at 1304 rptng Foxtrot 8

#### Abbreviations Used For Intercepts

AM	Amplitude Modulation mode
BC	Broadcast
CW	Morse Code mode
EE	English
GG	German
ID	Identifier/location
LSB	Lower Sideband mode
OM	Male operator
PP	Portuguese
SS	Spanish
t/c	Traffic
USB	Upper Sideband mode
w/	with
wx	Weather report/forecast
YL	Female operator
4F	4-figure coded groups (i.e. 5739)
5F	5-figure coded groups
5L	5-letter coded groups (i.e. IGRXJ)

(J.M., KY)

**10708:** YL/EE in AM at 0502 w/repeated 786-786-0000 until 0504 then went off the air. (Sabo, CA)

**10894.1:** SLHFB "I" in CW at 0512. Ltr sent every four secs. (Hall, Japan)

**11176:** MAC 0616 (C-141) in USB at 0136 wkg Albrook w/pp to McGuire Meteo. (Symington, OH)

**11214:** Dragnet Tango in USB at 1352 via Edmonton to Vacate. Giant Killer responded. Tango wanted to set up net with GK but GK unable comply. All GK units in playground on primary 4373. Called this freq Alpha Juliet. Checked 4373 kHz and calls noted were up on this freq. (Willmer, MI)

**11214:** Reno Command at 0459 w/pp to Slingshot via Trenton Military. Ref'd channel designators YC and VJ. Same evening at 0539 Reno Command thru Trenton w/pp to Huntress and Oak Grove. All USB mode. (Sabo, CA)

**11226:** Astrology, Mulberry, and WAR46 in USB at 0158. Called this Channel X905. Then QSY'd to S311. (Sabo, CA)

**11267:** 5 Mike Lima, 0 Delta Yankee, Alpha 7 Zulu, etc in USB at 0310 w/rdo checks, freq shifts & encrypting. (Fernandez, MA)

**11288:** Breakout in USB at 2019 wkg unid stn discussing losing a track and unid target. At 2044 hrd Slingshot wkg Skipper 05 discussing target. (Rome, LA) Slingshot in contact w/Baron 05. Two Black Hawk helios Omaha 76 and 96C in pursuit 0240 of cigarette boat, lights out, speed 45 kts., which had dropped a load of drugs after Shark 29 fired warning shots and pursued until water too shallow. Shark 29 went to pick up drugs assisted by Omaha 96C. Occasional msg from Home Plate. Suspect boat lost when Omaha 76 broke off due to low fuel. (Willmer, MI)

**11300:** STK, Khartoum Aeradio, Sudan in USB at 0142 wkg Cairo, Egypt. (O'Connor, NH)

**11410:** Durant and Charity in LSB at 1547 w/talk of data circuits and crypto maintenance. Called this freq Echo 18.

**11421.7:** T68 TTTTT in MCW at 0203 rptd over and over. The T is a cut zero. Signal down at 0205. (Ed.)

**11620:** HLL2/3, Seoul, ROK w/call tape in CW at 0627. (Hall, Japan)

**12315:** YL rptng Delta Foxtrot on top of TASSRTTY bcst. At 0905 5F GG msgs in AM for addrees 281 and 718. (Mason, England)

**12439.6:** Unid stn in CW at 0103 sends QWAF DE QLXC. Seems make contact (other end not this freq) & gives GR counts of t/c to fol & then RTTY comes up. (Hall, Japan)

**12522:** URRY, (poss Kap Wakula), clg UAT, Moscow. Then sends msg in 3rd shift Cyrillic RTTY. Hrd at 1252. (Galizot, Berlin)

**12658.3:** JNA, Tokyo clg CQ in CW at 0814. (Foss, AK)

**12752.7:** CKN, Vancouver, BC, Canada sending t/c which appeared to be military, then CW mkr. (Jelf, KY)

**12781:** YUR, Rijeka, Yugoslavia in CW w/vvv's and QSX 12 MHz CH5/6/12. Hrd at 0100. (Judkins, NC)

**12881:** SAG, Goteborg, Sweden in CW at 1343 w/t/c list & freq/channel listings. (Judkins, NC)

**12995:** VIP04, Perth, Australia in CW at 1114 w/call mkr. (Ed.)

**13214:** MAC606 in USB at 1047 wkg Croughton AB w/pp to meteo. (Symington, OH)

**13247:** Musketeer, Bluestone, and Scranton at 2223 re maintaining W-109 (this one) as primary, X-905



(11226) as secondary. Overhang to Sixpence at 0036 for rdo check. All USB. (Sabo, CA)

**13260.5:** VUC, (India alloc) called by WZZK, unid US vessel, in CW at 1246. Several other stns come up and are clg VUC. Very chirpy sigs. (Ed.)

**13267:** NOAA42 and NOAA43 (both are WP-3 a/c, modified Lockheed Electras) in USB at 2115 wkg KJY74, Miami, FL as they tracked Hurricane Gabrielle. NOAA43 also hrd wkg KJY74 on 8876 kHz (Echo). (McAttee, WV)

**13353.8:** Unid CW stn w/hand sent Morse characters incl spec charac IM OE OT AA. Bad echo to sig. Hrd 1231. (Ed.)

**13377.3:** KNY44, Ethiopian Embassy, Wash DC in CW at 1851 wkg (prob) MFA, Addis Ababa, Ethiopia. Stns exchange QRKs then shift to phone and conversed in what was prob Amharic. (Ed.)

**13388:** KKN39, US Dept of State in CW at 0557 w/call & QSX mkr. (Mason, England)

**13423:** Rapid audio tones, poss Piccolo transmission. Hrd at 1808. (Ed.)

**13630:** WHS-44 (cud this be WHX-44, FAA, Mt. Kahla, HI); KITT-88, FAA, Martinsburg, WV, N9D (poss FAA a/c), and KEM-80, FAA Hq, Wash., DC w/tfc for Civil Air Patrol exercise Response 89. KIA-21, FAA, Oklahoma City, OK cld Red Fire 8, Indiana CAP unit but was told this not his freq. USB at 1917. (Willmer, MI)

**14361.7:** SPXQ, M/S Grunwald at 1520 receiving auto CW msgs fm unid stn. Prob SOO236, Warsaw, Poland. Tfc on Polish lang. (Ed.)

**14392.8:** Unid auto CW stn at 1515 sending cut nbr grps. Sent very slowly. CUT - AUV4E6BDNT, PLAIN-1234567890. Signal weak with slight fading. (Ed.)

**14441.5:** NNNONPR made rdo checks w/Navy shore stn MARS unit NNN0ZPI and NIM for emergency tfc at 0000. NPR does not regularly use this net. NPR passed damage & casualty reports (Hurricane?) to NIM. (Gordon, CT)

**14450:** WGY908, FEMA, Denver, CO and WGY909, FEMA, San Francisco, CA in comms few minutes before switching to encrypted RTTY. USB at 2040. (J.M., KY)

**14607.5:** JPA23, Tokyo, Japan Interpol stn in CW at 0528 w/various bulletins re drug runners out of Beirut on the loose in Europe. Descriptions, etc sent to Kuala Lumpur and Hong Kong, though info comes from IP Athens. (Hall, Japan)

**14680:** YL/GG at 1902 announces 414 jfoll by 1-0 count and into 3/2 F grps. (Galizot, Berlin)

**14775:** Ramification and Musketeer exchanging sig checks in USB at 2053. (Sabo, CA)

**14905:** (See entry for 13630 kHz) CAP exercise Response 89. Stns Red Fire 4, Indiana CAP unit, Eagle 46, California CAP unit, Badger 41, Wisconsin CAP unit, and Sourdough 4, Alaska CAP unit passing tfc. One msg from WGY917, FEMA, Sacramento, CA to CAP, Cocco, FL re nbr of available ground S/R teams. (Willmer, MI)

**14905:** Nbr of CAP stns passing NCS "Shares" exercise tfc in LSB from 1800-2200. Few stns incl Profile 12 (NH), Pikes Peak 217 (CO), Sourdough 4 (AK), Eagle 46 & 68 (CA), and Badger 41 (WI). Non-CAP stns hrd incl AAR8USB, US Army MARS, Ft. Carson, CO, WGY918, FEMA, Denver, CO and WWJ63, FHWA, Nashville, TN. Also using CAP freq 7635 kHz (USB) and FAA freq 13630 kHz (USB). (J.M., KY)

**15657.8:** RJS, Soviet Naval stn, unk location, in CW at 0134 clg RMXV, unid. (Hall, Japan)

**15844:** YL/SS in AM at 1800 w/5F grps. (Willmer, MI)

**15867:** Slingshot wkg Icemaker in anti-smuggling ops. USB mode at 2334. (Sabo, CA)

**16463.1:** HZXS, Al Zohal, in USB at 1831 wkg Portishead, England, GKT62. (O'Connor, NH)

**16801.9:** Unid stn in CW at 2138 sending long parts list for machinery. (Rome, LA)

**16851.5:** 3FIO, m/v Asian Lily in CW at 0300 wkg HLO, Seoul w/Telexes mostly about fuel. (Hall, Japan)

**16919:** VIX 3/4/5/6, Canberra, Australia in CW w/vvv's and 6MMXKNSQ (?) rptng. Hrd at 1225. (Judkins, NC)

**16962.5:** DXF, Davao, PI in CW at 0631 w/tfc. Good freq to hear some interesting tfc lists as ships fm everywhere seem to pass by this place. (Hall, Japan)

**16795:** Philippine vessel MV Star Beach Durm gives sailing report in CW at 0552 to JNA, Tokyo leaving Seoul to Long Beach. (Hall, Japan)

# Order Back Issues of

# POPULAR COMMUNICATIONS



## BACK ISSUE ORDER FORM

Please send me the following issues @ \$2.50 each:

Month(s) & Year(s): \_\_\_\_\_

Number ordered @ \$2.50 each: \_\_\_\_\_ Total Payment Enclosed: \_\_\_\_\_  
(Check or M.O. only)

NAME: \_\_\_\_\_

COMPANY (Optional): \_\_\_\_\_

STREET ADDRESS: \_\_\_\_\_

CITY: \_\_\_\_\_ STATE: \_\_\_\_\_ ZIP: \_\_\_\_\_

**17013.1:** 5BA, Cyprus in CW at 0510 w/call mkr. (Webb, CA)

**17014:** UEK, Feodosia, SSR in CW at 1308 w/call & QSX mkr. As this is on the Black Sea, it's quite a haul and was pretty weak. (Hall, Japan)

**17019:** SLHFB "YU" (Cyrillic letter ...- ) in CW at 1301. First Cyrillic beacon I've ever hrd. Fairly strong sig. (Hall, Japan)

**17074.5:** PNK, Jayapura, Indonesia in CW at 0835 w/call mkr. (Webb, CA)

**17091:** XSQ/4, Guangzhou, PRC in CW at 1505 w/call mkr. (Webb, CA)

**17131.1:** UJQ7, Kiev, USSR in CW at 0540 w/call & QSX mkr. (Webb, CA)

**17149:** TIM, Limon, Costa Rica w/CQ in CW at 0135. (J.M., KY)

**17180:** HWN, Paris Naval Rdo, France in CW w/vvv's. Tfc garbled due to QRN. (Judkins, NC)

**17197.4:** 9VG, Singapore in CW at 1620 w/ARQ-TOR tones w/Morse code ID in between. (Webb, CA)

**18000:** Seems be internal PRC Aero net in USB at 0436 w/OM/CC ranting at pilot. (Hall, Japan)

**18005:** Spotless and Active Leader re maintaining channel W-109 as primary. USB at 0131. (Sabo, CA)

**18048:** NRT, Naval xmtng stn at Tsutsuka, Japan wkg unid. This stn is paired w/rdo receive facility Kamisewa. (Hall, Japan)

**18178:** CIOM2 rptd by YL in AM than off at 0050. Have hrd CIOT14B18Z99 rptd at 2345 on same freq. (Fernandez, MA)

**18982:** CW stn at 0606 w/continual tfc in 5L grps of ten, each set foll by KWMP. (Hall, Japan)

**18990:** Chilean navy stn at Arauco, Chile (located near Concepcion) clg Quito, Ecuador navy stn w/o success. Same freq US Navy stn, Balboa, Panama wky unid navy station. Pucara? SSB in SS at 1338; LOL, Navy stn, BA, Argentina trying contact Quito, Ecuador this freq and 23430 (id by LOL as secondary freq) w/o success. SSB at 1440; Tfc in SSB 2036-2050 between LOL (Argentina), Inca Peru (Peru), Radio Bolivar (Venezuela), and Quito (Ecuador). Other freqs agreed upon for msg passing 12513.8, 20471.5, 23881.5, and 25531.5 kHz. (Benevolo, Brazil) Believe these stns comprise net called Net Uno. (Ed.)

**19.4-19.5:** From 19480-19510 w/gradual skirt on low end & very sharp skirt on high end. Sig strength very flat across band w/noticeable propagation phasing although signal faded. No freq shifting of sound as noted on other intercept. Another bursting OTH radar noted on 18948-18953 (on 1 1/2 secs, off 11 secs) and 18745-18760 (on 8 secs, off 1 sec & definite shifting of pulse rate every 1-2 secs.) Hrd 0031. (Fernandez, MA)

**19715:** YL/EE at 1528 announces Echo Zulu India and rpts. (MOSSAD) (Galizot, Berlin)

**20192:** Jupiter control in LSB at 2328 w/live launch of Ariane 4 rocket. Flight 33 for ESA. Carried TV Sat 2 which to be used for high definition TV bcsts. Interesting discussion of Natal, Ascension Island (rented from NASA), and Libreville tracking stns in use during flight. (Willmer, MI)

**20701.5:** OM/FF/African mix in USB at 0528 w/some mentions of Mali. Hrd varying between 20701.5 and .3 kHz over 3 day period. (Hall, Japan)

**22252:** 3EQS3, m/v Timber Glory wkg PKX, Jakarta w/telegrams. Hrd in CW at 0716. Carrying timber. There goes another rain forest. (Hall, Japan)

**22254.9:** Zulu 5 India in USB at 1133 wkg Medical Team. Seems be net supporting move as several modes tried with little success. Best guess is USMC or Army Field Team in Korea. (Hall, Japan)

**22340.2:** DAL, Norddeich, Denmark in CW at 0205 w/mkr. (Rome, LA)

**22695:** LPL, ENTEL coastal stn in BA, Argentina, wkg in SSB 1815-1829 w/Liberian m/s Bulk Carrier Cynthia, EVC6. Vessel in N. Atlantic Ocean near Madeira Islands, enroute San Nicholas, Argentina. (Benevolo, Brazil)

**22710:** Coastal stn Rio, PPR, operated by EMBRA-TEL in SSB at 1415 wkg m/s Ore/oil carrier Maraca, PPVG owned by PETROBRAS in N. Atlantic Ocean near Cape Verde. (Benevolo, Brazil)

**23287:** Lima 9 Whiskey/7 Lima Romeo in USB at 2234 w/comms re setting up freq sked for up-coming exercise. (Fernandez, MA)

**25530:** Baltico (unid) in tfc w/Pergola (unid & not hrd). One msg mentioned Institut de Ayuda Financera at Cerrito, 572 (?) and other msg w/5L grps. (Benevolo, Brazil) Calis prob tactical types. (Ed.)

PC

# WASHINGTON PULSE

## FCC ACTIONS AFFECTING COMMUNICATIONS

### New Experimental Licenses

The Commission, by its Office of Engineering and Technology, Frequency Liaison Branch took the following actions:

KA2XYG, McDonnell Douglass Radio, on frequencies 155, 170, 200, 220, and 500 MHz to develop specific shapes useful for radar cross section signature reduction in 50-500 MHz range, to learn specific materials associated with the reduction of radar cross section signatures and to learn the techniques and tools involved.

KA2XYH, New York Stock Exchange, on frequency 72.52 MHz for research to design and develop a 72 MHz radio transceiver providing low power non-voice digital data.

KA2XYM, Westinghouse Community Service, Inc., on frequencies 1250-1350 MHz to fulfill U.S. government contracts (Navy).

KA2XYI, Pacific Service, Inc., on frequency 9445 MHz—demonstration of product for sale.

KA2XAR, State of Florida, on frequency 173.075 MHz to operate and conduct additional market test of an experimental stolen vehicle recovery system.

KA2XYO, Uniden Corporation of America, on frequencies 938.5125, 938.5375 and 938.5500 MHz to develop a new type of 900 MHz band repeater to be controlled by microcomputers.

KE2XEQ, Communications Satellite Corp., on frequencies 5925-6425 MHz to test and demonstrate antenna system.

KA2XAF, Iron Flagman Company, on frequencies 154.47875 and 154.45625 MHz to further develop a mobile traffic signal system.

KA2XBS, Robert McReynolds, on frequencies 9410-9445 MHz for testing navigational radar designed for marine use.

KA2XLZ, Motorola, Inc., on frequencies 6835.0 and 23375.0 to relay voice and data from test sites for field testing of multiple site transmissions and techniques for improving transmission quality.

KA2XYP, Hughes Aircraft Co., on frequencies 7000-11000 MHz for development and demonstration of GTAMS radar.

KA2XYR, Lockheed Corp., on frequencies 902-928 MHz for development of EIS system for commercial applications.

KA2XYX, Panasonic Industrial Co., on frequencies 151.715, 151.775, 169.445, and 171.905 MHz for pre-production testing of low power wireless microphone radio system.

KA2YYY, NSI Technology Serv., Corp., on frequencies 274.7 and 314.6 to fulfill U.S. government contract.

KA2XYZ, Panasonic Industrial Co., on frequencies 151.715, 151.775, 169.445

and 171.905 MHz for testing low power wireless microphone radio system.

KA2XZG, Alan M. Maslin, on frequencies 180.068-180.168 MHz for research in radio wave propagation and antenna systems.

KA2XZI, Lear Astronics Corp., on frequency 94 GHz - MMW radar data collection system.

KA2XZJ, Otto E. Aschoff, on frequencies 18.068-18.168 MHz for research and document propagation of cycle 22 on 18 MHz and experiment with antennas.

KA2XZK, Motorola, Inc., on various frequencies in the 800 and 900 MHz bands—station part of multi-site transmitter system for field testing of multiple site transmission and techniques for improving transmission quality.

KA2XZM, NAV-COM, Inc., on frequencies 159.090, 150.530, 154.680 and 154.815 MHz to test "AVL" system.

KA2XZO, Rockwell International Corp., on frequencies 93.69-94.17 GHz for radar data gathering system designed to collect and record radar video data.

KA2XZP, Thomas O. Donovan, on frequencies 18.068-18.168 MHz—station used to experiment with antennas and radio propagation.

KA2XZS, Aviation Systems, Inc., on frequency 334.55 MHz for developing and testing new concepts in ILS technology and antenna system.

KA2XZT, Raytheon Services Co., on frequency 26-30 GHz for development of an antenna test range.

KA2XZW, Trimble Navigation, Ltd., on frequency 218.2 MHz to demonstrate radio link for transmitting differential global positioning system information.

KA2XZX, Sangamo Weston, Inc., on 952 and 956 MHz band—for testing of meter reading equipment.

KA2XZY, Shannondale Wireless, on frequencies 2154.75, 2159.79 MHz (VIS) and 2150.25 (AUR)—to test the use of MMDS boosters.

KE2XZT, State of California, on frequency 401.7895 MHz for satellite data collection used for fire weather forecasting and water run-off prediction.

KE2XZW, State of California, on frequency 401.7895 MHz for satellite data collection—used for fire, weather forecasting and water run-off prediction.

KE2XZX, State of California, on frequency 401.7895 MHz for satellite data collection—used for fire, weather forecasting and water run-off prediction.

KA2XZU, TCE Systems, Inc., on various frequencies—to test, demonstrate, and sale microwave radio equipment.

KB2XDA, Versa-Link, Inc., on frequen-

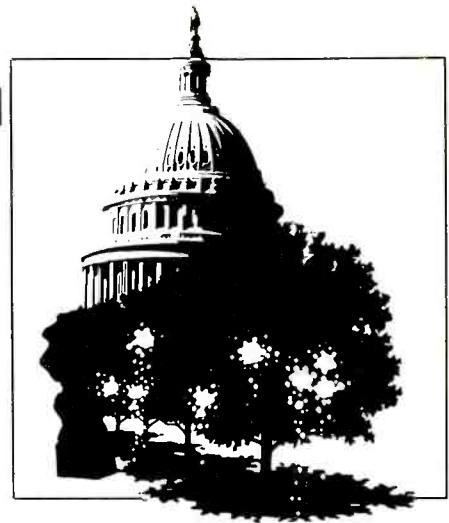

cies 928-929 and 952-960 MHz—to demonstrate the use of the 928/952 MHz point-to-multipoint frequency band; demonstrate Versa-Link radio products to prospective customers; and develop other Versa-Link 928/952 point-to-multipoint radio products.

KA2XZD, Transworld Communications, on various frequencies—develop and demonstrate HF and VHF communications equipment for commercial and military use.

KB2XDH, Aviation Systems, Inc., on frequencies 960-1215 MHz for developing and testing new concepts in ILS technology and antenna systems.

KB2XDK, Aviation Systems, Inc., on frequencies 108.05, 112.05 and 117.95 MHz for developing and testing concepts in ILS technology and antenna systems.

KB2XDL, Aviation Systems, Inc., on frequency 114.3 MHz for developing and testing new concepts in ILS technology and antenna systems.

KB2XDM, Ball Corporation, on frequencies 30 MHz-300 GHz—antenna test range.

KB2XDN, General Electric Radio Service Co., on frequencies 9.96, 10.06 and 10.16 GHz—request authorization to fulfill U.S. Government Contract.

KB2XDP, Harmon Industries, Inc., on frequencies 903-904, 918-926, 904-912 and 926-927 MHz for demonstration of products to prospective customers.

KB2XDR, Hillman Marine, Inc., on frequencies 156.800 and 156.925 MHz for demonstration of equipment to prospective customers (radios and antennas).

KB2XDV, Kaveh Pahlavan, on frequencies 910 MHz to 1.5 GHz—to fulfill U.S. Government Contract.

KB2XDU, NU-Metrics, Inc., on frequencies 173.3125 MHz for research in field of highway safety.

KB2XDZ, Wacom Products, Inc., on frequencies 30-1200 MHz for use as antenna test range for development of various land mobile and microwave services.

KM2XCB, Kayaba Industry Co., on frequency 153.595 MHz for research of automobile and motorcycle suspension systems.



# From Grove Enterprises The Leader in Listening Accessories



## For Scanning Enthusiasts

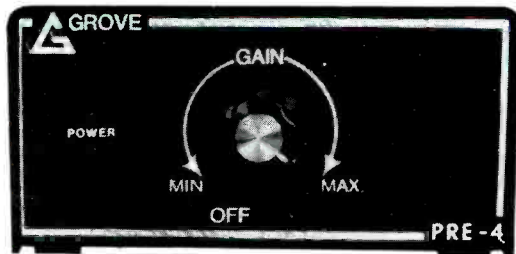

### GROVE PRE4 SCANNER BOOSTER

Bring in those weak, distant signals with the new Grove PRE4 Scanner Booster. A powerful tool for the serious scanner listener, the PRE4's transistorized, low-noise amplifier adds up to 20 dB of gain to those hard-to-hear signals. A front panel control allows you to customize the amount of amplification. Mounts indoors or out.

Using two scanners? The PRE4 has two jacks for simultaneous operation of any two 25-1300 MHz radios! In fact, the Grove Scanner Booster is perfect for any scanner, general coverage VHF/UHF receiver—even TV and FM.

The new Grove PRE4 Scanner Booster is now available from Grove Enterprises for \$69.00 plus \$2.00 UPS or \$3.00 parcel post. Requires optional 9-18 VDC/30ma power supply, \$9.95. Interconnect cable(s) for your scanner(s) \$7.50 each. (State model or connector required.)

(Not recommended in strong signal areas.)

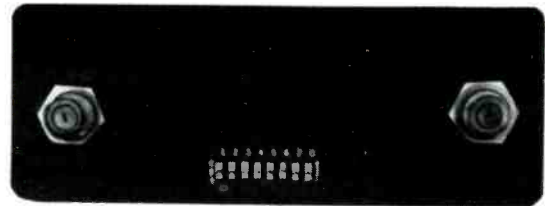

### GROVE FTR4 SCANNER FILTER

Interference. It's getting to be a real problem. But you don't have to put up with it any more.

Grove's new FTR4 Scanner Filter, equipped with F connectors, can reduce or even eliminate interference—no matter where it's coming from. Customize the settings yourself on the convenient dipswitch. Choose the reject/pass characteristics you need. A switchable 10 dB attenuator reduces RF saturation in dense signal environments while a high-pass filter removes shortwave bleed-through. The FTR4 comes with complete instructions.

The crystal clear 30 to 1000 MHz listening you have always dreamed about is now available!

The FTR4 Scanner Filter is just \$49.00 plus \$2.00 UPS or \$3.00 parcel post. (Scanner interconnect cable required, \$7.50. Specify your model or antenna connector. Input adapters: BNC, \$5.00, Motorola, \$7.50.)

## Improve Your Shortwave Reception

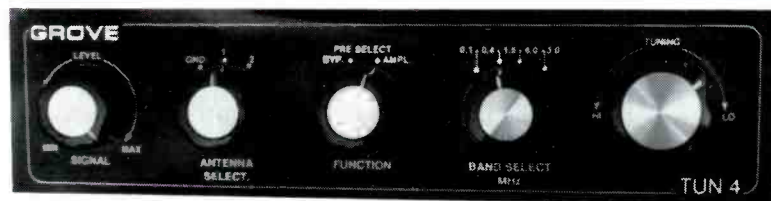

### THE NEW TUN4 MINITUNER PLUS

Grove Enterprises has taken two of their most popular products and combined them into one. The result is a listening tool so powerful that it improves reception over the entire 100 kHz to 30 MHz range! It's the all new TUN4 from Grove Enterprises!

Tune in that weak station. Then switch on the TUN4's low-noise, high-gain transistor amplifier. Peak the tuning control and hear an astounding improvement in signal strength.

You can also switch the TUN4 between two antennas, two receivers or even remove it from the circuit altogether—all at the touch of a switch. Fine tune your listening with the Grove TUN4. Just \$99.00 plus \$2.00 UPS or \$5.00 parcel post. Requires 12 VDC power supply, \$9.95. (Interconnect cable for your receiver, \$7.50 each. PL259 supplied unless otherwise specified.)

**Business Hours: 9am-5pm EST Monday through Friday**  
**Orders Only 1-800-438-8155 • Information 704-837-9200**  
**Send orders to Grove Enterprises • PO Box 98PC, Brasstown, NC 28902**

# SCANNING VHF/UHF

BY CHUCK GYSI, N2DUP

## MONITORING THE 30 TO 900 MHz "ACTION" BANDS

The scanning mailbag has been pretty full lately, so we're not going to waste any time getting to readers' letters.

George Gardinier of Baltimore, Ontario, checks in from north of the border with some frequencies: Cobourg police, 142.845; Port Hope police, 142.245; Police interagency, 142.770; area ambulance, 150.100 and 155.190; Cobourg and mutual aid fire, 153.515; Ontario Provincial Police, 41.96, 42.02, 42.06 and 42.22; Cobourg works, 169.170; Port Hope works, 169.440 and 169.110, and Brookside youth jail, 171.450. George says that during temperature inversions, he likes to listen to Rochester, N.Y., Toronto, aircraft, railroads, Royal Canadian Mounted Police and businesses. George also expressed an interest in starting up a local scanner club and wanted to know how to go about recruiting members. The best method is to get the word out. Try making up some fliers and ask area radio shops that sell scanners to distribute them to customers. You also might want to try running an ad in magazines such as POP'COMM. You might be surprised to find other scanner enthusiasts in your own neighborhood. And even if you don't generate enough interest for a club, you'll at least meet some fellow hobbyists in doing so.

Thad Hill of Houston, Texas, says he's about to become reacquainted with scanning after being away from the hobby for several years. He's thinking of buying Radio Shack's top-of-the-line PRO-2005 scanner, but is concerned that the radio might be a lot to spend by a novice. And you're probably right, Thad. If your re-entry into scanning doesn't become what you hope it will be, you'll be out a lot more money than if you had bought a radio at a lower cost and a few less features. If you're just entering the hobby, you're probably better off buying a scanner without many features and buttons; you'll only be confused and intimidated by a more sophisticated radio. The bottom line is this: If you really get sucked into the hobby, you can always upgrade to a better scanner at a later date. And you'll probably get another novice interested in the hobby willing to purchase your used scanner if you don't need two radios.

James G. Malta, N2HOQ and KNJ2KG, of Piscataway, New Jersey, wonders about some things he's hearing above 890 MHz. He says he's hearing computerlike noises between 890 and 902 MHz. First of all, the new cellular band that has opened up in some areas takes in 890-894 MHz. However, the space between 894 and 896 MHz is used for phones aboard commercial airliners. If you listen in the AM mode, you'll hear data being sent from the planes to

ground stations before and after telephone calls are placed. The data being sent, assumedly, is billing information for calls placed in the air. James also reports hearing communications on frequencies in the 935 MHz region. The 935-940 MHz band has opened up in many radio-congested metropolitan areas and is used for trunked business communications. Channels are spaced 12.5 kHz, as opposed to normal 25-kHz spacing normally found on UHF channels.

A reader from Massachusetts who prefers not to be identified helps solve a mystery frequency mentioned in this column in September 1989. In that column, Bruce A. Prescott, Registered Monitor KMA1GN, of Bellingham, Massachusetts, said he had heard a constant series of tones on 37.00 MHz. He tracked down the transmitter sites, however, they were in the middle of fields. Well, our anonymous reader says that Bruce probably is hearing Tenneco Communications Corp., which is licensed on 37.005 in both Hopkington, Massachusetts, and Woburn, Massachusetts. These stations are licensed as fixed stations in the developmental section of the Petroleum Radio Service. The anonymous guess is that the frequency is being used for some type of telemetry, or supervisory control and data acquisition for Tenneco's pipelines. The anonymous reader reports hearing the signal as very strong throughout eastern Massachusetts. Thanks for helping to solve a reader mystery!

Roy Jeffers of LaPorte, Texas, likes to listen to aircraft communications and passes along these frequencies used for approach at Houston International Airport: 119.100, 119.700, 120.800 and 123.800. In addition, 118.700 is used at Hobby Airport.

Gregory C. Halpin of York, Pennsylvania, checks in with some new frequencies in use in York County, Pennsylvania. Gregory says that York County has added four new fire frequencies as zone channels. The configuration now goes like this: 33.90, dispatch; 33.88, primary communications; 33.58, mutual aid; 33.48, Zone 1; 33.52, Zone 2; 33.54, Zone 3; 33.66, Zone 4; 154.280, mutual aid with surrounding counties (bases only); and 154.190, York City Fire Department. Gregory also sends along these frequencies of interest: 453.600, York County Emergency Management Agency Channel 1 (also used for paging for emergency management staff, magistrates and district attorneys as well as the county Hazardous Materials Response Team); 453.775, York County emergency management Channel 3 (not repeater) for on-scene communications. Gregory also passes along this tip: During a recent host-



Here's the well-organized monitoring post of Nick Anthony Beaumont of Fair Haven, Michigan. His scanning equipment includes Realistic PRO 2004 and 2005 radios.

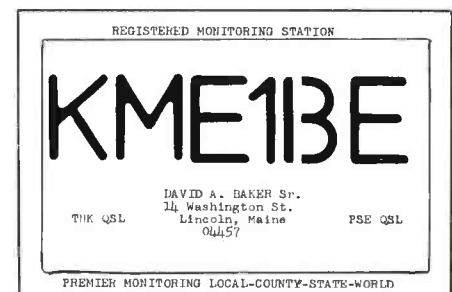

Station card from David A. Walker, Sr., N1GO1 and also Registered Monitor KME1BE. Why not send us your card?

age incident, police maintained contact with the suspect via cellular. It's a good place to check for the inside scoop if police are negotiating with the suspect. The incident Gregory monitored went on for 16 hours!

From Kaneohe, Hawaii, comes a letter from Bill Nieporte, who reports finding 50 cellular frequencies between 851 and 867 MHz. However, Bill, those alleged cellular calls you are hearing on your Radio Shack PRO-34 handheld are actually one of two things: Either you are very close to a cellular tower, or a transmitter that is causing false signals on frequencies that are not allocated for cellular, or you are hearing phone calls being placed by trunked two-way radio users who are allowed to interconnect their radios with telephone lines for the ease of placing and receiving calls. However, it is doubtful you'd hear these trunked phone calls from 851-855 MHz, because that portion of the 800-MHz band normally is not used for trunked communications.

Well-known VHF low-band DX'er Chuck Robertson followed up on something mentioned in the September 1989 *Scanning VHF-UHF* column. In that column, Russell Wright, WN4VCH, of Houston, Texas, reported hearing what sounded like a military



repeater identifying as "Thrush" on 30.48. Chuck, who lives in Creal Springs, Illinois, says that this station is Minisaga Probation in Ontario. Apparently, they use the repeater on Manitouline Island in Lake Huron for their juvenile delinquent reform camp. On this frequency, officers have "animal" ID's such as Lobo or Thrush and the seaplane ID's as Grey Goose. The officers at the camp use handheld and mobile radios. Meanwhile, Chuck reports that this past winter should be the peak of solar Cycle 22, which probably will be one of the most energetic cycles ever, as far as DX'ing is concerned.

Chris Sunseri of Metairie, Louisiana, sends along this list of frequencies used by the New Orleans Police Department: 460.025, F-1, Districts 1 and 8; 460.050, F-2, District 2; 460.100, F-3, Districts 3 and 7; 460.125, F-4, car to car; 460.200, F-5, Districts 4 and 5; 460.225, F-6, District 6; 460.300, F-7, tactical; 460.325, F-8, Felony Action Squad; 460.400, F-9, Internal Affairs; 460.425, F-11, car to car; and 460.475, F-10, detectives.

We're interested in hearing your frequency updates, comments, questions and listening tips here at POP'COMM. We're also interested in photos of your listening post or an antenna farm of radio dispatch installation. Write to: Chuck Gysi, N2DUP, Scanning VHF-UHF, Popular Communications, 76 North Broadway, Hicksville, NY 11801.

When it comes to effective multi-band DX antennas for limited space applications, it comes to the world class **ALPHA DELTA DX-SWL** family of High Performance SLOPERS!

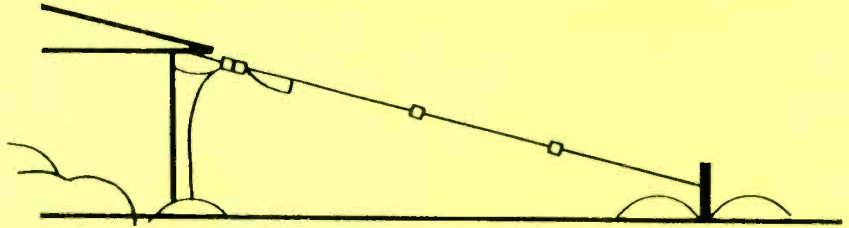

- Fully assembled, ready to use and built for long life. So strong, it can even be used to transmit—up to 2 kW!
- Superior multi-band performance on 13, 16, 19, 21, 25, 31, 41, 49, 60, 90, 120 meters plus the AM broadcast band (.5-1.6 MHz). All in a single compact antenna. Alpha Delta first!
- Efficient multi-band frequency selection by means of special RF choke-resonators—instead of lossy, narrow band traps.
- Overall length just 60 feet. Requires only a single elevated support—easier to install than a dipole.
- 50 ohm feedpoint at apex of antenna for maximum DX reception. A UHF connector is provided on the mounting bracket for easy connection to your coax.
- A top overall rating in Radio Database International's hard-hitting White Paper, "RDI Evaluates the Popular Outdoor Antennas."

- Model DX-SWL, AM broadcast thru 13 mtrs, 60' long. . . . . **\$69.95**
- Model DX-SWL-S, as above but 90 thru 13 mtrs, only 40' long. . . . . **\$59.95**

Available from your local Alpha Delta Dealer or direct. Add \$4.00 shipping and handling (U.S.A. only) Exports quoted.

**ALPHA DELTA COMMUNICATIONS, INC.**



P.O. Box 571, Centerville, Ohio 45459 • (513) 435-4772

CIRCLE 138 ON READER SERVICE CARD

# POPULAR COMMUNICATIONS

Here's what you've been looking for – an all new hard-hitting monthly magazine which gives a unique insider's view of what's really going on in the world of communications. POP' COMM is your primary source of information – bigger and better than any communications magazine, with exciting coverage of scanners, shortwave broadcast & utility stations, spy stations, pirate and clandestine broadcasters, RTTY monitoring, survivalist communications systems, FCC news, wiretapping and bugging, voice scrambling/unscrambling, surveillance/undercover communications, satellite & cable TV, sophisticated telephones, & more. What you've been looking for all along! Take advantage of substantial savings over the newsstand price by subscribing now. Don't miss out on even one single issue of POPULAR COMMUNICATIONS – order your subscription now.



**Twelve Issues \$18**

## POPULAR COMMUNICATIONS

76 N. Broadway, Hicksville, NY 11801

Yes! POPULAR COMMUNICATIONS is just the magazine I've been looking for. Start sending it to me now! I understand that I may cancel at any time for any reason, and receive a full refund on my unused subscription.

- 1 year - 12 issues **\$18.00**
- 2 years - 24 issues **\$35.00**
- 3 years - 36 issues **\$52.00**

Canada and Mexico - one year \$20.00 US, two years \$39.00 US, three years \$58.00 US. Foreign - one year \$22.00 US, two years \$43.00 US, three years \$64.00 US.

Paid by:  Check  Money Order  MasterCard  VISA

My account number is:

\_\_\_\_\_

Name \_\_\_\_\_

Street \_\_\_\_\_

City \_\_\_\_\_ State \_\_\_\_\_ Zip \_\_\_\_\_

## DX Helper

Macintosh Software W7-HF  
 MUF Map • MUF Plot  
 Gray Line • Great Circle  
 Prefix Zone, Oblast  
 WWW Alert • CW Dnt

\$39.95 Info  
 ppd \$1

Antennas West

Box 50062X, Provo, UT 84605

(801) 373-8425 See band openings on the map before they happen!

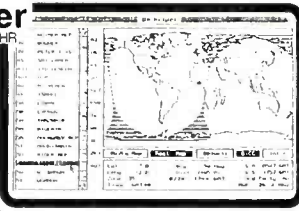

CIRCLE 11 ON READER SERVICE CARD

## CB RADIO OWNERS!

We specialize in a wide variety of technical information, parts and services for CB radios. 10-Meter and FM conversion kits, repair books, plans, high-performance accessories. Thousands of satisfied customer since 1976! Catalog \$2.

**CBC INTERNATIONAL**  
 P.O. BOX 31500PC, PHOENIX, AZ 85046

## CB TRICKS OF THE TRADE II

Book: Learn CB repair techniques and all CB tune-up procedures. Plus amplifier design theory, circuits & schematics. Also covers GMRS (UHF CB) and more.

Send Money Orders for \$19.95.

C.O.D. Orders Accepted

Medicine Man CB

P.O. Box 37

Clarksville, AR 72830

(501) 754-2076



CIRCLE 150 ON READER SERVICE CARD

## OFFICIAL scanner guides

The frequencies are listed by Community and a Master Cross Reference by Frequency, Call Sign, and License is included.

Included are State, County, and Local system descriptions, system maps, frequency allocation tables, and explanatory notes on specific frequency usage. Aeronautical and Maritime information has been expanded and the licenses are included in the community listings.

Connecticut		9,373 Listings	\$14.95
Maine	2nd Edition	8,312 Listings	\$14.95
Massachusetts	3rd Edition	13,728 Listings	\$21.95
New Hampshire	4th Edition	7,455 Listings	\$17.95
Rhode Island		3,083 Listings	\$14.95
Vermont		3,824 Listings	\$14.95

\* FREE UPDATE INCLUDED!

Please include \$2.05 shipping and handling for each guide.

\* ORDERS SHIPPED SAME DAY \*

OFFICIAL scanner guide

Post Office Box 712

Londonderry, New Hampshire 03053

CIRCLE 128 ON READER SERVICE CARD

\*\*\*\*\*PRESENTING\*\*\*\*\*

**CABLE TV  
 DESCRAMBLERS**

\*\*\*\*\*STARRING\*\*\*\*\*

**JERROLD, HAMLIN, OAK**

AND OTHER FAMOUS MANUFACTURERS

• FINEST WARRANTY PROGRAM AVAILABLE

• LOWEST RETAIL/WHOLESALE PRICES IN U.S.

• ORDERS SHIPPED FROM STOCK WITHIN 24 HOURS

FOR FREE CATALOG ONLY 1-800-345-8927

FOR ALL INFORMATION 1-818-716-5914

**PACIFIC CABLE CO. INC.**  
 7325 1/2 RESEDA BLVD., DEPT. 1147  
 RESEDA, CA 91335

Please send all reader inquiries directly.

# COMMUNICATIONS SHOP

**Advertising Rates:** SCAN members and POP'COMM subscribers are entitled to one FREE 30-word, non-commercial classified ad per year. Enclose subscription name label with ad copy. For those people not in the previously mentioned groups, non-commercial ads are 30 cents per word, including abbreviations and addresses; minimum charge \$6.00 per issue. Ads from firms offering commercial products or services are \$1.00 per word; minimum charge \$20.00 per issue. Boldface words are \$1.20 each (specify which words). Leading key words set in all caps at no additional charge. All ads must be prepaid in full at time of insertion; a 5% discount is offered for prepaid 6 time insertions. All ads must be typewritten double spaced.

**Approval:** All ad copy is subject to Publisher's approval and may be modified to eliminate references to equipment and practices which are either illegal or otherwise not within the spirit or coverage scope of the magazine.

**Closing Date:** The 10th day in the third month preceding date of publication. Because the advertisers and equipment contained in Communications Shop have not been investigated, the Publisher of Popular Communications cannot vouch for the merchandise listed therein. Direct all correspondence and ad copy to: PC Communications Shop, 76 N. Broadway, Hicksville, NY 11801.

**ELECTRONIC SPYING** is the name of the game. It's also the title of a startling book which reveals the closely guarded methods & equipment used by professionals & amateurs who eavesdrop on homes & businesses with (sometimes) legal and (usually) illegal bugs & wiretaps. Written in non-technical language everyone can easily understand, ELECTRONIC SPYING has photos & illustrations clearly revealing exactly how they do it & where they get the equipment (much of it inexpensive & easily available). Leaves nothing to the imagination! Latest techniques covered & offers an in-depth wealth of information on the ever increasing electronic invasion unavailable from any other source. This book is used by law enforcement agencies as a reference manual. Only \$8.95 (plus \$1.00 postage) per copy from CRB Research, P.O. Box 56, Commack, N.Y. 11725. (NY residents add sales tax.)

**WORLD'S MOST UNUSUAL Communications Books!** A large selection of outstanding titles covering scanners, "confidential" frequency registries, bugging, wire tapping, electronic surveillance, covert communications, computers, espionage, monitoring, and more! New titles being added constantly! Ask for our large new FREE catalog. CRB Research, Box 56-PC, Commack, NY 11725.

**SIDEBAND OPERATORS!** Join the oldest/largest network of 27 MHz SSB operators. Now more than 100,000 strong! Send self-addressed stamped long (#10) envelope for FREE details and application (no obligation). SSB Network, P.O. Box 908, Smithtown, NY 11787.

**COMMUNICATIONS PLANS, BOOKS, KITS!** AM/FM broadcasting (licensed/unlicensed), 1750 Meter transceivers, Ham/CB amplifiers, surveillance bugs, more. FREE catalog. PAN-COM, Box 130-P11, Paradise, CA 95967.

**HISTORIC WIRELESS/RADIO ARCHIVES!** Tom Kneitel's new book, "Radio Station Treasury (1900-1946)." Gigantic 176-page compendium listing stations that operated between the dawn of the spark era & the end of WWII. A profusion of frequencies, skeds, call signs, slogans, licensee data, power, locations, etc. Covers the world's AM band & SW broadcasters, "utes," point/point, press, aviation, maritime, police, federal, military, experimental, longwave, early FM/TV, secret WWII propaganda stations, more! Comprehensive sourcebook directory packed with huge array of fascinating features & facts about tens of thousands of stations in every nation & category, of every size & type! Unique reference guide, nothing ever before like it! Research radio history in your own community & throughout the world. Personally autographed by the author (upon request when ordering) Only \$12.95 plus \$1 postage (USA/Canada/APO/FPO) from CRB Research, P.O. Box 56, Commack, NY 11725. (NY residents add sales tax.)

**ESPIONAGE/EMBASSY Communications Guide,** by Tom Kneitel. What's behind mystery "numbers" transmissions, coded embassy messages, and stations operated by foreign governments in the USA & Canada. How nations monitor each other's official codes and communications. Illustrated! Includes largest/latest registry of stations (frequencies/call signs/locations/modes) operated embassies of the world's governments, intelligence agencies, U.N., Interpol, International Red Cross, U.S. State Department; HF/VHF/UHF. Now you can tune in on Embassy & Espionage Communications is \$10.95 + \$1 postage (USA/Canada/APO/FPO) from CRB Research, Box 56, Commack NY 11725. (NY residents add sales tax.)

**WANTED:** Allied Radio (Knight Kit) shortwave radio models Span Master or StarRoamer. Reasonable prices paid. Call 219-288-7280 (8-10 PM EST).

**DESIRE TO CORRESPOND** with monitors of Milt Air along coastline from New Orleans, LA to Panama City, FL. Clifford J. Powell, P.O. Box 388, Walker Springs, AL 36586.

**COMPLETE POP'COMM COLLECTION.** 1st issue September '82 through 1987. All in good to excellent condition. Some duplicates. \$45.00 1 ship. Grove Mintune-3 \$20.00. Jon Van Allen, 2872 W. 7140 So. West Jordan, UT 84084.

**SCANNER LISTENERS!** Canadian and American frequency books available. Send stamp for Catalog: DOYLE COMMUNICATIONS, Rte 8 Box 18, Lake Pleasant, NY 12108.

**CW? NO PROBLEM.** You can increase your speed, no matter how many times you've failed before. **Results guaranteed** when you follow the instructions. PASS Publishing's **CW Mental-Block Buster** program helps you **explode mental blocks** that hold you back. Based on 40 years of research, the **CW Mental-Block Buster** uses guided meditation, dynamic visualizations, and powerful affirmations to blast through mental blocks. **You can do code!** That means new bands, more contacts, more fun! (This is not a CW practice tape.) The **CW Mental-Block Buster** audio cassette and practice booklet are only \$24.95 ppd. in the US (NY residents add \$1.87 sales tax). (Quantity discounts available for classes.) PASS Publishing, P.O. Box 570, Stony Brook, NY 11780.

**Morse code got you down?** Why let a mental block stand between you and upgrading? Use PASS Publishing's **CW Mental-Block Buster** to **blast through those barriers.** Just follow the instructions for 30 days—**Results Guaranteed!** Based on 40 years of research, the **CW Mental-Block Buster** uses guided meditation, dynamic visualizations, and powerful affirmations to blast through mental blocks. **You can do code!** That means new bands, more contacts, more fun! (This is not a CW practice tape.) The **CW Mental-Block Buster** audio cassette and practice booklet are only \$24.95 ppd. in the US (NY residents add \$1.87 sales tax). (Quantity discounts available for classes.) PASS Publishing, P.O. Box 570, Stony Brook, NY 11780.

**BUGGED? WIRETAPPED?** Find out fast! Factory direct countermeasures equipment catalog \$1. Capri Electronics, Box 589W, Bayfield, CO 81122.

**The "MAP". Improve your RCVR'S selectivity and audio quality with the MAP.** No moods required. Instructions for R70/71, FRG7700/8800, NRD515/525 and others. KIWA 9815-61st. So., Seattle, WA 98118.

**FREE SOFTWARE** for IBM and compatible computers! Info. \$1.00. Blue Chip Engineering, Dept. 15, P.O. Box 1100, Walnut, CA 91789.

**PRO-2004/5 OWNERS:** Search-and-Store finds elusive frequencies while you work or sleep. Internal no-holes installation—Keyboard control—Retain present functions. Wired-tested-postpaid: Ten channel \$24.95 (check)—Selectable to 255 channels \$44.95—Key Research, POB 5054P, Cary, NC 27511.

**WANTED:** Anyone who can provide freqs and infor for Willow Grove NAS PA. and surrounding areas. Can provide central New Jersey freqs in return. Call Bill Days, 609-893-0691 Eves 602-562-3455.

**SURVEILLANCE-COUNTERMEASURES!** Transmitters, detectors, phone security, night vision, stunguns, secret devices, restricted books, **MORE! GUARANTEED LOWEST PRICES!** **HUGE CATALOG \$5.00 (REFUNDABLE)** protector P.O. Box 520294, Salt Lake City, UT 84152.



**MIL-SPEC COMMUNICATIONS**—new and used equipment, repair services and installations. Box 461, Wakefield, RI 02880, 401-783-7106. Catalog \$2.00 Credit to purchase.

**Tune In On Telephone Calls.** Tom Kneitel's new 160-page book. Everything you need to know to effectively use a scanner and communications receiver to eavesdrop on private telephone calls from homes, offices, cars, ships, aircraft, trains. Explanatory text, photos, extensive listings section covers USA/Canada on HF, VHF, UHF, and above; thousands of locations, frequency assignments. Explains equipment, best techniques, laws regarding monitoring cellular, cordless, ship/shore, high seas, Air Force 1, airliners, 1-way paging, more. Only \$12.95 (plus \$2 postage to USA/Canada/APO/FPO) from CRB Research, Box 56, Comack, NY 11725. NY residents add sales tax. Dealer inquiries invited.

**NEW! UNDERSTANDING & REPAIRING CB RADIOS** by Lou Franklin. Giant 380-page technical book picks up where **THE "SCREWDRIVER EXPERTS" GUIDE** leaves off. Includes circuit descriptions and troubleshooting guide for virtually all CB radios: 23 and 40-channel, crystal and PLL, solid-state and tube, AM, FM, SSB, CW, American, British and export models. Covers test equipment, transistor basics, synthesizers, receivers, transmitters, power supplies, T/R switching, antennas, interference, parts and accessory sources. Over 350 illustrations plus huge subject index. Moneyback Guarantee! Only \$29.95 plus \$3.50 U.S. & Canadian Air Mail, VISA/MC accepted. Free catalog of unique CB books, plans, and modification kits with order. Catalog only, \$2. **CB CITY INTERNATIONAL, BOX 31500PC, Phoenix, AZ 85046.** Thousands of satisfied customers since 1976.

**PROTECT YOURSELF FROM ELECTRONIC EAVESDROPPING!** SCRAMBLER PHONES, TRANSMITTER DETECTORS, TAPE RECORDER DETECTORS, EXECUTIVE SECURITY PRODUCTS, SURVEILLANCE BOOKS AND MUCH MORE! CATALOG \$3.00 (REFUNDABLE) DIVERSIFIED WHOLESALE PRODUCTS, P.O. BOX 1275-PC, REDONDO BEACH, CA 90278.

**Radio New York International** official off the air recording of our first broadcast live from the good ship Sarah. \$15.00 gets you a 60 minute cassette, plus an official letter and certificate from the RNI staff. RNI, Monticello, Maine 04760.

Interested in FM CB radio? For more information send SASE business envelope plus \$3 to GMRS, 107 West Caldwell, Phoenix, AZ 85041.

**THE NEW YORK MONITOR NEWSLETTER**—a monthly Newsletter that provides CB'ers with the latest up-to-the-minute Technical information—Radio Repair and Modification—Phase Lock Loop (PLL) Circuit/Expander—2 YEAR COURSE IN ELECTRONIC COMMUNICATION and much much more!! \$24 per year mail to **LORD/WYATT COMMUNICATIONS, P.O. Box 030128PCD, Brooklyn, NY 11203-0001.**

**TELEPHONE PAGER SYSTEM.** Up to 30 miles. Easy to build using CB radios and low cost parts. Complete plans \$14.95. Mike Mikalian, Box 131, Lynden, WA 98264.

**HURRY!** Get in the **WORLDWIDE CB DIRECTORY**. Correspond with CB'ers all over the world. For free info rush a (#10) SASE to: **WORLDWIDE CB DIRECTORY, P.O. Box 19786, Dept. C, New Orleans, LA 70119.**

**AM/FM/TV BROADCAST BAND AIRCHECKS** of metropolitan New York, N.J. & CT. area stations. Caught a NY station in the dead of night? Verify your logs with top-quality airchecks. Send your requirements for a free price quote to: AiResponse, 553 E. Fulton St., Long Beach, NY 11561-2416.

**FOR SALE:** TAD UHF Transceiver 30 watt, TAD VHF Transceiver 40 watt, both programmable from front panel, 99 channel, like new, UHF, \$695.00, VHF, \$595.00; Motorola MT-500 handheld, 5 watt, 4 channel, \$495.00; Midland UHF 8 channel transceiver, 30 watt, \$375.00; Pace Landmaster VHF Mobilephone, \$395.00; NEC digital pager, new, \$175.00; NEC tone-only pager new, \$100.00. Don F. Peyton, 409 N. Fredonia St., Suite 113, Longview, Texas 75601 (214) 758-1421.

Realistic PRO-34 \$200.00, PRO-2005 \$300.00, Uniden BC200XLT \$200.00, all units like new in boxes with many extras. First \$600.00 takes the lot, will ship UPS COD. Call Bud at (314) 895-7467 days or (314) 921-0779 nights.

**PRO-2004/5 OWNERS:** Search-and-Store finds elusive frequencies while you work or sleep. Internal no-holes installation—Key-board control—retain present functions. Wired-tested-postpaid: Ten channel \$24.95 (check)—Selectable to 255 channels \$44.95 Key Research, POB 5054P, Cary, NC 27511.

**PRIVACY PROBLEM—NEED INFORMATION?** New Electronics Surveillance, Debugging, Protection Catalog \$5.00 Kits—Assembled. **TECHNOLOGY SERVICES, 829G Ginette, Gretna, LA 70056.**

**225-400 MC RECEIVERS** Tunable, Government Reconditioned. Satcom Antennas 240-270 MC Military Helical Type, New (419) 726-2249.

**COMMUNICATIONS INTELLIGENCE GATHERING AND ANALYSIS** program. \$29.95 IBM Compatible. Stores Frequency, Date, Time, Call Sign, Mode and Notes. Date/Time may be automatically appended. During data entry, existing entries may be searched and displayed. Upon entry of Frequency, system displays "normal" allocation for given frequency. Built in complete help file. Can use to analyze data by sorting, selecting and listing on any record. The Computer Handyman, PO Box 503, Carmel, IN 46032-9867 (317) 844-6672.

**NEW VIDEO—SPYCRAFT: INSIDE SECRETS OF ESPIONAGE AND SURVEILLANCE.** Come on a true-to-life countersurveillance mission with a man who was a real-life James Bond. This is the most authentic look inside the spy trade ever produced—a hands-on training film! Color, over 50 minutes, (non-returnable) \$59.95. CEP, Incorporated, Box 865-9PT, Boulder, Colorado 80306, (303) 443-2294.

**FREDERICK 1635K** four channel VFT/FDM RTTY demodulator. All bauds and shifts keypad/remote programmable, red plasma display. Mint surplus from Federal Agency at Fort Meade. Original cost \$7000, sell \$900. Terry Thompson, Box 935, Dania, FL 33004. (305) 920-1909.

**CW Lite** is the **easiest** Morse code training method in the world, bar none! And it is the **fastest**, too. Just close your eyes and relax. This powerful **hypnosis cassette tape** does the rest. **Subliminals** speed you along! Only \$14.95 ppd in US (NY residents add \$1.12 tax). Order today! **PASS Publishing, Box 570, Stony Brook, NY 11790.**

**PRO-POWER II IS HERE!** Drop-in charger stands for all popular Hand-Held scanners, plus many other accessories. Call or write for free Catalog. **MetroWest, 822 N. Spring, LaGrange Park, IL 60525 (708) 354-2124.**

**VIDEOCIPHER II Manuals.** Volume 1 - HARDWARE, Volume 2 - SOFTWARE. \$32.45 each. Volume 3 - PROJECTS/SOFTWARE - \$42.45. Volume 4 - REPAIR/SOFTWARE - \$97.45 **COD's** 1-602-782-2316. 0100-032 Software Catalog - \$3.00 **TELECODE** Box 6246-PC, Yuma, AZ 85366-6426.

**"ANARC Guide To US Monitoring Laws":** texts of state scanner laws and the ECPA with concise interpretations by Frank Terranella. \$7.50 postpaid from ANARC Publications, P.O. Box 143, Falls Church, VA 22046.

**RF Limited Antennas.** Unique antennas, bandwidth **500 kHz to 1500 MHz**, adjustable gain 0 to 20 dB. (see POP/COMM 9/89). Model 505C (Mobile) w/16 ft. cable \$134.95. Model 707C (Base) w/50 ft. cable \$169.95. \$5.00 s&h. MC or VISA. Catalog: **DOYLE COMMUNICATIONS, Rte. 8 Box 18, Lake Pleasant, NY 12108 (518) 548-5515.**

**THE OUTLAW REPORTS** - Secret insider information on spy schools, ID change, precious gems, explosives, auto theft, super sources for suppliers of security gear, unusual weapons, electronics and more. Softcover, 180pp, \$28.50ppd. CEP, P.O. Box 865-OZT, Boulder, CO 80306.

**NextDay Reception Reports**

Two-Color Printing  
Rainbow Cardstock  
100 200 300  
\$19.95 \$24.95 \$29.95

Specify • Receiver  
• Antenna  
• Your 40-Word Personal Message

Sign, Trace, Test Report and U.S. Postage  
New York City, New York

• Command Attention • Send Clear Reports • Speed Replies • Save Time •  
Box 50062-P • Provo, UT 84605 • **AntennasWest**

CIRCLE 11 ON READER SERVICE CARD



# GILFER — first in Shortwave

**GILFER'S FAMOUS "CONFIDENTIAL FREQUENCY LIST" — \$19.95**

Popular Communications magazine says: "Can't imagine anyone attempting to listen to HF voice or CW/RTTY communications without a handy copy." Recognized worldwide as the indisputable leader and most comprehensive list of SW in the 4-28MHz region. Over 30,000 frequencies with call sign, country, details covering aero marine, embassy, weather, press, feeders, INTERPOL, time, channel marker and more. Now includes special section on worldwide FAX and RTTY stations. Charts also included. Add \$2 USA; Overseas add \$4 surface, \$10 air.

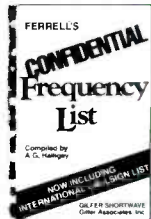

**VISIT GILFER'S STORE**  
Easy to find, accessible from New York City. Take Garden State Parkway (NE portion of N.J.), Exit 172. Gilfer is in the center of Park Ridge, opposite the Borough Hall. Store hours: M-F 10am-5pm, Sat. 10am-3pm.

**GILFER SHORTWAVE**  
52 Park Ave, Park Ridge, NJ 07656, Ph 201/391-7887

CIRCLE 129 ON READER SERVICE CARD

## New Scanner by AOR

**100 Channels 800 MHz**

- Includes antenna, rechargeable battery, charger/adaptor & belt clip. Full range of optional accessories available.
- Covers 27-54 MHz, 108-174 MHz, 406-512 MHz, and 830-950 MHz.
- 5 Scan Banks and 5 Search Banks
- 25 Day Satisfaction Guarantee, Full Refund if not Satisfied.
- No Frequencies cut out
- Size: 2" x 5 1/4" x 1 1/2" wt 12 oz.

**AR900**  
Total Price, Freight Prepaid (Express Shipping Optional)  
**\$299.00**



10707 E. 106th St. Indpls., IN 46256  
Toll Free 800-445-7717

Visa and MasterCard (COD slightly higher)  
In Indiana 317-849-2570 Collect FAX (317) 849-8794

CIRCLE 126 ON READER SERVICE CARD

# More QSO's More QSL's More Fun



when you speak their language.

- Add extra spice to your DX QSO's
- Let your DX friends know you care enough about them to learn their language. (After all, they've gone out of their way to learn English!)
- Break the phone pile-up with a few carefully chosen words in the DX station's own language. You'll be amazed at the difference. It's like adding 3 dB to your signal.

**The Radio Amateur's Conversation Guide** by OH1BR and OH3BAD gives you the 147 most often used phrases in eight languages: English, German, French, Italian, Spanish, Portuguese, Cyrillic Russian, Phonetic Russian, Phonetic Japanese. Phonetic alphabets and eight-language dictionary included in this rugged spiral-bound manual a MUST for any serious DXer or Contestor. Beat the competition. Order yours today. Only \$10.00 plus \$2.00 per order shipping.

Supplements available in less-used languages: Dutch/Flemish, Danish, Finnish, Swedish, Serbocroatian. \$4.00 per supplement. Be sure to state which language supplement you need.



## New cassette tapes in eight languages

Now you can hear the exact pronunciation of the sentences, phrases and words covered in *The Radio Amateur's Conversation Guide*. Each high quality language tape is recorded with proper dialect and usage in one of the languages in the Conversation Guide.

Tapes available in each of these languages:

- German
- Portuguese
- French
- Russian
- Spanish
- Japanese
- Finnish
- Swedish



**CQ Book Shop**  
76 North Broadway  
Hicksville, NY 11801

Please send the following:

Conversation Guide Book \$10

Language Tapes  
@ \$10 each

- German
- French
- Spanish
- Finnish
- Portuguese
- Russian
- Japanese
- Swedish

Supplements  
@ \$4 each

- Dutch/Flemish
- Danish
- Finnish
- Serbocroatian
- Swedish

Add \$2 for postage and handling in North America

Total \_\_\_\_\_

Name \_\_\_\_\_

Address \_\_\_\_\_

City \_\_\_\_\_ State \_\_\_\_\_ Zip \_\_\_\_\_

## Beaming In

(from page 4)

9 Hz." I thought the Navy was using those frequencies to communicate with submarines from that transmitter in Wisconsin.

The ad doesn't mention anything about putting up an antenna that will work in this band, but I think you're either going to have to string a wire to Uruguay, or else build a loading coil the size of the Houston Astro-dome.

Oddly enough, it's a great band for people who have problems with their CW speed. At those frequencies, CW can only be sent at less than 1 letter per minute. By the time you cranked out a couple of CQ's, UFO's would be outside your window zooming around and doing barrel rolls. Also, you'd probably have the FBI at your front door asking about the coded messages you're sending to submarines.

A friend of mine involved in SETI (Search for Extra Terrestrial Intelligence) at a university mentions that much of their intensive listening centers around 1420 MHz, known as the "hydrogen line." The theory is that this is the frequency of the hydrogen atom, and since hydrogen is the most common element in the universe, that might be used as some sort of interplanetary hailing frequency, like CB Channel 19, or VHF-FM Channel 16.

It's as good or bad a piece of logic as any, I suppose. In view of the fact that distant civilizations trying to send signals here would hope to penetrate our planet's biosphere, maybe they ought to forget about all of this hydrogen line gibberish and start monitoring the pollution line or the smog line. Just a suggestion.

In the meantime, if any of our readers pick up any good messages, be sure to let us know us know and send a copy of the QSL.

MILITARY RADIOS: pieces and parts. Pictures/Prices Sheets \$2 refundable. Baytronics, Box 591, Sandusky, OH 44870.

WANTED: MODIFICATION DETAILS for Realistic's PRO-32 and PRO-2021 scanners. Can trade antenna plans for CB and/or Scanners. ALAN FIFIELD, P.O. Box 539, MT. VIEW, HI., 96771.

SURVEILLANCE TRANSMITTER KITS are available to professional City, State and Government law enforcement agencies that operate on frequencies they prefer. Our transmitters have proven generally to outperform theirs. Four models of each: telephone, room, combination telephone/room transmitters tune from 65 to 305 MHz. Send \$1.00 (overseas airmail \$2.00) for catalog. Included is **Popular Communications'** book review of **"NOW HEAR THIS! ELECTRONIC EAVESDROPPING EQUIPMENT DESIGN"** by Winston Arrington. Book contains 58 transmitter schematics. SCHEFFIELD ELECTRONICS, 7223 S. Stony Island Ave., Chicago, IL 60649.

WANTED-MARANTZ. Old tube audio equipment-any condition. Will pay fair price. Call collect anytime. 516-874-8931.

TEST EQUIPMENT—Reconditioned (guaranteed), Terrific Prices, NBS Calibration available. Visa, M/C, Amex. COD Electronic Surplus, Inc., 4350 Town Plaza, Suite 203, Houston, TX 77045 (713) 728-9718.

WANTED—Information concerning computer interface with Bearcat DX 1000 communications receiver. What's possible? What's available? W. Ritz, 1244 Churchill Rd., Cleveland, OH 44124.

"TEN-HOUR LONG-PLAY" cassette recorder, as advertised in POPCOMM. Best offer. Call (912) 272-8690 or write 302 Ramsey St., Apt. 1A, Dublin, GA 31021."

**NEW! AIR-SCAN 5TH EDITION** by Tom Kneitel. Complete guide to aero comms. Now in **gigantic 192-page large-size format containing 60,000+** listings, including 2-30 MHz HF, 118 to 174 MHz VHF, 406 to 512 MHz UHF, and 800 MHz listings. Covers civil, military, private, and unlisted landing areas, heliports, and seaplane bases. Control towers, ground, approach/departure, FSS, unicoms, multicomms, crop dusters, air-ambulances, federal ops, traffic 'copters, aviation business, air-line enroute, airport security/fire, etc. throughout USA. All Canadian mil, civilian airports and seaplane bases listed, plus lots more, including how-to text on aero monitoring. Most comprehensive aero frequency guide ever compiled. Only \$14.95 + \$2 postage to USA/Canada/APO/FPO. NY State residents add \$1.13 sales tax. From: CRB Research Books, Inc., P.O. Box 56, Commack, NY 11725, or ask your favorite communications dealer.

**HEAR YOUR GOV'T. IN ACTION!** The **gigantic new 6th Edition of Kneitel's TOP SECRET REGISTRY OF U.S. Gov't. Radio Freqs., the ultimate scanner directory. Revised/Expanded to cover 80+** agencies, 192 large-size pages, 125,000 listings: freqs., many locations, call signs, tactical ID's, codenames, agent buzzwords, freq. usage/designator codes, code signals. Latest info: FBI, DEA, Secret Service, FCC, ATF, Immigration, Customs, Border patrol, CIA, NSA, Nat'l Forests, Nat'l Parks, GSA, FEMA, Treasury, Marshals, NASA, FAA, EPA, all Armed Forces, bug/surveillance freqs., much more, plus UHF Aero and many Canadian freqs. Extra: Most important 2-25 MHz HF freqs. included. Contains more and digs deeper than ever before! New 6th Ed. is \$17.95, add \$1 postage for 4th Class mail to N. American addresses, or \$3 for First Class mail. You Ain't Heard Nothin' Yet! Get your copy now. CRB Research, P.O. Box 56, Commack, NY 11725. NY Residents add sales tax. (Dealer inquiries invited—write on company letterhead.)

WANTED: FANON—COURIER Handheld Slimscan-6. Advise price, name, address, phone, to: Ronald Amon, 1436 Buckner St., Fredericksburg, VA 22401-5409.

FREE LIST—low cost ham radio equipment, very cheap, send S. A. S. E., Jim Brady—WA4DSO, 3037 Audrey Drive, Gastonia, NC 28054.

Kenwood R-2000 receiver, with DC cord, \$500. Send money order to David VanDensen, 888 E. Shady Lane, #241 Neenah, WI 54956 or call 414-734-2437.

WANTED—PRO2004's in non-working condition. Wanted for parts will pay reasonable price. Must have all internal parts. Send description and price wanted to Lester Jernigan, P.O. Box 5212, Jacksonville, AR 72026.

MILITARY ELECTRONICS: CPRC-26 Infantry Manpack Radio, compact, 50-54 MHz FM, Receiver-Transmitter sections, case, antenna, crystal, handset: \$22.50 a piece complete, \$39.50/pair. Patrol Seismic Intrusion Device ("PSID") TRC-3; \$42.50 a piece, \$147.50/set of four. R-108 Vehicular/Field Receiver, 20-28 MHz; \$27.50 mint. 45 Day Replacement Guarantee. Add \$4.50/piece shipping, \$9 maximum. Baytronics, Box 591, Sandusky, OH 44870.

BUGGED? COUNTERMEASURE SWEEPS. Telephones, Offices, Watercraft, Aircraft. Confidentiality Assured. Write or call for a free eavesdrop brochure and estimate. Central States Investigations, 1007 West Jefferson Street, Suite 160, Sprfld, IL 62702-4835. AC/217525-9499.



### PICKS UP A WHISPER 50 FEET AWAY!

The model WAT-50 miniature FM transmitter uses a 4-stage circuit NOT to be confused with a simple wireless microphone. Simply snap the unit on top of a 9V battery and you can hear every sound in an entire house up to 1 mile away! Use with any FM radio. Tunes to any frequency from 70mhz - 130mhz. Easy to assemble kit includes all parts and instructions. Only 29.98 tax Incl.



The **WIRELESS TELEPHONE TRANSMITTER** model WTT-20 is only about the size of a dime, yet transmits both sides of a telephone conversation to any FM radio with crystal clarity. Completely automatic. Uses power from the telephone line itself - never needs a battery! Up to 1/4 mile range. Tunes from 70mhz - 130mhz. Easy to assemble kit includes all parts and instructions. Only \$29.98 tax incl.

Call or send MO, VISA, MC for immediate delivery. Single kit orders include \$1.50 S&H. **FREE SHIPPING on orders of 2 or more. All orders shipped by U.S. Mail. COD add \$4.00. Personal checks allow 21 days.**

**DECO INDUSTRIES**  
BOX 607, BEDFORD HILLS, NY 10507  
914-232-3878

CIRCLE 127 ON READER SERVICE CARD



**YAESU SCANNING SOFTWARE**—Integrated computer control for **FRG9600, FT757GX** including terminal program for TNC's. Menu driven, on-screen help, supports 500 memory disk files, frequency searches, sorts and save to disk, etc. Demo disk \$7.00 refundable with purchase. \$49.95 ppd. Requires MS-DOS, serial port and interface. Upgrades one year. J & J Enterprises, 4001 Parkway, Bossier City, LA 71112.

**UNDERGROUND/COVERT RADIO!** THE UNDERGROUND FREQUENCY GUIDE by Harry Helms contains over 400 active frequencies for numbers stations, smugglers, and other shortwave mysteries. Latest details on station locations and purposes! Only \$6.95 plus \$1.00 shipping from SWL/DX Press, 10606-8 Camino Ruiz #174, San Diego, CA 92126.

**BC-200XLT W/CELL \$269, BC-760XLT W/CELL \$269, NEW RCI-2900 10 Meter Mobile!! CALL!! Radio Shack & Bearcat MODS!! CALL!! NEW Wilson WM-1000 ANTENNA!! CALL!! CB Radios, Ham Gear, CELLULAR Converters, MUCH MORE!! CATALOG 11.00. 6 Page Used Inventory 5.25 WE TAKE TRADES!! SAME DAY COD SHIPPING!! GALAXY, BOX-1202, AKRON, OHIO-44309 (216) 376-2402 EST.**

WANTED: Anyone with info or knowledge of HF facsimile, CCTIS specs., etc., Call Joe, days (516) 931-4000, eves. (516) 579-4397.

**FREQUENCY AGILE PHASE LOCKED FM SIGNAL GENERATORS**, 88-108 MHz. Meets broadcast specs. Pre-assembled/ tested 3 x 5 PC board, 12vdc powered. For info send SASE business size: JT Communications, 579 NE 44th Ave., Ocala, FL 32671.

**CODES, CIPHERS, AND SECRET LANGUAGES**—Thomas Jefferson's cipher wheel, heliograph signals, Morse code, American Indian signs, Esperanto and much more. With quizzes and brain teasers for each section, this book is filled with fun and intrigue! Order today! Hardcover, 272pp. Send \$21.45ppd to Paladin Press, P.O. Box 1307-91ZA, Boulder, Colorado 80306. (303) 443-7250.

**Radio Shack Dealer—lowest prices nationwide—new PRO-2005 scanner—400 channels reg. \$420, only \$399. PRO-34—reg. \$330, only \$319. DX shortwave—reg. \$199, only \$189. Save big on all R.S. equipment. No tax outside Florida. Call free orders only (800) 848-3004 or (407) 286-3040 for info. Electronics, Inc., 2200 S.E. Federal Hwy., Stuart, FL 34994.**

**TELEVISION SETS** made before 1946 wanted for substantial cash. Especially interested in "mirror-in-the-lid" and spinning disc sets. Finder's fee paid for leads. Arnold Chase, 9Rushleigh Road, West Hartford, CT 06117 (203) 521-5280.

**JUST ISSUED! HEAR YOUR GOVT. IN ACTION!** The gigantic new 6th Edition of Kneitel's TOP SECRET REGISTRY OF U.S. Gov't. Radio Freqs., the ultimate scanner directory. Revised/Expanded to cover 80+ agencies, 192 large-size pages, 125,000 listings: freqs., many locations, call signs, tactical ID's, codenames, agent buzzwords, freq usage/designator codes, code signals. Latest info: FBI, DEA, Secret Service, FCC, ATF, Immigration, Customs, Border patrol, CIA, NSA, Nat'l Forests, Nat'l Parks, GSA, FEMA, Treasury, Marshals, NASA, FAA, EPA, all Armed Forces, bug/surveillance freqs., much more, plus UHF Aero and many Canadian freqs. Extra: Most important 2.25 MHz HF freqs included. Contains more and digs deeper than ever before! New 6th Ed. is \$17.95, add \$1 postage for 4th Class mail to N. American addresses, or \$3 for First Class mail. You Ain't Heard Nothin' Yet! Get your copy now. CRB Research, P.O. Box 56, Commack, NY 11725. NY Residents add sales tax. (Dealer inquiries invited—write on company letterhead.)

**PROPAGANDA TAPES!** Authentic, rare recordings of WWII German and Japanese shortwave broadcasts by "Tokyo Rose," "Axis Sally," others. Cassette \$9.95. D-W Research, 4548 Auburn Blvd., #231-B, Sacramento, CA 95841.

**INTRODUCING INTERNATIONAL RADIO**—by Kenneth MacHarg. Non-technical beginner's guide to shortwave. From bookstores, or for \$3.95 plus \$1 shipping from: Radio, Box 1345, Jeffersonville, IN 47131.

**CABLE TV CONVERTERS.** Scientific Atlanta, Jerrold, Oak, Zenith, Hamlin. Many others. "New" MTS Stereo Add-On. Visa, M/C & Amex **1-800-826-7623. B&B Inc., P.O. Box 21-327, St. Paul, MN 55121.**

**TOMCAT'S BIG CB HANDBOOK**, by Tom Kneitel. Just published, 221 large pages, fully illustrated. Complete guide to worldwide AM, SSB, Freeband, 27 MHz operations. Everything they never told you (legal & otherwise) from world's leading CB authority. Only \$13.95 (plus 2¢ postage to North America) from CRB Research Books, Inc., P.O. Box 56, Commack, NY 11725. (NY's residents add sales tax). Dealer inquiries invited.

**PRO2004 OWNERS-400 CHANNELS/30 CPS SCAN RATE KIT-\$35.00 INSTALLED-\$55.00. LESTER JERNIGAN, P.O. Box 5212, Jacksonville, AR 72076.**

**SCANNER FREQUENCY SEARCH SERVICE.** Hear all there is to hear! SASE to: Heald, 6886P Jefferson Street, North Branch, MI 48461.

# RadioSporting

Magazine for competitive and active hams

A monthly magazine dedicated to quality and sportsmanship in amateur radio operating. Fresh, timely, practical and down to earth reading for little pistols and big guns. Edited by VE3BMV and writer by the world's best in their fields: ON4UN, SM0AGD, LZ2CJ, VE3BMV, KH6BZF, DJ9ZB, ZS6BRZ, W1WY, N2SS, K7GCC, K4ZN, W4GF, VE3JTO, WB4ZNH, WB9TBU, KQ2M, NS6X, W2XC, W3FG, KA3B, K1PLR, N3IK, N7CKD, KG6DX, AB0X, JE1CKA and others.

Includes DX News, QSL Info, 160m, 80m, 10m, 6m columns, DXpeditioning, Propagation, Awards, Contest Rules and Results, Traffic - Emergency, FCC News, New Products, Antennas, Technical News and articles, Equipment Reviews and Modifications, Computer Programs, Radio Funnies, Club Life, SWL, RTTY, VHF/UHF, Mail Box, Classified Ads and much more in a magazine format with the speed of a bulletin.

**RADIOSPORTING sponsors DX Centurion Award, Contest Hall of Fame and World Radio Championship contest.**

Subscription rates: 1 year USA \$18, Canada CDN\$28, Overseas US\$25; Personal checks, VISA, MASTERCARD accepted.

**TRY US!**  
Subscribe or send \$1 for your sample copy.

**RADIOSPORTING Magazine**  
PO Box 282, Pine Brook, NJ 07058, USA

## Log More RTTY with the Essential

**RTTY Frequency List**  
Over 1,000 active frequencies.  
\$10.95 plus \$1.25 (\$2 foreign)  
US Funds

\$2 shipping/handling

Catalog \$1

**Tiare Publications**  
P.O. Box 493  
Lake Geneva WI 53147

## THE ULTIMATE IN PC FAX



## PC HF FACSIMILE 4.0 \$99

A complete facsimile reception system for the IBM PC or Compatible. Receives up to 16 intensity levels.

Includes:  
Demodulator Software  
Frequency List  
80 Page Manual  
Tutorial Cassette  
Interpretation Guide

Features:  
Print on Epson, or HP Laser Jet  
Disk Save, Zooming, Image processing  
Unattended Image Capture and much more

## PC GOES/WEFAX \$250

Designed to receive images directly from U.S. and Soviet meteorological satellites. Includes all of the above feature plus a complete orbital tracking system and resolution of up to 256 gray levels.

**Software Systems Consulting**  
1303 S. Ola Vista, San Clemente, CA. 92672  
**(714)-498-5784**

## Advertiser's Index

AMC Sales, Inc.	61
ARRL	49
Ace Communications, IN.	15, 49, 77
Alpha Delta Communications	75
Antenna Supermarket	35
Antennas West	51, 76, 77
Antique Radio Classified	46
Associated Radio	64
Barry Electronics	51
Bob's Publications	67
CBC International	76
CQ Equipment Buyer's Guide	27
CRB Research	63
Communications Electronics	43
DECO	78
Datacom, Int.	58
Datametrics	12
Electron Processing	21
Elec. Equip. Bank	5, 12
Franklin-Belle Publishers	51
GRE America, Inc.	38, 57
Gilfer Shortwave	77
Grove Enterprises	73
JoGunn Ent.	51
Kenwood U.S.A. Corp.	Cov. IV
MFJ Enterprises, Inc.	37
Medicine Man	76
Microcraft Corporation	67
Official Scanner Guide	76
OPTOelectronics	1
Pacific Cable Co.	76
POP'COMM Book Shop	61
RF Limited	58
Radio Shack	7
Radio Sporting Magazine	79
React, International	59
Republic Cable Pdts., Inc.	46
Scanner World, USA	80
Signal Engineering	63
Software Systems Consulting	79
Somerset Electronics	13
Tiare Publications	79
Universal SW Radio	3, 42
Yaesu Electronics	Cov. III

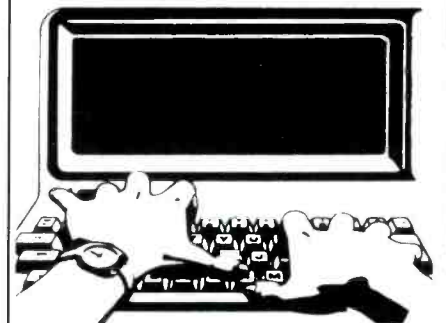

Reach this dynamic audience with your advertising message, contact Don Allen, N9ALK at (217) 344-8653.

"The Largest Dealer of Scanners in the World"



# SCANNER WORLD, USA®

10 New Scotland Ave., Albany, NY 12208 518/436-9606



**Regency**  
**MX-3000**

**Special \$149.99**  
(\$7.00 shipping)

### 30 CHANNELS—MOBILE/BASE —SCANNER WORLD EXCLUSIVE—

Features include simple programming of the following frequency ranges: 30-50 MHz, 144-174 MHz, 440-512 MHz. Digital display, priority, search, lockout, delay, dim control, top mounted speaker, one year factory warranty. Includes AC & DC cords, mobile mounting bracket, telescopic antenna. All for only ~~\$174.99~~ plus \$7.00 shipping (optional extended warranty: 3 years \$39.99; 2 years \$29.99.) MX3000 Service Manual \$5.00.

### Cobra SR-15

**\$199.99** (\$7.00 shipping)



100 channel pocket sized hand-held scanner (6"Hx1"Dx2 3/4"W) no crystal portable scanner. 29.54 MHz - 118.174 MHz, 406-512 MHz, bank scanning, backlight LCD display, automatic search, lockout, scan delay, priority key lock plus much more. Includes rubber antenna, rechargeable Ni-Cad battery pack, AC adapter, charger, earphone, and carry case. optional cigarette lighter adapter #15MPC \$12.99.

BEARCAT 100-XLT Hand-held 100 Channel	\$199.99 (7.00)
BEARCAT 70XLT Programmable Hand-Held	169.99 (6.00)
BEARCAT 55XLT Programmable Hand-Held	119.99 (5.00)
AD100U AC Adapter/Charger for 50 XL/55XLT	12.95 ( * )
BP55 Ni-Cad Battery Pack for 50XL	13.99 ( * )
VC001 Carry Case for 50XL/55XLT	11.99 (7.00)
PS001 Cigarette Lighter Adapter for 50XL/100XL/100XLT	12.95 ( * )
BEARCAT 140 AC Programmable Scanner	94.99 (5.00)
BEARCAT 145XL AC Programmable Scanner	98.99 (5.00)
BEARCAT 175XL AC Digital Scanner	159.99 (5.00)
REGENCY TS-1 Turbo Scan AC/DC	169.99 (7.00)
REGENCY TS-2 Turbo Scan AC/DC	274.99 (8.00)
BEARCAT 210 XLT AC/DC Digital Scanner	189.99 (7.00)
BEARCAT 800 XLT AC/DC Digital Scanner	264.99 (7.00)
REGENCY MA-257 Cigarette cord for HX1000/1200	16.99 (7.00)
REGENCY MA-917 Ni-Cad Battery for HX1000/1200	24.99 ( * )
REGENCY HX-CASE Hvy Leather case for HX1000/1200	19.99 ( * )
REGENCY MA-549 Drop In Charger for HX1000/1200	29.99 (5.00)
REGENCY MX-3000 AC/DC Digital Scanner	149.99 (7.00)
REGENCY Z-80 AC/DC Digital Scanner	109.99 (7.00)
Mobile Mounting Bracket for Z Scanners	5.99 ( * )
REGENCY RH-256 High Band Transceiver w/Ant.	329.99 (9.00)
REGENCY UC-102 Hi-VHF Hand Transceiver	124.99 (5.50)
REGENCY RH-606B High Band Transceiver w/Ant.	469.99 (9.00)
REGENCY R806 AC/DC Crystal Scanner	79.99 (6.00)
REGENCY INF-3 AC Informant Receiver	139.99 (7.00)
REGENCY INF-4 AC Informant Receiver	119.99 (7.00)
COBRA SRJ5 100 Channel Hand-Held	199.99 (7.00)
COBRA SR12 Digital Hand-Held Scanner	189.99 (6.50)
COBRA SR10 Digital Hand-Held Scanner	124.99 (6.00)
COBRA SR900 AC/DC Digital Scanner	104.99 (5.00)
COBRA SR925 AC/DC Digital Scanner	99.99 (7.00)
Book "Top Secret Registry of Gov't Frequency" 6th	14.99 (3.00)
Book "Covert Intelligence, Electronic Eavesdropping"	8.95 ( * )
Book "Betty Bearcat Frequency Directory"	7.99 ( * )
Book "Rail Scan Directory"	7.95 ( * )
Book "Air Scan Directory"	12.95 ( * )
RCD MRP-1 Single Channel Hand-Held	38.99 (3.00)
FANON M8HLU DC Crystal Scanner	89.99 (5.00)
FANON PSK-1 AC Adapted for M8HLU	12.99 ( * )
REGENCY HX-1500 Hand-held Scanner	199.99 (8.00)
FOX Mounting Bracket for BMP-1060	9.99 ( * )
ANT-1 Magnet Mount Mobile Scanner Antenna	29.99 (3.00)
ANT-6 Base Scanner Antenna w/50' cable	29.99 (4.00)
REGENCY CB-ONE CB Radio	34.99 (5.00)



## Z60 60 Channel Automatic Programmable Scanner

Includes Public Service and Aircraft Bands

### Scanner World Special

**\$119.99**

(plus \$7.00 shipping each)

Optional Accessories:  
Cigarette Lighter Plug RGMPC \$4.95  
Z Mobile Bracket — Special \$5.99

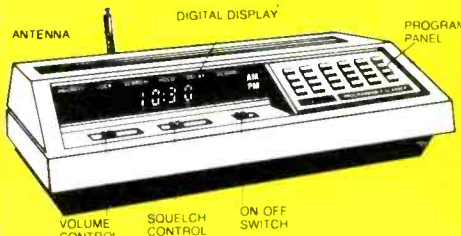

The Regency Z-60 is a compact, programmable 60 channel, multi band, FM monitor receiver for use at home or on the road. It is double conversion, super heterodyne used to receive the narrow band FM communications in the amateur, public safety and business bands. 30-50, 118-136, 144-174, and 440-512 MHz. Size 10 3/4" Wx2 7/8" Hx8 3/8" D.

Sophisticated microprocess-controlled circuitry eliminates the need for crystals. Instead, the frequency for each channel is programmed through the numbered keyboard similar to the one used on a telephone. A "beep" acknowledges contact each time a key is touched. The Z60 scans approximately 15 channels per second.

Any combination of channels can be scanned automatically, or the unit can be set on manual for continuous monitoring of any one channel. In addition, the search function locates unknown frequencies within a band.

Other features include scan delay, priority and a bright/dim switch to control the brightness of the 9-digit Vacuum-Fluorescent display. The Z60 can be operated on either 120VAC or 12 VDC. Includes one year warranty from Regency Electronics (optional 3 yr extended warranty only \$39.99, gives you a total of 4 yrs complete warranty or 2 yr extended warranty only \$29.99, gives you a total of 3 yrs complete warranty).



### UNIDEN Bearcat BC-600 XLT

**\$199.99** (\$7.00 shipping)

#### Digital Programmable 100 Channel Scanner

BC-600 XLT covers the following frequencies: 29.54 MHz, 118.174 MHz, 406-512 MHz. Features compact size of 6.5 1/2" Wx1 5/8" Hx7 3/8" D. Scan delay, priority, memory backup, channel lockout, bank scanning, key lock, AC/DC power cords, telescopic antenna, mounting bracket, supplied one year factory warranty, search direct channel access, track tuning service, search including programmed frequencies by pushing a single button for police, fire, emergency, aircraft, weather, and marine services. Plus exclusive optional features never available on any scanner before. First is an RF receive amplifier for boosting weak signals for only \$24.99 plus a CTCSS tone board is available for only \$59.99 to make this the number one scanner available in the USA. Optional cigarette lighter plug #600MPC \$4.99.

### BEARCAT BC-950XLT

Same features as BC-600XLT but also receives 800-954mhz.

**\$249.99** (\$7.00 shipping)

### BEARCAT 70XLT

#### 20 CHANNEL HAND-HELD SCANNER

Small size 6"Hx1"Dx2 3/4"W. Full digital readout, priority, search, channel lockout, scan delay, key lock. Covers following frequencies: 29.54mhz, 136.174mhz, 406.512mhz. Package includes rubber antenna, rechargeable Ni-Cad battery pack, AC adapter/charger, and carry case.

**SPECIAL PACKAGE DEAL \$169.99** (\$6.00 shipping each)

### SCANNER WORLD EXCLUSIVE

#### UNIDEN BEARCAT BC205XLT

**\$259.99** (7.00 shipping each)

Digital programmable 200 Channel hand-held portable scanner with raised button keyboard for easy programming of the following frequency ranges: 29.54MHz, 118.174MHz, 406-512MHz, 800-956MHz. Features include: Scan delay, memory backup, key pad lock, sidelit liquid crystal display, channel lockout, 10 twenty channel banks, direct channel access, automatic search, full one year factory warranty, 10 priority channels, Ni-Cad battery pack, AC adapter/charger, flexible rubber antenna carry case are all included. Size is 2-11/16"Wx1-3/8"Dx7-1/2"H. Optional extended 2 yr warranty \$59.99, 3 yr extended warranty \$79.99.



### SCANNER WORLD SPECIAL

**COBRA  
SR-925  
\$99.99**



(plus \$7.00 shipping each)

Digital programmable, 16 channel, AC/DC mobile/base, with raised button keyboard for easy programming of the following frequency ranges: 29.54mhz, 118.174mhz, 406.512mhz. Covering aircraft, marine, police, fire, weather, trains, public service, plus much more. Features include: digital display, priority scan delay, weather button, channel lockout, search, scan speed, automatic squelch, memory backup, one year factory warranty, external speaker jack (Extended warranty 2 years extra \$29.99, 3 years extra \$39.99).

#### Regency HX-1500 Hand-Held Scanner Package

Deal includes MA-549 Drop In Charger \$199.99 (plus 8.00 shipping)

### ORDERING INFORMATION

Call (518)436-9606 to place orders by phone or mail orders to **Scanner World, USA** 10 New Scotland Ave., Albany, NY 12208. Orders will be shipped same day received by United Parcel Service. **Scanner World** accepts Visa, MasterCard (COD shipments by United Parcel will be cash or certified checks only). Mail orders with personal or business checks will be held 4 weeks for bank clearance. Orders with cashiers checks or money orders shipped same day received. Prices, specifications and terms subject to change without prior notice. If items are out of stock we will backorder and notify you of delivery date. All shipments are F.O.B. **Scanner World** warehouse in Albany, NY. We are not responsible for typographical errors. All merchandise carries full manufacturer's warranty. Bid Proposals and Purchase orders accepted only from Government agencies. Free full line catalogue available upon request. New York State Residents add 7% sales tax. Any claims must be made within 7 days of merchandise receipt.

### SHIPPING CHARGES

(\*\*) Add (\$) per scanner, and \$3.00\* for all accessories ordered at same time. C.O.D. shipments will be charged an additional \$3.50 per package. Full insurance is included in shipping charges. All orders are shipped by United Parcel Service. Shipping charges are for continental USA only. Outside of continental USA, ask for shipping charge per scanner.

### Scanner World, USA®

10 New Scotland Ave., Albany, NY 12208

(518) 436-9606

FAX #: (518) 465-2945

Most orders Shipped Same Day Received!

Scanner World, USA • Albany, New York 12208 • (518) 436-9606

Scanner World, USA • 10 New Scotland Ave. • Albany, New York 12208 • (518) 436-9606



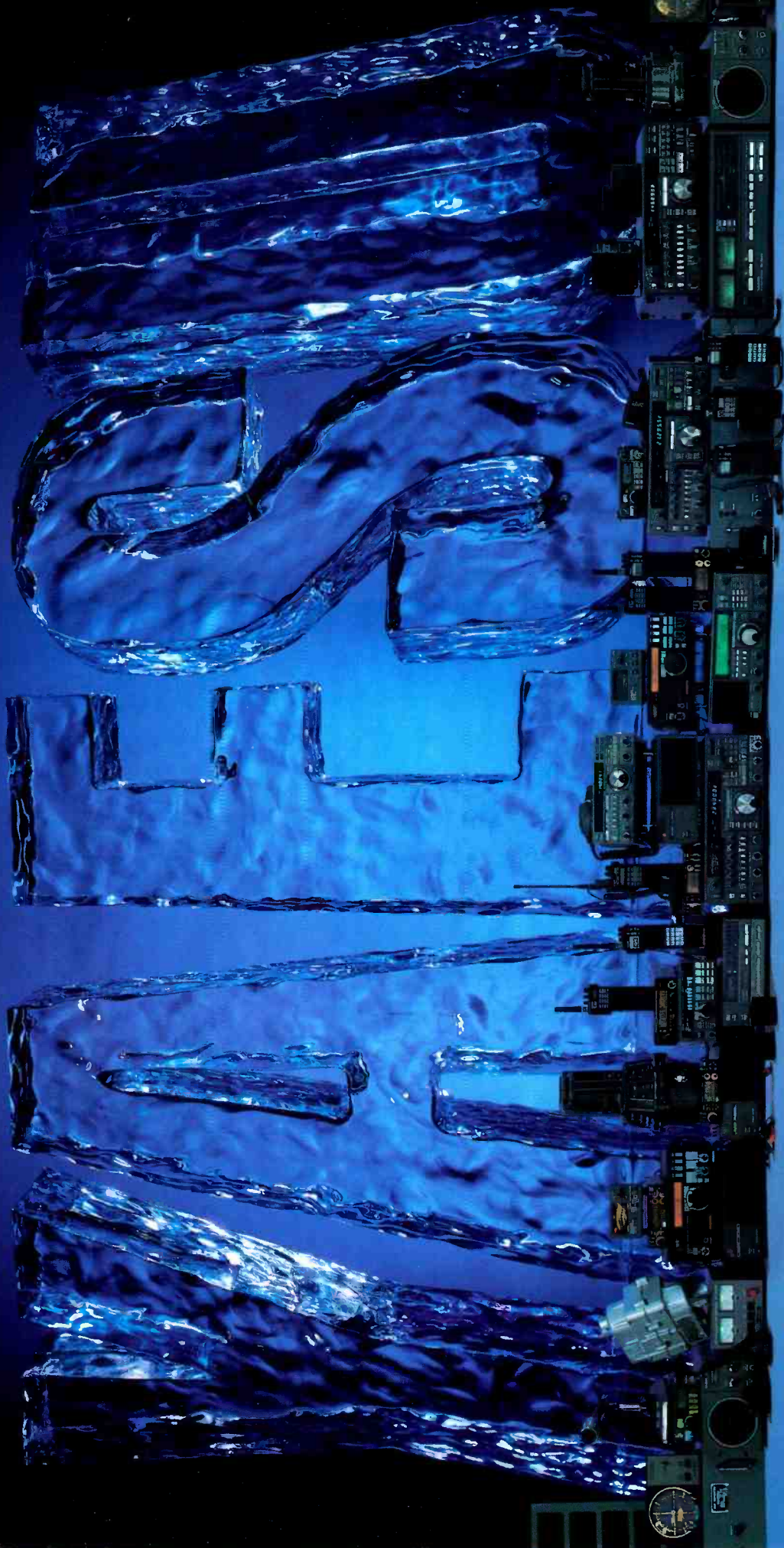

\* For More Information, call 1-800-999-2070





# KENWOOD

...pacesetter in Amateur Radio

**NEW**  
RZ-1 Wide-Band  
Receiver.

## Hear it All!



### R-5000

### R-2000

High performance receivers.

Scan the entire frequency range from 100 kHz to 905 MHz with Kenwood's R-5000, R-2000 and RZ-1. Listen in on foreign music, news, and commentary. Monitor local police, fire, and other public safety services, as well as the Marine channels, and the many other services 50 MHz and above.

(The VHF converter options must be used in the R-5000 and R-2000.)

### R-5000

The R-5000 is a high performance, top-of-the-line receiver, with 100 memory channels, and direct keyboard or main dial tuning—makes station selection



### R-2000

The R-2000 is an all band, all mode receiver with 10 memory channels and many deluxe features such as programmable scanning, dual 24-hour clocks with timer, all-mode squelch and noise blankers, a large, front-mounted speaker, 110 volt AC or 12 volt DC operation (with the DCK-1 cable kit), and 1.8-174 MHz VHF capability with VC-10 option.

#### Optional Accessories

##### R-2000:

• VC-10 VHF converter • DCK-1 DC cable kit for 12 volt DC use.

##### R-5000:

• VC-20 VHF converter • VS-1 Voice module • DCK-2 for 12 volt DC operation • YK-88A-1 AM filter • YK-88SN SSB filter • YK-88C CW filter • MB-430 Mounting bracket.

##### Other Accessories:

• SP-430 External speaker • SP-41 Compact mobile speaker • SP-50B Mobile speaker • HS-5 Deluxe headphones • HS-6 Lightweight headphones • HS-7 Mini-headphones.

super easy! Other useful features include programmable scanning, large, built-in speaker, 110 volt AC or 12 volt DC operation (with optional DCK-2 cable), VHF capability (108-174 MHz) with the VC-20 option, dual 24-hour clocks with timer, and even voice frequency readout with the VS-1 option.

easier. One hundred memory channels with message and band marker, direct keyboard or VFO frequency entry, and versatile scanning functions, such as memory channel and band scan, with four types of scan stop. The RZ-1 is a 12 volt DC operated, compact unit, with built-in speaker, front-mounted phones jack, switchable AGC, squelch for narrow FM, illuminated keys, and a "beeper" to confirm keyboard operation.

##### Optional Accessory

• PG-2N Extra DC cable

### RZ-1

### Wide-band scanning receiver



The RZ-1 wide-band, scanning receiver covers 500 kHz-905 MHz, in AM, and narrow or wideband FM. The automatic mode selection function makes listening

# KENWOOD

KENWOOD U.S.A. CORPORATION  
2201 E. Dominguez St., Long Beach, CA 90810  
P.O. Box 22745, Long Beach, CA 90801-5745