

CASINO FUN ONLINE—POKER, SLOTS, AND MORE

AUGUST 1998

Popular Electronics®

PLUS!
LED Readout
Circuits

Surface-Mount Audio Modules

Minimize design time by picking and mixing surface-mount audio modules

Monitor Search and Rescue Missions

Be part of the excitement as the drama unfolds—here are the frequencies where the action is hot and heavy

Notch It

Eliminate distortion, or dislodge unwanted in-band signals by using notch filter design

Plus:

- Gizmo—Digital Camcorder, Smart Games—& News!
- Zeners, Telephones, and Circuits
- The Music of Shortwave
- Microcontrollers V



A GERNSBACK PUBLICATION

\$4.99 U.S.
\$5.50 CAN.



Better Designs - Faster

With the Personal Design Solution

The Design Solution Includes: Electronics Workbench Personal Edition + EWB Layout

Electronics
Workbench[®]
Personal Edition

Full-featured schematic capture and SPICE 3F circuit simulation!

The world's best selling circuit design software. With analog, digital and mixed A/D SPICE simulation, a full suite of analyses and over 4000 devices. Imports netlists. Seamlessly integrated with EWB Layout or exports to other popular PCB programs. Still the standard for power and ease of use. Still the same effective price.

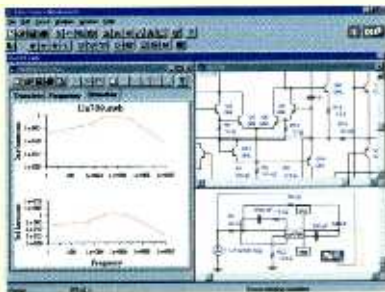

\$299
Version 5

HIGH-END FEATURES

TRUE MIXED ANALOG/DIGITAL	YES
FULLY INTERACTIVE SIMULATION	YES
PRO SCHEMATIC EDITOR	YES
HIERARCHICAL CIRCUITS	YES
VIRTUAL INSTRUMENTS	YES
ON-SCREEN GRAPHS	YES
ANALOG AND DIGITAL MODELS	OVER 4,000
FREE TECHNICAL SUPPORT	YES
DC OPERATING POINT	YES
AC FREQUENCY	YES
TRANSIENT	YES
FOURIER	YES
NOISE	YES
DISTORTION	YES

**30-DAY MONEY-BACK
GUARANTEE**

Electronics
Workbench **Layout**
Personal Edition

Power-packed PCB layout with autorouting and real-time DRC!

EWB Layout is a powerful board layout package for producing high-quality, multi-layer printed circuit boards. Offering tight integration with our schematic capture program, you can incorporate board layout and design and quickly bring well-designed boards to production.

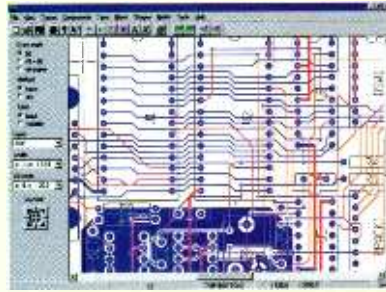

\$299
Version 5

POWER-PACKED FEATURES

AUTOROUTING	YES
REROUTE WHILE MOVE	YES
LAYERS	32 ROUTING LAYERS
BOARD SIZE	50" X 50"
LIBRARY SHAPES	OVER 3,500
BLIND AND BURIED VIAS	YES
EXTENSIVE OUTPUT	YES
SELECTIVE NET HIGHLIGHTING	YES
USER DEFINED PADS	YES
REAL TIME DESIGN RULE CHECK	YES
DENSITY HISTOGRAMS	YES
FREE TECHNICAL SUPPORT	YES

*Join over 85,000 customers
and find out why more circuit designers
buy Electronics Workbench than
any other circuit design tool.*

**CALL FOR INFORMATION
AND PRICING ON OUR
PROFESSIONAL EDITION.**

ELECTRONICS WORKBENCH Personal Edition	\$299.00	BUY BOTH AND SAVE	PERSONAL DESIGN SOLUTION	\$598.00
EWB LAYOUT Personal Edition	\$299.00			\$548.00

CALL 800-263-5552

For a free demo, visit our website
at <http://www.interactiv.com>

INTERACTIVE IMAGE TECHNOLOGIES LTD., 908 Niagara Falls Boulevard,
#068, North Tonawanda, New York 14120-2060 / Telephone 416-977-5550.

TRADEMARKS ARE PROPERTY OF THEIR RESPECTIVE HOLDERS. OFFER IS IN U.S. DOLLARS AND VALID ONLY
IN THE UNITED STATES AND CANADA. ALL ORDERS SUBJECT TO \$15 SHIPPING AND HANDLING CHARGE.

Fax: 416-977-1818 E-mail: ewb@interactiv.com
CompuServe: 71333,3435 / BBS: 416-977-3540



CIRCLE 26 ON FREE INFORMATION CARD

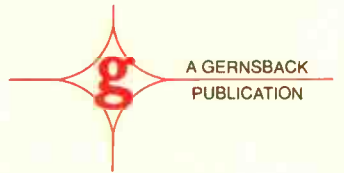

COVER STORY

28 Surface-Mount Audio Modules

Minimize design time by picking and mixing surface-mount audio modules. Come up with unique projects of your own using these modules and win a cash prize in our design contest—*Franklin J. Miller*

FEATURES

37 Monitor Search and Rescue Missions

Be a part of all the excitement through your communications receiver or scanner as the drama unfolds on land, at sea, or in the air. Here are the frequencies where the action is hot and heavy!—*Marc Saxon*

40 Notch It

Eliminate distortion, or dislodge unwanted in-band signals from frequencies you are trying to copy, by using a narrow bandwidth version of the bandstop filter—*Julian Kerr*

PRODUCT REVIEW

16 Gizmo

Sony Digital Camcorder, Smart Games Puzzle Challenge 2,
—plus Gizmo News and Wish List



Page 28

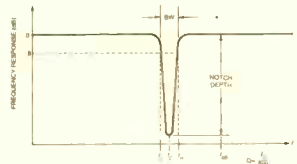

Page 40



Page 16

POPULAR ELECTRONICS (ISSN 1042-170-X) Published monthly by Gernsback Publications, Inc. 500 Bi-County Boulevard, Farmingdale, NY 11735. Periodicals postage paid at Farmingdale, NY and at additional mailing offices. One-year, twelve issues, subscription rate U.S. and possessions \$21.95, Canada \$28.84 (includes G.S.T., Canadian Goods and Services Tax Registration No. R125166280), all other countries \$29.45. Subscription orders payable in U.S. funds only. International Postal Money Order or check drawn on a U.S. bank. U.S. single copy price \$4.99. Copyright 1998 by Gernsback Publications, Inc. All rights reserved. Hands-on Electronics and Gizmo trademarks are registered in U.S. and Canada by Gernsback Publications, Inc. Popular Electronics trademark is registered in U.S. and Canada by Electronics Technology Today, Inc. and is licensed to Gernsback Publications, Inc. Printed in U.S.A.

Postmaster: Please send address changes to Popular Electronics, Subscription Dept., P.O. Box 338, Mount Morris, IL 61054-9932

A stamped self-addressed envelope must accompany all submitted manuscripts and/or artwork or photographs if their return is desired should they be rejected. We disclaim any responsibility for the loss or damage of manuscripts and/or artwork or photographs while in our possession or otherwise.

As a service to readers, Popular Electronics publishes available plans or information relating to newsworthy products, techniques, and scientific and technological developments. Because of possible variances in the quality and condition of materials and workmanship used by readers, Popular Electronics disclaims any responsibility for the safe and proper functioning of reader-built projects based upon or from plans or information published in this magazine.

C O L U M N S

- 8 Multimedia Watch**
Olympus Products, plus New Hardware and Software—*Marc Spiwak*
- 14 Net Watch**
Casino Fun Online—*Konstantinos Karagiannis*
- 47 Scanner Scene**
Time To Pack Your Trunk Again!—*Marc Saxon*
- 49 Think Tank**
Zeners, Telephones, and Circuits—*Alex Bie*
- 53 Ham Radio**
All MUXed Up!—*Joseph J. Carr*
- 56 Circuit Circus**
LED Readout Circuits—*Charles D. Rakes*
- 60 Computer Bits**
Microcontrollers V—*Jeff Holtzman*
- 62 Antique Radio**
The Remarkable *Chanalyst*—Conclusion—*Marc Ellis*
- 65 DX Listening**
The Music Of Shortwave—*Don Jensen*

D E P A R T M E N T S

- 4 Editorial**
- 6 Letters**
- 45 New Products**
- 46 Electronics Library**
- 68 Popular Electronics Market Center**
- 94 Advertising Index**
- 94A Free Information Card**

Larry Steckler, EHF, CET,
editor-in-chief and publisher

EDITORIAL DEPARTMENT

Edward Whitman, managing editor
Julian Martin, editorial advisor
Robert Young, technical editor
Evelyn Rose, assistant editor
Teri Scaduto, assistant editor
Debbie Cybula, editorial assistant
Alex Bie, contributing editor
Joseph J. Carr, K4IPV,
 contributing editor
Marc Ellis, contributing editor
Jeffrey K. Holtzman,
 contributing editor
Don Jensen, contributing editor
Konstantinos Karagiannis,
 contributing editor
Charles D. Rakes, contributing editor
Marc Saxon, contributing editor
Marc Spiwak, contributing editor

PRODUCTION DEPARTMENT

Ruby M. Yee, production director
Ken Coren, desktop production director
Melissa Giordano, desktop production
Kathy Campbell, production assistant

ART DEPARTMENT

Andre Duzant, art director
Russell C. Truelson, illustrator

CIRCULATION DEPARTMENT

Theresa Lombardo,
 circulation manager
Gina L. Gallo, circulation assistant

REPRINT DEPARTMENT

Christina M. Estrada, Reprint Bookstore

BUSINESS AND EDITORIAL OFFICES

Gernback Publications, Inc.
 500 Bi-County Blvd.
 Farmingdale, NY 11735
 516-293-3000
 FAX: 516-293-3115

President: **Larry Steckler**
 Vice-President: **Adria Coren**
 Vice-President: **Ken Coren**

**SUBSCRIPTION
 CUSTOMER SERVICE/
 ORDER ENTRY**

800-827-0383
 7:30 AM - 8:30 PM EST

**Advertising Sales Offices
 listed on page 94**

Composition by Mates Graphics
 Cover by Laewy Design



Since some of the equipment and circuitry described in POPULAR ELECTRONICS may relate to or be covered by U.S. patents, POPULAR ELECTRONICS disclaims any liability for the infringement of such patents by the making, using, or selling of such equipment or circuitry, and suggests that anyone interested in such projects consult a patent attorney.

We're *the* shop for home shops.

39.99
3-amp regulated power supply powers DC devices from home AC. #22-163

49.99
Auto-ranging digital multimeter. Simple push-button and slide-switch controls. #22-153

1.99
Durable project box with aluminum and plastic lid. #270-1801

19.99
Soldering work station has dual-powered iron—just flip a switch to go from 20W to 40W. #64-2184

5.99
6-piece, precision anti-static screwdriver set. Durable alloy steel shafts. #64-1963

29.99
Pocket-size torch kit. Produces 5000°F in an adjustable pinpoint flame. #64-2165

2.29
Multicolor heat-shrink tubing. Red, white, blue and clear. Pkg. of 7. #278-1610

9.99
Ball-bearing type 12VDC blower fan. 2,600RPM, 180mA. #275-260

Solutions for all your projects and repairs.

There's a RadioShack in your neighborhood with the tools, parts and accessories to complete virtually any small electronics project or repair. You'll find the hottest gear for everything from making simple repairs and testing circuits to building speaker systems and designing your own electronic devices. Even hard-to-find parts and accessories that might not be on our shelves are available for fast delivery direct to your door—just ask a store associate about RadioShack Unlimited. For our store nearest you, call 1-800-THE SHACK (1-800-843-7422).

R **RadioShack**
You've got questions. We've got answers.®

Prices apply at participating RadioShack stores and dealers. Independent RadioShack dealers and franchisees may not be participating in this ad or stock or special-order every item advertised.

CIRCLE 14 ON FREE INFORMATION CARD

www.americanradiohistory.com

Accredited B.S. Degree in Computers or Electronics

by studying at Home

Grantham College of Engineering
offers 3 distance education programs:

- B.S.E.T. emphasis in Electronics
- B.S.E.T. emphasis in Computers
- B.S. in Computer Science

NEW! -Electronics Workbench Professional 5.0
included in our B.S.E.T. curriculums
-Approved by more than 200 Companies,
VA and Dantes, (tuition assistance avail.)

For your free catalog of our programs dial

1-800-955-2527

<http://www.grantham.edu>

GCE

Your first step
to help yourself
better your future!



Grantham College of Engineering
34641 Grantham College Road
Slidell, LA 70460-6815

EDITORIAL

Y2K Problem—Boom or Bust?

It is difficult to pick up a newspaper or magazine nowadays without reading about the concern and apprehension that people all over the world will have when the clock strikes midnight on January 1, 2000. Many are calling it the "Year 2000 (Y2K) Problem" or the "Millennium Time Bomb." I read about many groups holding multi-day seminar sessions on this potential problem for CEOs, management information system directors, and programmers. The Senate is setting up a panel to review the potential effects of this computer glitch on the executive and judicial branches of the government, as well as on state and local governments, and on private business. In fact, I just came across a related Web site (www.greenwich2000.com) out of England, which is visited daily by hundreds of concerned people throughout the world. Research firms figure that private industry will pay between \$300 to \$600 billion dollars to fix this date problem. It will require knowledgeable people to laboriously go through line after line of arcane computer code, check the date-variable's digits, fix these little pieces of code, debug and test the routines, and then benchmark the entire program. In fact, the U.S. Federal Reserve forecast that the Y2K Problem could shave growth in the economy by a tenth of a percent over the next two years.

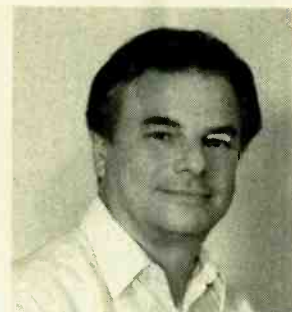

Why the worry you ask? Isn't it easy just to flip over a new calendar page—but this time see a lot of zeros in the year? For many "hard-copy"-oriented people out there—no problem. But for anyone who uses a computer and works with date-derived input data—there will be a great deal of trepidation. You see, back in the 60s and 70s many of the financial programs were developed, like banking, payrolls, inventory-control programs, bookkeeping and database management programs, distribution of government's benefits, etc. With the millennium in the far distant, these programmers—many using now-arcane languages like FORTRAN (FORmula TRANslation) and COBOL (COMMON Business Oriented Language)—wrote efficient programs requiring the user, or the computer clock just to utilize only the last two digits of the calendar year, since the first two year-digits were assumed to be 19. All time-related calculations were done with these last two digits. For example, if you deposited money in a bank in 1970 and withdrew it in 1999, you accumulated 99-70 or 29 years of interest. And if you withdrew it in 2000 you would have 30 years. Wrong! Some of these computer programs would assume that the money was put in at 00, or 1900. Hence the interest would be computed for -70 years!

On the other hand, the Y2K problem has created a boom for programmers—especially those retired-types—who can still recall their early programming days with FORTRAN and COBOL. Last Spring, a high-tech analyst reported that "We're going to see a lot of people coming out of retirement to do this for two or three years, and then going back into retirement."

So for many people, boom times are coming amidst a "bust time" for others.

Ed Whitman
Managing Editor

Some Say Watching Tropical
Fish Lowers Blood Pressure
& Relieves Stress...



They Could Be On To
Something.

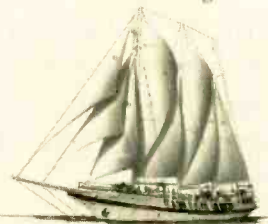

Discover the Caribbean aboard a Tall Ship.
6 & 13 day adventures from \$650.
For more information call your travel agent
or 1-800-327-2601.

Windjammer
Barefoot Cruises

P.O. Box 190120, Dept. 5568, Miami Beach, FL 33119

CIRCLE 172 ON FREE INFORMATION CARD

Little "black box" solves the phone company voice mail system dilemma...

New telephone accessory designed for users of the phone company's electronic voice mail service gives a visible sign—a blinking red light—that there are messages waiting.

Several years ago, I threw away my answering machine in order to subscribe to the phone company's voice mail service. I was tired of losing messages in power failures and missing messages when the tape ran out. Today, the only thing I miss about my answering machine is the blinking light that notified me of messages. But I am willing to sacrifice that convenience for the quality and reliability of the telephone company's service. Today, VoiceMail Light gives me the best of both worlds.

Visible sign. VoiceMail Light is a compact device, 3.5" x 1.4" x .8",

that will flash a red light to notify you of new messages. No more picking up the phone to listen for a broken dial tone or missing messages because you forget to do so! **Plug it in.** Just connect VoiceMail Light between your telephone and wall phone jack.



It's that easy. And VoiceMail Light is small enough to fit on the side of most telephones! **Highly compatible.** VoiceMail Light is compatible with any standard telephone as well as any telephone company voice mail

system that alerts users of new messages with a stutter dial tone (an audibly broken tone that you hear when you pick up the phone).

Try it risk-free. VoiceMail Light is backed by Comtrad's exclusive risk-free trial. Try it, and if you're not satisfied, simply return it within 90 days for a full "No Questions Asked" refund. VoiceMail Light is also backed by a 90-day manufacturer's warranty.

- VoiceMail Light* \$35 \$4 S&H
 - Additional units \$30 \$4 S&H
- VoiceMail Light is powered by two AAA batteries, not included.

Please mention promotional code 3583-13260.

Do you know how many seconds there are to the next millennium?

The Countdown watch marks hours, minutes and seconds until the millennium, or any important date you choose, for years to come.

by Mike Pestorelli

There are less than 750 days left until the year 2000. Imagine the growing excitement that will surround this momentous occasion—after all, it happens only once every 40 generations. Famous resorts, exclusive hotels, cruise lines and banquet halls all over the world are already booked in anticipation of this spectacular event in world history.

To usher in the new millennium with precision and style, Branco International has created the Countdown watch. This forward-looking watch not only tells the regular analog time, but it also displays a digital countdown of the hours, minutes and seconds to the year 2000.

Digital frame counts the hours, minutes and seconds to the moment of 1/1/2000

Countdown to any special moment. That's not all: this remarkable timepiece can count down to any special date you specify—birthdays, anniversaries, weddings, graduations, due dates, you name it. If you happen to know someone who has a hard time



remembering special occasions, why not get them the Countdown watch!

Celebrate in style. This watch not only tracks the time to the millennium, it does so in style. Its attractive, futuristic face shows the three globes of the sun, earth and moon to symbolize time. The attractive timepiece is

Analog part of the watch reads the present time

available in black or white and sports a stylish padded leather band. The watch features three

Quartz ATM and fine Swiss movements, for the ultimate in precision. It comes attractively packaged and makes a great gift.

Risk-free. Don't wait until the next century to order this unique timepiece. It comes with a one-year manufacturer's limited warranty and Comtrad's 90 day risk-free home trial. Try it yourself, and if you're not completely satisfied, return your purchase for a full refund, "No Questions Asked."

- CountDown Watch \$79.95 \$6 S&H
- Please specify white or black face.

Please mention promotional code 3583-13260.

For fastest service, call toll-free 24 hours a day

800-992-2966

comtradindustries
2820 Waterford Lake Drive, Suite 102 Midlothian, VA 23113

LETTERS

CORRECTIONS/ CLARIFICATIONS

The June 1998 **Popular Electronics** issue features an article entitled "Smart Batteries Have Arrived" by Bill Siuru. This article has a sidebar on page 42 entitled "Locating a Current Drain" in a vehicle battery. I feel that this discussion has a very serious flaw in it. The note instructs the reader to disconnect the positive terminal of the battery. One should *never* disconnect the positive terminal while the negative (ground) terminal is still connected. If the reader, while unbolting the positive connector, accidentally bumps or touches his/her wrench to anywhere on the frame of the vehicle, the battery will short-circuit and could easily explode causing severe injury and acid burns.

The sidebar should instruct the reader to disconnect the negative (ground) terminal first; then disconnect the positive terminal. The next step is to connect the ammeter in line between the battery's positive post and the positive cable. Next, reconnect the negative (ground) terminal to the battery's negative post.

Please let your readers know this before a battery explodes in someone's face. Someone could accidentally touch the vehicle frame, with his/her ring, while holding a wrench that was touching the positive terminal clamp.

R. J. F.

via e-mail

I went back and looked at the original notes I got from Fluke Instruments, and they said to disconnect the positive ter-

minimal and then reconnect it with an ammeter in series. However, the writer is correct—connecting it on the negative side (or going through the alternate procedure disconnect the negative side, then the positive side, add the ammeter to the positive side, then reconnect everything) is a bit safer. You should print the better procedure: negative connect to the negative side—just to be on the safe side, although I don't think it is anywhere as dangerous as he warns—smoking around a battery is a much greater hazard, for instance!—Bill Siuru

In the circuit diagram of Fig. 1, for the "Build a Power-Line Monitor" in April's issue, the lower end of resistor R42 should be connected to ground, not to the bus that connects pin 5 of IC1-b. Also, I couldn't get the harmonic distortion filter to notch out (at 120 Hz); i.e., I couldn't get a minimum voltage reading across capacitor C4 by adjusting R5, until I used a capacitance meter to select values for C1, C2, and C3 of *exactly* 0.1, 0.1, and 0.2 μF , respectively. Since 0.2 μF is not a standard size, I connected two 0.1- μF capacitors in parallel for C3.

I've had the monitor in operation for about three weeks and so far there have been no indications of harmonic distortion, outages, sags, or surges. The spike warning light does come on once or twice a day—usually after switching fluorescent lights in an adjacent room, and particularly if they are switched on and then rapidly off again. I was gratified to find that no spikes were getting through my computer's

surge suppressor. In terms of follow-up, I would like to see what circuit changes are needed to make a fourth-order filter in the harmonic distortion detector.

W. E.

Toronto, Ontario

Thanks for the feedback. Note that although the R42 error appears in the schematic of Fig. 1, it is not in the foil pattern of Fig. 3. As far as the performance of your unit, most likely during summertime operation the monitor will give some indication of outages, surges, etc., in your electric power. Perhaps some ambitious designer out there can upgrade the harmonic distortion detector to a fourth-order notch filter (first read the construction article on page 40 of this month's issue!).—Editor

I am interested in building the "Digital Capacitance Meter" construction featured in the March issue. In trying to match parts I have on hand, there appears to be a problem with the meter's display board shown in Fig. 3 on page 37. A 40-pin IC socket, which is called out in the Part's List, won't fit this PCB. Please help!

P. S.

Garland, TX

You are correct—an error was made on the foil pattern of this PCB. Use the full-scale layout shown below (foil-side up) for the display board of the Digital Capacitance Meter—Editor

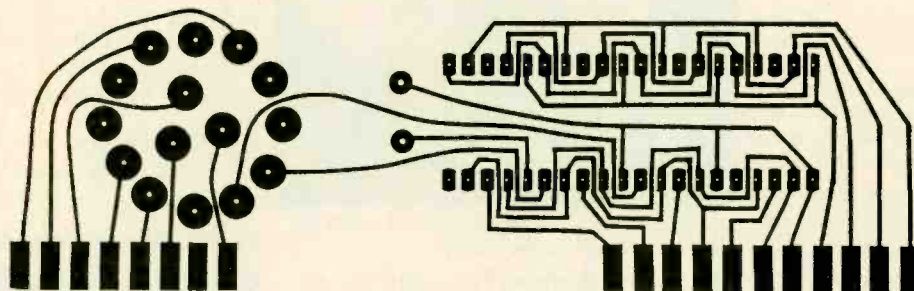

TELEPHONE CIRCUITS, AD INFINITUM!

I just received the May issue, and when I finished with the *Haves & Needs* section, I knew I had to write. This is for Al Conforti, but may be of interest to others. I use my telephones as they are for an intercom system. No additional circuitry is required. I just pick up my phone and dial my own number and hang up. In a couple of seconds, the phones start to ring. Instead of one ring followed by a pause and then another ring which indicates an outside call, I get two quick rings and a pause and then another two quick rings. When someone picks up one of the other phones, the ringing stops and I know to pick up my phone. I do not know if this will work with all systems, but I've been using it for years. And while I'm at it, in the September 1991 issue of **Radio Electronics** there was an article for a telephone in-use monitor entitled "Phone Line Sentinel" on page 60. This may be just what you are looking for.

T. M.
Racine, WI

I'm not sure what telephone system you have, but when I dial my own telephone number, I get a busy signal, and when I hang up—nothing happens!—
Editor

I am impressed with **Popular Electronics** readers' responses to my letter, as mentioned in the May *Haves & Needs* section asking for a circuit diagram for a telephone in-use indicator. I have received many responses. Now I have about 20 great circuits! I am sorry that I am busy and don't have time to respond to each of your letters. So a collective thanks to all of you who gave me a response!
Brenden McNeil
via e-mail

Well Brenden, take a look at this month's Think Tank column and your circuit's count will now go up to 22!—
Editor

HAVES & NEEDS

Is there a programmable radio/tape made by any manufacturer that can be programmed like a VCR? Suppose one would like to hear a 15-minute program which comes on, say, Tuesdays on radio station WBAL at 1:00 PM, but he does not have access to a radio at that time.

Or, perhaps, he would like the radio to switch programs automatically at various times during the day. With all types of clock radios and tape recorders already available on the market, why doesn't the manufacturers combine them in this practical consumer application?

George B. Wroe
4802 Butler Road
Glyndon, MD 21071

I would like to know if any of your readers could recommend a basic electronic circuit design computer program which does not require much math to use.

Charles Kenwood
1015 S. 25 Street
Lincoln, NE 68510

I am a barber who works regularly in London. Most of my equipment was bought in the U.S., so I have to use a converter whenever I use these tools in London. No matter what I do, I can't seem to stop my *Wahl* and *Andis* clippers from rattling unbearably. I feel it's a 50-Hz European to 60-Hz U.S. line frequency problem for the motors. If that is so, what circuitry would I be

able to build or buy that would solve this problem? My friends tell me they have the same problem in Jamaica, where the power-line frequency varies between 50 Hz to 60 Hz, instead of being a constant value.

B.B. Henriques
4132 Rainbow Drive
Decatur, GA 30034

Good questions, writers. Perhaps our readers will contact you directly with a solution or forward a response to the magazine.—Editor ■

ANTIQUE RADIO CLASSIFIED

Free Sample!

Antique Radio's
Largest Circulation Monthly.
Articles, Ads & Classifieds.



6-Month Trial: \$20.95. 1-Yr: \$40.95 (\$57.95-1st Class).
A.R.C., P.O. Box 802-L20, Carlisle, MA 01741
Phone:(978) 371-0512 VISA/MC Fax:(978) 371-7129

NAVY

YOU AND THE NAVY.
FULL SPEED AHEAD.

1-800-USA-NAVY

• ROBOTS • KITS • SOFTWARE • MORE •

TALRIK™ II

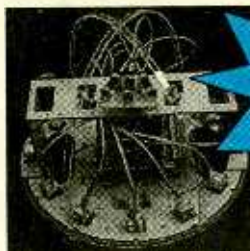

Order Today!
Mention this Ad for
FREE Insurance
on Your Order!

TALRIK™ Jr.

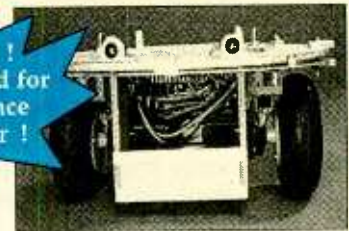

Autonomous, Programmable, Mobile Robot Platforms:

TAL2KIT - Kit to Build Serious R&D Talrik II Robot w/ 64k Memory, Sensors, Wheels, Servos, Micro-controller, Sensor Board, Body, Software * \$495.95

TALJRKIT - Kit to Build Super-Fun Talrik Jr. Robot w/ 2k Memory, Sensors, Wheels, Servos, Micro-controller, Birch-Body, Software * \$135.95

* First-time buyers of Mekatronix™ brand products need a Com-Kit \$19.95 OR a Com-Pack \$27.95 which plugs into the PC's serial port.

Program options: sBASIC, HC11 Assembly, C (ICC11), POGO, Forth or IC!

The TALRIK™ robot development platform offers sophisticated, expandable, programmable, autonomous, mobile robot kits with all the processor, memory, motor, and sensory functions found on robots costing a lot more!

SMARTER!
Has a MC68HC11
computer on board!

Orders Call NovaSoft™ Toll-Free:

1-888-Mr-Robot

Electronic Catalog with Pictures & Specs:

<http://www.mekatronix.com>

STRONGER!
Has 42 oz-in dual-ball
bearing servos

Technical Questions & Other Inquiries: novasoft11@aol.com or 804-272-5752 © 1998 NovaSoft™, Inc

Multimedia Watch

Olympus Products plus New Hardware and Software

MARC SPIWAK
ASSOCIATE TECHNICAL EDITOR
COMPUTER RESELLER NEWS

I am amazed by a product that started shipping last Fall that I had never seen before. I had heard about it, but I hear about far more products than I can write about, and I receive more products for testing than I even have time to test. If enough people had exposure to this product, I think it could change the face of photography. I'm talking about an *Olympus* digital photo printer that is so good, its prints rival 35 millimeter prints, and they're much better than photos from instant cameras.

I've had some doubts in my mind in recent months about how much of a threat digital photography is to traditional silver-based technology. The main problem is getting prints of digital images. I don't like ink-jet printers all that much because of all the maintenance. Plus it's relatively expensive and slow to print color photos on an ink-jet, and unless you buy very special and costly paper, the images just don't look right.

Another problem is that digital cameras have been rather expensive, especially for fancy ones with resolutions higher than 640 by 480. That resolution just doesn't do photographs any justice, especially if digital images are being compared to traditional film. However, once you get up into the 1024 by 768 region, and are making photo-album size prints, the images start to look incredibly sharp. I'd say that 1024 by 768 and up is more than adequate for 99.9 percent of the pictures people take. From close-ups to family portraits to outdoor vacation scenery, it's fine. Professional photographers, of course, need more.

OLYMPUS P-300 PERSONAL PHOTO PRINTER

Olympus has solved both of my problems, one with printing and the other with taking digital pictures. The *Olympus P-300 Personal Photo Printer* is a 300 dpi, photo-quality dye-sublimation printer. Dye-sublimation produces



The Olympus P-300 is a 300 dpi, photo-quality dye-sublimation printer that prints 24-bit color images on 4-inch by 5.5-inch glossy sheets. It connects directly to Olympus digital cameras.

continuous color tones, so the P-300's output is equivalent to a 2400 dpi ink-jet printer. It prints images on 4-inch by 5.5-inch glossy sheets at 1.5 minutes per page in true 24-bit color with 16.7 million colors. Photos can come from scanners, digital cameras, the Internet, wherever—as long as they're digital.

Not only do I feel that the P-300's glossy prints rival 35 millimeter prints, but the printer, in combination with *Olympus* digital cameras, offers the magnificent ability to print directly from the camera with no computer required.

In addition to the direct printing feature, the P-300 has a parallel port for PCs and a serial port for Macs. That way it can make prints taken by any digital camera, or ones not from a camera, but from the Internet or a scanner. Images can also be retouched and manipulated when a computer is involved. The P-300 prints 3.5- by 4.5-inch images on 4- by 5.5-inch sheets. It measures 10⁷/₈ inches front to back (with the small paper tray attached) by 2⁵/₈ high by 9⁵/₈ inches wide and weighs 5 pounds, 8 ounces. The paper tray holds 30 sheets, and a thumb wheel on the tray sets the number of prints that you want of the same image.

Aside from the shiny sheets, which are basically just that, the P-300 uses a special dye-sublimation ribbon that

looks a little like cellophane reeled up in a larger-than-life 110-film cartridge. The ribbon cartridge, good for 60 prints, slides into the side of the printer. Aside from the regular photo paper, there's also sticker-label photo paper and miniature sticker-photo labels, 16 to a sheet, great for sealing envelopes.

The P-300 costs \$399, and it comes with 10-print paper and a ribbon kit. Additional 60-print paper and ribbon kits sell for \$39.95. That's cheaper than *Polaroid's*, and way more convenient than having regular pictures developed. Plus, with the P-300, you only print images that come out the way you want them. With regular pictures, there's always a bunch of them with people who have their eyes closed, ones out of focus, and so on. The \$10 or \$15 you pay for film and developing 24 prints might only get you 10 good ones, so the P-300 can end up being less expensive to operate.

OLYMPUS D-500L DIGITAL CAMERA

The perfect complement to the P-300 printer is the *Olympus D-500L Digital Camera*. It has a maximum resolution of 1024 × 768 plus a 3× zoom, all glass aspherical F2.8 autofocus lens, and a through-the-lens (TTL) single-lens reflex (SLR) type viewfinder. In addition, there's a progressive-scan CCD with 850,000 pixels, a back-panel color LCD for reviewing images, three levels of compression, a serial port for connecting to computers, and a parallel port for connecting directly to the P-300 printer. It also has a built-in auto flash with red-eye reduction, fill flash, auto low-light and back-light mode, and more.

One of the best things is that the D-500L uses SmartMedia memory, and comes with a 2-megabyte card. Higher capacity media is available. SmartMedia are these tiny little memory cards that can be removed from the camera and changed like rolls of film.

With NRI training in Computer Programming, you can...

Build a top-paying career with up-to-the-minute programming skills



By 2008, computer-related employment will jump by an estimated 60% nationwide for trained programmers — with as many as 400,000 NEW jobs opening up!

Now, with NRI training, you can get the in-demand skills you need to build a top-paying career — or business of your own — in this high-growth, high-opportunity field!



“Those with up-to-the-minute skills can almost name their price.”

— The Washington Post —

In as little as a year, you can become the highly skilled computer programmer today's companies seek — and see your NRI training literally pay off! In fact, according to *The Washington Post*, annual starting salaries range from \$32,000 all the way up to \$47,000 in some cities for those with expertise in the top programming languages!

Master today's hottest languages!

NRI's step-by-step lessons and hands-on programming projects help you first master the design concepts used every day by successful PC programmers. You quickly move on to learn how to design, code, run, debug, and document programs in one of three of today's hottest languages — Visual Basic, C++, or Java — plus you learn to generate fully functioning Windows 95/98 programs. And you do it all using the powerful Pentium® computer system included in your course.

And our new Online Connection lets you send e-mail to your instructor, attend virtual discussion groups, download supplemental information, and more!

Train with a 233 MHz Pentium® processor-based multimedia PC, featuring...

- MMX™ technology ■ 32 meg RAM ■ 4 gigabyte hard drive ■ Super VGA color monitor
- 16X CD-ROM drive with sound card ■ 56K baud fax/modem ■ Windows 95/98 upgrade
- Netscape Navigator™ Web browser ■ And more!

With NRI's new PC Options Plan, you can keep up with late-breaking advances in technology by upgrading your computer system at special student rates. You'll get all the details shortly before your computer is scheduled for shipment. It's NRI's state-of-the-art guarantee!

Learn to tap the power of the Internet

Now your course includes bonus training in PC Communications and the Internet. Using the Netscape Navigator™ Web browser we provide, you can effortlessly move from one site to another as you explore the vast resources of the Internet and World Wide Web.

Send today for your FREE catalog

If the coupon is missing, write to us at the NRI School of Programming, 4401 Connecticut Ave., NW, Washington, DC 20008. Or...

**CALL 1-800-321-4634,
Ext. 3262**

SEND TODAY FOR FREE NRI CATALOG!

NRI Schools 4401 Connecticut Avenue, NW, Washington, DC 20008

Check one FREE career catalog only

- COMPUTER PROGRAMMING
- Networking with Windows NT
- PC Servicing
- Desktop Publishing with PageMaker
- Bookkeeping and Accounting
- Multimedia Programming
- Mastering Microsoft Office

OR GET YOUR AAS DEGREE!

- Accounting
- Business Management
- Computer Science
- General Studies

Name (please print) Age

Address

City/State/Zip

A Division of The McGraw-Hill Companies

Accredited Member, Distance Education and Training Council

5413-0898





The Olympus D-500L digital camera has a maximum resolution of 1024 x 768 plus a 3x zoom, color LCD, built-in auto flash, and more.

They can also be quickly read in PC Card adapters, floppy-disk adapters, and desktop readers to avoid the dreaded serial link between the camera and computer. After images are saved or printed, the card can be erased and reused over and over again. The D-500L's 2-megabyte card can store from 3 to 25 images depending on the compression setting.

The zoom provides wide-angle shots equivalent to 50mm on a 35mm camera, and a telephoto focal length equivalent to 150mm. A macro focus mode provides close-ups from just under a foot away. The camera weighs 16.5 ounces and measures 4.5 inches wide by 3.25 inches high by 5.1 inches front to back. The camera will quickly eat four fresh AA batteries, so the optional rechargeable nickel metal hydride AA batteries and charger are a good idea to get a hold of.

The D-500L takes excellent digital photographs, and its suggested retail price (SRP) recently dropped to \$799. There's also a big brother D-600L (for a lot more money) that takes 1280 by 1024 images and is otherwise identical to the D-500L, plus several less expensive little brothers to choose from. All Olympus cameras will print directly to the P-300 printer. The D-500L/P-300 combination works so well together and makes such good prints, that I might never buy film again.

CD TRAVELER 2020

I recently came across a new portable CD-ROM drive for notebook computers that has some features I really like. EXP Memory Products' CD Traveler 2020 uses a PC-Card interface to achieve performance up to 20x. The drive can use three different power sources. It can pull power from the notebook computer through the PC

Card interface for portable use. If it's used as a portable audio CD player, six AA alkaline cells can provide power. An AC power adapter is also included.

The drive is 5.4 inches wide, 7.4 inches deep, and 1.4 inches high, and weighs less than a pound. It has play and skip controls, line output, and headphone jacks, and a volume control for headphones. The drive features POWER and BUSY status lights, and power automatically turns off to conserve battery power. A handy PC Card holder is molded into the bottom of the drive for easy traveling. The drive allows hot connecting and disconnecting, which is something that parallel-port drives cannot do. It costs \$399.

NEW ULTRA ATA HARD DRIVES

There's a new addition to the IDE family of hard drives, but don't run out and buy one expecting better perform-



EXP Memory Products' CD Traveler 2020 uses a PC-Card interface to achieve performance up to 20x. It can pull power from the notebook computer through the PC Card interface.

mance, unless your system is brand new, the IDE controller on your motherboard can't talk as fast as the new hard drives. The current interface, called Fast ATA, supports a burst data transfer rate of 16.7 megabytes per second. Ultra ATA (UATA) doubles the burst rate to 33 megabytes per second—close to Ultra Wide SCSI's 40 megabytes per second.

New chipsets support U-ATA, as do most new systems. Ultra ATA is back-

ward compatible with Fast ATA. So you can buy one and use it in any IDE-based system, but it won't be as fast as it could be unless your motherboard supports it or you buy a special controller card. Unfortunately for IDE, SCSI will still be the performance king. Ultra2 SCSI LVD, or low-voltage differential, offers transfer rates of up to 80 megabytes per second.

NEW SOFTWARE

ComicBase from Human Computing is a must-have for comic-book collectors. It's a collection of descriptions of over 3000 comic book titles, plus values on over 70,000 issues with price histories for the past four years. It creates price labels and reports to help you buy, sell, and evaluate comic books. You can search for a character's first appearance, second appearance, death, and so on. *ComicBase* includes over 200 megabytes of color and black and white artwork. The deluxe version, which costs \$129, runs under Mac OS and Windows 95. A Mac-only version costs \$49.

Elektrosen's new *CD-R Suite* is a compilation of useful CD-R utilities. It lets you copy CDs, record Web sites, mix custom audio CDs, and more. The package includes *Replicator*, *WebGrabber 2.2*, and *GEAR Audio*. *Replicator* lets you duplicate any compact disc, CD-ROM, Video CD, or CD-I. *WebGrabber 2.2* saves Web and FTP sites to a CD for off-line browsing. All downloading and recording functions are controlled from the browser. *GEAR Audio* lets you record audio and make custom CDs. It can remove clicks and scratches from recordings. You can even print jewel case song indexes. *CD-R Suite* has a suggested retail price of \$129.

New from *Expert Software* is *Speak Spanish*, where you learn Spanish as you explore a virtual city. You visit shops, a hotel, a theater, and so on. You can also record your voice and practice pronunciation with a native speaker. Graphics, animation, and sound help the language sink in more effectively than learning from books. Other titles help you learn German and French. *Expert Software* has been sending me lots of new titles, all reasonably priced at \$14.99 each. There's *Animated E-Mail*, that can turn your e-mail into animated messages, *Animated Clip Art*, *Internet Game Commander*, and many more.

WHERE TO GET IT

Access Software

4750 Wiley Post Way
Building 1, Suite 200
Salt Lake City, UT 84116
801-359-2900
www.accesssoftware.com

**CIRCLE 60 ON FREE
INFORMATION CARD**

Elektroson, Inc.

2105 S. Bascom Ave.
Suite 160
Campbell CA 95008
408-371-4800
www.elektroson.com

**CIRCLE 61 ON FREE
INFORMATION CARD**

EXP Computer, Inc.

12-C Mauchly
Irvine, CA 92618
800-EXP-6922
www.expnet.com

**CIRCLE 62 ON FREE
INFORMATION CARD**

Expert Software, Inc.

800 Douglas Road, Executive Tower
Coral Gables, FL 33134
800-759-2562
www.expertsoftware.com

**CIRCLE 63 ON FREE
INFORMATION CARD**

Hasbro Interactive

50 Dunham Road
Beverly, MA 01915
978-921-3700
www.hasbro.com

**CIRCLE 64 ON FREE
INFORMATION CARD**

Human Computing

4509 Thistle Drive
San Jose, CA 95136
408-266-6883

**CIRCLE 65 ON FREE
INFORMATION CARD**

LucasArts Entertainment Company

PO Box 10307
San Rafael, CA 94912
415-472-3400
www.lucasarts.com

**CIRCLE 66 ON FREE
INFORMATION CARD**

Olympus America Inc.

Digital & Imaging Systems Group
Two Corporate Center Dr.
Melville, NY 11747
800-347-4027
www.olympus.com

**CIRCLE 67 ON FREE
INFORMATION CARD**

Tex Murphy: Overseer is new from *Access Software*. A gorgeous client's father is dead of an apparent suicide, but she says he was murdered. *Tex*

Murphy, P.I., must investigate a dark secret. The story twists and turns, and is full of danger, espionage, and a lot more. One box includes DVD and CD-ROM versions. The cast includes Michael York and Rebecca Broussard. *Tex Murphy: Overseer* costs \$79.95.

Hasbro Interactive just released *Mastermind* and *Sorry!* on CD-ROM. *Mastermind* is a game of logic, with four different games, graphics, and sound. There are variations for children and adults. *Mastermind* is for ages eight and up. *Sorry!* is the classic game of slide and pursuit, with animated game pieces and four game varia-

tions. Kids and adults will like playing *Sorry!* You won't be sorry after spending \$19.95 for each of these games.

Lucasarts' Star Wars Rebellion is a strategy game of galactic expansion. Players choose the Rebel Alliance or the Galactic Empire. Players battle for control of the galaxy containing up to 200 systems. *Star Wars Rebellion* takes place just after the destruction of the first Death Star in *A New Hope*. Characters are drawn from the movies, the Timothy Zahn novels, and the Dark Horse comic books. There are 55 characters in all. Join the fun for only \$49.95. ■

PC-BOARD DESIGN

made easy



Why have more than 25,000 pc board designers chosen EAGLE as their layout tool?

Mainly because EAGLE is so easy to use that you can start designing your own boards within a few hours. But there are many other good reasons! Check out our Web Site for a free demo and more detailed information.

EAGLE 3.5

Schematic Capture • Board Layout
Autorouter

for Windows® 95/NT

Windows 95 and Windows NT are registered trademarks of Microsoft Corporation.

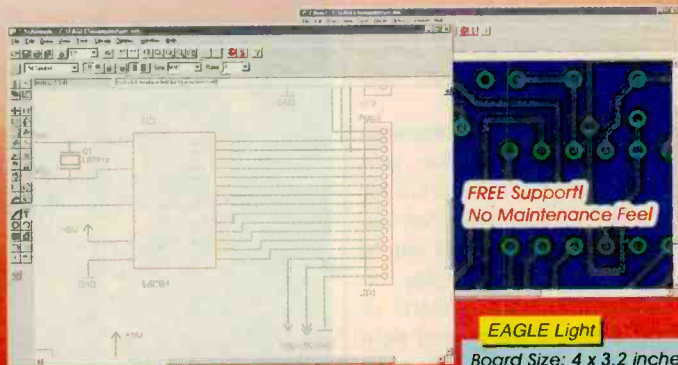

FREE Support!
No Maintenance Fee!

EAGLE Light

Board Size: 4 x 3.2 inches
2 Signal Layers
1 Sheet per Schematic

100\$

EAGLE Standard

Board Size: 6.3 x 4 inches
4 Signal Layers
99 Sheets per Schematic

398\$

EAGLE Professional

Board Size: 64 x 64 inches
16 Signal Layers
99 Sheets per Schematic

798\$

Order a FREE demo today and experience EAGLE first hand. You will be surprised!

800-858-8355

www.cadsoftusa.com

CadSoft Computer, Inc., 801 S. Federal Highway, Delray Beach, FL 33483
Hotline (561) 274-8355, Fax (561) 274-8218, E-Mail: Info@cadsoftusa.com

These prices include Schematic Capture and Board Layout. The Autorouter Module is available for 50/199/398\$. Pay the difference for Upgrades.

CIRCLE 13 ON FREE INFORMATION CARD

NET WATCH

Casino Fun Online

KONSTANTINOS KARAGIANNIS

Anyone who's been to the illuminated slice of desert known as Las Vegas, or aboard a river-boat casino, or within any of the many popular gambling cities in this country and abroad knows how much fun can be had. Everywhere you look there are happy people, who got this way either by winning money or allowing their losses to not seem so bad—thanks to the numerous free drinks offered at tables and slot machines.

It sure is hard to capture the particular atmosphere of otherworldliness that casinos have. Finding a window in one of these places is difficult, and few of them have clocks on the walls. Once you enter, you're catapulted into a place that doesn't really obey the laws of the time-space continuum.

Oh, yeah, and you could lose a lot of money.

As fun as the casino experience can be, it pays (literally) to keep your wits about you. Remember that those little chips you're stacking on the blackjack table in front of you represent real, hard-earned cash. Keep in mind that if you insert a couple hundred dollars into a dollar slot machine, with each "3 coin" pull you're losing three dollars. It's amazing how fast your funds can disappear.

This month, we'd like to introduce you to a new form of casino fun, one that actually allows you to have fun for free, if you'd like. Sites on the Net are now offering free downloads of virtual casino games that you can play on your PC, and even Java versions of these games that can be played right through a Java-capable browser such as Navigator or Explorer.

Of course, to make money, the sites also offer real gambling for real, credit-card-obtained cash. But the beauty of Internet gambling is that you don't really need to use money if you don't want to. While there are several Net casinos that require you slap down real funds (they outnumber the free ones, actually), I came up with a couple of sites that allow you to have

some free fun. No real-world casino would ever allow you to play a few

hands of blackjack "just for kicks." Now you can watch your virtual winnings



The Gold Club Casino offers a virtual version of the ultimate game of chance—roulette. Watch the numbers speed by and wait to see if the ball lands on your lucky number or color!



Blackjack has long been considered a game where a skilled player can get a statistical edge over the casino. Find out how up-to-speed your skill in this game is, without risking any cash.

pile up or disintegrate without a care. And if Lady Luck seems to be on your side at a particular net session, who knows? Maybe you can try putting a little real money down on that table floating in cyberspace.

GOLD CLUB CASINO

If you like playing games of chance and you have a computer, it's likely you have found yourself perusing a few casino-game software titles at your local computer store. Everyone gets sick of Windows Solitaire after a while, and the idea of having a good poker game on your PC might have appealed to you. Or, perhaps you've been trying to learn the basic strategies involved in playing Blackjack, and wouldn't mind a little practice.

Whatever your reasons, you may have seriously considered at one time or another plunking down anywhere from \$20 to \$50 on a CD-ROM. Now you don't have to spend a cent to get high quality, multimedia casino action on your computer.

Point your Web browser over to the *Gold Club Casino* site and download the company's proprietary game package. With it, you can have access anytime to a wonderful-looking collection of games. Choose from Roulette, Blackjack, Slotmachine, Videopoker, Poker, and Pai Gow Poker.

When you run the program, it will ask you if you want to play for fun or money. Selecting the former will bring up the game-selection screen and will automatically give you \$4000 of fun money. Clicking on to play for real money will bring you to the Cashier section of the program where you can use a credit card to purchase real credits or chips (you have to be online at the time, obviously).

I only played the games locally (offline) for fun and found them to be just as pleasing to the eye as even the most expensive store-bought titles. While you should realize that *Gold Club Casino* is offering this excellent-looking and -sounding interface so that you'll want to play, play, and keep playing,

HOT SITES

GalaxiWorld
<http://www.galaxiworld.com>

Gold Club Casino
<http://www.goldclubcasino.com>

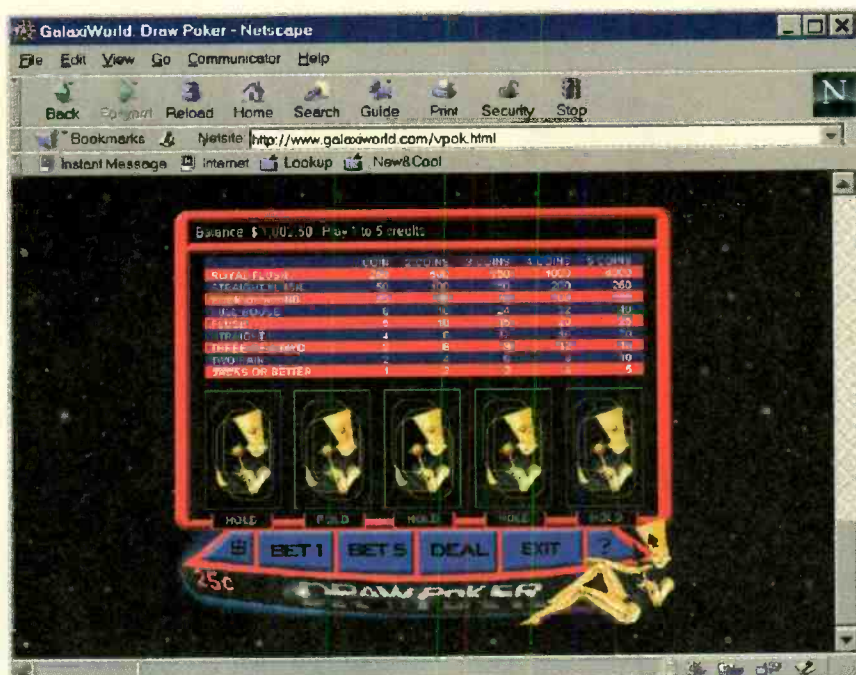

Using Java applets to create virtual Video Poker, Slots and other games of chance, GalaxiWorld spares its users from having to download any software to enjoy the site.

you don't need to risk your paycheck to do so.

The Roulette table is a lot of fun. After you place your bet, you click the wheel. While it spins, a close-up shot of the passing numbers appears onscreen, and you eventually see the ball land in its socket. Possibly, the one you bet on.

Blackjack had a wonderful interface, too. Even though you're the only one playing (so much for card counting), the simulation still shows a full table. You place your bet, and the cards fly onto the table. Before you know it, you may be stuck holding a 16 while the dealer is showing a ten-value card. Decisions, decisions, decisions... At least it doesn't have to be real money on the table, right? Of course, getting dealt that natural 21 makes you wish it were, sometimes.

You'll find that the other game interfaces are rendered perfectly as well. Certainly a much more exciting package to have on your PC than Solitaire.

GALAXIWORLD

When first hearing the name of this site, I thought it was some kind of virtual gaming site, but one more along the lines of the shoot-em-up in outer space variety. Still being finished at the time of this writing, it should be in full swing by the time that you read this.

In keeping with its out-of-this-world

nomenclature, *GalaxiWorld* has designed a visually compelling casino site that makes you feel as if you've traveled to a gambling spot floating out in space somewhere. After you spend a moment looking at the animations and moving star fields, you can get a free membership to the site. All they need at first is a user name, password, and e-mail address. You can then select as much "fun money" as you'd like to play with. The site wasn't offering gambling for real money just yet, which to many might make the site even more appealing.

Then, it's off to the games. Unlike the earlier site, there's no need to download any software. *GalaxiWorld* employs tiny Java applets to simulate various casino games. Try to download the latest version of either Navigator or Explorer for the best results.

While still a beta site, *GalaxiWorld* only offered two choices—Video Poker and Slots—but will soon offer (easily by the time this is in print) a whopping 52 games. To be perfectly honest, I didn't even know that there were this many games of chance in existence!

The two games I was able to try out work on the same principle. A virtual machine appears on your screen, and you choose how many coins you'd like to play (from one to five). Then, if playing poker, you hit DEAL. The cards

(Continued on page 66) 15

GIZMO®

DIMINUTIVE DIGITAL CAMCORDER

MODEL DSR-PD1 DVCAM DIGITAL CAMCORDER. From Sony Electronics Inc., 1 Sony Drive, Park Ridge, NJ 07656; Tel. 800-686-SONY; Web: www.sony.com. Price: \$2975.

Dan and Annie Weatherbee are creating a documentary about the preparation, training, and challenges facing the astronauts aboard the Space Shuttle Atlantis. The camera they select for the job must be small, lightweight, able to use existing lighting conditions, and easy for the astronauts and their trainers to use—without distracting them from their own mission.

Moss Landing Laboratories uses a camcorder mounted on the back of a sea lion to obtain unique underwater footage of whales in their natural habitat in the Monterey Bay area. The camcorder, and its waterproof casing (donated by Pace Technology), must be small and lightweight enough so as not to hinder the speed and agility of the sea lion. High light sensitivity is required to capture images in the depths of the ocean, and the video output must be good enough to be broadcast on TV.

The popular MTV show *Road Rules* was looking for a camcorder that could be used both on screen by the cast, and behind the scenes by the crew, as the show follows five young adults around the country as they strive to complete a variety of missions. The camcorder had to have a sleek, high-tech look on the air, yet be easy for the cast to use. It also had to be small and lightweight to allow the greatest freedom of motion to tape scenes as varied



as bouncing inside a giant inflatable ball and capturing images of ghosts in a haunted castle.

All three of these disparate groups selected the same camcorder—and not a professional unit. They chose Sony's *DSR-PD1 DVCAM* digital camcorder—a consumer model that's available to

anyone (who can afford it, that is). Their own comments explain why.

"The astronauts have ... agreed to take the *DSR-PD1* into orbit with them during the mission," said producer Annie Weatherbee. "The camera is so small, it fits in the pocket of their flight suits. They can take it out, shoot

footage, and put it away without interfering with the mission or taking themselves out of the action.”

Besides reducing the amount of drag, which makes it easier for the sea lions to keep pace with the whales, and providing PCM stereo digital audio recording of whale song, “Sony’s DSR-PD1 digital camcorder and DVCAM cassettes made our research much more manageable,” noted Dr. Jenifer Hurley from Moss Landing. “We could download the information to a computer. We will also be able to freeze an image and study it clip-by-clip, if necessary, and duplicate or edit the same video over and over without the quality of the image degrading.”

“The DSR-PD1 provided the outstanding video quality needed to contribute to the production of the show and the camcorder’s ease of use was very important when working with amateurs,” said Tod Dahlke, director of business development of MTV’s *Road Rules*. “We wanted to capture life as it happened, and the DSR-PD1 let us.”

In singing the praises of this particular Sony model, Weatherbee, Hurly, and Dahlke inadvertently yet effectively summed up the many advantages of digital video (DV) in general, and the DVCAM format in particular. Digital video, by the way, should not be confused with digital features (zooms or special effects, for instance) that are offered on analog camcorders. Just as all audio material recorded on a CD, MiniDisc, or DAT is recorded as a stream of digital bits (0s and 1s), both the audio and video portions of a digital video recording are digitally encoded on a DVCAM. (See the accompanying box for more on digital standards.)

Strictly speaking, Sony’s DSR-PD1 DVCAM digital camcorder is *not* a DV camcorder, but they share some similarities. The company calls DVCAM “a more reliable and higher end format than the consumer DV format.” The two are somewhat, but not entirely, compatible. DVCAM’s track pitch is 15 mm compared to DV’s 10 mm, and

DVCAM offers both a drop frame and a non-drop frame (SMPTE) time-code system. For audio recording, DV uses an unlock mode, in which the audio and video sampling frequencies are independent, while DVCAM uses a lock mode, in which the two sampling frequencies are synchronized. Both DV and DVCAM cassettes can be recorded using either DV or DVCAM video gear, but DV-formatted cassettes can be played back on DVCAM equipment only if they’ve been recorded in SP mode. Editing between the two formats gets even more confusing, due to the difference in track pitch. Depending on the specific models involved, you may or may not be able to digitally transfer video from a DV to the DVCAM. To further confuse things, the DSR-PD1 uses the “mini DVCAM” flavor of tape, not the standard size.

The first thing you’ll notice about the DSR-PD1 is its diminutive size. The overall dimensions of the camcorder are 2-3/8 × 5-1/8 × 4-5/8 inches, taking into account the color viewfinder and lens, which protrude (back and front, respectively) from the top of the unit, and the battery compartment bump-out on the right side. The main body of the camcorder actually measures just 4-3/4(H) × 3-3/8 (W) × 1-3/4 (D) inches. It weighs in at just over one pound.

The uppermost portion of the DSR-PD1 is home to the viewfinder on one side and the lens on the other. At the top of the unit is a built-in microphone and an accessory shoe. On the right side, just behind the lens, are the zoom controls and a FOCUS button that allows you to focus manually, using the focus ring that encircles the lens. Just to the right of the viewfinder is a dial used to customize the viewfinder to your eye. On the “front panel” (below the lens) is a light that indicates when the unit is recording, and a covered jack labeled “DV in/out.”

To the left of the viewfinder is a hinged door that opens to reveal a 2-1/2-inch (measured diagonally) “Swivelscreen” color LCD that can be used during recording or for playback. Inside the Swivelscreen compartment are controls for adjusting brightness, volume, menu options, and more, all surrounding a small speaker.

Just below the LCD screen is the battery compartment. The DSR-PD1

uses an “Accupower” lithium-ion battery system that earns its name by letting you know, to the minute, just how much battery life remains at any given time. The time is displayed next to the battery icon at the lower left side of the image in the viewfinder or on the LCD—keep an eye on it when you’re using the Swivelscreen to discover just how quickly that luxury drains battery power!

Directly below the standard viewfinder is the multi-position power control dial. A small green button on the dial must be depressed before the power switch can be moved from the off position to VTR (for playback), camcorder, or photo standby mode. A press of the large, round red button in the center of the power dial starts actual recording.

Located a bit further down the rear panel, the START/STOP mode button appears at first glance to be redundant. It turns out to activate one of three modes of recording. In normal mode, pressing the record button once starts a recording and pressing it a second time stops it. In the second mode, the camcorder records only while you hold down the record button, and stops as soon as pressure is removed. In the five-second mode, recording starts when you press record, and it automatically stops five seconds later.

The idea behind the latter two modes is that instead of 30 minutes of boring, live-action recording, you’ll get quick, punchy scenes of lively video. Of course, you have to master your timing in five-second mode. Press record when your daughter is climbing up the diving-board ladder, instead of when she’s poised to begin her dive, and you might not get to see her shear the water upon landing! The point is, of course, that nobody wants to see her climb the ladder, and your video will be much improved for having omitted that part.

Two other “front panel” buttons are labeled AE LOCK and FADER. AE lock takes the camcorder out of automatic exposure mode and can be used to lock in an exposure setting to compensate for such problems as strong back-lighting, insufficient light, or taping a bright subject in a dark background. The fader allows you to fade a scene in or out, giving your recording a more professional look. When fader is

activated, it affects not just the picture—the sound also fades in or out. The fade-in/-out function can be used only in the normal START/STOP mode.

Running alongside the START/STOP mode, AE LOCK, and FADER buttons is a rubberized panel that contains soft-touch video playback controls. When the camcorder is in playback mode, the STOP, REW, PLAY, FF, and PAUSE controls light up within that panel. At all other times, the panel remains darkened. Rounding out the “front panel” is a battery-lock slide-switch, used to keep the battery compartment securely locked shut.

The DSR-PD1 uses a 1/3-inch color CCD with 680,000 pixels. Its zoom system allows for 20× digital or 10× optical zooming. Only one audio mode is offered: 12-bit/32-kHz provides “CD-like” sound and the ability to dub in a second soundtrack along with the first. (CDs are actually recorded with a resolution of 16 bits and a sampling rate of 44 kHz.) The camcorder is capable of taking up to 340 individual still shots on a 40-minute tape.

The DSR-PD1 is an intuitively easy camcorder to use. Our first attempts were at a small family birthday party, held in the backyard, and at an Easter Egg hunt the next day. We hadn't had a chance to familiarize ourselves with the camcorder—in fact, we didn't even open the manual before we used it. Yet we managed, without a hitch, to charge and install the battery, pop in a tape, and make a decent recording.

Actually, we did experience one difficulty. Phone calls to every electronics store in the vicinity of our suburban Long Island home—including *Circuit City*, *Nobody Beats the Wiz*, and *RadioShack*—failed to turn up a DV cassette. We were able to pull some editorial strings and have one Fed Ex'd from *Sony*, but Joe Consumer does not have that option. Several days later, we did locate a store in Manhattan that had them in stock, at a price of about \$12, but it will be some time before you can pop into *K-Mart* or *CVS* and buy a tape for a DVCAM or a digital camcorder.

The quality of our first DVCAM taping was merely “decent” but not through any fault of the DSR-PD1. Technically, the recording was excellent. Pure, deep colors, smooth zooms, little to no jitters. It suffered, however,

from lack of restraint on the part of the videographer, who let the camera run during several interrupted starts of “Happy Birthday” (while waiting for someone else to get his camcorder up and running), and the hammed up antics of a three-year-old who, each time he found an Easter egg, would turn to the camcorder, hold it up, and say “Cheese!”

The first problem could be resolved via some heavy-duty editing, which we'll come to later. It could have been avoided in the first place, however, if we'd known about the stop/start and five-second recording modes. Subsequent recordings benefited enormously from their use. (The second problem will be outgrown soon, we hope.)

The DSR-PD1 is a pleasure to use. Its slim dimensions and light weight make it effortless to hold (even for folks with small hands) for long periods of time. The color viewfinder, which can easily be adjusted to suit your vision, is surrounded by comfortable soft rubber eyecup that can be bent back by eyeglass wearers to get a better view. Using the Swivelscreen removes the artificial barrier of a camcorder pressed up against one's face; it makes the videographer feel as if he's part of the action, and the subject feel less self-conscious. The screen can pivot around to any angle, allowing you to capture some interesting shots. If you turn it completely around, it can be used simultaneously with the viewfinder, allowing the subject to see himself just as you do.

Whether you opt for the viewfinder or the Swivelscreen—and we'd suggest the viewfinder if you intend to do any long-term taping, since the LCD screen is a huge power drain—you'll be presented with a comprehensive on-screen display. The time code indicates the recording or playback time in hours, minutes, seconds, and frames. Remaining battery power is noted via both an icon and the actual time in minutes—quite accurately, according to our experience. The tape indicator, on the other hand, displays the minutes used, rather than those remaining. A tiny hand, surrounded by lines that make it appear to be moving, lets you know that the DSR-PD1's Super SteadyShot image-stabilization func-

tion, which uses motion sensors to compensate for unintentional hand movement, is active. The display also informs you of any other special features, such as the fader or power zoom, that are currently in use.

Although there's generally no need to make adjustments to any of the camcorder's many settings and features—virtually everything is automatic—it is possible to change settings and opt for manual control of functions via an on-screen menu. The MENU button is found inside the Swivelscreen compartment, along with arrow buttons used to navigate the menu and an EXECUTE button used to make your menu selections. If you're using a tripod, for instance, you could shut off the SteadyShot system. The on-screen menu is also used to take advantage of the camcorder's three automatic exposure modes: sports, for capturing high-speed action; sunset/moon, for recording night views, sunsets, or even fireworks or neon signs; and landscape, for capturing a landscape through a window (as you drive along a scenic route) or through a screen door or wire fence. The menu is also used to adjust the white balance, the digital zoom, and the remote control.

What's most striking about recording with this digital camcorder is *that it's virtually the same as recording with any analog camcorder*. There's no new set of rules or terminology to learn. There's nothing in the least bit intimidating about shooting videos with the DSR-PD1. It feels as if you're using a very high quality, very compact analog camcorder.

Taking still shots is also a straightforward matter. With the power knob turned to “Photo,” you press START/STOP lightly as you line up your shot. When you're ready, simply press harder. It takes about seven seconds for a photo to be recorded, during which time “Photo Rec” flashes in the display, sound is still recorded, and the image you see is similar to an animation. Photos can be displayed on any video monitor or can be printed on a video printer.

Whether you're taping action scenes or still shots, things begin to get a bit tricky and intimidating during playback and editing, primarily because so many options—most of which require additional connectors

It's Not Just Training...

"I needed a refresher in fundamentals and a piece of paper that said I had a degree. CIE gave me both."

Louis P. Biant
Senior Engineer
Sental Corp.

"CIE allowed me to use my G.I. Bill benefits and independent study allowed me to continue my studies while deployed."

Charles Hopper
Electronics Senior Chief
U.S. Navy

"The fact that I intended to continue pursuing my Associate Degree with CIE was a key factor in being considered for my current position."

Annamarie Webster
Project Engineer -
Instrumentation
Ketchikan Pulp

"My associates at work recommended CIE... The lessons were structured so they were easy to comprehend."

Vincent R. Buescher
Communications Technician
AT&T

"I reenrolled and received my A.A.S. degree from CIE because of the good experiences I had in one of CIE's career courses."

Maurice M. Henthorn, Jr.
Electronic Technician
The Denver Post

Independent study from CIE will give you the skills you need to win your own independence in a successful career.

At CIE, we pride ourselves in keeping pace with the latest developing technologies. In turn, this assures our students that upon graduation they can mesh seamlessly into a variety of exciting and rewarding technology-based careers.

Back in the 1930's, we specialized in teaching radio and television sciences. Today, it's computer technology, programming, robotics, broadcast engineering, information systems management, and the electronics behind it all.

But some things have not changed, like the desire of CIE's faculty and staff to see their graduates succeed.

That is why at CIE we teach not only the hands-on, practical aspects of electronics technology, but also delve into the "why" behind today's technology. Why does it work the way it does?

The insights to be gained from such a broad, rich and comprehensive

education at CIE matches or exceeds those gained through

traditional commuter institutes while providing an education schedule to match your commitments and lifestyle.

Our patented learning program is specifically tailored for independent study and backed up by a caring team of professional educators who are at your call whenever you need their help.

At CIE, we'll match our training with your background and career goals and help you decide which of the many career courses that we offer suits you best. We offer an Associate Degree Program and through our affiliation with World College a Bachelor Degree



Computer Programming



Electronics Technician

Program.

If you have the sincerity, the smarts and the desire, CIE can make it happen. CIE is already the institute of choice for many Fortune 1000 companies. Why shouldn't you be next?

...It's an Education.



1776 East 17th Street
Cleveland, OH 44114
(216) 781-9400 • 1-800-243-6446

YES! Please send me more information on:

- CIE's Associate Degree Program
- CIE's Career Courses
- World College's Bachelor Degree Program

Name _____

Address _____

City _____ State _____ Zip _____

Phone: _____

Check for G.I. Bill Active Duty Veteran

AH 122

and/or equipment—are available.

The easiest way to check out your recordings is to play them back right on the camcorder, using either the Swivelscreen or the viewfinder. When you select VTR mode, the playback buttons on the front panel become activated and illuminated. The supplied remote control can also be used to select playback functions, which includes viewing stills or playing video at normal, double, or 1/3 speed, or frame-by-frame.

The digital camcorder offers several convenient search functions. You can locate the beginning of a recorded scene by searching for the date recorded. During playback, if you come across a scene you know you'll want to return to, you can mark it with the ZERO SET memory button. It's also possible to search only for photo-recorded still pictures. To find the end of the recording again, you can press the END SEARCH button located inside the LCD screen compartment.

But what's the point of buying a digital camcorder if the only way you can view the superb video it tapes is on a 2-1/2 inch LCD screen? Of course, there are other options.

You can use the supplied cable to directly connect the DSR-PD1 to any monitor with a video/audio input jack. The problem with using "any monitor" is that it won't display the excellent picture quality of the original recording. For a better picture, you can use the included S-video cable to hook up the camcorder to an S-video monitor.

As for editing, an S-VHS VCR is okay, and you can even use a standard VHS VCR. But you really should use either a digital VCR or another DVCAM. In either of those cases, you'll need to use a DV connecting cable—which is not supplied. A DV cable will allow you to record picture, sound, and system data.

The DSR-PD1 offers a host of features to ensure accurate editing. Its drop-frame time code provides for frame-accurate editing. Extended data code stores date, time, shutter, speed, gain, and iris data. A Control-L (LANC) editing interface connects to Sony VCRs and editing controllers using an optional VMC-LM7 LANC/microphone adapter. The DVCAM is compatible with the IEEE-1394

firewire interface but, once again, the necessary connectors are not provided.

Ditto for the VMC-LM7 adaptor and the RK-G128 cable needed for audio dubbing from any source other than the built-in microphone. It is possible to add narration or music to the original recording without erasing or degrading the existing soundtrack. The AUDIO DUB button on the remote control is used to record the second soundtrack. Once you've added the narration or music, a menu option called audio mix allows you to adjust the balance between the two soundtracks.

We loved recording on the DSR-PD1. Its size, weight, and overall design combine to make it one of the simplest, most comfortable camcorders we've ever used—even though it was one of the most technically advanced. The Swivelscreen, though certainly not unique to DVCAMs, enabled on-the-spot playback and added versatility. The quality of the audio and video are incredible.

Unfortunately, without a DVCAM-compatible VCR or a second DVCAM camcorder, and lacking the audio and firewire adapters and cables, we were

not able to realize one of the main strengths of the DVCAM format—the ability to make multiple generations of edits with no loss of quality.

That won't be a problem for the professionals producing the NASA documentary, MTV's *Road Rules*, or recording whale activity. And you can be sure that the price of the DSR-PD1 and the currently available editing equipment will keep DVCAM primarily a product for video professionals for the foreseeable future.

BRAIN STRAIN

SMART GAMES PUZZLE CHALLENGE 2. From Smart Games, Inc., 27 Congress Street, Suite 211, Salem, MA 01970; Tel. 978-745-9900; Fax: 978-745-5400; Web: www.smartgames.com. Suggested retail price: \$29.95.

Been spending a lot of time playing games on your computer? You're probably developing your hand-eye coordination. You might be building up some muscles in the arm you use to control the mouse or joystick. Perhaps



you even get your heart-beat racing at an almost-aerobic rate during some fast-action sequences.



In the main puzzle menu, icons represent each of the 20 games offered in Smart Games Puzzle Challenge 2.

But, let's face it—PC gaming is not a good form of exercise. Not for your body, and, usually, not for your mind. *Smart Games Puzzle Challenge 2* might not do anything to reduce your waistline, but it will give every portion of your brain a true workout. The new version presents 20 different types of puzzles, in far-ranging categories. There are logic problems, tests of your spatial ability, word puzzles, number challenges, trivia contests, and even some interesting "sporting events." Every game offers several increasingly challenging levels of play, assuring that you're never bored—but frequently frustrated!

If you don't relish the thought of spending hours (we dare you to walk away sooner!) alone at your computer station, you can compete with friends or family members or, via the Internet, with Smart Games players from around the world. At the Smart Games Web site, you can challenge other members of the Frequent Thinker's club. If you're not on-line yet, the purchase price of the software includes 30-day free access to AT&T's WorldNet Service.

Smart Games is aimed at players aged 14 and up, and according to the accompanying literature, "even younger members of the family enjoy the lower levels of *Smart Games Puzzle Challenge 2*." Maybe so, but only if they're both bright and are willing to put in the time and effort needed to master the puzzles.

Take *Gates of Trivia*, for instance. As avid *Jeopardy* fans (not at all bad at playing along with the TV show),

that was the first puzzle we tried. Well, after several hours, we were still on level one. Set up like a Solitaire game, *Gates of Trivia* poses multiple-choice questions in eight categories—History; Music; Art, Literature & Language; TV & Movies; Science; Geography; Sports & Leisure; and Number, Please. Under each heading is a stack of question cards. Every level of the game has several rounds of questions; each round adds a card to each stack and difficulty to each question. You must answer each question in every category correctly before proceeding to the next round.

In the first round of the first level, there are only two cards under each heading and only two possible answers to each question. In subsequent rounds, however, not only are more question cards added, but so are more possible answers from which to choose. If you correctly answer all the questions under a heading, the "gates of trivia" swing shut on that category. If you miss one or more answers, you are told only that "You didn't answer all of the questions correctly," not which ones you've answered incorrectly. If you have four questions, each with four possible answers, there are dozens of possible combinations of answers. It could take you quite some time to get them all right—as we can attest.

Next, we tried one of the word games: *Down & Across*. With years of crossword puzzles and Scrabble games under our belts, we were confident we'd garner top scores. Wrong again! The object is to take a group of given words (usually related in some way) and arrange them on a grid, using the least possible amount of space and making sure that every word touches another. The goal is to create as many words as possible, and to avoid creating "non-words." It's a lot harder than it sounds, and it gave us a new respect for crossword-puzzle writers.

Still sticking with words, we delved into *It's a Wrap*, a question-and-answer game that requires you to come up with the right responses to several clues, and then use those responses to come up with the correct answer to a final question. The answers are all related in some way, and usually you're told how. They might rhyme, or be anagrams. Just like in the other games, they are

increasingly difficult to figure out. It's a *Wrap* is a game well-suited to playing with others. Because the clues are often twisted or wacky, you'll all have a good time figuring things out, and you'll appreciate each other's help as much as the added company.

Feeling the need for a different type of challenge, we chose *PicPax* for our next Smart Games adventure. In this game, a small square containing a geometric pattern in blue and yellow is shown in the lower left corner. A larger square is at the right of the screen, and the pieces needed to replicate the pattern are strewn in the middle. You must select, flip, and/or rotate those pieces then move them into their correct positions in the large square. In the early levels of the game, some of the pieces are already in place. Higher levels leave all the work to you.

We're not sure if it's because another of our hobbies—quiltmaking—requires the precise positioning of a lot of little geometric shapes, or because we spend what seems like an inordinate amount of time piecing together jigsaw puzzles with our three-year-old, but we breezed right through every puzzle in *PicPax* in no time. It took us by surprise, because we consider ourselves much more proficient at trivia and word games than those that require spatial skills.



This nerdy-looking gy pops up at the end of each game to let you know how well (or poorly) you've done.

The next spatial challenge we attempted was called *Borderlines*. In this game, you are shown a scrambled image made up of repeated shapes, each with different patterns along their edges. You must move and rotate the pieces so that the edge patterns match on all sides, forming complete pictures of various flowers or pieces of fruit, for instance, or sometimes just match-

ing colors. The rules are deceptively simple, but the easier early levels provide good training for the more challenging brain-teasers that lie ahead.

Slide Show is another visual challenge. The game developer has divided a picture into pieces and then removed some of the pixels from each piece and placed them into others. The result is a pixelated mess. Your job is to slide the pixels around, trying to arrange them into a complete picture. We tried only the lower levels of play, and we found them to be relatively easy—the closest to a “no-brainer” in *Smart Games Puzzle Challenge 2*.

The game of *Leap Frog* also sounds childishly simple. Take your green bullfrog and jump over yellow, blue, and brown toads to make them disappear (checkers style). Score bonus points for jumping over a yellow toad first, a brown toad last, all the yellow toads first. But as you leap from one lily pad to the next, the first one just might disappear. Jump on a rock or an alligator, and you might find yourself sliding back to a lily pad.

We experienced a glitch while playing *Leap Frog*. We should have been able to move the frog simply by clicking on the space where we wanted it to move—but that had no effect other than to make a noise. Through trial and error, we learned that we could select *Navigate* from the Tool Bar, click on *Go to Leap Frog*, and when we returned, the move would be made. Of course, that method was too ponderous and time-consuming, and we quickly gave up and called *Smart Games’* toll-free technical help number.

The recorded announcement informed us that all operators were busy, but if we left a message, someone would get back to us as soon as possible. A helpful, polite man did return our call within an hour—but by that time our computer had conked out completely—through no fault of the program. We replaced the monitor, booted back up, and found that *Smart Games* was working perfectly once again—and that the *Leap Frog* scores we’d tallied previously had been recorded despite our computer problems.

Moving right along, we tried playing *Fool’s Jewels*, in which you must use domino-like tiles, linked in various combinations, to cover up pieces

of coal (which carry negative point values) and magnify jewels (which are worth varying points). More jewels are found in another spatial-relations game called *Ice House*, in which your goal is to use a little yellow tractor to push the jewels into the ice cubes that match their color.

Ice House is a good example of how the game’s creators use the early levels to prepare you for more difficult ones. In each level of play, a new concept is introduced. Level One lets you get acquainted with moving one type of jewel with the tractor; in Level Two, there are two types of jewel. Level Three introduces X-ray blocks that are used to reveal jewels within seemingly empty cubes. Spring-loaded wall sections that push cubes back a square make their first appearance in level four. The gradual introduction of increasingly difficult concepts, which will be used in more complex combinations in higher levels of play, keeps the frustration level low while allowing you to learn as you play.

Brain Candy dares you to match up assorted candies by four different attributes: type, color, pattern, and number. It’s not as sweet and innocent as it sounds, though, once again, early levels prepare you well for more

advanced games.

Several other games involve spatial relations and/or moving from a starting point to the end in the shortest/quickest possible route. *Odyssey* challenges you to find the easiest way home as you move across a board made up of squares, each of which features arrows that specify your next move. You gain points by landing on the bonus squares before heading to home “base.” *In Mass Transit*, you must find the shortest train route between the start and finish points, working with train schedules between several different stations. *Pipeline* should be required gaming for plumbers. It challenges you to use straight lengths of pipe, as well as ell, crosses, t-shapes, and caps, to connect the water main to the valve and several the fixtures. In *Mirror Mirror*, you must make a beam of light hit a target by manipulating reflective single- and double-sided mirrors, splitters that allow light to both bounce off and pass through, and black holes that absorb all light. *Sticks & Stones* requires you to correctly place a specified number of sticks and stones into a grid of hexagons, so that the specified number of each item is in every row and column.



Occasionally, the word fragments presented in *Writer’s Block* will form a quotation when properly assembled.

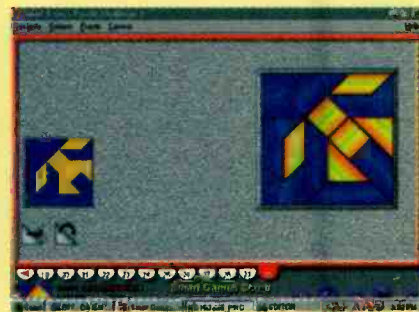
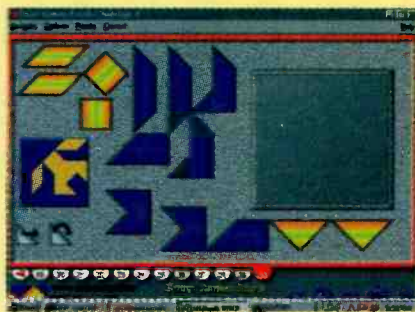

Take the scattered pieces shown at left in *PicPax*, and flip and rotate them as necessary to recreate the given pattern.



Take the pixelated image (left) in Slide Show, and set it straight (right).

The only “sports” games included—and calling it that is a bit of a stretch—is *Polf*. You guessed it, it’s a cross between pool and golf. Once again spatial relations come into play, as you select the angle of each shot and the weight of the cue (which determines the strength of the shot). As in pool, the ball ricochets off walls (and other obstacles). As in golf, the goal is to get the ball into the hole in as few shots as possible, avoiding obstacles such as sand traps and water holes, and to come in under par. This is the one game in which we actually beat Smart Games’ best score in one round, getting a hole in one on a par 2 hole!

There’s only one math game included in the program. *Math Path* is a numerical maze in which your route is determined by the value of the numbers shown and by the mathematical signs (+, -, ×, ÷) encountered along the way. We made it as far as Level Eight pretty easily, but we’ve been stuck on Level Nine for a couple of days now.

That’s the way it goes with Smart Games. You find yourself breezing along, acing each level of a game. As you complete each level, the Smart Games Braniac encourages you with a big smile and a “Yeah! That’s the best score possible for this game.” Just when you’re beginning to feel a bit smug (and very brainy), you’ll complete a level only to be told, “That’s your best score for this game, and yet... you can do better.” Go back and try again, and you’re likely to get a frown along with the message, “You didn’t beat your best score.” You can keep trying until you get it right, ask a friend for help, or take a break and switch to another game for a while. That’s one of the nicest things about this program: There’s always another game to play.

Having reached a mathematical

dead-end, we decided to try a truly unique game: *Say What?* This “audio jigsaw” presents you with bits of sound that, when properly unscrambled, form a readily identifiable soundbite (a snippet of Beethoven’s Fifth, for instance, or President Kennedy saying, “And so, my fellow Americans, ask not what your country can do for you but what you can do for your country”). Some of the puzzle pieces display soundwaves on them, allowing you to match them visually as well as audibly. Some pieces are “flipped” (played backward) and can be surprisingly hard to differentiate from the forward-playing bits. As far as we know, this is the only PC game that puts your ears to a test.

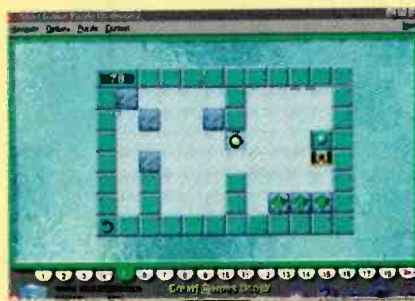

In *Ice House*, you must use the little yellow tractor to move gemstones from the starting position (left) into home position (right).

placed; in others, the grid pattern might be diamond shaped (which, we suppose, could be considered a pyramid with a mirror image). Some or all of the vertical and horizontal rows are marked with red arrows. You must use the given letters to create words within those rows, filling in all the spaces of the grid. Sometimes there are themes that link the words. Sometimes there are more letters than spaces. As always, the puzzles increase in difficulty, presenting the solver with letter lists in which U and Y are the only “vowels”, or Z is used for most of the consonants. A nice feature of *Word Pyramid* is that you have the ability to change what Smart Games calls the “font” of the letters (actually the color of the letter and the background) until you find a contrast that’s easiest on your eyes.

Eyestrain might become a worry, as you become hooked on one game, or find yourself stuck on a level for a long period of time, unwilling to move onto another level or game until you’ve perfected your score on this one. There are so many various puzzle challenges that it’s quite easy to spend an entire day at

Ready for another foray into the world of words, we moved on to *Writer’s Block* and *Word Pyramid*. In *Writer’s Block*, you’re presented with a collection of words that’s been broken up into short groups of letters. Your goal is to take those groups and piece them together to form words. In some puzzles, you must then form the words into phrases to achieve the highest possible score.

Finally, *Word Pyramid* presents you with a usually empty, usually pyramid-shaped grid, with a bunch of letters arrayed beneath it. In some levels, a few letters have already been

the computer, moving from one game to another, without ever getting bored. Don’t be surprised to find yourself most enthralled with a game that you wouldn’t expect to hold your interest (“Oh, I’m not good at word games...”). Become sufficiently addicted, and *Smart Games Puzzle Challenge 2* might even be good for your waistline, as you find yourself forgetting meals and snacks.

In fact, perhaps the biggest challenge you’ll face once you’ve installed *Smart Games Puzzle Challenge 2* on your computer is ever getting any work done again!

GIZMO NEWS

CEMA OKAYS HOME NETWORKING STANDARD

The EIA-709 standard for home networking, which was recently approved by the Consumer Electronics Manufacturers Association (CEMA), enables a new generation of intelligent products such as lights, appliances, heating, ventilation and air conditioning (HVAC) equipment, security systems, and audio/video equipment to be networked together to create automatized homes and apartments.

The standard is divided into three parts. EIA-709.1 defines a common protocol and transceivers for networking consumer products over existing power lines using narrow-band signalling (EIA-709.2) and free topology twisted-pair media (EIA-709.3). The communication protocol provides peer-to-peer communication for networked control and is suitable for implementing both peer-to-peer and controller-based systems. It defines a rich set of features that can be used to support simple on/off functions or complex devices. Those features include acknowledged and unacknowledged messaging services, a full suite of network-management services, authentication for message security, prioritization for important messages, and router-compatible addressing that can be used with off-the-shelf routers. Currently, power-line and free-topology twisted pair are defined in the standard, but the media-independent protocol is capable of supporting communications options including radio frequency, infrared, coaxial cable, and fiberoptics.

"EIA-700 was based on an existing protocol that is widely used by more than 3500 companies worldwide in the residential and commercial sector," noted Jim Dasson, chairman of the CEMA Home Control Systems Subcommittee. "Now companies can confidently build products to this standard, knowing that it is stable and satisfies the stringent requirements of CEMA."

The LonMark Interoperability Association is responsible for ensuring that products from different manufacturers work together. A LonMark logo will appear on products that meet EIA-709 requirements.

IN-FLIGHT FIRE RISK?

Several major airlines have begun installing ports in some first- and business-class sections, that allow passengers to recharge laptop batteries or power the computers without draining the battery. But the Portable Rechargeable Battery Association, a trade group based in Atlanta, has warned the Federal Aviation Administration (FAA) that, if improperly used, batteries can overheat, emit fumes, and even catch fire. Although the group is not aware of any such incidents, such fires are a possibility, particularly if the battery is old or if the type of battery does not match the charger being used. The risk is greater on airplanes, where the recharger ports are intended for general use, and not specially designed for specific battery types.

According to the FAA, the on-board rechargers offer several safety systems, including automatic tripping mechanisms in both the port and the adapter that leads to it. Meanwhile, an industry group known as the World Airline Entertainment Association is helping the FAA establish standards for airline rechargers and adapters.

HERE COMES INTERNET2

More than 20 universities are participating in a project known as Internet2, which plans to create a network that is 1000 times faster than the Internet as we now know it. The plan is to have it up and running—for use by the university community only—with in a few years. Although it won't be available to the general public, it's expected that technical advances developed during the creation of Internet2 will trickle down to the rest of us on the existing World Wide Web.

Vice President Al Gore, who spelled out some of the details behind Internet2 in April at a White House press conference that coincided with the spring meeting of the University Corporation for Advanced Internet Development, declared, "We will end the days when the World Wide Web is known by some as the world wide wait."

An ultra-high-speed "backbone" of computers will directly link universities in a hard-wired network that uses fiberoptics. The Internet2 network is said to be able to transmit the entire

contents of the 30-volume Encyclopedia Britannica in just one second. The new Internet will also differ from its predecessor in the granting priorities to network-critical projects, such as telemedicine. On today's Internet, every transmission is handled in the same manner.

DEFINING THE "DIGITAL DIVIDE"

According to a study conducted at Vanderbilt University in Nashville, Tennessee, a gaping "digital divide" separates black and white Americans in Cyberspace. The study, which was published in April in *Science*, was based on telephone interviews of more than 5800 people in December 1996 and January 1997.

The largest discrepancies in computer ownership and usage were found among high-school and college students. The study found that less than one-third of the black students own a home computer, compared to almost three-quarters of the white students. The gap remained even when the results were adjusted for differences in household income. While 59 percent of white students polled had been online in the previous six months, that figure was only 31 percent for black students.

The study results bode ill for the future of the U.S. economy. "If a significant segment of our society is denied equal access to the Internet, U.S. firms will lack the technological skills needed to remain competitive," stated the report.

Further widening the gap is the fact that white students who do not have access to a home PC are more than twice as likely as their black counterparts to have used the Web in the previous week, pointing out the need to provide Internet access in schools, libraries, and community centers in primarily black neighborhoods.

The problem is being addressed on two fronts. Significantly more Afro-Americans than whites plan to purchase a home computer in the next six months. And the FCC has announced a change in the disbursement of federally subsidized Internet connections. Originally intended to be distributed on a first come, first served basis, qualified schools, libraries, and health-care facilities in the poorest areas will be first in

line to receive the discounted hookups.

THE DIGITAL VIDEO STANDARD

Until recently, high prices and the lack of a digital video (DV) standard made consumer units unpractical. Digital video was for professionals only. Realizing the missed sales opportunities, several dozen major manufacturers banded together to create a single standardized digital video format, opening the door for sales of consumer models 3 - 4 - without any Betamax/VHS style industry infighting.

The agreed-upon DV standard provides for excellent video and audio quality. Digital video delivers over 500 lines of horizontal resolution, compared with 240 lines from VHS and 8mm, 400 lines from S-VHS, and 425 lines from Hi8. In fact, the only way you'll get higher resolution from a camcorder is to use a professional Betacam SP. The DV format provides three times the color bandwidth of VHS recordings, and splits the video signals into luminance (brightness) and chrominance (color). That separation, and the additional data found in the larger bandwidth, translates into far superior color. DV's higher signal-to-noise ratio (54 dB) greatly reduces the amount of "snow" on recordings,

improves contrast, and allows cleaner, smear-free highlights. An error-correction system removes those annoying tape dropouts during tape playback. Finally, DV recordings don't suffer from the jiggling that appears on analog recordings as a result of the tape itself moving. As for audio, the DV format allows for two PCM, or pulse code modulation, stereo recording modes: 16-bit mode for recording with CD-quality sound; and 12-bit mode, which trades off some audio resolution but allows you to dub a second stereo track over the first without losing the original video recording.

Wait, there's more. The digital video format allows the camcorder to double as a digital still-video camera, producing jitter-free still shots and allowing you to create slide shows or print out photographs. Frame-by-frame editing is another advantage. And digital video supports the IEEE 1394 interface standard, commonly called "Firewire," which uses one cable to transport audio, video, and control signals, making easy work of complex connections. That means you can easily link any firewire-equipped digital camcorder (although all DV camcorders are compatible with IEEE 1394, some will require optional interfaces) to your computer to download taped sequences

and still shots, edit them on your PC, send them via e-mail, and incorporate them in web pages.

Mini-DV cassettes are quite tiny, measuring about $2\frac{1}{2} \times 2 \times \frac{1}{2}$ inches. The high-density metal-evaporated tapes offer only 30 minutes of recording time. That's because digital video is extremely data-intensive—one second of digital video signal contains close to 100 times more data than one second of a digital audio signal. Data compression is used to squeeze a half-hour's worth of digital video data onto that one small tape.

The DVCAM format is the Sony-developed professional iteration of the DV format. By using a wider track pitch, it achieves better performance and the higher reliability required in the professional environment.

Even though the benefits of digital video are immense, don't expect digital camcorders to replace analog ones any time soon. The current prices of digital camcorders (around \$3000), digital VCRs (about \$600), and even DV mini-cassettes (\$12 for 30 minutes) are prohibitive for all but the most dedicated videophiles. But, as prices begin to drop, you can be sure that DV camcorders will make dinosaurs of all the analog models.

WISH LIST



**Cerwin-Vega HT Series
Home Theater Speakers**

Surrounded by Speakers

The *HT Series Home Theater* six-piece system from *Cerwin-Vega* (555 East Easy Street, Simi Valley, CA 93065-1805; Tel. 805-584-9332; Web: www.cerwinvega.com) provides affordable, realistic cinema sound in a home environment. The system includes four HT-SAT5 satellites, one HT-CTR25 center channel speaker, and the HT-S15 15-inch powered subwoofer. The magnetically shielded satellites use special 5- $\frac{1}{4}$ inch mid/low-frequency drivers engineered for tremendously high excursion to deliver extended low-frequency performance from a relatively small enclosure. Stiff, yet lightweight midwoofer cones with inverted dust domes, provide excellent transient response, while one-inch silk inverted dome tweeters deliver consistently distortion-free high-frequency response. The acoustically matched, dual-ported, magnetically shielded center-channel speaker features a low-profile cabinet design to fit unobtrusively into the home-theater setup. The powered subwoofer has a built-in 200-watt amplifier with auto-on feature. A phase switch on the subwoofer's rear panel allows custom adjustment of acoustic polarity. Price: \$1626.

SURFACE-MOUNT AUDIO MODULES

I've been designing and building audio equipment for more than 25 years. During that time, I've used the same subcircuits time and again. That's the reason that I decided to design and build a series of prefabricated circuits (modules) that could be used as building blocks in future audio projects.

The first step in that endeavor was to determine which audio circuits were best suited to modular design. I came up with 24 audio modules (which seemed to cover all of the audio processing that might be needed), plus two power-supply circuits. The next step was to come up with a format—a system whereby the modules could easily be put to good use.

The criteria I had in mind included uniform size and power-supply connections. Other factors called for keeping size to a minimum (thus the surface-mount design). As the circuits would all be on small printed-circuit boards— $1\frac{1}{16} \times 7\frac{7}{8}$ -inch—I decided to design them as vertical (upright) boards, with a row of connecting pins across their bottom edge. The pins would allow the tiny modules to be easily inserted into a larger printed-circuit board; a motherboard of sorts. Using such a series of modules, any audio circuit designer could assemble a wide variety of audio devices that would be small, rugged, and perform well.

It was determined that ± 18 volts (SIP-18V) would be a good choice for one of the power-supply circuits. The second power-supply module (SIP-PS, a self-contained unit) was designed for those instances when a lower current might be needed. When all was said and done, the series contained 26 modules (24 audio circuits and two power-supply units), which are referred to as SIPs (for Single In-line Pin devices).

The SIP Lineup. With 26 SIPs to choose from, it was necessary to devise an appropriate module identification scheme and to produce a short description of each module. The assortment of modules include:

Pick and mix the modules you need to build that special audio project. Minimize design time by interconnecting pre-assembled modules to form the equipment you need. Come up with your own projects of your own using these modules and win a cash prize in our design contest.

SIP-1: Dual variable-gain amplifier built around a BA15532 that is configured for non-inverting operation. An external resistor sets the gain of each stage separately.

SIP-2: Dual electronic balanced-input circuits for micro-

Electrify Your Library

It's as Easy as 1-2-3 With EBC

Choose any

5 Books for only

\$4.95

Values to \$330.00

with membership

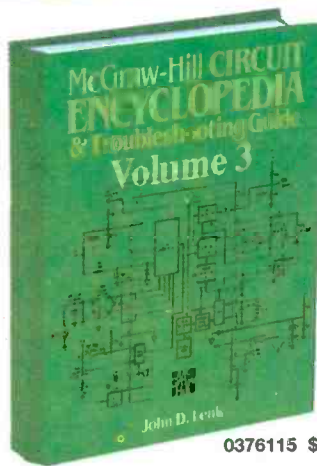

0376115 \$39.95

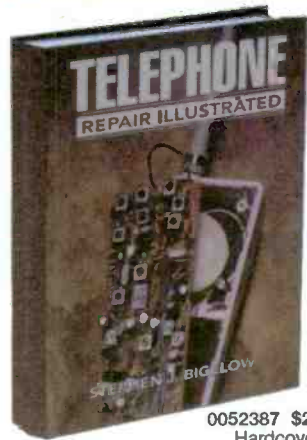

0052387 \$28.95 Hardcover



0157537 \$44.95 Hardcover

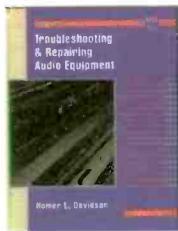

0157553 \$44.95 Hardcover



0116113 \$40.00 Hardcover



0444331 \$50.00 Hardcover



0157626 \$24.95

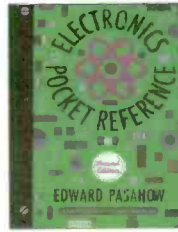

0487375 \$24.95



0331898 \$89.50 Hardcover

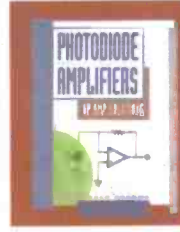

024247X \$49.00 Hardcover

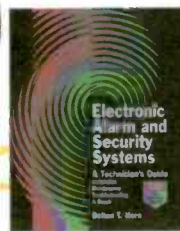

0305285 \$39.95 Hardcover

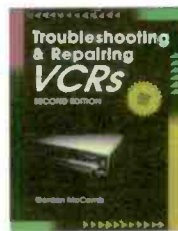

1550178 \$22.95



157154X \$21.95



0535469 \$29.95 Hardcover



Your one-stop electronics resource!

YES! Please send me the books listed below, billing me just \$4.95, plus shipping/handling & tax. Enroll me as a member of the **Electronics Book Club** according to the terms outlined in this ad. If not satisfied, I may return the books within 10 days without obligation and my membership will be cancelled. I agree to purchase just 2 more selections at regular club prices during the next 12 months and may resign anytime thereafter.

--	--	--	--

If you select a book that counts as 2 choices, write the book number in one box and XX in the next.

- Please bill me
 Check or money order enclosed payable to: The McGraw-Hill Companies
 Charge my Visa MasterCard AMEX Discover

Acct.# _____ Exp. Date ____/____/____

Name _____ Signature _____
(required on all orders)

Address/Apt.# _____

City/State _____

Zip _____ Phone _____

Valid for new members only, subject to acceptance by Electronics Book Club. Canada must remit in U.S. funds drawn on U.S. banks. Applicants outside the U.S. and Canada will receive special ordering instructions. A shipping/handling charge & sales tax will be added to all orders. © 1998 EBC

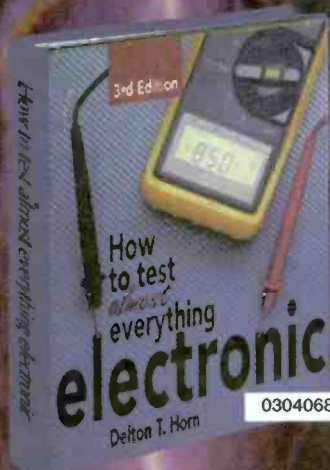

0304068 \$17.95

See other side for more great selections! ➔

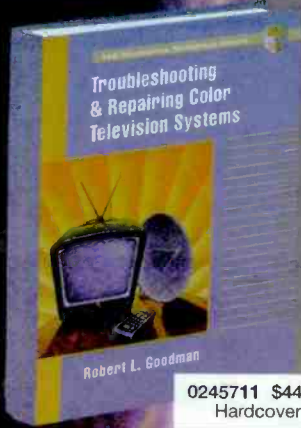

0245711 \$44.95 Hardcover



0699208 \$65.50 Hardcover



0116725 \$49.95 Hardcover



9126383 \$44.95 Hardcover



0305552 \$44.95 Hardcover

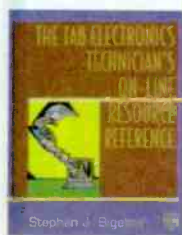

036219X \$44.95 Hardcover



057278X \$60.00 Hardcover

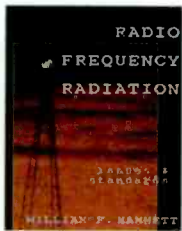

0259291 \$55.00 Hardcover



0245363 \$52.95

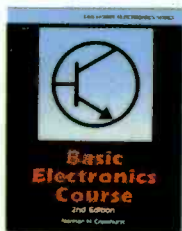

1574875 \$19.95

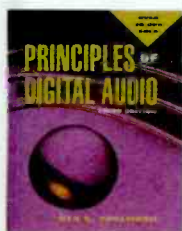

0504695 \$44.95

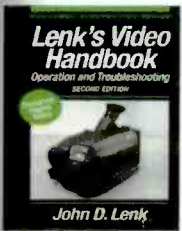

0376166 \$49.50 Hardcover



0317917 \$60.00



0434921 \$29.95 Hardcover



5879336 \$39.95

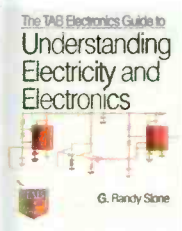

0582165 \$19.95



076512X \$49.95



912979X \$39.95

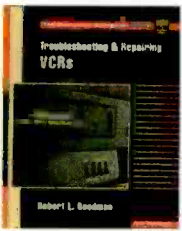

0242003 \$24.95

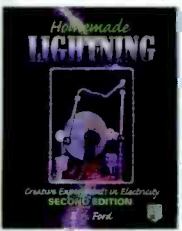

0215286 \$19.95

Choose any 5 Books for only \$4.95 with membership

Values to \$330.00

PHONE: 1-614-759-3666 (Monday-Friday 8:30 am - 5:00 pm EST)
FAX: 1-614-759-3749
INTERNET: www.bookclubs.mcgraw-hill.com

If card is missing, write to: Electronics Book Club, A Division of The McGraw-Hill Companies, P.O. Box 549, Blacklick, OH 43004-0549



NO POSTAGE NECESSARY IF MAILED IN THE UNITED STATES

BUSINESS REPLY MAIL
FIRST CLASS MAIL PERMIT NO. 4474 COLUMBUS, OH
POSTAGE WILL BE PAID BY ADDRESSEE

ELECTRONICS BOOK CLUB
A Division of The McGraw-Hill Companies

P.O. Box 182600
Columbus, OH 43272-3027



JOIN NOW TO GET THESE GREAT CLUB BENEFITS:

The largest selection of electronics books available anywhere - at up to 50% off publishers' prices.

Free 10-day trial on every book you order. You must be satisfied - or you may return any book within 10 days with no obligation.

Free Bonus Book Program that lets you earn points for bigger book-buying power!

Great Club Terms: simply buy 2 more books at exclusive member savings within the next 12 months with no further obligation.

Dependable Service and Delivery: you're guaranteed to get the best choice of books from all publishers. Every 3-4 weeks, you'll receive the Club Bulletin, packed with the newest and best electronics books. When the Bulletin arrives, if you want the Main Selection, do nothing - it will be shipped automatically. If you want another book or no book at all, just indicate your choice on the Reply Form and return it by the date specified. If you ever receive a book you don't want due to late delivery of the Club Bulletin you may return it at our expense.

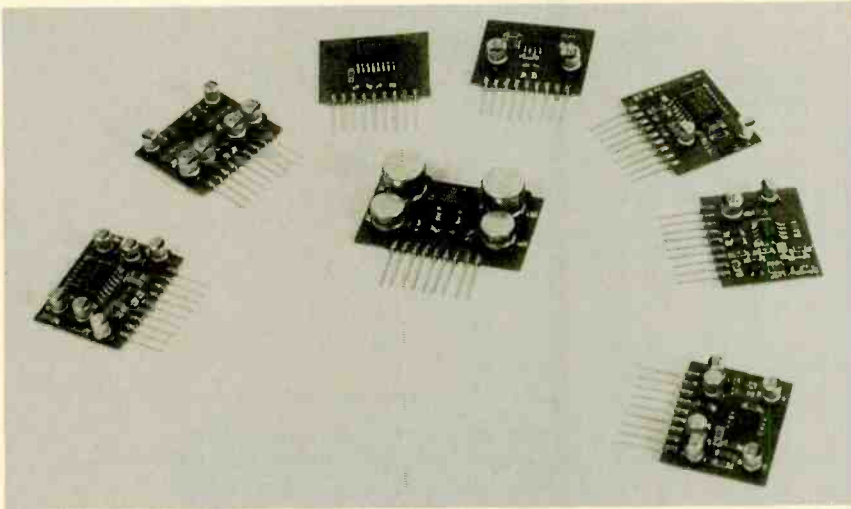

There are 24 audio plus two power supply modules in the SIP lineup. Only a third of the available modules are shown here.

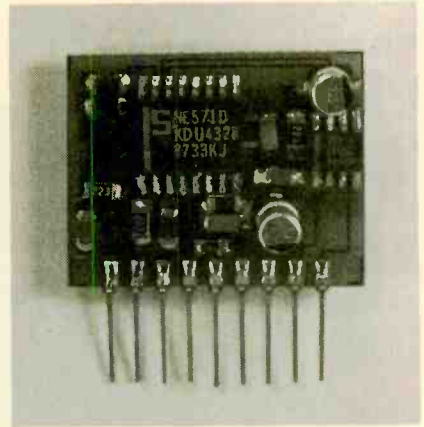

All of the SIPs were assembled on small printed-circuit boards, measuring $1\frac{1}{16} \times 7\frac{1}{8}$ -inch, except the power-supply modules, whose printed-circuit boards are only slightly (about $\frac{1}{2}$ inch) larger.

PARTS LIST FOR SIP-1

- C1, C2—1- μ F, 50-WVDC, surface-mount, electrolytic capacitor (Panasonic VA series)
- C3, C4, C7, C10—22- μ F, 6.3-WVDC, surface-mount, electrolytic capacitor (Panasonic VA series)
- C5, C6—22-pF, 50-WVDC, surface-mount, ceramic capacitor, Panasonic 1206
- C8, C9—0.1- μ F, 50-WVDC, surface mount, ceramic capacitor, Panasonic 1206
- IC1—BA15532 dual amplifier, integrated-circuit (Rohm)
- R1—R4—100,000-ohms, 5%, surface-mount resistor (Panasonic 1206)
- Printed-circuit board, connector pins, wire, solder, hardware, etc.

PARTS LIST FOR SIP-7

- C1, C2—0.47- μ F, 25-WVDC, surface-mount, ceramic capacitor (Panasonic 1812)
- C3, C4, C8, C9—10- μ F, 25-WVDC, surface-mount, electrolytic capacitor (Panasonic VA series)
- C5, C11—220- μ F, 4-WVDC, surface-mount, electrolytic capacitor (Panasonic VA series)
- C6, C7—0.0022- μ F, 50-WVDC, surface-mount, ceramic capacitor (Panasonic 1209)
- C10, C12—0.1- μ F, 50-WVDC, surface-mount, ceramic capacitor (1209)
- IC1, IC2—LM386M9 low-voltage, audio amplifier, surface-mount, integrated circuit (National Semiconductor)
- R1, R2—10-ohm, surface-mount resistor (Panasonic 1206)
- Printed-circuit board, connector pins, wire, solder, hardware, etc.

phones that use 0.1% precision resistors to create a common mode of 70 dB.

SIP-3: Dual electronic balanced-input circuits for line. Again, 0.1% precision resistors are used to create a common mode of 70 dB.

SIP-4: Dual electronic balanced-output designed to drive 600-ohm lines directly.

SIP-5: Special line-driving circuit with a current driver so it can drive low-impedance circuits (such as 150 ohms) to very high levels with low distortion.

SIP-6: Dual summing amplifier. The actual summing resistors are placed outside the SIP on a motherboard. This SIP can also be used as an inverting amplifier with the proper choice of external resistor. It can have gain or loss, depending on the resistor value selected.

SIP-7: Dual headphone amplifier for driving headphones or small speakers.

SIP-8: Automatic-level control for line-level circuits (great for communications work).

SIP-9: Dual voltage-control circuit for operating remote-volume controls and line-level signals.

SIP-10: Four common-buffer amplifiers that can be used to drive a common signal four ways with isolation.

SIP-11: Dual electronic SPST switch for noiseless switching or remote switches.

SIP-12: Video distribution amplifier—one in and three out. The inputs and outputs are designed to work

with 75 ohms.

SIP-13: Ducker circuit, where one circuit controls the other. The levels can be set externally via a potentiometer or a fixed resistor. The unit requires line-level signals.

SIP-14: Electronic mike/line switch. It can be operated remotely by a control voltage.

SIP-15: Automatic feedback notch filter. Great for eliminating unwanted ringing that occurs in a typical live-microphone environment.

SIP-16: Function generator based on the EXAR2206 monolithic single-chip function generator. The unit will generate sine and square waves. Needs an external resistor and capacitor to set the selected frequency.

SIP-17: Combination meter driver and audio oscillator. The oscillator is set to about 1 kHz and the meter driver is used with a 200- μ A DC meter.

SIP-18: Rumble/scratch filter for fixing common problems in audio systems. It requires line-level signals. Great for limiting the bandwidth.

SIP-19: Microphone preamp/quarter-watt amplifier. Operates from a single supply. Can be used to amplify microphone signals, and then to listen to it using the other half of the circuit.

SIP-20: DC-DC converter that allows a unit that requires a dual-voltage supply to run from a single supply.

SIP-21: Dual-gain, general-purpose amplifiers that operate on a single-ended supply voltage. External

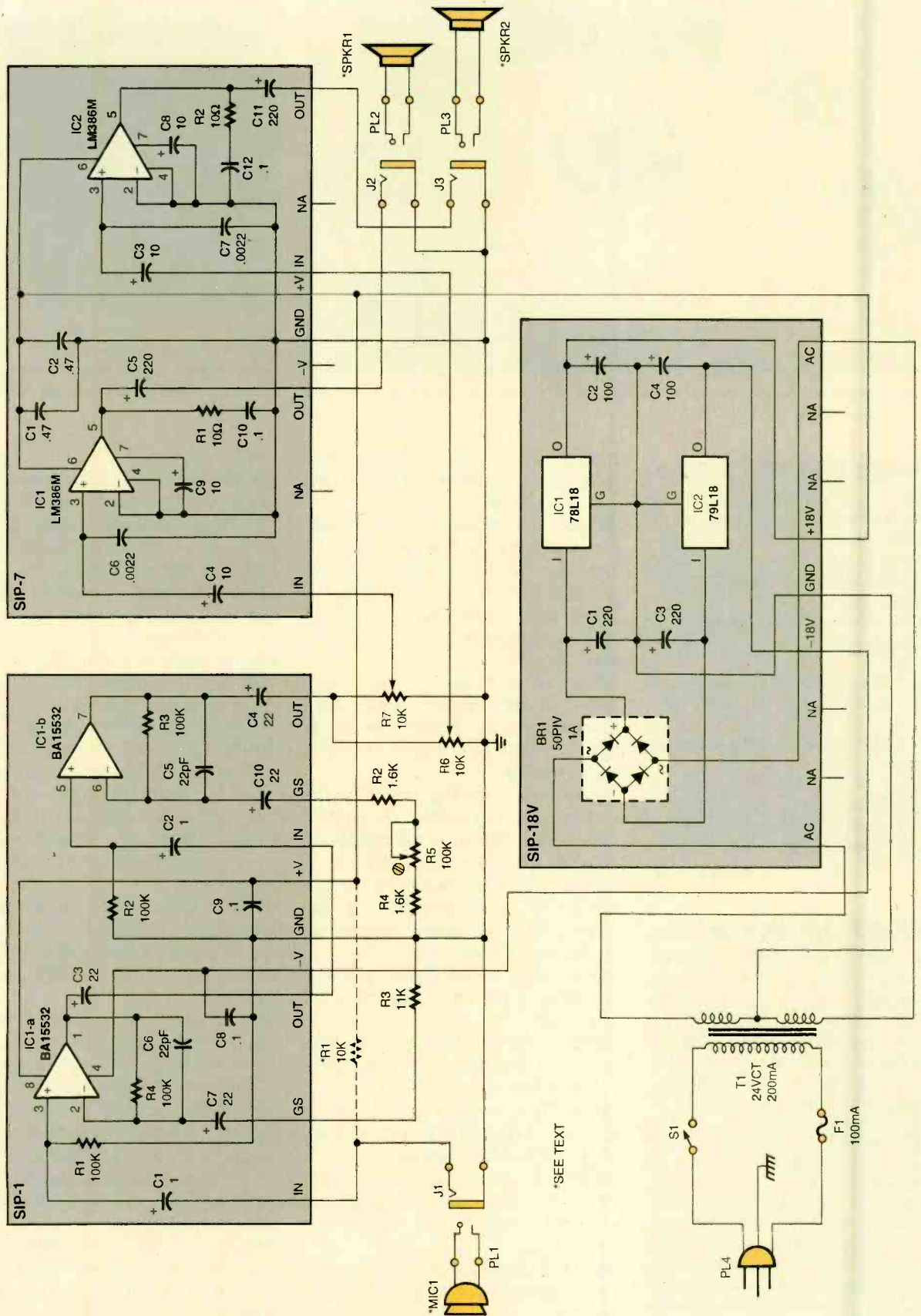
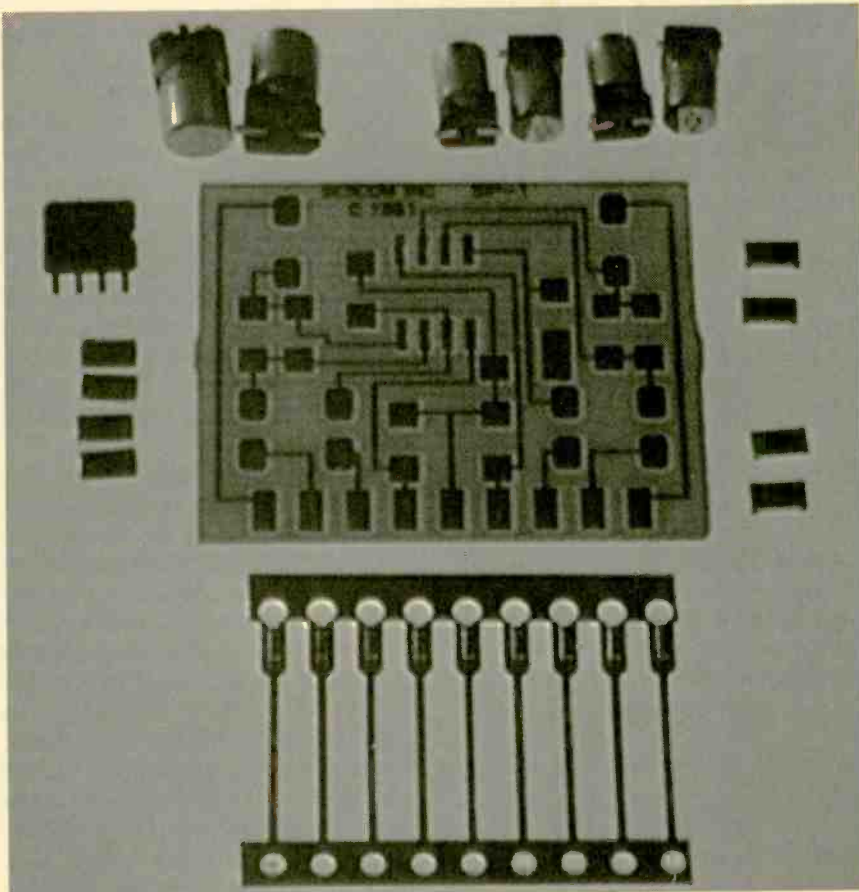

Fig. 1. The Auctioneer's Amplifier—which is comprised of SIP-1 (dual variable-gain amplifiers), SIP-7 (dual headphone amplifiers), and SIP-18V (±18-volt power supply)—is but one example of the type of equipment that can be fabricated by combining SIP modules.



Shown here are all the parts required to assemble a single SIP module. When assembling a SIP, lay out all of the required components on the work area, with the components separated according to part number and/or value, and make certain that they are all there and in the proper quantity before beginning.

resistor sets the gain of each stage separately.

SIP-22: Dual summing amplifier that operates on a single supply voltage. Summing resistors are placed outside the SIP on a motherboard. Can also be used as an inverting amplifier with the proper choice of external resistor. It can have gain or loss depending on the selected resistor value.

SIP-23: Fast-attack limiter for line-level audio signals. Release time is set externally. Another pin is used to set the window within which the limiter operates.

SIP-24: Dual unity-gain buffer amplifiers. In addition, there are two power-supply elements that will be useful.

SIP-18V: Voltage rectifier and ± 18 -volt regulators. Just supply 30 volts AC at 100 mA (min.) to the unit.

SIP-PS: Complete self-contained power supply. Delivers ± 18 volts at 35 mA.

Tools You Will Need. Any hobbyist

ought to be able to assemble surface-mount, printed-circuit boards. But because the SIPs are built using surface-mount components, there are some special tools that will be required. Chief among the items needed to assemble the SIPs is a well-lighted work area. A 20-watt halogen lamp does a splendid job of lighting the work area. In addition to the light requirement, the workplace should be slightly raised above conventional tabletop height. A 4- x 4-inch block of wood works well in this application.

In addition, there are a few special tools that will make assembly easier, some of which you may already have on hand. But if you don't, be sure to get them before you begin trying to assemble your SIPs. You'll need a small pair of tweezers (such as the General Hardware #401 AA). The tweezers are very useful for placing small parts on the printed-circuit board. Fine-gauge solder is a must, as is flux cleaner. You should also keep a

PARTS LIST FOR SIP-18V

- BR1—1-amp, 50-PIV, surface-mount, full-wave bridge rectifier
- C1, C3—220- μ F, 50-WVDC, surface-mount, electrolytic capacitor (Panasonic VA series)
- C2, C4—100- μ F, 50-WVDC, surface-mount, electrolytic capacitor (Panasonic VA series)
- IC1—78L18 positive 18-volt, 100-mA, fixed-voltage regulator, surface-mount, integrated circuit
- IC2—79L18 negative 18-volt, 100-mA, fixed-voltage regulator, surface-mount, integrated circuit
- Printed-circuit board, connector pins, wire, solder, hardware, etc.

PARTS FOR THE MOTHERBOARD

- F1—100-mA fuse
- J1—3.5-mm phone jack
- J2, J3— $\frac{1}{4}$ -inch phone jack
- MIC1—Dynamic or electret condenser microphone (see text)
- PL1—3.5-mm phone plug
- PL2, PL3— $\frac{1}{4}$ -inch phone plug
- PL4—Three-conductor AC line cord with molded plug
- R1—10,000-ohm, $\frac{1}{4}$ -watt, 5% resistor
- R2, R4—1600-ohm, $\frac{1}{4}$ -watt, 5% resistor
- R3—11,000-ohm, $\frac{1}{4}$ -watt, 5% resistor
- R5—100,000-ohm, trimmer potentiometer
- R6, R7—10,000-ohm audio-taper potentiometer
- S1—SPDT switch
- SPKR1, SPKR2—8-ohm, 5-watt (min.) high-efficiency speaker
- T1—24-volt, 0.2-amp, center-tapped power transformer (Mouser # 41FK200).

Printed-circuit, perfboard, or experimenter's board, wire, solder, hardware, etc.

Note: The SIPs are available from Sescom Inc., 2100 Ward Drive, Henderson, NV 89015-4249. All prices include shipping within the continental US. California, Florida, and Nevada residents must include appropriate state sales tax. Visa, Master Card, American Express, or money orders accepted. Phone orders: 800-634-3457; Fax orders: 702-565-4828. Office phone: 702-565-3400. Tech line: 702-565-3993. For more information, checkout our web site sescom.com.

small-gauge solder wick handy. In case you need to remove solder from a component or printed-circuit pad. Many of those items can be purchased from your local

RadioShack or other electronics supplier.

A magnifier with a built-in light is also useful when working with such small items. There are two types available. One type of magnifier—the Precision Optical 959 double loop—simply clips onto your glasses, while the other type is like a headband that fits over both eyes. (Those items should be available from larger hardware stores.)

A low-wattage, soldering-iron heating element (such as the Ungar 9830) with a very fine tip (like the Ungar 9012) is another must. (The tip is not supplied with the iron, but do get one; it is very handy.) The holder assembly for the specified iron heating element is the Ungar 9800. That completes the list of tools that you should have before you attempt to build your first SIP.

Since you'll be working with relatively small components, be sure that your work area is clean, neat, and organized. You don't want to misplace any of the tiny parts that you'll be working with in the clutter.

SIP Assembly. Before beginning SIP assembly, make sure you have all of the components that you'll need laid out before you. That way they can easily be located when they are needed. Be sure that the soldering iron is hot and tinned. Tinning the soldering-iron tip enhances heat transference—that's important since holding the soldering iron against the component and/or circuit board for too long can damage both those items.

Begin assembly by positioning the board so that the nine connection fingers point toward you. Remember that this is a surface-mount assembly; thus the components are soldered to the foil side of the board. Before attempting to solder any component in position, melt a little solder on the pin-4 pad of the IC and on one of the two-point pads (those intended for the resistors and the bypass capacitors) on the module's printed-circuit board.

Using the tweezers, place the IC on the proper pads. Make sure that the IC is properly aligned and oriented. Reheat the solder at pin 4 while holding the IC in place with

the tweezers. Once the solder becomes molten and flows to the connection terminal of the component, remove the iron. As the solder cools, the component will adhere to the pad. You'll have a little time to quickly make final alignment adjustments until the solder cools and sets.

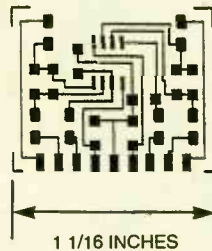

Fig. 2. All of the modules in the SIP series (except the two power-supply modules) were assembled on small printed-circuit boards, measuring $1\frac{1}{16} \times \frac{7}{8}$ inches. A full-size template for SIP-1 (dual variable-gain amplifiers) is shown here.

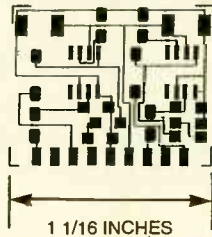

Fig. 3. Use this full-size template of SIP-7's printed-circuit layout to etch your board.

Once the IC(s) are in place, mount all of the two-pad components—resistors, jumper (if required), and bypass capacitors. Be careful of alignment. You can use the same trick that you used for the IC. Place a small amount of solder on one of the pads for the two-pad component. Then place the component in position using the tweezers as before and reflow the solder. Continue the process until one side of each component is mounted.

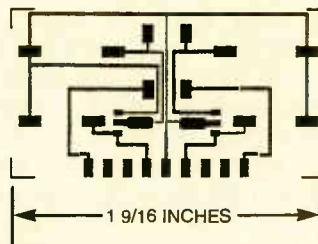

Fig. 4. Shown here is a full-size template for the ± 18 -volt power supply's (SIP-18V's) printed-circuit layout. Note that the board for the power-supply module is slightly (about $\frac{1}{2}$ inch) larger than the other boards.

Once that has been accomplished, secure the other terminal of each component in place.

Once those components are in place, mount and solder the aluminum electrolytic capacitors on to the board. Use the same technique as outlined for the other two-pad components. When done, check to be sure that all soldered components are firmly mounted and that the soldered joints are mechanically sound. At the same time, look for shorts or open solder connections.

The final step is to secure the pins that are used to make connections to the other circuits. Slip them onto the printed-circuit board and solder them into place. After the pins are in place, remove the shorting bar from the rear of the pin assembly and another shorting bar on the bottom of the pins. Obviously, you cannot use the SIP until that's done. The rear shorting bar can be cut off with an X-Acto knife. Use a cutter to remove the bottom bar. Double-check the board, and clean any excess flux from the board. Correct all mistakes now. If all is OK, you can put the finished SIP aside until you need it in a project.

If you found the assembly description difficult, a VHS video tape showing in great detail how each step is accomplished is available (for \$12.95) from the supplier listed in the Parts List. The tape shows how to assemble a SIP, but more important, it also shows how to handle assembling any project that calls for surface-mount components.

Auctioneer's Amplifier. Thus far we've discussed the reasons for developing the SIP modules and how to assemble them. Now, you might be wondering what kind of

POPTRONIX®

Online Edition

We're on the web FREE

<http://www.poptronix.com>

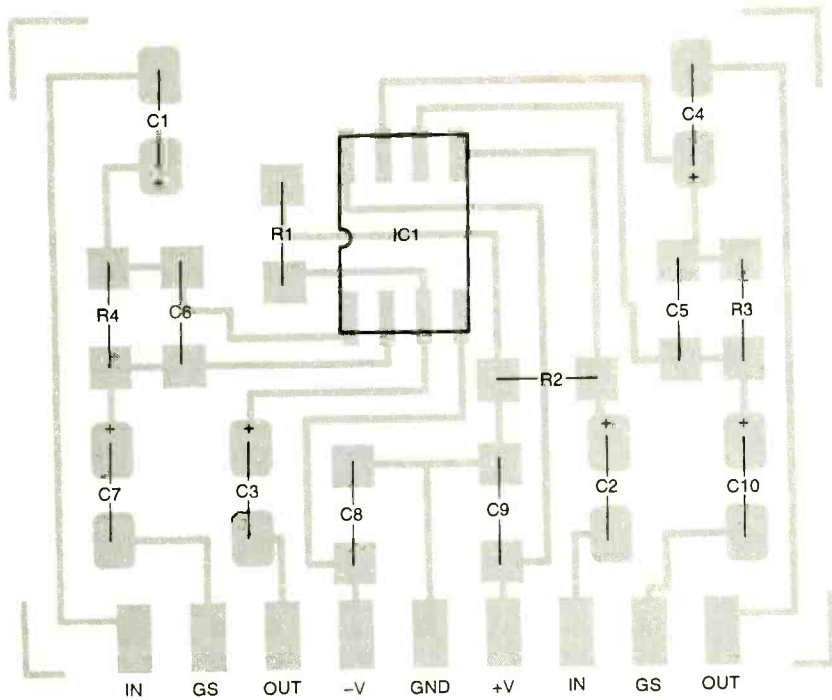

Fig. 5. Following this parts-placement diagram, assemble SIP-1, making sure that all components are properly oriented. Start by melting a little solder on one of the pads for each component, as outlined in the article.

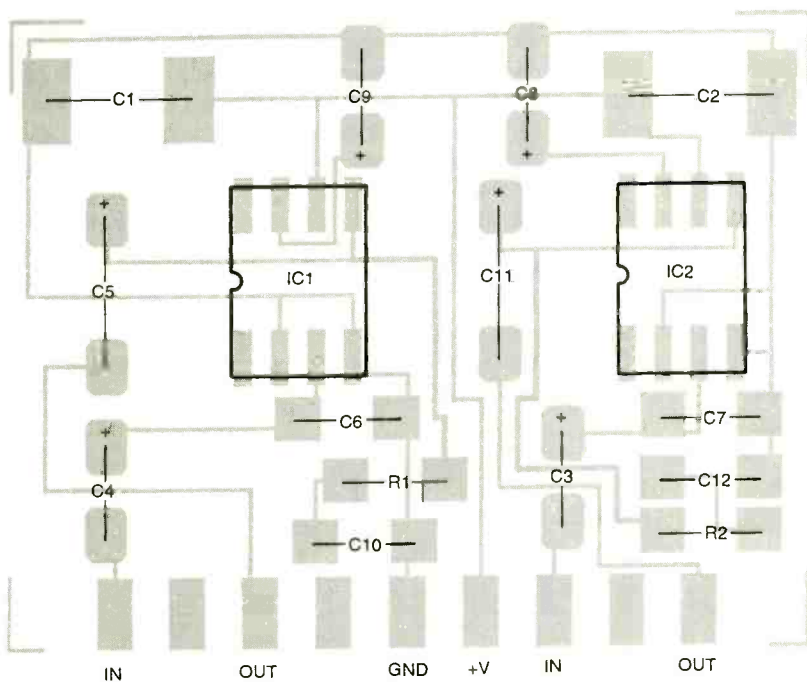

Fig. 6. Shown here is the parts-placement diagram for SIP-7. Aside from component orientation, when assembling the surface-mount SIPs be sure that all the components have good solder joints and that there are no shorts between adjacent component pads.

devices can be built using the tiny modules. The applications for the audio SIPs are endless—all it takes is a good imagination and some forethought.

As an example of the type of equipment that can be fabricated

using SIP modules, the author combined three SIPs—SIP-1 (dual-gain general-purpose amplifiers), SIP-7 (dual headphone amplifiers), SIP-18V (± 18 -volt power supply)—to produce the *Auctioneer's Amplifier* shown in Fig. 1. The *Auctioneer's*

TABLE 1—SIP PRICE LIST

MODEL	ASSEMBLED SIP	SIP KIT
SIP-1	\$20.00	\$10.00
SIP-2	\$33.00	\$15.00
SIP-3	\$33.00	\$15.00
SIP-4	\$33.00	\$15.00
SIP-5	\$22.00	\$9.50
SIP-6	\$16.00	\$7.00
SIP-7	\$24.00	\$12.00
SIP-8	\$36.00	\$16.50
SIP-9	\$29.00	\$16.50
SIP-10	\$22.00	\$12.00
SIP-11	\$22.00	\$16.00
SIP-12	\$50.00	\$25.00
SIP-13	\$28.00	\$11.00
SIP-14	\$25.00	\$11.00
SIP-15	\$40.00	\$17.00
SIP-16	\$31.00	\$21.00
SIP-17	\$19.00	\$10.00
SIP-18	\$20.00	\$7.00
SIP-19	\$19.00	\$10.00
SIP-20	\$29.00	\$11.00
SIP-21	\$18.00	\$8.00
SIP-22	\$15.00	\$8.00
SIP-23	\$35.00	\$14.00
SIP-24	\$18.00	\$8.00
SIP-18V	\$20.00	\$12.00
SIP-PS	\$40.00	\$25.00

Note: Kit prices good through 1/31/99

Amplifier was developed after remembering that people are always trying to get the attention of perspective buyers at trade shows, arts and crafts shows, and other such gatherings.

The input to the circuit is provided by microphone M1. Audio picked up by the microphone (either dynamic or electret condenser type) is converted to an electrical signal. Resistor R1 is used when an electret condenser microphone is selected as the pick-up device. The

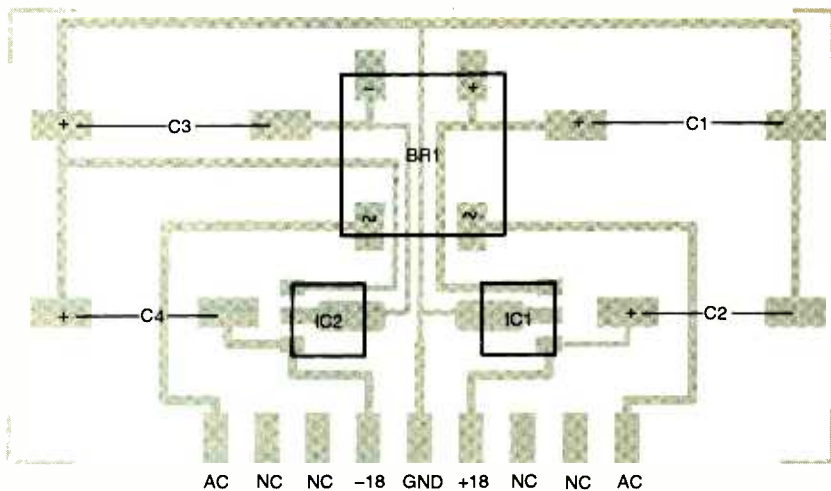

Fig. 7. The parts-placement diagram for the power-supply module (SIP-18V) is shown here. Once all the needed SIPs have been assembled, put the SIPs to the side and devise a motherboard to complete the project.

output of the microphone (a signal on the order of a few millivolts) is amplified in two stages by SIP-1. In the first stage of amplification, the microphone signal is fed to the non-inverting input of IC1-a of SIP-1. That amplifier produces a fixed-gain output of 30 dB (determined by R3, a 11k resistor) that is applied to the non-inverting input of IC1-b where the signal is further amplified (to a level determined by the values of

R2, R4, and the setting of R5) and output at pin 7. The gain of the second stage of amplification is adjustable from 10 dB to 30 dB. The pin-7 output of IC1-b is split across R7 and R6 (a pair of 10k potentiometers), which are used as left- and right-channel volume controls.

From there, the signal splits and is fed to the two inputs of SIP-7 (a dual headphone-amplifier circuit comprised of a pair of LM386 low-voltage, audio-power amplifiers) through a pair of 10k potentiometers (R6 and R7). The left- and right-channel outputs of SIP-7 are fed through jacks J1 and J3 to a pair of high-efficiency, 8-ohm speakers. Suitable speakers are available from RadioShack. The speakers should

have a power-handling capacity of 5-watts minimum.

Power for the circuit is provided by the final module, SIP-18V—which is comprised of a full-wave bridge rectifier (BR1), several electrolytic capacitors, and a pair of three-terminal regulators—coupled with T1 (a 24-volt, 0.2-amp, center-tapped transformer, Mouser # 41FK200).

Assembly. The construction of the Auctioneer's Amplifier is very simple. Start by assembling the three SIP modules. Printed-circuit templates for SIP-1, SIP-7, and SIP-18V are shown in Figs. 2, 3, and 4, respectively. Parts-placement diagrams for SIP-1, SIP-7, and SIP-18V are shown in Figs. 5, 6, and 7, respectively. Once the SIPs have been assembled, the next step is to decide how the SIPs are to be interconnected.

The best way to interconnect the modules is to devise a sort of "motherboard," which can be handled in a couple of ways—a printed-circuit motherboard or one fabricated from either perfboard or experimenters board. For those who prefer to use a printed-circuit board to accomplish the interconnections between the SIPs, a printed-circuit template of the author's motherboard is shown in Fig. 8. Once the motherboard has been prepared, mount the modules and support components, using Fig. 9 as a guide, in their proper positions as you would do with any other electronics

(Continued on page 44)

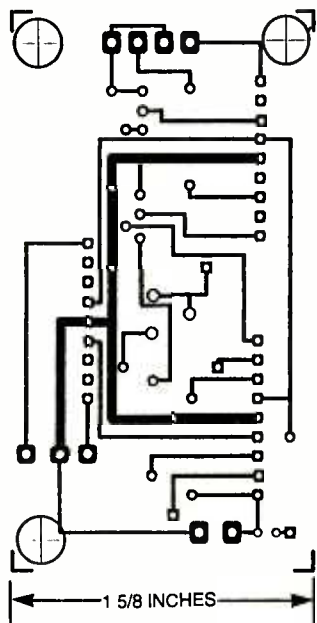

Fig. 8. The various discrete components and the SIP modules of the Auctioneer's Amplifier were brought together on a printed-circuit motherboard. A template of the motherboard's foil pattern (which measures 2⁷/₈ by 1⁵/₈ inches) is shown here full scale.

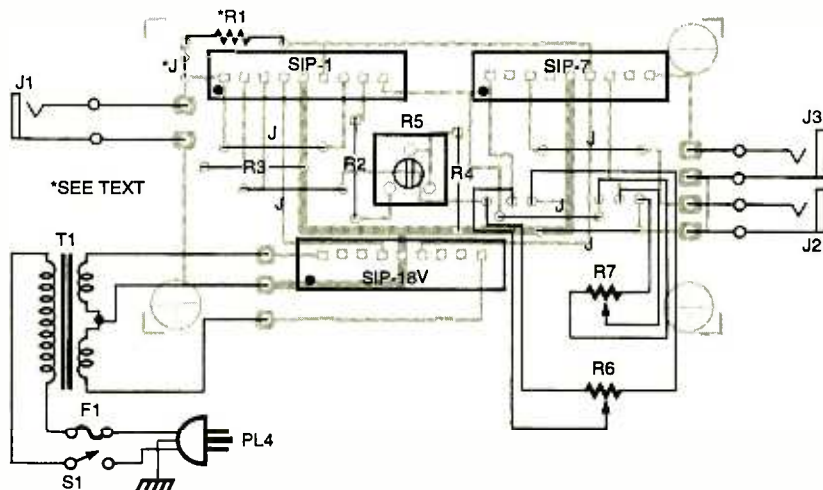

Fig. 9. This diagram shows the part-placement diagram for the Auctioneer's Amplifier's motherboard. Note that R1 on the motherboard is used only if the microphone used in the circuit is an electret type; otherwise that component must be eliminated.

Monitor Search and Rescue Missions



You can be a part of all the action through your communications receiver or your scanner as the drama unfolds on land, at sea, or in the air. Here are the frequencies where the action is hot and heavy.

MARC SAXON

Your communications receiver and/or scanner could give you the inside track on high-drama search and rescue (SAR) missions at sea and over land. You might be able to pick up the original distress calls, and then listen in as skilled specialists locate and attempt to save lives and property.

Listen as Coast Guard choppers scour the ocean for a sinking trawler, and then pluck the crew members from the sea. Monitor mountain rescue squads searching for a family who never returned from a skiing trip. Fly along with the Civil Air Patrol as pilots track the source of a rescue beacon signal. Follow the action as an urban search team checks for survivors of a major waterfront explosion.

SAR missions are more common than most people think, given the possibilities. Think about accidents, equipment malfunctions, ship fires, earthquakes, floods, storms, and tornadoes. Then there are those other unexpected problems that frequently occur in coastal areas,

lakes, rivers, and the ocean—anywhere from the wide open spaces to urban centers. These are problems that can face people at work, at home, on a boat, while flying, or even while camping.

Awareness of a problem situation may first occur because a distress signal was transmitted, or because a ship or aircraft failed to appear at its destination. A skiing party may have gotten caught in an avalanche. Even when a general location is given, a search must be made to find the exact spot. It's vital to reach the area as quickly as possible with medical assistance, food, water, and the means to return survivors to safety and salvage their property. For that reason, as soon as the alert signal goes out, a network of groups and personnel springs into action. Their activities are coordinated via radio communications.

Locally, there are numerous REACT and other private, state, local, and sheriff's rescue teams performing SAR operations. Many teams are trained for specialized SAR operations underwater, and in

coastal, mountain, cave, snow, and deep wilderness areas. Although many REACT teams use 462.675 MHz, and mountain rescue teams often operate on 155.16 MHz, local teams generally communicate on assorted frequencies from the Business and Special Emergency Radio Services. Presumably, many teams will soon be using newly authorized frequencies in the 220-MHz band.

National HF Channels. Nationally, SAR activities are most often provided by the Coast Guard and the military, as well as the Civil Air Patrol. National and international SAR and distress frequencies are somewhat standardized, and they dot the communications spectrum from the HF through the UHF bands.

If you have a communications receiver, SSB (USB mode) maritime distress calls are sent out on 2182, 4125, 6215, 8291, 12290, and 16420 kHz. In Alaska, SSB emergencies are handled on 5167.5 kHz.

Maritime SAR coordination operations in SSB are on 3023 and 5680 kHz. Good HF frequencies to monitor for US Coast Guard and/or Navy SAR operations in SSB include: 2182, 2261, 3109, 3120, 3123, 5692, 5696, 5718, 8980, 8984, 9006, 11195, 11198, 11201, 15081, and 15087 kHz. Combined US and Canadian Coast Guard SAR operations are on 2103.5 kHz. Listen for US Air Force SAR operations on 5704, 6714, and 11440 kHz. Manned Space Vehicle SARs are on 10003 and 19993 kHz.

Canadian Forces SAR operations are on: 5718, 5850, 6693, 6705, 6714, 8993, 9006, 9027, and 17995 kHz.

National VHF/UHF Beacons. In 1979, the Search and Rescue Satellite (SARSAT) program was activated using three polar-orbiting NOAA satellites with Canadian and French Emergency Position Indication Radio Beacon (EPIRB) receivers. A year later, the Russians joined SARSAT by tuning in Russian EPIRB receivers aboard that nation's three polar-orbiting Space System for Search of Vessels in Distress (COSPAS) satellites. Orbiting every 102 minutes, SARSAT satellites are positioned at 528 miles above the Earth. COSPAS satellites are at an altitude of 621



Your scanner brings in plenty of SAR action on the maritime channels. (US Coast Guard photo)



Air/ground communications are a staple of almost all SAR operations. (US Coast Guard photo)

miles and circle every 105 minutes. SARSAT and COSPAS satellites monitor 121.5 and 406.025 MHz. SARSAT also monitors 243.0 MHz. They sense when an emergency beacon sends a signal and can then download that information to ground facilities. Using the Doppler shift of the beacon, the satellites determine the location from which the signal is coming. As the satellite approaches the beacon, the frequency appears to become lower. Accuracy is 6 to 12 miles for the 121.5 MHz-unit, and coverage is for about half of the Earth. The 406.025-MHz unit has a 1-to-3 mile accuracy and covers the entire Earth.

Each 406-MHz EPIRB-S transmitter sends out a unique 15-digit code, identifying its nationality and giving other vital information. That information is automatically retransmitted as a data burst every 50 sec-

TABLE 1—VHF/UHF SCANNING GUIDE

30.45 MHz	US Army Nuclear/Chemical Accident Incident Control
34.01 MHz	US Coast Guard operations
34.90 MHz	US Army Nuclear/Chemical Accident Incident Control
40.50 MHz	US Army/Navy SAR
117.975 MHz	National Parks Service SAR (A/G)
121.5 MHz	Aeronautical Distress Frequency, also rescue and survival beacons as well as ELT, EPIRB-A, EPIRB-B, and EPIRB-S aeronautical and marine emergency beacons
121.935 MHz	National Parks Service SAR (A/G)
121.965 MHz	National Parks Service SAR (A/G)
122.75 MHz	Interplane
122.9 MHz	SAR Training/Practice, also secondarily for SAR operations
123.075 MHz	Interplane (helicopter)
123.1 MHz	Primary VHF SAR operations
123.585 MHz	National Parks Service SAR (A/G)
126.7 MHz	Canadian Coast Guard helicopters (Pacific coastal areas)
128.95 MHz	Interplane (Pacific Ocean)
130.55 MHz	Interplane (Caribbean Sea)
131.8 MHz	Interplane (Atlantic Ocean)
132.015 MHz	National Parks Service SAR (A/G)
138.45 MHz	US Air Force SAR
138.75 MHz	US Air Force SAR
143.28 MHz	US Coast Guard Auxiliary
148.125 MHz	Civil Air Patrol (Secondary)
148.15 MHz	Civil Air Patrol (Primary)
149.5375 MHz	Civil Air Patrol (A/G & Interplane)
149.875 MHz	Civil Air Patrol (Packet Radio)
150.45 MHz	Nuclear Emergency Search Team
155.16 MHz	Mountain Area Rescue Squads
156.30 MHz	US Coast Guard operations
156.75 MHz	EPIRB-C rescue beacons
156.80 MHz	Maritime Distress Frequency, also EPIRB-C rescue beacons
156.85 MHz	SAR Training/Practice
157.05 MHz	US & Canadian Coast Guard operations
157.075 MHz	US & Canadian Coast Guard operations
157.10 MHz	Coast Guard Liaison Frequency, also SAR Training/Practice
157.125 MHz	Canadian Coast Guard operations
157.15 MHz	US & Canadian Coast Guard operations
157.175 MHz	US Coast Guard Auxiliary, Canadian Coast Guard
161.65 MHz	Canadian Coast Guard operations
161.825 MHz	Canadian Coast Guard operations
161.90 MHz	Canadian Coast Guard operations
162.475 MHz	Canadian Coast Guard operations
163.00 MHz	Nuclear Emergency Search Team
164.025 MHz	Nuclear Emergency Search Team
164.10 MHz	Nuclear Emergency Search Team
164.225 MHz	Nuclear Emergency Search Team
164.2375 MHz	Nuclear Emergency Search Team
164.30 MHz	US Coast Guard (helicopters & shore stations)
164.55 MHz	US Coast Guard (helicopters & shore stations)
164.775 MHz	Nuclear Emergency Search Team
167.825 MHz	Nuclear Emergency Search Team

onds. The information, and the location from which the signals are being transmitted, are dispatched to SAR organizations.

EPIRB-A and EPIRB-B are emergency beacons that operate on 121.5 and 243.0 MHz. An ELT (Emergency Locator Transmitter) is similar to EPIRB-A and EPIRB-B units; it is usually installed in airplanes and survival craft. All can transmit AM voice signals and an unmodulated carrier, as

well as a series of descending audio tones. Keying up on 121.5 or 243 MHz for at least 30 seconds will activate the SRSAT. Type EPIRB-C units operate on 156.75 and 156.80 MHz, sending out an alternating two-tone alarm signal.

It is not at all unusual for misleading emergency beacon signals to be sent out either by accidental activation or as a prank. Fraudulent maritime distress calls have become

TABLE 1—VHF/UHF SCANNING GUIDE

167.85 MHz	Nuclear Emergency Search Team
167.95 MHz	Nuclear Emergency Search Team
167.975 MHz	Nuclear Emergency Search Team
169.60 MHz	Nuclear Emergency Search Team
169.675 MHz	Nuclear Emergency Search Team
172.30 MHz	Nuclear Emergency Search Team
220.8025 MHz	Rescue teams
220.8075 MHz	Rescue teams
220.8125 MHz	Rescue teams
220.8175 MHz	Rescue teams
220.8225 MHz	Rescue teams
220.8275 MHz	Rescue teams
220.8235 MHz	Rescue teams
220.8375 MHz	Rescue teams
220.8425 MHz	Rescue teams
236.0 MHz	US Navy/Air Force Sea Survival Training
237.9 MHz	US Coast Guard operations
240.6 MHz	US Coast Guard operations
241.65 MHz	US Coast Guard operations
242.8 MHz	US Coast Guard (interplane)
243.0 MHz	Military Aeronautical Distress, also ELT, EPIRB-A, and EPIRB-B beacons
251.9 MHz	US Air Force/Navy SAR, also Training/Practice
252.8 MHz	US Air Force/Navy SAR
259.0 MHz	US Air Force SAR
261.3 MHz	Search area marker buoys
263.8 MHz	US Coast Guard operations
275.1 MHz	Search area marker buoys
282.0 MHz	US Coast Guard operations
282.3 MHz	Search area marker buoys
282.8 MHz	Primary UHF SAR Frequency
287.8 MHz	US Coast Guard operations
305.4 MHz	US Air Force Direction Finding
342.2 MHz	US Coast Guard operations
381.0 MHz	US Air Force SAR
381.7 MHz	US Coast Guard operations
381.8 MHz	US Coast Guard (Primary UHF helicopter frequency)
383.9 MHz	US Coast Guard operations
386.5 MHz	US Navy SAR
406.025 MHz	EPIRB-S rescue beacons
408.5125 MHz	FEMA Urban SAR Teams
409.4875 MHz	FEMA Urban SAR Teams
410.4875 MHz	FEMA Urban SAR Teams
410.5125 MHz	FEMA Urban SAR Teams
410.80 MHz	Nuclear Emergency Search Team
413.2125 MHz	FEMA Urban SAR Teams
416.0375 MHz	FEMA Urban SAR Teams
416.8125 MHz	FEMA Urban SAR Teams
416.9375 MHz	FEMA Urban SAR Teams
417.5875 MHz	FEMA Urban SAR Teams
417.6625 MHz	FEMA Urban SAR Teams
457.525 MHz	Shipboard survival handheld radios
462.675 MHz	REACT and other rescue teams

all too common on 156.80 MHz. Such unfortunate false alarms have at times triggered sincere SAR attempts, serving only to endanger personnel and equipment, waste time and effort, and degrade the efficiency of SAR activities. Yet, even false alarms generate communications that are interesting to monitor.

VHF/UHF Monitoring. A scanner offers many and diverse exciting

monitoring opportunities in the realm of SAR operations. Listed here is a selection of the more interesting national frequencies on which you'll want to be certain to "watch" for activity, although not all will produce results in your specific area.

You'll note representative frequencies from the military services as well as Civil Air Patrol, the Department of Energy's Nuclear Emergency Search Team, FEMA's



SAR communications and distress calls may be monitored on many frequencies located throughout the communications spectrum. You can monitor with a communications receiver and a scanner! (US Coast Guard photo)



A HH-65 Dolphin helicopter heads out on its next SAR assignment. Will you be monitoring? (US Coast Guard photo)

Urban Search and Rescue Teams, REACT, etc., as well as the new narrow-band channels assigned in the 220-MHz band.

Communications are FM mode, except for those in the 117.0-139.0- and 225.0-399.975- MHz bands (which are AM mode). SAR activities you can monitor on a scanner include air/ground (A/G) as well as interplane, intership, ship/shore, handheld portable, land mobile, and point-to-point communications.

An outside-mounted antenna is always a plus for your scanner, and should allow you to monitor stations located at considerable distances from your station, especially those airborne communications. Another worthwhile monitoring aid would be an RF preamplifier to significantly boost the strength of any weak incoming signals on frequencies above 100 MHz.

Our suggestion is to program as many of these frequencies into your scanner as you have available memory slots. From the descriptions here, you may be able to determine which will be most or least likely to produce results for you. As time passes, you can isolate those you want to keep for permanent installation in your scanner's memory. ■

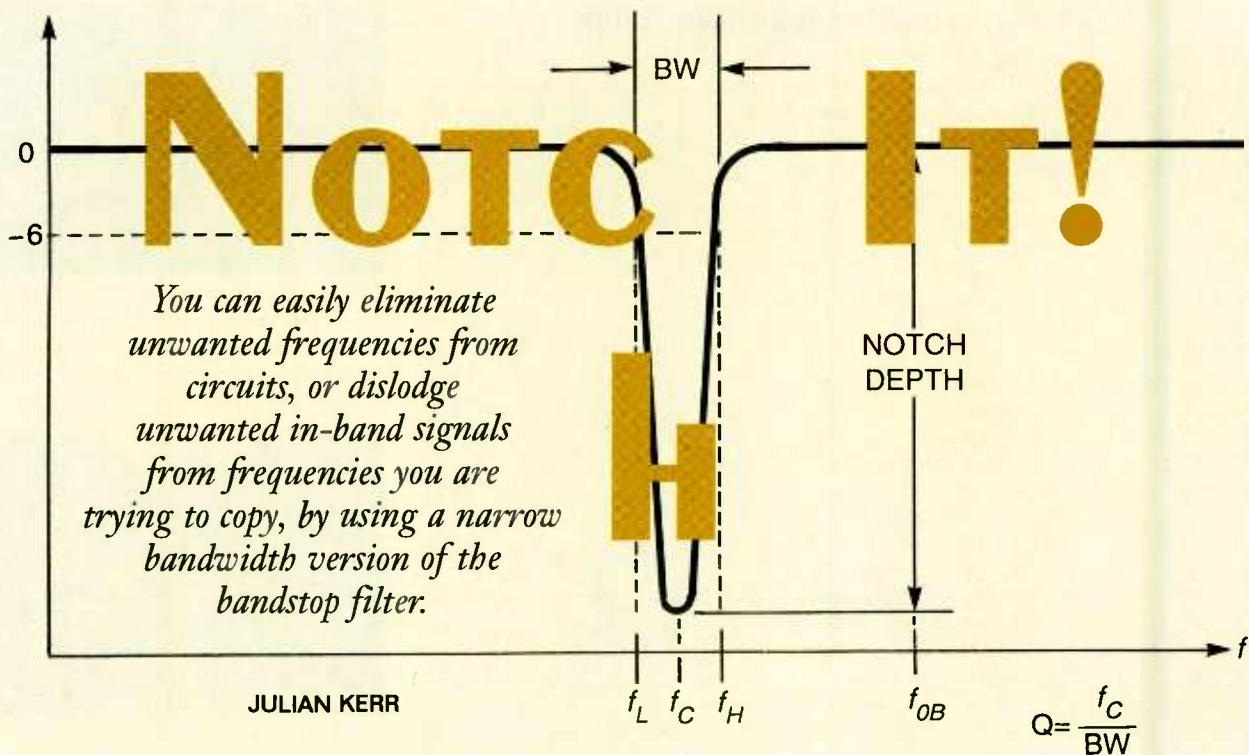

Anyone who builds or experiments with electronics circuits has at one time or another been faced with the problem of removing unwanted frequencies from the signal of interest. In most cases, a simple low-pass, high-pass, bandpass, or band-reject filter will suffice. Such filters are great for blocking entire bands of frequencies, but what do you do when the offending frequency is within the band of interest?

I recently encountered just such a dilemma while experimenting with a circuit that was designed to operate below 500 Hz. Because of the circuit's design parameters, a 60-Hz, AC-hum problem soon became apparent. Aside from 60-Hz, AC hum, interfering in-band signals can also be induced by oscillators, motors, or other signal-generating devices used in (or near) the circuit. The signals from such sources are often difficult to suppress, particularly if the interfering signals are of greater power than the frequencies that they intrude upon, or if errors were made in laying out the circuit. One way to eliminate unwanted in-band interference is with a notch filter.

Notch Filters. A notch filter is functionally similar to a bandstop or band-reject filter in that it is designed to arrest a particular band of frequencies. But unlike the bandstop/reject filter, the notch filter has a very narrow rejection band. Its rejection band is focused around the center frequency (f_C) of the circuit. The frequency response for a notch filter is shown in Fig. 1. The bandwidth (BW) of such a filter is the difference between the frequencies at the two -6 dB points (f_L and f_H) when the out-of-notch response is at the reference 0-dB point. The filters bandwidth is given by: $f_H - f_L$.

The sharpness or "Q" of a notch filter—a measure of the narrowness of the filter's bandwidth—is defined as the ratio of the center frequency (f_C) to bandwidth. The Q of a notch filter is given by:

$$Q = \frac{f_C}{BW} \quad (1)$$

For instance, a notch filter that's centered on 60 Hz and has -6 dB points at 58 and 62 Hz (a 4 Hz-bandwidth) has a Q of 60/4 or 15.

The notch filter does not entirely remove the offending signal; instead, it greatly suppresses the

offending signal, thereby reducing its presence in the affected band of frequencies. The degree of suppression, called the notch depth (see Fig. 1), is defined by the ratio of the gain of the circuit at an out-of-notch frequency (e.g., f_{OB}) to the gain at the notch frequency. Assuming that the input signal levels at both frequencies are equal, the notch depth can be calculated from the output voltages of the filter at the two different frequencies using:

$$\text{Notch Depth} = 20 \log_{10} \left(\frac{V_{fc}}{V_{ob}} \right) \quad (2)$$

Notch depths of -40 to -60 dB are relatively easy to achieve with proper circuit design and component selection.

Twin-Tee Filter Networks. One of the most popular forms of notch filter is the twin-tee filter. An example of a twin-tee filter is shown in Fig. 2. As its name implies, the circuit is comprised of a pair of T-networks. In our example, the T-networks consist of $C1/C3/R2$ and $R1/R3/C2$. The center frequency of the network is given by:

$$f_C = \frac{1}{2\pi} \sqrt{\frac{C1 + C3}{(C1)(C2)(C3)(R1)(R3)}} \quad (3)$$

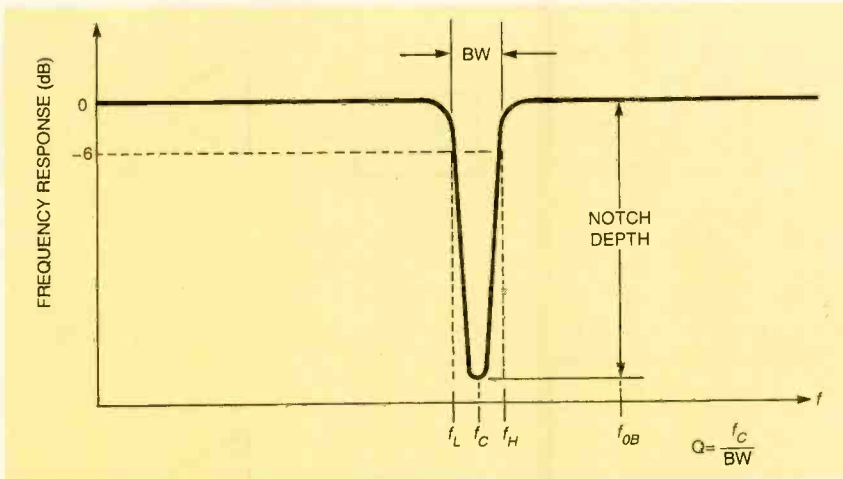
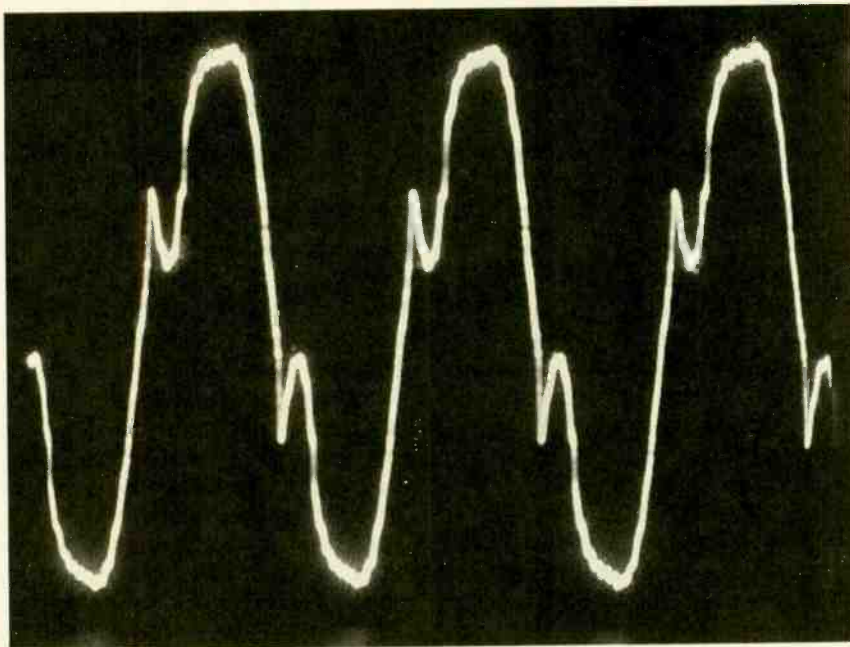

Fig. 1. The frequency response for a notch filter is shown here. The function of the notch filter is similar to that of a bandstop or band-reject filter. But unlike the bandstop/reject filter, which is designed to block a whole range of frequencies, the notch filter has a very narrow rejection band.



Here is an example of the 60-Hz hum found in one of my projects and recorded on an oscilloscope.

That expression can be simplified by adopting a convention that calls for the following relationships: $C1 = C3 = C$; $R1 = R3 = R$; $C2 = 2C$; and $R2 = R/2$. If that convention is adopted, then the equation can be reduced to:

$$f_C = \frac{1}{2\pi RC} \quad (4)$$

where f_C is the filter's center frequency in hertz (Hz), R is resistance in ohms, and C is capacitance in farads. Be sure to use the right units when working the problems, i.e., 10,000 ohms for 10 kilohms or 1×10^{-9} for 0.001 μF .

In designing a filter, it is wise to first select a capacitor value and then calculate the required resistance. That's done because there are many more standard resistance values than capacitance values. Besides potentiometers can be easily used to trim the values of resistances; it is more difficult to use trimmer capacitors for the same purpose. For 60-Hz filters, some common values for resistor R and C are:

CAPACITANCE (μF)	RESISTANCE (Ω)
0.001	2,652,582
0.01	265,258
0.15	17,684

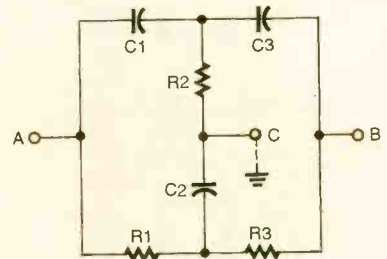

Fig. 2. The twin-tee filter (shown here), one of the most popular forms of notch filter, is comprised of a pair of T-networks, one consisting of $C1/C3/R2$ and the other built around $R1/R3/C2$.

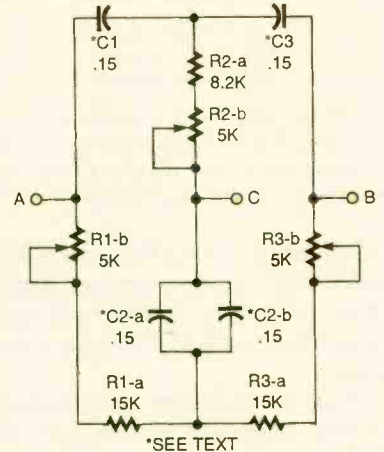

Fig. 3. Here is a 60-Hz twin-tee notch filter that uses potentiometers to tune the filter's central frequency.

There are two factors that govern the notch depth of the twin-tee filter. One of the factors is the values of the components; they must be very close to the calculated values. The other determining factor is that the two filters must be closely matched to one another. For example, let's say that a 60-Hz notch filter was assembled using 0.15- μF -capacitor and 17,684-ohm resistor values, and that the capacitors were randomly selected from among a group of a dozen or so good-quality units, while the resistors were 18k, 5% metal-film units. The notch depth at 60 Hz was only 10 dB, but at 58 Hz, it was 48 dB. Obviously, there was a mismatch, which caused a significant shift in notch frequency.

Now let's suppose that a second filter was built using the same values. In this case, the 0.15- μF capacitors were selected from about 20 on hand. In order to match the capacitors as close as possible, each was measured using a capacitance

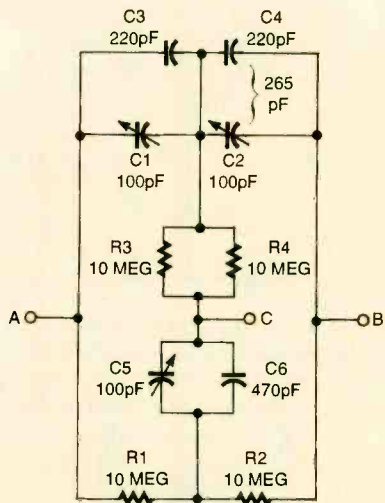

Fig. 4. Another form of adjustable circuit is shown here. This one differs from the one in Fig. 3 in that it uses trimmer capacitors rather than potentiometers as the adjustable element.

meter. The reason for that was to find those that closely matched each other, and only incidentally how close they come to the calculated value.

Errors in the mean capacitance of the selected group can be trimmed out using a potentiometer instead of resistors in the twin-tee network. Figure 3 shows a 60-Hz twin-tee notch filter wherein potentiometers are used to tune the filter's central frequency. Each potentiometer in that circuit must be adjusted several times to null the output signal, stopping when there is no further suppression of the output signal.

An oscilloscope or AC voltmeter, along with a well-calibrated signal source, can be used to check the operation of circuit. If you are unsure as to the accuracy of the signal source, a frequency counter can be used to monitor the signal-source output. (Keep in mind that in our example, a shift of only 2-Hz produced a 38-dB difference in notch depth!)

Another form of adjustable circuit is shown in Fig. 4. Although, it is similar to the circuit in Fig. 3, this one uses trimmer capacitors rather than potentiometers as the adjustable element. In the Fig. 4 circuit, four capacitors (two fixed and two variable, C1-C4) combine to form an equivalent capacitance of 265 pF. The capacitor combination allows the circuit to be adjusted above

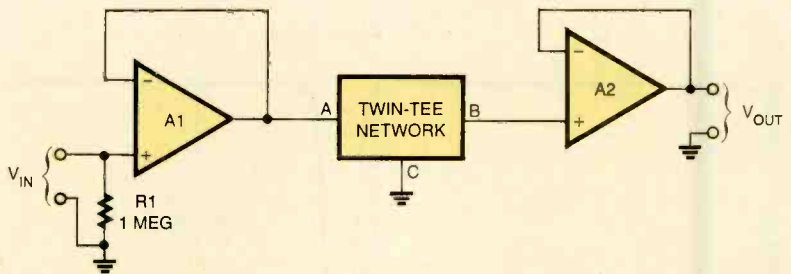

Fig. 5. Shown here is a basic active twin-tee filter. In this circuit, the basic twin-tee network is cascaded with input- and output-buffer amplifiers.

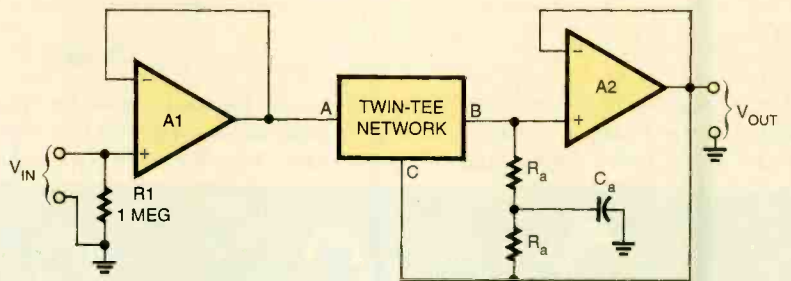

Fig. 6. Altering the active twin-tee circuit as shown here produces a filter circuit with superior characteristics.

and below the design value by a margin sufficient to cancel out any tolerance problems.

The 10-megohm resistors specified should be matched to each other using an ohmmeter. Again, the goal is to match the resistor values as close as possible to each other, and only incidentally close to the design value. It is desirable that the resistance values be exactly equal; failing that, they should be as closely matched as possible. The difference between their mean value and the design value can then be trimmed out via the variable capacitor.

The performance of the twin-tee filter can be vastly improved by incorporating one or more op-amps into the filter's design, turning the basic circuit into an active twin-tee filter.

Active Twin-Tee Notch Filters.

Active filters are simply filter networks that use one or more active devices (such as op-amps) in their design. Figure 5 shows a basic active twin-tee filter, wherein the basic twin-tee network is cascaded with input- (optional) and output- (required) buffer amplifiers. Note that in Fig. 5 and subsequent active twin-tee filter schematics, the "twin-tee" net-

works, which are identical to the previous networks, are shown as functional blocks for the sake of simplicity. Be aware that points "A," "B," and "C" represent the same positions as in the previous illustrations. The buffer amplifiers, both of which are configured as unity gain, non-inverting voltage followers, isolate the filter network from the outside world. For low-frequency applications, 741, 1458, and similar devices can be used. For higher frequency applications—i.e., circuits with an upper cut-off frequency above 3 kHz—non-frequency-compensated devices, such as the CA-3130 or CA-3140, can be used.

Altering the active twin-tee circuit in Fig. 5 as shown in Fig. 6 produces a filter circuit with superior characteristics. In the Fig. 6 circuit, port-C of the twin-tee network (the common point) is connected to the output terminal of the output buffer amplifier. There is also a feedback network consisting of two resistors (R_a) and a capacitor (C_a). The values of R and C in the twin-tee network are found from Eq. 4, while the values of R_a and C_a are found from:

$$R_a = 2RQ \quad (5)$$

and

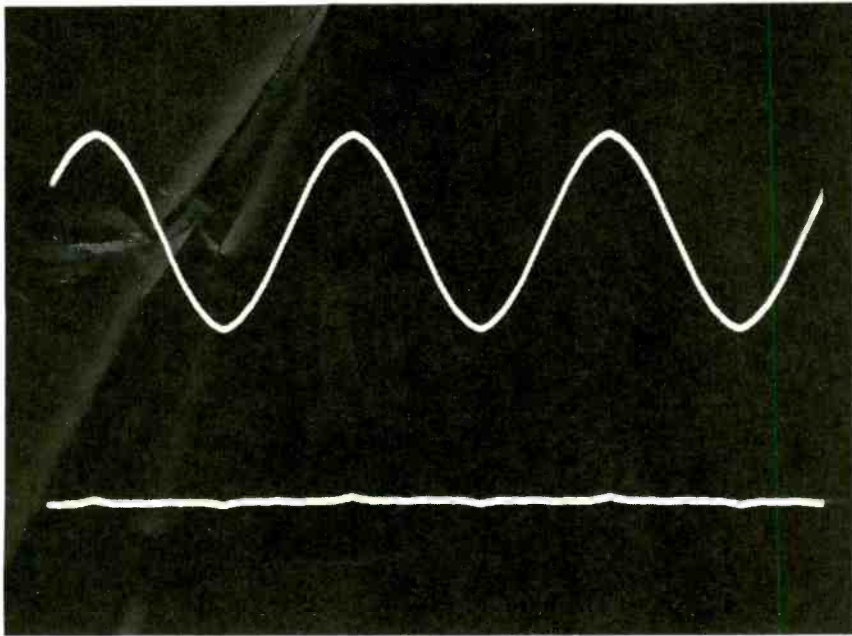

Shown here is the input (upper) and output (lower) traces for a signal that was on a frequency of precisely 60 Hz.

FOR FURTHER READING

IC User's Casebook

Joseph J. Carr
Howard W. Sams & Co.
(Indianapolis, IN, 1988);
Cat. No. 22488

Integrated Electronics

Harcourt, Brace, Jovanovich
Technology Publications
(San Diego, CA, 1990)

IC Op-Amp Cookbook

Walter G. Jung
Howard W. Sams & Co.
(Indianapolis, IN, 1974)

Handbook of Operational Amplifier Circuit Design

David F. Stout and Milton Kaufman
McGraw-Hill
(New York, 1976)

5. Select R_Q : $R_Q = 2QR = (2)(8)(265,392 \text{ ohms}) = 4.24 \text{ megohms}$.

6. Select $C_Q = C/Q = 0.01 \mu\text{F}/8 = 0.0013 \mu\text{F}$.

When the circuit in Fig. 6 was built using the twin-tee network of Fig. 3, with potentiometers for adjustments, the null was close to -48-dB deep.

Figure 7 shows two variations on the Fig. 6 circuit. Figure 7A shows the addition of a notch-depth control (R_2), consisting of a 5k potentiometer in a feedback loop connected between the output of amplifier A2 and the input port of the twin-tee network. An active twin-tee filter with variable Q control is shown in Fig. 7B. In that circuit, a non-inverting follower (A3) is connected in the feedback loop in place of R_Q and C_Q . The Q of the notch is set by the position of R1, the 10k potentiometer. The Q of that circuit can be adjusted from 1 to 50.

Other Approaches. The twin-tee filter is not the only possible approach to making a notch filter. In Fig. 8A we see a circuit (in block form) in which the responses of a high-pass filter (HPF) and a low-pass filter (LPF) are overlapped. The two filters, which may be active filters in their own right, are connected in parallel, with their outputs summed together in a two-input inverting follower amplifier (A2). The gain of that circuit is -1, unless the HPF and LPF sections have either gain or loss in their own right.

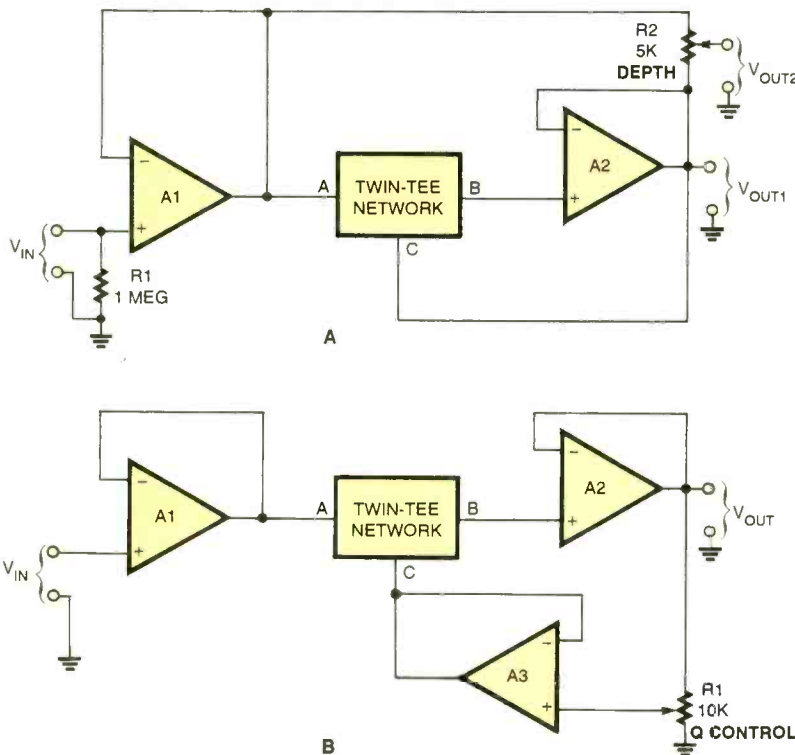

Fig. 7. Shown here are two variations on the circuit in Fig. 6. The circuit in A incorporates an additional notch-depth control; the circuit in B has a feedback loop connected from the output of A2 to the input of the twin-tee network.

$$C_Q = \frac{C}{Q} \quad (6)$$

For example, let's design a 60-Hz notch filter with a Q of 8.

1. Select a trial value for C of $0.01 \mu\text{F}$.

2. Calculate the value of R from Eq. 4, which works out to 265,392 ohms.

3. Calculate $R/2$: $265,392/2 = 132,696 \text{ ohms}$.

4. $C_2 = 2C = (2)(0.01 \mu\text{F}) = 0.02 \mu\text{F}$.

SURFACE-MOUNT

(continued from page 36)

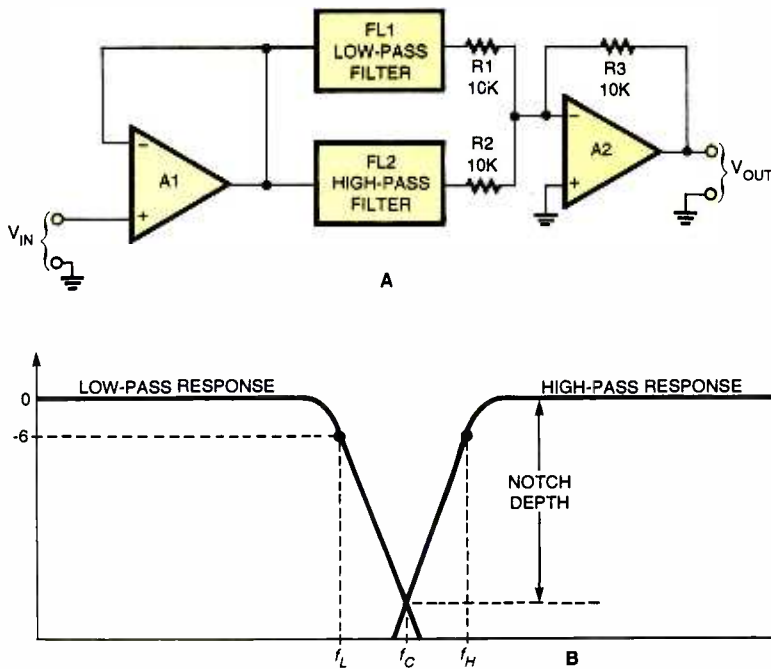

Fig. 8. The twin-tee filter is not the only possible approach to making a notch filter. Shown in A is a circuit that is comprised of both high-pass and low-pass filters, which together function as a notch filter. The overlapping frequency responses of the circuit are shown in B.

The overlapping frequency responses of the circuit are shown in Fig. 8B. The lower notch frequency (f_L) is the -6 dB frequency of the low-pass filter, while the upper notch frequency (f_H) is the -6 dB frequency of the high-pass filter. The depth of the notch is set by the point where the responses of the high-pass and low-pass filters cross.

The notch filter of Fig. 8A is often implemented using a single state-variable filter, because those types of active filters have both low-pass and high-pass outputs.

Another approach to the notch filter is shown in Fig. 9. That circuit is sometimes called the active-inductor, notch filter. The notch frequency for that circuit is set by:

$$f_C = \frac{1}{2\pi\sqrt{R_a R_b C_a C_b}} \quad (7)$$

Equation (7) can be simplified to

$$f_C = \frac{1}{2\pi R \sqrt{C_a C_b}} \quad (8)$$

If the following conditions are met:

$$\frac{R_3}{R_1} = \frac{R_2}{R_a + R_b} = \frac{R_2}{2R} \quad (9)$$

It is possible to use any one of the elements, C_a , C_b , R_a , or R_b , to

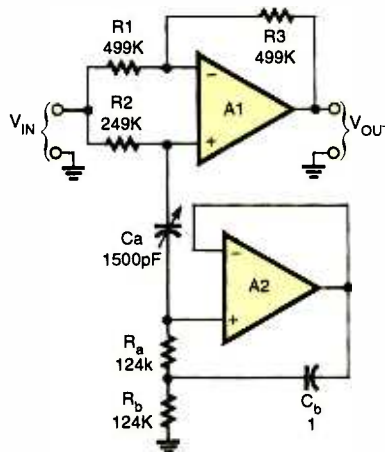

Fig. 9. Sometimes called the active-inductor, notch filter, this variation of the notch filter can be varied via C_a .

tune the filter. In most cases, C_a is made variable and C_b is a large value-fixed capacitor. The 1500-pF variable capacitor can be made by paralleling all sections of a three-section broadcast variable, with a single small fixed or trimmer capacitor.

Conclusion. Unwanted signals, such as 60-Hz interference, as well as other extraneous signals are a pain in the transistor, but they are also quite easy to get rid of using ordinary notch-filter circuits. ■

construction project. At this point, the modules are treated as any other electronics component.

Note: Connections between SIP-7 and the speaker jacks should be handled through twisted wire. For the best performance, single-conductor, shielded cable is recommended for the input and volume controls.

Next, select an enclosure for the project and determine where on the front and rear panels the on-board components will be placed. The project can be housed in a small aluminum enclosure, like RadioShack part #270-253. Place the front-panel components so that they are neat and easily accessible.

The power transformer (T1) was selected, because the combined total-current draw of the modules amounts to less than 100 mA. In addition, the unit's small dimensions allow a smaller enclosure to be used to house the project.

The project can be expanded as you see fit; remember, your imagination is the only limiting factor.

SIP Construction Contest. The applications for the SIPs are really unlimited, and we're very interested in what you are able to come up with. So, we've come up with a little contest. Design some type of audio circuit built around the SIP modules. Send your design to: SIP Contest, **Popular Electronics**, 500 Bl-County Blvd., Farmingdale, NY 11735. If your design is publishable, we'll present your design to our readers and pay the author of the winning entry our regular rates for an article. On the other hand, if your design is presented as a part of a SIP-circuits article, we'll pay each contributor \$50 for their design. If there are similar entries, the one with the earliest postmark will be selected.

Table 1 list the prices for the individual SIPs in kit form or fully assembled. The Parts Lists gives additional SIP ordering information.

Hope you like the Auctioneer's Amplifier project. ■

NEW PRODUCTS

CLAMP-ON METER

Addressing the requirements of both the electrical contractor and the HVAC technician, the *ACDC-620T Clamp-On Meter* is the first such meter to contain true RMS AC and DC amperage; true RMS AC and DC voltage; temperature (with optional thermocouple); and differential temperature, capacitance, and resistance measurement capabilities. Measurement ranges are up to 1000A for AC and DC current, up to 1000V for AC and DC voltage, up to 4000 μ F in capacitance, temperature up to 2502°F (1372°C), and resistance up to 4k-ohms.



The circuitry allows recording of maximum, minimum, and average values of all possible parameters. Peak values of AC voltage and current can also be measured, typically for motor inrush current applications. The jaw's two-inch inside diameter gives the user flexibility in making measurements.

Among features of the ACDC-620T are dual display for temperature readout in both Celsius and Fahrenheit, min/max average recording, overload protection on all ranges, and PEAK-hold with a 1 ms response time. Other features include auto and manual ranging, auto power off, sleep mode, and data hold. There is an audible, as well as visual, continuity indicator; and a low-battery indicator. The LCD display is fully annunciating and offers a 4000-

count, 4-digit readout.

Designed to conform to UL, ULc, TUV, CE, and IEC standards, the *ACDC-620T Clamp-On Meter* comes complete with test leads, carrying case, 9-volt battery, and instruction manual. The meter retails for \$249.95. For more information, contact *Amprobe Instrument*, 630 Merrick Road, P.O. Box 329, Lynbrook, NY 11563; Tel. 516-593-5600; Fax: 516-593-5682.

CIRCLE 80 ON FREE INFORMATION CARD

LOW-PASS FILTERS

Three new low-pass filters were recently introduced by *Progressive Concepts*: *LPF7000*, *LPF7002*, and *LPF7003*. With an ever-increasing number of FM broadcast transmitters being used by professionals and hobbyists alike, there is a greater potential for harmful radio-frequency interference. Most FM transmitters produce harmonics at even multiples of the fundamental frequency. If your harmonics fall on or near a TV channel or maritime frequency, you could cause severe inter-



ference to that channel. Use of a low-pass filter is the best method of eliminating this type of interference.

These filters have a bandpass of 0–108 MHz and offer up to 75 dB of attenuation to harmonic energy in the range of 120–500 MHz. With an insertion loss of less than 0.01 dB, these filters are well-suited for use on power levels as low as 100 mW up to 300 watts. The *LPF7000* is rated at 25 watts maximum, the *LPF7002* at 125 watts, and the *LPF7003* at a maximum input of 300 watts. Input and output impedances are both 50 ohms, and the filters are available with SO-230 "N"-type connectors.

Prices start at \$69. For more information, contact *Progressive Concepts*, P.O. Box 586, Streamwood, IL 60107; Tel. 630-736-9822; Fax: 630-736-0353.

CIRCLE 81 ON FREE INFORMATION CARD

PUZZLE CORNER



© 1998 by Dabble Cybula

ACROSS

- | | |
|------------------------------------|----------------------------------|
| 1 Fold-up bed | 29 Shriveled |
| 4 Popular Internet service (abbr.) | 32 House of prayer |
| 7 Little bit | 33 Fool |
| 10 Football game sound | 34 Typeface |
| 11 Prompt | 35 Clairvoyance |
| 12 Part of a book | 36 Period of time |
| 13 Dined | 38 Likely |
| 14 Airport abbr. | 41 Voiced |
| 15 Computer picture button | 42 The broadcasting of sound |
| 16 Pound | 43 Russian ruler |
| 18 Lendel of tennis | 46 Major League Baseball (abbr.) |
| 20 Compass point | 48 Young man |
| 21 Napkin fabric | 49 Dinner drink |
| 23 Point | 50 Arthur, of Maude |
| 26 What Sinatra does | 51 Once ___ while |
| 27 Father of Radio, Nikola | 52 Total |

- 53 Canadian province (abbr)
54 Lad

DOWN

- 1 Large wooden box
2 Vows
3 That place
4 Playing card
5 Family vacation
6 Depart
7 Tic-___-Toe
8 In the past
9 Play room
12 Metal fastener
17 Car signal
19 Picks up/radiates signals
22 Writing liquid
23 Viper
24 Sick
25 Actress West
26 Attack
28 Emerg. Med. Tech.
29 Saint (female)
30 Baseball stats.
31 Tear
32 Listen ___ me
34 Collapsed
37 Stallone role
38 Improvise
39 Musical keyboard
40 Present time
41 A mineral
43 Airline (abbr.)
44 Comic Caesar
45 Conjunction
47 Flying mammal
(Solution appears on page 66)

ELECTRONICS LIBRARY

TEACH YOURSELF ELECTRICITY AND ELECTRONICS: 2ND EDITION

by Stan Gibilisco

This book has become the standard introduction to the essentials of electricity and electronics for everyone from students to hobbyists to technicians. The field's most comprehensive, user-friendly, self-teaching guide has been updated with new chapters on cutting-edge technologies, bringing the reader practical information on wireless technologies, computers, and the Internet.

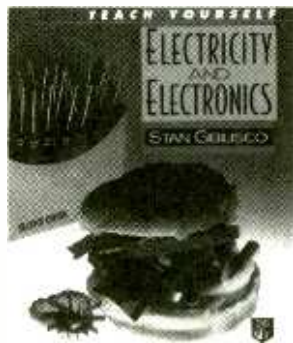

Subjects covered range from DC and AC concepts to semiconductors and integrated circuits. Assuming no prior background in electronics, this guide features a conversational writing style, quizzes, self-tests, and more than 500 illustrations. After mastering the concepts explained in the text, readers will understand how to make simple current-voltage-resistance determinations, accurately calculate power and impedance, determine waveform combinations, design basic electronic circuits, and optimize circuit efficiency.

The book also provides information on cellular communications, transducers, wireless LANs and security systems, microprocessors, and cyberspace.

Teach Yourself Electricity and Electronics: 2nd Edition costs \$34.95 and is published by Tab, McGraw-Hill, Inc., 11 West 19th St., New York, NY 10011; Tel. 800-2MCGRAW or 212-337-5951; Web: www.tabelectronics.com.

CIRCLE 90 ON FREE INFORMATION CARD

SHORT WAVE LISTENING GUIDE

by Ian Poole

Providing a thorough introduction for radio amateurs who are interested in the traditional area of shortwave listening, this book is full of practical information. It explains exactly what shortwave listening is, how radio waves travel, what equipment is needed, how to set up and run a shortwave listening station, and how to obtain an amateur-radio license.

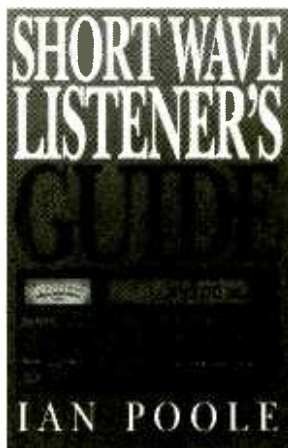

Each topic is clearly explained and illustrated. There's a description of wave propagation by all modes relevant to the HF bands. Various types of transmissions which can be encountered on the short wave band are explored: Morse, amplitude modulation, single sideband, frequency modulation, data modes including RTTY, packet, and AMTOR.

Practical considerations for shortwave listening are also discussed, from buying new or second-hand equipment, making and erecting an aerial, to selecting ancillary equipment to enhance the operation of receivers and aeriels.

BooksNow To order books in this magazine or, any book in print. Please call anytime day or night: (800) **BOOKS-NOW (266-5766)** or (801) 261-1187 ask for ext. 1456 or visit on the web at <http://www.BooksNow.com/popular-electronics.htm>.

Free catalogs are *not* available.

Short Wave Listener's Guide costs \$28.95 and is published by Newnes, Butterworth-Heinemann, 225 Wildwood Avenue, Unit B, P.O. Box 4500, Woburn, MA 01801-2041; Tel. 617-928-2500; Web: www.bh.com/newnes.

CIRCLE 91 ON FREE INFORMATION CARD

THE ARRL OPERATING MANUAL: 6th Edition

from The American Radio Relay League

The sixth edition of this book has everything needed to operate a ham station. The scope of ham radio has widened to include using satellites, computer software, repeaters, and the Internet and the scope of the book has widened to cover these areas.

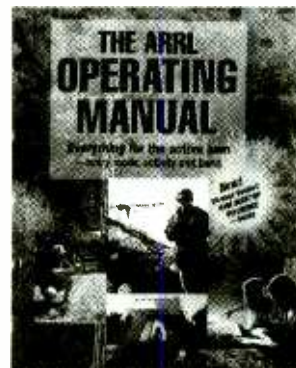

Among the additions and revisions are completely new chapters on DXing and on the Internet, a revised SWL chapter, and updated operating and reference information on contests, satellites, and APRS, VHF/UHF. There is also a 24-page Ham Desktop Reference booklet included, with all the most frequently referred to charts and tables: band plans, beam headings, WAS map, third-party traffic countries, Q-signals, CW abbreviations, W1AW schedule, and QSL bureaus.

The ARRL Operating Manual costs \$25 and is published by The American Radio Relay League, 225 Main Street, Newington, CT 06111-1494; Tel. 888-277-5289 or 860-594-0200; Fax: 860-594-0259; Web: www.arrl.org.

CIRCLE 92 ON FREE INFORMATION CARD

(Continued on page 48)

SCANNER SCENE

Time to Pack Your Trunk, Again!

MARC SAXON

Only last month we were discussing the increasing popularity of trunked 800-MHz communications systems and listing the new scanners designed to monitor them. Now here comes *RadioShack* to add yet another one of these specialized scanners to their product line.

This one is the *PRO-2050*, a desk-top *TrunkTracker*-unit. You'll recall that *RadioShack* previously brought out a handheld *TrunkTracker*. The new *PRO-2050* provides 300 user-programmable memory channels arranged in ten banks of 30 channels each. A duplicate channel alert warns you when the frequency you are storing already exists in the unit's memory.

It has the capability to scan conventional analog two-way communications. In addition, it can track *Motorola* Type I, Type II (such as *Smartnet* and *Privacy Plus*), and hybrid trunked systems in the 800-MHz band. In its trunking mode, the *PRO-2050* will easily follow a conversation as it quickly switches from one frequency to another within the group of channels used by a trunked system licensee.

The *PRO-2050* scans at 50 channels/second, and can search from 100 to 300 frequencies/second. The generous frequency coverage runs from 29.00–54.00 MHz, 137.00–174.00 MHz, 406.00–512.00 MHz, and 806.00–956.00 MHz (except for the cellular bands), plus the 108.00–137.00 MHz VHF aeronautical band. This triple-conversion receiver has its first IF at approximately 380.6 MHz, its second IF at 10.85 MHz, and its third IF at 450 kHz. The sensitivity is 0.5 μV below 174 MHz, 0.4 μV in the 406–512 MHz range, 1.0 μV above 806 MHz, and 1.5 μV in the VHF aeronautical band.

There are five pre-programmed service-search banks that allow instant searching of public service, police, fire/emergency, aeronautical, and weather channels. When in its service-search mode, the scanner may be personally programmed to skip over any 20 channels. During regular searches, the user may select an additional 50 frequen-



In its trunking mode, the PRO-2050, a desk-top TrunkTracker-unit from RadioShack will easily follow a conversation as it quickly switches from one frequency to another within the group of channels used by a trunked system licensee.

cies to skip. It can also be set to skip over data or unmodulated signals.

Get a look at the new *PRO-2050* at any *RadioShack* store.

FULL COVERAGE OF THE 800-MHZ BAND

A new reader asked where he can purchase a scanner having full coverage of all frequencies in the 800-MHz band. He observes that stores don't carry them. No, it's been a while since the FCC's edict that scanners made after April of 1994 had to be produced minus the ability to receive the two cel-

lular bands and couldn't be user-modified to restore that function.

At this point, it appears that the best way to obtain a full coverage 800-MHz scanner is via the second-hand equipment route. But note that this brings in several considerations, including the fact that even pre-1994 scanners usually required some very minor internal modification to restore full 800-MHz coverage. Yet, some few models resisted being modified for full 800-MHz coverage.

Your best bet would be to get a list of some of those scanners that lent

themselves to modification, and then seek them out in good used condition at communications shops, swap meets, or in hobby publications. If the modification hasn't been done yet, do it yourself using one of the excellent manuals commercially available (such as are listed on the Web at: www.crbbooks.com).

In my opinion, the best pre-1994 desk-top scanners that could be readily converted for full 800-MHz coverage include the *RadioShack* PRO-2004, PRO-2005, and PRO-2006.

INSURING COLLECTIBLES

Speaking of older scanners, O.W. Stridiron of Indiana writes that he has been collecting what he calls "numerous historic scanners" dating back to 1968. These include examples from *Tennelec*, *Robyn*, *Sonar*, *Regency*, *Electra*, and others from bygone days. He guesses this collection is worth a lot of money, so he would like to get it insured. However, he doesn't believe his homeowner's policy would cover it. He asks if we have any suggestions.

Many hobbyists now collect pre-1980 scanners (and CB radios) as an investment. They often turn up inexpensively at flea markets, hamfests, and attic sales; yet on the collecting market, some makes and models are worth big bucks. You should be able to obtain insurance on this collection as fine arts/antiques at replacement cost (subject to a deductible) as part of your homeowner's policy.

I'm told that you'll need to furnish a list of the scanners in your collection along with their serial numbers and appraised replacement values. It would probably be useful to videotape or at least take still photos of the scanners. Should you want additional coverage, it shouldn't cost more than about 1 percent of the total appraised value. So, if your collection is worth \$10,000, it would cost no more than \$100 per year to insure. If there's a loss, the insurer will attempt to replace the items rather than pay you for them. Only in the event that they cannot be replaced would payment be made.

AUDITING AUDITORS

A taxing inquiry was received from an anonymous Texan who asks if we can supply any frequencies used by the Criminal Investigation Division of the IRS. So far as we have been able

to determine, the following simplex and repeater output frequencies are used nationally: 415.00, 415.725, 418.175, 418.20, and 418.225 MHz. Note, though, that these folks can probably also operate on the communications frequencies of other federal agencies (such as the DEA) during combined tactical operations.

MORE MAILBAG MATTERS

According to *The Radio Monitor's Newsletter of Maryland (RMNM)*, DC Army National Guard helicopters (from Davison AAF) are being used in the National Capital area to augment federal and Washington Metro Police units in squelching drugs. During these operations, the helicopters use the tactical ID RAID (*Reconnaissance And Interdiction Detachment*) and operate into a repeater that has its output on the odd channel of 161.00 MHz (input frequency is 158.00 MHz). For more information on *RMNM*, write to them at P.O. Box 394, Hampstead, MD 21074-0394, or drop an e-mail to: RBscan@aol.com.

We receive at least two letters per month from those irked by their desk-top-scanners advising that the 9-volt batteries (intended to retain the units' memories) are drained right after they are installed. Actually the batteries are fine, but the scanner doesn't know that. The problem is a loose battery contact. The scanner's one battery contact that looks like a circular set of prongs needs just a bit of prong-tightening with a pliers to end the problem.

Keep in touch with questions, frequencies, and suggestions. Our e-mail address is: Sigintt@aol.com, or you can write to *Scanner Scene*, **Popular Electronics**, 500 Bi-County Blvd., Farmingdale, NY 11735. ■

ELECTRONICS LIBRARY

(continued from page 46)

1998 IC MASTER CATALOG

from *Hearst Business Communications, Inc.*

Listing the latest product information, these three volumes reference specifications for over 100,000 current ICs, including 13,000 new ones. Using this comprehensive catalog, readers can identify alternate devices and verify manufacturer contact information. The easy-to-use *1998 IC MASTER CATA-*



LOG contains hundreds of manufacturer-supplied supplemental data pages. The updated Alternate Source Directory lists over 120,000 pin-for-pin equivalents, and it includes NTE and Philips ECG parts.

Organized in ten Master Selection Guide, this resource covers base part numbers for all the included ICs. Additional information is provided in the Part Number Index, the Military Parts Directory, the Application Notes Directory, and the Manufacturers & Distributors Directory.

Now there is an unbeatable combination of search tools: the *IC MASTER CATALOG*, the enhanced *1998 IC MASTER CD-ROM for Windows*, and *IC MASTER* online. Subscribers to the catalog (in the printed or CD-ROM version) have access for one year to *IC MASTER* online: <http://icmaster.com>. The Web site offers the complete *IC MASTER* database, which is continuously updated, and includes devices discontinued over the last five years.

The CD-ROM version contains all the product information found in the printed version, plus it covers discontinued ICs—more than 135,000 devices on one disc! Users are able to link to datasheets on IC manufacturer's Web sites for selected devices.

The 1998 IC MASTER CATALOG costs \$195 (the CD-ROM version costs \$235) and is published by *Hearst Business Communications, Inc.*, 645 Stewart Avenue, Garden City, NY 11530; Tel. 516-227-1300; Fax: 516-227-1453; Web: <http://hearstelectroweb.com>.

CIRCLE 93 ON FREE INFORMATION CARD ■

BooksNow

To order books in this magazine or any book in print. Please call anytime day or night: (800) BOOKS-NOW (266-5766) or (801) 261-1187 ask for ext. 1456 or visit on the web at <http://www.BooksNow.com/popularelectronics.htm>.

Free catalogs are not available.

Zeners, Telephones, and Circuits

ALEX BIE

As we continue in our discussion of diodes, we examine a familiar component that is widely used in today's electronic equipment; namely, the Zener diode. Without Zener diodes, power supply designs would be totally different, requiring another means of generating a stable reference voltage. These diodes are now very cheap and widely available, making them ideal for use in a host of circuits.

Diode characteristics

Zener or voltage reference diodes have unique characteristics, see Fig. 1. It can be seen that they conduct like a normal diode in the forward direction. However, in the reverse direction, the diode does not conduct any current until a certain voltage is reached. At this point the diode "breaks down," current is carried, and virtually the same voltage is present across the diode regardless of the amount of current flowing—resulting in a known stable voltage. A series current-limiting resistor, R1, must be placed in the circuit to limit the current to the diode, D1, as shown in Fig. 2.

Although voltage reference diodes are usually called Zener diodes, there are two processes which can give the same effect. The first is called "impact ionization," and the second effect is "Zener breakdown," or "Zener effect." Impact ionization is the predominant effect below about 5.5 volts, whereas Zener effect is the major process above this value. The two phenomena operate in totally different ways. Impact ionization occurs when a high electric field is present in a semiconductor. This causes the electrons to be attracted strongly towards the positive voltage, and in view of the field strength, their velocity increases rapidly. When a high energy electron collides with the lattice of the semiconductor, it can cause an existing

("What is A...?" series by Ian Poole, G3YWX, reprinted by permission from *Practical Wireless*, Arrowsmith Court, Station Approach, Broadstone, Dorset BH18 8PW, England.)

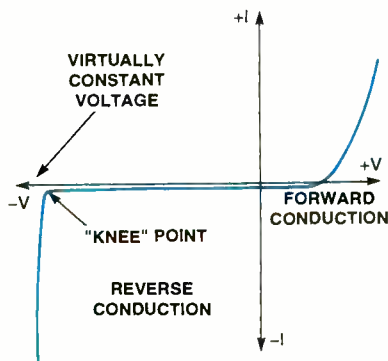

Fig. 1. Characteristics of a Zener or "reference diode."

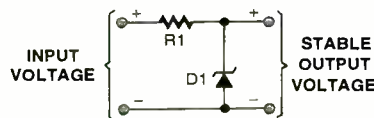

Fig. 2. A basic circuit for use with a Zener or reference diode.

atom to generate an electron hole pair. The electron and hole then migrate in opposite directions because of the field, and the electron may generate further electron hole pairs as the result of another collision. If the field is sufficiently strong, the vast number of collisions means that a large number of new hole electron pairs are generated and what is called "avalanche" breakdown occurs. This happens only when a specific field is exceeded; *i.e.*, when a certain reverse voltage is exceeded for that diode, making it conduct in the reverse direction for a given voltage. This is just what is required for a voltage reference diode.

The Zener effect operates in a different way than in impact ionization. Normally electrons are contained within atoms in the crystal lattice. In this state, they are in what is called the "valence band." If a large electric field is placed across the semiconductor, this may be sufficient to pull the electrons out of the atom into the "conduction band." When they are free from the atom, they are able to conduct electric-

ity—hence the name conduction band. However, for the electrons to pass from the valence band into the conduction band there must be a certain force to pull them free. Once a certain level of electric field is present, a large number of electrons are pulled free. This allows current to suddenly start to flow when a certain reverse voltage is reached.

Voltage Reference

Voltage reference diodes are widely used in electronic circuits. Although seldom used by itself in the basic circuit that is shown in Fig. 2, this configuration is used as part of a larger circuit to ensure that current to the diode remains almost constant and that maximum stability is maintained. Temperature variations must also be borne in mind if a constant voltage is required. Like many other components, particularly semiconductors, the parameters change with temperature.

It is found that Zener diodes with a Zener voltage of around 5.5 volts are most stable. The reason for this is that the temperature coefficients for the two breakdown methods are opposite to one another. At a voltage of 5.5 volts, the coefficients tend to balance one another out, giving the optimum temperature stability.

When designing a circuit, sufficient current must be allowed to flow through the diode. For the standard 500-mW types, currents of a few milliamps are best. If too little current is allowed to flow, the diode will not stabilize properly and an incorrect voltage may result. This has been the cause of many design engineers scratching their heads because the wrong voltage came out of otherwise correctly built circuits!

Easy To Use

Zener voltage regulator diodes (or commonly "reference diodes") are cheap and very easy to use. They come in a variety of sizes. The most common types are capable of dissipating 500 mW of power (for example, the 1N5221-1N5281 series). However,

larger versions are available which can dissipate powers of several watts (e.g., the 1N4728–1N4764, 1-watt series, or the 1N5333–1N5388, 5-watt series). Reference diodes are normally used

for more specialized applications, often in protection circuits. However, for the average home-project builder a selection of the 500-mW versions can be a great advantage just like a good

selection of resistors and capacitors can be for your parts box.

Next month, we will continue our "What is a ...?" series with varactor diodes. Now here's some solutions to readers' questions that have come to our column.

TELEPHONES AS INTERCOMS—ONE APPROACH

In the May column, letters from Al Conforti and Brenden McNeil requested a circuit for using telephones for an intercom. Here's a circuit that I use which works with handsets from old rotary dial phones and not much more. There must be a million of these K500-type phones floating around somewhere—and using only the handset portion is easier than using the complete phone.

The circuit shown in Fig. 3 generates a ring signal when one end is off-hook, similar to a telephone ring— $\frac{1}{2}$ second on and $1\frac{1}{2}$ seconds off. Of course, this can be changed with different timing components with the 555 ICs. Omitting IC1 and IC2, and connecting "A" to "B" and "C" to "D," generates a constant ring that can be coded with a finger on the hook switch. It can be done on either or both ends. This is handy for personal ringing if several people use the same line (i.e., "dit-da" for Al, "da-dit-da" for Kathy, etc.).

Here are some suggestions for parts selection. Resistor R1 must be chosen so that the current flowing between the handsets (path indicated by an "X" in the figure) is 10–20 mA with both ends of the handsets off the hook. Select resistors R4 and R5 for a pleasant ring volume with the piezo buzzers. The ringers chosen are standard items, such as the *RadioShack* 273-060 or 273-066, or similar. The handset switches, S1 and S2, are pushbutton spring-loaded SPDT-types that will operate with the handset weight. Finally the 10–18-volt power supply can be unregulated.

The box to hold the handset and components should be about 3 inches wide by 2 inches deep by 3–5 inches long—big enough and heavy enough to stay put. Mount the buzzer on the side or inside the box—not on the top where it can collect coffee or other foreign matter. Two U-shaped guides on top will keep the handset centered over the hook switch.

—John C. Warren, Glendora, CA

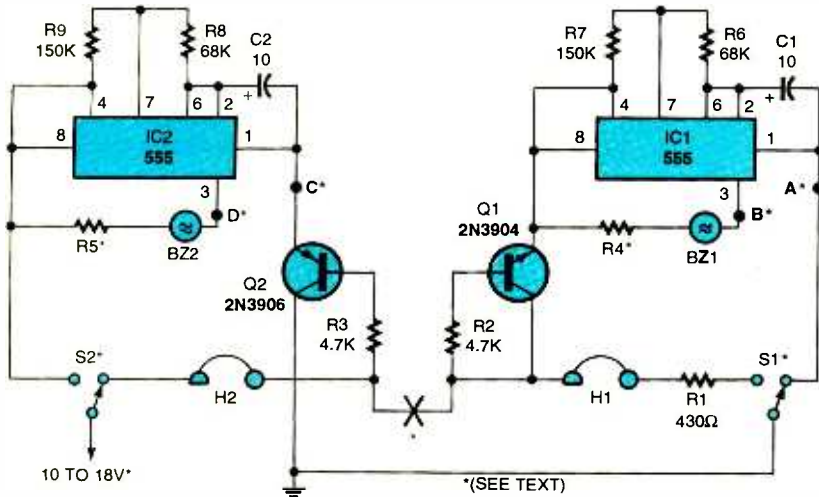
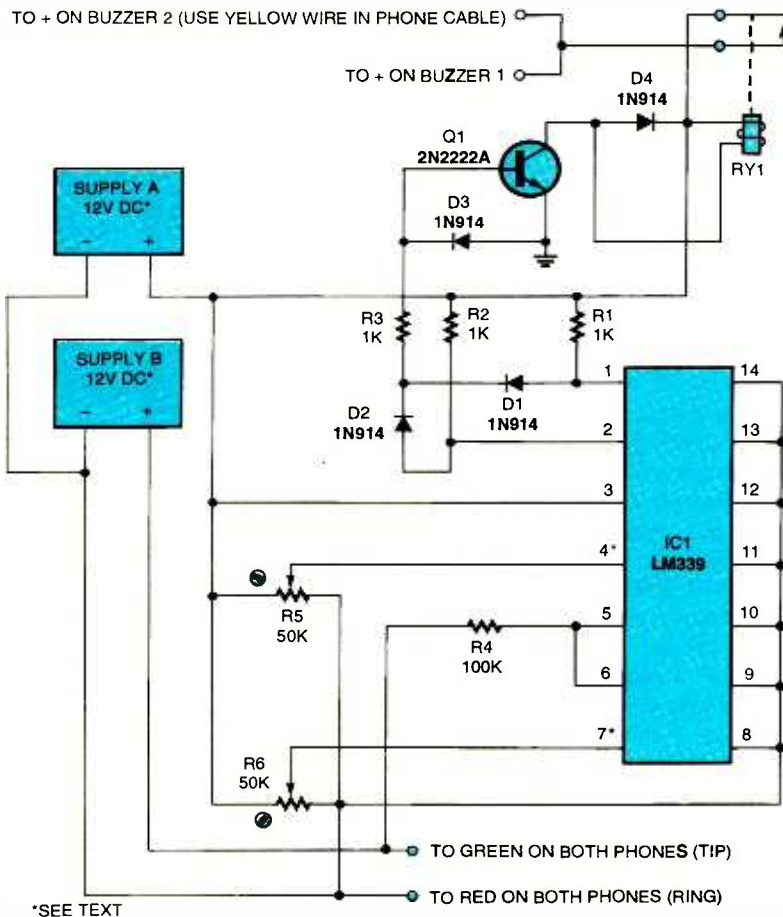

Fig. 3. Here's a useful circuit that works with just the handsets from old telephones to make a very practical intercom system.



Very neat circuit, John. It certainly makes good use of discarded old phones—or at least the handsets. The 555 timers can be found as NTE9555M, SK3564 or RadioShack 276-1723 equivalents. Excellent transistor substitutes for the 2N3904 are the NTE123AP or SK3854; for the 2N3906 use the NTE159 or SK3466.

TELEPHONES AS INTERCOMS— ANOTHER APPROACH

In the May column, requests were made asking how to hook two phones together as an intercom. I have just completed such a project to link my house with my adjacent shop. Hooking up two phones so you can talk is simple—signaling when you want to talk is more difficult! For my project I used two old rotary-dial telephones from a thrift shop. I also picked up a regulated 12-volt dual power supply from a computer (*Editor—if you can't find a cheap dual supply, you can use two inexpensive modular adapters—look in the Marlin P. Jones catalog; Tel. 800-652-6733; part 8637-PD, 12-volt, 1.5 amp module supply*). The design uses two 12 VDC supplies, one to operate the phones, the other for the signal circuit. The circuit shown in Fig. 4 uses only three wires if the power supplies have a common ground. This is important for cost, as the run between my home and shop is over 70 feet.

To hook the phones up to talk, put +12 VDC to the green wire in the phones and negative to the red wire. Each buzzer is connected to the yellow phone wire. (*Editor—In general for most telephones, the green wire is positive line (tip), the red wire is negative line (ring), and the yellow wire is for the bell. This convention may change with different telephones—so check first before wiring it into the circuit*). The signal circuit logically combines the outputs of two of the four comparators in the LM339 quad comparator IC using the 1N914 diodes.

When the sense voltage on pins 5 and 6 is between the upper limit found at pin 4 (set to about 10 volts) and the lower reference limit at pin 7 (set to about 5 volts), the output is low. When the sense voltage is outside this window-range, the output is high, driving transistor Q1 and holding the 12-volt SPDT relay, RY1, on. When one telephone handset is off the hook, the volt-

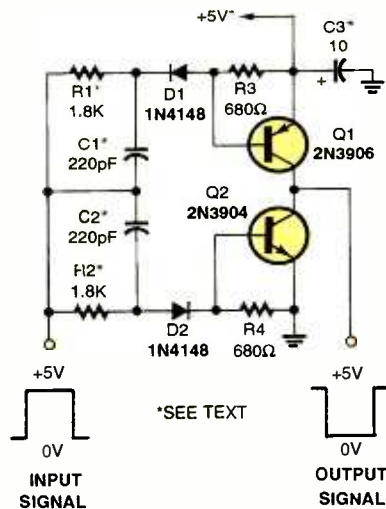

Fig. 5. Here's a neat little interface circuit that functions as a high current complementary buffer/driver.

age supply drops to about 6-1/2 to 7 volts, turning off Q1 and causing RY1's contacts to switch—which sounds the buzzers on both phones. Picking up the second handset causes a further drop to about 4 volts, once again turning on Q1 and with it, the relay and buzzers. For the phone in the house, I installed the buzzer inside its enclosure after removing the original bell. The IC, Q1, buzzers, and relay are readily available from RadioShack. Hope this helps the readers out.

—Dale Edmonds, Hazel Green, AL

Well Dale, you certainly can make good use of old telephones, too. If you have difficulty finding these semiconductors in RadioShack, a good substitute for the LM339 is NTE834 or SK3569, and for the 2N2222A transistor, you can use an NTE123A or SK3444. So readers, let's hope that these circuits satisfy your telephone/intercom needs for the time being!

HIGH CURRENT COMPLEMENTARY BUFFER/DRIVER

I've spent the last year or so refining this "building-block" circuit to provide a fast, high-output current inverting buffer which could be directly interfaced to any type of CMOS logic gate or timing device. This circuit provides rail-to-rail output voltage swings of at least ± 50 to ± 100 mA of current with a propagation delay of less than 10 nanoseconds. The original prototype featured two of these blocks in cascade, interfaced to a

TLC555 CMOS timer chip. Each block produced an inverting function—an inverting output along with a non-inverting output, which were then available without further loading of the TLC555's output. This made a nifty, high-output drive pulse generator!

The new circuit of Fig. 5 is much simpler. However, the circuit function is rather complex. A standard single-transistor saturated-switch, as you already know, is rather slow and can either source or sink high currents, but not both—I required fast switching with sink and source capability.

To accomplish this, I saw that a complementary/symmetry design would be necessary. At first glance, you would expect a short circuit between the complementary transistors, Q1 and Q2, (2N3906 and 2N3904, respectively) due to their polarities. This is true if the input is held at half-way between the supply rails, although the current is limited. However, the circuit is only intended for use with rectangular waveform inputs where only one transistor is "on" for any length of time. Whenever the input state changes, the "off" transistor will turn on and help pull the "on" transistor out of saturation by reverse-biasing the collector-base junction of the "on" transistor. Resistors R3/R4 allow the rapid discharge of its base emitter capacitance, which is isolated from the input by the 1N4148 diodes. Timing components, R1/C1 and R2/C2, allow fast turn-on times with capacitor C3 absorbing the inevitable current glitch between the transistors. Use a good quality tantalum capacitor for C3. Resistors R1 and R2 provide bias currents of 2 mA; namely, 1 mA through each transistor and 1 mA through resistors R3 and R4, when in the "on" state. This is the "key" to rapid turn-off times. The time constant of $R1 \times C1$ (and $R2 \times C2$) is a "magic" number for these particular semiconductors: it should end up between 300 to 400 nanoseconds. For instance, if you require a 10 volt supply, $R1 = R2 = 4.3k$, and $C1 = C2 = 82$ pF, using the nearest standard values ($4.3k \times 82$ pF = 350 ns, or $1.8k \times 220$ pF = 390 ns).

As you can see, the prototype is biased for a 5-volt supply. If you require a different supply voltage, R1, R2 and C1, C2 must be changed as follows: subtract 1.3 volts from the supply voltage used and divide the result by 2 mA to obtain the new values for R1 and R2.

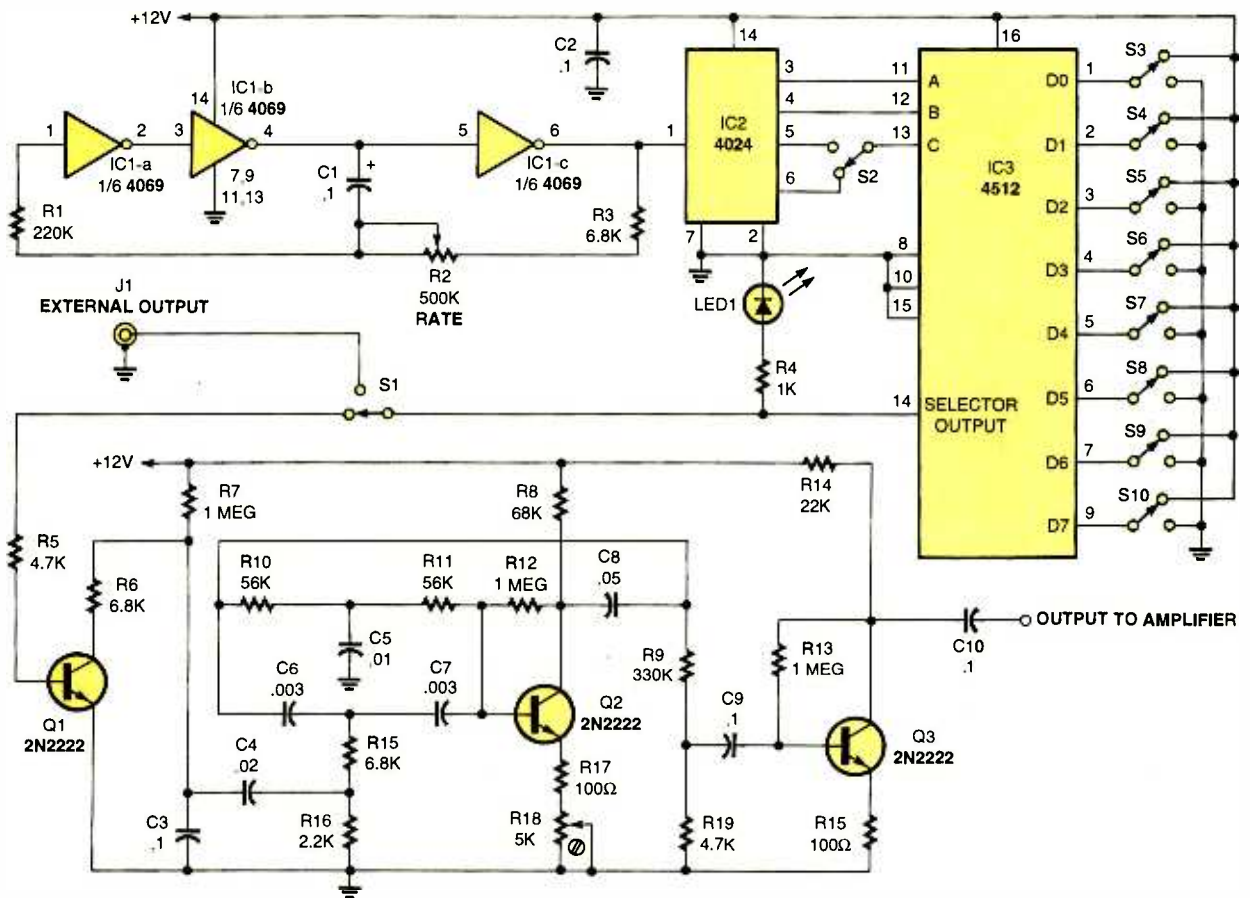

Fig. 6. Use this novel multiplexer-derived circuit to generate all types of musical sounds. For the 4512 IC you can substitute the NTE4512B; for the 4024 IC you can use the NTE4024B or SK4024B; and for the 4069 IC you can substitute the NTE4069 or SK4069UB.

Use short, direct leads when building this circuit, and connect C3 directly between the emitters of the transistors. You can use an oscilloscope to "tweak" the values of C1 and C2 for best overall performance. However, don't make them any larger in value than necessary, as the input waveform will begin to become distorted.

—Skip Campisi, S. Bound Brook, NJ

This is a useful circuit with an excellent explanation along with practical design information. I am sure that our hobbyists can find many applications for this circuit.

A MULTIPLEXED MUSIC-BOX

The circuit shown in Fig. 6 may be of interest to the readers. The idea came about after reading the article on multiplexers in the April *Circuit Circus* column; however, my circuit uses a 4512 CMOS 8-channel data selector IC as the multiplexer/demultiplexer.

A 4069 hex inverter IC supplies variable clocking to a 4024 binary counter.

The outputs of the counter address pins 11, 12 and 13 on the 4512. Since all CMOS inputs have to go somewhere, the eight SPDT switches within IC3 meet this requirement. Obviously, if all the switches D0–D7 are at 12 volts or ground, there will be no output at pin 14 of the multiplexer. However, setting the switches (say, at pins 1, 2 and 3) to 12 volts and leaving the others at ground, will produce output pulses at pin 14 of the 4512. A wide variety of delayed pulses can be realized with various switch combinations. By changing the address input to the 4512, more variety can be obtained. The output of the 4512 can be switched to an external jack and used for other purposes.

I've used this circuit to trigger a percussion generator set up to produce sounds similar to wood blocks being struck. The oscillator is a common twin-tee type. The only adjustment needed is to set the 5k trimmer potentiometer just below the point where oscillation occurs when triggered.

—Robert C. Barg, Rochester, NY

Well Robert, here's a good example of how one article generates thoughts to create another novel design.

MAILBAG

Think Tank circuit designer Alex Belenky confirmed a couple of errors in two of his recently published circuits. In the April "Visible Auto-Battery Voltmeter" circuit, page 55, Fig. 7, pin 4 should **not** be floating, but connected to pin 8 of the LM3914 IC. In the June "Bug Detector" circuit, page 18, Fig. 5, the value of resistor R9 should be 2.43k (**not** 2.43 ohms).

That's about it for this month's column. Remember—this is **your** column—keep those circuits, solutions and ideas coming in. For each of your circuits that appear, you'll receive a book from our library. Send in enough circuits to fill a whole column and you will get a nifty kit or electronics tool to make your construction easier. Write me—Alex Bie, *Think Tank*, **Popular Electronics**, 500 Bi-County Blvd., Farmingdale, NY 11735. ■

HAM Radio

All MUXed Up!

JOSEPH J. CARR, K4IPV

Many years ago, an electronics shop teacher told me that there was a way to send multiple telephone conversations over the same radio channel. Later, I saw medical and scientific instruments that passed two data streams along the same twisted pair wire from one place to another. Both of these are examples of multiplexing (MUX). There are several techniques available, but traditionally industry has used time domain multiplexing (TDM) and frequency domain multiplexing (FDM). Recently, I received e-mail from a reader asking about multiplexing—so here goes.

Suppose you have two signals, call them "Signal A" and "Signal B" (see Fig. 1A). In non-MUXed transmitters, either one, but not both could be sent to the transmitter's modulator. If we tried to send both of them in the same channel by simple linear mixing, then we would not find it easy to separate them at the other end of the line. But with TDM we provide an alternating switch, such as a Sampler Switch shown in Fig. 1A; then we can alternately take discrete amplitude samples of the two signals over a period of time and then apply the composite waveform to the transmitter.

Consider Fig. 1B, where the sampling process takes the two individual signals and samples them. This process produces sampled waveforms such as we see in Fig. 1C. At the output of the switch, however, those two sampled signals are combined into a composite signal (Fig. 1D). It is this signal that modulates the transmitter.

You might fairly ask: "Uhhh...but doesn't combining those signals mess up the waveforms at the receive end?" Yep! Sure does. Another switch has to be provided at the receiver end to demodulate the signal and recover the audio. In some cases, a synchronizing pulse from the transmitter is needed to lock the receiver demodulator to the transmitter. In other cases, the interleaved samples form the basis for the sync signal at the receiver. In some very expensive equipment, both transmitter and receiver are synchronized

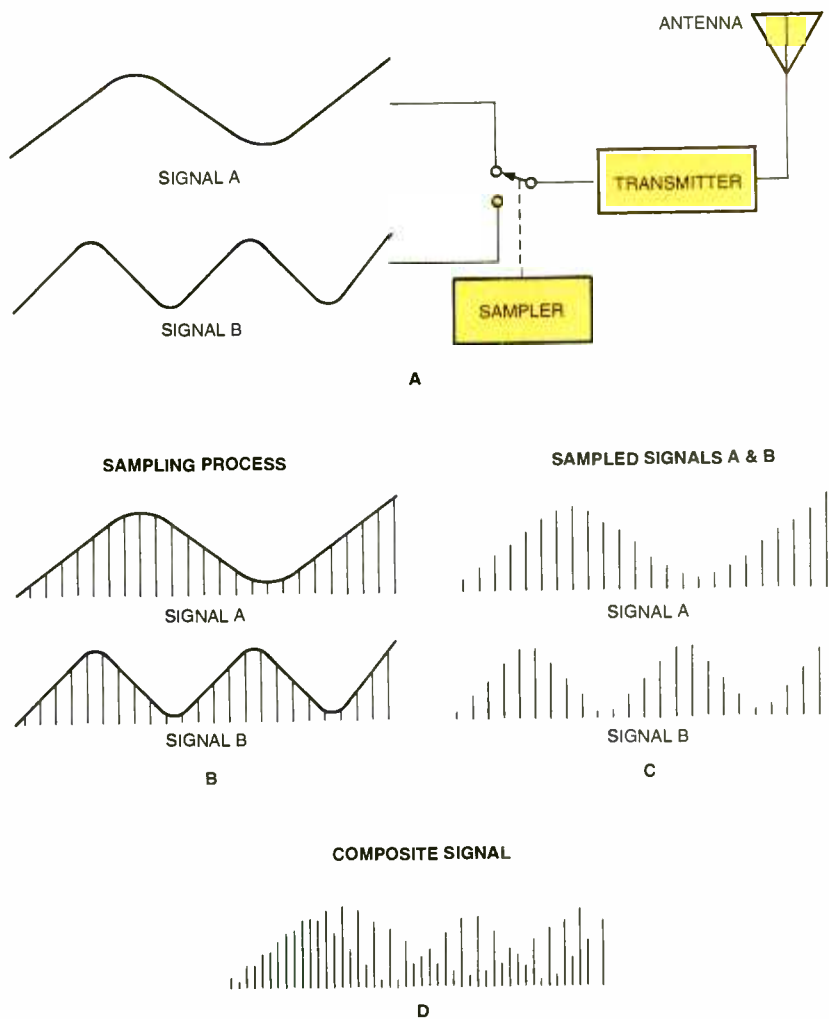

Fig. 1. In the time domain multiplexing circuit of A, the two transmitter inputs (signal A and signal B) use a switch to sample the amplitudes in time. This sampling process is illustrated in B, with the sampled amplitudes over time shown in C. The composite interleaved time signal to the transmitter is pictured in D.

to a common source, such as the 60-kHz WWVB signal, or an atomic Rubidium or Cesium standard, etc. In FM stereo broadcasts, a 19-kHz pilot signal is transmitted along to help with the synchronization process.

In radiotelephony and normal telephones, the bandwidth of the modulating audio is limited to about 3000 Hz. According to a rule called Nyquist's Criteria, we must sample at a rate that is at least twice the highest frequency component, so that means sampling at

6000 Hz or higher. Note that your computer's sound card usually samples speech at 8000 Hz, and is therefore a little higher fidelity than telephones.

Now let's take a look at Frequency Domain Multiplexing, or FDM. In this case, let us assume that there are three complex audio speech signals (Base Signals A, B, and C, which are shown as amplitude spectrums vs. frequency in Fig. 2), each spread out over an audio frequency range of 300 to just under 3000 Hz. In this case, the modu-

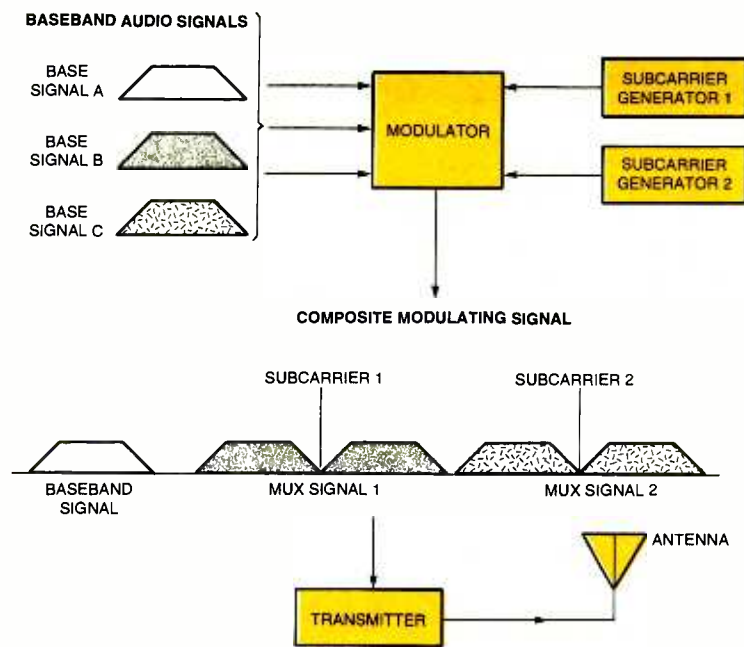

Fig. 2. In frequency domain multiplexing, three baseband audio inputs are applied to a modulator. The other modulation inputs are the higher frequency subcarrier generators 1 and 2. The composite modulator output, which is applied to a transmitter, consists of three waveforms—one at baseband and the other two centered about the two subcarrier frequencies.

lator amplitude modulates Base Signal B with Subcarrier 1 (assumed at 8 kHz), and Base Signal C with Subcarrier 2 (assumed at 14 kHz). Both Subcarrier 1 and Subcarrier 2 are different frequencies, separated by just enough frequency to allow a small safety zone, or "guard band" between them.

The composite modulating signal that is sent to the transmitter will consist of three waveforms:

- Baseband Signal A occupying the spectrum 300 to 3000 Hz (unchanged),
- An amplitude-modulated MUX Signal 1 (Subcarrier 1 at 8 kHz, with upper and lower sidebands of Base Signal B, extending from 5 kHz to about 11 kHz) and
- An amplitude-modulated MUX Signal 2 (Subcarrier 2 at 14 kHz, with upper and lower sidebands of Base Signal C, extending from slightly greater than 11 kHz to 17 kHz).

These signals are then used in composite to modulate the transmitter, either AM or FM. In actuality, the FDM system won't use straight AM, but rather will use either Double-Sideband Suppressed Carrier (DSBSC) or Single-Sideband Suppressed Carrier (SSBSC) for Subcarrier 1 and Subcarrier 2. These forms of modulation saves transmitter energy by conserving spectral space.

WANT SOME FREE PC LAYOUT SOFTWARE?

If you are in the habit of designing circuits for the projects that you build, then you might want to take advantage of a new service that I recently found out about. Would you believe online ordering of your own custom-printed-circuit boards (PCBs) that are delivered in just a couple of business days?

Recently, I got an e-mail from Stan Reifel of *ExpressPCB*. Here's how the service works. First, you download and install the *ExpressPCB* computer-aided design (CAD) software from the *ExpressPCB* Web site. Second, do your PCB layout on your computer. Third, order the PCB over the Internet by sending *ExpressPCB* the file (this is a click button on the *ExpressPCB* software screen). Fourth, wait a few days to get your board.

When I first read Stan's e-mail I decided to ask for a sample board made by *ExpressPCB*. I've seen a lot of trash boards offered in the amateur market, and did not want to pass along anything that was inferior. When the sample arrived, I was truly impressed. I know what PCBs are supposed to look like, and recognized immediately that this was a good product.

So how do you tell a good PCB from a piece of junk? One good indication is

the crispness of the conductor tracks and component pads. PCB manufacture is a photographic process, and poor control of that process results in the same problems as in actual photos—fuzziness. Also, look at how well the board is tinned. Good tinning has a smooth, shiny appearance. It does not look dull, or sloppy, or have little bitty splashes coming out from the tracks.

The boards supplied by *ExpressPCB* are double-sided, with connection between top and bottom surfaces made with "vias" (i.e., little holes that are plated through). Double-sided plated-through PCBs are not new, but a lot of PCB services that deal in the amateur market cannot do them or do them poorly. The sample board was outstanding. Another way to see the quality of a PCB is to look at the tinning under a microscope. It should be evenly applied and not have a lot of gaps. Using an admittedly poor microscope, I could not see any problems with the sample board. I was truly impressed with the product.

So how much does it cost? When you design the PCB on the layout software, you will be able to click on a button and have it calculate the cost for you. The Web site example shows that the first board will cost right around \$100. That may seem like a lot, but let me provide some perspective. Some readers will recall the little MMIC preamplifier project I did back in December 1995. It used a *Mini-Circuits* MAR-1 MMIC device to provide a near-DC to 1000-MHz, 20-dB gain preamplifier. The board was about 1.2 × 3 inches, single-sided. When I bought fifty at a time, the price was reasonable. But if I bought just one, then the price could be up to \$500! The problem is that PCB shops charge a "set-up fee" that can vary from nothing at all to \$500.

If you are making a product to sell, then paying \$100 for the first article, a PCB, is a bargain. You can get additional boards for sale to your customers (Note: Amateur radio historically has seen a lot of really good products designed by individual hams, and then sold through small display ads or classified ads in magazines such as **Popular Electronics**).

Now let's talk a bit about the software. I've used several PCB-layout CAD software packages in my time. I

(Continued on page 59)



Last Chance to Get a Year or more of Popular Electronics Fun for \$18.95 a Year

Dear Popular Electronics reader:

Like everything else around us, our subscription prices are going up. When I heard the news, I talked management into giving our regular readers a last chance to start a new subscription or extend their current one before the price increase takes effect. I've even managed to convince them that you should be allowed to extend your subscription for as long as you wish. So if you live in the United States, you can guarantee that your annual subscription to Popular Electronics will continue to cost only \$18.95 a year—and you select the term – one, two, three, four, five..... up to a maximum of ten years.

Popular Electronics readers get the know-how they need to build exciting, educational, and useful projects like these... a professional-quality home-security system...a nine-band shortwave receiver...a radio-controlled car...a telephone scrambler...an aviation receiver...and even a robot!

PLUS...Gizmo, our honest and straight-shooting review of the latest consumer-electronics gear...Market Center, featuring mail-order merchants that are ready to help you in all your hobby activities...articles and columns covering every aspect of the electronics hobby— including antique radio, shortwave listening, ham radio, computers, scanners, circuit design, and more!

SAVE MONEY... This special Last Time rate saves you \$40.93, each year, off the newsstand price. In fact, if you don't currently subscribe, but during the course of the year buy at least four issues on the newsstand, you will pay more for those four issues then for a complete 12-month, one-year subscription. If you sign up for more than one year, you guarantee that savings for even longer and are totally protected against any future increases for the entire length of your subscription. So act now! This offer expires August 31, 1998.

Send no money with your order, unless you prefer. We'll be glad to bill you when we ship your first issue. This special offer is one you will want to share with your friends, be sure that you tell them about it.

Get going today, fill out the coupon on the attached Last Chance Certificate and start saving now! This really is a last time offer and will not be repeated. Offer expires August 31, 1998.

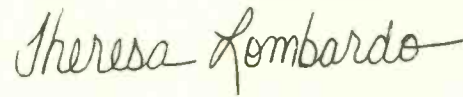

Theresa Lombardo
Circulation Manager

Popular Electronics[®]

Circuit Circus

LED Readout Circuits

CHARLES D. RAKES

This month we are going to spend our time together exploring several LED readout circuits that are fun to build, and with a little imagination just might be useful in existing or future projects, too. Many years ago, when the vacuum tube ruled and all radios glowed in the dark, there were several special indicator tubes that graced many of the top receivers of that day. The 6C5 was known as the *Shadowmeter* tube in some sets, and as the *Shadowgraph* in others, while many receivers used the 6T5 *Target Tuning* tube. If memory serves correctly, they were generically known as "magic eye" tubes. All of them produced a magic green glow that changed shapes as stations were tuned in and as signals varied in strength. In most cases, the magic eye tube monitored the receiver's automatic-gain-control (AGC) voltage and varied accordingly. The following circuits are solid-state versions of yesterday's magic eye indicator tubes.

INDICATOR CIRCUIT—PYRAMID CONFIGURATION

Our first circuit, see Fig. 1, uses an LM339 quad voltage-comparator IC in a four-level indicator circuit. The LEDs are arranged in an inverted pyramid configuration, as illustrated in Fig. 2A, with the lowest input level at the bottom and the maximum level at the top.

The circuit's operation is rather sim-

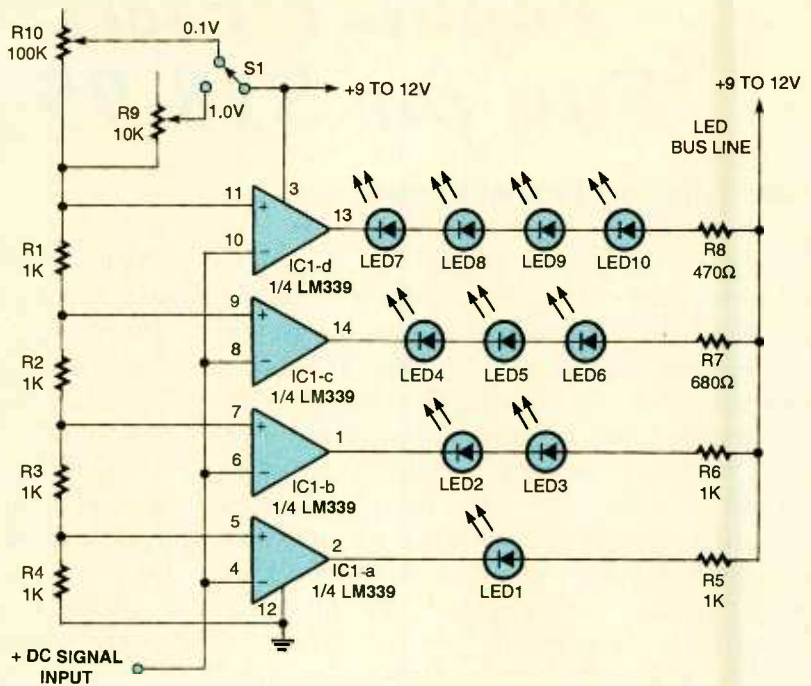

Fig. 1. This handy circuit indicates DC voltage with increasing LED illumination arranged in an inverted pyramid configuration. Smallest input value turns on LED1; next increment turns on LED2 and LED3, etc. Circuit shown has a range from 0.1 volts to 0.4 volts ("A" position) or 1.0 volts to 4.0 volts ("B" position).

ple with SPDT switch S1 in the "A" position, the input sensitivity is set to 0.1-volt per output step. A 0.1-volt DC input signal turns on LED1, 0.2 volt turn on LED2 and LED3, 0.3 volt turns on LED4-LED6, and 0.4 volt turns on LED7-LED10. In switch position "B," the input sensitivity is set to a 1-volt per output step. As the input voltage rises through the operating range, the inverted pyramid builds from the bottom up (i.e., LED1 indicates 1 volt, LED2 and LED3 show 2 volts, etc.).

Calibrating the two input voltage ranges is also a simple matter. Switch S1 to the "A" position and connect a positive 0.1-volt DC source to the input. Carefully adjust potentiometer R10 until LED1 just turns on. Increase the input voltage until LED2 and LED3 turn on. The input voltage for the second step should be very close to 0.2 volts. The circuit's accuracy may be improved by matching the values of R1-R4, or by using 1% precision resistors. The circuit

may be calibrated for an existing application. As an example, it can be connected to monitor a receiver's AGC output, but you will need to refer to the

PARTS LIST FOR INDICATOR CIRCUIT—PYRAMID CONFIGURATION (FIG. 1)

- IC1—LM339 quad voltage comparator, integrated circuit (NTE839, SK3569, or equivalent)
- LED1-LED10—Light-emitting diode, any color
- R1-R4—1000-ohm, 1/4-watt, 5% resistor (1% for improved accuracy)
- R5-R6—1000-ohm, 1/4-watt, 5% resistor
- R7—680-ohm, 1/4-watt, 5% resistor
- R8—470-ohm, 1/4-watt, 5% resistor
- R9—10,000-ohm potentiometer
- R10—100,000-ohm potentiometer
- S1—SPDT switch

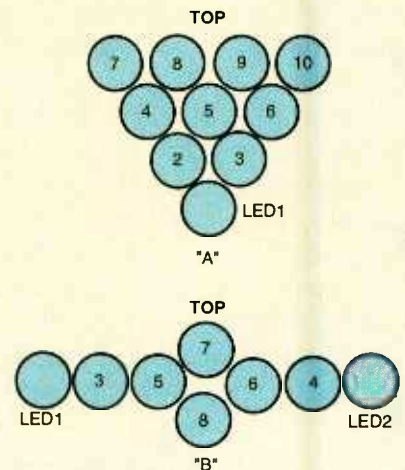

Fig. 2. The LED inverted-pyramid pattern configuration for the circuit of Fig. 1 is shown in Fig. 2A, while Fig. 2B shows the LED bar pattern for the circuit of Fig. 3.

receiver's schematic for the hook-up and to insure that the AGC output is positive. Resistors R9 or R10 can be adjusted for the best input/output coverage, depending on which range is used.

INDICATOR CIRCUIT— BAR CONFIGURATION

The circuit in Fig. 1 can be modified for a variety of LED-output indicator arrangements. The output circuit in Fig.

3 matches the LED layout shown in Fig. 2B, providing the LEDs are physically arranged with LED1 and LED2 at the outermost ends, LED3 and LED4 the next inner pair, then LED5 and LED6 as the next inner pair, and finally LED7 and LED8 are arranged in a vertical fashion. The two outermost LEDs turn on first, followed by LEDs 3 and 4, then 5 and 6, and 7 and 8, in that order. The input circuitry is the same as the circuit in Fig. 1.

INDICATOR CIRCUIT— SINGLE OUTPUT

Our next entry, Fig. 4, changes the basic indicator circuit from a bar type output to a single output, where only one LED is on at a time. Here's how it's accomplished. Transistors Q1, Q2, and Q3 operate as switches to turn off or to allow an LED to be turned on, depending on which direction the input voltage is going. Without an input to the circuit, none of the LEDs are turned on, and the voltage at the cathodes is near the supply-voltage level, allowing all three of the transistors to be switched on. Since the transistors are connected in an emitter-follower

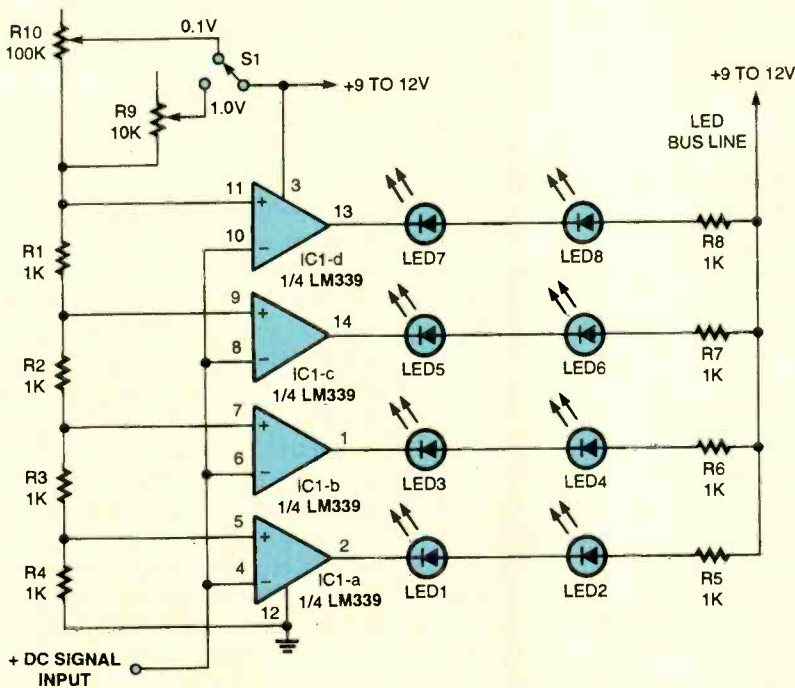

Fig. 3. In this indicator circuit, the LEDs illuminate in a bar-configuration. The smallest input value turns on LEDs 1 and 2, next increment turns on LEDs 3 and 4, next increment turns on LEDs 5 and 6, and finally an upper-range value of input signal turns on LEDs 7 and 8.

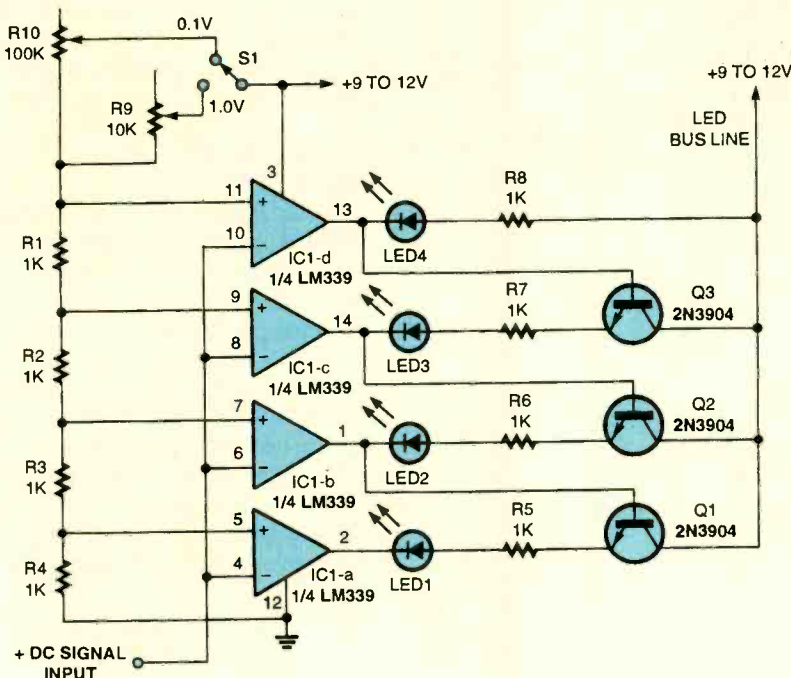

Fig. 4. This circuit shows the DC voltage input in single output steps. As the input rises in 0.1-volt increments, the next LED lights.

INDICATOR CIRCUIT—BAR CONFIGURATION (FIG. 3)

IC1—LM339 quad voltage comparator, integrated circuit (NTE839, SK3569, or equivalent)

LED1—LED8—Light-emitting diode, any color

R1—R4—1000-ohm, 1/4-watt, 5% resistor (1% for improved accuracy)

R5—R8—1000-ohm, 1/4-watt, 5% resistor (1% for improved accuracy)

R9—10,000-ohm potentiometer

R10—100,000-ohm potentiometer

S1—SPDT switch

INDICATOR CIRCUIT—SINGLE OUTPUT (FIG. 4)

IC1—LM339 quad voltage comparator, integrated circuit (NTE839, SK3569, or equivalent)

LED1—LED4—Light-emitting diode, any color

Q1—Q3—2N3904 general-purpose NPN transistor (NTE123AP, SK3854, or equivalent)

R1—R4—1000-ohm, 1/4-watt, 5% resistor (1% for improved accuracy)

R5—R8—1000-ohm, 1/4-watt, 5% resistor (1% for improved accuracy)

R9—10,000-ohm potentiometer

R10—100,000-ohm potentiometer

S1—SPDT switch

configuration, very little base-bias current is needed to turn them on. If LED1 is on, and the circuit's input voltage is less than what is required to turn on LED2, LED1 will remain on. When the input voltage to the LM339 comparator IC rises and LED2 turns on, Q1's base is taken to ground, turning it and LED1 off. The same happens to LED2 when LED3 turns on, and the same for LED3 when LED4 is operated. Hence, as the DC input signal to the IC rises, the next

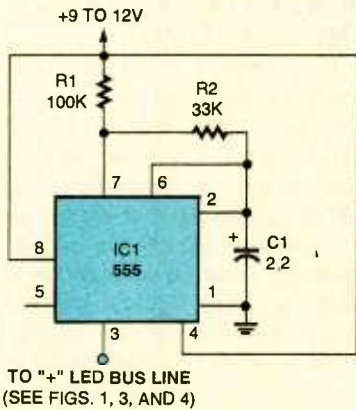

Fig. 5. Add this timer circuit to the LED bus lines of Figs. 1, 3, and 4. With the values of R1, R2, and C1 shown, the LEDs pulse at about two flashes per second.

FLASHING OPTION FOR INDICATOR CIRCUITS (FIG. 5)

- C1—2.2-μF, 25-WVDC, electrolytic capacitor
- IC1—555 oscillator/timer, integrated circuit (NTE9555M, SK3564, or equivalent)
- R1—100,000-ohm, 1/4-watt, 5% resistor
- R2—33,000-ohm, 1/4-watt, 5% resistor

“higher” LED goes on, and the previous LED is extinguished.

FLASHING OPTION FOR INDICATOR CIRCUITS

A flashing option may be added to the indicator circuits of Figs. 1, 3, and 4 by using the 555 IC oscillator circuit shown in Fig. 5. The 555's output, at pin 3, supplies a pulsed DC power source for the LED bus line. The oscillator's component values are selected to produce about two flashes per second, but the rate can be varied by changing the values of R1, R2, and C1. To increase the pulse rate, reduce one or more of the component values; to decrease the pulse rate, do the reverse.

DOT/BAR DISPLAY INDICATOR CIRCUIT

Our next indicator circuit, see Fig. 6, uses an LM3914 IC dot/bar display-driver that offers up to ten outputs. The IC contains ten comparators, an internal voltage divider, a voltage-reference source, and options for setting the LED's operating current, and a choice of a dot/bar output. All of these features come in an 18-pin package, which can be purchased for less than four bucks

DOT/BAR DISPLAY-INDICATOR CIRCUIT (FIG. 6)

- IC1—LM3914 dot/bar display-driver, integrated circuit (NTE1508, or equivalent)
- LED1—LED8—Light-emitting diode, any color
- R1—33,000-ohm, 1/4-watt, 5% resistor
- R2—10,000-ohm potentiometer

at most major mail-order houses.

The LM3914 indicator circuit shown in Fig. 6 uses only four of the IC's outputs to drive the LED-indicator arrangement shown earlier in Fig. 2B. This circuit operation is similar to the circuit in Fig. 3. The input-operating range is set by R2, and R1 sets the current for all of the LEDs.

Setting up the LM3914 circuit for a 0.1-volt input per output step is an easy task. Connect a positive 0.4-volt source to the IC's input at pin 5. If an adjustable supply isn't handy, connect a 1000-ohm linear potentiometer across a 1.5-volt battery and use this arrangement for the variable input supply. Adjust R2 to the point where LED7 and LED8 just turn on. Lower the input voltage to zero, and then slowly increase the voltage until LED1 and LED2 turn on. The input should be close to 0.1 volt. If R2 is set to its minimum resistance or replaced with a jumper, the circuit's default input range is 0.13-volts to 1.3-volts for a ten-bar or dot output. The circuit may be set up to monitor almost any varying positive DC voltage by resetting R2, or by adding an external voltage divider to the circuit's input at pin 5.

The operating current for all of the LEDs is determined by the value of R1, which is connected across an internal 1.25-volt reference source (pin 7 to circuit ground). The current available for the LEDs is ten times the current that flows through R1. The current through R1 is about 1.25 mA, so the total available LED current is about 12.5 mA.

ANALOG-METER INDICATOR

Our final entry, see Fig. 7, places the LM3914 in a basic voltmeter circuit with a display of ten LEDs arranged in the shape of an analog meter. The LEDs can be physically arranged in a semi-circular configuration for a representative effect of increasing voltage. A change in the LED colors throughout the range will add flair to the voltmeter. Also, a potentiometer has been added to vary the LED current. The display may be operated in the dot mode to conserve power or in the bar mode for effect.

The voltmeter circuit may be calibrated in the same manner as our last circuit. Set the range switch to the 1-volt position and the dot/bar switch, S1, to the dot position; then connect a positive 1-volt DC source to the input.

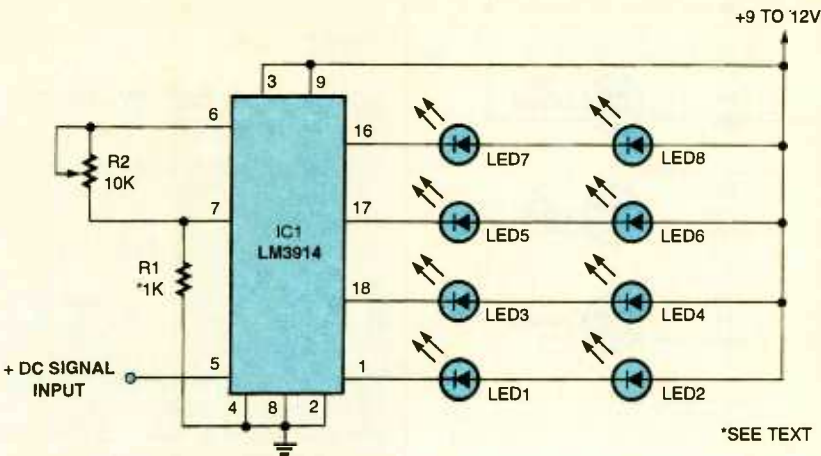

Fig. 6. This indicator circuit uses a convenient LM3914 IC for reduced components requirements. The operation of this circuit is similar to that of Fig. 3. Increasing DC signal input turns on LED1 and 2, then LED3 and 4, etc. Text describes calibration for an 0.1-volt input per output-step increment.

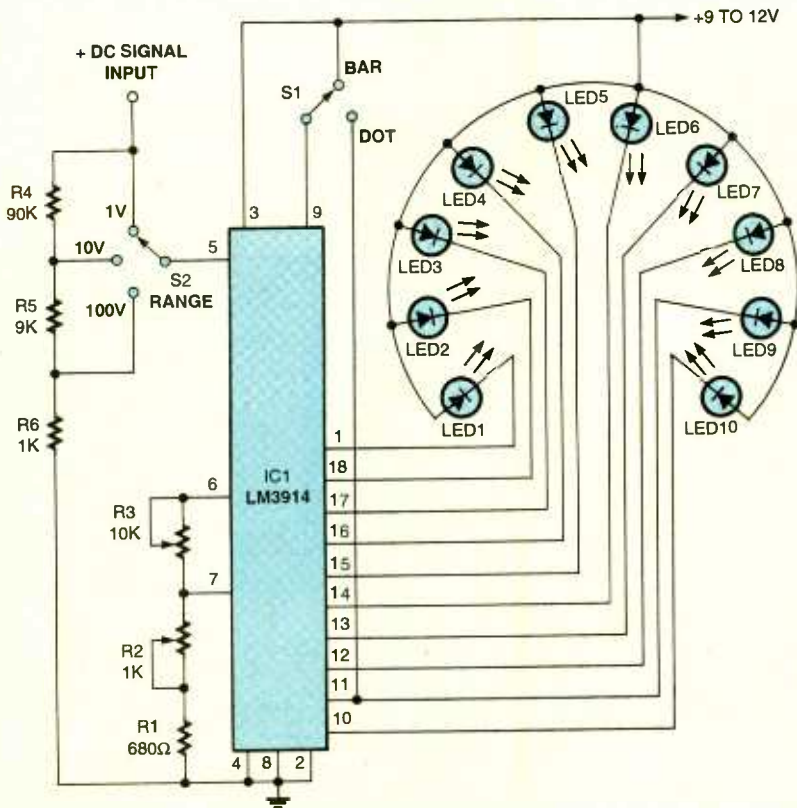

Fig. 7. This circuit shows a typical analog meter using LED indicators. The range position sets maximum ranges of 1.0, 10, and 100 volts, while the ten LEDs light in one-tenth-maximum range increment steps.

ANALOG-METER INDICATOR (FIG. 7)

- IC1—LM3914 dot/bar display-driver, integrated circuit (NTE1508, or equivalent)
- LED1—LED10—Light-emitting diode, any color
- R1—680-ohm, 1/4-watt, 5% resistor
- R2—1000-ohm potentiometer
- R3—10,000-ohm potentiometer
- R4—90,000-ohm, 1/4-watt, 1% resistor
- R5—9000-ohm, 1/4-watt, 1% resistor
- R6—1000-ohm, 1/4-watt, 1% resistor
- S1—SPDT switch
- S2—SP3T switch

Adjust R3 to the point where LED10 just turns on. Change the range switch to the 10-volt position, and LED1 should light—if not, readjust R3. Resistors R4, R5, and R6 should have 1% tolerance for best accuracy.

Take a close look at these indicator circuits and see if you can find a place for one that will either add flair to an existing project, or become the heart of a new circuit discovery.

Well, that's about it for this session, but be sure to join us again next month for a new workbench adventure. ■

HAM RADIO

(continued from page 54)

normally use a DOS program called *Easy-PC* (which had just been released in a Windows 95/NT version). The *ExpressPCB* CAD software is very user-friendly. If you have any experience with any Windows program, you will not find it difficult to pick up skill at *ExpressPCB*.

There is a library panel of electronic circuit layouts for a very large number of components. By clicking on the desired symbol, you can then drag it into the design area of the screen. What you see is not a schematic diagram symbol, but rather the PCB pad layout. By the way, CAD software of this class can cost better than \$600.

The computer-system requirements show that about 4 megabytes of hard drive space is needed. The program runs in the Windows 95 or Windows NT environments. A 66 MHz or better CPU and an 800 × 600 VGA color display are recommended.

Stan Reifel of *ExpressPCB* can be reached via e-mail at support@

expresspcb.com. The Web site where the software can be downloaded, plus additional information about this service, is at www.expresspcb.com, or contact the company directly at *Engineering Express*, 56 Concord Avenue #33, Cambridge, MA 02138, Tel. 617-441-9497.



The *Mirage B-510-G* 2-meter ham-band amplifier supplies up to 100 watts in the FM, SSB, or CW modes.

TWO-METER MOBILE LOUDENBOOMER

The photo above shows a neat little 2-meter ham-band amplifier for mobile or portable use. It is called the *Mirage B-510-G*. This amplifier will boost your handheld or mobile 2-meter ham rig power, up to a level between 5 and 100 watts. An LED PowerGraph indicator makes adjustment of the output-power level easier. The *Mirage B-510-G* will accommodate FM, SSB, and CW transmitters. Also built into the *Mirage* amplifier is an adjustable low-noise GaAsFET preamplifier for the rig's receiver. Gains of 5 to 15 dB help you to dig out really weak stations.

The *Mirage B-510-G* offers a number of protection modes. A "High SWR" LED indicator will keep you from damaging the unit when someone clips off your antenna (or you don't look what you are doing). The unit also has reverse polarity protection, an over-temperature LED indicator, and an "On-Air" LED indicator.

The size of the *Mirage B-510-G* is 6.5 wide × 2.25 high × 9 deep inches. It comes with a heatsink, and cooling fan, as well as a BNC patch cord to use with a 2-meter handheld. Cost is \$224.95, and the unit comes with a one-year warranty. Contact *Mirage Communications Equipment* (which is an *MFJ Enterprises* company) at 800-647-1800, or via e-mail at mirage@mfj.com. They have a Web site at www.mirageamp.com.

Comments? I can be reached by snail-mail at P.O. Box 1099, Falls Church, VA, 22041, or by e-mail at carrij@aol.com. ■

COMPUTER BITS

Microcontrollers V

JEFF HOLTZMAN

Microcontrollers are like miniature computers, complete with permanent and temporary storage, I/O, and other capabilities—all on a single chip. In this series, so far, we've been looking at a new line of microcontrollers known as AVR and sold by *Atmel Corp.* This month we'll get the software tools up and running and write a test program to verify correct operation of the evaluation board. There are several devices in the AVR line; we've been using the *Atmel AT90S1200* for our experiments thus far.

As discussed last time, Atmel sells (for a reasonable \$50) a small evaluation board that programs AVR chips, and provides basic I/O indicators (eight LEDs and eight momentary switches). The LEDs are connected to Port B, and the switches to Port D. The "high" side of the switches are brought to a set of header pins mounted opposite a corresponding set of header pins that connect to the actual I/O pins of Port D. By connecting the two headers together, you can use the on-board I/O. Alternatively, you can connect the I/O pin headers to an external circuit for prototyping your own device hook-ups. There is a corresponding set of headers for the LED and Port B.

The evaluation kit comes with a pair of ribbon cables so that you can jumper the switches and LEDs to the microcontroller. One of the cables that came with my unit was crimped incorrectly, so there were shorts and opens that caused me some grief. I ended up creating my own jumper using two 34-pin socket headers and a 3/4-inch length of ribbon cable. Fortunately, the headers on the evaluation board are spaced properly so that all the pins line up using the single header connector.

THE TOOLS

The eval board comes with copies of Atmel's Assembler, Debugger, Simulator, and device Programmer. Both DOS and Windows versions are included; updates are available on Atmel's web site. I've been using the Windows versions under NT 4.0 with-

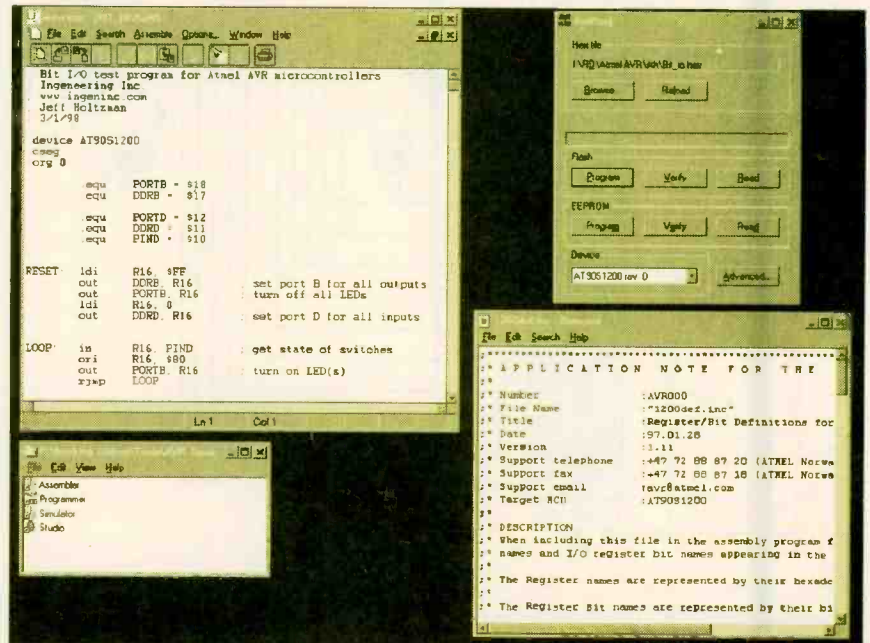

When developing assembly language code for the AT90S1200, it's handy to keep the assembler, the programmer, and a copy of Notepad open. A folder collecting icons for all the programs doesn't hurt either.

LISTING 1

Bit I/O Test Program for Atmel AVR Microcontrollers

```
.device AT90S1200
.cseg
.org 0

.equ PORTB = $18
.equ DDRB = $17

.equ PORTD = $12
.equ DDRD = $11
.equ PIND = $10

RESET: ldi R16, $FF          ; set port B for all outputs
        out DDRB, R16      ; turn off all LEDs
        ldi R16, 0
        out DDRD, R16      ; set port D for all inputs

LOOP:  in R16, PIND         ; get state of switches
        ori R16, $80
        out PORTB, R16     ; turn on LED(s)
        rjmp LOOP
```

out experiencing any problem.

The Assembler contains a basic text editor that is adequate for writing short test programs. For more extensive work, you'll probably want to substitute your own text editor and launch

the command-line compiler separately. You can assemble programs and run them in the simulator without actually having any other hardware. However, the simulator has no (simulated)

(Continued on page 64)

One scientist's vision revolutionizes the hearing industry, benefiting millions of people...

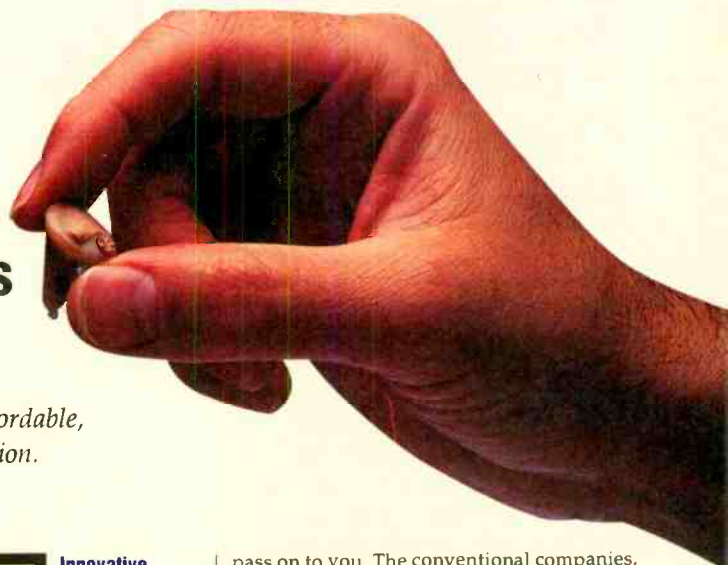

Crystal Ear® uses sophisticated electronics to provide affordable, cosmetically-pleasing and easy-to-use hearing amplification.

by Harold Sturman

One day a friend asked my wife Jill if I had a hearing aid. "He certainly does," replied Jill, "Me!" After hearing about a remarkable new product, Jill finally got up the nerve to ask me if I'd ever thought about getting a hearing aid. "No way," I said. "It would make me look 20 years older and cost a fortune." "No, no," she replied. "This is entirely different. It's not a hearing aid... it's Crystal Ear!"

No one will know. Jill was right. Crystal Ear is different—not the bulky, old-styled body-worn or over-the-ear aid, but an advanced personal sound system so small it's like contacts for your ears. And Crystal Ear is super-sensitive and powerful, too. You will hear sounds your ears have been missing for years. Crystal Ear will make speech louder, and the sound is pure and natural.

I couldn't believe how tiny it is. It is smaller than the tip of my little finger and it's almost invisible when worn. There are no wires, no behind-the-ear devices. Put it in your ear and its ready-to-wear mold fits comfortably. Since it's not too loud or too tight, you may even forget that you're wearing it! Use it at work or at play. And if your hearing problem is worse in certain situations, use Crystal Ear only when you need it.

A fraction of the price. Hearing loss is the world's number-one health problem, but in

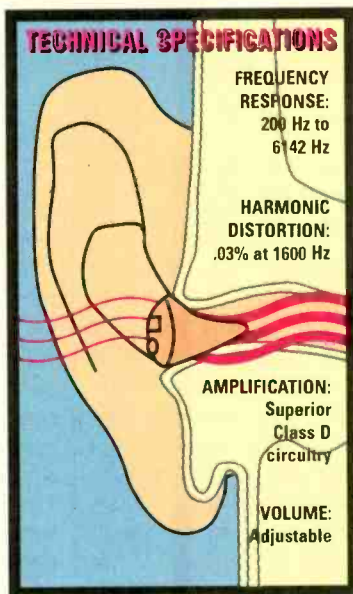

Innovative, breakthrough technology solves common problem...

Hearing loss, which typically begins prior to teenage years, progresses throughout one's lifetime. Nearly 90 percent of people suffering the type of loss Crystal Ear was designed for choose to leave the problem untreated. Crystal Ear is now available to help these people treat their hearing loss with a small and very affordable Class I in-the-canal hearing amplifier.

most cases it goes completely untreated. For many millions of people, hearing devices are way too expensive, and the retail middlemen want to keep it that way. What's more, treating hearing loss the old retail way can involve numerous office visits, expensive testing and adjustments to fit your ear. Thanks to Crystal Ear, the "sound solution" is now affordable and convenient. Almost 90% of people with mild hearing loss, and millions more with just a little hearing dropoff, can be dramatically helped with Crystal Ear. Plus, its superior design is energy-efficient, so batteries can last months, not just weeks.

You'll feel years younger! Wear Crystal Ear indoors, outdoors, at home and at work. Crystal Ear arrives ready to use, complete with batteries, two different fitting sleeves, a cleaning brush and even a carrying case. Crystal Ear is a breakthrough advance in the hearing device field. It is made in the USA, using state-of-the-art micro-manufacturing techniques that cut costs dramatically—savings that we can

pass on to you. The conventional companies, domestic and foreign, don't like that! **Don't be fooled by high prices.** No hearing device, no matter how expensive, can eliminate background noise, despite claims by the manufacturers. Crystal Ear does not promise miracles—just an affordable, sound solution to many common hearing problems.

DON'T TAKE OUR WORD FOR IT...

"My father spent over \$5000 on another brand. I showed him my Crystal Ear, he tried it, and he decided it worked better than his brand, even though it was a small fraction of the cost!"



—A satisfied Crystal Ear user

"Over 32 million Americans experience some loss of hearing. Though most cases go untreated, over 90 percent of these people would be disappointed to learn from their doctor that there is no medical or surgical cure. There is, however, an effective treatment: electronic amplification."

—Dr. Dale Massad, MD

Risk-free. Try Crystal Ear and hear what you've been missing. It comes with a 90-day manufacturer's limited warranty as well as our risk-free home trial. If you're not satisfied, return it within 30 days for a full refund.

Crystal Ear®: Three credit-card payments of \$99.95 \$12 S&H. If not purchasing a pair, please specify right or left ear.

Please mention promotional code 3461-13261

For fastest service, call toll-free 24 hours a day

800-992-2966



comtrad industries

2820 Waterford Lake Dr., Suite 102
Midlothian, Virginia 23113

COMPARE CRYSTAL EAR AND SEE THE DIFFERENCE

	MOST IN-CANAL BRANDS	CRYSTAL EAR
Require fitting	Yes	No
Require testing	Yes	No
Battery life	160 hours	320 hours
Impact resistance	Average	Excellent
Whistling/feedback	Frequent	Limited
Telephone use	Yes	Excellent
Retail price	\$1,000-2,000	\$299.85

August 1998, Popular Electronics

ANTIQUE Radio

The Remarkable *Chanalyst*— Conclusion

MARC ELLIS

In last month's column, we introduced you to the *Chanalyst*, a signal-tracing system "par excellence" marketed towards the end of 1938 by radio servicing writer and publisher John F. Rider. As discussed last time, this versatile instrument not only allowed the service person to monitor the signal at several points in the set at once, but also provided an indication of the strength of the observed signal as it passed through the various stages. This gave the diagnostician an indication of whether the signal was being properly amplified at each point.

The *Chanalyst* contains five separate test channels, each designed to monitor a specific function in the radio. Last time, we discussed the Wattage Indicator, Oscillator, and RF-IF Channels. Now we'll continue with the Audio Frequency and Electronic Voltmeter channels.

THE AUDIO FREQUENCY CHANNEL

As you can see from the original schematic (Fig. 1), the AF-channel is nothing more than a single-stage audio amplifier. This high-gain amplifier has a response that is flat over the audio frequency range covered by the highest fidelity sets of the era. The output of the amplifier is fed to a detector/tuning eye indicator network as in the three channels we looked at last month.

An audio signal from any point in the receiver under test can be picked up by the audio test probe and fed into the channel's input jack (J3 on the schematic). By noting the reading of a calibrated level control adjusted to just close the eye, one can measure the strength of the observed signal and compare it with audio measured elsewhere in the set. An output jack (J6) is provided for listening to the output of the channel on a headset, so that the observed signal can be checked for hum, noise, or distortion. The output can also be connected to a scope or fed to an external amplifier.

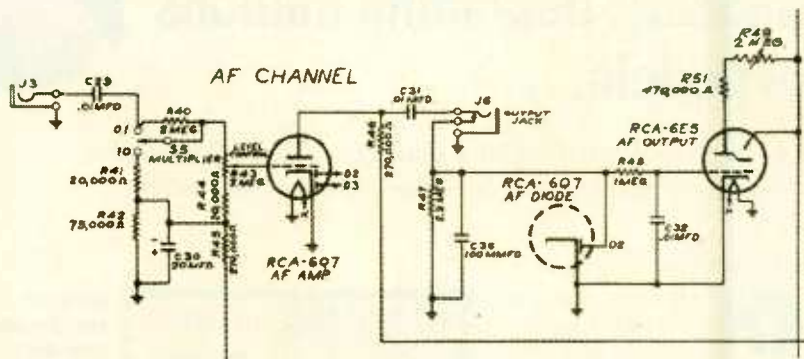

Fig.1. Audio channel section of the *Chanalyst* schematic is essentially a single-stage high-gain amplifier.

THE ELECTRONIC VOLT METER CHANNEL

The electronic voltmeter is a DC vacuum tube voltmeter (VTVM) with ranges of ± 5 , 25, 125 and 500 volts. The meter is zero-centered, so that plus-or-minus voltages can be measured without reversing the probe connections. While a modern reader might take a "so-what-else-is-new" attitude about the inclusion of a VTVM in this piece of test equipment, such a meter was quite an innovation when the *Chanalyst* came out in the late 1930s.

Armed with a VTVM, which presented a negligible load to the circuit being tested, the service person could measure sensitive voltages, even at tube grids. Oscillator and AVC voltages, virtually unmeasurable with the strictly mechanical voltmeters of the time, could be checked without disturbing the normal operation of the radio. The Electronic Voltmeter channel is there for trouble-shooting stages pinpointed as defective using the diagnostic tools in the *Chanalyst*. However, it could also be connected to the output of the Oscillator or RF-IF-channel to provide a more accurate signal level reading than that provided by the tuning eye and level control.

CHANALYST KNOCKOFFS

If you are a dedicated radio-meet attendee, you may well have run into

at least two "me-too" products very similar in concept to the *Chanalyst*. They are both so similar that either (1) the *Chanalyst* design must have been unpatentable (after all, it is just a convenient assemblage of standard circuits) or (2) the knockoffs must have been manufactured under RCA/Rider license. I'm talking about the Meissner *Analyst* and the Hickok *Traceometer*.

Like the *Chanalyst*, the *Analyst* contains four channels monitored by tuning eyes (Oscillator, RF-IF, Audio, and what Meissner dubs "Line Current"). There's also a metered "Electronic Voltmeter" channel. The Oscillator and RF-IF channels each have three bands, as in the *Chanalyst*, and all bands cover virtually the same frequency ranges as their *Chanalyst* counterparts. The voltage ranges on the *Analyst's* Electronic Voltmeter and the current range on the Line Current channel are also identical or very close to those on the *Chanalyst*. The channels are equipped with almost identical attenuator range and level controls, as well as an identical pattern of input and output jacks.

The circuitry and tube complements of the two units are quite similar as well. But though the two units are very similar electrically, they are quite different in appearance. The *Chanalyst* panel has a basically horizontal arrangement, with all of the channels grouped around the

centrally located VTVM meter. It is basically metallic in finish, with attractive hammertone accents and engraved indicator markings.

The *Analyst* panel is laid out vertically, with a "stacked" arrangement of the channels. Finish is black enamel, with the indicator areas behind the knobs, "reversed-out" in bare metal. The red knobs contrast agreeably with the basically black panel. My *Analyst* documentation comes from a Meissner publication dated 1949—an indication that this equipment was put on the market several years after the *Chanalyst*.

The other "*Chanalyst* knockoff" often seen at the radio meets is the Hickok *Traceometer*. This is a very serious looking instrument (see Fig. 2) because, though it has the same channel setup and essentially the same circuitry as the *Analyst* and *Chanalyst*, the output of each channel is shown on a meter rather than a tuning eye. The general panel layout is quite similar to that of the *Chanalyst*, except that the four tuning eyes at the top of the *Chanalyst* front panel are replaced by an array of four meters, making five meters in all! A most imposing piece.

Again, almost all of the channel specs (bands, ranges, etc.) are virtually identical with those of the original *Chanalyst*. The circuitry is similar, too, except for the differences resulting from the need to drive meters rather than tuning eyes. Another nice departure is the inclusion of a built-in speaker for audio monitoring.

All three of these signal tracers are interesting devices indeed. Someday, I'd like to restore one to full operation and give it a permanent place on my workbench. The only problem is—I can't decide which one!

ANTIQUÉ RADIO LIBRARY

A couple of new "old" books have been sitting on my desk for awhile from Lindsay Publications, P.O. Box 538, Bradley, IL 60915. This is the company that brings us those fascinating reprints of electrical and electronic books from the past. Looks like I have just about enough space to discuss them here—so here goes.

Radio For The Millions

Soft cover, 6- × 9-inches, 192 pages; \$11.95, plus \$1.00 S&H.

This title was recently re-reprinted by Lindsay after their original reprint was

Model 533D Display Tube Tester, Net

\$151.00

"HICKOK" MODEL 156-A TRACEOMETER

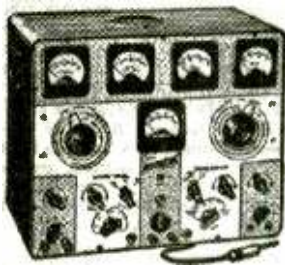

scale with ranges of 0-25, 25-50, 50-500 volts, all ranges with constant

Permits the tracing of a signal through the receiver from Antenna to Speaker, allowing the simultaneous checking of all sections of the circuit. Five precision Indicating Meters. Five metered test circuits—1: RF-IF low frequency circuit, three ranges, 95-1600kc.; 7-voltage ranges, 5000 microvolts to 25 volts; shielded test lead prevents distortion and loading of circuits. 2: Oscillator-HF circuit; three ranges, 600kc. to 15mc.; 7-voltage ranges 0-750 volts; shielded capacitive test lead prevents loading of circuits under test. 3: A-F Voltmeter, 7 ranges, 0-500 volts through frequency ranges of 20-20,000 cps. plus or minus 2 db., with input impedance of 2 Meg. 4: D.C. V.T. Voltmeter, center zero

Abridged detail from 1949 radio catalogue shows imposing panel of Hickok Traceometer.

Twin-Bed Radio

CAN BE TUNED FROM EITHER SIDE



Illustration from *Radio For the Millions* is typical of the quaint projects to be found in this book.

sold out, and I can understand why. The original volume, published in the mid-1940s, was probably one of the most beloved collections of radio construction ideas ever published. It combined, between hard covers, two *Popular Science* publications: *The Popular Science Radio Annual* and *The Second Radio Annual*. My own recollections of the colorful, and often eccentric, projects to be found within its pages were presented in my October, 1997 column.

This book contains almost eighty construction projects of varying complexity and about a dozen short "servicing hints" articles. The majority of the projects are radio receivers. Many of these are regenerative in order to extract the maximum performance from a minimum number of tubes and components. The physical packaging of the radios definitely leans towards the novelty side, with the emphasis on

midget sets and radios designed for use in very specialized situations.

Just to give you a flavor of the offerings in the book, here are some of the receiver-project titles: Letter Radio Can Be Mailed; Europe on One Tube; Twin-Bed Radio (can be tuned from either side—see Fig. 3); Novel Lamp Radio; Four Dollars Builds This Loudspeaker Set; Sliding Panel Tunes Novel Radio; Week-ENDER's Radio (built into a luggage case); Book-End Radio For Your Den; and Cane-And-Seat Radio.

Among the "non-receiver" projects, you'll find: Homemade "Audio" Telegraph; Light-Beam Transmitter; Inexpensive Dual-Turntable Phonograph ("...provides sound accompaniment for your own home-movie films"); Television Antenna; "B" Supply For Portables; Two Way Radio Station; and "Wireless" Radio Phonograph.

The book is profusely illustrated,

with many quaint and oddly compelling drawings and photographs. You'll find it great fun to browse through, even if you are never tempted to build "Radio For Your Floor Lamp" or "Camper's Radio Uses Fishpole Antenna."

Harper's Electricity Book for Boys
Soft cover; 5- × 7-inches; 408 pages; \$19.95 paper, \$26.95 cloth; either plus \$1.00 S&H.

Originally published in 1907 by Harper and Brothers, this volume was written and illustrated by Joseph H. Adams, who had previously authored *Harper's Outdoor Book for Boys*. Written in an age when the science and technology of electricity seemed about to transform society, the book represents an effort to familiarize youngsters with its principles using a highly "hands-on" approach.

Following a simple start with cells, batteries, pushbuttons and switches, Part 1 of the book progresses through magnets, induction coils, measuring instruments, and bells. In Part 2, the emphasis is on more complex technology, such as the telegraph, telephone, dynamos and motors, and electroplating.

The principles are illustrated through many projects which, technically at least, could be built with simple hand tools and limited resources. The author's detailed line drawings for the various projects are fun to look at, and the illustrations for the simpler projects look as if they could be readily followed. But when it came to building a telephone receiver and transmitter, induction coil, electric motor, or (wow!!!) lead-acid storage battery complete with an acid-tight asphalt-lined wood case...well, the drawings seem a little inadequate. In any case, this is a fun read, and a most interesting period piece. ■

COMPUTER BITS

(continued from page 60)

switches or lights, so all you can do is test non-I/O-oriented algorithms.

I find it useful to keep copies of the Assembler and the Programmer running, along with a copy of Notepad. In the latter, I display the file "1200def.inc," which provides many definitions useful in 1200 programming, such as I/O register names. For simplicity, in our first

few test programs we'll just enter the relevant definitions directly into our code. Later, we'll "include" the definitions file indirectly. Unfortunately, the debugger only works with the expensive In Circuit Emulator, not our little \$50 eval board.

To run the Programmer, the eval board must be connected to your PC via a straight-through cable with 9-pin male and female connectors on opposite ends. When you start up the programmer, it scans the serial ports on your PC. If it doesn't find a board, the program refuses to run.

The Programmer provides a simple interface for downloading hex files from disk to the 1200's Flash or EEPROM; and conversely, for uploading Flash and EEPROM contents to the PC. We'll only use the flash in this installment.

BRINGING IT ALL TOGETHER

Listing 1 shows a simple test program you can use to verify that all the software and hardware is running correctly. Enter the program exactly as shown in the Assembler and save it in a convenient location. Then click the Options menu, and specify the Output File Format as Intel, and click "Save before assemble."

Next, assemble the file (i.e., create the object code); to do so, just click the Assemble menu. If all goes well, a message dialog pops up and says "Assembly complete with no errors." If the dialog mentions errors, correct them, and re-assemble.

Now download the code. With power to the eval board off, insert a 1200 into the U101 socket, observing polarity. Then power up the board. If all is well, all four system LEDs light up briefly. Then D110, D111, and D112 will extinguish in turn. After boot completes, only the Power LED (D144) should be lit. Make sure your serial cable is connected, then run the Programmer software. Click the Browse button, navigate to where the assembled hex file is located, and load the file. Make sure the Device selector is set for the correct AVR chip.

Finally, in the group labeled Flash, click the Program button. The whole sequence takes place very rapidly; you should see a progress bar increment across the front of the Programmer dialog. If the download process completes successfully, you'll see the message

VENDOR INFORMATION

Atmel Corporation

2325 Orchard Parkway
San Jose, CA 95131
Tel. 408-441-0311
Web: www.atmel.com

Part Numbers:

AT90S1200-16PC is the 16-MHz 1200 in a 20-pin DIP package.
AT90S8515-8PC is the 8-MHz 8515 in a 40-pin DIP package.
ATMCU00100 is the evaluation board.

Arrow/Schweber Electronics

Tel. 800-833-3557

AVROne

Web: www.avrone.com

DonTronics

Web: www.dontronics.com

Marshall Industries

Tel. 800-833-9910
Web: www.marshall.com

Pioneer Standard Electronics

Tel. 216-587-3600
Web: www.pios.com

"Erasing, Programming, Verifying, OK" appear briefly above the progress bar. You should also see LEDs on the eval board flash.

THE TEST PROGRAM

The test program is a model of concise, clever programming—not. All it does is set up Port B of the 1200 for output to drive the LEDs, and Port D for input to read the switches. Then the program goes into an infinite loop, alternately reading the switches and writing the LEDs. In practice, what should happen is that whenever you press one of the momentary switches on the evaluation board, the corresponding LED should light. For even more fun, you can press several switches and light several LEDs simultaneously.

Almost. Actually, because of the limited pin count of the 1200, Port D only has seven bits, D0, D1, ...D6. (Higher-end AVR chips give you all 7 bits. Such a deal!). So after reading the states of the switches, we mask off bit 7 by ORing it with the command "\$80," which just sets the high bit of the byte.

That's it for now. You might want to play with setting up a delay, so that, for example, whenever the user presses a switch, an LED remains on for say half a second. That's where we'll pick up next time; in the meantime, you can contact me at jeff@ingeninc.com. ■

DX LISTENING

The Music of Shortwave

DON JENSEN

I awoke one morning to a familiar sound. In that half-awake world where dream meets reality, it took me back to the Peruvian altiplano. In youthful vagabond days, I had bummed across South America, and in my sleepy haze I was back again in a scruffy room at the Hotel Savoy, at the end of Avenida El Sol near the Cuzco railroad station.

The sound had a name: "El Condor Pasa." I'd first heard the plaintive melody one day, long ago, drifting in my window from out of the studio loudspeakers of shortwave station, Radio Tawantinsuyo, next door to the hotel.

It wasn't Cuzco, Peru, of course. I was in my own bedroom at home. And the song—even Simon and Garfunkle's pallid Americanized-version of "El Condor Pasa" ("I'd rather be a hammer than a nail")—was coming from my AM clock radio.

That is the power of music. It can transport you, as it did me, to another time and place. For SWLs, music often is a big reason why we listen to shortwave programming. And some of the best, the most fascinating, the most melodic, the most rhythmical music, comes from South American shortwave stations in Peru, Bolivia, and Ecuador.

Mostly we think hot rhythms, the merengue and salsa, when we think Latin American music. But the musical sound of the Andean region of South America is something different. That's because these fascinating melodic lines are only partly Latin. The more important influence is the music of Incas—the Indian people who established a vast empire long before the first Spanish Conquistadors arrived in the 16th Century.

The indigenous music, according to Incan mythology, began after the god

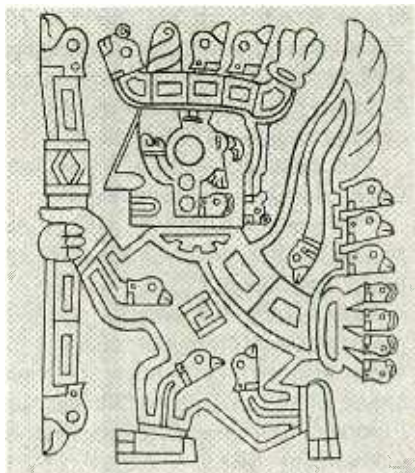

Traditional Inca design, from the QSL card of Radio Union in Lima, Peru.

Viracocha rose from the sea to teach his new peoples to sing a pentatonic scale, E-G-A-B-D, an almost oriental sound to our western ears.

A MUSICAL MIX

Traditionally, the Incas played flutes, particularly the quena and the pinkillo, and drums to accompany the human voice. To this mix, the conquistadors brought the Spanish guitar and European rhythms. The resulting musical form would be called the huayno (pronounced: WINE-yo). In 1912, Peruvian folklorist Daniel Alomia Robles wrote "El Condor Pasa," the most famous of the huaynos, based on traditional themes he had gathered while traveling through the Andes mountains, highlands, and valleys.

Besides "El Condor Pasa," a tribute to the giant bird that soars the Andean skies, other huaynos often heard on Peruvian shortwave stations include "Cuando el Indio Lloro" (When the Indian Cries), "Virgenes del Sol" (Virgin Priestesses of the Sun) and "El Picaflor" (The Playboy).

A huayno is generally sung, either in Spanish or the Indian Quechua language, accompanied by the flutes and a rapidly strummed pint-sized guitar—the charango. The sound is distinctive, carrying a kind of inherent melancholy,

according to Richard Leggett, a British SWL and musical scholar. The omission of some musical tones from the descending scale causes the melody to lose its regular pattern of notes.

Though challenged today by American rock, the huayno still is the most popular musical type in Peru, especially in the more rural regions. There are, of course, other musical types native to the country—for example, the huayla, a bit faster, and the yaravi, a bit sadder.

In Bolivia, where it is spelled huaino, another instrument often is added to the mix—a bamboo panpipe called the siku. It is played by the musician as a kid would blow across the mouth of a bottle. The result, particularly the low notes, is a haunting, breathless sound, that is like nothing else in the world.

Ecuador, too, produces a similar Andean sound, but with certain differences. The two most common types of Ecuadorian music heard on shortwave are the passacalle and the pasillo. The passacalle, like the huayno, has the distinctive Andean Indian flavor. However, it often features the local native flute, the roncador, and sometimes, incongruously, the electronic organ.

The other predominant Ecuadorian musical-type is the pasillo, especially sad songs, usually of love-gone-sour. Consider these titles: "Lagrimas," "Dos Lagrimas," "Cuatro Lagrimas," and "Vaso de Lagrimas." Translated: "Tears," "Two Tears," "Four Tears," and "A Glassful of Tears." Talk about tear-jerkers!

Many DXers I know, like me, love to listen to this music of Andean countries of South America. You may too. Give it a try!

BUT WHERE TO TUNE?

There are simply dozens of shortwave stations in Peru, Ecuador and Bolivia. Nearly all of them are broadcasting primarily to local audiences in Spanish, or one of several Indian languages such as Quechua or Aymara. A major exception is the longtime religious broadcaster, HCJB, the Voice of

CREDITS—Brian Alexander, PA; Richard D'Angelo, PA; Mark Fine, VA; Mark Mohrmann, VT; Ed Newbury, NE; Denis Pasquale, PA; Ed Rausch, NJ; Giovanni Serra, Italy; Tom Sundstrom, NJ; Robert Yajko, PA; North American SW Association, 45 Wildflower Road, Levittown PA 19057.

the Andes, in Quito, Ecuador, which airs programs to international audiences in a number of different languages. But it also has a half-hour weekly program called "Musica del Ecuador," or traditional Ecuadorian music. For SWLs looking for an introduction to the Andean musical sound, it is an easy station to hear, and a good place to begin your musical adventure. At this writing, "Musica del Ecuador" can be heard several times during HCJB's Thursday night (Friday morning UTC) transmissions to North America on 9745 kHz.

The other stations of the Andean region of South America may be more difficult to tune. But during the early morning hours, and an hour or two before your local sunrise, try Bolivia's, Radio Illimani in LaPaz, on 4945 kHz, or Peru's Radio Santa Rosa in Lima, on 6045 kHz, both of which have terrific musical programs featuring huayno/huaino selections.

Radio Andina in Huancayo, Peru, sometimes puts in a very nice signal on 4995 kHz, both during the predawn hours and during the early U.S. evenings, and features a lot of huaynos. Another one to try is Radio Frecuencia San Ignacio in Cajamarca, Peru, during the evening hours.

AND THE ENVELOPE, PLEASE

Dave Fiedler of Los Angeles writes with a question about return postage. "I've been sending reception reports to stations for more than a year now and have received a number of QSLs in reply. But it seems to me that some SW stations aren't replying because their budgets are tight, and it takes a lot of postage to send QSLs to listeners like me. I'm willing to send return postage with my reception reports, but how? A station can't use U.S. stamps to mail an airmail reply back to me."

That's right, Dave. And sending return postage certainly does help, particularly with the smaller SW stations. There are three possible answers.

First, you may purchase an International Reply Coupon (currently \$1.05) at your post office and include it with your reception report. An overseas station can exchange it for sufficient postage stamps to mail a reply to you by surface mail.

Next, some SWLs favor sending along a "green stamp," meaning a U.S.

\$1 bill, which, as a practical matter, is exchangeable for anything in most countries.

Last, the best approach is to include stamped self-addressed envelopes (SASEs) with your station reports. But where can you get mint foreign postage stamps in just the right denominations to post an airmail reply to the U.S.? One source is Bill Plum (12 Glenn Road, Flemington NJ 08822-3322), a longtime SWL himself. For more information and a price list, send Bill a SASE with 32 cents postage (U.S., of course!).

Our next letter comes from Sally Claire of Raleigh NC, who writes:

"I'm going to Europe in August and I'd like to meet some SWLs while I'm there. Any thoughts?"

Sure, Sally, but time is short. A great place to meet European shortwave listeners—and many of them speak English—is at the 36th annual European DX Council conference at Gothenberg, Sweden, August 28–31. American SWLs are always welcome for this fun weekend. The address for information is EDXC '98, P.O. Box 214, Helsinki, Finland FIN-00101, Or send an e-mail inquiry to edxc98@srs.pp.se.

DOWN THE DIAL

Looking for something to tune on shortwave? Try these:

ARGENTINA—11710 kHz, RAE, Buenos Aires, is heard here at 0230 UTC, with English news and features.

BRAZIL—11805 kHz, Radio Globo has been logged around 2000 UTC on this frequency with Brazilian music and ads and announcements in Portuguese. The distinctive identification is "Radio Globoooooo!"

ECUADOR—4870 kHz, "La Voz del Upano" is noted here with Ecuadorian music and Spanish announcements until sign off around 0145 UTC.

PERU—4461 kHz, Radio Norandina has plenty of Andean regional music around 1000 UTC. Some other Peruvian shortwavers with similar programming about the same time include Radio Quillabamba on 5025 kHz and Radio Ilucan on 5630 kHz.

SOUTH AFRICA—15240 kHz, Channel Africa has English around 1700 UTC, with news, stock market report, and interviews.

SUDAN—9200 kHz, Radio Omdurman, Republic of Sudan Radio, is heard ending its English service at 1858 UTC.

THAILAND—9680 kHz, Radio Thailand has English scheduled beginning at 0030 UTC, with interval signal, identification, and local news and commentary.

TURKEY—6900 kHz, Turkish Meteorological Station in Ankara has Turkish programming, including Turkish music, on this frequency around 0430 UTC.

UZBEKISTAN—7105 kHz, Radio Tashkent's English program includes a newscast, feature programs, music, and the station's identification and address. Tune this one from 2130 to 2159 UTC sign off. ■

NET WATCH

(continued from page 15)

appear, and you decide which of the five you'd like to hold by clicking on them. Then, hit DRAW and see how lucky you are. A chart at the top of the machine shows you what the payout for each type of bet and hand is (*i.e.*, a two-coin wager pays six coins for a three-of-a-kind). The standard Slots had a similar interface that explains what you can win for each bet.

There were still a few glitches with the server that caused a delay between some of the gaming steps, but not a problem that made any of the applets malfunction. Of course, you should keep in mind that *GalaxiWorld* is investing \$25 million (!) in the development of this site, and I have a feeling it'll be pretty perfect soon.

Well, that about wraps it up for this month. Until next time, I wish you lots of luck. Feel free to e-mail me at netwatch@comports.com, or send snail mail to *Net Watch*, Popular Electronics, 500 Bi-County Blvd., Farmingdale, NY 11735. ■

Solution to puzzle (Page 45)

COT	AOL	TAD	
RAH	CUE	PAGE	
ATE	ETA	ICON	
THROB	IVAN		
ESE	LINEN	AIM	
SING	TESLA		
SHRINK	TEMPLE		
TRICK	FONT		
ESPERA	NAPT		
ORAL	AUDIO		
TSAR	MLB	LAD	
WINE	BEA	INA	
ADD	ONT	BOY	

Market Center TM

Carpet Rover Robot Kit \$115.00

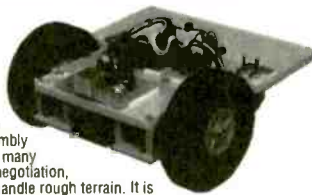

Build your own functional Carpet Rover Robot
The kit comes complete with all hardware, structural components, 2 Hitec servos, First Step Basic Stamp kit, software and an illustrated assembly manual. This robot is an excellent foundation for many experiments such as, obstacle avoidance, maze negotiation, computer art and line tracking. Large 3" wheels handle rough terrain. It is a lot of fun to build and even more fun to operate. Check out our web site for more information and other robot kits.

• **Line Tracker Option \$20.00** • **Infrared Proximity Det \$30.00** • **Mobile Robots Book \$48.00**

Quantity discounts available. \$7.50 Shipping & Handling for USA, call for international and quantity shipping charges. IL residents add 6.25% sales tax to total.

Many more robot kits, ask for our free catalog!

Lynxmotion, Inc.
104 Partridge Road
Pekin, IL 61554-1403 USA



Tel: 309-382-1816
Fax: 309-382-1254
www.lynxmotion.com
jfray@lynxmotion.com

MAY THE SOURCE BE WITH YOU

Don't let the dark forces of ignorance defeat you. Tap into the source of free or low cost government publications—the free CONSUMER INFORMATION CATALOG.

Call toll-free 1-888-8 PUEBLO

Or set your coordinates for our web site

www.pueblo.gsa.gov

The World's Largest Source for Home Automation

- The Best & Most Comprehensive Home Automation Catalog in the Industry.
- Best Customer Service & Technical Support



FREE
144 page full color catalog!

Thousands of hard-to-find automation, X-10 and wireless control products. Computer interfaces, software, development tools, lighting control, telephone systems, security systems, surveillance cameras, infrared audio/video control, home theater, touchscreen control, HVAC, pet care automation, wiring supplies, books and videos and much more!

World's Largest Selection!

Lowest Prices Guaranteed!

HOME AUTOMATION SYSTEMS, INC.

Questions: 714-708-0610 Fax: 714-708-0614

e-mail: catalog@smarhome.com

www.smarhome.com

Call for a **FREE** Catalog! 800-762-7846

800-SMART-HOME

Dealers/Resellers ask about our HASPRO Dealer Program 800-949-6255

Weeder Technologies

Add \$4
Ship/Hand
US & Canada

FREE CATALOG!



Pro-Kit

PO Box 2426, Ft. Walton Beach, FL 32549

850-863-5723

Stackable RS-232 Kits

Digital I/O - 12 I/O pins individually configurable for Input or output. DIP switch addressable; stack up to 16 modules on same port for 192 I/O points. Turn on/off relays. Sense switch transitions, button presses, 4x4 matrix decoding using auto-debounce and repeat. **\$32**

Analog Input - 8 Input pins. 12-bit plus sign self-calibrating ADC. Returns results in 1mV steps from 0 to 4095. Software programmable alarm trip-points for each input. DIP switch addressable; stack up to 16 modules on same port for 128 single-ended or 64 differential inputs. **\$49**

Home Automation (X-10) - Connects between a TW523 and your serial port. Receive and transmit all X-10 commands with your home-brewed programs. Full collision detection and auto re-transmission. **\$39**

Caller ID - Decodes the caller ID data and sends it to your serial port in a pre-formatted ascii character string. Example: *12/31 08:45 850-863-5723 Weeder, Terry <CR>*. Keep a log of all incoming calls. Block out unwanted callers to your BBS or other modem applications. **\$35**

Touch-Tone Input - Decodes DTMF tones used to dial telephones and sends them to your serial port. Keep a log of all outgoing calls. Use with the Caller ID kit for a complete in/out logging system. Send commands to the Home Automation or Digital I/O kits using a remote telephone. **\$34**

Telephone Call Restrictors

Two modes of operation; either prevent receiving or placing telephone calls (or call prefixes) which have been entered into memory, or prevent those calls (or call prefixes) which have "not" been entered.

Block out selected outgoing calls. Eypass at any time using your password. **\$35**

Block out selected incoming calls. Calls identified using Caller ID data. **\$48**

Phone Line Transponder

7 individual output pins are controlled with buttons 1-7 on your touch-tone phone. Automatically answers telephone and waits for commands. Monitor room noises with built in mic. "Dial-Out" pin instructs unit to pick up phone and dial user entered number(s). Password protected. **\$49**

IR Remote Control Receiver

Learns and records the data patterns emitted by standard infrared remote controls used by TVs, VCRs, Stereos, etc. Lets you control all your electronic projects with your TV remote. 7 individual output pins can be assigned to any button on your remote, and can be configured for either "toggle" or "momentary" action. **\$32**

DTMF Decoder/Logger

Keep track of all numbers dialed or entered from any phone on your line. Decodes all touch-tones and displays them on a 16 character LCD. Holds the last 240 digits in a non-volatile memory which can be scrolled through. Connect directly to radio receiver's speaker terminals for off-air decoding of repeater codes, or numbers dialed on a radio program. **\$55**

EARN MORE MONEY!

Be an FCC LICENSED ELECTRONIC TECHNICIAN!



Learn at home in spare time. No previous experience needed!

No costly school. No commuting to class. The Original Home-Study course prepares you for the "FCC Commercial Radiotelephone License." This valuable license is your professional "ticket" to thousands of exciting jobs in Communications, Radio-TV, Microwave, Maritime, Radar, Avionics and more...even start your own business! You don't need a college degree to qualify, but you do need an FCC License.

No Need to Quit Your Job or Go To School
This proven course is easy, fast and low cost! **GUARANTEED PASS**—You get your FCC License or money refunded. **Send for FREE facts now. MAIL COUPON TODAY!**

Or, Call 1-800-932-4268 Ext. 240

COMMAND PRODUCTIONS

FCC LICENSE TRAINING, Dept. 240
P.O. Box 2824, San Francisco, CA 94126
Please rush FREE details immediately!

NAME _____
ADDRESS _____
CITY _____ STATE _____ ZIP _____

CONTROL

RELAYS • LIGHTS • MOTORS

MEASURE

TEMPERATURE • PRESSURE • LIGHT LEVELS • HUMIDITY

INPUT

SWITCH POSITIONS • THERMOSTATS • LIQUID LEVELS

MODEL 30 \$79 <ul style="list-style-type: none"> • PLUGS INTO PC BBS • 24 LINES DIGITAL I/O • 8 CHANNEL • 8 BIT A/D/IN • 12 BIT COUNTER • UP TO 14K BPP/SEC 	MODEL 45 \$189 <ul style="list-style-type: none"> • RS-232 INTERFACE • 8 DIGITAL I/O • 8 ANALOG INPUTS • 2 ANALOG OUTPUTS • 2 COUNTERS-24 BIT
MODEL 100 \$279 <ul style="list-style-type: none"> • 12 BIT 100 KHZ A/D • 4 ANALOG OUTPUTS • 3 TIMER COUNTERS • 24 DIGITAL I/O 	MODEL 150-02 \$179 <ul style="list-style-type: none"> • RS-232 INTERFACE • TRMS, 24 AMPS • 12 BIT A/D • OPTO-ISOLATED • COMPLETE DMM
MODEL 40 \$99 <ul style="list-style-type: none"> • RS-232 INTERFACE • 20 LINES DIGITAL I/O • 8 ANALOG INPUTS • PWM OUTPUT 	MODEL 70 \$239 <ul style="list-style-type: none"> • RS-232 INTERFACE • 18 BIT A/D • 5.5 DIGIT • UP TO 60 BPP/SEC

Prairie Digital, Inc.

PHONE 608-643-8599 • FAX 608-643-6754
846 SEVENTEENTH STREET • PRAIRIE DU SAC, WISCONSIN 53578

CIRCLE 48 ON FREE INFORMATION CARD

EPROM+ The Professionals' Choice!

A DEVICE PROGRAMMER FOR BENCH AND FIELD

WEBSITE
www.arlabs.com

Uses parallel printer port!
Excellent software!
Supports all standard parts!

FIRST GENERATION EPROMS 2708, TMS2716*, 25XX
SECOND GENERATION EPROMS (24, 28, 32 PIN) 2716 - 27C180 (8 MEG) *ADAPTER REQUIRED (DIAGRAMS INCLUDED)
16 BIT EPROMS (40, 42 PIN) 27C1024 - 27C160 (16 MEG)
FLASH EPROMS (28, 32 PIN) 28F, 29C, 29EE, 29F FAMILIES PLUS BOOT BLOCK DEVICES
EEPROMS/NVRAMS (24, 28, 32 PIN) 28C04 - 28C01H, X221H/12, ER5901, PLUS DALLAS 12XX
SERIAL EPROMS* (8, 14 PIN) 17XX, 24XX, 25XX, 35XXX, 59XX, 85XX, 93XX, 95XX+ER140H
BIPOLAR PROMS* (16 - 24 PIN) 74SXXX AND 82SXXX FAMILIES
MICROCONTROLLERS* (ALL FAMILIES) 874X, 875X, 87CSXX, 87C75X, 89CSXX, 89CX051, 68705, 68711, PIC12XXX - 16CXXX, 17C4X PLUS FLASH AND 14000

- READ, PROGRAM, COPY, COMPARE FILE LOAD/SAVE (PLUS MUCH MORE!)
- FULL SCREEN EDITOR W/25 CMDS + BYTE/WORD MODES
- RUNS UNDER DOS, WIN3.1/95 ON ANY SPEED MACHINE
- SUPPORTS INTEL HEX, S-RECORD AND BINARY FILES
- MADE IN USA • 30 DAY MONEY BACK GUARANTEE

\$289

SYSTEM INCLUDES: PROGRAMMING UNIT, PRINTER \$5.00 SHIPPING • \$5.00 C.O.D.
 PORT CABLE, POWER PACK, SOFTWARE & MANUAL VISA • MASTERCARD • AMEX

ANDROMEDA RESEARCH, P.O. BOX 222, MILFORD, OH 45150
 (513) 831-9708 FAX (513) 831-7562

ATTENTION CABLE VIEWERS
Own Your Own Unit Today
Cable TV Converters &
Descramblers
All Makes / All Models

Call 1-800-577-8775

Technical Info: 847-584-2099

**OVER
30,000
ITEMS
IN STOCK**

**LARGE VARIETY
SAME DAY SHIPPING**

Minimum Orders \$20.00

Not Including Shipping & Handling

Dalbani®

The Ultimate Saving Source

SEMICONDUCTORS

Original #	Brand	Replaces
7805	Tesla	960
7806	Ank	962
7809	Ank	1910
7810	Samsung	1968
7812	Tesla	966
7815	Tesla	968
7818	Tesla	958
7824	Tesla	972
7905	Tesla	961
7906	Tesla	963
7908	Tesla	965
7912	Ank	967
7918	Tesla	959
7924	Tesla	971



YOUR CHOICE

\$45¢
each

POPULAR FUSE KIT 180 Piece Kit

Kit Contains 10 Pieces of each of these items:

- AGC Type : 0.5A, 1A, 1.5A, 2A, 2.5A, 3A, 4A, 5A, 6A, 10A, 15A
- Ceramic Type : 15A
- GMA Type : 1A, 1.5A, 2A, 3A, 4A, 5A

Everything Comes in a Durable Plastic Box

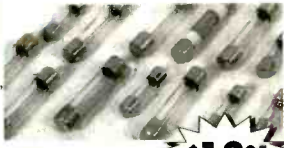

\$13.95

Item # 10-2050

TUN-O-WASH® (CFC Free)

Fast drying electronics grade cleaner for tuners, controls and PC boards.

- CFC and HCFC free
- Not for use on energized equipment
- Due to the chemical content, this product can be only shipped by UPS ground service.

Item # 30-0100
(12.5 Oz aerosol)



\$11.75

DALCO DIGITAL MULTIMETER

- DC Voltage: 200m-1K
- AC Voltage: 200-750V
- DC Current: 20m-20
- Transistor and Diode Test
- Continuity Buzzer
- Polarity indicator appears on LCD
- Test Probes Included
- Dimensions: 4.96" x 2.76" x 9.4"
- Weight: 6 oz.
- 9V Battery Included



\$9.95

Item # 50-2895

Dalco® ECONOMICAL SOLDER WICK

5 Feet

Removes solder easy

- Length: 5 feet
- Width: 0.15"
- Safer Desoldering
- Fast Response

Item # 51-1050



\$1.10

SOLDER ROLL

- 1 LB Spool
- 370° F melting point
- Fastest solder
- Alloy 60/40, tin lead, non corrosive flux, Diam.1.0mm

Item # 51-1005



\$5.49

DUAL HELPING HANDS

- Hold Work in any Position to leave hands free for soldering

Item # 50-1325



\$3.45

SOLDERING IRON

- General Purpose Applications
- 117V AC, 30 Watts

Item # 51-1335



\$3.25

WELLER WLC100 SOLDERING STATION

Weller®

- Ideal for the professional, serious hobbyist
- Variable power control (5-40W)
- 40W pencil iron and ST# inter changeable tip
- Replaceable heating element
- Cushioned foam grip • Safety guard-iron holder
- On/off switch with "power-on" indicator light

Item # 51-1505



\$38.90

SHIP UP TO 5 lbs FOR ONLY

\$3.95

UPS
2ND DAY AIR



Plus handling & C.O.D. charge if it applies

THE MOST POPULAR VCR ALIGNMENT TOOL KIT

\$24.99

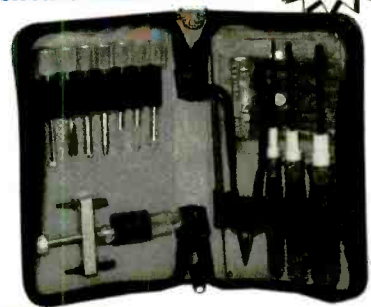

- VCR Head pull
- Retaining ringremover
- Micro screwdriver
- Fitted vinyl Case
- 7 Assorted head & guide aligner
- Dimensions: 9 1/2"(W) X 12 1/4"(L)
- 3 Reverseable screwdrivers (Small-Flat-Phillips)
- Spring hook
- Hex key set
- Soft zippered case

Item # 50-888

HEAVY DUTY COLOR CODED LEADS

- 10 Leads
- 11" Long Wire Lead
- Insulated 11/2" Alligator Clips
- 20 Gauge Wire Size
- Black, Green, Red, Yellow, White

Item # 56-500



\$2.95

Dalco® SWING ARM MAGNIFYING LAMP

- Spring-Balanced 45" extension arm with 3 conductor cord 120V 60Hz
- Steel Shade supplied with a precise 3 diopterlens and a 22W fluorescent circline tube
- Comes with a lamp

Item # 54-0120

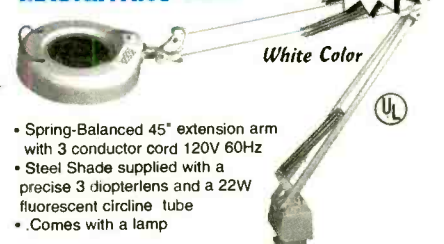

\$36.72

White Color



Dalbani®

4225 NW 72ND AVE. MIAMI, FLORIDA 33166
TEL : (305) 716-1016 ----- FAX : (305) 594-6588

**Free 400 Page Color Catalog
With your First Order**

1-800-325-2264

CIRCLE 153 ON FREE INFORMATION CARD

CALL TOLL FREE
(800) 292-7711 orders only
Se Habla Español

C&S SALES
EXCELLENCE IN SERVICE

LOOK FOR OTHER
MONTHLY SPECIALS
ON OUR WEBSITE

NEW XK-700 Digital / Analog Trainer
 Elenco's newest advanced designed Digital / Analog Trainer is specially designed for school projects. It is built on a single PC board for maximum reliability. It includes 5 built-in power supplies, a function generator with continuously sine, triangular and square waveforms and a 1560 tie point breadboard area. Tools and meter shown optional. (Mounted in a professional tool case made of reinforced metal).

XK-700
Assembled and Tested
\$189.95

XK-700 - SEMI KIT
w/ Fully Assembled PC Board
\$174.95

XK-700K - Kit
\$159.95



Made in the USA

Volt Alert™ By FLUKE

Volt Alert™ is the new pocket-sized AC line voltage detector from Fluke. Easy to use - just touch the tip to an outlet or cord. When it glows red, you know there's voltage in the line.

Electrician's, maintenance, service, and safety personnel can quickly test for energized circuits and defective grounds on the factory floor, in the shop, or at home.

- Fits in shirt pocket for convenience.
- All outer surfaces are unconductive for safety.
- Detects voltage metallic contact.



#1AC \$19.50

DIGITAL LCR METER
Model LCR-1810 **NEW**

\$99.95



- Capacitance .1pF to 20µF
- Inductance 1µH to 20H
- Resistance .01Ω to 2000MΩ
- Temperature -20°C to 750°C
- DC Volts 0 - 20V
- Frequency up to 15MHz
- Diode/Audible Continuity Test
- Signal Output Function
- 3 1/2 Digit Display

20MHz Sweep / Function Generator with Freq Counter

B&K 4040

- 0.2Hz to 20MHz
- AM & FM modulation
- Burst Operation
- External Frequency counter to 30MHz
- Linear and Log sweep



\$399

10MHz B&K 4017 \$309
 5MHz B&K 4011 \$239



Model M-6100

The M-6100 is Elenco's most sophisticated meter with almost every possible feature available. The M-6100 even has a computer interface for viewing and storing data on a personal computer. It comes complete with software, RS-232 cable, test leads and manual.

\$125

Model XP-581

4 Fully Regulated DC Power Supplies In One Unit
 4 DC voltages: 3 fixed - +5V @ 3A, +12V @ 1A, -12V @ 1A
 1 Variable - 2.5 - 20V @ 2A

\$89.95



SATELLITE FINDER

Model SF-100A

- Aligns Satellite Dishes
- Range 950-2050MHz
- Audio Tone
- Compact Size
- Self Power Check



\$39.95

Digital Multimeter

Model M-1700

\$39.95

11 functions including freq to 20MHz, cap to 20µF. Meets UL-1244 safety specs.



Technician Tool Kit
TK-1500



28 tools plus a DMM contained in a large flexible tool case with handles ideal for everyone on the go.

\$49.95

Kit Corner

over 100 kits available

AK-700

\$14.95

Phone kit with training course.



RADIO CONTROL CAR KIT

MODEL AK-870

- 7 functions
- Remote control included

\$24.95



No Soldering Required

Model AM/FM-108K
Transistor Radio Kit

with training course

\$29.95



35mm Camera Kit

Learn all about photography

AK-540

\$14.95



No Soldering Required

The New DMM900 Series Handheld Digital Multimeters

For high-performance digital multimeters that are accurate, reliable, and rugged, the DMM900 Series extends the Tektronix line of already affordable DMMs. Twice the accuracy. Up to 10 times the resolution. And a full range of capability that spans voltage, current, digital multimeters features a dual numeric display, 3-year warranty, and autoranging capability. All backed by the reliability of the Tektronix brand.

Features
DMM912, DMM914,

DMM916

- 40,000 Count Display
- 0.06% Basic DC Volts Accuracy (DMM916)
- DC Voltage Ranges from 400mV to 1,000V
- AC Voltage Ranges from 4V to 750V (True RMS)
- AC and DC Current Ranges from 10,000µA to 10A
- Resistance Ranges from 400Ω to 40MΩ
- Capacitance Ranges from 4nF to 40µF
- Frequency Ranges from 400Hz to 2MHz
- Temperature Measurements from -50°C to +980°C (DMM916, DMM914)
- 3 Year Warranty
- CE Marking

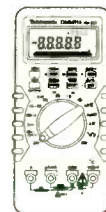

DMM 912
\$189

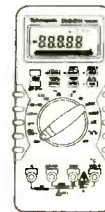

DMM 914
\$235

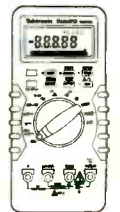

DMM 916
\$275

GUARANTEED LOWEST PRICES ON TEK DMMs

WE WILL NOT BE UNDERSOLD C&S SALES, INC.

150 W. CARPENTER AVENUE
 WHEELING, IL 60090

FAX: (847) 541-9904 (847) 541-0710

http://www.elenco.com/cs_sales/



15 DAY MONEY BACK GUARANTEE

FULL FACTORY WARRANTY

PRICES SUBJECT TO CHANGE WITHOUT NOTICE

**Same Day
Shipping**

C & S SALES
Your one stop source for
all your electronic needs!

CALL OR WRITE FOR OUR
NEW FREE 64 PAGE
CATALOG!
(800) 445-3201

Fluke Scopemeters



- 123.....NEW.....\$950
- 92B.....\$1445
- 96B.....\$1695
- 99B...NEW...\$2095
- 105B.....\$2495

**ALL FLUKE
PRODUCTS
ON SALE**

**B & K PRECISION
SCOPES**

100MHz THREE-TRACE

Model 2190A



- 1mV/division sensitivity
- Sweeps to 5ns/division
- Dual time base
- Signal delay line
- 15KV accelerating voltage

\$1295.00

60MHz DUAL-TRACE

Model 2160



- 1mV/division sensitivity
- Sweeps to 5ns/division
- Dual time base
- Signal delay line
- V mode displays two signals unrelated in frequency.
- Component tester

\$895.00

40MHz DUAL-TRACE

Model 1541C



- 1mV/division sensitivity
- Video sync separators
- Z axis input
- Single Sweep
- V mode displays two signals unrelated in frequency
- Component tester

\$695

60MHz, CURSORS & READOUTS, DUAL TIME BASE

Model 2260



- Cursors and readouts
- 1mV/div sensitivity
- 23 calibrated ranges - main time base
- 19 calibrated ranges - delayed time base
- Signal delay time
- V mode - displays 2 signals unrelated in frequency
- Component tester
- Z-axis input
- Single sweep

\$1225

20MHz DUAL-TRACE

Model 2120B - 2 Year Warranty

Special \$375

Model 2125A with delayed sweep

\$599.95



- 1mV/division sensitivity
- AUTONORM triggered sweep operation
- AC, TVH, TVV and line coupling
- Calibrated 19 step time-base with x10 magnifier
- Compact low-profile design

**Affordable Spectrum
Analyzers by B&K**

500MHz Series
Model 2615 - \$1595
Model 2620 w/ tracking generator - \$1895

1.05GHz Series
Model 2625 - \$2395
Model 2630 w/ tracking generator - \$2995



Quality Scopes by Elenco

Lowest Prices of the Year!

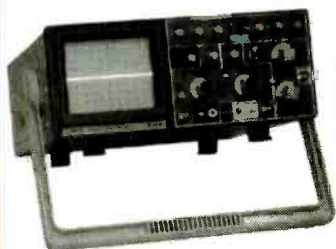

60MHz

DS-603 \$1350

- Analog / Digital Storage
- 20MS/s Sampling Rate

S-1360 \$749

- Analog with Delayed Sweep

100MHz

S-1390 \$995

- Analog

**Includes
Free Dust
Cover and
Probes**

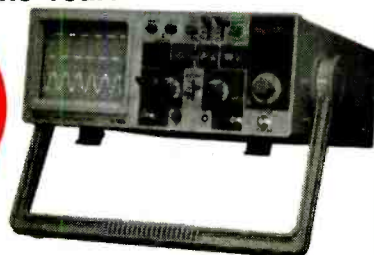

25/30MHz

DS-303 30MHz \$1095

DS-203 20MHz \$725

- Analog / Digital Storage

S-1330 \$439

- 25MHz Analog
- Delayed Sweep

S-1325 \$325

- 25MHz Analog

**2 Year
Warranty**

SIMM MODULE TESTER

B & K 898

\$625

- Tests 72 and 30-pin SIMMs to 36 bits.
- Stand alone and portable. No other equipment required.
- Automatically identifies width, depth and speed of SIMMS.
- 10 built-in tests identify most memory defects. Preheat cycle prior to test.



PORTABLE SEMICONDUCTOR TESTER

B&K 510

- In or out-of-order circuit tests for transistor, FETs, SCRs and darlington.

\$199.00



Fluke Multimeters

Model 70III	\$85	Model 83	\$235
Model 73III	\$115	Model 85	\$269
Model 75III	\$139	Model 87	\$289
Model 77III	\$154	Model 863E	\$475
Model 79III	\$175	Model 867BE	\$650

B&K Precision Multimeters

Model 391	\$143	Model 388A	\$99
Model 390	\$127	Model 2707	\$75
Model 389	\$109	Model 2860A	\$79
Model 5390	\$295	Model 5370	\$219
Model 5380	\$265	Model 5360	\$195

MX-9300

Four Functions in One Instrument

Features:

- One instrument with four test and measuring systems:
 - 1.3GHz Frequency Counter
 - 2MHz Sweep Function Generator
 - Digital Multimeter
 - Digital Triple Power Supply
- 0-30V @ 3A, 15V @ 1A, 5V @ 2A



\$459⁹⁵

GUARANTEED LOWEST PRICES

C&S SALES, INC.

150 W. CARPENTER AVENUE
WHEELING, IL 60090
FAX: (847) 541-9904 (847) 541-0710
http://www.elenco.com/cs_sales/



**15 DAY MONEY BACK
GUARANTEE**

FULL FACTORY WARRANTY

PRICES SUBJECT TO CHANGE WITHOUT NOTICE

UPS SHIPPING: 48 STATES 5%
OTHERS CALL FOR DETAILS
IL Residents add 8.25% Sales Tax

CIRCLE 130 ON FREE INFORMATION CARD

Kenwood CS-4125 Sale!!!

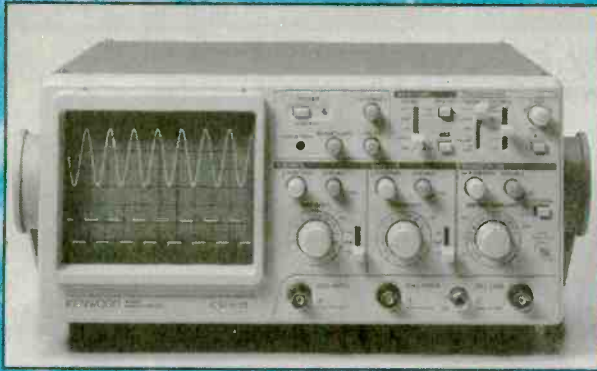

Free **KENWOOD** t-shirt
with purchase of
CS-4125 oscilloscope!!!



KENWOOD

MODEL CS-4125

20 MHz, 2 Channel, includes probes
Suggested Price \$595.00

SUPER SPECIAL \$384.00!!!

PRINT™
Products International

8931 Brookville Rd * Silver Spring, MD, 20910 * 800-638-2020 * Fx 800-545-0058
www.prodintl.com

SPARE SCOPE PROBE SPECIAL:

Kenwood PC-35 - 10:1, DC to 50 MHz

Regular \$62.00

SALE \$29.95

Kenwood PC-41 - 10:1/1:1, DC to 50 MHz

Regular \$62.00

SALE \$29.95

Call today for your free 84 page test & measurement instrument catalog!

CIRCLE 46 ON FREE INFORMATION CARD

World Passing You By?

Are you interested in Microprocessors & Embedded Control Systems? If not you should be! Look around, just about everything these days has an embedded microprocessor in it. TVs, cars, radios, traffic lights & even toys have embedded computers controlling their actions. The Primer Trainer is the tool that can not only teach you how these devices operate but give you the opportunity to program these types of systems yourself. Examples & exercises in the Self Instruction manual take you from writing simple programs to controlling motors. Start out in Machine language, then move on to Assembler, & then continue on with optional C, Basic, or Forth Compilers. So don't be left behind, this is information you need to know!

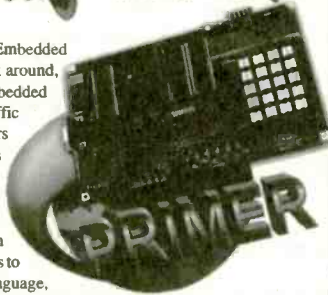

Examples Include:

- Measuring Temperature
- Using a Photocell to Detect Light Levels
- Making a Waveform Generator
- Constructing a Capacitance Meter
- Motor Speed Control Using Back EMF
- Interfacing and Controlling Stepper Motors
- Scanning Keypads and Writing to LCD/LED Displays
- Bus Interfacing an 8255 PPI
- Using the Primer as an EPROM Programmer
- DTMF Autodialer & Remote Controller (New!)

The PRIMER is only \$119.95 in kit form. The PRIMER Assembled & Tested is \$169.95. This trainer can be used stand alone via the keypad and display or connected to a PC with the optional upgrade (\$49.95). The Upgrade includes: an RS232 serial port & cable, 32K of battery backed RAM, & Assembler/Terminal software. Please add \$5.00 for shipping within the U.S. Picture shown with upgrade option and optional heavy-duty keypad (\$29.95) installed. Satisfaction guaranteed.

EMAC, inc.

11 EMAC WAY, CARBONDALE, IL 62901
618-529-4525 Fax 457-0110 BBS 529-5708

World Wide Web: <http://www.emacinc.com>

1985 - 1998

OVER

12

YEARS

OF SERVICE

Learn MICROCONTROLLERS EMBEDDED SYSTEMS and PROGRAMMING...

...with the AES learning system/
embedded control system.
Extensive manuals guide you
through your development
project. All programming and
hardware details explained.
Complete schematics. Learn to
program the LCD, keypad digital,
analog, and serial I/O. for your applications.

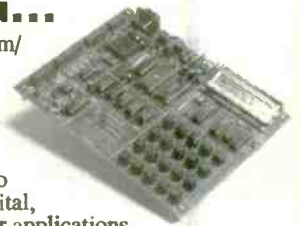

**THREE MODELS AVAILABLE. Choose from an
Intel 8051, Intel 8088, or Motorola 68HC11
based system. All models come with:**

- 32K Byte ROM, 32K Byte RAM • 2 by 16 Liquid Crystal Display • 4 by 5 Keypad • Digital, Analog, and Serial I/O • Interrupts, timers, chip-selects • 26 pin expansion connector • Built-in Logic Probe • Power Supply (can also be battery operated) • Powerful ROM MONITOR to help you program • Connects to your PC for programming or data logging (cable included) • Assembly, BASIC, and C programming (varies with model) • Program disks with Cross Assembler and many, well documented, program examples • User's Manuals: cover all details (over 500 pages) • Completely assembled and ready to use • Source code for all drivers and MONITOR • Optional Text Book

Everything you need. From \$279.
Money Back Guarantee

Call for Free Info Pack, or see
WEB at <http://www.aesmicro.com>
714-550-8094, FAX 714-550-9941

AES
Advanced Educational Systems

Call 1-800-730-3232

AES 575 ANTON BLVD., SUITE 300, COSTA MESA, CA 92626, USA

Digital Oscilloscopes

100 MSa/s Parallel Port Based DSO

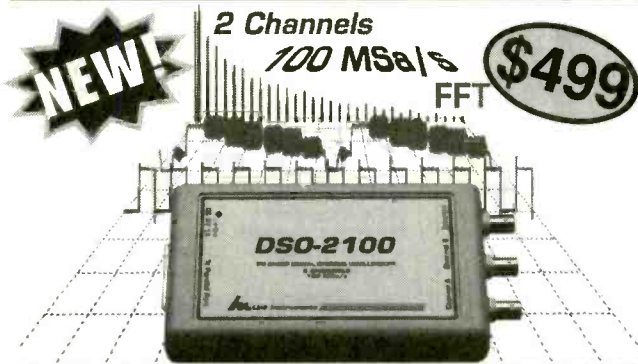

- 2 Ch. Digital Oscilloscope
- 100 MSa/s Max Single-Shot Rate on Both Channels
- 60MHz Input Bandwidth
- 32K Samples Per Channel
- Optional FFT Spectrum Analyzer*, Advanced Math* and TV Line Trigger**
- IEEE Pulse Parameter Measurements
- One touch **Auto-Setup**
- Advanced Pulse Triggering*
- Hands-Free Voice Control
- Easy to use Windows and DOS Software Included
- **Parallel Port** Interface to Laptop or Desktop PC
- Small and Lightweight (9 oz and 6.3" x 3.75" x 1.25")
- **Free Demo Software** on Web

For \$499 you get the model DSO-2102S Oscilloscope, Probes, Interface Cable, Power Adapter, and Windows and DOS Software.
 *DSO-2102M \$599 **TV-Line Module \$149

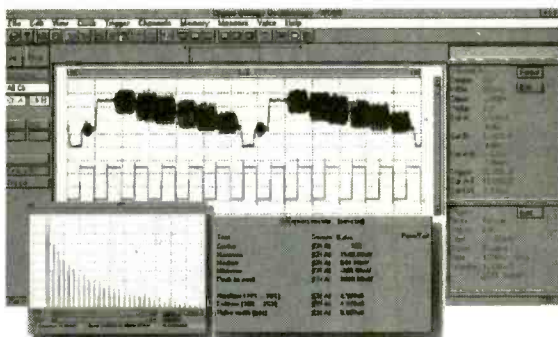

DSO w/Logic Analyzer (ISA based)



- 200 MSa/s Max Single-Shot Sample Rate
- 2 Oscilloscope Channels
- 8 Logic Analyzer Channels
- 10 Channels Simultaneously
- 125 MHz Single Shot Bandwidth
- Up to 128K Samples/Channel
- FFT Spectrum Analyzer included

DSO-28264 (10Ch, 200MSa/s, 64k) \$1999

DSO-28464 (20Ch, 200MSa/s, 64k) \$3799

All prices include Probes and Software



Link Instruments (973) 808-8990

369 Passaic Ave. • Suite 100 • Fairfield, NJ 07004
 www.LinkInstruments.com/pe8 • Email: Sales@LinkInstruments.com

CABLE T.V. EQUIPMENT

Friendly, Knowledgeable Service



ORDERS CALL:
1-800-361-4586



- All Equipment New
- Convertors & Descramblers
- 30 Day Money Back Guarentee
- 6 Month Warranty
- Visa, MC, C.O.D. Welcome

KDE ELECTRONICS, INC.

P.O. Box 1494

Addison, IL 60101

Info. 630-889-0281 HRS: Mon-Fri, 9-6 CST
 Fax 630-889-0283 Sat, 10-2 CST

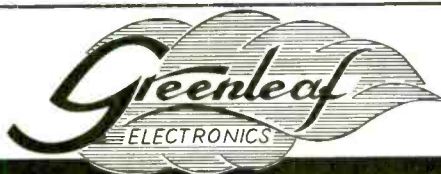

CABLE TV Converters & Descramblers

Compatible with
**Jerrold, Scientific Atlanta,
 Pioneer, Oak, & Hamlin
 Equipment**

BRAND NEW!

6-MONTH GUARANTEE

LOWEST PRICES

Volume Control & Parental Lockout Available

Greenleaf Electronics

1-800-742-2567

NO ILLINOIS SALES

It is not the intent of Greenleaf Electronics to defraud any pay television operator and we will not assist any company or individual in doing the same.

CABLE TV EQUIPMENT

1 Year Warranty
30 Day Money
Back Guarantee



"ABSOLUTE LOWEST
WHOLESALE &
RETAIL PRICES"
CABLE U.S.A.
1-888-388-CUBE

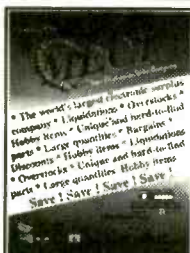

Free Catalog

If you are not getting this catalog you are missing out on some of the best deals in electronics today! We have thousands of items ranging from unique, hard-to-find parts to standard production components. Call, write, or fax today to start your free subscription to the most unique catalog in the industry, filled with super values on surplus electronic and hobbyist type items. If you have a friend who would like to receive our catalog, send us their name and address and we will gladly forward them a complimentary 100 page catalog.

Why pay more? Call today.



340 East First Street Fax Order Line
Dayton, Ohio 45402 1-800-344-6324

Order Toll-Free
1-800-344-4465

CIRCLE 151 ON FREE INFORMATION CARD

Printed Circuit Boards

Print and Etch Special
\$0.24/Square Inch Single Sided
\$0.32/Square Inch Double Sided
Traces Solder Plated, FR4

Prototypes as low as \$60

FR4 0.062 Material Special
\$0.07 per Square Inch

Shipping & Handling \$15.00 min

Visit us at www.impulse.net/~cic/

Channel Island Circuits

358 South Fairview Ave. Unit C

Goleta CA 93117

email: cic@impulse.net

Phone/Fax: 805-964-4449

SENCORE TV & VCR REPAIR TEST EQUIPMENT

- | | |
|--|-----------|
| 1 VC93, VCR Analyzer | \$800.00 |
| 2 Sc61 100 MHz (Scope) Waveform Analyzer | \$900.00 |
| 3 TVA 92 TV Video Analyzer | \$900.00 |
| 4 LC 102 Capacitor & Inductor Tester | \$1000.00 |
| 5 VA62A Universal Video Analyzer | \$800.00 |
| 6 Variable Isolation (PR570) XFMR | \$500.00 |
| 7 CR7000 CRT Analyzer and Restorer | \$1000.00 |

Leo Tomanek

5440 Baltimore Dr., #127

La Mesa, CA 91942

(619) 460-0773

VIDEO SYNC GENERATOR



Restores Horizontal and Vertical Sync Lines from Distorted Video



Lost Sync



Restored Sync with VSG

For Free Information Package and Pricing



Call 219-236-5776

www.south-bend.net/rcd



R.C. Distributing, PO Box 552, South Bend, IN 46624

Cable T.V. Converters & Equipment

Lower Prices
Dealer Discounts
30-Day Money back
1-year warranty
MC, Visa, AE, COD



No Florida Sales

www.cable4you.com

1-(800) 888-5585

PROGRAMMERS

ADVANTECH EETOOLS NEEDHAMS DATA I/O ICE TECHNOLOGY HILO SYSTEM GENERAL CHROMA MODULAR CIRCUIT TECHNOLOGY XELTEK



PROMAX EMP-20 MEGAMAX MEGAMAX4 SIMM/SIP TESTER EMUPA

CALL ADVANTECH LABTOOL 599 EETOOLS SIMMAX
629 ICE TECH MICROLV 795 CHROMA SIMM/SIP
650 EETOOLS ALLMAX + 359 MOD-MCT-EMUPA/R
409 EETOOLS MEGAMAX 279 MOD-MCT-EMUP/R
509 EETOOLS MEGAMAX4 49 EPROM 1G TO 512K
369 XELTEK SUPERPRO II 69 EPROM 1G TO 1MEG
409 XELTEK SUPERPRO II P 99 EPROM 4G TO 1MEG
249 XELTEK SUPERPRO L 199 EPROM 16G TO 1 MEG
165 XELTEK ROMMASTER II 89 EPROM 1G TO 8MEG
479 MOD-MCT-EMUPA 129 EPROM 4G TO 8MEG
739 STAG ORBIT-32 250 EPROM 8G TO 8MEG



LABTOOL48 MICROMASTER SUPERPRO ALLMAX PLUS ROMMASTER2

General Device Instruments

Sales 916-393-1655 Fax 916-393-4949 BBS 983-1234
Web www.generaldevice.com E-Mail ledevice@best.com

CABLE TV CONVERTERS

Equipment & Accessories
Wholesalers Welcome

Call C&D ELECTRONICS

1-888-615-5757 M-F 10a-6p

CALLER ID SEEN ON YOUR TV



TVMessenger

Only \$89.95

Never be interrupted by unwanted calls again!

TVMessenger offers:

- Convenience
- Security
- Callers' log
- Visual call indicator



Modern Electronics

2609 S 156 Cir, Omaha, NE 68130

1-800-906-6664

PARTS EXPRESS

ELECTRONICS & MORE

Solid Brass Binding Posts

- ◆ Heavy Duty 5 Way Binding Posts
- ◆ Solid Brass Construction
- ◆ Ideal For High Power Applications
- ◆ Audiophile Quality

When only the best will do! These rugged 5 way solid brass binding posts are perfect for all high power and high performance applications. For use in speakers cabinets with walls up to 1-1/4" thick. Available in red or black color coded versions. Each post includes a plastic shoulder washer, flat washer, and nut. Can be tightened with 9/16" wrench or nut driver. 3-1/8" overall length.

#090-473 (Black)
#090-474 (Red) \$9.50 (1-9) \$8.50 (10-UP)

Eminence Horn Drivers

Super quality, U.S. made compression horn driver features a huge 34 oz. magnet, 2" Kapton voice coil, and titanium diaphragm.

◆ 8 ohms ◆ 40 watts RMS power handling capability (conservative) ◆ Fs: 600 Hz.

◆ Response: 1,000-14,000 Hz. ◆ Sensitivity: 100 dB 1W/1m. ◆ Dimensions: diameter: 5-3/16", depth: 2-1/8". ◆ Net weight: 6 lbs.

◆ Replacement diaphragms: 16 ohm - #260-101, 8 ohm - #260-106, \$18.90 each.

#260-105 \$49.95 (1-3) \$44.50 (4-UP)



CCD Board Cameras With Audio



#335-525 (Standard lens)
#335-530 (Pin hole lens) \$99.95 (1-3) \$88.90 (4-UP)

Dayton Loudspeaker Co. Professional Sound Reinforcement Drivers



Part #	Size	RMS Power	Price (1-3)	Price (4-UP)
295-060	10"	250 W	\$70.50	\$64.80
295-065	12"	300 W	94.90	86.95
295-070	15"	300 W	99.80	91.30
295-075	18"	350 W	135.90	124.60

If you haven't received a copy of our current 268 page catalog ... have one added to your order or please give us a call and we will send one out to you immediately.



MOTOROLA

KSN1165A High Power Bullet Tweeter

◆ Power handling: 200 watts RMS/400 watts max ◆ Frequency response: 1,800-30,000 Hz ◆ SPL: 92 dB ◆ Manufacturer model number: KSN1165A ◆ Dimensions: A: 4-1/4", B: 4-1/4", C: 3".

#270-014 \$12.95 (1-3) \$11.50 (4-UP)



Dayton Loudspeaker Co. 5-1/4" Treated Paper Cone Woofer

Magnet structure is fully shielded to permit audio/video use. ◆ Power handling: 30 watts RMS/45 watts max ◆ Voice coil diameter: 1" ◆ Voice coil inductance: .33 mH ◆ Impedance: 8 ohms ◆ DC resistance: 6.0 ohms ◆ Frequency response: 45-6,000 Hz ◆ Magnet weight: 9.5 oz. ◆ Fs: 43.4 Hz ◆ SPL: 88dB 1W/1m ◆ Vas: .61 cu. ft. ◆ Qms: 1.82 ◆ Qes: .51 ◆ Qts: .40 ◆ Xmax: 2.5mm ◆ Net weight: 2-1/2 lbs. ◆ Dimensions: A: 5-1/4", B: 4-3/4", C: 3-1/8", D: 3-3/8", E: 1-3/8".

#295-300 \$13.50 (1-3) \$12.15 (4-UP)



Soft Dome Tweeters

Part #	Model	Price (1-3)	Price (4-UP)
277-010	MDT-29	\$42.50	\$39.50
277-011	DMS-29	46.50	44.50
277-014	DMS-30	57.50	55.50
277-015	MDT-30	49.90	47.50
277-020	MDT-33 Pair	199.90	195.50
277-025	MDT-10	35.50	33.90
277-030	MDT-20	42.50	39.90
277-035	MDT-39	46.50	45.50
277-040	MDT-40	58.50	56.50



Amplified Video Switching Center

High quality video switching center gives you the flexibility to watch and/or

record different sources simultaneously without the need to move complicated cables. Connect your VCR, CATV, satellite, video game, or home computer to two television sets. Gives you total control of your video system. 4 inputs, 2 outputs, all connections via "F" connectors. Pushbutton design. Amplified, broadband circuitry minimizes signal loss and crossover. Simulated wood grain cabinet. Net weight: 4 lbs.

#180-155 \$42.90 (1-3) \$38.50 (4-UP)



FLUKE 70 Series III Analog/Digital Multimeters

Part # Model Price

392-042	77-III	\$174.75
392-026	70-III	96.50
392-032	73-III	125.95
392-036	75-III	154.80
392-038	26-III	213.50
392-046	79-III	193.80



Advanced Speaker Designs For The Hobbyist And Technician

A MUST FOR SPEAKER DIVERS

#500-042 \$16.95 EACH



DYNAUDIO AUTHENTIC TECHNOLOGY

ESOTEC Cast Frame Woofers

Part #	Description	Price (1-3)	Price (4-UP)
297-210	8 Ohm, 15W-75, 5-1/4"	\$127.50	\$119.90
297-215	4 Ohm, 15W-75, 5-1/4"	127.50	119.90
297-230	8 Ohm, 17W-LQ, 6-1/2"	131.90	125.95
297-235	4 Ohm, 17W-LQ, 6-1/2"	131.90	125.95
297-240	8 Ohm, 20W-75, 7-1/2"	145.90	139.90
297-245	4 Ohm, 20W-75, 7-1/2"	145.90	139.90



LARGEST SELECTION OF SPEAKER DRIVERS IN THE COUNTRY!

CALL TOLL FREE

1-800-338-0531

KEY CODE: POPOM

725 Pleasant Valley Dr., Springfield, OH 45066-1158

Phone: 513-743-3000 ◆ FAX: 513-743-1677 ◆ E-Mail: sales@parts-express.com

CIRCLE 156 ON FREE INFORMATION CARD

SEC Sun Equipment Corporation

P. O. Box 97903, Raleigh, NC 27624 E-mail: sunequipco@ipass.net
To request FREE CATALOG, please call, fax, write, or e-mail us.

Quality Test Equipment for Cost-Minded People

LODESTAR Lodestar Electronics Corp. Since 1979

One Year Warranty. 15 Day Money Back Guarantee. OEM WELCOME.
School purchase order accepted. Bids accepted. VISA, Mastercard
SALES REP/DISTRIBUTORS/OEM WANTED. Discover, AmrExpr
1-800-870-1955 / (919)870-1955 Fax: (919)870-5720

DC POWER SUPPLY (CC/CV)

All models: protection of short ckt, overload, reverse polarity, over-voltage; Constant Current & Voltage (CC/CV) are fully adjustable. Regulation: $\pm 0.1\%$ +3mV (line), $\pm 0.1\%$ +3mV (load), ± 1 mV ripple.

SINGLE OUTPUT
Analog Displays
PS-303 \$159.00, 30V/3A.
PS-305 \$219.95, 30V/5A.
PS-1610S \$289.00, 16V/10A.
PS-2243 \$139.00, 12V/24V select, 3A.
PS-2245 \$159.00, 12V/24V select, 5A.
8107 \$399.95, 30V/10A.
8110 \$289.95, 60V/3A.
8112 \$399.95, 60V/5A.

Digital Voltmeter & Analog Ammeter
8200(8201) \$179.95(\$239.95), 30V/3A(5A)
Digital Displays 8210/8300 \$199.95, 30V/3A.
8211/8301 \$259.95, 30V/5A.

DUAL OUTPUTS
Independent/Tracking
Analog Display
8108 \$549.95, 60V/3A.
8109 \$699.95, 60V/5A.
PS-303D \$314.95, 30V/3A. PS-305D \$399.95, 30V/5A.
TRIPLE OUTPUTS, a fixed 5V/3A output, Independent/Tracking
Digital Displays 8202(8203) \$499.95(\$549.95), dual 30V/3A(5A).
Analog Displays 8102(8103) \$399.95(\$489.95), dual 30V/3A(5A),
with Parallel (30V/6A) and Series (60V/3A) Mode operation

NTSC/PAL TV COLOR BAR GEN.

CPG-1366A \$159.95, VHF NTSC,
Freq.: 45.75, 175.25, 187.25 MHz,
RF Output: 10mV.
Impedance: 75 Ohm;
Video Output: BNC, 1V_{p-p}.
CPG-1367A \$159.95, VHF PAL.

SWR/RF/mW POWER METER

310 \$89.95, 1.8-150MHz, RF Power:
0-4W/20W/200W 3 ranges; SWR
Measurement: 1.0- ∞ , 4W minimum.
Accuracy: 5%-10%; Insert Loss: 3dB
Input/Output Imp.: 50 Ω ; SO-239 plug
320 \$89.95, 150-520MHz Spec. 310.
330 \$119.95, 1.8-520MHz Spec. see 310.
SWR-3P \$26.95 1.7-150MHz,
RF Power: 0.5-10W, 0.5W-100W.
SWR-2P \$22.95, 1.7-30MHz, RF Power: 0.5-10W.

mW RF Power Meter 340 \$219.00, 1.8-500MHz, RF

Power: 20mW/200mW/2W 3 ranges; Imped.: 50 Ω ; Accuracy:
 $\pm 10\%$ full scale; SWR < 1.15 ; N-type connector; BNC type output.

FM STEREO MODULATOR

AG-2011A \$549.00
RF SECTION:
Carrier: 98MHz ± 2 MHz,
Output: 10mV, 1mV & 0.1mV
COMPOSITE SIGNALS:
Pilot: 19KHz ± 2 Hz, 0.8Vrms
INT. MODULATION: 400KHz,
1KHz $\pm 1\%$, 1Vrms, distortion $< 5\%$; L-R Separation: > 50 dB.
EXT. MODULATION: Freq.: 50Hz-15KHz
L-R Separation: > 45 dB 100Hz-3KHz; > 35 dB 50Hz-15KHz.

TOOLKITS - ELECTRONIC/PC

9245 \$29.99 U.S. Patented, 45-pcs. Contents: IC inserter/extractor
with securers & bows, 3-prong part retriever, #0 phillips screwdriver,
1/8" flat screwdriver, self-hold tweezers, metal tweezers, extra
parts tube, soldering iron, solder, crimping tool, long-nose plier,
cutting plier, zipper vinyl case. Bits include: Phillips: #0/#1/#2/#3/
Flat: 1/8"/3/16"/1/4"/9/32"; PZ1/PZ2; T8/T9/T10/T15/T20/T25/
T27/T30/T40/T45; Hex: 5/64"/3/32"/1/8"/5/32"/3/16". Sockets:
3/16" (5mm)/7/32" (5.5mm)/1/4" (6mm)/9/32" (7mm)/5/16" (8mm).
8G23 \$34.99 23-pcs. Contents: IC inserter/extractor with securer &
bows, 3-prong part retriever, 3/16"/1/4" nutdriver, 3/16"/1/8" slot-
ed screwdriver, #0/#1 phillips, reversible T10/T15 bits, re-versible
#2 phillips/1/4" slotted bits, tweezers, long-nose plier, cutter, 6" adj.
wrench, soldering iron, solder, crimping tool, zipper case, manual.
Different packages available, call/write/e-mail/fax for detail.

STEREO/ALIGNMENT/SWEEMAR SCOPE

STEREO SCOPE OS-7505B \$369.00, 0-10MHz/20mV.
ALIGNMENT SCOPE OS-7001A \$369.00, 0-200KHz/1mV.
SWEEMAR SM-6225B/C \$1999.95
Freq Range: (AM)490KHz; (FM)10-
11.4MHz, Accuracy: $\pm 0.1\%$; Marker:
(AM)455KHz, ± 5 KHz; ± 10 KHz;
(FM)10.7MHz, ± 7.5 KHz, ± 150 KHz

RF SIGNAL GENERATOR

SG-4160B \$124.95, 100KHz-150MHz
up to 450MHz on 3rd harmonics in 6
ranges; AM modulation; Accuracy: $\pm 5\%$.
RF Output: 100mVrms to 35 MHz,
Modulation: Int. 1KHz (AM) $\pm 30\%$;
Ext. 50Hz-20KHz, at least 1V_{min} input.
Audio Output: 1KHz, 2V_{min} minimum.

SG-4162AD (with Freq. Counter) \$229.95, Spec. see SG-4160B.
COUNTER SECTION: 10Hz-150MHz, Max Input: ± 3 V effective
Gate Time: .1, 1sec. Input Sensitivity: 35mV, 10Hz-200MHz.
Input Impedance: 1M Ω (HF), 50 Ω (VHF). Display: 7-digit LEDs.

AM/FM STD SIGNAL GEN.

SG-4110A \$1799.00, Freq: 0.1-110MHz, Display 6-digit LED;
Resolution: 100Hz (0.1-34.999MHz); 1KHz (35MHz-110MHz).
Accuracy: $\pm (5 \times 10^{-3} \pm 1 \text{ count})$; Output: -19dBu-99dBu, 1dB steps.
Impedance: 50 Ω VSWR 1.2: 100 preset frequency & store functions

AUDIO GENERATOR

AG-2601A \$124.95, 10Hz-1MHz in 5
ranges; Output: sinewave 0-8V_{pp}; square
10V_{pp}. Output Imped: 600 Ohm.
Distortion: $< 0.05\%$ 500Hz-50KHz;
 $< 0.5\%$ 50KHz-500KHz.
AG-2603AD \$229.95, with 6-digit,
Int/Ext. Freq. Counter, 10Hz-150MHz,
Output Control: 0/-20/-40dB & Fine adjuster. Spec see AG-2601A

FUNCTION GENERATOR

FG-2100A \$169.95, 0.2Hz-2MHz in 7
ranges; sine, square, triangle, pulse &
Ramp; Output: 5mV_{pp}-20V_{pp}, 1%
distortion. VCP: 0-10V/req. to 1000:1.
FG-2102AD \$229.95 see FG-2100A,
4-digit counter display, TTL & CMOS
outputs, 30ppm ± 1 count accuracy.

FG-2020B \$159.00 0.5Hz-500KHz, Sine, Square, Triangle.
FG-2103 \$329.95, Digital sweep generator, 0.5Hz-5MHz in 7
ranges. Operating Mode: sweep, AM, gated burst, VCG.
Freq. Counter: Int. 0.5Hz-5MHz, Ext. 5Hz-10MHz.
FG-513 \$769.95, 13 MHz, Microprocessor embedded digital sweep;
Sine, Square, Triangle, Pulse, Ramp, TTL & DC; $\pm (0.1\% \pm 1 \text{ digit})$.
Freq. Counter & TCXO. 5Hz-100MHz, 6.5 digits, x1/x20 attenuatn

AC MILLIVOLT METER

MV-3100A \$159.95 wide band
5Hz-1MHz; 3 scales, mV, dB & dBm;
300 μ V-100V in 12 ranges, 10 μ V
resolution; -70-40dB in 12 ranges,
0dB=1Vrms, 0dBm=775V; $\pm 3\%$
accuracy; Input Impedance 10M Ω ;
Noise $< 2\%$. MV-3201B \$309.95 dual
channels, simultaneous measurement.

OSCILLOSCOPES

OS-7305B \$249.00 DC-7MHz, 3"
CRT, Horiz: 25V/div, 10Hz-100KHz
in 4 ranges; Vert: 10mV/div, Int. &
Ext. Sync.; Input: 1M Ω /35pF.
OS-7010A \$299.95 10MHz, 5" CRT,
Horiz: 2V/div, Vert: 10mV-10V/div.
OS-622G \$389.95 20MHz, 2 CH/X-Y
Alt trigger, trigger lock, hold OFF, TV
syn., 8x10 div., 1mV/div., Horiz: 2 μ s-5s/div; Vert: 1mV-5V/div.
OS-653G \$699.95 50MHz, 2 CH/delay sweep, Alt trigger, TV syn.
OS-6101G \$1499.95 100MHz, 4ch/8 traces, delay sweep, cursor
readout. 2 years warranty for OS-622G, OS-653G, & OS-6101G.

UHF ATTENUATORS

RT-8815U (50 Ω) \$299.00 / RT-8817U (75 Ω) \$299.00, 950MHz,
81dB, 0.5W max.; Steps: 1/2/3/5/10/20/20, 8 switches.
08SE-2 (50 Ω) \$399.00 / 08TE-2 (75 Ω) \$399.00, 950MHz, 81dB,
0.5W max.; Steps: 10dB+7.1dBx10, Electronic adjustment knob.

MICROPROCESSOR TRAINER

BGC-8088 \$699.00, learn
computer theory. Excellent
for school & individual
who want to learn about
ROM, RAM, I/O ports,
programming, & run a
8088 Microprocessor. An
easy to understand step-
by-step manual guides
you to achieve your goal.
56-key keyboard, LCD
display, RS-232, UART.

GRID DIP METER

DM-4061 \$89.95 1.5-250MHz,
6 bands; 6 plug-in coils,
2 transistor, and 1 diode.
Modulation: = 2KHz Sinewave.
Crystal Oscillator: 1-15MHz.
Wave absorption meter. 9VDC battery.

FREQUENCY COUNTER

FC-5250C \$119.95 10Hz-220MHz
(HF)10Hz-20MHz, (VHF)10-200MHz.
Gate Time: .1, 1sec. Max. Input: 10V_{p-p}.
Input Sensitivity: 35mV/10Hz-200MHz
Input Imped.: 1M Ω (HF), 50 Ω (VHF).
Display: 7-digit LEDs, 9V adapter (\$6)
FC-5260A \$129.95
10Hz-600MHz, 7-digit LEDs.
FC-5270 \$149.95
10Hz-1.2GHz, 8-digit LEDs.
FC-5600B \$229.95
10Hz-600MHz, 10-digit LEDs.
FC-5700 \$299.95 10Hz-1.3GHz, 10-digit LEDs. Period measure.

SIGNAL TRACER/INJECTOR

(\$ Reduction!) SE-6100 \$434.95 \$89.95
TRACER: Gain 60 dB maximum.
Attenuation: 0/20/40/60dB
Input Imped: 100K Ω ; Meter: VU 100 μ A
Output Imped: 600 Ω ; Speaker: 8 Ω
INJECTOR: =1KHz Squarewave;
Zero adjust; Surface mount device (SMD) test probe. LT-06 \$21.95
Output Level: Variable 0-4.5V_{pp}; 9V battery or adapter (\$6.00).

LCR METERS

MIC-4070D \$179.95, Induct.: 0.1 μ -200H, Capacit.: 0.1p-20mF,
Resist.: 1m Ω -20M Ω , 2Q range, Dissipation factor measurement,
Zero adjust; Surface mount device (SMD) test probe. LT-06 \$21.95

DIGITAL MULTIMETER

DMM-120 \$24.95, 3 $\frac{1}{2}$ digit, 600VDC, 2ADC
500VAC, 2M Ω , hFE/diode/continuity test, 1.2%
DMM-123+Capacitance \$44.95, 3 $\frac{1}{2}$ digit,
600VDC/600VAC, 10ADC/AC, 2G Ω , 20 μ F,
hFE/diode test, continuity beeper; 0.8% accuracy
DMM-124+Cap.+Temp.+Freq. \$69.95, 3 $\frac{1}{2}$ dig,
600VDC/500VAC, -58-752°F, 2G Ω , 20mF,
200KHz, 3 ϕ phase/diode/continuity test; 1.2%.
DMM-125 \$54.95, Autorange/Bargraph, 32 M Ω ,
600VDC/AC, 10ADC/AC, diode/continuity test.
MIC-35 \$59.95, Autorange, 3 $\frac{1}{2}$ LCD, 20m Ω ,
1000VDC/750VAC, 20ADC/AC, data hold,
diode/continuity test, free holster, 0.3% accuracy.
MIC-39 \$129.95, Autorange/Bargraph, True RMS, 3 $\frac{1}{2}$ LCD, 40pF,
40M Ω , 1000VDC/750VAC, 20ADC/AC, 600KHz freq. cnt., data
hold, sleep mode, memory, read functions, holster, 0.3% accuracy.

AUTO. CAPACITANCE METER

CM3300A \$139.00 10 ranges, 99pF - 99mF, fully automatic.
Resolution: 0.1pF lowest, 0.1% full scale.
Accuracy:
0.5% of full scale ± 1 digit to 99.9 μ F,
1% of full scale ± 1 digit to 99.9 μ F.
Display: 3 digit LED.
Unit: pF, nF, μ F, mF, Overrange indicators.

AUTO DISTORTION METER

DM-3104A \$799.95
DISTORTION MEASURE
Range: 0.01% to 30%,
0.1/0.3/1/3/10/30% 6 ranges.
Freq: 400Hz $\pm 10\%$, 1KHz $\pm 10\%$ (HPF).
Input: 3mV-100V; Ratio measure 20dB.
Auto. Freq. Switching Ranges:
Fundamental Freq. = (fo) $\pm 10\%$;
Fund. Rejection: > 80 dB at (fo) $\pm 5\%$; > 70 dB at (fo) $\pm 10\%$.
Harmonic Accuracy: ± 0.5 dB, 1.8(fo)-20KHz.
LEVEL MEASURE Range: 0 to 100V in 0.3/1.1/3/1/30/100V
Freq Response: > 5 dB/20-50KHz, ± 1 dB/20-100KHz.
DM-3204 \$1,599.00 dual channels; Spec see DM-3104A.

WOW-FLUTTER METER

WF-3103A \$699.95 Freq Range: 3KHz $\pm 10\%$ JIS/CCIR;
3.15KHz $\pm 10\%$ DIN.
Measurem.: 0.3/1.1/3/1/3% full scale.
Accuracy: $\pm 5\%$ of full scale.
WF-3105A \$799.95, digital display;
Function: L/N/WOW/Flutter/WTD.
Freq Counter: 10Hz-9.99MHz.
Indication: CCIR/DIN/JIS.

Popular Electronics, August 1998

MCM ELECTRONICS®

The Source For
All Of Your
Electronics Needs

Prices Effective June 18, 1998
through August 31, 1998

When ordering, please
provide this code: ▼

SOURCE CODE: POP55

For over 20 years, MCM has been the leading supplier to the electronics service industry. Huge inventory, rapid delivery and competitive prices have made MCM the choice for:

- Hobbyists
- Educators
- Service Technicians
- Installers

Discover the MCM difference, call today for your free catalog.



"Linker III" Telephone Line Simulators

Full featured bi-directional line simulator tests modems, fax machines, answering machines and standard telephones without connection to your phone lines. Caller ID version generates nine pre-programmed Caller ID messages. Meets all Bellcore specifications. Generates true dial tone (350Hz and 440Hz at -15dB) and 20Hz ring (1.5 REN).

Order #	Description	(ea.)
72-6543	Linker II	\$229.00
72-6549	Caller ID Linker II	379.00



Telephone Information Recorder

Clearly records both sides of a telephone conversation. Also captures and displays the outgoing number, and all incoming Caller ID information as the call is in progress and when the tape is played back. Records four hours on a standard cassette tape.

Order #	(ea.)
36-1125	\$199.00



**FREE
Catalog!**

1-800-543-4330

www.mcmelectronics.com

Hours M-F 7 a.m.-9 p.m., Sat. 9 a.m.-6 p.m., EST.

Same Day Shipping!
In stock orders received by 5:00 p.m. (YOUR TIME), are shipped the same day.



MCM AUDIO SELECT™ Poly Treated 5 1/4" Paper Cone Woofer

Treated cone resists moisture and provides exceptionally smooth response. Power capacity 60/100W RMS/peak, frequency response 48Hz-6KHz, 1", 8ohm voice coil, 13.3 oz. magnet.

Order #	Reg.	
55-1205	\$19.29	\$7.99

SAVE
22%



Popular Replacement Tweeter

Trim profile allows mounting in tight spaces. 4 1/4" diameter, 3 oz. magnet. Power capacity 10W RMS, frequency response 2-20KHz. 8ohm.

Order #	Reg.	
53-020	\$4.99	\$3.99

SAVE
20%



MCM AUDIO SELECT™ 8" Polypropylene Woofer

Poly cone provides immunity to humidity, making this ideal for automotive applications. Power capacity 70/100W RMS/peak, frequency response 40Hz-3.5KHz, 1 1/2" voice coil, 18 oz. magnet. Foam surround. 8ohm.

Order #	Reg.	
55-1195	\$12.50	\$10.50

SAVE
16%



ATC Lead Wire Fuse

Finally there is a fast, easy and low cost way to tap an automotive fuse box. Standard ATC type fuse has attached 6" lead wire, making accessory connection a snap!

Order #	Amperage	Order #	Amperage
60-3855	5	60-3875	20
60-3860	7.5	60-3880	25
60-3865	10	60-3885	30
60-3870	15		

Your choice
\$2.29



32 Piece Security Bit Set

Handy pocket size set contains many of the bits commonly used to remove tamper resistant screws found in many of today's electronic products. Items like IBM PS/2 monitors, cable boxes and telephone equipment. Contains torq bits, spanner bits, tri wing bits, security hex and torx bits, all housed in a pocket sized carrying case. Bits fit any standard 3/8" driver.

Order #	(ea.)
22-1875	\$15.99

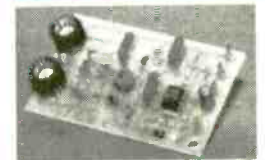

High Power FM Transmitter

Pre-assembled module transmits line-level audio to any standard FM radio. Output may be adjusted from 88-108MHz. Requires 9-15VDC supply, 150mA. Recommended power supply of eight "AA" batteries or AC adaptor (not included). Board dimensions 2" x 2 1/2" x 3/4".

Order #	Description	(ea.)
28-4851	Transmitter Module	\$24.95
58-1490	12VDC, 500mA Adaptor	2.61

MCM ELECTRONICS®

650 CONGRESS PARK DR.
CENTERVILLE, OH 45459

A PREMIER FARNELL Company

SOURCE CODE: POP55

Our Complete Catalog is now online 

www.cit.com

Circuit Specialists Inc.

SINCE 1971

Check Out What We Have To Offer:

Fantastic DMM Offer!!!

Don't let the price fool you. This meter is a digital multimeter designed for engineers and hobbyists. Equipped with 5 functions and 19 ranges. Each test position is quickly and easily selected with a simple turn of the FUNCTION/RANGE selector rotary switch.

General Rubber Boot Included

Display: 3-1/2 Digit LCD, 21mm Figure Height

with Automatic Polarity

Overrange Indication: 3 Least Significant Digits Blank

Temperature for Guaranteed Accuracy: 23°C±5°C RH<75%

Temperature Ranges:

Operating: 0°C to 40°C (32°F to 104°F)

Storage: -10°C to 50°C (14°F to 122°F)

Power: 9V Alkaline or Carbon-Zinc Battery(NEDA1604)

Low Battery Indication: BAT on Left of LCD Display

Dimensions: 188mm long x 87mm wide x 33mm thick

Net Weight: 400g

DC Voltage (DCV)

Range: Resolution: Accuracy:

200mV 100µV ±(1%rdg+2dgt)

2000mV 1mV ±(1%rdg+2dgt)

20V 10mV ±(1%rdg+2dgt)

200V 100mV ±(1%rdg+2dgt)

1000V 1V ±(1%rdg+2dgt)

Maximum Allowable Input: 1000V DC or Peak AC.

DC Current (DCA)

Range: Resolution: Accuracy:

200µA 100nA ±(1.2%rdg+2dgt)

2000µA 1µA ±(1.2%rdg+2dgt)

20mA 10µA ±(1.2%rdg+2dgt)

200mA 100µA ±(1.2%rdg+2dgt)

10A 10mA ±(1.2%rdg+2dgt)

Overload Protection: mA Input. 2A/250V fuse.

AC Voltage (ACV)

Range: Resolution: Accuracy:

200V 100mV ±(1.2%rdg+10dgt)

750V 1V ±(1.2%rdg+10dgt)

\$19.00 any qty

High Quality Full Sized DMM

Our Best Offer Ever on a



CAT NO	DESCRIPTION	PRICE
9300G	Rugged High Quality DMM with Rubber Boot	\$19.00

Positive Photofabrication Kit

Make your own PCB's

Kit includes the basic items needed to fabricate pre-sensitized printed circuit boards (does not include artwork). Also included is a basic process guide to assist the user in the basics of exposing, developing and etching a PCB. All items fit conveniently in the plastic development tray, and a tight fitting lid is included for handy storage. Additional recommended supplies for fabricating PCB's are: exposure bulb, etchant tank, eye protection, art-work, paper towels.

Kit Includes

- 1 each 3"x5" pre-sensitized single sided PCB
- 1 each 4"x6" pre-sensitized single sided PCB
- 1 each 6"x6" pre-sensitized single sided PCB
- 1 each 500ml developer liquid
- 1 each 500ml ferric chloride etching liquid
- 2 each foam brushes
- 1 each plastic development tray
- 1 each rubber gloves
- 1 each instruction sheet



new!

CAT NO	DESCRIPTION	PRICE
416-K	Photofabrication Kit	\$27.95

Positive Photo Resist Pre-Sensitized Printed Circuit Boards

These pre-sensitized printed circuit boards are ideal for small production runs. They provide high resolution and excellent line width control. High sensitive positive resist coated on 1oz. copper foil allows you to go direct from your computer plot or art work layout. No need to reverse art.

Single-Sided, 1oz. Copper Foil on Paper Phenolic Substrate	PRICE	EACH
CAT NO DESCRIPTION 1 10 50		
PP101 100mm x 150mm/3.91" x 5.91"	\$2.55	\$1.90 \$1.70
PP114 114mm x 165mm/4.6" x 6.6"	2.98	2.45 1.98
PP152 150mm x 250mm/5.91" x 9.84"	5.40	3.98 3.60
PP153 150mm x 300mm/5.91" x 11.81"	6.15	4.48 4.10
PP1212 305mm x 305mm/12" x 12"	12.78	10.65 8.52

Single-Sided, 1oz. Copper Foil on Fiberglass Substrate	PRICE	EACH
CAT NO DESCRIPTION 1 10 50		
GS101 100mm x 150mm/3.91" x 5.91"	\$ 3.90	\$2.98 \$2.60
GS114 114mm x 165mm/4.6" x 6.6"	4.80	3.49 3.20
GS152 150mm x 250mm/5.91" x 9.84"	8.69	5.98 5.78
GS153 150mm x 300mm/5.91" x 11.81"	10.20	7.20 6.80
GS1212 305mm x 305mm/12" x 12"	18.88	15.73 12.59

Double-Sided, 1oz. Copper Foil on Fiberglass Substrate	PRICE	EACH
CAT NO DESCRIPTION 1 10 50		
GD101 100mm x 150mm/3.91" x 5.91"	\$ 5.07	\$3.68 \$3.38
GD114 114mm x 165mm/4.6" x 6.6"	5.95	4.29 3.99
GD152 150mm x 250mm/5.91" x 9.84"	10.47	7.39 6.98
GD153 150mm x 300mm/5.91" x 11.81"	11.95	8.69 8.30
GD1212 305mm x 305mm/12" x 12"	22.09	18.35 14.68

Exposure System

Just place your presensitized board and artwork centered under the exposure fixture. Place the convenient acrylic sheet over the board and artwork to hold everything in place. Turn on light. Volial! Exposure takes about 5 minutes. Kit includes one fluorescent tube, stand and acrylic weight.



new!

Features

- Exposes boards in about 5 minutes!
- Convenient acrylic sheet to hold board in place during exposure (12.5" x 8.5")
- Fluorescent light fixture with plastic cover designed to aid in proper light refractions for even exposure

CAT NO	DESCRIPTION	PRICE
416-X	Fluorescent Exposure System	\$31.95
416-B	Extra Replacement Fluorescent Tube	16.95



Etching Tank

This handy etching system will handle PC boards up to 8" x 9", two at a time. Ideal for etching your PCB's! System includes an air pump for etchant agitation, a thermostatically controlled heater for keeping etchant at optimum temperature and a tank that holds 1.35 gallons of etchant. A tight fitting lid is also supplied to prevent evaporation when system is not being used. Typical etching time is reduced to 4 minutes on 1oz. copper board!

REDUCES ETCHING TIME!

CAT NO	DESCRIPTION	PRICE
12-700	Etch Tank System	\$37.95



Developer

This product is used as the developer on our positive photo-resist printed circuit boards. Includes instructions. 50 gram package, mixes with water, makes 1 quart.

CAT NO	DESCRIPTION	1	10	25
POSDEV	Positive Developer	\$.95	\$.80	\$.50

Etching Chemicals/Ferric Chloride

A dry concentrate that mixes with water to make 1 pint of etchant, enough to etch 400 sq. inches of 1oz board.

CAT NO	DESCRIPTION	1	5
ER-3	Makes 1 pint	\$3.50	\$2.75



CIRCUIT SPECIALISTS, INC.

SINCE 1971
800-811-5203
602-464-2485
602-464-5824 (FAX)

RECEIVE OUR LATEST 132 PAGE CATALOG!

It's chock full of all types of electronic equipment and supplies. We've got I.C.'s, capacitors, resistors, pots, inductors, test equipment, breadboarding supplies, PC supplies, industrial computers, data acquisition products, personal computers and computer parts, plus much, much more. FAX us your name and address or call **800-811-5203, ext. 5**, to leave a message on our catalog request line.



Color Weather Proof Bullet Camera

1/3" CCD with removeable rotation capable mounting bracket

Specifications

Image Sensor: Interline transfer CCD 1/3" format
 Effective Pixel: 512(H)x492(V) pixels/NTSC
 512(H)x582(V) pixels/PAL
 Scanning System: 2 : 1 interlaced
 Sync System: Internal sync
 Sync Pulse: 15.734KHz +1%(H)/15.625KHz +1%(H)
 59.94Hz +1%(V)/ 50Hz +1%(V)
 Sub-Carrier 3.57 MHz +30ppm
 400 TV lines (H)
 Resolution: More than 46dB (typ)
 S/N Ratio: 0.45
 Gamma Characteristics: 1 LUX (F1.2 10 IRE)
 Min. Illumination: Composite video signal :
 Video Out: 1.0Vp-p
 White Balance: Auto white balance
 Electronic Shutter: 1/60 - 1/100,000 SEC(N) 1/50 - 1/100,000 SEC (P)
 Power Supply: DC 12V +10%
 Power Consumption: 240mA (typ)
 Lens: 4mm (78 or 92 degree) F : 2.0
 Ambient Operating Temp: -5 deg. C +40 Deg. C
 Ambient Storage Temp: -10 Deg. C +50 Deg. C RH 95% MAX

Dimension: 2 1/8" (L) x 1 1/4" (D)
 Weight: 3 oz.



PRICE EACH
 1 5

CAT NO	DESCRIPTION	1	5
WDB-5407S	Color Water Tight Bullet Camera	\$299.00	\$269.00

(water tight for outdoor use, not suitable for sustained underwater use)

CCD Bullet Cameras

Available with standard or pinhole lens. Virtually indestructible bullet shaped casing. This sleek B&W camera can be mounted on walls or ceilings along narrow corridors or virtually any location for virtually any surveillance application. 0.5 lux minimum illumination with 380 lines of resolution. Even includes a built-in electronic iris for automatic light compensation.

Features

- Extremely low power consumption
- No blooming, no burning
- 0.5 LUX minimum illumination
- CCD area image sensor for long camera life
- Ultra small size allows for simple application and installation
- Built-in electronic auto iris for automatic light compensation
- Ultra compact camera

Specifications

Image Pick-Up Device: 1/3" CCD area sensor
 No. of Pixels: EIA = 512(H) x 492(V)
 Pixel Pitch: EIA = 9.6um(H) x 7.5um(V)
 Scanning System: EIA=525 lines, 60 field/sec
 Sync System: Internal sync
 H. Resolution: 430 TV line
 V. Resolution: 400 TV line
 Usable Illumination: 0.5 Lux F1.6
 S/N Ratio: More than 48dB
 Gamma Characteristic: 0.45
 Video Output: 1.0 - 1.1 up-p 75 Ohm
 Electronic Shutter Time: EIA=1/60 - 1/50,000 sec
 Lens F No. Focal Length: STD : 1.6 Open / 4.3mm(78 deg) Pinhole: 4.3 fixed / 2.8mm(91.4 deg)

Power Consumption: DC 9V (8-10V), 110mA
 Operational Temp.: -10 deg +50 deg C RH95% max
 Storage Temp: -20 deg +60 deg C RH95% max
 Dimensions: STD : 22mm(W) x 22mm(H) x 38mm(D) Pinhole: 22mm(W) x 22mm(H) x 30mm(D)
 Weight: 35g max



PRICE EACH
 1 5

CAT NO	DESCRIPTION	1	5
WDB-07S	Standard Lens Version	\$144.00	\$129.00
WDB-07P	Pinhole Lens Version	144.00	129.00
WDP-07S/water	Standard Lens Weather Proof	169.00	152.00
WDP-07P/water	Pinhole Lens, Weather Proof	169.00	152.00

CCD Dome Camera with Audio

B&W DOME camera with integrated microphone. Ideal security system application. 12 VDC operation.

Specifications

Image Device: 1/3" interline transfer CCD
 Picture Elements: EIA=542(H)x492(V)
 Scanning System: 2:1 Interlace
 Synchronization System: Internal
 Horizontal Resolution: 380 TV Lines
 Sensitivity: Under 0.3 LUX
 Electronic Iris (linear): EIA = 1/60-1/100,000 sec
 Video Output: 1.0Vp-p, 75 ohm
 S/N Ratio: More than 50dB
 Power Supply: 12V DC (±20%)
 Gamma: f=1
 Power Consumption: 110 mA max
 Operating Temp.: -10°C ~ +50°C
 Operating Humidity: RH 95% Max
 Weight: 100g
 Applied Lens: 3.6mm -92°, 4.3mm -78°
 AI/EE/Flicker Less/Mirror Image: Jump soldering selection
 Audio Pick-up Sensitivity: -60dB (0dB=1V/ubar)
 Audio Frequency Range: 20 Hz ~ 20 kHz
 Audio S/N Ratio: More than 40dB
 Audio Output Level: 1Vp-p/600 ohm
 Dimensions: 87 x 55.5mm



CAT NO	DESCRIPTION	1	5
WDBB-6500	B&W Dome Camera	\$144.00	\$129.00

1/3" CCD Board Cameras

Available with PINHOLE LENS with AUDIO; STANDARD LENS with AUDIO; and STANDARD LENS with INFRA-RED and AUDIO. These are the world's smallest commercially available CCD board cameras!

World's Smallest B&W Board Cameras

Specifications

Image Pick-Up Device: 1/3" CCD area Sensor
 Picture Elements: EIA=512(H) x 492(V)
 Pixel Pitch: EIA=9.6um (H) x 7.5um (V)
 Scanning System: 2 : 1 Interlace
 Scanning Frequency: EIA=525 lines, 60 field/sec (II) 15.750 KHz x 60 HK
 Resolution: 430 Lines
 Minimum Illumination: 0.03 LUX
 S/N Ratio: 45DB
 Lens Mounting: 4.3mm standard, 5mm pinhole
 Video Output: 1.0 VP-P/750OHM composite signal
 Power Requirement: 8-12 VDC (9VDC standard)
 Power Consumption: 100mA
 Operating Temperature: -20C -+ 70 C RH 95% Max
 Storage Temperature: -40C -- 85 C RH 95% Max
 Audio Pick-Up Sensitivity: -60 DB (0DB = 1B/UBAR, 1KNZ)
 Audio Frequency Range: 20 Hz to 20KHz
 Audio S/N Ratio: More than 35DB
 Audio Output Level: 1VP-P/600 OHM

Dimensions

WDP-2000 30mm (H) x 30mm (W)
 WDS-2005 30mm (H) x 30mm (W)
 WDI-4000 44mm (H) x 30mm (W)

CAT NO	DESCRIPTION	1	5
WDP-2000	1/3" B&W Pinhole Lens with Audio	\$89.00	\$77.00
WDS-2005	1/3" B&W Standard Lens with Audio	89.00	77.00
WDI-4000	1/3" B&W Infra-RED with Audio	89.00	77.00
WDPH-55BW	Plastic Housing Option for B&W Board Cameras (WDP-2000 & WDS-2005 ONLY)	13.00	12.00



SEE OUR ON-LINE CATALOG AT www.cir.com

CIRCUIT SPECIALISTS, INC. 800-811-5203
 SINCE 1971 602-464-2485
 602-464-5824(FAX)

ESD Safe Soldering Stations

- Auto-Temp 136ESD & Auto-Temp 137ESD
- Meets applicable military standards
- ESD safe featuring ceramic heating element and state of the art P.T.C. sensor to ensure accurate temperature performance

Features

Fine Tune Temperature from 150° C (300° F) through 450° C (850° F) without unnecessary tip or heating element changes.
 Precision "Tip Temperature" accuracy is mastered to within ±3° C (6° F) using state of the art circuit technology and a built-in P.T.C. sensor located at the top of each ceramic heater shaft for full safe accuracy.
 Fast Heat Up & Recovery. A long life Japanese made ceramic heating element facilitates fast heat up, fast recovery and exacting temperature control with minimal overshoot. Heat-up time to working temperature is attained in about 45 seconds.
 Spike Free Circuit. "Zero voltage" switching and fully grounded design meets military application standards for protection of electro-sensitive devices against line transience and voltage spikes. Tip leakage is less than 0.4 mv or 0.5 ohm resistance.
 External Calibration Port. A calibration port is located on the face of the unit thus temperature adjustments are quick and convenient.
 Lightweight Soldering Iron. Ergonomic mini handle that stays "cool". Handle assembly cord is made from silicone rubber that won't be damaged when coming into contact with high temperature irons.
 Isolated Power Unit. The power unit is isolated from the AC line by a high quality



136ESD 137ESD w/ Digital R/O
 front panel. Superior High Insulation ceramic heater provides insulation rated over 100Mohms at 750° F. Optional SMD Tip Series for re-work applications. Range of interchangeable Tips Available for maximum system flexibility.

SEE www.cir.com FOR OUR SELECTION OF REPLACEMENT TIPS, REPLACEMENT IRONS AND SMD TIPS.

CAT NO	DESCRIPTION	1	5
136ESD	Electronic Temp Controlled ESD Safe Soldering Station	\$99.00	\$88.00
137ESD	Electronic Temp Controlled ESD Safe Soldering Station w/ Digital Readout	129.00	114.00

August 1998, Popular Electronics

COPY RENTAL TAPES

WITH OUR VIDEO STABILIZERS

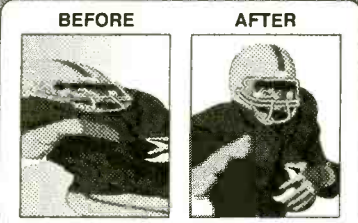

The clearest picture possible playing back movies. **GUARANTEED** to eliminate copy protection.

- No Rolls/Jitters/Flickers/Fading
- Works on all TV's, VCR's Beta & Cable
- Gold Video Connectors & Cables Included
- 1 Year Warranty
- Money Back Guarantee

VISION ELECTRONICS

1-800-562-2252

2609 S. 156TH CIRCLE • OMAHA, NE 68130
<http://www.modernelectronics.com>

Expandable 8051 SBC, Multi-Tasking PC WatchDog, PC & Printer Port Data Acq...

Remotely Downloadable, Expandable SBC starts at \$99. Stack on cards expand SBC to fit your needs. Use our I/O cards or design your own with our proto board. Projects up in no time!

- Atmel's 89C5X, 11.059MHz, 4.75" x 3.15"
- Load program then run or debug, its that simple!
- RS232 & RS485 ports. Has 5 External Interrupts
- Cards: A/D, D/A, D/I/O, LCD/Keypad, Counter.
- FREE Assembler, Disassem, Simulator, Basic, C.

- We also have...
- ◆ **UNIQUE PC WATCHDOG..** monitors up to 4 programs, resets or alarms if any fails. Only \$80.
 - ◆ 8 chan A/D, 24 D/I/O & Counter for a PC \$65.
 - ◆ **PRINTER PORT**, 8 channel 8 bit A/D, 8 TTL D/I, 8 D/O @ 35mA \$87

Innovation West (626) 309-6085
 Fax: 309-9972 inovwest@aol.com
<http://members.aol.com/Inovwest/>

7 SECOND IC REMOVER

Remove 100's of good IC's per hour
 Won't damage IC's or circuit boards

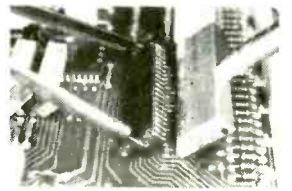

- 8 Desoldering Tools (Remove 6 thru 40 pin IC's) \$ 89.95
- 10 Desoldering Tools (Remove 6 thru 64 pin IC's) \$114.95

FRANKS ELECTRONICS

P. O. BOX 357 — GLEN, MISS. 38846
 Orders By Mail Only. No COD's.

Filter Wiz v2.0

ACTIVE FILTER design software for Windows. Provides mastery of lowpass, highpass, bandpass and bandstop filters. Enhance critical signal components while controlling noise and other interference.

Meets the needs of both novice and professional designer. Standard (LE) version \$89, PRO version \$199.

Download: <http://www.schematica.com>
sales@schematica.com FAX: 250-642-2644

ADAPT-11 68HC11 Modules for Solderless Breadboards

- miniature 2.0" by 2.8" module
 - plugs vertically into solderless breadboard for easy development
 - BOOT/RUN switch for easy programming via PC serial port
 - all I/O lines on dual row connector
- Complete modular prototyping system! Expansion accessories available!



For just US\$74.95, our Starter Package (AD1ISP) provides everything you need to get going fast! Now you can harness the power of the popular 68HC11 in your projects! Includes ADAPT-11 with 68HC811E2, providing 2K EEPROM (re-programmable), 8 channel 8-bit Analog-to-Digital Converter (ADC), hardware timers, counters, interrupts, Serial Peripheral Interface (SPI), Serial Communications Interface (SCI), & more! On-board RS-232 interface (cable included), 5-volt regulator, 8MHz crystal, reset circuit, and convenient program/run switch. Comes with non-commercial versions of HC11 Assembler, BASIC, & C, as well as handy utilities & example code. Includes Motorola 68HC11 Pocket Programming Reference Guide and manual with schematic. All you need is a PC to write & program your software, a DC power supply, and a solderless breadboard (or protoboard) to build your application circuits on (or use our modular accessories).

TECHNOLOGICAL ARTS
 309 Aragona Blvd., Suite 102, Box 418, Va. Beach, VA 23462
 1641 Bayview Avenue, Box 1704, Toronto, ON M1G 3C2
 voice/fax:(416) 963-8996 www.tintering.com - techart

Digital Entertainment GREAT VALUES ON!

USBS dish
SAVE 30%-50% Compare to Cable
 MORE ENTERTAINMENT OPTIONS
 ALL THE HOT ACCESSORIES
 PAY LESS

1010 Frontier Dr.
 Fergus Falls, MN 56537
 Fax: 218-739-4879
 Int'l: 218-739-5231
 Call Now 800-500-9275
www.skyvision.com Skyvision

Quality Microwave TV Systems

WIRELESS CABLE - IPTS - MMDS
 ATV - INTERNATIONAL - DIGITAL
 Amplifiers • Antennas • Books • Components
 • RF Frequency 2100-2700 MHz
 • SASE For "FREE" Catalog or Send \$1
PHILLIPS-TECH ELECTRONICS
 P.O. Box 13074 • Scottsdale, AZ 85267-3074
 CATALOG/INFO: 602-947-7700
 ORDER LINE: 800-890-MMDS
 FAX LINE: 602-947-7799
 WEBSITE: www.phillips-tech.com
 E-MAIL: product@phillips-tech.com
 Visa • M.C. • AmEx • Discover • COD's • Quantity Pricing

Slot Machines \$ 449.00

Free Shipping
 Slot Machine Demo
 Video \$ 5.99
 40 - Minutes
 33" High 20" Wide 14" Deep
Brochure \$ 1.00
 Magic Box
 Test Chips
 Filter Kits
 Notch Filters

Video Media www.nutnet.com
 P.O. Box 93/6025
 Margate, FL 33093
 (954)-752-9202

!!!BROADCAST FARTHER!!!

The model 220 is an 80-110 MHz RF amplifier that connects to mono or stereo FM transmitters and produces a powerful 2-15 watt signal which could broadcast up to 5 miles or more! Requires 50-150 mW drive. Step by step plans complete with part source information and antenna designs... ONLY \$14 PLUS \$2 S&H NO C.O.D.'s

Progressive Concepts
 BOX 586 STREAMWOOD, IL 60107
 (630) 736-9822 FAX: (630) 736-0353

Debco is a Kit Builders Paradise

Electronic Kits - Plans - Parts - Computers - Amateur Radio
 Call Debco today for your FREE copy of
 The Electronic Experimenter's Journal
1 800 423 - 4499
 Debco Electronics 4025 Edwards Rd. Cincinnati, OH 45209

SURVEILLANCE HIDDEN CAMERAS

DIRECT FROM MANUFACTURER—BEST PRICE IN THE MARKET
 Ultra miniature hidden camera, in dome, smcalle or motion detector w/ mic. 8W or Color. Wide view angle. LOW light sensitivity → super sharp images, plus video and audio output. From \$189.00. Also 1/3" B/W board camera remote. only \$39.00 USD. Wireless hidden camera, start at only \$249.00 USD. Plus \$5.95 for S/H. Wholesale Welcome. COD, Check, Money Order or Visa/MC.

BOLIDE INTERNATIONAL CORPORATION
 PH: (800) 355-8895 or (818) 575-8178
 9660 Flair Drive #318, El Monte, CA 91731
<http://www.bolide-international.com>

Be a private investigator

Home study. Learn surveillance, interrogation, undercover skills. Solve crimes, earn great pay.
Free literature: 800-223-4542

Name _____ Age _____
 Address _____ Phone _____
 City/State _____ Zip _____

School of Private Investigation, Dept. JRJ341
 6065 Roswell Rd., PCDI, Atlanta, Georgia 30328

"Get the skills you need at a price you can afford!"

Earn up to \$45 an hour or more as a skilled Computer Programmer.

Cash in on the explosion of opportunities. Start your new career or even open a business of your own as a highly-paid computer programmer.

Computer programmers today can almost write their own ticket to financial well-being and job satisfaction. Only Foley-Belsaw's unique in-home training programs can give you the skills you need at a price you can afford.

You'll learn the three hot computer languages — QBasic, C and Visual Basic. You'll even work with the hot new C++. With this easy-to-learn knowledge, you'll write your first QBasic program by the end of the first SkillPak of lessons. Soon you'll be programming sound and graphics, and even learning how to program for the Windows environment — the most popular application program today.

It's easy to cash in!

Look at some of the things professional computer programmers do. "Wrote a C program to clean up a WordPerfect file; edited the resulting file as data errors were found." This work would take a trained programmer less than five hours to complete, and they could make over \$200 for the work. That's money you could be making — and soon — with training from the Foley-Belsaw Institute of Computer Programming.

Everything is included!

We provide you with all the materials you'll need to become a professional computer programmer. You'll receive 37 lessons, designed for you by the Foley-Belsaw Professional Programmer Staff. Other valuable materials include a *Programmer's Handbook*, *Programmer's Examples* on two 3.5 inch disks, *Programmer's Flowchart Template*, and a booklet, *Selecting the Right Computer*.

Other schools force you to buy a complete computer package as part of their training program. At Foley-Belsaw we understand that your needs as a programmer may not fit into a "one size fits all" approach. Why should you pay hundreds of dollars for a computer system that you may not need?

We'll tell you what you need to know so that when you're ready to buy your own computer, you can get the machine that fits your needs at the lowest possible price. That's the Foley-Belsaw way.

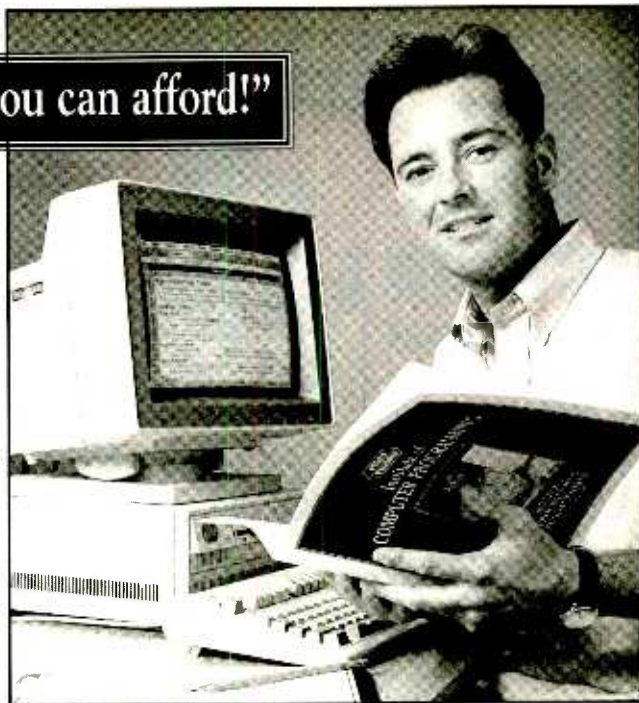

Get the free facts today.

Whether you want to change careers, have a profitable part-time job or start your own business, Foley-Belsaw Institute's new computer programming course is the first step. A profitable future in computer programming can be yours. Call or write today for a fact-filled information kit including a free copy of *Computer Programming — A Profitable Career In Your Spare Time*. See how easy it is to begin a money-making career as a sought-after computer programmer. Our free full-color information kit outlines the steps of the computer programming course and shows you everything you will receive as part of your training.

Mail this coupon or call today
Toll Free 1-800-487-2100!

Your free opportunity kit will be rushed to you!

If coupon is missing, write to: Foley-Belsaw Company, 6301 Equitable Road, Kansas City, MO 64120

Call or complete & return this coupon to: Foley-Belsaw Institute, 6301 Equitable Road, Kansas City, MO 64120

YES! Rush me a free information kit on Computer Programming right away. Dept. 35538

Other career courses:

- Locksmithing, Dept. 13121
- Small Engine Repair, Dept. 52995
- Saw & Tool Sharpening, Dept. 21927
- VCR Repair, Dept. 62820
- Computer Repair, Dept. 64722
- TV/Satellite Dish Repair, Dept. 31591
- Gunsmithing, Dept. 92623
- Woodworking, Dept. 43859
- Upholstery, Dept. 81530
- Vinyl Repair, Dept. 71463
- Electrician, 95397
- Computer Specialist, Dept. 38362
- Networking Specialist, Dept. 39349

I understand that there is ABSOLUTELY NO OBLIGATION and NO SALESMAN WILL CALL.

Name _____

Address _____

City _____ State _____ Zip _____



Interactive catalog: www.tekview.com

TV cable CONVERTERS & EQUIPMENT

TekView Electronics



* 30 days money back guarantee
* 1 yr warranty
* Quantity Discounts
* Dealers Welcome!

VISA MC AMEX C.O.D.

(800)739-2253

ELECTRONIC COMPONENTS

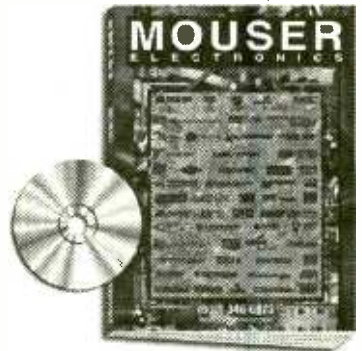

Visit our web site!
www.mouser.com

FREE catalog is available on the internet, CD-ROM, or in paper!

- 70,000+ Products • 145 Suppliers
- Same Day Shipping • No Minimum Order

800-992-9943

817-483-6828 Fax: 817-483-0931
www.mouser.com catalog@mouser.com

958 North Main St., Mansfield, TX 76063

CIRCLE 152 ON FREE INFORMATION CARD

CD ROM LIBRARY OF ELECTRONICS HOME-STUDY, with over a hundred interactive computer aided software tutorials on electronics theory together with schematics:

CONTENT:

- Communications electronics program including:
 - Digital Electronics.
 - AM and FM radio electronics.
 - Television fundamentals.
 - CET (certified electronics technician) test preparation.
- Complete FCC radiotelephone Question Pool, with all questions, and answers, including help with all questions.

ALL of the home-study elements listed above will be sent to you on a CD ROM for \$55 (includes shipping and handling).

Available ONLY from TUTOR-TECH, at 170 Locksunart Way #2, Sunnyvale, CA 94087. (408) 481-9543.

- Check our Web site: <http://home.earthlink.net/~tutortech9>

COMPLETE INTEGRATED CAD/CAE SYSTEM Schematic, Simulation and Layout

EDWIN NC^{*} Delux 3

- ⊕ Full integration of Schematic and Layout
- ⊕ On-line help
- ⊕ Library viewer with editing possibility
- ⊕ Up to 100 schematics sheets
- ⊕ Up to 32 layers
- ⊕ Automatic DRC with user specified parameters
- ⊕ Automatic component renaming
- ⊕ Mixed-mode simulation (AC, DC and TD analysis)

Optionals:

- ⊕ Thermal Analysis for PCI: \$ 29.99
- ⊕ EDSpice Simulator (Spice): \$ 59.99
- ⊕ EDCoMx (Spice model generator): \$29.99

FOR ONLY \$149.99

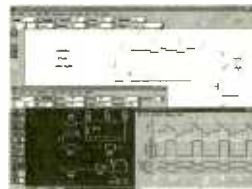

EDAShop

P.O. Box 55-8207

Miami, Florida 33255-8207

Phone: (305) 267-4005 Fax: (305) 267-0709

Web site: <http://www.edashop.com>



Windows is registered trademark of Microsoft Inc.

* The "NC" version (Non-Commercial) is destined only for students, hobbyists and educational institutions. Companies must purchase the "Professional" version. However, there aren't any differences between "NC" and "Professional" versions.

REMEMBER, ONLY YOU CAN PREVENT FOREST FIRES.

A Public Service of the USDA Forest Service and Your State Forester.



Do You Repair Electronics?

- Repair Databases for TV, VCR, Monitor, UL Audio, FCC, and more.
- Over 76,000 records
 - Private user forums
 - Live on-line chat rooms

RepairWorld.com

Electronic Corp / 10240 Sq. Eastman, OH 43021 614-896-9000

Smithy / 3-in-1 Lathe-Mill-Drill

Benchtop machine shop

4 models starting at **\$995**

- Make your own parts and repairs
- Easy to use, free training
- Work metal, wood, or plastic

FREE Info Dept. PE, PO Box 1517, Ann Arbor, MI 48106-1517

Call 1-800-345-6342



Call Today And SAVE! **Unbeatable PRICES!**

CABLE TV

**DESCRAMBLERS
CONVERTERS · FILTERS
VIDEO STABILIZERS**

- FREE** ▶ 30 Day Trial
FREE ▶ Product Catalog
FREE ▶ 1 Year Warranty

100% MONEY BACK GUARANTEE



Arrow Technologies
Omaha, Nebraska

TOLL FREE 888-554-ARROW

888-554-2776

ALL ELECTRONICS

C O R P O R A T I O N

QUALITY PARTS

FAST SHIPPING

DISCOUNT PRICING

CALL, WRITE, FAX
or E-MAIL For A
Free 96 Page
CATALOG.
Outside the U.S.A.
send \$3.00 postage.

KOSS Digital Stereo Headphones

Koss MAC-5
Made for the Ford Motor Company for use in Windstar and Aerostar Vans. These light-weight, adjustable headsets have great sound quality with great bass response for home or studio use. Supra-Aural foam ear cushions for hear-through sound and comfort. The 8' rubberized cords are terminated with 3.5 mm stereo phone plugs. Frequency response: 20-20,000 HZ.

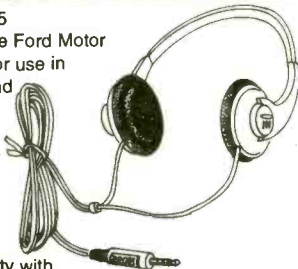

\$1250 each

CAT #HP-5

10 for \$100.00

Power Cord And Light Tester

This handy little pocket tester senses the presence of AC voltage. When it is near a "hot" wire a red LED lights. Useful for finding breaks in AC line cords, finding non-working lights in light strings or checking for voltage before doing household repairs. Includes two button batteries.

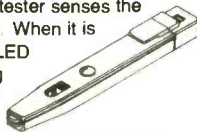

CAT # GVD-500

\$250 each

Resettable Circuit Protector 0.65 - 1.3 Amps

Raychem "Polyswitch" # RXE-065S-1
Unlike traditional fuses, they automatically reset when fault condition is cleared. Can be paralleled for higher ratings. Current: 0.65 Amps. Trip Current: 1.3 Amps. Max Voltage: 60 Volts. 0.33" diameter. UL, CSA listed.



CAT # RXE-065

3 for \$100

10 for \$20.00
500 for \$85.00
1K for \$150.00

SPECIAL LOW PRICING Automotive Multi-Voltage Adaptor

Sanbor M-24
Regulated DC converter plugs into car cigarette lighter and provides power for portable audio and communications devices and many battery operated devices that operate on 500 ma or less. Voltage selector switch for 1.5, 3, 4.5, 6, 7.5 and 9 volts. Polarity switch. Six varieties of output plug including, 2.1, 2.5 and 1.3 mm co-ax power plugs, 2.5 and 3.5 mm phone plugs and 9 volt battery snap.

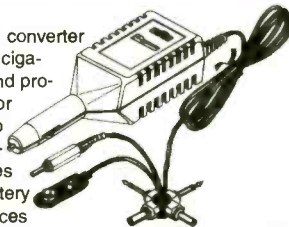

\$200 each

CAT #APC-522

10 for \$15.00

Filtered Modular Jack

Corcom # RJ11B-4L-B "Signal Sentry™" 4 pin, RJ-11 modular jack with built-in ferrite block for inductive filtering. Fits the same space as non-shielded jacks. 0.52" x 0.8" x 0.59" high. UL, CSA listed. Large quantity available.



CAT # MT-4F

\$125 each

10 for \$10.00 • 100 for \$85.00
1000 for \$650.00

Special Purchase Video AB Switch

Jebsee # SW78S
Compact, shielded two position co-ax switch. Standard F connectors for 75 ohm input and outputs. Good quality assembly with solid switching action.



CAT# ABS-2

\$175 each

10 for \$15.00
100 for \$100.00

"Ultrabright" Red LED

PAINFULLY BRIGHT RED LED
2500 to 4000 mcd @ 20 ma. These T 1 3/4 (5 mm diameter) red LEDs are significantly brighter than conventional LEDs. At close range, they are painful to look at. They are great for attention getting displays that can be seen from a distance. Water clear in off-state.



CAT # LED-42

2 for \$120

10 for \$5.00
100 for \$45.00
1000 for \$400.00

High Brightness FLASHER LEDs

T 1 3/4 (5mm) high brightness RED LEDs with built-in flasher unit.

3-5 Vdc operation

CAT # LED-4 2 for 90¢

100 for \$40.00 - 1000 for \$300.00



3 Volt Lithium Coin Cell

Panasonic # BR2330-1GU
3 volt, 255 mAh coin cell. Lithium batteries have a very long shelf life and are great for memory back-up protection. 0.9" diameter x 0.12" thick. 0.7" between positive and negative pc leads.



CAT #LBAT-16

2 for \$150

20 for \$12.00
100 for \$45.00
1K for \$300.00

"Hi-8" Video Cassette

SONY Hi-8 Top quality, metal particle 120 minute video cassettes. Used for a short time, then bulk-erased. Each cassette has its own plastic storage box.

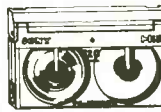

CAT # VCU-8

\$300 each

10 for \$28.00
100 for \$250.00

ORDER TOLL FREE

1-800-826-5432

MAIL ORDERS TO:
ALL ELECTRONICS CORP.
P.O. BOX 567
VAN NUYS, CA 91408-0567

FAX (818) 781-2653 • INFO (818) 904-0524
INTERNET <http://www.allcorp.com/>
E-MAIL allcorp@allcorp.com

NO MINIMUM ORDER • All Orders Can Be Charged to Visa, Mastercard, American Express or Discover • Checks and Money Orders Accepted by Mail • Orders Delivered in the State of California must include California State Sales Tax • NO C.O.D. • Shipping and Handling \$5.00 for the 48 Continental United States - ALL OTHERS including Alaska, Hawaii, P.R. and Canada Must Pay Full Shipping • Quantities Limited • Prices Subject to change without notice.

MANUFACTURERS - We Purchase EXCESS INVENTORIES... Call, Write, E-MAIL or Fax YOUR LIST.

CIRCLE 28 ON FREE INFORMATION CARD

Modern computing and standard surge suppressors...a recipe for disaster.

Almost all surge protection devices use MOV's (metal oxide varistors) as their active element. MOV's are sacrificial/wear/limited life components. Surge suppressors based on this technology are doomed to failure. These surge "suppressors" also don't suppress a thing. They divert powerline surges equally to the ground and neutral wire. When you put current on the common ground wire of interconnected equipment some of that current will flow (through the inherent ground loops) to the data lines. This is a major cause of lock-ups and misoperations that plague today's computer environments. Another fact; all modern computers use switch mode power supplies. During surges the power supply capacitors must charge to the clamping level of the MOV before the MOV turns on. A recent study has shown that it takes a 3000A surge 15 microseconds (15,000 nanoseconds) to charge the typical capacitors of these power supplies to that level. The surge is virtually over before the MOV reacts. (See five things you probably don't know about your surge suppressor at www.fivethings.com.)

THE POINT: Standard surge suppressors allow too much current to hit the computer. Standard surge suppressors divert surge current to the ground wire and disrupt data transfer. Standard surge suppressors eventually fail without warning. Modern computers have logic voltage levels (the signals that transmit the data) and power supply voltages that are dramatically lower than that of their recent predecessors. Modern computers use integrated circuits with transistors of ever decreasing physical geometries. Modern computers are virtually always interconnected to other computers or peripheral equipment. The bottom line; *modern computers are much more sensitive and susceptible to powerline anomalies.*

INTRODUCING BRICK WALL SURGE FILTERS. . . The World's Best Surge Suppressor

Initially engineered for critical, non-fail industrial applications, this patented device protects indefinitely and sets a new standard for every measure of surge suppressor and powerline filtering performance.

A Brick Wall 1) Utilizes NO MOV'S or Any Other Sacrificial Components (a two pound inductor and nine capacitors are the heart of the unit) 2) Has No Joule Rating or Surge Current Limitations 3) *HAS BEEN TESTED AND CERTIFIED BY UL TO THE MOST DEMANDING CLASSIFICATION OF A NEW GOVERNMENT SPECIFICATION; CLASS I, GRADE A. Which Means: UL PUT ONE THOUSAND 3000A, 6000V SURGES (this is the largest surge an interior environment can experience) THROUGH A UNIT (at 60 second intervals) AND DOCUMENTED NO FAILURE OR PERFORMANCE DEGRADATION OF ANY KIND WHATSOEVER.*

i.e.: A Brick Wall Will Not Fail.

We know of no cord connected, MOV based surge protection device that has, or can pass this test.

A Brick Wall possesses UL's lowest Suppressed Voltage Rating (let-through voltage) of 330V. This is the lowest rating they will grant. In that test of one thousand 6000V, 3000A surges, *UL NEVER SAW THE LET-THROUGH VOLTAGE EXCEED 290V. YOU CANNOT DO BETTER THAN THIS FOR A POINT-OF-USE SURGE PROTECTION DEVICE.* Once again, we know of no other surge protection device that could come close to this performance level.

A Brick Wall is a current activated *Series Mode* device. *Since it is not wired in parallel, nor voltage activated, it does not have to wait for the capacitors of the power supply to charge before it becomes effective. YOUR EQUIPMENT IS PROTECTED INSTANTANEOUSLY (and indefinitely).*

These devices were engineered utilizing a current limiting/surge filtering technology. *THEY DO NOT DIVERT ANY SURGE CURRENT TO THE GROUND WIRE. They Will Not Cause Your Computer System To LOCK-UP, CRASH OR MISOPERATE as a consequence of surge diversion. Your current surge "suppressor" will.*

Powerline Filtering

In addition to all this, Brick Wall Surge **FILTERS** are the best AC powerline filters you can buy (that we have been able to find anyway). Industrial machinery, copiers, coffee makers, laser printers, fluorescent lights, refrigerators, etc., all cause powerline noise that can cause your computer to misoperate. A Brick Wall Surge Filter will make powerline noise related problems disappear.

You Can't Buy a Better Surge Protection/Powerline Filtering Device...Anywhere.



**BRICK WALL DIV.,
PRICE WHEELER CORP.
1-800-528-0313**

Fax: 1-800-528-6623 E-Mail: info@brickwall.com

Web: www.brickwall.com

Visa - MC - AMEX

ASK ABOUT OUR NEW IN-LINE UPS/SERVER PROTECTOR



Available in Modular Form

VARIAC

Excellent for controlling & testing various electronic products such as, Motor, Transformer, Lighting Control, School Electronics Lab / **1000VA**



\$69.89

Qty. 3+

DIGITAL MULTIMETER

Basic Digital Multimeter with Transistor "hfe" and Continuity Test.



Qty. 3+

\$11.99

1-888-456-4517

**Associated Elec.
& Eng. Co./ AEEC**

PO Box 4766,
Santa Clara CA 95056

Buy recycled.



It would mean the world to them.

Recycling keeps working to protect their future when you buy products made from recycled materials. For a free brochure, write *Buy Recycled*, Environmental Defense Fund, 257 Park Avenue South, New York, NY 10010, or call 1-800-CALL-EDF.



ALFA ELECTRONICS, INC.

HIGH QUALITY TEST EQUIPMENT PROVIDER

1-800-526-2532 (526-ALFA)

15 Days Money Back Guarantee!



DMM
DMM-895 (\$179.00): true rms, AC/DC (V,A), Ω, bar graph, freq, capac., dBm, logic, diode
DMM-885 (\$149.00): AC/DC (V,A), Ω, bar graph, freq, capac., logic, diode
DMM-20 (\$74.95): AC/DC (V, A), Freq, cont., Capac, Induct., Ω, hFE, diode, duty cycle
DMM-22 (\$89.95): 4000counts, bar graph, Freq, AC/DC(V,A), Ω, Capacitance, diode, contin.
DMM-23T (\$99.95): 4½ digit, true rms, high resol. (10µV, 10nA, 10mΩ), hFE, diode, contin.
DMM-10 (\$19.95): 3½ digit, DC/AC V, Ω, hFE, diode, signal output(+3V,-0.5Vsq, 50% duty)



DMM-113 (\$24.95): Pocket Size, DC/ACV, Ω, diode, Continuity beeper
DMM-120 (\$24.95): economy type, DCV, ACV, DCA, Ω, hFE, diode
DMM-122 (\$59.95): DC/AC(V,A), Ω, hFE, diode, capacitance, freq, logic, continuity
DMM-123 (\$44.95): DMM + capacitance, DC/AC(V,A), Ω, hFE, diode, continuity
DMM-124 (\$69.95): Electrical+Temp, DC/ACV, Ω, capacitance, freq, 3 phase, diode, contin.
DMM-125C (\$54.95): Autorange + bar graph, DC/ACV, Cap, Ω, diode, continuity beeper

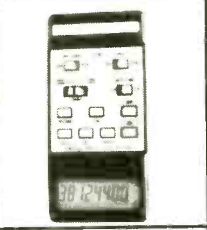
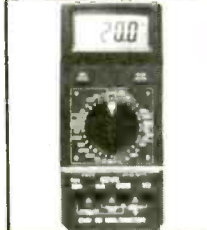

LCR METER
CAP-15 (\$49.95): 3½ digit, 0.1pF-20mF, 9 Ranges, 0.1pF resolution zero adjustment.
LCR-24 (\$139.95): 0.1µH-200H, 0.1pF-2000µF, 0.01Ω-20MΩ, diode test. *New Model*
LCR-814 (\$189.95): 0.1µH-200H, 0.1pF-20mF, 1mΩ-20M Ω, Q Factor, dissipation, zero adjust
LCR-131D (\$229.95): autorange, 0.1µH-10kH, 0.1pF-10mF, 1mΩ-10MΩ, Q Factor, serial/parallel, 120Hz/1kHz testing mode.

FREQ. COUNTER
FC-1200 (\$129.95): 1.25GHz Handheld, 8 digits display, 10ppm accuracy, sensitivity 5mV (130-350MHz), 30mV (400MHz), 22mV (800MHz), batteries or 9V adapter.
FC-2500 (\$179.95): 2.5GHz Handheld, 8 digits display, 4ppm accuracy, sensitivity <50mV, batteries or 9V adapter.
FC-5270A (\$149.95): 1.2 GHz bench type, 8 digit, 10 ppm, 35mV sensitivity, 10Vp-p max. input, power by 9V adapter.
FC-5700 (\$329.95): 1.3GHz bench type, 8 digit, 1 ppm accuracy, 20mV sensitivity, period 0.1µs to 100ms. Ideal for test & repair of audio instrument.

OSCILLOSCOPE

Dual Trace, Component Test, 6" CRT, X-Y Operation, TV Sync, CH2 Output, Graticule Illum, 2 Probes(x1,x10)

- PS-200 20 MHz Dual Trace \$339.95
- PS-205 20 MHz Dual w/ Delay Sweep \$429.95
- PS-400 40 MHz Dual Trace \$494.95
- PS-405 40 MHz Dual w/ Delay Sweep \$569.95
- PS-605 60 MHz Dual w/ Delay Sweep \$769.95
- PS-1000 100MHz Dual Trace \$999.95

Digital Scope:

- DS-303 30MHz Digital, 20 Samples/sec \$849.95
- DS-303P RS-232 interface, 30MHz \$1,049.95

Scope Probe:

- HP-9060 (60MHz) \$15, HP-9150 (150MHz) \$22, HP-9250 (250MHz)\$29, HP-9258 (250MHz,100:1)\$39

AUDIO/RX/FUNCT. GENERATOR

RF Generator

- SG-4160 (\$124.95) 100kHz-150MHz sinewaves in 8 ranges, 100mV at 35MHz
- SG-4162 (\$229.95): same as SG-4160, plus 6 digits int/ext freq. counter (150MHz).

Audio Generator

- AG-2601 (\$124.95) 10Hz-1MHz, 0-8Vpp sine, 0-10Vpp squarewave
- AG-2603 (\$229.95): same as AG-2601, plus 6 digits int/ext freq. counter (150MHz).

Function Generator

- FG-2100A (\$169.95) 2Hz-2MHz, 5mV-20Vpp
- FG-2102AD (\$229.95) same as FG-2100A, plus int. counter and TTL, CMOS output.
- FG-2103 (\$329.95) Sweep 0.5Hz-5MHz, linear/log, VCG, GCV, 6 dig. int/ext counter

POWER SUPPLIES

Single Output DC Power Supplies

- Short Circuit and overload protected
- Constant current, constant voltage mode
- 0.02%+2mV line regulation; 0.02%+2mV load regulate

Analog Meters Display

- PS-303 (\$159.00) 30V/3A
- PS-305 (\$219.95) 30V/5A
- PS-8110 (\$289.95) 60V/3A
- PS-8112 (\$399.95) 60V/5A
- PS-1610 (\$289.00) 16V/10A
- PS-8107 (\$399.95) 30V/10A

Digital Voltage, Analog Current

- PS-8200 (\$179.95) 30V/3A
- PS-8201 (\$239.95) 30V/5A

Digital Volt & Current Display

- PS-8300 (\$199.95) 30V/3A
- PS-8301 (\$259.95) 30V/5A

Dual Tracking

- Short Circuit & overload protected
- Constant current & voltage mode
- Independent or Tracking

Dual Tracking (Analog V & I Displays)

- PS-303D (\$314.95) 30V/3A/30V/3A
- PS-305D (\$399.95) 30V/5A/30V/5A
- PS-8108 (\$549.95) 60V/3A/60V/3A
- PS-8109 (\$699.95) 60V/5A/60V/5A

Triple Output

- One fixed 5VDC, 3 Amp output
- Parallel to double current output (PS-8102 & PS-8103 only)

Triple Output (Analog displays)

- PS-8102 (\$399.95) 30V/3A/30V/3A
- PS-8103 (\$489.95) 30V/5A/30V/5A

Digital Displays

- PS-8202 (\$499.95) 30V/3A/30V/3A
- PS-8203 (\$549.95) 30V/5A/30V/5A

GW/INSTEK® Test & Measuring Instrument ISO 9002 Cert. #934163 (2 Years Warranty)

OSCILLOSCOPE		DC POWER SUPPLIES		FUNCTION GENERATOR	BENCHTOP DMM
OS 658G \$849.95	OS 622G \$369.95	Triple Output	Single Output	Programmable	
<ul style="list-style-type: none"> Dual CH / Delay sweep Readout & Cursor menu Built-in delay line Z-axis input, CH1 output TV syn., trigger level lock 2 probes (x1, x10) <p>OS-305 (\$229.95) - 5 MHz One Channel OS-310 (\$324.95) - 10 MHz One Channel</p>	<ul style="list-style-type: none"> Dual CH/X-Y operation 1 mV/div sensitivity Z-axis input, CH1 output TV syn., trigger level 2 probes (x1, x10) <p>OS-6192</p>	<ul style="list-style-type: none"> 2 variable out 0-30V, 0-3A One fixed 5V, 3A output Auto track, serial, parallel Const. volt, current mode 4 analog or 2 digital display <p>PC-3030 (\$499.95) PC-3030D (\$549.95)</p>	<ul style="list-style-type: none"> Const voltage, current mode Voltage regulation <0.01% Current regulation <0.2% PS: 2 analog or 1 digital disp PR: 2 analog or 2 digital disp <p>Analog Meters Display</p> <ul style="list-style-type: none"> PS-1830 (\$209.95) 18V/3A PS-1850 (\$229.95) 18V/5A <p>Digital Meters Display</p> <ul style="list-style-type: none"> PS-3030 (\$219.95) 30V/3A PS-6010 (\$209.95) 60V/10A <p>PR-3060 (\$329.95) 30V/6A PR-6030 (\$329.95) 60V/3A PR-1810H (\$349.95) 18V/10A</p>	<ul style="list-style-type: none"> High stability, low drift One fixed 5V, 3A output 100point program (PPS ser) 50point program (PPT ser.) Auto serial/parall. (PPT ser) Auto track (PPT series), IEEE-488-2 and SCPI compatible command set (optional) <p>PPS-1860G (\$1,149.95) PPS-3635G (\$1,149.95)</p> <p>PPS-6020G (\$1,149.95) PPT-1830G (\$1,499.95) PPT-3615G (\$1,499.95)</p> <p>FG-8015G (\$179.95) Sweep • 0.02Hz-2MHz, no counter • Sine/Squ/Tri/pulse/Ramp</p> <p>FG-8016G (\$239.95) • 0.02Hz-2MHz w/ counter • Pulse, function generator</p> <p>FG-8017G (\$249.95) Sweep • Sine/Tri/Squ/TTL/CMOS • 0.02Hz-2MHz, FM mod.</p> <p>FG-8019 (\$399.95) Sweep • 0.02Hz-2MHz w/counter • INT/EXT AM/FM mod</p> <p>FG-8020G (\$209.95) • 0.02Hz-2MHz</p> <p>FG-8050 (\$499.95) Sweep • 0.05Hz-5MHz w/counter • INT/EXT AM/FM mod</p> <p>FG-830G (\$1,799.95) 30MHz Synthesized Function Gen. • Output sine, tri, square, sync out, arb. waveform</p>	<ul style="list-style-type: none"> DM-8034 (\$179.95) 3½ dgt • AC/DC(V,A), Ω, diode • 1000V, 20A, 0.5% accu. DM-8040 (\$339.95) 3½ dgt • ACV to 50kHz, true rms DM-8055 (\$649.95) 5½ dgt • 0.006% basic accuracy • 1µV, 1mΩ, 1nA resolution • dBm, auto, REL, min/max DM-8055G (\$889.95) GPIB • Same function as DM-8055 <p>Intelligent Counters</p> <ul style="list-style-type: none"> FC-8131 (\$469.95) 1.3GHz FC-8270 (\$629.95) 7GHz UC-2010G (\$294.95)
<p>Auto-set Cur or Read-out Oscilloscope</p> <p>100 MHz OS-6192 *NEW* \$1349.95</p> <ul style="list-style-type: none"> Dual channels Auto-set for parameter selection Automatic Peak to Peak Memory for 10 user-defined settings <p>RS-232 Remote control Triggering DC-250 M-Hz Alternate trigger Component tester</p>					

ALFA ELECTRONICS P.O. BOX 8089 PRINCETON, NJ 08543
 TEL: (800) 526-ALFA (2532) / (609) 897-1135 FAX: 609-897-0206 E-mail: alfa0168@aol.com
 Call/Wire/Fax/E-mail for FREE CATALOG
 Visa, MC, AMEX, COD, PO Accepted OEM Welcome
 1 Year Warranty (2 Years for GW/Instek)

August 1998, Popular Electronics

Introducing Eagan Technical Services, Inc.

Surface Mount Rework System

The Eagan Technical Services SMT Rework System and Procedures were developed to meet the needs of several high volume computer repair facilities and provide an efficient and economical method for removal and installation of Surface Mount devices. The system includes all tools, supplies, and materials required to perform nondestructive removal and installation of most package/types of surface mount components.

Just \$249.95!

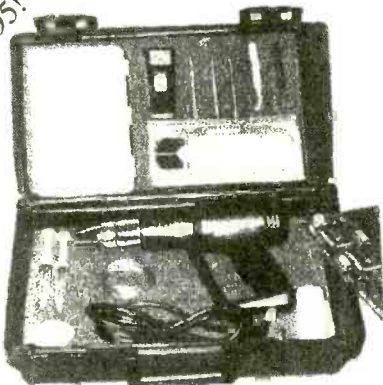

- SMT Reflow Gun
- Reduction Nozzle
- Set of 3 Probes
- Set of 2 Tweezers
- Cleaning Sponge
- Illuminated Magnifier
- Water-Soluble Flux
- Organic Core Solder
- Flux Applicator
- Tool/Parts Box
- Instructional Video
- Practice PC Board
- Instruction Booklet



Eagan Technical Services, Inc.
1408 Northland Drive, Suite #304
Mendota Heights, MN 55120
Phone: 612.688.0098 Fax: 612.688.7829
Toll Free: 800.285.1873 Internet Address: www.eagantech.com

CABLE TV CHANNELS

EQUIPMENT *Direct!* **GUARANTEED**

FREE 30 DAY TRIAL

SAVE \$1000's

The Nationwide source for cable TV equipment.

"BUY WHERE THE DEALERS BUY."

FREE

TV Cable Describers, Converters and Magic Box Catalog. Open Every Day!

YOUR VCR TAPES CAN PLAY AS CLEAR AS DAY!

UNJAM NOW WITH Video Decoder

2 Year Warranty

CALL NOW!

Member Better Business Bureau

MEGA ELECTRONICS

1-800-676-6342

FREE 30 Day Trial

VISA • MC • CDD

The Pocket Programmer

\$129.95



The portable programmer that uses the printer port of your PC instead of an internal card.

Easy to use software that programs E(E)prom, Flash & Dallas Ram. 27(C)/28(C)(F)/29(C)(F)/25 series from 16K to 8 Megabit with a 32 pin socket. Adapters available for MCU's 874X, 875X, Pic, 40-Pin X 16 & Serial Eprom's, PLCC, 5-Gang and Eprom Emulator to 32K X 8.

Same Name, Address & Phone # for 13 Years.... Isn't it Amazing ?

Intronics, Inc.
Box 13723 / 612 Newton St.
Edwardsville, KS 66113 Add \$4.75 COD
Tel. (913) 422-2094 Add \$4.00 Shipping
Fax (913) 441-1623 Visa / Master Charge

ATTENTION DEALERS: WHOLESALE ONLY!



Formerly JES, Inc.

BEST PRICES!
FAST SERVICE
SAME DAY SHIPPING

EXCLUSIVE:



NEW! Wavemaster 99 Channel

• Sleep Timer • Std./HRC Switch • Parental Control

10+	20 +	50+
\$57	52	45

	5+	10+	20+
Panasonic 145	\$72	65	60
Refurb. Panasonic 145	57	55	52
Panasonic 100	52	49	--
Panasonic 175	---	CALL!	---
Starcomm DQN (99 ch; Refurb.)	49	45	39

TOLL FREE:
800-322-9690



FAX:
516-246-5634

SURVEILLANCE

The Latest High Tech Professional Electronic Devices

Our latest catalog offers a HUGE selection of surveillance, counter-surveillance/privacy devices: **pinhole camera \$129⁰⁰**, hidden video, **"realtime" 12-Hour telephone recorder \$139⁰⁰**, 12 hour VOX recorder, phone call register, scanners, bug/phone tap detectors, voice disguisers, phone scramblers, locksmithing tools, vehicle tracking, and much more. Wholesale/retail.

We will not be undersold.

Catalog \$5.00 or

www.spyoulet.com

SPY OUTLET

PO Box 337, Buffalo NY 14226
(716) 691-3476/(716) 695-8660

Electronic Training Videos

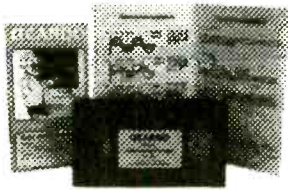

Learn electronics quickly and easily with UCANDO's computer-animated training videos. Students can learn at their own pace and professionals will find the UCANDO videos to be a valuable source of reference material. If these videos aren't the best learning tools you've ever seen, return them within 30 days for a

complete refund. These videos are being used by Tech-Schools, CET's, Military Branches, Ham Operators, Industries, and more, across the United States and around the world. Order today and see how UCANDO is ...

"Changing The Way The World Learns Electronics."

VCR Maintenance & Repair ... \$29.95 All others ... \$44.95 each
 • Intro to VCR Repair • Direct Current • Alternating Current • Semiconductors • Power Supplies • Amplifiers • Oscillators • Digital 1 • Digital 2 • Digital 3 • Digital 4 • Digital 5 • Digital 6 • AM Radio • FM Radio Part 1 • FM Radio Part 2 • TV Part 1 "Intro to TV" • TV Part 2 "The Front End" • TV Part 3 "Audio" • Fiber Optics • Laser Technology •

SAVE!!! 6 videos for only \$240 or 12 videos for only \$450



1-800-678-6113

or mail check or money order to:

UCANDO Videos
 P.O. Box 928
 Greenville, OH 45331



FREE Shipping ... FREE Catalog

CIRCLE 136 ON FREE INFORMATION CARD

OSCILLOSCOPES from \$169 !!!

ATC O-Scope uses printer port to turn PC-AT into Digital Storage Oscilloscope, Spectrum Analyzer, Freq. Counter, Logger, DVM. DC-500KHz

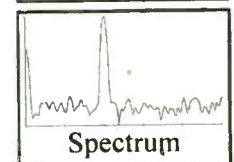
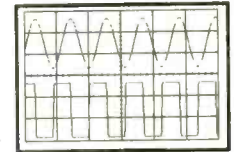

- Print, log to disk, or export data
- Accepts standard scope probes
- Uses standard printer port
- Small and portable
- Works with laptops
- Same day shipping
- Made in U.S.A.
- Single channel units from \$169
- Dual channel units from \$349

Options:

- Probe sets
- Automotive probes
- Battery packs

Order yours today.

800 980 9806 MC/Visa/Amex

Allison Technology Corporation

8343 Carvel, Houston, TX 77036 USA

PH: 713 777 0401, FAX: 713 777 4746, BBS: 713 777 4746

<http://www.atcweb.com>

Any waveform you want!



Starting at

\$795

Quantity 1

Money back guarantee

Telulex Inc. model SG-100

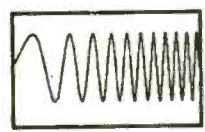

DC to 20 MHz linear and log sweeps

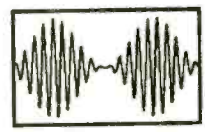

Int/Ext AM, SSB, Dualtone Gen.

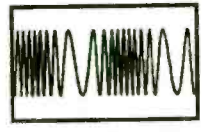

Int/Ext FM, PM, BPSK, Burst

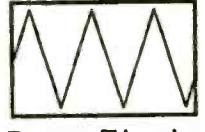

Ramps, Triangles, Exponentials

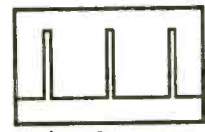

Pulse Generator



Noise



Arbitrary Waveforms

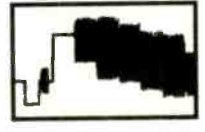

Unlimited Possibilities!

● **Synthesized Signal Generator**

Clean sinewaves DC-20 MHz with .001% accuracy! .1 Hz steps. DC Offset. RS232 remote control.

● **Arbitrary Waveform Generator**

40 Megasamples/Second. 32,768 points. 12 bit DAC

● **Function Generator**

Ramps, Triangles, Exponentials & more to 2 MHz!

● **Pulse Generator**

Digital waveforms with adjustable duty cycle

Telulex Inc.

2455 Old Middlefield Way S Tel (650) 938-0240 <http://www.Telulex.com>

Mountain View, CA 94043 Fax (650) 938-0241 Email: sales@Telulex.com

CIRCLE 142 ON FREE INFORMATION CARD

August 1998, Popular Electronics

Turn Your Multimedia PC into a Powerful Real-Time Audio Spectrum Analyzer

Features

- 20 kHz real-time bandwidth
- Fast 32 bit executable
- Dual channel analysis
- High Resolution FFT
- Octave Analysis
- THD, THD+N, SNR measurements
- Signal Generation
- Digital Filtering
- Triggering, Decimation
- Transfer Functions, Coherence
- Dynamic Data Exchange (DDE)
- Time Series, Spectrum Phase, Spectrogram and 3-D Surface plots
- Real-Time Recording and Post-Processing modes

Applications

- Distortion Analysis
- Frequency Response Testing
- Vibration Measurements
- Acoustic Research

System Requirements

- 486 CPU or greater
- 8 MB RAM minimum
- Win. 95, NT, or Win. 3.1 + Win. 32s
- Mouse and Math coprocessor
- 16 bit sound card

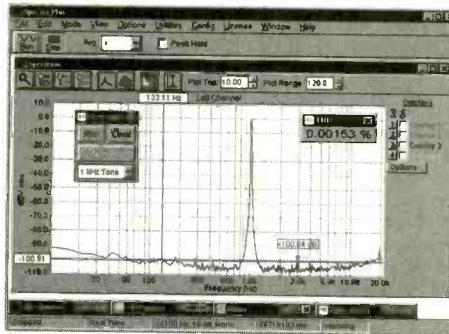

Priced from \$299

(U.S. sales only - not for export/resale)

Professional Quality Sound Cards Available... Call

DOWNLOAD FREE 30 DAY TRIAL!

www.telebyte.com/pioneer

PHS

Pioneer Hill Software
24460 Mason Rd. N.W.
Poulsbo, WA 98370

Spectra Plus 4.0
Affordable Signal Processing Software

Sales: (360) 697-3472

Fax: (360) 697-7717

e-mail: pioneer@telebyte.com

Super Savings!!! Super Savings!!!



10 Watt Multimedia Speakers

Amplified speaker system features 10 watt max. power

output, 80Hz-20KHz frequency response, 0.5% THD, 40dB signal-to-noise, 2" x 4" full range speaker. Separate controls for volume and power. Includes cables and wall transformer. Size: 3-7/8" (D) x 3-1/2" (W) x 5-1/2" (H).

Retail Price: \$34.95

No. 220-0201.....\$9.95 (per pair)



50 Watt Multimedia Speakers

Amplified speaker system features 50 watt max. power

output, 80Hz-20KHz frequency response, 3" magnetically shielded full range speaker. Separate controls for power, volume and tone. Includes LED power indicator and front headphone jack. Includes cables and wall transformer. Size: 5-1/8" (D) x 4-1/2" (W) x 7" (H).

Retail Price: \$79.95

No. 220-0203.....\$29.95 (per pair)



20 Watt Multimedia Speakers

Amplified speaker system features 20 watt max. power

output, 80Hz-20KHz frequency response, 0.3% THD, 45dB signal-to-noise, 3" full range speaker. Separate controls for volume, power and tone. LED power ON indicator. Includes cables and wall transformer. Size: 5-1/2" (D) x 3-3/4" (W) x 7-1/8" (H). Retail Price: \$59.95

No. 220-0202.....\$19.95 (per pair)

Super CHARGER™

Alkaline and Ni-Cd Charger for AAA, AA, C and D Cell batteries. Incredible space-age technology automatically and safely recharges regular alkaline (1.5V) and nickel cadmium (1.2V) batteries. Mfg: Buddy L. Model #8000. *Repackaged*



No. 140-0140.....\$7.95 (ea)

MECI 340 E. 1st St.
Dayton, Ohio
45402
Call for a free catalog

Order Toll-Free
1-800-344-4465
Fax Order Line
1-800-344-6324

CIRCLE 150 ON FREE INFORMATION CARD



CABLE CONVERTER DIAGNOSTIC TEST CHIP

WE STOCK A COMPLETE LINE OF CHIPS, TOOLS, WIRELESS QUICK INSTALL TEST BOARDS AND DIAGNOSTIC CUBES FOR ALL CONVERTERS!

***ANYONE IMPLYING ILLEGAL USE WILL BE DENIED SALE. WE SELL PRODUCTS ONLY!! TO TECHNICIANS OR CABLE REPAIR FACILITIES!!

#1 IN CUSTOMER SERVICE & TECH. SUPPORT!

*ALL ORDERS SHIP WITHIN 24HRS, UPS/ FED-X.

*PRIORITY NEXT DAY SHIPPING AVAILABLE!

*SALE= BUY 5 TEST BOARDS AND GET 1 FREE.

*MON-FRI - 8AM-7PM - SAT 10AM-2PM EST.

*WEB PAGE [HTTP://WWW.800-GOCABLE.COM](http://WWW.800-GOCABLE.COM)

VISA MasterCard VISUAL COMMUNICATIONS INC.
ORDERS/CATALOG 1-800-GO-CABLE
TOLL FREE TECH. DEPT. 1-888-319-TECH EST. 1976

MO-TECH DISTRIBUTORS YOUR MIDWEST PANASONIC CONVERTER WHOLESALER

PANASONIC

TZPC1453G2

"Top of the line converter" featuring sleep timer, parental lock, standard/HRC switchable, last channel recall, favorite channel memory, and 83 channel capable.

TZPC1003

One of our best selling converters featuring sleep timer, parental lock, last channel recall, favorite channel memory, and 80 channel capability.

TZPC175DG2

Our "Top of the line" converter with volume control. Featuring sleep timer standard/HRC switchable, parental lock, last channel recall, favorite channel memory and 83 channel capable.

Phone (810) 739-2710
Fax (810) 739-3517

BUGGED??

Eavesdropping is unbelievably widespread! Electronic devices with amazing capabilities can be monitoring your telephone and room conversations RIGHT NOW! Are you sure you're safe? FREE CATALOG tells you fast! Includes Free Bonus details on fantastic opportunities now open in Counter-Surveillance field. Exciting, immensely interesting and EXTREMELY profitable! (up to \$250 hr) full/part-time income. Call Now! 1-800-732-5000

FCC License Preparation

Electronics Tech., Avionics, Marine & Radar HOMESTUDY—Fast, Easy & Inexpensive Manuals, Audio, Video, PC disks, latest Q&A Series Free 1-800-800-7555 "Guaranteed Pass" See at <http://www.worldaccessnet.com> BusinessShowcase/wpt. 4701 NE 47th St. Vancouver, WA 98661 - WPT Publications

CABLE TV CONVERTERS

Equipment & Accessories
Wholesalers Welcome

Call C&D ELECTRONICS
1-888-615-5757 M-F 10a-6p

LASER WINDOW BOUNCE OPTICAL RECEIVER
 Operates With Our Laser Pointers
 And HeNe Gas Systems

High Sensitivity Optical Receiver with built in speech filter and low noise light biased pre-amplifier. Include cushioned headsets with separate volume controls and all instructions to demonstrate and utilize this remarkable property of laser light.



Uses Scattered and Direct Reflections

- LLR3 Plans...\$10.00 LLR3K Kit/Plans.....\$69.50
- LLR30 Ready to Use.....\$99.50
- EXT10 Optional Range Extension Lens...\$39.50

ULTRA BRIGHT LASERS



- 1 Year Warrantee
 Batteries Included
 All Metal Enclosure
- LAPN65 Versatile...15mw equiv 2000 ft....\$29.95
 - LAPN65F Focusable Model of Above.....\$34.95
 - LAPN63 Brightest...30mw equiv 3000 ft....\$49.95
 - LAPN63F Focusable Model of Above.....\$74.95
- CREATE YOUR OWN LIGHT SHOW!!!**
- LAPN65PT Laser Multi Pattern Generator..\$29.95
 - LAPN65M Mini Key Chain All Metal.....\$39.95
 - LAPN67...5mw @ 670nm **LOWEST COST**.....\$19.95

WIRELESS LAB KITS
 ALL PARTS TO BUILD 6 EXCITING TRANSMITTER PROJECTS

- 1 Super Sensitive Ultra Clear 1 Mile+ Voice Transmitter
 - 2 1 Mile+ Telephone Transmitter
 - 3 Line Powered Telephone Transmitter (never Needs Batteries!)
 - 4 Tracking/Homing Beacon "Beeping Transmitter"
 - 5 Transmitter Rebroadcasts Video or Audio Outputs
 - 6 Short Range TV/FM Disrupter NEAT PEAKING Discretion Advised
- All 6 Above Kits Plus FREE Info Data Pack on HELPFUL HINTS Building and Tuning Wireless Devices
- COMBOX Parts and Plans for above!..\$59.50
 COMBOP Plans for all the above!.....\$10.00

KINETIC ELECTRIC GUN
 PIONEER A FUTURISTIC WEAPON!



500 Joules Energy Storage
 Constant Current Charging
 Triggered Spark Switch
 Ballistic Velocities
 Handheld Battery Operated
 Labeled A Dangers product

- EGUN1 Plans with Parts List.....\$20.00
 All Parts are Individually Available

3 MI FM BROADCAST TELEPHONE TRANSMITTER
 Tunable On FM Broadcast. Excellent Telephone Project. Only Transmits When Phone is Used

- VWPM7K Kit/Plans\$39.50
- BEEP1K Beeper Alert Kit..\$19.95

10-14" of Explosive Bolts of Lightning

250KV TESLA COIL
 Transmit Wireless Energy
 Strange and Bizarre
 pyrotechnical effects.

- Ion Motors Anti-Gravity
 Size 20" H x 8" Sq
 Weight - 25 Pounds
 115 Volts/2 Amps AC
 Labeled "Use Caution"
- BTC3 Plans.....\$15.00
 - BTC3K Kit/Plans.....\$399.50
 - BTC30 Ready to Use.....\$499.50
 - BTC4 Plans 24 to 30" Sprk...\$20.00

HIGH POWER STUNGUNS

- STUN100 100KV StunGun...\$29.50
- STUN200 200KV StunGun...\$49.50
- STUN300 300KV StunGun...\$69.50

ION RAY GUN PROJECTS ENERGY!



Star Wars Technology Demonstrates Weapons Potential! See Ions in Motion!
 IOG7/9 Plans.....\$10.00
 IOG7K Kit/Plans.....\$99.50

HIGHER POWERED DEVICE

- IOG9K Kit/Plans.....\$149.50
- ATTENTION!** HIGH VOLTAGE EXPERIMENTERS
 Battery Powered Mini Sized Modules for research in:
 HOVERCRAFT, ION GUNS
 FORCE FIELDS, SHOCKERS etc
 MINIMAX4 4KV@10ma.....\$19.50

GRAVITY GENERATOR

Demonstrates a unique phenomena of electrical reactions that produce the effect of "anti-gravity". You build and levitate a small mock space ship from simple materials. Excellent scientific demonstration of a fascinating method of levitation. **Levitate an Object!**

- GRA1 Plans and Book.....\$20.00
- GRA1K Pwr Sup Kit/Plans...\$99.50
- GRA10 Assbled Pwr Sup...\$149.50

SHOCK FORCE FIELD/VEHICLE OBJECT ELECTRIFIER

Hand Shock Balls. Wonders. Electrify Objects. Great Payback for Those Who Buy!
 SHK1K Kit of Pwr Module....\$19.50

1 800 221 1705 **ORDERS ONLY!** FAX 1 603 672 5406 INFO 9-5pm 1 603 673 4730 **FREE CATALOG ON REQUEST**
 Pay by MC, VISA, Cash, Chk, MO, COD. Please Add \$5.00 S&H plus \$5.00 If COD. Overseas Please Contact for PROFORMA

ATTENTION CABLE VIEWERS

CABLE VIEWERS. . .get back to your BASIC Cable Needs

Call 800-577-8775

For information regarding all of your BASIC cable needs.



- 5 GOOD REASONS TO BUY OUR FAR SUPERIOR PRODUCT**
- ❖ PRICE
 - ❖ EFFICIENT SALES AND SERVICE
 - ❖ WE SPECIALIZE IN 5, 10 LOT PRICING
 - ❖ ALL FUNCTIONS (COMPATIBLE WITH ALL MAJOR BRANDS)
 - ❖ **ANY SIZE** ORDER FILLED WITH SAME DAY SHIPPING

We handle NEW equipment ONLY - Don't trust last year's OBSOLETE and UNSOLD stock!
COMPETITIVE PRICING—DEALERS WELCOME

HOURS: Monday-Saturday 9-5 C.S.T.

It is not the intent of B.E.S.W. to defraud any pay television operator as we will not assist any company or individual in doing the same. Refer to sales personnel for specifications.

**BASIC
 ELECTRICAL
 SUPPLY &
 WAREHOUSING
 CORPORATION**

P.O. Box 8180 ■ Bartlett, IL 60103 ■ 800-577-8775

AUTOMATIC TELLER MACHINES

ATM crimes, abuses, vulnerabilities and defeats exposed! 100+ methods detailed, includes: Physical, Reg. E, cipher, PIN compromise, card counterfeiting, magnetic stripe, false front, TEM-PEST, tapping, spoofing, inside job, vibration, pulse, high voltage - others, con jobs. Histories, law, security checklist, internal photos, figures. *Much more!* \$39.

CELLPHONE MODIF. GUIDE

How cellphones operate and are modified. Vulnerabilities to hack attack and countermeasures. Details on programming NAMs, ESNs, etc (cloning), control data formats, computing encoded MINs, ESNs, SIDHs, operating systems, PROM programming, forcing ACK, test mode and resets, cable diagrams, scanning, tracking, scanner restorations, freq allocations, roaming, Step-by-steps to keypad-reprogram 100+ popular cellphones. *More!* \$49.

PAGER / BEEPER MANUAL

How Pagers work, different types and uses, freqs, advantages over and uses with cellphones, and tips and tricks. How Pagers are hacked/countermeasures. And plans for a **Personal Pocket Paging System** (xmitter and receiver). *More!* \$29.

PHREAKING CALLER ID & ANI

How they work and dozens of ways of defeating Caller ID, ANI, *69, *57, Call Blocking, *67 etc. Describes ESS, SS7, CN/A, CAMA, DNR, Diverters, Centrex - *more!* \$19.

SECRETS OF SOLDERLESS BREADBOARDS

100 MHz from SB designs? Major firm offers such boards! SBs are excellent for many final and permanent circuits, and for many RF, Hi-V and Hi-I circuits! And much safer to health and environment. Comprehensive. Dozens of tips! \$29.

HACKING THE INTERNET

The latest tricks and methods being used on the Net to pirate software (warez) and the newest hacking websites. *Updated every two months.* Includes examples, countermeasures, password defeats, UNIX, Sprintnet, brute force methods, lots of tips, *and more!* \$29.

COMPUTER PHREAKING

Describes in detail how computers penetrate each other, and how VIRUSES, TROJAN HORSES, WORMS are implemented. Dozens of computer crime and abuse methods and countermeasures. Includes disk filled with hacker text files and utilities, and the legendary FLUSHOT+ protection system. Internet advice, password defeats, glossary - *much more!* Manual + PC Disk! \$39.

MANY MORE TITLES!

- Hacking Fax Machines - \$29
- PBX Hacking - \$19
- Voice Mail Hacking - \$29
- Beyond Phone Color Boxes - \$29
- Hacking Answer. Machines - \$19
- The Hacker Files - \$39
- Internet Cons & Scams - \$19
- Internet Tracking & Tracing - \$29
- Hacking the Internet - \$25
- Cookie Terminator - \$19
- Beyond Van Eck Phreaking - \$29
- Casino Hacking - \$25
- Credit Card Scams - \$29
- Social Engineering - \$29
- Cons & Scams - \$29
- Polygraph Defeats - \$25
- By an Order of the Magnitude - \$49
- Ultimate Success Manual - \$19
- Stealth Technology - \$19
- Secret & Survival Radio - \$19
- Secret & Alternate IDs - \$15
- Rocket's Red Glare - \$29
- High Voltage Devices - \$29
- Mind Control - \$29
- Under Attack! - \$29
- Radionics Manual - \$29
- Heal Thyself - \$19



SPECIAL PROJECTS

We will design & build just about anything! Ask for our free **SP Application Form!** Hardware now done as **SPECIAL PROJECTS** only

THE DIRTY-2 DOZEN!

24+ Disks. See CATALOG!

STOPPING POWER METERS

As reported on "60 MINUTES"! All-new 6th Edition! Over 45 pages jam-packed with how devices can slow down (even stop) watt-hour meters - while loads draw full power! Device plugs into one outlet and normal loads into other outlets. Describes meter creep, overload droop, etc. Plans only! \$29.

THE I.G. MANUAL: External magnetic ways (applied to meter) to slow down and stop power meters while drawing full loads. Plans \$25.

KW-HR METERS: How watt-hour meters work, calibration, error modes (many), ANSI Standards, etc. Demand and Polyphase Meters. Experimental results to slow and stop meters by others. \$25.

All 3 (above). *Only \$59!* (Add \$20 for SPM Video)

MAIL \$3 FOR OUR LATEST CATALOG TO: (\$1 w/order)

CONSUMERTRONICS

2430 Juan Tabo, NE, #259, ABQ, NM 87112
P.O. Box 23097 ABQ, NM 87192

505-237-2073 (9-5, M-F) NOTE: Take \$2.00 OFF all New Orders over \$20 placed by Mail or Fax

Full online Catalog: www.tsc-global.com/consumer.html

Fax: 505-292-4078 (all hours, orders only) Web Adventure: www.tsc-global.com

Established in 1971. Featured on CBS "60 Minutes," Forbes, New York Times. Add \$5 total S/H (US, Canada). Sold for educational purposes only. Postal M.O. is fastest. VISA, MC OK. COD add \$7. See Catalog for LIMITED WARRANTY, SPECIAL PROJECTS and all other Policies

ORDER TODAY! \$29 SPM THE VIDEO!



Now its easier to learn about KW-HR Power Meters than ever before! This educational video shows you how they work and their anatomy. Demonstrates SPMEM device and external magnetic methods used to slow and stop meters! Hosted by a top expert in the field. From the novice to the pro, an excellent source of info on these exciting devices! Great in combo with our SPM related manuals! *Only \$49 for SPM video + SPM manual!!*

New and Pre-Owned Test Equipment

Goldstar

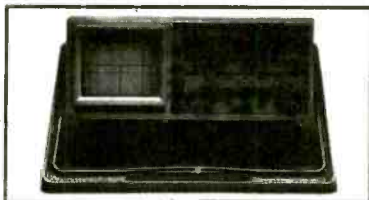

Model OS-9100P → **\$899.00**
Full 100 MHz Bandwidth!

- Dual-Channel, High Sensitivity
- TV Synchronization Trigger
- Calibrated Delayed Sweep
- Includes Two Probes, 2 Year Warranty

Spectrum Analyzer
B+K Precision
Model 2625

- 150kHz - 1050MHz
- 80dB Dynamic Range
- AM/FM demod Included

Only \$2,195.00!

Pre-Owned Oscilloscope Specials

Tektronix 2213	60 MHz	\$549.00
Tektronix 2215	60 MHz	\$649.00
Tektronix 465	100 MHz	\$599.00
Tektronix 465B	100 MHz	\$729.00
Tektronix 475	200 MHz	\$829.00
Tektronix 475A	250 MHz	\$1,199.00

- Professionally Refurbished
- Aligned & Calibrated to Original Specifications
- The Industry Standard of Oscilloscopes
- 1 Year Warranty - The Longest Available!!!

We Buy Surplus
Test Equipment

Leader CATV Signal Level Meter Model LF 941
✓ TV/CATV Coverage from 46 - 870 MHz
✓ Video/Audio Carrier Measurements **\$695.00!**

Just Released! → "Series III" Multimeters

Fluke Model 87III \$309.00 !!!

SIMMax
Module Tester
* Tests 72/30 pin SIMMs
* Stand alone/portable
* Identifies SIMM properties
* 10 built-in tests identify most memory defects
Only \$599.00!

See us on the Web!
www.fotronic.com

Test Equipment Depot

A FOTRONIC CORPORATION COMPANY
99 Washington St. Melrose, MA 02176
(781) 665-1400 • FAX (781) 665-0780

email: afoti@fotronic.com



1-800-996-3837
TOLL FREE 1-800-99-METER

Low Cost CAD Software Now In Windows™95

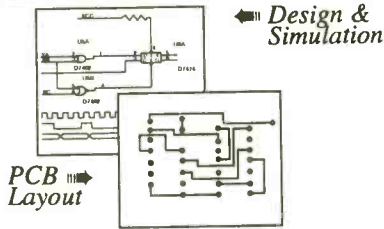

- Easy to use schematic entry program (**SuperCAD**) for circuit diagrams, only \$149. Includes netlisting, bill of materials, extensive parts libraries.
- Digital simulator (**SuperSIM**) allows you to check logic circuitry quickly before actually wiring it up. Works directly within SuperCAD and displays results in "logic analyzer" display window. Starting at \$149 this is the lowest cost simulator on the market. Library parts include TTL, and CMOS devices.
- Analog simulator (**mentalSPICE**) for \$199. Allows AC, DC and transient circuit analysis. Includes models of transistors, discreties, and op amps.
- Circuit board artwork editor and autorouter program (**SuperPCB**), starting at \$149. Produce high quality artwork directly on dot matrix or laser printers. You can do boards up to 16 layers including surface mount. Includes Gerber and Excellon file output. Autorouter accepts netlists and placement data directly from the SuperCAD schematic editor.
- **New!**--Complete electronic design package (**mentalMAX**) including schematic editor, analog and digital circuit simulation, and printed circuit board layout with autorouter for only \$549!

Write or call for free demo disks:
MENTAL AUTOMATION, INC.
5415 - 136th Place S.E.
Bellevue, WA 98006
(425) 641-2141
Internet: <http://www.mental.com>

FULL MOTION VIDEO AND MINIATURE TRANSMITTER...

THE WORLD'S
SMALLEST
VIDEO CAMERA
and TRANSMITTER

HIGH RES
BLACK AND WHITE
COLOR AND OTHER
MODULES AVAILABLE

EXTREME
CAMERA SYSTEMS

\$499
COMPLETE

IN THE PALM OF YOUR HAND

I stuck one on my R/C glider and it was like sitting in the cockpit as I watched from my portable TV.... J. Power, Avid R/C Hobbyist

"I can't believe the picture that this tiny camera delivers.....I simply attached a 9 volt battery to the camera and broadcast to my TV....I even threw a tape in my VCR and recorded the action....WOW!" S. Dewar...Go Kart enthusiast

"In my business, I get paid to know what's out there. This miniature camera and transmitter combo unit is simply UNBELIEVABLE! I haven't seen anything like it anywhere at any price. F. Rasmussen, Covert Camera Retailer

- FINE SIZE 1.0" X 0.5" X 0.75"
- LOW LIGHT SENSITIVITY 2 LUX
- RANGE 1/4 MILE TO 1 MILE
- 9V BATTERY RUNS CAMERA AND TRANSMITTER FOR FIVE HOURS
- ALL CAMERA FUNCTIONS AUTOMATIC
- 2.9 OZ (NOT INCLUDING BATTERY)
- AMAZING RESOLUTION 470 L.O.R.
- UHF, 900 MHZ OR 2.4 GHZ

\$499
COMPLETE

www.extremecam.com
1-800-891-4466
AFFORDABLE CAMERA SYSTEMS FOR THE REAL WORLD

LEADER

For Professionals Who
Know The Difference

- Oscilloscopes
- Video Sync/Test Generators
- Waveform Monitors/Vectorscopes
- EFP/ENG Instruments
- RF Signal Level Meters
- Audio Generators & Meters
- Frequency Counters
- Meters & Bridges
- Power Supplies
- Function Generators
- RF Generators

PRINT™
Products International

Test Instruments, Equipment, Tools & Supplies For Electronic Production, Maintenance & Service
8931 Brookville Road, Silver Spring, MD, 20910 * 800-638-2020 * Fax 800-545-0058

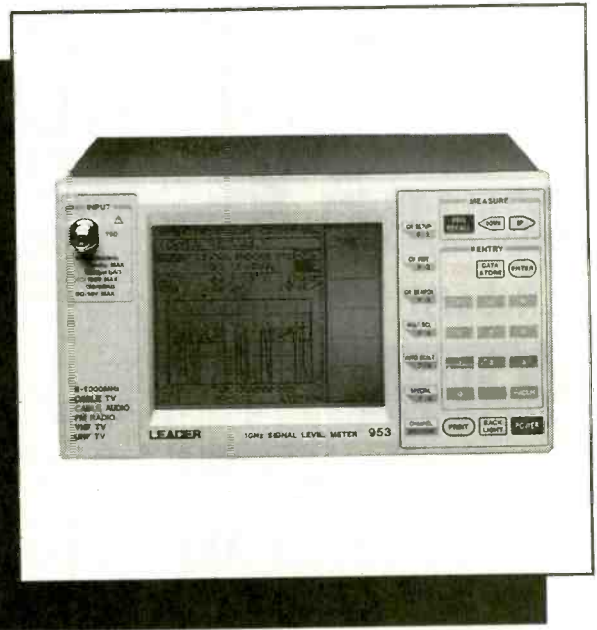

Call, fax or email for your free test and
measurement instrument catalog today!
800-638-2020 * Fax 800-545-0058
www.prodintl.com

CIRCLE 47 ON FREE INFORMATION CARD

MONDO • TRONICS

ROBOT STORE

* KITS *

Your

* BOOKS *

Mailorder

* PARTS *

Source

* VIDEOS *

For

* MODELS *

Robots!

* MORE! *

(REQUEST OUR FREE CATALOG)

www.robotstore.com

800-374-5764

Or write to us:

4286 Redwood Hwy #226-137
San Rafael CA 94903

Phone 415-491-4600 • Fax 415-491-4696

Email info@mondo.com

AUDIO-VIDEO-LASERS

VIDEO STABILIZER: Works with all videotapes. \$45.95 + \$6.00 S&H. Free brochure. 30 day moneyback. **STAR DEVELOPMENT**, Box 92457, Milwaukee, WI 53202. (414) 860-1471.

BUSINESS OPPORTUNITIES

EASY WORK! Excellent pay! Assemble Products At Home. Call Toll Free 1-800-467-5566 Ext. 5730.

\$400 WEEKLY ASSEMBLING electronic circuit boards/products from home. For free information send SASE: **Home Assembly-PE** Box 216 New Britain, CT., 06050-0216.

ADVANCED TECHNOLOGY Home Based Businesses. 250pg Comprehensive Guidebook, insider information, 24hr. recording/Fax Back (800) 326-4560 x 139.

Inventions/new products. ISC, America's leading invention firm, helps submit to companies. Patent Services. 1-800-288-IDEA.

CABLE TV

Cable TV Descramblers. One Piece Units. Pioneer, 6310's Scientific, Atlanta 8580's, DPV 7's and others. Lowest Prices. Money back guarantee. PRECISION ELECTRONICS, Houston, TX 1-888-691-4610.

CONFUSED?? DESCRAMBLERS. WILL EXPLAIN ALL YOUR OPTIONS, ALL MAKES AND MODELS AVL. DEALERS ARE WELCOME. OPEN 6 DAYS 9AM TILL 7PM EST, TOLL FREE # (888) 238-0967 ROYAL ENGINEERING INC. UNIVERSAL BOX IX HERE NOW.

CABLE TV SECRETS www.cabletvsecrets.com or \$9.95-Box 527 Pataskala, OH. 43062.

Cable TV Signal Eliminator - Powerful, user tunable filter for removing severe interference OR unwanted channels! Eight models, for channels (2-3)(4-6)(7-13) (14-17)(18-22)(23-29)(30-36)(95-99). Each \$30.00, add \$4.00 for S/H. Quantity discounts. Money back guarantee. Visa, Mastercard or check. COD \$5.00 extra. Website http://starcircuits.com/tvfilter. **Star Circuits**, PO Box 94917, Las Vegas, NV 89193. 1-800-433-6319.

CABLE DESCRAMBLERS AND CONVERTERS. SHOP NO MORE. BEST PRICES AND TECH SUPPORT. EXTREME ELECTRONICS. 1-888-609-4910.

CABLE TV EQUIPMENT & ACCESSORIES. Wholesalers Welcome! 30 Day Moneyback Guarantee! Free Catalog! PROFORMANCE ELECTRONICS, INC. 1-800-915-1512.

CABLE TV major brands including Zenith St. 1600 \$199.00, new Zenith add-on \$99.00, Jerrold model CFT 2014 \$249.00. One year exchange guarantee, accepted Visa, M/C, Am-ex, Discover. Call 1-800-822-8530.

CABLE DESCRAMBLERS AND CONVERTERS 10 lot Decoders \$38.00 each. 10 lot Converters \$57.00 each. Visa and Mastercard Accepted. (304) 337-8027.

CB-SCANNERS

CB Radio Modifications! Frequencies, kits, high-performance accessories, books, plans, repairs, amps, 10-Meter conversions. The best since 1976! Catalog \$3.00. **CBCI**, Box 31500PE, Phoenix, AZ 85046.

Scanner frequencies, complete guide. Send SASE and \$5.00 to Guide 3625A Norwood Rd., Huntington, W.V. 25705.

SATELLITE EQUIPMENT

FREE CATALOG-Satellite TV/GPS-DIY Technical Books, Installation Videos, Computer Analysis Software www.baylin.com 800-843-2425.

SKYVISION! Your Satellite Home Entertainment Source. **Best Values:** DBS and C/Ku-band equipment, including 4DTV. Most complete selection: Parts-Tools-Upgrades-Accessories! Free Discount Buyer's Guide. Call 800-543-3025. International 218-739-5231. www.skyvision.com.

DSS TEST CARD authorizes all channels, for information call toll free 1-888-416-7296. Plus free bonus.

COMPUTER SOFTWARE

FREE!! IBM Shareware and CD-ROM Disk Catalog. MOM 'N' POP'S SOFTWARE, POB 15003-E, Springhill, FL 34609. 1-352-688-9108, momnpop@gate.net.

EDUCATION

BE A COMPUTER PROGRAMMER. Train at home for an exciting new career with ICS-Accredited Member of the Distance Education and Training Council. Call today for free information with absolutely no obligation: 1-800-595-5505, ext. 2349.

PLANS-KITS-SCHEMATICS

"HEATH COMPANY is selling photocopies of most Heathkit manuals. Only authorized source for copyright manuals. Phone: 616-925-5899, 8-4 ET."

ELECTRONIC PROJECT KITS: 49 McMichael St., Kingston, ON., K7M 1M8. \$3.00 catalog. www.qkits.com. **QUALITY KITS**

MONITORS MADE SIMPLE. Learn to repair computer monitors! Case studies, illustrations, parts sources, manufacturers included! 136 pages soft-cover, \$19.95 + \$2.50 shipping. Order today! Send check or money order to **Pikes Peak Press**, 321 W. Henrietta Ave., PO Box 1801, Woodland Park, CO 80866. (719) 687-1499.

Eavesdropping Equipment, 117 schematics and text. Free explanation sheet. \$65.00 + S&H \$6.00. Also kit schematics. **Sheffield Electronics**, PO Box 377940, Chicago, IL 60637-7940. (773) 324-2196. http://www.adnetmk.com/sheffield.

FASCINATING electronics! Hi-tech gadgets, detectors, descrambler, jammers, 3-D stereo, high voltage, robotics, countermeasures, more! Catalog \$2.00. **QUANTUM RESEARCH**, 17919-77 Avenue, Edmonton, Alberta T5T 2S1.

CATALOG: Broadcasting/micro transmitters, amplifiers, antennas. Start your own radio station books. Audio, TV, Ham, CB, Surveillance, Science projects and more. **www.panaxis.com PAN-COM INT'L**, PO Box 130-8, Paradise, CA 95967.

SECRET ELECTRONIC GARAGE DOOR OPENER USES MAGNET send SASE to MAI-E 41 East Campus Court Racine, WI 53402.

AWESOME KITS: Voice Changers, Levitators, Lasers, Gas Sensors and more! Catalog \$1.00. **LNS Technologies**, PO Box 67243, Scotts Valley, CA 95067 www.cnet.com/~lnstech.

VIDEO DESCRAMBLERS

BUY WHERE THE DEALERS BUY. GUARANTEED LOWEST PRICE. STARTING AT \$39.99. DESCRAMBLERS FOR ALL SYSTEMS, MAKES AND MODELS. DEALERS WELCOMED, QUANTITY DISCOUNTS. CALL NOW 1-800-586-9920.

SECURITY

EMPLOYEE/NANNY SURVEILLANCE Clock radio with wireless audio/video camera. Watch employees, nannies or ? Other products available. **LOWEST PRICES!** (800) 813-0007 **SURVEILLANCE SPECIALISTS**

SECURITY Systems and Surveillance Camera Equipment. Do it yourself and save. Camera's, monitors, VCR's, motion and glassbreak detector's, control panel's, siren's more. www.a1security.com.

ALTERNATIVE ENERGY

FANTASTIC self running motors, generators & Anti-gravity. Free information. Energy Research, Box 1514 Jackson, CA 95642

GOVERNMENT FORECLOSED

GOV'T FORECLOSED homes from pennies on \$1.00. Delinquent Tax, Repo's. REO's. Your Area. Toll Free (1) 800-218-9000 Ext. H-14087 for current listings.

• **68HC11 Micro-Controllers •**

MRC1164GP (kit/asm)* - Controller w/ 64k \$77.95/\$97.95
 MSCC11GP (kit/asm)* - Controller \$27.95/\$37.95
 *Uses any 68HC11 Chip (sold separately)

• **68HC11 Expansion Boards •**

ME11GP (kit/asm) - 32k & I/O expansion board for the EVBU \$46.95/\$68.95
 MRSXGP (kit/asm)- Sensor & I/O expansion board for MRC1164GP \$59.95/\$88.95

• **Programmable Autonomous Mobile Robot Kits •**

ROBOBUGGP (kit/asm)* - serious six-legged robot \$547.95/\$788.95
 TAL2 (kit/asm)* - R&D robot vehicle \$495.95/\$798.95
 TALJR (kit/asm)* - expert robot vehicle \$135.95/\$215.95

• **Communications Boards •**

*First-time buyers of Mekatronix™ brand products need the Com-Kit \$19.95 OR the Com-Pack \$27.95.
 The card plugs into the back of your PC's serial port/cable.
 You can then Program your robot or micro-controller in sBASIC, HC11 Assembly, C (ICC11), POGO, Forth or I.C.

• **Servos •**

MS455RGP -42 oz-in dual ball bearing servo \$13.95
 MS455HGP -Servo modified/continuous rotation \$19.95

• **Software •**

HSDL11GP - MC68HC11 115.2 Kbps downloader \$8.95/ W95
 ICC11GP -v4.5 HC11 C-Compiler \$71.50 Dos /\$125.50 Win
 TGPPD01 -Program disk w/ collision avoid. progrm \$8.95
 TGPPD01 -Program disk w/ line following progrm \$19.95
 TGPPSD -Example robot programs & source code \$18.95
 TJAIPDGP -TJ Artificial Intell. program \$18.95
 REMRPDGP -IR reading software for select IR TV remotes \$28.95
 EDUPD01GP -Software & Tutorial for Middle & High Schoolers \$28.95

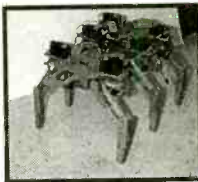

• **Sensors/Emitters •**

GP1UYRGP32/40 \$6.89/ \$3.49
 32khz/40khz Infrared Digital Sensors
 GP1UYHGP32/40 \$9.89/5.89
 32khz/40khz Infrared Analog Sensors
 MIR27ERGP \$1.39
 Corresponding IR emitters

• **MORE •**

CCAMPALGP -Wireless color mini-camera spy \$298.95
 BC12A500 -A/C adapter/robot battery charger \$9.55
 AANCGP -6 AA Rechargeable NiCad batteries \$14.55
 IRREMPG - Remote control module for Talrik Jr. \$22.95

Orders: Toll Free: 1-888-MR-ROBOT
 E-mail: novasoft11@aol.com

Web Catalogs:
<http://www.mekatronix.com/>
<http://members.aol.com/novasoft11>

For Technical Questions & other inquiries:
novasoft11@aol.com or 804-272-5752

© 1998 NovaSoft™, Inc.

FREE CASH GRANTS!

FREE CASH GRANTS! College. Scholarships. Business. Medical bills. Never Repay. Toll Free 1-800-218-9000 Ext. G-14087.

SEIZED CARS

SEIZED CARS from \$175.00. Porsches, Cadillacs, Chevys, BMW's, Corvettes. Also Jeeps, 4WD's. Your Area. Toll Free 1-800-218-9000 Ext. A-14087 for current listings.

BEST BY MAIL

Rates: Write National, Box 5, Sarasota, FL 34230

MONEYMAKING OPPORTUNITIES

AMAZING INCOME OPPORTUNITY - Thousands Weekly. No experience necessary 1-800-781-3631 ext. 1.

SELL 21 ROYALTY FREE Software. Earn \$50 an hour 24 hours a day. Make money while you sleep. 888-526-7856 Ext. 4379. <http://teleepages.com/carmenpr>

HOMEWORKERS FORTUNE 5000, Weekly pay. No Selling. 800-811-2141 Code 51234.

OF INTEREST TO MEN

CASH NOW FOR FUTURE PAYMENTS! We buy payments from Insurance Settlements, Annuities, and Class Action Awards. We also buy Owner Financed Mortgage Notes. Call R&P Capital at 1-800-338-5815. Ext. PE500.

EXCITING NEW COLLECTIBLE. Obsolete stock certificates, bonds, 10 samples, catalog \$10.00. Satisfaction guaranteed. Clinton Hollins, Box 112, Dept. PE, Springfield, VA 22150-0112.

GOOD WORKS GOD'S GLORY (Matt. 5:16) Jesus Saves (Rom. 10:9).

OLD TIME RADIO

LONG AGO RADIO. Over 7000 old radio programs available on cassette/CD's. For free sample catalog: 1-877-Long-Ago. www.longagoradio.com

\$139* Laser LightShow

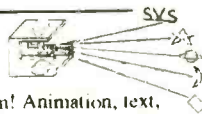

Draw with a laser beam! Animation, text, music & more! Includes galvos, mirrors, servo amp, demo software disk, analog and digital computer interface. Use an inexpensive pen pointer or high power gas laser.

Computerized Motors \$39*

Includes: 2 Stepper motors, 2 DC motors, computer interface, training manual, & demo software disk. Expandable! Up to 12 motors, up to 3 amps per phase.

Now with 4 Axis Linear Interpolation

* Add \$6 for shipping. Computer with parallel printer port & cable, assembly, power supply, & laser are required

FREE FLYER

Voice 510-582-6602 Fax 510-582-6603



1273 Industrial Pky West Bldg. 460
 PO Box 55125 Hayward CA 94545-0125

LEARN ELECTRONICS!



Home study. Make excellent money. Repair and install camcorders, TVs, VCRs, stereos, sound and lighting, alarm systems, and more!

FREE LITERATURE: 800-223-4542

Name _____ Age _____

Address _____ Phone (____) _____

City/State _____ Zip _____

School of Electronics, Dept. ELJ341 PCDI, 6085 Reswell Rd., Atlanta, GA 30328

BEST DEALER PRICING!

CABLE DIRECT
 CONVERTERS • FILTERS
 DESCRAMBLERS

IMPROVE YOUR IMAGE WITH
VIDEO STABILIZERS

FREE CABLE TV CATALOG!

100% MONEY BACK GUARANTEE!



Now you can tune-in your favorite cable TV programming and **SAVE \$100'S** - **EVEN \$1000'S** on premium **CABLE TV EQUIPMENT.**



MODERN ELECTRONICS
1-800-906-6664

2609 S. 156TH CIRCLE • OMAHA, NE 68130
<http://www.modernelectronics.com>

August 1998, Popular Electronics

ADVERTISING INDEX

Popular Electronics does not assume any responsibility for errors that may appear in the index below.

Free Information Number	Page	Free Information Number	Page
— AES	72	157 MCM Electronics	77
27 Alfa Electronics	85	— Mega Electronics	86
28 All Electronics	83	150 Mendelson's	88
— Allison Technology	87	151 Mendelson's	74
— Andromeda Research	68	— Mental Automation	91
— Arrow Electronics	82	16 MicroCode Engineering	CV4
— Associated Electrical & Eng.	84	— Minicam International Ltd.	91
— Basic Electrical Supply	89	— Mo-Tech	88
130 C&S Sales, Inc.	70	— Modern Electronics	74, 93
— Cable USA	74	— Mondo-tronics	92
13 Cadsoft	13	152 Mouser	82
— Channel Island Circuits	74	— NovaSoft	7, 93
— Circuit Specialists	78	— NRI Schools	11
— Cleveland Inst. of Electronics	21	— Parallax	CV3
— Command Productions	68	156 Parts Express	75
— Comtrad Industries	5, 61	— Pioneer Hill Software	88
— Consumertronics	90	48 Prairie Digital Inc.	68
153 Dalbani	69	— Price Wheeler	84
— Eagan Technical Services	86	46 Print	72
— EDASHOP	82	47 Print	91
— EDE Spy Outlet	86	— Pro Planet	74
— EMAC	72	14 Radio Shack	3
— Foley-Belsaw	81	— Schematica Software	80
— Fotronic Corporation	90	— Silicon Valley Surplus	93
— Franks Electronics	80	— Skyvision Inc.	80
— General Device Instruments	74	155 Sun Equipment	76
— Grantham College of Eng.	4	— Tab Books	29
— Greenleaf Electronics Inc.	73	— Technological Arts	80
— Home Automation Systems	67	— Tek View	82
— Information Unlimited	89	142 Telulex	87
— Innovation West	80	— TUTOR-TECH	82
26 Interactive Image Technologies	CV2	136 UCANDO Videos	87
— Intronics, Inc.	86	— Video Media	80
— James Electronic Services	86	— Vision Electronics	80
— KDE Electronics	73	— Visual Communications	88
— Leo Tomanek	74	— Weeder Technologies	67
— Link Instruments	73	172 Windjammer Barefoot Cruises	4
— Lynxmotion	67		

ADVERTISING SALES OFFICES

Gernsback Publications, Inc.
 500 Bi-County Blvd.
 Farmingdale, NY 11735-3931
 1-(516) 293-3000
 Fax 1-(516) 293-3115

Larry Steckler, EHF/CET
 President (ext. 201)
 e-mail advertising@gernsback

Adria Coren
 Vice-President (ext. 208)

Ken Coren
 Vice-President (ext. 267)

Christina Estrada
 Assistant to the President (ext. 209)

For Advertising ONLY
 1-516-293-3000
 Fax 1-516-293-3115

Larry Steckler
 publisher

Arlne Fishman
 advertising director (ext. 206)

Marie Falcon
 advertising assistant (ext. 211)

Adria Coren
 credit manager (ext. 208)

**Subscription/
 Customer Service/
 Order Entry**
 1-800-827-0383
 7:30 AM - 8:30 PM EST

ADVERTISING SALES OFFICES EAST/SOUTHEAST

Stanley Levitan
 Eastern Sales
 1 Overlook Ave.
 Great Neck, NY 11021-3750
 1-516-487-9357, 1-516-293-3000
 Fax 1-516-487-8402
 slevitan26@aol.com

**MIDWEST/Texas/Arkansas/
 Oklahoma, Colorado, Arizona**

Ralph Bergen
 Midwest Sales
 One Northfield Plaza, Suite 300
 Northfield, IL 60093-1214
 1-847-559-0555
 Fax 1-847-559-0562
 bergenrj@aol.com

PACIFIC COAST/Mountain States

Anita Bartman
 Hutch Looney & Assoc., Inc.
 6310 San Vicente Blvd.
 Suite 360
 Los Angeles, CA 90048-5426
 1-213-931-3444 (ext. 227)
 Fax 1-213-931-7309
 anita@hlooney.com

Build a Weather Station with

PARALLAX and BASIC Stamp Computers

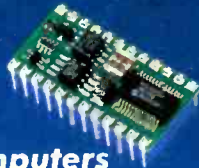

Orders and Tech Support:

Parallax Inc

3805 Atherton Road #102
Rocklin, CA 95765
916.624.8333
fax 916.624.8003
toll free 888.512.1024
<http://www.parallaxinc.com>

BASIC Stamp Computers

BASIC Stamps are a little solution for a big project. BASIC Stamps consist of a microcontroller, EEPROM, resonator and a few other components mounted on a small module the size of a postage stamp. The simple Parallax BASIC programming language commands include HIGH, LOW, INPUT, OUTPUT, IF, THEN, FOR, NEXT, TOGGLE, GOSUB, and GOTO. Check <http://www.parallaxinc.com> for a complete code listing and sample source code.

Build a Weather Station with your BASIC Stamp II

The following two code fragments show you how to measure wind speed and wind direction. Most anemometers produce a pulse with each rotation, and can be connected directly to a BASIC Stamp I/O pin. With 5 VDC applied to the wind vane, the 12-bit LTC 1298 A/D converter (Parallax #2791E - \$26) returns a 0 to 5 VDC value that corresponds to a wind direction. Schematics and source code are available at <http://www.parallaxinc.com/stamps/anemometer.htm>

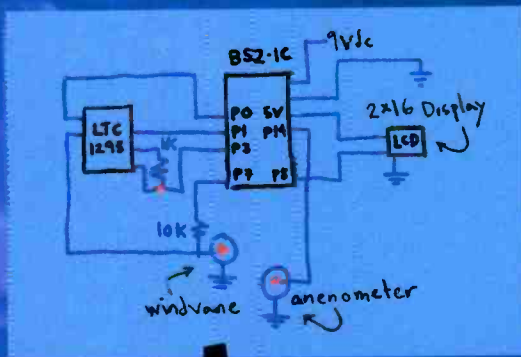

Get_Direction:

```
low CS          ' Select A/D
shiftout DAT,CLK,lsbfirs,[cfg4] ' Send configuration
shiftin  DAT,CLK,msbpost,[AD\12] ' Receive data
high CS        ' Deselect A/D
```

return

Get_Speed:

```
high AN_PWR    ' Turn on I/O pin
count AN,2000,pulses ' Count pulses for 2000 ms
mph=pulses*/458/seconds ' Calculate wind speed
low AN_PWR    ' Turn off I/O pin
```

return

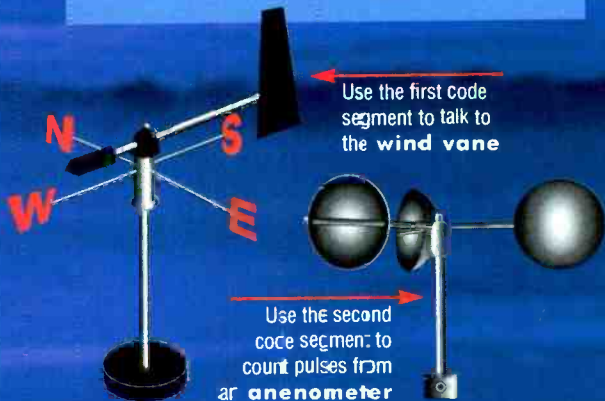

BS2 Carrier Board (#27120) \$20



BS2 Starter Kit Contents



BS2-IC Module

BASIC Stamp II Starter Kit (#27203) \$149

The BASIC Stamp II Starter Kit includes the BS2-IC module, carrier board, manual and application notes, software and serial cable. Free telephone and e-mail technical support is included with the purchase of every product.

BS2-IC Module (#BS2-IC) \$49

BS2-IC module has 16 I/O lines, 2048 bytes EEPROM (program and data), 500 instr. max program length, and 50k baud serial I/O. Command set includes LOOKUP, LOOKDOWN, READ, WRITE, plus those identified above.

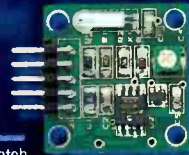

2-line x 16 character Serial LCD Display (#27910) \$54



LCD showing weather measurements. Use the BASIC Stamp's SEROUT instruction (requires one I/O line, ground and power) to communicate with the Serial LCD display.

Solutions Cubed Pocket Watch

Would you like to time-stamp your weather data? Try adding this real-time clock manufactured by Solutions Cubed. The Pocket Watch B uses a simple serial interface to communicate with the BASIC Stamp. Small size (less than 1.2" wide, 5-pin SIP package) could plug right into a BASIC Stamp carrier board.

Pocket Watch B (#27962) \$27



Call and request our new product catalog!

- Australia +61 2 6772 2777, +61 39 338 3306 • Austria +49 5232 8171 • Belgium +32 4 377 5151 • Bulgaria +359 2 72 77 50 • Brazil +55 11 453 5588, +55 11 801 0045 • Canada (514) 336-9426, +403 730 8603 • Czech Republic +42 49 5813 252 • Finland +358 31 266 1885 • France +33 328 550 328 • Germany +49 5232 8171 • Greece +30 1 902 0115 • Hungary +36 1270 7680 • India +91 422 232 561 • Ireland +44 1 977 683 665, +35 31 821 5060 • Israel +972 3 498 543 • Italy +39 0542 55400 • Japan +81 3 3251 1779 • Netherlands +31 10 450 4949 • New Zealand +54 947 82323 • Poland +48 34 648 882 • Slovak Republic +42 7 580 2574 • South Africa +27 11 493 6242 • Sweden +46 431 41 00 88 • Switzerland +011 41 32 631 11 54 • Taiwan +886 2 647 1978 • Thailand ++66 2 739 1181 • United Kingdom +44 1 977 683 665 • United States 818 882-7621, 800 344-4539 (Digi-Key), 800 831-4242 (Jameco), 800 538-5003 (JDR), 800 652-6733 (Marlin P. Jones), 415 491-4600 (Mondo-Tronics), 800 843-7422 (Radio Shack Unlimited), 303 512-2060 (TechAmer.ca)

CIRCLE 30 ON FREE INFORMATION CARD

High-end features. Low-end price.



\$299

CircuitMaker 6:
Schematic design
and simulation
software

\$299

TraxMaker 3:
Printed circuit
board layout
software

CircuitMaker Version 6 and TraxMaker Version 3 give you the features of professional, high-end software at a fraction of the cost. Plus, with exceptional ease-of-use you'll spend less time learning to use the software and more time designing. Both applications are compatible with your existing software, and feature outstanding technical support. Call now for your free functional demo.

CircuitMaker 6 is a powerful schematic design and simulation program featuring:

- Professional schematic features including printout borders, title block and barred pin names
- Symbol editor and Macro feature for custom devices
- Fast, accurate SPICE3f5/XSPICE-based simulation
- Complete array of analysis types, including Fourier, AC, DC, Parameter sweep, Transient and more
- Virtual instruments including a digital oscilloscope, multimeter, Bode plotter, curve tracer and more
- Extensive library of over 4,000 models
- Tight integration with TraxMaker® for quick PCB layout
- Output PCB netlists in Protel®, Tango® and TraxMaker® formats for use in a variety of PCB layout programs
- Windows 3.1, 95 and NT

TraxMaker 3 is a powerful printed circuit board layout program featuring:

- Over 2,000 component footprints in a fully-documented, indexed library. Documentation shows footprints actual size
- Built-in autorouter and Design Rules Check
- Supports up to 6 signal layers plus power and ground planes, silk screen overlays and solder and paste masks
- Board sizes up to 32" x 32", with no pin limitations
- Intelligent manual routing with unrout capabilities
- Import any PCB netlist in CircuitMaker®, Protel® or Tango® format
- Output RS274X Gerber files, Excellon N/C drill files and Bill of Materials
- Print to any Windows-compatible printer or plotter
- Windows 3.1, 95 and NT

MICRO CODE ENGINEERING INC For free demo software, or to order, call **1-800-419-4242**
927 West Center Street • Orem, UT 84057 • Phone (801) 226-4470 • Fax (801) 226-6532 • www.microcode.com