

THE SHOCKING FACTS ABOUT SURGE SUPPRESSORS

Popular Electronics[®]

FEBRUARY 1992

THE NEXT WAVE IN HOME ENTERTAINMENT?

Will the new generation of CD-based, interactive multimedia products revolutionize the way we work and play, or are CDTV, CD-I, MPC's, the Data Discman, and others just the next wave in hype?

ELECTRONICALLY TUNE PIANOS AND OTHER INSTRUMENTS

Build a precision audio generator and use it to tune pianos, organs, and more to within .01 Hz

TROUBLESHOOTING PARALLEL CONNECTIONS

Learn how to properly and safely connect parallel peripherals to any computer

BUILD THE POWER BLOCK

An inexpensive solution to your power-line protection needs

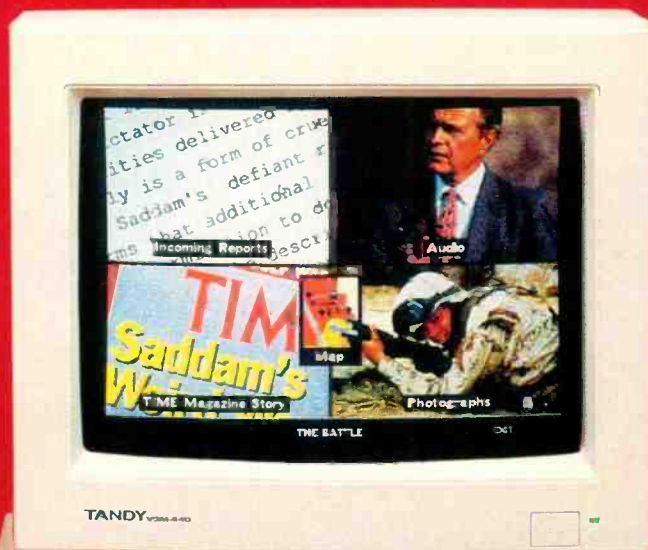

\$2.95 U.S.
\$3.75 CANADA

A
GERNSBACK
PUBLICATION

3 NEW
FactCards
IN THIS ISSUE

#BXBDCCH***** 5-DIGIT 60506
#S1506DH1997GADD6# FEB92 13
ROBERT DAHM RESP
997 GRAND AVE 075
AURORA, IL 60506

We Only Skimped On The Price.

Introducing The Fluke Series 10—From \$69.⁹⁵

Actual size: Easy to carry, easy to use.

Fluke quality: Made in the USA by Fluke, with the same rugged reliability that's made us the world leader in digital multimeters. Count on hard-working high performance—and a two-year warranty to back it up.

Large, easy-to-read display: 4000 count digital readout.

New! Min/Max record with relative time stamp and Continuity Capture™: Makes intermittent problems easier to find. Records highs and lows—and "time stamps" when they occurred. In continuity mode, opens or shorts as brief as 250 μs are captured and displayed.

New! V Chek™: For fast accurate checks on power sources and supplies, set your meter on V Chek—and let it do the rest. V Chek will determine continuity/ohms; if voltage is present, it will automatically change modes to measure AC or DC volts, whichever is detected. For most initial troubleshooting checks, here's the only setting you need to make.

Capacitance: Autoranging from .001 μF to 9999 μF. No need to carry a dedicated capacitance meter.

Autoranging with manual option: Your choice, depending on your situation.

Sleep Mode: Shuts itself off if you forget, extending long battery life even further.

New! Slide switch and a few pushbuttons control all functions: Designed for true one-hand operation.

Fast, accurate tests and measurements: AC and DC voltage measurements to 600 volts, ohms to 40 MΩ; audible continuity test; and diode test.

Safety—a Fluke standard: Designed to meet UL1244, IEC 1010, CSA and VDE safety requirements; extensive overload protection built in.

Audible Continuity: To perform fast continuity checks, just listen for the beep; no need to watch the display.

New! TL75 Hard Point™ Test Leads: Comfort grip with extra strong tips for extended service life.

For high performance at Fluke's lowest price, get your hands on the new Series 10. Stop by your local Fluke distributor and feel what a powerful difference the right multimeter makes—at the right price. For a free product brochure or the name of your nearest distributor, call 1-800-87-FLUKE.

Fluke 10	Fluke 11	Fluke 12
\$69.95*	\$79.95*	\$89.95*
4000 count digital display	V Chek™	V Chek™
1.5% basic dc volts accuracy	Capacitance, .001 to 9999 μF	Min/Max recording with relative time stamp
2.9% basic ac volts accuracy	4000 count digital display	Continuity Capture™
1.5% basic ohms accuracy	0.9% basic dc volts accuracy	Capacitance, .001 to 9999 μF
Fast continuity beeper	1.9% basic ac volts accuracy	4000 count digital display
Diode Test	0.9% basic ohms accuracy	0.9% basic dc volts accuracy
Sleep Mode	Fast continuity beeper	1.9% basic ac volts accuracy
Two-year warranty	Diode Test	0.9% basic ohms accuracy
	Sleep Mode	Fast continuity beeper
	Two-year warranty	Diode Test
		Sleep Mode
		Two-year warranty

* Suggested U.S. list price.

Optional holster with tilt-stand available.



The New Series 10.
A Small Price For A Fluke.

FLUKE AND PHILIPS
THE T & M ALLIANCE

©1991 John Fluke Mfg. Co., Inc. Prices and specifications subject to change. Ad no. 00130.

FLUKE®

CIRCLE 16 ON FREE INFORMATION CARD

www.americanradiohistory.com

Popular Electronics®

THE MAGAZINE FOR THE ELECTRONICS ACTIVIST!

CONSTRUCTION ARTICLES

HOW TO ELECTRONICALLY TUNE PIANOS AND OTHER INSTRUMENTS	Steven A. Brown	29
<i>Build a precision audio generator and use it to tune pianos and more to an accuracy of .01 Hz</i>		
PROTECT YOUR EQUIPMENT WITH THE POWER BLOCK	John Yacono	37
<i>Safeguard your expensive electronics gear with this low-cost, multi-outlet surge suppressor</i>		
3 x 3 VISUAL CONTINUITY TESTER	Richard Hampton	53
<i>More than a simple continuous signal-path indicator, this circuit gives a relative resistance reading as well</i>		

FEATURE ARTICLES

THE SHOCKING FACTS ABOUT SURGE SUPPRESSORS	Robert Angus	35
<i>Learn the truth about what surge suppressors can, and cannot, do.</i>		
TROUBLESHOOTING PARALLEL CONNECTIONS	John Yacono	41
<i>Learn how to safely and properly interconnect parallel devices, even if you don't have the equipment manuals</i>		
A PA-SYSTEM PRIMER	Sam Allen	55
<i>Explore the differences between PA systems and home audio equipment</i>		
ALL ABOUT PROPER INPUT TERMINATION	Charles Hansen	58
<i>Leaving the inputs of unused gates unconnected can lead to hard-to-diagnose malfunctions</i>		

PRODUCT REVIEWS

GIZMO		5
<i>Including: Commodore CDTV Player, Philips CD-I Player, Sony Data Discman, Tandy Multimedia PC, and more!</i>		
PRODUCT TEST REPORT	Len Feldman	22
<i>Canon E40 8mm Camcorder</i>		
HANDS-ON REPORT		61
<i>Protel Schematic circuit-design software</i>		

COLUMNS

ANTIQUE RADIO	Marc Ellis	63
<i>With the collectors-contest results</i>		
CIRCUIT CIRCUS	Charles D. Rakes	65
<i>More alarm circuits</i>		
THINK TANK	John Yacono	68
<i>More fun with op-amps</i>		
COMPUTER BITS	Jeff Holtzman	72
<i>Norton Desktop for windows</i>		
DX LISTENING	Don Jensen	74
<i>Air traffic on SW</i>		
HAM RADIO	Joseph J. Carr	76
<i>What's a balun transformer?</i>		
SCANNER SCENE	Marc Saxon	78
<i>A look at the mail bag</i>		

DEPARTMENTS

EDITORIAL	Carl Laron	2
LETTERS		3
FACTCARDS		49
POPULAR ELECTRONICS MARKET CENTER		50A
FREE INFORMATION CARD		51
ELECTRONICS LIBRARY		80
NEW PRODUCTS		86
ELECTRONICS MARKET PLACE		95
ADVERTISER'S INDEX		98

Popular Electronics (ISSN 1042-170X) Published monthly by Gernsback Publications, Inc., 500-B Bi-County Boulevard, Farmingdale, NY 11735. Second-Class postage paid at Farmingdale, NY and at additional mailing offices. One-year, twelve issues, subscription rate U.S. and possessions \$21.95, Canada \$26.84 (includes G.S.T. Canadian Goods and Services Tax Registration No. R125166290), all other countries \$29.45. Subscription orders payable in U.S. funds only. International Postal Money Order or check drawn on a U.S. bank. U.S. single copy price \$2.95. © 1992 by Gernsback Publications, Inc. All rights reserved. Hands-on Electronics and Gizmo trademarks are registered in U.S. and Canada by Gernsback Publications, Inc. Popular Electronics trademark is registered in U.S. and Canada by Electronic Technology Today, Inc. and is licensed to Gernsback Publications, Inc. Printed in U.S.A.

Postmaster: Please send address changes to Popular Electronics, Subscription Dept., P.O. Box 338, Mount Morris, IL 61054-9932.

A stamped self-addressed envelope must accompany all submitted manuscripts and/or artwork or photographs if their return is desired should they be rejected. We disclaim any responsibility for the loss or damage of manuscripts and/or artwork or photographs while in our possession or otherwise.

As a service to readers, Popular Electronics publishes available plans or information relating to newsworthy products, techniques, and scientific and technological developments. Because of possible variances in the quality and condition of materials and workmanship used by readers, Popular Electronics disclaims any responsibility for the safe and proper functioning of reader-built projects based upon or from plans or information published in this magazine.

Larry Steckler

*EHF, CET
Editor-In-Chief and Publisher*

EDITORIAL DEPARTMENT

Carl Laron

Editor

Robert A. Young

Associate Editor

John J. Yacono

Associate Editor

Byron G. Wels, K2AVB

Associate Editor

Teri Scaduto

Assistant Editor

Kathy Terenzi

Editorial Assistant

Marc Spiwak

Editorial Associate

Joseph J. Carr, K4IPV

Marc Ellis

Len Feldman

Jeffrey K. Holtzman

Don Jensen

Charles D. Rakes

Marc Saxon

Contributing Editors

PRODUCTION DEPARTMENT

Ruby M. Yee

Production Director

Karen S. Brown

Production Manager

Marcella Amoroso

Production Assistant

Janice Box

Editorial Production

ART DEPARTMENT

Andre Duzant

Art Director

Injae Lee

Illustrator

Russell C. Truelson

Illustrator

Jacqueline P. Cheeseboro

Circulation Director

Michele Torrillo

P-E Bookstore

BUSINESS AND EDITORIAL OFFICES

Gernsback Publications, Inc.
500-B Bi-County Blvd.
Farmingdale, NY 11735
1-516-293-3000

Fax: 1-516-293-3115

President: **Larry Steckler**

Customer Service/Order Entry

1-800-435-0715

7:30 AM - 8:30 PM EST

Advertising Sales offices listed on page 98

Cover photography by Diversified Photo Services

Composition by
Mates Graphics

 The
Audit
Bureau
of Circulation



The publisher has no knowledge of any proprietary rights which will be violated by the making or using of any items disclosed in this issue.

MULTIMEDIA MADNESS

There's a new buzzword in consumer electronics. The word is "multimedia," and it represents a product category that the consumer-electronics industry fervently hopes will bring it out of its present doldrums.

What is multimedia? Not a new technology, *per se*, it combines the power of microprocessors with the audio-, video-, and data-storage capabilities of compact discs to provide instant access to text, graphics, animation, music, sound, photographs, and eventually, full-motion video.

It is also not really a new product. Multimedia-capable computers have been around for several years. However, recently adopted computer standards and the introduction of three (mutually incompatible) consumer products aimed specifically at the non-computer user, could make multimedia a mass-market product.

The potential of multimedia is enormous. It could provide customized instruction on virtually any topic, and could teach in ways that books and even live instruction would be hard-pressed to duplicate. It could place libraries of pertinent facts at the fingertips of researchers, and provide customized research facilities that could make getting and using those facts easier than ever before. And it can entertain; one of the first applications for these machines is videogames—and live-action tour guides, store catalogs, and more could soon be with us.

The key word in all of this is potential. The first wave of multimedia hardware is impressive; the first wave of multimedia software is less so. Limited to games, basic encyclopedias, and the like, the software is entertaining and informative, but far from compelling.

Still, the promise of multimedia is exciting. So exciting, in fact, that this month, **Gizmo** departs from its usual format to bring you exclusive coverage of the multimedia phenomenon, including in-depth reviews on the first three consumer-oriented multimedia products; **Gizmo** also looks at two multimedia products for computer users. Read the reviews, then make a point of seeing these products in action. Once you do that, the odds are good that you, too, will be caught up in multimedia madness.



Carl Laron
Editor

ENGINEERING PROS AND CONS

As a graduate Electrical Engineer with over 17 years of experience, I was very curious about what Harry L. Trietley had to say about the field in his article "What Do Electrical Engineers Do?" (**Popular Electronics**, September 1991). Since the article was undoubtedly aimed at some of the younger members of your audience, who are both impressionable and about to make one of the most important decisions of their lives, they should be aware of some of the facets of this profession that were either glossed over, sugar-coated, or totally ignored by Mr. Trietley.

While factually correct in his depiction of engineering tasks, he seems to accept as a given that after age 40 an engineer should move into management. Not all engineers are suited by education and/or temperament to be managers. Unfortunately, in many companies, if you wish to advance both financially and in status, you must move into management. I have seen far too many excellent technical people become frustrated, ineffective, unhappy managers.

Mr. Trietley also seems to give short shrift to the phenomena of "salary compression." When you are an impressionable 17-year-old and you hear about college graduates with four-year degrees starting at \$30,000 per year, it sounds like fabulous wealth. When you hear of working engineers with maybe 15 years of experience making over \$60,000 per year, it sounds like riches beyond comprehension. When you hear of working engineers with maybe 15 years of experience making over \$60,000 per year, it sounds like riches beyond comprehension. However, when you are making that kind of money and are paying a mortgage and raising a family, you are just another faceless slob trying to make ends meet. When "good" raises given to engineers are significantly less than the rate of inflation, you are continually losing ground that you will never be able to make up.

Most important, Mr. Trietley completely ignores the fact that in the U.S. today there is a tremendous surplus of engineers. If you add up new

engineering graduates, foreign students who desire to stay, and new immigrants who are engineers, they far more than exceed the creation of new engineering jobs and attrition by death, retirement, and leaving the field for other reasons. The laws of economics apply to labor. When there is a true shortage of people, the price of their labor goes up. When there is an over-supply of a given talent, the price of their labor is deflated and goes down. Engineering is, and will continue to be, in a deflated mode.

It seems that Mr. Trietley might have been less than candid in the intent of his article. As the engineering vice-president for a young and growing instrumentation company, having a large over-supply of engineering labor definitely works to his advantage in terms of the cost of future labor. If he wants to encourage young people to become engineers, that is fine. But I don't believe that what is primarily a hobbyist magazine with (hopefully) a large number of impressionable young readers should be the forum for that type of propaganda.

I have one final question for Mr. Trietley: If engineering is such a wonderful career, would he encourage one of his children to become an engineer? I, and almost all of my working colleagues, are actively discouraging our children from choosing this field.
J.D.S.
Seaford, NY

There is truth in what J.D.S. says. I urge the reader to re-read the next-to-last paragraph of my article, regarding the "flip side" of the story. If the tone of my article is too rosy, though, that of J.D.S. is too negative.

His comments on salary compensation are right on the mark. Engineers start high, advance rapidly the first few years, and then level out. However, whether you look at starting salary or at the plateau, engi-

LETTERS

neering pays higher and generally has a lower unemployment rate than other professions available with a Bachelor's degree. In most companies, for instance, a B.S. in physics or chemistry makes you a lab technician. You need a Ph.D. to be regarded as a "professional." The employment prospects for nontechnical and nonbusiness Bachelor's degrees are often dismal.

It is unfortunate but true that salary eventually levels out without moving into management, sales, or some other area. However, that is equally true of most other jobs. Employers differ. Some enlightened larger companies offer "parallel path" technical positions similar in pay and influence to first-level management.

At this time, engineering, like most other areas of employment, is suffering cutbacks. Most of the time, however, as a hiring manager I have encountered difficulty in finding qualified engineers, immigrant or native.

I have read of other engineers as discouraged as J.D.S., and realize they are genuine. A recent syndicated newspaper column by Joyce Kennedy related several horror stories regarding older engineers and encouraged her readers to contact the American Association of Concerned Engineers, Box 667, Trilby, FL 33593. You might also contact Keats Pullen (2807 Jerusalem Road, Kingsville, MD 21087), who is compiling research on such problems.

Finally, to answer the last question raised by J.D.S.: My younger daughter has recently chosen to study engineering, and, yes, I encouraged her.—Harry L. Trietley

PLANNING AHEAD

I'm a 14-year-old who has been interested in electronics and computers since I was a child, amazed by the circuits, wires,

and lights. Since I was about 12 or 13, I've been buying **Popular Electronics**, reading all the articles, and making every single project that I thought would be useful. The magazine, in addition to books and my father, has taught me a great deal.

Then I read Harry L. Trietley's article, "What Do Electrical Engineers Do?" (**Popular Electronics**, September 1991). That made me think, and I decided that this would be the perfect career for me! What could be better than getting paid to practice your favorite hobby? I am most interested in Production Engineering and Design, or maybe even computer hardware. People might think that I'll change, or lose interest, but I don't think so. Unlike other teenagers, who party and don't care about the future, I do. I know what I'm going to do. I've been working hard, achieving honors in all core subject areas, and I hope to attend MIT.

I would like to thank **Popular Electronics** for all the great articles, and encourage Mr. Trietley to write more on electrical engineering. In the meantime, wish me luck. I hope to become a successful engineer in the field! Thanks!
W.d'H.
Airdrie, Alberta, Canada

HAVES & NEEDS

I've been a subscriber to **Popular Electronics** for many years. Several years ago, I built an Alarm Clock/Thermometer around the MA 1026 module. It worked beautifully for years—until we had a severe thunderstorm recently. I guess the lightning damaged the chip. I tried to buy another module from Radio Shack or Digi-Key, but they no longer have it. I'd be very grateful if any of your readers could help me to find one. Thank you.
Elias M. Raffoul
4301 Lois Street
Dearborn, MI 48126-3635

Never before has so much professional information on the art of detecting and eliminating electronic snooping devices—and how to defend against experienced information thieves—been placed in one VHS video. If you are a Fortune 500 CEO, an executive in any hi-tech industry, or a novice seeking entry into an honorable, rewarding field of work in countersurveillance, you must view this video presentation again and again.

Wake up! You may be the victim of stolen words—precious ideas that would have made you very wealthy! Yes, professionals, even rank amateurs, may be listening to your most private conversations.

Wake up! If you are not the victim, then you are surrounded by countless victims who need your help if you know how to discover telephone taps, locate bugs, or “sweep” a room clean.

There is a thriving professional service steeped in high-tech techniques that you can become a part of! But first, you must know and understand Countersurveillance Technology. Your very first insight into this highly rewarding field is made possible by a video VHS presentation that you cannot view on broadcast television, satellite, or cable. It presents an informative program prepared by professionals in the field who know their industry, its techniques, kinks and loopholes. Men who can tell you more in 45 minutes in a straightforward, exclusive talk than was ever attempted before.

Foiling Information Thieves

Discover the targets professional snoopers seek out! The prey are stock brokers, arbitrage firms, manufacturers, high-tech companies, any competitive industry, or even small businesses in the same community. The valuable information they filch may be marketing strategies, customer lists, product formulas, manufacturing techniques, even advertising plans. Information thieves eavesdrop on court decisions, bidding information, financial data. The list is unlimited in the mind of man—especially if he is a thief!

You know that the Russians secretly installed countless microphones in the concrete work of the American Embassy building in Moscow. They converted



HAVE YOUR VISA or MC CARD AVAILABLE

what was to be an embassy and private residence into the most sophisticated recording studio the world had ever known. The building had to be torn down in order to remove all the bugs.

Stolen Information

The open taps from where the information pours out may be from FAX's, computer communications, telephone calls, and everyday business meetings and lunchtime encounters. Businessmen need counselling on how to eliminate this information drain. Basic telephone use coupled with the user's understanding that someone may be listening or recording vital data and information greatly reduces the opportunity for others to purloin meaningful information.

The professional discussions seen on the TV screen in your home reveals how to detect and disable wiretaps, midjet radio-frequency transmitters, and other bugs, plus when to use disinformation to confuse the unwanted listener, and the technique of voice scrambling telephone communications. In fact, do you know how to look for a bug, where to look for a bug, and what to do when you find it?

Bugs of a very small size are easy to build and they can be placed quickly in a matter of seconds, in any object or room. Today you may have used a telephone handset that was bugged. It probably contained three bugs. One was a phony bug to fool you into believing you found a bug and secured the telephone. The second bug placates the investigator when he finds the real thing! And the third bug is found only by the professional, who continued to search just in case there were more bugs.

The professional is not without his tools. Special equipment has been designed so that the professional can sweep a room so that he can detect voice-activated (VOX) and remote-activated bugs. Some of this equipment can be operated by novices, others require a trained countersurveillance professional.

The professionals viewed on your television screen reveal information on the latest technological advances like laser-beam snoopers that are installed hundreds of feet away from the room they snoop on. The professionals disclose that computers yield information too easily.

This advertisement was not written by a countersurveillance professional, but by a beginner whose only experience came from viewing the video tape in the privacy of his home. After you review the video carefully and understand its contents, you have taken the first important step in either acquiring professional help with your surveillance problems, or you may very well consider a career as a countersurveillance professional.

The Dollars You Save

To obtain the information contained in the video VHS cassette, you would attend a professional seminar costing \$350-750 and possibly pay hundreds of dollars more if you had to travel to a distant city to attend. Now, for only \$49.95 (plus \$4.00 P&H) you can view *Countersurveillance Techniques* at home and take refresher views often. To obtain your copy, complete the coupon below or call toll free.

RADIO-ELECTRONICS VIDEO OFFER		PE
500-B Bi-County Blvd. Farmingdale, NY 11735		
Please rush my copy of the Countersurveillance Techniques Video VHS Cassette for \$49.95 plus \$4.00 for postage and handling.		
No. of Cassettes ordered _____		
Amount of payment \$ _____		
Bill my <input type="checkbox"/> VISA <input type="checkbox"/> MasterCard		
Card No. _____		
Expire Date _____ / _____		
Signature _____		
Name _____		
Address _____		
City _____ State _____ ZIP _____		
All payments in U.S.A. funds. Canadians add \$4.00 per VHS cassette. No foreign orders. New York State residents add applicable sales tax.		

GIZMO

FEBRUARY 1992

VOLUME 5,
NUMBER 2

A CHRONICLE OF CONSUMER ELECTRONICS

Multimedia Madness!

Sometimes, and particularly when it comes to consumer electronics, invention can be the mother of necessity. It's possible for manufacturers to come up with a product for which the average person feels no prior need whatsoever—and have that product, in the course of a few short years, become an indispensable part of American households. The prime example, of course, is the VCR. Consumers initially greeted the new device with skepticism: "Why in the world would I want to record TV shows?" Now, of course, we've all experienced the convenience of bowling on Monday nights without missing *Murphy Brown* and the pleasure of skipping past the commercial breaks when playing back a show. Watching rented movies on video has become one of our favorite pastimes, and we know few parents who could imagine raising their toddlers without the "electronic babysitter"—a VCR and a tape of *The Little Mermaid* or *Teenage Mutant Ninja Turtles*. The Walkman is another example of a consumer product that seemed to be little more than a novel gimmick when it was introduced; but it, too, has had an enormous impact, changing the way the world listens to music.

Now we're hearing the rumblings of change once again. This time, it takes the form of a new technology—or, more accurately, a combination of existing technologies used in a new way. Multimedia and interactive entertainment devices are based on the same optical technology used in compact discs, and the microprocessor technology used in computers. But instead of just music, multimedia discs combine graphics, animation, sound, photographic images, and eventually full-motion video. And you don't necessarily have to be computer literate to use multimedia or interactive devices. While some are computer-based products, others are stand-alone devices that hook up to your television and audio system and are deliberately aimed at technophobes. They could possibly change the way we learn, work, and relax.



CIRCLE 50 ON FREE INFORMATION CARD

The concept of interactive multimedia is nothing new to industry insiders. Five years ago in San Francisco, at what we believe to have been the first industry conference devoted to the promotion of a consumer-friendly device called CD-I or Compact Disc-Interactive, we were regaled by glowing descriptions of applications such as a tourist guide to a foreign city, in which the armchair traveler could direct the device to turn down certain streets and see video images of the actual shops and sights on the real street. Why, they could even opt to "walk" into a shop to see the type of merchandise sold there,

into a restaurant to check out the menu, or into a museum to see the locations and themes of its various exhibits. Then they could step back to see a street map of the whole neighborhood or the whole city, or call up a subway map. Other potential applications included encyclopedias in which the researcher could pick and choose precisely the level of information required about each topic. For instance, you might look up Shakespeare and learn when he lived and that he was a playwright, and see a picture of him. Intrigued? Then call up a list of his works by title. Still interested? Get a synopsis of

TURN PAGE FOR CONTENTS

This month in GIZMO®

Multimedia Madness: An Introduction	pg. 5
Commodore Dynamic Total Vision CDTV Player	pg. 9
Pysognosis Ltd. Lemmings	pg. 9
The New Grolier Electronic Encyclopedia	pg. 9
Philips CDI910 Compact Disc- Interactive Player	pg. 11
ABC Sports Golf: Palm Springs Open	pg. 11
Cool Oldies Jukebox	pg. 11
Sony Data Discman Model DD1-EX	pg. 13
Compton's Concise Encyclopedia	pg. 13
Magnavox CDD461RS CD-ROM Drive and CD-Audio Player	pg. 18
Microsoft Bookshelf	pg. 18
PC Globe Electronic Atlas	pg. 18
PC-SIG Library	pg. 18
Tandy 2500 SX/20 Multimedia PC	pg. 20
Multimedia Beethoven: The Ninth Symphony	pg. 20

Gizmo is published by Gernsback Publications, Inc., 500-B Bi-County Blvd., Farmingdale, NY 11735. Senior Writers: Chris F. O'Brian, Teri Scaduto. Contributors to this issue: Stephanie Jacangelo. ©Copyright 1991 by Gernsback Publications, Inc. Gizmo is a registered trademark. All rights reserved.

one, or all, of his plots—accompanied by (remember, this is multimedia) dramatic readings of the most famous lines, and even a few minutes of video showing the scene acted out. And think of the possibilities for fascinating interactive videogames! Customized learning and research for children and adults, plus family fun—all on a machine easier to use than a VCR. What a combination! We left San Francisco convinced that we'd seen a glimpse of the future—and the near future at that, for they were promising to have multimedia players and software on the market in a year or so.

As we write this—in October, 1991—multimedia has finally hit the market for real. Surprise—it took years for manufacturers to reach any decisions on formats and standards, and for a new breed of software developers to create multimedia programs. After all that time, there is still no one, all-encompassing standard—and no applications quite as impressive as those we heard described five years ago. Instead, there are now two competing (read: incompatible) forms of free-standing, interactive multimedia players—Commodore's CDTV and Philips' CD-I; a portable entry, the Data Discman from Sony; free-standing CD-ROM drives that enterprising computer users can use with their appropriately equipped PC's to create their own multimedia systems; and an industry-standard Multimedia PC (MPC) that supports scores of compatible titles.

None of the technologies discussed in this month's **GIZMO** can handle real video—yet. Converting video into the digital form that computers use requires an enormous amount of storage space and processing power. Even though a 5-inch CD can hold more than 550 megabytes of data—the equivalent of 225,000 pages of text—it can hold only a few minutes of video. There are various “tricks” that let video be incorporated onto CD's. First, you can reduce the area of motion to only a portion of the screen—it can play in a “window.” Second, you can use digital compression techniques to reduce the amount of storage space required. But once the Motion Picture Experts Group, or MPEG, video standard is formally adopted this year (or next), CDTV, CD-I, and MPC machines all promise full-motion-video capability.

Perhaps the software doesn't live up to the original hype, but we have seen dozens of practical, entertaining, and enlightening multimedia programs. There might not be a “killer app” yet—but the industry is still young, and there are a lot of bright, imaginative thinkers putting quite a bit of energy into it.

We think the field shows sufficient promise to be worthy of an entire issue of **GIZMO**. We'll give you a general over-

view of each of the products, followed by hands-on reviews of those items that we were able to get our hands on. Next month, we'll provide capsule reviews of some of the software available for each format.

CDTV. Commodore's CDTV (for Commodore Dynamic Total Vision) was arguably the first stand-alone multimedia device on the market: introduced in the beginning of 1991, it actually went on sale in May. It is being marketed as an educational and entertainment device that would be comfortable in the family living room. It plays special CDTV discs, which can contain audio, graphics, and even video—although not the full-screen, full-motion video that you might expect. However, we've seen demonstrations of CDXL, a CDTV-compatible, interim technology that allows full-motion video in a ½-screen window at a rate of 12 frames per second. (TV broadcasts are 30 frames per second.) It works for some applications, but you won't mistake it for true video.

CDTV is a proprietary system made only by Commodore, who has had a mixed record when it comes to consumer acceptance of its products in the U.S. The head of Commodore's Consumer Interactive Products Division, Nolan Bushnell, has an appropriate claim to interactive fame. He started the videogame boom of the 1970's with “Pong,” the first consumer videogame. Commodore had, of course, been in the computer business for quite some time before Bushnell came on board in 1989. Although many readers may not remember Commodore's PET computers of the early 1980's, we'd be surprised if anyone was unfamiliar with the VIC 20 or Commodore 64, two of the most popular home computers ever built.

As the computer industry matured, and less powerful computers such as the 64 were relegated to closets and garage sales, Commodore introduced their Amiga, which has a small (when compared to the IBM-PC and Macintosh) but intensely loyal following because of its superb graphics and the inclusion of a MIDI (Musical Instrument Digital Interface) port.

The CDTV player is similar to the Amiga in that it is also based on the 68000 and includes a MIDI port. In fact, the CDTV unit is basically an Amiga 500 without a keyboard, disk drive, or computer monitor—and all of those can be added, using ports on the back of the player. However, Commodore is not marketing CDTV as such. They don't want to scare off consumers by letting on that CDTV is “a computer in A/V clothing.”

CD-I. Compact Disc-Interactive is aimed at the same market as is CDTV. Although CDTV was introduced first, CD-I has the longer track record—Philips announced the technology in 1986.

As we go to press in mid-October 1991, Philips has officially introduced CD-I in the U.S. Judging from their gala introduction at the Ed Sullivan theater in New York and the displays we've seen in local retailers (including Macy's and Sears), it looks as if this time CD-I is for real. Philips appears to be ready to market the player intensively. (Perhaps by the time you read this, that will seem like old news.)

Philips' track record would suggest that they will be a powerful competitor in the interactive market. They, along with Sony, are responsible for bringing us CD-DA, the compact-disc digital-audio standard that has been nothing short of a phenomenal success. (Philips is also responsible for introducing the Laser Disc and the compact cassette, which remains the most popular listening format.) To ensure the success of CD-I, Philips has created a CD-I standard and teamed up with some powerful allies. Kodak joined Philips at the Summer Consumer Electronics Show to establish that CD-I is compatible with Photo CD, a new process invented by Kodak that will allow you to have your photo developer put your standard photographs on a digital compact disc so that you can view them on your TV via a Photo

CD player—or your CD-I player. Matsushita has also embraced CD-I, and was reported to be ready to introduce a CD-I player in Japan by the end of 1991. Radio Shack will be marketing a Memorex-brand CD-I player by the time you read this. Nintendo has agreed to permit Philips Interactive Media of America to develop CD-I titles based on such well-known games as Super Mario and Donkey Kong.

The CD-I player is based on a 68070 microprocessor. It is a powerful computer in its own right. But like CDTV, it's not being marketed that way. In fact, as far as we could determine, Philips has no plans to sell expansion products for CD-I. They won't even talk about the covered expansion port in the rear of the machine, which will likely allow for true video capability when the MPEG standards are agreed upon in 1992 or 1993.

DATA DISCMAN. Both CDTV and CD-I are meant primarily for the family, and are intended to sit in the family room, next to the TV. Sony, long a proponent of carry-along consumer electronics, has introduced a portable interactive product. In September 1991, they announced that their Data Discman was to come to the U.S. in time for the Christmas shopping season.

(A similar version was introduced in Japan more than a year earlier.)

The Data Discman is a pocket-sized device that plays "Electronic Books." Those are 3.14-inch CD-ROM discs that come packaged in protective caddies resembling microfloppy diskettes. The discs all conform to the Electronic Book standard, which is based upon existing CD-ROM standards. That means that it is relatively inexpensive for existing CD-ROM titles to be converted to the Electronic Book format. In addition, the system required to retrieve information from any Electronic Book is built into the Data Discman, resulting in a standard user interface. No matter how different the material contained in various Electronic Books may be, the manner in which that information is retrieved is always the same—and doesn't require any familiarity with computers.

That makes the Data Discman another consumer (as opposed to computer) item. Because of its portable, individual nature, however, it isn't aimed at families in the same way that CDTV and CD-I are—even though it does include a video jack so that its output can be viewed on a TV screen. Software that is bundled with the Data Discman includes three general-interest ti-

Train at HOME to be an Electronics Technician!

As the demand for computers and microprocessors in business, manufacturing and communications continues to grow, so does the need for qualified technicians. It's not unusual for experienced technicians to earn from \$30,000 to more than \$40,000 a year.* Now through Peoples College of Independent Studies you can train for this exciting field without interrupting your job or home life.

Choose From Five Programs of Study

- Electronics & Microprocessor Technology
- Industrial Electronics & Microprocessor Technology
- Communications Electronics with Microprocessor Technology
- Computer Servicing & Electronics Technology
- Specialized Associate Degree In Electronics Technology

Professional Equipment Is Included

Depending on the program you select, you'll perfect your skills using this advanced equipment, included in the price of tuition:

- IBM-Compatible Personal Computer
- Digital Multimeter
- Digital Logic Probe
- Elenco Oscilloscope
- Portable Cellular Telephone

(* Source: U.S. Bureau of Labor Statistics)



Exclusive Extras That Enhance Your Training

Peoples College introduces some training firsts to make your learning experience more complete:

- Accelerated Learning System — a scientifically proven study system that helps you learn faster and easier than ever before.
- Video Tutor Training Tapes — give you a permanent, visual record of informative lectures and close-up demonstrations.
- Experience Labs — professionally designed experiments that give you hands-on "bench" experience.
- Industry Certification Training Guide — provided with four of our programs. Prepares you for examinations you may take for your professional license or certification.

Easy Payment Plans — No Finance Charges

To help you get started on your education, Peoples College has reduced tuition rates and offers low monthly payment plans with no finance fees. So don't delay, call or write for more information today!

For COLOR CATALOG Mail Coupon or Call TOLL FREE 1-800-765-7247

Programs offered only in United States, Canada, Puerto Rico and Virgin Islands. No Obligation. No sales person will call.

Our programs are accredited by the Accrediting Commission of the National Home Study Council

YES! I would like to know more about your training programs. Send a catalog to:

Name _____
 Address _____
 City _____
 State _____ Zip _____

Phone # _____
PEOPLES COLLEGE
 OF INDEPENDENT STUDIES
 233 Academy Drive • P.O. Box 421768
 Kissimmee, FL 34742-1768
 Member, D.I. Peoples Group E0292

CIRCLE 15 ON FREE INFORMATION CARD

OPEN

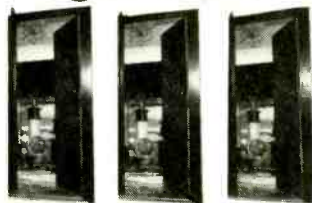

TALK TO



COUNSEL



Can you open doors in your community?

If you have prior experience and/or interest in international education and exchange students, and the communication and interpersonal skills needed to promote international student exchange programs, OPEN DOOR Student Exchange is interested in you.

Would you love talking to families, schools, churches, civic groups and local media?

We need Area Representatives and State Coordinators who can locate and interview prospective host families, interview U.S. students to participate in our overseas programs, and generate interest in the OPEN DOOR program in your local community.

Do you find counseling rewarding?

OPEN DOOR Area Representatives also provide local support to visiting foreign students, their host families and schools involved. They deal with questions and provide advice as needed.

OPEN DOOR Student Exchange is a not-for-profit organization providing intercultural learning opportunities for high school students and families since 1964. For more information about specific assignments available in your area and our expense/compensation packages, please call:

1-800-366-OPEN (6736).



OPEN DOOR
STUDENT EXCHANGE



250 Fulton Street, P.O. Box 71, Hempstead, NY 11551

ties with family appeal—*Compton's Concise Encyclopedia*, *The Wellness Encyclopedia*, and the *World Travel Translator*. Quite a few of the other available discs seem to be aimed mainly at travelers and businessmen.

Although we expect that the Data Discman will get some use at home, we would expect it to be popular where its portability makes it indispensable. Business people who need access to huge amounts of corporate information might find the Data Discman a convenient tool. Many large corporations now distribute CD-ROM discs to their salesmen and field personnel; transferring that data to the Electronic Book format should be a relatively simple process.

CD-ROM. CD-ROM, or Compact-Disc Read-Only Memory, is the oldest of the interactive formats—its history dates as far back as 1985, when the High Sierra Group (an *ad-hoc* committee of computer vendors, software developers, and CD-ROM system integrators named for the locale of their meetings) proposed a standard CD-ROM format. Their proposal has since been approved by the International Standards Organization or ISO.

CD ROM was established mainly for business use. Many of the early titles were for professional use and research. Some of the earlier CD-ROM's included such titles as *Books in Print*, *Educational Resources Information Center*, *Tax Library*, *Trademark Information Database*, *Applied Science and Technology Index*, etc. There were also titles that were better suited to home use, including Grolier's *The Electronic Encyclopedia* and *PC-SIG CD-ROM*, a collection of thousands of shareware and public-domain programs.

The same is true today. CD-ROM is firmly entrenched in the business world, and they're making it easier than ever to do research at many libraries. But the growth area these days is in the consumer market. CD-ROM drives are coming down in price, and many drives are being bundled with titles that are sure to appeal to home users.

One of the advantages that CD-ROM has over other interactive formats is that it is simply an extension of computers—there's nothing really new to learn. And computer owners don't have all too much to buy.

Computers are also inherently more efficient when compared to the previous three interactive formats we've discussed because they use a keyboard for input. But that assumes, of course, that you don't mind using a keyboard and don't have an inherent fear of personal computers; when it comes to consumers, that often isn't the case.

The original use of the compact disc, of course, was audio. Today's CD-ROM

discs and drives can also support audio. That wasn't the case with some of the earliest drives, but we've come a long way in the last five years. The Magnavox CD-ROM drive that we got a hands-on look at this month gives you a good idea of just how far.

MULTIMEDIA COMPUTERS. In March 1991, a group of 12 computer hardware and software companies joined together to form the Multimedia PC Marketing Council. Council members include CompuAdd, Creative Labs, Fujitsu, Headland Technology/Video Seven, Olivetti, Media Vision, Microsoft Corp., NCR, NEC Technologies, Philips Consumer Electronics, Tandy Corp., and Zenith Data Systems. The council's main objective was to establish a common multimedia platform and to educate consumers about multimedia. To that end, they have developed an MPC trademark that will identify compatible software and hardware. In other words, consumers will know that any PC bearing the MPC trademark will be able to run any CD applications also bearing the trademark. They won't have to worry about whether they have enough memory in their machines, etc.



The MPC trademark indicates a product that is compatible with every other Multimedia PC product.

A multimedia PC consists of a PC, a CD-ROM drive, an audio board and speakers or headphones for audio output, and the Microsoft Windows operating system with Multimedia Extensions. The minimum PC configuration is a 10-MHz 80286 machine with 2 megabytes of RAM, a 30-megabyte hard disk, and a VGA display. A faster machine with more memory will give better performance, of course.

Although Multimedia PC's will be sold as stand-alone computers (we take a look at a Tandy machine this month), upgrade kits will also be available (we'll be reporting on one in an upcoming issue), and you can assemble your own multimedia PC around an existing 10-MHz AT-compatible computer with the addition of a CD-ROM drive, an audio board, a MIDI port, and Microsoft Windows with Multimedia Extensions.

Now, let's get busy and give each format a workout!

Slow—but Ready—Wins the Race

COMMODORE DYNAMIC TOTAL VISION (CDTV) INTERACTIVE MULTIMEDIA PLAYER. Manufactured by: Commodore International, 1200 Wilson Drive, West Chester, PA 19380. Price: \$999.

LEMMINGS. Published by: Psygnosis Ltd. (South Harrington Building, Sefton Street, Liverpool L34BQ, United Kingdom). Price when purchased separately: \$49.95.

THE NEW GROLIER ELECTRONIC ENCYCLOPEDIA. Published by: CDTV Publishing, 1200 Wilson Drive, West Chester, PA 19380. Price when purchased separately: \$395.95.

Spending a good portion of our waking hours working (and occasionally playing) on our PC's, we tend to forget that computers are still regarded by millions with, if not quite fear and loathing, at least profound mistrust and wariness. That attitude is enhanced by unfamiliarity with the machines, but not necessarily alleviated by frequent contact. We know plenty of people who have to use computers every day at work, but would never want one in their homes.

Commodore International didn't let their position as the second largest home-computer manufacturer divert their attention from that unfavorable public attitude when it came to designing CDTV, their entry into the interactive-multimedia market. CDTV is, in essence, an Amiga computer, based on a Motorola 68000 16/32-bit CPU, and having 1 megabyte of RAM. Some might consider it underhanded to sneak Amigas into the homes of unsuspecting consumers under the guise of a harmless component that most strongly resembles a CD player, but we call it good marketing and common sense. Nolan Bushnell calls it offering "computing

power without computer complexity."

While standard play is, indeed, quite simple, the advantage to having a computer behind its facade is that those users who actually like computers have the option of configuring CDTV for more complex uses. The unit's rear panel boasts serial and parallel ports, a floppy-disk drive interface, and future options will include a keyboard and a 3½-inch floppy drive—all of which will allow the unit to be used as a home computer. A "personal memory port" hidden beneath a door on the front panel allows users to save up to 512 kilobytes of data—game scores or personal finance information, for instance—on "smart cards." For musicians and videophiles, the rear panel also sports a connector for MIDI-based instruments, and standard composite and S-video ports so that you can record the output of CDTV programs—and with a promised expansion card, even gen-lock the output of CDTV to a second video source.

But we're getting ahead of ourselves. First and foremost, CDTV is intended to provide hassle-free education and entertainment to the average consumer. The back panel might have all sorts of computer connectors, but the front panel is clean and straightforward, with only the bare minimum of control buttons (power, volume, play/pause, stop, fast forward, reverse, reset, and CDTV/TV selector). The well into which discs are inserted, an LCD panel, and a headphone jack round out the front panel.

Not only does CDTV look like a CD player, it can be used to play standard audio CD's and CD + G's (compact disc plus graphics). The audio quality, when CDTV is connected to a stereo system, is indistinguishable from that of a good CD player, and all the features you'd expect from a high-end CD player are offered. An on-screen display is used to program discs for playback.

Like a CD player or a VCR, the player connects to a television set and home audio system and is controlled via a handheld remote control, and playback simply requires inserting a program into the playing mechanism—all comfortingly familiar actions.



CIRCLE 51 ON FREE INFORMATION CARD

Which symbol represents a variable inductor?

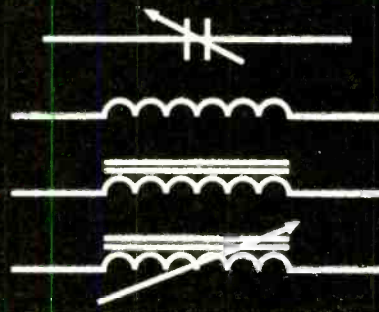

What is the principal disadvantage of neon lights?

What are out-of-phase signals?

Heath Video Courses speed your learning curve!

Learn basic electronics at home at your own pace with four, 60-minute video tapes. Know the variable inductor symbol. Recognize a PN junction. Understand oscillator fundamentals. Clearly SEE what most basic electronic books can only describe.

DC ELECTRONICS. Covers electron movement to troubleshooting and repairing a simple electronic circuit. **EV-3101-A.**

AC ELECTRONICS. Follow-up to DC Electronics. Covers the principles of AC, voltage and electrical measurement. Includes motors, generators and test instrument meter movements. **EV-3102-A.**

SEMICONDUCTORS. Complete the DC/AC videos and you're ready to learn how semiconductor devices are made, plus the principles of discrete devices, integrated circuits & optoelectronic devices. **EV-3103-A.**

ELECTRONIC CIRCUITS. Complete the basic course with amplifier configurations, biasing, coupling, audio amplifiers, closed-loop vs. open-loop operation and more. **EV-3104-A.**

An activity-filled workbook and explanation of how to solve each problem comes with each tape so you learn three ways — video, workbook and hands-on!

Order today!
Call Toll free,
24-hours a day,
1-800-253-0570.

VIDEO TAPES
\$44.95
EACH

We accept VISA, MasterCard, American Express and Heath Revolving Charge card. Use Order Code 601-065.

Heath®

Benion Harbor, MI

Call for a FREE catalog 1-800-44HEATH

Price does not include shipping and handling ED-23R-R3 or applicable sales tax.

CIRCLE 10 ON FREE INFORMATION CARD

One difference becomes immediately apparent, however. Before a disc can be loaded into the CDTV player, it must be placed in a special "caddy" (which can best be described as a cross between a plastic CD box and a 3½-inch floppy-disk shell). That goes for audio CD's and CD + G's as well as multimedia discs. We think the caddy is a mistake. Even though it helps keep the cost down, it makes CDTV more difficult to use—for adults (particularly those accustomed to CD players) as well as children. We were willing to put up with the disc caddies for our first CD-ROM drive. But in a home-entertainment device—where discs are likely to get switched often—it's hard to accept.

The most obvious difference as far as the consumer is concerned, however, is the software itself. CDTV plays a wide assortment of proprietary multimedia discs written for reference, general education, and entertainment of adults and children.

The first disc we used was "Welcome to CDTV"—a multimedia "manual" that is supplied in place of a written user's guide. CDTV is intended to be an "intuitive" medium, unlike the computer, which requires volumes of intimidating written support. Perhaps we're not "typical" consumers, but we'd rather be intimidated than bored to distraction as we were by the introductory disc—which, incidentally, isn't all too intuitive. It provides detailed information about each feature of the main unit and the remote control, explains how to set the clock and use the unit as a CD player, and provides a catalog of available multimedia titles. A lot of information is provided—using graphics accompanied by very slow narration. Not all of that information is needed to simply get started (remember all those peripheral ports we mentioned earlier?). It might not have been so bad if they had informed us at the start that we could use the fast-forward key to skip those areas not of immediate interest. But by the time they got to that vital bit, we were already pulling our hair out in aggravation.

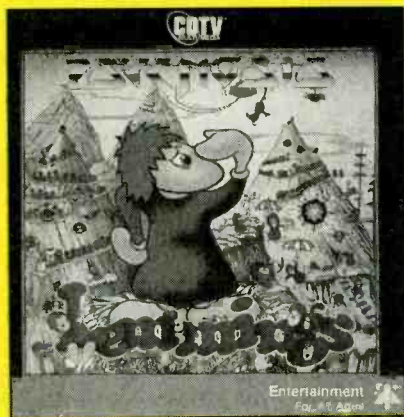

Psygnosis, Ltd.'s Lemmings

The infrared transmitter is located along one of the long sides of the rectangular remote control. Unlike most remote controls, which are meant to be held in one hand, the CDTV remote is designed to be held in both hands. The buttons located on the right ("A" and "B" buttons) and left (up, down, left, and right arrows) sides of the remote will be familiar to video-game players and are used to initiate disc action and select program options, and to move a pointer around the screen, respectively. The center portion of the remote contains the buttons used to play audio CD's—a numeric keypad and rewind, fast forward, play/pause and stop buttons—as well as power and volume buttons. In addition, the escape button, which generally acts as a "help" key, and the enter button, which can sometimes be used to select disc options, are also in the center section.

The remote is easy to use, but there were a few problems with it. Two-hand operation was comfortable for us, but our four-year-old "guest reviewer" had some trouble getting a grip on it; her hands were just too small. That is a real problem for a product that is aimed at the entire family. She also had difficulty aiming it properly, especially when she got involved in the programs she was using. A wider infrared range would have helped. But the main problem we had was playing action games: The arrow buttons simply didn't provide a high enough degree of control to play well. The optional joystick is sure to be an improvement.

We tried out about a dozen CDTV titles ranging from *A Bun for Barney*, an interactive storybook for preschoolers, to *The Illustrated Works of William Shakespeare*. Most of the titles we saw came with written instructions (in place of the liner notes that accompany most audio CD's). Those instructions are usually quite brief. As you'd expect from programs aimed at non-technical consumers, each strives to be as intuitive as possible, relying as much as possible on on-screen directions. In general, they succeed.

We'll talk only about the two titles that Commodore is currently bundling with the \$999 CDTV package: *The New Grolier Electronic Encyclopedia*, which includes all 21 volumes of Grolier's *American Academic* on one disc, and our favorite, the adventure game *Lemmings*. Capsule reviews of other CDTV multimedia titles will appear in next month's issue of **GIZMO**.

Probably the most laudable home multimedia application—in other words, the excuse that parents will use to buy it for the kids—is in reference works, where school kids could have all the information contained in a set of encyclopedias or a dictionary not only at their fingertips, but presented in an interesting, and easily ac-



The New Grolier Electronic Encyclopedia

cessible, manner. Grolier's Electronic Encyclopedia consists of 30,000 articles; 2000 pictures, illustrations, and maps; and sounds to accompany many of the articles. You can browse through the graphics, and call up any article that piques your interest. Or you can use the on-screen "keyboard" to point and click on letters to spell out a specific search word. You can then instruct the system to search for all instances of that word appearing either in a title or anywhere within the text. From within an article, you can point and click on any highlighted word to jump to an article on that subject.

We typed in the word "Beatles" and came up with a list of 15 articles containing that word. Those ranged from a general piece on rock music, to articles about each member of the band, to articles on Ed Sullivan and Michael Jackson. (Surprisingly, the Michael Jackson piece didn't mention that he now owns the rights to many of the Beatles' hit songs.) Within the "Rock Music" article, we found it easy to jump to articles on other bands—the Grateful Dead, for instance.

If, however, we had wanted to search for the Grateful Dead from the original screen using the "keyboard," we would have been limited to searching for either "grateful" or "dead"—there's no way to search for more than one word. That means that you can't limit your search parameters. Researching French wines would require typing in one of those two words, and then scrolling through the list of all matching entries to find your other search word. Luckily, the lists are easy scroll through—and sometimes you find an interesting related topic that you wouldn't have come up with on your own.

That's what happened with our Beatles search. We kept skipping to other topics that were highlighted in the "Rock Music" article, and read up on Bob Dylan, the Jefferson Airplane, and a half-dozen other rock references. What surprised us, however, was that no photographs or other illustrations accompanied any of those articles—and neither did any musical snippets.

Sound and illustrations do accompany articles on individual musical instru-

(Continued on page 21)

Imagination That!

CDI910 COMPACT DISC-INTERACTIVE PLAYER; Manufactured by Philips Consumer Electronic Company, One Philips Drive, Knoxville, TN 37914. Price: \$1000.

ABC SPORTS GOLF: PALM SPRINGS OPEN. Published by Fathom Pictures, Inc., Sausalito, CA. Price when purchased separately: \$49.98.

COOL OLDIES JUKEBOX. Published by PIMA, 1111 Santa Monica Blvd. Los Angeles, CA 90025. Price when purchased separately: \$19.98.

Five years after consumer-electronics writers first heard the term "Compact Disc-Interactive" and five months after the official release of Commodore's CDTV, Philips rolled out the first market-ready CD-I players. What took so long?

The answer can be summed up in a word: standardization. While Commodore forged ahead, using their own Amiga as the basis for CDTV and disregarding what the big companies were up to (behavior consistent for a maverick company that's managed to successfully market an alternative to IBM-compatible PC's), Philips followed a different path. No stranger to innovation—Philips introduced the audio cassette, the laserdisc, and the audio compact disc—the company has developed a strong respect for worldwide standards to support new technologies. (In fact, Philips originally refused Dolby a license because their noise-reduction system wouldn't be compatible with all existing cassette players.) When Philips was finally ready to launch CD-I, the format already had the backing of nine major consumer-electronics manufacturers, including Sony and Matsushita, and was supported by a worldwide standard. Some 26 titles were re-

leased at the same time, all conforming to the CD-I standard. In addition, agreements had been reached with Nintendo for CD-I-compatible video games and with Kodak for Photo CD's. That level of acceptance within the field wasn't achieved overnight.

Back in 1986, Philips and PolyGram, a leading CD marketing and distribution company, established a company called American Interactive Media (AIM) with the goals of garnering support for the CD-I format, creating an interactive standard, and developing a diverse library of software titles. In recognition of its completed mission and in anticipation of the October, 1991 launch of CD-I—which Philips has dubbed "The Imagination Machine"—AIM was renamed PIMA, or Philips Interactive Media of America. Besides in-house developing, PIMA is also developing software through outside ventures, partnerships, and licensing agreements (more than 100 companies have licensed the technology from Philips). And a second CD-I machine was scheduled to be launched before Christmas under the Memorex label, and sold at Radio Shack stores along with a selection of CD-I-compatible software.

Their backgrounds and backing aren't the only significant differences between CD-I and CDTV players. First, CD-I cannot be expanded into a computer, and there is no CD-I equivalent of "smart cards" for storing data. Although its insides are computer controlled (a multimedia controller contains the audio, video, and text decoder circuits and memories needed to play CD-I discs; the M68070 microprocessor controls play and runs the interactive programs), from the outside, CD-I is strictly a consumer item. Second, CD-I requires no "disc caddy"—a distinct advantage over CDTV. CD-I discs simply sit in the tray like audio CD's in a standard CD player. While both formats play CD's and CD+G's, neither can play the multimedia discs intended for the other machine. And, although Commodore says



CIRCLE 52 ON FREE INFORMATION CARD

DIGITAL VIDEO STABILIZER ELIMINATES ALL VIDEO COPYGUARDS



While watching rental movies, you will notice annoying periodic color darkening, color shift, unwanted lines, flashing or jagged edges. This is caused by the copy protection jamming signals embedded in the video tape, such as Macrovision copy protection. THE DIGITAL VIDEO STABILIZER: RXII COMPLETELY ELIMINATES ALL COPY PROTECTIONS AND JAMMING SIGNALS AND BRINGS YOU CRYSTAL CLEAR PICTURES.

WARNING

THE DIGITAL VIDEO STABILIZER IS INTENDED FOR PRIVATE HOME USE ONLY. IT IS NOT INTENDED TO COPY RENTAL MOVIES OR COPYRIGHTED VIDEO TAPES THAT MAY CONSTITUTE COPYRIGHT INFRINGEMENT.

FEATURES

- Easy to use and a snap to install
- State-of-the-art Microchip technology
- 100% automatic
- Compatible to all types of VCRs and TVs
- The best and most exciting Video Stabilizer in the market
- Light weight (8 ounces) and compact (1x3.5x5")
- Uses a standard 9 Volt battery (last 1-2 years)
- Fast UPS delivery
- Air shipping available
- UNCONDITIONAL 30 day money back guarantee
- 1 year warranty

(Dealers Welcome)

To Order: \$59.95 ea + \$4 for p & h
Visa, M/C, COD Mon-Fri: 9-6 EST
1-800-445-9285 ext. 6312
FREE 20 Page Catalog
SCO Electronics Inc. Dept. 6312
581 W. MERRICK RD. VALLEY STREAM, NY 11580

CIRCLE 13 ON FREE INFORMATION CARD

CABLE TV DESCRAMBLERS How You Can Save Money on Cable Rental Fees

Bullet Proof



1 Unit 5+

BEST Super Tri-Bi Auto/
Var. Gain Adjustment \$119.95...\$85
Jerrold Super Tri-Bi ... \$109.95...\$79
Scientific Atlanta \$109.....\$79
Pioneer \$109.....\$79
Panasonic TZPC145.... \$99.95....\$79
Stargate Converter..... \$95.....\$69
Digital Video Stabilizer. \$59.95....\$29
Wireless Video Sender..\$59.95....\$49.95

**US Cable'll Beat
Anyone's Price
Advertised In
this Magazine!**

30 Day Money Back Guarantee

FREE 20 page Catalog

Visa, M/C, COD or send money order to:

U.S. Cable TV Inc. Dept. 5312
4100 N. Powerline Rd., Bldg. F-4
Pompano Beach, FL 33073

1-800-772-6244 ext. 5312

For Our Record

I, the undersigned, do hereby declare under penalty of perjury that all products purchased, now and in the future, will only be used on Cable TV systems with proper authorization from local officials or cable company officials in accordance with all applicable federal and state laws. FEDERAL AND VARIOUS STATE LAWS PROVIDE FOR SUBSTANTIAL CRIMINAL AND CIVIL PENALTIES FOR UNAUTHORIZED USE.

Date: _____

Signed: _____

No Florida Sales!

CIRCLE 14 ON FREE INFORMATION CARD

otherwise, Philips claims that only CD-I will be compatible with Kodak's Photo CD. Finally, on the whole, CD-I seems a bit more elegant—in most cases, it is faster paced, smoother, and easier to control than CDTV—and all of the games have the same “feel.”

Physically, the two players are similar, although the CD-I player's front panel is a bit simpler. It offers buttons to open and close the disc tray; turn the power on and off, play, stop, and pause CD-I, CD + G, and audio discs; skip to the next or previous CD track; and control headphone volume. There's also a headphone jack, the disc tray that slides open to accept discs, and the vacuum-fluorescent display. The display tells you what type of disc is inside the tray and, when you're playing CD + G's or CD's, lets you know if you're in the play, pause, “favorite track,” shuffle, repeat, or scan modes; which track is playing; and time remaining (or time elapsed).

The CD1910's remote looks completely different from that of the CDTV player. The CD-I “thumbstick” remote is shaped like the standard remote control, and is designed for one-hand action. The top section contains a joystick (“thumbstick”) surrounded by four “action” buttons. The thumbstick is used to move the arrow (cursor) around the screen, and the buttons start an action on a CD-I disc. The bottom section of the remote contains controls for playing audio CD's and volume controls. We often found ourselves using two hands, however, for better control and stability. A CD-I mouse is available optionally, as is a brightly colored “Roller Controller” for children as young as two years old.

Unlike CDTV, CD-I comes with a written manual. Most of the action is intuitive, however, and we rarely had to refer to the booklet. When we needed to, however, it was for the most part well-organized and easy to understand.

When you first power up a CD-I player, an introductory screen appears. By pointing and clicking on icons arrayed across the bottom of that screen, you can dim the TV screen, open and close the disc tray,

and access other “start-up” screens. The “Info” screen provides a *brief* overview of the player's capabilities in a choice of languages (English, French, or Spanish). “Settings” is used to set the time and date (in 12- or 24-hour clocks and MM-DD-YY or DD-MM-YY) as well as various such audio-CD parameters as auto shuffle, repeat track or disc, scan time, and auto favorite-track selection. Even after referring to the manual, the “Memory” screen had us baffled—until we tried playing a standard CD, that is.

When a CD is inserted, the “Audio” screen automatically appears. Screen graphics indicate what mode the disc is in, the total number of tracks (or track number when in play) and total playing time (or remaining time). A row of numbered boxes corresponding to the track numbers on the disc, and icons for what mode the disc is in and various special functions make it easy to program discs for play. “Favorite-Track Selection” allows you to select and store in memory only those tracks that you like best. A keyboard screen is used to label your FTS memory program—that's what the memory screen is for. It displays the names of those stored programs and how much memory they use up. It's a nice feature, and quite easy to use.

Of course, you'll be playing more than audio CD's on your “Imagination Machine.” The introductory models are being packaged with *ABC Sports Golf: Palm Springs Open*, *Golden Oldies Jukebox*, and an audio CD (as well as coupons for discounts on the future purchase of a CD and a CD-I disc).

ABC Sports Golf allows you to participate in a realistic, “live” golf tournament. The course is made up of the 18 most challenging holes from several famous golf courses in Palm Springs. From one to four people can play, and you can opt to play a full 18 holes, the back nine, or practice on any one of your choice. The opening graphics for each hole is an actual video image of the real-life site. Superimposed on that is a video image of a golfer. At the bottom of the screen are three icons: a box labeled “club” to the left, one labeled “map” to the right, and a bar in the center.

Before hitting the ball, you can check your position and the location of obstacles such as sand traps on the map and select a club (by pointing and clicking on the appropriate icons). By pushing the thumbstick up, an icon representing the flag in the hole appears, to help you further orient yourself on the course. When you're ready to swing, you hit an action button that activates your aim. To get a straight shot you have to hit the action button again as an indicator moves from right to left along the top of the bar. Press it too soon, and you hook your shot to the left; too late gets

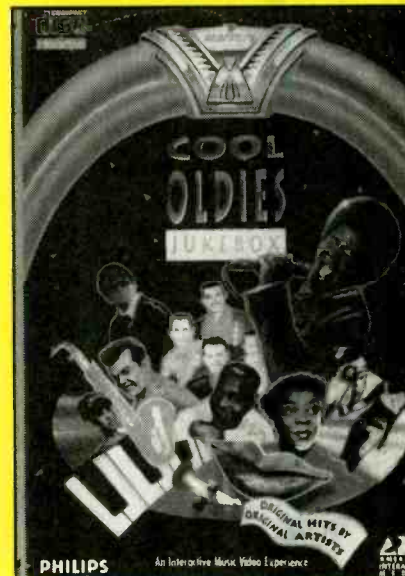

PHILIPS An Interactive Music Video Experience
PIMA's Cool Oldies Jukebox

you a right hook. Next, you select your swing strength in a similar manner. This time, the press of the action button sets your swing in motion.

What makes the game seem more realistic is the running commentary before and after each shot. There are two announcers—a straight man and an wise guy with an Australian accent. Their patter sounds just like what you'd expect from sports commentators. Unfortunately, most of the comments about our play ran along the lines of “Par is nowhere in sight today.” “I agree. It's starting to look like bowling scores.” And, when we had trouble on the green, “This looks like jalopy golf—putt, putt, putt.” They also provide a running commentary about where your last shot went, and pointers for the next one: “You've got an easy shot if you just keep it off to the left.” The comments are often amusing—and there's a much larger variety of them than in most games of this sort. Still, there were times when we would have liked to play in silence. The manual said that it was possible to speed up play by skipping “the stroke display and verbal commentary by pressing an action button,” but we were never able to do so. Nor were we able to “skip the map at the beginning of a turn by pressing an action button.”

When you make a particularly good shot, the “crowd” applauds and an inset shows your player smiling. Bad shots draw a groan from the crowd and an inset of your player looking quite upset.

We are not golfers, but we managed to catch on pretty quickly—at least on the drives. Once we got to the green, it was another story. We never mastered the art of putting, either knocking the ball right off the green or tapping it so that it barely

(Continued on page 19)



Fathom Pictures' ABC Sports Golf: Palm Springs Open

A Walkman Encyclopedia

DATA DISCMAN MODEL DD1-EX. Manufactured by: Sony Corporation of America, Sony Drive, Park Ridge, NJ 07656. Price: \$549.95.

COMPTON'S CONCISE ENCYCLOPEDIA, VERSION 1.0. Published by: Britannica Software Inc., 345 Fourth Street, San Francisco, CA 94107. Price when purchased separately: \$129.95.

In the dozen or so years since the introduction of the Walkman, we've come to expect innovative portable products from Sony. And we haven't been disappointed—there's been the Watchman, the Discman, the Video Walkman, and the portable DAT player. Now that the public has become used to the idea of bringing entertainment devices wherever they go, perhaps the next logical step is carry-along information devices. The general concept isn't new. After all, pocket calculators are indispensable in many fields, and there are plenty of portable electronic spell-checkers, dictionaries, encyclopedias, and even Bibles, on the market today. And now there's Sony's latest, the *Data Discman*.

The Data Discman might have used pocket-sized entertainment and information devices as a springboard, but it represents a giant leap forward. That's because it uses for its information source pint-sized CD-ROM discs called "Electronic

Books"—tapping a technology that was formerly reserved only for people with access to computers equipped with CD-ROM drives. The result is a 4.13 x 1.61 x 5.24-inch device that weighs just 1.5 pounds (including battery) and that provides easy access to, for example, the information contained in all 26 volumes of *Compton's Concise Encyclopedia*. Change discs, and you can look up any phone number contained in the Yellow Pages for the entire country. Change again, and get a ten-language translator, an interactive cookbook, a five-city travel guide, or the *King James Bible*. Then there's the *Library of the Future* disc, which contains the complete text of 150 classic works, including all of Shakespeare, all of Sherlock Holmes, *The Bible*, *The Koran*, *The Book of Mormon*, *The Bhagavad Gita*, *The Word of Buddha*, *The Teachings of Confucius*, *The Illiad*, *The Odyssey*, *War and Peace*, *Leaves of Grass*, *Gulliver's Travels*, and, believe it or not, even more.

Intended for use by people who don't have computers, and might not even want to know the first thing about computers, the Data Discman requires no knowledge of computer-style information-retrieval techniques, lingo, or operation. In fact, it's not much more difficult to use than a Walkman. Using the Data Discman entails learning how to insert an Electronic Book (in keeping with their non-computer stance, Sony rarely refers to them as discs) and operate forward, reverse, fast-forward, fast-reverse, yes, and no buttons. Because each CD-ROM disc has been developed to

Earn Your B.S. Degree in ELECTRONICS or COMPUTERS



By Studying at Home

Grantham College of Engineering, now in our 41st year, is highly experienced in "distance education"—teaching by correspondence—through printed materials, computer materials, fax, and phone.

No commuting to class. Study at your own pace, while continuing on your present job. Learn from easy-to-understand but complete and thorough lesson materials, with additional help from our instructors.

Our Computer B.S. Degree Program includes courses in BASIC, PASCAL and C languages — as well as Assembly Language, MS DOS, CADD, Robotics, and much more.

Our Electronics B.S. Degree Program includes courses in Solid-State Circuit Analysis and Design, Control Systems, Analog/Digital Communications, Microwave Engr, and much more.

An important part of being prepared to *move up* is holding the right college degree, and the absolutely necessary part is knowing your field. Grantham can help you both ways—to learn more and to earn your degree in the process.

Write or phone for our free catalog. Toll free, 1-800-955-2527, or see mailing address below.

Accredited by
the Accrediting Commission of the
National Home Study Council

GRANTHAM
College of Engineering
Grantham College Road
Slidell, LA 70460

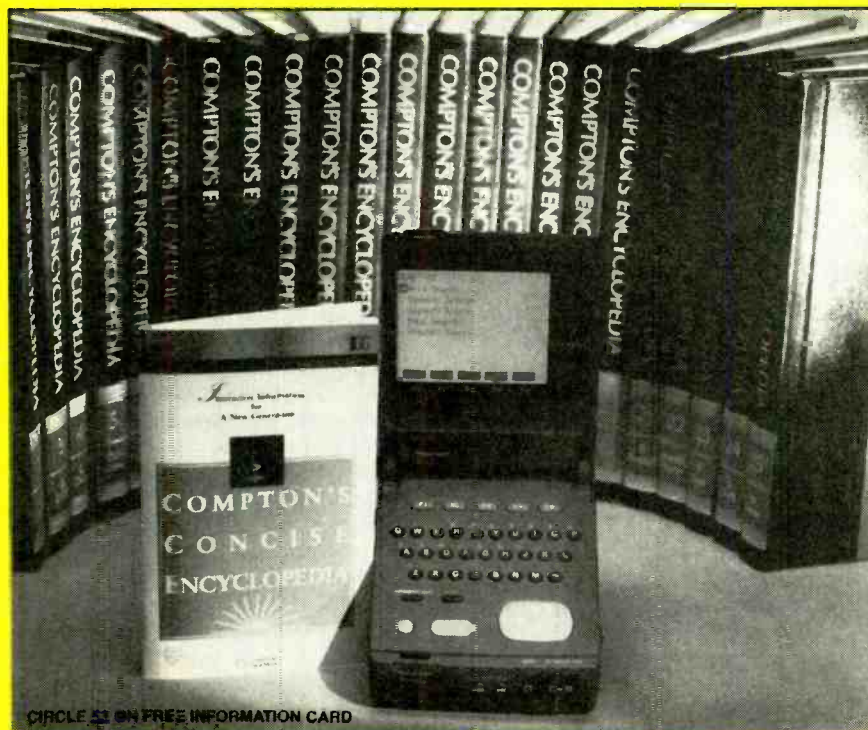

CIRCLE 51 ON FREE INFORMATION CARD

meet the internationally accepted "Electronic Book" standard. All of them are "read" in the same basic fashion. Learn to use one, and there's no need to even glance at the on-screen help for any of the others.

When the Data Discman is closed, the unit's front-panel controls are the only ones visible. Used primarily when listening to 3-inch audio CD's (CD singles), those include stop and play/pause buttons, a volume control, fast-forward and reverse keys, and a headphone jack. The top of the Data Discman flips open to reveal a 3.5-inch (diagonal) LCD screen on the underside of the lid. All the controls, which include five function keys, a tiny QWERTY-style keypad, alpha/numeric and upper- and lower-case shift keys, yes and no keys, and a cursor keypad with four arrows, are on the base of the unit. The control panel also flips open, and Electronic Book discs, in special caddies, are inserted in a slot directly beneath the keyboard.

An Electronic Book is a 3.15-inch optical disc (it looks just like a CD single) that comes inside a caddy that looks just like a 3½-inch microfloppy case. Actually, that's just what it is, but the plastic carrier is about twice as thick as that of a microfloppy. (No caddy is required when playing a CD single.) Each Electronic Book can hold up to 200 megabytes of digital data in text, graphics, or a combination of both. That's the equivalent of about 100,000 printed pages or 32,000 graphic images.

Three Electronic Books are bundled with the Data Discman: *Compton's Concise Encyclopedia* from Britannica Software; Houghton Mifflin's *Wellness Encyclopedia*, a health encyclopedia based on the University of California at Berkeley's *Wellness Letter*; and Passport Books' *World Travel Translator*, a ten-language translator. Our sample unit came with only one of those three—the encyclopedia—but each book is used in the same way, so our description is representative of each.

The start-up screen contains a menu from which you can select to jump right in and start using the encyclopedia, or take your time and watch a demonstration, or peruse the help screens. The cursor keypad is used to move up and down the menu, and the yes button is used to make a selection. At the bottom of this (and every) screen are five boxes that correspond to the five function keys. Not all function keys are active or work the same way at all times; those that are active at any given time will have their function indicated in the on-screen boxes. At the opening screen, the two boxes farthest to the right are labeled "esc" and "sel" and they work precisely the same as the no and yes buttons, respectively, in this case.

We opted first for the demo, which

basically extols the virtues of the Data Discman, and next for the instructions, which are brief and easy to follow. Our pre-production model didn't come with a manual (the manual that will be included wasn't ready yet), but we didn't really miss it—we had no trouble learning to use the Data Discman as we went along.

Then we opted to actually use the encyclopedia. The second menu offers five search options. To use "Word Search," you must type in the first few letters of a word. The system will find and list all words beginning with those letters. Once you select the word you want, the system provides a list of every article heading in which that word appears. "Endword Search" works in the same way, but uses the last letters of a word. Those two searches could come in handy if you're not sure of the spelling.

If you're more confident about your search parameters (and your spelling), "Keyword Search" is more efficient. You can type in up to five words as search criteria. If for example, you were writing a paper on the affect of television on political and social events, and wanted to use President Kennedy as an example, you might type in "Kennedy" and "television." The system lists two related topic headings. The first deals with the Kennedy-Nixon debates, in which Kennedy's good looks and polished television persona were credited with helping him win the 1960 presidential election. The second article deals with the public impact of televised coverage of Kennedy's assassination. Typing in one word gives you a broad search parameter, and each additional word narrows the selection process. If your parameters are too narrow, and no match can be found, you can delete one of your search word by scrolling up to it (using the cursor pad) and then using F2 to activate the delete function (the corresponding on-screen box is labeled "del" to remind you of that option.)

Some Electronic Books also provide a feature called "Multi Search" that provides prompts for those who aren't sure how to properly set up a Keyword Search. We weren't able to try it, but according to Sony, the publisher can pre-program up to four questions. The user's answers are then used as keywords for a "Keyword Search."

Some people—including us—enjoy simply browsing through reference books, looking for interesting tidbits, and two menu options provide different ways to do just that. "Menu Search" allows you to scroll through a list of general topics. Each time you select a topic, a more specific list of topics appears in successive menus (similar to the arrangement of a table of contents in a book). In the "Graphics Search" mode, you can scroll through

every graphic contained in the encyclopedia. When one catches your interest, you can use the yes key to see the related article or articles.

Once you're actually reading an article, bold arrows occasionally appear on screen, pointing to words about which other articles contain additional, related information. You can opt to jump to that other article, using what Sony calls a "Consultation Search," and then return to the original article, or keep jumping to find additional text or graphic information. It's a lot easier than having to pull out different printed volumes for each related article.

As we used the encyclopedia (and two other titles that will be discussed next month), we were impressed by how intuitive the system is, and how easy it is to navigate through volumes of data. We like knowing that any other Electronic Book we tried would function in the same manner—we wouldn't have to waste any time learning to use each piece of software. And we like its versatility. The unit comes with a rechargeable battery pack and an AC adaptor. It can also run off a car battery, using an optional DC adaptor, or can use standard "AA" batteries.

There are, however, some problems inherent in such a small package. First of all, the screen is tiny, displaying only 10 lines of 30 characters each. It has adjustable contrast, a back light, and is certainly legible, but you really wouldn't want to read the complete works of William Shakespeare on a screen that size. There is a composite video output, however, so you can view the data on a television monitor—ten lines at a time. You can scroll through text line by line by pressing the up or down arrows on the cursor keypad, or page by page using the left or right arrows, but neither action is particularly smooth. We would have liked to see a steady scroll mode, with an adjustable scrolling rate, for extended reading sessions. The keyboard is also quite tiny, making it somewhat difficult to input words.

At its introduction in November, there were to be 23 Electronic Books available. Those include games, reference works, travel guides, business guides, cookbooks, airline flight information, movie reviews, and current-events reviews. Ten new titles were to be released in January, with more to follow each month. We can certainly see the advantage to carrying an interactive travel guide and a translator disc on vacation or business trips. And an electronic cookbook on a portable device that can be used in the kitchen makes more sense than one on a computer in the den or hooked up to a TV in the living room.

Sony might just have come up with the information equivalent to the Walkman. ■

5 sure steps to a fast start as a high-paid computer service technician

1. Choose training that's right for today's good jobs

Jobs for computer service technicians will almost double in the next 10 years, according to the latest Department of Labor projections. For you, that means unlimited opportunities for advancement, a new career, or even a computer service business of your own.

But to succeed in computer service today, you need training—complete, practical training that gives you the confidence to service any brand of computer. You need NRI training.

Only NRI—the leader in career-building, at-home electronics training for more than 75 years—gives you practical knowledge, hands-on skill, and real-world experience with a powerful 386sx/20 MHz computer you keep. Only NRI gives you everything you need for a fast start as a high-paid computer service technician.

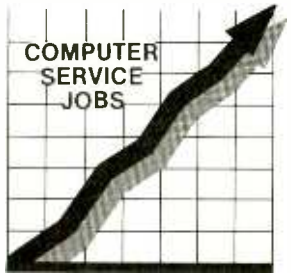

1992 Good pay, too! 2002

Plus, now you train with and keep the latest in diagnostic hardware and software: the R.A.C.E.R. plug-in diagnostic card and QuickTech diagnostic software, both from Ultra-X. Using these state-of-the-art diagnostic tools, you learn to quickly identify and service virtually any computer problem on IBM-compatible machines.

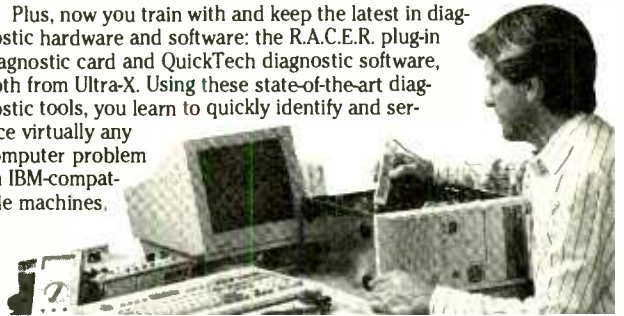

4. Make sure you've always got someone to turn to for help



Throughout your NRI training, you've got the full support of your personal NRI instructor and the entire NRI technical staff. Always ready to answer your questions and help you if you should hit a snag, your instructors will make you feel as if you're in a classroom of one, giving you as much time and personal attention as you need.

5. Step into a bright new future in computer service—start by sending for your FREE catalog today!

Discover for yourself how easy NRI makes it to succeed in computer service. Send today for NRI's big, full-color catalog describing every aspect of NRI's one-of-a-kind computer training, as well as training in TV/video/audio servicing, telecommunications, industrial electronics, and other growing high-tech career fields.

If the coupon is missing, write to: NRI School of Electronics, McGraw-Hill Continuing Education Center, 4401 Connecticut Avenue, NW, Washington, DC 20008.

R.A.C.E.R. and QuickTech are registered trademarks of Ultra-X, INC.



2. Go beyond "book learning" to get true hands-on experience

NRI knows you learn better by doing. So NRI training works overtime to give you that invaluable practical experience. You first read about the subject,

studying diagrams, schematics, and photos that make the subject even clearer. Then you do. You build, examine, remove, test, repair, replace. You discover for yourself the feel of the real thing, the confidence gained only with experience.

3. Get inside a powerful computer system

If you really want to get ahead in computer service, you have to get inside a state-of-the-art computer system. That's why NRI now includes the powerful new West Coast 386sx/20 MHz mini tower computer as the centerpiece of your hands-on training.

As you build this 1 meg RAM, 32-bit CPU computer from the keyboard up, you actually see for yourself how each section of your computer works. You assemble and test your computer's "intelligent" keyboard, install the power supply and high-density floppy disk drive, then interface the high-resolution monitor. But that's not all.

You go on to install a powerful new 40 meg IDE hard disk drive—today's most-wanted computer peripheral—included in your course to dramatically increase the data storage capacity of your computer while giving you lightning-quick data access.



	For career courses approved under GI Bill <input type="checkbox"/> check for details.
<input checked="" type="checkbox"/> CHECK ONE CATALOG ONLY	
<input type="checkbox"/> Microcomputer Servicing	<input type="checkbox"/> Computer Programming
<input type="checkbox"/> TV/Video/Audio Servicing	<input type="checkbox"/> PC Software Engineering Using C
<input type="checkbox"/> Telecommunications	<input type="checkbox"/> Desktop Publishing & Design
<input type="checkbox"/> Industrial Electronics/Robotics	<input type="checkbox"/> Word Processing Home Business
<input type="checkbox"/> Basic Electronics	<input type="checkbox"/> Bookkeeping & Accounting
Name _____	
Address _____	
City _____ State _____ Zip _____	
Accredited Member, National Home Study Council 18-022	

Romming Around the World

CDD461RS CD-ROM DRIVE AND CD-AUDIO PLAYER. Manufactured by: Magnavox, One Philips Drive, P.O. Box 14810, Knoxville, TN 37914. Price: \$549.

THE NEW GROLIER ELECTRONIC ENCYCLOPEDIA. Published by: Grolier Electronic Publishing, Inc., Sherman Turnpike, Danbury, CT 06816. Price when purchased separately: \$395.

MICROSOFT BOOKSHELF. Published by: Microsoft Corp., One Microsoft Way, Redmond, WA 98052. Price when purchased separately: \$295.

PC GLOBE ELECTRONIC ATLAS. Published by: PC Globe Inc., 4700 S. McClintock, Suite 150, Tempe, AZ 85282. Price when purchased separately: \$79.95.

PC-SIG LIBRARY. Published by: PC-SIG, 1030 D East Duane Ave., Sunnyvale, CA 94086. Price when purchased separately: \$299.

Even before there were "official" multimedia computers—that is, PC's that meet the specifications put forward by the MPC Marketing Council—there were multimedia computers. That's because as early as 1985, CD-ROM drives with digital audio outputs became available.

In those early days, most CD-ROM software either didn't or couldn't take advantage of the audio outputs. So what did computer users do with their audio outputs? Fortunately, nearly all CD-ROM drives that supported audio also included memory-resident programs that would allow you to play audio CD's. In effect, the program turned your CD-ROM drive into a standard CD player.

Because CD-ROM drives are typically used during only a small portion of the time that their host computer is used, a CD-ROM drive with a CD-audio-play program can be a cost-effective way to add compact-disc audio to your office or work area. You'll enjoy not only the novelty of using your computer as an audio device, but the knowledge that you're getting your money's worth from your drive. There used to be one aspect of that setup that we didn't like, however. We don't always have our computer on when we work, and we didn't like having to boot up our computer and run the audio-play software just to listen to our latest CD.



Finally, someone has come up with an elegant solution: Magnavox has introduced their *CDD461RS Combination CD-ROM Drive and CD-Audio Player*. Unlike other CD-ROM drives, the Magnavox unit has front-panel controls for audio functions. The rear panel offers standard RCA-type phono jacks for audio outputs, and a 15-pin data I/O connector. You don't even have to hook the drive up to a computer to use it simply as a CD player. You do, however, have to hook it up to an audio amplifier, or plug a set of headphones into the front-panel jack.

Along with the headphone jack, the front panel of the CDD461 features other controls that you might expect to find on a CD audio player: play and pause buttons, previous- and next-track buttons, a "shuffle" button that lets you play CD tracks in a random order, and a button that stops play and opens and closes the disc drawer (which is a big improvement over the CD-carrier caddy used by most CD-ROM drives). A two-digit display keeps you informed of the track being played.

Many potential users will be interested in an external CD-ROM drive not only because it's easier to hook up an external drive to an audio amplifier, but because many computers don't have enough room to mount an internal drive! The drive is not small when compared to external drives on the market; it measures about 3½-inches high, 14-inches wide, and 12-inches deep. It's about the right size to fit underneath your monitor.

Hooking up the drive is a reasonably simple procedure. A host interface board must be installed in an empty 8-bit slot in your computer. Four jumpers must be set on the board, two for the I/O address where the board will reside, and two for

the DMA (Direct Memory Access) channel that it will use. (Actually, it's likely that the default settings will work fine.)

After the hardware is installed, the MS-DOS CD-ROM Extensions and the driver software must be installed. The CD-ROM extensions make it possible for the MS-DOS operating system to access data on the CD-ROM. The CD-ROM device driver provides a device-specific interface between the MS-DOS extensions and the drive's interface board. When the software is installed, your computer treats the CD-ROM drive just like any other drive, albeit one you can't write to.

Although it's possible to install the software manually, an INSTALL program handles all of the details—such as changing your AUTOEXEC.BAT and CONFIG.SYS files—for you. You don't have to worry about what a device driver is or what CD-ROM extensions are needed to get everything working properly. The manual also provides instructions on how to install the software in a non-automatic way.

Even with the simple front-panel controls, the drive comes with two audio-play programs. One is a memory-resident program that brings up on screen a "front panel" of a CD player. A Windows version of the software is also supplied. We have two misgivings, however. Even with the power of a PC controlling the drive, you can't program songs to play in a particular order. (You can, however, play all the songs on a disc in a random order.) Also, once you decide to use the audio-play software, the front-panel controls become useless; you have to open and close the disc drawer to reset the drive and restore front-panel control.

Although playing CD audio discs on a CD-ROM drive is a nice feature and a good

way to pass the time, it's not what a CD-ROM drive is really for. But Magnavox has bundled some popular and useful CD-ROM applications: *The New Grolier Electronic Encyclopedia*, *Microsoft Bookshelf*, *PC Globe Pak*, and *The PC-SIG Library*.

While *The New Grolier Electronic Encyclopedia* is not an MPC application, with its audio outputs and numerous photos it is a multimedia product. It's an excellent product that normally sells for \$395.

Microsoft Bookshelf is another excellent choice for demonstrating the capabilities of CD-ROM. It contains a "bookshelf-full" of reference tools: *The American Heritage Dictionary*, *Roget's Electronic Thesaurus*, *The World Almanac and Book of Facts*, *Bartlett's Familiar Quotations*, *The Chicago Manual of Style*, *Forms and Letters*, *Houghton Mifflin Usage Alert and Spelling Verifier and Corrector*, and the *U.S. ZIP Code Directory*.

PC Globe Pak contains three programs from PC Globe, Inc.: *PC Globe*, *PC USA*, and *GeoJigsaw*. They're fine programs, but there's no added value over the floppy-disk versions.

The PC-SIG Library contains thousands of shareware and public-domain programs from the PC Software Interest Group. Programs range from word processors and database managers to ham-radio software. The sheer volume of titles on the disk is impressive.

The four bundled titles are all standard CD-ROM titles. It's unclear, however, whether the marketing strength of the Multimedia PC Marketing Council will result in software manufacturers "forgetting" that non-multimedia PC's with CD-ROM drives exist. Even if that were to happen, however, you don't have too much to worry about because you can use the Magnavox drive in a multimedia system. CD-ROM and MPC are not inherently incompatible, and the average transfer rate and seek time are within the specifications of the MPC. Assuming your PC's processor and memory meet the minimum specifications for an MPC, adding an audio card will turn your present PC into an MPC. The CDD461 might represent the way to go for PC owners who want to get their feet wet before taking the multimedia plunge. ■



"I took parts from a TV, VCR, and a radio and got a TV, VCR, and radio that don't work."

IMAGINATION THAT

(Continued from page 12)

moved. Maybe it just takes a while to get used to slopes and breaks; we have been improving with practice.

Instead of Golden Oldies Jukebox (which contains songs by Ricky Nelson, The Diamonds, and The Big Bopper, among others), we received Cool Oldies Jukebox, which features primarily soul tunes from the 1950's and 1960's by artists like The Platters, James Brown, and Jerry Butler. The main screen looks like an old-fashioned jukebox, but a picture of each artist is displayed as you flip through the selections. To select a song, you point and click on the artist.

As each song plays, you can look at a picture of the artist or a "slide show" of pictures, or have the lyrics scrolled on the screen, or you can opt for "Trackfax," which displays a combination of graphics and "liner notes." Those consist of a brief biography of the artist, along with facts pertaining to the year the song became a hit. For example, during Janis Ian's "Society's Child," a song about a forbidden interracial romance, the graphics and text described related social and political

events from 1967: Thurgood Marshall's appointment to the Supreme Court, and the release of films dealing with racial relations, such as "Guess Who's Coming to Dinner." Granted, not every "Trackfax" ties in so well with the song—we could find no common ground between the song "Apple, Peaches, Pumpkin Pie" and Vietnam War protests, except that the protests occurred during the year that the song was released. There are also trivia questions ("What Broadway Musical was inspired by the life of Conway Twitty?"—"Bye-Bye Birdie"), and you can create and store your own customized play lists—which is another use for CD-I's memory function.

We tried out quite a few CD-I titles. Surprisingly, there was no electronic encyclopedia among the launch titles. And we didn't get the chance to play any videogame-type programs. However, by the time you read this, Super Mario, Princess Zelda, Link, and Donkey Kong should have joined the ranks of CD-I titles. We're sure that the release of those and other games will endear the CD-I player to quite a few souls.

They say good things are worth waiting for. We'd imagine that CD-I falls into that category. ■

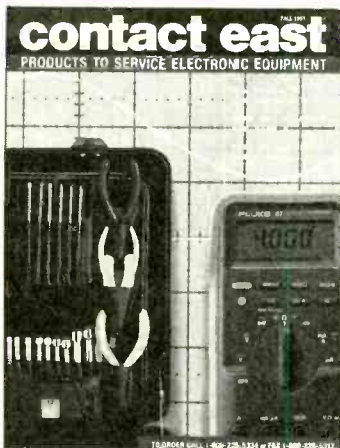

FREE CATALOG TEST INSTRUMENTS & HARD-TO-FIND TOOLS

Packed with over 10,000 quality products for testing, repairing, and assembling electronic equipment. A full selection of test instruments, power protection equipment, precision hand tools, tool kits, soldering supplies, and much more. Products are shown in full color with detailed descriptions and pricing. All products come with a 100% satisfaction guarantee. SAME-DAY shipment program.

In a hurry to receive your catalog?

Call (800) 225-5370

In Massachusetts call (508) 682-2000

Contact East, Inc., Dept. R494

335 Willow St., No. Andover, MA 01845

CIRCLE 9 ON FREE INFORMATION CARD

Be an FCC LICENSED ELECTRONIC TECHNICIAN!



No costly school. No commuting to class. The Original Home-Study course prepares you for the "FCC Commercial Radiotelephone License." This valuable license is your professional "ticket" to thousands of exciting jobs in Communications, Radio-TV, Microwave, Maritime, Radar, Avionics and more...even start your own business! You don't need a college degree to qualify, but you do need an FCC License.

No Need to Quit Your Job or Go To School This proven course is easy, fast and low cost! **GUARANTEED PASS**—You get your FCC License or money refunded. **Send for FREE facts now. MAIL COUPON TODAY!**

COMMAND PRODUCTIONS

FCC LICENSE TRAINING, Dept. 100
P.O. Box 2824, San Francisco, CA 94126
Please rush FREE details immediately!

NAME _____
ADDRESS _____
CITY _____ STATE _____ ZIP _____

You've Come a Long Way, PC

2500 SX/20 MULTIMEDIA PC. Manufactured by Tandy Corporation, 700 One Tandy Center, Fort Worth, TX 76102. Price: \$2999.

MULTIMEDIA BEETHOVEN: THE NINTH SYMPHONY. Published by: Microsoft Corporation, One Microsoft Way, Redmond, WA 98052. Price: \$79.95.

Personal computers have come a long way in the last decade. A long way from the early text-filled green-screen machines that, at most, beeped at you.

When the IBM PC was first introduced, it didn't look as if it was going to change the computer world too much. Even when IBM brought out their color adapter and display, they were greeted by sneers from most. "Who needs color? Isn't that what they use on 'toy' computers?"

Apple's Macintosh computer changed the way people thought about the importance of graphics on computers. The PC-compatible world played catch-up for some time, trying to match the graphics and ease-of-use features of the Macintosh. They seem pretty certain that they've finally got a winner with the multimedia PC.

Tandy, one of the charter members of the Multimedia PC Marketing Council, is also one of the first to offer Multimedia PC's—that is, complete, ready-to-use computers that conform to the MPC specifications. But what is this thing called MPC? According to a Tandy brochure, "A multimedia personal computer combines text, impressive graphics, high-quality sound, animation, and interactivity in a powerful yet affordable system. It gives us new and better ways to conduct business, to teach and learn, and to have fun."

Five different MPC models are available from Tandy, ranging in price from \$2799 to \$5499 depending on the microprocessor, internal memory, etc. We tried one of their middle-of-the-road MPC machines, the 2500 SX/20, a PC running an 80386SX processor at 20 MHz. It has a 52-megabyte hard drive, 2 megabytes of RAM, and a VGA graphics adapter. Of course, since it is a Multimedia PC, it also contains a CD-ROM drive with audio outputs and an internal audio board.

The 2500 SX/20 computer is pre-loaded with software and is practically ready to run when you take it out of the box. You first have to attach a monitor (which is not included with the PC), a mouse, and a keyboard. But few hookups could be easier. The rear panel has labels above the



connectors, and making the right connection is a snap—each cable can be connected in only one way. Turning the power switch on is all that's left.

When powered up, the PC expects to see the supplied Multimedia System Disc in the CD-ROM drive. If it's not there, you're greeted with an on-screen message to "Insert the disc and hit Enter to continue." There's even a picture to show how it's done. We like the idea. Unfortunately, it doesn't work. When you hit the enter key, nothing happens—you have to reboot the machine with the disc in place before it works correctly. That's not a major problem; we imagine that most people would press the front-panel reset button when they ran into trouble. But it is sloppy.

The system disc contains tutorials on using the mouse and hooking up headphones. It also contains various demonstration programs, and some applications, including *MusicBox*, which lets you play audio CD's in the CD-ROM drive. If we were cynical, we would say that the disc is nothing more than an advertisement for some new multimedia titles. Instead, we'll say that it's a valuable demonstration of some of the power of multimedia. It gives examples of everything from *Mixed Up Mother Goose* to Time Magazine's *Desert Storm* to Microsoft's *Multimedia Beethoven*.

Also included on the disc is Microsoft Windows with Multimedia Version 1.0 (which you shouldn't have to even think about unless your hard drive crashes since

the software is pre-installed). Windows, of course, is a graphical user interface for PC's that is supposed to make using computers easier by making their operation more intuitive. If you've ever watched a new user in front of Windows, you know that its operation is not necessarily intuitive. But the extraordinary popularity of Windows does have a decided benefit—it makes program developers design their user interfaces the same way. So once you know how to run Windows, you'll be able to run any program that runs under Windows.

If you want to use a Multimedia PC, you had better get used to Windows. The default system software is Microsoft Windows version 3.0 or later with Microsoft's Multimedia Extensions version 1.0 or later. The Extensions add support for multimedia devices and multimedia data types. That is, they provide a common way to access sound and animation (and even video—although no such applications are available yet).

Included on the system disc is HyperGuide, an easy-to-use "manual" for Windows with Multimedia. As with any other Windows application, HyperGuide is intuitive only to people who have used Windows before. However, a paper manual supplied with the computer should get neophytes up and running HyperGuide in no time, and HyperGuide should have them proficient in Windows in short order as well.

Once you browse the system disc, you'll

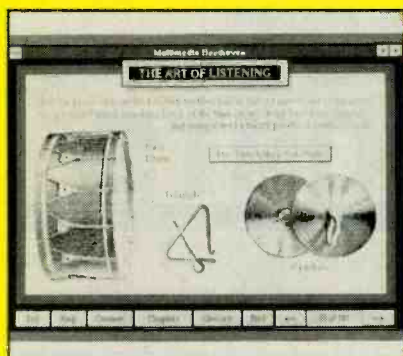

Multimedia Beethoven: The Ninth Symphony

be itching to insert your own applications. To do that, you press the drive's faceplate. That unlatches the drive from its locked position, and it springs out partially from its bay. When you pull the drive out fully, you can lift the disc cover and insert a CD-ROM disc on the platter. To play the disc, you must close the drive cover and push the drive back into its latched position.

We think the drive is a pretty good compromise. It's not as elegant as a sliding tray like the kind we're used to with our CD-audio players. But it's a heck of a lot more convenient than drives that require that the disc be inserted into a "disc caddy" carrier before it can be put in the drive. (That may not sound like so big a deal. But when you must switch between several CD-ROM's, it gets quite bothersome.) We do have a complaint, however. Because the disc drawer must slide out, you can't put your keyboard immediately in front of the base unit or it will make it impossible to open the disc tray without sliding it out of the way.

The sound board included in the computer is the "Sound Blaster Pro." It features line and microphone inputs, an audio output jack, a joystick/MIDI port, and volume control. (No speakers or headphones are included with the computer, though—a mistake in our book.) The board also offers a CD-ROM data interface, but it's not used. Instead, a separate CD-ROM interface board is used, leaving the computer with two 16-bit slots open for further expansion.

Multimedia PC's will undoubtedly be a winner in the new interactive and multimedia market. They may not be the only winner, however. They have an advantage over other formats in that there is already a large base of machines that can be upgraded to be compatible with the MPC standard. The disadvantage they face is the fear that many people have of computers. That, however, may be overcome by the almost sure acceptance of MPC's in the schools, which are always interested in finding new teaching tools.

The teaching power of multimedia seems to be real. When we were presented

with the opening menu on Tandy's system disc, we simply clicked on the audio icon next to one of the four selections to hear a description of what each choice would do—a totally painless way to learn how to use the system.

The best educational example we've seen yet is *Multimedia Beethoven: The Ninth Symphony*, a Voyager Company title licensed by Microsoft. It uses on-screen text and graphics to teach us about Beethoven. It adds sound to the visual presentation to teach us about Beethoven's music. We can listen to the symphony measure-by-measure as an on-screen commentary helps us to appreciate some aspects that we would otherwise overlook. Concepts that might be missed when listening to the complete orchestra can be played through the sound board, where the concept is isolated. We'll never listen to Beethoven's Ninth the same way again.

School districts will use MPC's as a substitute or supplement for textbooks. There's been enthusiastic response so far. And with a standard in place, that enthusiasm will undoubtedly grow. And we can just imagine how businesses will use MPC's to teach and train employees.

That's not to say that consumers aren't important potential MPC customers, too. Don't forget that Multimedia PC's are standard DOS PC's, too. There are a lot of potential applications in the home for a PC besides playing multimedia titles. Anyone looking for a one-stop solution for multimedia will find that Tandy's MPC machines are worth more than just a look. ■

SLOW—BUT READY—WINS

(Continued from page 10)

ments. For each one, you see a drawing, and hear a scale played and then a few bars of music in the style typically played on that instrument (a polka on the accordion, a jazz riff on the saxophone, etc.). Many animal articles also have photographs and sound accompaniments, allowing you to hear a lion roar or a bear growl. It certainly makes doing research more exciting than using the old-fashioned print encyclopedias.

Lemmings, on the other hand, is pure entertainment. Actually, it's not much different from standard videogames, except that it comes on a CD-ROM disc instead of in a game cartridge, and that its audio quality is far superior. The goal is to help "hordes of mindless but delightful" lemmings, which drop from a trapdoor into a hostile environment, reach a safe haven. The problem is that, like their real-world namesakes, the creatures will follow each other, single file, over cliffs or into the sea, unless you help them by endowing individual lemmings with special powers that

enable them to dig down, across, or diagonally through obstacles; to build bridges across chasms; to act as a blocker, stopping their buddies from reaching a trouble spot; and to float instead of fall. To do so, you must move the cursor to the appropriate icon at the bottom of the screen, click the "A" button, and then move the cursor up to the lemming who is to be transformed (always a moving target). Each level of play is more difficult than the last, and the beginning levels are basically training courses in how each of the powers can be used to save the lemmings. As you reach the higher levels of play (there are 120 in all) especially, you need to move around the screen quickly and accurately. This is one of those cases when a mouse or joystick would be a tremendous improvement over the remote control—but we did pretty well even with that handicap.

The combination of Grolier's and Lemmings is a smart move on Commodore's part, giving buyers a look at two distinctly different sides of CDTV. The encyclopedia is sure to appeal to any parents who have been considering shelling out a few hundred dollars and several linear feet of shelf space for the printed version. And if Lemmings has the same addictive effect on other CDTV users as it did on us, then it will serve to quickly familiarize newcomers with the new system.

Those two discs didn't suffer from the lag-time problems of the CDTV introductory disc. Once a search is completed in Grolier's, you move quickly through the articles, and sound and illustrations are accessed promptly. Lemmings is fast-moving (often too fast for us beginners!). Unfortunately, the same cannot be said for most of the CDTV titles we tried, especially compared to similar programs used on other interactive and multimedia systems. The lag time between pressing a button and seeing a response appear on screen was frustrating, to say the least, and we usually found ourselves hitting the buttons more than once, not sure whether our first try had registered. Commodore might have won the race to the market, but when it comes to playing speed, it comes in last.

But don't count CDTV out. There are a few groups of people that will appreciate its other features. For example, those who think that they might, at some time in the future, want to buy a computer are getting in CDTV the option to upgrade fairly easily and inexpensively to an Amiga. Electronic musicians—many of whom are already Amiga enthusiasts—will find several MIDI applications among the many CDTV titles. And then there's Commodore's loyal following of Amiga owners, many of whom would be more likely to select another Commodore product—and get the option to expand to have another Amiga—when shopping for a multimedia player. ■

PRODUCT TEST REPORTS

By Len Feldman

Canon E40 8mm Video Camcorder

The trend towards smaller, lighter, yet full-featured 8mm video camcorders continues. One of the latest entries is Canon's Model E40, weighing in at just over 2 pounds (if you don't include the battery and cassette) and measuring only 4¹⁵/₁₆ inches wide by 11⁷/₁₆ inches deep by 4¹⁵/₁₆ inches high. The cam-



CIRCLE 120 ON FREE INFORMATION CARD

The Canon E40 8mm Camcorder.

cord incorporates a high-resolution 1/3-inch CCD pickup, an infrared auto focus system, a gain-up (increased gain) switch for low-light recording, and a scrolling character generator (with two scroll modes) that allows titles and dates to be superimposed on the video when dubbing to a VCR.

The camcorder features what Canon calls their 180-degree Flexigrip, a com-

ination rotating grip and viewfinder that makes shooting at any angle easier. The Flexigrip arrangement also serves as a protective covering for the camcorder's audio and video outputs. The E40 features a 7.0-56mm f1.8, 8-times power-zoom lens with 1/1000th and 1/100th of a second high-speed shutter modes. For accurate exposures, the E40 uses a correlated two-field metering system and auto backlight compensation.

Other features on this camcorder include fade-to-white (with simultaneous sound-track fading), automatic dating, self timer (with 10- or 30-second delay), interval timer, (records for 1/2-second intervals every 10, 20, or 60 seconds), 20x high-speed search, flying erase head, automatic stop and power-off, record search and review, and recording reminder (a 10-second timekeeper for avoiding overly short or long scenes that is visible in the electronic viewfinder).

The E40 is powered by a supplied BP-E77K battery pack that provides 45 minutes of continuous recording. Other supplied accessories include an AC battery charger, a DC coupler (used when powering the camcorder from the AC charger), an RF modulator (used for viewing tapes via TV sets that are not equipped with direct audio and video inputs), a shoulder strap, and a lens cap that can be attached

to the hand-grip strap using a supplied lens-cap cord so that the lens cap will never be accidentally lost. A wide variety of optional accessories is available as well, such as carrying cases, a car battery adaptor, a wireless remote control, a higher capacity battery pack, a battery-operated video light, and an assortment of lens converters and filters, all of which are detailed in the 85-page operating manual that comes with the E40.

CONTROLS

Along the left side of the camcorder body are a title character button, the date button, an auto/manual-focus selector button, the white-balance selector (with settings for automatic white balance, lock, and gain up), the fade button, and the shutter-speed selector button. The cassette compartment is also found on this side of the camcorder body. Controls along the top surface of the camcorder include a cassette-eject button; the power switch; a mode selector switch (camera or playback) and its associated indicator light; the interval timer button; set, shift, and forward and reverse search buttons associated with creating titles for your videos; and a counter reset button. The set, shift, and search buttons become play, stop, fast forward, and fast reverse buttons during tape playback.

On the right side of the camcorder body, near the

Why take chances in today's job market?

Graduate as a fully trained electronics professional.

To get ahead and stay ahead in today's economy, you need the electronics training CIE has been providing its 150,000-plus successful graduates with for nearly 60 years.

Meet the Electronics Specialists.

When you pick an electronics school, you're getting ready to invest time and money. And your whole future depends on the education you receive in return. That's why it makes so much sense to go with number one... with the specialists... with CIE!

There's no such thing as a bargain education.

If you talk to some of our graduates, and we recommend you do, chances are you'd find a lot of them shopped around for their training. Not for the lowest priced, but for the best training available. They pretty much knew what was available when they picked CIE as number one.

Because we're specialists we have to stay ahead.

At CIE we have a position of leadership to maintain. Here are just a few of the ways we hang onto it...

Programmed Learning.

That's exactly what happens with CIE's Auto-Programmed Lessons®. Each lesson uses famous "programmed learning" methods to teach you important electronics principles. You explore them, master them completely, before you start to apply them. You thoroughly understand each step before you go on to the next. You learn at your own pace.

And, beyond theory, some courses come fully equipped with electronics equipment to actually let you perform hundreds of hands-on experiments.

Experienced specialists work closely with you.

Even though you study at home, CIE's faculty and staff stand ready to assist via CIE's toll free number. And, each time you return a completed exam you can

be sure it will be reviewed, graded and returned with the appropriate instructional help, you get it fast and in writing from the faculty technical specialist best qualified to answer your question in terms you can understand.

Pick the pace that's right for you.

CIE understands people need to learn at their own pace. There's no pressure to keep up...no slow learners hold you back. If you're a beginner, you start with the basics. If you already know some electronics, you move ahead to your own level.

"Same Day" grading cycle.

When we receive your lesson, we grade it and mail it back the same day. You find out quickly how well you're doing!

State-of-the-art laboratory equipment.

Some courses feature the CIE Microprocessor



Training Laboratory. An integral part of computers, microprocessor technology is used in many phases of business, including service and manufacturing industries. The MTL gives you the opportunity to program it and interface it with LED displays, memory devices and switches. You'll gain all the experience

needed to work with state-of-the-art equipment of today and tomorrow.

New Courses!

CIE now offers two new career courses: Automotive Electronics and Computer Operation and Programming.

CIE offers you an Associate Degree.

One of the best credentials you can have in electronics — or any other career field — is a college degree. That's why CIE offers an Associate in Applied Science in Electronics Engineering Technology. And all CIE career courses earn credit toward your degrees.

Which CIE training fits you?

Beginner? Intermediate? Advanced? CIE home study courses are designed for ambitious people at all entry levels. People who have: No previous electronics knowledge, but do have an interest in it; Some basic knowledge or experience in electronics; In-depth working experience or prior training in electronics.

At CIE you start where you fit and feel comfortable where you start, then go on from there to your Diploma, Associate Degree and career!

Today is the day. Send now.

Fill in and return the postage-paid card attached. If some ambitious person has already removed it, cut out and mail the coupon below. You'll get a FREE CIE school catalog, plus complete information on independent home study. Mail in the coupon below or, if you prefer, call toll-free 1-800-321-2155 (in Ohio, 1-800-523-9109).

YES! I want to get started. Send me my CIE school catalog including details about the Associate Degree program. (For your convenience, CIE will have a representative contact you — there is no obligation.) **AH25**

Print Name _____

Address _____ Apt. _____

City _____ State _____ Zip _____

Age _____ Area Code/Phone No. (_____) _____

Check box for G.I. Bulletin on Educational Benefits Veteran Active Duty

CIE CLEVELAND INSTITUTE OF ELECTRONICS, INC.
1776 East 17th Street • Cleveland, Ohio 44114 • (216) 781-9400



A school of thousands.
A class of one.
Since 1934.



Accessories supplied with the E40 include an AC battery charger, a DC coupler, an RF modulator, and a shoulder strap.

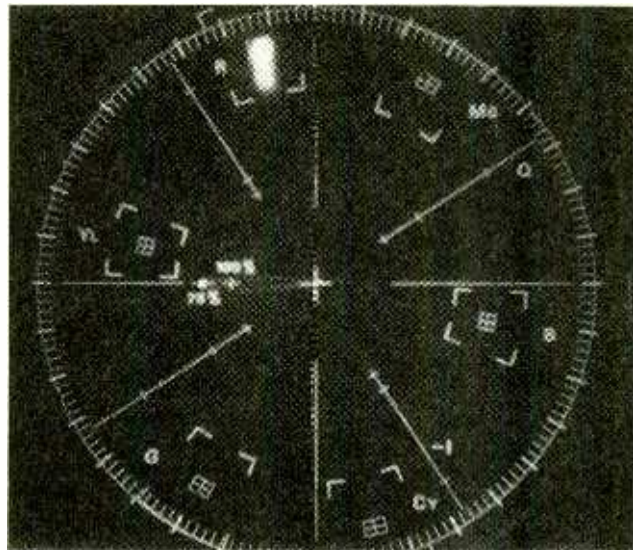

As shown in this vectorscope photo, phase accuracy and color saturation were as perfect as APEL has ever measured for an 8mm camcorder.

bottom of the unit, are the video and audio outputs and the DC-voltage input terminals that are normally covered by the adjustable Flexigrip feature mentioned earlier. The start/stop button is conveniently located below the viewfinder so that your thumb engages it when you hold the camcorder by its hand-grip strap, while your forefinger and middle finger fall naturally on the power-zoom buttons above the viewfinder.

The viewfinder has a diopter adjustment ring so that those who wear glasses need not wear them when peering through the viewfinder. The usual tripod screw-thread socket is found on the underside of the camcorder, where a tiny compartment housing a long-life lithium battery is also located. This battery is used to maintain the time and date information, as well as any titles created, in memory.

TEST RESULTS

As usual, the camcorder was turned over to the Advanced Product Evaluation Laboratory (APEL) for testing. APEL determined that with the sensitivity switch in the gain-up position, mini-

mum required illumination was 2.1 lux, which is close enough to the 2.0 lux claimed by Canon. In the normal setting of this switch, minimum illumination was 4.3 lux. The white-balance adjustment was found to be below average, both in the auto and white-balance lock modes, with readings of 10 IRE when the camcorder was pointed at a white surface. White-bal-

once readings indicate the amount of chrominance (color) that appears on a neutral or white object when the balance control is set for optimum, with lower readings being better. Color contamination, or the appearance of color bursts on a fine black and white pattern was also unduly

high, with an initial reading of 30 IRE. Suspecting that we might be dealing with a faulty unit, APEL acquired a second sample. While it was considerably better than the first one, the 20 IRE reading for color contamination on this unit was also well above average. Phase accuracy and color saturation, on the other hand, were as perfect as APEL has ever measured for an 8mm camcorder.

As is true of nearly all CCD-pickup based camcorders, there was virtually no streaking, lag, or image retention when panning quickly across a scene that included points of light. The camera's horizontal resolution measured 350 lines, but for a complete record/play cycle, resolution decreased to a still better-than-average 250 lines. The chroma AM signal-to-noise ratio read directly from the camera output was 46.0 dB, while the luminance signal-to-noise ratio measured in this way was 39.6 dB. These readings are typical of what we have come to expect from standard 8mm camcorder equipment. Going through the entire

TEST RESULTS—CANON E40 8mm VIDEO CAMCORDER

Specification	Mfr's Claim	PE Measured
Video Section		
Minimum illumination		
Gain up setting	2.0 lux	2.1 lux
Normal setting	N/A	4.3 lux
White balance	N/A	10 IRE
Color contamination	N/A	20 IRE*
Horizontal resolution		
Camera	320 lines	350 lines
Record/play	240 lines	250 lines
Signal-to-noise ratio		
camera, chroma AM	43 dB	46 dB
camera, luminance	40 dB	39.6 dB
Minimum focus distance	24 inches	23 inches
Wide macro focus	4 mm	Confirmed
Audio Section		
Max. microphone output	N/A	0.42 volts
Additional Data		
Power requirements	6.6 W	8.5 W
Weight (less battery/cassette)	2.05 lbs.	N/A
Weight (with battery/cassette)	N/A	2.75 lbs
Suggested retail price:	\$1249.00	

*Measured for second sample obtained from manufacturer

record/play cycles, the chroma AM signal-to-noise ratio decreased to 39.3 dB, while the luminance S/N actually increased somewhat, to 41.0 dB.

The built-in microphone, mounted above the lens near the front of the camcorder, delivered a maximum output level of 0.42 millivolts. There is no provision on this unit for connecting an external microphone. The minimum focus distance in the normal operating mode was 23 inches, while with the macro (close-up) feature it was 1/32 inch.

HANDS-ON TESTS

Our own tests of the Canon E40 confirmed the fact that color contamination was higher than we would have liked to see. Of course, this is less noticeable when shooting under real-life conditions than it is under lab test conditions. However, when we aimed the camcorder at white objects, the problem of color contamination was evident during playback.

In all other respects, the E40 was a delight to use. We particularly like the way in which the viewfinder angle can be adjusted in 18-degree increments. This feature was particularly useful when the camcorder was mounted on a tripod, and adjusted for head-on shooting of an object that was only about three feet above the floor. Rather than having to crouch down and risk a backache, we were able to tilt the viewfinder upward, lock it in place and stand erect for the "shoot."

For more information on the E40 8mm Camcorder, contact Canon (One Canon Plaza, Lake Success, NY 11042-1113) directly, or circle no. 120 on the Free Information Card.

FREE CATALOG

Call (800) 992-9943

Over 36,000
Electronic Components

Call Today for Your
FREE SUBSCRIPTION

If You Order Today,
WE SHIP TODAY!!



MOUSER ELECTRONICS

(800) 992-9943

Stocking Locations Across America.

CIRCLE 6 ON FREE INFORMATION CARD

THIS SPACE CONTRIBUTED AS A PUBLIC SERVICE

A defense against cancer can be cooked up in your kitchen.

There is evidence that diet and cancer are related. Follow these modifications in your daily diet to reduce chances of getting cancer:

1. Eat more high-fiber foods such as fruits and vegetables and whole-grain cereals.
2. Include dark green and deep yellow fruits and vegetables rich in vitamins A and C.
3. Include cabbage, broccoli, brussels sprouts, kohlrabi and cauliflower.
4. Be moderate in consumption of salt-cured, smoked, and nitrite-cured foods.
5. Cut down on total fat intake from animal sources and fats and oils.
6. Avoid obesity.
7. Be moderate in consumption of alcoholic beverages.

No one faces cancer alone.

AMERICAN CANCER SOCIETY

LEARN VCR

CLEANING/MAINTENANCE/REPAIR

EARN UP TO \$1000 A WEEK, WORKING PART TIME FROM YOUR OWN HOME!



Secrets Revealed!

NO Special Tools or Equipment Needed.

EARN UP TO \$60 AN HOUR AND MORE!

THE MONEY MAKING OPPORTUNITY OF THE 1990'S

If you are able to work with common small hand tools, and are familiar with basic electronics (i.e. able to use voltmeter, understand DC electronics) . . . IF you possess average mechanical ability, and have a VCR on which to practice and learn. . . then we can teach YOU VCR maintenance and repair!

FACT: up to 90% of ALL VCR malfunctions are due to simple MECHANICAL or ELECTRO-MECHANICAL breakdowns!

FACT: over 77 million VCRs in use today nationwide! Average VCR needs service or repair every 12 to 18 months!

Viejo's 400 PAGE TRAINING MANUAL (over 500 photos and illustrations) and AWARD-WINNING VIDEO TRAINING TAPE reveals the SECRETS of VCR maintenance and repair—"real world" information that is NOT available elsewhere!

Also includes all the info you'll need regarding the BUSINESS-SIDE of running a successful service operation!

FREE INFORMATION

CALL TOLL-FREE 1-800-537-0589

Or write to: Viejo Publications Inc.

4470-107 Sunset Blvd. #600

Los Angeles, CA 90027. Dept. PE

CIRCLE 11 ON FREE INFORMATION CARD

U.S. Periodicals STATEMENT OF OWNERSHIP, MANAGEMENT AND CIRCULATION Required by 39 U.S.C. 3685		
1A TITLE OF PUBLICATION POPULAR ELECTRONICS	1B PUBLICATION NO. 0 7 6 3 2 9 6 8	2 DATE OF FILING 10/9/91
3 FREQUENCY OF ISSUE MONTHLY	3A NO. OF ISSUES PUBLISHED ANNUALLY 12	3B ANNUAL SUBSCRIPTION PRICE \$21.95
4 COMPLETE MAILING ADDRESS OF KNOWN OFFICE OF PUBLICATION (Street, City, County, State and ZIP+4 Code (Post offices)) 500-B 81-COUNTY BLVD. FARMINGDALE, NY 11735		
5 COMPLETE MAILING ADDRESS OF THE HEADQUARTERS OF GENERAL BUSINESS OFFICES OF THE PUBLISHER (Post office) 500-B 81-COUNTY BLVD. FARMINGDALE, NY 11735		
6 FULL NAMES AND COMPLETE MAILING ADDRESSES OF PUBLISHER, EDITOR, AND MANAGING EDITOR (This item MUST NOT be blank) PUBLISHER (Name and Complete Mailing Address) LARRY STECKLER 500-B 81-COUNTY BLVD. FARMINGDALE, NY 11735 EDITOR (Name and Complete Mailing Address) CARL LARON 500-B 81-COUNTY BLVD. FARMINGDALE, NY 11735 MANAGING EDITOR (Name and Complete Mailing Address)		
7 OWNER (If owned by a corporation, its name and address must be stated and also immediately thereunder the names and addresses of all stockholders owning or holding 1 percent or more of its total amount of stock. If not owned by a corporation, the names and addresses of the individual owners must be given. If owned by a partnership or other unincorporated firm, its name and address as well as that of each individual must be given. If the publication is published by a nonprofit organization, its name and address must be stated. (Form must be completed.)		
8 FULL NAME AND COMPLETE MAILING ADDRESS GERSBACK PUBLICATIONS INC. 500-B 81-COUNTY BLVD. FARMINGDALE, NY 11735 LAWRENCE STECKLER 500-B 81-COUNTY BLVD. FARMINGDALE, NY 11735		
9 OWNERS, MORTGAGEES, AND OTHER SECURITY HOLDERS OWNING OR HOLDING 1 PERCENT OR MORE OF TOTAL AMOUNT OF BONDS, MORTGAGES OR OTHER SECURITIES (If none are held, so state)		
10 FOR COMPLETION BY NONPROFIT ORGANIZATIONS AUTHORIZED TO MAIL AT SPECIAL RATES (Section 412 J) ONLY (Do not check, unless nonprofit status of the organization and the exempt status for Federal income tax purposes (check one)) <input type="checkbox"/> HAS NOT CHANGED DURING PRECEDING 12 MONTHS <input type="checkbox"/> HAS CHANGED DURING PRECEDING 12 MONTHS (If changed, publisher must submit explanation of change with this statement)		
11 EXTENT AND NATURE OF CIRCULATION (See instructions on reverse side)		
A TOTAL NO. COPIES (Net Press Run)	159,190	AVERAGE NO. COPIES EACH ISSUE DURING PRECEDING 12 MONTHS
B PAID AND/OR REQUESTED CIRCULATION	38,536	ACTUAL NO. COPIES OF SINGLE ISSUES PUBLISHED DURING PRECEDING 12 MONTHS
1 Sales (through dealers and carriers, street vendors and counter sales)	49,316	162,180
2 Mail Subscriptions (Post and/or air mail)	87,850	
C TOTAL PAID AND/OR REQUESTED CIRCULATION (Sum of B1 and B2)	4,290	
D FREE DISTRIBUTION BY MAIL, CARRIER OR OTHER MEANS (Samples, complimentary, and other free copies)	92,140	
E TOTAL DISTRIBUTION (Sum of C and D)	9,205	
F COPIES NOT DISTRIBUTED	57,845	
1 Office use, left overs, unaccounted, spoiled after printing	159,190	
2 Return from News Agents		
G TOTAL (Sum of E, F1 and F2 should equal net press run shown in 11A)		
12 I certify that the statements made by me above are correct and complete		
SIGNATURE AND TITLE OF EDITOR, PUBLISHER, BUSINESS MANAGER OR OWNER		EDITOR

PS Form 3526, Dec 1985

(See instruction on reverse)

Electronics Paperback Books

GREAT PAPERBACKS AT SPECIAL PRICES

BP248—TEST EQUIPMENT CONSTRUCTION \$5.95. Details construction of simple, inexpensive, but extremely useful test equipment. AF Gen, Test Bench Ampl, Audio Millivoltmeter, Transistor Tester and six more.



BP267—HOW TO USE OSCILLOSCOPES AND OTHER TEST EQUIPMENT \$6.95. Mastering the oscilloscope is not really too difficult. This book explains all the standard controls and functions. Other equipment is also described.

BP265—MORE ADVANCED USES OF THE MULTIMETER \$5.95. Use these techniques to test and analyze the performance of a variety of components. Also see how to build ad-ons to extend multimeter capabilities.



BP256—INTRO TO LOUDSPEAKERS AND ENCLOSURE DESIGN \$5.95. We explore the variety of enclosure and speaker designs in use today so the reader can understand the principles involved.

BP263—A CONCISE INTRO TO dBASE \$6.95. The dBASE series of programs are probably the best known database programs for microcomputers. This book is designed to help you get started working with them.



BP260—CONCISE INTRO TO OS/2 \$5.95. If you are a multitasking PC user and want to get the most out of your computer, then you must learn its OS/2 operating system. This book shows you just how to do that, quickly and easily.



BP249—MORE ADVANCED TEST EQUIPMENT CONSTRUCTION \$6.95. Eleven more test equipment construction projects. They include a digital voltmeter, capacitance meter, current tracer and more.



Digital Audio Projects

BP245—DIGITAL AUDIO PROJECTS \$5.95. Practical circuits to build and experiment with. Includes A/D converter, input amplifier, digital delay line, compander, echo effect and more.



BP247—MORE ADVANCED MIDI PROJECTS \$5.95. Circuits included are a MIDI indicator, THRU box, merge unit, code generator, pedal, programmer, channelizer, and analyzer.



BP257—INTRO TO AMATEUR RADIO \$6.95. Amateur is a unique and fascinating hobby. This book gives the newcomer a comprehensive and easy to understand guide to the subject.



PCP102—INTRODUCING DIGITAL AUDIO \$9.95. Covers all kinds of digital recording methods—CD, DAT and Sampling. Bridges the gap between the technician and the enthusiast. Principles and methods are explained.

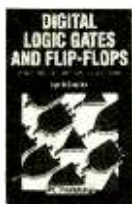

PCP107—DIGITAL LOGIC GATES AND FLIP-FLOPS \$10.00. Thorough treatment of gates and flip-flops for enthusiasts, student and technicians. Only a basic knowledge of electronics is needed.

BP251—COMPUTER HOBBYISTS HANDBOOK \$8.95. A wrapup of everything the computer hobbyist needs to know in one easy to use volume. Provides a range of useful reference material in a single source.



PCP108—COMPUTERS AND MUSIC \$9.95. Explains the basics of computers and music with no previous knowledge of computers needed. Covers types of music software and explains how to set up your own computer music studio.

- BP195—INTRODUCTION TO SATELLITE TV**..... \$9.95. A definitive introduction to the subject written for the professional engineer, electronics enthusiast, or others who want to know more before they buy. 8 x 10 in.
- BP190—ADVANCED ELECTRONIC SECURITY PROJECTS**.....\$5.95. Includes a passive infra-red detector, a fiber-optic loop alarm, computer-based alarms and an unusual form of ultrasonic intruder detector.
- BP235—POWER SELECTOR GUIDE**.....\$10.00. Complete guide to semiconductor power devices. More than 1000 power handling devices are included. They are tabulated in alpha-numeric sequence, by technical specs. Includes power diodes, Thyristors, Triacs. Power Transistors and FET's.
- BP234—TRANSISTOR SELECTOR GUIDE**.....\$10.00. Companion volume to BP235. Book covers more than 1400 JEDEC, JIS, and brand-specific devices. Also contains listing by case type, and electronic parameters. Includes Darlington transistors, high-voltage devices, high-current devices, high power devices.
- BP99—MINI-MATRIX BOARD PROJECTS**.....\$5.50. Here are 20 useful circuits that can be built on a mini-matrix board that is just 24 holes by ten copper-foil strips.
- BP117—PRACTICAL ELECTRONIC BUILDING BLOCKS—Book 1**.....\$5.75. Oscillators, Timers, Noise Generators, Rectifiers, Comparators, Triggers and more.
- BP184—INTRO TO 68000 ASSEMBLY LANGUAGE**.....\$6.95. The 68000 is a great new breed of microprocessor. Programming in assembly language increases the running speed of your programs. Here's what you need to know.

BP179—ELECTRONIC CIRCUITS FOR THE COMPUTER CONTROL OF ROBOTS \$7.50. Data and circuits for interfacing the computer to the robot's motors and sensors

- BP239—GETTING THE MOST FROM YOUR MULTIMETER**..... \$5.95. Covers basics of analog and digital meters. Methods of component testing includes transistors, thyristors, resistors, capacitors and other active and passive devices.
- BP97—IC PROJECTS FOR BEGINNERS**.....\$5.50. Power supplies, radio and audio circuits, oscillators, timers, switches, and more. If you can use a soldering iron you can build these devices.
- BP37—50 PROJECTS USING RELAYS, SCR'S & TRIACS**..... \$5.50. Build priority indicators, light modulators, warning devices, light dimmers and more.
- RADIO—100 RADIO HOOKUPS**.....\$3.00. Reprint of 1924 booklet presents radio circuits of the era including regenerative, neutrodyne, reflex & more.
- BP42—SIMPLE LED CIRCUITS**.....\$5.50. A large selection of simple applications for this simple electronic component.
- BP127—HOW TO DESIGN ELECTRONIC PROJECTS**.....\$5.75. Helps the reader to put projects together from standard circuit blocks with a minimum of trial and error.
- BP122—AUDIO AMPLIFIER CONSTRUCTION**.....\$5.75. Construction details for preamps and power amplifiers up through a 100-watt DC-coupled FED amplifier.
- BP92—CRYSTAL SET CONSTRUCTION**.....\$5.50. Everything you need to know about building crystal radio receivers.
- BP45—PROJECTS IN OPTOELECTRONICS**.....\$5.50. Includes infra-red detectors, transmitters, modulated light transmission and photographic applications.

BP185—ELECTRONIC SYNTHESIZER CONSTRUCTION \$5.95. Use this book to learn how to build a reasonably low cost yet worthwhile monophonic synthesizer. You'll learn a lot about electronic music synthesis in the process

CHECK OFF THE BOOKS YOU WANT

ELECTRONIC TECHNOLOGY TODAY INC.
P.O. Box 240, Massapequa Park, NY 11762-0240

SHIPPING CHARGES IN USA AND CANADA

\$0.01 to \$5.00	\$1.50
\$5.01 to \$10.00	\$2.50
\$10.01 to 20.00	\$3.50
\$20.01 to 30.00	\$4.50
\$30.01 to 40.00	\$5.50
\$40.01 to 50.00	\$6.50
\$50.01 and above	\$8.00

SORRY No orders accepted outside of USA & Canada

Number of books ordered

Name _____
Address _____
City _____ State _____ Zip _____

Total price of merchandise \$ _____
Sales Tax (New York State Residents only) \$ _____
Shipping (see chart) \$ _____

All payments must be in U.S. funds

Total Enclosed .. \$ _____

P-292

How To Electronically Tune Pianos

**Popular
Electronics®**
FEBRUARY 1992

Traditionally, piano-tuning has been the exclusive domain of craftsmen who've spent years perfecting their skills. Having to discern pitches by ear, they were as much practitioners of art as of science, with accompanying fees for their services ranging as high as \$60. But the *Precision Audio-Frequency Generator* described in this article will change all of that.

Coupled with an oscilloscope and a digital frequency counter, the generator allows you to tune a piano or another instrument (say a violin) to an accuracy of 0.01 Hz, or better, throughout most of its range.

Just the Basics. A block diagram of the Precision Audio Frequency Generator, which consists of several sub-circuits—an audio-amplifier/filter circuit, an automatic level control, a variable voltage-controlled oscillator, a frequency divider circuit, an integrator, and an audio output amp—is shown in Fig. 1.

An electret microphone element is used to pick up the audio tone produced by the instrument. That signal is then fed to an amplifier/filter/level-controlled circuit and output via channel 1 (CH1) to an oscilloscope for display.

The variable voltage-controlled-oscillator (VCO) is used to produce a signal of from less than 10 kHz to more than 99 kHz. The VCO output is fed to a digital frequency counter for display, and is also routed to a chain of frequency dividers, where the signal is divided by 10, 100, or 1000, depending on the setting of a selector switch.

From there, the selected signal fre-



And Other Instruments

BY STEVEN A. BROWN

This circuit will let you use your oscilloscope and digital frequency counter to tune pianos and more to an accuracy of .01 Hz.

quency divides along two paths; one going to CH2 (which feeds the oscilloscope's sweep synchronization input) and to an integrator that converts the squarewave output of the divider into a triangular waveform. The output of the integrator is then amplified and fed to a set of stereo headphones via an audio output jack.

A Closer Look. A complete schematic diagram of the Precision Audio Frequency Generator is shown in Fig. 2. An electret microphone element (which has a flat frequency response to within 3 dB down to 20 Hz) is used to pick up audio from the piano or other instrument. The microphone element, con-

nected to J2, converts the audio to an electrical signal, which is fed to the non-inverting input of U2-a (half of an LM358 dual op-amp that is configured as a unity-gain voltage follower).

At the same time, about +4 volts DC is also delivered to U2-a's non-inverting input at input pin 3 via Q1 and R3, so that the microphone signal rides on the DC voltage. The output of U2-a is then fed to U2-b, which is configured as an inverting amplifier. That op-amp provides a gain 40 dB when S1 is in the FLAT position. Capacitor C6 is included in the circuit to roll off frequencies above 4400 Hz. Those frequencies are not wanted in this application.

When S1 is placed in the LP position, C7 rolls off frequencies above 13.5 Hz, which is an octave below the lowest note on the keyboard, so that the rolloff is 6-dB-per-octave from that note upward. Placing S1 in LP position permits tuning of the lowest two octaves of

the piano, where overtones would otherwise make the fundamental of the waveform difficult to see.

The output of U2-b at pin 7 is fed to a compander (U3). The compander, which is used as an automatic level control, provides a variable gain of from 0 to 20 dB, depending on the input level. Thus, U3 maintains a more constant output amplitude over a 10:1 range for a rapidly-decaying note. The output of U3 is fed via J3 (CH 1) to an oscilloscope.

The VCO portion of a CMOS phase-locked loop (U5) is used as the oscillator in the circuit. The frequency of the VCO is adjustable via R10 (FINE) and R11 (COARSE). For stability, a separate voltage

regulator, U4, is used to power U5 and its associated circuitry. Devices with a low-temperature coefficient were selected for the frequency-determining components, C15, R12, and R13, in the VCO.

The VCO's output is attenuated by a 10:1 voltage divider, comprised of R15 and R16 before being routed to J4, which is the output to an external frequency counter. The VCO output is also fed through R14, which is used as a current limiter, to a chain of cascaded 4017 CMOS decade counter/dividers (U6–U8). Each counter/divider output is routed via its associated resistor (R17–R19, respectively) to rotary switch S2.

The squarewave output selected by S2 travels along two paths; in one path, the signal is routed to J5 (CH 2); in the other path, the signal is fed to an audio output circuit consisting of U9, Q2, and Q3. The portion of that signal that goes to the audio circuit is applied across C16 to the input of U9-a (half of a second LM358 dual op-amp) through R20. Capacitor C16 is used to extend the rise time of the selected squarewave-output signal to 20 microseconds so that it doesn't cause glitches to appear at CH 1.

The output of U9-a can be adjusted via R21, (in effect serving as a VOLUME control). The squarewave output of U9-a is fed to U9-b, which is configured as

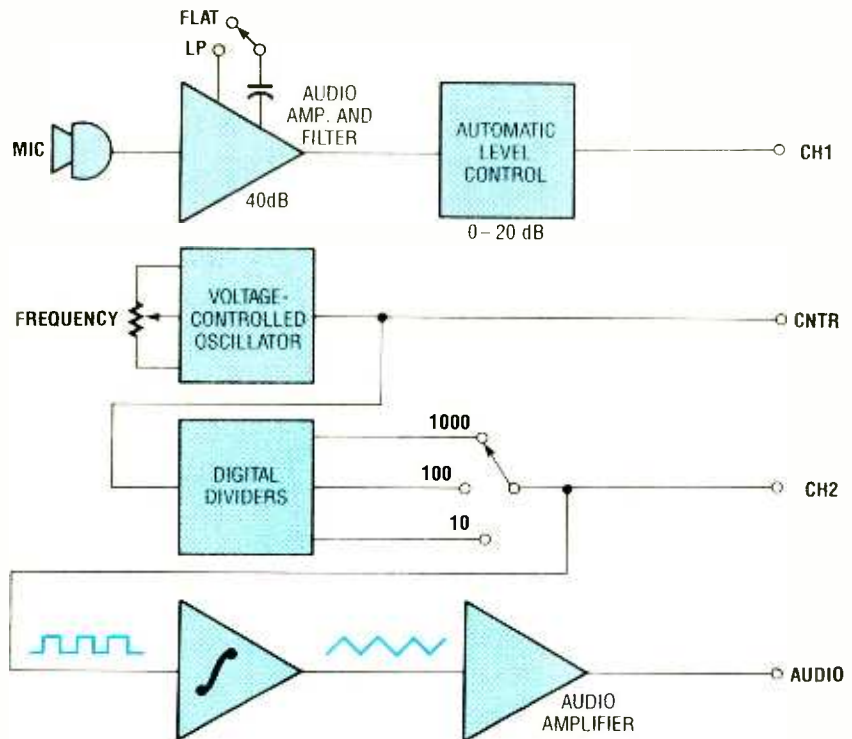

Fig. 1. The Precision Audio Frequency Generator is comprised of several sub-circuits—an audio amplifier/filter circuit, an automatic level control, a voltage-controlled oscillator, a frequency-divider circuit, an integrator, and an audio-output amp.

an integrator. The integrator transforms its squarewave input to a triangular waveform, which approximates the waveform of a vibrating string. The output of U9-b is simultaneously fed to the bases of two transistors, Q2 and Q3, for

amplification. The output of that pair of transistors is fed through C19 to J6. Connecting a set of stereo headphones to J6 allows that signal to be audibly compared to the pitch of the note being played.

PARTS LIST FOR THE PRECISION AUDIO-FREQUENCY GENERATOR

SEMICONDUCTORS

- U1, U4—78L09, 9-volt, 100-mA voltage-regulator, integrated circuit
- U2, U9—LM358 dual op-amp, integrated circuit
- U3—NE570 compander, integrated circuit
- U5—CD4046 CMOS phase-locked loop, integrated circuit
- U6, U7, U8—CD4017 CMOS decade counter/divider, integrated circuit
- Q1, Q2—2N4401 (or similar) general-purpose NPN silicon transistor
- Q3—2N4403 (or similar) general-purpose PNP silicon transistor

RESISTORS

- (All fixed resistors are 1/4-watt, 5% units, unless otherwise noted.)
- R1—27,000-ohm
 - R2, R22—47,000-ohm
 - R3, R16, R20—1000-ohm
 - R4, R5—12,000-ohm
 - R6—1.2-megohm
 - R7—200,000-ohm

- R8, R9, R23, R24—33,000-ohm
- R10—1000-ohm linear-taper potentiometer
- R11—100,000-ohm linear-taper potentiometer
- R12—12,000-ohm, 1% metal-film
- R13—300,000-ohm, 1% metal-film
- R14—10,000-ohm
- R15, R17–R19—9100-ohm
- R21—10,000-ohm linear- or audio-taper potentiometer
- R25—470,000-ohm

CAPACITORS

- C1, C4, C20—47- μ F, 16-WVDC, electrolytic
- C2, C3, C13, C14—0.22- μ F, monolithic ceramic
- C5—4.7- μ F, 16-WVDC, electrolytic
- C6—27-pF, ceramic-disc
- C7—.01- μ F, 10% polyester
- C8–C12, C17—10- μ F, 16-WVDC, electrolytic
- C15—0.001- μ F, 5% polystyrene
- C16—.01- μ F, ceramic-disc

- C18—0.1- μ F, 10% polyester
- C19—470- μ F, 16-WVDC, electrolytic

ADDITIONAL PARTS AND MATERIALS

- J1—See text
- J2—1/8-inch mono phone jack
- J3, J4, J5—RCA or BNC jacks (see text)
- J6—1/8-inch stereo headphone jack
- S1—SPST miniature toggle switch
- S2—SP3T rotary switch (see text)
- Perfboard materials, enclosure, electret microphone element (Radio Shack 270-090 or equivalent), knobs, 3/8-inch heat-shrink, 12-volt AC-to-DC adapter, Walkman-type stereo headphones, shielded audio cable wire, solder, hardware, etc.

Note: The software described in the text for the IBM or compatible PC is available for \$10 postpaid from Andromeda Electronics, 125 N. Prospect St., Washington, NJ 07882. NJ residents must add sales tax. Specify 5/4-inch or 3/2-inch disk. Check, money order, VISA, or M/C accepted.

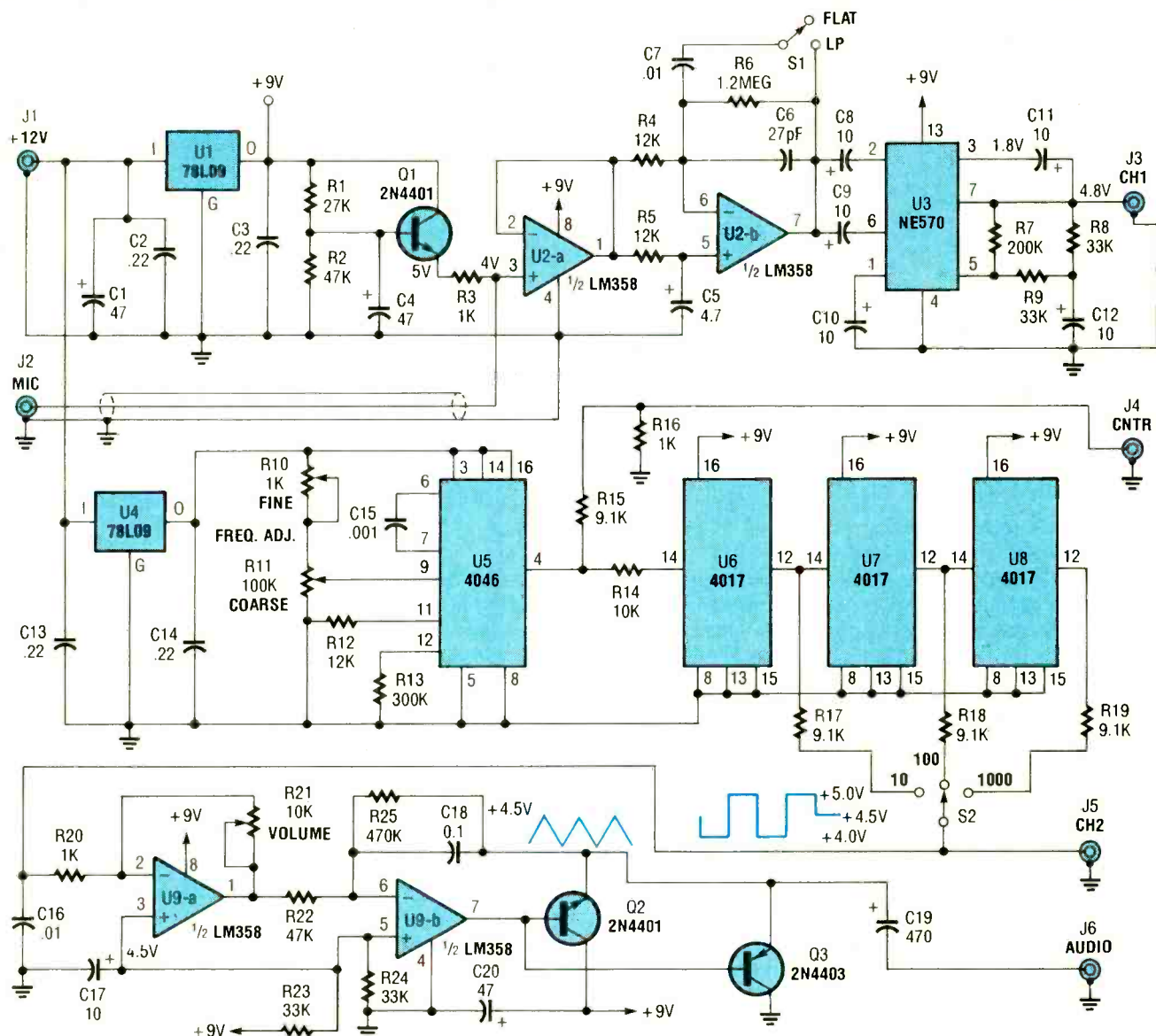

Fig. 2. One section of the Precision Audio Frequency Generator uses an electret microphone element to pick up audio from the piano. That signal is then processed and sent to one channel of a dual-trace oscilloscope. The other section of the circuit is used to produce a variable-frequency signal that is fed to a digital frequency counter and after conditioning, is presented to the second channel of the scope and output to a set of stereo headphones.

Construction. The author's prototype of the Precision Audio Frequency Generator was hard-wired on a section of perfboard. Once you've collected all of the necessary components, begin assembling the circuit using Fig. 2 as a guide. It is suggested that you socket the IC's. The benefit of using sockets is that they help to avoid thermal and static-discharge damage to the IC's (especially the CMOS units, U5-U8) during assembly.

Also, when assembling the board, attention should be paid to the parts layout. For example, to prevent feedback from the output to the input, U2

and U3 should be positioned on the opposite side of the board from U9. The components that set the lower and upper limits of the VCO frequency must be temperature-stable; capacitor C15 should be a polystyrene unit, and both R12 and R13 should be 1% metal-film resistors.

Assemble the board-mounted portion of the project first, leaving the off-board components (all of the jacks and controls) for last. Once that's done, label and solder over-sized lengths of wire (which will be trimmed later) to the appropriate points on the board for connection to the off-board compo-

nents. Note that in Fig. 2 shielded audio cable is indicated for the connection from J1 (the mic jack) to the circuit board. Once you've completed the circuit board assembly, check your work for the usual construction errors: mis-connected components, improper polarity, cold solder joints, etc.

Once you are reasonably sure that the circuit board has been properly wired, put the board to the side for a while and begin preparing the enclosure that will house the board. The author used a plastic enclosure with a metal lid to house the prototype. Prepare the enclosure by drilling several

PIANO SUPPLY HOUSES

American Piano Supply Co.
Box 1005
Clifton, NJ 07014

Ford Piano Supply
166 East 82nd St.
New York, NY 10028

Schaff Piano Supply Co.
2009 N. Clybourn Ave.
Chicago, IL 60614

Tuners Supply Co.
94 Wheatland St.
Somerville, MA 02145

1274 Folsom
San Francisco, CA 94103

761 Piedmont Ave.
Atlanta, GA 30308

holes in its lid—starting with four holes for potentiometers R10, R11, and R21, and switch S2 across what will be the upper edge of the lid. Although S2 is shown as a single-pole, 3-position rotary switch in Fig. 2, any single- or double-pole, multi-position switch will do.

Drill six more holes below the ones previously drilled to accommodate all of the I/O jacks and controls, except J1. That jack should be mounted to the side of the enclosure. Note: Various types of jacks were used for J1–J6. For example, J1 was selected to mate with an AC-to-DC adapter; for J2, the author used a 1/8-inch mono phone jack; for J3 and J5, he used RCA jacks (although BNC types are fine); for J4, a BNC jack (which might be replaced by an RCA unit); and for J6, a 1/8-inch stereo headphone jack. It will be necessary to drill appropriate size holes for each jack type.

Once mounted, all of the jacks, except for J1, will be grounded via the enclosure lid. That means that it will not be necessary to provide a ground wire for each jack. However, the shield of the microphone cable connected to J2 should not be expected to serve as the sole ground-return for the outputs, especially where the high-current audio output is concerned. To handle the expected current, a separate wire should be soldered between Q3's collector and the ground terminal of J6. The ground terminal of J6 (which should contact the lid of the enclosure), in turn, provides the necessary ground-return path. The remaining two terminals of J6 should then be bridged and wired to C19.

Once the holes for the panel-

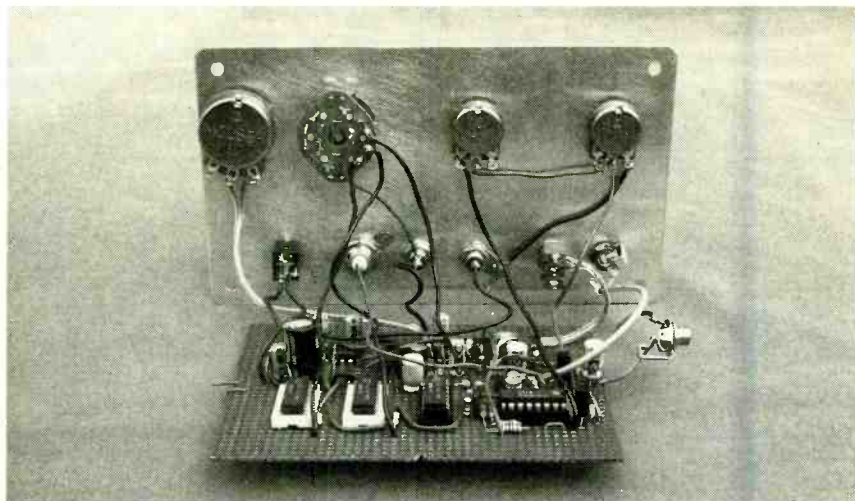

The author's prototype circuit was hard-wired on section of perfboard. Shown here is the perfboard assembly wired to the panel-mounted components prior to being installed in its enclosure.

mounted components have been drilled, drill a single hole in the side of the enclosure for J1. That jack requires a separate connection to circuit ground. Mount the off-board components to the enclosure and measure off the minimum length of wire for each connection that will be necessary to connect the off-board components to the board, and solder them in place. Keeping the wiring between the board and panel-mounted controls and jacks short and direct helps to prevent crosstalk between channels. Once all of the off-board components have been wired to the board and the connections checked for accuracy, the board should be rechecked for errors before going on.

The final step before installing the circuit into its enclosure is to insert the IC's into their sockets. Be very careful when handling the CMOS IC's; they're static sensitive. Once the IC's have been installed and properly seated, turn your

attention to the preparation of the microphone element. Solder the microphone element to one end of a ten-foot length of shielded audio cable or flexible coax. To the other end of the cable, solder a 1/8-inch mono phone plug. To provide strain relief, the microphone element should be slipped into a 3/4-inch length of 3/8-inch diameter heat-shrink tubing. Afterward, fill the space between the cable and the tubing with quick-setting two-part epoxy. It isn't necessary to heat the tubing, and doing so could damage the microphone element.

Before being placed into operation, the Precision Audio-Frequency Generator should be checked out on your test bench. The DC adapter used to power the circuit should be capable of delivering at least 11 volts DC into a 20 mA load, even at the lowest point in its output ripple. All but the smallest (100 mA) 9-volt adapters will suffice, and all 12-volt units can be used without excep-



The electret microphone element that's used to pick up audio from the piano is mounted to one end of a length of microphone cable and a phone jack is connected to the other end.

tion. Be sure the polarity is correct before applying power.

Plug a set of stereo headphones into the AUDIO jack: **DO NOT** use a monophonic set; the plug on mono sets will destroy Q2 and Q3. Set S2 to the 100 position, and advance the VOLUME control, R21, clockwise. You should hear a tone whose pitch should change slightly as you adjust R10, and noticeably as you adjust R11. The pitch will become ten times lower when you switch S2 to the 1000 position, and ten times higher when you switch to the 10 position.

Connect a scope and a digital frequency counter to the output jacks, using 1:1 cables. If your scope has only one channel, connect J5 to the scope's external trigger input. Set the gate time of the counter to 1 second. Verify that the reading on the counter can be varied from less than 10,000 Hz to more than 99,999 Hz by adjusting R11. If not, you can replace R12, which sets the upper frequency limit, with a smaller value, or R13, which sets the lower limit, with a larger value.

Plug in the microphone and speak into it, observing the output waveform on channel 1. The amplitude should be about 2 volts peak-to-peak for a wide range of input amplitudes, although some variation will occur. If the unit does not check out, go back and carefully check all of the circuit connections, verifying that the voltages at various points agree with those indicated on the schematic. Correct any errors that you may find and verify that the problem(s) have been solved, then move on to the phase of construction.

Operation. To tune a piano, the audio generator can be placed on the piano, but the scope and frequency counter need to be placed on a stand, within easy reach. I have found that a platform of plywood, mounted to the top of a camera tripod with a 1/4-inch bolt, makes an excellent stand. The instruments can be secured to the platform with a bolt, and adjusted to any convenient angle.

The microphone should be placed in close proximity to the soundboard of the piano, in such a way so as to exclude ambient noise. A four-inch square of 2-inch polyurethane foam serves that purpose well, if a hole is drilled or punched through its center and the microphone inserted nearly all

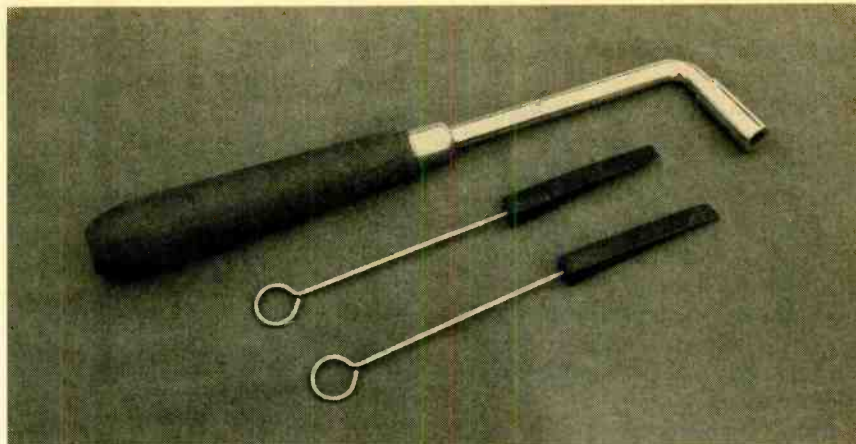

Aside from the audio generator, a few additional tools—a wrench (known in the trade as a tuning hammer), and a pair of rubber wedges, or mutes, with wire handles—will be needed to tune the piano. The mutes are inserted between the strings as necessary, so that only one string at a time will sound when a key is struck.

the way through. The essential tools required to adjust the tension of the strings are a wrench (known in the trade as a *tuning hammer*), and a pair of rubber wedges, or mutes, with wire handles. The mutes are inserted between the strings as necessary, so that only one string at a time will sound when a key is struck. Those and other useful tools can be obtained from your local piano supply house, which will be listed in the yellow pages. If there are none in your area, you can order tools from one of the supply houses listed elsewhere in this article under the heading of "Piano Supply Houses."

Before you attempt to tune your piano, you are urged to do some further reading. It is beyond the scope of this article to provide a course in piano tuning and repair have been written by skilled craftsmen, some of which can be found in practically any library. (See the listing entitled "Suggested Reading").

Basically, the procedure to follow is first to set the audio generator to the frequency of the note that you wish to

tune. As an example, let's start with the note on the keyboard that provides the reference pitch for all the other keys: A above middle C, which is the 49th key on the keyboard, counting from key 1 at the extreme left of the keyboard, and is denoted A49. All the other keys are tuned relative to the pitch to which A49 is tuned. The international standard for A49 is 440.00 Hz.

When setting the pitch of the audio generator, switch S2 must be set for the correct range. For keys between G23 and C64, S2 should be set to 100. For keys C64 and above, S2 is set to the 10 position. For keys G23 and below, set S2 to the 1000 position. Once the correct range is selected, adjust the COARSE and FINE frequency controls until the correct reading is displayed.

Once that is done, check channel 2 of the scope for the presence of a 440 Hz squarewave, and trigger the sweep to that waveform. Now switch to channel 1, but leave the sweep locked to channel 2. Mute two of the strings for this note, so that only one string will vibrate when the note is struck. Strike the key, and observe the waveform on channel 1. If the note is flat, or lower than 440 Hz, the waveform will move to the right. If it is sharp, or higher than 440 Hz, it will move to the left. The speed of motion will correspond to the degree of sharpness or flatness.

As the tension of the string is adjusted to bring the note in tune, the waveform will drift more slowly across the screen. For the best resolution, the sweep period should be adjusted to display two or three complete cycles. When the waveform is arrested, the string is in

SUGGESTED READING

Electronic Piano Tuning
Floyd A. Stevens, Ph.D.
Nelson-Hall, 1974

Piano Servicing, Tuning and Rebuilding
Arthur A. Reblitz
The Vestal Press, 1976

Piano Tuning and Allied Arts
William B. White
Tuners Supply Co., 1978

tune. The mute can now be repositioned, and the other two strings tuned the same way.

The VCO will drift slightly during operation. That is to be expected, and is more noticeable during the first 30 minutes. It isn't necessary to readjust the oscillator every time the least-significant-digit of the display drifts up or down by a few counts, as that digit represents more precision than is required. The least-significant-digit can be allowed to drift ± 4 before readjustment is necessary.

If the pitch of the string is far removed from the setting of the VCO, the waveform will move across the screen too rapidly for its direction of motion to be seen. In that case, adjust the frequency of the VCO up or down as required to arrest the motion of the waveform. That will tell you whether the pitch is sharp or flat. If A49 is flat by more than 20 cents (an explanation of this term follows), the pitch should not be adjusted to 440 Hz.

The 88 keys of the piano keyboard comprise a little more than seven octaves, an octave being a doubling of frequency. See Table 1. In the Equal-Tempered Scale, each octave is divided into 12 steps, called semitones, that progress upward in a geometric scale. Unlike channels in a radio band, which are spaced in a linear scale an equal number of hertz apart, each semitone is higher than the preceding one by a fixed ratio. Since it takes twelve steps to double the frequency, the ratio between adjacent semitones is the twelfth root of 2, or 1.0594631...—an irrational number. Multiply 440 by that number, and you get 466.16, the pitch of the next key higher than A49. Multiply 440 by the inverse of this number (1/1.0594631), and you get 415.30, the pitch of the next key lower than A49. Notice that as you go up the scale, the difference in hertz between adjacent keys becomes geometrically wider.

If the ratio between two pitches is other than an integer multiple of semitones, the cents unit is used. The cent is one-hundredth ($1/100$) of a semitone. It is also a ratio, being the twelve-hundredth root of 2, or 1.000577807.... The pitch of any key on the keyboard, relative to A49, can be calculated from the ratio:

$$2 \epsilon / 1200$$

where ϵ equals the absolute value in cents of the difference in pitch be-

TABLE 1—THE EQUAL-TEMPERED SCALE

Note/ Octave	Key#	Hertz	Stretch in Cents	Note/ Octave	Key#	Hertz	Stretch in Cents
A/0	1	27.184	-20	F/4	45	349.03	-1
Bb/0	2	28.817	-19	Gb/4	46	369.78	-1
B/0	3	30.548	-18	G/4	47	391.77	-1
C/1	4	32.384	-17	Ab/4	48	415.07	-1
Db/1	5	34.329	-16	A/4	49	440.00	0
D/1	6	36.391	-15	Bb/4	50	466.16	0
Eb/1	7	38.578	-14	B/4	51	493.88	0
E/1	8	40.895	-13	C/5	52	523.25	0
F/1	9	43.352	-12	Db/5	53	554.37	0
Gb/1	10	45.956	-11	D/5	54	587.33	0
G/1	11	48.717	-10	Eb/5	55	622.61	+1
Ab/1	12	51.644	-9	E/5	56	659.64	+1
A/1	13	54.746	-8	F/5	57	698.86	+1
Bb/1	14	58.035	-7	Gb/5	58	740.42	+1
B/1	15	61.522	-6	G/5	59	784.44	+1
C/2	16	65.180	-6	Ab/5	60	831.57	+2
Db/2	17	69.096	-5	A/5	61	881.02	+2
D/2	18	73.204	-5	Bb/5	62	933.41	+2
Eb/2	19	77.602	-4	B/5	63	988.91	+2
E/2	20	82.217	-4	C/6	64	1047.7	+2
F/2	21	87.106	-4	Db/6	65	1110.7	+3
Gb/2	22	92.285	-4	D/6	66	1176.7	+3
G/2	23	97.773	-4	Eb/6	67	1246.7	+3
Ab/2	24	103.65	-3	E/6	68	1321.6	+4
A/2	25	109.81	-3	F/6	69	1400.1	+4
Bb/2	26	116.34	-3	Gb/6	70	1484.3	+5
B/2	27	123.26	-3	G/6	71	1572.5	+5
C/3	28	130.59	-3	Ab/6	72	1667.0	+6
Db/3	29	138.35	-3	A/6	73	1766.1	+6
D/3	30	146.58	-3	Bb/6	74	1872.2	+7
Eb/3	31	155.29	-3	B/6	75	1984.7	+8
E/3	32	164.53	-3	C/7	76	2103.9	+9
F/3	33	174.31	-3	Db/7	77	2230.3	+10
Gb/3	34	184.73	-2.5	D/7	78	2320.2	+10
G/3	35	195.71	-2.5	Eb/7	79	2506.3	+12
Ab/3	36	207.41	-2	E/7	80	2656.9	+13
A/3	37	219.75	-2	F/7	81	2818.1	+15
Bb/3	38	232.81	-2	Gb/7	82	2989.2	+17
B/3	39	246.66	-2	G/7	83	3170.6	+19
C/4	40	261.32	-2	Ab/7	84	3363.0	+21
Db/4	41	276.86	-2	A/7	85	3567.1	+23
D/4	42	293.33	-2	Bb/7	86	3783.6	+25
Eb/4	43	310.86	-1.5	B/7	87	4013.2	+27
E/4	44	329.44	-1	C/8	88	4259.2	+30

•Standard pitch, A49= 440 Hz
Values shown are stretched for the average piano

tween A49 and the key in question. That's always the ratio of the higher pitch to the lower, so to calculate the pitch of a key higher than A49, simply multiply the pitch of A49 by the calculated ratio. To calculate the pitch of a note lower than A49, multiply A49 by the inverse of that ratio. For example, to calculate the pitch of middle C (C40), which is 9 semitones, or 900 cents, down from A49, multiply the value of A49 (we'll use 440 Hz) by the inverse of 2 to the 900/1200 power, or:

$$C40 = (440) 1/(2^{900/1200}) = 261.63 \text{ Hz}$$

The calculated value would, of course, have been different for any val-

ue of A49 other than 440 Hz. Many pianos do not have A49 tuned to 440 Hz. The reason for that is that when they are first tuned at the factory, they are usually tuned a semitone lower, so that they will stay in tune longer during shipment and in the store. It takes a minimum of five tunings to bring the piano up to standard pitch, each tuning bringing all the keys up by 20 cents. If a step greater than 20 cents is attempted, the piano will not stay in tune for long. Therefore, if you find a piano that is still a semitone lower than standard pitch, it is best to tune it to that pitch, unless the owner wants it raised. If

(Continued on page 94)

The Shocking Facts About Surge Suppressors

BY ROBERT ANGUS

Learn about the devices that can protect your delicate electronic wares against the ravages of power surges.



The summer of 1991 produced some violent weather throughout the Midwest and in other parts of the nation, including tornadoes, violent thunderstorms, and hurricanes. Since the storms caused numerous power outages, the sale of surge suppressors for use with satellite receivers, computers, pieces of home-office equipment, and other delicate electronic hardware soared.

However, that is not to say that the millions of sensitive electronic components now in homes across the country have all the protection they need. While lightning strikes and the massive surges that occur when a power outage ends cause most of the trouble, delicate electronic circuitry is bombarded by thousands of tiny power surges every day—surges that eventually lead to equipment failure.

The most susceptible of electronic components is the integrated circuit, the basic building block of practically every electronic product in the home. When such microcircuitry gets jolted by a current stronger than it was designed for, the individual components and connectors heat up. If the voltage is strong enough, it can cause one or more IC's to melt or burn out. The usual

diagnosis at the repair center is "IC failure," and they fix it by replacing the chip or the circuit board it's on. In the case of weaker voltages—the kind that come along when an electric motor on the same circuit switches off—this process of aging takes much longer, but the end result is the same. If you can protect your equipment from all of that, you can add years to the life of your computer, VCR, or whatever.

To help you define your surge-suppression needs there are some questions you need to know the answers to: What does a surge suppressor do? Why do some cost \$170 or more while others can be had for a tenth of that price? If I don't live in a part of the country subject to frequent electrical storms and power outages, is a surge suppressor a good investment?

Function and Cost. Figuratively speaking, you can think of a surge suppressor as a large and rather expensive fuse. Both are designed to take the brunt of an electrical overload, protecting your home and your equipment from damage. In a pinch, you can al-

ways put a penny in the fuse socket to get the lights to come back on, but you'll lose the protection that a fuse of the proper value would provide. Likewise, your electronic equipment will operate perfectly well under normal conditions without any surge protection at all, or with inadequate protection. But a surge can wipe out computer memory, fuse delicate integrated circuits in VCR's and CD players, set a television on fire, or wipe out a satellite receiver.

It should be mentioned that surge suppressors, as useful as they are, cannot withstand the destructive effects of a direct lightning strike. For that you need a lightning arrestor, available from your local power company for about \$300.

You'll find surge suppressors listed in catalogues of computer hardware and home-automation equipment, at your local electronic-parts shop, in hardware stores, and elsewhere. You can buy single-outlet plug-in units for less than \$10 or a whole-house model for

\$70. Strips and blocks with multiple outlets (in some cases providing protection for telephone lines and cable TV as well as AC) range in price from less than \$20 to more than \$170. Which raises the question: if I can protect my whole house for \$70, why buy a \$170 model for my home-office equipment, another for the stereo system, and a third for the satellite/TV in the living room?

The answer, of course, is that you get what you pay for. The more expensive units tend to be better-built, using more and more expensive parts. However, the tiny hits surge suppressors take day after day from fluctuations in line voltage or the refrigerator motor switching on and off eventually cause even the most expensive one to fail, requiring replacement.

What's Available. There are two types of surge suppressor commonly available to consumers: hybrids, the "Caddillacs" of surge suppression; and MOV (Metal-Oxide Varistor)-only models, the kind most commonly used for home electronics. A hybrid design uses one or more MOV's to take the initial jolt and one or more silicon junction diodes or gas tubes to compensate for the MOV's rapid fatigue at higher current levels, and its leakiness. Regardless of a surge suppressor's type, the size and number of MOV's in the circuit directly affects its ability to suppress energy.

While there are hundreds of models on the market, not all of them carry manufacturers' specifications; and many of the "specs" really aren't very helpful. If you're serious about surge suppression, check for the Underwriters' Laboratories seal on any unit you're interested in. (You'd be surprised at just how many of these products have not received full UL approval.) The device should conform to the UL 1449 standard (the only recognized standard for suppressors).

The standard permits, but does not require, a manufacturer to specify the transient voltage shunted between the ground and hot lines, the ground and neutral lines, and the hot and neutral lines. The best units usually display all three ratings: the lower the numbers, the greater the protection. A number below 400 generally indicates a hybrid unit; MOV-only types usually rate above 400. Another important number is the joule rating, which indicates energy dissipation provided by the suppressor be-

tween each line. The higher the number, the more effective the unit. A specification of 70 joules for each leg suggests very good suppression.

Instead of following the UL recommendation, many manufacturers prefer to talk about wattage, clamping voltage, and response time—figures engineers consider essentially useless because there is no commonly-agreed means of measuring them. In fact, published specifications for some low and medium priced units actually meet or exceed those for the most expensive models. According to David Kerr, an electrical engineer on AT&T Bell Laboratories' Protection Development Group, products that don't comply with UL 1449 aren't really surge suppressors. The large type on the box or the ad may suggest that they are, but smaller type somewhere else usually identifies them as "spike protector," "power shields," "lightning sponges," "surge

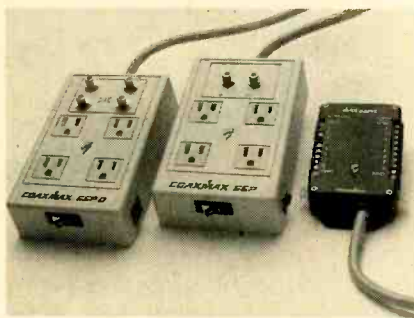

These high quality surge suppressors protect equipment from spikes on both power lines and TV transmission cables.

busters," and so on. Some are little more than multiple power strips, so buyer beware!

Because surge suppressors, like fuses, burn out eventually, most better-quality models feature some way of indicating that they're blown out. Usually there's an LED that glows when the unit is providing protection, but goes out once the unit dies. Some models have an audio indicator instead of an LED so that the suppressor needn't be on display in your listening or living room. Some units have both visual and audible indicators.

Nowadays, some manufacturers go one step further: they include a circuit breaker that shuts down the system until the user resets it, or a circuit that prevents the unit from passing any electrical current once surge protection is lost.

Low Voltage Protection. Thus far, we've been talking about high voltage (i.e., 120-volt 60 Hz AC current). The explosion of fax machines, sophisticated home-telephone equipment, modems, and video equipment has caused both consumers and manufacturers to examine the need for low-voltage surge protection as well. If you're skeptical as to their necessity, consider that near-miss lightning strikes can induce voltage peaks in phone lines and the coaxial cable that links a rooftop or satellite antenna with your TV receiver, VCR, or satellite unit.

Some manufacturers now include telephone inputs on their surge suppression strips while others market stand-alone telecom boxes for as little as \$13. "The important thing is that the circuits be physically separate for the two kinds of current," says the Bell Labs engineer.

Audio noise, both generated outside and inside the protected circuit can also be a problem, which a properly engineered suppression device is designed to stop. Heavy-duty motors like those in air conditioners and refrigerators not only soak-up a lot of voltage when they go on (thus reducing the amount available to other equipment in the same circuit) and dump surplus power on the line when they switch off, but they also generate noise in the 1-kHz–1-MHz range. Since only two volts separates a logic level of 1 from a logic level of 0, such noise is capable of confusing computer data. Likewise, computer noise can re-enter the main power line if not filtered by a protection circuit.

How Much Protection is Needed?

There's a common misconception about the amount of protection needed for various kinds of home-electronics equipment. If you read the electronics catalogues, you can easily get the idea that you can get by with a relatively low level of protection on your audio or video gear, but you need more for home computer or satellite TV. The truth is that a good surge suppressor is a good surge suppressor, whether it's protecting a CD player or an IBM 486; an inadequate one is equally inadequate whether it's protecting the TV, fax machine, or a satellite receiver. Perhaps the worst thing about the cheap units is that people aren't

(Continued on page 93)

Protect your Equipment

I recently bought a 386SX, so it was natural that I started looking into surge suppressors (which, by the way, are good to have for audio and video equipment, too—more on that later) to protect my investment. Already having a good idea about the inexpensive components that go into making such devices, I was really surprised at the relatively high cost of even the “moderately priced” power strips. After doing some math, I discovered that the lowest-priced device had a 100% mark up!

That seemed a bit high, so I had to ask myself why that might be. The answer to that question revolves around knowing how to indicate the “health” of a semiconductor surge suppressor. Until I started designing the *Power Block* surge suppressor (described in this article), I didn’t know how the “big guys” could do it (neither did five other technically inclined people—three of them with engineering degrees), but I found out and I’ll pass along what I’ve learned as I describe the project.

Giving MOV’s a Check Up. Using MOV’s (which stands for metal-oxide varistors) is the ultimate in simplicity: just place one between the line that you wish to protect and ground. When a high-voltage spike rears its ugly head on the protected line, the MOV absorbs the spike and conducts it to ground. That means under normal operating conditions (with no spike on the line), an MOV appears as an open circuit. But when a spike is present, the MOV becomes a near short. As you’ll see, that makes detecting a blown MOV a tough task.

When a MOV blows out, it usually becomes an open circuit. They can only short out if their leads melt and fuse together, which is pretty unlikely. That’s why a blown MOV is tough to detect: they’re supposed to be open-circuits under normal (spike-less) conditions. The *only* way to detect a faulty MOV is to expose it to a high voltage (on the order of 300 volts) and check for sufficient current flow.

That’s obviously not at all practical, so how can store-bought power strips indi-

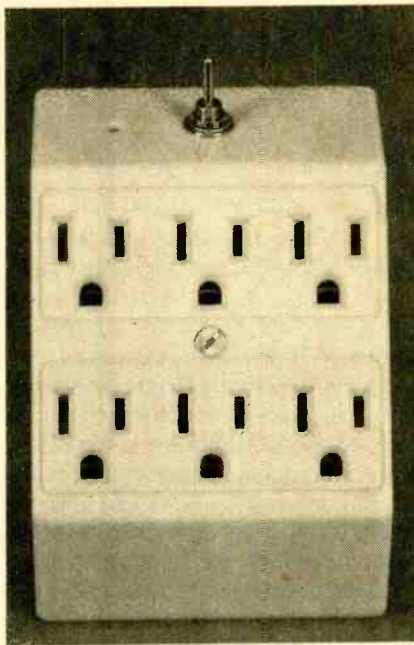

with the Power Block

BY JOHN YACONO

*Build a six-outlet
surge suppressor that
offers all the
protection and features of
expensive commercial
units.*

cate the “health” of their MOV’s? The truth is they don’t! The neon lamps on power strips are really used to monitor a special fast-blow fuse. The fuse and neon lamp are placed in series with the unit’s MOV’s. The lamp is lit so long as the fuse is fine. When the fuse blows, the neon lamp goes out, indicating that at least one of the MOV’s has probably had to handle enough current to cause it to fail.

Misdirected Priorities. Our circuit is not like typical store-bought units, in fact it’s different from any on the market. The reason for that is the amount of hype over certain unnecessary but popular features that are designed to impress non-technical consumers.

Key among the pointless features is a circuit breaker. I’m unsure as to what their supposed purpose on a power strip is. There is no circuit breaker known to man that’s fast enough to react to voltage or current spikes; that’s why MOV’s were invented.

Perhaps they might be intended to prevent current overloads, but isn’t that what a building circuit breaker is for? Then again, they could be used to prevent local (very local) overloads. But, local overloads of 15-amps (the rated current of most units) are pretty unlikely. Further, most electrical devices have their own built-in current-limiting devices, such as fuses and circuit breakers. Most computers often have active (as well as passive) current-limiting devices in their power supplies. The addition of an overrated circuit breaker to such devices is just plain overkill. Still, if you’ll sleep better at night knowing that your Power Block has a circuit breaker, feel free to add one.

Another interesting artifact found in most powerstrips is their so called “noise-suppressing filter.” With the exception of very-high priced units, such filters are token items. I borrowed a powerstrip sporting a noise filter that was said to eliminate herring-bone patterns in video equipment and line hum from audio. Ha! Upon connecting it to a baby monitor that was susceptible to line hum, I discovered the claims of the manufacturer to be only so much ad-

vertising hokum. (For those thinking the hum was picked up by the antenna, running the unit on battery power eliminates it altogether. Further, to prove the hum wasn't picked up by the power-cord from the adapter, I wrapped it around a hefty piece of ferrite without any change in sound quality.)

Again, line filters are a bit of overkill on most devices (computers, stereo equipment, and the like), which often filter the AC line quite well all by themselves. Come to think of it, I've owned four computers, six TV's, and four stereos, none of which were susceptible to AC-hum. (Coincidence? Nah!) On the other hand, good filters can come in handy in the ham shack, but that's a different story altogether.

Oddly enough, there are some design features of merit not included in most (perhaps any) units. Let's take a look at the Power-Block circuit and discuss some of those attributes in detail.

The Power-Block Circuit. As you follow this explanation of the Power-Block circuit refer to Fig. 1. The Power Block is made from a 2-to-6 wall-outlet adapter. As the name implies, the adapter has two plugs (denoted PL1 and PL2) and six grounded AC outlets (shown as SO1-SO6). When you first get the unit, PL1's contacts are directly wired to sockets SO1-SO3 and PL2's leads are connected to sockets SO4-SO6. That arrangement is modified in the Power Block so that the hot side of sockets SO1-SO3 is connected to S1-a (one section of the unit's main power switch), which receives power from the hot terminal of PL2. Similarly, sockets SO4-SO6 are connected to the neutral line from PL1 through switch S1-b (more on that later).

The MOV's protect the hot and neutral lines by steering any high voltages to ground. If the current rises above 7 amps, fuse F1 blows. Note that NE1 (used as the "healthy-MOV indicator") is connected to the neutral terminal through current-limiting resistor R1, and is connected to the hot line through F1. So when F1 blows, NE1 is extinguished, signaling that the MOV's might be damaged and should be replaced along with F1.

The strange switching arrangement achieves a few noteworthy ends: If power switch S1 is off, the neutral-line sockets, SO1-SO3, are still protected. The hot line of sockets SO4-SO6 are

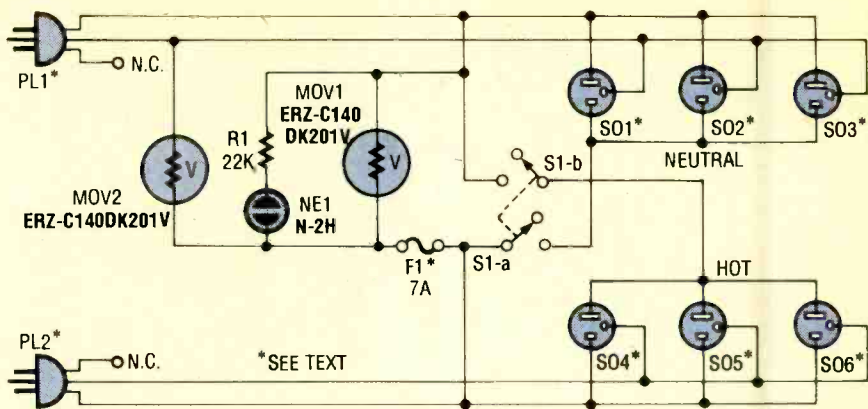

Fig. 1. The circuit for the Power Block is a bit strange looking, but quite simple. The plugs (PL1 and PL2) and the sockets (SO1-SO6) are part of a two-to-six outlet adapter.

also protected even when the Power Block is off. That is a very important feature if there is any possibility of the devices plugged into the Power Block being exposed to internal arcing or surges from a source other than the AC line (an antenna for instance). Internal arcing in TV's is a common problem; I had one TV that did it and a friend of mine just bought two different, very expensive TV's, both with arcing problems because of their large picture tubes. Any stray high voltage in a device connected to sockets SO1-SO3, can find two paths to ground. That improves your devices' chances for "survival." Along the same lines, SO3-SO6 can rely on their hot lead for extra protection. I've yet to see that feature incorporated in a standard design.

You might be wondering why the two sets of sockets don't have the same line protected, which would allow you to use a SPST switch. The reason relies on game theory—namely limiting your losses; when sitting down to build the Power Block, you'd have to figure out which line to protect. Since either line (neutral or hot) might fall victim to high voltage, you can't make a clear choice

between them. The best that you can do is cut your losses and protect one line for three sockets, and the other line for the remaining three. If one set of devices gets hit at least the other three are completely unaffected (a guaranteed 50% minimum survival rate versus a fifty-fifty chance at a possible 100% casualty rate).

That strategy also provides you with the ability to connect TV's, and other tuners that make use of external antennas to one group of sockets, and computers, modems, and other sensitive (low risk) devices to the other group. That helps separate the sensitive devices should there be a lighting strike on an antenna with the power switch off. For that reason, the grounds of the two sets of sockets are also separate.

Take note that whatever AC outlet the Power block is plugged into is always protected, whether the block is on or off. There are a few reasons for that: First among them is the fact that even with S1 open, a high-voltage arc could easily jump the gaps between its contacts, damaging any device connected to it. (That flaw is true of manufactured units as well, but they provide no path to ground for the high voltage with the power switch off.) Also, that allows NE1 to always indicate the health of the MOV's. You need never flip the power switch without knowing if your devices are protected beforehand (another design oversight of all manufacturers).

Enough belittling the mechanisms of industry, let's get to the construction details.

Mechanical Preparation. Although the Power Block is electrically a simple device, the layout of the project requires a step-by-step approach. I rec-

PARTS LIST FOR THE POWER BLOCK

- MOV1, MOV2—ERZ-C140K201U zinc-oxide transient absorber
- NE1—N-2H neon lamp
- F1—7-amp, Pico II, fast-acting fuse
- R1—22,000-ohm, 1/4-watt, 5% resistor
- S1—DPDT miniature toggle (5-amps minimum)
- PL1, PL2—Two-to-six AC adapter
- SO1-SO6—Part of PL1/PL2 (see text)
- Insulation or heat shrink tubing, electrical tape, and solder.

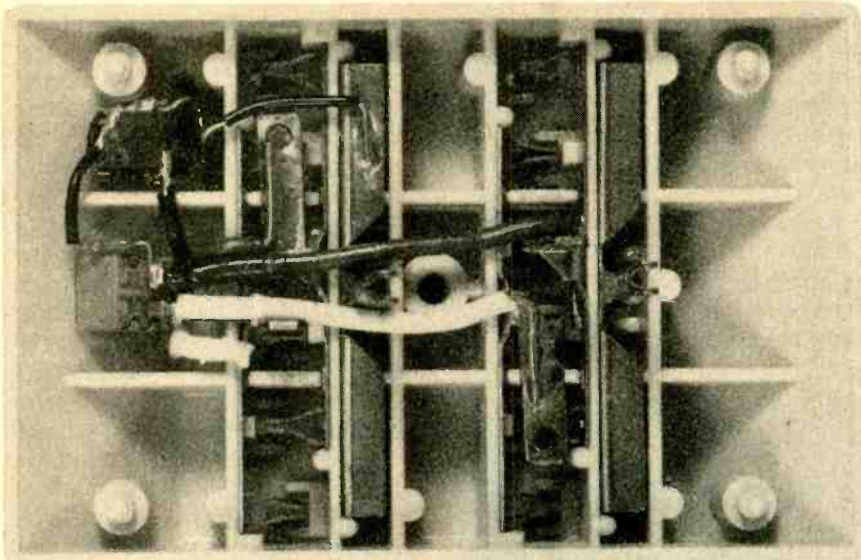

This is the interior of the Power Block. Take note of the orientation of the four heavy-gauge wires. The MOV's are sandwiched together up in the left corner.

ommend that you at least read all the instructions presented in this article before you begin, otherwise you may end up covering up areas that you'll need to get at later.

You should start by preparing the Power Block cabinet (made from a two-to-six outlet adapter available at most hardware and electronics-parts stores). They come with a long screw through their middle that has a little washer-like nut used to hold the back cover on. Gently but firmly grasp the nut with small-nose pliers and back it off the screw.

If you break the nut (like I did) don't worry; you can make a sufficiently good one out of a small, thin piece of cardboard by poking a hole in it and threading it on the screw. Alternatively, if you have an old wall socket or switch lying in a drawer someplace, check to see if it has the cardboard screw retainers on it. The threads are identical, so they make an excellent replacement. As you'll see later, the large screw will hold the unit snug up against a wall outlet, so whatever replacement you might use doesn't have to be mechanically strong.

Allow the screw to fall out, and remove the cardboard backing by gently prying it away from the four posts (one in each corner). The holes in the cardboard are sized to provide a snug fit, so the backing should come off easily. But be careful not to crack the case though; it is made from a pretty brittle plastic.

Looking inside, you'll see that all the

hot contacts in the top three sockets and the hot contact on the top plug are made from a single strip of pressed metal. All the other terminals in the unit are manufactured in like fashion. (In fact, the hot and neutral terminals are identical, the neutral ones are just upside down.) Now remove the socket contacts by grabbing each plug contact and giving it a pull. They should all come out with relative ease.

Take one of the hot/neutral strips and bend its plug contact so it will point away from the middle of the case when the strip is reinstalled. (That will undo a bend that the factory made.) Do this with another terminal strip and set them all aside.

Now you're ready to drill the holes for the power switch and neon bulb. Place the case face down with the grounds pointing toward you. If the outlets in your house are oriented correctly (ground down), the surface that will be on top when the unit is plugged in will be the furthest one from you. Mark the spot that's centered in the small middle compartment on that surface of the case. Make another mark centered between the right post and the wall of the compartment to the right. The marks indicate where to drill the holes for the switch and neon bulb, respectively; now you're ready to drill.

When drilling through plastics as brittle as the cases, it is imperative that you go very slowly. A continuously variable-speed drill or hand drill is a must. If you have neither, an X-acto knife, patience, and elbow grease will do. If you'll be

using a drill, then drill pilot holes first. That'll reduce the chances of chipping the plastic or "missing the mark." No matter what cutting implement you use, don't press hard, apply just enough force to "peel" the plastic from the surface.

Install the power switch in the hole you've just made for it. If you're going to use a DPDT switch with six terminals (like I did) snip off the unused solder tabs as they stick out too far. Position the switch that so its up position will turn it on. Now you can start wiring.

Final Assembly. There are some important precautions that you should take into consideration when wiring your unit. Perhaps the most important is to use heavy-gauge solid household wire on everything that doesn't have leads of its own. As a reference, I used 14-gauge wire. Also, you should insulate the leads of all your components with heat-shrink tubing or spooled insulation—don't use electrical tape. When soldering any wire to the power terminals, solder at least a 1/2-inch portion of the bared wire with liberal amounts of solder. That will reduce the amount of heat generated at the junction by current flow when the device is in use. Keep all those points in mind, and don't be afraid to reread this paragraph if necessary.

Throughout the rest of the wiring procedure, refer to the photos for orientation. Start by stripping a little over a 1/2-inch of insulation from a 1 3/4-inch piece of black wire. Bend the bared part of the wire to form a right angle with the insulated portion. Now follow the same procedure with a small piece of white wire.

Take one of the terminal strips that you've bent and solder the black wire to its bent plug contact. The wire should be oriented so that its insulated portion points away from the strip. Flow liberal amounts of solder all over the joint. Pick up an unmodified strip and tuck the bent portion of the white wire under its plug contact so that the bare portion points in the direction of the strip and the insulated portion points away from the plug contact. The insulated part of wire should be perpendicular to the strip. Solder the wire to the strip (not the plug contact) with lots of solder. For the rest of the assembly procedure, don't solder anything in place until you're told to do so.

Place the strip with the white wire back in the case in the top position. Make sure that it is well seated in position. Bend the white wire to touch the underside of the bottom contact of the switch on the left (if you connect it to the topside you won't have room for further wiring). Now cut any excess wire, remove the strip, and strip a small bit of insulation from the wire's end. Put the strip back in and form the wire so that the bare nib presses *firmly* against the switch terminal. The contact pressure is important since you can't use a lot of solder to secure the joint. Place the terminal strip with the black wire back in the case in the spot just below the previous one and follow the same procedure to position the wire at the remaining bottom-most switch lead (again on the underside of the terminal). Install the ground terminal strip for that group of sockets.

Cut a black and a white 3½-inch piece of wire and strip and bend them as before. You will need to solder the white wire to the remaining modified strip but, unlike the little black wire, the insulation must cross the strip. You must also solder the black wire to the unmodified terminal so its insulation runs along the narrow edge of the plug contact. Make sure its bare portion is placed under the plug contact as you did for the small white wire.

The last two terminal strips have to be inserted simultaneously. Do so with the white wire to the left and the black wire to the right. The wires should point to the switch if oriented correctly. The white wire should pass between the ground terminal and unmodified plug contact of the top socket bay. Trim, strip, and position them to apply firm pressure to the underside of the remaining two contacts. Remove the two terminals you've just prepared and install their ground strip. Once that is done, the really tricky part of the circuit-assembly procedure is complete (*sans* solder, of course). You need only follow a couple of simple tips and the schematic diagram in Fig. 1 to complete the unit.

When connecting any component leads to the switch, don't run them through the holes on the switch terminals. That would only make the MOV's and the fuse harder to replace should anything blow out. Solder the bottom two terminals of the switch only after all the necessary components are connected to them. The lower two termi-

nals should be put back in the case *after* the other two terminals are soldered to the switch (remember, contact pressure is important). Solder the remaining two terminals of the switch only after everything is connected to them.

Take advantage of the thick leads of the MOV's to create a strong harness, especially for the sake of the neon bulb, whose wires are flimsy at best. The MOV that runs to ground need only be con-



The unused holes on the back of the unit have been covered with tape. The backing must be put in place as shown before attaching the Power Block to a wall socket.

nected to one of the ground strips. Keep all the component leads as short as possible.

When all the components are in place and well soldered, check the wiring of the circuit with a multimeter. Make sure that all the wires lay flat and put the backing in place. Use black electrical tape to cover the unused slits in the back. The back should engage the two posts at the bottom, but the wires will keep it from the two top ones. Insert the long screw and thread the locking nut (or cardboard) onto it and the project is complete.

Installation and Use. Before you use the Power Block, you should make sure that the two sockets that it plugs into are part of the same circuit. It is possible (although very unlikely and possibly

hazardous) that the two sockets, although they are in the same outlet box, are connected to two different circuit lines. The quickest and surest check to determine whether or not that is the case is to take a look behind the outlet cover.

Start by turning the circuit breaker for the outlet in question off. Remove the screw in the middle of the outlet to release the cover and take a look inside. You may have to remove the two screws securing the outlet to the junction box depending on whether or not the wires are connected to the sides of the outlet or the back. There may be one or two sets of household wires (each with a hot, neutral, and ground wire). If there is one triplet of wires, you're free and clear. If there are two sets, the outlet should have two tabs, one connecting the hot leads together and the other bridging the neutral leads. If that is not the case, then it's a good idea to check out another outlet (and possibly even call an electrician; a madman has wired your house.)

If the outlet is okay, then you can mount the Power Block in two different ways: For one, you can leave the wall-outlet cover off and push the Power Block in while you secure it with the large screw. For the other way, put the outlet cover back in place, plug the Power Block in, and secure them both with the large screw. Either way you must leave the cardboard backing of the Power Block in place and it's a good idea to use the screw to secure the assembly. The Power Block was not meant to be plugged in and pulled out repeatedly. Make sure that S1 on the Power Block is in its off position and turn on the circuit breaker.

As soon as you flip the breaker on, the neon bulb should glow. That means any device connected to the block is protected. If it doesn't glow, turn off the breaker (noting whether it has been tripped) and check the unit, first looking for fried components, and, failing to find the culprit that way, check it with a meter.

If the neon bulb glows, then plug a lamp into one of the top sockets and flip the main power switch. Of course, the lamp should light (if its own switch is on). Switch the block off and try one of the lower sockets. If everything checks out fine, your Power Block is now ready to provide your equipment with many hours of protection. ■

Troubleshooting

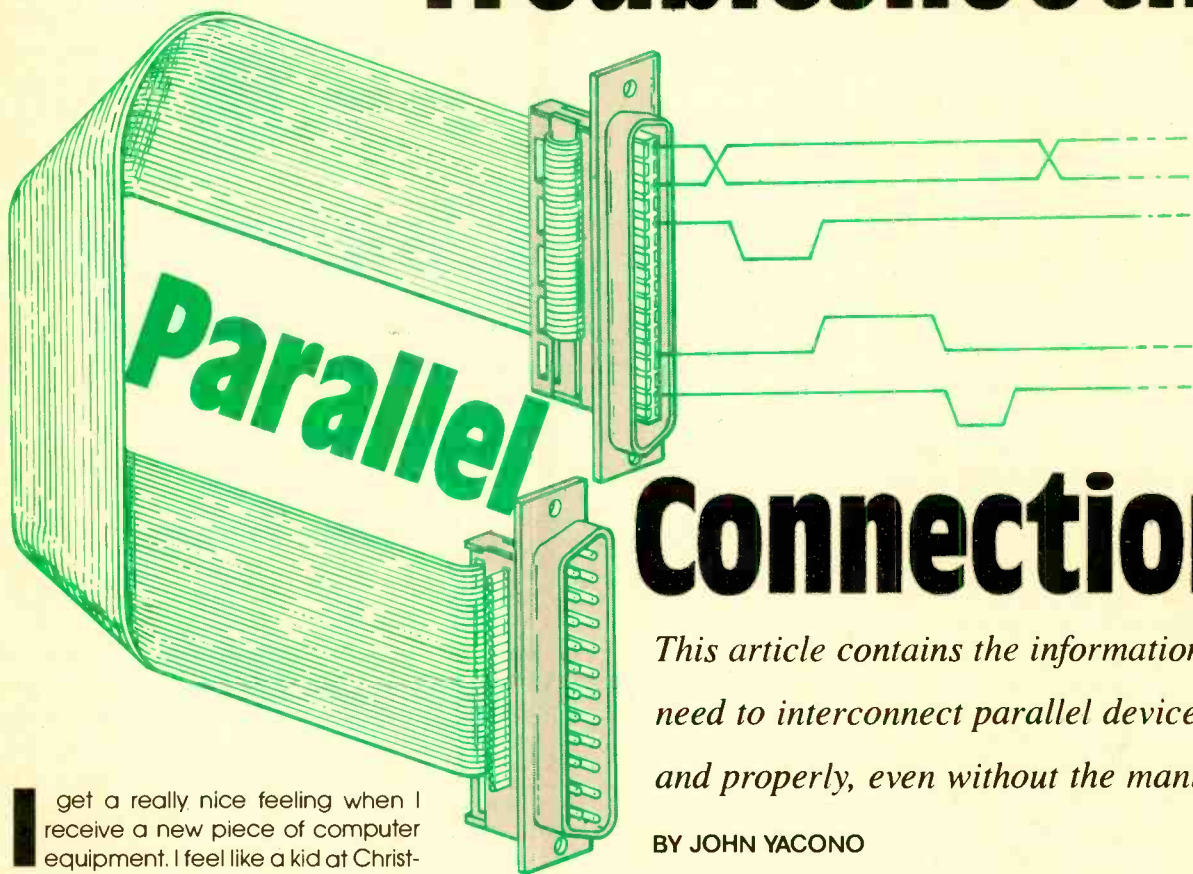

Connections

This article contains the information you'll need to interconnect parallel devices safely and properly, even without the manuals.

BY JOHN YACONO

I get a really nice feeling when I receive a new piece of computer equipment. I feel like a kid at Christmas time as I rip open the box and reveal my new possession. That excited feeling overtook me the first time I got a parallel printer; but it quickly fled when I realized that the all-important cable that was needed to connect it to my computer was *not* in the box.

Since I didn't want to wait for a mail-order cable to arrive, I *schleped* over to a somewhat-local computer store in search of a cable. The choices were numerous, and it quickly became apparent that some homework on my part was in order. This article is the result of the studying I did and the additional experience I gained by helping out friends in similar situations. I hope it will serve as a comforting life jacket in what may be unfamiliar waters.

First I'll briefly cover the most common signals used by parallel links (for a more in-depth explanation see the story entitled "All About Parallel-Port Signals," **Popular Electronics**, January 1992). Then I'll cover some of the fine points for setting up and using the hardware and software to make troubleshooting easy. After that, I'll jump into the nitty-gritty of sleuthing out the port

signals so that you can design an appropriate cable. Finally, I'll round-off our discussion with some of the unusual problems that you may encounter—including a lack of documentation—with some additional troubleshooting tricks and solutions. Keep in mind that most of the information and techniques presented here apply to just about any parallel device (plotters and special test equipment for example) not just printers.

The Most Common Interfaces. Most parallel peripherals have a male Centronics-standard 36-pin connector like the one shown in Fig. 1A. That connector can also be found on the back of some computers, but most IBM-compatible computers use a DB-25 connector like that in Fig. 1B. The DB-25 connector is usually female (having holes instead of pins) to distinguish it from any serial connectors, which are normally male, on the computer. The Amiga 1000, however, uses a male DB-25 connector for its parallel interface.

If your computer and/or peripheral doesn't sport one of those connectors, never fear—connectors vary, but the function of the signals used typically don't. So the information that I'll present will be useful to you even if your equipment doesn't use typical connectors. The port-investigating techniques presented later in this article should allow you to figure out what the pins on your connectors do anyway.

By the way, even if your equipment does use the standard connectors, please don't try to hook up parallel equipment on the basis of the pin descriptions alone—especially with a straight-through (*i.e.*, pin-for-pin) cable—even if both the computer and the peripheral have the Centronics-style connector. As you'll see, doing so will more than likely damage your equipment. Please wait until after you've read all the cautions presented in the course of this article before getting under way.

Getting back to Fig. 1, the arrows indicate the flow of signals through the connectors: incoming signals have ar-

rows pointing toward the connectors; outgoing signals have arrows pointing away. Of course, it is assumed that the connector in Fig. 1A is on the back of a peripheral, and the one in Fig. 1B is on a computer, otherwise the arrows should be reversed. The grounds are indicated with circles. (Note that some of the signal lines have a standard abbreviation shown in parenthesis.)

To simplify matters, a summary of signals, their source, and the pins they occupy on the 36-pin Centronics-style connector is provided in Table 1. All of the signals are represented by standard TTL voltage levels: a signal between 2.4 and 5 volts is a high or a binary 1, anything between 0 and 0.8 volts is a low or binary 0. Signals between 0.8 and 2.4 volts are considered invalid. Taking the "data-strobe" line first, the computer generates a momentary low signal on that line to tell the peripheral that there is data ready and waiting to be picked up from the data lines ("Data 0–Data 7").

The data lines (pins 2–9) carry the eight bits that make up a byte of data. The byte usually represents a character. Some peripherals only handle 7-bit data. Under such circumstances, the data 7 (D7) line is either ignored or sometimes used for parity checking. You will need fairly sophisticated software to provide parity bits, so you may wish to disable the device's parity checking (see the unit's owner's manual for instructions on doing so).

When a strobe pulse is received by a peripheral, it picks data off the data lines. When it's ready for more data, it pulls the "acknowledge" line momentarily low. In that way, the peripheral keeps the computer waiting until it signals its readiness to receive more data.

A peripheral can also stop the flow of data by holding the "busy" line high. When the peripheral detects a strobe pulse, it holds the busy line high until it has processed the data. When it's ready for more data, it pulls the busy line low again, allowing the computer to send more data. The busy line is sometimes used to halt the computer for other reasons. For example, if it's out of paper or "off line" (which I'll explain in a moment). Be aware that the polarity of the busy signal can sometimes be altered by a peripheral's DIP switches.

Note that the acknowledge and busy lines perform the same job in different ways. That being so, some pe-

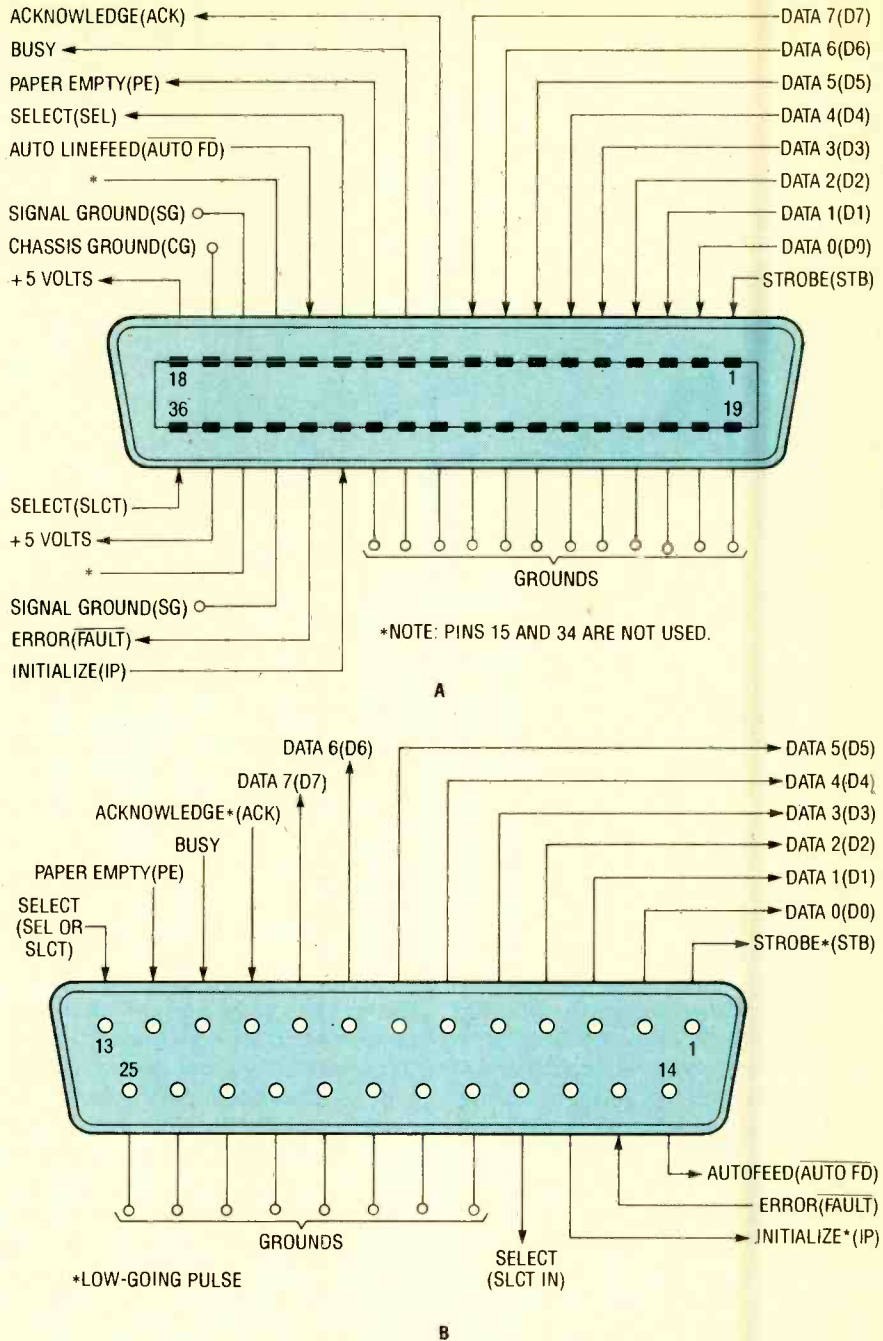

Fig. 1. Most parallel devices have the 36-pin connector shown in A. Most IBM-compatible computers have the connector shown in B on their parallel-printer cards.

ripherals support only one of those "handshaking" lines, but not both.

There are some other handshaking lines dedicated to indicating and controlling the peripheral's status. For example, if a peripheral needs to tell the computer that it's out of paper, it can do so by holding the "paper empty" line high until its supply is replenished. That feature is supported by most IBM-style parallel ports, but not on many other home computers.

Also, a peripheral can tell the computer that it's powered-up and on line by holding the "select" line (at pin 13) high (note that there are two select lines, don't confuse them). That is sometimes a necessary signal line because some peripherals can be powered up but taken off line by sending them a special "deselect" character (denoted in printer manuals as DC3 or XOFF, which has the ASCII value 19). Such equipment can be brought back on line by

TABLE 1—COMMON CENTRONICS CONNECTOR SIGNALS

Signal Name	Pin(s)	Source	Use	Description
Data strobe	1	Computer	Control	A brief low pulse to clock data.
Data 0-Data 7	2-9	Computer	Data	Carry the 8-bits that make up each character.
Acknowledge	10	Peripheral	Control	A low pulse indicates reception of a character.
Busy	11	Peripheral	Control	High if peripheral is not ready for more data.
Paper Empty	12	Peripheral	Control	High if peripheral needs more paper.
Select	13	Peripheral	Control	High if the peripheral is on line.
Auto Linefeed	14	Computer	Control	Low if peripheral must generate linefeeds.
Signal Ground	16, 33	—	Ground	0-volt signal reference.
Chassis Ground	17	Peripheral	Ground	Frame ground.
+ 5 Volts	18, 35	Peripheral	—	Positive pull-up voltage.
Ground Returns	19-30	—	—	Shield wires between pins 1-12.
Input Prime	31	Computer	Control	Low pulse resets the peripheral.
Fault	32	Peripheral	Control	A low indicates a general error condition.
Select	36	Computer	Control	Enables DC1/DC3 protocol when high.
Not used	15, 34	—	—	Undefined.

sending them a "select" character (denoted as DC1 or XON, which has the ASCII value 17).

On some peripherals, the select/deselect feature can be enabled and disabled by the computer port. For those devices, if the computer holds the "select" line at pin 36 (not to be confused with the select line at pin 13) high, the DC1/DC3 feature is enabled. Holding that line low disables that feature.

Further, by holding the "autofeed" line low, the computer can tell the peripheral to accompany each carriage return with a linefeed (i.e., the computer informs the peripheral that it will probably not be sending line-feed characters so the peripheral should step in and add them).

There are three types of grounds present on the standard Centronics interface. Those at pins 16, and 33, are "signal" grounds. They permit the signal grounds of the two devices being connected to form a common ground or signal reference.

Pin 17 is typically a chassis ground, which is sometimes internally connected to the ground power line in computers and peripherals. No harm should come to your equipment if your home-made cables don't support this function. In fact, if you suspect that your household power outlets are wired improperly, then don't wire your cables to use that pin. You might end up frying the equipment.

The remaining grounds are called "ground returns." They are used to

shield the more important lines from one another. If the cable is made of ribbon cable, each ground-return wire will naturally fall in between two signal lines. For example, the ground-return wire to pin 19 on the Centronics connector is between the wires for pin 1 and pin 2. That provides some distance between the signal wires to reduce coupling. In quality cables not made with ribbon cable, shielding is provided by wrapping a ground return around each signal line to form twisted pairs.

Some peripherals provide 5-volt lines to hold a handshaking line high if needed. For example, let's say that a computer port doesn't generate a high for the autofeed signal, but a printer needs that line high to work as desired. The cable preparer can resolve the problem by tying the autofeed line to either pin 18 or 35 at the printer end of the cable. However, keep in mind that pin 35 is not supported by all peripherals.

If you find that voltage on both the computer and the peripheral, you may be tempted to connect those pins together—don't! It will cause the 5-volt supplies in the peripheral and the computer to enter a "tug-of-war" that can be fatal to one or both units.

If the computer sends a low-going pulse though the "input-prime" line (often called the "initialize" line), a peripheral that supports that line will reset its parameters to some default configuration. The default configuration is typically the device's power-up state.

A peripheral can indicate some general error by holding the "fault" line low. Like the busy line, sometimes peripherals use that line to indicate that they are simply off line or just out of paper. That's enough about parallel-port signals for now. Let's talk about the first steps that you should take for making a cable.

Start by Reading. The first step in interfacing is to do some homework: Nothing can make an interfacing job easier or safer than reading the manuals for the equipment involved. There is no amount of experience that will make that first step a waste of time—unless, of course, you already know the operation of the devices by heart.

When one or both manuals are not available, there are ways to intelligently investigate the operation of a parallel device. I'll present some helpful tips for doing just that a little later.

While reading the manuals, there are three kinds of information that you should look for; the lines used for communication and handshaking; the internal switch or jumper settings (if any); and the common error indications and how to resolve them. Knowing the lines that are used will give you most of the information that you'll need to build a cable and interconnect its handshaking lines properly. Familiarity with the switch settings will allow you to set up the devices so that they'll operate in a predictable manner. The information that you find on errors and solutions will help you to deal with common problems that might still arise. As you find all such information, write it down (preferably on one side of a sheet of paper), or dog-ear or otherwise mark each page containing such "goodies" for later reference.

Computer Interrogation. Before you start wiring up anything, you should make sure that the parallel port on your computer is properly configured and that the computer is aware of its presence. If the parallel port is hard-wired into your computer (perhaps a part of the main circuit board), you can skip this step—chances are that the port is ready to go.

Some computers (such as Zenith Data Systems models) come with a special configuration program that will provide that sort of information. For computers that have an IBM-compati-

ble BIOS (Basic Input/Output System), you can perform a simple procedure to make sure the computer is on speaking terms with the parallel port—and you don't have to remove the cover!

When such a computer is first turned on, its BIOS gathers information about the resources that are available. For example, to talk to a peripheral, the computer needs to know where (or what "address") to send the information to. If you wanted to send a letter to a friend, you'd need to know his address right? Once the BIOS gets the address (or addresses if you have more than one parallel output on your computer), it is stored in specific place in the computer's memory.

On advanced machines (say a 386 or even some of the later XT's), that information is displayed on the monitor while the device is booting up. At that time, the computer will list the number of ports (both parallel and serial) and their addresses. Check to see if that is the case with your computer. If it is not, you can look (or "peek") at an area of memory to find out if the BIOS found any parallel ports.

To peek at the memory, you'll need to have the program DEBUG.COM (which is provided along with DOS) in the current directory or somewhere along the current path defined by the path statement. Then type:

```
DEBUG
```

and hit the enter key. The computer should respond with a dash (-) prompt. At the prompt type:

```
DQ:408 40D
```

followed by the enter key. The computer will respond with a display that looks similar to this:

```
0000:0400 BC 03 78 03 78 02 ..x.x.
```

Now respond to the dash prompt with a "Q" to exit the debug program.

The group of "hexadecimal" numbers in the middle is the only thing of interest, so you can ignore the 0000:0400 on the left and the dots and letter(s) on the far right. The first four hexadecimal digits (BC 03) indicate the address of the first parallel port—referred to as line-printer one or LPT1 in DOS "lingo." However, the two pairs of numbers are in reverse order, the address is really 03BC in hex. That is the typical address for the first parallel port. The address of the second parallel port

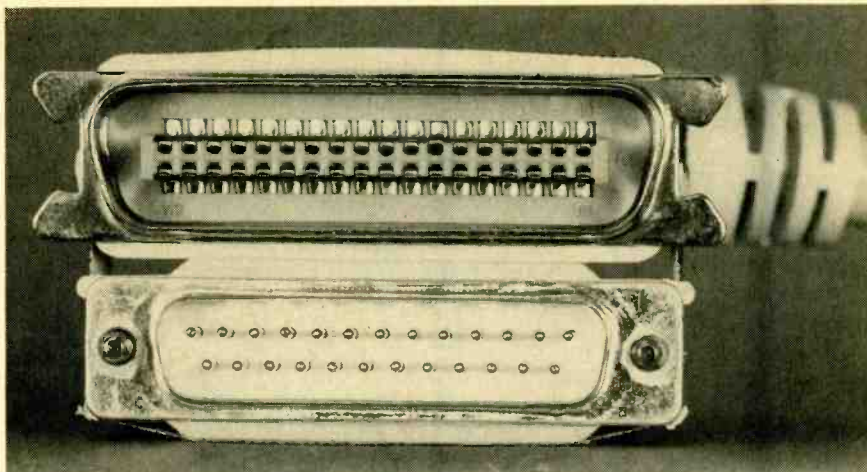

Shown here are the most-common connectors found on a parallel cable, the 36-pin Centronics (top), and the DB-25 (bottom).

(called LPT2) is represented by the next four digits: 78 03. Just as for the first four digits, the two pairs of numbers must be rearranged, so the address in hex is 0378. That is the common address for LPT2. The last address, as you may have guessed is 0278 in hex, which is represented by the last four digits. That address is the standard address for LPT3.

If any of those addresses are zero (indicated by 00 00), then that particular port is not responding. For example, if the display looks like:

```
0000:0400 BC 03 00 00 78 02 ....x.
```

Then LPT2 did not respond to the BIOS interrogation. Of course, that is not a problem if you don't intend to use LPT2.

I recently came across a machine with an intermittent parallel-port card. It provided me with an evening of "amusement" because it was fine when I ran this test, but failed while I was busy configuring some software. After much head-scratching and a few reboots, I finally noticed that the port was not always responding during boot-up. It turned out that there was a bad batch of boards produced by a manufacturer (that will remain nameless). The company goofed, but in a sense so did I: I should know enough to perform certain steps more than once. The lesson I learned is to always double-check the test results after re-booting.

Setting the Port. Assuming that you do need one of the unresponsive ports (and the port is not intermittent), you should investigate three possibilities in order: first check to see if there's an expansion card in the computer that can act as the desired port. You could

alternatively check the shipping invoice that came with your computer for such a card, but keep in mind that the parallel port usually shares a card with a video adapter. If you haven't got a parallel card, then you'll need to buy one, set its jumpers and switches, and install it.

If a card is present, it may just be disabled, so check its jumpers and/or DIP switches against the proper settings as listed in the board's manual. Specifically, you'll need to set the device address (as explained earlier) and the device interrupt line (which depends on your computer type). Complex multi-function boards may require that you specify the board's job as well.

If you haven't got a manual for the expansion board, you can sometimes get away with gleaning the information you need off the board's silk screening. However, a word of caution is in order: silk-screens sometimes contain errors. It is easier and cheaper for a manufacturer to correct an erroneous manual than it is to correct a silk screen, so when errors of that sort arise, the manual is updated, but the screen work is not.

The third, and typically the most fatal, reason why a parallel port may not respond is device failure. If you remove the board and all the jumpers seem right, try cleaning the card-edge connector foils with a pencil eraser. Swab the foils with rubbing alcohol to remove eraser deposits and reinsert the board (preferably in a different expansion slot than you took it out of). While reseating it, apply even pressure and make sure it fits firmly in the socket. Reboot the computer and check the port addresses again. If there is no response, the port

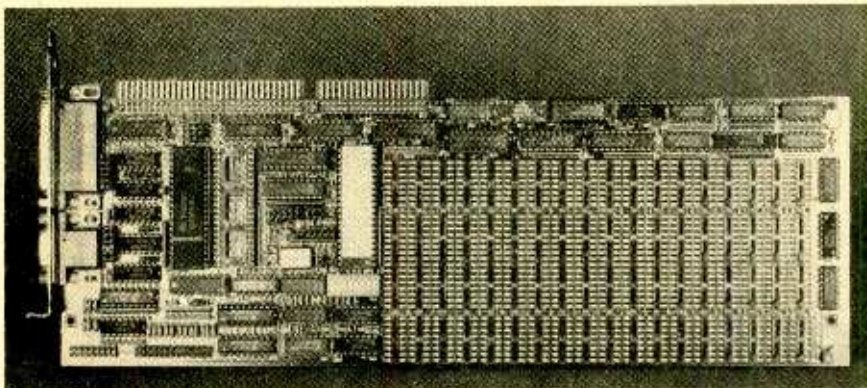

Even on multi-function boards, it is possible to set all the jumpers and switches without the documentation. You have to know what to look for on the silk screening, though.

has been damaged, so it's time for a new expansion board.

If the port you are interested in (LPT1, LPT2, or LPT3, for example) responds, but its address is not standard, you may wish to reconfigure that port's switches or jumpers. Leaving it as it is may cause problems with some software. Again, check the expansion board's manual for the proper configuration information (or use the silk screen if you must), and reboot and check the address to verify the results.

Using the Operating System. When sending test data to the peripheral, avoid using any software other than the operating system. The fewer the levels of software between you and the peripheral, the fewer the possible errors, and the easier it is to configure and correct the overall system.

One thing that many people neglect to do (until they realize they must) is set up their operating system to "play nicely" with the peripheral. Once again, some time spent reading—in this case, your operating-system manual and peripheral manual—will reveal what must be done.

As an example of a common setup procedure, this command will set up an IBM-compatible running with DOS 3.0 (the pound sign and the letters in *italic* are not to be taken literally):

```
MODE LPT#:n,m,P
```

where # is the line-printer number (either 1, 2, or 3); *n* is the maximum number of characters per line (either 80 or 132); and *m* is the number of lines per inch (either 6 or 8); the optional *P* at the end indicates that you want the computer to keep trying to send information through the parallel port no matter how many times it takes.

If you have a compatible, include the MODE command in your AUTOEXEC.BAT file and then reboot the computer *before* you begin troubleshooting. That's a worthwhile thing to do because if you have to reboot the computer during the course of troubleshooting the link, the command will be automatically executed as the computer reboots. That gives you one less thing to remember and do as you proceed. Furthermore, you'll eventually have to put the command in the AUTOEXEC.BAT file anyway.

It's also a good idea to take advantage of the *P* option. That will keep you from manually having to tell the computer to keep trying to talk to the peripheral. However, once the link is working well, it's a good idea to disable the *P* option since it prevents the computer from prompting you if it has trouble with the peripheral.

Once the operating system is set up properly, it can be used to directly send data to a port. The exact command that you use will depend on your machine, but one of the best methods is to have the operating system copy a text file to the output port. For example, if using MS-DOS in a directory containing a text file called TEXT.TXT, I would enter this command:

```
COPY TEXT.TXT LPT1:
```

to send the file straight to the LPT1 port.

It is important that you send a file that contains only alphabetic characters. Special control characters (like the DC1 character) can disable or otherwise foul the peripheral to produce results that are confusing and make it difficult to troubleshoot the link. Be careful in that respect, many word-processing programs create files that look like plain alphabetic text when viewed

within the software that generated them, but actually contain all kinds of strange stuff. Look at the text file from your operating system to be sure that what you see in your word processor is what you get.

One way to be sure that only alphabetic text is sent out of the port is to redirect characters generated by the operating system that would normally appear on the screen to the parallel port. For example, in DOS you could do something like this:

```
DIR >LPT1:
```

That requests a directory, which is always composed of simple alphabetic text, but redirects the directory text to parallel port LPT1 instead of allowing it to appear on the screen. If your operating system does not support that method of redirection, check its manual for a similar command that you can use.

Setting the Peripheral's Switches.

The peripheral must also be configured. For that, step there is little substitute for a manual. However, in some peripherals, the switches are labeled. If you don't find any such labels near the switches, check the inside cover of the peripheral, even if the switches are located elsewhere. Older Radio Shack printers, for example, have the switch functions listed on the inside of the printer's cover, even though the switches are on the back of the cabinet.

If you have neither a manual nor labels to go by, it's a good idea to write down the current switch settings and leave the switches alone until you're sure that they must be the source of any problems you might encounter. Later I'll present some examples of improper switch settings and the symptoms they present.

Some Cautionary Notes. Before you jump into tackling parallel wiring, you should be familiar with some important rules and precautions: Always use caution when dealing with the data lines on a parallel interface. Even though the handshaking lines of such ports are open-collector types (*i.e.*, they can be shorted to ground), their data outputs can be harmed by shorts to ground. Further, all the lines, whether handshaking or data, can be harmed by any voltage greater than 5 volts. That means that you should make sure that you do not mistakenly connect a paral-

tel port to a serial port. Although I have seen parallel equipment survive such abuse, it should always be feared and avoided.

If you're unsure whether or not a port is parallel, check the voltages present at the port. If you take any readings above 5-volts or below zero volts, chances are that the port is serial or a damaged and hazardous parallel port.

There is one exception to that rule: Integral Data Systems (IDS for short) equipment does generate some strange voltages at their connectors. If you have an IDS piece of equipment, you must use a manual and extreme caution. No amount of experience will really ensure success with such equipment, and you shouldn't risk your computer port or the peripheral gambling on your talent.

What you should glean from all this is that you should know the inputs from the outputs so that you can connect the output of one device to the input of another, and vice versa. That's the key to safely connecting such devices. One final precaution: double-check your wiring before powering-up TTL devices—an ounce of prevention....

If you are mindful of all those things, you should be able to use the information that you've gotten from the manuals (if any) to wire a sufficient cable. If it fails to work properly, immediately turn your equipment off and use the tricks that follow.

Inputs to Outputs. Of course, not all cabling jobs are simple to size up or obey all the standards. However, armed with a little knowledge of parallel communication and the machines in question, you can use a couple of simple tricks to figure out how to properly connect the devices, or at least to quickly determine that interconnecting them is impossible.

The techniques presented here will require the use of test equipment. For the following procedure, an oscilloscope is most useful as the low-going handshaking pulses (typically as fast as 2.5 μ s in duration) are too quick for even a good digital multimeter to detect. Alternatively, a logic probe of sufficient speed could be used.

To provide an input or output with a little protection, if you must tie it low in the course of troubleshooting, do so via a 12k resistor to limit current flow to a

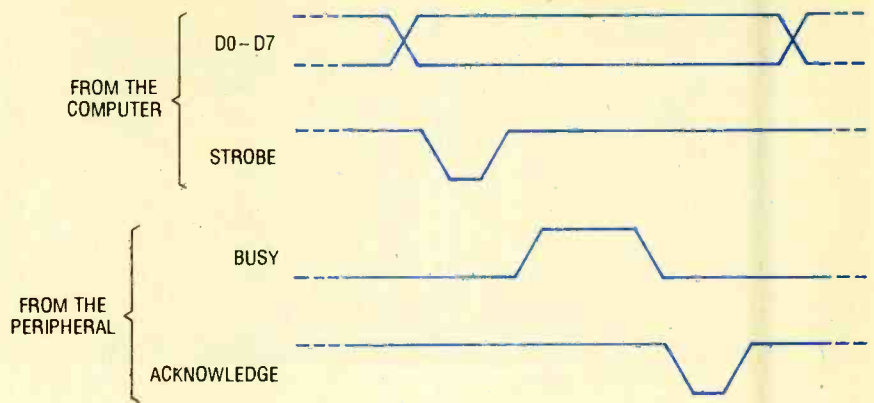

Fig. 2. This figure shows the timing of the data and handshaking lines. The data lines are lumped together in a single band because their logic value is unimportant.

safe level. **Using a resistor to tie unknown pins low is an absolute must, so never, ever forget to do it, even if it is not clearly stated in these instructions.**

One good technique that can help you to troubleshoot a peripheral link that sits there and does nothing is to feed the outputs on each device back to an input on that same device, while leaving the data lines properly connected. That will cause the two devices to operate out of sync once you get data flowing, but at least you'll be able to hunt for any non-standard handshaking lines that may need servicing.

To do that at the computer end, start by connecting the strobe output to the acknowledge input. Now tie the busy and paper-empty inputs low, and tie the select (pin 13 on a DB-25 or Centronics-style connector) and fault lines high. If the computer manual indicates the presence of any other handshaking line(s) that needs to be serviced, connect it to the appropriate logic level. If you send output through the port, you should now be able to observe logic-level changes on the data pins with your test equipment.

That technique will usually work because when the computer sends the strobe pulse, it considers the falling edge to be the start of transmission. By the time the strobe line is low, the computer has already begun waiting for the acknowledge pulse. Interestingly enough, most computer ports only concern themselves with the rising edge of the acknowledge pulse; and pay no attention to the pulse's logic level or its falling edge. Since the computer starts waiting for the rising edge

of the acknowledge pulse right after the falling edge of the strobe pulse, you can often use the rising edge of the strobe pulse in place of the rising edge of the acknowledge pulse. So the computer sends itself what it thinks is the rising edge of the acknowledge pulse, allowing data to flow out of the computer provided all of its other handshaking lines are properly serviced.

If data still refuses to flow, tie any possible remaining handshaking lines low and then high to see if any of them enable the computer to proceed. That will require some trial and error, but you should be able to get the computer port going.

Once data is flowing, you can attempt to narrow the number of handshaking lines needed by disconnecting each one individually and noting whether it has any effect on data flow. If disconnecting a handshaking line stops data flow, reconnect it and test another handshaking line. If disconnecting a line has no effect, leave it disconnected. The handshaking lines remaining after you've tested them all will be essential to the computer, so write them down along with their required logic level.

Now you must remove any hang ups at the peripheral end. To help you do that, you can use the free-running computer port as a byte generator (albeit, an expensive byte generator).

Start by connecting handshaking inputs to handshaking outputs at the peripheral end. To do that, you should connect either the acknowledge output or the busy output (whichever seems active) back into the strobe input. If both those outputs seem func-

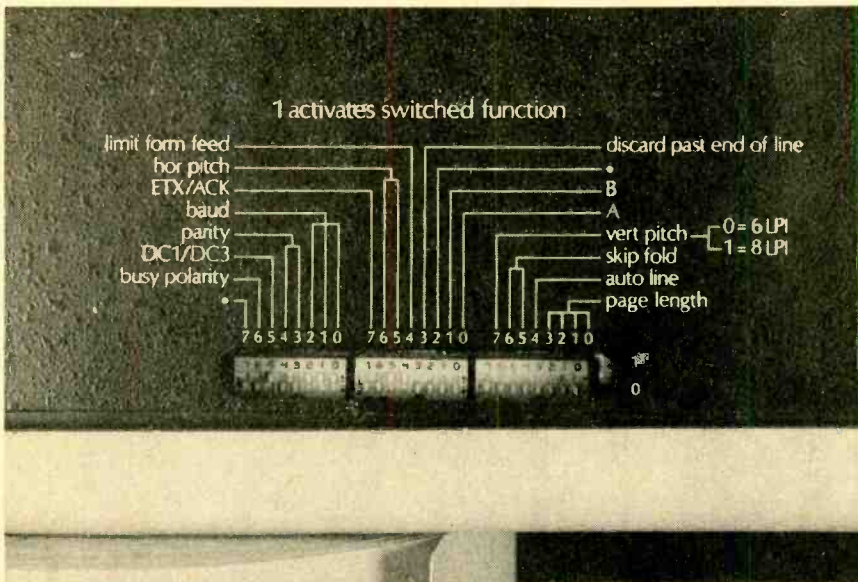

Setting DIP switches without documentation is possible provided they are clearly labeled. Unlike the unit shown here, there are some peripherals that have DIP switches in one place and the labels elsewhere.

tional, try using just the acknowledge output. If, after you've finished the rest of this procedure, that doesn't appear to work, try using the busy output and repeating the procedure.

Now tie the other handshaking inputs on the peripheral to the appropriate logic level. For most devices that means you should tie the select line at pin 36 on the Centronics connector low, the autofeed line low (at least during testing), and pull the initialize line low and then high. That should enable the peripheral to receive data. If the peripheral still refuses to work, turn it off, unplug its power cord, wait a few moments, then plug it back in and turn it on. Unplugging the cord may seem drastic, but for some peripherals (like certain Digital Equipment Corporation units), it is necessary to clear its "sinuses."

Again, the computer and peripheral will not be in-sync, but this is a good technique to help you determine which handshaking lines are of importance. If the peripheral ignores the incoming data, hunt for unusual handshaking lines as you did for the computer port. Once data is flowing, test for and eliminate unnecessary handshaking connections as you did for the computer port and document your results.

From the documentation that you've developed from your tests, you should be able to create a suitable cable. If you find that one or more handshaking lines are lacking in one or both devices, you can tie the appropriate pins to the

right logic level. Just remember that if a pin needs to be tied high, it should be connected to the 5-volt line on the device it's attached to and nothing else. For example, if the computer needs to have a pin tied high, but the peripheral doesn't support that pin, the pin should be connected only to the computer's 5-volt supply and not the peripheral's equivalent pin or the peripheral's 5-volt line.

Of course, there are rare cases where pulsed handshaking lines are not supported on one or both devices. You'll discover whether or not that is the case as you examine your notes. That can make connecting the equipment seem impossible, but it's really not, as you'll soon see.

Handling the Unusual. You may come across peripherals that might generate either acknowledge or busy signals, but not the signal the computer is looking for. There are two different fixes for that. The one you should use depends on which signal is lacking.

If the busy signal is missing, try feeding the peripheral's acknowledge output to the computer's busy input. In that way, the acknowledge pulse mimics the activity of the busy signal to accommodate the computer. Look at the timing diagram in Fig. 2 to see the similarity between the acknowledge and busy lines.

In rare instances, the reverse is necessary: you must feed the peripheral's

busy-signal output to the computer's acknowledge input. In such cases, the busy-signal's activity imitates that of a missing acknowledge pulse.

There are a small number of computer ports that are incapable of generating data-7 signals. That line on such ports may not be connected to anything inside the computer. That can result in the data 7-input on the peripheral floating high. And that will likely result in the improper operation of the peripheral—for example, a printer might only print graphics. The cure is to disconnect that line from the computer and tie it low at the peripheral.

There are two seemingly nasty errors that can be cured by properly setting the peripheral's DIP switches or tying the autofeed input to the appropriate logic level. One is that the print all occurs on a single line. That's an indication that neither the computer nor the printer is generating linefeeds. Assuming that your printer has no DIP switch to enable linefeed generation, a quick fix is to disconnect the autofeed line from the computer and tie it to ground. The printer should now add a linefeed to each carriage return received, solving the problem.

The other symptom is double spacing when you are sure you've requested single-spaced output. That indicates that both the computer and printer are generating linefeed characters. Again assuming that the proper DIP switch is nowhere to be found, you should disconnect the autofeed line from the computer, and connect that line to a source of 5 volts from the printer. Check pins 13 and 35 on the printer's Centronics connector to see if they are suitable voltage sources.

Jobs Without Manuals. To work "in the dark," you should first become thoroughly familiar with the functions of each line of the standard parallel interface. Study the operation (as in Table 1) and timing (as shown back in Fig. 2) of the lines so that you'll know what to look for, and be able to recognize the behavior of each line when you see it. Many of the procedures presented here require that you use some of the techniques mentioned in the "Inputs to Outputs" section. Refer back to that text where indicated.

It will be assumed that you have configured both devices to the best of your ability using the setup procedures pre-

sented throughout this article, and that you've checked the voltages on the connectors. Now examine the circuit board that the interface connector is mounted on in the unknown device(s). Look for pins that are obviously connected to the ground bus on the board. The ground bus foils are generally fat and, of course, the ground runs to every chip on the board. Jot those connector pin numbers down so that you'll know those pins are inconsequential to troubleshooting the link. Similarly, look for pins that are obviously connected to the 5-volt bus (which should also run to all the chips on the board) and document them as well. Following that procedure should eliminate about half of the pins.

Plug the undocumented device or devices in and turn them on. Using either an oscilloscope or multimeter, measure and record the voltage of each pin. That test will reveal which pins are inputs and which are outputs: inputs (whether for control or data) will have voltages in the TTL noise range (i.e., 0.8–2.4 volts); whereas outputs will be at valid logic levels.

For now, let's talk about what that test tells us about the operation of a computer port and how to apply that information. The test is particularly revealing for computer ports because the inputs are only used for handshaking. By using some trial and error, as described earlier, you should be able to connect those inputs to the appropriate logic levels to enable the computer to transmit data.

If the port begins to operate non-stop, then you've arrived at all the proper logic levels, and the port doesn't require an acknowledge pulse. If, in the course of trying out different logic configurations, one or more of the outputs change state each time that you change the logic level of one particular input, then that input is for the acknowledge line.

By observing the timing of the output signals and comparing them to Fig. 2 (presented earlier), you should be able to determine which one is the data-strobe line—it will generate a brief pulse after the other lines have settled. If your computer requires activity on the acknowledge line, then connect the data-strobe line to the acknowledge line to turn the computer into a byte generator. Remove the handshaking connections one-by-one to determine

TABLE 2—BINARY VALUES OF CHARACTERS

COLUMN		0	1	2	3	4	5	6	7
BITS	D7	0	0	0	0	0	0	0	0
	D6	0	0	0	0	1	1	1	1
	D5	0	0	1	1	0	0	1	1
	D4	0	1	0	1	0	1	0	1
ROW	D3 D2 D1 D0								
0	0 0 0 0			<SPACE>	0	@	P		p
1	0 0 0 1			!	1	A	Q	a	q
2	0 0 1 0			"	2	B	R	b	r
3	0 0 1 1			#	3	C	S	c	s
4	0 1 0 0			\$	4	D	T	d	t
5	0 1 0 1			%	5	E	U	e	u
6	0 1 1 0			&	6	F	V	f	v
7	0 1 1 1			'	7	G	W	g	w
8	1 0 0 0			(8	H	X	h	x
9	1 0 0 1)	9	I	Y	i	y
10	1 0 1 0			*	:	J	Z	j	z
11	1 0 1 1			+	;	K	[k	{
12	1 1 0 0			,	<	L	\	l	
13	1 1 0 1			-	=	M]	m	}
14	1 1 1 0			.		N	^	n	~
15	1 1 1 1			/	?	O	_	o	

These characters are not common to all peripherals

This character is not common to all peripherals

which lines are monitored by the computer, as mentioned earlier.

The remaining outputs must be data and handshaking outputs. You can tell the difference between the remaining handshaking outputs and the data outputs because the logic levels of the data outputs will depend on the data being transmitted. The handshaking outputs, on the other hand, will always appear at the same logic level during data transmission. At this point, you should have created all the documentation that you'll need for the computer port.

Checking the voltage levels on a peripheral's connector can also tell you much about the pin functions. All of the pins that are at specific logic-levels must be handshaking outputs. The pins at noise voltage levels are either data inputs or handshaking inputs.

Momentarily pull each input pin low and monitor the other pins. If, in the course of tying each pin low, the print head shifts in place or the peripheral beeps, you've probably found the ini-

tialize line. If pulling a particular pin low causes one or two pins to go high, and/or it produces a low pulse on a normally high pin, then you've found the important handshaking lines. The pin you pulled low is the data-strobe pin, and the line with the low-going output pulse is the acknowledge line.

The pin or pins that went high support the busy and fault lines. One way to sort-out the fault line is to open the peripheral's cover. Some peripherals are able to detect cover removal via a micro-switch and generate a fault signal. Also on some peripherals, depriving the peripheral of paper (if applicable) will cause the device to generate a fault signal as well as a paper-empty signal, if the peripheral supports that line. That procedure can help you find the paper-empty pin and it also can help you distinguish between the fault and busy lines.

That gives you enough information about the peripheral to connect it to the computer, which can help you per-

(Continued on page 94)

3x3 VISUAL CONTINUITY TESTER

This handy little tester does more than indicate a continuous circuit path; it also gives a relative resistance reading.

BY RICHARD HAMPTON

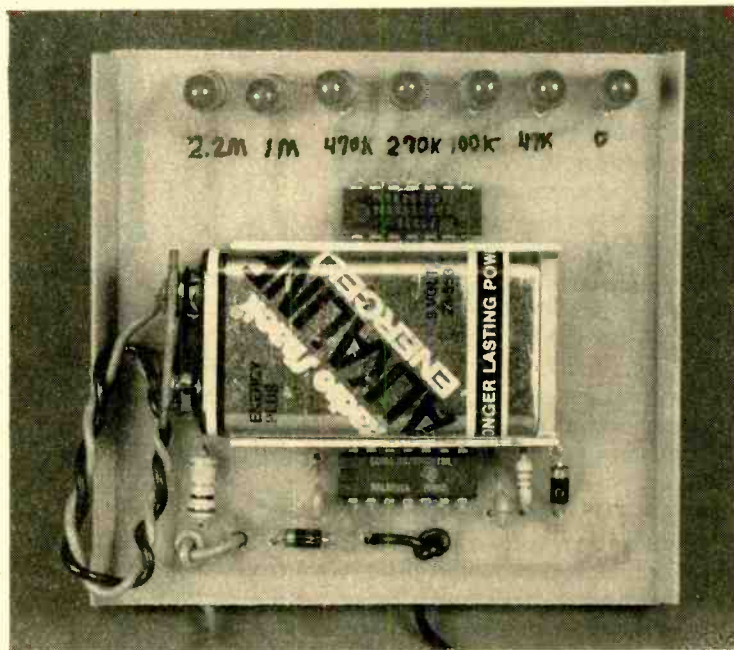

Whether you're an electronic hobbyist or professional, or maybe just an occasional tinkerer, one thing you simply can't do without is some sort of test equipment. One of the more basic test instruments is the continuity tester.

There are all kinds of continuity testers, ranging from a simple light bulb and battery to sophisticated, commer-

cial-grade units. One drawback with the majority of testers is that they indicate complete circuit paths only, with no indication as to the resistance in the path. However, the 3 x 3 Visual Continuity Tester described in this article can tell you more than just continuity: By

judging the rate at which a particular LED flashes, you'll be able to estimate the resistance.

Circuit Description. Figure 1 is a schematic diagram of the 3 x 3 Visual Continuity Tester. The circuit consists of two IC's (a 4011 CMOS quad 2-input NAND gate, U1, and a 4024 binary counter, U2), seven LED's, and a handful of additional components. All of the gates in U1 are wired as inverters.

Two of the inverters (U1-a and U1-b) comprise an astable-multivibrator (free-running oscillator) circuit, whose operating frequency depends on the amount of resistance detected between the test probes. Feedback from the output of the oscillator (at pin 4 of U1-b) back to the input of the circuit (at U1-a, pins 1 and 2) is provided via C1. Resistor R1, along with the unknown resistance between the test probes, completes the RC timing circuit. The frequency of the oscillator decreases as the resistance between the test-probes increases.

The output of the oscillator is fed to pins 12 and 13 of U1-c, the output of

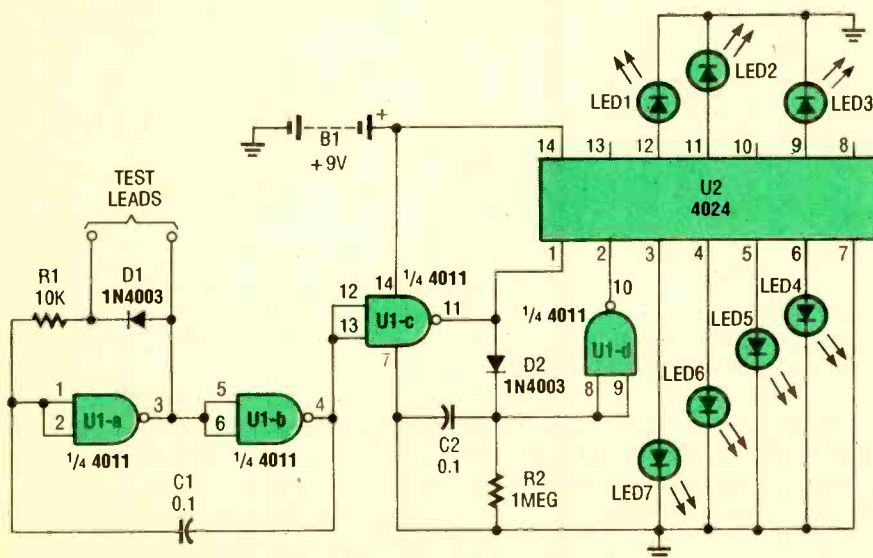

Fig. 1. The 3 x 3 Visual Continuity Tester consists of two IC's, seven LED's, and a handful of additional components.

which then divides along two paths. In the first path, U1-c's output is applied to the clock input of U2 (a 4024 binary counter) at pin 1; in the other path, the signal is fed through D2 and across capacitor C2, causing it to begin charging. The charge on C2 is applied to U1-d at pins 8 and 9. The output of that inverter (U1-d) is fed to the reset terminal (pin 2) of U2. If there is continuity or a measurable resistance between the test probes, U2's reset terminal is pulled low, triggering the counter and allowing it to process the input pulses (count).

The rate of the count is proportional to the resistance between the test probes. If the resistance between the test probes is low, the counter advances rapidly. If a large resistance is detected between the test probes, the counter advances slowly. The counter provides a 7-bit binary output that is wired to seven LED's.

When the test probes are placed across a short circuit, LED7 flashes. If the tester is placed across a resistance of, say 2 megohms, LED1 will flash. In either case, the LED whose assigned value most closely corresponds to the resistance connected between the two probes will flash continually at a steady pace, while the other LED's will seem to flash intermittently.

PARTS LIST FOR THE 3 × 3 VISUAL CONTINUITY TESTER

SEMICONDUCTORS

U1—CD4011 quad 2-input NAND gate, integrated circuit

U2—CD4024B binary counter, integrated circuit

D1, D2—1N4003 1-amp, 200-PIV, rectifier diode

LED1-LED7—Light-emitting diode

ADDITIONAL PARTS AND MATERIALS

R1—10,000-ohm, ¼-watt, 5% resistor

R2—1-megohm, ¼-watt, 5% resistor

C1, C2—0.1-µF, ceramic-disc capacitor

Perfboard materials, enclosure, 9-volt transistor-radio battery, battery holder and connector, test-lead wire, test probes, hook-up wire, solder, hardware, etc.

Note: An etched and drilled printed-circuit board is available for \$5.00 from Richard Hampton, 17005 E. 4th Street South, Independence, MO 64056; order part VC-3. Missouri residents add \$0.29 state sales tax.

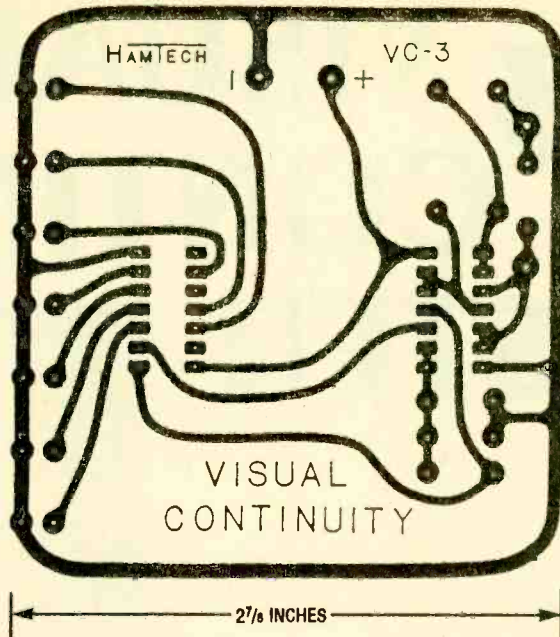

Fig. 2. The continuity tester was built on a printed-circuit board, measuring 3 × 3 inches; here is the template for that printed-circuit board.

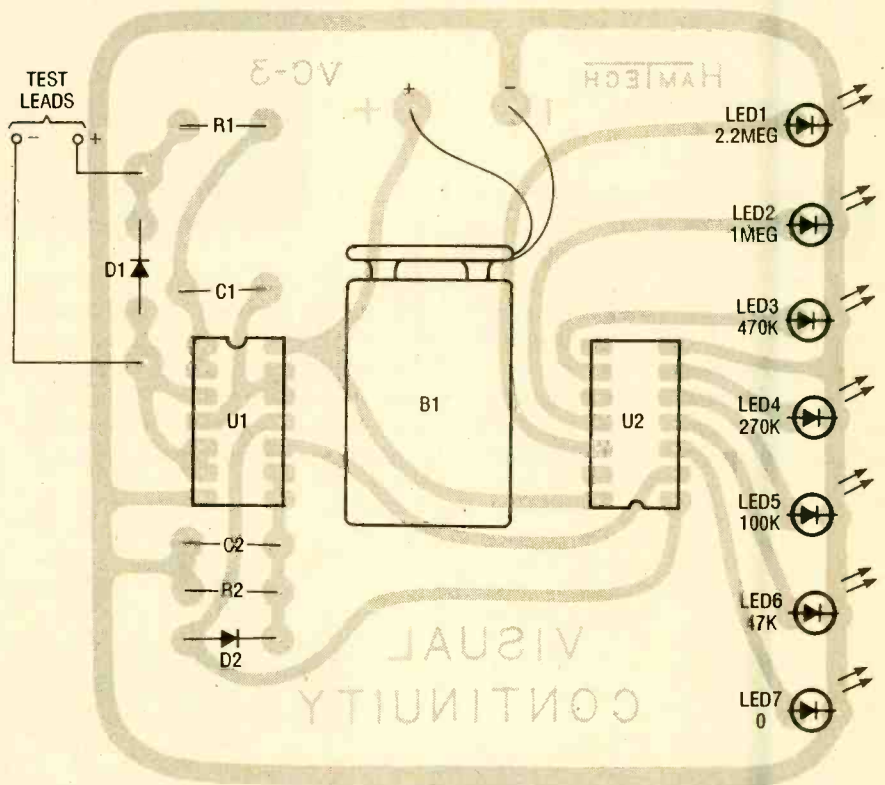

Fig. 3. Assemble the printed-circuit board using this parts-placement diagram as a guide. When assembling the project, be sure to pay attention to the orientation of the semiconductors and battery polarity.

The circuit is powered from a 9-volt battery (B1). Since the circuit is off in the presence of an open circuit, you can expect a long battery life.

Circuit Construction. The continuity tester was built on a printed-circuit

board, measuring (what else?) 3 × 3 inches. A template for that printed-circuit board is shown in Fig. 2. A parts-placement diagram corresponding to the Fig. 2 template is shown in Fig. 3. When assembling the project, be sure
(Continued on page 98)



A PA-SYSTEM PRIMER

BY SAM ALLEN

Public-address systems are quite different from home audio equipment. We explore the distinctions so you can set up simple PA systems of your own with confidence.

Most of you are probably familiar with hi-fi audio amplifiers, but you may not know a lot about public-address (or PA) systems. The purpose of this article is to give you a basic understanding of PA systems. Audio-system engineering is a complex subject, so this article will only scratch the surface; but the information in this article will get you started, and provide enough detail to permit you to install a simple system or add to an existing one. If a particular system is still too complex for you to take on after reading this article, at least you will be able to talk intelligently with a qualified PA installer.

In this article, I will tell you some of the basics of setting up PA systems. I'll explain the theory and practical aspects concerning the areas where PA systems differ from home-audio systems—with the assumption that you know a little about home audio.

PA Basics. Let's begin with a brief description of a typical PA system. The heart of a PA system is an amplifier. The amplifier's output power can range from 10 to hundreds of watts. Usually it will include a built-in mixer, which allows you to adjust the level of several different inputs, and a master volume control.

Typically the amplifier can handle two main types of inputs: line-level inputs (to accept the -20 to $+30$ dBm signals produced by plain audio equipment like tape decks, tuners, etc.) and

"balanced-line" inputs (for signals from -80 dBm to -20 dBm that are typically produced by PA microphones). We will discuss balanced-line microphone inputs in greater depth a little later.

Another major portion of a PA system is the speaker set up. Simple systems will generally have one or two large speakers, typically located at the front of a room near the microphone. That is called a "single-source" system.

The trend in more recent installations is to have an "array" of many small speakers. An array system offers several advantages. First, it gives every part of the room fairly equal volume. That is not the case for a single-source system so the volume is usually uncomfortably loud near the speaker, but barely audible in a far corner of the room. Also, since you can locate the speakers for an array system further from the microphone and operate them at a reduced volume, you can reduce feedback problems.

However, feedback can be limited in either a single-source or array system by adding another component to a PA system: an equalizer. An equalizer can be adjusted to attenuate the frequencies that give the most feedback problems. Now let's discuss balanced-line microphones and see how they can reduce both feedback and hum.

Microphones. A variety of microphone types can be used in PA systems,

but a few unifying characteristics that most PA microphones have are low impedance, balanced-line cables, and directionality. On the subject of impedance, all audio inputs are given a rated impedance to indicate their compatibility with signal sources, such as microphones. However, the impedance rating is not necessarily the impedance of the input itself. Instead, the rating is a standardized value like 150 ohms or 600 ohms, which indicates that the device will work well with signal sources with the same specification.

For example, modern microphones work best when they are used with an input that has an impedance that is at least ten times greater the microphone's own impedance, so an input with a rated impedance of 150 ohms may have an actual impedance of 1500 ohms or more. On the surface, this looks like an impedance mismatch, but it will actually yield optimum results. So, to avoid a lot of confusion, manufacturers label each input with a rated impedance equal to that of the microphones that will work best with that input.

As mentioned, another characteristic of most PA microphones is directionality. Directional microphones are more sensitive to sound coming from a given direction. They can be used to help solve feedback problems and reduce noise pick up by pointing their sensitive side toward a desired audio source and away from the speakers.

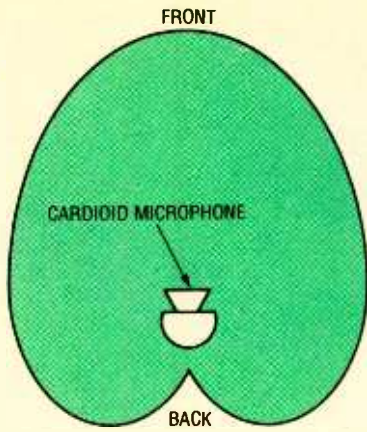

Fig. 1. A cardioid microphone has a heart-shaped pickup pattern. It is most sensitive to sounds in front and least sensitive to sounds directly in back of the microphone. You can orient the microphone so that a noise source is in back of the microphone.

The most popular type of directional microphone is the cardioid microphone. Figure 1 illustrates the "pick up" pattern of a cardioid microphone. The heart-like shape of the pattern indicates how close a sound source of a particular power must be to the microphone to make it produce an electrical signal of a particular magnitude. As you can see, sources in back of the microphone must be much closer than sources in front of it to produce the same response. In other words, the microphone is more sensitive to sound directly in front of it than it is to sound directly behind it.

The cable used for PA microphones also helps reduce noise. The type of microphone cable you're probably most familiar with has one conductor in the center surrounded by a shield (see Fig. 2A). That is called an "unbalanced line." In an unbalanced line, the grounded shield is used as one conductor in the circuit. The center conductor is called the high or hot side of the circuit. Unbalanced lines are fine for runs up to about 25 feet, but longer runs are susceptible to hum and also to noise pick-up.

A balanced line can be used for cable runs of several hundred feet. It consists of two ungrounded conductors that carry the audio signal, surrounded by a shield (see Fig. 2B). Both of the signal-carrying conductors are hot (they are called signal high and signal low to distinguish them) and equal in voltage, but opposite in polarity. It is the

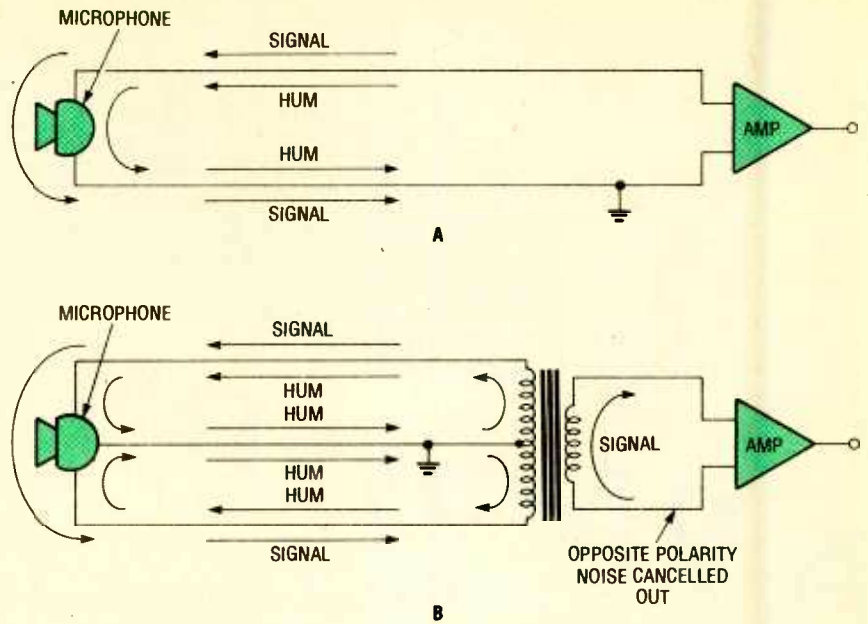

Fig. 2. In an unbalanced line (A), the shield provides enough protection against hum pickup for about 25 feet. But in longer runs, induced noise can be a problem. A balanced line (B) is better for long runs because the induced noise is canceled out.

opposite polarity that makes a balanced line less susceptible to hum pickup. Hum induced in one conductor will be canceled out by the hum of opposite polarity induced in the other conductor.

Since a balanced line requires three conductors, microphone cables for PA systems are typically terminated in "XLR"-type connectors (see Fig. 3). The signal conductors are connected to pins 2 and 3 and the grounded shield is connected to pin 1. The cable shield is also connected to the outer shell of the connector.

All microphones in a system should be wired with the same polarity. Microphones come from the factory with pin 2 connected to the positive terminal, so you won't need to worry about the po-

larity unless you wire a connector yourself.

Newer systems will usually have a provision for providing power to capacitor microphones. The microphone power supply is connected to the microphone input jacks (see Fig. 4). The negative side of the supply is connected to the ground, pin 1. The positive side is connected to both hot lines, pins 2 and 3 through matched 6.8k resistors. That arrangement allows both dynamic and capacitor microphones to be connected: Since both signal-carrying conductors are connected to the positive side of the power supply, no power-supply current will flow through the coil of a dynamic microphone.

Speakers. PA systems are classified in two general categories: sound-reinforcement systems and sound-distribution systems. A sound-reinforcement system takes a signal from a microphone and amplifies it to cover a large room. A sound-distribution system is used to distribute sound to a number of rooms, like a background-music system in a large building. The main technical difference is the length of the wire runs to the speakers: the speakers in a sound-reinforcement system may be located close to the amplifier, but the speakers in a sound-distribution system can be located hundreds of feet away from the amplifier.

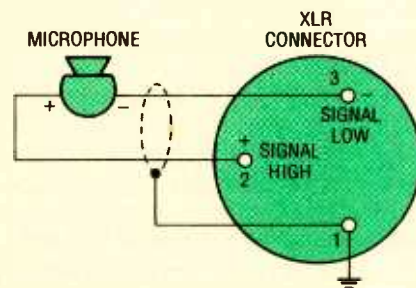

Fig. 3. This is the standard XLR connection: pin 1 is ground, pin 2 is signal high, and pin 3 is signal low. By observing this standard, all microphones in the system will be the same polarity.

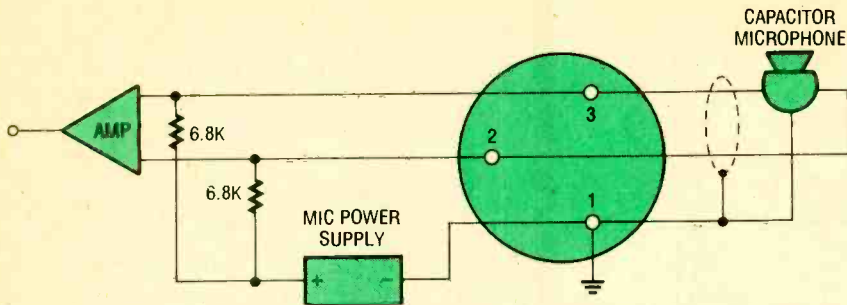

Fig. 4. Capacitor microphones can be remotely powered over the same three-conductor cables used for other types of microphones. The power supply is connected to the microphone jack as shown here. This method allows you to use dynamic microphones interchangeably with capacitor types because there is no difference in potential between pins 2 and 3.

There is an important difference between a home-audio system and a distribution system. In a home-audio system, speakers must match the output impedance of the amplifier and must be able to handle the full power output of the amplifier. If you were to add additional speakers to the line, you change the impedance so it is difficult to add multiple speakers to the line. For example, if you place two 8-ohm speakers in parallel, the effective impedance is 4 ohms. Adding additional speakers in parallel will further reduce the impedance. You can match the impedance by wiring speakers in series-parallel combinations, but that is an awkward solution if the speakers are far apart.

On the other hand, in a PA system there is often a need to have many speakers connected to a single output. For simplicity's sake, you want to be able to run a single line from the output and tap into the line at any point to connect a speaker. For that reason, PA systems use a "constant-voltage line" (see Fig. 5) that can distribute the audio through long wire runs without any appreciable loss of signal. They are called that because they carry voltages of 25 or 70 volts.

In such a system, a transformer is present at each speaker location to provide the speaker with the desired wattage at the speaker's rated impedance. Since the wattage is selectable, the speaker doesn't need to be able to handle the full power output of the amplifier. For example, if you have a 100-watt amplifier, you can use up to ten speakers rated at 10 watts each by using the ten-watt tap on each speaker transformer. This has another advantage: you can use higher wattage taps

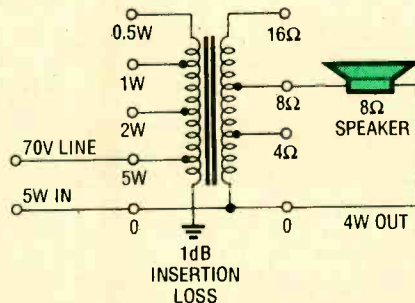

Fig. 5. When using a 70-volt speaker transformer, you choose the power by connecting the 70-volt line to the terminal marked with the appropriate number of watts. Connect the speaker to the terminal marked with the correct impedance.

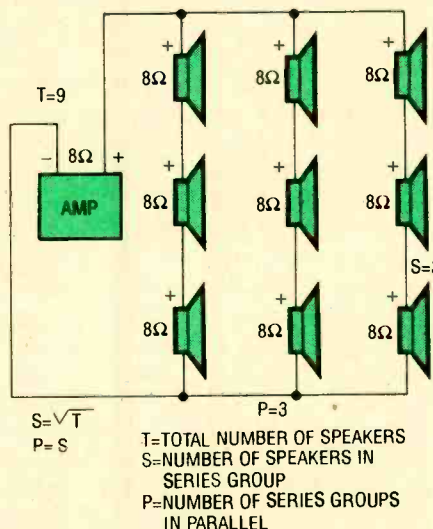

Fig. 6. Series-parallel connection can enable you to use multiple speakers without a constant voltage line. You must determine the total number of speakers needed (T), then take the square root of that number to find the number of speakers to place in a series group and the number of groups to connect in parallel. This system only works with numbers that have whole numbers as their square root.

and speakers in noisy locations and low wattage taps and speakers in quiet areas.

When planning a PA system, you must select an amplifier with sufficient power to drive all the speaker installations. However, determining the total power needed is not as simple as adding up the speaker wattages. There is a small power loss in each of the transformers that must also be added in. To make things easy to figure out, most transformers are marked according to the total power they will draw from the line, not by just what they send to the speaker. So to figure out the amplifier power needed you just sum up the wattage ratings of the transformers. On a purely practical note, it is usually a good idea to get an amplifier that can provide more wattage than absolutely required for the present set-up so you can add more speakers later if necessary.

Wiring Speakers. Since speaker lines are usually permanently installed in a building, you need to follow the electrical codes when running them. That means you should use cable that is marked CL2 on the outer jacket. Never run such wiring in the same conduit as wires carrying higher voltages, and keep them at least 2-inches away from higher voltage wires in open areas. You should consult the National Electrical Code for complete details on "Class-2" circuits if you are interested in more information.

When a large number of speakers are grouped close together in an array, you can match the impedance using series-parallel connections like that shown in Fig. 6. That scheme eliminates the need for a constant-voltage line and the associated transformers that would be required.

There's another trick you can use to avoid using a constant-voltage line when the number of speakers is small. Most amplifiers have outputs for 4-ohm, 8-ohm, and 165-ohm speaker lines. All these outputs share a common ground. Normally, you would connect a 4-ohm speaker system between the 4-ohm terminal and ground, an 8-ohm system between the 8-ohm terminal and ground, etc. But by connecting these outputs to the speaker line in different ways, you can get other values of output impedance. For example, let's say you wish to connect four 8-ohm speak-

(Continued on page 92)

Leaving the inputs of unused gates unconnected can cause hard-to-diagnose problems. Here's how to avoid those problems.

BY
CHARLES HANSEN

All About Proper Input Termination

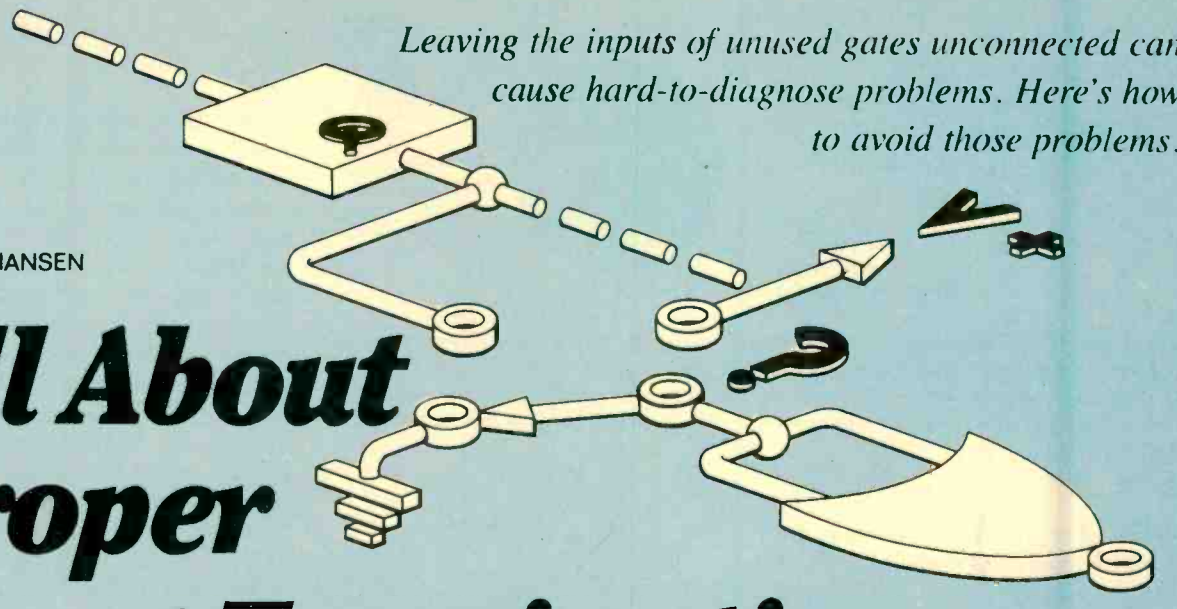

One of the real advantages of integrated circuits is that they often contain multiple copies of a device in a single package. For example, linear circuits come in dual and quad formats, and logic IC's have as many as eight individual gates in a case.

While it is more efficient to use all the sections of all the IC's in a circuit that you have designed, there are times when one or more of them are left over. Whenever this occurs, the inputs of the unused devices *must* be properly terminated. By way of example, linear and CMOS digital circuits have very high input impedances, and if the inputs are left floating, the device becomes susceptible to noise, radio-frequency interference, and power-supply glitches. That can produce oscillation or unwanted output states that can interfere with the proper operation of the circuit you spent so much time developing.

Also, any IC with floating inputs can pick up sufficient noise to cause current flow in the IC substrate. That can lead to intermittent circuit failures that cannot be predicted. In some cases, the unwanted response can produce such high power dissipation in the IC that the device can fail.

Unused gates aren't the only candidate for proper termination. Functioning inputs are sometimes connected to switches or other mechanical compo-

nents where they may be left floating momentarily during the movement of the switch. We'll cover the remedy for that later.

CMOS-Logic Termination. We will be addressing 4000-series (metal-gate) CMOS here, but the following rules also apply to high speed (polysilicon gate) CMOS as well.

Floating CMOS inputs can self-bias the IC so that it operates in the linear region. Figure 1 shows the equivalent circuit for a typical CMOS inverter. The self-bias condition is caused by the reverse leakage current of the input protection diodes. Since the input diodes are part of the silicon chip itself, they are very well matched and their leakage currents are nearly equal. That results in a voltage divider action that causes the floating input to settle near 50% V_{dd} , which is in the noise region for CMOS. That undesirable situation results in both the P- and N-channel output FET's conducting simultaneously. Since CMOS has a very high gain, any noise picked up at the floating inputs can cause the gate to oscillate, which results in high power dissipation and can lead to failure. The oscillation, which can occur at a very high frequency, can propagate over the power supply lines and cause faulty logic operation in the other components in the circuit. More importantly, the high-current driv-

er gates (4049, 4050, 4502) are especially susceptible to damage due to excess power dissipation caused by floating inputs.

The easiest way to terminate the inputs of unused CMOS logic gates is to tie them to either V_{ss} (usually ground) or V_{dd} . If ground or V_{dd} is not in the vicinity of the input pins of an unused gate, but the input pin of another gate is near, you can tie the inputs together. This method can often solve trace-layout problems during the routing of PC boards. The only drawback is that additional fanout is required of the logic that provides the input signal to the two gates. That adds additional capacitance to the circuit (7.5 pF per input), which can slow down the logic transitions. Since CMOS can provide a fan out of over 40 however, this is only a problem where the circuit is being pushed to maximum speed.

CMOS inputs that are terminated at a connector or mechanical switch may be unintentionally left floating when the board is removed for service, or when the switch wiper is momentarily between its contacts during operation. In such cases, a 100k to 1-megohm resistor should be connected from each of the inputs to ground. That resistor also provides protection against electrostatic discharge (ESD), which can damage CMOS logic IC's.

Another potential problem with

CMOS is latch-up. Inherent in the device structure is a silicon controlled rectifier (SCR) formed by parasitic resistance and transistors in the various doped layers of silicon that form the device. As long as the input voltages remain within the power-supply limits and the input and output currents under all conditions are kept at less than 10 mA, the phantom SCR cannot fire. If these rules are violated, however, the SCR can fire and latch-up. Once that happens, the power supply becomes shorted through the device and it will be destroyed.

One of the more common ways to exceed the input voltage limits is by using a capacitor at the logic inputs of CMOS circuits. Capacitive-coupled CMOS circuits are very useful as economy one-shots and time delays, but under some conditions, the capacitor can drive the CMOS input above or below the power supply rail, which can cause latch-up. Problems are practically guaranteed if the capacitor is larger than .01 μF or $+V_{\text{dd}}$ is 6 VDC or higher.

A capacitor used to implement a time-delay function causes the input voltage to change slowly. For that reason, only Schmitt gates should be used for these functions. If conventional gates are used, when the capacitor voltage passes through the 50% V_{dd} logic-transition point, all the problems with floating inputs can occur. The Schmitt gate prevents this problem because its input turn-on and turn-off points do not occur at the same voltage, however one problem can still arise.

Let's take an example to illustrate. Figure 2A shows a one-shot formed by two 2-input NAND Schmitt gates. Initially, the inputs to U1-a are both high, and the output of U1-a is low. Capacitor C1 is uncharged, and the output of U1-b is high by virtue of the low input provided by R2. If a low logic pulse is provided at the input of U1-a, its output will go high. Since the voltage across C1 cannot change instantly, a high input appears at U1-b and its output goes low. Then C1 charges through R2 until the voltage across R2 falls back to the low input level of U1-b and the output of U1-b again goes high. The duration of the output pulse is determined by the values of R2 and C1.

It's a nice little circuit, fairly accurate, and works very well. So what's the prob-

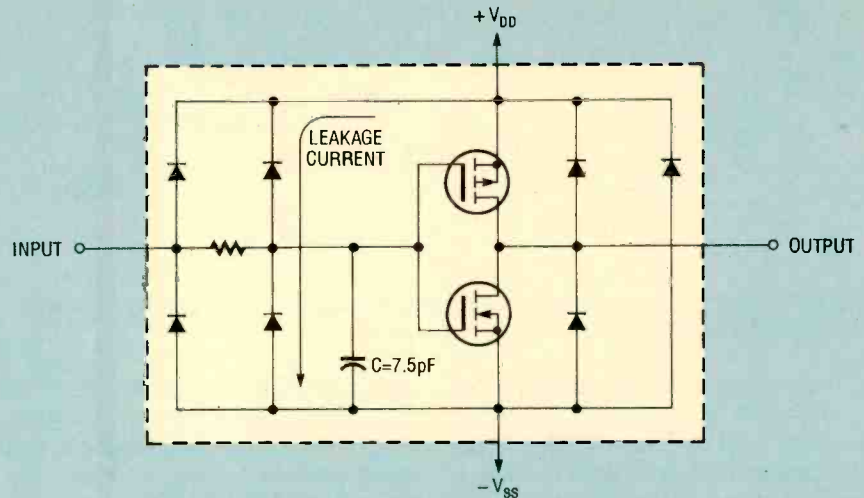

Fig. 1. This is the equivalent circuit for an inverter. The leakage current through the matched input-protection diodes pulls the FET inputs up to half the supply voltage.

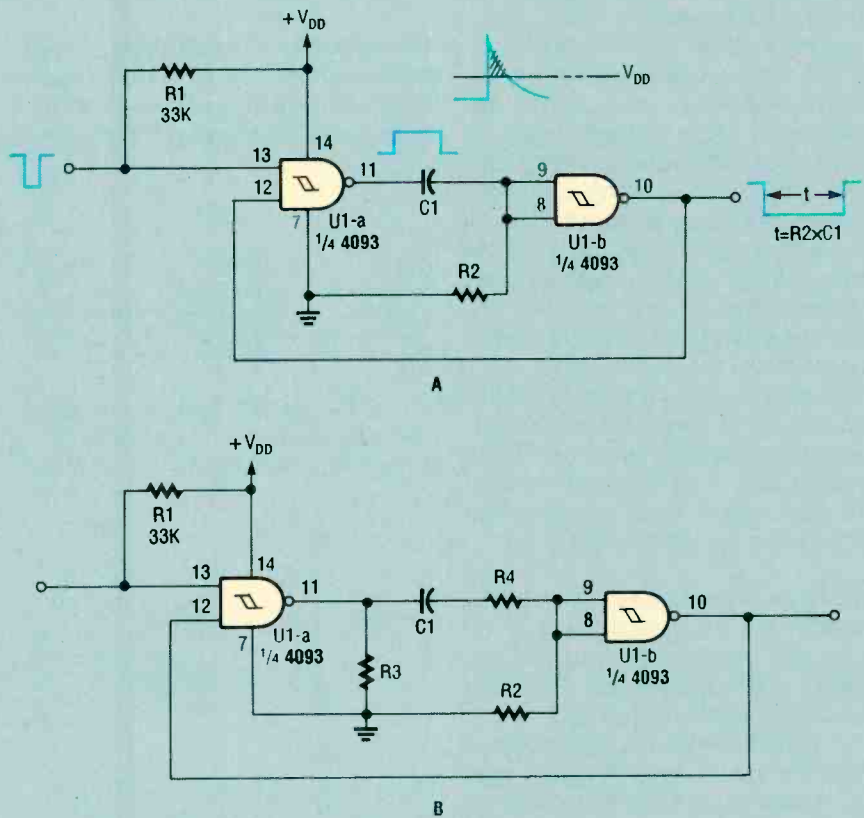

Fig. 2. Using the one-shot design in A can produce undesirable results if it is retriggered during a timing cycle. A safer one-shot is shown in B.

lem? Once the output pulse completes its low-to-high logic transition and the one-shot resets, C1 must still discharge through R2 and the low output of U1-a. If the circuit is re-triggered before C1 completely discharges, it will still have some voltage across it. When the output of U1-a goes high to re-initiate the one-shot cycle, the input to U1-b will be the sum of the high output of U1-a and

the voltage that remains across C1. The input voltage to U1-b can be driven above the power-supply rail by the amount of voltage still left across C1, causing the gate to latch up. The excess voltage is shown by the shaded area in the waveform of the voltage across R2.

The solution is to add two resistors as shown in Fig. 2B. Resistor R4 is selected

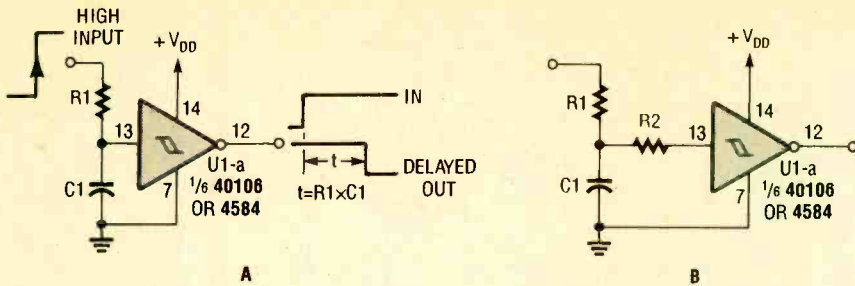

Fig. 3. Although the one-shot in A looks harmless enough, it can be damaged by early retriggering. A similar but safer circuit is shown in B.

to keep the input current well below the 10-mA latch-up level; about 1 mA is safe. For a 12-VDC supply, R4 can be 10k. Resistor R3 is added to provide a path for C1 to discharge if the power to the circuit is turned off. Its value can be 150k. And don't forget to use or properly terminate the two other gates (not shown) in the package.

Figure 3A shows another simple delay circuit, again using a Schmitt gate. When a high input is applied to R1, the output response (a low logic level) will be delayed until C1 charges to the logic-high input level. Problems can occur, however, if there is a glitch in the power supply that causes it to drop below the voltage across C1, or if power is turned off. The solution again is to add resistor R2, as shown in Fig. 3B, to keep the input current below the latch-up level.

For more complex 4000-series CMOS circuits such as flip-flops and counters, the unused pins (set, reset, etc.) have preferred terminations spelled out in the component data sheets. They should never be left floating!

TTL-Logic Termination. Don't let the relatively low input impedance of TTL logic trick you into thinking it is unaffected by floating inputs. They can also be susceptible to noise.

TTL gates draw the least input current when the input is high. A typical high input draws 50 μ A, while a low input will draw from 0.2 to 2 mA, depending on the logic family. For that reason, unused inputs should be tied high rather than low to minimize power-supply current.

For LS (low-power Schottky) TTL logic, any unused inputs can be tied directly to V_{CC} . However, to protect a standard TTL device from power-supply transients, all the unused inputs should be tied to V_{CC} through a 1k current-limiting pull-up resistor. Up to 25 unused inputs can use the same 1k resistor.

Unused TTL inputs can also be tied to

used outputs on the same gate or of other gates. There will be an additional load on the output that drives these tied inputs, and you must not exceed the fan-out limit for the driving gate. The fan-out limit is typically 10 standard TTL loads (inputs) or 20 LS loads, but check the gate's data sheet to be sure.

Comparator Termination. Linear comparators are high-gain, wide-bandwidth devices whose unused inputs cannot be left open. There are two

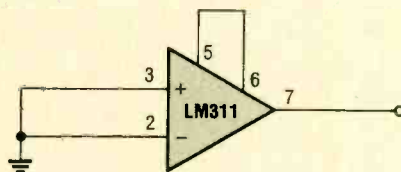

Fig. 4. The LM311 has two pins (5 and 6) that must be properly terminated by connecting them together if not used.

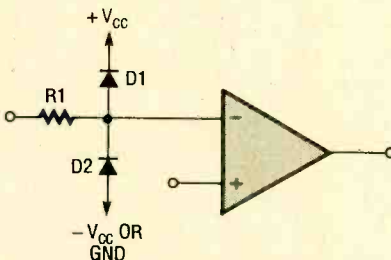

Fig. 5. Additional input protection like that shown here is a good idea when connecting comparators to devices that do not share the comparators voltage-supply bus.

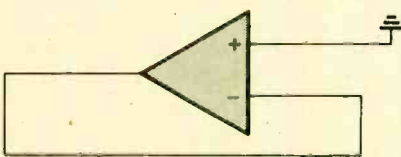

Fig. 6. The output of an unused op-amp should be tied to the inverting input. That dampens any possible oscillation.

mechanisms at work that can cause the comparator to oscillate: First, any unterminated high-impedance inputs are very susceptible to noise since the input bias current is typically 25 nanoamps. Second, the device can oscillate if the input terminals are coupled to the output terminals by stray capacitance. The necessary stray capacitance is readily supplied by the pins on IC sockets, interconnecting wires, or PC-board traces longer than an inch.

In addition to the oscillation problem, if an unused input gets more than -0.5 VDC below ground due to stray pickup, current can flow in the IC substrate, which can make all the other comparators in the package respond incorrectly. For those reasons, all unused inputs should be grounded.

For comparators such as the LM339 with a grounded-emitter NPN output stage, it is helpful to connect the output pin to ground as well.

The versatile LM311 comparator has an "extra" set of auxiliary inputs (pins 5 and 6) that also must be properly terminated (see Fig. 4). Any stray coupling between the output terminal (especially pin 7) and these pins can result in unwanted oscillation. So, if the strobe or balance features of the LM311 are not used, pins 5 and 6 must be connected together as shown in Fig. 4.

If signals are applied to any linear circuit from a source off the PC board, or from one that does not use the same power-supply voltage as the IC, it is a good idea to put clamping diodes and a current-limiting resistor at the input to prevent damage to the IC from static electricity or voltage spikes of any kind. That is shown in Fig. 5.

Op-amp Termination. Improperly terminated op-amps will have the same tendency to oscillate as comparators. One of the advantages of op-amps is that the same basic device is often available in single, dual, and quad form. Therefore, a package type can often be chosen to eliminate the possibility of there being an unused device. Let's say your design requires three general-purpose op-amps. Instead of using a quad LM348, you can use three 741's or a 741 and a dual op-amp such as the 747 or 1458.

However, if you simply must use a quad IC because of space or other reasons, the inputs of the unused op-

(Continued on page 92)



PROTEL SCHEMATIC CIRCUIT-DESIGN SOFTWARE

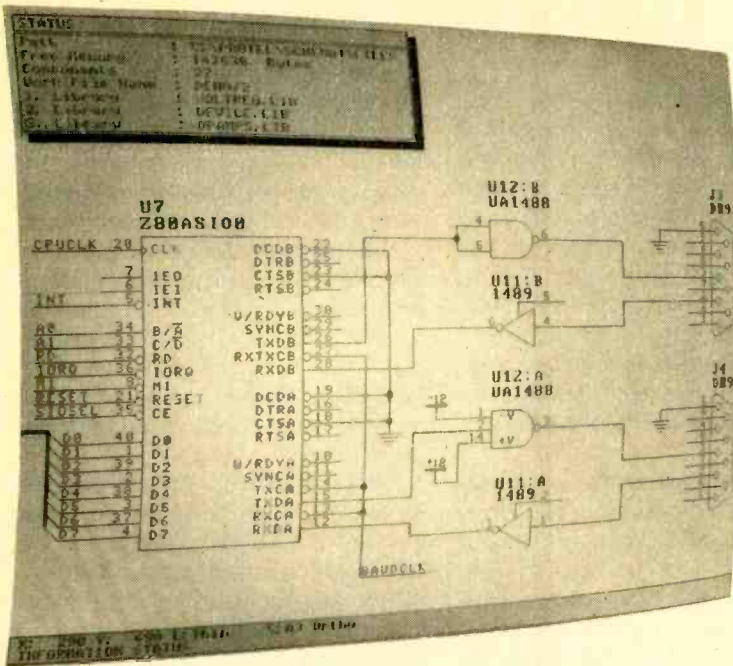

CIRCLE 119 ON FREE INFORMATION CARD

A high performance, low cost schematic-diagram design program.

Chief among the things the so-called "computer revolution" is responsible for is the increase in the number and scope of American small businesses. The advent of the PC spawned a number of computer-related concerns; typically three- or four-employee manufacturers equipped to produce any type of computer accessory imaginable. More important, small businesses are now using computers to allow one person to perform functions that formerly required two or more separate employees, such as accounting, drafting, and secretarial work. These jobs are now being shared by individuals of the business, most of whom wear several hats.

As smaller electronics companies branch out into new fields, they might find themselves at a loss to provide some of the services required. Maintenance companies might attempt to bid on government contracts, only to discover that complete system documentation must be part of the bid. Installers might need to document changes made to equipment, or to supply information on a custom interface that they've provided. Computer-peripheral manufacturers might be required to provide schematics and PC-

board layouts, but with the speed and flexibility only an in-house draftsman could provide. These problems can all be solved by Computer Aided Design (CAD) programs, with one limitation: until recently, software packages that could perform these functions were priced in the thousands.

In a move to capture the intermediate-schematic producer market, Protel Technology has introduced Protel Schematic. It is a PC-based schematic-design program that provides all of the functions of high priced packages at a more reasonable price. The schematics produced can be output to an ink plotter, a photoplotter, a laser printer, or a standard dot-matrix printer. If a complete concept-to-PC board system is desired, Protel Schematic files can be used with Protel Autotrax—a program that automatically places components and routes tracks to design a printed-circuit layout directly from the schematic file. Program modules shipped with Protel Schematic also produce netlists (which document all the connections on a schematic) and complete bill-of-materials printouts.

Operation. If the idea of a schematic-design program is new to you, simply

think of it as a customized CAD program. Rather than doing actual drawing, the schematic is designed by placing pre-designed blocks on the screen, and connecting them with "wires" (lines). These blocks may represent resistors, diodes, IC's, DB-25 connectors, Darlington transistors, you name it. Outlines are available for generic-size IC packages, and for specific IC's as well. For instance, placing a 7404 on the screen puts all six of the inverters on the schematic; each of the six inverters can then be moved around and connected at will.

Actual operation of Protel Schematic is very straightforward. No menus are visible when viewing the schematic. Hitting the return key pulls down the main menu, which displays functions such as "block," "edit," "place," and "quit." Choosing a function from this menu pulls down a second menu. At any menu, selecting a function can be done by using the arrow keys to move the cursor to the function and hitting return, or by "pointing and clicking" with a mouse, or by simply typing the first letter of the desired function. For example, to put a 7404 IC on our schematic you simply hit "P" (for Place), "C" (for Component), type in "7404," and move

the crosshairs to the desired location. A return (or a click) completes the action, and backs up one menu to let the user place another component. At each step of the process, keys are available that let the user rotate the component (or block of components) and zoom in and out on the schematic, making the procedure much easier.

While using the mouse or the keyboard is easy, once past the basic stage you'll probably want to make full use of the macro functions. They operate identically to most word-processor macros—they simply play-back a given series of keystrokes. For the above example, a macro could be created to automatically enter the P-C-7404-return sequence whenever the F1 key is pressed. With that macro set up all that you'd need to do is position the crosshairs, hit F1, and you're done. At the elementary level, macros can be used to place wires and junctions, or delete components with a single keystroke. More advanced users will find macros helpful when editing component names or performing repetitive house-keeping functions. With 222 macros

available, the macro library proves to be a source of real programming power.

Is it Friendly? Once a person is assured a software package can deliver all of the functions they desire, their next concern is how "user friendly" it is. User friendliness means different things to different users, but a common test of friendliness might be to ask "how fast can I get up to speed with this program, and how briefly can I use the manual?" (Indeed, some software reviewers evaluate programs by seeing just how far they can get without consulting the manual.)

The ideal program from that perspective would be one that was completely menu driven, and has menu-driven, context-sensitive help screens. Unfortunately, programs of this type have a couple of major drawbacks: First, the extensive help files (and programs to use them) tend to use up a lot of disk space that could be better used once the user learns the package. Second, by covering all of the bases "on screen," the software tends to lack the flexibility available from more thoroughly documented packages.

From a "first glance" point of view, Protel Schematic is anything but friendly. Schematic does have pull-down menus, but no help screens. The manual itself is informative, but the information is arranged in a tutorial manner. Using the program without the manual, especially if the operator is new to CAD systems, would lead to one dead end after another. On the other hand, if one takes the time to run through the tutorial (an hour or two), the package suddenly becomes much more friendly. Often-used operations become automatic, and much faster than using a menu. The use of keystroke macros suddenly starts to make sense. Once the initial learning-curve doldrums are passed, the program is quite friendly and quick to use.

A secondary, but more legitimate criteria for user-friendliness comes after the package has been thoroughly learned: when you want it to perform a function that isn't part of the standard software. In the case of a schematic-design program, this equates to needing a part that isn't in the library. Depending on the application, the lack of a specific part could bring the whole drawing to a halt. Protel Schematic

solves this problem through the use of a separate program module called the SLM (Schematic Library Manager). The SLM is a library-part editor program that lets the operator alter existing parts, or create new ones. Somewhat less friendly than the main program, SLM allows creation of block-like components (square IC packages) or bit-mapped components (inductors, resistors, etc.). By choosing the proper mode, any desired part can be created, named, and placed in a library for use at any time in the Schematic program. In addition, libraries can be combined or altered as needed to suit a particular application.

Another important aspect of friendliness is configuration flexibility. Once the user bumps up against the constrictions of a program's default settings, it becomes necessary to alter some of them. For instance, it may be necessary to hide the pin numbers or component names of the parts. Line widths may need to be altered, or larger or smaller pads are required. The program's setup menu allows the user to alter key macros, screen colors, the cursor type, the automatic backup function, and more.

When all else fails, and you have read the instructions, there is yet another type of user friendliness. This friendliness is found on the Protel BBS, where users of Protel software gather to exchange ideas and information. The staff is available to answer product-related questions, and if the call is made during business hours, it's often possible to have a real-time "chat" (type) with the system operator (sysop). (Questions the author posted on the BBS were answered the next business day.) The answer to a complex question is only a phone call away.

The combination of user-definable components, extensive program flexibility, and cooperative on-line support makes Protel Schematic a package that will grow along with the user, rather than being left behind in favor of a new program. At less than the cost of a new drafting table, (\$495 to be exact) Protel Schematic is clearly a good choice for students, businesses, hobbyists, or any serious schematic producer. If you're interested, Protel Schematic is available from Protel Technology, Inc. (50 Airport Parkway, San Jose, CA 95110; Tel. 1-800-544-4186). You can contact them for more information, or circle No. 119 on the Free Information Card. ■

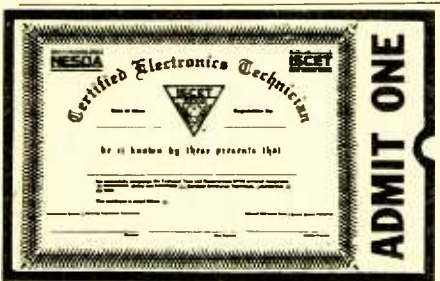

Your Ticket To SUCCESS

Over 28,000 technicians have gained admittance worldwide as certified professionals. Let your ticket start opening doors for you.

ISCET offers Journeyman certification in Consumer Electronics, Industrial, Medical, Communications, Radar, Computer and Video. For more information, contact the International Society of Certified Electronics Technicians, 2708 West Berry Street, Fort Worth, TX 76109; (817) 921-9101.

Name _____
Address _____
City _____
State _____ Zip _____

Send material about ISCET and becoming certified.

Send one "Study Guide for the Associate Level CET Test." Enclosed is \$10 (inc. postage).

ANTIQUE RADIO

By Marc Ellis

With The Collectors-Contest Results

About a year ago, I read a newspaper column that I wish I'd kept. The author, who writes in one of the local dailies, was sharing his thoughts about what I now recognize as the age-old columnist's dilemma. He had just received an avalanche of mail about a column he'd developed from his "topics to use when desperate for ideas" file and was totally bowled over by the response. Particularly since he'd previously run a care-

my point. Last year's contest to determine who could provide the most interesting information about the theremin amazed me by drawing dozens of responses. Our current contest, designed to find out how readers organize their antique-radio collections and gain the sympathy of family members who might not understand the hobby, also amazed me. It elicited only five letters!

Why were so many people interested in writing to me about an obscure and rare electronic musical instrument and so few willing to write about a much more universal topic? I don't know, but I'd certainly welcome reader comments on the subject. In the meantime, let's take a look at the responses of the five intrepid contestants who chose to send in entries.

MOST CREATIVE ENTRY

Willy R. Young (Smithville, TN) writes that his hobby facilities include a 12 x 12-foot workshop and a 12 x 10-foot storage shed. Even so, he has a hard time finding room for all of his radios (he stopped counting after acquiring about fifty). To relieve the clutter, Willy invented an eight-foot high "lazy Susan" that takes up less than four square feet of floor space—yet can hold up to about forty table-model radios.

The basic parts of the lazy Susan are: four 1-foot by 8-foot pieces of plywood (cut from a 4 x 8-foot sheet); an 8-foot length of 2 x 2 lumber; two pieces of

plywood about two-feet square; one bar-stool swivel (available at home centers or large hardware stores). Each of the 1 x 8 pieces of plywood is nailed along one face of the eight-foot 2 x 2, so that the pieces radiate out from it like the spokes of a wheel. Figure 1 illustrates the top view of the unit. The two-foot-square pieces of plywood are nailed into the top and bottom of the lazy-Susan assembly, serving as covers and adding rigidity.

The swivel assembly is bolted both to the bottom (which could be either end, actually) of the lazy Susan and to the floor. Chances are you wouldn't want to bolt it to your floor as Willy did, but you could accomplish almost the same thing by attaching the bottom of your swivel to a plywood base large enough (perhaps three feet square) to prevent the lazy Susan from tipping.

The result is a storage piece consisting of four eight-foot-tall "V"-shaped compartments, each a little less than a foot on a side. Thanks to the swivel mounting, the assembly can be turned to access any of the compartments. Thus, it can be conveniently tucked out of the way in a corner.

Willy didn't install shelves on his storage/display piece—probably because he didn't want to be restricted to radios of specific heights. Instead he attached hanging hardware to the back-cover mounting screws of each radio so that he could suspend it on a compartment wall. Since Willy keeps the lazy Susan



Mark Starin operating his vintage military-communications gear at the Manchester (NH) air show.

fully crafted and (to his mind) much more interesting series of columns without receiving so much as a postcard!

Most of us who write regularly for publications feel in tune with our audiences, or we wouldn't be doing what we're doing. Yet, from time to time, we provoke reader responses of unexpected interest (or lack of same). I guess that the unpredictability is part of what makes this business so much fun.

All of which brings me to

next to his workbench, he decided to devote one of the four compartments largely to tool storage.

Willy's wife has no trouble coexisting with the radio collection. His antiques share space with her collectibles on display shelves in the living areas of their home. And some of Willy's radios even enhance the decor of a beauty shop that she operates!

MOST UNUSUAL ENTRY

When I first saw the photo sent in by Mark Starin (Manchester, NH), I was instantly transported back to my teen years in the 1940's. Back then, just after World War II, military-surplus radio gear was flooding the market, and prices were cheap enough so that even a kid on a limited budget could pick up a couple of good pieces. As I studied the BC-342, ART-13, and BC-375, I could almost whiff once again the exotic smell of fungus-proofing compound and feel the '342's band-switch move slowly under my hand as I exerted pressure to turn the mighty gears within.

Mark combines his ham-radio hobby with his taste for vintage military gear, and actually operates some of the transmitters and receivers on the ham bands. The photo shows him operating the BC-342 and ART-13 (the two stacked pieces at the left) at the Manchester (NH) Air Show. He also likes to use early ham equipment, and his collection includes a Heathkit DX-40 transmitter from the 1950's and a Drake 2-B receiver from the 1960's.

He doesn't have any special system for storing his gear, though he reports that empty Xerox paper boxes make fine containers for parts storage. Even though the equipment is

arranged reasonably neatly in the basement, Mark's wife periodically asks the classic question: "When are you going to get rid of that junk?"

Mark usually answers that he's operating an electronic orphanage. The old gear attaches itself to his person and, in the manner of a stray cat or dog, follows him home, and takes up permanent residence in his basement. But even though he's been repeating this story since 1974, his wife still refuses to buy it!

LOWEST-PROFILE ENTRY

Rudolph Chernich (Hoyt Lakes, MN) decided to enter this contest even though he was convinced that I'd probably be choosing the winners at random. You



Willy Young's lazy-Susan storage piece is situated near his workbench, so part of one section is used to hang tools.

wound me to the quick, Rudy. What have I ever done to give you an idea like that?

Rudy doesn't get any

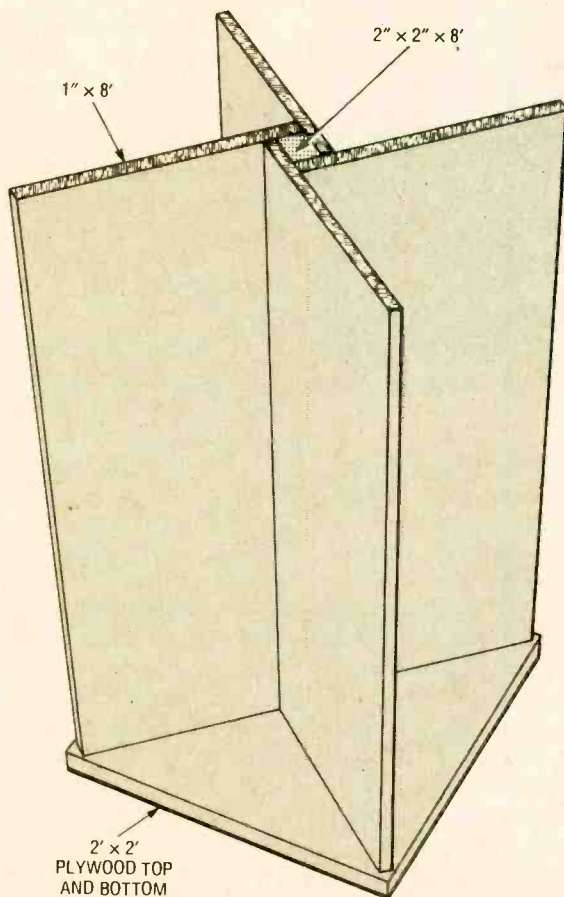

Fig. 1. The top view of the lazy Susan shows how plywood panels are attached to the 2 x 2-foot "spine."

static about his collection because he maintains a low profile, keeping it all in his ham shack arranged along two walls generally visible only to himself. He didn't pass along any special storage tricks, but he sent a photo that shows that he uses the time-honored "stack 'em six high and pray" technique.

As for cataloging, Rudy keeps a typewritten list that includes the make, model number, and cabinet style of each of his acquisitions. The list he sent me includes 35 radios, but he comments that the collection now includes several more.

MOST DETAILED ENTRY

I probably don't have the room to do full justice to Larry Kenan's (Westlake Village, CA) long and interesting letter, but I'll take a crack at it! Larry owns about 50 radios. His oldest is a 1921 Grebe CR-8; his newest, a 1955 Zenith Transoceanic. Many of these are on display in his home office.

But while Larry likes looking at his radios, he gets more enjoyment from the restoration work he does prior to putting them on display. His neat and well-organized workshop attests to his strong interest in this phase of radio collecting. In fact, the workshop itself is a period piece, equipped (with some exceptions) like a service shop of the late forties or early fifties—just before the emphasis shifted from radio to television repairing.

Larry's detailed rationale for including each of the various pieces of test equipment on his bench goes a bit beyond the scope of this contest. But I think it's of general interest, so I'll try to summarize.

The equipment lineup in-
(Continued on page 91)

CIRCUIT CIRCUS

By Charles D. Rakes

Alarm/ Sounder Circuits

Last month, we took a look at some simple alarm/sensor circuits, most of which were built around SCR's. This month we'll build on that discussion by presenting a couple of more alarms and throw in a few sounder circuits to boot. Like all of the circuits presented in this segment of **Popular Electronics**, this month's entries will be built around readily available components.

DELAYED ALARM

Our first alarm/sensor cir-

often included in commercial home-security systems.

The detection loop is composed of S1, U1-a, and LED1 (which gives a visual indication of a breach). A diode, D1, is connected in series with the detection-loop's output to protect the detection-loop circuit by blocking any signal from additional sensor circuits that might be connected in parallel. Diode D2 provides the same protection for a second sensor loop, which is not shown. Several additional sensor circuits may be added to the system by duplicating the one shown. Now let's take a look at the circuit's operation.

Assuming that the protected area has not been

breached (i.e., S1 is in its normally-closed position), when power is first applied to the circuit, a positive voltage is applied to the input of U1-a through S1 and R1, causing its output to go low. That low is applied to the gate of SCR1, causing it to remain off. At the same time, C6 rapidly charges toward the +V supply rail through S2, LED2, R4, and D3. The charge on C6 pulls pin 5 of U1-b high, causing its output at pin 4 to be low. That low is applied to the base of Q1, keeping it off. Because no trigger voltage is applied to the gate of SCR2 (via Q1), the SCR remains off and BZ1 does not sound.

But should S1 open, the

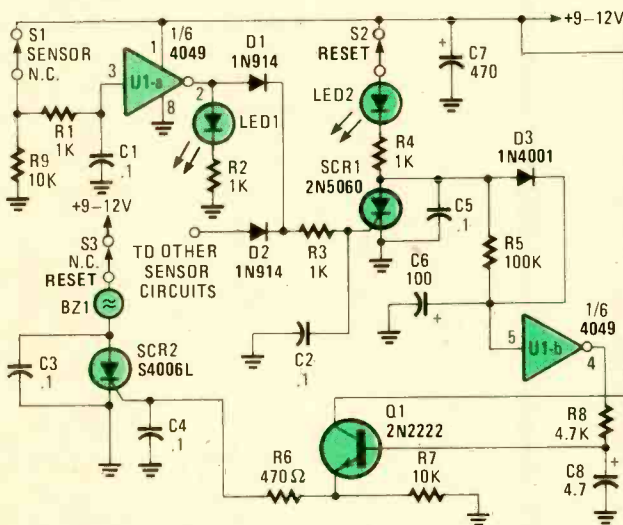

Fig. 1. Two SCR's, a transistor, a 4049 hex inverter, and a few support components, all combine to form a closed-loop detection circuit with a delay feature that allows you to enter a protected area and deactivate the circuit before the sounder goes off.

cuit, see Fig. 1, is built around two SCR's, a transistor, a 4049 hex inverter, and a few support components, all of which combine to form a closed-loop detection circuit with a delay feature. The delay feature allows you to enter a protected area, and deactivate the circuit before the sounder goes off. Similar delay features are

PARTS LIST FOR THE DELAY ALARM

SEMICONDUCTORS

U1—4049 CMOS hex inverting buffer, integrated circuit
SCR1—2N5060 or similar 0.8-amp, 30-PIV sensitive-gate, silicon-controlled rectifier
SCR2—S4006L or similar 6-amp, 400-PIV silicon-controlled rectifier
Q1—2N2222 general-purpose NPN silicon transistor
D1, D2—1N914 general-purpose small-signal silicon diode
D3—1N4001 general-purpose silicon rectifier diode
LED1, LED2—Light-emitting diode (any color)

RESISTORS

(All resistors are ¼-watt, 5% units.)

R1-R4—1000-ohm
R5—100,000-ohm
R6—470-ohm
R7, R9—10,000-ohm
R8—4700-ohm

CAPACITORS

C1-C5—0.1-µF, ceramic-disc
C6—100-µF, 16-WVDC, electrolytic
C7—470-µF, 16-WVDC, electrolytic
C8—4.7-µF, 16-WVDC, electrolytic

ADDITIONAL PARTS AND MATERIALS

S1—Normally-closed sensor switch
S2, S3—Normally-closed switch
Perfboard materials, enclosure, IC socket, 9- to 12-volt power source, wire, solder, hardware, etc.

input to U1-a is pulled low via R9, forcing the output of U1-a high, lighting LED1. That high is also applied to the gate of SCR1 through D1 and R3, causing SCR1 to turn on. With SCR1 conducting, the charge on C6 is slowly discharged through R5 and SCR1 to ground. As the charge on C6 decays, the input of U1-b at pin 5 is pulled low, forcing its output high. That high slowly charges C8 through R8 to a voltage slightly less than the positive supply rail.

Transistor Q1 remains off until C8 has charged to a level sufficient to bias Q1 on. That allows sufficient time to enter the protected area and disable the alarm before it sounds. Once C8 has developed a sufficient charge, Q1 turns on and supplies gate current to SCR2 through R6, causing the SCR to turn on and activate BZ1. If the circuit is reset before the delay has timed out, no alarm will sound.

The delay time can be lengthened by increasing the value of either or both C6 and R5; decreasing the value of either or both of those components will shorten the delay time.

All of the switches used in the circuit are of the normally-closed (N.C.) variety. Switch S1 can be any type of N.C. security switch that suits your application; for example, a magnetic window switch. Switch S2 can be either a pushbutton or toggle switch. Since S3 is used to disable the sounder (BZ1) only, anything from a key-operated security switch to a hidden toggle switch may be used.

555-BASED ALARM

The next alarm circuit, see Fig. 2, has a single 555 oscillator/timer (U1) performing double duty; serving both in the alarm-

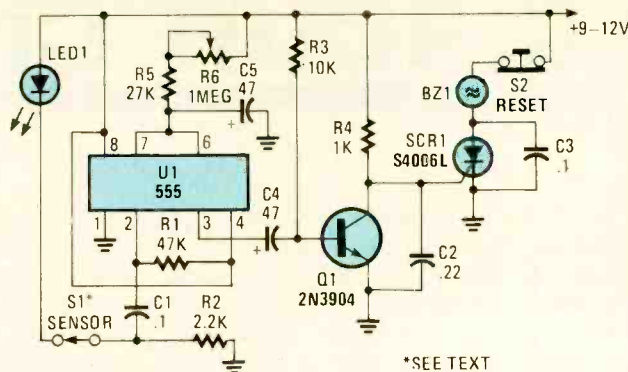

Fig. 2. In this alarm circuit, a single 555 oscillator/timer (U1) performs double duty; serving both in the alarm-trigger circuit and the entry-delay circuit.

PARTS LIST FOR THE 555-BASED ALARM

SEMICONDUCTORS

- U1—555 oscillator/timer, integrated circuit
- Q1—2N3904 general-purpose NPN silicon transistor
- SCR1—S4006L or similar 6-amp, 400-PIV silicon-controlled rectifier
- LED1—Light-emitting diode (any color)

RESISTORS

(All fixed resistors are ¼-watt, 5% units.)

- R1—47,000-ohm
- R2—2200-ohm
- R3—10,000-ohm
- R4—1000-ohm
- R5—27,000-ohm
- R6—1-megohm potentiometer

CAPACITORS

- C1, C3—0.1-µF, ceramic-disc
- C2—0.22-µF, ceramic-disc
- C4, C5—47-µF, 16-WVDC, electrolytic

ADDITIONAL PARTS AND MATERIALS

- S1—Normally-closed sensor switch
- S2—Normally-closed pushbutton switch
- Perfboard materials, enclosure, IC socket, 9- to 12-volt power source, wire, solder, hardware, etc.

trigger circuit and the entry-delay circuit. In this application, the trigger input of U1 at pin 2 is held high via R1. A normally-closed sensor switch, S1, supplies a positive voltage to the junction of R2 and C1, and lights LED1. With both ends of C1 tied high, there is no charge on C1. But when S1 opens, C1 (initially acting as a short) momentarily pulls pin 2 of U1 low, triggering the timed delay cycle.

At the beginning of the

timing cycle, U1 produces a positive voltage at pin 3, which charges C4 to near the positive supply voltage. Transistor Q1 is heavily biased on by R3, keeping its collector at near ground level. With Q1 on, SCR1's gate is clamped to ground, holding it off. When the delay circuit times out, pin 3 of U1 goes low and ties the positive end of C4 to ground. That turns Q1 off.

When Q1 turns off, the voltage at the gate of the

SCR goes positive, turning on the SCR and sounding the alarm. The delay time is adjustable from just a few seconds (R6 set to its minimum resistance) to about one minute (R6 adjusted to its maximum resistance).

LOW-LEVEL SOUNDER

Our next circuit, see Fig. 3, is a simple low-level noise maker that's ideally suited to certain alarm applications. When the sounder is located in another part of the building, the sound level is loud enough to be heard, but is not loud enough to warn off an intruder. A single 2N3904 NPN transistor is connected in a Hartley audio oscillator, with a 1k to 8-ohm transistor-output transformer doing double duty as the circuit's inductor and output coupling device.

The circuit produces a single-frequency tone that

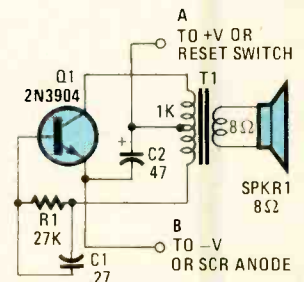

Fig. 3. The Low-Level Sounder produces low-level noise that's loud enough to be heard, but not loud enough to warn off an intruder in another location.

can be varied in frequency by changing the value of either or both R1 and C1. Increasing the value of either component will lower the output frequency and decreasing their values will raise the frequency. Don't go below 4.7k ohms for R1 because you could easily destroy Q1.

The sounder circuit can be connected to any of the detection circuits discussed

PARTS LIST FOR THE LOW-LEVEL SOUNDER

- C1—0.27- μ F, ceramic-disc capacitor
 - C2—47- μ F, 16-WVDC, electrolytic capacitor
 - Q1—2N3904 general-purpose NPN silicon transistor
 - R1—27,000-ohm $\frac{1}{4}$ -watt, 5% resistor
 - T1—1000-ohm to 8-ohm transistor-output transformer
 - SPKR1—8-ohm, 4-inch speaker
- Perfboard materials, wire, solder, hardware, etc.

this month or last month. To connect this circuit to the one shown in this month's Fig. 1, tie the A lead of the sounder to S3 in Fig. 1 and the B lead to the anode of SCR2.

DUAL-TONE SOUNDER

Our next circuit, see Fig. 4, is a sounder circuit that should make the "coolest"

of intruders very nervous and with any luck make the bandit's stay very short. An outside horn-type speaker works best with the circuit. However, such devices require a great deal of power, so this sounder should only be used in alarm circuits where at least a 6-amp SCR is used as the sounder driver.

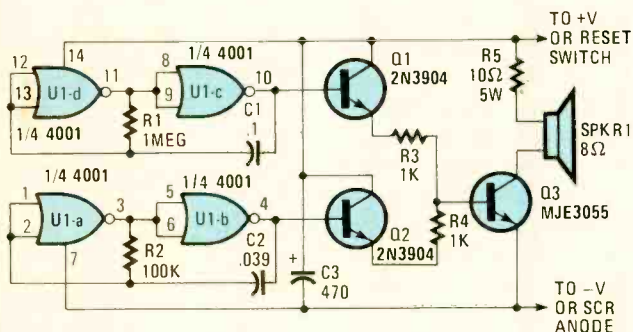

Fig. 4. The Dual-Tone Sounder is intended for use in circuits that use at least a 6-amp SCR as the sounder driver.

PARTS LIST FOR THE DUAL-TONE SOUNDER

SEMICONDUCTORS

- U1—4001 CMOS quad 2-input NOR gate, integrated circuit
- Q1, Q2—2N3904 general-purpose NPN silicon transistor
- Q3—MJE3055 NPN power transistor

RESISTORS

(All resistors are $\frac{1}{4}$ -watt, 5% units, unless otherwise noted.)

- R1—1-megohm
- R2—100,000-ohm
- R3, R4—1000-ohm
- R5—10-ohm, 5-watt power resistor

CAPACITORS

- C1—0.1- μ F, ceramic-disc
- C2—.039- μ F, ceramic-disc
- C3—470- μ F, 16-WVDC, electrolytic

ADDITIONAL PARTS AND MATERIALS

- SPKR1—8-ohm outdoor horn-type speaker
- Perfboard materials, heatsink, IC socket, wire, solder, hardware, etc.

Protel Easytrax 2™

Outstanding value in Printed Circuit Board/CAD for your Macintosh and PC

Protel Easytrax 2 is a new, low-cost design package for PC and Macintosh users that includes everything required to produce professional quality Printed Circuit Board artwork.

Our easy-to-learn menu-driven design system breaks the 'expert barrier' you'll be designing in minutes, not hours. Our comprehensive tutorials guide you through the program's extensive features that take the tedium out of board layout.

- Comprehensive library of Through-hole devices
- Gerber photoplotting and N/C drill tapes
- On-the-fly library components creation
- Intelligent Pad to Pad autorouting
- Switchable Metric/Imperial grid
- Auto-panning
- PostScript™ printing
- Powerful user-definable Macros
- Independent print/plot program
- Multi-layer boards of up to 32 X 32 inches.

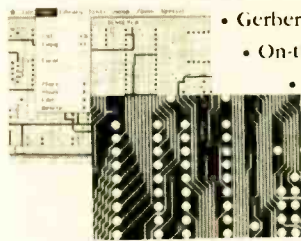

At Protel, we offer free technical support, 24-hour BBS, and 30-day money back guarantee. Prices start at

\$450

Free Evaluation Package Toll Free: 800-544-4186

Protel Technology, Inc.
50 Airport Parkway, San Jose, CA 95110
Tel: 408-437-7771 Fax: 408-437-4913



CIRCLE 8 ON FREE INFORMATION CARD

In this circuit, a single CMOS 4001 quad 2-input NOR gate, two 2N3904 general-purpose NPN transistors, and a single MJE3055 power transistor combine to generate a two-tone output. Gates U1-a and U1-b are configured as a simple feedback oscillator with R2 and C2 setting the oscillator's frequency. With the values shown, the circuit oscillates at about 500 Hz.

Gates U1-c and U1-d are connected in a similar oscillator circuit, but operates at a much lower frequency. The oscillator frequencies (and thus the tones that they produce) can be altered by increasing or decreasing the values of R1 and C1 for the low-frequency oscillator and R2 and C2 for the high-frequency oscillator. Decreasing the

values of those components will increase the frequency, while increasing their values will decrease the frequency.

The two oscillator outputs are connected to separate amplifiers (configured as emitter followers), whose outputs are used to drive a single power transistor (Q3, an MJE3055). A 10-ohm, 5-watt resistor, R5, is used to limit the current through the speaker and Q3 to a safe level. To boost the sound level, R5 can be replaced with another speaker.

ALTERNATE SENSOR

Any alarm system can be enhanced by mixing the type of sensors used to detect an intruder. A simple mechanical switch will do a fine job of detecting an intruder, but physical con-

(Continued on page 90)

THINK TANK

By John J. Yacono

More Fun with Op-Amps

As I promised last month, we'll continue our discussion on simple op-amp theory. Last time around a reader presented a circuit containing an op-amp wired as an inverting amplifier, so let's look at how they work. The simplest way to determine the gain of an inverting amplifier is to do some math. Let's start off with a basic equation that holds true for all op-amp circuits (as presented last month):

$$V_O = A_{OL} (V_{in+} - V_{in-})$$

In plain English, that translates to: The output voltage is equal to the voltage difference between the non-

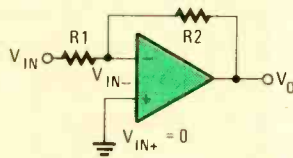

Fig. 1. In this simple inverting-amplifier circuit, the resistors limit the gain to a useful value. However, this circuit is not practical.

inverting input and the inverting input multiplied by the open-loop gain. If you're unsure as where those voltages can be found on an op-amp, take a look at the inverting amplifier circuit shown in Fig. 1. As we mentioned last month, the value of A_{OL} (the open-loop gain) depends on the op-amp in question; however, it is typically a very large number.

Since the non-inverting input voltage is zero for the circuit shown, the previous equation reduces to:

$$V_O = -A_{OL} V_{in-}$$

If we can find a way of writing V_{in-} in terms of V_O , V_{in-} , $R1$, and $R2$, then we can figure out the gain of the circuit, just as we did for a non-inverting circuit last month. First, let's find another way of writing V_{in-} and we'll come back to that equation a little later.

Since an op-amp only permits a very tiny amount of current to flow into its inputs, it can be considered an open circuit. If you remove the op-amp from the circuit in Fig. 1 and rearrange the resistors, you get a voltage divider, like the one shown in Fig. 2. The current flowing through $R1$ is more or less equal to the current through $R2$, since the current into the op-amp is close to zero as we discussed. The current through the resistors is denoted I in Fig. 2. By Ohm's Law the current through $R1$ should equal the voltage drop across the resistor—which is $V_{in-} - V_{in-}$ —divided by the resistance. In mathematical terms:

$$I = (V_{in-} - V_{in-})/R1$$

If you use the same reasoning for $R2$, you get:

$$I = (V_O - V_{in-})/R2$$

Since the current, I , equals

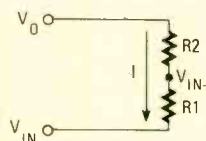

Fig. 2. Since an op-amp permits only tiny amounts of input current to flow, it can be considered an open circuit. So the feedback network can be viewed as though it was a simple voltage divider.

itself, we can set those two equations equal to one another:

$$\begin{aligned} (V_{in-} - V_{in-})/R1 \\ = (V_O - V_{in-})/R2 \end{aligned}$$

Now let's start to find V_{in-} in terms of the other voltages and resistor values.

Multiplying both sides by $R1$ and $R2$ gives us:

$$\begin{aligned} R2 V_{in-} - R2 V_{in-} \\ = R1 V_O - R1 V_{in-} \end{aligned}$$

Moving the V_{in-} 's to one side:

$$\begin{aligned} R1 V_O + R2 V_{in-} \\ = R2 V_{in-} + R1 V_{in-} \end{aligned}$$

Separating V_{in-} 's from the rest and cleaning up a little:

$$\begin{aligned} R1 V_O + R2 V_{in-} \\ = (R2 + R1) V_{in-} \\ (R1 V_O + R2 V_{in-})/(R2 + R1) \\ = V_{in-} \\ (1/(R2 + R1)) (R1 V_O + R2 V_{in-}) = V_{in-} \end{aligned}$$

Now, if we take the left side of that and plug it into the equation for V_O that we derived earlier (the second equation), we get:

$$\begin{aligned} V_O = -A_{OL} ((1/(R2 + R1)) \\ (R1 V_O + R2 V_{in-})) \end{aligned}$$

Let's move some of the stuff on the right to the left:

$$\begin{aligned} -(V_O (R2 + R1))/A_{OL} \\ = R1 V_O + R2 V_{in-} \end{aligned}$$

Since A_{OL} is really quite large, the quantity on the left is close to zero. If we use that approximation and do some rearranging, we get:

$$\begin{aligned} 0 = R1 V_O + R2 V_{in-} \\ -R1 V_O = R2 V_{in-} \\ V_O/V_{in-} = -R2/R1 \end{aligned}$$

Of course that last equation (the output over the input) tells us the gain of the circuit. The minus sign indicates that a positive input signal generates a

Give a Friend a Year of Electronics Fun this Christmas...



Does fighting the crowds at Christmas short-circuit your holiday fun? Don't blow a fuse this year. . . for the friend who shares your love of project-oriented electronics — or a youngster who may need only a spark to ignite a life-long interest — give a gift subscription to Popular Electronics.

. . . Because when you give him Popular Electronics, you're giving month after month of challenging construction projects — including complete plans for testing equipment, electronic worksavers for home and car, add-ons and modifications for hi-fi, computers, radio and TV.

He'll get the how-to he needs to build exciting, useful projects like these. . . a touch light dimmer. . . a traveler's theft alarm. . . an economy NiCd battery charger. . . a voice synthesizer. . . a wave form generator. . . the ultimate burglar alarm. . . a stereo graphic equalizer. . . and many, many more!

PLUS. . . testbench tips and techniques. . . circuit design. . . electronics fundamentals. . . book reviews, and new product news including our 12-page "Gizmo" section. . . regular columns on computers, scanners, dx'ing, ham and antique radio. . . the list goes on and on!

SAVE MONEY. . . A great gift to receive, Popular Electronics is also a great gift for *you* to give! The Special Holiday Rate saves you \$16.45 off the newsstand price on each gift. You can save another \$16.45 when you start or extend your own subscription at the same time. It's our "thank-you" for sharing Popular Electronics with a friend this Christmas.

Send no money, unless you prefer. We'll be glad to bill you in January, next year. Just take a brief moment to go over your gift list and make sure you haven't forgotten anyone who might appreciate the many benefits of Popular Electronics. Then write the names on the attached Gift Certificate and mail it back in the postage-paid reply envelope. . . we'll take it from there!

Your friends will receive a handsome gift announcement card signed with your name just before Christmas. And all through the new year they'll remember and appreciate your thoughtful gift!

So don't blow a fuse. . . take it easy and enjoy the holidays. Give Christmas gifts of Popular Electronics!

Popular Electronics[®]

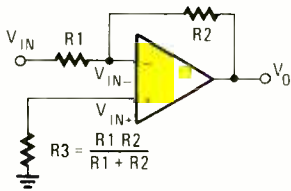

Fig. 3. This is a more practical inverting-amplifier circuit. The additional resistor prevents problems due to unbalanced bias currents at the op-amp's inputs.

negative output and a negative input signal generates a positive output; that is what is meant by the term "inversion."

However, there is a problem with the circuit in Fig. 1 that is not apparent from the math. When the input voltage (V_{in}) is zero, the voltage at the non-inverting input will not be zero because of the voltage drop across R1. What that means is that the op-amp output will not be zero when the input is zero (whoops!).

To resolve the problem, a resistor is added to the circuit as shown in Fig. 3. The value of the resistor should be equal to the parallel combination of R1 and R2 (as indicated by the equation in the figure). To help explain why, take a look at Fig. 4. When the input voltage (V_{in+}) is zero and the output voltage (V_o) is zero, R1 and R2 are effectively in parallel and both of them are connected to ground. The output voltage will only be zero if the two op-amp input voltages (V_{in+} and V_{in-}) are equal. They can only be equal if they have equal resistances to ground. So R3 must be equal to the parallel combination of R1 and R2. With that circuit under our belts, let's take a look at what some readers have done with inverting op-amp circuits.

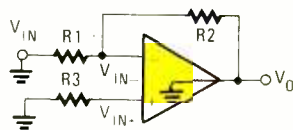

Fig. 4. If the input voltage is zero and the output voltage is zero, then R1 and R2 are really in parallel.

TELEPHONE AMPLIFIER

I'm back again. I really enjoyed "Think Tank II," so here's another goody. This circuit (see Fig. 5) is a telephone-receiver amplifier. Integrated circuit U1 is a quad dual-input, internally compensated op-amp. Only two of its op-amp sections are used.

Section U1-a is configured as a high-gain inverting voltage amplifier that is inductively coupled to the phone line via L1. Inductor L1 is a home-made unit that consists of 250 turns of fine, enamel-coated wire wound on an iron core. That op-amp receives the few millivolts produced by L1 via C1 and R1 and amplifies it. Capacitor C1 acts as the negative-feedback component that limits the circuit's high-frequency gain, while R3 limits the low-frequency gain. Resistor R3 is particularly important because without it, the amplifier would saturate.

Op-amp U1-b is configured as a difference amplifier. That unit receives the signal from U1-a via C3 and R4 and amplifies the difference between it and half the supply voltage. Transistor Q1 is configured as a common-collector amplifier to further amplify the signal, ensuring sufficient signal to drive the speaker. Capacitor C5 is used to remove any DC component provided by transistor Q1.

Inductor L1, the circuit board, and even the power supply can be housed in a

gutted telephone cradle. The modified "phone" can then be placed next to the existing phone for easy access, and there you have it.

—Bobby Triplett,
Raleigh, NC

I like it, I like it. It should be mentioned that the pick-up coil (L1) should be placed next to the receiver end of a telephone handset that is off-hook. If you don't want to wind L1 yourself, you should be able to get a ready-made pick-up coil (complete with a suction cup to hold it to the handset) at your local electronics emporium.

AN AUDIO ALARM

My mother is a primary school teacher who has been concerned for some time about the noise level in her class. She asked me if a decibel meter or some other device might help her to show the class just how loud they got. That's why I built this audio alarm (see Fig. 6). Since she has been using it, her students have become more aware of the noise. The alarm seems more effective than telling the kids to quiet down.

In the circuit, U1 amplifies the audio picked up by the condenser microphone. The gain of that op-amp is equal to $-R5/R4$. Resistor R1 limits current, while R2 and

R3 center the output of the amplifier to $\frac{1}{2}B+$ to allow a single-ended supply to be used. Diodes D1 and D2 rectify the output of U1, and C3 filters the resulting pulsing DC. Thus, a DC voltage proportional to the ambient sound level is produced.

That voltage is presented to the non-inverting input of U2. The inverting input is provided with a reference voltage of between 0 and $\frac{1}{2}B+$, which is set by R11. (That control effectively sets the noise level for the alarm.) As long as the noise level is low enough to keep the voltage at pin 3 lower than the voltage at pin 2, the output of U2 stays low (approximately 1 volt). That is enough to bias Q1 partially on. A voltage divider, formed by R8–R10 and Q1 (when it's partially on), prevents Q2 from turning on.

When the noise level is high enough to bring the voltage at pin 3 higher than the voltage at pin 2, the output of U2 goes high. That turns Q1 fully on and drives Q2 into saturation. The piezo buzzer then sounds until the power is cut off.

There is a simple procedure to adjust the noise level: turn R11 until the alarm sounds, then back-off slightly, and reset the alarm. Once that control is set, it should require no further adjustment.

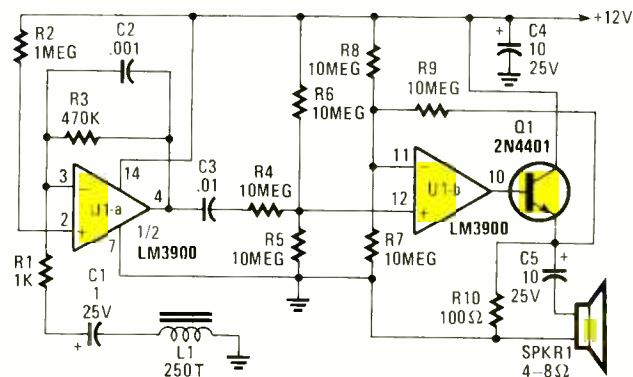

Fig. 5. This telephone amplifier is great for the hearing impaired, or anyone in a noisy environment. It also lets the whole family listen in on a conversation.

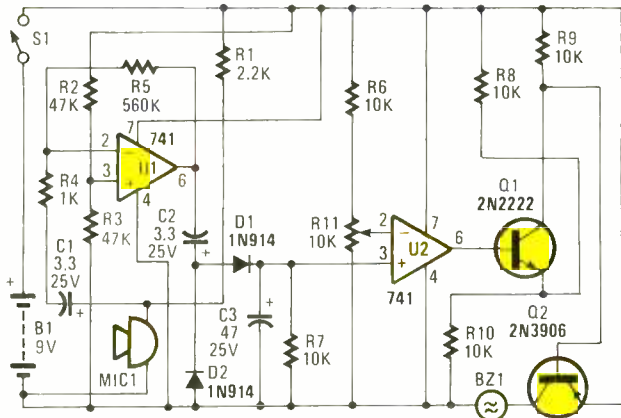

Fig. 6. If you're concerned about the noise in your surroundings, this audio alarm might just help you gain control of the situation. It goes off when things get too noisy.

The circuit is very forgiving of the tolerance of some of its components. For example, C1 and C2 only need to be greater than .47 μ F, and C3 only needs to be over 40 μ F. Resistors R11 and R6 need to be equal, but their value can be higher; the value (10k) shown was chosen only to limit power consumption. The same is true of R2 and R3. In fact, U1 and U2 can be replaced by a 1458 or other op-amp, and Q1 and Q2 can be replaced by any small signal or switching transistors of the right types. Since the circuit requires only 6 or 7 mA in the standby mode, and only 15 mA when the piezo element is active, it can be powered by a rechargeable battery.

Perhaps you may not think this is worth a book, but my mother says to tell you that she certainly does. She says she's found it to be very useful. I hope some of your readers will, too.

—M.E. Allen,
Terrace, BC, Canada

As you've probably know by now, I agree with your mother—it's certainly worth at least a book. A good candidate as a replacement for the 741's in the circuit would be a 747. It is basically a dual 741.

I like to hear from you op-amp fans. I know there are

thousands upon thousands of op-amp circuits that would be just right for these pages. If you think you've got one, or any kind of circuit you feel is valuable, send it to *Think Tank*, **Popular Electronics**, 500-B Bi-County Blvd., Farmingdale, NY 11735.

Popular Electronics®

Our annual gift to advertisers — audited circulation

We know advertisers want the best circulation value for their advertising dollar. As a publisher, we need to verify that our circulation is helping advertisers reach their target markets and potential customers all year long.

That's why our annual gift to advertisers is subjecting our records to independent verification by the largest and oldest circulation auditing organization in the world — the Audit Bureau of Circulations.

In fact, 4,800 advertisers, publishers and advertising agencies rely on ABC for audited circulation data. An ABC audit means that our circulation records are regularly

checked and verified by ABC auditors and findings are published in a concise report.

We have a year-round commitment to providing this verified, audited circulation information to advertisers.

Audited circulation — it's our gift to you.



Audit Bureau of Circulations
Member

SUPER LONG PLAY TAPE RECORDERS

12 Hour Model — USES 120 TAPE \$119.00*

Modified Panasonic Slimline high quality AC-DC provide 6 continuous hours of quality recording & playback on each side of cassette for 12 hours total. Includes • Voice level control • Digital counter, etc. TDK — 120 Cassette Furnished.



PHONE RECORDING ADAPTER

Records calls automatically. All Solid state connects to your telephone Jack and tape recorder. Starts recording when phone is lifted. Stops when you hang up. \$28.50* FCC APPROVED



VOX VOICE ACTIVATED CONTROL SWITCH

Solid state Self contained Adjustable sensitivity. Voices or other sounds automatically activate and control recorder. Uses either recorder or remote mike. \$28.50*



* Add for ship & handling. Phone Adapter & Vox \$2.00 each. Preorders \$5.00 each. Calif. Res. add tax. Mail order VISA available. Dealer inquiries invited. Free data.

AMC SALES INC. Dept. B 9316 Eubank Street
Box 328 Downey, CA 91201
Phones (213) 569-8514 1-800-26-2488
FAX (213) 423-1478
Mon. Fri. & PAC TIME

CIRCLE 7 ON FREE INFORMATION CARD

LEARN to CLEAN/MAINTAIN/REPAIR CAMCORDERS



EARN \$85 AN HOUR!

HUGE EXPANDING MARKET!

Work from your home — part time or full time! No prior experience needed! Average mechanical ability only requirement for your success! Over 1.5 million camcorders in use! Over 5 million expected to be sold in 1991 alone!

It is a fact that the vast majority of camcorder malfunctions (just like VCR's) are due to simple mechanical failure... We can show you how to easily fix those breakdowns and earn an average \$150.00/hr. while working at home!

Get In Now — Soon camcorders will be like VCR's, i.e., one in almost every home!

For a camcorder cleaning job you can earn \$65.00 for less than 30 minutes work.

For a camcorder repair job you can earn over \$100.00.

FREE INFORMATION PACKAGE call or write:
Toll-Free 1-800-537-0899
Viejo Publications, Inc.
4470-107 Sunset Blvd., #600
Los Angeles, CA 90027, Dept. PEC

CIRCLE 12 ON FREE INFORMATION CARD

February 1992, Popular Electronics

COMPUTER BITS

By Jeff Holtzman

Norton Desktop For Windows

Ever since Windows 3.0 came out, I've been looking for something that would help make sense of the ever increasing mass of programs and data stored on my hard disk. The Peter Norton division of Symantec recently delivered a utility package—Norton Desktop For Windows—that makes the best cut on that ideal that I've seen. Norton Desktop For Windows (or NDW for short) can work in tandem with Windows' built-in file and program managers, or it can function as

The biggest change lies in the way that NDW gives you a feeling of greater control over what's happening on the "desktop," the background of all the Windows applications. In the default condition, NDW places a column of icons corresponding to your disk drives down the left side of the screen, and another column corresponding to some of the built-in tools. The bottom edge of the screen is where the regular Windows applications icons go, and the top edge presents a standard Windows main menu bar (File, Edit, Disk, View, etc.). You can add your own application icons to the desktop: Simply open the appropriate group, drag the icon to the desired position, and release the mouse button (that's the essence of the "drag-n-drop" philosophy that we'll be seeing more and more of).

Speaking of groups, NDW starts with the program groups already defined on your system, allows you to modify them in the usual ways, but adds the capability for nested groups (group within groups within groups...). One special group is called AutoStart; it runs whenever you start the NDW. I load a clock and a memory-watch utility through it. You can accomplish the same thing via the RUN= and LOAD= lines in WIN.INI, but AutoStart allows you to set things up visually, rather than by editing a text file.

You get at NDW's file manager by double-clicking on one of the drive icons, which causes a file

manager window to pop up. Double-click on another drive icon and you can copy and move files simply by dragging them from one window to the other. The drive windows have a row of buttons that allow you to perform common operations (copy, move, delete, etc.) without going through the menus. You can totally customize the button bar and the entire menu system for that matter. For example, I use the Run and DOS commands on the File menu often. It was a simple matter to add those commands to the main-menu bar, so that they're never more than a mouse click away.

Some of the utilities are really useful; others are less useful. For instance, I really like the file finder and key finder, but I don't use the backup program, because it doesn't work with tape drives (only floppy and hard disks). The file viewer works fairly well, but not as well as the one in Lotus' Magellan, the standard as far as I'm concerned. There's also a print icon that allows you to print a file simply by dragging it (from a drive window) and dropping it on the printer icon. It works by invoking the application that created the data file, and using its built-in print facilities.

You can optionally create a list of common applications and make that list available through the control menu of every application; you can also optionally make a list of currently running applications available through the control menu. Those fea-

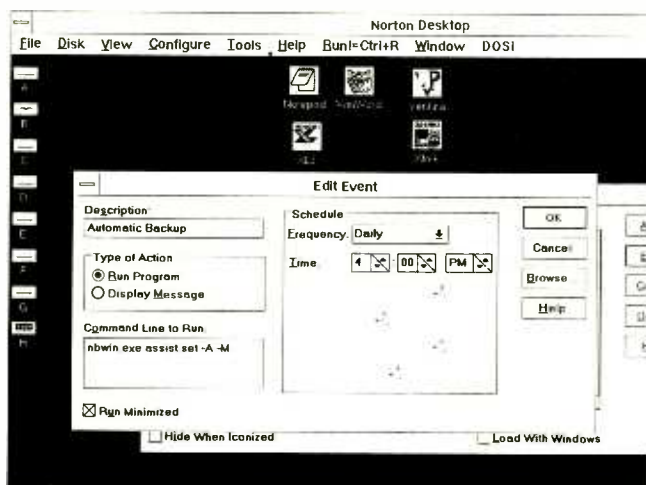

Norton Desktop For Windows can work in tandem with Windows' built-in File and Program managers or function as a substitute for them.

a complete substitute for them.

NDW also includes a slew of miscellaneous utilities that aid in backing up, viewing, and locating files; building and running Windows batch files, editing icons, locating esoteric keyboard symbols, and scheduling singular or recurring events. There's also a calculator with business and scientific modes, an icon editor, erase and format protection, and more.

tures are very handy; I use them all the time.

THE FLOATING OPERA

There's a lot to like about NDW, but it doesn't go far enough. Icons have a tendency to float ambiguously; I'd like a way to quickly organize all icons of a given type in a given area. For example, the ability to bring all the drive icons together in a rectangle and center it vertically along the left edge of the screen. Placing icons accurately is difficult due to the way NDW treats background colors. Icons of different types are not distinguished. Drive icons basically look like tool icons, which basically look like standard Windows application/document icons. There should be a visual way of distinguishing different types of icons,

and a way of organizing different types separately.

The way some of the tools work leaves something to be desired. For example, NDW includes a scheduling program that will run any program (or simply display a message) once or regularly. Regular operations can occur hourly, daily, week daily, weekly, or monthly—but not yearly. That makes the program useless for birthday and anniversary reminders, not to mention important business reminders.

You can customize the program extensively, including completely revamping the menu structure. However, one bug in the current version prevents added menu-bar items from displaying properly. In addition, menu customization affects the short menus

VENDOR

Norton Desktop for Windows (\$149)
Symantec Corporation
10201 Torre Avenue
Cupertino, CA 95014-2132
800-441-7234
408-252-3570
408-253-9600

only, not the long ones; the difference is confusing until you understand what's going on, and it is inconvenient even when you do.

The Launch List feature is very useful, but less powerful than some shareware utilities that perform the same function. For example, it would be nice to be able to specify the state (screen location, windows size, and starting directory) of a launched application. You could use the batch lan-

guage to set those things, then launch the batch file rather than the application. But it would be easier to do it directly.

NDW doesn't do some things that it could in the background. For example, formatting a floppy makes you wait. Copying files makes you wait. You can save your configuration, but that includes only NDW icons, not running applications. I could go on, but I don't want to give the impression that all those criticisms outweigh the positive virtues of this program.

NDW is not perfect, but it's far and away the single best source of Windows utilities available, either commercially or as shareware. If Version 1 is this good, I can't wait to see Version 2! ■



THIS IS HOW SOME PEOPLE START THE MOURNING

May we suggest you start your day a little differently? To learn more about healthy eating, contact the American Heart Association, 7320 Greenville Ave., Box 24, Dallas, TX 75231.

You can help prevent heart disease. We can tell you how.

American Heart Association 

This space provided as a public service.

FULL- OR PART-TIME BUSINESS:

You can make good money in VCR repair!

Professional-level home study program. You will master easy-to-learn high-profit repairs *without* investing in high-tech instruments or an expensive workshop.

Send or call today for more information on our approved home study career course.

**Free career kit:
800-223-4542**

Name _____

Address _____

City _____ State _____ Zip _____

The School of VCR Repair
2245 Perimeter Park, Dept. VB341
Atlanta, Georgia 30341



DX LISTENING

By Don Jensen

Air Traffic on SW

Scanner fans know that in the U.S. and Canada, domestic commercial airliners, private planes, airport control towers, and ground crews operate on the 108- to 136-MHz VHF aeronautical band, not shortwave. But does that leave SWL's out in the cold when it comes to monitoring aeronautical signals on their shortwave receiver? Not at all!

There's a lot of aeronautical traffic you can monitor on the shortwave frequencies. For instance,



This lovely view of the Rio Potengi at Natal, Brazil, was sent in response to an SWL reception report by Radio Poti, a shortwave outlet in that "cidade mais lindo" (most beautiful city).

in-bound and out-bound commercial jetliners on overseas flights use frequencies in 11 shortwave bands between 2,000 and 26,000 kHz. Military aircraft, here and abroad, also communicate on SW.

The best introduction to this different and fascinating aspect of SW DX'ing I've found is a newly published book, *Worldwide Aeronautical Communications*, by Robert E. Evans, published by Universal Radio (1280 Aide Drive, Rey-

noldsburg, OH 43068; \$6.95 & \$1 shipping). Evans includes a short introduction—the what, when, where, and how—of shortwave aeronautical monitoring, a discussion of the different types of air traffic you will hear, and the various airline networks.

Beginning aeronautical monitors and those with some experience in tuning in this sort of radio traffic will find his frequency list of aeronautical channels of special interest. And, as the author points out, all of the aeronautical stations listed were actually monitored within the past two years using a variety of passive and active antennas mounted on his seventh-floor apartment balcony. This is "stuff" you, too, can hear!

WHERE SHOULD YOU TUNE?

By international agreement, these are the SW aeronautical bands: 2,851–3,019, 3,401–3,497, 4,651–4,696, 5,451–5,676, 6,526–6,682, 8,816–8,960, 10,006–10,096, 11,276–11,396, 13,261–13,357, 17,901–17,967, and 21,940–21,977 kHz. Military transmissions generally can be found above or below these frequency ranges. Almost all voice transmissions are in the upper-sideband (USB) transmission mode and with few exceptions, transmissions are in English.

Evans offers some practical tips: Don't expect to hear what isn't there. It's a waste of time looking for radio signals from east-bound transatlantic flights

en route from the U.S. to Europe during the morning hours. Those flights only take place in the afternoons and evenings. Also you won't hear much from European air-traffic control stations on shortwave. Those communications, as with those within North America, use VHF frequencies, not SW.

When should you listen? He suggests that commercial air traffic on transatlantic flights can be best heard between 2200 and 0200 UTC with the summer being noticeably better than the winter. For the Pacific and Southeast-Asian areas, propagation conditions are better during the colder months. The optimum time window is around 0900 to 1200 UTC.

Where's a good place to begin? How about with the VOLMET networks; that chain of SW stations airs weather data for overseas flights on regular and predictable schedules. There's the Pacific VOLMET, which includes weather from Honolulu on the hour and half hour; from Tokyo at 10 and 40 minutes past the hour; from Hong Kong at 15 and 45 past the hour; and from Auckland, New Zealand, at 20 and 50 past the hour. This net uses several frequencies, including 6,679 and 8,828 kHz. You can also try Shannon (Ireland) Aeradio's weather on 8,957 kHz on the hour and at 25, 30, and 55 minutes past the hour.

For the rest of the fascinating story of aeronautical radio on shortwave, I recommend you read Evans' book.

IN THE MAIL

Writes Randy Turner of Springfield, PA: "I was interested in your September column about the lack of humor programs on short-wave. And I was surprised to read about the demise of the "Royal Canadian Air Farce" show on *Radio Canada International*.

"Actually, 'Air Farce' is a live production company that travels around Canada and they were scheduled to begin doing live shows again in the fall. During the summer months they were replaced by a program called *Comedy Classics*."

Randy, I appreciate you bringing us up to date on a couple of very funny shows. As faithful RCI listeners know, when the budget crunch hit the Canadian shortwave broadcaster last spring, most of the RCI-produced English language programs, including the very popular "SWL Digest" show, were "deep-sixed."

But, proving that there may be a silver lining to the darkest of clouds, this loss of RCI-originated programming led to the SW broadcaster picking up a good number of excellent programs from the Canadian Broadcasting Corporation's domestic AM network. In this instance, SWL's may have come out ahead.

Brad Cobo writes from Duncanville, TX: "I've been an SWL for about a year now. I've received my first QSL cards from *WCSN*, *WSHB*, and *KHBI*, the stations of the World Service of the Christian Science Monitor. They don't have any signatures by anyone. They just have places for the listener to fill in program details, times, etc.

"My question is this: Do most SWL's complete these cards and send them back to the stations to have them validated, then returned? If

you do send them back, do you run the risk of having them lost in the mail? If you do get them back from the stations, they'd probably be bent and torn. That would just ruin them!

"Since I started SWL'ing on my own, I only have **Popular Electronics'** "DX Listening" column to guide me. I'm hoping you could give me an answer."

As you know, Brad, QSL cards, traditionally, have been sent by stations in reply to SWL reports. The theory is that they serve as confirmations of reception. The purpose is to give the listener something tangible to show that, yes, he or she did receive the station on a particular date and short-wave frequency.

But today, the larger international broadcasters get so many QSL requests that it has become a costly and time consuming job checking out each report for correctness. So, by and large, they take you at your word that you did, in fact, receive their station, and they send you a QSL card without actually checking your report details for accuracy. While this means that a QSL rarely is real proof of reception, these cards do serve as attractive souvenirs from foreign SW stations. As such, most listeners still like to collect them.

A few broadcasters have carried this a step further. They provide SWL's with blank QSL cards, usually sent out with their program schedules. If you want QSL's from these stations, you have to fill out the cards—time, date, frequency, and

*CREDITS: Dan Ferguson, VA; Mike Wolfson, OH; Dave Weinrich, ND; William Wentworth, MA; Richard D'Angelo, PA; Hans Johnson, MD; North American SW Association, 45 Wildflower Road, Levittown, PA 19057.

programming you received—and return them to the station. Usually they will stamp or sign the QSL cards to "validate" them before mailing them back to you for your collection.

Can these QSL's be damaged in the mail? Perhaps, but it doesn't seem to be too much of a problem for SWL's. Most seem to feel that having such a QSL for their DX "shack" wall or album is better than having nothing tangible to show for their receptions.

I look forward to hearing from the rest of you out there. What are you hearing? What are your favorite SW programs? Any questions or comments? How about a photo of you and your "shack?" The address, as always, is *DX Listening*, **Popular Electronics**, 500-B Bi-County Blvd., Farmingdale, NY 11735

DOWN THE DIAL

Here are some of the countries and stations being logged by SWL's:

ALASKA—11,715 kHz. *KNLS*, the religious broadcaster at Anchor Point, Alaska, transmits most of its programs in Russian and Chinese. But you can find English at 0800 to 0900 UTC.

ANTIGUA—5,975 kHz. The *British Broadcasting Corporation's* World Service is easily logged on this frequency during the evening hours, say around 0130 UTC. The signal is being relayed by a transmitter on this West Indian island.

PAKISTAN—21,730. *Radio Pakistan* has English news, read at slow speed, at 0230 UTC.

SPAIN—9,630 kHz. *Spanish Foreign Radio* from Madrid is logged on this frequency in English at 0030 and again at 0500 UTC. ■

Make the
most of your
general
coverage
transceiver
with
*Monitoring
Times!*

Every month *Monitoring Times* brings everything you need to make the most of your general coverage transceiver: the latest information on international broadcasting schedules, frequency listings, international DX reports, propagation charts, and tips on how to hear the rare stations. *Monitoring Times* also keeps you up to date on government, military, police and fire networks, as well as tips on monitoring everything from air-to-ground and ship-to-shore signals to radioteletype, facsimile and space communications.

ORDER YOUR SUBSCRIPTION TODAY before another issue goes by. In the U.S., 1 year, \$19.50; foreign and Canada, 1 year, \$26. For a sample issue, send \$2 (foreign, send 5 IRCs). For MC/VISA orders (\$15 minimum), call 1-704-837-9200.

MONITORING TIMES

Your authoritative source,
every month.

P.O. Box 98
Brasstown, N.C. 28902

HAM RADIO

By Joseph J. Carr, K4IPV

What's a Balun Transformer?

Last month we took a look at folded dipole antennas; those antennas (to refresh your memory) consist of a pair of parallel conductors that are shorted at the ends and are fed at the center of one conductor. One of the problems with the folded dipole is that its feedpoint impedance is close to 300 ohms, which is not a good match to the low-impedance outputs normally used by modern transmitters and transceivers.

In last month's column, we demonstrated a way that the impedance of the

first syllables of *BAL*anced and *UN*balanced. A true balun transformer converts a balanced load into an unbalanced load, allowing you to go from a balanced dipole to an unbalanced, coaxial-cable transmission line (or vice versa). The balun may or may not provide impedance transformation or matching, depending on its design.

Two common impedance ratios for balun transformers are 1:1 and 4:1. The 1:1 version is usually used with conventional single-wire dipoles that are fed from 75-ohm coaxial cable. The 4:1 types—which are bidirectional, and can be used backwards—are used where a 4:1 or 1:4 impedance transformation is needed (such as with folded dipoles or elsewhere).

The typical balun is wound on a ferrite toroidal core, although air-core and ferrite-rod, solenoid-wound (i.e., cylindrical) types are also viable. Figure 1 shows the basic construction of two types of balun transformers; Fig. 1A is a basic toroidal balun, while Fig. 1B shows the solenoid version. For full-power amateur-radio operation, the balun should be wound on a large toroid such as the Amidon Associates (12033 Otsego Street, North Hollywood, CA 91607) CF-123 or FT-200-61.

For use on the 3- to 30-MHz high-frequency band, six turns of #12 or #14 enameled- or formvar-coated solid wire should be wound on the CF-123 core or ten turns wound on the

FT-200-61 core. (The two core types have different permeability values.)

The power handling capacity of toroidal cores can be increased by stacking two or three on top of each other. When stacking cores, wrap each core in a single layer of fiberglass adhesive backed tape, and then wrap the entire assembly in a final single layer of the same tape. Some people use plastic electrical tape, but I've not tried it so I won't advise you to take that approach.

BALUN CONFIGURATIONS

A balun transformer can be wound in either bifilar or trifilar configurations. The bifilar configuration consists of two wires simultaneously and closely wound on a core. The trifilar is wound in the same manner, except that it uses three wires instead of two. Some builders twist the wires together in a drill mandrel, but I do not recommend that practice because it is dangerous, plus it does not work as well as the flat-winding schemes shown in Fig. 1.

Figure 2 shows how the various windings are interconnected to produce three types of balun transformers; the 1:1, the 4:1, and the 50-to-75 ohm types. Shown in Fig. 2A is a trifilar-wound unit that provides balanced to unbalanced transformation, and yet maintains a 1-to-1 ratio between the input and output impedances. Such units are used on ordinary dipoles that present a 75-ohm load impedance, and are fed

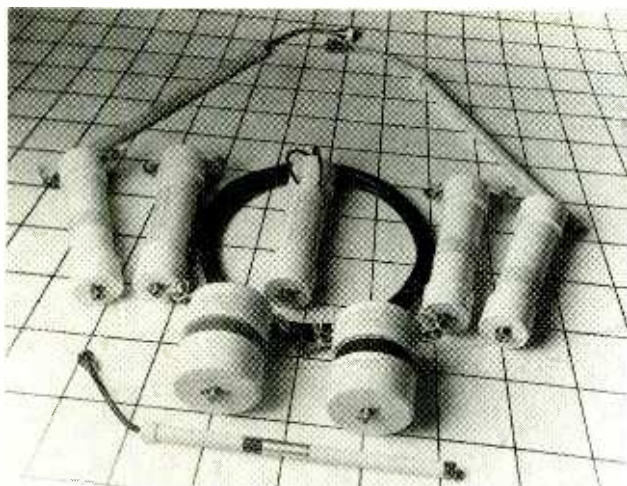

Balun transformers come in a variety of shapes and sizes. Shown here several of those manufactured by Radio Works.

folded dipole could be transformed to more closely match that of the transmitter by using a 4:1 balun transformer. This month we'll discuss what a balun transformer is, and why it's needed.

WHAT'S A BALUN TRANSFORMER

The word balun is actually an acronym formed by the

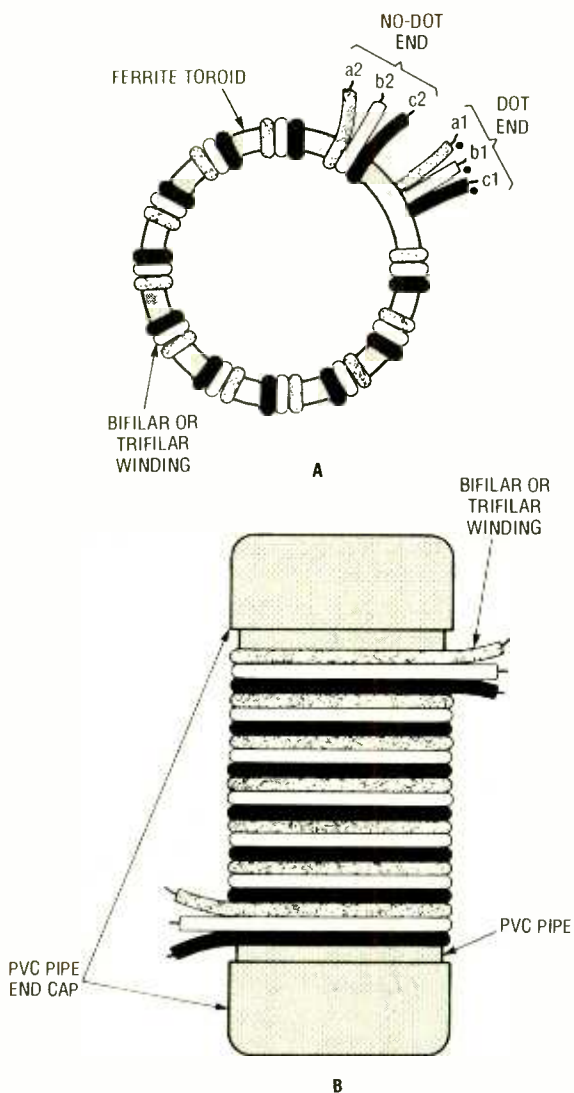

Fig. 1. Balun transformer winding methods: the Toroidal-core wound unit in A is the preferred type; a solenoid-wound (air-core) unit is shown in B.

via 75-ohm coaxial cable (e.g., RG-59/U or RG-11/U).

Why use a 1:1 balun transformer, you ask? The reason for that becomes obvious when one looks at the antenna patterns produced by conventional dipoles with and without a balun transformer at the feed-point. Without a balun, the idealized "figure-8" pattern is distorted due to radiation caused by currents flowing on the outside conductor of the coaxial cable. Ideally, that current is geometrically balanced by currents flow-

ing in the opposite direction in the inner conductor. But, that ideal is rarely achieved. However, the problem can be negated (restoring the pattern to very near the ideal) using a 1:1 balun transformer.

Figure 2B shows a 4:1 balun transformer. Note that in this case, the transformer is bifilar wound—two windings wound over a single core. That is the type of balun that is used to convert the 300-ohm impedance of the folded dipole to the 75-ohm impedance of coaxial cable.

The balun transformers shown in both Figs. 2A and 2B are broadband RF units that are designed to cover a wide range of impedances. For example, the 1:1 transformer can also work with 52-ohm coax, while the 4:1 transformer will convert the 200-ohm impedance of certain loop antennas to 50-ohms for coax input.

The balun-transformer configuration shown in Fig. 2C is a little different. That one is designed to match 75-ohm loads to 50-ohm transmission line. Note that that configuration contains two silver-mica capacitors, which are used for frequency compensation. Also note that L1 has half as many turns as L2 and L3 (3T and 6T, respectively, when wound on CF-123 forms, and 5T and 10T, respectively, when wound on FT-200-61 forms). Note that in the other versions discussed all windings have the same number of turns.

Balun's are commercially available from a wide variety of sources. Any ham-radio store will carry a good variety. Several commercial current- and voltage-mode balun transformers are made by Radio Works (P.O. Box 6159, Portsmouth, VA, 23703; 804-484-0140). Also, in addition to coil forms, Amidon offers balun kits.

For those interested, more information on balun transformers can be found in *The ARRL Antenna Book*, or my own *Practical Antenna Handbook* (published by TAB Books).

DIGITAL FREQUENCY COUNTER

One of the things that astounds "old-timers" like myself (first licensed 1959) is the big improvement in prices caused by the well-known solid-state "learning

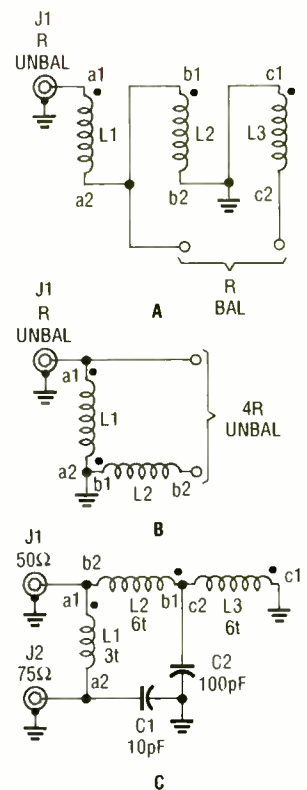

Fig. 2. The wiring in A shows how the coils of the 1:1 balun transformer are interconnected; B shows the 4:1 coil configuration; and C shows a 75/50 ohm layout. Note that the last has a pair of silver-mica capacitors connected in the circuit.

curve." As companies improve processes and designs, they are often able to either drop prices considerably, or offer a whole lot more product for the same price (inflation notwithstanding, of course). One area where such progress is routine is in the manufacture of digital frequency counters (DFC).

In the mid-1960's, hams simply did not own DFC's, unless they also had a trust fund to finance an elegant life style. A typical DFC of that period cost about \$3,000, which was a year's pay for a minimum wage worker. And they weighed a ton—"portable" counters took two good men and a strong boy to lift! Today,

(Continued on page 90)

SCANNER SCENE

By Marc Saxon

A Look at the Mailbag

Continuing with their aggressive pursuit of the scanner market, Radio Shack has introduced the *Realistic PRO-41*, a 10-channel, direct-entry, programmable handheld scanner. Frequencies covered include 29 to 54 MHz, 137 to 174 MHz, and 406 to 512 MHz. There's an LCD readout with a review key to display frequencies. The

ond delay. Unwanted channels may be locked out. The memory will be retained for as long as 30 minutes with the batteries removed.

Speaking of batteries, the PRO-41 uses five "AA" type, and will take nickel-cadmium rechargeable types if you wish to use them. An optional AC adapter is available, as is an optional vehicle power cord.

The PRO-41 has a built-in speaker, but you can use headphones, or even an extension speaker. The rubberized antenna easily removes via a BNC connector. There's also a belt-clip supplied.

The price of the Realistic PRO-41 is \$119.95, which puts it within nearly everybody's grasp. Look for it at any of Radio Shack's many stores across the U.S. and Canada.

FROM OUR READERS

An inquiry from John W. McConnell, Iowa City, IA, provides us with the information that his local police operate on 460.05 and 460.10 MHz. His question involves the police agency's announced plans to install computers in all police vehicles; John wonders how this will affect his ability to monitor that agency.

It seems that each agency approaches the use of computers differently, but in many areas the introduction of computers does not mean the end of monitoring. Often, normal voice dispatching and communications continue as usual.

The computer (non-voice) communications are reserved for sending data such as license-plate checks; or providing a written record of various names, addresses, dates, descriptions, alarms, serial numbers, and other data requiring confirmation or retention; or for leaving messages with officers who are away from their vehicles.

Horace Jackson of North Carolina wrote to tell us of a story reported in his local newspapers. A tourist recently left his 1982 Audi parked outside his room at a Washington, NC, motel. When the gentleman got up one morning, he saw that his car was gone—probably because he had accidentally left the key in the ignition. The police were immediately notified.

Within minutes after the police sent out the stolen car alarm, a scanner listener in a nearby community called the police to say that he'd seen a car that fit the description parked on his street. The police confirmed that it was the stolen vehicle. The tourist got his car back, albeit minus a tape deck and 30 tapes. Chalk up one more good reason for the public to be encouraged to keep tuned to police communications!

From Duncanville, TX, we got a note from Brad Cobo wondering about using a fringe-area UHF-TV antenna for UHF scanner reception. In particular, he asked about possible impedance

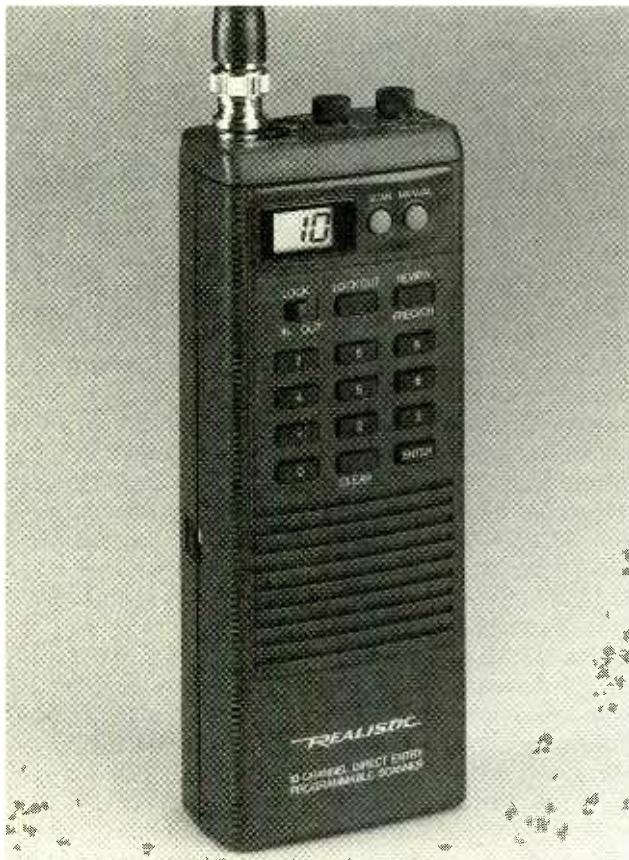

The Realistic PRO-41, available at Radio Shack, is a ten-channel, direct-entry, programmable handheld that offers big coverage at a small cost.

low-battery indicator in the PRO-41 sends out an audible beep. The scan rate is 10 channels per second, with an automatic 3-sec-

mismatch problems inasmuch as TV antennas are 300-ohm designs while scanners are designed to use 50-ohm antennas.

UHF-TV antennas have become popular with scanner owners living in outlying areas who want to receive UHF communications from a distant area. For starters, for scanner use, such antennas need to be mounted with their elements vertically polarized (as opposed to horizontal mounts for TV reception). The best you can do with the impedance mismatch is to use a commercial matching transformer (Radio Shack 15-1253 or equivalent) that will bring the 300-ohm antenna to 75 ohms, and then use 75-ohm TV cable to your scanner. Yes, there's still a mismatch, but that's about as close as you're going to get with this Mickey Mouse arrangement.

Users report reasonably good distant UHF scanner reception in the direction the antenna is pointed where there previously had been none at all, subject to some further improvement by the addition of (you guessed it) a TV signal booster inserted in the coaxial line. All of this is very unorthodox and annoys purists, so please don't tell anybody you heard about it here!

Your reward for buying a used scanner at a flea market can often be a headache that's twice as big as the bargain you thought you got. That's how it was with Nelson Eshelman, who bought an ADC Model SS-16. Now he's hoping that someone can let him know where to contact the manufacturer. We can't; we're not familiar with this company. If any of our readers know how he could reach the company called

ADC, Nelson would welcome the information. Write to him at 943 Caves Highway, Cave Junction, OR 97523.

Reader G.S., of Florida, has a scanner and a cellular phone in his vehicle, each requiring its own antenna. He wants to know if he can get a signal splitter to run both pieces of equipment from the same antenna without damaging either piece of equipment. We had a similar inquiry in last October's column asking about a scanner and a 2-meter band ham rig running from the same antenna. Once again, we don't recommend such a setup, although we see no problems if the two units are connected to the antenna by a rotary coaxial switch that permits only one set at a time to be hooked to the antenna. That goes for the phone and the scanner as well as the ham rig and the scanner.

From Detroit, a post card from Kyle Harris arrived with the suggestion that he would like to know if the federal Housing and Urban Development agency has frequencies we could publish. He has seen their people using handheld transceivers and would like to hear what they have to say, and he is sure that other city-dwellers would like to do the same.

Our information has it that HUD uses 164.50, 164.8625, 165.6625, 168.00, and 169.10 MHz.

'TIL NEXT TIME

Come by again next month. And let us hear from you with questions, ideas, news items, frequencies, and other scanner-related tidbits. We are *Scanner Scene*, **Popular Electronics**, 500-B Bi-County Boulevard, Farmingdale, NY 11735. ■

WATCH FOR THIS ISSUE ON SALE JANUARY 7, 1992



OUR FEBRUARY ISSUE FEATURES:

BUILD THIS SCANNER CONVERTER

Allows unrestricted coverage of the 800-MHz band.

BUILD THE HYPER CLOCK

You've never seen a clock project like this before!

BUILD A SWEEP/FUNCTION GENERATOR AND FREQUENCY COUNTER

We finish up this pro-quality benchtop generator with complete construction details.

NEW LIFE FOR AM RADIO?

Will the new AMAX receivers breathe new life into our venerable broadcast band?

PLUS:

Hardware Hacker Audio Update
Video News Computer Connections
Drawing Board And Lots More!

Don't miss even one issue—Order Now!
Call TOLL FREE 1-800-999-7139

#5PE13

ELECTRONICS LIBRARY

Passport to World Band Radio 1992

from International Broadcasting Services, Ltd.

World-band radio provides listeners with broadcasts that simply can't be found on any other media. News and entertainment programs from around the world offer glimpses at other cultures and newscasts originating from other countries can offer surprisingly different angles on familiar news stories. This book is a directory to short-wave radios and their use. Set

top ten shows for 1992, how to get started in the hobby, reviews of world atlases, and a look at tracking the Gulf War by radio. The buyer's guide provides information on what to look for in terms of prices and features when buying a world-band radio and individual reviews of portable and table-top models. The programming guide takes a look at 1992 program highlights, a country-by-country listing, world time, and station addresses, and "The Blue Pages"—24-hour grid that contains complete, around-the-clock and around-the-world program listings.

Passport to World Band Radio 1992 costs \$19.95 (including shipping) and can be ordered from International Broadcasting Services, Ltd., Box 300 Penn's Park, PA 18943; Tel: 215-794-8252.

CIRCLE 81 ON FREE INFORMATION CARD

NATIONAL 800/900 TELEPHONE SERVICE CODE BOOK

from Kenneth Sperry

Most people are unaware that there are codes hidden within the digits following "800" and "900" in telephone numbers. For instance, the first three numbers following the "800" in toll-free numbers and the "900" in toll calls identify the specific long-distance carrier that handles those calls. This book provides the keys to those codes, as well as Carrier Identification Codes (CIC's). CIC's are three-digit dial-up numbers for directly accessing the telephone facilities and services of all long-distance carriers from phones in the U.S., Canada, and the West Indies. There are more than 750 CIC's assigned to almost 600 companies, including many "private" CIC's held by states, federal agencies, military switchboards,

banks, data and computer services, emergency networks, credit-card companies, satellite services, paging services, and large corporations for their own internal voice/data communications. All of those are listed in this book, along with some interesting toll-free numbers and a brief discussion of the new Unix anti-hacker telephone-security program. That information could be effectively put to use by professionals or hobbyists, or just to keep informed about the communications systems we all use.



The National 800/900 Telephone Service Code Book is available for \$9.95 plus \$3.50 for UPS shipping (NYS residents add \$1.08 sales tax) from CRB Research Books, Inc., P.O. Box 56, Commack, NY 11725

CIRCLE 82 ON FREE INFORMATION CARD

EQUIPMENT, TOOLS & SUPPLIES FOR ELECTRONIC MAINTENANCE & SERVICE 1991-1992

from Print Products International Inc.

This 64-page catalog includes items from such major manufac-

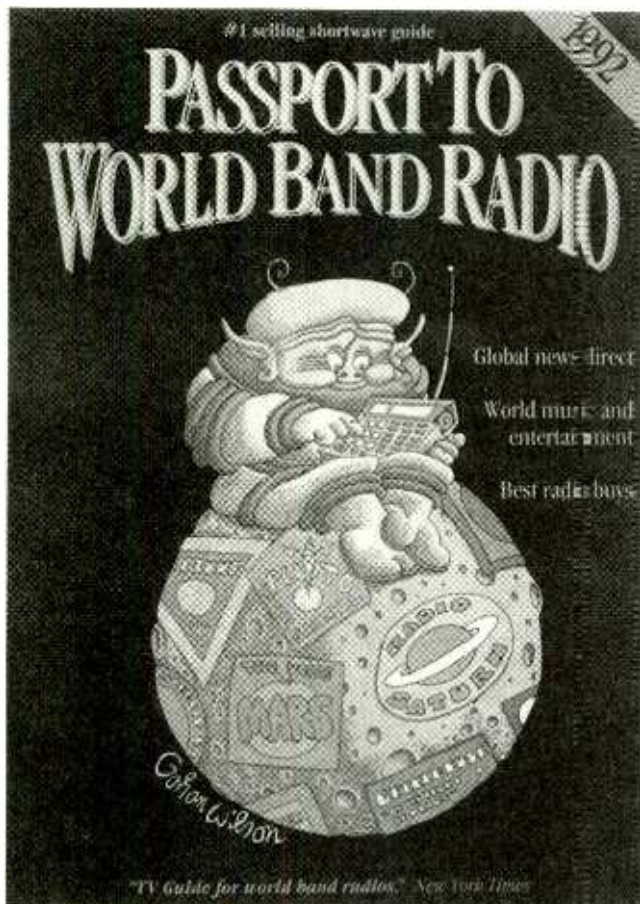

up like a magazine in book form—complete with advertisements—it contains a collection of articles, a buyers guide to world-band radio, and programming guides. The articles include a look at the world of world-band radio, a look at the

turers as Pace (soldering/desoldering and surface mount rework and repair equipment); Hitachi, B&K, Kenwood, Leader, Simpson, Triplett, Global Specialties, Beckman, Soar, and Vector Viz (test equipment); Logical, C.S.T., and American Reliance (programmers); and Tripp Lite (power protection equipment). Print's own custom tool kits and cases are also featured. New products include Helper service monitors and radio test equipment; Landmark PC troubleshooting equipment; AEMC test equipment and power-demand analyzers; Stat-icide static-detection meters; Strategic Products convection heating ovens; Ungar soldering equipment; Fieldpiece field-service equipment; and spectrum analyzers from Avcom, Pentek, and B&K. Product prices and descriptions are accompanied by photographs and some illustrations.

The 1991-1992 Equipment, Tools & Supplies for Electronic Maintenance & Service Catalog is free upon request from Print Products International Inc., 8931 Brookville Road, Silver Spring, MD 20910; Tel: 800-638-2020 or 301-587-7824.

CIRCLE 83 ON FREE INFORMATION CARD

BEYOND THE NINTENDO MASTERS

by Clayton Walnum & Andy Eddy

Can't drag your kids away from the Nintendo long enough for them to read a book? Then they're probably advanced enough in their video-game playing to benefit from this "advanced guide for serious Nintendo gamers." Aimed at tournament players, this book provides power-play strategies, tips, and secrets to improving scores in 17 games, in the categories of fantasy, science fiction, arcade, military, and action and sports. Those include Super Mario Brothers 3, Castlevania II: Simon's Quest, Defender of the Crown, Teenage Mutant Ninja Turtles, Zelda II: The Adventure of Link, World Championship Wrestling, and Batman. The book briefly outlines each game's objectives, organization, characters, and general strategy, and then goes

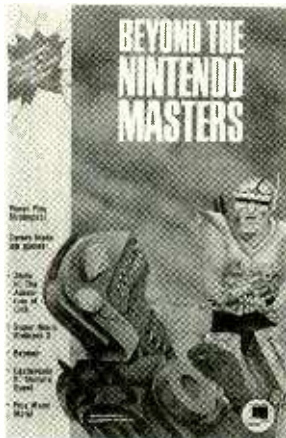

on to a detailed look at strategies for each level of game play. A special chapter details secret hints for various games, including a password to make Rambo and other characters invisible; codes for skipping to advanced play levels in several games; and ways to get extra lives, weapons, game time, and bonus points.

Beyond the Nintendo Masters costs \$9.95 and is published by Hayden Books, 11711 North College Avenue, Suite 140, Carmel, IN 46032; Tel: 1-317-573-2500.

CIRCLE 84 ON FREE INFORMATION CARD

ELECTRICAL WIRING FOR THE HOME

by Jeff Markell

Aimed at average people with limited experience in construction, this book explains how they can do their own wiring—with the proviso, of course, that all such work must be inspected and approved by a licensed electrician before power is turned on. For projects ranging from hooking up a new single-room circuit to wiring an entire dwelling, the book explains how to do the job in strict accordance to the restrictions and requirements detailed in the National Electrical Code. The book begins with an introduction to the fundamentals of electricity and electrical theory, and goes on to explain how to read plans and obtain permits, and to describe various types of branch circuits. The book's second section is devoted to the tools and materials needed for an installation, including conductors, cables, conduits, electrical boxes, and box connections.

Basic wiring techniques are described next, with specific advice on rough wiring and finish wiring. The final section explores the installation of low-voltage supplementary systems, with step-by-step directions on how to install such devices as smoke, heat, intruder, microwave, and ultrasonic detectors; alarm controls; alarm systems; doorbells, chimes, and buzzers; and intercom systems. An entire chapter covers the wiring for home-entertainment systems. References to the Na-

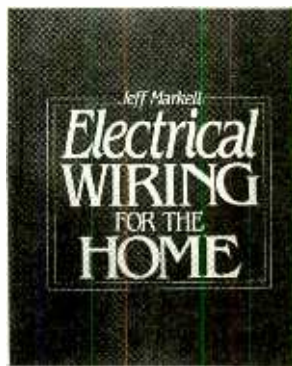

tional Electrical Code appear throughout the text, as they apply to and govern each project; actual tables and charts reprinted from the Code appear in an appendix.

Electrical Wiring For the Home costs \$33.00 and is published by Prentice Hall, Englewood Cliffs, NJ 07632.

CIRCLE 99 ON FREE INFORMATION CARD

ELENCO PRECISION CATALOG 91/92

from C&S Sales

While most of the test equipment featured in this catalog carries the Elenco brand, digital and analog oscilloscopes from Hitachi, OWI Movit robot kits, and Fluke multimeters are also included. Elenco products include analog and digital multimeters, oscilloscopes, trainers, power supplies, logic probes, AC current meters, and various testers. A wide selection of Elenco educational kits includes a strobe light, a digital lock, an

Shortwave Listening Guidebook

by Harry Helms

The world is talking on shortwave radio, and here's the book that tells you how to listen in! In direct, nontechnical language, Harry explains how to get the most from your shortwave radio. Its 320 heavily illustrated pages are filled with practical advice on:

- antennas
- when and where to tune
- selecting the right radio for you
- accessories
- reception techniques



Learn how to hear the BBC, Radio Moscow, ham radio operators, ships at sea, even Air Force One! Includes hundreds of frequencies for stations around the world and the times you can hear them.

Only \$16.95 plus \$3.00 shipping (CA residents please include sales tax).

HighText
Publications, Inc.
7128 Miramar Road
Suite 15L, San Diego, CA 92121

FM mic, and a telephone bug. Each kit comes with a PC board and an instruction book. Other products featured in the catalog include breadboards, soldering tools, test leads, radios, and cellular-telephone accessories.

The Elenco Precision Catalog 91/92 is free upon request from C&S Sales, Inc., 1245 Rosewood Avenue, Deerfield, IL 60015; Tel: 708-541-0710 or 800-292-7711; Fax: 708-520-0085.

CIRCLE 85 ON FREE INFORMATION CARD

HOME REMOTE-CONTROL & AUTOMATION PROJECTS: Second Edition

by Delton T. Horn

The 77 projects in the second edition of this book include 15 all-new ones, and updates and improvements on the original projects that make them more useful and effective with today's electronic appliances and devices. The projects are designed to be simple, but impressive, and easy to adapt to other, specialized applications. While the first couple of chapters deal with the basics of remote control and automation and building techniques, in the remainder of the book the emphasis is on practical applications instead of theory. Each project is illustrated and contains step-by-step instructions and wiring diagrams. A small sampling includes a sound-activated intrusion detector, an automated staggered light dimmer, an over/under-temperature alert, a remote telephone ringer, and an overvoltage protector. There's also new material on potentiometer IC's, stepper



motors, and techniques for using a PC as a home-control center.

Home Remote-Control & Automation Projects costs \$18.95 and is published by TAB Books, Division of McGraw-Hill Inc., Blue Ridge Summit, PA 17294-0850; Tel: 1-800-822-8138

CIRCLE 98 ON FREE INFORMATION CARD

1000 AUTOCAD TIPS AND TRICKS: SECOND EDITION

by George O. Head and Jan Doster Head

For those who'd prefer to spend their time drawing and designing instead of reading complex manuals, this book provides a well-organized collection of time- and effort-saving techniques, shortcuts, and tricks. Despite the book's size and complexity, the reader should have no trouble finding the information needed. The book is organized into three separate sections, for beginning, intermediate, and advanced AutoCAD users. Each of those sections is divided into nine chapters that each address a major subject area: drawing; editing; viewing; layers, blocks, and attributes; inquiry, text, and annotation; utilities; 3D; miscellaneous; and Release 11. Each of those chapters is further divided into a how-to section, a section providing additional tips for increased productivity, and a section of AutoLISP programs relating to the topic. The book provides drawing and editing tips, working AutoLISP programs designed to speed up work, 3D shortcuts and enhancements, and more than 200 previously unpublished tips. Unless otherwise noted, all the tips, features, and commands work with Release 10 and Release 11. Two free updates containing additional tips are included in the book's purchase price.

1000 AutoCAD Tips and Tricks costs \$24.95 and is published by Ventana Press, P.O. Box 2468, Chapel Hill, NC 27515; Tel: 919-942-0220; Fax: 919-942-1140.

CIRCLE 86 ON FREE INFORMATION CARD

THE AUDIO DICTIONARY Second Edition

by Glen D. White

Intended both as a supplement to textbooks in acoustics and audio-related courses, and as a source of information for the layman interested in recorded music or acoustics, this book covers the terminology and basic concepts of sound recording, sound reinforcement, and musical acoustics. Arranged dictionary-style to make it easier for readers to find information and because that style lends itself to cross-referencing, the book contains definitions of fundamental principles and standards, along with more abstract and subjective concepts. Mathematics are kept to a minimum, and many of the entries take on an anecdotal—and occasionally humorous—tone. Nine appendices follow the definitions. Those include data on impedance and frequency response, advice on how to deal with over-zealous stereo salesmen, explanations of frequently used symbols and units, notes on audio measurements, a discussion of digital audio, and a history of high fidelity.

The Audio Dictionary: Second Edition costs \$19.95 and is published by the University of Washington Press, P.O. Box 50096, Seattle, WA 98145-5096; Tel: 206-543-4050; Fax: 206-543-3932.

CIRCLE 87 ON FREE INFORMATION CARD

CAMCORDER SURVIVAL GUIDE

by Robert I. Wolenik

Camcorders are becoming increasingly popular—so why do we dread watching vacation videos shot on a camcorder as much as those old home movies? The reason is simple: There's more to making a good video than pointing and hitting the REC button. This book provides the information aspiring videographers need to make good videos. Its first five chapters are devoted to choosing the right camcorder. Comprehensive discussions of various formats, standard and deluxe features, and manufacturers are

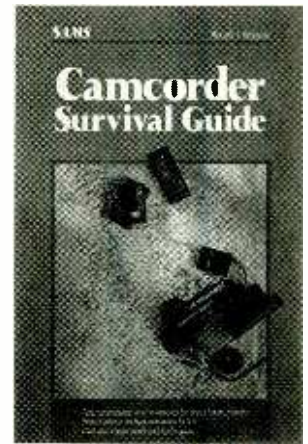

included, with an emphasis on evaluating the virtues of each in light of your own specific needs. The book continues with an explanation of how to use all the basic camcorder features, before describing advanced techniques in making home videos, such as proper lighting, sound, and composition. It explains how different techniques are needed for recording vacations, sporting events, and indoor affairs. Once the tape is recorded, editing can greatly improve its quality. The book shows how to make copies, compose and edit videotape presentations, generate special effects with advanced editing techniques, and even use desktop video to create multimedia presentations using Amigas, Macintosh, and IBM-compatible computers. For those who discover they have a knack for making interesting videos, the book explores ways to make money as a videographer—taping special events, how-to demonstrations, and news stories. Other less lucrative but interesting camcorder uses suggested in the book include making a record of your valuables for insurance purposes, using it as a tool in losing weight, making video postcards, and converting old movies to video. The book also explains how to maintain your camcorder, and how to make some minor repairs.

The Camcorder Survival guide costs \$9.95 and is published by Sams, 11711 North College Avenue, Suite 140, Carmel, IN 46032; Tel: 1-317-573-2500.

CIRCLE 95 ON FREE INFORMATION CARD

SELECT 5 BOOKS for only \$4⁹⁵

(values to \$133.75)

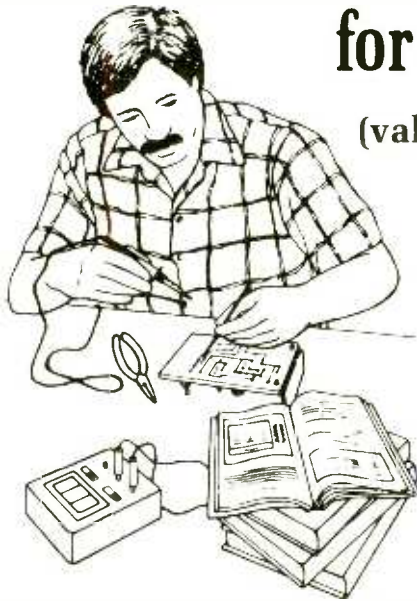

2613P \$17.95

Your most complete source for electronics books for over 25 years.



Build Your Own IBM Compatible and Save a Bundle

3632 \$18.95



3804P \$19.95



2947P \$13.95



3157P \$16.95



2980P \$19.95



3460 \$22.95



3374P \$16.95

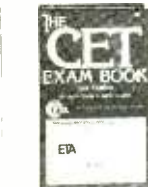

2950P \$13.95



3414 \$39.95
Counts as 2



3274 \$25.95
Counts as 2



3485 \$27.95



2996P \$14.95



2880P \$14.95



585928-9 \$24.95



1604P \$17.95

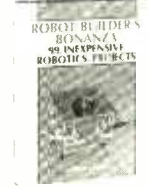

2800P \$16.95



3219 \$27.95
Counts as 2

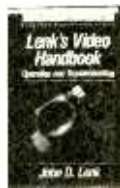

10018 \$39.95
Counts as 2



3677 \$34.95
Counts as 2

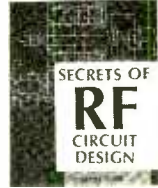

3710 \$32.95
Counts as 2



3262P \$17.95



3531 \$26.95



2728P \$9.95



2887 \$16.95



2983P \$18.95



2867P \$10.00

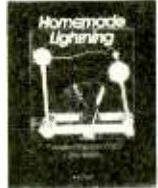

3576P \$14.95



3778 \$27.95



3627 \$29.95
Counts as 2



1936 \$10.00
Counts as 2

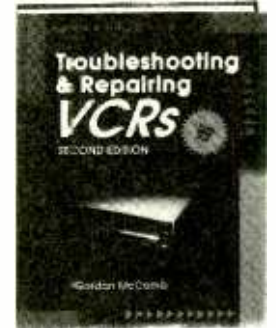

3777 \$22.95
Counts as 2



3672 \$28.95
Counts as 2



3220 \$10.00
Counts as 2



3358 \$28.95
Counts as 2



10024 \$32.95
Counts as 2



2925P \$9.95

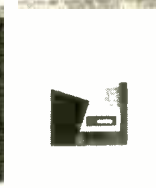

1738 \$2.00

Membership Benefits • Big Savings. In addition to this introductory offer, you keep saving substantially with members' prices of up to 50% off the publishers' prices. • **Bonus Books.** Starting immediately, you will be eligible for our Bonus Book Plan, with savings of up to 80% off publishers' prices. • **Club News Bulletins.** 15 times per year you will receive the Book Club News, describing all the current selections—mains, alternates, extras—plus bonus offers and special sales, with scores of titles to choose from. • **Automatic Order.** If you want the Main Selection, do nothing and it will be sent to you automatically. If you prefer another selection, or no book at all, simply indicate your choice on the reply form provided. You will have at least 10 days to decide. As a member, you agree to purchase at least 3 books within the next 12 months and may resign at any time thereafter. • **Ironclad No-Risk Guarantee.** If not satisfied with your books, return them within 10 days without obligation! • **Exceptional Quality.** All books are quality publishers' editions especially selected by our Editorial Board. PE292

If card is missing, use this address to join:
ELECTRONICS BOOK CLUB, Blue Ridge Summit, PA 17294-0810

©1992 ELECTRONICS BOOK CLUBSSM
A shipping/handling charge and sales tax will be added to all orders.

All books are published by McGraw-Hill, Inc. (Publishers' Price as shown)

NEW PRODUCTS

3-Phase and Motor-Rotation Tester

A special combination instrument from *Extech Instruments* pairs their popular *Model 480300 3-Phase Rotation tester* with their *Motor Rotation Tester*. Like the original 3-phase rotation tester, the *model 480303 3-Phase and Motor-Rotation Tester* checks the phase sequence and determines if the phase is live. It has a 100–660-VAC rated test range for testing the phase orientation of three phase power sources over a 50–70-Hz frequency range. The unit has five LED indicators; two indicate correct or incorrect phase orientation and the rest indicate whether each of three phases is



live. The other side of the unit is a motor-rotation unit that measures the rotation direction of motor shafts to ensure that the motor is not damaged by incorrect wiring. The tester, which measures 5.9 × 3.3 × 1.5 inches, comes with 40-cm test leads with alligator clips.

The *model 480303 motor and phase rotation tester* costs \$89; the phase-rotation tester without the motor-tester function costs \$49. For more information, contact *Extech Instruments Corporation*, 335 Bear Hill Road, Waltham, MA 02154; Tel: 617-890-7440; Fax: 617-890-7864. All inquirers will receive *Extech's 1992 catalog*.

CIRCLE 102 ON FREE INFORMATION CARD

VIDEO FILTERS

High-quality filters offer a convenient means for videographers to improve image quality and get some creative effects. The *B + W-Filters* from *Scheider Corporation of America* come in a wide variety of sizes to fit virtually all camcorder lens diameters, and in the three most popular types: UV, neutral-density, and polarizing filters. The UV filter is 100% clear, so it will not affect the white balance as it reduces haze and increases contrast by filtering out ultraviolet light. The "Top Pol" linear polarizing filter reduces reflection from water, plastic, or glass. The lens is a neutral gray that does not alter the natural color of the subject or the white balance. It increases contrast, reduces haze, and is fully UV absorbing. Depending on the position and intensity of the sunlight, colors are reproduced with increased saturation and richness. Its rotating mount permits different degrees of polarization. For use in scenes of too-intense light, the neutral density filters in no way affect the color and contrast values of the original scene, but merely reduce the light intensity to a point where aperture or shutter-speed adjustments are again possible. Those lenses are also effective in close-up taping where a diffused background is required.



All of the filters feature *Schott optical glass*, anti-reflection coatings on both sides, and black anodized-brass mounts.

The *B + W Filters* are priced according to type and diameter size. Screw-in filters, for example, range in price from \$36 for

39mm to \$104 for 82mm. For additional information, contact *Schneider Corporation of America*, 400 Crossways Park Drive, Woodbury, NY 11797; Tel: 516-496-8500.

CIRCLE 103 ON FREE INFORMATION CARD

STAND-BY UNIVERSAL POWER SUPPLY

Featuring 1000VA of power and network compatibility, the *Tripp Lite BC 1000LAN UPS* is designed for use with PC workstations and file servers. The UL-listed unit supplies 1000VA/900 watts of continuous

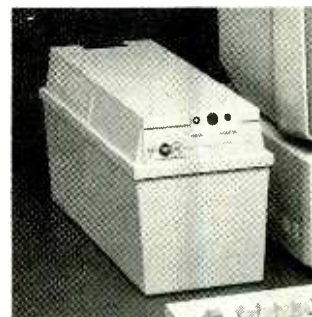

power while providing complete spike, line-noise, and RFI/EMI filtering. The unit also offers brownout protection at 103 VAC for AC outlets, and Novell-approved network compatibility via a panel-mounted DB-9 connector. When used with *Tripp Lite's UPS-monitoring software* and cabling, the unit will provide automatic, unattended shutdown of networks in the event of a power failure. The compact BC 1000LAN can be plugged in and used right out of the box. Other features include system-status indicator lights, a resettable alarm that signals operation from the battery, and larger batteries for longer backup times.

The BC 1000LAN has a suggested retail price of \$869. For further information, contact *Tripp Lite*, 500 N. Orleans, Chicago, IL 60610-4188; Tel: 312-329-1777; Fax: 312-644-6505.

CIRCLE 104 ON FREE INFORMATION CARD

GET THE LATEST ADVANCES IN ELECTRONICS

WITH A SUBSCRIPTION TO

Radio **Electronics**®



ENJOY THE WORLD OF ELECTRONICS EACH MONTH!

Now you can subscribe to the best electronics magazine. The only one that brings you articles on—electronics projects, technology, circuit design, communications, new products and much more.

Radio-Electronics looks to the future and shows you what new video, audio and computer products are on the horizon. What's more you'll find helpful, monthly departments such as Video News, Equipment Reports, Hardware Hacker, Audio Update, Drawing Board, Communications Corner. All designed to give you instruction, tips, and fun.

Radio-Electronics gives you exciting articles like:

- ISDN: The Telephone Network of Tomorrow
- The Facts on FAX
- A Digital Phone Lock
- How To Design Switching Circuits
- EIA-232 A real standard for serial interfacing?
- Build a synergy card for your PC
- '386 Power at a '286 price
- Build a biofeedback monitor
- More on Multiplexing



FOR FASTER SERVICE CALL TODAY

1-800-999-7139

DON'T DELAY SUBSCRIBE TODAY!

Just fill out the order card in this magazine and mail it in today.

5PEB1

MULTI-CHANNEL AMPLIFIER

The four-channel, high-power AMP-268 amplifier from *Cooustic* has the versatility to be used in a variety of different car-audio systems. A complete bi-amp system, it includes two separate stereo amplifiers and two asymmetrical electronic crossovers in one chassis. It provides the



lower distortion, high sound-pressure level, and higher dynamic-range capability of a bi-amp system without the high cost and installation nightmares of a system with separate components. The continuously adjustable crossovers allow users to set separate crossover points for high and low pass channels, allowing customization of the system to any car's interior. The AMP-268 can drive front and rear channels in full range, or by switching on the high- and low-pass filters it will bi-amp a system so that the front channel drives a pair of mid-tweeters while the rear channel drives a pair of woofers or tweeters. It can also be configured as a three-channel amp, using the front channel in full range while the bridged rear channel drives a subwoofer. For more powerful bass, it can function as a 2-channel subwoofer driving a pair of subwoofers. An additional "mixed" output, which sums the front and rear inputs at all times, shares the low-pass filter with the rear channel, offering two options for adding more power to the system. The amplifier's variable power output is selectable at 4×45 watts, 2×45 watts + 1×100 watts, or 2×100 watts, to provide flexible system design and expansion.

The AMP-268 multi-channel amplifier has a suggested retail price of \$419.95. For more infor-

mation, contact Cooustic, Division of Concept Enterprises, Inc., 4260 Charter Street, Verdon, CA 90058-2596; Tel: 213-582-2832 or 800-227-8879; Fax: 213-582-4328.

CIRCLE 105 ON FREE INFORMATION CARD

UNIVERSAL VARIABLE-SPEED TRANSFORMER

Designed to optimize the performance of all *Minicraft* power tools, the MB750 *Universal Variable-Speed Transformer* has microchip-controlled electronic variable speeds for a variety of power-tool applications, as well as full-torque control for work requiring lower speeds. Its resettable overload cut-off ability provides an extended life span for the transformer and power tools. The MB750's output ranges from 50-VA constant to a 100VA peak. Its speed control ranges from as low as 500 rpm up to 30,000 rpm. Its primary voltage is 120 volts, 60 Hz.



Three separate outlets are provided for quick power-tool changeover. The work-center transformer offers 60 vertical storage spaces for power-tool accessories, and a recessed tool rest for small wrenches, chuck keys, screwdrivers, and sanding discs.

The MB750 *Universal Variable-Speed Transformer* has a suggested retail price of \$89.95. For further information, contact *Minicraft* at 800-288-5331.

CIRCLE 106 ON FREE INFORMATION CARD

PC THEFT PROTECTOR

To protect PC's, monitors, printers, office equipment, and audio and video components from theft or unauthorized removal, *Cepco* has introduced the *Thiefbug* system. The *Thiefbug* itself is installed in the electrical outlet box, where it cannot be seen. It detects when

either the item is unplugged or the power cord is cut, and uses the existing AC-power wiring to transmit a coded alarm signal to a monitoring unit at another location. Monitoring units plug directly into the 115-VAC power outlet and can monitor as many *Thiefbugs* as needed. The monitors range from single buzzer or relay modules to wall-mounted monitoring panels that

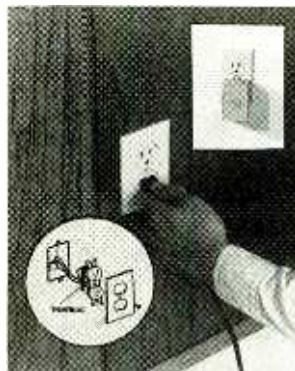

can identify up to 512 locations from the coded signals and provide audible, visual, and electrical (relay) outputs.

A complete system for protecting one PC (one *Thiefbug* and one buzzer or relay module) costs \$83. For further information, contact *Cepco*, 21515 Parthenia Street, Canoga Park, CA 91304; Tel: 818-998-7315.

CIRCLE 107 ON FREE INFORMATION CARD

TOOL KIT

A collection of 24 tools for basic dismantling and repair of electronic equipment is available from *Jensen Tools*. The *Mean Little Kit (JTK-6)* includes seven sizes of screwdrivers, a 4-inch adjustable wrench, 2 pairs of pliers, a wire stripper, a knife, an alignment tool, a hex-key set, scissors, a burnisher, a soldering iron solder aid, and more. The collection comes in either a vinyl case or a deluxe blue



Cordura Plus case. Both cases are designed to hold an optional Beckman Probe-Meter.

The *Mean Little Kit* costs \$99 in vinyl and \$104 in cordura. For more information, contact *Jensen Tools, Inc.*, 7815 South 46th Street, Phoenix, AZ 85044; Tel: 602-968-6241.

CIRCLE 108 ON FREE INFORMATION CARD

MORSE CODE TAPE

Learning Morse code can be difficult, but *The Rhythm of the Code* music tape from *Kawa Records* can make it easier. The audio cassette is a musical learning tool that helps teach Morse code with a flare and fun of a musical beat, by demonstrating the Morse-code rhythm using musical instruments. The idea is that once the listener begins to feel the rhythm, they'll be able to pick up the code quickly and easily. The first song demonstrates the code in alphabetical order, with each character played four times with a modern drum beat and bass line. Listeners are encouraged

"The World's First Music that makes the Morse Code Fun!"



THE RHYTHM OF THE CODE MORSE CODE ALPHABET

KAWA RECORDS

to sing along, using the "Di" and "Dah" syllables. The second song is an instrumental version of the first; no voice announces the characters. Song three demonstrates the Morse code backwards. The tape can be used by aspiring hams, short-wave listeners, no-code technicians, and people seeking to upgrade their code skills.

The *Rhythm of the Code* is available by mail order only for \$5.95 postpaid, from *Kawa Records*, P.O. Box 319, Weymouth, MA 02188.

CIRCLE 109 ON FREE INFORMATION CARD

The Importance Of Setting Standards.

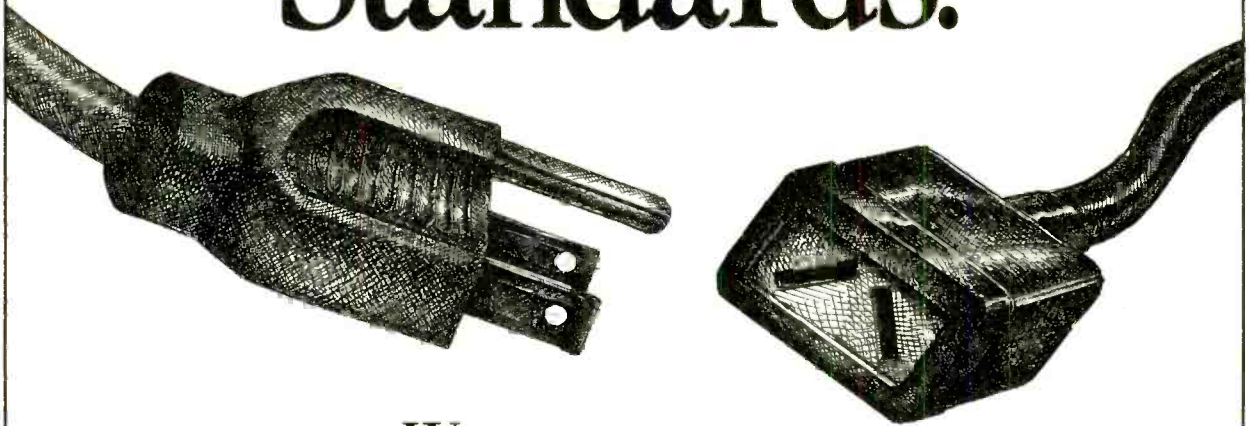

Without standardization in electronics, television wouldn't be seen, radio wouldn't be heard, computers wouldn't share information.

Fortunately the Electronic Industries Association (EIA) has been setting electronics standards since 1924 for everything from early tube radios to today's cellular telephones and stereo TV's.

Standards create *markets and jobs*. Today EIA, an internationally accredited standards making body, is helping to make HDTV a reality by working with the federal government and other industry organizations, to develop a timely, uniquely American transmission standard. For home automation,

EIA also is close to completing a standard which will permit all home electronic products to communicate with each other.

Our more than 1,000 member companies are manufacturers representing every facet of the American electronics industry—from defense to consumer products.

EIA is proud of the contributions it has made through its standards making process toward the growth and vitality of the U.S. electronics industries.

Setting the standard for more than 66 years.



ELECTRONIC INDUSTRIES ASSOCIATION

1722 Eye Street, N.W., Suite 300, Washington, D.C. 20006

CIRCUIT CIRCUS

(Continued from page 67)

tact is necessary with the switch before it can be triggered to send a signal to the alarm-detection part of the circuitry.

The circuit in Fig. 5 can be used as a sensor that can trigger an alarm without direct contact being made by the intruder. In this circuit, a visible or invisible light source radiates on the sensor, keeping the detec-

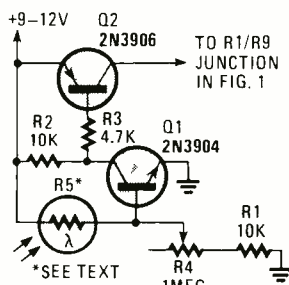

Fig. 5. The Alternate Sensor uses light to detect the presence of an intruder. It does so by detecting interruptions in a light beam or link.

closed to open, setting off the alarm.

To achieve that, a light-dependent resistor (LDR), whose resistance varies inversely in with the amount of light hitting its sensitive surface is used. A bright light aimed at R5 causes its internal resistance to drop as low as a few hundred ohms; in total darkness, the unit's resistance can rise to several megohms. The light-dependent resistor (R5) is connected between the +V supply and the base of Q1. As long as R5 detects light, it supplies ample base current to cause Q1's collector to saturate to near ground level. That also pulls the base of Q2 (a 2N3906 general-purpose PNP transistor) to near ground level, turning it on and clamping its collector to the +V rail.

The circuit functions as a light-sensitive electronic switch that can be used to replace the mechanical sensor switch in Fig. 1. As long as the light source remains uninterrupted, the

voltage to the base of Q2, causing it to turn off. Turning Q2 off sets off the alarm.

The LDR should be located in one end of an opaque tube facing out toward the light source. The tube's length should be at least 2-inches in length and just large enough in diameter to let the LDR slide snugly in place. The longer you make the tube, the more directional the sensor becomes. A 6- to 12-inch tube will allow the LDR to be aimed at a light source 10 to 20 feet away and pick up anything that crosses in between the light source and the sensor.

UNTIL NEXT TIME

That's all for now, but be sure to join us next month for more entertaining and educational circuits and ideas. Until then may the flow be with you. ■

PARTS LIST FOR THE ALTERNATE SENSOR

RESISTORS

(All fixed resistors are ¼-watt, 5% units.)

R1, R2—10,000-ohm

R3—4700-ohm

R4—1-megohm potentiometer

R5—Light-dependent resistor (Radio Shack #276-1657, or similar)

ADDITIONAL PARTS AND MATERIALS

Q1—2N3904 general-purpose NPN silicon transistor

Q2—2N3906 general-purpose PNP silicon transistor

Perfboard materials, opaque tube, 9- to 12-volt power source, wire, solder, hardware, etc.

tion loop in what could essentially be called a normally-closed condition.

As long as the light source striking R5 remains uninterrupted, the switch remains closed. But let an intruder pass between the light source and the sensor, and the circuit goes from

electronic switch remains closed; but if an object moves between the light source and R5, R5's internal resistance rises, causing the current supplied to the base of Q1 to drop to a level that allows Q1's collector to rise to the +V supply level. That applies a positive

HAM RADIO

(Continued from page 77)

however, DFC's are very light and small, and are often designed to be handheld. Today prices for amateur-grade counters with ranges up to 600 MHz cost on the order of \$130. And recent advances have made gigahertz-level counters commonly available.

One such counter is the handheld Model 2300 offered by Optoelectronics, Inc. (5821 N.E. 14th Avenue,



Operating over the 1- to 2,400-MHz (or 2.4 GHz, which is low-microwave) range, the Optoelectronics Model 2300 handheld, digital frequency counter boasts a 10-mV sensitivity and has an 8-digit readout with a "display hold" function.

Fort Lauderdale, FL, 33334; 1-800-327-5912). Operating over the 1- to 2,400-MHz (or 2.4 GHz, which is low-microwave) range, the unit boasts a 10-mV sensitivity and has an 8-digit readout. It also has a "display hold" function so that measurements can be made, and then held for a while before you write it down. In most counters, the reading disappears as soon as the transmitter is unkeyed. The hold feature makes it possible to minimize on-air time for testing. But the best thing about the Model 2300 is its price—It costs just \$99! ■



One tree can make
3,000,000 matches.



One match can burn
3,000,000 trees.



A Public Service of This Magazine
& The Advertising Council

ANTIQUÉ RADIO

(Continued from page 64)

cludes two multimeters: a Radio Shack 20,000 ohms-per-volt unit for general measurements and an Eico VTVM (vacuum-tube voltmeter) for testing the more sensitive circuits. The shop is also equipped with two signal generators: a general-purpose unit by McMurdo Silver and an RCA unit with sweep capability for use in oscilloscope alignment of AM and FM receivers.

The bench oscilloscope is a 1937 RCA. Thanks to its tiny 2-inch screen, the scope fits neatly on a 10-inch shelf. For checking tubes, Larry relies on a World War II navy surplus tester by Hickock. For post-

war types, he also has a later Hickock civilian model. Miscellaneous equipment includes an audio generator, a capacitor tester, a signal tracer, capacitor and resistor substitution boxes, and "A" and "B" power supplies.

The shop is equipped with an almost-complete set of Rider's manuals, including Volumes 1-5 (abridged) and Volumes 6-20 (a full set runs through Volume 23).

For references on radio-servicing techniques, Larry recommends *Elements of Radio Servicing* by Marcus and Levy as well as anything by John F. Rider. Finally, for those curious about the radio shown on the bench, it's a 1925-vintage RCA Model 20 with an RCA

Model 103 loudspeaker. Note the optional filament voltmeter plugged into the front panel.

BRIEFEST ENTRY

What is certainly our briefest entry was submitted by Rusty Yount (Pleasureville, KY). Had there been a larger group of contestants, Rusty might have been disqualified because he sent just a two-paragraph note and didn't include a photo. But since we have only five entries ... what the heck, Rusty, welcome to the winner's circle!

Rusty keeps his collection in the basement, and because the collection is so small his parents have never bugged him about it. He's working on a system of switched outlets arranged so that he can turn on radios, or groups of radios,

tuned to specific frequencies. Unfortunately, his letter didn't mention why he wants to do that.

CONTEST EXTENSION

That wraps it up for this month, folks. All five contestants will receive a reprint copy of *100 Radio Hookups*, a 1924 Gernsback publication detailing virtually every radio-receiving circuit in use at that time. That leaves three unclaimed copies, since we were originally going to award eight prizes. And I'm going to send these out to the next three folks who'd care to write me about their antique-radio collections. Don't forget to include a photo! Send your letters to me c/o *Antique Radio*, **Popular Electronics** magazine, 500-B Bi-County Blvd., Farmingdale, NY 11735. ■



Rudy Chernich's ham shack also serves as a repository for his radio collection.

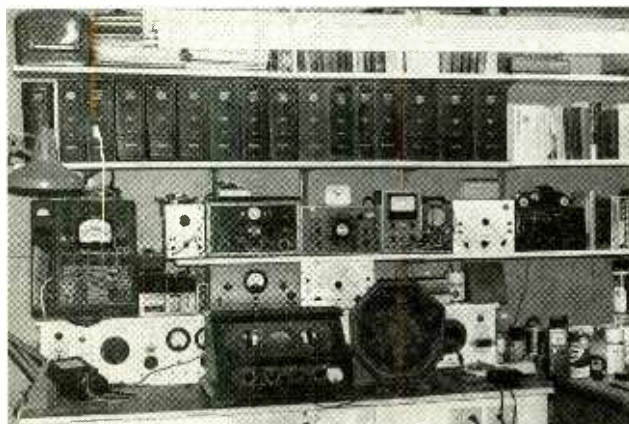

Larry Kenan's carefully-organized shop reflects his strong interest in repair and restoration. Every piece of equipment is there for a reason.

Enter A World Of Excitement with a Subscription to Popular Electronics

Get the latest electronic technology and information monthly!

Now you can subscribe to the magazine that plugs you into the exciting world of electronics. With every issue of *Popular Electronics* you'll find a wide variety of electronics projects you can build and enjoy.

Popular Electronics brings you informative new product and literature listings, feature articles on test equipment and tools—all designed to keep you tuned in to the latest developments in electronics.

So if you love to build fascinating electronics, just call toll free the number below to subscribe to *Popular Electronics* . . . It's a power-house of fun for the electronics enthusiast.



1 yr \$18.95 2 yrs \$36.95

FOR FAST SERVICE CALL TODAY

1-800-827-0383

(7:30 AM-8:30 PM—EASTERN STANDARD TIME)

APEB2

INPUT TERMINATION

(Continued from page 60)

amp must be properly terminated to prevent oscillation caused by stray positive feedback coupled from the output back to the inputs. One technique is to ground the inputs. Alternatively, the unused op-amp can be connected as a grounded-input voltage follower as shown in Fig. 6. I often use this termination method and include two pads on the PC board at the output and non-inverting input. In this way, I can later "reclaim" the unused op-amp by cutting the trace from the non-inverting input to ground and jumpering the spare pads to the new circuitry.

Analog Switches and Multiplexers.

Analog switches are a combination of digital logic and FET transistors. The logic section is used to interface with CMOS, TTL, and other logic families, and determines whether each of the FET's should be on or off.

The FET output is commonly used to switch an analog signal from the input to the output of the device. Some analog switches, such as the CMOS 4066, can support analog signals traveling in either direction. These are called "bilateral switches."

The treatment of these mirrors that of their digital- or analog-only counterparts. Unused digital inputs should be tied to digital ground for CMOS devices, or to $+V_{CC}$ for TTL devices (using a terminating resistor as appropriate). Unused analog inputs and outputs should be connected to analog ground.

Transistor and Darlington Arrays.

Transistor and Darlington arrays consist of a number of (usually) open-collector NPN transistors with a single connection for all the emitters. Some of these arrays, such as the ULN2001 through ULN2004 or the MC1411 through MC1416 series, are Darlington transistor pairs with very high gain. Unused transistors or drivers should have their base leads connected to the grounded emitter lead to prevent noise pickup.

If a design situation occurs where the inputs are not used on a component that is not covered in this article, by all means consult the data sheet and application notes to find out how the unused inputs are to be terminated. ■

PA SYSTEM PRIMER

(Continued from page 57)

ers in parallel, which is a total impedance of 2 ohms. By connecting one side of the speaker line to the 4-ohm tap and the other to the 16 ohm tap, the resulting output impedance will be about 1.4 ohms, which is close enough to the two-ohm impedance of speakers to work satisfactorily.

Connecting the speaker line to the 4-ohm and the 8-ohm taps results in an impedance of about 0.7 ohms. So you can connect eight 8-ohm speakers in parallel between those terminals. Instead, you can use the same connections to wire sixteen 16-ohm speakers to the PA amplifier. The disadvantage of this method is that you are limited to these few combinations, and you can't add or remove speakers from the line without upsetting the impedance balance.

Array Complexities. No matter how you wire the speakers to the amplifier, when an array of speakers is used in large rooms, the placement of the speakers is critical. The layout of a speaker array can be a complex task and as such is beyond the scope of this article, but I want to mention some of the factors involved so you will understand why you should leave the design up to a professional.

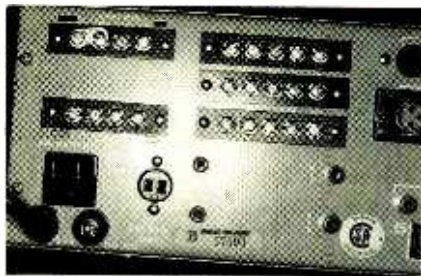

Professional systems have provisions for 25-volt and 70-volt constant-voltage speaker lines. The set of screw terminals in the upper left corner of this amplifier are the constant-voltage outputs.

When speakers are grouped close together, they will interact in ways that will alter the coverage pattern. This is called the "comb-filter effect." To take a simple example, say there is an array consisting of two speakers. A listener located on the center line between the two speakers would hear both signals at the same time because the sound

paths from the speakers are equal. Thus the listener will hear the same frequency response that a single speaker would produce.

A listener that is closer to one of the speakers will hear the sound from the closer speaker first. So the sounds from the two speakers will arrive out of phase with one another. The destructive interference that causes at certain frequencies results in a frequency response that looks comb-like. That makes the sound very unnatural.

The simplest solution for that problem is to use only a single speaker location. In the case of an array of overhead speakers, you can avoid comb-filter effects if you use a lot of speakers closely spaced; then the comb-filter effects are largely canceled out by other combinations of speakers that are located close by.

In large rooms, there is also the problem of time delay. Sound travels at about 1130 feet/second under normal conditions, while the signal carried over speaker wires travels so fast that it is almost instantaneous. So a listener will notice a time delay between the sound coming from a nearby speaker and one further away. To compensate for that in a professional system, signal-delay devices are placed in the line to the speakers.

The acoustics of the room can also play a role in how speakers are placed. Professional system designers sometimes use computer programs to analyze the room acoustics and develop a plan for speaker placement that provides the best results.

But don't let me discourage you from working with PA systems. If the system will be installed in a relatively small room with no unusual acoustic properties, and a single source speaker system is used, most electronics hobbyists should be able to install the system. Sound distribution systems can also be installed by most knowledgeable hobbyists. A sound distribution system is simpler to design because the speakers are placed in different rooms, so there is not the problem of interaction between speakers.

So go ahead and volunteer your services when a local organization wants a PA system installed in a small meeting hall or you want to add a background music system to your office. You'll find it an interesting and challenging change of pace. ■

SURGE SUPPRESSORS

(Continued from page 36)

getting the protection they think they have.

However, even the less-than-perfect units have their uses. For example, if you're the kind of person who wears both belt and suspenders, you might consider buying both a whole-house suppressor and individual smaller units for your computer, satellite, or audio/video equipment. The more protection you have, the better.

Alternatively, you could plug three or four inexpensive units on a line one after another to approximate the protection of a good surge suppressor. The first unit in line will take the brunt of a surge, passing any overload onto the next unit, and so on, until the risk to the equipment is minimal. However, by the time you've assembled enough inexpensive ones, the cost is comparable to a single more-expensive model.

Whatever product you buy, it's important to read the warranty to learn what's being protected, and for how long. When the product is a surge suppressor, it's more important to study the warranty than the promises on the package. While some warranties may run as long as five years, none covers failure of the product before that time due to normal use. A rare few cover injury or damage to equipment resulting from its use. Most simply promise to replace the suppressor in case of defective workmanship. Careful reading of the warranty may indicate that although the product is advertised as a surge suppressor, it is being warranted by the manufacturer only as a power strip or AC spike protector.

As manufacturers cram ever-more sophisticated circuitry onto ever-smaller silicon chips in a growing number of household products (your microwave oven already contains a micro-processor, and the bathroom fixtures you buy a year or two hence could be next), the need for surge suppression is likely to grow. Likewise the people who purchase high-tech consumer electronics need to know what sort of protection their equipment requires and should be able to separate worthless claims and specs from those that are important. We hope that this article has provided you with the information you need to make an informed decision. ■

Popular Electronics

REPRINT BOOKSTORE

- | | |
|--|--|
| <ul style="list-style-type: none"> <input type="checkbox"/> 221 Popular Electronics (1991 back issues) \$4.00
Write in issues desired _____ <input type="checkbox"/> 220 Popular Electronics (1990 back issues) \$4.50
Write in issues desired _____ <input type="checkbox"/> 119 Popular Electronics (1989 back issues) \$4.75
Write in issues desired _____ <input type="checkbox"/> 118 Hands-On Electronics (1988 back issues) \$5.00
Write in issues desired _____ <input type="checkbox"/> 117 Hands-On Electronics (1987 back issues) \$5.25
Write in issues desired _____ <input type="checkbox"/> 116 Hands-On Electronics (1986 back issues) \$5.50
Write in issues desired _____ <input type="checkbox"/> EH91 Experimenters Handbook (1991) \$4.50 <input type="checkbox"/> EH90 Experimenters Handbook (1990) \$5.00 <input type="checkbox"/> EH88 Experimenters Handbook (1988-89) \$5.50 <input type="checkbox"/> EH87 Experimenters Handbook (1987) \$6.00 <input type="checkbox"/> HH91 Popular Electronics Hobbyist Handbook (1991) \$5.00 <input type="checkbox"/> HH90 Popular Electronics Hobbyist Handbook (1990) \$5.50 <input type="checkbox"/> HH89 Popular Electronics Hobbyist Handbook (1989) \$6.00 <input type="checkbox"/> 126 Radio-Electronics Annual 1986 \$6.00 <input type="checkbox"/> 211 Radio-Electronics (1991 back issues) \$4.00
Write in issues desired _____ <input type="checkbox"/> 210 Radio-Electronics (1990 back issues) \$4.50
Write in issues desired _____ <input type="checkbox"/> 109 Radio-Electronics (1989 back issues) \$4.75
Write in issues desired _____ <input type="checkbox"/> 108 Radio-Electronics (1988 back issues) \$5.00
Write in issues desired _____ | <ul style="list-style-type: none"> <input type="checkbox"/> 107 Radio-Electronics (1987 back issues) \$5.25
Write in issues desired _____ <input type="checkbox"/> 106 Radio-Electronics (1986 back issues) \$5.50
Write in issues desired _____ |
|--|--|

REPRINTS REPRINTS

- 169 Think Tank (133 Circuits) **\$3.50**
- 169A Think Tank Vol. 2 **\$3.00**
- 168 Fact Cards (#34-66) **\$4.00**
- 168C Fact Cards (#67-99) **\$3.50**
- 168D Fact Cards (#100-132) **\$3.50**
- 167 Designing With IC's **\$4.00**
- 166 Collected Works of Mohammed Ulyses Fips (62 pages, April Fools Collection) **\$5.00**
- 165 How to Repair CD Disc Players **\$5.00**
- 164 Modern Electrics (April 1908) **\$3.00**
- 163 Receiving Satellite TV **\$5.00**
- 162 Build Your Own Satellite TV Receiver **\$5.00**
- 161 Descrambling (Feb. 1984) **\$4.00**
- 160 New Ideas - 42 Circuits **\$3.50**
- 159 Low Frequency Receiving Techniques Building and using VLF Antennas. **\$5.00**
- 158 Electro Importing Co. Catalog (Circa 1918) **\$5.95**
- 157 All About Kits **\$2.00**
- 156 How To Make PC Boards **\$2.00**
- 155 IBM Typewriter To Computer **\$2.00**
- 154 How To Repair VCR's **\$3.50**
- 150 Pay TV Decoder (1981) **\$3.00**

To order any of the items indicated above, check off the ones you want. Complete the order form below, **include your payment**, check or money order (DO NOT SEND CASH), and mail to **Popular Electronics**, Reprint Department, P.O. Box 4079, Farmingdale, NY 11735. Please allow 4-6 weeks for delivery.

If you need a copy of an article that is in an issue we indicate is unavailable you can order it directly from us. We charge 50¢ per page. Indicate the issue (month & year), pages and article desired. Include payment in full, plus shipping and handling charge. Make checks payable to Gernsback Publications, Inc.

ARTICLE _____

PAGES _____

MONTH _____

YEAR _____

TOTAL PAGES _____

(@ 50¢ each)

TOTAL PRICE _____

MAIL TO: Popular Electronics

Reprint Bookstore, P.O. Box 4079, Farmingdale NY 11735

All payments must be in U.S. funds

SHIPPING CHARGES IN USA & CANADA

\$0.01 to \$5.00	\$1.50	\$30.01 to 40.00	\$5.50
\$5.01 to \$10.00	\$2.50	\$40.01 to 50.00	\$6.50
\$10.01 to 20.00	\$3.50	\$50.01 and above	\$8.00
\$20.01 to 30.00	\$4.50		

SORRY — We only ship to USA & Canada

Total price of merchandise \$ _____
 Sales Tax (New York State Residents only) \$ _____
 Shipping Charge (see chart) \$ _____

Name _____ Total Enclosed: \$ _____

Address _____

City _____ State _____ Zip _____

PE292

PARALLEL CONNECTIONS

(Continued from page 48)

form the rest of the procedure more easily. Wire the data-strobe and acknowledge lines properly between the computer and the peripheral. If you're sure that you know which peripheral pin supports the busy line, wire it to the appropriate computer input as well. Remember, if one of the units can't generate or use either the busy or acknowledge signals needed, you can fool the device as described in the section entitled "Handling the Unusual." Now tie the remaining computer inputs high or low in such a way as to permit unobstructed operation (the right logic levels should be in your notes if you have investigated the operation of the computer port.) Now apply the eight data outputs from the computer to eight unknown inputs on the peripheral. Tie any remaining unknown inputs on the peripheral low.

Now for the trial and error part: Try to send one of the characters shown in Table 2 from the computer to the peripheral. It's a good idea to choose a character that has only a few high bits, like an exclamation, which has only 2 high bits. If the peripheral doesn't output anything, keep trying different characters and turn off the peripheral between each attempt to reset it. It can sometimes speed up matters to move diagonally across the chart (from ! to 2, then onto C, T, e, etc.) and when you come to the end of one diagonal group of letters start with another (like ", 3, D, etc.).

If you run through all the characters in the chart and nothing happens, pull one of the grounded inputs high and run through the chart again. If you still get nothing, pull the high input low again, and take one of the other inputs high. Run through the chart again and repeat this procedure of pulling each low input high one at a time until you get a response.

When the peripheral responds, make sure that it produces one of the characters in the chart (even if it's not the one you sent out to it). If it responds with something not on the chart try again. Once you meet with success, take note of the character that you sent and the peripheral-generated character. Write down the bit pattern of the peripheral-generated character. Disconnect one

of the inputs that you've tied to ground and tie it high.

Try transmitting the character that you just transmitted and note the result. If you get the same character that you got last time, then the input you just altered is not a data input, so disregard it for the rest of the tests. If the peripheral generates a character that's not on the chart or just sits there, chances are the input that you just altered was either D0, D4, or D7 (you can find out which with some further experimentation). If the peripheral does generate a character that appears on the chart, compare its bit pattern with that of the character it generated earlier. There should be one bit high in the new character that was low in the old one. The altered bit indicates that the bit is controlled by the input that you changed—one bit down, seven to go.

Bring that input low again and try pulling one of the other inputs high and send the same character that you attempted to output before. Evaluate the bit that this input controls just as you did the last one. Repeat the procedure to evaluate the remaining inputs that you've tied low. When you finish, you should know the bits that are controlled by those inputs, and which inputs are inconsequential.

Now transmit a character that has one bit set differently than the character that you've been attempting to transmit. Take note of which wire transmits that bit from the computer (look back at Fig. 1 for help). Note, as you did when testing the tied inputs, which bit in the generated character changes, if any. If the character does not change, you can disconnect the wire carrying the bit that you altered; the input that it's tied to is not used for data and can be discarded for the rest of the tests. If the peripheral generates a character that's not on the chart or just sits there, chances are the input that you just altered was either D0, D4, or D7 so make a note of that. As with the tied inputs, if the recently generated character differs from the former one by one bit, the input that the wire is connected to supports that bit. Repeat the procedure, alter each bit in the output character one-by-one until you know which bit is controlled by each wired input. When this procedure is completed, you should have enough documentation to wire a cable to suit the devices. ■

TUNE PIANOS

(Continued from page 34)

the piano is less than a semitone below standard pitch, then bring it up by 20 cents. Never bring a piano down in pitch, always up.

You may have noticed the slight discrepancy between the value that we calculated for middle C and the value listed in Table 1. As indicated in the table, C40 is "stretched" downward by 2 cents. The reason for that is that because of their stiffness, steel strings generate overtones that are slightly higher than true harmonics. That makes an octave sound flat, unless it is stretched to compensate. The pitches shown in Table 1 are stretched for the average piano tuned to standard pitch, which will produce excellent results for any piano.

To include the -2¢ stretch in our previous calculation of C40, the exponent of 2 would have been 902/1200. For any pitch other than standard, you'll have to calculate and tabulate a new table of pitches. That's an involved and tedious task. Fortunately, there is an easier approach: A computer program for the PC, available from the vendor named in the Parts List, will do the work for you and print the results. It calculates the pitches for all 88 keys for any value of A49, and can optimize the stretch for the type of piano, whether spinet, upright, or grand. It can also generate tables of unstretched values.

When tuning the strings in sequence, it's best to start with key 1 and work your way up the keyboard to key 88. The top-octave strings do not sustain well, and may present some difficulty in reading their waveforms on the scope. The stereo headphones can be used here to give an audible indication of relative pitch. They are also useful when tuning in a noisy environment, which can disrupt the waveform display. It is possible, with practice, to tune the entire piano without the microphone and oscilloscope; that is done by listening to the tone in the headphones while carefully adjusting each string of the instrument for zero-beat.

If you use the Precision Audio-Frequency Generator to tune an organ or other non-stringed instrument, no stretch should be used. The pitches can be calculated from the formula given in this article. ■

ELECTRONICS MARKET PLACE

FOR SALE

CABLE descrambler liquidation. Major makes and models available. Industry pricing! (Example: Hamlin Combo's, \$44 each... Minimum 10 orders). Call **WEST COAST ELECTRONICS**, 1 (800) 628-9656.

LONG play cassette recorder—Records 12 hours on a single standard cassette. Voice-activated. Also miniature long play recorders, mini microphones, telephone record controllers, stun guns, surveillance/countermeasure devices. Catalog \$2.00 **PRODUCTIVE ELECTRONICS**, Box 930024-E, Norcross, GA 30093.

CABLE TV descramblers, converters, lowest prices guaranteed, best quality, free catalog, CNC CONCEPTS INC., Box 34503, Minneapolis, MN 55434. 1 (800) 535-1843.

HUGE 92 page communications catalog of short-wave, amateur and scanner equipment. Antennas, books and accessories too. Send \$1.00 to: **UNIVERSAL RADIO**, 1280 Aida Dr., Dept. PE, Reynoldsburg, OH 43068.

CLASSIFIED AD ORDER FORM

To run your own classified ad, put one word on each of the lines below and send this form along with your check to:

Popular Electronics Classified Ads, 500-B Bi-County Boulevard, Farmingdale, N.Y. 11735

PLEASE INDICATE in which category of classified advertising you wish your ad to appear. For special headings, there is a surcharge of \$11.00.

() Plans/Kits () Business Opportunities () For Sale
() Education/Instruction () Wanted () Satellite Television
()

Special Category: \$11.00

PLEASE PRINT EACH WORD SEPARATELY, IN BLOCK LETTERS.

(No refunds or credits for typesetting errors can be made unless you clearly print or type your copy.) Rates indicated are for standard style classified ads only. See below for additional charges for special ads. **Minimum: 15 words.**

1	2	3	4	5
6	7	8	9	10
11	12	13	14	15 (\$23.25)
16 (\$24.80)	17 (\$26.35)	18 (\$27.90)	19 (\$29.45)	20 (\$31.00)
21 (\$32.55)	22 (\$34.10)	23 (\$35.65)	24 (\$37.20)	25 (\$38.75)
26 (\$40.30)	27 (\$41.85)	28 (\$43.40)	29 (\$44.95)	30 (\$46.50)
31 (\$48.05)	32 (\$49.60)	33 (\$51.15)	34 (\$52.70)	35 (\$54.25)

We accept MasterCard and Visa for payment of orders. If you wish to use your credit card to pay for your ad fill in the following additional information (Sorry, no telephone orders can be accepted.):

Card Number _____ Expiration Date _____

PRINT NAME _____

SIGNATURE _____

IF YOU USE A BOX NUMBER YOU MUST INCLUDE YOUR PERMANENT ADDRESS AND PHONE NUMBER FOR OUR FILES. ADS SUBMITTED WITHOUT THIS INFORMATION WILL NOT BE ACCEPTED.

CLASSIFIED COMMERCIAL RATE: (for firms or individuals offering commercial products or services) \$1.55 per word prepaid (no charge for ZIP code)... **MINIMUM 15 WORDS.** 5% discount for same ad in 6 issues within one year; 10% discount for 12 issues within one year if prepaid. **NON-COMMERCIAL RATE:** (for individuals who want to buy or sell a personal item) \$1.25 per word, prepaid... no minimum. **ONLY FIRST WORD AND NAME** set in bold caps at no extra charge. Additional bold face (not available as all caps) **30¢ per word additional.** Entire ad in boldface, \$1.85 per word. **TINT SCREEN BEHIND ENTIRE AD:** \$1.90 per word. **TINT SCREEN BEHIND ENTIRE AD PLUS ALL BOLD FACE AD:** \$2.25 per word. **EXPANDED TYPE AD:** \$2.05 per word prepaid. Entire ad in boldface, \$2.45 per word. **TINT SCREEN BEHIND ENTIRE EXPANDED TYPE AD:** \$2.55 per word. **TINT SCREEN BEHIND ENTIRE EXPANDED TYPE AD PLUS ALL BOLD FACE AD:** \$2.95 per word. **DISPLAY ADS:** 1" x 2 1/4"—\$205.00; 2" x 2 1/4"—\$410.00; 3" x 2 1/4"—\$615.00. **General Information:** Frequency rates and prepayment discounts are available. **ALL COPY SUBJECT TO PUBLISHERS APPROVAL. ADVERTISEMENTS USING P.O. BOX ADDRESS WILL NOT BE ACCEPTED UNTIL ADVERTISER SUPPLIES PUBLISHER WITH PERMANENT ADDRESS AND PHONE NUMBER.** Copy to be in our hands on the 18th of the fourth month preceding the date of issue (i.e.; Sept. issue copy must be received by May 18th). When normal closing date falls on Saturday, Sunday or Holiday, issue closes on preceding work day. Send for the classified brochure. Circle Number 49 on the Free Information Card.

**CABLE TV DESCRAMBLERS
★ CONVERTERS ★
and ACCESSORIES.**

**SAVE MONEY.
DON'T RENT!**

PANASONIC,
PIONEER, JERROLD, OAK,
SCIENTIFIC ATLANTA
AND MORE. LOWEST PRICES.
FREE CATALOG.
(800) 234-1006
CABLE READY COMPANY

JERROLD, Tocom and Zenith "test" chips. Fully activates unit. \$50.00. Cable descramblers from \$40.00. Orders 1 (800) 452-7090. Information (213) 867-0081.

OUR monthly picture flyer lists quality surplus parts at low prices. Swap meet every month. STAR-TRONICS, Box 683, McMinnville, OR 97128.

CB RADIO OWNERS!

We specialize in a wide variety of technical information, parts and services for CB radios, 10-Meter and FM conversion kits, repair books, plans, high-performance accessories. Thousands of satisfied customers since 1976! Catalog \$2

CBC INTERNATIONAL

P.O. BOX 31500PE, PHOENIX, AZ 85046

FREE electronics catalog. Transistors, IC's, electronic components, etc. Call **INTERNATIONAL MICROELECTRONICS**, (817) 561-2244, PO Box 170415, Dept. PE, Arlington, TX 76003.

SPEAKER repair. All makes — models. Stereo & professional kits available. Refoaming \$18.00. **ATLANTA AUDIO LABS**, 1 (800) 568-6971.

Quality Microwave TV Antennas

WIRELESS CABLE • IFTS • MMDS • Amateur TV
Ultra High Gain 50db(+) • Tuneable 1.9 to 2.7 Ghz.

- 36-Channel System Complete \$149.95
- 12-Channel System Complete \$114.95
- Call or write (SASE) for "FREE" Catalog

PHILLIPS-TECH ELECTRONICS
P.O. Box 8533 • Scottsdale, AZ 85252
(602) 947-7700 (\$3.00 Credit all phone orders)
MasterCard • Visa • COD's • Quantity Pricing

LIFETIME WARRANTY

FREE CATALOG

FAMOUS "FIRESTIK" BRAND CB ANTENNAS AND ACCESSORIES. QUALITY PRODUCTS FOR THE SERIOUS CB'er. SINCE 1962

FIRESTIK ANTENNA COMPANY
2614 EAST ADAMS
PHOENIX, ARIZONA 85034

POCKET-SIZE police radar transmitter, one mile range, \$41.00 complete, \$31.00 kit. **INNOTEK**, PO Box 80096, Fort Wayne, IN 46825. (219) 489-1711.

OSCILLOSCOPE 50MHz, dual channel, solid state calibrated, manual \$250.00 1 (800) 835-8335.

X-Y Scanner Kit for your Laser

- ◆ 2 Lissajous Oscillators
- ◆ 2 Audio inputs 2 Galvo's
- ◆ Computer interface
- ◆ Fun to build and use !!

99⁰⁰
4Lbs 900/20

Sharon Valley Surplus 1273 Industri-prkwy W. bldg 460
415-582-6602 Hayward Ca. 94544-7025
CALL OR SEND FOR OUR FREE KIT CATALOG

PLANS & KITS

HOBBY/broadcasting/ham/CB/surveillance transmitters, amplifiers, cable TV, science, bugs, other great projects! Catalog \$1.00 **PANAXIS**, Box 130-H2, Paradise, CA 95967.

BUILD — five-digit, ohms, capacitance, frequency, pulse, multimeter. Board, and instructions \$9.95. **BAGNALL ELECTRONICS**, 179 May, Fairfield, CT 06430.

FASCINATING Electronic Devices! Dazers! Lasers! FM/AM/phone transmitters! Detectors! Kits/assembled! Catalog \$2.00. **QUANTUM RESEARCH**, 16645-113 Avenue, Edmonton, Alberta T5M 2X2.

DESCRAMBLER kits. Complete cable kit \$44.95. Complete satellite kit \$49.95. Add \$5.00 shipping. Free brochure. No New York sales. **SUMMIT PE**, Box 489, Bronx, NY 10465.

CABLE DESCRAMBLERS OAK M358 COMBO \$39.95

Jerrold, Zenith, Hamlin, Sci. Atlanta, Pioneer & MORE! OUR PRICES ARE BELOW WHOLESALE!

CABLE + PLUS

14417 Chase St. #481-B Panorama City, CA 91402
1-800-822-9955 • Other Info. 1-818-785-4500
NO CALIF SALES — DEALERS WANTED

SATELLITE TV descrambler. Build your own. Easy to follow instructions, parts list, circuit board and wiring diagram. Send: \$9.95. **ABG ENTERPRISES**, 27081C, Halifax, NS, Canada, B3H-4M8.

AUTOMOTIVE electrical system monitor IC controlled with case. Complete kit \$6.95. Assembled \$9.95. S&H \$3.00. NY residents add tax. **VRELECTRONICS CORP.**, PO Box 313, Flushing, NY 11365. (718) 357-9091.

PC BOARDS etched and drilled for .70 cents per square inch. Send your requirements to: **JM ELECTRONICS**, Box 150454, Altamonte Springs, FL 32715-0454. Or call (407) 767-8196.

SURVEILLANCE — countermeasures! Guaranteed lowest prices! Huge catalog \$5.00 (refundable). **PROTECTOR**, PO Box 520294-E, Salt Lake City, Utah, 84152.

KITS, sound, light, high tech and unusual. Send for free catalog **JM ELECTRONICS**, Box 150454, Altamonte Springs, FL 32715-0454.

FM-stereo transmitter kit. Broadcast any audio signal, CD player, VCR to FM stereo radios throughout home/yard. PC board and components: \$22.00. **TENTRONIX**, 3605 Broken Arrow, Coeur d'Alene, ID 83814.

BUILD — 0 to 15 volts programmable power supply. Includes schematics and instructions. Easy to build. \$2.00 — **JAS**, PO Box 8274, West Chester, OH 45069.

CMOS/MOSFET Vehicle alarm. Simple digital circuit operates under 20 μ A! Automatic arming; adjustable time delays; pre-alarm warning. Send \$8.00 for schematic and instructions. **MURPHY VEHICLE SECURITY**, PO Box 2751, Silver Spring, MD 20915-2751.

AC/DC VOLTAGE
AC/DC CURRENT
DIODE TEST LOGIC TEST
LED TEST GOOD/BAD
5 FREQ RANGES
5 CAPACITANCE RANGES
LOW BATTERY WARNING
CONTINUITY TEST/BUZZER
TRANSISTOR CHECKER
20 MHZ FREQ COUNTER

PRO 400

\$69⁹⁵ Stock No. 990092

2 YEAR WARRANTY
PARTS & LABOR

KELVIN Electronics
(516) 756-1750 (1800) 445-9212
FAX (516) 756-1763 VISA MC

UNIVERSAL IR remote controller. Trainable for most controllers. Options for Rs-232 interface, multiple event timer and LCD. Complete schematic and software \$18.00. **SUM WARE**, Suite 225, 1651 West Foothill Blvd., Upland, CA 91786.

ZENITH ST5612 cable box modify instructions. No parts needed! Includes photos and explanations. Send \$19.99 to **JIM CHASE**, Box 148332, Nashville, TN 37214.

ZAPPER! electronic simple and cheap to build, battery powered, great party fun, plans \$2.00 to: **P.A.R.**, 417 Associated Road, A-313, Brea, CA 92621.

ANTIQUE RADIO CLASSIFIED Free Sample!

Antique Radio's
Largest Circulation Monthly,
Articles, Ads & Classifieds.
6-Month Trial: \$15. 1-Yr: \$27(\$40-1st Class).
A.R.C., P.O. Box 802-L8, Carlisle, MA 01741

SATELLITE TV

FREE catalog — Lowest prices world wide. **SKYVISION**, 1048 Frontier, Fergus Falls, MN 56537. 1 (800) 334-6455. (See full page ad the Market Center)

**CABLE TV
"BOXES"**

**Converters-Descramblers
Remote Controls-Accessories**

- ★ Guaranteed Best Prices ★
- ★ 1 Year Warranty - C.O.D.'s ★
- ★ Immediate Shipping ★
- ★ FREE CATALOG ★

Call or Write
NAS/TRANS-WORLD CABLE CO.
3958 North Lake Blvd. • Suite 255
Lake Park, Florida 33403
1-800-442-9333
1-800-848-3997

WANTED

INVENTORS! Confused? Need help? Call **IMPAC** for free information package. USA/Canada: 1 (800) 225-5800. (24 hours).

INVENTIONS/new products/ideas wanted: Call **TLCI** for free information/Inventors Newsletter 1 (800) 468-7200 24 hours/day — USA/Canada.

JOBS in Kuwait. Tax free construction workers \$75,000.00. Engineering \$200,000.00. Oil field workers \$100,000.00. Call 1 (800) 743-3440. Ext. 3012.

T.V. FILTERS

T.V. notch filters, phone recording equipment, brochure \$1.00. **MICRO THinc.**, Box 63/6025, Margate, FL 33063. (305) 752-9202.

EDUCATION/INSTRUCTION

LEARN IBM PC assembly language. Book \$18.00. Disk \$5.00. **ZIPFAST**, Box 12238, Lexington, KY 40581-2238.

VCR repair. Save money — make big profits! Learn how from *How to Keep Your VCR Alive*. "This detailed, step-by-step manual enables anyone with no previous knowledge or experience to fix most VCR problems easily, quickly, and inexpensively with a few simple tools." — *Small Press Review*. Highly recommended by *Popular Electronics*, *Modern Electronics*, *Popular Communications*, *Electronic Servicing*, *Videomaker*, *Library Journal*, and many other electronics and video magazines "Far better than Viejo at 1/7 the cost." 400+ page book, with 724 illustrations, plus professional head-cleaning tool, \$24.95. Check B. Daltons and Waldenbooks. Or write **WORTHINGTON PUBLISHING**, PO Box 16691H, Tampa, FL 33687-6691. Or call 1 (800) 233-8277 toll-free for Visa or MC. Money-back satisfaction guarantee!

LEARN computer software at home. Catalog \$1.00 refundable. **SOFT-TECH**, 1516 Osprey, Suite 207, Desoto, TX 75115.

MAKE a thing... Make a living... Study **Industrial Design Technology** and bring your ideas to life. Learn to problem-solve, sketch, render and design. Develop models, create prosthetic appliances. Build your future in movie and theater special effects, toy and product, exhibit, transportation, furniture/fixture, architectural and amusement environmental design at **THE ART INSTITUTES OF PITTSBURGH, FORT LAUDERDALE, SEATTLE OR THE COLORADO INSTITUTE OF ART**. For information write 526 Penn Avenue, Dept. 34, Pittsburgh, PA 15222 or call 1 (800) 851-5500.

CATCH the hottest wave in telecommunications and prepare for the future now. Laser/fiber optics, photonics and electronics. It's all part of the exciting **Media/Telecommunications Technology** program at **THE ART INSTITUTE OF DALLAS**. For further information write 8080 Park Lane, Dept. 34, Dallas, TX 75231 or call 1 (800) 275-4243.

BEST BY MAIL

Rates: Write National, Box 5, Sarasota, FL 34230

OF INTEREST TO ALL

VCR REPAIR - TECHNICIANS' SECRETS REVEALED Do it yourself, literally save hundreds. Start your own community business! Complete easy to follow manual with Schematics/Diagrams. Includes 800 numbers of all major manufacturers for ordering parts direct. More. \$14.95 to: **ACME VCR REPAIR**, 2104 Renwick Lane, Antioch, CA 94509.

ELECTRONIC ENGINEERING. 8 volumes complete. \$109.95. No prior knowledge required. Free brochure. **BANNER TECHNICAL BOOKS**, 1203 Grant Ave., Rockford, IL 61103.

50% CASH DISCOUNT At over 1,000 select Holiday Inns, Hilton Hotels, Best Western & More! Information \$1.00. **DISCOUNT TRAVEL SERVICE**, 662 Franklin Ave., Garden City, NY 11530 Suite 421.

FINANCIAL

RECEIVING PAYMENTS on a Mortgage? We will buy that Mortgage for CASH! Call (914)723-7795. WE PAY GENEROUS REFERRAL FEES

MONEYMAKING OPPORTUNITIES

WE PAY UP TO \$300.00 weekly Woodburning Picture Frames. Everything supplied. No experience or selling. Bay Frame, PO Box 1588-(PE), Jackson, TN 38302.

PERSONAL-MISCELLANEOUS

SINGLES! MEET OTHER FUN Exciting People Call INTRODUCTIONS 1-900-776-4225. \$2/Min.

BUSINESS OPPORTUNITIES

YOUR own radio station! Licensed/unlicensed. AM, FM, TV, cable. Information \$1.00 **BROADCASTING**, Box 130-H2, Paradise, CA 95967.

EASY work! Excellent pay! Assemble products at home. Call toll free 1 (800) 467-5566 Ext. 5730.

MAKE \$75,000.00 to \$250,000.00 yearly or more fixing IBM color monitors. No investment, start doing it from your home (a telephone required). Information, USA, Canada \$2.00 cash for brochure, other countries \$10.00 US funds. **RANDALL DISPLAY**, Box 2168-H, Van Nuys, CA 91404, USA. Fax (818) 990-7803.

HOME assembly work available! Guaranteed easy money! Free details! **HOMEWORK-P**, Box 520, Danville, NH 03819.

MAKE \$\$\$! Become an American electronics dealer! Profit opportunities since 1965. Call Wayne Marks, 1 (800) 872-1373.

EARN money repairing microcomputers. Booklet lists suppliers of Apple, Compaq, IBM, and other parts and supplies. Send \$6.00 to **LGI COMPUTER SERVICES**, PO Box 711225, Houston, TX 77271. Texas residents add 6.25% tax.

EARN extra money working from home. Assemble products, mail brochures. Information: **LEE**, Box 2048, Winnetka, CA 91306-2048.



TUBES - 2000 TYPES DISCOUNT PRICES!

Early, hard-to-find, and modern tubes. Also transformers, capacitors and parts for tube equipment. Send \$2.00 for 28 page wholesale catalog.

ANTIQUE ELECTRONIC SUPPLY
6221 S. Maple Ave. • Tempe, AZ 85283 • 602-820-5411

CABLE EQUIPMENT

CABLE TV secrets — the outlaw publication the cable companies tried to ban. HBO, Movie Channel, Showtime, descramblers, converters, etc. Suppliers list included. \$9.95. **CABLE FACTS**, Box 711-H, Pataskala, OH 43062.

REPAIR SERVICE

HEATH/Heathkit I can repair your audio, instruments, general and weather products no longer serviced by Heath. Factory trained. Call (219) 287-9373.

HOME EXTERMINATION

NEW book: "Become Roach-Free" Exterminator explains: in detail. \$20.00 EPE, POB 74C, Calhoun, LA 71225-0074.

BOARD ASSEMBLY

ELECTRONIC assembly services. Board assembly in small or large quantities. Mechanical assembly also available. Excellent pricing. **TWP**, (512) 572-3381.

SPECIALIZED SECURITY

SURVEILLANCE — Audio/video/infra-red. Personal protection equipment. Public, private, corporate uses. Extensive book; \$9.00. Was "Security Systems" catalog. **TRI-TRON OF ATLANTA**, 1857F Fox Hollow, Lilburn, GA 30247-3363.

MASTERCARD AND VISA are now accepted for payment of your advertising. Simply complete the Classified Ad order form and we will bill you.

★★★★PRESENTING★★★★
**CABLE TV
DESCRAMBLERS**
★★★★STARRING★★★★
JERROLD, HAMLIN, OAK
AND OTHER FAMOUS MANUFACTURERS

- FINEST WARRANTY PROGRAM AVAILABLE
- LOWEST RETAIL / WHOLESALER PRICES IN U.S.
- ORDERS SHIPPED FROM STOCK WITHIN 24 HRS.
- ALL MAJOR CREDIT CARDS ACCEPTED

FOR FREE CATALOG ONLY 1-800-345-8927
FOR ALL INFORMATION 1-818-709-9937

PACIFIC CABLE CO., INC.
7325 1/2 Reseda Blvd., Dept. 2011
Reseda, CA 91335

FREE CATALOG!
1-800-648-7938
JERROLD HAMLIN OAK ETC
**CABLE TV
DESCRAMBLERS**

- Special Dealer Prices!
- Compare our Low Retail Prices!
- Guaranteed Prices & Warranties!
- Orders Shipped Immediately!

REPUBLIC CABLE PRODUCTS, INC.

4080 Paradise Rd. #15, Dept. PE292
Las Vegas, NV 89109

For all other information (702) 382-9026



ANNOUNCING:
AN END
TO
HIGH MONTHLY
CABLE FEES!

All Jerrold, Oak, Hamlin, Zenith, Scientific Atlanta, Magnavox and all specialized cable equipment available for shipment within 24 hours. For fast service MC/VISA or C.O.D. telephone orders accepted. 60 Day Guarantee (Quantity Discounts). Send self-addressed Stamped envelope

1-800-232-5017



**C.O.D. ORDERS
ACCEPTED**



CABLE-TRONICS, INC.

1304 E. Algonquin Road Suite 501
Algonquin, Illinois 60102



**It brings out the best
in all of us.**

© 1987 UNITED WAY

ELECTRONICS PAPERBACKS

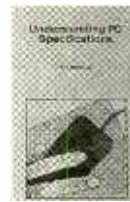

□ **BP282—UNDERSTANDING PC SPECIFICATIONS**...\$7.25. Explains difference between types (XT, AT, 80386, etc.), math co-processors, input devices, memory, RAM discs, floppy drives, hard discs, displays and more. Everything you need to know if you can't tell your E.M.S. from your E.G.A.!

□ **BP278—EXPERIMENTAL ANTENNA TOPICS**...\$5.95. Packed with 28 different antenna topics. Learn how to build helical, crossed field, dipoles, loop and frame, phased array, VHF whips and more. An experimenter's dream book.



□ **BP276—SHORT WAVE SUPERHET RECEIVER CONSTRUCTION**...\$5.95. Everything you need to know to build your own receiver plus a variety of enhancement you can add later—input filter, rf amplifier, product detector. S meter, and more.

□ **BP271—HOW TO EXPAND, MODERNIZE AND REPAIR PCs AND COMPATIBLES**...\$7.75. Includes PC overview, memory upgrades, adding a hard disc, adding floppy drives, display adapters and monitors, installing a co-processor, preventive maintenance, repairs, do it yourself PCs and more.



□ **BP266—ELECTRONIC MODULES AND SYSTEMS FOR BEGINNERS**...\$7.25. Describes more than 60 modular electronics circuits—how they work, how to build them, and how to use them. A wonderful book for the experimenter.

□ **BP255—INTERNATIONAL RADIO STATIONS GUIDE**..... \$7.95. Provides the casual listener, amateur radio DXer and the professional radio monitor with an essential reference work designed to guide him or her around than ever more complex radio bands.

MAIL TO: **Electronic Technology Today, Inc.**
P.O. Box 240
Massapequa Park, NY 11762-0240

SHIPPING CHARGES IN USA AND CANADA

\$0.01 to \$5.00	... \$1.50	\$30.01 to 40.00	.. \$5.50
\$5.01 to \$10.00	.. \$2.50	\$40.01 to 50.00	.. \$6.50
\$10.01 to 20.00	.. \$3.50	\$50.01 and above	.. \$8.00
\$20.01 to 30.00	.. \$4.50		

SORRY, No orders accepted outside of USA and Canada

Total price of merchandise	\$ _____
Shipping (see chart)	\$ _____
Subtotal	\$ _____
Sales Tax (NYS only)	\$ _____
Total Enclosed	\$ _____

Name _____
Address _____
City _____ State _____ Zip _____

CONTINUITY TESTER

(Continued from page 54)

to pay attention to the orientation of the semiconductors; and pay particular attention to battery polarity when connecting the power source. Connecting the battery with reversed polarity can destroy the semiconductors.

A small battery holder fashioned from a 1 3/4- x 2-inch strip of scrap sheet metal (bent to conform to the battery's body) was used to hold the battery to the board between the two IC's. A commercially available battery holder will also fit that area. A homebrew holder was used because the sheet metal was available, and to help keep costs down.

Although the author chose not to do so, the circuit can be housed in any suitably sized enclosure. The enclosure will require at least eight holes; seven in the top for the LED's and one in the side, through which to feed the test leads. Note: If the circuit is to be placed in an

enclosure, it will be necessary to either move the battery or the LED's off-board to allow the LED's to protrude through the case. (I'd opt for moving the battery, since doing so involves adding no wire leads to the board).

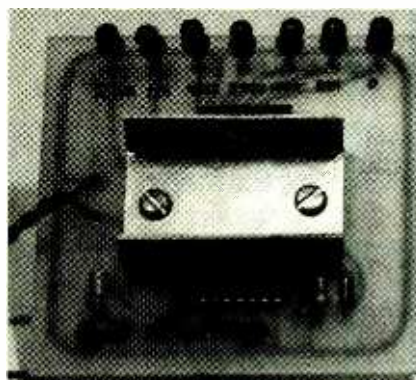

If you decide to mount a battery holder on the board, care should be taken so as not to sever or short the circuit-board traces. In the case of the latter, it may be necessary to use insulating washers on the foil side of the board.

The test leads can be terminated in the test terminal of your choice: probe

tips, alligator clips, hook clips (which the author used for his prototype), etc.

Test and Operation. To check the continuity tester, insert a 9-volt battery in the battery clip. Touch the two test probes together. The LED's should flash very rapidly. When the test points are opened, the LED's should extinguish. As was noted earlier, the rate at which the LED's flash is proportional to the resistance between the two test points.

As mentioned, the continuity tester also gives a relative indication of the resistance between its probes. For example, if a resistance of 330k is connected between the test probes, LED3 will flash at a 2 Hz rate, while all others flash at a rate that's either faster or slower than 2 Hz. With a little practice it is easy to judge the 2-Hz flash rate.

The tester can be used to test semiconductor junctions and other components. A forward-biased silicon junction will cause LED5 to flash at 2 Hz. No LED's will flash when the test points are connected to a reverse biased junction (effectively an open circuit). ■

ADVERTISING INDEX

POPULAR ELECTRONICS magazine does not assume any responsibility for errors that may appear in the index below.

Free Information No.	Page		
7	AMC Sales	71	— Kelvin
—	Antique Electronic Supply	97	— Monitoring Times
—	Antique Radio Classified	96	6 Mouser
—	CBC International	95	— NAS/TransWorld
—	CIE	25	— NRI Schools
—	Cable Plus	96	8 Protel Technology
—	Cable Ready Company	95	— Pacific Cable
—	Cable-Tronics	97	15 People's College
—	Command Productions	15	— P.E. Reprint Book Store
9	Contact East	15	— Phillips Tech
—	EIA	89	5 Radio Shack
—	Electronic Tech. Today	28, 97	— R.E. Video Offer
—	Electronics Book Club	85	— Republic Cable
—	Firestik II	96	13 SCO Electronics
16	Fluke Manufacturing	CV2	— Science Probe
—	Grantham College	13	— Silicon Valley Surplus
10	Heathkit	9	— The School of VCR Repair
—	HighText Publications, Inc.	81	14 U.S. Cable
98	— IS CET	62	11,12 Viejo Publications

ADVERTISING SALES OFFICE

Gernsback Publications, Inc.
500-B Bi-County Blvd.
Farmingdale, NY 11735
1-(516) 293-3000
President: Larry Steckler
Assistant to the President: Christina Estrada

For Advertising ONLY
516-293-3000
Fax 1-516-293-3115
Larry Steckler
publisher
Arlene Fishman
advertising director
Denise Haven
advertising assistant
Kelly McQuade
credit manager

Customer Service/Order Form
1-800-435-0715
1-800-892-0753
7:30 AM - 8:30 PM EST

SALES OFFICES

EAST/SOUTHEAST
Stanley Levitan, Eastern Sales Manager
1 Overlook Ave.
Great Neck, NY 11021
1-516-487-9357, 1-516-293-3000
Fax 1-516-487-8402

MIDWEST/Texas/Arkansas/Oklahoma
Ralph Bergen, Midwest Sales Manager
One Northfield Plaza, Suite 300
Northfield, IL 60093-1214
1-708-446-1444
Fax 1-708-559-0562

PACIFIC COAST/Mountain States
Marvin Green, Pacific Sales Manager
5430 Van Nuys Blvd, Suite 316
Sherman Oaks, CA 91401
1-818-986-2001
Fax 1-818-986-2009

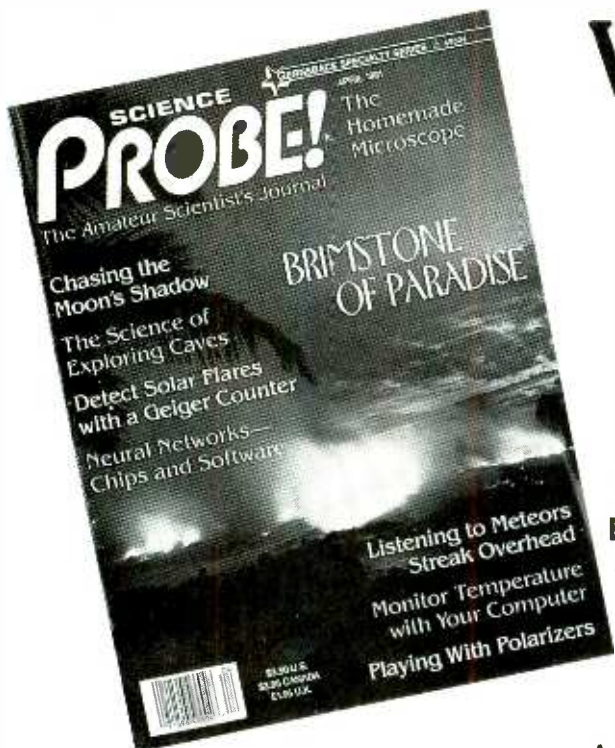

Welcome to . . .

SCIENCE PROBE!®

The Amateur Scientist's Journal

Embark on an irresistible new journey into the realm of mystery, challenge, and exploration! The perfect magazine for the budding scientist, the serious amateur, the professional who would like to relax, and those who simply want to gaze at the stars.

Science PROBE! — the *only* magazine devoted entirely to Amateur Scientists! If you are fascinated by science in all its many forms . . . if you can't stay away from a microscope, telescope, calipers, or test tube — we invite you to share the wonders in every issue of **Science PROBE!** You will join a community of Amateur and Student Scientists who enthusiastically seek scientific knowledge or follow scientific pursuits for their own sakes and not merely as a profession.

Obtain your next issue of **Science PROBE!** by visiting a quality Newsstand, Convenience Store, or Supermarket or by reserving your personal copy through the mail by completing the coupon below.

From your very first issue of **Science PROBE!** you will be involved in a world of scientific facts, experiments, and studies pursued by amateur scientists who are university students, investors, academicians, engineers, or office workers, salesmen, farmers—whose *quest* is to probe into the mysteries of science and reveal them to all.

Plan to become a **Science PROBE!** reader!

Articles to appear in upcoming issues of **Science PROBE!** are:

How an Amateur Mapped the Milky Way
Make your own Seismometer
Operate a Solar-powered Weather Station
Grow Crystals Automatically
Experiment with a Saltwater Aquarium
How to Keep a Science Notebook

If you're fascinated by science in all its many forms, if you are compelled to experiment and explore, then **Science PROBE!** is your kind of magazine!

Science PROBE!
 500-B Bi-County Boulevard
 Farmingdale, NY 11735

Please forward my copy of **Science PROBE!** as soon as it comes off the press. I am enclosing \$3.50-U.S.A. (\$4.23-Canada-includes G.S.T.) plus \$1.00 for shipping and handling. Better still, please enroll me as a subscriber and send the next four (4) quarterly issues of **Science Probe**. I am enclosing \$9.95-U.S.A. (Canada: \$16.00—includes G.S.T.)

Next Issue Only Next Four Issues (1 Year)

Offers valid in the U.S.A. and Canada only. No foreign orders.

Name _____

Address _____

City _____ State _____ ZIP _____

All Orders payable in U.S.A. Funds only.

7PB22

ON SALE AT QUALITY NEWSSTANDS, CONVENIENCE STORES AND SUPERMARKETS
GET YOUR COPY TODAY—\$3.50-U.S.A.—\$3.95-Canada

THE PARTS PLACESM



NEW! Now You're Talking! This book will help you earn your first Amateur Radio license and get on the air. It includes all the questions on the new codeless Technician class exam and the Novice written exam. The book also provides helpful tips on equipment and antennas. Illustrated. Over 300 pages. #62-2414 . . . 16.95



Special-Order Hotline. Your local Radio Shack stocks over 1000 popular electronic components. Plus, we can special-order over 10,000 items from our main warehouse—ICs, semiconductors, tubes, crystals, even SAMS[®] manuals. No postage charges or minimum requirements for this service. Come in for details!



NEW! PC/XT Experimenter's Circuit Card. This premium-quality prototyping board fits a computer's XT expansion bus connector. Features durable epoxy glass construction and plated-through holes on standard 0.100" centers. Accepts D-sub connector shown at right. 3 7/8 x 10 1/16 x 1/16". #276-1598 29.95

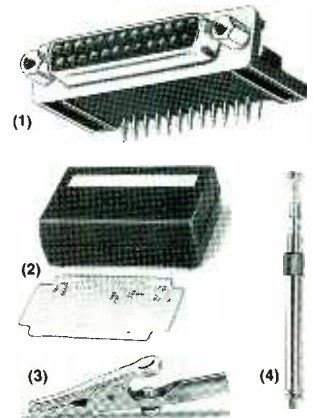

(1) **NEW! Right-Angle D-Sub 25 Female Connector.** Ideal for use with PC/XT circuit card at left. #276-1504, 2.49
 (2) **Box/Board Combination.** Molded box and 2 x 3 1/8" circuit board. #270-291 . . . 4.99
 (3) **2" Slim Alligator Clips.** #270-346 . . . Pkg. of 8/2.19
 (4) **Cordless Phone Handset Antenna.** #270-1411 . . . 2.99



Mercury Bulb Switch. Just the thing for motion detectors, alarms, experiments and school science projects. Rated 2 amps at 12VDC. Compact T-1 1/2 size envelope. #275-040 1.29



(1) **Two-Tone Piezo Buzzer.** Extra-loud. Operates from 8 to 16VDC. #273-070 10.95
 (2) **Electromechanical Buzzer.** Loud 12VDC buzzer in a sturdy metal case is great for alarms. #273-051 2.49



(1) **Stackable Banana Plugs.** Jack permits "chain" hook-ups. #274-734, Set of 2/1.59
 (2) **Nylon Binding Posts.** #274-662 Set of 2/1.59
 (3) **Micro-Clip Jumpers.** 20" long. #278-017 . . . Pair/3.49



Super-Bright Strobe Tube. Perfect for photo replacement, hobby projects and experiments. Trigger: 4 kV. Anode: 200V min. Bulb is about 1 1/2" long and has 1 3/4" leads. #272-1145 3.29

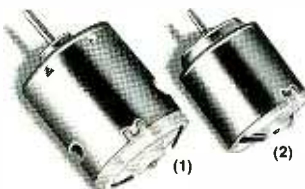

(1) **High-Speed 12VDC Motor.** Up to 15,200 RPM! About 2" long. #273-255 2.99
 (2) **Low-Voltage Motor.** For science projects and solar power demos. Requires 1 1/2 to 3VDC. #273-223 99c



(1) **Lead-Free Solder.** 96% tin, 4% silver. 0.032" size. 0.25 oz. #64-025 1.99
 (2) **Rosin Soldering Paste Flux.** 1 oz. #64-021 . . . 1.79
 Over 100 soldering items and tools for electronics are in stock now at Radio Shack!

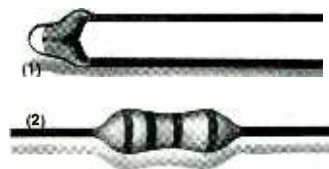

(1) **Hi-Precision Thermistor.** Resistance changes in proportion to temperature. #271-110 1.99
 (2) **500-Piece Resistor Set.** 1/4-watt, 5% tolerance. Includes 54 popular values. #271-312 Set 7.95



Car Electrical System Tester. Spot problems before you're stranded! Plug this analyzer into your vehicle's lighter socket. Color-coded LEDs pinpoint problems in your battery, alternator and regulator. #22-1635 5.95

Since 1921 Radio Shack has been the place to obtain up-to-date electronic parts as well as quality tools, test equipment and accessories at low prices. Our nearly 7000 locations are ready to serve you—NOBODY COMPARES
 Prices apply at participating Radio Shack stores and dealers. Radio Shack is a division of Tandy Corporation

Radio Shack[®] SINCE 1921
AMERICA'S TECHNOLOGY STORESM