

Popular Electronics

WORLD'S LARGEST-SELLING ELECTRONICS MAGAZINE

JULY 1975/75¢

HOW TO PROGRAM READ-ONLY MEMORIES

Have Fun With
Electronic Dice

Listen In to
Apollo/Soyuz
Transmissions

Precision Matching
of Resistors

Audio Frequency
Meter Project

LAB TEST REPORTS

Phase Linear 4000
Stereo Preamp

JVC CD-1669

Stereo Cassette Deck

Pioneer SE-700

Stereo Headphones

Courier "Cruiser"

CB Transceiver

Heathkit IO-4510

Dual-Trace Scope

Home Emergency Light for "Blackouts"

AUTOMATIC "ON" WHEN AC POWER IS LOST



510076 BLU 02200C98 6410 N8V75
MR ADOLPH L BALUKA
220 DOWNING AVE
07

Get the news before it's news...

with a "behind-the-scenes" Scanner Radio from Radio Shack!

Realistic® scanners seek and lock-in on exciting police, fire and emergency calls, even continuous weathercasts*. There's one to cover the "action" in your area—10 models in all.

PRO-6—VHF-Hi and VHF-Low

Continuously, automatically scans up to 4 crystal-controlled channels on 148-174 or 30-50 MHz. It stops on each active channel until the conversation ends, then resumes scanning. You don't miss a thing—it's like 4 radios in one! Lighted channel indicators, switches for bypassing any channels, scan/manual switch, variable volume and squelch, built-in speaker and antenna, earphone jack. With 4 "AA" cells. Requires up to 4 crystals. #20-171.

PRO-5—UHF "Metro" Band

Same as the PRO-6, but covers 450-470 MHz now used in many larger cities. Requires up to 4 crystals. #20-169.

Accessories Available. Plug-in antenna, 12VDC adapter or AC adapter/battery charger, nickel cadmium batteries.

Pocket Size, Both Models **119⁹⁵** each

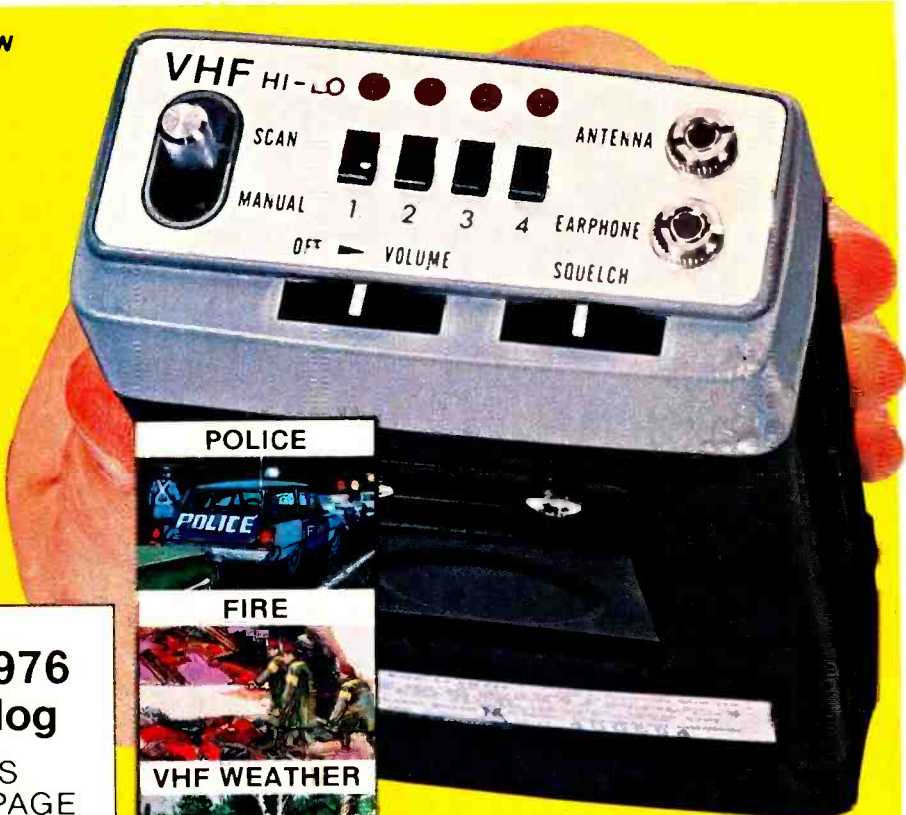

*On VHF Hi-Band Stations not in all localities.

The PRO-16—a Super Scanner for the ultimate at-home or mobile listening post



229⁹⁵

Scans up to 16 crystal-controlled channels, in any combination, on 30-50 and 148-174 MHz VHF and 450-470 MHz UHF. Like 16 radios in one! Lockout buttons and indicator lights for each channel, manual selector, squelch, variable scan rate, scan-delay in/out button, 12 VDC/120 VAC operation, mobile mounting bracket. Requires up to 16 crystals. U.L. listed. #20-165

FREE New 1976 Radio Shack Catalog

OVER 2000 PRODUCTS
EXCLUSIVES ON EVERY PAGE
BEAUTIFUL FULL COLOR

Stereo • Quadraphonic • Phonographs
TV Antennas • Radios • Citizens Band
Kits • Recorders • Tape • Tools
Auto Tune-Up • Electronic Parts
Test Instruments • More!



164 pages of the finest in home and hobby electronics. Respected brand names like Realistic, Micronta, Archer, Science Fair — and they're available only at Radio Shack stores and dealers nationwide! See what's really new in electronics by getting this catalog now.

SEND FOR YOURS TODAY!
FILL OUT COUPON BELOW

1976 Mail to Radio Shack, P. O. Box 1052, 534
Catalog Ft. Worth, Texas 76101 (Please print.)

Name _____ Apt. No. _____

Street _____

City _____

State _____ ZIP _____



Master Charge or Bank Americard at participating stores

REALISTIC®
at
Radio Shack®

A TANDY CORPORATION COMPANY

OVER 3000 STORES • 50 STATES • 7 COUNTRIES
Retail prices may vary at individual stores

RALLY IV

DIGITAL STOPWATCH KIT

STURDY ANODIZED
ALUMINUM CASE
PHOTOGRAPHED

**ACTUAL
SIZE**



- ★ BRIGHT 6 DIGIT LED DISPLAY
1/100 SEC. TO ONE HOUR
- ★ HIGH ACCURACY .003 %
CRYSTAL CONTROLLED
- ★ 4 FUNCTIONS
STANDARD, SPLIT, RALLY
AND SEQUENTIAL
FOR SINGLE, MULTI-LEG,
OR INTERRUPTED EVENTS
- ★ 24 HOUR TIMEKEEPING
CAPABILITY
- ★ OPTIONAL NICADS
AND CHARGER
\$10.00 ADDITIONAL

\$ **69⁹⁵**
PLUS 2.95
POSTAGE
AND HANDING
FLORIDA SALES
ADD 4% TAX

ONE EVENING
ASSEMBLY



ALPHA ELECTRONICS DEPT. 1

P O BOX 1005 MERRITT ISLAND FLA. 32952

305-636-6951



TELEPHONE IN YOUR
'ALPHAKIT' ORDER



DIGITAL MULTIMETER

**NEW
FEATURES
AND PRICE**

FEATURED COVER DECEMBER '74 POPULAR ELECTRONICS

**BRIGHT
YELLOW
3 1/2 DIGIT
DISPLAY**

**AUTO ZERO
AUTO POLARITY**

- ★ FIVE FUNCTION DC VOLTS 1MV TO 600V,
AC VOLTS 1MV TO 300V, DC CURRENT 1 μ A TO 2A,
AC CURRENT 1 μ A TO 300MA, OHMS 1 OHM TO 6M
- ★ EXCEPTIONAL ACCURACY
.1% OHMS & DC VOLTS, 1% AC/DC CURRENT & ACV
- ★ OPERATES ON 5 VOLTS, 4 AA NICADS
- ★ COMPLETE KIT OF PARTS LESS TEST LEADS & BATT.

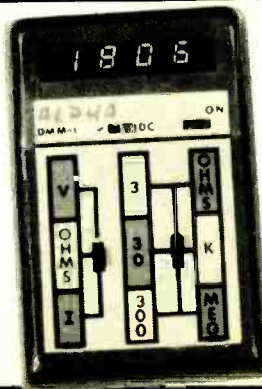

79⁹⁵
+2.95 P & H
FLA. SALES
ADD 4% TAX
MODEL
DMM-1ER

"CLEAR"... **"Solid"...**
"POWERFUL"...
"Crisp"... **"PENETRATING"...**

Speech Compression is built-in every Johnson CB radio. State-of-the-art circuitry electronically selects voice frequencies that penetrate noise and interference . . . then boosts the level of modulation to give your signal that powerful "Johnson sound." It's one of many engineering advances — like receiver "steep skirt" filtering to cut interference and automatic threshold limiting to slice out noise — that gives U.S.-made Johnson CB that extra edge of performance. Performance that's backed by a full 1-year parts and labor warranty with over 700 authorized service centers nationwide.

Messenger 250
 100% solid-state base station



Messenger 123B 23-channel
 mobile with +/- ground switch



Messenger 130 and 132
 "The radiotelephone CB System"
 with private listening option



write for free catalog

E.F. Johnson Co.

Waseca, Minnesota 56093 • In Canada: A. C. Simmonds & Sons, Ltd.

CIRCLE NO. 33 ON READER SERVICE CARD

Popular Electronics®

WORLD'S LARGEST SELLING ELECTRONICS MAGAZINE

FEATURE ARTICLES

HOW TO PROGRAM READ-ONLY MEMORIES	Robert D. Pascoe	27
<i>An experimenter's guide to programmable ROM's.</i>		
WHAT'S NEW IN MARINE RADIOTELEPHONE	Len Buckwalter	36
<i>FCC rules changes, license requirements, and equipment overview.</i>		
A NEW NATIONAL TV NETWORK?		47
PRECISION MATCHING OF RESISTORS	James Demas	50
<i>A technique for matching resistors to better than 0.5%.</i>		
LISTEN IN TO APOLLO/SOYUZ TEST PROJECT	Richard S. Flagg	76
<i>Frequencies and times for the upcoming joint space effort.</i>		

CONSTRUCTION ARTICLES

HOME EMERGENCY LIGHT FOR "BLACKOUTS"	William Oldacre	31
<i>Goes on automatically when ac power fails.</i>		
THE POWER GUARD	Jules H. Gilder	34
<i>Boosts voltage and eliminates TV picture shrinkage during brownouts.</i>		
BUILD A SEMICONDUCTOR LASER COMMUNICATIONS SYSTEM	Forrest M. Mims	39
<i>Pulse modulation achieves ranges up to 3000 feet.</i>		
A LOW-COST AUDIO-FREQUENCY METER	Charles Green	45
HAVE FUN WITH ELECTRONIC DICE	R.M. Stitt	48
<i>Electronic game of chance uses TTL & LED's.</i>		

COLUMNS

STEREO SCENE	Ralph Hodges	16
<i>Choosing an FM Antenna.</i>		
SOLID STATE	Lou Garner	64
<i>Many Uses For Flasher/Oscillator.</i>		
TEST EQUIPMENT SCENE	Leslie Solomon	68
<i>Testing CB Modulation And Capacitors.</i>		
AMATEUR RADIO	Herbert S. Brier	74
<i>Using the OSCAR Satellites.</i>		
HOBBY SCENE	Editorial Staff	77
CB SCENE	Len Buckwalter	78
<i>Fundamental Blocking.</i>		

PRODUCT TEST REPORTS

PHASE LINEAR 4000 STEREO PREAMPLIFIER	56
JVC AMERICA MODEL CD-1669 CASSETTE DECK	58
PIONEER MODEL SE-700 HI/FI HEADPHONES	60
COURIER "CRUISER" MOBILE AM CB TRANSCEIVER	61
HEATHKIT MODEL IO-4510 DUAL-TRACE TRIGGERED-SWEEP OSCILLOSCOPE	62

DEPARTMENTS

EDITORIAL	Art Salsberg	4
<i>The ATIS Connection.</i>		
LETTERS		6
NEW PRODUCTS		12
NEW LITERATURE		15
NEWS HIGHLIGHTS		24
TIPS & TECHNIQUES		84
ELECTRONICS LIBRARY		85

POPULAR ELECTRONICS, July 1975, Volume 8, Number 1, Published monthly at One Park Avenue, New York, NY 10016. One year subscription rate for U.S., \$6.98; U.S. Possessions and Canada, \$7.98; all other countries, \$8.98. Second Class postage paid at New York, NY and at additional mailing offices. Authorized as second class mail by the Post Office Department, Ottawa, Canada and for payment of postage in cash. Subscription service and Forms 3579, P.O. Box 2774, Boulder, CO 80302. POPULAR ELECTRONICS including ELECTRONICS WORLD, Trade Mark Registered. Indexed in the Reader's Guide to Periodical Literature. COPYRIGHT © 1975 BY ZIFF-DAVIS PUBLISHING COMPANY. ALL RIGHTS RESERVED.

Ziff-Davis also publishes Boating, Car and Driver, Cycle, Flying, Modern Bride, Popular Photography, Skiing and Stereo Review. Editorial correspondence: POPULAR ELECTRONICS, 1 Park Ave., New York, NY 10016. Editorial contributions must be accompanied by return postage and will be handled with reasonable care; however, publisher assumes no responsibility for return or safety of manuscripts, art work, or models. Forms 3579 and all subscription correspondence: POPULAR ELECTRONICS, Circulation Dept., P.O. Box 2774, Boulder, CO 80302. Please allow at least eight weeks for change of address. Include your old address, enclosing, if possible, an address label from a recent issue.

EDGAR W. HOPPER
Publisher

ARTHUR P. SALSBERG
Editorial Director

LESLIE SOLOMON
Technical Editor

JOHN R. RIGGS
Managing Editor

ALEXANDER W. BURAWA
Associate Editor

EDWARD I. BUXBAUM
Art Director

JOHN McVEIGH
Assistant Editor

ANDRE DUZANT
Technical Illustrator

HERBERT S. BRIER
LEN BUCKWALTER
LOU GARNER
GLENN HAUSER
JULIAN D. HIRSCH
RALPH HODGES
ART MARGOLIS
WILFRED M. SCHERER
Contributing Editors

JOSEPH E. HALLORAN
Advertising Director

JOHN J. CORTON
Advertising Sales

LINDA BLUM
Advertising Service Manager

PEGI McENEANEY
Executive Assistant

STANLEY NEUFELD
Associate Publisher

FURMAN H. HEBB
Group VP, Electronics & Photo

ZIFF-DAVIS PUBLISHING COMPANY
Popular Electronics
Editorial and Executive Offices
One Park Avenue New York, New York 10016
212-725-3500
Hershel B. Sarbin, President
Furman Hebb, Executive Vice President
Vincent Perry, Financial Vice President and Treasurer
Phillip T. Heffernan, Senior Vice President, Marketing
Edward D. Muhlfeld, Senior Vice President, Sports Division
Philip Sine, Senior Vice President
Frank Pomerantz, Vice President, Creative Services
Arthur W. Butzow, Vice President, Production
Lawrence Sporn, Vice President, Circulation
George Morrissey, Vice President
Sydney H. Rogers, Vice President
Sidney Holtz, Vice President
Charles B. Seton, Secretary
Edgar W. Hopper, Vice President, Electronics Div.
William Ziff, Chairman
W. Bradford Briggs, Vice Chairman

Midwestern Office
The Pattis Group, 4761 West Touhy Ave.,
Lincolnwood, Illinois 60644, 312 679-1100
GERALD E. WOLFE, THOMAS HOCKNEY
Western Office
9025 Wilshire Boulevard, Beverly Hills, CA 90211
213 273-8050; BRadshaw 2-1161
Western Advertising Manager, BUD DEAN

Japan: James Yagi
Oji Palace Aoyama, 6-25, Minami Aoyama
6 Chome, Minato-Ku, Tokyo 407-1930/6821,
582-2851

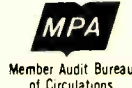

The publisher has no knowledge of any proprietary rights which will be violated by the making or using of any items disclosed in this issue.



Editorial

THE ATIS CONNECTION

CB'ers of the future may someday find Damocles's Sword hanging over them in the event they abuse the Service's rulings (transmitting foul language, exceeding the five-minute communication limit, not using station call signs, "skip" communications, etc).

If the FCC's Docket No. 20351 is ever put into effect, all new CB gear will be fitted with an automatic transmitter identification system (ATIS) that will spew out call signs in coded form. The ATIS identifier would only be mandatory for new transmitters placed in service one year after the final rules are adopted. CB manufacturers, as well as manufacturers of other transmitters in the Safety and Special Radio Service, would then be compelled to include an ATIS in each new transmitter. The encoding of the call sign into the ATIS would have to be performed by a first- or second-class commercial radiotelephone licensee or the manufacturer. (Note: ATIS installation and design require that the transmitter will *not* function unless this is done.)

The proposed system is alphanumeric. It would be binary coded in ASCII (American Standard Code for Information Interchange), with the station's call sign transmitted automatically at the beginning and the end of each transmission and, if transmission exceeds 30 seconds duration, once each thirty seconds. The ATIS information would be applied to the carrier by audio-frequency shift keying (AFSK) 85 Hz above and below a 1200-Hz center frequency, with "0" being 1115 Hz and "1" being 1285 Hz. Transmission of the 22-character code, which also includes the gear's serial number (how's that for a theft deterrent?), is suggested at a rate of 100 bauds (a baud is a pulse per second). Accordingly, each code transmission would consume about 1/4 to 1/5 of a second. You'll hear it, of course. However, the ATIS will not eliminate the operator's need to identify transmissions vocally as presently outlined in the FCC's Part 95.95 Rules and Regulations.

The proposal is certainly interesting. It would have the advantage of exposing those CB'ers who flagrantly violate the operating rules in one way or another. Equally important, it would doubtlessly motivate these people to operate according to the rules (which promise to be loosened in the near future). Although the fractional-second "brrrrr" audio code that would sound whenever one presses or releases the mike's "talk" button might be a slight irritant, it would serve a most useful purpose. It would also alert the receiving party that transmission had ended. Naturally, ATIS would add a few dollars to cost, but one can easily chalk that up to a one-shot insurance premium cost.

There might well be other objections, considerations and suggestions from various parties. For example, should a subaudible system be adopted; will the proposed system be compatible with future designs for nonvoice control functions such as selective calling, repeater control, and so on? Time will tell.

Art Salsberg

New 21"^(diag.) Heathkit digital-design Color TV

Popular Electronics editors called the digital-design GR-2000 "the color TV of the future." Now you can enjoy the same technology and features in the new GR-2050 with the convenient, popular 21-inch picture tube.

On-screen electronic digital channel numbers—big, bright, bold, and easy to read, even from across the room. **On-screen electronic digital clock time**—low cost insurance against missed programs. In 12 or 24 hour format, 4 or 6 digits. **Silent, electronic, touch-tuning**, thanks to the combination VHF-UHF varactor tuner. No knobs to turn, nothing to wear out. Just touch to tune...on the front panel or the Remote. **Programmable digital counter/channel selector**—a computer-like programming board for you to pre-program any 16 stations, UHF or VHF, or both, in any order, even repeating if you wish. Touch the tune button and the counter silently sweeps up or down through all 16 channels, stopping when you release the button.

Exclusive fixed ten-section LC bandpass filter—does away with adjusted traps yet eliminates interference from adjacent channel, etc. And it never needs instrument alignment.

100% solid-state—with more ICs than any other set and a black negative matrix picture tube for brighter, more vivid pictures.

Easy to build with modular circuits. Easy to service with built-in digital dot generator, check-out meter, and slide-out service drawer. Build the GR-2050 TV of the future... Remote, \$89.95. Cabinets from \$119.95*



599.95 less cabinet



New 2½-digit Heathkit DMM—only \$79.95

Full function capability. Four overlapping AC & DC voltage & current ranges plus five resistance ranges with accuracy of 1% on DCV, 1.5% on ACV, 1.5% on AC & DC current, and 2% on resistance. Ranges: (full scale) DCV, 2, 20, 200, 1000V; ACV, 2, 20, 200, 700V rms (25 Hz to 10 kHz); DC current, 2, 20, 200, 2000 mA; AC current, 2, 20, 200, 2000 mA (25 Hz to 10 kHz); Ohms, 200, 2k, 20k, 200k, 2000k ohms. Lighted panel indicators show overrange, positive and negative DC voltages and current at a glance. All solid-state design uses IC circuitry for a clear non-blinking display with up-date every 16 msec. One megohm input impedance with overload protection on all ranges; automatic decimal positioning; isolated floating ground; universal banana jack inputs; 120 or 240 VAC operation; one circuit board for easy assembly; blue & white heavy-duty metal case. Kit IM-1212, \$79.95; Assembled SM-1212, \$125*.

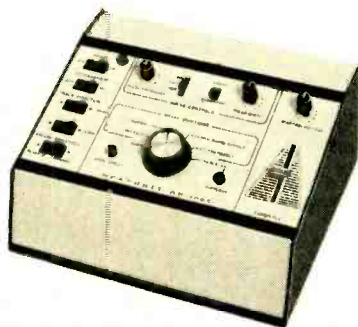

New Model Railroad Control Center/Power Supply provides acceleration and braking of unsurpassed realism plus power for two HO or N-gauge engines and accessories. Throttle slide control plus 5-position Brake switch (Run, Release, Normal, Quick-Service, Emergency), and Mode switch (Momentum or Direct). Adjustable pulse width and frequency allow accurate control at low speeds, eliminate "jack rabbit" starts. Voltage control optimizes for each engine. One circuit board; builds in two evenings. Kit RP-1065, \$79.95*.

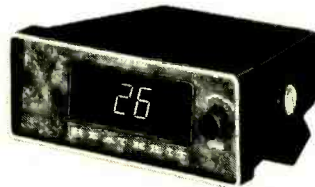

New Digital Tachometer is faster than any meter-type tach. Numbers whirl by to show peak performance level your engine reaches. Great for monitoring best cruising RPM for your car, camper, boat (inboard or outboard), planes, cycles, mowers, tractors, even stationary engines. 2-digit electronic readout shows RPMs from 100 to 9900 in 100 RPM steps. For 4, 6, or 8 cyl., 4-cycle engines; 2, 3, or 4 cyl. 2-cycle engines; 2, 3, or 4-rotor Wankel engines; conventional, C-D, or factory electronic ignitions (12 v. neg. grd. only). Black die-cast case with bracket. Kit CI-1079, \$49.95*.



New Breakerless Ignition Adapter develops timing signal electronically so your car is timed correctly at all speeds and stays correct for longer periods. For use with C-D ignition systems only, it replaces the points of all pre-1975 GM V-8 and V-6 engines, and all AMC V-8s with external dwell adjustment. Unit mounts under hood; sensor mounts in distributor without removing points (switch returns engine to point timing when you wish). Operates from -37.2°C to +35°C. Easy to build. Kit CP-1051, \$44.95*.

Send for
FREE
Catalog



HEATHKIT ELECTRONIC CENTERS —
Units of Schlumberger Products Corporation
Retail prices slightly higher.

ARIZ.: Phoenix; CALIF.: Anaheim, El Cerrito, Los Angeles, Pomona, Redwood City, San Diego (La Mesa), Woodland Hills; COLO.: Denver; CONN.: Hartford (Avon); FLA.: Miami (Hialeah), Tampa; GA.: Atlanta; ILL.: Chicago, Downers Grove; IND.: Indianapolis; KANSAS: Kansas City (Mission); KY.: Louisville; LA.: New Orleans (Kenner); MD.: Baltimore, Rockville; MASS.: Boston (Wellesley); MICH.: Detroit; MINN.: Minneapolis (Hopkins); MO.: St. Louis (Bridgeton); NEB.: Omaha; N.J.: Fair Lawn; N.Y.: Buffalo (Amherst), New York City, Jericho (L.I.), Rochester, White Plains; OHIO: Cincinnati (Woodlawn), Cleveland, Columbus, Toledo; PA.: Philadelphia, Pittsburgh; R.I.: Providence (Warwick); TEXAS: Dallas, Houston; VA.: Norfolk (Va. Beach); WASH.: Seattle; WIS.: Milwaukee.

HEATH		Heath Company,	
Schlumberger		Dept. 10-07	
		Benton Harbor, MI 49022	
Please send my free 1975 Heathkit Catalog.			
NAME _____			
ADDRESS _____			
CITY _____		STATE _____	ZIP _____
*PRICES ARE FACTORY MAIL ORDER, FOB			
PRICES & SPECIFICATIONS SUBJECT TO CHANGE WITHOUT NOTICE.			
			CL-568

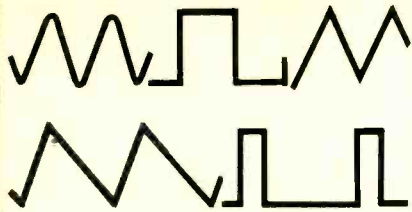

0.1 Hz. to 100 KHz.

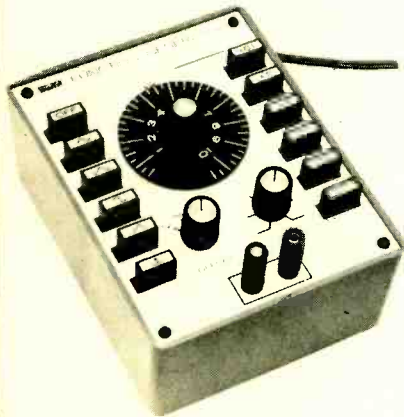

For only \$39.95

Our new FG-2 Function Generator kit gives you all five of the most useful waveforms for design and testing at one fourth the cost of previous similar instruments. Thanks to improved IC's the FG-2 now features amplitude stability of ± 1 db over any range, Sine wave distortion of less than 1% from 20 Hz. to 20,000 Hz. and an output of 4.0 Volts peak-to-peak with adjustable offset. The offset selector lets you put the positive peak, negative peak, or the center of the waveform on DC ground. The DC coupled circuit keeps the waveforms in exactly the same position no matter what the level control setting.

Gray impact plastic case 5 $\frac{1}{4}$ x 6 $\frac{1}{4}$ x 2 $\frac{1}{2}$.
115 Volts 60 cycle power supply included.

FG-2 Function Generator Kit
shipping weight 3.0 lbs.....\$39.95 PPD

GET OUR NEW 1975 CATALOG

listing this and other unique kits

"F R E E"

by simply circling our number
on the reader service card.



SOUTHWEST TECHNICAL
PRODUCTS CORPORATION

DEPT. PE

219 W. Rhapsody
San Antonio, Texas 78216

Letters

MORE ON OBTAINING PARTS

I found the February 1975 Editorial ("It's a Tough World Out There"), dealing with finding parts for projects, both interesting and true. I currently have several projects underway, but at a standstill because I can't find the parts I need. My new policy is never to start any project, no matter how simple it is, until I know exactly where to locate every item needed.

I realize that quite a few projects call for the latest IC's that aren't available at the time of publication. I cannot fault this because, after all, POPULAR ELECTRONICS wouldn't be the fine source of information it is if you didn't keep up with new developments.

GEORGE H. THOMPSON, JR.
Goleta, Calif.

Amen! to your February Editorial. Getting all the parts needed for a project might be difficult for people in the States, but it can't begin to compare with the frustrations we overseas subscribers must endure.

Wouldn't it make your projects more feasible and attractive to get companies to market complete kits of parts for your projects?

JACK BENNETT
Berlin, Germany

Whenever we publish construction plans for a project using a brand new device, we first make sure the device is available—either directly from the manufacturer or through an authorized distributor. For most major construction projects, we do try to get a company to supply a complete kit of parts or a kit of the parts that are difficult to obtain except in large orders.

FEEDBACK ON AM BCB DX'ING

Another reason for DX'ing the medium-wave band ("How to Listen to Out-of-State AM Broadcasts," April 1975) is good listening. My favorite station is WWL out of New Orleans. Doubtless, many readers will find favorite stations or programs out of state as I did.

LEONARD H. PONDER
Chandler, N.C.

I thoroughly enjoyed "How to Listen to Out-of-State AM broadcasts." However, I have an important correction for you. Cleveland Cavalier games are no longer carried on WERE. Station WWWE (1100 kHz, 50 kW) has carried these games for the past two seasons. WWWE covers 38 states on a normal night, and we have recently received reception reports from the West Coast and Sweden. DX'ers who want to listen to WWWE should tune us in after the sun sets in the West.

JIM ARCARO
WWWE Engineer
Cleveland, Ohio

MEMORY TRANSLATOR

I was very enthusiastic when I first saw "Build a Portable A/D Memory Translator" (April 1975). But after reading the text, I have some apprehensions. According to the text, an uncompensated telephone line cannot be expected to convey frequencies much outside a 300- to 3000-Hz passband. The proposed recentering of the carrier at 2000 Hz would seemingly introduce intolerable distortion for deviations much beyond ± 1000 Hz unless the changes also produce a suitable reduction in deviation.

Furthermore, the unmodified version with a 7000-Hz ± 2000 Hz output would not appear to be suitable for low-cost recorders, most of which would be hard pressed to accommodate the carrier, let alone the upper sideband. I was wondering whether the required linearity could be achieved if the carrier were centered at 3000 Hz (± 2000 Hz), switchable to 1650 Hz (± 1350 Hz) for telephone applications, and how it would affect the "chart recordings by mail" application.

J.P. LANE
Roanoke, Va.

The change to the 2000-Hz center frequency also reduces the FM deviation to ± 800 Hz so that limitations in telephone-line performance will not be due to bandwidth. The 7000-Hz ± 2000 Hz FM output may be out of the 3-dB bandwidth of a low-cost recorder, but this is not critical for operation of the Translator. The Translator will operate well with virtually any tape recorder since it has a built-in 7000-Hz filter for improved sensitivity in this band and, more importantly, the FM detector has good AM rejection—meaning that low-amplitude signals will still control the phase-locked loop. We determined that the 10,000-Hz response can be down as much as 30 dB in a poor recording apparatus and still the Translator will detect properly.

The chart recording by mail arrangement depends mainly on the initial 15-second ground reference as explained in the text. Any comments concerning bandwidth changes or special calibration should be forwarded with the cassette.

—Author

WESTINGHOUSE MAKES COLOR CRT'S TOO

"The New Color TV Picture Tubes" (March 1975) explained the advancements in color CRT's very well. However, when the author listed the major manufacturers of tubes, he left out Westinghouse Electric Corp. Westinghouse was making color picture tubes in the 1950's. In fact, it introduced the first all-glass rectangular color tube, the 22EP22, in 1956.

Most of Westinghouse's market is for private labels. The company has also developed some types of color tubes for the more discriminating European market and has marketed these tubes for a number of years under the (W) label.

ROBERT RUSSELL
Wellsburg, N.Y.

SOME COMMENTS ON FAA CAREER

Readers whose interest was sparked by "How to Become an FAA Electronics Technician" (April 1975) might like to know of a college program that can help them land a position. Mercer County College offers the A.A.S. degree in Aviation Electronics Technology.

PETER J. HOLSBERG
Associate Professor of
Electrical Engineering
Mercer County Community College
Trenton, N.J.

One thing not mentioned in "How to Become an FAA Electronics Technician" is the fact that ET's must do shift work. At almost all FAA facilities, there are evening, midnight, and weekend shifts that must be manned. Normally, the ET works a shift until he is promoted to a staff position.

GERALD D. PELTON
FAA Electronics Technician

H.H. SCOTT

Audio Pioneer

Hermon Hosmer Scott, founder and former president of H.H. Scott, Inc., of Maynard, Massachusetts, died recently in Newton, Mass., at the age of 66. He established his firm in 1947 and retired in 1972. The name H.H. Scott was among the handful of brands familiar to hi-fi equipment buffs during the early days of the industry.

Mr. Scott held a number of patents, including those for the dynamic noise suppressor and RC oscillator.

BUILD & TEST CIRCUITS AS FAST AS YOU THINK!

- POWER FOR THE PROFESSIONAL
- ECONOMY KITS FOR THE HOBBYIST
- A MODEL AND A PRICE FOR EVERYONE



PROTO BOARD 203

Breadboard Prototyping with 5 Volt, 1 AMP Regulated Power Supply included!
A total ready-to-use power breadboard prototest device with a built-in regulated, short-proof power supply. Just plug-in and start building! 2 extra floating 5-way binding posts for external signals. Self-contained with power switch indicator lamp and power fuse. 24-14 pin DIP capacity. Attractive two-tone quality case. All metal construction. 9¾" L x 6½" W x 2¾" H. 5 lbs. Order today!

\$75

Add \$2.50 shipping/handling

A modestly priced kit for the economy-minded experimenter . . .

PROTO BOARD 100

A low cost, big 10 IC capacity breadboard kit with all the quality of QT sockets and the best of the Proto Board series . . . complete down to the last nut, bolt and screw. Includes 2 QT-35S Sockets; 1 QT-35B Bus Strip; 2 5-way binding posts; 4 rubber feet; screws, nuts, bolts; and easy assembly instructions.

19⁹⁵

Add \$1.50 shipping/handling.

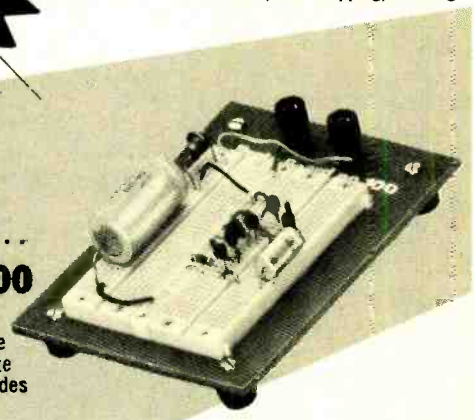

PROTO-CLIP
for Power-On,
Hands-Off Signal
Tracing. No more
shorting leads.
Costs less than . . .

\$5

Bring IC leads from pc board for fast signal tracing and troubleshooting. Inject signals. Wire unused circuits into boards. Scope probes and test leads lock onto Dynagrip inset (see circle) for hands-off testing. Plastic construction eliminates springs, pivots. Non-corrosive nickel/silver contacts for simultaneous low resistance connections.

PC-14, 14-pin Proto Clip, \$4.50 ea.
PC-16, 16-pin Proto Clip, \$4.75 ea.

Add 75¢ shipping/handling.

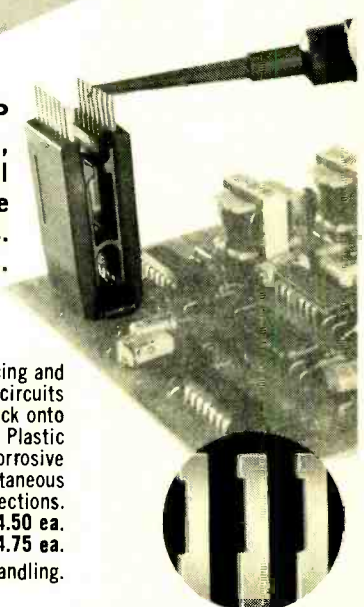

Order today off-the-shelf from CSC or local distributor. Charge: BAC, MC, AX. Write for free catalog. Free English/Metric Slide Rule with each order. Dealer inquiries invited.

Foreign orders add 15%.

Patents Pending Made in USA
Prices subject to change

CSC Continental Specialties Corp.

Box 1942, New Haven, CT 06509 • 203/624-3103

W. Coast Off.: Box 7809, S. Francisco, CA 94119 • 415/383-4207
Canada: Available thru Len Finkler Ltd., Ontario
CIRCU NO. 14 ON READER SERVICE CARD

Compare what you get training and you'll

Compare costs

Only NRI offers five complete TV/Audio Servicing Courses from \$370 to \$1,095 . . . with convenient, inexpensive time payment plans. In the Master Course in color TV servicing, with a 25" diagonal solid-state color TV, you save as much as \$600 under the next leading home study school.

NRI saves you tuition because our costs are lower. We pay no salesmen, and we engineer our own kits and training equipment. We don't buy "hobby kits" from others. Nor do we penalize you with big interest charges for time payments. We pass the savings on to you.

Compare training

NRI is one of the few home study schools that maintains its own full-time staff of technical writers, editors, illustrators, development engineers and publications experts. The people who design the kits also design the lessons . . . so that theory and practice go hand in hand. The lessons aren't "retro-fitted" to an outside-source "hobby kit." At each stage of building, you experiment with the *power on*; you don't wait till the set's completed to learn troubleshooting. The NRI set is designed exclusively for training. It is also a superb 100% solid-state receiver for your personal use.

Compare choices

Most schools offer one course in color TV servicing, period. Only NRI offers you five different courses to match your needs and budget. The comprehensive 65-lesson course, complete with 7 kits, costs as little as \$370. Or you can choose the \$465 course that includes a 12" diagonal black & white portable TV for hands-on experience. Then there's the 19" diagonal solid-state color TV course for \$795; the advanced color TV course for trained technicians with an 18" diagonal color TV for \$645; and finally, the magnificent 25" diagonal solid-state color TV course, complete with console cabinet, oscilloscope, TV pattern generator, and a 3½ digit digital multimeter, for \$1,095. Other schools charge you hundreds of dollars more for an equivalent course.



in TV/Audio home choose NRI.

Compare equipment Compare schools

NRI has engineered the widest variety of professional electronic lab equipment ever designed entirely for training at home. When you enroll in the Master Course in TV/Audio Servicing, for instance, you receive kits to build a wide band, solid-state, triggered sweep, service type 5" Oscilloscope; color pattern generator; solid-state radio; and a digital multimeter.

Before you settle on any home training course, compare the over-all program. See if you are getting kits engineered for experimentation and training . . . or merely "hobby kits". Count the experiments . . . compare the components. Don't just count kits. (Some schools even call a slide rule a kit.)

Home study isn't a sideline with NRI. We've been its innovating leader for 60 years. Ask any of the hundreds of thousands of NRI graduates. They'll tell you . . . you can pay more but you can't buy better training.

Along with each course, NRI provides bite-size, fully-illustrated lessons; personally graded tests; and the kind of person-to-person teaching that makes learning easier and faster.

Send for the free NRI full-color electronics catalog and discover why so many choose NRI. You'll find courses offered in TV/Audio Servicing, FCC License, Complete Communications Electronics, Digital Computer Electronics, Marine and Aircraft Electronics, Mobile Communications, etc.

**MAIL CARD
FOR YOUR
FREE NRI
CATALOG**

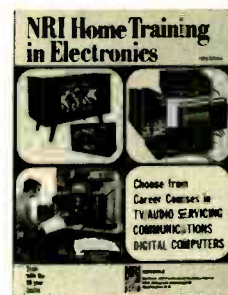

NO SALESMAN WILL CALL.

**AVAILABLE FOR CAREER
STUDY UNDER GI BILL**

Check box on card for information.



NRI SCHOOLS
McGraw-Hill Continuing Education Center
3939 Wisconsin Avenue,
Washington, D.C. 20016



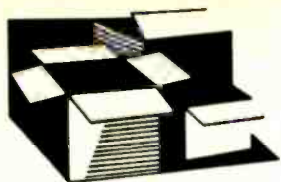

New Products

Additional information on new products covered in this section is available from the manufacturers. Either circle the item's code number on the Reader Service Card inside the back cover or write to the manufacturer at the address given.

EICO DIGITAL LOGIC PROBE

The model DLP-6 Digital Logic Memory Probe can be used with DTL and TTL systems, and provides detection capabilities for pulse durations as short as 50 nanoseconds. The indicator system consists of three LED's. The bottom LED lights green for logic 1, the center LED lights red for logic 0, and the top LED lights yellow to indicate a positive- or negative-going transition. Each LED remains in the "on" stage for 200 nanoseconds regardless of pulse duration. A memory switch causes the LED to remain on permanently after a positive or negative pulse occurs. Available in either kit (\$19.95) or factory-assembled (\$29.95) form.

CIRCLE NO. 69 ON READER SERVICE CARD

CROWN STEREO OUTPUT CONTROL CENTER

Crown's Model OC-150 provides flexible control of an audio system. Output monitoring of three separate amplifiers is



provided by two meters, operating in either the average- or peak-reading modes with five full-scale ranges. Three speaker systems can be switched singly or in parallel by front-panel controls. Two headphone jacks have discrete levels of attenuation, for headphones with various degrees of sensitivity. The Crown OC-150 weighs 10 lb (4.5 kg) and measures 17" W x 8 1/2" D x 5 1/4" H (43.2 x 21.6 x 13 cm). \$299.00.

CIRCLE NO. 70 ON READER SERVICE CARD

TEMPEST LAB SERIES 1 SPEAKER SYSTEM

The Tempest Lab Series 1 loudspeaker system by the Tempest Div. of ESS, Inc. combines the high-frequency Heil air-motion transformer with a dynamic 12-inch woofer in a two-way bookshelf configuration. The long-excursion woofer is back-loaded through a low-frequency phased vent path,

resulting in bass response down to 30 Hz, according to ESS. Above the crossover frequency of 1500 Hz, the Heil "power ring" tweeter is active. A dual control panel allows for flexibility in response shadings. Power handling capacity is 60 W rms of continuous program material, 160 W on music peaks. A minimum amplifier output of 10 W rms is recommended. Available with a walnut vinyl finish, and foam grille options of brown, blue and rust. It measures 27"H x 15"W x 13-7/8"D (68.6 x 38.1 x 35.2 cm).

PIONEER AM/FM STEREO TUNER

Pioneer announces its most sensitive AM/FM stereo tuner, the Model TX-9500. Among the FM circuit features are three dual-gate MOSFET's in the front end, four dual-ceramic filters, an eight-stage limiter, a linear detector, phase-locked-loop multiplex demodulator, and a two-step muting



circuit. A built-in 440-Hz test tone, calibrated to correspond to 50% FM modulation, enables recordists to preset recording levels before taping program material. Two meters facilitate tuning. Rear panel connections are provided for multipath scope outputs, fixed and variable audio outputs, and a 4-channel MPX output jack for future discrete FM broadcasts. A two-position de-emphasis switch allows proper demodulation of regular and Dolby-encoded broadcasts. TX-9500 specs include a frequency response of 20-15,000 Hz +0.2 dB, -1.5 db; stereo separation better than 35 dB between 50 and 10,000 Hz; and an FM sensitivity of 1.5 µV (IHF). Harmonic distortion is rated at less than 0.2% (stereo), stereo S/N at 75 dB, selectivity at 85 dB, and capture ratio at 1.9 dB. The tuner measures 16 1/2" W x 14 3/8" D x 5 7/8" H (42 x 36.5 x 14.9 cm). \$399.95.

CIRCLE NO. 71 ON READER SERVICE CARD

ADS MOBILE HIGH FIDELITY SYSTEM

ADS introduces its Model 2001 high-power bi-amplified speaker system for use where space is limited and only 12 V dc is available—vans, campers, and boats. The two acoustic-suspension speaker systems contain specially designed 4-inch (10-cm) long-excursion woofers and 1-inch (2.5-cm) soft-dome tweeters. A total of 160 W rms is provided by four independent amplifiers, which are powered by a high-frequency dc/dc upverter. The system draws a maximum of 26 A from a 12-V storage battery. Frequency range of the 2001 is said to be 50-25,000 Hz (DIN). Each speaker enclosure weighs 4 lb (1.8 kg) and measures 6 7/8" H x 4 1/4" W x 4" D (17.5 x 10.8 x

10.2 cm). Power amplifiers measure 9 3/8" W x 6 1/2" D x 3 5/8" W (23.8 x 16.5 x 9.2 cm). The power supply (attachable to the amplifier module) is 6 1/4" W x 3 5/8" H x 3 1/2" D (15.9 x 9.2 x 8.9 cm). \$450.

CIRCLE NO. 72 ON READER SERVICE CARD

CONTINENTAL SPECIALTIES LOGIC MONITOR

Continental Specialties' Logic Monitor simultaneously displays static and dynamic logic states of DTL, TTL, HTL, and

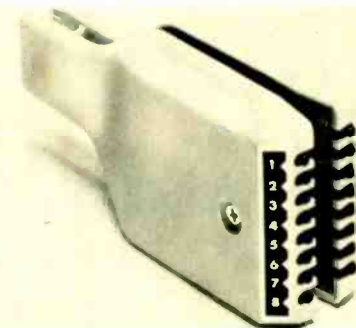

CMOS DIP IC's. Whenever the voltage at a pin exceeds 2 V, the numbered LED corresponding to that pin lights, indicating a logic one. The Logic Monitor clips onto the DIP, and requires no external power supply, calibration or adjustment. Input impedance is 100,000 ohms, and it draws a maximum of 150 mA at 15 V according to the manufacturer. The unit weighs 3 oz (85 g) and measures 4" L x 2" W x 1 1/2" D (10.2 x 5.1 x 3.8 cm). \$84.95.

CIRCLE NO. 73 ON READER SERVICE CARD

UHER PORTABLE CASSETTE DECK

Uher's Model CR134 portable stereo cassette deck features a special head design incorporating four tracks in-line, and a photo-sensitive electronic control for the



tape-drive mechanism. The deck has automatic tape reversal, built-in condenser microphone, a speaker, a stereo amplifier with a 1-W/channel output, and defeatable ALC. It can be powered from line current or rechargeable batteries. Frequency response is rated at 25 to 15,000 Hz ± 2 dB, S/N at 56 dB, and wow and flutter (rms) under 0.12%. Stereo and mono operation are possible. The CR134 measures 7" W x 7" D x 2" H (17.8 x 17.8 x 5.1 cm). \$378.

CIRCLE NO. 74 ON READER SERVICE CARD

PICKERING CD-4 QUADRAHEDRAL CARTRIDGE

The new Pickering XUV/4500Q cartridge can play stereo, SQ, QS, and CD-4 discs while tracking at one gram or less. It is said to provide good frequency response and separation to beyond 50,000 Hz. The XUV/4500Q features the patented

POPULAR ELECTRONICS

Quadrhedra™ stylus assembly, with the Quadrhedron™ stylus tip, which is a new shape in diamond styli. In four-channel discrete playback, its frequency response is 10 to 50,000 Hz (± 1.5 dB in the base bands, ± 2 dB in the carrier bands), with a channel separation of 35 dB nominal at 1000 Hz, and 25 dB nominal at 30,000 Hz. The cartridge provides a nominal output of 3.4 mV at 5.5 cm/s. \$139.95.

CIRCLE NO. 75 ON READER SERVICE CARD

H-P 15-MHZ DUAL-TRACE OSCILLOSCOPE

A new 15-MHz dual-channel oscilloscope, the Model 1222A from Hewlett-Packard, has a built-in delay line to make visible the leading edges of traces. This feature is especially valuable in digital and pulse work. The Model 1222A also gives the user the option of viewing channels A and B in either the A+B or A-B modes. The scope is said to have 3% vertical accuracy, cali-



brated 8 x 10 cm display, internal graticule to eliminate parallax, dc coupling, triggered sweep and pushbutton beam-finder. Vertical calibration is adjustable from 2 mV/cm to 10 V/cm. Built-in TV sync separation makes possible automatic triggering on frame or line. The calibrated sweep is said to be accurate to within 4%. The Model 1222A also has AUTOMATIC or NORMAL triggering. The scope weighs 16¼ lb (7.3 kg), and requires 35 watts at 100, 120, 220, or 240 volts. \$895.

CIRCLE NO. 76 ON READER SERVICE CARD

HEATH LAB-GRADE POWER SUPPLY

The Model IP/SP272 is one of Heath's new 2700 Series of lab-grade power supplies with analog or digital readout. The power supply produces 0 to 15 V at 5 A, has a large 3½-digit readout, constant-current and constant-voltage operation, remote voltage and current programming, automatic compensation for lead voltage drops, and complete output protection, according to Heath. The digital readout has two-decade autoranging to provide good resolution for low voltage and current settings. Load regulation is rated at 0.05% + 1 mV for voltage, 0.1% + 3.5 mA for current. Built-in standards allow calibration to within +1.0% for voltage and within 1.5% for current. Closer tolerance is possible if lab standards are used. The IP/SP 2721 is available in kit (\$219.95) or assembled (\$340.00) form.

CIRCLE NO. 5 ON READER SERVICE CARD

JULY 1975

SYLVANIA COLOR TV TEST JIG

GTE Sylvania's Model CK3000 test jig is said to be compatible with 7000 solid-state, tube, and hybrid color television chassis. It can be used with chassis generating anode voltages up to 30,000 V, and can handle delta 70- and 90-degree tube, hybrid, transistor, and SCR sweep circuitry with a range of impedances. A built-in alternate supply permits testing of focus voltages as low as 4500 V. A set of programmers for the jig's patented yoke circuit provides correct matching to six different receiver deflection outputs. The CK3000 also contains a 90-degree slotted-mask, in-line 13-inch (33-cm) CRT. Optional accessories are

adapter kits for seven popular name brands and discrete adapters for 41 more. The test jig weighs less than 25 lb (11.4 kg).

CIRCLE NO. 78 ON READER SERVICE CARD

PEARCE-SIMPSON MARINE RADIO TELEPHONE

The new Bimini 25 vhf FM marine radio-telephone features full legal (25 watts) power output, a backlighted channel selector knob with provisions for 12 transmit and 14 receive channels, a snap-on mounting cradle and quick-connect power plug. The solid-state transceiver also has a two-position transmitter output switch (25 watts high, 1 watt low), and a noise-canceling ceramic microphone. The re-

20 hi-fi watts in 1.2 cubic inches

What a powerhouse! SK3154 packs a 20-watt RMS audio amplifier in one small module. With virtually flat response from 15 Hz to 70 kHz. In the SK3154 package you'll find all the information you need. Just follow the instructions for adding 12 easy-to-get

passive components, power supply and hardware — and you've got one channel of a fine stereo or quad amplifier. The fun — and a super finished product — are yours. (Ten and 15-watt SK modules also available.) Start now! See your RCA electronics distributor.



Solid fun in 399 pages

Electronic organ, temperature alarm, tachometer, light-operated switch — 68 useful solid-state projects in one book. Complete instructions plus some theory. \$2.95 optional price. At your RCA electronics distributor.

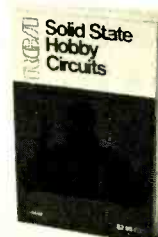

RCA

RCA Solid State, Box 3200,
Somerville, N.J. 08876.

CIRCLE NO. 38 ON READER SERVICE CARD

The CROWN VFX-2

electronic crossover

Commercial sound contractors across America have been asking for an electronic crossover for use on sophisticated sound installations. There's no more waiting. And the Crown VFX-2 embodies all you expect in high quality and performance capabilities from the people at Crown.

Only the Crown VFX-2 electronic crossover will give every installation **maximum** versatility. Such **flexibility** for so little cost. And never before has an electronic crossover been offered that can be easily and readily adjusted with front panel controls.

Tunable from 20- to 20,000 Hz, this solid state component is compatible with 600 ohms loads and up, and features both balanced and unbalanced inputs and outputs.

Overall noise and distortion are extremely low. IM distortion is less than 0.01% at rated output, and noise is more than 97dB below rated output with open inputs.

Providing either crossover or bandpass functions, the VFX-2 utilizes two continuously variable filters per channel, and filter roll-off is at a fixed 18 dB/octave.

Applications include stereo bi-amping, mono tri-amping, and combining the bandpass filter with the normal two-way crossover on a mono signal. And all connections are quarter-inch phone jacks for positive electrical contact.

The VFX-2 is designed for standard 19" rack mounting and measures in at 3 1/2" high by 5 3/4" deep and includes a clear plastic cover for protecting control settings.



Write for complete specifications.

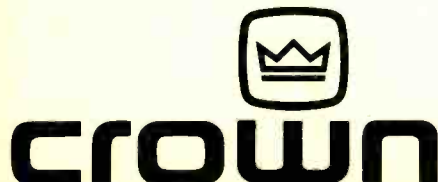

BOX 1000 • ELKHART, IN. 46514 • 219/294-5571
CIRCLE NO. 15 ON READER SERVICE CARD

ceiver section claims a sensitivity of 0.7 μ V, a spurious signal and adjacent channel rejection of 50 dB. The Bimini 25 requires a 13.6-V dc source, and draws 5 A on transmit (high), 1 A on low, and 0.15 A during receive. The transceiver weighs 3.5 lb (1.6 kg), and measures 11" W \times 6 1/2" D \times 3" H (27.9 \times 16.5 \times 7.6 cm).

CIRCLE NO. 79 ON READER SERVICE CARD

AKG STEREO HEADPHONES

Philips Audio Products' Model K-140 lightweight headphones have earcups that are universally jointed, allowing flexible



positioning. Bass response is said to be unaffected by the shape of the listener's ears, or by air leaks between the ears and cushions. Microphone-derived transducers are used and are said to deliver very transparent sound images. \$34.50.

CIRCLE NO. 80 ON READER SERVICE CARD

GRILLE FOAM ADD-ON KITS

A series of speaker grille replacement kits, featuring sculptured acoustic foam, available from the Dew Foam Company, are said to be acoustically transparent, and easy to install. They are available in brown and black, and can be painted with any color acrylic or lacquer paint. The grille is cut to size, and applied using pressure-sensitive material which is supplied. Kits are available for three sizes of speaker enclosures: SMALL (up to 10 1/4" \times 16 3/4" or 26 \times 42.5 cm); MEDIUM (up to 13 3/4" \times 23 7/8" or 34.9 \times 60.6 cm); and LARGE (up to 16 7/8" \times 28 1/4" or 42.9 \times 71.8 cm), and are priced at \$6.95, \$9.95, and \$14.95, respectively. Address: Dew Foam Co., 14768 Raymer St., Van Nuys, CA 91405.

REAR-MOUNTED AUDIBLE INSTRUMENT ALARM

Floyd Bell Associates' Model AL-100-RM is an audible alarm designed for rear-panel installation. The unit produces a continuous tone at about 2600 Hz, with a sound output to 90 dB. In operation, the alarm draws 4 to 16 mA from a 5- to 30-V dc source. Tin-plated screw-type terminals are used. The AL-100-RM is said to have sealed electronics, and can be used in marine and commercial applications at temperatures from -20° to +65°C (-4°F to 149°F). Address: Floyd Bell Associates, Inc., 555 Marion Road, Columbus, OH 43207.

BOZAK AUDIO SIGNAL PROCESSOR

The Bozak Model 919 Audio Signal Processing Center permits the user to blend three different two-channel input signals with separate level, bass, mid-range, and treble controls for each input. Input channels include phono, microphone, and switch-selected choice of tape, tuner, or



auxiliary inputs. A "panning" circuit allows the user to "locate" the microphone anywhere between the right and left channels, and the stereo blend control varies the "width" of the output from mono (in which the sound comes from one spot) to extra-wide (in which the sound source appears to have a wider frontal area). A "cue selector" makes it possible to monitor each of the inputs separately. Claimed distortion is less than 0.1% from 20 to 20,000 Hz with a full 10-volt output into a 200-ohm load. The unit weighs 21 lb (9.5 kg) and measures 17 3/4" W \times 10 5/8" D \times 7" H (45.1 \times 27 \times 17.8 cm). An optional walnut enclosure is available. \$797.

CIRCLE NO. 81 ON READER SERVICE CARD

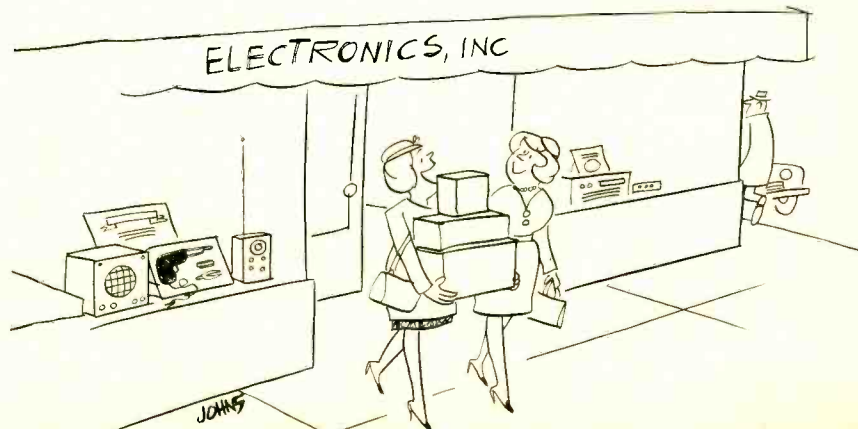

"I'll say one thing for Charles.
He's no problem on birthdays and Christmas."

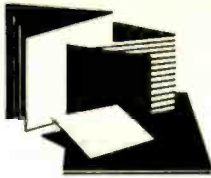

New Literature

NSC PRODUCT GUIDE

National Semiconductor has published a 15-page guide to some 300 functional products that make up its line of bipolar TTL/MSI devices. The guide is divided into eight sections: multiplexers and demultiplexers, counters, display products, memory products, shift registers, latches and storage registers, decoders and comparators, and miscellaneous TTL products. Address: Marketing Services Dept., National Semiconductor Corp., 2900 Semiconductor Dr., Santa Clara, CA 95051.

IDI INDICATOR LIGHTS

A comprehensive 24-page selection guide to pilot and indicator lights is available from Industrial Devices Inc. It reviews the specifications of a variety of custom, stock, and off-the-shelf lights in three different light sources: neon, incandescent, and

solid-state, and compares the advantages and disadvantages of each. Address: Industrial Devices Inc., Edgewater, N.J. 07020.

DATA CONVERSION APPLICATIONS NOTE

A six-page applications note from Datal Systems, called "Know Your Conversion Codes," is a handy summary of the various digital codes used in data conversion modules. Various codes such as straight binary, complementary binary, BCD, complementary BCD, offset and complementary offset binary, sign-magnitude BCD, and two's complement are discussed in detail. Also covers code relationship to internal circuitry in the conversion module. Address: Datal Systems, Inc., 1020 Turnpike St., Canton, MA 02021.

AMATEUR RADIO EQUIPMENT CATALOG

The new catalog from MFJ Enterprises describes many new products, including CW and SSB audio filters, electronic keyers, frequency standards, audio amplifier modules, QRP rigs, pc boards, and electronic components. Address: MFJ Enterprises, Box 494, Mississippi State, MS 39762.

CRYSTAL OSCILLATOR GUIDELINES

An applications bulletin from Vectron Labs, entitled "How to Specify Crystal Os-

cillators," covers clock oscillators, TCXOs, and oven-controlled oscillators; includes 16 diagrams and illustrations. A comparison of these oscillator types is given, as well as a discussion of timing applications. Address: Vectron Laboratories, Inc., 121 Water Street, Norwalk, CT 06854.

RECEIVING TUBE PRICE LIST

A new 12-page Export Price List covering more than 2,000 receiving tube types is available from the International Components Corp. This list contains many American, Japanese, and European consumer and industrial receiving tubes, including many classic and antique types. Address: International Components Corp., 105 Max-ess Rd., Melville, NY 11746.

IEEE STANDARDS CATALOG

The new 32-page IEEE Standards 1975 Catalog lists more than 350 standards publications by subject as well as numerical sequence. Standards developed by the IEEE cover test methods, installation practices, units, definitions, symbols, and applications methods. Among the standards listed are those which deal with antenna design, communications, power generation and distribution, microwaves, rotating machinery, and electromagnetic compatibility. Address: IEEE Standards Dept., 345 E. 47th St., New York, NY 10017.

You don't have to buy a new car to get an electronic ignition.

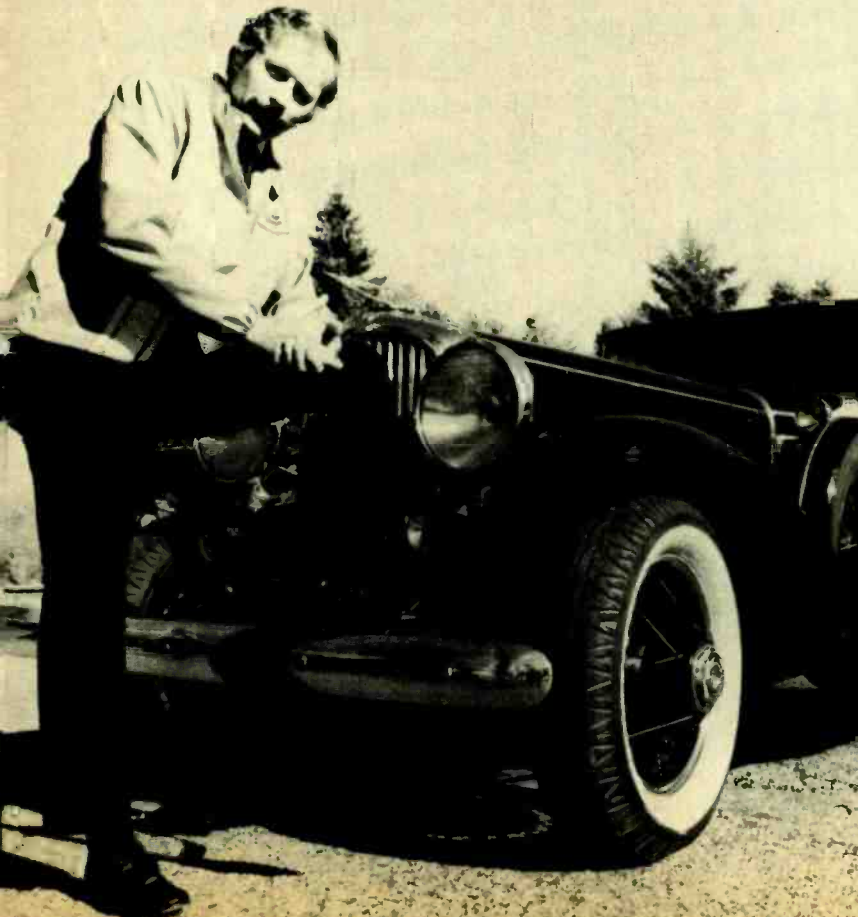

Most of you know the evaluation of automotive electrical systems . . . an evaluation characterized only occasionally by efficiency and performance. I know that, and that's why I use the Delta Mark Ten B CDI on all my cars, new and old. And believe me, you don't have to have a new car to appreciate the best electronic ignition available today. Study these features and you'll know what I mean.

1. Mark Ten and Mark Ten B Capacitive Discharge Ignition Systems are manufactured by Delta Products, Inc., a company with a conscience, and with a proven record of reliability both in product and in customer relations.
2. The Mark Ten CDI's really do save money by eliminating the need for 2 out of 3 tune-ups. Figure it out for yourself. The first tune-up or two saved pays for the unit, the rest is money in your pocket. No bunk!
3. Because the Mark Ten CDI's keep your car in better tune, you actually can save on expensive gasoline.
4. With a Mark Ten, spark plugs stay clean and last longer . . . fouling is virtually eliminated.



No matter what kind of car you drive, it too can use a Delta quality lift.

I want to know more about Mark Ten B CDI's. Send me complete no-nonsense information on how they can improve the performance of my car.

Name _____
 Address _____
 City _____ State _____ Zip _____



DELTA PRODUCTS, INC.

P.O. Box 1147, Dept. PE, Grand Junction, Colo. 81501
303-242-9000

Mark Ten B, assembled	\$64.95 ppd	Standard Mark Ten, assembled	\$49.95 ppd
Mark Ten B, kit	\$49.95 ppd	Delakit®	\$34.95 ppd

CIRCLE NO. 17 ON READER SERVICE CARD

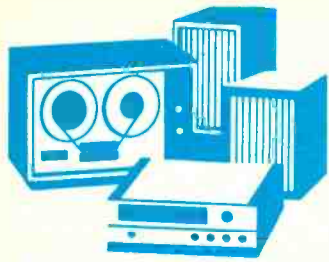

Stereo Scene

By Ralph Hodges

CHOOSING YOUR FM ANTENNA

FROM its beginning, FM has supplied entertainment and information to a great number of people. Of course, many cannot afford the ultimate in an FM tuner; but being dependent on the airwaves, they often have a strong desire to own such a paragon to obtain exciting performance in terms of low distortion, high signal-to-noise ratio, and good stereo separation. But a "super tuner" does not, as an automatic consequence, necessarily provide the ultimate in signal-pulling power, number of listenable stations, and freedom from external interference.

There's a large distinction to be made between a tuner's function as a receiver—that is, as a potent grabber of airborne electromagnetic radiation—and as a *signal processor*, which is the role it plays once it has that

clean, strong signal in its grasp. Many "super" tuners, while designed to excel in both areas, surpass the performance of their lesser brethren mostly in the signal-processing functions (low distortion, noise, etc.). As receivers, their superiority may not be so pronounced. So in practice, what this means is that someone with reception problems could possibly find a readier cure by adding a very good FM antenna to an adequate tuner. I realize that is an easy statement to make, because the problem is where and how to find that very good antenna. The various designs that are available can be confusing, to say the least.

I don't think antenna designers are by nature secretive men, but they tend not to launch into full-dress discussions of their trade with the greatest

enthusiasm. You might think they were wary of unscrupulous imitators, except that all of their work is usually right out in the open—literally on rooftop display—to inspect and copy if you're so inclined. No, the real cause of their reticence seems to lie in the craft itself, which is more than commonly resistant to textbook solutions.

The consumer should not despair, however. Armed with a little savvy about antenna terms and specifications, and a knowledge of what he needs for his location, he can get the desirable, "very good" FM antenna.

Gain. A primary function of an antenna is, of course, to provide the receiver with the strongest possible signal. So an antenna should have high sensitivity or high gain. Gain over what? Gain over a dipole, the simplest type of efficient antenna, with two metallic rods cut to the proper length to receive FM frequencies as shown in Fig. 1. The antenna's directional response is roughly like a figure-eight, with best results at 90° and 270°. Those signals coming in on-end are not received too well.

The dipole is the reference antenna that is used in comparing more complex designs. It is the cheapest to make, and one of its forms (the "folded" dipole) is often included in the "package" with a tuner as a T-shaped piece of TV-type lead-in.

For years, antenna design concentrated on gain as a way of overcoming the noisy front ends of typical r-f receivers. Now some experts believe that the best possible results have been achieved, given present-day techniques and materials, and the emphasis is shifting to *directionality*.

Directionality. With tuners as quiet and sensitive as they are today, extremely high antenna gain is no longer such a necessity, except in some rural areas. In fact, it can be a liability if it is available to *all* signals impinging on the antenna.

Remember that the sky is crowded, with (potentially) hashed-up versions of the very signal you want to receive. I refer here to the phenomenon called multipath reception—the simultaneous reception of one signal from multiple sources. Only one of the sources is the transmitting antenna. The others are reflectors of the signal, such as hills, water towers, tall buildings, and anything else that rears itself high enough above the terrain and

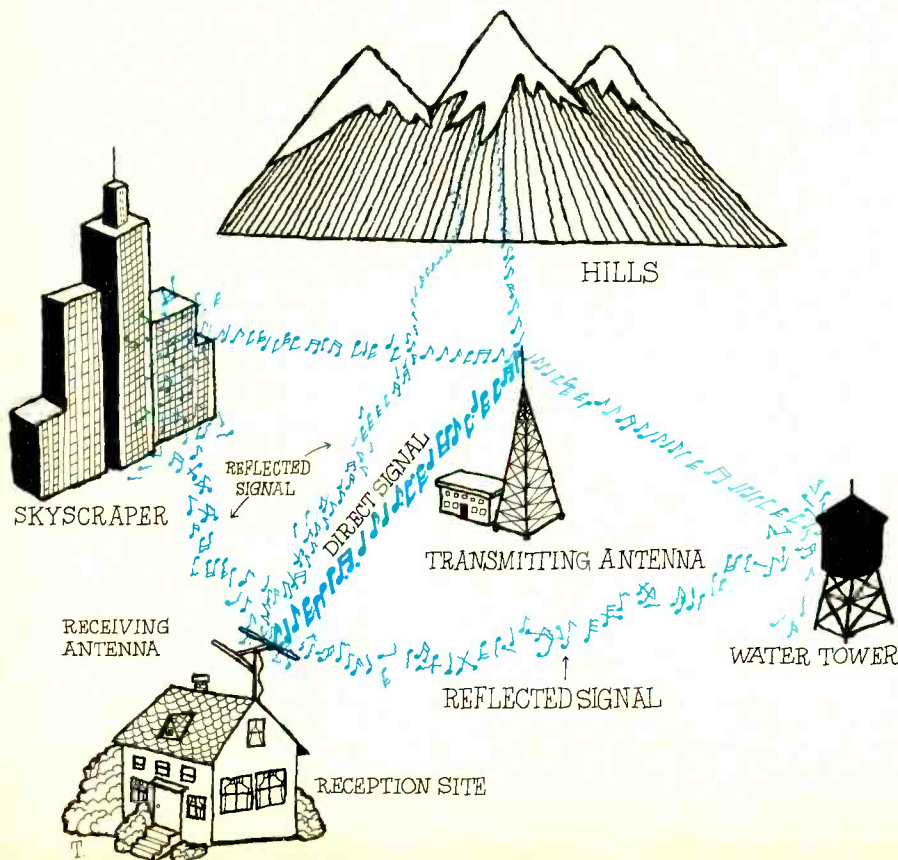

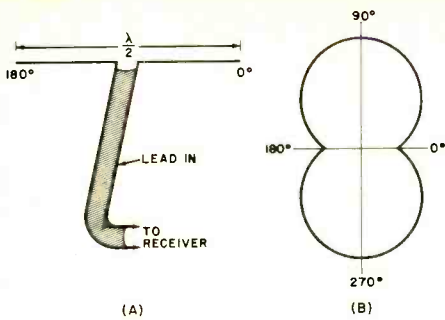

Fig. 1. Simplest antenna is the half-wave dipole (A). Its polar diagram is shown at (B).

contains a significant amount of conductive material. Like billiard cushions, they bounce the signal away from its straight-line path. Then one of these reflected signals can hit your antenna as well as the signal straight from the transmission site. But what's wrong with that?

What's wrong is that the reflected signal arrives at your antenna later than the direct one, since the reflection requires it to travel a longer route. Then the two signals experience phase interference and the result is some ugly distortion of the original broadcast waveform.

Multipath causes ghosts in TV reception and rasping distortion in FM. The latter is particularly noticeable at high audio frequencies and during loud musical passages. It is curable, much of the time, if the receiving antenna is highly directional since no late reflections of significant strength will arrive from precisely that same direction.

Antennas And Tuners. A high-gain antenna will help any tuner rise above its basic sensitivity specification and provide noise-free reception of stations that may have been out of range before. A highly directional antenna will have the same effect on other tuner specifications—capture ratio, AM suppression, and selectivity, to name a few. Selectivity is simply a tuner's ability to reject broadcast frequencies close to the one to which it is tuned. If you can aim your directional antenna away from the offending stations and right at the one you want to receive, you save the tuner the trouble of trying to sort things out internally. (If the interfering stations lie in the same direction as the desired one, the antenna usually can't do much, however.)

Good capture ratio and AM suppression are assets to any tuner in eliminating multipath effects. Capture

JULY 1975

SIBLING RIVALRY



Which one you like best depends on what you want to do with it.

Our Ultra Dynamic cassette can play back every note your system can record.

Or, for a few Hertz less and a lot of cents less, you can have quality almost as good in our Low Noise cassettes. (It's so good, many people compare it to our competitors' top-line products.)

However, both cassettes feature Maxell "tensitized" tape strength to pre-

vent stretching. Both Maxell cassettes feature the strongest shells made to prevent warping and popping. Both cassettes come in 120 minute lengths that really work.

So, while our two cassettes have a few differences, they're all in your favor.

Maxell Corporation of America, Moonachie, New Jersey 07074. Also available in Canada.

maxell.

For professional recordings at home.



CIRCLE NO. 27 ON READER SERVICE CARD

Get inside digital electronics!

Bell & Howell Schools now offers you two fascinating learn-at-home programs that can equip you with professional know-how in the expanding field of digital technology!

The world of electronics is an astounding place—a world that, in the short span of 70 years, has taken us from a simple mechanical age into an age where electronic sophistication has actually helped man set foot on the lunar surface.

One area of this space-age technology that has been successfully harnessed for consumer and industrial use is digital electronics. It is this breakthrough that has given us such remarkable new products as tiny pocket calculators and digital-display wristwatches. And now, you can learn about some of the many extraordinary applications of digital electronics in two special learn-at-home programs from Bell & Howell Schools.

Start your exploration of electronics at home!

With these exciting home learning adventures from Bell & Howell Schools you'll experience the true thrill of discovery as did such electronic pioneers as Thomas Edison and Dr. Lee DeForest. And think about this... they didn't discover electronics in a classroom, and you don't have to either!

Whichever program you choose, test new electronic theories as you build and experiment with the exclusive Electro-Lab® electronics training system!

With your very first lesson you'll receive a special Lab Starter Kit, so you'll be able to see how basic electronic principles actually work in practice. Then, step by step, as your understanding of electronics increases, you'll actually be able to perform your own experiments and work on fascinating projects from "scratch"—like building the exclusive Electro-Lab® electronics training system. This important project helps you learn electronic skills through "hands on" experience with professional testing equipment. The Electro-Lab® system consists of a design console to help you learn how to hookup circuits—a digital multimeter for measuring electrical voltage, current and resistance. And a solid-state "triggered sweep" oscilloscope that, among other things, you'll use to analyze the operation of tiny integrated circuits. The "triggered sweep" feature locks in signals for easier reading.

I. HOME ENTERTAINMENT ELECTRONICS Learn how digital technology is being applied to home entertainment products—build and experiment with the new generation 25" diagonal color TV with digital features!

To learn the most advanced electronics technology you must work with up-to-date training tools. That's why



you'll build Bell & Howell Schools' 25" diagonal color TV with digital features as part of your training. Step by step you'll learn about the many exciting applications of the most up-to-the-minute electronics technology. And you'll have the confidence in knowing that the advanced skills you're learning will be valuable for years to come.

"Hands on" training will help you understand advanced applications of digital technology!

Your "hands on" training will give you a professional's understanding of how this advanced technology works. How features such as on-screen, digital display channel numbers and a digital time readout in hours, minutes and seconds are possible. You'll learn to program an automatic channel selector so that it skips over dead channels and "homes-in" on the channels of your choice.

And, how "state-of-the-art" integrated circuitry and the 100% solid-state chassis add immensely to your understanding of circuit theory and TV servicing techniques. You'll also become thoroughly familiar with the technology behind features such as digitally-automated tuning, and the outstanding color clarity of the Black Matrix picture tube.

By actually building and experimenting with this exceptional equipment, you'll gain the occupational skills, specialized knowledge—and the self-confidence that could open up exciting new directions for you!

II. DIGITAL INDUSTRIAL ELECTRONICS

Our exclusive digital trainer will help you discover today's exciting applications of digital electronics in industry.

Industry is constantly finding new applications for digital technology. Today, this technology is helping to set new standards of accuracy and providing a more precise method of control in refining, food processing, transportation and in manufacturing plants.

Now Bell & Howell Schools has a learn-at-home program that could get you involved in the industrial uses of this challenging technology. The program provides a solid background in basic electronic principles and the opportunity for you to experiment and learn with the Bell & Howell digital trainer. This remarkable piece of equipment lets you set up and examine a range of complex digital circuits like those in use in industry today. You will work with circuitry which has many of the numerical

and process control applications used in a number of today's most sophisticated manufacturing operations.

Bell & Howell Schools is with you every step of the way!

You'll be pleased to know that, throughout all of these dynamic Bell & Howell Schools' programs, you're just a toll-free phone call away from expert assistance should you need it.

For even more personal attention... Bell & Howell Schools has a truly unique idea—

You can attend in-person help sessions scheduled in over 50 major cities at various times throughout the year, where you can meet and talk with fellow students and receive additional assistance from an instructor.

Once you've completed this program, your skills in electronic troubleshooting could lead you in exciting new directions. While we cannot offer assurance of income opportunities you can use your training: to seek out a job in the electronics industry, to upgrade

your current job, or as a foundation for advanced programs in electronics.

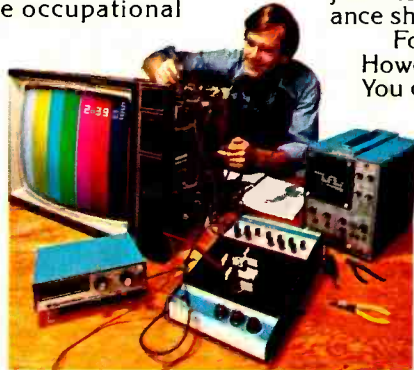

Now... audio/quadrasonics... first home program of its kind!

It's another first from a leader in home learning. Bell & Howell Schools proudly introduces America's first learn-at-home program in audio electronics featuring the exploration of quadrasonics. It's the 4-channel "wrap-around" sound system that has opened a new era in audio technology! You'll actually build Bell & Howell's 4-channel audio center including amplifier and FM-FM Stereo receiver as a part of the development of professional know-how in this exciting and promising new field. Get more details now... check the appropriate box on card and mail today!†

Why not aim yourself in an exciting new direction today—just check the Bell & Howell Schools' program you're interested in and...

Mail the postage-free card right away!

We'll see that you get more details! Taken for vocational purposes, these programs are approved by the state approval agency for Veterans' Benefits.

†Cabinet and speakers available at extra cost.

Simulated TV picture/test pattern.

"Electro-Lab®" is a registered trademark of the Bell & Howell Company.



If card has been removed, write:

An Electronics Home Study School
DeVRY INSTITUTE OF TECHNOLOGY

ONE OF THE



BELL & HOWELL SCHOOLS

4141 Belmont, Chicago, Illinois 60641

ratio specifies the tuner's ability to reject weaker signals at essentially the same frequency as the desired one (note that multipath has the same average frequency as the direct signal, and is also usually weaker), while AM suppression has to do with fluctuations in the desired signal's strength before it reaches the tuner's input (such fluctuations are due to multipath and a host of other interference factors). Respectively, the two specifications refer to a tuner's effectiveness in ignoring spurious FM and also AM effects on the incoming signal. The better tuners are astonishingly good at this, but an appropriate antenna can be even better. A highly directional antenna helps the tuner's capture ratio by making reflections much weaker than the direct signal. A tuner's AM suppression is profited by both high gain and high directionality.

Which Antenna? There are four basic types of antennas available to the FM enthusiast: outdoor beams (both "yagi" and "log-periodic" types) which are exclusively for FM, outdoor TV antennas, indoor FM "rabbit ears" and simple indoor dipoles. Which is right for you? That depends on where you live, what you listen to, and what kind of a tuner you have.

The typical rooftop FM antenna is a variant of the yagi or log-periodic principle. Sometimes it's a hybrid of the two. A pure yagi has only one active crossbar ("element") connected to the tuner. The other elements are "parasitic," either directing the signal to the active element or reflecting it back. (The reflection here won't cause multipath.) The log-periodic design connects several elements to the tuner input, and these elements "couple" in mysterious ways to provide gain over a more-or-less wide range of frequencies. Whatever the principle, the elements progressively increase in length so that, observed from above, the antenna assumes an arrowhead shape that should be pointed at the desired station's antenna (Fig. 2).

Both of these antennas can be very high in directionality and gain. Both also have their shortcomings: impedance variation (responsible for losses in the antenna-tuner coupling), limited bandwidth, and susceptibility to interference. I wish I could advise as to which of these weaknesses is most tolerable, but the fact is that it depends on local (sometimes very local) reception conditions. The best antenna for you can't be readily pinpointed by even the most expert of experts. An adequate antenna is the one your next-door neighbor likes.

Other Solutions. A TV antenna can serve very well for FM unless it has an FM trap (optional on most large outdoor antennas). The FM band is located in approximately the center of the vhf TV band. Often there is interference between the two, so the trap is used to wipe out the interloping FM from the TV.

Assuming there is no trap, using the same antenna for both TV and FM introduces lots of other potential problems. Sometimes it will work fairly well when the antenna is connected directly to both. More often, a so-called "signal splitter" is required. Even then, there may be trouble. The TV screen is usually the first to suffer, with snow starting to appear.

Can you find happiness with an indoor antenna such as the familiar rabbit ears? Many authorities resist the idea, but it seems to be possible—particularly in urban areas where multipath rejection is more important than gain. They are mildly directional and insensitive to signals arriving from the sides. Their great advantage over a twin-lead dipole is that they are rigid (therefore easily rotated and aimed) and their telescoping elements are tunable to various wavelengths. But rabbit ears don't offer exciting performance in any case.

The final alternative is to build your own antenna, and sometimes excellent results can be obtained. But that is a subject we can't pursue here.

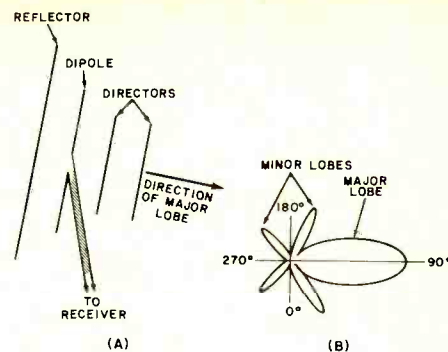

Fig. 2. Typical four-element beam (A) has directional polar plot (B).

Accessories. After you've chosen an antenna—presumably an outdoor one if you can manage it—your subsequent decisions will involve the proper lead-in cable and whether or not you need a rotator.

There are two basic types of lead-in: coaxial (or unbalanced) and twinlead (balanced). Coax is immune to positioning and weather, and some types have low losses. Its characteristic impedance (for RG-59) is 75 ohms. If a balanced antenna or tuner input is to be used with coax, it is necessary to use a "balun" (balanced-to-unbalanced line converter).

Balanced line can be used, but if it is not of the shielded variety, some problems may arise. If unshielded twinlead is bent sharply, run close to a metal object or gets wet, its nominal 300-ohm impedance can take off into the blue. This type of line also deteriorates badly after some exposure to the elements. The problems involved in using unshielded twinlead are often such that it is hardly worth bothering with. Shielded twinlead, if you can find it, is weather-sealed, shares the noise-immunity characteristic of coax, and has lower losses.

A rotator—an electric motor mounted on the antenna mast to point the antenna toward the direction of interest—plays no part in the inherent performance of an antenna. It is, however, necessary if you want to aim a good directional antenna at stations lying at different compass points. ♦

UPCOMING AUDIO SHOWS

October 10-12
October 31-November 3

BALTIMORE HI-FI SHOW
AUDIO ENGINEERING SOCIETY
(52nd Convention)

Location to be determined
Waldorf-Astoria Hotel, NYC

November 6-10
February 12-16, 1976
March 12-14, 1976

PHILADELPHIA HI-FI SHOW
DETROIT HI-FI SHOW
SAN DIEGO HI-FI SHOW

Benjamin Franklin Hotel
Cobo Hall
San Diego Community Concourse

Quad Almighty.

Sansui QRX-7001



The universal 4-channel receiver.

Since 4-channel has been created, music lovers everywhere have been waiting for a universal method to decode every 4-channel system. SANSUI has created it, and here it is, like a revelation: Quad Almighty.

The SANSUI vario-matrix* now incorporated in every SANSUI 4-channel receiver is able to decode effectively with remarkable musicality and clarity, all 4-channel matrix encoded records, QS or SQ, tapes and broadcasts. The Sansui QRX-7001 as well as the QRX-6001 also incorporates our CD-4 demodulator.

Of course the Sansui vario-matrix has the unique synthesizing capacity to give you breathtakingly beautiful 4-channel reproduction from all of your stereo records, tapes or broadcasts.

Also available is the SANSUI QRX 6001, 3500, 3000, and QR 1500 for the fullest line of 4-channel receivers.

Hear a demonstration of any of the QRX family of Quad receivers at your franchised Sansui dealer today or write to us for our booklet: "The Sounds of SANSUI".

* Sansui's unique technology that permits the highest degree of channel separation and gives unequalled 4-channel synthesizing from any 2-channel source.

SANSUI ELECTRONICS CORP.

Woodside, New York 11377 • Gardena, California 90247 • SANSUI ELECTRIC CO. LTD. Tokyo, Japan
SANSUI AUDIO EUROPE S.A. Antwerp, Belgium • ELECTRONIC DISTRIBUTORS (Canada) B.C.



CIRCLE NO. 49 ON READER SERVICE CARD

www.americanradiohistory.com

NEWS HIGHLIGHTS

GE Leaving Phono Business

General Electric has announced it is getting out of the portable phonograph business. The company is closing its last audio manufacturing facility in Decatur, Ill., where it produces phonos, changers and Show 'N Tell phono viewers, among other products. However, inventory will allow GE to market products at least through 1975.

Economic Ups and Downs

The EIA's Consumer Electronics Group reports that 1974 consumer electronic sales were the third highest in the industry's history. However, they were down 11.8% from 1973, the record year. In two other areas, substantial gains are expected in 1975. Litton Industries predicts that industry sales of home microwave ovens will exceed 900,000 units, representing a retail market of \$360 million. That would be a 25% increase over 1974 sales. The Air Conditioning and Refrigeration Institute projects that sales of electronic air cleaners, which remove a large portion of dirt, pollen, and smoke from indoor air, will pass 200,000 units in 1975. Annual sales were 10,000 units in 1960, 100,000 in 1970, and about 194,000 in 1974.

IC's In The Body

Researchers are now readying biomedical sensors using IC's for actual insertion in the body. This will allow a doctor to monitor biological activities of his patients during their normal routines. Data from the sensors can be transmitted to a nearby receiver, which is linked to a diagnostic unit in the doctor's office by a telephone connection. It is possible that, in the future, medical check-ups will involve nothing more than dialing your physician and moving within range of your telemeters. Any bioelectric phenomenon, such as EKG, EEG, muscular activity and nerve transmissions could be monitored in this way.

Checkless Bill Paying

"Pay-by-Phone" service, a computer-based method of checkless bill-paying, allows a subscriber with any type of Touch-Tone telephone to initiate a transaction by punching out code numbers identifying his bank account, personal security code, payee, and amount, either to an automated or live teller. Subscribers with conventional rotary dial phones can use the service by giving the same information to a customer service representative. A verified bank statement is provided as proof of payment. The system eliminates check writing, addressing envelopes, applying postage, and manually posting payments. It can also be extended to permit payments to be made from savings accounts as well as conventional checking accounts. Telephone Computer Service of Seattle is the developer. The first fully operative Pay-by-Phone system is operated by a bank in Minneapolis. If and when your bank is prepared to offer the service, they will undoubtedly let you know.

Electronic License Plates

An electronic license plate is being developed that may some day play an important role in automobile operation. The license plate is a microwave transceiver which would automatically communicate with official vehicles. It could respond with an identifying code number when electronically interrogated, and serve as a transponder for use in a cooperative-avoidance radar. The plate includes an r-f detector, a frequency doubler, a modulator, and an antenna. It would be about 12 inches long, 6 inches high, and half-an-inch thick. Covering the circuitry would be a plastic radome displaying the license number of the vehicle. Other uses might include an automatic speeding indicator, toll-billing device, and reception of safety messages about road and weather conditions.

Recording "Firsts"

RCA Records has released Massenet's "Thais" as the first opera to be recorded in full-surround discrete four-channel sound. It stars Anna Moffo, in the title role, Jose Carreras, Gabriel Bacquier, and Justino Diaz, with Julius Rudel conducting the New Philharmonia Orchestra and the Ambrosian Opera Chorus of London.

Anagram, a Springfield, Va. computer firm, is set to tackle the highly competitive music industry with its 13-rank Wurlitzer Theatre organ and a computer named "Genii." According to the company, development of the computer permits exploration of utilization of computers in the music field. The "Musictran" translation of written music to computer language is processed by the "Marvel" computer program developed by Anagram. Its first album, "Two Loves Have I: Jean and Genii," is produced mainly for organ and computer buffs and to demonstrate the capabilities of both the organ and the computer.

Bicentennial Amateur Callsigns

The FCC has authorized amateurs to use special callsigns during the bicentennial celebration year, 1976. Use of the call letters will be optional, and no notification to the Commission will be required. Callsign prefixes or prefixes plus digit can be changed in accordance with the following:

WA—AA	KH6—AH6
WB—AB	KJ6—AJ7
W—AC	KL7—AL7
K—AD	KM6—AH7
WD—AE	KP4—AJ4
WR—AF	KP6—AIΦ
WN—AK	KS4—AH4
KB6—AG2	KS6—AH3
KC4—AL4	KV4—AJ3
KG6—AG6	KW6—AG7

These special callsigns can be used from 0500 GMT January 1, 1976 until January 1, 1977. Suffixes remain unchanged.

MITS Altair Computer Report

A Computer Language You Can Understand

ALTAIR BASIC is an inexpensive, general-purpose computer language with the power for advanced data processing. It is easy to learn and to use.

ALTAIR BASIC is part of the overall MITS computer concept. That is, **computers must be made understandable and affordable.**

ALTAIR BASIC comes in three versions. The first of these is a 4K BASIC designed to run in an Altair with as little as 4,000 words of memory. This powerful BASIC language has **6 functions** (RND, SQR, SIN, ABS, INT, and SGN) in addition to **15 statements** (IF... THEN, GOSUB, RETURN, FOR, NEXT, READ, INPUT, END, DATA, LET, DIM, REM, RESTORE, PRINT, STOP) and **4 commands** (LIST, RUN, CLEAR, SCRATCH).

The second ALTAIR BASIC option is the 8K BASIC designed to run in an Altair with as little as 8,000 words of memory. This BASIC language is the same as the 4K BASIC only with **8 addi-**

tional functions (COS, LOG, EXP, TAN, ATN, INP, FRE, POS) and **4 additional statements** (ON... GOTO, ON... GOSUB, OUT, DEF) and **1 additional command** (CONT). This BASIC has a multitude of advanced STRING functions and it can be used to control low speed devices—**features not normally found in many BASIC languages.**

The third ALTAIR BASIC is the EXTENDED BASIC version designed to run on an Altair with as little as 12,000 words of memory. It is the same as the 8K BASIC with the addition of PRINT USING, DISK I/O, and double precision (13 digit accuracy) add, subtract, multiply and divide.

ALTAIR BASIC is only the beginning. MITS is currently engaged in an extensive software development program. Our Disk Operating System is scheduled for delivery in August. Other software now available includes an Assembler, System Monitor, and Text Editor.

ALTAIR USERS GROUP

The Altair Users Group is both a means of communication among Altair Users and a method of building a comprehensive library of Altair Programs. All Altair purchasers are entitled to a free, one year membership in this group.

Members of the Altair Users Group are encouraged to submit programs by entering Altair "Software Contests." Winners of these contests are awarded **prizes of up to \$1,000** credit toward the purchase of an Altair Computer or Altair options.

Contest winners are announced in the Altair newspaper, **Computer Notes**, which is published monthly and mailed free to all members of the Altair Users Group. **Computer Notes** contains complete update information on Altair hardware and software developments, programming tips, general computer articles and other useful information.

Associate Memberships are available to non-Altair customers for only \$30.00 a year. Membership fees are refunded to Associate Members who buy an Altair Computer within 8 months after they become a member.

COMPUTER TRADE-IN

If you have a Mark 8 or a Scelbi-8H computer and **you'd rather have an Altair 8800**, we will offer you \$150.00 on a trade-in for an Altair plus 4K of memory.

For an Altair Computer kit, send in your used computer plus a check for \$561.00 (\$439.00 for an Altair plus \$264.00 for memory plus \$8.00 for postage and handling minus \$150.00). For an assembled Altair with 4K of memory, send in your used computer plus a check for \$817.00.

PRICES

Altair Computer kit with complete assembly instructions	\$439.00
Assembled and tested Altair Computer	\$621.00
1,024 word memory board	\$176.00 kit and \$209.00 assembled
4,096 word memory board	\$264.00 kit and \$338.00 assembled
Full Parallel Interface board	\$92.00 kit and \$114.00 assembled
Serial Interface board (RS232)	\$119.00 kit and \$138.00 assembled
Serial Interface board (TTL or teletype)	\$124.00 kit and \$146.00 assembled
4K BASIC Language (when purchased with Altair, 4,096 word memory and Interface board)	\$60.00
8K BASIC Language (when purchased with Altair, 2 4,096 word memory boards and Interface board)	\$75.00
EXTENDED BASIC (when purchased with Altair, 3 4,096 word memory boards and Interface board)	\$150.00

NOTE: Altair Computers and software come with complete documentation and operating instructions. BASIC language is available on either paper tape or cassette tape (specify). **Warranty:** 90 days on parts for kits and 90 days on parts and labor for assembled units. Prices, specifications and delivery subject to change.

MITS

"Creative Electronics"

MITS/6328 Linn. N.E., Albuquerque, NM 87108 505/265-7553

MAIL THIS COUPON TODAY!

Enclosed is check for \$ _____

BankAmericard # _____ or Master Charge # _____

Altair 8800 Kit Assembled Options

Include \$8 for postage and handling (list on separate sheet)

Time Payment Plan Altair Users Group Associate

Please send free Altair System Catalog

NAME _____

ADDRESS _____

CITY _____ STATE & ZIP _____

MITS/6328 Linn. N.E., Albuquerque, NM 87108 505/265-7553

ALTAIR TIME PAYMENT PLAN (kits only)

The Altair time payment plan allows you to be the owner of an Altair Computer with 256 words of memory for **just \$68.75 a month**. Each month (for 8 months) you send in your payment and we send you part of an Altair kit until you have the complete system. The advantages to this plan are: **NO interest** or financing charge, **GUARANTEED price** based on today's price, and free, immediate **membership to the Altair Users Group**.

Here's how our payment plan works:

	You Pay	You receive
Month One	\$68.75	Assembly, Operators, and Theory of Operation manuals
Month Two	\$68.75	Power Supply (includes board and all components)
Month Three	\$68.75	Expander Card
Month Four	\$68.75	Case with hardware
Month Five	\$68.75	1K Static Memory Board with 256 words of memory
Month Six	\$68.75	CPU Board with all components except processor chip
Month Seven	\$68.75	Control Board with all components
Month Eight	\$68.75	Processor chip
Total	\$550.00	(Retail price: Altair \$439.00, Memory \$103.00, Postage and handling \$8.00—total \$550.00)

Our terms are cash with order, BankAmericard or Master Charge. If you send in an early payment we will make an early shipment. By the same token, a late payment will result in a late shipment. (After 60 days past due, the balance of the deal is cancelled. All payments must be made within 10 months)

Offer expires July 30, 1975.

Portable Digital Multimeter at an Analog Price

ONLY
\$99⁹⁵

less batteries and optional AC adapter/charger



MODEL 280
Shown actual size

9 reasons why our new meter should be your next:

- 1. ANALOG PRICE**
- 2. RELIABLE**
Fully overload protected
Built-in battery check
Impact-resistant Cyclac® case
- 3. EASY TO READ**
Large 3-digit LED readout
Automatic polarity, decimal point and out-of-range indication
- 4. COMPLETELY PORTABLE; USE IT ANYWHERE**
Only 4.38 x 6.38 x 2" deep
Operates from 4 ordinary "C" cells or AC with optional adapter/charger
- 5. HIGH-LOW POWER OHMS**
Measures accurately in solid state circuitry
- 6. HIGH RESOLUTION**
1mV, 1μA, 0.1 ohm
- 7. DIGITAL ACCURACY**
DC volts typically ±1% F.S.; AC volts and ohms typically ±2% F.S. except ±2.5% on highest range
- 8. RANGES**
DC and AC volts, 0-1, 10, 100, 1000V;
DC and AC current, 0-1, 10, 100, 1000mA;
Ohms, 0-100, 1K, 10K, 1 meg, 10 meg.
10 meg industry standard input impedance
- 9. IN STOCK AT YOUR DISTRIBUTOR**

BK PRECISION

PRODUCTS OF DYNASCAN
1801 W. Belle Plaine Ave. Chicago, IL 60613

HOW TO PROGRAM READ-ONLY MEMORIES

*An experimenter's guide to programmable ROM's—
what they are and practical applications for them.*

BY ROBERT D. FASCOE

PROGRAMMABLE read-only memories are unique among the digital integrated circuits readily available to experimenters. What makes it unique is that it is user programmable. You decide what you want the PROM to do and program it to do just that. The only "tools" you need are a pair of regulated power supplies, some switches, and a resistor. The programming procedure itself is outlined later on in this article.

The PROM is one member of the standard ROM family of memories. Once it is programmed, its memory is nonvolatile, which means that, if power is removed from and then reapplied to the PROM, the stored information remains intact. By contrast, a RAM (random-access memory) has a volatile memory; if power is interrupted, when it is again applied, whatever information was stored in the memory will be erased.

The ROM (and PROM) can be made from bipolar transistors, in which case it is called a bipolar ROM. It can also be made from metal oxide semiconductor devices, which makes it a MOS-ROM. Whichever type it is, the ROM is a digital device that "remembers" information on the standard binary format of 1's and 0's. The logic levels remembered by the bipolar

ROM are the same as those used in TTL circuits, whereas the levels remembered by the MOS-ROM are determined by the supply voltage required by the device itself.

Organization. An important characteristic of the ROM is its organization. The ROM remembers quantities of binary "bits" that are organized into "words." Each word has a certain number of bits. For example, one type

of ROM can remember 256 bits of information organized into 32 words of eight bits apiece (32 words \times 8 bits = 256 bits).

Some of the more commonly available ROM's can remember 256, 1024, 2048, or 4096 bits in a single IC chip. With the various types of ROM's, the manufacturer determines how the total number of bits is organized in the chip.

The organization of the bits deter-

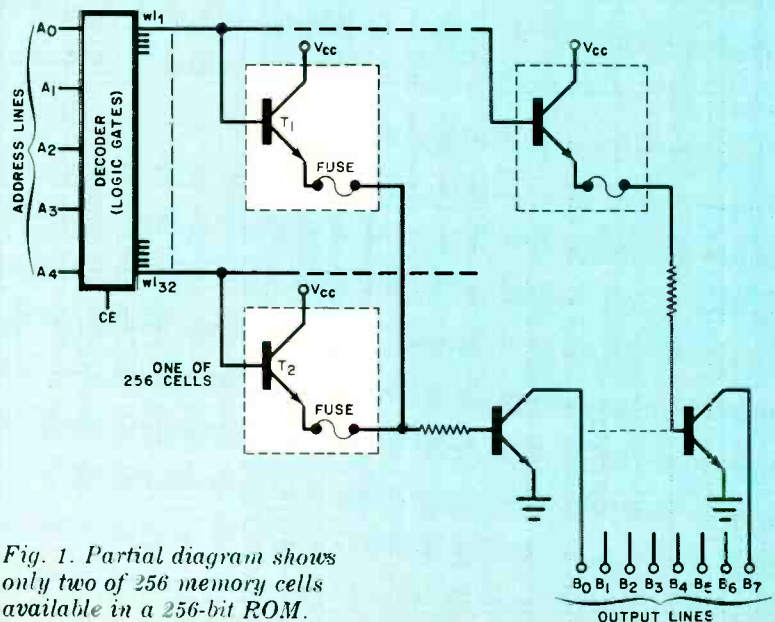

Fig. 1. Partial diagram shows only two of 256 memory cells available in a 256-bit ROM.

SOME APPLICATIONS FOR PROM'S

THERE are countless applications for the ROM. Some of the more traditional ones use the ROM as lookup-table (trigonometry, logarithms, etc.) memories in calculators; as micro-instruction systems in computers; and character generators for displaying alphanumeric characters on a CRT screen. The following are examples of what you can do with an 8223 PROM:

Character Generator. A seven-segment display device can be used to create the numerals 0 through 9, a number of upper- and lower-case letters of the alphabet, and some mathematical punctuation—all with a single 8223 PROM chip. Because the display has only seven segments, it cannot form all 52 upper- and lower-case or even all 26 upper- or lower-case letters.

In Fig. A is shown the logic diagram for an alphanumeric/punctuation generator. Beside it is the "truth table" we used for generating the 32 possible characters. Note that the entire memory storage capability is "used up" in this truth table. (This truth table

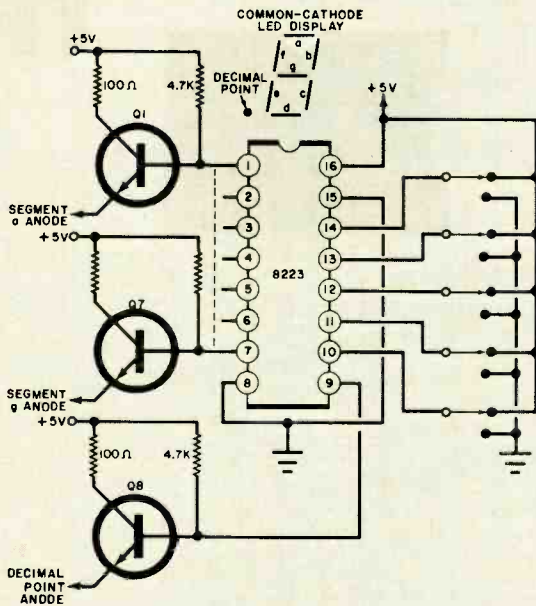

Fig. A. Once PROM is programmed according to truth table at right, it can generate numbers, letters, etc., on 7-segment display device.

assumes a buffering transistor between the outputs of the 8223 and segments of the display. The display can be either an RCA 2100 incandescent or common-anode LED display. For common-cathode LED displays, all B_0 through B_7 logic levels must be reversed.)

All eight output lines from the 8223 PROM are used, with one output assigned to each segment of the display and a final one for

Figure Displayed	Address (A_4-A_0)	Outputs (B_7-B_0)	Segments on
0	00000	00111111	abcdef
1	00001	00000110	bc
2	00010	01011011	abdeg
3	00011	01001111	abcdg
4	00100	01100110	bcfg
5	00101	01101101	acdfg
6	00110	01111101	acdefg
7	00111	00000111	abc
8	01000	01111111	abcdefg
9	01001	01101111	abcdfg
.	01010	10000000	decimal point
-	01011	01000000	g
=	01100	01001000	dg
A	01101	01110111	abcefg
b	01110	01111100	cdefg
C	01111	00111001	adef
c	10000	01011000	deg
d	10001	01011110	bcdeg
E	10010	01111001	adefg
F	10011	01110001	aefg
G*	10100	00111101	acdef
H	10101	01110110	bcefg
h	10110	01110100	cefg
i*	10111	00010000	e
J	11000	00011110	bcde
L	11001	00111000	def
n*	11010	01010100	ceg
o	11011	01011100	cdeg
P	11100	01110011	abefg
r*	11101	01010000	eg
U	11110	00111110	bcdef
u	11111	00011100	cde

*These letters are only approximations, included only to use up the PROM's program capability.

mines the number of address (input) and output lines that will be available in a given ROM. Address input pins are the means by which a specific word in the memory is accessed or selected. If a particular ROM is organized with 32 words of eight bits per word, each word can be addressed with five input address lines ($2^5 = 32$). The address 00000 would be for word one, 00001 for word two, 00010 for word three, and so on until 11111 would be for word 32. The number of output pins for a small memory is determined by the number of bits used per word in the memory's organization. In our example, the ROM would have eight output pins.

The address lines for a ROM are usually denoted by the legends A_0 , A_1 , A_2 , etc., while the output lines would

be denoted by B_0 , B_1 , B_2 , etc. For a five-address-line input and eight-line output ROM, the address pins would be labelled A_0 , A_1 , A_2 , A_3 , and A_4 , and the output pins would be labelled B_0 , B_1 , B_2 , B_3 , B_4 , B_5 , B_6 , and B_7 .

Illustrated in Fig. 1 is a basic 256-bit (32-word by eight-bit) bipolar ROM. The address lines are fed to logic gates that decode the 32 possible combinations of 1's and 0's that appear on the five address lines. These 32-word lines are denoted by the legends w_1 through w_{32} . For the particular ROM shown, there are eight output transistors whose collectors are labelled B_0 through B_7 . The memory "cells" are denoted by the legends T_1 and T_2 . There are 256 of these basic memory cells for a 256-bit ROM.

The output lines from the ROM

would be either high (logic 1) or low (logic 0), depending on whether or not a conduction path exists between the memory cell and the output transistor in each line. As an example, if a 0 is to be stored at B_0 in word 32, the T_2 resistance link (fuse symbol) must be present. If, on the other hand, a 1 is to be stored at B_0 of word 32, the fuse must be electrically removed (blown) from the circuit.

Most ROM's have a pin labelled CE, for "chip enable," that permits the output to be isolated from the rest of the circuitry inside the IC. So, if a 1 is placed at CE (while the address is being changed), the outputs will be at the logic-1 level. The placement of this specific binary information into the ROM is called "programming." The means of programming is determined

the decimal point. To use up the entire storage capability of the PROM, the entire 00000 through 11111 series was used on the address lines (A₀ through A₄). We will discuss later how to perform the actual "programming" procedure for the PROM.

An extension of the single-character generator is the word generator. Here, we have several PROM's and an equal number of displays, each programmed with identical information. Depending on the number of PROM's and displays desired, this system can be used to generate words, strings of numbers, identification and license numbers, etc. You simply set the address lines of each PROM to generate the character you want.

Model RR Track Patterns. The PROM can also help an HO model railroader remember track patterns for his train layout. As an example, suppose an HO train layout has eight track switches and 10 possible track configurations. A PROM can be used to remember the positions of the various switches for the 10 possible track patterns, as shown in Fig. B. The outputs of the PROM would be connected to the track switches through electronic switches (driver transistors). This ensures that the output voltage levels of the PROM are converted to the proper voltages and currents needed to move or position the track switches.

The PROM must be programmed with the appropriate binary codes. The words w₁ through w₁₀ can then be the various track patterns that the train can have. The one-shot multivibrator's output is coupled to the CE input of the PROM so that the switches do

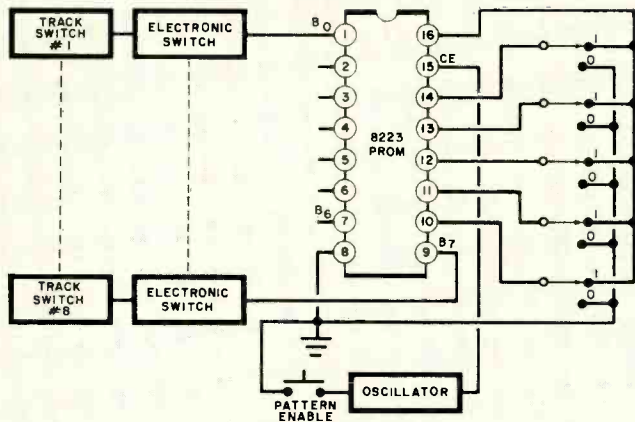

Fig. B. In model-railroad system, PROM would be programmed to control all possible combinations of switches on track.

by the type of ROM. The two major types of ROM's are the custom-programmed and the field-programmable ROM.

With custom-programmed ROM's, the manufacturer places the binary information (links or no links) into the memory as specified by the user. Custom programming of ROM's can be very expensive when only small quantities are ordered. To reduce the high cost of small quantities of ROM's, manufacturers offer the field-programmable ROM or PROM.

The PROM is an ordinary ROM that has all of its on-chip fuses intact. A 256-bit PROM would have 256 of these fuses, one for each bit of memory. The user can program information into the PROM simply by blowing selected on-chip fuses. The fuses are blown

open by passing a specific amount of current through them for a specified period of time. (The Signetics 8223 is an example of a 256-bit PROM. It is readily available from a number of surplus-parts suppliers for about \$4.50. This PROM is organized into 32 words of eight bits per word.)

Erasable PROM's. ROM's are usually thought of as having permanent binary information programmed into their memories. Once information is programmed into an ordinary ROM, it cannot be altered. Recently, however, a new type of PROM—the erasable PROM—has become available. This type of PROM permits information stored semi-permanently to be erased and new information to be reprogrammed in.

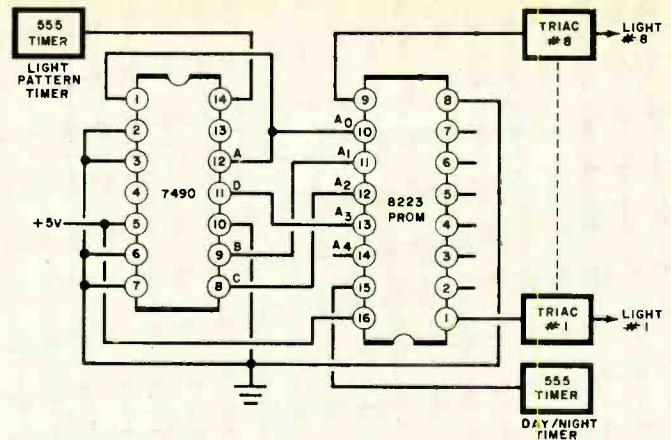

Fig. C. Clocked by timer circuit, 7490 counter delivers a 4-bit input to PROM, which controls triacs to turn lights on and off.

not have voltage across their coils continuously. With the PROM remembering the various track positions for the eight switches, you need only select the pattern you wish and push a button to initiate the selection of that pattern.

Intruder Deterrent. When you go away from home for a day or longer, you probably use mechanical timers to turn on and off house lights to make it appear that someone is home. A PROM can be used for this purpose and is much more effective in deterring intruders than are mechanical timers.

Shown in Fig. C is a system, built around a PROM, for turning on and off house lights in a certain sequence. Suppose that there are eight lights located throughout the house. The lights can be controlled by individual triacs, with the triacs controlled by the outputs from the PROM.

Assume that 10 light patterns are to be used in the evening hours. Word one can be a basement and a living room lights-on command, word two can be a living room and a kitchen lights-on command, and so on.

The various patterns of lights (words) can be selected by changing the address inputs, which are connected to a 7490 decade counter. A 555 timer can be used to change the outputs, of which there are a possible 10, of the 7490. This, in turn, changes the lighting sequence for the house. With this arrangement, various lights in the house can be changed every so often to give the appearance that someone is home and moving from room to room.

One type of erasable PROM, the 2048-bit MM5203, is made by National Semiconductor Corp. It can be erased by concentrated shortwave ultraviolet light. (It is available, surplus, for about \$24.) The MM5203 is housed in a 16-pin dual in-line package (DIP) with a quartz top that is transparent to shortwave UV light. The 2048 bits are organized as either 256 words of eight bits per word or 512 words of four bits per word.

The advantage of the erasable PROM, as opposed to the nonerasable PROM, is that it can be used over and over again for different programs. The unwanted information is simply erased by directing UV light through the IC's quartz "window" and reprogramming as desired.

Another type of erasable PROM

PREPARING A PROGRAMMING AND ADDRESSING TRUTH TABLE FOR PROM'S

Because the PROM is a logic element, programming and addressing it must conform to the rules of logic. To do this, a truth table must be drawn up for the programming procedure. This same truth table is also used for addressing the ROM after programming has taken place so that stored information can be retrieved.

There are two approaches you can use when working up your truth table. The first is an arbitrary table, used mainly for demonstration purposes. Since you would key in the address codes by manually setting switches, you can use any address system that suits your fancy. The truth table accompanying the diagram in Fig. A is an example of the arbitrary approach.

For more practical applications, address code selection would be under the control of the digital system in which the PROM is to be used. In this case, the programming truth table for both input and output codes must conform to those required by the system. A typical example is a BCD-to-7-segment decoder.

Let us assume a 7490 decade counter's encoded output is to be used to drive a seven-segment LED display. All decoding can be accomplished with a PROM. The PROM will then feed inverter/buffer transistors, which in turn will power the display's segments. The truth table, with the 7490's DCBA output lines feeding the 8223's A_7, A_6, A_5, A_4 , address lines respectively, would be:

$A_7, A_6, A_5, A_4, A_3, A_2, A_1, A_0, B_7, B_6, B_5, B_4, B_3, B_2, B_1, B_0$

NO.	D	C	B	A	g	f	e	d	c	b	a
0	X	0	0	0	0	X	0	1	1	1	1
1	X	0	0	0	1	X	0	0	0	0	1
2	X	0	0	1	0	X	1	0	1	1	0
3	X	0	0	1	1	X	1	0	0	1	1
4	X	0	1	0	0	X	1	1	0	0	1
5	X	0	1	0	1	X	1	1	0	1	0
6	X	0	1	1	0	X	1	1	1	1	0
7	X	0	1	1	1	X	0	0	0	0	1
8	X	1	0	0	0	X	1	1	1	1	1
9	X	1	0	0	1	X	1	1	0	1	1

The DCBA in the heading represents the outputs from the 7490, while the g f e d c b a represents the display segments controlled. The X's are don't-care states, since there is no input to the A_4 input nor output termination for the B_7 output lines of the 8223 PROM.

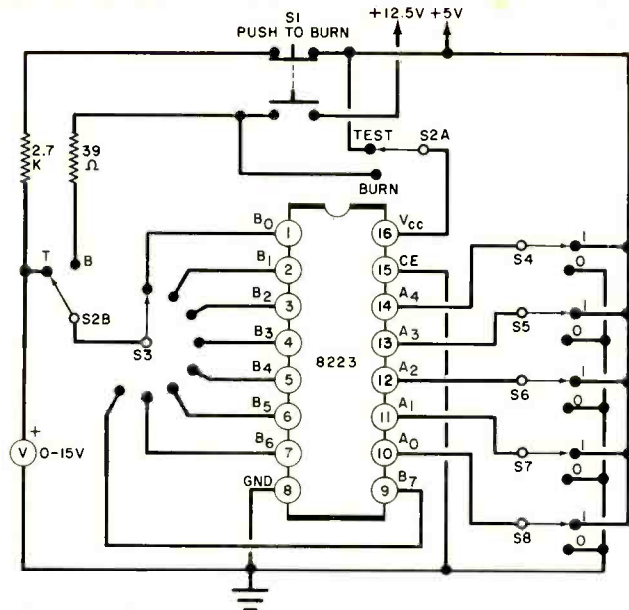

Fig. 2. In this programming setup, both power supplies must be regulated. Once PROM is programmed, its memory can be checked as described in the text.

—this one not so readily available to experimenters—is the Nitron Company's NC7010 EAROM. This device can be erased electrically in one second. It can be erased and reprogrammed up to a million times. The NC7010 is organized as 512 words of two bits per word.

How to Program a PROM. The 8223 PROM used in the applications described is shipped with all of its outputs at a logic-0 level. This means that all of its on-chip fuses are intact. If a logic 1 is to be written into the PROM's memory, the fuses must be blown. The procedure for blowing selected fuses is called programming. It can be performed with the circuit shown in Fig. 2. The +5- and +12.5-volt power supplies must be regulated. Switch S_1 is a two-circuit push-button switch, with one set of contacts normally open and the second set normally closed. Switch S_2 is a dpdt slide or toggle switch, while switch S_3 must be a *non*-shorting rotary switch with eight or more positions.

After wiring together the Fig. 2 circuit, program the PROM as follows:

1. Set S_2 to the BURN position. (Note: Never operate S_1 when S_2 is set to BURN.)

2. Feed the proper logic-1 (+5-V) and logic-0 (0-V or ground) code for word one onto address lines A_0 through A_7 via S_4 through S_8 .

3. Set S_3 to the first PROM output line position in which a fuse is to be blown according to your programming truth table.

4. Depress S_1 for about a half second and release. This action, in blowing the fuse, develops considerable localized on-chip heat; so, **do not depress S_1 for longer than a full second.**

5. Allow several seconds of cooling down time for the chip.

6. Set S_3 to the next output line in which a fuse is to be blown.

7. Repeat steps 4 and 5 for each output line in which a fuse is to be blown.

8. Set S_4 through S_8 for the logic required for word two.

9. Repeat steps 3 through 7.

10. Continue to address the PROM for each succeeding word, repeating steps 3 through 7 as you proceed from word to word, until you have completed programming the PROM.

The schematic diagram shown in Fig. 2 depicts a program and test circuit. As you finish steps 3 through 7 for each word, set S_2 to TEST (do not change the address code yet) and, observing the meter, check the PROM's outputs by cycling through S_3 's positions. Logic 0 will be indicated by the pointer swinging to near the scale's zero index, while logic 1 will be indicated by about a +5-volt reading. Once you have verified that the program has "taken" for a given word, set up the circuit for programming into the PROM's memory the next word that you want.

After making sure that the PROM is properly programmed, affix some identifying code on its case and truth table and file away the latter in a safe place where it will not get lost. ♦

HOME EMERGENCY LIGHT for "BLACKOUTS"



- Automatic "on" when ac power fails
- Full-wave battery-charging circuit
- Doubles as lantern flashlight
- Compact, neat design

BY WILLIAM OLDACRE

WHEN a power blackout occurs, one is likely to get caught in the dark without ready access to a flashlight or candle. Here is a hand emergency light to solve the problem, minimizing possible injury and fear due to darkness.

This emergency light goes on automatically whenever ac power is interrupted for one second or more, providing several hours of light before a recharge is needed. (The 1-second delay is built in to prevent flickering.) In addition, the system includes a battery charger which maintains full charge on ordinary nickel-cadmium batteries. It can also double as a portable flashlight and is designed into a neat, small package.

This home safety device is simple to build, requiring easy-to-get parts and modification of an inexpensive lantern-type flashlight.

How It Works. The schematic of the emergency light is shown in Fig. 1.

Transformer $T1$, $RECT1$ (a full-wave bridge rectifier), and filter capacitor $C1$ form a low-voltage dc power supply. When line voltage is applied to the circuit, $LED1$ glows. Current through $LED1$ is limited by $R1$. The power supply provides charging current for battery $B1$, two NiCd cells. Diode $D1$ prevents the battery from discharging back through the LED. Charging current is limited by either $R3$ or $R4$. When switch $S1$ is in the SLOW position, $R3$ allows 33 mA to flow into the battery. When $S1$ is placed in the FAST position, $R4$ provides 100 mA, which charges $B1$ more quickly.

The dc voltage also energizes relay $K1$. Since the relay coil is energized under normal (line voltage-on) conditions, it might tend to get very warm. To keep the coil cool, resistor $R2$ is placed in series with it, lowering the amount of continuous current flow. The path between the battery and the light bulb ($I1$) is controlled by the relay contacts. Under line-on conditions, no

current can flow through the bulb.

When the line power drops out, however, the relay coil is de-energized, and the contacts complete the circuit between the battery and the light bulb. The bulb automatically lights up, providing emergency illumination. To prevent the emergency light from flashing on and off whenever the line voltage drops for a fraction of a second (for example, when your refrigerator compressor kicks in), we take advantage of the fact that it takes about one second for the voltage across $C1$ to decay to the point where the relay drops out. The exponential properties of the RC circuit smooth out any instantaneous variation in line voltage.

The flashlight is a self-contained unit which connects to the power supply through a three-conductor power plug-jack combination. When independent flashlight operation is desired, switch $S2$ takes over the relay's switching operations by pro-

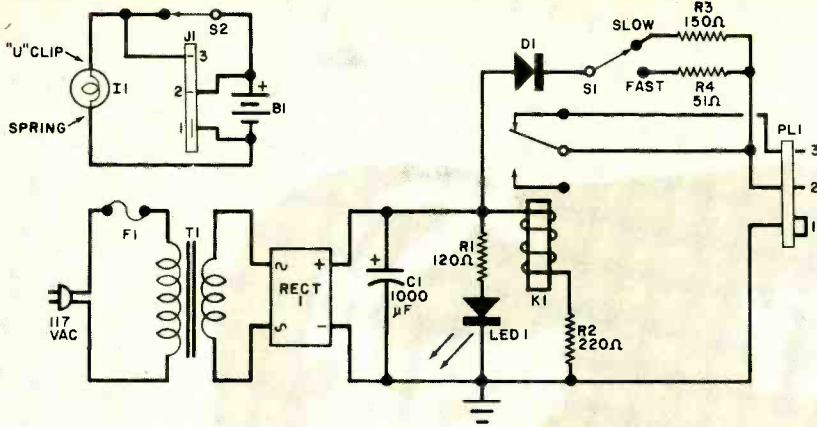

Fig. 1. Schematic of the emergency light. Power failure causes K1 to drop out, supplying power to I1.

PARTS LIST

- B1—Two General Electric GC-3 1.25-volt, 1.2 A-hour nickle-cadmium batteries
 C1—1000- μ F, 16-volt upright electrolytic capacitor (Radio Shack 273-958 or equivalent)
 D1—1-A, 50-PIV silicon rectifier
 F1— $\frac{1}{4}$ -A fuse (Buss AGC $\frac{1}{4}$ or equivalent)
 J1—Three-conductor power jack (Cinch-Jones S303AB or equivalent)
 K1—6-volt SPDT relay (Radio Shack 275-004 or equivalent)
 LED1—Light emitting diode (Sprague ED-123 or equivalent)
 PL1—Three-conductor power plug (Cinch-Jones P303AB or equivalent)
 R1—120-ohm, 1-watt resistor
 R2—220-ohm, $\frac{1}{2}$ -watt resistor
 R3—150-ohm, $\frac{1}{2}$ -watt resistor
 R4—51-ohm, 2-watt resistor
 RECT1—2-amp, 50-PIV bridge rectifier (Radio Shack 276-1151 or equivalent)
 S1—SPDT miniature toggle switch

- S2—SPST pushbutton switch (furnished with lantern)
 T1—6.3-volt, 300-mA filament transformer (Radio Shack 273-1384 or equivalent)
 Misc.—Chassis box (4" x 2 $\frac{3}{8}$ " x 6" (Radio Shack 27-252 or equiv.), lantern (Sears 4841, Ray-O-Vac L295 or equiv.), fuse clips (Buss 5682-41 or equiv.), metal battery holder (Radio Shack 270-1439 or equiv.), piece of 1" wood 4" sq., $\frac{3}{4}$ " x $\frac{1}{8}$ " aluminum angle stock, $\frac{1}{4}$ "-inch metal spacers, printed circuit or perforated board, line cord, rubber grommets, battery holder, wood screws, machine hardware, brass shim stock, adhesive-backed decorative vinyl, dry-transfer lettering, hookup wire, solder, etc.
 Note—A pre-drilled, etched epoxy printed circuit board is available for \$3.75 postpaid from William Oldacre, Box 12951, University Station, Gainesville, FL 32601.

(10-cm) leads should be connected from LED1 to the appropriate pads on the circuit board. Three 4-inch (10-cm) leads should be run from the board for S1, and three 10-inch (25.4-cm) leads for PL1. Drill holes in the utility box for pc board standoffs, rubber feet, LED1, S1, and the line cord. Insert the line cord through its hole using a grommet or strain relief and connect its leads to the transformer primary. Then mount the circuit board in the utility box using $\frac{3}{8}$ -inch (0.64-cm) metal spacers.

The prototype uses Cinch-Jones three-conductor power connectors, but substitutions are OK. Drill two mounting holes in the wood block and a hole for PL1's leads through the cover of the utility box. Install a grommet in the hole for the leads.

Plug PL1 is mounted on a 3 $\frac{1}{2}$ " x 3 $\frac{1}{2}$ " x $\frac{3}{4}$ " (8.9 x 8.9 x 1.9 cm) block of wood, which is covered with walnut grained adhesive-backed vinyl. Drill holes on the bottom side for mounting hardware (make sure these don't go all the way through), PL1, and the top two metal guide rails (completely through the block). These rails should be fashioned from $\frac{3}{4}$ " x $\frac{1}{8}$ " (1.9 x 0.32 cm) aluminum angle stock. Round the corners of the aluminum, and drill two holes for securing hardware. Position

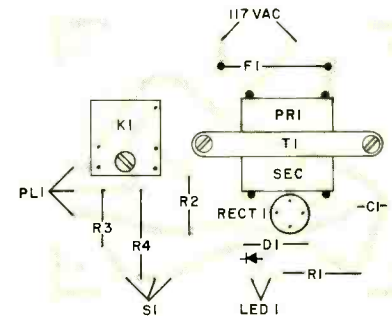
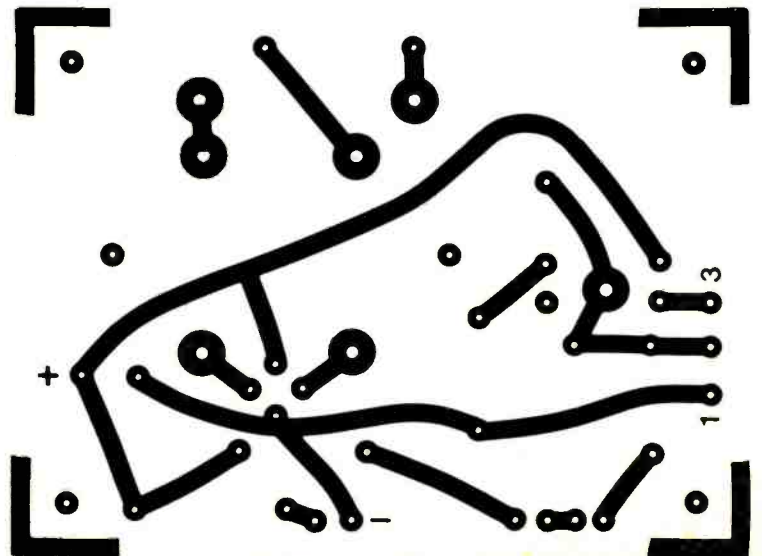

Fig. 2. Etching and drilling guide for pc board is below; component placement at right.

viding an alternate path for current flow from the battery to light bulb I1.

Construction. The emergency light is composed of two units: a portable flashlight and the base/recharger which it plugs into.

Components forming the recharger circuit should be mounted on a printed circuit or perforated board. Etching and drilling and component placement guides for pc board fabrication are shown in Fig. 2. Mount the components on the board, paying close attention to the polarities of C1, D1, the leads to LED1, and RECT. (Align the rectifier so that the dot on the top of the case faces north. The pin facing north is the +dc output. South is negative, east and west are the ac inputs from the secondary.) Fuse F1 can be mounted either on the back panel using a panel-mount holder, or on the circuit board using standard fuse clips. The clips require 4-40 mounting hardware. The two 4-inch



the rails so that they accept the flashlight you choose to use (the one in the photo is a Sears model), and then drill holes into the top of the wood block to match those in the guide rails. Give the rails a brushed appearance by rubbing them lengthwise with fine steel wool under running water. Then attach the rails to the block with 1/2" (1.25 cm) roundhead wood screws.

Secure plug *PL1* to the wood block and attach the appropriate leads from the circuit board. Mount the block on the top of the utility box's cover, lining up the holes you previously drilled. Secure the block to the cover with roundhead wood screws.

Final assembly of the base/recharger may now be accomplished. First, label the front panel as shown in the photo using dry-transfer letters. Then apply several light coats of clear acrylic spray. This will prevent the letters from being worn off. After the spray has dried, secure *S1* in its mounting hole. If your *LED1* has no mounting collar, use a 1/4-inch (0.64-cm) O.D. rubber grommet to

SELECTING AN INCANDESCENT BULB.

The battery power source used in the emergency light holds a power capacity of 1.2 ampere-hours at 2.5 volts (when fully charged). This means that it can keep a 1.2-A current flowing for one hour. Alternatively, it can sustain a 0.6-A current for two hours, 0.3-A for four hours, and so forth. Obviously, the smaller the current drain from the power source, the longer the flow can continue. You will have to decide for yourself how long you will need the light to function before the NiCd cells are completely discharged.

If you live in an area plagued with frequent (but brief) power blackouts, this discharge time is not too important. Alternatively, if your neighborhood gets rare (but prolonged) power losses, duration of the power source should be extended.

These factors will dictate your choice of lantern light bulb. The type PR-2 light bulb, which draws 0.5 A at 2.4 volts, will discharge the battery source in about 2 hours and a quarter. If you choose a PR-4 bulb instead, the NiCd cells will last about 45% longer, since it draws only 0.27 A at 2.3 volts. Although the PR-4 will produce less light than the PR-2, many builders will prefer it because it is easier on the supply. If even longer duration (and a lower light level) are desired, you can choose a less demanding bulb type or add current-limiting resistors in series with the bulb.

Fig. 3. Base with recharger is shown without cover. Flashlight plugs into socket on wooden block.

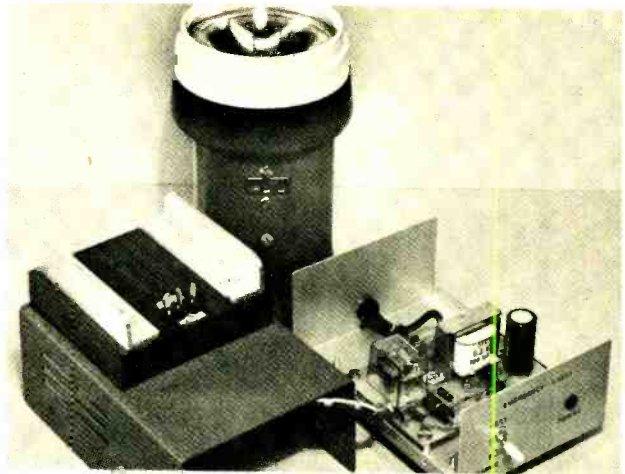

keep the LED secure. Slip the cover onto the utility box and secure it with the hardware provided for this purpose. This completes the assembly of the base/recharger.

It is necessary to modify the hand lantern that you choose. Disassemble the lantern, and find the "molding line" running down the middle of the housing. This can be used to accurately center the power jack *J1*. Cut a hole in the bottom of the housing that conforms to the power jack you will install. Use a very sharp safety knife to cut the plastic. Drill holes for the mounting screws for the jack and for a metal battery holder. Rather than soldering inside the lantern housing, prewire the components outside the housing as shown in Fig. 4. Replace the light bulb with a lower voltage unit (see accompanying box).

Do not solder the light bulb lead to the brass rivet on the back of the bulb's nylon retainer nut. Instead, remove the compression spring and solder the lead to one loop of spring. Then replace the spring and feed the wire through the hole in the rivet. To make bulb replacement more convenient, install a small in-line connector in the lead between the spring and terminal of jack *J1*. A U-shaped clip which fits around the barrel of the lamp socket is furnished with the lantern. Solder two leads to the clip, one of which is connected to terminal

3 of *J1*. Connect the other to *S2* as shown in the schematic. Note that *S2* is the lamp's original ON/OFF switch. Fasten the U-shaped clip to the lamp socket base. Complete the wiring of *J1* and *S2*, and then install two 1.25-volt NiCd batteries in the metal holder. Reassemble the lantern.

Testing. Make one final check of all wiring before applying power to the unit. Then, setting the lantern aside, plug the line cord into a wall socket. A distinct click should be heard as the relay is energized, and *LED1* should glow. If all is well, plug the lantern into the base/recharger. If *I1* lights up, switch it off with *S2*. (If this doesn't turn *I1* off, disconnect the line cord and recheck all wiring.) Allow the batteries to charge for about ten minutes with *S1* in the FAST position. Then simulate a power failure by disconnecting the line cord. The lantern should light up after a one-second delay. If the lantern checks out OK, plug the line cord back into the wall socket, and allow the batteries to charge for at least 16 hours.

Operation. The lantern should be placed where fail-safe illumination is most needed. After the initial charge (with *S1* in the FAST position), use the SLOW charge rate, as this will offer extended battery life and slightly lower consumption. ♦

Fig. 4. Modifying flashlight is best done by working outside the flashlight housing.

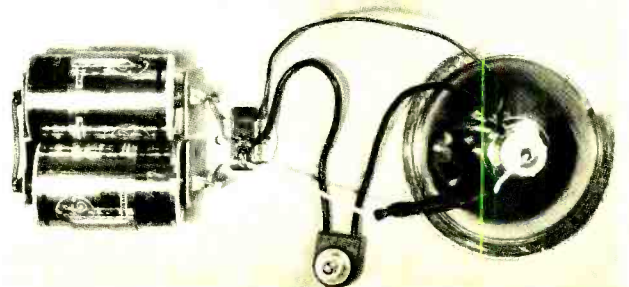

DURING the summer months, when power demands peak, brownouts are an all too common occurrence. As power companies cut back on the amount of voltage delivered to the ac outlets in your home, the picture on your TV receiver is likely to shrink and lose color, your lights might dim slightly, and some of your appliances may have difficulty operating on the unaccustomed low voltage. Some electrically operated appliances can even be irreparably damaged if they are operated on too low a voltage.

Most people just grit their teeth and try to bear with the inconveniences of the brownout situation. This is one way to approach the problem, but a more practical approach would be to use a device that will restore the line voltage level to normal. This is exactly what the Power Guard is designed to do. It is completely automatic. As the

line voltage begins to fall below a predetermined level, the Power Guard compensates for the reduction by boosting the voltage available at its output. Then, when the power company restores normal service, the Power Guard switches itself out of the line, to remain ready to go into action again when the next brownout occurs.

About the Circuit. A voltage-sensing circuit that operates a relay, causing it to switch a transformer in and out of the ac line is the heart of the Power Guard (see Fig. 1). The sensing circuit is made up of the voltage divider formed by *R1* and *R2*, neon lamp *I1*, and silicon controlled rectifier *SCR1*.

When switch *S1* is set to ON, line voltage is applied across the *R1/R2* divider network. Assuming that this potential is greater than 105 volts ac, *I1* will fire. This, in turn, indicates that the power available at the wall outlet is at a "normal" level. By adjusting *R2*, the line potential at which *I1* is triggered can be varied.

When *I1* comes on, it applies current to the gate of *SCR1*, triggering the silicon controlled rectifier into conduction and energizing relay *K1*. When this happens, the relay's lower set of contacts places output receptacle *SO1* directly across the ac line.

Capacitor *C1* across the solenoid of *K1* eliminates the possibility of relay chatter that would normally be caused by the rectified voltage coming through *SCR1*.

When a brownout occurs and the line voltages drops below the value predetermined by the setting of *R2*, *I1* extinguishes and removes gate current from *SCR1*. This causes the SCR to cut off on the next zero crossing of the line voltage and deenergizes *K1*. This, in turn, switches the secondary of *T1* into the circuit, which is designed to add the primary and secondary voltages. This "boosted" voltage is then delivered to *SO1*. The magnitude of the voltage boost depends on the secondary voltage of *T1* at the reduced line voltage. The point at which the boost comes into play depends on the setting of *R2*. (Note also that, when the boost circuit is operating, *I2* comes on to provide a visual indication that line voltage is down.)

Tracking, the opening and closing of the relay's contacts caused by minor changes in line voltage, is eliminated by *I1*. The reason for this is that the neon lamp's firing voltage is higher than that required to maintain it in the ionized state. So, while the lamp requires about 110 volts to fire, it will not extinguish until the line voltage drops to 105 volts.

CONSTRUCTION

THE POWER GUARD

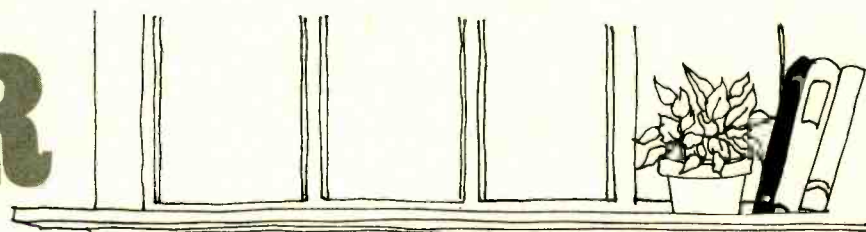

**Boosts voltage
and eliminates TV
picture shrinkage
during summer
brownouts**

BY JULES H. GILDER

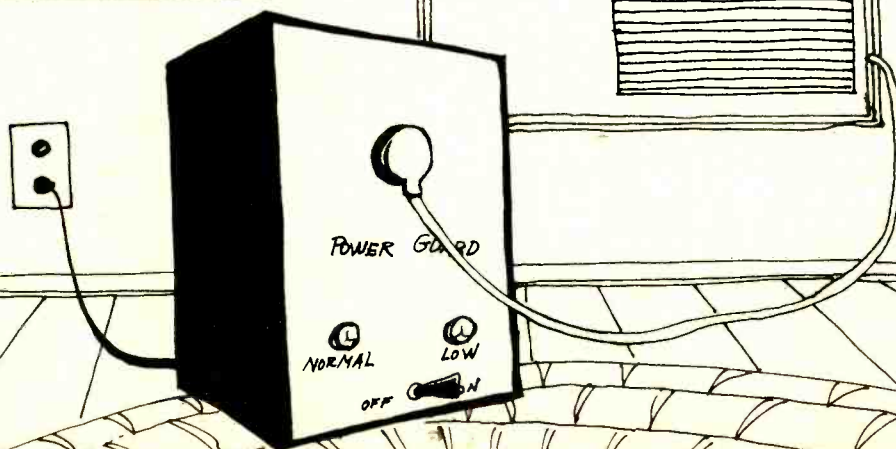

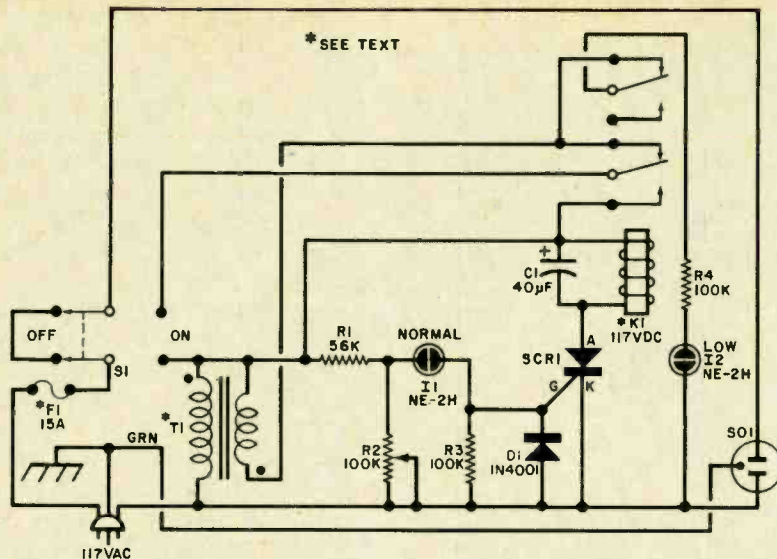

Fig. 1. Voltage-sensing circuit switches transformer in and out of circuit to keep voltage up during brownout.

PARTS LIST

C1—40- μ F, 200-volt electrolytic capacitor
 D1—Silicon rectifier (1N4001 or similar)
 F1—15-ampere fuse (3AB, 15A)
 I1, I2—NE-2H neon lamp
 K1—117-volt dc relay with dpdt contacts rated at 20 amperes or more
 R1—56,000-ohm, $\frac{1}{2}$ -watt resistor
 R2—100,000-ohm trimmer potentiometer
 R3, R4—100,000-ohm, $\frac{1}{2}$ -watt resistor
 S1—Heavy-duty dpdt power switch rated at 25 amperes or more
 SCR1—200-volt silicon controlled rectifier (HEP-R1211 or similar)

SO1—Three-contact chassis-mounting ac receptacle
 T1—Autotransformer (Allied Electronics Cat. No. 705-0144 16-ampere or 705-0104 8-ampere type) or high-current filament transformer (See text)
 Misc.—Metal chassis box; heavy-duty three-wire line cord with plug attached; fuse holder for F1; perforated board and solder clips; machine hardware; hookup wire; solder; etc.
 Note: A power relay, 15-ampere (about 1750-watt) transformer, and 15-ampere fuse are available from Jules Gilder, Rd#2, Box 458, Monticello, NY 12701, for \$17 plus \$3 postage.

Since most electrical appliances and electronic instruments are designed to operate properly on line voltages ranging from 105 to 125 volts, no change in performance will be noted until the line drops below 105 volts. Using this as the trigger point, you can add between 10 and 20 volts to the potential available during the brownout to obtain normal service.

Placing S1 in its OFF position effectively removes the Power Guard from the system. With S1 set to OFF, therefore, the line voltage is coupled directly to SO1.

Construction. The circuit of the Power Guard is very simple. Hence, it can easily and conveniently be assembled on a piece of perforated epoxy-fiberglass or phenolic board. The transformer can then be mounted on the floor of a metal case large enough to accommodate it and the board assembly without crowding. Don't forget to leave room for SO1 to mount on the front of the case and for the line cord exit hole and fuse holder

on the rear of the case. If you build a 15-ampere Power Guard, you should have no difficulty mounting all of its components in a standard (preferably steel) metal case measuring 9" \times 7" \times 6" (22.9 \times 17.8 \times 15.2 cm).

Since you will be working directly with line voltages, it is very important that you check all wiring carefully before you apply power. Make certain you use a three-wire line cord and connect the neutral (green) lead to chassis ground via a large solder lug and to the third contact on SO1.

It is best to use an autotransformer for T1. However, if you can't locate one, you can substitute an ordinary filament transformer. If you do use a filament transformer, you must take care to assure that the primary and secondary are properly phased to provide a boost in voltage. (The transformer's secondary must also be rated at a greater current than would be drawn by any load plugged into SO1.) To determine the proper phasing, wire the transformer as shown in Fig. 2 and measure the potential at the

"output" leads. Transpose the secondary leads and again measure the output voltage. The connection scheme that yields the higher voltage is the proper phasing setup.

Setup and Use. To use the Power Guard properly, it is necessary to first adjust R2 so that the system triggers SCR1 at the correct voltage level. The simplest way to adjust R2 is to plug the Power Guard into a variable transformer and decrease the potential applied to the system's power plug to 105 volts. If you don't have access to a variable transformer, a filament transformer connected as a "bucking" instead of "boosting" autotransformer can be used.

When the potential is 105 volts, adjust R2 so that I1 just extinguishes. At this point, the relay in the system should not be energized, and the booster winding in the Power Guard should be in the circuit. If you measure the voltage at SO1 it should be between 110 and 120 volts ac.

Once R2 has been adjusted for the proper triggering level, it need not be touched again. The Power Guard is ready to use.

Appliances can be permanently plugged into SO1 and the Power Guard's switch set to OFF when no brownouts are expected. Then, during the months when you can expect brownouts, just flip the switch to ON,

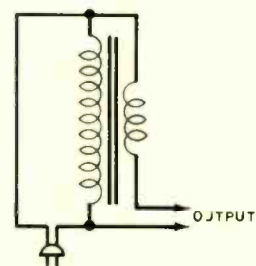
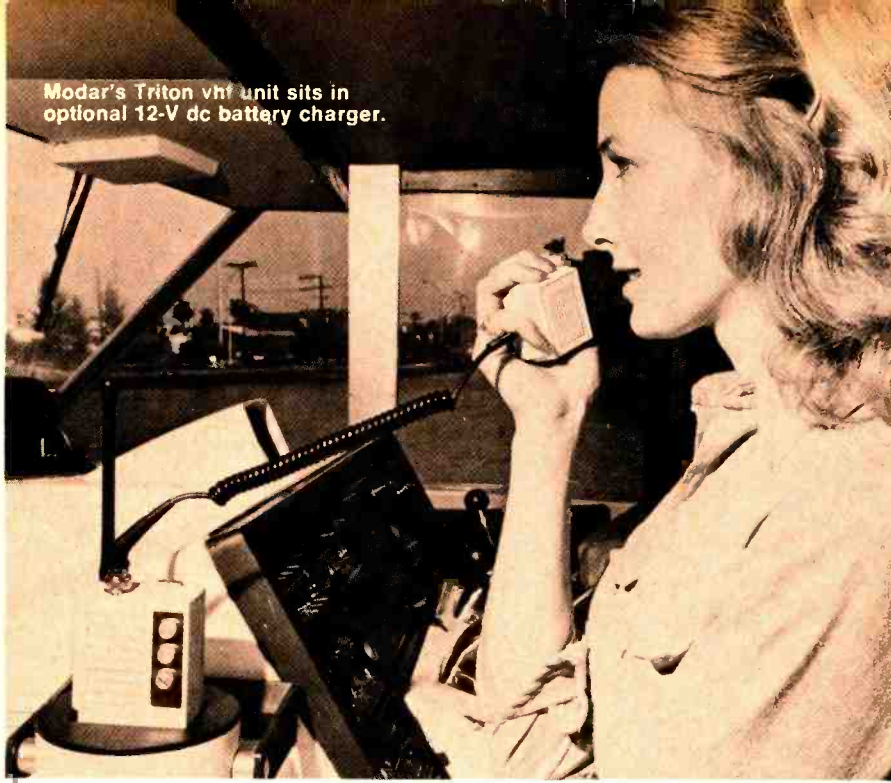

Fig. 2. Circuit to determine proper transformer phasing.

and the system will automatically adjust itself to the varying conditions as they occur.

If a high-current transformer is used for T1 and the contacts on K1 can handle the load, a single Power Guard can be used to service several appliances simultaneously. In this case, you can mount several SO1-type receptacles on the front of the Power Guard's front panel and wire them into the system in parallel with each other. Don't forget to also replace fuse F1 when you go to the higher power-handling capacity of the system. ♦

Modar's Triton vhf unit sits in optional 12-V dc battery charger.



WHAT'S NEW IN **MARINE** **RADIOTELEPHONE**

FCC rules changes, license requirements, and equipment overview.

BY LEN BUCKWALTER

PLEASURE-BOAT owners are sailing through the greatest change-over ever to affect marine radio. Since 1972, when the FCC ordered a five-year exodus from the old band on 2-3 MHz, more than half of the quarter-million radio-equipped boats have switched to the new system. They're now on vhf FM, a band that lies from 156 to 162 MHz and promises to alleviate the communications glut that choked the old channels. With the final deadline less than two years away, vhf FM is having a growing impact on every aspect of the marine radiotelephone—from the tip of the antenna (it's now shorter) to the ground plate (it's missing). Anyone planning to buy a boat or operate a radio should know something about the new band's benefits—and limits.

One big boon is that interference on vhf mostly disappears. Because the old band's medium frequencies skipped through the ionosphere, voices from

well beyond the horizon could clobber local communications. Even the Coast Guard complained that a distress call could be lost in the gibberish of voices on the frequency. That kind of "QRM" is just about licked on vhf because transmission range is barely more than line-of-sight; two stations almost have to "see" each other to exchange signals. Another vhf advantage is less susceptibility to ignition interference from the boat's own engine. It's partly due to the higher frequency, where spark plug and generator noises don't have much effect. Also, the modulation mode in the new service is FM, not AM, where a receiver does a better job of slicing away amplitude-modulated ignition noise (which creates most of the problem). You won't have to labor through a tedious, tricky suppression procedure to quiet the boat's electrical system.

You won't have to pay a hefty installation fee, either, because most vhf FM

models come in a "do-it-yourself" package. On the older band, a technician with a commercial radiotelephone ticket had to come aboard, tune the radio into the antenna and log the start-up. In many cases he'd also have the boat hauled out of the water to be fitted with a ground plate—a copper sheet fastened to the hull to act as an electrical counterpoise for the antenna. That's all done away with in vhf because the higher operating frequency allows self-contained antennas that need no external ground. These factors enable the manufacturer to pretune each set at the factory into a 52-ohm load, and eliminate a second tune-up when the radio is installed aboard ship. In a typical vhf FM installation, you merely mount the antenna at the highest point, run 52-ohm coaxial cable from set to antenna, and hook a dc power cable to the hot and ground side of the boat's 12-volt electrical system.

The current crop of marine radios also boasts a wholesale change-over to solid-state circuitry. Here the advantages multiply. Equipment cabinets are so small and unitized they'll fit under the dash of a runabout or even aboard a rowboat if you provide external battery power. The minuscule current drain of the receiver lets you monitor the emergency and calling channel for hours without running the risk of a dead boat battery.

Disadvantages. Are there any disadvantages to the new breed of marine radios? A lingering objection by old timers has been that no-one was on the new band to hear their calls—especially a shout to the U.S. Coast Guard in time of distress. There was some merit to that complaint until about 1974, when conditions vastly improved. By that time, the Coast Guard filled gaps in its radio coverage of most boating areas after erecting lofty new antennas atop buildings, towers and mountains. Now, if you call for help in some regions, you might communicate through one of the Guard's skypiercing towers up to 100 miles away.

The scarcity of other boats to talk to has also undergone dramatic change. As the deadline looms closer, the number of boats getting on vhf FM is growing in a geometric spiral. It's estimated that more than 130,000 of the marine radio fleet—more than half the total—is now licensed for the new service. There'll be stubborn holdouts



Raytheon 1205 SSB transceiver is for blue-water sailors.

on 2 MHz right up to the deadline at the end of 1976; but, they'll talk to fewer and fewer stations. After the cut-off date, the old-style AM marine radio will be worth no more than ballast.

One limitation of vhf FM for some might be its just-to-the-horizon range. Under normal conditions of antenna height, boat-to-boat communications reach out 20 or 30 miles, or about double that distance when talking to a shore station with a high antenna. Although these moderate distances should serve the needs of almost any boat under 30 feet, they're not intended for the blue-water sailor. When cruising offshore or ocean-racing beyond sight of land, the bigger boat should be equipped with SSB, or single-sideband, which can span hundreds of miles over water. Since SSB is an electronically sophisticated system, it is more costly than the customary vhf FM transceiver. For the same amount of transmitter wattage, an SSB station puts out a signal about six times more powerful and two SSB stations, thanks to a reduction in bandwidth, can operate where one AM station existed before. If your brand of long-distance sailing demands SSB, the FCC insists that you *first* install a regular vhf FM set. With SSB gear starting at about \$700, the electronics represent more than \$1000.00—a significant part of a boat's total cost.

The price of a typical vhf FM set is more than what the old timers paid for lower-frequency radios on 2-3 MHz back at the beginning of the decade. Inflation aside, the higher tag is due to more stages in both receiver and transmitter of the vhf rig. The set also

has more elaborate filtering for good selectivity. A current \$400 vhf FM transceiver, though, is a far cry from the \$1000 versions introduced to the market about six years ago. Today's prices are also significantly offset by the do-it-yourself nature of the vhf FM installation. Another plus: the sets are so compact and light, it's practical to pack them up and return them through the mail for factory service if no local technician with the required FCC ticket and right facilities is available.

About Rules. No matter what you need in the way of two-way radio, be sure you know the FCC deadlines to avoid chucking good equipment overboard or buying someone's white elephant. Here's how the rule changes might affect you:

1. *An old-type marine radio that operates on 2-3 MHz.* If you now own a boat with such a set installed, it's legal to use it until the deadline, January 1, 1977. Although the Coast Guard will monitor the distress frequency (2182 kHz) until the bitter end, the radio then becomes obsolete and illegal to operate.

2. *In the market for a boat?* Be wary if the prospective boat already has an old-type marine radio installed. If you become the new owner, and want to license the old rig, the FCC will deny your application. So don't let an old radio sweeten the seller's deal—you must install vhf FM if you file a license. The same restriction, incidentally, applies if you buy a secondhand radio. You won't be able to license an AM radio for installation aboard your boat. Any new boat you buy can take only the new-type, or vhf, radio.

3. *You lost your old-type radio in a storm.* This is a minor exception; you can replace it with an old-type radio. It will probably have to be a second-hand model, though, because manufacturers long ago stopped making the old-style AM sets. In any case, all old-style radiotelephones should utter a final gasp at the outset of 1977, so you'll be mighty lonely on the 2-3 MHz band.

Let's take a closer look at a typical vhf FM radio for a small cabin cruiser, runabout, or sailboat. Its price tag runs about \$350-\$450 for a model of 12-channel *capability*. The set, however, is factory-fitted with crystals for only three to five channels. Additional channels can be added at a later time or, in some cases, the manufacturer

sells a plug-in channel module for a do-it-yourself frequency addition. Since the module is sealed and pre-tuned, no technician's license is required. When you purchase additional crystals for a conventional set, a licensed technician is required to make the tuning adjustments. With crystals priced at about \$15 per channel, you can see that the number of factory-installed channels has a significant impact on a radio's price tag and should be considered when making your selection.

How Many Channels? At least two marine channels are mandatory for every boat-owner. One is channel 16, the distress, safety, and calling frequency monitored continuously by the Coast Guard and by many other boats. That channel is also the "calling" frequency to raise other boats. Once communications are established, the stations must move to another channel to avoid jamming channel 16.

The second mandatory channel is 6, the ship-to-ship safety channel. With every craft fitted with this channel, you're always assured of communications with someone within hailing distance. Two other extremely popular channels are 26 and 28, both reserved for the marine operator (or "Public Correspondence"). By raising the marine operator, you can place a land-line call to any telephone or even another boat hundreds of miles



At top is Realistic's TRM-12 12-channel rig. Pearce-Simpson Catalina, above, has batteries.

beyond your communicating range. Once you have safety and telephone-company channels, other crystals may be added to cover frequencies assigned to local marinas, yacht clubs, and other local organizations. A weekend boatman should be able to satisfy his communications needs with approximately six to nine channels. Only far-ranging vessels require, say, 20 channels (out of a possible 38) in a set that costs upwards of \$1000.

Almost any vhf set will have one crystal in the receiver section for picking up continuous marine weather from a network of National Weather Service stations strung along every major waterway of the U.S. In most cases, the frequency is 162.55 MHz, but check your local area for possible exceptions on 162.40 MHz. A good source of local frequency information is a nearby marine dealer. If you want to follow the FCC's basic suggestions on channels, see the accompanying table.

Besides the total number of channels, transmitter power also influences the price of a marine radio. Many sets offer a maximum of 25 watts, the legal limit, but there are lower-cost units of 10 watts, or even

less. Power won't make much difference in range unless something is operating at less than highest efficiency in your transmitting system, or the distant station has a poor receiver of low sensitivity. Any set you buy has a transmitter power switch with two positions; the first delivers full r-f power, while the other position reduces r-f output to one watt. This minimizes interference to other radios while you're talking to a nearby boat.

The range of marine communications depends heavily on the antenna. With vhf's straight-line propagation, a higher antenna position on the boat improves the signal's ability to look farther over the horizon. Most popular design is the fiberglass whip with its excellent immunity to the weather. The fittings are plated with chrome or other stainless metal. As mentioned earlier, these antennas need neither tuning nor ground plates. A quarter wave on 2.5 MHz, for example, is almost 100 feet long, which means a vertical whip on the old band is electrically lengthened by tuning at the transmitter. At 156 MHz, on the other hand, a quarter wavelength is only 1.5 feet so antenna elements can be physically resonant to the signal without

external tuning. In actual practice, however, vhf marine antennas are somewhat longer than 1.5 feet to improve signal strength by compressing the radiation pattern to lower angles (where the distant boats lie). Typical marine antennas run about 4 to 9 feet long and come with 52-ohm coaxial cable that can be cut to any length. A solderless connector is often supplied so you can route the cable between antenna and transmitter and easily trim it to size.

Licenses. Licensing a marine radio is easier than ever. No professional help is required to obtain, fill out, and file the forms. You'll need two applications—one for an operator's license, the other to license the station—and both are secured from the FCC's nearest field office. (Look under "U.S. Government" in the phone book if you don't know where it is.) By phone or mail, ask for FCC form 502 for the station license and FCC Form 753-A for the radiotelephone operator's permit. These papers include helpful instructions, but here's what you can generally expect:

Restricted Radiotelephone Permit. This is the operator's license, good for life, at a one-time fee of \$8. There are no technical questions to answer and the form is mostly a declaration that you're not an alien.

Station License. This one is issued for a five-year period and costs \$20 initially, and each time the license is renewed. Since it takes three to six weeks to receive a shipboard license, a local FCC office can issue you an interim 6-month permit on the spot for a \$5 fee. You can get on the air right away and you'll receive the identical call letters when the regular station license arrives.

According to Lou Arnone, an official in the marine division of the FCC's Washington office, the greatest problem with licensing today is when the radio-owner fails to notify the Commission of a change of address: Far from a minor matter; it ultimately causes FCC computers to do battle with undelivered renewal forms, send registered letters and, finally, begin a legal proceeding that could revoke a ship's license. It costs nothing, he points out with a bit of irony, to have the address changed. And sailing without a marine radio could prove much more inconvenient when you're slowly drifting out of gas toward someplace like Tahiti. ♦

Channel Designators	Type of Communications	Recreational Vessel Channel Capability					
		4	6	8	12	16	24
16 (Mandatory)	Distress, Safety & Calling (Intership & ship-to-shore)	*(Number of recommended channels each group)					
		1	1	1	1	1	1
06 (Mandatory)	Intership Safety (Intership)	1	1	1	1	1	1
65, 66, 12, 73, 14, 74, 20	Port Operations (Intership & ship-to-shore)		1	1	2	3	7
13	Navigational (Intership & ship-to-shore)				1	1	1
15 & 162.550 MHz	Environmental (Ship receive only)			1	1	2	2
17	State Control (Ship-to-shore)				1	1	1
07, 09, 10, 11, 18, 19, 79, 80	Commercial (Intership & ship-to-shore)						
67, 77, 88, 08	Commercial (Intership)						
68	Non-Commercial (Intership & ship-to-shore)	1	1	1	1	1	1
09, 69, 71, 78	Non-Commercial (Ship-to-shore)		1	1	1	1	3
70, 72	Non-Commercial (Intership)				1	2	2
24, 25, 84, 85, 26, 27, 86, 87, 28	Public Correspondence (Ship-to-shore)	1	1	2	2	3	5



BUILD A

SEMICONDUCTOR LASER COMMUNICATIONS SYSTEM

State-of-the art communicator

uses pulse modulation to achieve a

possible range greater than 3000 feet.

BY FORREST M. MIMS

COMMUNICATING on a light beam is fairly common with light-emitting diodes ("Experimenting With Light-Beam Communications," POPULAR ELECTRONICS, April 1975, p. 40), but for longer distances and greater efficiency, a laser light source is recommended. With the system described here, it is possible to get a range of more than one kilometer (3300 ft). Since it uses a PIN photodiode in the receiver, the system can be operated in daylight or darkness without an expensive infrared filter.

Though most light-beam communicators use amplitude or intensity modulation, this system employs pulse-frequency or pulse-rate modulation (PFM or PRM). This type of modulation is almost immune to transient atmospheric effects and noise from interfering light sources. Also, the output signal from the PFM receiver is constant in amplitude over the entire communicating range, while that from an AM system becomes progressively weaker as range is increased.

Transmitter. As shown in Fig. 1, a modular amplifier (AMP1) boosts the voice signals from a dynamic microphone. In a pulse-frequency modulator (Q1 and Q2), Q2 is a UJT connected in a relaxation-oscillator mode. With no input from AMP1, Q1 is saturated (with very low emitter-to-collector resistance) and Q2 oscillates at a frequency determined by the time constant of C2 and R6. When an input is present on the base of Q1, the frequency of Q2 is varied in direct proportion to the amplitude of the modula-

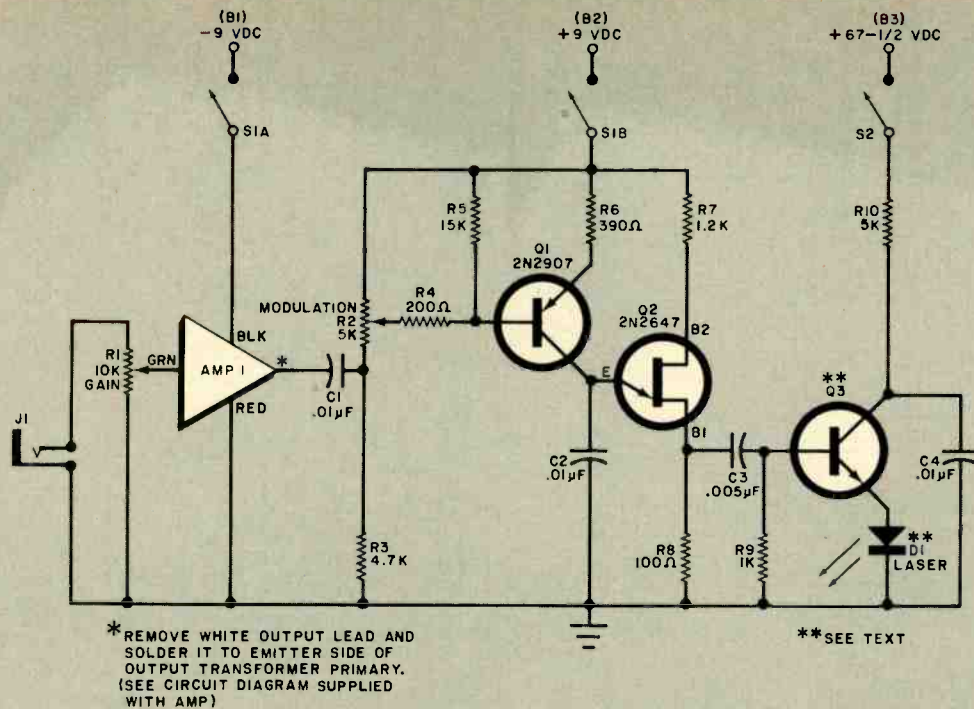

Fig. 1. A commercial modular audio amplifier modulates a UJT oscillator to drive the laser.

PARTS LIST (TRANSMITTER)

AMP1—Modular audio amplifier (Radio Shack 277-1240 or similar)
 B1, B2—9-V transistor radio battery
 B3—67½-V battery (Eveready 457 or similar)
 C1, C2—0.01- μ F capacitor
 C3—0.005- μ F capacitor
 C4—0.01- μ F, 100-V capacitor (disc or paper only)
 D1—Laser diode (see table at right)
 J1—Microphone jack
 Q1—2N2907 transistor
 Q2—2N2647 UJT
 Q3—Selected npn switching transistor (see text)
 R1—10,000-ohm potentiometer

R2—5000-ohm potentiometer
 R3—4700-ohm, ¼-W resistor
 R4—200-ohm, ¼-W resistor
 R5—15,000-ohm, ¼-W resistor
 R6—390-ohm, ¼-W resistor
 R7—1200-ohm, ¼-W resistor
 R8—100-ohm, ¼-W resistor
 R9—1000-ohm, ¼-W resistor
 R10—5000-ohm, ½-W resistor
 S1—Dpdt toggle switch
 S2—Spdt toggle switch
 Misc.—LMB B-H 643 enclosure, lens, battery retainers and clips, brass tubing, telescope, mounting hardware, 200-ohm dynamic microphone, epoxy, pc board, solder, etc.

SUITABLE LASERS

	RCA SG2001	RCA SG2002	RCA C30025	LDL LD22
Power output (W)*	1	2	0.5	6
Threshold current (A)	4	4	1.5	8
Peak current (A)	10	10	5	25

*Typical power output at peak forward current.
 Note: The prototype laser has been successfully operated with all three of the RCA lasers listed above.

Addresses: The manufacturers will provide current prices and specifications upon request. Write to: RCA, Electronic Components, Box 1140, New Holland Pike, Lancaster, PA 17604; Laser Diode Laboratories (LDL), 205 Forrest St., Metuchen, NJ 08840.

tion frequency. The center frequency is determined by the setting of R2.

The resulting PFM signal across R8 triggers a laser drive circuit comprised of relaxation oscillator C4, Q3, R10, and D1. Transistor Q3 is an npn switching transistor operated in a nonconventional avalanche mode. A charge is placed on C4 through R10 until the breakdown voltage of Q3 is reached. The capacitor then discharges through Q3 and the laser. The pulse is very fast (50 ns) and high in current (5 to 10 A) to fire the laser. The cycle then repeats. The large current surge does not mean that the battery has to supply 5 or 10 amperes. The surge comes from the charge stored on the capacitor.

Transistor Q3 oscillates independently of the modulator even when

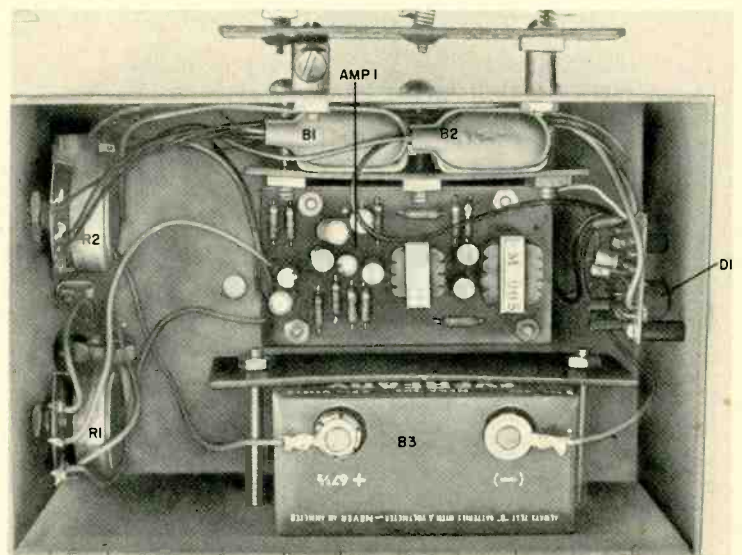

Photo shows layout of prototype transmitter. Mounting for boresighting telescope is at top.

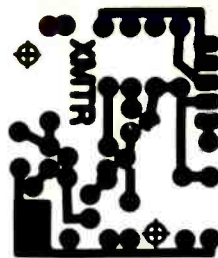
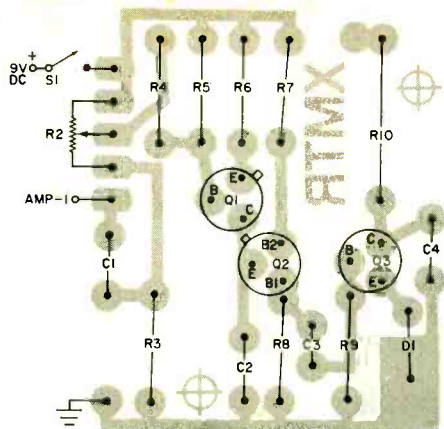

Fig. 2. Actual-size etching and drilling guide for transmitter is above. component layout at left.

the latter is in the relaxation mode. However, with an input, the oscillation varies with the signal. Potentiometer *R2* adjusts the carrier frequency to achieve the best modulation. A carrier of about 20 kHz gives the best results for the circuit used here. This is much higher than the 6 or 8 kHz required for acceptable voice transmission and insures good quality for both voice and music.

The transmitter is assembled on a printed circuit board as shown in Fig. 2. All components can be installed after the board is prepared, with the exception of *Q3* and the laser diode. Transistor *Q3* must be selected by using a test jig such as that shown in Fig. 3, which measures breakdown voltage. Ideally, a 15-MHz oscilloscope should be used to measure the current delivered by the transistor under test. This is done by measuring the pulse voltage across *R3* in the test circuit. Since this is a 1-ohm resistor, the voltage measured is equal to the current.

If a 15-MHz scope is not available, a lower-bandwidth scope, connected across *C1*, can be used to measure the transistor's breakdown voltage. The graph in Fig. 4 can be used to deter-

mine the peak current delivered by the transistor.

Not all transistors will oscillate in the test circuit. For best results, try common npn switching transistors such as 2N914, 2N2222, 2N3643, 2N4400, 2N5188, HEP50, etc. Select a transistor that gives a peak current between the laser's threshold and peak-allowable currents (as specified by the manufacturer). High currents give high output power. Install the transistor on the pc board and note its current for future reference.

Several lasers can be used, as listed in the table. Do not install the laser yet. Instead, connect an infrared LED (SSL-55C, TIL31, TIL27, etc.) in the circuit for preliminary testing. This permits you to get the circuit operating properly without the possibility of damaging the laser diode.

Receiver. In the receiver (Fig. 5), infrared radiation from the laser strikes PIN photodiode *D1* and generates a current which is amplified by *IC1*. Capacitive coupling between amplifier stages blocks dc signals from ambient sunlight and other light sources.

The output of *IC1* can be fed directly to an earphone for AM operation. For

PFM, however, a threshold discriminator is necessary. The monostable multivibrator composed of *Q1* and *Q2* forms the threshold circuit. When an amplified pulse from *IC1* exceeds the trigger threshold of the multivibrator (a few tenths of a volt), *Q2* delivers a pulse of constant width and amplitude. This can be picked up at the collector of *Q2*, but best results are obtained by adding an amplifier (*AMP1*) for loudspeaker operation.

The pc board for the receiver is shown in Fig. 6. Use care when installing the IC to avoid bridging the copper portions.

Receiver sensitivity can be improved somewhat by the addition of potentiometer *R7*, which can be adjusted to reduce the threshold of the multivibrator and permit detection of weak signals. (There is no provision for *R7* on the pc board. It can be added by removing a short section of foil from the negative line to *Q1* and *Q2* and soldering the potentiometer's leads across the gap.)

The photodiode used in the prototype was a high-quality EG & G device costing about \$15. This diode has a highly linear response and can be operated in broad daylight. Less expensive detectors (even ordinary silicon solar cells) can also be used; but light baffles, shields, or an infrared filter will be necessary for daylight operation.

Assembly. Check the pc boards for errors and then mount them in suitable enclosures. The enclosures noted in the parts lists were used in the prototype because the hinged lids permit rapid access to the batteries and pc boards.

Assemble the receiver first. Use a chassis punch or nibbling tool to cut a hole in one end of the cabinet for the lens. A 2" plastic lens was used in the prototype, but most any simple lens can be used as long as its focal length is 4 1/4" or less. The larger the lens, the better its light gathering power.

Use L brackets to mount the pc board in the enclosure with the photodiode at the exact center of the lens opening. For the lens given in the parts list, the diode should be exactly 4 1/4" from the inside cabinet wall in which the lens hole is cut.

Mount the threshold adjust pot (*R7*, if used), gain control (*R15*), and power switch (*S1*) on the end of the case opposite the lens opening. Use appropriate mounting hardware for the

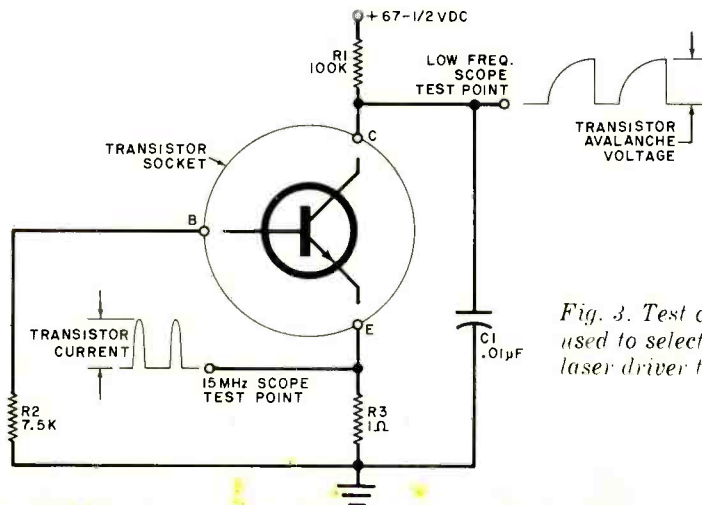

Fig. 3. Test circuit used to select laser driver transistor.

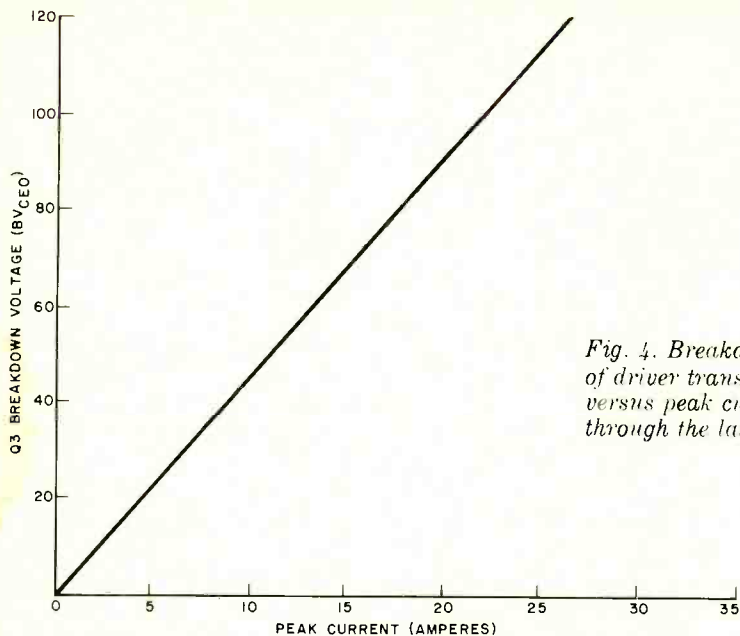

Fig. 4. Breakdown voltage of driver transistor versus peak current through the laser diode.

speaker, AMP1, and the two 9-volt batteries. Scraps of pc board 1" x 3" make good battery retainers. Use rubber grommets as standoffs for AMP1. Complete receiver assembly by wiring

the various components to one another. Then mount the lens using a flexible adhesive such as Dow Corning Silastic". The plastic lens mentioned in the parts list can be mounted

by bending its shoulders with a hot soldering iron.

There are two steps to the transmitter assembly. First, prepare appropriate mounting holes for the controls, hardware, and lens tube assembly. A 9/16" hole should be adequate for the lens tube. Then install all components and batteries except the laser pc board. Make the necessary connections to the board but don't mount it.

Install an infrared LED (note proper polarity) instead of the laser. Test the receiver by pointing it toward a line-powered incandescent lamp. If the receiver is properly aligned with respect to the lamp, a 120-Hz buzz should be heard from the speaker.

Now point the transmitter LED toward the receiver lens and turn on the power. Talk into the microphone or place it near a radio while adjusting R2. It should be possible to get good-quality audio from the receiver. If not, make sure the transmitter LED is properly aligned with respect to the receiver. Then try adjusting R7 in the

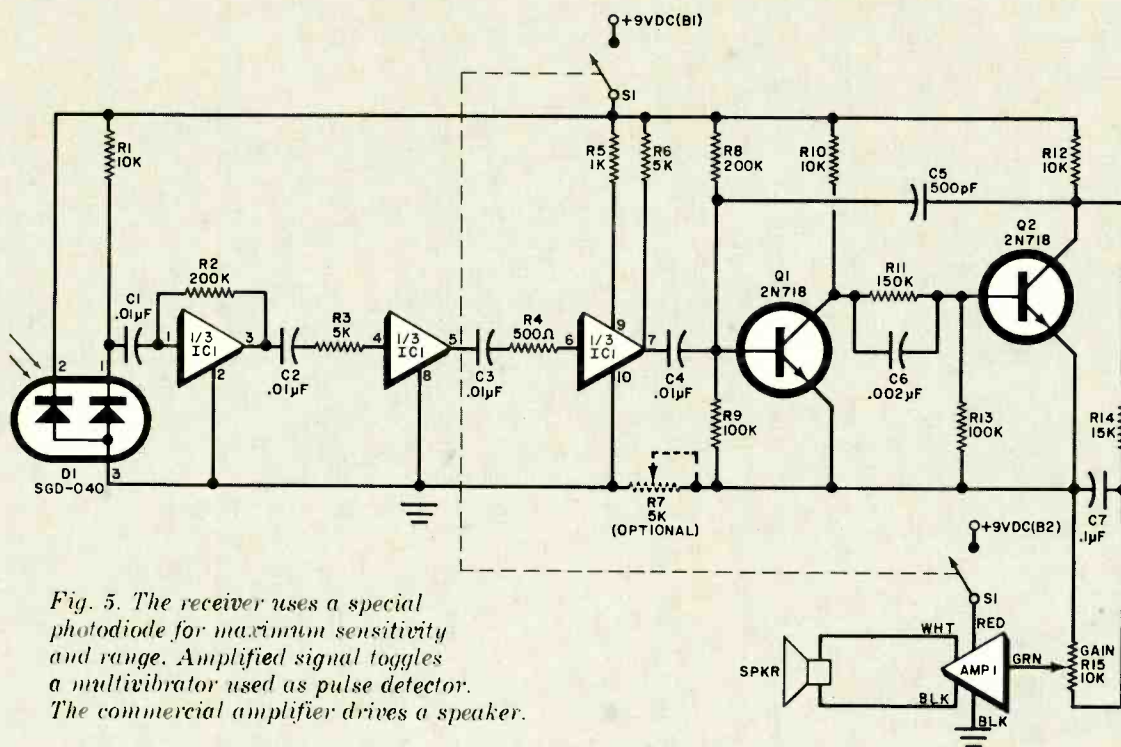

Fig. 5. The receiver uses a special photodiode for maximum sensitivity and range. Amplified signal toggles a multivibrator used as pulse detector. The commercial amplifier drives a speaker.

PARTS LIST (RECEIVER)

- AMP1—Modular audio amplifier (Radio Shack 277-1240 or similar)
- B1, B2—9-V transistor radio battery
- C1 to C4—0.01-μF capacitor
- C5—500-pF capacitor
- C6—0.002-μF capacitor
- C7—0.1-μF capacitor
- D1—SGD-040B PIN photodiode (EG&G; available from Cramer Electronics, 85 Wells Ave., Newton, MA

- 02159, for \$15 plus postage; see text)
- IC1—CA3035 amplifier array (RCA)
- Q1, Q2—2N718 npn switching transistor (or equivalent)
- R1, R10, R12—10,000-ohm, ¼-W resistor
- R2, R8—200,000-ohm, ¼-W resistor
- R5—1000-ohm, ¼-W resistor
- R3, R6—5000-ohm, ¼-W resistor
- R4—500-ohm, ¼-W resistor
- R7—5000-ohm potentiometer (optional, see text)

- R9, R13—100,000-ohm, ¼-W resistor
- R11—150,000-ohm, ¼-W resistor
- R14—15,000-ohm, ¼-W resistor
- R15—10,000-ohm potentiometer
- S1—Dpst toggle switch
- Spkr—8-ohm miniature speaker
- Misc.—LMB B-H 643 enclosure, lens, battery retainers and clips, mounting hardware, cement, solder, pc board, etc.

receiver. If no signal is heard, check the transmitter wiring. Also, the LED may be bad, Q3 may not be oscillating, or one or more of the batteries may be weak.

Proper operation of the system is obvious since a slight misalignment of the transmitter with respect to the receiver will cause loud noise and oscillation from the receiver and then silence. This illustrates the PFM mode of operation. Unlike simple AM systems, a PFM light-beam communicator gives constant receiver amplitude at all ranges out to the threshold cut-off point.

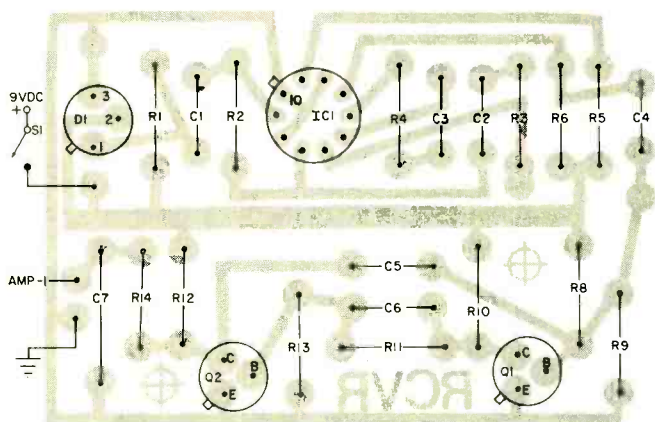

Fig. 6. Actual-size etching and drilling guide for receiver at right. Component layout is at left.

mount the laser pc board in the cabinet. A telescoping lens tube made as shown in Fig. 7 is inserted in the tube receptacle. Use a simple lens with a diameter of 12 to 15 mm and a similar focal length. Use epoxy to secure the lens in place.

Optical Alignment. Both transmitter and receiver must be aligned with infrared light for best results. This is no problem with the receiver if the lens called for in the parts list is used since its infrared focal length is 4 1/4". For other lenses, add perhaps a quarter of an inch to the visible focal length.

Alignment of the transmitter is more difficult due to the small size of the laser source. An approximate alignment can be made by placing the lens a millimeter or so farther from the laser chip than the visible focal length

SAFETY CONSIDERATIONS

The GaAs laser used in this system has a peak optical power output of a few watts if operated at maximum current. That is a lot of light compared to the output of low-power helium-neon lasers; but the optical pulses are brief so that the average power is far less than that of most helium-neon devices.

According to the U.S. Air Force School of Aerospace Medicine, GaAs lasers emitting 10 watts per pulse are not capable of producing detectable eye damage. Three principal factors contribute to this safety margin: the absorption of the infrared in the eye's vitreous humor, imperfect focusing of the infrared, and the laser's low average power.

Nevertheless, a few basic precautions must be followed to insure utmost safety:

1. As with any source of bright light, do not look directly into the laser beam.
2. Avoid pointing the laser at shiny surfaces (mirrors, unpainted metal, etc.) because reflected light can be as potentially dangerous as direct light.
3. Do not point the laser in a direction in which bystanders might look into the beam.
4. Turn off the laser transmitter when it is not in use, to preserve its life and that of the battery.

current delivered by the meter will destroy the laser chip.

With the laser in place, test the system again. If it works properly, a 1/2" length of brass tubing (available from hobby shops) is carefully soldered to the back of the pc board with the laser chip at the exact center. Cut a slot from the tube as shown in Fig. 7 to prevent possible shorts. If the tube is not soldered properly the first time, try again until it is centered and level. This tube becomes the laser lens receptacle.

Next use two 7/16" standoffs to

of the lens. An approximate alignment will give a broad beam suitable for communications up to about 1000 feet. For long ranges, the beam must be made nearly parallel by adjusting the lens for as small a beam spread as possible. This is easily done if an infrared image converter is available.

Surplus sniperscopes are ideal for this purpose, but they are expensive. Kodak makes infrared-sensitive phosphor screens which glow orange when struck by a beam from an IR laser or LED. These screens cost about \$25 (a lot less than electronic

Photo of receiver prototype. Leave a clear path for light to hit diode.

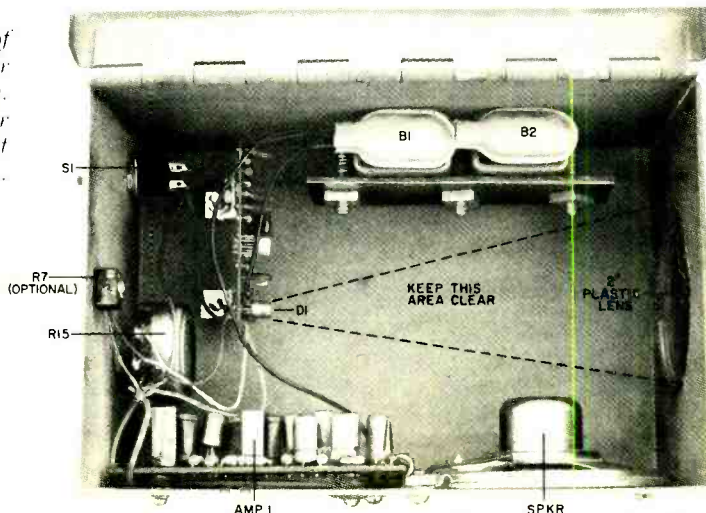

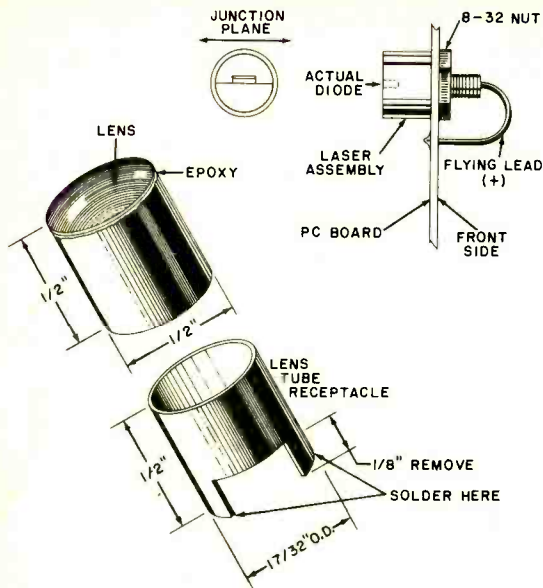

Fig. 7. Mounting details for laser and lens tube.

image systems). Write Special Product Sales, Kodak Apparatus Div., Eastman Kodak Co., Rochester, NY 14650 for details and prices.

Align the laser lens by pointing the beam at a white card (or the phosphor screen) at least 3 feet away and focus the lens for the smallest spot size. Use the infrared viewer to see the spot if the white card is used.

When the optimum focus point for the lens is found, use white glue to secure the lens in place and prevent need for realignment.

Telescope Alignment. Range tests of a few hundred feet are relatively straightforward, but long-range operation requires the addition of an alignment telescope for the transmitter. You can use any spotting or rifle telescope of 3X to 10X as long as it has a cross hair. For the sake of economy, in the prototype, an inexpensive 10X pocket telescope was obtained from

Radio Shack for about \$3 (Cat. No. 63-844). (Also available from other electronics outlets.) A cross hair was added by cementing two human hairs to a $\frac{3}{8}$ " washer which was then cemented to a shoulder inside the telescope eyepiece section.

The telescope must be boresighted with the laser. Make an adjustable mount similar to the one shown in Fig. 8. Use two sections of pc board for the mounting platform. Solder three nuts to the back of one board and use springs to permit adjustment.

Aligning the telescope is fairly easy if a phosphor screen or infrared viewer is available. The transmitter is mounted on a tripod with an appropriate nut and the laser is caused to illuminate a fixed spot at least 50 feet away. The telescope is then aligned until the crosshair falls on the target. Recheck the laser to make sure it still illuminates the target and alignment is complete. Perform the alignment at

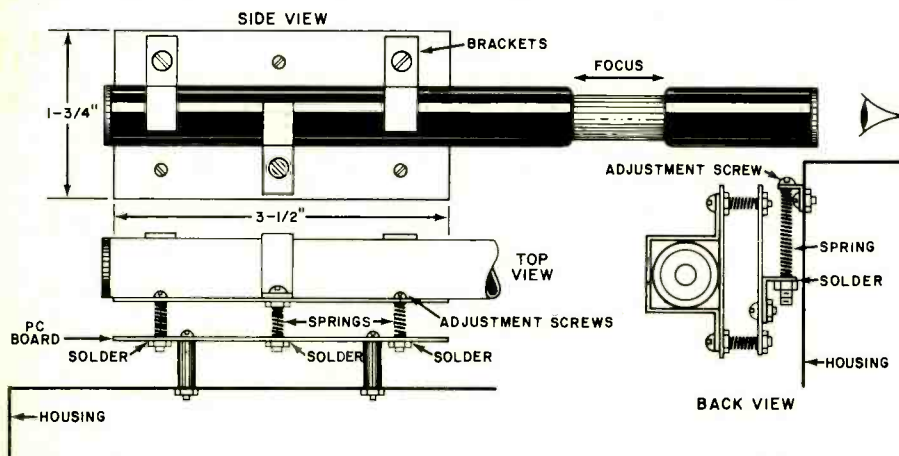

Fig. 8. Details for mounting the telescope which is used to boresight the transmitter.

night for fast results and use a flashlight to illuminate the target when the telescope is being used.

Range Testing. When the telescope is boresighted with the laser, the system is ready for long-range testing. Begin by mounting the laser on a tripod and pointing the telescope at a fence post, car, or other object at least 1000 feet away. Place the microphone near a radio to get a continuous audio signal. Proceed to the target site, and point the receiver toward the transmitter. It will be necessary to move the receiver about until the optimum detection angle and point are found. If no signal is received, the laser beam has probably crossed the telescope field of view at a point beyond the range of the initial alignment target. Therefore, proceed a few feet toward the telescope side of the laser until the signal is received. An infrared viewer is helpful in finding the brightest spot in the projected beam (which is only a few feet across at $\frac{1}{2}$ mile).

Once test techniques for a 1000' range have been perfected, longer ranges can be tried. These tests will be simplified by compensating for the laser-beam crossover problem by appropriately adjusting the horizontal telescope adjustment.

The prototype communicator has been used to achieve a range of 3380' (1.03 km). This could be increased to well over a mile by increasing the laser current, reducing the transmitter beam width, or increasing the receiver lens size. For example, the prototype uses a laser with a threshold current of 4.1 amperes. While the laser can be operated at a top peak of 10 A, transistor Q3 delivers only about 5 A. Therefore, the laser output is only a few hundred milliwatts, while more than a watt would be available at 10 A. With the full 10-A current, the optical-communication range equation shows that range would be slightly more than doubled.

Similarly, a diverging beam of light follows the inverse square law, so doubling the diameter of the receiver lens from 2 to 4 inches will double the range.

More Information. For further reading on laser communications, see: *Semiconductor Diode Lasers*, R.W. Campbell and F.M. Mims, Howard W. Sams & Co., 1972; and *Light Beam Communications*, F.M. Mims, Howard W. Sams & Co., 1975. \diamond

A LOW-COST AUDIO- FREQUENCY METER



Four ranges from 5 Hz to 50 kHz.

BY CHARLES GREEN

FOR experimenters who do a lot of work in the audio-frequency range, but can't afford a modern frequency meter, here's an easy-to-build, low-cost unit that may just fill the bill. The meter measures frequency (sine or square waves) from 5 Hz to 50 kHz in four switch-selectable ranges. Sensitivity is 0.2 volt rms over most of the range.

Circuit Operation. As shown in Fig. 1, the input signal at *J1* is amplified by *Q1*, a high-input-impedance FET. In *IC1*, a differential dc amplifier arranged in a Schmitt trigger configuration, the waveform is squared off. It is further amplified by *Q2*, another FET. Zener diode *D1* limits the output swing to 9.1 volts.

The waveform then passes to diode array *IC2*, whose circuit includes switch-selected capacitors (via *S2A*) and resistors (via *S2B*) which differentiate the square wave into a series of sharp fixed-amplitude pulses. The rectified dc from the diode array drives the meter, *M1*. The average indication on *M1* is proportional to the number of pulses per second from the differen-

tiator, the number of pulses being determined by the frequency of the input.

Construction. Since only low frequencies are involved, neither the layout nor wiring of the meter is critical. In the prototype, adhesive-backed copper strips and pads were used (Circuit-Stik, Quick-Circuits, Circuit-Zaps, etc.) These are available through many mail-order houses. A simpler way might be to use perforated board, with clips and sockets to mount the components.

The enclosure should be just large enough to mount the switches, meter, and input jacks on the front. Mount the circuit board on spacers on the bottom of the enclosure and the battery assembly of two sets of four AA cells in holders on the rear wall. Use press-on type to identify the components on the front panel. Carefully remove the front cover of the meter and, using a small piece of white paper with the letters Hz on it, cover the μ A marking on the meter scale.

Calibration. To calibrate the meter,

you will need an audio-frequency generator (or other known frequency source) covering the range from 50 Hz to 50 kHz.

Before turning on the power to the meter, make sure that the needle indicates zero. If necessary, use the zero-adjust screw to set the needle on zero.

Set RANGE switch *S2* to X1000 and turn on the power. Connect the high output of the signal generator to *J1* and the ground to *J2*. Adjust the audio generator for an output of 20,000 Hz at 0.2 volt rms. You may have to adjust potentiometer *R14* to keep the meter from going off scale.

Adjust *R7* (in the *IC1* circuit) for maximum meter indication. Slightly reduce the audio generator output and readjust *R7* for maximum meter indication. Repeat the process until the best sensitivity has been attained (the lowest generator output voltage that will cause *M1* to indicate).

Set the audio generator to 50 Hz at about 1 volt rms and set the RANGE switch on X1. Adjust potentiometer *R11* to get a reading of 50 (full scale) on the meter.

Set the audio generator to 500 Hz

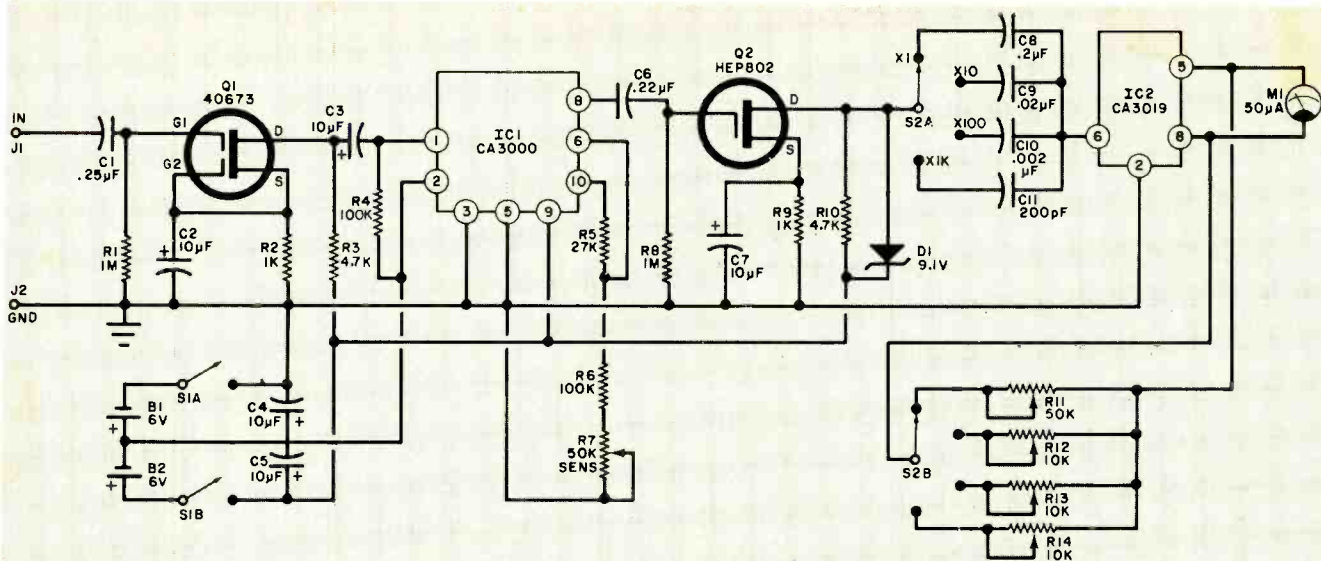

PARTS LIST

B1, B2—6-volt battery (4 AA cells in series)
 C1—0.25-µF, 100-V ceramic or paper capacitor
 C2 to C5, C7—10-µF, 6-V electrolytic capacitor
 C6—0.22-µF, 12-V ceramic or paper capacitor
 C8—0.2-µF, 10%, 12-V ceramic or paper capacitor
 C9—0.02-µF, 10%, 12-V ceramic or paper capacitor

C10—0.002-µF, 10%, 12-V ceramic or paper capacitor
 C11—200-pF, 10%, 12-V ceramic or paper capacitor
 D1—9.1-V, 1-W zener diode (HEP104 or similar)
 IC1—CA3000 dc amplifier (RCA)
 IC2—CA3019 diode array (RCA)
 J1, J2—Banana jack (one red, one black)
 M1—50-µA meter (Midland 23-200 or similar)
 Q1—40673 dual-gate FET (RCA)
 Q2—HEP802 FET
 R1, R8—1-megohm, ½-W, 10% resistor
 R2, R9—1000-ohm, ½-W, 10% resistor
 R3, R10—4700-ohm, ½-W, 10% resistor

R4, R6—100,000-ohm, ½-W, 10% resistor
 R5—27,000-ohm, ½-W, 10% resistor
 R7, R11—50,000-ohm pc potentiometer (Radio Shack 271-219 or similar)
 R12 to R14—10,000-ohm pc potentiometer (Radio Shack 271-218 or similar)
 S1—Dpdt switch (Calectro E2-105 or similar)
 S2—2-pole, 5-position nonshorting rotary switch (one position not used) (Calectro E2-163 or similar)
 Misc.—Aluminum cabinet (LMB 442 or similar), battery holders, mounting hardware, wire, solder, etc.

Fig. 1. High input impedance is provided by FET Q1. IC1 is Schmitt trigger and IC2 is a diode array.

and the RANGE switch to X10. Adjust R12 to get full scale reading of 500 on the meter.

Repeat these steps for the X100 and X1000 ranges, using 5000 and 50,000 Hz inputs and adjusting R13 and R14 respectively.

Disconnect the audio generator and install the metal cover on the frequency meter.

Operation. The one-megohm input resistance (and the high impedance of Q1) places minimum loading on any

circuit being tested. The basic sensitivity of 0.2 volt rms is good from about 30 Hz to 40,000 Hz, but the actual sensitivity depends on the particular FET used for Q1. From 5 Hz to about 30 Hz the sensitivity is approximately 0.4 volt rms. The maximum input voltage is determined primarily by the voltage rating of Q1 (which has no internal diode protection gate).

When measuring an unknown frequency, always use the highest range first and then switch down until the meter indicates on scale. If the voltage of the unknown signal is not higher than the basic sensitivity of the meter (at least 0.2 volt rms) an erroneous frequency indication may be observed. Always measure the voltage value of the unknown frequency before measuring its frequency. If necessary, use some form of voltage divider at the input to the frequency meter.

At periodic intervals, check the battery voltage and, if necessary, recalibrate the frequency meter to compensate for changes in characteristics due to component aging.

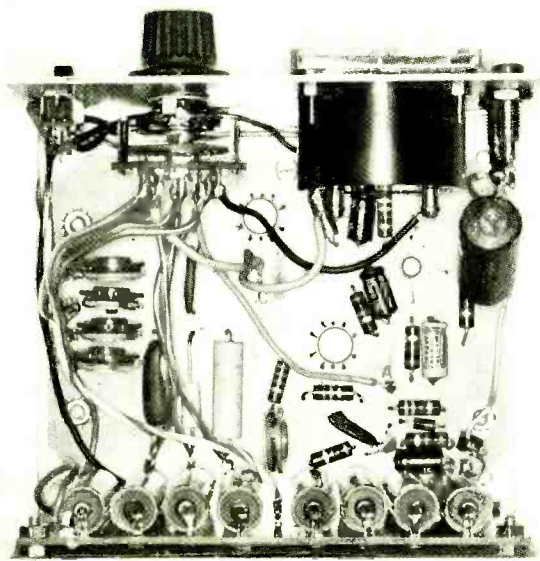

Photo shows the arrangement of the author's prototype.

A NEW NATIONAL TV NETWORK ?

*Communication satellites may make a
national pay TV network a reality.*

IT IS possible that there will be a new, fourth television network in the United States. It will differ from the "Big Three" in several respects—signals will be carried by coaxial cable rather than the airwaves; programming will include current films, sports events, concerts and theatre; and viewers will pay a per-program fee in addition to a monthly service charge.

Regional "Pay TV" has gained some acceptance with more than 130,000 homes subscribing to its services. (This is not to be confused with "Cable TV," which duplicates standard TV broadcast fare.) Now three companies, including two regional Pay TV firms, have applied for FCC permis-

sion to form a *national* network using the cable format. The stimuli of this renewed interest in a Pay TV network are developments in satellite communications and increased public acceptance of the two representative Pay TV systems.

Under the proposed format, program material would be beamed to a domestic communications satellite (See drawing) from a central network studio (A or B). Member cable systems (1 through 8) would receive the program through an earth station connected to their cable plant. Home viewers subscribing to the service would have their choice of regular commercial programming or the spe-

cial "pay" programs sent by the cable network.

The cost of the required earth stations has been steadily dropping because of advances in technology. At present such installations cost about \$100,000, but this is expected to drop 50% in ten years. An RCA communications satellite, part of the Global Communications system, would be employed.

Home Box Office, UA-Columbia Cablevision, and RCA Global Communications are actively pursuing the idea of such a "cable network." UA-Columbia says that 40% of the 10,000 subscribers to its Wayne, N.J., system have purchased the special events channel. In Brookhaven, N.Y., 4,000 of the 24,000 subscribers bought it in less than five months.

UA-Columbia hopes to build earth stations in 1976 for its cable systems at Fort Smith, Ark.; Laredo, Texas; Yuma, Ariz.; El Centro, Calif.; and Pasco and Kennewick, Wash. AT&T proposes to build an earth station at Orlando, Fla., to provide the Home Box Office features to several of its cable systems in central Florida, as well as to nearby systems operated by other cable companies.

Studies made by Knowledge Industry Publications, Inc. show that the establishment of a national cable TV network would require a capital investment of more than \$75 million, and that the network would operate at a loss for the first four years. Afterward, profits are expected to steadily grow, with a cumulative cash flow exceeding \$400 million in 10 years. This compares to estimates of \$4.2 billion in advertising revenues projected for broadcast TV networks by 1984. ♦

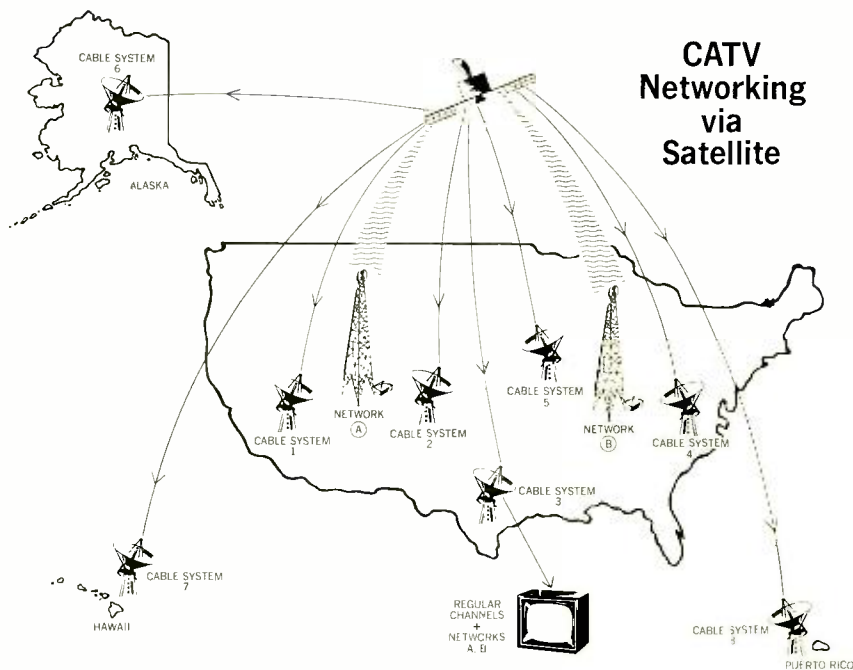



HAVE FUN WITH ELECTRONIC DICE

Electronic game of chance uses TTL & LED's

BY R. M. STITT



The rolling of dice is one of the oldest games known to man. In ancient times, dice were actually carved out of bones, with various characters on the six sides. Today, we have electronic dice. Though some of the character of the game may be lost

in the transition from rolling the bones to pushing a button, the chances of winning and losing are still the same (sometimes better, since there are no mechanical irregularities to modify probabilities). Also, electronic dice can be used in the dark and don't emit

rattling noises that can be disturbing to some people.

The electronic dice device described here is easily built and comes in a neat, simple package. It makes an ideal game for children and grownups whatever their ages.

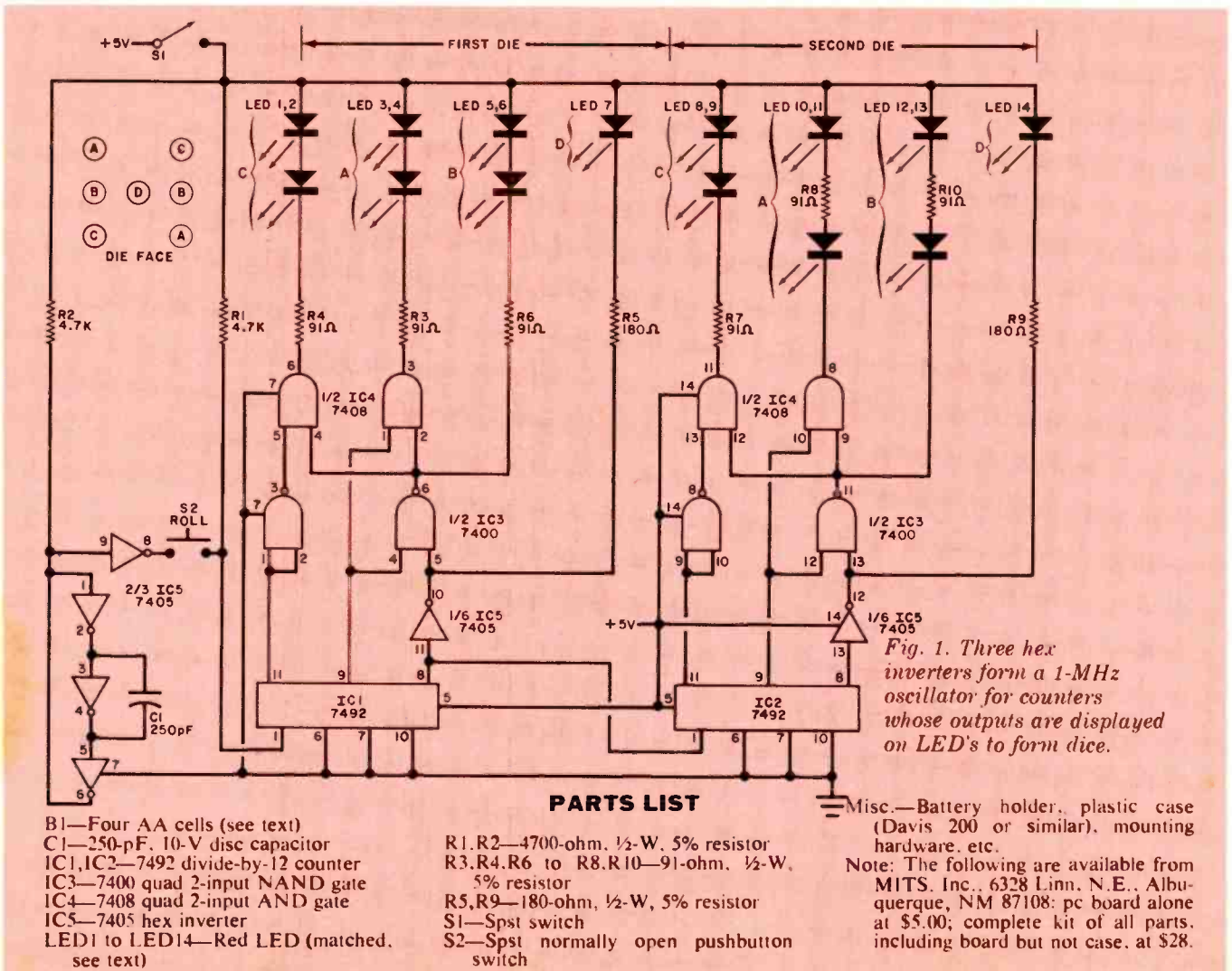

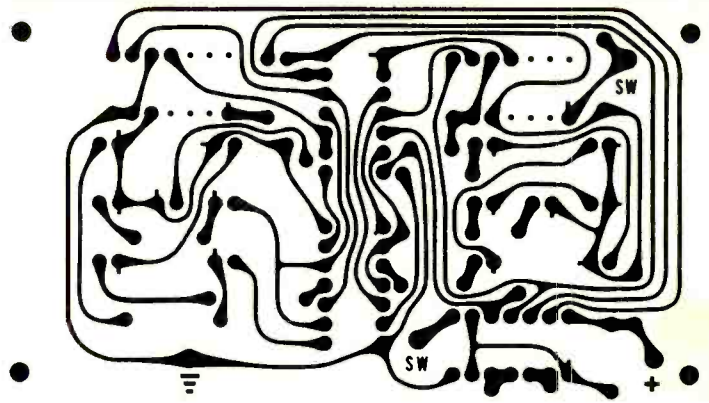
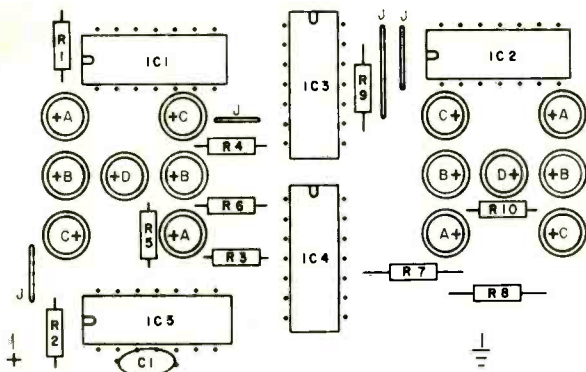

Fig. 2. Actual-size foil pattern is shown at right. Component installation at left.

Circuit Operation. As shown in Fig. 1, three of the six inverters in *IC5* are interconnected with *C1* and *R2* to form a clock oscillator running at about 1 MHz. A fourth inverter in *IC5* is used as a buffer to drive the first die circuit (*IC1*). This IC is a divide-by-12 counter consisting of a divide-by-2 (not used) and a divide-by-6 (used). The outputs of the counter are decoded by one inverter in *IC5*, two NAND gates in *IC3* and two AND gates in *IC4*. The decoded outputs then drive directly the six LED's which form the face of one die.

The output (carry) from the first die is used to drive the second die circuit formed by *IC2* and the remaining elements of the other IC's.

When the roll switch, *S2*, is operated, the clock oscillator is coupled to the first die, and its circuit runs through its states at a rate of 1 million times per second. The second die runs

through its states at about 166,000 times per second. When *S2* is released, the LED indication is truly random, with the same probability as an actual pair of theoretically perfect dice would have.

Construction. Neither the circuit layout nor lead dress is particularly critical, but an effort should be made to minimize the length of the lead between the 1-MHz oscillator and the first counter (*IC1*). If desired, a pc board can be made, using the etching and drilling guide shown in Fig. 2.

There are two ways to mount the LED's. The first is to mount them directly on the pc board in their designated places, making sure that their tops are at least 3/16" to 1/4" above the tops of the integrated circuits. Then the top cover of the enclosure must be drilled so that the seven LED's for each die protrude

through the holes. The pc board can then be mounted on the top cover using suitable mounting hardware. The LED's should be selected (by connecting them to a 5-volt dc source through a 180-ohm, 1/2-watt resistor) to make sure that they all glow with about the same brightness.

The pc board fits in the plastic case given in the parts list. When the top of this case has been drilled for the LED's, it is covered with a red anti-glare filter that obscures the unlit LED's. This makes the face of each die clear.

The batteries (in their holder) are secured to the bottom of the case and a piece of foam rubber is placed on top of the batteries so that the pc board and LED's make a tight fit when the case is closed. The foam rubber keeps things from moving about. Of course, with this approach, the pc board need not be attached to the cover. In the prototype, nickle-cadmium cells were used. Although their initial price is high, they can be recharged many times.

The second way of mounting the LED's involves drilling the top cover and attaching the LED's to it with epoxy. Then lengths of insulated wire can be used to interconnect the LED's and the pc board.

Operation. When the power switch is first turned on, the dice should illuminate in combination. This initial state is determined primarily by the mismatches in the thresholds of the IC's and will vary with the IC's. Therefore, this "start-up" state is not random and should not be used as a "throw" of the dice.

When the roll pushbutton is depressed, all 14 LED's should go on. Some will be brighter than others due to the differences in their duty cycles. When the button is released, the display will be a random roll. ♦

A ROLL-DOWN CIRCUIT

While testing the electronic dice, we experimented with finding a way to produce a "roll-down" similar to the effect obtained when regular dice are thrown. This can be done by using the circuit shown here to replace the three-inverter oscillator portion of Fig. 1.

The output of the UJT is coupled to pin 9 of *IC5*, while pin 8 of *IC5* is connected directly to the junction of *R1* and pin 1 of *IC1*. The *R1* of the original circuit is required because the 7405 (hex inverter) has an open collector on its output transistor. Note the new position of the roll pushbutton.

When the roll switch is pushed, the UJT forms a conventional oscillator with a frequency determined by *R_A* and *C_A*, whose values can be changed as desired. When the switch is released, the dc supply is removed from the timing circuit and *C_B* is included in the circuit. As the charge on *C_B* leaks off,

less and less voltage is applied to the timing circuit and the oscillator frequency drops. This causes the dice display to "slow down" and, as the voltage drops to almost zero, the dice stop rolling. Reclosing the roll switch will start the roll again. The value of *C_B* can be changed to vary the duration of the roll-down time.

—The Editors

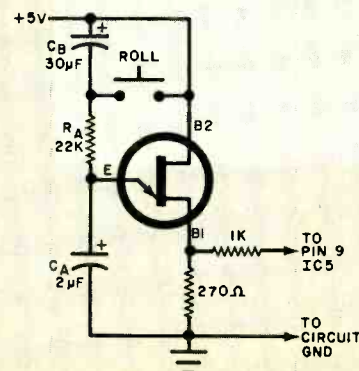

Precision Matching of RESISTORS

Home experimenter technique for matching resistors to better than 0.5%

BY JAMES DEMAS

PRECISION matching of resistor values is extremely important in such circuits as bridges and differential amplifiers. At first glance, you might think that an easy way to match values is to use expensive 1% or better precision resistors. A close look at the situation, however, will reveal a basic flaw in this plan. If you use 1% resistors, one resistor might be 1% higher and the other 1% lower than the nominal value required. Hence, the matched-pair tolerance would be 2%.

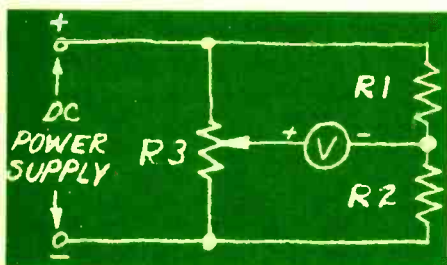

Ordinarily, when you need closely matched resistor pairs, the absolute resistance value is not as important as how close the values are to each other. Closely matched resistors whose absolute values are "in the ballpark" of those required will usually suffice for a given application.

While commercial manufacturers generally use expensive laboratory-type equipment, the home experimenter must find a more economical means for matching resistors. Fortunately, all he needs is a high-impedance multimeter, a 0-to-30-volt power supply, and a 10-turn potentiometer. The meter should have a 10-megohm or greater input impedance and a sensitive low-voltage range, preferably 0.6 volt or less full scale. Almost any value for the potentiometer's resistance between a few hundred and about 50,000 ohms will do for this test circuit.

Resistance-Ratio Method. The Wheatstone bridge that you must set up with the meter, power supply, potentiometer, and resistors to be matched is shown in the schematic diagram. With this setup, you can easily obtain resistance ratios that will permit you to match resistors to better than 0.5%.

The resistors to be matched in the diagram are R_1 and R_2 . These will form one voltage-divider leg of the bridge, while the potentiometer (R_3) will form the other leg. When using this circuit, with R_1 and R_2 in place, adjust R_3 for a null, indicated by the meter reading as close as possible to zero on the most sensitive range. This balances the bridge.

Interchange R_1 and R_2 . If the values of R_1 and R_2 are identical, transposing the two resistors will not affect the meter reading. However, any difference in the resistances will unbalance the bridge and cause the meter to read some positive or negative voltage above or below the null point by an amount proportional to the ratio of the two resistor values.

The resistances of R_1 and R_2 are related by the formula

$$\frac{R_2}{R_1} = \frac{1 + \frac{\Delta E^*}{E}}{1 - \frac{\Delta E^*}{E}}$$

* $\Delta E = E_2 - E_1$

where R_1 and R_2 are the values of the resistors to be matched, E is the power supply voltage, E_2 is the meter reading after transposing the resistors, and E_1 is the initial meter reading after nulling. The formula applies only if the power supply and meter are connected as shown. Also, E_2 and

E_1 have polarity signs that must be carried into the calculations.

A sample calculation of how to use the formula is instructive. Assume two 175,000-ohm resistors are compared using an 18.5-volt supply potential. The initial null is at -1.0 mV (E_1) and the final voltage (E_2) is -1.96 V. This yields

$$\frac{\Delta E}{E} = \frac{-1.96 \text{ V} - (-0.001 \text{ V})}{18.5 \text{ V}} = -0.1059$$

$$\therefore \frac{R_2}{R_1} = \frac{1 + (-0.1059)}{1 - (-0.1059)} = 0.8086$$

This means that the value of R_2 is lower than that of R_1 by $1 - 0.8086$, or about 19.1%.

For matching resistor values greater than 5000 ohms, use an 18- or a 27-volt supply potential. For resistors of less than 5000 ohms, use a 9-volt supply potential. Resistances of less than 1000-ohms should not be matched by this procedure because of their excessive power dissipation.

Another point to keep in mind is that, when the values of R_1 and R_2 exceed about 50,000 ohms, the first equation will be in error, owing to the meter's inherent loading effect on the circuit. This results in a ΔE measurement that will be too small. To correct for the error, replace the ΔE entry in the formula with

$$\Delta E \left(\frac{R_m + 0.5R_1}{R_m} \right)$$

Where R_m is the input impedance of the meter. Finally, because of noise pickup and the magnitude of the correction term, resistances greater than

10 megohms cannot be reliably matched.

With the resistance-ratio method, you can obtain matching accuracies of almost 0.05%. If you use a very sensitive meter—say a DMM with a 10-mV full-scale range—you will in all likelihood be able to match resistors to better than 0.01%.

Matching the Resistors. There's an obvious—but usually impractical—procedure for matching resistors: select one resistor from a batch having the same nominal value and proceed to measure ratios until you hit on a close match. A more practical procedure would be to trim one resistor to make it equal to the other.

The initial trimming is of two types. In series trimming, the lower resistance is increased by adding in series with it another resistor of the proper value. In parallel trimming, the larger resistance is decreased by connecting a resistor of the proper value in parallel. Series trimming is preferred where possible. When the lower-value resistor is a standard or reference that cannot be modified, however, you have no alternative but to employ parallel trimming.

In series trimming, if R_2 is greater in value than R_1 (you can always change your reference to make R_2 the smaller resistance), the necessary series resistance for R_1 , designated R_s , can be calculated by using the formula

$$R_s = R_1 \left(\frac{R_2}{R_1} - 1 \right)$$

The absolute value of R_1 may not be known, requiring that you use the nominal value for computation. The closest commercially available value for R_s can be used. These two error sources, however, usually prevent the trimmed pair from being perfectly matched. But the matching will still be much better than if you just took two precision resistors of the same nominal value and used them.

With parallel trimming of the larger-value resistor, trimming resistor R_p 's value can be computed by

$$R_p = \frac{R_2}{\frac{R_2}{R_1} - 1}$$

Again, R_2/R_1 is greater than 1, and the nominal value of R_2 is used in the cal-

ulation. This procedure works well if R_2/R_1 is not too close to 1.000. As the ratio approaches unity, R_p becomes prohibitively large. Hence, with parallel trimming, use an R_p that is slightly lower in value than that calculated from the equation. This makes R_2 a little lower in value than R_1 . Then series trim as discussed above for any final adjustment of the ratio.

If the match is still inadequate, further trimming will make it approach the ideal. With series trimming, if R_s is too low, add another resistor of lower value in series with R_1 and R_s to correct the value. If R_s is too large, the combination of R_s and R_1 is greater than R_2 . Several solutions are possible. Series trim smaller resistance R_2 . Alternatively, connect a suitable resistance in parallel with R_s —NOT the series combination of R_s and R_1 —to reduce it to the correct value.

The required parallel trimming resistor, R_p , for R_s is calculated by

$$R_p = \frac{R_s \left(1 - \frac{R_1}{R_2} \right)}{\frac{R_1 + R_s}{R_2} - 1}$$

where R_1/R_2 is just the inverse of the original ratio determined for the resistor pair, and $(R_1 + R_s)/R_2$ is the ratio determined after the first trim.

The most economical type of resistors to use for matching are 10% composition types. Using 10% composition resistors and the matching procedure outlined above, you can be sure of better than 1% matching for less than the cost of two 5% resistors. Absolute accuracy will be sacrificed, however. But if you buy your resistors all at one time and from the same place, they will usually be from the same batch. Resistors in a given batch are usually closely matched.

Matching composition resistors to better than 0.5% is possible, but such resistors have poor inherent long-term stability, especially for values exceeding 1 megohm. Stability can be improved by operating the resistors well below their rated power and by burning them in before matching. Once matched, treat the resistors as you would semiconductor devices. Don't overheat them and use a low-power soldering iron and heat sinks on the leads.

For the highest possible stability, wire-wound, oxide, and metal-film resistors are recommended. ♦

... here Today!
"IGNITION OF THE FUTURE"
ALLISON
"OPTO-ELECTRIC"

★ The BEST... the ULTIMATE...
of ALL the Ignition Systems!

● (We challenge ANYONE
to dispute this Fact)

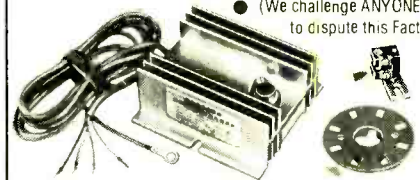

● Never wears out or needs any Maintenance!



● Does more than Pay for itself in
GAS SAVINGS

...it gives you Maximum Power
with continuous PEAK PERFORMANCE

...while reducing Maintenance
and Operating Costs!



● The Allison OPTO-ELECTRIC System eliminates the Points and Condenser replacing them with an OPTO-ELECTRONIC TRIGGER, using a Light-Emitting Diode and Photo transistor. As there are NO moving parts in rubbing contact... Timing adjustments are PERMANENT. The only "TRUE" Electronic Ignition... that you can buy for under \$100.

● Gives 40-Times more Timing Accuracy than ANY system using "Mechanical" Breaker-Points! UNLIMITED RPM! "Electronically-Controlled" DWELL automatically supplies HIGHEST Performance at both Low and High speeds. Spark Strength does not fall off at high RPM. POSITIVE SPARK helps eliminate "Misfire" for faster acceleration and improved Engine Performance! Smoother running (No timing fluctuation as with Magnetic Units). Easier Starting under any condition! Sparkplugs LAST 3 to 10-Times LONGER.

All SOLID-STATE Components UNAFFECTED By Temperature, Moisture, or Vibration! Highest grade materials Guarantee you solid, Dependable Performance.

★ Perfect Timing and Dwell never change.

Pays for itself! Eliminates ignition Tune-Ups forever! "INFINITE LIFE"... Once installed... Never needs replacing.

● PERFECT TIMING INCREASES Engine Efficiency and Gas Mileage. SAVES Precious Fuel! Allison gives you MAXIMUM Engine Efficiency 100% of the time... and that's the name of the game for BETTER Gas Mileage and Economy.

★ PROVEN RELIABILITY!

Dyno Tested up to 15,000 RPM.
Road and Race Proven.
(Opto-Electric Systems won at
INDY Two years in a row!)

● QUICK AND EASY INSTALLATION

★ If you want the BEST, and SAVE! This is IT!

● ORDER with CONFIDENCE...

SATISFACTION GUARANTEED!

1-YEAR FACTORY WARRANTY.

Only \$49.95
COMPLETE.

● As you can see, you're not taking any chances at all. Send your Order Today State Make, Year, Engine Size (Calif. Res. add Tax).
● (So New... it's Sold ONLY FROM FACTORY DIRECT).
You may use your MASTER CHARGE or BANKAMERICARD. Send us (1) Your Number, (2) Interbank No., (3) Exp. Date.
● Before buying any other Type ignition system.

Send Postcard for our FREE BROCHURE.

★ If you have already installed a C-D ignition system. Modernize and Increase its Efficiency...
CONVERT YOUR "C-D" UNIT TO BREAKERLESS!
Opto-Electric "TRIGGER UNIT"... Only \$34.95

● Our BEST Salesmen are the owners and users of our ALLISON System!



ALLISON
AUTOMOTIVE COMPANY

1269-P, East EDNA PL., COVINA, CAL. 91722

CIRCLE NO. 48 ON READER SERVICE CARD

IF YOU ARE READY FOR SERIOUS CAREER

Learn College-Level



ADVANCEMENT NOW—

Electronics at Home

With CREI's unique Electronic Design Laboratory Program

There is only one way to a career in advanced electronics—through advanced training. You can get such training through a resident engineering college or you can take a CREI specialized college level electronics program at home.

Wide Choice of Programs. CREI offers you program arrangements with *fourteen* areas of specialization in advanced electronics. You can select exactly the area of specialization for the career you want.

CREI also offers program arrangements *both* for those with extensive experience in electronics *and* for those with only limited experience. All programs are college-level, except for a brief introductory level course, which is optional.

Unique Laboratory Program. CREI now offers a unique *Electronic Design Laboratory Program* to train you in the actual design of electronic circuits. You also get extensive experience in tests and measurements, breadboarding, prototype building and in other areas important to your career. The Lab Program makes it easier for you to understand the principles of advanced electronics. Only CREI offers this complete college type laboratory program.

The Lab Program includes professional equipment which becomes yours to keep. You will especially appreciate the Electronic Circuit Designer, which is available only through this program and which you will find extremely valuable throughout your professional career.

College Credit. You can actually earn college credit through CREI programs, which you can use at recognized colleges for an engineering degree. CREI maintains specific credit transfer arrangements with selected colleges in the U. S.

Industry Recognized Training. For nearly 50 years CREI programs have been recognized throughout the field of electronics. CREI students and graduates hold responsible positions in every area of electronics and are employed by more than 1,700 leading organizations in industry and government.

Qualifications to Enroll. To qualify for enrollment, you should be employed in electronics or have previous experience or practical training in the use of electronic equipment. You must also be a high school graduate or true equivalent.

All CREI Programs are available under the G.I. Bill

Send for FREE Book. If you are qualified, send for CREI's full color catalog describing these college-level programs and your career opportunities in advanced electronics. Mail card or write for your copy of this book.



CREI CAPITOL
RADIO
ENGINEERING
INSTITUTE

McGraw-Hill Continuing Education Center
3939 Wisconsin Avenue Northwest
Washington, D. C. 20016



Accredited Member, National Home Study Council



Product Test Reports

ABOUT THIS MONTH'S HI-FI REPORTS

The three, very different products in this month's reports have two things in common: they are all innovative and they deliver outstandingly fine performance.

Many people think a preamplifier should do nothing but amplify and possibly alter the frequency response of a signal. Phase Linear's very different philosophy is exemplified by its Model 4000 preamplifier. In addition to all of the usual preamplifier features, it has a unique autocorrelator circuit that removes most of the hiss, hum, and rumble from a signal without the least audible effect on its frequency response. It also has a dynamic expander that restores much of the dynamic range removed from every recorded or broadcast program.

JVC's new deluxe cassette deck, Model 1669, combines a very smooth, solenoid-operated, remote-controlled tape transport with a refined ferrite head that extends its useful frequency response to just short of 20 kHz. The JVC1669 has its own ANRS noise reduction system, which is similar to the Dolby system in its effect.

Pioneer's headphones deliver the performance you would expect from the better electrostatics at a fraction of their price, and in a nearly "feather-weight" package.

—Julian D. Hirsch

PHASE LINEAR MODEL 4000 STEREO PREAMPLIFIER

Superb preamp features unique signal processing system.



The preamplifier measures 19"W × 8 $\frac{3}{8}$ "D × 7"H (48 × 23 × 18 cm) and weighs 18 pounds (8.2 kg). It retails for \$599.

General Description. The separate bass and treble controls for each channel have selectable turnover frequencies of 40 or 150 Hz for the bass and 2000 or 8000 Hz for the treble. (A separate switch is provided for bypassing the tone control circuits.) Each control is an 11-position switch. The volume control, which cannot reduce the output to zero, is augmented by a 20-dB attenuator switch to provide an adequate control range.

Channel balance is by means of a "joystick" control located in the center of the front panel. Although this is basically a stereo preamp, it has built into it an SQ decoding matrix with Phase Linear's own front-back logic system that can be used to decode SQ discs or FM broadcasts or to synthesize rear-channel "ambience" outputs from stereo programs.

Input selection and tone and volume settings are made with rotary controls. All other switching functions are available via lever switches. Lever switches also control the special signal-processing circuits and an "active equalizer" that provides a slight boost at very low and very high frequencies where most speaker systems fall off appreciably in their responses.

Perhaps the most unique feature of the preamp is its "autocorrelator" noise reduction system that operates on any input source. Unlike the Dolby system, the autocorrelator does not require specially processed program material. In a sense, it is a dynamic low-pass filter whose action is controlled by the levels and frequency distribution of the program material. There is, however, an important difference.

Signals in the 200- to 2000-Hz band are sensed to determine the presence of discrete frequency components, as opposed to random noise. Any discrete frequencies detected cause "windows" to open up on the preamp's 2000- to 20,000-Hz response range at harmonics of the control signals. (The control signals are assumed to be musical fundamentals.) In this manner, the normal harmonic structure of the program is not affected; yet, the portions of the 2000- to 20,000-Hz spectrum not required to pass the harmonics are closed off, excluding noise components not related to the signal.

A small control knob on the front panel permits continuous operational threshold adjustments to be made for the autocorrelator. Adjustment of the control is not critical. As it is turned counterclockwise, the hiss suddenly drops. Only after considerable additional rotation do the highs in the program drop out. Within its operating range, the system reduces hiss by about 10 dB, with no effect on the frequency content of the output signal.

The autocorrelator switch also turns on a low-frequency dynamic filter that removes rumble and hum from only the phono signals. Its threshold adjustment is via a screwdriver-operated control that is accessible through a hole in the front panel. The filter cuts the response at 20 Hz and below by some 15 dB without any loss of low-frequency program material.

The second unique feature of the preamp is its "Peak Unlimiter and Downward Expander." Turned on by a separate lever switch, it is a sophisti-

Unique noise reduction and dynamic range-expanding circuitry are among

the many features of the Phase Linear Model 4000 preamplifier. The preamp has inputs for two phono cartridges and two high-level program sources and a tape playback input for one of the two tape decks it can control. The other tape recorder's playback can be monitored during recording, and it is possible to copy from it to the first deck while listening to another program source through the preamp.

LABS REPORT

cated volume-expansion system that provides several different expansion characteristics according to the instantaneous program level, with different time constants in each operating area. A small knob on the control panel is used to set the threshold for the filter system.

When the filter system is operating, a red LED flashes on signal peaks. The total expansion is 7 or 8 dB, sufficient to restore much of the dynamics of a program normally suppressed by recording and broadcast compressors or limiters. The filter is not detectable in action, nor does it add any unnatural qualities to the signal.

The preamp's various inputs and outputs are located on the rear apron. In addition to the four channel outputs, there is a second pair of front-channel outputs. A third set of outputs is on the front panel—two stereo phone jacks for the front and rear channels. Since these come after the signal-processing circuits, they can be used to supply a noise-reduced signal to another tape deck or amplifier.

Two screwdriver controls next to the PHONO 1 inputs compensate for any effect the cartridge's inductance might have on the preamp's equalization so that a true RIAA-equalized response can be achieved. Recommended settings for most phono cartridges are given in the instruction manual.

There are six accessory ac outlets on the rear apron. Three are switched via a heavy-duty relay to control up to 25 amperes of current, which might be required if the preamp were to be used to control power to two high-power amplifiers like the Phase Linear Model 700's.

Laboratory Measurements. In addition to their conventional turn-over points near the frequency extremes, the tone controls have a limited range of about ± 8 dB. Their effects are quite subtle, even when used to the fullest extent; but they make it possible to equalize the response of a good speaker system and make it even better.

Although its function might seem to be much like that of a loudness control, the active equalizer is totally different. At the low end, it begins to boost the response below 70 Hz to about +6 dB at 20 Hz. At the high end, the boost begins at 10,000 Hz and is only 3.5 dB at 20,000 Hz. With most

speaker systems, it can be left on at all times, producing no obvious coloration but definitely enhancing the total sound quality.

The RIAA equalization was accurate to within ± 0.5 dB from 20 to 20,000 Hz. With proper adjustment of the cartridge compensation controls, the flat response was maintained over the full frequency range. (Most preamps suffer a loss of several decibels beyond 10,000 Hz due to interaction with the phono cartridge.)

To produce a 1-volt reference output, the high-level inputs required 0.175-volt and the phono inputs 1.8-mV signals. The phono inputs overloaded at 62 mV. The unweighted noise in the outputs was -68 dB on the phono inputs, referred to 1 volt. Referred to the rated 8-volt output, each would be improved by 18 dB. (If the associated power amplifier has level controls, they should be set to

require at least several volts from the preamplifier at rated output to gain the maximum S/N advantage.)

The THD at 1000 Hz was less than 0.03% up to a 2-volt output, increasing slowly to 0.1% between 6 and 7 volts and to 0.17% at the rated 8 volts. The IM distortion was less than 0.05% up to 1 volt, 0.25% at 5 volts, and 0.6% at 8 volts.

The dynamic nature of the peak limiter and autocorrelator system prevented us from making measurement of them. They and the SQ decoder were evaluated subjectively by extended listening tests. The autocorrelator proved to be by far the most effective noise reducer that does not require preprocessed signals that we have used. In A-B comparisons, it appeared to be about as effective as the Dolby B system in hiss reduction. Since it can be used with the Dolby or any other noise-reduction system, the

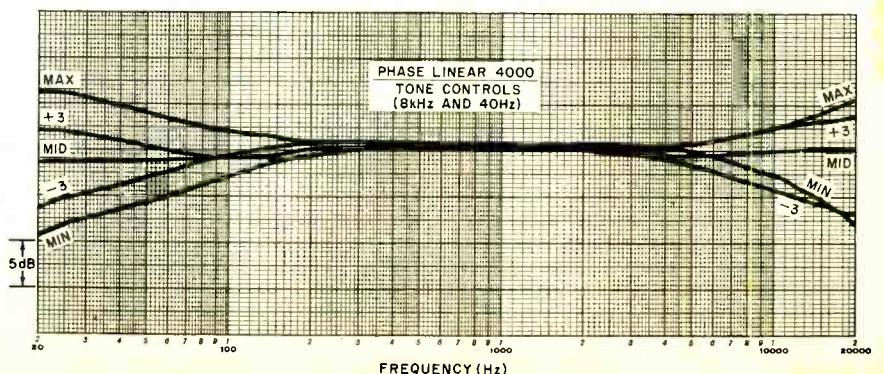
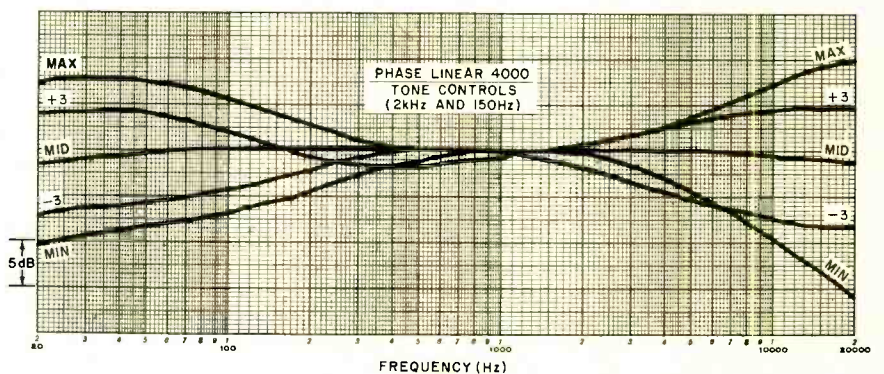
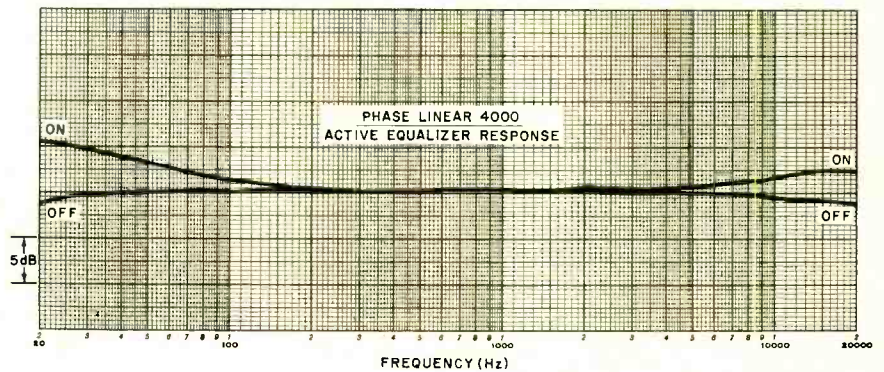

combination of the two actually reduces hiss to complete inaudibility even under very high-level listening conditions.

The peak limiter/downward expander contributed almost as much noise reduction as the autocorrelator. During low-level passages, switching in the expander dropped the level noticeably, with a corresponding noise reduction. On program peaks, switching it in gives a level increase of about 3 dB that is clearly audible. Over most of the intervening range of levels, there is no audible effect. At no time did we hear any "breathing" or other side effects from the expansion process.

The reduction in low-frequency noise accompanying the use of the

autocorrelator adds immeasurably to the sense of realism in the sound. Regardless of the quality of the turntable, most records have considerable low-frequency noise, and the dead silence that replaces it must be heard to be believed.

As an SQ decoder, the Model 4000 appeared to be about as good as the various "partial-logic" systems offered in many receivers. It is substantially better in its front-rear directionality than a simple matrix, but it cannot compare to the latest "variable-blend wave-matching" SQ logic systems.

User Comment. By using the full signal processing facilities of the preamp, it is possible to make a fantastic improvement in program realism.

Used with high-power amplifiers of comparable quality and good speaker systems, the result is an overall realism—even with older stereo and mono discs—that one would believe to be impossible if it could not be repeatedly demonstrated.

We consider the Phase Linear Model 4000 to be one of the most outstanding electronic developments to appear on the hi-fi scene in recent memory. It is unequalled in its ability to provide full-fidelity music reproduction, free from unwanted noises of all types and with a restored dynamic range that some of us occasionally forget is lacking in our recorded and broadcasted programs.

CIRCLE NO. 65 ON READER SERVICE CARD

JVC AMERICA MODEL CD-1669 CASSETTE DECK

Smooth transport operation and automatic noise reduction.



A solenoid-controlled, two-motor transport and JVC America's own automatic noise reduction system (ANRS) are standard features in the company's Model CD-1669 deluxe cassette deck. Light-touch pushbutton controls operate the solenoids, while a logic system makes it possible to manipulate the controls in any manner without the possibility of tape damage or the necessity of stopping tape motion.

The deck measures 16 $\frac{5}{8}$ "W \times 12 $\frac{1}{16}$ "D \times 5 $\frac{5}{8}$ "H (42.2 \times 30.1 \times 14.3 cm) and weighs 18 $\frac{3}{4}$ pounds (8.5 kg). It retails for \$499.95.

General Description. Separate toggle switches are provided for selecting the optimum bias and equalization for NORMAL, low-noise/high-output (SH), and chromium-dioxide (CHROME) tape formulations. Illuminated legends near the switches indicate when the deck is in the RECORD status, the circuits are set for CHROME tape, and the ANRS is

switched on. The ANRS can be activated manually by operating a toggle switch. It can also be activated automatically by a piece of conducting foil attached to the rear edge of the cassette.

Two large illuminated meters provide monitoring facilities for the recording and playback levels. They are located electrically ahead of the playback level controls. A PEAK light between the meters flashes if momentary peaks exceed the maximum undistorted recording level.

The cassette cover, with cassette, pops up at a touch of the EJECT button. The tape index counter is internally illuminated by a lamp that flashes when the tape is in motion. A three-position MEMORY MODE switch can be set to stop the tape during rewind when the counter returns to a zero reading. It can also be set to automatically return the tape to PLAY at that point. In any mode, the transport shuts down when the tape stops for any reason.

A switch is provided for transferring the recording inputs between the LINE and MIC/DIN sources. Two slide-type controls with detented settings permit the recording gain and playback level to be set as desired.

There are six transport control buttons. Three are for REWIND, PLAY, and FAST FORWARD. A long STOP button sits in front of these three buttons, while the RECORD button is located some distance away. The RECORD and PLAY buttons must be depressed simul-

taneously to make a recording. A novel feature of this deck is its ability to transfer from the PLAY to the RECORD mode at any time while the tape is playing by pressing both the RECORD and PLAY buttons. Finally, the PAUSE button, when depressed, instantly stops tape motion without interrupting the recording mode.

On the rear apron are the LINE inputs and outputs, a DIN connector, and a socket for the remote-control accessory supplied with the deck. The accessory duplicates all the transport controls, except PAUSE, on a small box that measures 5" \times 2" \times 1 $\frac{1}{2}$ " (12.7 \times 5.1 \times 3.8 cm). The box is equipped with a 16' (4.9-m) cable.

An insert on the front edge of the deck's walnut base contains the headphone jack and two standard phone jacks for the MIC inputs. The recess is covered by a sliding clear plastic door when access to it is not required.

Laboratory Measurements. The equalization switch on the deck changes the playback response to the 70- μ s characteristic for CrO₂ tapes. This produced a playback frequency response within ± 2 dB from 40 to 10,000 Hz, the tape limits, with the 70- μ s Teac 116SP test tape. Problems with older 120- μ s tapes prevented us from measuring the playback response with ferric-oxide tapes; but listening to previously recorded tapes convinced us that the equalization was accurate for both cases.

In the recording mode, a 77-mV LINE or a 0.3-mV MIC input yielded a 0-dB meter indication. The corresponding playback was 0.34 volt. The mic inputs overloaded at 35 mV. The record/playback performance was tested with two types of tape: TDK SD using both NORMAL and SH bias and equalization, and TDK KROM-O₂ chromium-dioxide tapes.

At a 0-dB recording level, the 1000-Hz playback THD was about 1.9%. This was essentially all random hiss, since we could see no harmonic components in the output of our distortion analyzer. The reference 3% THD was reached at recording inputs of +5.5 dB (TDK SD/NORMAL), +5 dB (TDK SD/SH), and +4 dB (CrO₂).

The unweighted S/N was about 49 dB. It improved to about 55 dB with IEC A weighting and to about 60 dB when ANRS was used. The difference between the tapes never exceeded 1 dB in these measurements. The noise level increased by only 3 dB, an unusually low figure, through the MIC inputs at maximum gain.

The overall record/playback frequency response at a -20-dB recording level was ± 2 dB from 26 to 16,000 Hz with all the tapes used. (The low-frequency response reached 23 Hz at the -2-dB point when using CrO₂ tape.) There were slight differences in the high-frequency responses of the tapes, however, with TDK SD/SH giving the flattest overall response, TDK SD/NORMAL having about 0.5 dB greater output between 10,000 and 15,000 Hz, and the CrO₂ output sloping slightly downward beyond 13,000 Hz. The frequency response, measured at a 0-dB level, revealed the early and pronounced drop in high-frequency response that one finds with all cassette recorders and most open-reel machines due to tape saturation. As would be expected from the improved, high-frequency properties of chrome tape, the 0-dB high-

frequency output with CrO₂ tape was somewhat better than it was with ferric-oxide tape.

The unweighted wow and flutter measured 0.05% and 0.19%. A combined record/playback measurement yielded slightly lower numbers of 0.03% and 0.17%. In its fast speeds, the transport handled a C-60 cassette in about 75 seconds. The recorder's meters responded to a 0.3-second tone burst—a standard test for the ballistic response of a VU meter—with an overshoot of about 10%. A 200 nanoweber/meter Dolby-level tape indicated between +3 and +4 dB on the meters. (The +3-dB point corresponds to a CAL mark for the ANRS, which is claimed to be compatible with the somewhat similar Dolby system.)

The PEAK light flashed at +5 dB, the approximate input that produces 3% distortion on playback. The tracking of the ANRS, the change in overall record/playback frequency response when the ANRS is used, was very good at -30- and -40-dB levels, with typical differences of 1 dB or less below 12,000 Hz. At -40 dB, the ANRS introduced a gradual rolloff in response beginning at about 1000 Hz. It reached 2.5 dB at 13,000 Hz.

User Comment. The electrical and mechanical performance of the deck was fully up to the standards of a top-quality cassette recorder. Programs taped from records and FM broadcasts have a fidelity that makes it almost impossible to tell the recording from the original. Although other decks can do this, few can match the operating ease and versatility of the JVC deck.

The logic-and-solenoid control of the transport puts one in mind of the finest open-reel recorders. It is literally impossible to do anything wrong when operating the controls. The controls themselves have a light but posi-

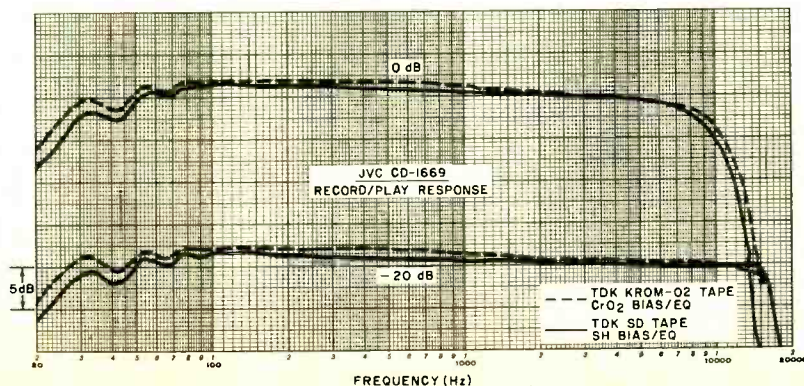

FREE EICO CATALOG

346 Ways To Save On Instruments, Burglar Alarms, Automotive & Hobby Electronics!

The more you know about electronics, the more you'll appreciate EICO. We have a wide range of products for you to choose from, each designed to provide you with the most pleasure and quality performance for your money. The fact that more than 3 million EICO products are in use attests to their quality and performance.

"Build-it-Yourself" and save up to 50% with our famous electronic kits.

For latest EICO Catalog on Test Instruments, Automotive and Hobby Electronics, Eicocraft Project kits, Burglar-Fire Alarm Systems and name of nearest EICO Distributor, check reader service card or send 50¢ for fast first class mail service.

**EICO—283 Malta Street,
Brooklyn, N.Y. 11207**

*Leadership in creative electronics
since 1945.*



CIRCLE NO. 19 ON READER SERVICE CARD

tive feel. The MEMORY MODE rewind is a great convenience, both as a means of returning to the beginning of a selection and as an effortless way to repeat any given selection.

This recorder has more recording "headroom" than most cassette decks. One can record with the meters regularly reaching the 0-dB mark or even going into the red area without serious risk of overload distortion. Unlike most recorders, this deck produced a useful volume level with 200-ohm headphones as well as with the usual 8- to 16-ohm "standard" phones to which other recorders are restricted.

The automatic switching of the ANRS with a suitably prepared cassette is an excellent idea, and it

worked to perfection. The noise-reduction system is said to be compatible with other such cassette tape systems, presumably referring to the Dolby system. Although the two systems are not entirely identical in their characteristics, it appears that they are sufficiently alike to permit a Dolby-encoded tape to be played through the JVC deck with perfectly acceptable results, and vice versa. When we tried changing tapes and decks, both systems seemed to afford about the same amount of noise reduction. Neither had a significant effect on overall frequency response.

When we switched tapes, the differences in response were usually no greater than one would expect for two machines without noise-reduction

systems. One exception to this was the playing of prerecorded Dolby-encoded tapes in the Advent CR/70 series, which sounded a trifle dull in their highest registers through the JVC deck. Even so, it was not the type of change that would have been detected without previous familiarity with the sound of these tapes or by a comparison to playback through a Dolby machine.

By and large, we feel that the deck can do just about everything that any other two-head cassette machine can. In many respects, it is superior to most others. This performance, plus superior operating "feel," excellent construction, and versatile operating features, easily justify the price.

CIRCLE NO. 66 ON READER SERVICE CARD

PIONEER MODEL SE-700 HI/FI HEADPHONES

New "high-polymer" material provides light weight and uncolored performance.



Hi-fi headphones have traditionally been either electromagnetic or electrostatic in

design. The electromagnetic phones resemble miniature loudspeakers. They can be very efficient and are capable of delivering a high acoustical output with very low distortion, but their frequency response is as irregular as that of a dynamic loudspeaker. On the other hand, electrostatic phones can have a smooth response over a wide frequency range, but their acoustical output is limited and they require dc polarizing and high signal voltages for proper operation.

Recently, a new type of headphone that combines the advantages of both types of phones with few of their disadvantages has been developed. It uses a specially processed plastic material, known as a "high polymer" (HP), that has piezoelectric properties.

When an electric field is applied across the thickness of a sheet of this material, the length or width changes. One of the first headphones to use the HP material is the Model SE-700 stereophones from U.S. Pioneer Electronics Corp.

The 13-ounce (370-g) headphones have earcups that are flat, with perforated back surfaces, and surrounded by soft foam ear pads. The phones are fitted with a 3-m (about 10') long straight—not coiled—cord that is terminated in a three-circuit plug for stereo operation. Although the phones are not completely transparent to outside sounds, they do not appreciably attenuate room noises.

The retail price of the Model SE-400 headphones is \$79.95.

General Information. The Pioneer phones use a bimorph element that consists of a 7-micron (0.3-mil) film of polyvinyl fluoride sandwiched between two metal electrodes. The whole is formed into a curved surface and is clamped at the edges. When an audio signal is applied across the electrodes, the element flexes and produces an acoustical output. The HP elements have most of the performance attributes of electrostatic drivers and some unique advantages of their own.

An HP element does not require the high-level signal voltages of an electrostatic element. It, therefore, does not need a step-up transformer. Addi-

tionally, there is no need for a polarizing voltage.

The Model SE-700 phones are rated to generate a 100-dB sound-pressure level (SPL) with only 3 volts applied to their elements. The elements themselves are capacitive in nature, with a value of about 0.1 μF . They can withstand high voltages (more than 30 volts rms) without sustaining damage. As is the case with an electrostatic element, the entire surface of an HP element is driven uniformly and is free of the majority of the spurious resonances common to dynamic drivers. Unlike electrostatic (and electret) phones, whose operation depends on surface effects and can be affected by humidity, the polarization of HP elements is within the plastic material itself and is permanent.

The phones can be driven from any power-amplifier speaker or headphone output capable of developing several volts. Their high impedance, however, makes them unsuitable for use with tape decks or other components designed to drive only low-impedance phones.

Laboratory Measurements. We tested the phones on a Koss-type acoustic coupler (artificial ear), driving them from a power amplifier at a constant 3-volt output. The resulting response curve was one of the smoothest we have ever obtained for a headphone. The output varied by only ± 3 dB over a frequency range of 20 Hz

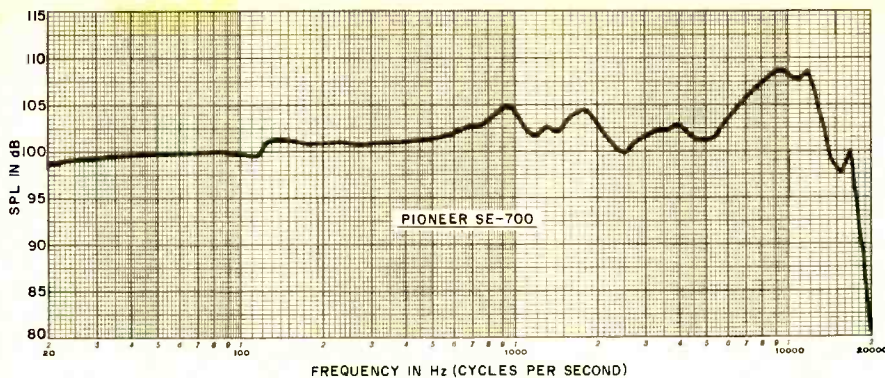

to 7500 Hz. There was a rise in output in the 10,000- to 12,000-Hz range that roughly coincided with the diaphragm resonance of our microphone.

We did not attempt to apply a microphone correction to the curve because the other limitations of the headphone coupler measurements would not justify it. In any event, the overall response of 20 to 17,000 Hz, ± 5 dB places the Model SE-700 phones in contention for top honors with respect to range and the smoothness of performance within that range.

The acoustic output over most of the range measured approximately 100 dB SPL, as rated by Pioneer. At 1000 Hz and an SPL of 106 dB, we measured 1% distortion in the acoustical output. The impedance of the phones was greater than 50,000 ohms at frequencies below 150 Hz. It decreased smoothly to about 400 ohms at 20,000 Hz.

User Comment. All the measurements we made on the phones indicated that they should compare to the

best electrostatic phones in overall quality and freedom from coloration. Having made that comparison, our ears agree with the indications given by the laboratory instruments we used in the bench tests. Overall, this is as smooth and uncolored a headphone as we have heard, bested slightly in transparency only by some of the better ES phones. In addition, it is one of the most comfortable to wear and its light weight and absence of a "closed-in" feeling imparted by most phones with tightly sealed earcups makes it almost easy to forget you are wearing the phones.

Further, these phones can play *loud*, without distortion. We proved this, since no amplifier we had on hand, including a couple of brutes rated at 200 watts/channel, could overload them to the point of audible distortion.

Considering all the positive attributes of the SE-700, we feel they are a notable bargain at the price.

CIRCLE NO. 67 ON READER SERVICE CARD

COURIER "CRUISER" MOBILE AM CB TRANSCEIVER

Automatic delta tuning brings in off-frequency signals.



FULL 23-channel AM operation is provided by the Courier "Cruiser" mobile CB transceiver through a crystal-controlled synthesizer scheme. The transceiver is designed to be operated from 13.8-volt dc, positive- or negative-ground electrical systems. It has a special *automatic* delta-tune system that brings in a slightly off-frequency signal on the nose.

Among the more or less standard features are an adjustable squelch, a noise blanker/anl system that can be switched in and out as needed, zener-diode regulation, line filter, reverse-polarity protection, PA operation, external-speaker jacks, and a local/distance (LOC/DX) switch. The indicators include an ON THE AIR light and a meter that indicates both rela-

tive signal strength and relative output power, depending on the mode of operation.

The transceiver measures a compact 9"D x 6"W x 2"H (22.9 x 15.4 x 5.1 cm). It comes with mobile mounting bracket and hardware and a detachable push-to-talk microphone with attached coiled cord. The transceiver retails for \$219.95. An optional accessory power supply, Model PS20A, for using the rig as a base station is available for \$34.95.

The Receiver. A dual-gate MOSFET r-f amplifier, protected by shunt diodes at the input, serves as the receiver's front end. This plus double conversion (to a 10.635- to 10.595-MHz first i-f and a 455-kHz second i-f) provided a measured 0.35- μ V

sensitivity for 10 dB (S + N)/N modulated 30% by a 1000-Hz tone. The primary-image and i-f signal rejection measured an excellent 70 dB. Needless to say, the receiver's sensitivity is better than is usual for CB rigs.

Signal strengths of 100 μ V (40 dB above 1 μ V) or more in or near the CB range tended to introduce spurious signals. Otherwise, the rejection of other spurious signals measured 50 dB.

Mechanical and ceramic filters provide the selectivity at the 455-kHz i-f. This scheme provided good voice intelligibility, with an overall audio response of 375 to 2400 Hz at the -6-dB points. The adjacent-channel selectivity at the i-f itself was 60 dB. However, due to desensitization by an adjacent signal in practice, the 60-dB figure can be derated to 50 to 55 dB. Even so, this is still better than the standard minimum.

Applied to the r-f amplifier, mixer, and first i-f stages, the agc maintained the audio output to within 12 dB with an r-f input signal variation of 80 dB at 1 to 10,000 μ V. Some 6 dB of this change occurred with the first 20 dB r-f change at 1 to 10 μ V which is somewhat better than par for this end of the range.

The S meter was quite conservative in its indication. It required a 3000- μ V input signal to register an S9. Signals of 100 μ V registered only S5. The squelch threshold range was 0.25 to 500 μ V.

The audio section of the receiver consists of a series gate (that is switched on or off simultaneously with the r-f noise blanker) and two amplifier stages that are followed by the customary push-pull (class-B) power stage. This setup was capable of developing somewhat more output than usual, measuring 4.5 watts at 6% distortion with 1000-Hz signals into an 8-ohm load.

Frequency Synthesizer. Six crystals in the 37.600- to 37.850-MHz range produce the first i-f and four crystals in the 10.180- to 10.140-MHz range create the second i-f for receiving in the conventional frequency synthesis system.

The automatic delta tune (ADT) system is like the automatic frequency control (afc) schemes used in FM receivers. It operates at the 455-kHz i-f and consists of a limiter, ceramic discriminator, dc amplifiers, and a variable-capacitance diode to correct the frequency of the 10.160-MHz crystals in the direction that maintains an exact 455-kHz i-f signal. Its range is about \pm 1300 Hz.

The Transmitter. On transmit, one of four crystal frequencies in the 10.635- to 10.595-MHz range is mixed

with one of the signals in the 37.6-MHz range at the synthesizer to produce the transmitter carrier. The carrier goes through a spurious-response filter and on to two r-f driver and the power amplifier stages. The output of the power amplifier is a triple-pi network that matches to a nominal 50-ohm load. Included here are two TVI traps, one of which is fixed at 81 MHz to attenuate the third harmonic, while the other is adjustable around 54 MHz for reducing the second harmonic. Harmonic radiation can therefore be well below FCC requirements.

The driver and power amplifier are conventionally modulated by the receiver's output section. (A speech amplifier is switched in automatically.) Automatic modulation control, or amc, is provided, using a compression system. Electronic switching is used for transmit/receive transfer.

The carrier power measured 4 watts. With a 1000-Hz test tone, compression started at about 90% modulation, with 5% distortion. The distortion rose to 10% with 6 dB of compression. However, time constants of the amc are such that during dynamic operation with voice, peaks can go to a full 100% modulation with a well filled r-f envelope for a good signal punch, while holding adjacent-channel splatter down to better than 55 dB.

The transceiver draws 1.1 to 1.6 amperes on transmit, while on receive, the drain is 350 mA.

User Comment. From an opera-

tional point of view, where difficulties might crop up with a strong local signal, pulling out the squelch control knob conveniently engages the LOC position of the LOC/DX switch. This reduces the receiver's gain by about 20 dB for coping with the situation. With the knob pushed in, the receiver operates at maximum sensitivity.

Although a delta-tune facility is not a real necessity on AM, the ADT in this rig eliminates the need for manipulating a variable control. The user simply pushes a button to place the ADT into operation for automatic frequency correction, indicated by a mid-scale pointer swing of a separate meter. When the ADT is disengaged, off-frequency signals cause the meter's pointer to swing to one side of center-scale.

The two meter movements are very small edgewise units, which can make reading them quite difficult in some installations. The knob for the channel selector is also quite small and requires quite a bit of finger pressure to rotate it. The PA, NB (noise blanker), and ADT systems are very easy to switch in and out as desired via a trio of pushbuttons on the front panel.

From the point of view of performance, the Cruiser stacks up well against larger base-station rigs with its good sensitivity and selectivity, fine audio quality, highly effective noise silencing, and a fully modulated signal that can be maintained without adverse splatter.

CIRCLE NO. 68 ON READER SERVICE CARD

HEATHKIT MODEL IO-4510 DUAL-TRACE TRIGGERED-SWEEP OSCILLOSCOPE

Digitally controlled time base gives stable sweep trigger to 15-MHz bandwidth scope.



THE oscilloscope is perhaps the most useful of all electronic test instruments. It lets you see what a waveform looks like as well as measure the waveform's amplitude and period (assuming it has been properly calibrated)—all without the need for other instruments.

The evolution of the oscilloscope over the past few years has been rapid, due to the development of new and better components. While older capacitively coupled (ac) scopes were often limited to a bandwidth of little more than the audio range, the new generation of direct-coupled (dc) scopes features vertical amplifiers that can respond to inputs ranging from dc to many megahertz. Many of the new scopes have true triggered-sweep systems that provide maximum trace stability. Some even have independent vertical sections that provide dual-trace operation.

The constant improvement in oscilloscopes has resulted in some excellent instruments for the service and

experimenter benches. An excellent example of an up-to-the-minute service instrument is the Heathkit Model IO-4510 triggered-sweep, dual-trace oscilloscope that sells for \$549.95 in kit form. (This scope is also available assembled as the Model SO-4510 for \$750.) The published specifications are impressive, such as a dc to 15-MHz vertical bandwidth and 45-MHz triggering bandwidth.

The Model IO-4510 does not have the bulky "box" look so long associated with oscilloscopes. Instead, it is housed in a low-profile case that measures 21½"D × 13"W × 7"H (54.6 × 33 × 17.8 cm). The cabinet has a large adjustable carrying handle that doubles as a tilt stand.

General Information. The triggered sweep switch has 20 positions, spanning a range of 100 ns/cm to 0.2

s/cm. A separate control permits continuous adjustments on any given range of the switch. A 5× magnifier permits close examination of the displayed waveform at any point in the sweep.

Unlike some triggered-sweep scopes, the Heath instrument does not have the usual touchy sweep trigger stability adjustments and controls. A novel, digitally controlled time base provides rock-steady automatic triggering. Instead of the trace disappearing from the CRT screen when the trigger signal is absent, this new approach produces a constant base line to indicate that the system is working and that all controls are properly set. As soon as the channel input probe is connected to a signal source, the base line disappears and the signal's waveform is displayed.

Another nice touch is the location of the delay line. It is wired between the signal that triggers the sweep and the vertical amplifiers. This enables you to see at least 20 ns of the waveform before the trigger point. Hence, with this setup you can see *all* of the waveform.

In the auto-trigger mode, the trigger is initiated at zero crossing, although a couple of controls are provided to allow the time base to be triggered at any desired positive or negative point on the input wave form. It is this automatic sweep triggering that makes the Heath scope easier to use than conventional triggered-sweep instruments.

The scope employs a rectangular 10 × 6-cm post-deflection-acceleration CRT that produces a bright, sharp trace display. The engraved graticule on the CRT screen has a brightness control that makes it easy to set the graticule's visibility.

Assembly and Performance. The kit went together in about 35 hours of assembly time. Almost all of the electronic components that make up the scope mount on printed circuit boards, of which there are separate assemblies for each function in the instrument. The boards interconnect with each other and mount in the mainframe by way of heavy-duty plug connectors and factory-prepared wiring harnesses.

After assembling and checking out the scope according to the step-by-step instructions given in the manual that accompanied the instrument, we performed a few tests with the aid of our laboratory-grade 1-Hz to 1-MHz

square-wave generator and a standard r-f signal generator/frequency counter.

The scope's rise time measured considerably better than the 24-ns figure specified by Heath. The tunnel-diode output from our square-wave generator, with its extremely fast rise time, produced a clean wavefront, with a complete absence of ringing and other visible distortion products. The control of each of the two traces was complete. There was no interaction between the two channels, other than a slight dimming of the beam intensity when we switched in both traces. We merely turned up the scope's intensity control to compensate for the loss of brightness.

We used our r-f generator and frequency counter to run some bandwidth tests. The scope responded to 30 MHz before the amplitude of the displayed waveform became too low to be of much use in tests. With the scope's vertical gain control turned up to maximum, there was still a waveform displayed (admittedly, very low in amplitude) to about 65 MHz of input signal. We ran this test for the purpose of determining at what point the scope's triggered sweep system would become unstable and lose sync. To our surprise, the instrument remained in sync at 65 MHz, which is well beyond the 45-MHz figure stated in the published specs. Even switching between positive- and negative-transition triggering did not upset the synchronization.

The vertical amplifiers responded to signals down to 1 mV in amplitude. This, plus the results of our bandwidth and stability tests, was most impressive for an oscilloscope in its price range.

Comment. It is a fundamental engineering maxim that the test equipment you use must be at least one order of magnitude better than the device or equipment being tested. In this era of ultra-fast digital electronic equipment and broadband audio gear, this places heavy demands on an oscilloscope. Equally important, a scope bought now should be usable even with the next generation of developments in electronics.

The Heathkit Model IO-4510 oscilloscope will easily handle most jobs in modern electronics. It will undoubtedly not be obsoleted for a long time to come.

CIRCLE NO. 5 ON READER SERVICE CARD

A very quiet announcement from Phase Linear:

Just between you and us, the new Phase Linear 2000 preamplifier is one of the quietest preamps ever made... so quiet it can match the performance of preamplifiers selling at twice the price.

The latest generation of integrated circuits reduces total harmonic distortion to 0.1%, typically .03%, and gives you a signal-to-noise ratio of 74dB below 10mV. That's quiet!

A highly advanced integrated circuit phono preamplifier creates the sonic excellence you have come to expect from Phase Linear.

A variable ambience injection circuit gives you more of the music — allows for the recovery of music lost with most preamplifiers.

Other features:

Individual detented bass and treble controls with a professional feel in each channel. Turnover points at 50Hz, 150Hz, 2kHz, and 5kHz, where up to 12dB of boost or cut may be applied... *a switchable low frequency active equalizer* for up to 6dB boost below 50Hz for a flatter bass response... *two complete tape circuits* for easy control and tape-to-tape dubbing... *a comfortable size* that complements other Phase Linear products: 5½" x 19" x 6" ... and an *outstanding value at \$299.00.*

Visit your dealer and quietly ask for a demonstration.

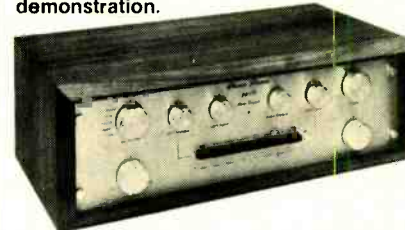

Phase Linear 2000

THE POWERFUL DIFFERENCE
CIRCLE NO. 32 ON READER SERVICE CARD

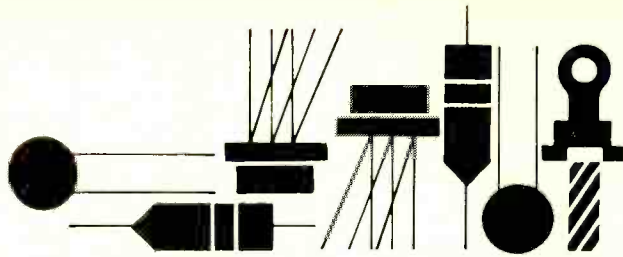

Solid State

By Lou Garner

MANY USES FOR FLASHER/OSCILLATOR

WHILE most solid-state devices, except for highly specialized memories and custom IC's, are suitable for use in a variety of projects, semiconductor manufacturers occasionally introduce new units so versatile that they have as many potential applications as the proverbial mongrel dog has fleas. The ubiquitous 741 op amp is one example; the popular 555 timer and the CA3062 photo detector and power amplifier are others.

The latest member of this relatively exclusive club of "super-versatile" devices is the LM3909 LED flasher/oscillator, recently introduced by the National Semiconductor Corporation (2900 Semiconductor Drive, Santa Clara, CA 95051).

Comprising one pnp double collector and three npn transistors, a zener diode and nine resistors on a monolithic chip, as illustrated schematically in Fig. 1A, the LM3909 is packaged in an 8-lead plastic mini-DIP. Lead terminal connections are identified in Fig. 1B. With a maximum power dissipation rating of 500 mW, the device is specified for an operational temperature range of -25°C to $+70^{\circ}\text{C}$. Its maximum

supply voltage rating, established by the internal zener, is 6.4 volts. Although the device will operate on voltages as low as 1.0 volt, with a power drain of only a few hundred microwatts, it is capable of delivering current pulses of as much as 200 mA, thus providing sufficient drive for a load such as an 8-ohm PM loudspeaker.

Unique among pulse-generating IC's, the LM3909 can deliver an output pulse with an amplitude higher than the dc source voltage. Thus it can drive LED's when powered by a dc supply of as little as 1 volt, even though 1.6 volts is required, normally, to energize the diode. This action is achieved by discharging the external timing capacitor through the LED in series with the source voltage, boosting the voltage applied to the diode. In practice, this capability, coupled with the LM3909's extremely high efficiency, makes it feasible to assemble a LED flasher circuit that will operate for more than a year, 24 hours a day, on a size D flashlight cell. In some cases, in fact, a cell's operating life in a flasher circuit may actually exceed its nominal shelf life!

With internal timing and LED current limiting resistors, the LM3909 requires only three external components for operation as a flasher—a LED, a timing capacitor, and a dc power source, as shown in Fig. 1C. Generally, the timing capacitor will be an electrolytic type, with a 3-volt rating suitable for LED flashers operating on dc supplies of 6 volts maximum. With the values specified on the diagram, the circuit's nominal flashing rate is 1 Hz, but its actual rate will depend on the capacitor's *true* value, taking tolerances into account. (Most small electrolytics have a rather broad capacitance tolerance range, typically from -20% to $+100\%$.) The circuit's average current drain ranges from a little over 0.6 mA with a new cell to less than 0.3 mA as the battery nears the end of its useful life. If an alkaline cell is used, it should have a useful life of over two and a half years, assuming that the flasher operates continuously.

With its extremely long battery life, the basic LED flasher circuit is ideal for use in boat mooring floats and rural lane markers, as well as in sales and advertising displays. It also makes a good night location marker for emergency equipment and controls, such as fire extinguishers and hoses, fire axes, special lighting gear, first-aid cabinets, fuse boxes, switches, locks, and control valves. Other potential applications include toy trucks and cars, children's vehicles, model trains, R/C model planes and boats, games, advertising novelties, and dress accessories and jewelry.

Other LED flasher circuits for the LM3909 are shown in Fig. 2. All of these use readily available components and can be breadboarded for experimental tests, or assembled on perforated or pc board. Except where noted, the resistors are rated for $\frac{1}{4}$ or $\frac{1}{2}$ watt; the capacitors are electrolytics; and the LED's are conventional devices.

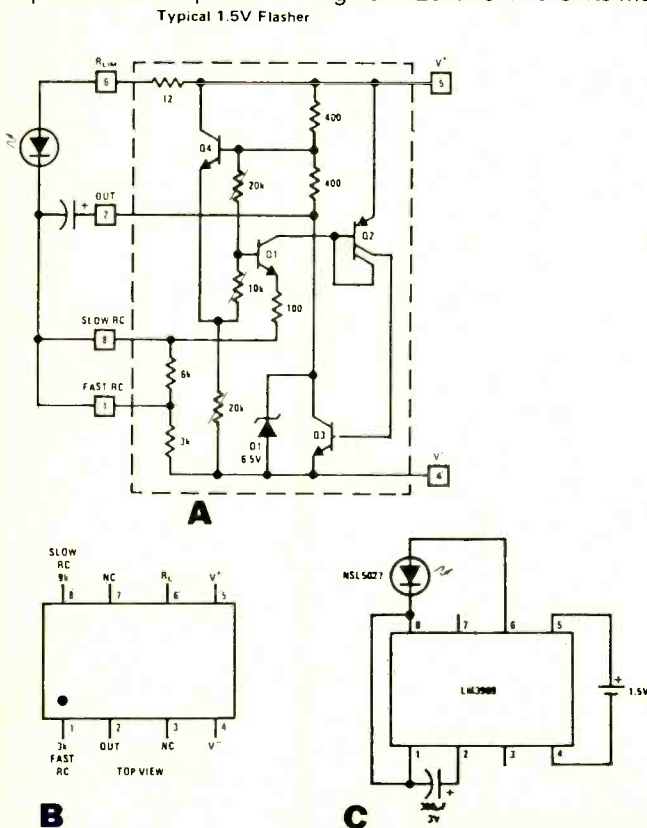

Fig. 1. Internal schematic of the LM 3909 (A), lead connections (B), basic flasher circuit (C).

wing tips. Other applications include advertising displays and games.

Although the LM3909 is designed specifically for use as a low-voltage LED flashing device, its versatility is such that it can be used in a variety of other circuits. Some additional applications are illustrated in Fig. 3.

The high-voltage flasher circuit in Fig. 3A can be used as an alternative to a neon warning lamp for dc power supplies. It is particularly valuable for remote indicator applications because the IC limits the maximum voltage on the LED to less than 7 volts above ground. In operation, the timing capacitor is charged through the 43,000-ohm series resistor, pin 2, and the IC's internal resistors, then discharged periodically through the LED when pin 2 is shunted to ground internally. With the component values specified, the nominal flashing rate is 1.7 Hz and the circuit will work satisfactorily with a dc source voltage of 85 to 200 volts.

Interestingly, the surprising LM3909 may be used to flash incandescent bulbs as well as LED's. A basic incandescent lamp flasher is shown in Fig. 3B. Here, a type #47 bulb is used in conjunction with a 6-volt dc power source, such as four series-connected flashlight cells. The circuit's nominal flashing rate with a 400- μ F timing capacitor is 1.5 Hz.

One of a number of possible nonflasher applications for the LM3909 is illustrated in Fig. 3C, a 1-kHz square-wave oscillator. This circuit can be used in test equipment designs and as a clock source for digital timers, calculators, or control circuits. In operation, the circuit delivers a positive-going pulse with a peak-to-peak amplitude of slightly more than 1 volt. A 10,000-ohm potentiometer serves as the output signal's symmetry control.

A useful "buzz box" continuity and coil checker circuit is

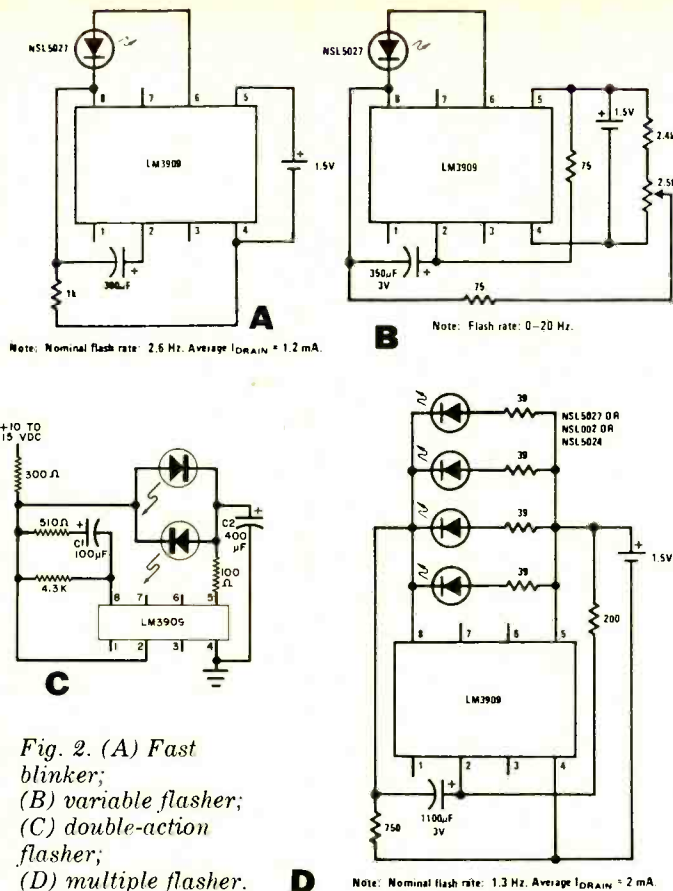

Fig. 2. (A) Fast blinker; (B) variable flasher; (C) double-action flasher; (D) multiple flasher.

The fast blinker circuit in Fig. 2A has a nominal flashing rate of 2.6 Hz and an average current drain of 1.2 mA. It is useful in conjunction with the basic slow-speed flasher to provide additional identification. In an apartment, office, or home, for example, the standard 1-Hz flasher could be used as a marker/locator for fire fighting and emergency lighting equipment, while the fast blinker might be used to identify controls, switches and locks. With the higher flashing rate, battery life is correspondingly shorter, but it still can be several months to over a year.

A variable flasher circuit is shown in Fig. 2B. With a flashing rate of 0 to 20 Hz, depending on the adjustment of a 2500-ohm potentiometer, this circuit can be used for experimental tests and in games, toys, and advertising displays. It should be of value, too, in psychological experiments and response time tests. If the rate control is calibrated, the design could be used for a simple photographic darkroom timer.

Designed to flash two LED's alternately, the double-action flasher circuit in Fig. 2C requires a somewhat higher source voltage and operates at (approximately) a 2.5-Hz rate. Capacitor C2 determines the flashing speed. In operation, one LED is energized as C2 charges, the second as C2 discharges. This circuit can be used with individual LED's or with dual-element devices, such as the MV5491. If a red/green flasher is desired, the green LED's anode should be connected towards pin 5, since a higher voltage pulse is available in this direction.

Four LED's are flashed simultaneously by the multiple flasher circuit in Fig. 2D. With an average current drain of only 2.0 mA and a nominal flashing rate of 1.3 Hz, this circuit can be used where a special identification pattern is needed, such as a bar, square or arrow. It should be useful, too, in toys and models. With a model plane, for example, the four LED's could be located on the nose, tail and two

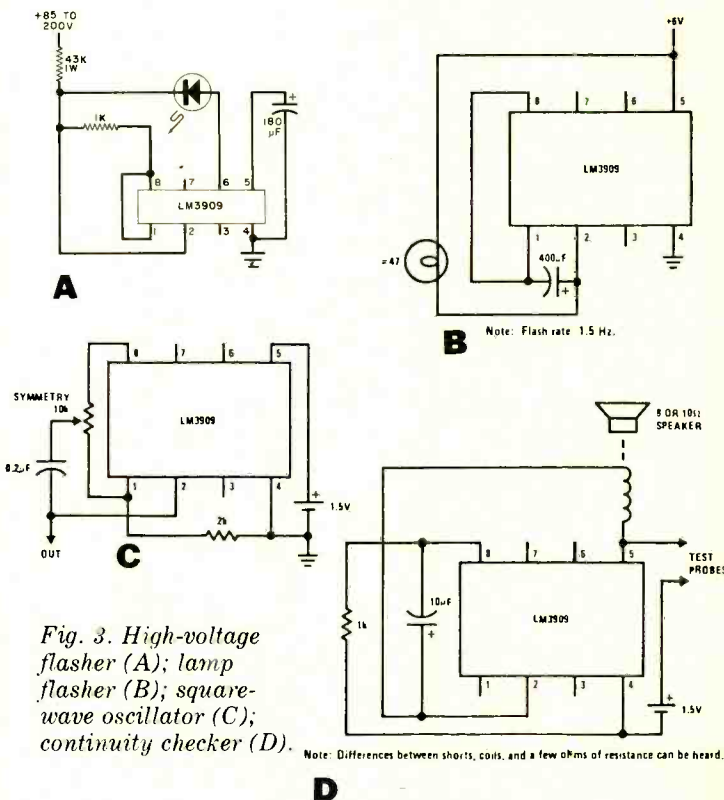

Fig. 3. High-voltage flasher (A); lamp flasher (B); square-wave oscillator (C); continuity checker (D).

given in Fig. 3D. Here, the LM3909 is used as an audio-frequency oscillator to drive a small PM loudspeaker. With practice, an operator can distinguish the differences be-

veen shorts, coils, and a few ohms of resistance by the quality of the sound obtained from the loudspeaker. This design could be assembled conveniently in a small plastic case or metal box for use as either a portable or bench test instrument.

Would you believe a flashlight that identifies itself in the dark? Such an intelligent device can be assembled using the LM3909. The basic circuit and light assembly is illustrated in Figs. 4A and 4B. A conventional two-cell flashlight may be used as the base for project construction, with the LM3909, 200- μ F timing capacitor, and LED installed in a translucent plastic cap attached to the back end of the case. Only one insulated contact strip in addition to the case connection is needed for flasher power since circuit current is drawn through the relatively low resistance (generally less than 2 ohms) of the flashlight bulb. The LED flasher operates continuously, of course, but the battery life is essentially unchanged due to the circuit's low current drain. If a single-cell flashlight is used, pins 1 and 8 of the LM3909 should be shorted together.

An emergency lantern/flasher application for the LM3909 is given in Fig. 4C. The IC drives an external transistor which, in turn, supplies current to a heavy-duty PR13 incandescent lamp bulb. With the component values indicated on the diagram, the nominal flashing rate is 1.5 Hz. Separate switches permit the user to select either flasher or lantern type operation. Operating power is supplied by a conventional 6-volt lantern battery. If desired, the flashing feature may be added to a standard 6-volt lantern, for, as a general rule, there is adequate free space within the typical lantern's case for circuit components.

The applications discussed above and illustrated in Figs. 1, 2, 3, and 4 are but a sampling of the many ways in which the versatile LM3909 can be used in practical circuits. Space permitting, I'll present additional circuits in future columns. One further hint—sometimes a flasher circuit will fail to operate due to a LED defect that is not apparent because it reduces the device's light output by only 10% or so. These LED's can be identified by a substantial increase in their current conduction between 0.9 and 1.2 volts. If you assemble an LM3909 LED flasher circuit, then, and it doesn't work, *check the LED*—you may have to get the LED out!

Reader's Circuit. One of our friends north of the border, Martin Jansen (991 Fleet Ave., Winnipeg, Manitoba, Canada R3M 1K5), submitted the interesting electronic "coin flipper" circuit illustrated in Fig. 5. Featuring a pair of popular IC's, the design may be used for assembling an executive decision maker (YES/NO) or as the basis for an electronic version of such games as "put and take" or "heads and tails." Standard, readily available components are used throughout, and the circuit can be assembled quite easily in

a small pocket-sized plastic or metal case for convenient use at appropriate times.

In operation, a pulse generator, IC1, serves to drive a JK flip-flop, IC2, when control switch S2 is closed. The flip-flop, in turn, alternately energizes a pair of light-emitting diodes, LED1 and LED2. The pulse rate, determined by timing capacitor C1, is faster than the eye can follow, so that it is impossible to tell which LED is on at any given moment. When S2 is opened, one or the other of the two LED's will remain lit, the other dark, the selection essentially a random choice depending on the precise instant that S2 is released. One of the LED's is used to represent YES, HEADS, PUT or a similar word, while the other represents the corresponding opposite expression, such as NO, TAILS, or TAKE. Thus, the instrument provides the user a random choice of two alternative decisions.

Except for trimmer potentiometer R3, all the resistors are 1/4 or 1/2 watt, while C1 is a small low-voltage ceramic or tubular paper capacitor. Almost any standard LED's may be used for the output indicators, LED1 and LED2, with R4's and R5's values chosen to limit their "on" current within specified maximum ratings.

Martin writes that he assembled his original model on a piece of Veroboard, mounting the assembly in an empty metal spice box, which he painted with model paints. However, with neither layout nor lead dress critical, the circuit might be wired on perf board, on a suitable pc board, or even point-to-point, if sockets are provided for the IC's.

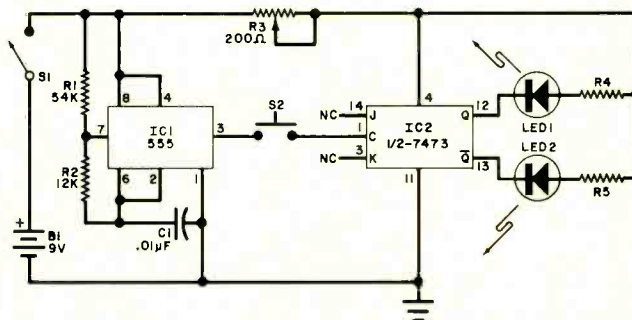

Fig. 5. Reader's electronic coin-flipper circuit.

When the wiring is completed and checked for errors, the circuit should be switched "on" and R3 adjusted to set IC2's voltage (between pins 4 and 11) to 5.0 volts. Afterwards, the completed unit may be used as is or mounted in an appropriate metal or plastic case, as preferred.

Device/Product News. RCA's Solid State Division (Box 3200, Somerville, NJ 08876) has announced a number of new power transistors which should spark the creative juices of imaginative experimenters and hobbyists. In-

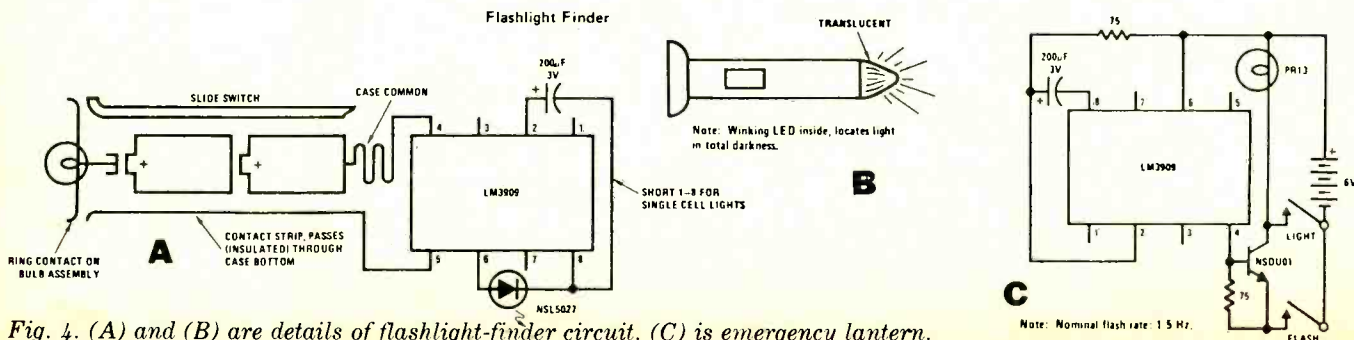

Fig. 4. (A) and (B) are details of flashlight-finder circuit. (C) is emergency lantern.

cluded are five new high-voltage silicon npn devices, types 2N6510-2N6514, designed primarily for use in electronic ignition systems. These have voltage ratings from 200 to 350 volts, depending on type, maximum collector currents of 7 amperes, device dissipations of 120 watts, and a dc beta range of 10 to 50. All five types are supplied in hermetic steel TO-3 packages. In addition to the high-voltage devices, three new 10-ampere pnp Darlington transistors, types RCA8203, RCA8203A, and RCA8203B, have been added to RCA's growing family of Darlington units. These new transistors are monolithic silicon pnp complements of npn types 2N6386, 2N6387, and 2N6388, and have voltage ratings from -40 to -80 volts, 60 watts device dissipation, and gains of 1000 at 5 amperes. Suitable for operation directly from an IC without a predriver, and designed for low- and medium-frequency applications in audio amplifiers, power switching circuits, hammer drivers, and series and shunt regulators, they are supplied in the TO-220AB straight lead version of the VERSAWATT plastic package.

From high power to high frequency—the Amperex Electronic Corporation (Solid State and Active Devices Division, Slatersville, RI 02876) has developed ten new small-signal uhf transistors with gain-bandwidth products from 2 GHz to 6 GHz at collector currents between 100 μ A and 150 mA. The new transistors offer low intermodulation distortion and low cross-modulation distortion for wide-band and similar sophisticated linear applications. Noise figures are as low as 1.9 dB at 500 MHz.

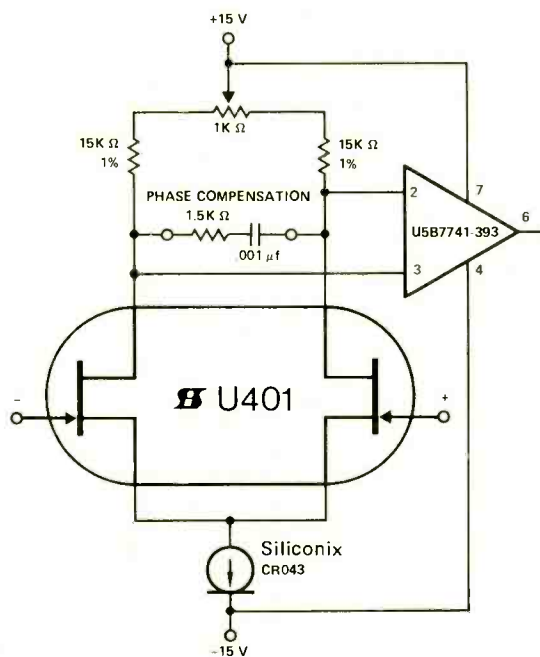
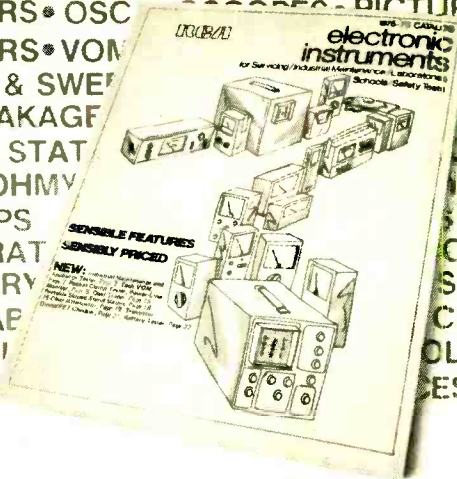

Fig. 6. Dual FET combined with op amp.

Siliconix has a suggestion for those of you who may need tightly spec'd FET input op amps... simply team one of its dual FETs with a standard bipolar op amp. One suggested circuit is illustrated in Fig. 6. Here, a U401 dual FET, in conjunction with a CRO43 current regulator diode, is used as an input driver for a U5B7741-393 op amp. Matched 1% drain load resistors are used while a 1-K pot serves as a null adjustment. Phase compensation is provided by a 1.5-K resistor in series with a 0.001- μ F capacitor. According to Siliconix, this combination offers an input current rating of 15 pA maximum, 1 pA typical, an offset (without nulling) of 6 mV maximum, a drift of only 12 mV/ $^{\circ}$ C, a CMRR of 90 dB, and a slew rate of 0.5 V/ms. \diamond

APPLIANCE & INDUSTRIAL MAINTENANCE
TESTERS • OSC
TESTERS • VOM
AF, RF & SWE
AC LEAKAGE
SOLID STAT
VOLTOHM
ISOTAPS
GENERAT
BATTERY
PORTAB
AC VO
TESTE



CASES
RATORS
METERS
ELECTRONIC
METERS
SOUND
MONITORS
SUPPLIES
CURRENT
COLOR BAR
CESSORIES

RCA Test Instruments... The broad line for a wide range of applications.

Whether it's for use in consumer or industrial electronics, laboratories, schools, safety tests or for everyday electrical or electronic maintenance, there's an RCA Electronic Instrument for your application.

And you can find out about them all in the new 1975 RCA Electronics Instruments Cata-

log. It's yours free for the asking. Just contact any one of the more than 1,000 RCA Distributors worldwide. Or write RCA Distributor and Special Products Division, Cherry Hill Offices, Camden, N.J. 08101.

RCA Electronic Instruments

CIRCLE NO. 37 ON READER SERVICE CARD

NEW

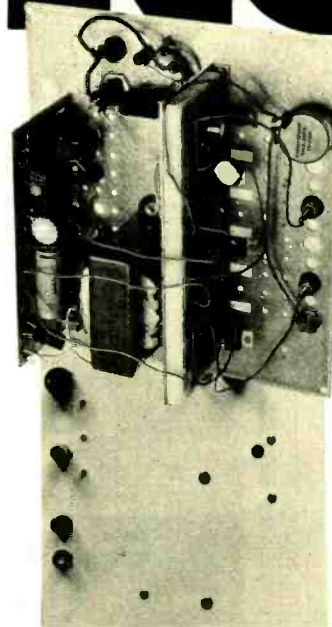

... UNIVERSAL
ELECTRONIC
INSTRUMENT
DESIGN AND BUILD
YOUR OWN
ELECTRONIC
INSTRUMENT
IN HOURS, NOT DAYS!

Think of it. No circuit board to assemble or solder; just push your electronic components into the SK-10; no panels to lay out and machine — simply mount your parts... combine your design with the self-contained power supplies and you've got a finished instrument.

Available in 3 kit versions to meet your unique requirements, it combines the SK-10 socket with the UMP-01 universal panel and gives the designer an instrument in 1/10th the time it would take with custom instruments.

From \$50.00 to \$85.00 depending on the power supplies you want. Write for free literature.

CIRCUIT DESIGN, INC.

Div. of E&L Instruments
P.O. Box 24
Shelton, Conn. 06484

CIRCLE NO. 10 ON READER SERVICE CARD

WE'LL SAVE YOU MONEY

SONY
PIONEER
Sansui

ON FAMOUS BRAND
NATIONALLY
ADVERTISED

**STEREO COMPONENTS,
VIDEO & PROFESSIONAL
PRODUCTS EQUIPMENT**

WRITE TODAY FOR OUR QUOTE AND
OUR COMPLETE AUDIO CATALOG.

FAST DELIVERY IN FACTORY SEALED CARTONS
FOR IMMEDIATE QUOTE
CALL (202) 723-6060

THE COST OF YOUR CALL WILL BE DEDUCTED
FROM ANY ORDER OVER \$200.00.

A.D.R. AUDIO VIDEO
6200 CHILLUM PLACE N.W.
WASHINGTON, D.C. 20011

Master Charge/BankAmericard Honored on Mail Orders

CIRCLE NO. 1 ON READER SERVICE CARD



12 REASONS YOUR CAR NEEDS TIGER CDI

Instant starting in any weather - Eliminates tune-ups - Increases gas mileage - Increases horsepower 15% - Improves acceleration and performance - Spark plugs last up to 70,000 miles - Reduces engine maintenance expense - Amplifies spark plug voltage to 45,000 volts - Maintains spark plug voltage to 10,000 RPM - Reduces exhaust emissions - Dual ignition switch - An Unconditional LIFETIME GUARANTEE Installs in 10 minutes on any car with 12 volt negative ground - No rewiring - Most powerful, efficient and reliable Solid State Ignition made.

SATISFACTION GUARANTEED or money back

TIGER 500 assembled \$53.95
TIGER SST assembled \$42.95

Post Paid in U.S.A.

Send check or money order with order to:

Tri-Star Corporation
P. O. Box 1727 C
Grand Junction, Colorado 81501

DEALER INQUIRIES INVITED
CIRCLE NO. 47 ON READER SERVICE CARD

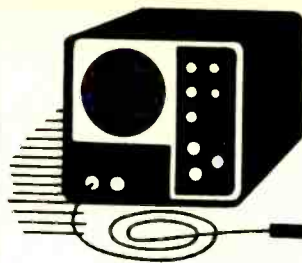

Test Equipment Scene

By Leslie Solomon

TESTING CB MODULATION AND CAPACITORS

READERS frequently ask us how they can accomplish some testing chore that would normally be easy if they had the proper equipment—but the latter is too expensive for occasional use. There are usually ways to get around such problems. Here are two examples.

Checking CB Modulation. The typical CB'er is interested in knowing just how well modulated his transmitter is. Possibly he has had complaints about poor audio quality from his listeners on the other end. Obviously, the closer a transmitter is to having 100% modulation, the better the received signal. With less than 100% modulation, the audio "volume" is reduced. Modulation over 100% produces interfering "splatter," which can make transmission almost unintelligible, and is also illegal.

The transmitter can be checked easily with a modulation monitor, but this is an expensive instrument that is usually found only in professional r-f service shops.

To do your own modulation checking, you can build up the circuit shown in Fig. 1. You will need an oscilloscope on which you can gain access to the four electrostatic deflection plates of the CRT. Or, you can build a suitable power supply for almost any type of electrostatic CRT that you have on

hand. There is no need for the vertical and horizontal deflection circuits—just access to the deflection plate connectors.

The tuned input circuit is preset for the 27-MHz CB band and a short antenna is added. The rest of the circuit consists of a capacitor (C_1) that couples the r-f signal to the upper vertical deflection plate of the CRT. The other plate is grounded. A simple diode detector and filter circuit couples the demodulated audio signal to the left horizontal deflection plate, with the right plate grounded.

To use the modulation monitor, apply power to the CRT circuit and allow it to warm up until a spot is displayed on the CRT. The modulation monitor does not need a power supply. Then turn on the CB rig and orient the monitor's antenna until the CRT spot changes to a vertical line when the CB transmitter is energized. Adjust the monitor tuning capacitor and antenna so that the vertical line is longer than half of the CRT screen.

With the CB microphone shielded so that it does not pick up any signals, ac hum in the transmitter will show up as a broadening of the vertical line.

Speaking into the microphone at a normal level and with the normal mouth-to-microphone distance should cause the thin vertical line to change into a trapezoid. The trap-

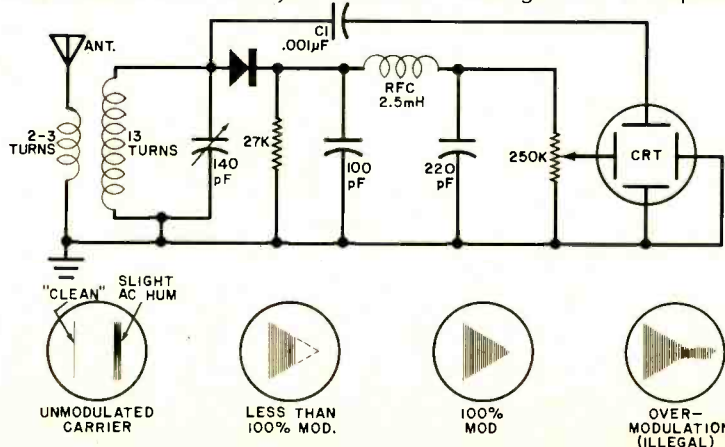

Fig. 1. Circuit for checking modulation. Waveforms show scope results.

ezoid will change to a triangle at the 100% modulation point. (See the four traces in Fig. 1.) When the shape is a trapezoid, the transmission is legal because it is modulated less than 100%. You can adjust the potentiometer to change the width of the trace.

If the triangle develops a "tail," as in the right-hand trace, the modulation is over 100% and is illegal. This tail is what causes the splatter that is so annoying on the band. Any rig that produces this effect should be checked before it is put back on the air. However, remember that FCC rules require that any adjustments on the frequency-sensitive portion of the transmitter must be made by a licensed Radio Technician.

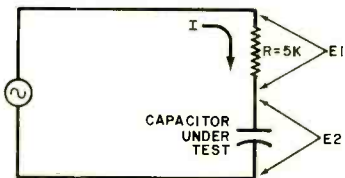

Fig. 2. Capacitor test circuit.

Capacitor Testing. There are several different types of capacitor testers available—some of them very expensive—but the simplest approach uses just an ordinary filament transformer, a fixed resistor, and an ac voltmeter. The basic circuit is shown in Fig. 2.

Connect the resistor and the capacitor to be tested in series across an ac source of known frequency. Although almost any audio frequency will do, the 60-Hz commercial line can be used. It is stable and convenient, but use the transformer to isolate the circuit for safety's sake.

First calculate the current flowing through the circuit. To do this, measure the voltage across the resistor, calling it E_1 . The current is then $I = E_1/R$. For example, if the resistor is 5000 ohms and the voltage drop is 7.5 V, the current is 0.0015 A.

To determine the capacitor value, first measure the voltage drop across the capacitor, calling it E_2 . Then the capacitance is $C = I/(2\pi fE_2)$. Thus, in the example, if E_2 is 5 V, $C = 0.0015/(6.28 \times 60 \times 5) = 0.7 \mu\text{F}$.

This approach is limited in accuracy since many capacitors may leak and produce erroneous meter indications. Also, the procedure cannot be used to check electrolytic capacitors.

If you are checking a number of capacitors, it might be handy to add a scale to the meter calibrated to read capacitance rather than voltage. ♦

BEST CB RECREATIONAL COMMUNICATIONS

PACE has the largest selection in Citizen Band 2-way radio equipment and accessories. Each unit is specifically designed to bring you more fun in recreational communication from your home, car, motor home, trailer, boat, dogsled, or whatever you use in your pleasure hours. Call your base camp from your fishing skiff to find out what's on for lunch; or, talk to other mobile units in your caravan for information on road or campsite conditions. A CB radio from PACE can also be very helpful if you need assistance.

PACE gives you the widest choice in sizes—and the greatest variety of RF power and channel options. Use CB Two-Way communications, engineered by PACE, to bring you more enjoyment on your travel outings this summer. See your PACE dealer or give us a call.

((P)) PACE COMMUNICATIONS

Division of PATHCOM INC., 24049 S. Frampton Ave., Harbor City, Calif. 90710
Export: 2200 Shames Drive, Westbury, New York 11590
Available in Canada from Superior Electronics Inc.

See your dealer today

CB2300 \$219.95	CB2376A \$179.95	CB100ASA \$109.95	CB10-2 \$69.95	CB125 \$59.95	CB155 \$94.95
--------------------	---------------------	----------------------	-------------------	------------------	------------------

CIRCLE NO. 30 ON READER SERVICE CARD

FREE McIntosh CATALOG and FM DIRECTORY

Get all the newest and latest information on the new McIntosh Solid State equipment in the McIntosh catalog. In addition you will receive an FM station directory that covers all of North America.



MX 113

FM/FM STEREO - AM TUNER AND PREAMPLIFIER

SEND TODAY!

McIntosh Laboratory, Inc.
East Side Station P.O. Box 96
Binghamton, N.Y. 13904
Dept. PE

NAME _____
ADDRESS _____
CITY _____ STATE _____ ZIP _____

If you are in a hurry for your catalog please send the coupon to McIntosh.

For non rush service send the Reader Service Card to the magazine.

CIRCLE NO. 25 ON READER SERVICE CARD

Learning with CIE is



Electronics no picnic.

**It takes work.
And a few
sacrifices.
But
it's worth it!**

The minute you start your CIE course you'll see why CIE is different than other home-study schools.

Because as a CIE student you'll get the kind of electronics training that prepares you for a career, not just a job. We'll give you a meaningful, well-rounded foundation in electronics theory and practice. And with our special Auto-Programmed® Lessons, we'll make sure you grasp the key theories and methods of modern Electronics. No "fun and games" frills. No time-wasting, superficial lesson material. No "snap" exams.

We'll challenge your thinking.

We have to. Because after you graduate, employers will expect you to really know how to analyze and troubleshoot virtually all kinds of electronics equipment. Some employers of electronics personnel have told us that our graduates have what it takes.

That's why we're so thorough. We've got a 40-year reputation to uphold and we're going to keep it by giving our students the best *independent home-study* training we can.

Sure, some of our weaker students drop out. (Learning Electronics with CIE is no free ride.) But you can bet on this... the ones who do make it are ready! Ready to go out and make it in the rewarding world of Electronics. And that's the reason you want to learn, isn't it?

You can have attractive job opportunities

There have already been many exciting developments and breakthroughs in

Electronics and some people might assume there will be no new frontiers... no new worlds to conquer. Not so.

Electronics is still growing. In nearly every one of the new and exciting fields of the Seventies you'll find electronics skills and knowledge in demand. Computers and data processing. Air traffic control. Medical technology. Pollution control. Broadcasting and communications.

Importance of an FCC License

If you want to work in commercial broadcasting... television or AM or FM broadcasting... as a broadcast engineer, federal law requires you to have a First Class Radiotelephone License. Or if you plan to operate or to maintain mobile two-way communications systems, microwave relay stations or radar and signaling devices, a Second Class FCC License is required.

But even if you aren't planning a career which involves radio transmission of any kind, an FCC "ticket" is valuable to have as Government certification of certain technical skills. It's a job credential recognized by some employers as evidence that you know your stuff.

A good way to prepare for your FCC License exam is to take one of the CIE career courses which include FCC License preparation. We are confident you can successfully earn your license, if you're willing to put forth an effort,

because the vast majority of CIE students have. In fact, based on continuing surveys, close to 9 out of 10 CIE graduates have passed their FCC exams!

So if you are serious about getting ahead in Electronics... if you are willing to put in the extra work... get in touch with us.

We have many *career* courses for you to select from. If you already have some electronics training, you may want to skip our beginner-level courses and enroll in an intermediate program. Or, if you're really hot, there's a tough, college-level course called "Electronics Engineering" that can make you even better.

Send today for FREE school catalog

Send today for our FREE school catalog and complete package of *independent home-study* career information. For your convenience, we will try to have a representative call to assist in course selection. Mail reply card or coupon to CIE... or write: Cleveland Institute of Electronics, Inc., 1776 East 17th Street, Cleveland, Ohio 44114.

Do it TODAY.

G.I. Bill Benefits

All CIE career courses are approved for educational benefits under the G.I. Bill. If you are a Veteran or in service now, check box for G.I. Bill information.

CIE Cleveland Institute of Electronics, Inc.

1776 East 17th Street, Cleveland, Ohio 44114

Accredited Member National Home Study Council

Yes, I want your FREE school catalog and career information package today.

I am especially interested in:

- | | | |
|--|--|-------|
| <input type="checkbox"/> Electronics Technology | <input type="checkbox"/> Industrial Electronics | PE-84 |
| <input type="checkbox"/> FCC License Preparation | <input type="checkbox"/> Electronics Engineering | |
| <input type="checkbox"/> Color TV Maintenance | <input type="checkbox"/> Other _____ | |
| <input type="checkbox"/> Mobile Communications | | |

Print Name _____

Address _____

Apt. _____

City _____

State _____

Zip _____

Age _____

Check box for G.I. Bill information.

Veteran

On Active Duty



Amateur Radio

By Herbert S. Brier, W9EGQ

USING THE OSCAR SATELLITES

UNTIL recently, working "real" DX on the vhf bands with low-power equipment was limited to a few hardy souls using sophisticated stations and techniques. All this has changed. Amateurs need no longer rely on the moon, fickle sunspots, etc., to propagate their signals—OSCAR can do the job reliably!

The Orbital Satellite Carrying Amateur Radio program officially started in 1961, when OSCAR 1 was assembled. OSCAR hitched a ride on a U.S. Air Force satellite booster and entered into a 300-mile (483-km) high polar orbit on December 12, 1961. Over 570 amateurs in 44 states and 28 countries reported hearing the cheery CW "Hi" from the satellite's 140-mW, 2-meter beacon.

OSCAR 2, another simple beacon, was launched in 1963, paving the way for OSCAR 3, an orbiting repeater. "Three" received signals near 144.1 MHz and retransmitted them near 145.9 MHz. During its 230 active orbits, hundreds of amateurs worked each other through OSCAR from state to state, country to country, and continent to continent.

The booster carrying OSCAR 4, launched December 1965, malfunctioned, and the satellite went into a highly elliptical orbit, which decayed after a few passes. However, before OSCAR 4's fiery reentry, the first satellite contact between the USSR and the USA was accomplished. OSCAR 5, built by Australian amateurs, followed in 1970. It transmitted continuous beacon signals on 145 MHz and 29.5-MHz beacon signals that could be turned on and off from the ground.

OSCAR 6 and OSCAR 7. OSCAR 6 was launched on October 15, 1972, and is still going strong! It receives signals between 145.9 and 146 MHz and repeats them between 29.45 and 29.55 MHz, with a power output of about 1.3 watts.

OSCAR 7, entering orbit November 15, 1974, contains all the features of the previous OSCAR's in one package. Constructed by Australian, Canadian, German and American amateurs, it contains two complete repeaters. Repeater "A" receives between 145.85 and 145.95 MHz and transmits between 29.4 and 29.5 MHz with an output of 2 watts PEP. On alternate days, OSCAR 7's repeater "B" receives between 432.125 and 432.175 MHz and retransmits between 145.975 and 145.925 MHz with a maximum power of 14 watts PEP. (Note: as the 432-MHz frequencies increase, the 145-MHz frequencies decrease.)

Besides functioning as repeaters, both OSCAR's transmit beacon signals and send telemetry information about their internal operation. They can also be programmed from the ground to send important messages to listeners. The OSCAR 6 beacon operates on 29.45 MHz. In contrast,



Stuart Cowan, W2LX, Rye, N.Y., and his home-constructed, 40-watt, 146-MHz transmitter. He has worked a dozen countries in three continents using the OSCAR satellites. Antennas include a 14-element Yagi, a beam, and a center-fed wire doublet.

OSCAR 7 sends three beacon signals. On "A" days they are found at 29.502 MHz (CW and RTTY) and 432.1 MHz (RTTY), while on "B" days the beacon is active on 145.972 MHz (CW or RTTY).

OSCAR'S are powered by nickel/cadmium batteries, which are recharged through solar cells distributed over their outer surfaces. OSCAR 7 has a larger and more efficient charging system than OSCAR 6 has, so it can run continuously. OSCAR 6, on the other hand, must be shut down periodically to allow its batteries to recharge completely.

Using the Satellites. Probably the best way to start using the OSCAR satellites is to listen to them. You'll need a sensitive receiver capable of receiving 10-meter and/or 2-meter CW and SSB signals, and a fairly good receiving antenna. The best "starter" antennas are circularly polarized to minimize fading. Consult the Radio Amateurs Handbook (ARRL), Specialized Communications Techniques (ARRL), or the VHF Handbook (Radio Publishing) for plans of antennas and other OSCAR accessories.

The OSCAR's cross the United States each evening from south to north between approximately 7 and 11 p.m., local standard time. From north to south they make passes between 7 and 11 a.m. On the present OSCAR 7 schedule, Mode A (2- and 10-meter) operates Monday, Thursday, and Saturday evenings; Mode B (2-meter), on Sunday, Wednesday, and Friday evenings. Tuesday evenings and each morning (except weekends) are reserved for tests, class-room demonstrations and special schedules.

Start listening on the appropriate frequency (29.45, 29.502, or 145.972 MHz) shortly before 7 p.m., until the beacon signal is heard. Carefully note the acquisition time. The satellite will be in the same position at about the same time two days later. In addition, you will probably be able to hear the next pass about 115 minutes later, when OSCAR will have progressed 28.73 degrees to the west. If the second pass is louder than the first, listen again another 115 minutes later. On alternate days, each pass occurs about an hour earlier (or later) than the day before. After a few days you'll become familiar with the pattern.

For precise information, copy W1AW on Sunday afternoons. At 2000 GMT, all OSCAR north-to-south



Holding a personal 3-continent "QSO" are (left to right) Phil Haller, W9HPG, ARRL Central Div. Director; Arnim Rudder, 9Y4AR, Trinidad; and S. Mittelsdorf, DL3UT, W. Germany. At Hamfesters picnic in Chicago.

equatorial crossing times for the following week are transmitted on CW. Frequencies are 3.58, 7.08, 14.08 and 21.08 MHz. The bulletins are repeated on RTTY at 2100 GMT on 3.625, 7.095, 14.095 and 21.095 MHz. Included are overpass times on each orbit for major cities like Detroit, Denver, New York, Houston, and San Francisco. This same information is available in printed form from AMSAT, Box 27, Washington D.C., 20044 (include a SASE).

You can identify the beacons by their strings of 5-digit numbers, with "Hi Hi" every 90 seconds, on CW (20 wpm) or RTTY. OSCAR 7's 10-meter beacon is somewhat stronger than the one aboard OSCAR 6. As soon as you can hear the beacon, tune into the appropriate passband for signals coming through the down-link. Most will be on CW, and the rest probably on SSB.

The satellite moves quickly, so you must continually compensate for resulting Doppler frequency shift. A usable pass will last anywhere from less than a minute to about 20 minutes. At first, signals will seem to pop in and out before they can be tuned in, and then the pass will be over. After a little practice, however, you'll get the "hang" of OSCAR operation. When the satellite is directly overhead, you should be able to hear stations within a 2500-mile (4025-km) circle centered on your QTH.

Transmitting. To avoid "hogging" the satellite's translator, your effective radiated power (erp) shouldn't exceed 100 watts. This can be achieved with 10 watts into a beam with a 10-dB gain, or 100 watts into a nondirectional antenna.

Many amateurs have old 146-MHz AM/CW transmitters stashed away, and many dealers have similar units on their used-equipment shelves. These can be resurrected and keyed for OSCAR work. Another source of 146- and 432-MHz transmitters is the 150- and 450-MHz commercial FM

gear available from surplus dealers. They can usually be retuned for the adjacent amateur band and modified for CW operation without much trouble. Commercially manufactured vhf SSB gear is being introduced; hf-to-vhf "transverters" can also be used. Amateur literature contains plenty of suggestions for the homebrewer. A good "junk box" will provide most of the parts needed to get on 2 meters or 70 cm.

When you are ready for two-way OSCAR work, tune your receiver to the OSCAR downlink passband. Send a short string of slow dots on the input passband and tune in your own signal. For OSCAR 7, choose 10-meter frequencies between 29.400 and 29.445 MHz for CW, RTTY, and SSTV; 29.445-29.455 MHz "potluck"; and 29.455 to 29.495 MHz for SSB. Do not operate above 29.495 MHz, or you'll cause interference with the beacon signal. After tuning in your own signal and noting how you sound to other operators, you're ready to make contacts.

Meetings and Literature. The 1975 ARRL Technical Symposium will be held Sept. 12, 1975 and the ARRL National Convention, Sept. 13 & 14, in Reston, Va. They will be sponsored by the Northern Virginia Amateur Radio Council and the Foundation for Amateur Radio. For details, write: Registration Chairman, P.O. Box 682, McLean, VA 22101.

If you are looking for some extra door prizes for your next meeting, hamfest, etc., Radio Shack will send you ten copies of their Archer Transistor Substitution Guide free, on request, for a limited time only. The 96-page booklet sells for \$1.25 at Radio Shack stores. Among other things, it lists over 20,000 commercial transistor types, which may be directly replaced or substituted for with one of 37 Archer transistors. Write, on your club or organization stationery, to: Radio Shack Transistor Guide, 2617 W. 7th St., Fort Worth, TX 76107. ♦

ALTAIR 8800 USERS !

Get your system going inexpensively with our memory and Input/Output cards. All are fully 8800 compatible and include every standard 8800 feature plus more. Check these features:

- Designed for maximum versatility to meet your system requirements
- Easy to assemble and use
- Maximum noise rejection built in
- Two sided epoxy, plated thru holes
- Gold plated edge contacts
- 100% GUARANTEED

INPUT/OUTPUT

This one card will meet all common I/O requirements. Interface your Altair with the TV Typewriter and at the same time a teletype or modem, plus other devices.

- Two input and two output ports (parallel)
- One serial I/O for any teletype and/or EIA RS-232C device, uses a UART
- Two special ports for any imaginable control needs
- Program serial data from 35 to 9600 baud
- Full I/O handshaking provided

ORDER KIT No. 3P+S \$125.

MEMORIES

Our high speed, low power static read write memory (RAM) allows the 8800 to run at top speed. All our memory IC's are 100% tested to Military STD-883! Each card accepts up to 4096 8 bit words.

ORDER KIT No. 4KRA

- w/4Kx8 \$225.
- w/2Kx8 125.
- w/1Kx8 85.

Our PROM card accepts up to eight 1702A or 5203 erasable programmable read only memories. All necessary 8800 interface logic is provided but NO PROM's.

ORDER KIT No. 2KRO \$ 50.

Write for assembled unit pricing. Send for our FREE flyer or order now from:

PROCESSOR TECHNOLOGY CO.
2465 Fourth St., Berkeley, Calif. 94710
(415) 549-0857

Terms: All items postpaid. California residents add sales tax. 20% deposit required on COD orders. Discounts: 5%, orders over \$375; 10%, over \$600.

CIRCLE NO. 36 ON READER SERVICE CARD

Planning? to move.

Let us know 8 weeks in advance so that you won't miss a single issue of **POPULAR ELECTRONICS**.

Attach old label where indicated and print new address in space provided. Also include your mailing label whenever you write concerning your subscription. It helps us serve you promptly.

Write to: P.O. Box 2774, Boulder, CO 80302, giving the following information:

- Change address only.
- Extend subscription. Enter new subscription.
- 1 year \$6.98
- Payment enclosed (1 extra BONUS issue)
- Bill me later

AFFIX LABEL	
<p>If you have no label handy, print OLD address here.</p> <p>name _____ please print</p> <p>address _____</p> <p>city _____</p> <p>state _____</p> <p>zip code _____</p>	<p>name _____</p> <p>address _____</p> <p>city _____</p> <p>state _____</p> <p>zip code _____</p>

Add'l postage per year: Add \$1 for Canada; \$2 for all other countries outside the U.S.



LISTEN!

We're one of the country's largest Mail Order Houses of Stereo Equipment and Musical Instruments.

Our volume buying power enables us to pass the savings on to you. Listen to us ... You can't go wrong.

Fill out this coupon and mail to address below for our latest Free Catalogs.

Name _____

Address _____

City _____

State _____ Zip _____

AUDIO CATALOG
 MUSICAL INSTRUMENT CATALOG

STEREO DISCOUNTERS

7A AYLESBURY ROAD □ TIMONIUM, MD. 21093

(301) 252-6880

CIRCLE NO. 44 ON READER SERVICE CARD

now available for the telephone experimenter

COMPLETE CONSTRUCTION PLANS

TELEPHONE PLANS \$3.00 each
 Answering Device, Automatic Dialer, "Black Box", Call Diverter, Call Limiter, Conference Bridge, Central Dial Exchange, Melodic Ringing Generator, Recorder-Actuator, Remote Control, Schematics, Speakephone, Teleink Burglar Alarm, Voice Scrambler, Dial/Tone Converter, Tone/Dial Converter.

MISC. PLANS \$6.00 each
 Biofeedback Conditioner, Multifrequency Encoder Network, Horticulture Stimulator, Dodecahedron Speaker Enclosure, Photographic Pinhole Camera.

ALL OF THE CONSTRUCTION PLANS ABOVE \$24.95 AIRMAILED

LEARN THE SECRETS OF YOUR TELEPHONE

Telephone Electronics Line

Have you ever wondered what lies behind that telephone dial? Now you can learn the tricks of the telephone trade. Get the inside story of telephone systems—their quirks and flaws, and remain up to date on vital occurrences within the telephone industry. TELEPHONE ELECTRONICS LINE is a publication designed for the telephone enthusiast, Phone Phreak, and experimenter, containing interesting articles which offer a wealth of hard to find information. Technical theory is also discussed, among the following terms:

Current News Items • Code Numbers Illustrations • Games • Facts • Plans Projects • History • Comics • Stories Facts previously Tel. Co. confidential is now published in TEL!

One year subscription rate: United States \$6.00, Canadian & foreign \$8.00.

ALL OF THE CONSTRUCTION PLANS ABOVE PLUS A ONE YEAR SUBSCRIPTION TO TELEPHONE ELECTRONICS LINE \$29.95 AIRMAILED.

THE LEGAL ASPECTS OF INTERCONNECTION

\$29.95 AIRMAILED

The complete reference book to your LEGAL RIGHTS as a telephone subscriber. Study toll evasion, tariffs, wiretapping, customer provided equipment, and many more!

ALL OF THE CONSTRUCTION PLANS ABOVE AND A ONE YEAR SUBSCRIPTION TO TEL PLUS "THE LEGAL ASPECTS OF INTERCONNECTION" \$49.95 AIRMAILED.

TELEPHONICS COMPANY OF AMERICA
 22035 BURBANK BLVD., WOODLAND HILLS CA 91364 USA

CIRCLE NO. 45 ON READER SERVICE CARD

LISTEN IN TO APOLLO/SOYUZ TEST PROJECT

BY RICHARD S. FLAGG

AT 1220 GMT on July 15, 1975 (as of this writing), a Soyuz manned spacecraft will be launched from the Soviet Cosmodrome at Tyuratam. Seven and a half hours later, a manned Apollo spacecraft will be launched from Cape Canaveral, Florida. The combined operation will be called the Apollo-Soyuz Test Project (ASTP).

It is hoped that the Soyuz and the Apollo will rendezvous and dock at 1615 GMT, July 17. After some experiments, the two spacecraft will separate at 2254 GMT, July 19. The Soyuz is scheduled to return to earth at 1050 GMT, July 21, while the Apollo will stay in space until July 24.

The Soyuz will be injected into an 88.7-minute period orbit inclined at 51.5° to the equator. Approximately 78 minutes after launch, Soyuz will cross the equator at 41.6° proceeding northwest. The next north-bound equator cross will occur 88.7 minutes later at 32.54° west longitude. Each succeeding equatorial crossing will then occur 22.54° farther west along the equator at 88.7-minute intervals. These crossings can be plotted on a world map to find out where Soyuz is for reception purposes.

Soviet tracking ships will be stationed near Sable Island (Nova Scotia) and in the Gulf of Honduras. The "circle of coverage" for these ships is 1600 km (almost 1000 miles) centered on the ship. If a 1600-km circle, centered on the listener's location, overlaps the ship coverage, then communications can be monitored when the spacecraft is in the overlap area.

The easiest frequency to hear will be the 121.75-MHz transmissions using a 70-kHz voice-modulated FM transmission with 4 watts output. The Soyuz antenna is linearly polarized. The Apollo will use the same frequency, method of modulation, and power, but its antenna will be right-hand polarized. There will be several ground stations scattered about the U.S.A. (also many abroad) to maintain contact with the spacecraft. Downlink

voice communications to these stations will be on 296.8 MHz from Soyuz and 2287.5 MHz from the unified S-band system aboard the Apollo. Frequencies that will be used are shown in the table.

Experience during previous Soyuz flights has shown that a dipole antenna is sufficient to receive the 121.75-MHz signals if the receiver has a 3- or 4-dB noise figure. To ensure good voice signals, an antenna having about 10 dB of gain is suggested. A low-noise antenna preamplifier will also help.

SPACECRAFT FREQUENCIES

20.008 MHz (A)*	Soyuz. PDM, CW
121.75 MHz*	Soyuz, Salyut-4. 70-kHz voice FM
259.7 MHz*	ASTP. Intership AM voice
296.8 MHz*	ASTP. downlink AM voice to US ground stations from Salyut
922.75 MHz*	Soviet earth satellites. Beacon and telemetry
2287.5 MHz*	Apollo unified S-band center frequency

Notes:

(A) Intermittent use during flight.

* Will be used during ASTP flight

Legality of Monitoring. Listeners should be aware of Section 605 of the Communications Act of 1934 ("Unauthorized Publication of Communications") which states that it is unlawful to divulge the contents of any interstate or foreign communications which have been received, with the exception of communications broadcast or transmitted by amateurs or others for the use of the general public, or relating to ships in distress.

According to this rule, there appears to be no legal problem involved with the monitoring of spacecraft transmissions as long as the contents are not divulged to someone not present when the signals were received.

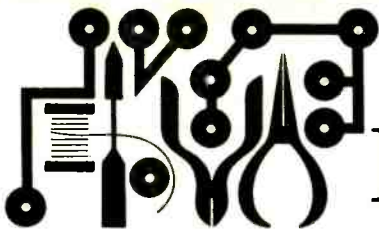

Hobby Scene

FM PREAMPLIFIER

Q. How about a schematic for an FM signal booster?

—Jeff Gold, Van Nuys, CA.

A. The circuit shown will provide about 24 dB gain across the FM broadcast band. It's fairly immune to cross-modulation, as it can handle interfering signals up to about 15 millivolts with 10% cross-modulation at maximum gain. IC1 is an RCA CA3005 amplifier, and allows connection of an

agc line. Reverse agc can be applied by varying the voltage at pin 12 from 9 volts (maximum gain) to 3 volts (full cutoff). Dynamic agc range is about 60 dB. L1 is made by winding four turns of #22 wire, center tapped, on a 1/4-inch OD coil form with an "E" material slug. L2 is the same as L1, but has no center tap. C1 (A and B) is a two-gang FM tuning capacitor (approx. 2.9-30 pF). Peak C1 and the 10-pF trimmer for maximum signal.

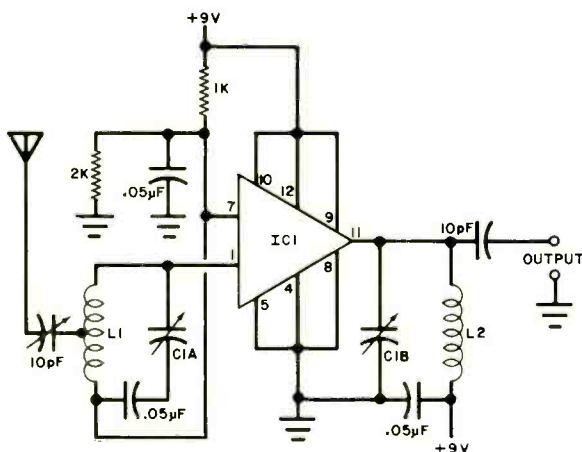

ZENER DIODE TESTER

Q. I bought a batch of zener diodes, but they are unmarked except for polarity. I want to find out the breakdown voltage of each of them, which is supposedly between 5 and 15 volts. Is there a circuit that will do this?—Joseph Gargiulo, Brooklyn N.Y.

A. The circuit shown here will be useful for testing zener diodes. Care must be taken lest the current rating be exceeded. Assuming the diodes are half-watt models, maximum current for a 5-volt zener will be 100 mA, and 25 mA for 20-volt zeners. For one-watt diodes, maximum current is 50 mA (20-volt zeners) and 200 mA (5-volt devices). With the switch in the half-watt position, current is limited to 20 mA. In the one-watt position, it is 40 mA. Most half- and one-watt diodes will zener at 20 mA, so set the switch to the half-watt position. Using an electronic volt-

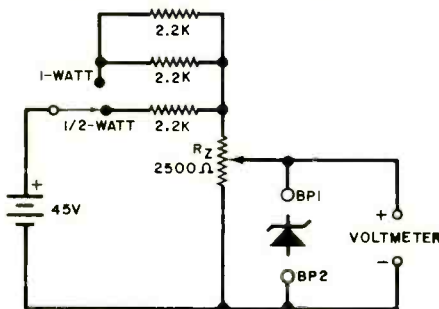

meter, set the 2500-ohm potentiometer so that the voltmeter indicates 0 volts, then install the test diode between binding posts as shown. Slowly turn the potentiometer and note the increase in the voltmeter reading. If the zener is OK, you will reach a point where any further rotation of the pot will produce no increase in the voltage. This is the zener voltage. For some higher-powered zeners, it might be necessary to set the switch to one watt, if a run in the half-watt setting indicates no zenering action.

free

The "NEW LOOK"

1975 LAFAYETTE Radio Electronics CATALOG

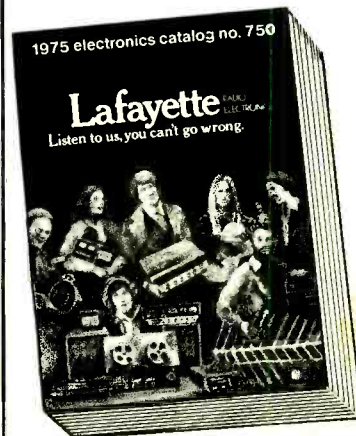

The ONLY Nationally Distributed Full-line Catalog with a MAJOR Showing of the Newest NAME-BRAND electronics products for 1975.

FREE SEND TODAY

SAVE on exclusive Lafayette Products plus MAJOR BRANDS

• Stereo and 4-Channel Systems • Tape Equipment • Car Stereo • CB and Ham Gear • Police/Public Service Receivers • Antennas • Cameras • TV • PA and Test Equipment • Musical Instruments and Amplifiers • Books • Electronic Calculators • Security Systems • PLUJS PARTS, TUBES, BATTERIES, HARDWARE, MORE!

Lafayette

Listen to us, you can't go wrong.

Dept. 35075

Lafayette Radio Electronics
111 Jericho Tpke., Syosset, L.I., N.Y. 11791

Send me your FREE 1975 Catalog

Name Apt.
Street
City State
Zip

Send a 1975 Catalog to my friend

Name Apt.
Street
City State
Zip

CIRCLE NO. 24 ON READER SERVICE CARD

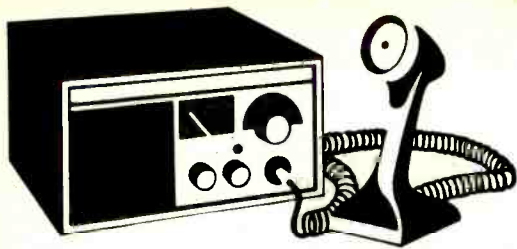

CB Scene

By Len Buckwalter

FUNDAMENTAL BLOCKING

MOST next-door neighbors will take a lot of guff. For instance, I've played my hi-fi at 102 dB after midnight, and none of my neighbors has ever complained. (I can still lean over the back fence and borrow a cup of sugar.) However, there is nothing that enrages a neighbor like interfering with his TV reception. A few microvolts of CB signal in the wrong place will cause the local populace to raise a furor that will make you want to move to Broken Jaw, Wyoming.

One of the trickier causes of TVI is not the fault of the CB'er or his rig. It is called fundamental blocking.

When a CB transceiver is located very close to a TV set, or if their antennas are not many feet apart, a 27-MHz carrier can be strong enough to "side-step" the TV's tuned circuits. It is possible for a powerful 27-MHz fundamental to impress a voltage somewhere in the TV chassis and be rectified into video or audio interference. The result: jellied Johnny Carson.

A clue to distinguishing fundamental blocking from second-harmonic interference is the distribution of the problem over the TV band. Second harmonic tends to produce a herringbone design on channel 2. Fundamental blocking can tear the picture (or sound) on any, or every, channel. The effect varies from station to station because of differences in TV signal strength.

The greatest victim of fundamental blocking is probably your own TV set because it is so near. Since this brand of interference is cured at the TV set, not at the CB transceiver, you can usually add the required filtering to your set and restore the family peace. But try to cure a neighbor's set and you'll need the diplomatic credentials of a Talleyrand. The dilemma is that, if you take it upon yourself to install a filter on a neighbor's TV, you'll probably be blamed for every trouble that

befalls the set for the next decade — from falling knobs to fly specks on the CRT. No one has yet figured out how to explain, convincingly, that hanging a passive filter on a TV's antenna terminals can't cause a breakdown somewhere else in the receiver.

An ironic twist to all of this is that the FCC is on the side of the CB'er when it comes to fundamental blocking. Literature put out by the Commission states that most TVI is caused by deficiencies in TV receiver design. A mass-produced set simply doesn't have sufficient shielding and rejection of signals beyond its tuning bandwidth. But try explaining that to your neighbors.

One solution is to tell the suffering viewer that some TV manufacturers offer high-pass filters to cure the problem. (Generally, it's a Drake TV-300-HP.) The policy varies in the industry, but some manufacturers will supply the component at no charge to a set owner upon request. (Sometimes you can get assistance in this matter by inquiring at a local FCC field office.) If the filter is provided, but installation is not, it is wise to have the TV owner get a service technician to make the connections. They may involve removing the back of the set to get at the input to the tuner (sometimes necessary in bad cases of TVI) and the owner may not like the idea of your poking around in there.



Fig. 1. High-pass filter.

Helping out. However, if your neighbor welcomes any technical help you want to volunteer, there are ways to deal with fundamental blocking. The easiest is to purchase a high-pass filter that is made for connecting to the external antenna input terminals (Fig. 1). Try this location before attempting to put the filter inside the set.

Another device you can try is an easily home-brewed wave trap which removes the CB signal at the TV antenna terminals. When tuned to resonance, the trap is a short circuit to the CB signal but won't affect TV signals. A

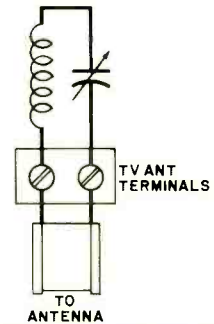

Fig. 2. Series-tuned wave trap.

schematic of the trap is shown in Fig. 2. The coil is made by closely winding 22 turns of 20-gauge enamelled wire on a 1/4-in. form (a pencil will do). Strip the enamel clean at both ends. The tuning capacitor is a common trimmer rated at 3-30 pF. Mount both the coil and capacitor on a small perforated board about 2 inches (5.1 cm) square. Attach a few inches of twinlead to the board and wire the trap as shown. The free ends of the twinlead connect to the TV terminals along with the regular TV antenna lead.

Now turn on the CB set and watch the interference on the TV screen. With a plastic tuning tool, adjust the capacitor until it hits resonance on 27 MHz and clears the TV picture. The capacitance of your hand can effect the tuning so do it by trial and error — tune, take your hand away, tune again, etc.

There's a chance that you won't be able to null out the CB signal. Although the values given here should work, distributed capacitance and/or inductance in your circuit can nudge the resonance point out of the 27-MHz band, beyond range of the tuning capacitor. This is cured by adjusting the coil. Try spreading the coil turns to reduce inductance and raise the trap's frequency.

Once in a while, the coil will have insufficient inductance and require a few additional turns. It is easier,

though, to try reducing the capacitance first. A good way to determine whether the trap is on frequency is to monitor it with a grid-dip meter. As you change the circuit parameters, the meter should null when the frequency hits 27-MHz resonance. As this is done, leave the tuning capacitor screw at its midrange. If you don't have a grid-dip meter, use the TV screen as the measuring instrument. When the trap is on frequency, interference should drop out. Then touch up the capacitor adjustment once more.

Which Is Better? As to whether the high-pass filter or the trap is better for reducing fundamental blocking, I'll have to duck the question. TVI is a cantankerous problem that usually succumbs only to trial-and-error treatment. The high-pass filter has the advantage of attenuating interference below 50 MHz and thus prevents blocking from police, fire, and other services in the low vhf band from 30 to 50 MHz or transmitters active in the h-f region. The trap, on the other hand, is inexpensive to make and can be centered right on the offending 27-MHz CB signal.

If nothing works, and your neighbor threatens to tear down your antenna, that is a possible solution. Moving a CB antenna 10 or 20 feet farther from a TV antenna can take some of the punch out of fundamental blocking. ♦

Coming Up In The August
Popular Electronics®

- SPECIAL REPORT ON CB TRANSCEIVERS
- ELECTRONIC CROSSOVER NETS FOR HI-FI
- DOPPLER ULTRASOUND STETHOSCOPE
- BUILD A GIANT ELECTRONIC SCOREBOARD
- WILL AUDIO GO DIGITAL?
- LAB TEST REPORTS:
 - Sherwood S-7310 Stereo Receiver
 - Stanton 3004-II Cartridge
 - McKay Dymek DA-3 AM Antenna
 - Dynascan Cobra 29 CB Transceiver
 - Exact 190 & 195 Function Generators

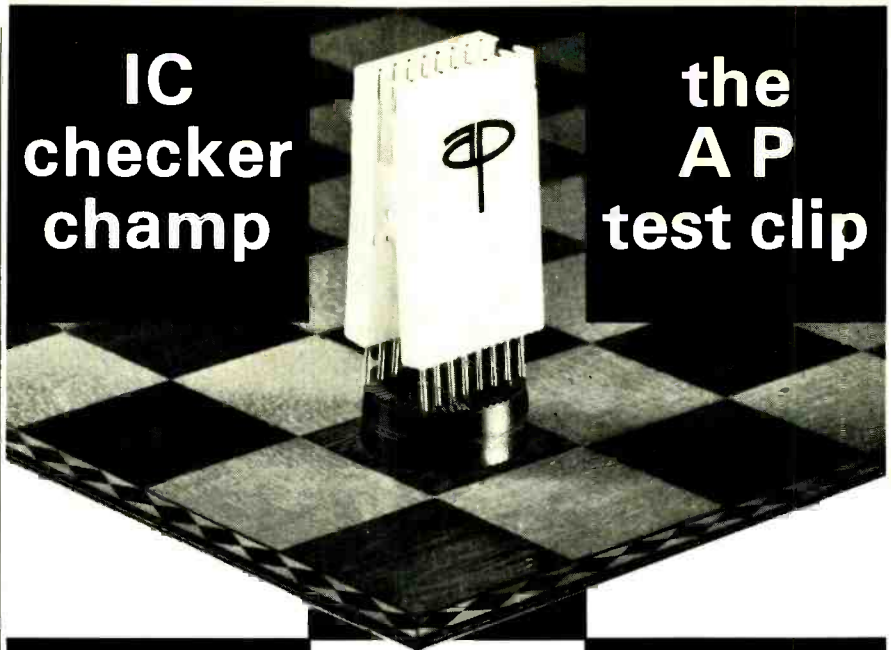

**IC
checker
champ**

**the
A P
test clip**

**new
lower pricing**

TC-14 \$5.25 ea.
TC-16 5.75 ea.
TC-24 13.85 ea.

All products are guaranteed
to meet or exceed
published specifications

A P TEST CLIPS
provide full access
to DIP leads

11 models
available to fit
all DIP sizes



A P PRODUCTS INCORPORATED
Box 110-H, Painesville, Ohio 44077
(216) 354-2101 • TWX 810-425-2250

CIRCLE NO. 2 ON READER SERVICE CARD

Innovation!



The Mark VIII FM Digital Tuner perpetuates SAE's leadership in FM digital tuners established by the SAE Mark VIB. Features include: A quartz-crystal-referenced digital readout using an L-E-D display; P-L-L (phase-locked-loop) multiplex; a five gang, MOS-FET front end, linear-phase monolithic IF filters; no-thump F-E-T muting and switchable de-emphasis for use with special noise reduction systems. We invite you to audition the Mark VIII from SAE — where innovation is a tradition.

SAE
*Components
for the
Connoisseur*

SAE, Inc., Dept. PL675
P.O. Box 60271, Terminal Annex
Los Angeles, California 90060

Gentlemen:

Please rush free information on the Mark VIII
by return mail.

Name _____
Address _____
City _____ State _____ Zip _____

CIRCLE NO. 40 ON READER SERVICE CARD

The better the training the better you'll

Send for
FREE
illustrated
career
guide

NTS guide
to careers in
Electronics

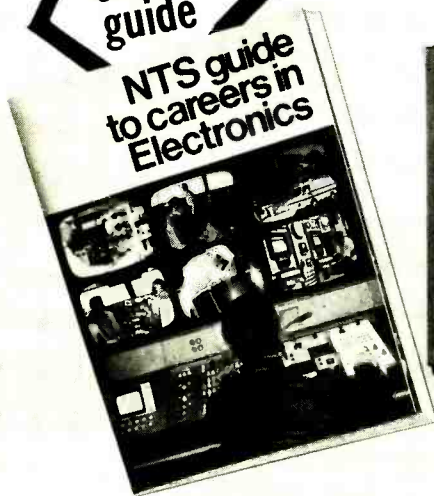

IN-CIRCUIT TRANSISTOR TESTER

COMPU-TRAINER

TROUBLESHOOTER
VOM

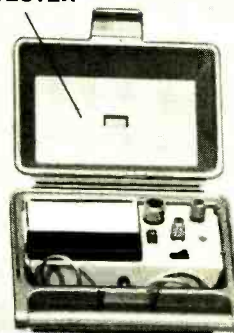
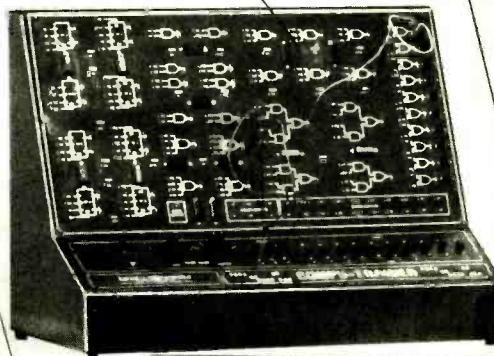

SOLID-STATE
OSCILLOSCOPE

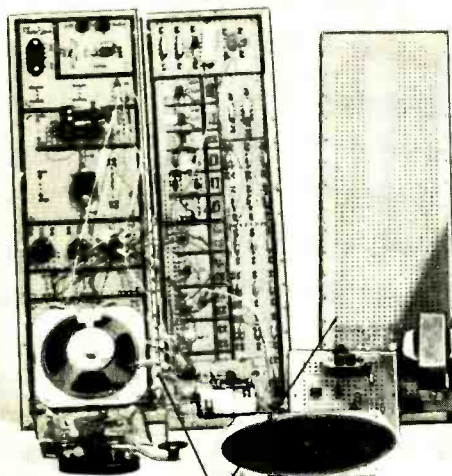

ELECTRO-LAB

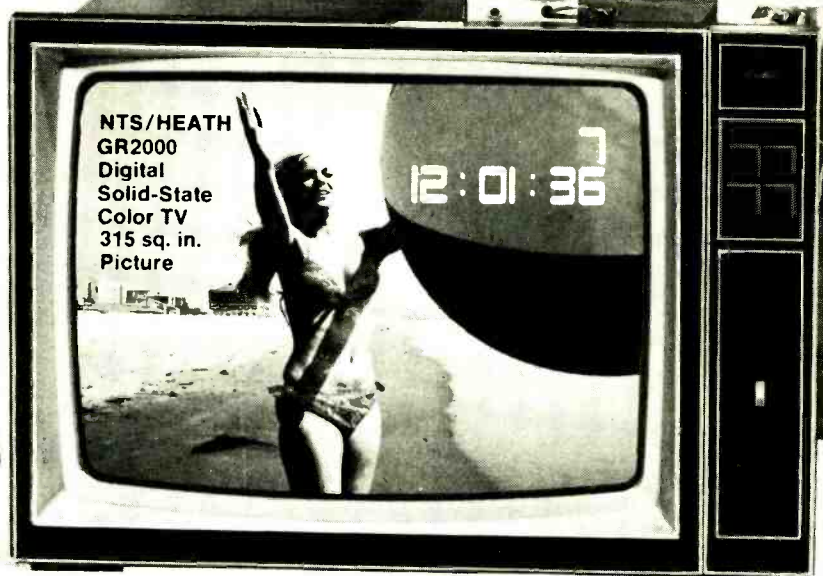

(Simulated TV Reception)

As an NTS student you'll acquire the know-how that comes with first-hand training on NTS professional equipment. **Equipment you'll build and keep.** Our courses include equipment like the **NTS/Heath Digital GR-2000 Solid State color TV** with first-ever features like silent varactor diode tuning; digital channel selection, (with optional digital clock), and big 315 sq. in. ultra-rectangular screen.

Also pictured above are other units — 5" solid state oscilloscope, vector monitor scope, solid-state stereo AM-FM receiver with twin speakers, digital multimeter, and more. It's the kind of better equipment that gets you better equipped for the electronics industry.

This electronic gear is not only designed for training; it's field-type — like you'll meet on the job, or when you're making service calls. And with NTS easy-to-read, profusely illustrated lessons you learn the theory behind these tools of the trade.

Choose from 12 NTS courses covering a wide range of fields in electronics, each complete with equipment, lessons, and manuals to make your training more practical and interesting.

Compare our training; compare our lower tuition. We employ no salesmen, pay no commissions. You receive all home-study information by mail only. All Kits, lessons, and experiments are described in full color. Most liberal refund policy and cancella-

and the equipment be equipped.

COMPARE OUR
KITS AND LESSONS.
COMPARE OUR
TUITION.

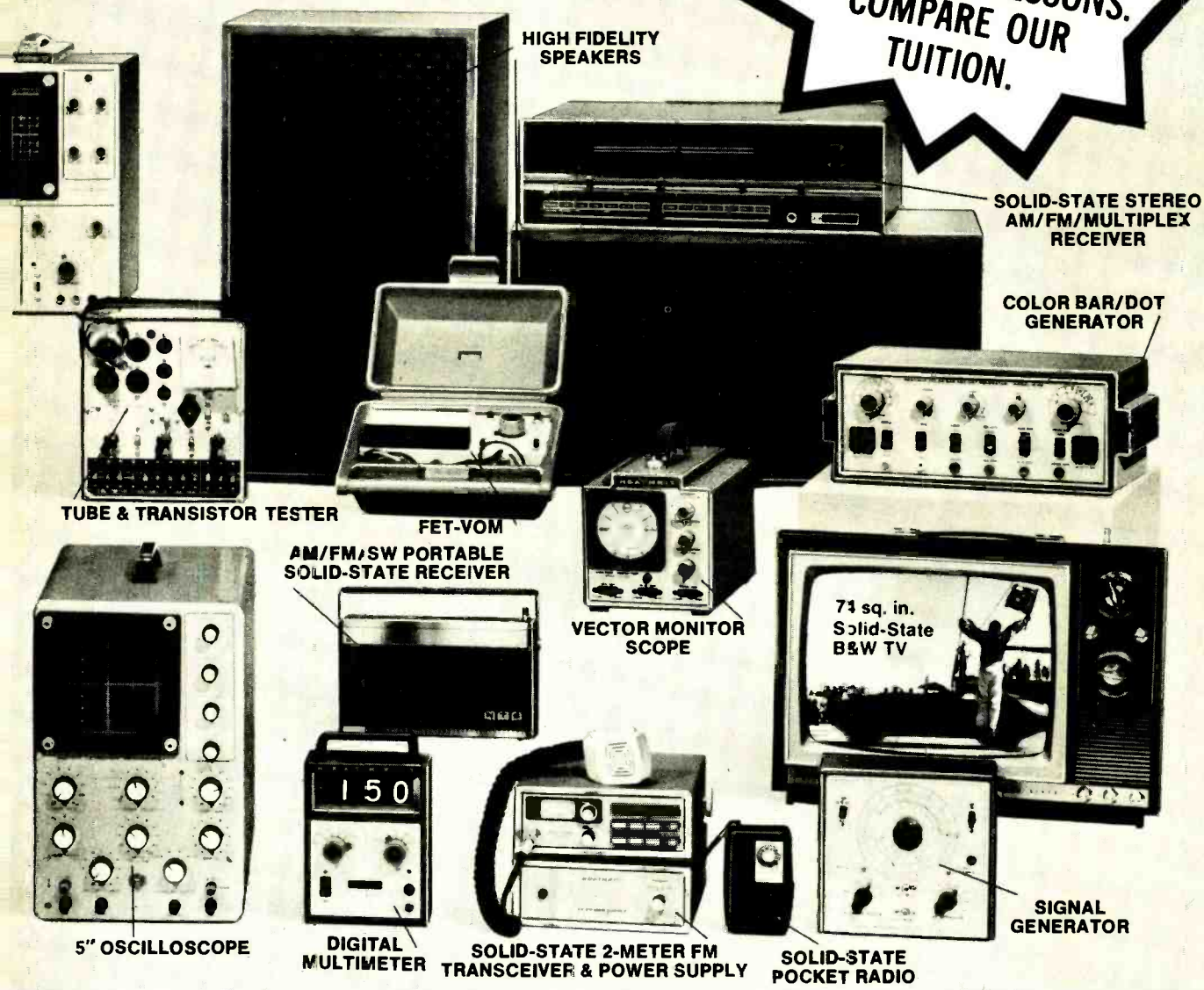

tion privileges spelled out. Make your own comparisons, your own decision. Mail card today, or clip coupon if card is missing.

NO OBLIGATION. NO SALESMAN WILL CALL

APPROVED FOR VETERAN TRAINING

Get facts on new 2-year extension

NATIONAL TECHNICAL SCHOOLS

TECHNICAL-TRADE TRAINING SINCE 1905
Resident and Home-Study Schools
4000 So. Figueroa St., Los Angeles, Calif. 90037

NATIONAL TECHNICAL SCHOOLS Dept. 205-07E
4000 South Figueroa St., Los Angeles, Calif. 90037

Please send FREE Color Catalog and Sample Lesson.
NO OBLIGATION. NO SALESMAN WILL CALL.

- | | |
|---|--|
| <input type="checkbox"/> Color TV Servicing | <input type="checkbox"/> Electronics Technology |
| <input type="checkbox"/> B & W TV and Radio Servicing | <input type="checkbox"/> Computer Electronics |
| <input type="checkbox"/> Electronic Communications | <input type="checkbox"/> Basic Electronics |
| <input type="checkbox"/> FCC License Course | <input type="checkbox"/> Audio Electronics Servicing |

NAME _____ AGE _____

ADDRESS _____ APT # _____

CITY _____ STATE _____

Please fill in Zip Code for fast service _____

- Check if interested in G.I. Bill information.
 Check if interested ONLY in classroom training in Los Angeles.

LARGE-LARGE DISCOUNTS LOW - LOW PRICES

NATIONALLY
ADVERTISED STEREO EQUIPMENT
AT LOWEST PRICES!

TURNABLES · SPEAKERS · RECEIVERS
AMPLIFIERS · TAPE RECORDERS

WRITE FOR QUOTE ON
NATIONALLY ADVERTISED BRANDS OF STEREO
COMPONENTS. SATISFACTION
GUARANTEED!

Clifford's
HI-FI WHOLESALERS
P. O. Box 809
Kankakee, Illinois 60901
(815)-939-7868

CIRCLE NO. 12 ON READER SERVICE CARD

SAVE!

MONEY • TIME • FREIGHT

QUALITY STEREO EQUIPMENT
AT LOWEST PRICES.

YOUR REQUEST FOR QUOTA-
TION RETURNED SAME DAY.

FACTORY SEALED CARTONS—
GUARANTEED AND INSURED.

SAVE ON NAME BRANDS LIKE:
A.D.C. KLH
A.R. SHURE
DYNACO KOSS
SONY FISHER

AND MORE THAN 50 OTHERS
BUY THE MODERN WAY
BY MAIL—FROM

ia
illinois audio

Department 217S
12 East Delaware
Chicago, Illinois 60611
312-664-0020

CIRCLE NO. 21 ON READER SERVICE CARD

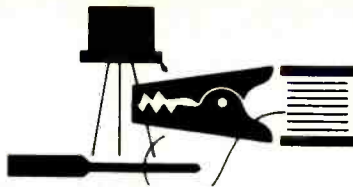

Tips & Techniques

CALIBRATOR FOR VOM's

If you are unsure of the accuracy of your VOM, here's a simple calibrator with which you can check performance on the voltage, current, and resistance scales. Mercury cells, which keep a fairly constant output voltage across their terminals, and precision (1%) resistors are used. The voltage standard consists of B1, a 4.2-V mercury

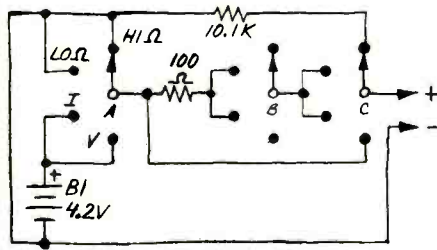

battery (VS-133 or equivalent). A standard current source of 42 mA is derived from a mercury cell/precision resistor series combination. This same resistor (100 ohms) is used as a *LOW OHMS* standard, while a 10.1-kilohm precision resistor provides a *HIGH OHMS* calibration point. Resistors should be capable of dissipating at least 1/4W. Switch S1 is a 3P4T model (Calectro E2-166 or equivalent).

—Donald Walton

FELT TIPS AND TECHNIQUES

Fine-tip permanent markers (such as the "Sharpie" by Sanford Corp.) have many applications in experimenting. They can write on glass, so the fading type numbers on tube envelopes can be rewritten. The markings are waterproof, so hand perspiration won't obliterate them. Acetone or nail polish remover will erase the characters. Another application is in drawing lines on prototype pc boards instead of using inconvenient layout tape. The markings are also resistant to pc board etchant as well as layout tape. If you're imaginative, no doubt you can think of other useful applications.

—Garry Barnett

ORDINARY TYPING ERASER SAFELY CLEANS PC BOARDS

The raw copper conductor patterns on non-plated printed circuit boards have a habit of oxidizing rather quickly. The oxide often serves as a barrier that prevents solder from flowing properly around the pads to which leads are to be soldered. To avoid this problem, you could use steel wool as the oxide removing agent. However, the

safer approach and simpler tool to use is an ordinary typing eraser. The abrasive in the eraser is likely to remove a great deal less of the copper than does steel wool. And the eraser comes with its own built-in brush that can be used to sweep away the residue after erasing is completed.

—Steve Sekel

MAGNETIC HOLDER FOR SOLDERING PENCILS

A soldering pencil is ideally suited for pc work, but it can be hard to keep in place on a workbench. The pencil tends to roll because of its round shape. To keep it stationary, a magnetic latch (sold in hardware stores) can be used. The latch will hold it securely in place, yet it doesn't slow down soldering time.

—Thomas Fox

SOLDERING BNC CONNECTORS

Here's an easy and neat way to solder BNC connectors. Instead of fanning out the cable braid, wind 12 turns of No. 18 or 20 wire over a 3/8-in. (9.5-mm) length of braid, starting about 3/4 in. (19.1-mm) from one end of the wire. Apply solder to this coil.

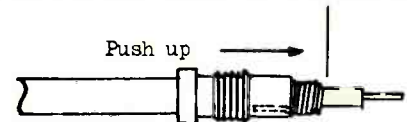

Bend the 3/4-in. (19.1-mm) lead down alongside the cable jacket. Finally, slide the male section of the BNC over the 3/4-in. (19.1-mm) lead (with which it should make a good, tight contact) until it lines up with the top of the coil. Proceed with the rest of the standard technique.

—Raul Lopez

PLASTIC SCREW ANCHORS MAKE INSULATED HEAT-SINK MOUNTS

In some circuits, mounting the heat sinks for SCR's and power transistors presents a problem because the cathode or collector must be isolated from the chassis to which the heat sink is to be secured. Obviously, a

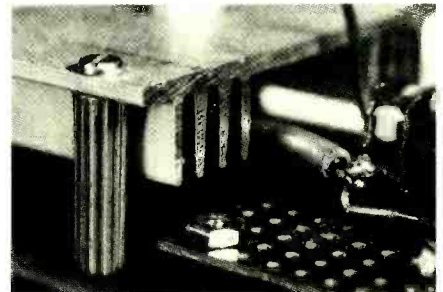

good nonconducting anchor must be found, and almost made to order are the plastic screw anchors sold in any hardware or houseware store. These anchors provide sturdy support for the heat sink while maintaining electrical isolation from the chassis. Anchors designed for 9/32-in. (7.14-mm) holes work well with No. 4 through No. 6 hardware. They can be cut to length as required.

—David Kraeuter

POPULAR ELECTRONICS

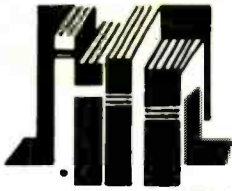

Electronics Library

LEARNING ABOUT SYNTHESIZERS

by J. Linton

The introductory manual contains a brief history of electronic music, a discussion of how a synthesizer works, and lists of synthesizer manufacturers and of some groups using synthesizers. Tips are given on selecting a synthesizer, and a list of reading sources and music trade magazines is given. A glossary of electronic music terms will be valuable to those not acquainted with this field.

Published by Music Studios, South Village Square, Amherst, MA 01002. 23 pages (8½" x 11"). \$5.00 soft cover.

ELECTRONIC DATABOOK—A GUIDE FOR DESIGNERS (2nd Edition)

by Rudolf Graf

Designers active in many fields will find some useful information in this volume. Data covering frequency allocations, modes of communication, representative communications systems, passive components and circuits, active components and amplifier configurations, mathematical relationships, formulas, and symbols, and physical configurations of components are included. Many monographs, tables, and curves are reproduced.

Published by Van Nostrand Reinhold Co., 450 W. 33rd St., New York, NY 10001. 312 pages (8½" x 11"). \$10.95

PRACTICAL DIGITAL ELECTRONICS—AN INTRODUCTION

by Juris Blukis and Mark Baker

In a world where computers and data communications are becoming ever more important, a knowledge of digital logic and circuits is desirable. This two-volume set, prepared by the Hewlett-Packard Company will provide an introduction to this field. Suitable for secondary schools and higher levels, the text and laboratory workbook aim at giving the student a working knowledge sufficient to prepare for troubleshooting or maintaining digital electronic equipment, including calculators, computers, digital instruments, and data communications equipment. The set is recent enough to treat CMOS and LSI, while providing a simple explanation of binary logic.

Published by Hewlett-Packard Co., 1501 Page Mill Road, Palo Alto, CA. 94304. 8½" x 11". Text and Workbook \$8.00 each.

JULY 1975

SPECIALIZED COMMUNICATIONS TECHNIQUES FOR THE RADIO AMATEUR

edited by the ARRL Staff

The more "exotic" communications techniques employed by radio amateurs are described in this new book. Seven chapters make up the volume, covering Communications Techniques, Amateur Television, Slow-Scan Television, Facsimile, Radioteletype, Space Communication, and Advanced Techniques. Hardware for each type of communications system is described and illustrated, and instructions are given for modifying surplus commercial gear for amateur use. The Facsimile chapter gives conversion techniques for Telefax receivers and describes how to receive weather-satellite pictures. Advanced Techniques such as laser and digital communications are explained.

Published by the American Radio Relay League, 225 Main St. Newington, CT 06111. 208 pages. \$3.00 soft cover.

FM ATLAS AND STATION DIRECTORY (3rd Edition)

by Bruce Elving

This updated book presents frequency, program, and geographical information about the 4000 FM broadcast stations located in North America. Data are given on program format, output power, antenna height, stereo capability, antenna polariza-

tion, operating frequency and call letters. The introductory pages discuss trends in FM broadcasting, four-channel FM, illegal FM stations, translators and boosters, FM DXing, Dolby circuitry, and the status of AM-FM all-channel radio legislation. Also listed are network affiliations, and SCA activities. The book contains outline maps showing station distribution, and an FCC chart for computing station coverage.

Available from FM Atlas, Box 24, Adolph, MN 55701. 96 pages. \$2.50 soft cover.

TTL COOKBOOK

by Don Lancaster

This book explains what transistor-transistor logic (TTL) is, how it works, and how to use it. TTL basics are given in Chapter One, and a catalog of TTL devices, including electrical and physical specifications, forms Chapter Two. Logic is covered in Chapter Three, such as one- and two-input systems, tri-state logic, and data-selector logic. Gate and timing circuits are covered in Chapter Four. Succeeding chapters discuss clocked logic, flip-flops, counters, shift registers, noise generators, and rate multipliers. A number of practical applications, including digital counters and test instruments, are described and illustrated.

Published by Howard W. Sams & Co., 4300 W. 62nd St., Indianapolis, IN 46206. 336 pages. \$8.95 soft cover.

SIDETALK TWINS NEW



- 23 channels AM with full 4 watts of maximum legal output power.
- 46 channels SSB with full 12 watts PEP maximum legal output power.
- Switchable noise blanker circuit for suppressing unwanted SSB and AM impulse noise.
- Built-in PA circuit with front panel control.
- Full range RF gain control for receiver sensitivity adjustment.
- Clarifier for compensating the transmitter frequency drift and error of received signals.
- AM, LSB and USB mode status indicator lights.
- Receive and transmit indicator lights.

- Mobile unit CB 1000M also features:
- Full-size "S" meter for monitoring incoming signal strength and relative output power strength.
- Base unit CB 1000B also features:
- Clock with alarm and automatic turn-on timer.
 - Multiple functioning full size meter for monitoring:
 - incoming signal strength.
 - relative power output.
 - antenna performance.
 - Engineering for 110V AC and 12V DC applications.

(+) and (-) ground applications

CB 1000M \$349.95

CB 1000B \$449.95

See one at your dealer now. Pickup the SIDETALK TWINS to enjoy super communications power.



Pace Communications, Div. of Pathcom Inc., 24049 S. Frampton Ave., Harbor City, Ca. 90710. Available in Canada from Superior Electronics Ind.

62

CIRCLE NO. 31 ON READER SERVICE CARD

85

ELECTRONICS MARKET PLACE

NON-DISPLAY CLASSIFIED: COMMERCIAL RATE: For firms or individuals offering commercial products or services, \$1.80 per word (including name and address). Minimum order \$27.00. Payment must accompany copy except when ads are placed by accredited advertising agencies. Frequency discount; 5% for 6 months; 10% for 12 months paid in advance. **READER RATE:** For individuals with a personal item to buy or sell, \$1.10 per word (including name and address.) No minimum! Payment must accompany copy. **DISPLAY CLASSIFIED:** 1" by 1 column (2-1/4" wide), \$215.00. 2" by 1 column, \$430.00. 3" by 1 column, \$645.00. Advertiser to supply cuts. For frequency rates, please inquire.

GENERAL INFORMATION: First word in all ads set in bold caps at no extra charge. All copy subject to publisher's approval. All advertisers using Post Office Boxes in their addresses **MUST** supply publisher with permanent address and telephone number before ad can be run. Advertisements will not be published which advertise or promote the use of devices for the surreptitious interception of communications. Closing Date: 1st of the 2nd month preceding cover date (for example, March issue closes January 1st. Send order and remittance to **POPULAR ELECTRONICS**, One Park Avenue, New York, New York 10016, Attention: Hal Cymes.

FOR SALE

FREE! Bargain Catalog—I.C.'s, LED's, readouts, fiber optics, calculators parts & kits, semiconductors, parts. Poly Paks, Box 942PE, Lynnfield, Mass. 01940.

GOVERNMENT Surplus Receivers, Transmitters, Snoopscopes, Radios, Parts. Picture Catalog 25 cents. Meshna, Nahant, Mass. 01908.

ELECTRONIC PARTS, semiconductors, kits. FREE FLYER. Large catalog \$1.00 deposit. BIGELOW ELECTRONICS, Bluffton, Ohio 45817.

LOWEST Prices Electronic Parts. Confidential Catalog Free. KNAPP, 3174 8th Ave. S.W., Largo, Fla. 33540.

RADIO—T.V. Tubes—36 cents each. Send for free catalog. Cornell, 4213 University, San Diego, Calif. 92105.

AMATEUR SCIENTISTS, Electronics Experimenters, Science Fair Students... Construction plans—Complete, including drawings, schematics, parts list with prices and sources... Robot Man — Psychedelic shows — Lasers — Emotion/Lie Detector — Touch Tone Dial — Quadraphonic Adapter — Transistorized Ignition — Burglar Alarm — Sound Meter... over 60 items. Send 25 cents coin (no stamps) for complete catalog. Technical Writers Group, Box 5994, University Station, Raleigh, N.C. 27607.

METERS—Surplus, new used, panel or portable. Send for list. Hanchett, Box 5577, Riverside, CA 92507.

WE SELL CONSTRUCTION PLANS, TELEPHONE: Answering Machine, Speakerphone, Carphone, Phonevision, Auto Dialer, Touch Button Dialer, Central Dial System. TELEVISION: \$35.00 Color Converter, Video Tape Recorder. \$25.00 Camera. HOBBYIST: Electron Microscope, 96 Hour Tape Music System, Ultrasonic Dishwasher, Radar-Oven. Plans \$4.95 each. NEW ITEM: \$75. Electronic Pocket Calculator, \$7.50. COURSES: Telephone Engineering \$39.50, Detective Electronics \$22.50, Integrated Circuit Engineering, \$49.50. NEW SUPER HOBBY CATALOG plus year's subscription to Electronic News Letter AIRMAILED \$1.00. Don Britton Enterprises, 6200 Wilshire Blvd., Los Angeles, Calif. 90048.

MECHANICAL, ELECTRONIC devices catalog 10 cents. Greatest Values — Lowest Prices. Fertik's, 5429 "D", Philadelphia, Pa. 19120.

SOUND SYNTHESIZER KITS—Surf \$12.95, Wind \$12.95, Wind Chimes \$17.95, Electronic Songbird \$6.95, Musical Accessories, many more. Catalog free. PAIA Electronics, Box J14359, Oklahoma City, OK 73114.

BUGGED??? New locator finds them fast. Write, Clifton, 11500-L N.W. 7th Avenue, Miami, Florida 33168.

DISCOUNT PRICES

B & K, SENCORE, LEADER and RCA
Test Equipment
RAYTHEON, ICC/MULLARD Tubes
TELEOMATIC Test Jigs
Free Catalog

FORDHAM RADIO SUPPLY CO., INC.
558 Morris Ave. • Bronx, N.Y. 10451

FREE CATALOG. Parts, circuit boards for POPULAR ELECTRONICS projects. PAIA Electronics, Box C14359, Oklahoma City, OK 73114.

YOU WILL SAVE BIG MONEY! Surplus, Clearouts, Bankruptcy, Inventory, Deals. Catalog \$1 (redeemable). ETCOA Electronics, Box 741, Montreal, H3C 2V2, U.S. Inquiries.

TELEPHONE "BUGGED"? Countermeasures Brochure \$1.00, Negeye, Drawer 547, Pennsboro, W. VA 26415.

HEAR POLICE/FIRE Dispatchers! Catalog shows exclusive directories of "confidential" channels, receivers. Send 10 cent stamp. Communications, Box 56-PE, Commack, N.Y. 11725.

CONVERT any television to sensitive, big-screen oscilloscope. Only minor changes required. No electronic experience necessary. Illustrated plans. \$2.00. Sanders, Dept. A-33, Box 92102, Houston, Texas 77010.

CD IGNITIONS, VHF/UHF monitors, crystals, CB radios, Southland, Box 3591-B, Baytown, Texas 77520.

CRYSTALS, Scanners, \$3.88, include make and frequency. G Enterprises, P.O. Box 461PC, Clearfield, UT 84105.

ALPHA/THETA BRAINWAVE biofeedback instruments. Analog instruments from \$125; digital processing systems from \$225. BioScan, Box 14168-E, Houston, Texas 77021.

SURPRISE! Build inexpensively, the most Unusual Test Instruments, Futuristic Gadgets using Numerical Readouts! Catalogue Free! GBS, Box 100A, Green Bank, West Virginia 24944.

TELEPHONES UNLIMITED, equipment, supplies. Catalog 50 cents. Box 1654E, Costa Mesa, Calif. 92626.

JULY SPECIALS

DIGITAL

7404	Hex inverter	\$1.19
7406	30V hex inverter	.29
7410	Triple 3 input NAND	.17
7437	Quad 2 input NAND buffer	.29
7442	BCD to decimal CDDR	.79
7490	Decade counter	.59
74107	Dual J-K flip flop	.39
74123	Retrig monost mult	.89
74175	Quad D flip flop	1.69
8263	3 input 4 bit mult	5.99
8267	2 input 4 bit mult	2.79
74C00	Quad 2 input NAND gate	.19

MEMORY

1103	Fully decoded — 1024 bit static RAM	MOS — 18 pin	\$1.99
5260	Fully decoded — 1024 bit dynamic RAM	MOS — 16 pin	.99

SPECIAL PURCHASE LED DISPLAY MAN 3M
\$25 ea. 5/\$1.00 8/\$1.50

16 BIT MICROPROCESSOR CHIPS

MM5750	Arithmetic and logic unit	\$30.00 ea.
MM5751	Control and read only memory	\$40.00 ea.
(Imp-16 standard set or extended set)		
Set of 4 MM5750 and 1 MM5751		\$129.00

CT5005 CALCULATOR CHIP

12 digit — 4 function with memory chain operation	\$4.95 ea.
---	------------

8008 CENTRAL PROCESSING UNIT

8 bit microcomputer capability — 16 pin DIP	\$44.95 ea.
---	-------------

POCKET CALCULATOR KIT

5 function plus constant — addressable memory with individual recall — 8 digit display plus overflow — battery saver — uses standard or rechargeable batteries — all necessary parts in ready to assemble form — instructions included. 3" x 5" ASSEMBLED



\$19.95
\$24.95

LINEAR

301	Hi perf amp	mDIP	\$1.19
311	Volt comp.	mDIP	.79
555	Timer	mDIP	.89
567	Tone decoder	mDIP	2.75
3900	Quad amp	DIP	.33
75453	Dual per. drv	mDIP	.30

TTL

7400	\$.19	7485	\$ 1.39
7401	.19	7486	.44
7402	.19	7489	2.75
7403	.19	7490	.76
7404	.22	7491	1.29
7405	.22	7492	.79
7406	.39	7493	.79
7407	.39	7494	.89
7408	.25	7495	.89
7409	.25	7496	.89
7410	.19	74105	.49
7411	.29	74107	.49
7413	.79	74121	.57
7415	.39	74122	.53
7416	.39	74123	.99
7417	.39	74125	.69
7420	.19	74126	.79
7422	.29	74141	1.23
7423	.35	74145	1.15
7425	.39	74150	1.09
7426	.29	74151	.89
7427	.35	74153	1.29
7430	.22	74154	1.59
7432	.29	74155	1.19
7437	.45	74156	1.29
7438	.39	74157	1.29
7440	.19	74161	1.39
7441	1.09	74163	1.59
7442	.99	74164	1.89
7443	.99	74165	1.89
7444	1.10	74166	1.65
7445	1.10	74173	1.65
7446	1.15	74175	1.89
7447	1.15	74176	1.65
7448	1.15	74177	.99
7450	.24	74180	1.09
7453	.27	74181	3.65
7454	.39	74182	.89
7460	.19	74190	1.59
7464	.39	74192	1.49
7465	.39	74193	1.39
7472	.36	74194	1.39
7473	.43	74195	.99
7474	.43	74196	1.85
7475	.75	74197	1.15
7476	.47	74198	2.19
7483	1.11	74199	2.19

Data sheets supplied on request. Add \$.50 for items less than \$1.00.

15% Off on orders over \$25.00
15% Off on orders over \$100.00
20% Off on orders over \$250.00

LINEAR CIRCUITS

301	Hi perf. op amp	mDIP	\$.32
307	Op amp	mDIP	.29
308	Micro-pwr op amp	mDIP	.99
309K	5V reg 1A	TO-3	1.50
310	V follr. Op Amp	mDIP	1.19
311	Hi perf. V comp	mDIP	1.05
319	Hi-speed dual comp	DIP	1.29
320	Neg. regulator (5V, 5.2V, 12V, 15V)	TO3	1.25
324	Quad op amp	DIP	1.89
339	Quad comp	DIP	1.69
340T	Pos V reg (5V, 6V, 8V, 12V, 15V, 18V, 24V)	TO-220	1.75
372	AG-IF strip det	DIP	.79
376	Pos V reg	mDIP	.59
377	2 w stereo amp	DIP	2.69
380	2w audio amp	DIP	1.29
380 B	.6w audio amp	mDIP	.89
381	Lw noise dual preamp	DIP	1.69
550	Prec. V reg	DIP	.79
555	Timer	mDIP	.99
565	Phase locked loop	DIP	2.75
562	Phase locked loop	DIP	2.65
565	Phase locked loop	DIP	2.65
566	Function gen	mDIP	2.50
567	Tone Decoder	mDIP	2.95
709	Op amp	DIP	.29
710	Hi speed V comp	DIP	.39
723	Volt reg.	DIP	.69
739	Dual hi perf amp	DIP	1.19
741	Comp. op amp	mDIP	.35
747	Dual 741	DIP	.79
748	Freq adj 741	mDIP	.39
1304	FM mux st demod	DIP	1.19
1307	FM mux st demod	DIP	.82
1800	Stereo Multiplexer	mDIP	.69
1458	Dual Comp op amp	DIP	2.75
3900	Quad amp	DIP	.39
7524	Core mem sense amp	DIP	.79
7525	Core mem sense amp	OIP	.95
75451	Dual prl. driver	mDIP	.39
75452	Dual prl. driver	mDIP	.39
75453	Dual prl. driver	mDIP	.39
75491	Quad seq driver	DIP	.79
75492	Hex dig. driver	DIP	.89

Data sheets supplied on request. Add \$.50 for items less than \$1.00.

MEMORIES

1101	256 bit RAM MOS	\$1.75
1103	1024 bit RAM MOS	3.95
2101	1024 bit static RAM	6.95
5203	2048 bit UV eras PROM	19.95
5260	1024 bit RAM	2.95
5261	1024 bit RAM	2.95
5262	2048 bit RAM	7.95
7489	64 bit ROM TTL	2.75
8223	Programmable ROM	3.95
74200	256 bit RAM tri-state	7.95

CALCULATOR & CLOCK CHIPS

5001	12 DIG 4 funct fix dec	3.95
5002	Same as 5001 exc btry pwr	4.95
5005	12 DIG 4 funct w/mem	5.95
MM5725	8 DIG 4 funct chain & dec	2.25
MM5736	18 pin 6 DIG 4 funct	4.95
MM5738	8 DIG 5 funct K & Mem	5.95
MM5739	9 DIG 4 funct (btry sur)	5.95
MM5311	28 pin BCD 6 dig mux	4.95
MM5312	24 pin 1 pps BCD 4 dig mux	4.45
MM5313	28 pin 1 pps BCD 6 dig mux	4.95
MM5314	24 pin 6 dig mux	4.95
MM5316	40 pin alarm 4 dig	5.95

LED'S AND OPTO ISOLATORS

MV10B	Red TO 18	\$ 25 ea.
MV50	Avial leads	20
MV5020	Jumbo visible red	25
ME4	Infra red diff. dome	.60
MAN1	Red 7 seg. .270"	2.50
MAN2	Red alpha num. 32"	4.95
MAN4	Red 7 seg. .190"	2.15
MAN5	Green 7 seg. .270"	2.95
MAN7	Red 7 seg. .270"	1.35
MAN8	Yellow 7 seg. .270"	3.95
MAN66	60° high dir. view	4.65
DL707	Red 7 seg. .3"	2.15
MCT2	Opto-iso transistor	6.95

CMOS

4000 AE	\$.40	4019 AE	\$ 2.10	4066 AE	\$ 1.05
4001 AE	.40	4020 AE	2.20	4068 AE	.40
4002 AE	.40	4021 AE	2.05	4069 AE	.40
4006 AE	1.75	4023 AE	.40	4071 AE	.40
4007 AE	.40	4024 AE	1.45	4072 AE	.40
4008 AE	2.45	4025 AE	.40	4073 AE	.40
4009 AE	.80	4027 AE	1.20	4075 AE	.40
4010 AE	.80	4028 AE	1.75	4078 AE	.40
4011 AE	.40	4030 AE	.85	4081 AE	.40
4013 AE	.80	4042 AE	1.90	4082 AE	.40



Satisfaction is guaranteed. Shipment will be made via first class mail — postage paid — in U.S., Canada and Mexico within three days from receipt of order. Minimum order — \$5.00. California residents add sales tax.

INTERNATIONAL ELECTRONICS UNLIMITED

(408) 659-3171

P.O. BOX 1708 MONTEREY, CALIF. 93940 USA

Altaj Electronic Bargains

PRICES SLASHED! WE WANT YOUR BUSINESS. SATISFACTION GUARANTEED ON EVERY ITEM



CALCULATOR BASIC KIT WITH TICHP
Includes case with matching all function keyboard, and 9 digits of LED readouts plus a Texas Instruments TMS 103 NC calculator chip. (Same style chip as in TI Datamath calculator). All the basics for building your own hand held calculator. Special — \$9.95 Quantity Limited. Now Includes P.C. Board

\$2.95



**BURROUGHS PANAPLEX II
12 DIGIT READOUT**

#BR13251 Neon 7 segment readout. Latest design for calculators, etc. Requires 160 VDC. Right hand decimals. Brand new, factory fresh. We include mating socket FREE.
NOTE With purchase of above readout array we offer motorola 2N5401 PNP High Voltage driver transistor for 10¢ each.



LM309K
TO-3 Case, 1 AMP 5 VDC Voltage Regulator. Brand New By National \$1.19

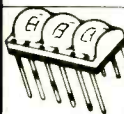

3 DIGIT LED READOUT ARRAY
Like Litronix DL-33. 3 MAN-3 style readouts in one package. Factory new units Designed for calculators. Special — \$1.39 (3 Digits)

LITRONIX DL707

READOUTS

.30 IN. CHAR. Common Anode.

SPECIAL — \$1.19



MAN-3 LED READOUTS

Brand new, factory prime units. .12 in. character. Common cathode. Perfect for calculators. 39¢ ea. Best Price Anywhere!

**CALCULATOR CHIP BONANZA
PRICES SLASHED!**

The newest and easiest to use chips available today. Made by famous US mfg. All are 28 pin DIP. Features: direct LED segment drive, low power consumption, internal keyboard debounce, internal clock oscillator, single supply voltage, internal keyboard encoding, and floating decimal point. Does not require many external components as do older types like CT5001, 5002, 5005, etc. We offer the most sophisticated functions for the lowest price anywhere.

Chip #1 — 8 Digit, Constant, Six Function (+, -, x, +, %, √) — \$3.95
Chip #2 — 8 Digit, Memory, Six Function (+, -, x, +, %, √, M) — \$4.95
Chip #3 — 8 Digit, Memory, Six Function (+, -, x, +, %, 1/x) — \$4.95

DIGITAL ALARM CLOCK IC

The newest and easiest to use alarm chip on the market today. Features:

1. Single supply voltage.
2. LED intensity control
3. Simple time set.
4. 4 or 6 Digit LED Display
5. AM-PM Indication
6. 24 Hr. Alarm.
7. 10 minute snooze.
8. Outperforms MM5316

Order #70250 — \$6.95 (2 FOR \$12)

MM5314 NATIONAL CLOCK CHIP

The most popular clock chip around. We made a huge special purchase of factory fresh, prime units. Lowest price in USA. 24 Pin DIP. 4 or 6 Digits. With Specs. \$3.95

CMOS

- | | |
|--------------|-----------------|
| CD4001 - 33c | CD4017 - \$1.39 |
| CD4002 - 33c | CD4030 - 59c |
| CD4009 - 69c | 74C02 - 39c |
| CD4011 - 33c | 74C04 - 39c |
| CD4012 - 33c | 74C107 - \$1.49 |
| CD4016 - 69c | |



DIGITAL WRIST WATCH CRYSTAL

Brand new, mfg. by CTS-KNIGHT. 32.768 KHZ. Standard, most popular type. Special \$1.95

COLOR ORGAN CONTROL MODULE
Completely self-contained Has SCR circuitry. AC line cord, etc. From a close out by a mfg. of color organs. New, unused \$1.95

GE POWER TRANSISTOR ASSORTMENT

Plastic power devices. Includes NPN and PNP, Darlington's, high voltage, high current, and various other types. Cases are color coded for easy sorting. Un-tested but includes many useable units. **SPECIAL — 20 FOR \$1**

1024 BIT SIGNETICS P-ROM
82S1291-256X4 bipolar, field programmable ROM. Fully TTL compatible. 50 ns. max address access time. Much faster than MOS type units. Perfect for code conversions, microprogrammers, hand-wired algorithms, controllers, etc. With specs. Regular \$35 ea. **SPECIAL — 3.95**
BEST MEMORY BUY IN USA!

1 AMP RECTIFIER RIOT!

We bought over 10 million pieces untested. 1N4000 series. Also a few 1 watt ZENERS mixed in. Sample tests show this lot contains many useable devices, some even up to 1 KV. Sold as is assorted, but you will be happy. 100 PCS — \$1.29 500 PCS — \$4.95

Free 28 Pin Socket with purchase of any clock or calculator chip. **\$1 VALUE-FREE BONUS**

POCKET CALCULATORS

8 Digit. LED various styles. These are complete units, but are customer returns for various reasons. We got these from the mfg. and have not checked them out or culled through them. Includes 4, 5, and even 6 functions. No choice. A super value just for parts. **SPECIAL -- \$7.95**
Sorry — no Data Available — Sold as is —

7805 STYLE REGULATORS

TO-220 Plastic Case 5VDC Regulator. Brand New by National — 99c

FACTORY NEW LED'S

Jumbo Red-Like MV5024-8/\$1
Jumbo Green-Like MV5222-5/\$1
Jumbo Yellow-5/\$1
Mini Red-Like MV50-10/\$1

8008 MICROPROCESSOR

Computer on a chip. 8 Bit Parallel CPU. Can address 16k x 8 bits of memory. With specs. Factory tested units. **\$34.95**

CT7001 BY CAL-TEX

Digital alarm clock chip with calendar feature. 4 or 6 digits. Also has timing circuitry for radio ON-OFF control factory fresh. **\$6.95**

2102-1K RAM's for above — **\$4.95 or 8 For \$30**

JUMBO LED READOUT

Twice the size of regular readouts. .65 inches. Like Litronix DL747. Outperforms and easier to read than SLA-3, only 20 MA per segment. Our best readout for digital clocks. \$2.95 ea (6 FOR \$15) Common Anode

TTL SUPER SPECIAL

74121 — ONE SHOT 4/\$1

LINEAR IC SPECIALS

555V-75c 567V-\$1.95 723CH-59c 741CV-39c
LM324 by National — Quad 741C in one DIP — \$1.79

12VDC REED RELAY

Coil is 500 OHM. SPST-No. \$1.49 Sub-Mini.

FILTER CAPS

1000 MFD 16VDC upright style. **4 FOR \$1**

PRIME TTL DIP IC'S

- | | | |
|----------|-----------|------------|
| 7400-16c | 7448-89c | 74151-75c |
| 7402-16c | 7453-16c | 74153-89c |
| 7404-16c | 7473-37c | 74154-95c |
| 7406-24c | 7474-37c | 74157-99c |
| 7408-16c | 7475-65c | 74161-99c |
| 7410-16c | 7476-39c | 74163-1.19 |
| 7413-49c | 7483-85c | 74164-1.29 |
| 7420-16c | 7490-69c | 74165-1.49 |
| 7427-24c | 7492-75c | 74174-1.29 |
| 7430-16c | 7493-75c | 74175-1.39 |
| 7437-39c | 7495-75c | 74181-2.75 |
| 7438-35c | 7496-75c | 74192-1.25 |
| 7440-16c | 74121-38c | 74193-1.25 |
| 7442-69c | 74123-75c | 74195-79c |
| 7447-89c | 74150-70c | 74197-79c |

8038 FUNCTION GENERATOR

Brand new Voltage controlled oscillator. Has sine, square wave, and triangular outputs. \$4.50 each.

IN4148 DIODES

High speed switching diodes. Brand new units, however, leads are cut and bent for PC board insertion, still plenty long. 30 For \$1

MONSANTO COLORED READOUTS

.27 IN. Character. Common Anode
MAN 5 — GREEN — \$1.29
MAN 8 — YELLOW — \$1.29

PHASE LOCKED LOOP

565A by Signetics. Extremely stable. High linearity, wide frequency range. TTL compatible. Perfect for tone decoders, FSK, SCA receivers, frequency multiplication and division — \$1.75. **WITH SPECS**

MOTOROLA POWER TRANSISTOR

MJ3029 — T03 Case — NPN Silicon High Voltage — VCEO — 250V Used in horiz. and vert. TV Circuits. Regular Price \$4. Our Price 95c

ELECTROLYTIC CAPACITORS

- 10MFD 25VVDC — Upright — 7c
- 50MFD 15VVDC — Upright — 10c
- 50MFD 15VVDC — Axial — 10c
- 100MFD 15VVDC — Upright — 14c

PLASTIC SILICON TRANSISTORS

Use for drivers in clock or calculators.

YOUR CHOICE 6 FOR \$1 ALL NEW UNITS

- MPS2714 — NPN
- MPS3704 — NPN
- 2N 3904 — NPN
- 2N 3906 — PNP
- 2N 4249 — PNP

ZENERS

IN746 — 400MW — 3.3V
IN752 — 400MW — 5.6V
YOUR CHOICE 8 FOR \$1

TTL IC ASSORTMENT

Various types. Most are marked. Our best selling assortment. Untested but includes many useable devices. **200 PCS FOR \$3.95**

Our lower prices and superior quality have made ALTAJ one of the fastest growing electronic suppliers in the USA. Put your trust in our unconditional money back guarantee.

ALTAJ ELECTRONICS
P.O. BOX 38544
DALLAS, TEXAS 75238

TERMS: Check or money order. No COD. Add 10% Pstg. and Hdq. Tex Res. add 5%.

**Announcing the
NEW STANDARD
in Stereo Testing!**

**The All-New Model
SR12 STEREO TEST
RECORD**



**The most complete...
most sophisticated...
most versatile Test Disc
available today...**

For Just \$5.98!

Who needs the New Model SR12? You do. Whether you're an avid audiophile, a casual listener, or a professional technician... the new MODEL SR12 will be the most important disc in your entire collection. MODEL SR12 has been produced by Stereo Review Magazine for music lovers who want immediate answers to questions about the performance of their stereo systems and how to get the best possible sound reproduction. It is the most complete test record of its kind—containing the widest range of checks ever included on one test disc.

Make these important stereo checks BY EAR... (no test instruments required)

- Frequency response
- Separation
- Cartridge tracking
- Channel balance
- Hum and rumble
- Flutter
- Cartridge and Speaker Phasing
- Anti-Skating Adjustment
- "Gun Shot Test" for Stereo Spread
- Multi-purpose Musician's "A"
- Equal-tempered Chromatic Octave
- Guitar-tuning Tones.

Attention professionals: For the ultimate in stereo testing, 7 critical TEST EQUIPMENT checks...

- 1,000-Hz square waves to test transient and high-frequency response of phono pickups.
 - 500 to 20,000 Hz frequency-response sweep.
 - Sine-wave tone-bursts to test transient response of pickup.
 - Intermodulation test using simultaneous 400-Hz and 4,000-Hz signals.
 - Intermodulation sweep to show distortion caused by excessive resonances in tone arm and cartridge.
 - 1,000-Hz reference tones to determine groove velocity.
 - 3,000-Hz tone for flutter and speed tests.
- Sample waveforms—illustrating both accurate and faulty responses are provided in the instruction Manual for comparison with the patterns appearing on your own oscilloscope screen.

FREE Instruction Manual Includes Detailed Instructions, Charts, Tables and Diagrams

CHARGE YOUR ORDER TO YOUR AMERICAN EXPRESS, BANKAMERICARD, MASTER CHARGE OR DINERS CLUB ACCOUNT.



Ziff-Davis Service Division, Dept. R,
595 Broadway, New York, N.Y. 10012. PE-75

Please send the SR12 Stereo Test Record @ \$5.98, postpaid (\$8 outside U.S.A.).

Enclosed is \$_____ (Residents of Calif., Col., Fla., Ill., Mich., Mo., N.Y. State, D.C. and Tex. add applicable sales tax.)

CHARGE:

BankAmericard Master Charge
 American Express Diners Club

Account # _____ Exp. Date _____

Master Charge Interbank # _____
(4 numbers over your name)

Signature _____

Print Name _____

Address _____

City _____ State _____ Zip _____

ELECTRONIC IGNITION: Capacitor, transistor, pointless. Auburn sparkplugs. Information 10 cents. Anderson Engineering, Epsom, N.H. 03234.

WHOLESALE SCANNERS, CB, Crystals, Directories, SSB/AM, Catalog 25 cents. G—Enterprises, Box 461P, Clearfield, Utah 84105.

LEARN DESIGN TECHNIQUES. Electronics Design Newsletter. Digital, linear construction projects, design theory and procedures. Annual subscription \$6.00, sample copy \$1.00. Valley West, Box 2119-B, Sunnyvale, California 94087.

DIGITAL IC Manual—Latest Edition—1500 types by types/diagram number \$3.95. 32—function digital computer kit—IC, transistors, instructions, \$14.00. IC applications manual—numerous circuits—Analog/Digital, \$3.95. Electronics, P. O. Box 127, Hopedale, Mass. 01747.

ELECTRONIC COMPONENTS—all kinds, send for free catalog. Epic, Box 20152A, Minneapolis, Minn. 55420.

AUTHENTIC, INSTRUMENTED, FLYING ROCKETS for casual or serious experimenters. Over 80 scale original, multi-stage or ready-to-fly models. Solid-propellant engines for safe, electric launch system liftoffs up to 2,500 feet. Measure altitude, temp. inversions, more. Real telemetry, electronic tracking, aerial still and movie photography with super-miniaturized equipment. New, detailed tech manual and full-color catalog. 25 cents from ESTES INDUSTRIES Dept. 18L, Penrose, Colo. 81240.

LIFE-GUARD: The finest HEAT-SMOKE-GAS Alarm available, 100% solid state. COSMIC ELECTRONICS, Box 282, Lawrence, NY 11559.

DIGITAL ELECTRONICS! Highly effective course brings immediate results. \$10.00. Satisfaction or \$11.00 refunded! Plans, Projects, Free Literature. DYNASIGN, Box 60A7, Wayland, Mass. 01778.

UNSCRAMBLERS: Fits any scanner or monitor, easily adjusts to all scrambled frequencies. Only 4" square \$29.95, fully guaranteed. Dealer inquiries welcomed. PDQ Electronics, Box 841, North Little Rock, Arkansas 72115.

ELECTRONIC parts, low prices, free flyer: DARTEK ELECTRONICS, Box 2460, Dartmouth, Nova Scotia, Canada. U.S. Inquiries.

ALPHA/THETA Biofeedback Instruments, \$29.95 hobbyist models to professional models with on time Digital Recorder... DIGITAL: Heart Monitor, Thermometer, VOM, Frequency Counter, Function Generator, Logic Probe with readout, Tach and Dwell meter, etc. Free Catalog. COSMIC ELECTRONICS, Box 282, Lawrence, NY 11559.

SURPRISE! SURPRISE! Digital Piano Tuning Device tunes musical instruments Accurately! Perfectly! Inexpensively! Construction—Instruction—Plans Complete \$12.95 Airmailed Postpaid! Moonlighting quickly repays \$40 electronics investment! GBS, Box 100P, Green Bank, West Virginia 24944.

PYROTECHNICAL chemicals, casings, fuse, tools, literature, supplies. Catalog-50 cents, with samples — \$2.00. Westech, Logan, Utah 84321.

READ AND USE MICROCOMPUTER Hardware/Software ideas in ECS monthly. Write for free catalog and subscription inf. MP Publishing Co. Box 378P, Belmont, Massachusetts 02178.

RECONDITIONED Test Equipment, \$0.50 for catalog. Walter, 2697 Nickel, San Pablo, CA 94806.

7400 SERIES TTL PINOUT HANDBOOK

COVERS ENTIRE 7400/7400 SERIES D.I.P. I.C.'S

PIN CONNECTIONS - FUNCTIONAL SPECS

CROSS REFERENCE - ONLY \$2.95 FROM:

TTL PINOUT HANDBOOK, IMS ASSOCIATES, INC.

1298 E 14TH ST. SAN LEANDRO, CALIF. 94577

INCL. 30¢ POST-CALIF. RES. ADD. 20¢ SLS. TAX.

GROUND FAULT DETECTORS, TESTERS. Audible and Visual Continuity testers, Tone Generators, Music tone synthesizers. Direct Manufacturer Sales. Write for Brochures. Kabo Electronics, Box 477, Natick, Mass 01760.

MONITOR RECEIVER, Preamp, Scanner, UHF Converter kits. Hamtronics, 182 Belmont, Rochester, NY 14612.

FREE giant bargain electronic catalog listing thousands of components, tubes, transistors, IC's, kits, test equipment. EDLIE'S, 2700-PE Hempstead Tpke., Levittown, N.Y. 11756.

CONSTRUCTION PROJECTS: Laser, \$2.00. TV Camera, \$3.95. Catalog. Technologic, Box 5262, Orchard Lake, Michigan 48033.

FREE Bargain Catalog. Ultrasonic devices, LEDs, transistors, IC's, keyboards, Xtals, unique components. Chaney's, Box 15431, Lakewood, CO 80215.

CARBON FILM RESISTORS. Brand new as low as 2-1/4 cents. FREE samples and specifications. COMPONENTS CENTER—PE, Box 134, New York, NY 10038.

ALPHA BRAINWAVE MONITOR—New from EICO. Model BW300 Kit, \$34.95; Wired, \$59.95 Postpaid. Send check or money order. M&K Electronic Corp., 135-33 Northern Blvd., Flushing, N.Y. 11354.

POTTER BRUMFIELD
Type KHP Relay
4 PDT 3A Contacts
24 VDC (650 coil) \$1.50 EA.
120 VAC (10.5 MA coil) \$1.75 EA.

DIP SOCRETS	TTL SPECIAL
8 PIN PCB \$.22	7400 DIP TTL Sigmatic/House Numbered
14 PIN PCB .26	
16 PIN PCB .30	7404 DIP TTL Hex Inverter Sigmatic/House Numbered
24 PIN PCB .75	
40 PIN PCB 1.25	Each \$.17 Ten for \$1.50
14 PIN WIRE WRAP .35	

FAIRCHILD "TRIMPTS"

Brand new 20 turn precision trimmers. These are prime parts mostly individually packed in sealed envelopes. These values in stock:

50 OHM 1K	5K	25K
500 OHM 2K	10K	

Each only \$.89 10 for \$7.50

CARBON RESISTORS

Carbon Resistors 1/4-Watt 5%-full prime All values in stock. 10 per value (minimum quantity). 10 for \$.45

2102-2 MOS 1024 BIT MEMORY (DIP)

FULLY DECODED STATIC RANDOM ACCESS MEMORY DIRECTLY TTL COMPATIBLE INPUTS AND OUTPUT SINGLE 5V SUPPLY - NO CLOCKS OR REFRESH

\$5.00 each 8 for \$34.95

DIODE ARRAY

10 - 1N914 Silicon Signal Diodes in one package. 20 leads spaced .1"; no common connections. Each \$.25 10 for \$2.25

Numeric Display 1/4" Single Digit GaAsP LED

COMMON CATHODE WITH RH DECIMAL SUPER SPECIAL \$ 59 TEN for \$4.95

Compact - 10 digits in 3" panel width Highly legible - bright red V-character easily read within 10 feet over a wide viewing angle (160°) Low power - 125 mW per digit at typical brightness

SPECIAL 8223 PROM

8 BIT 32 WORD MEMORY \$3.00 EA. 10 - \$29 WE PROGRAM FOR \$5 EACH

RECTIFIER SPECIAL! 1N4007 - 1 AMP - 1000 volt PIV \$.13 each 10 for \$1.00

SEND FOR FREE FLYER! C.O.D. PHONE ORDERS ACCEPTED—\$10 MINIMUM

All IC's new and fully tested, leads plated with gold or solder. Orders for \$5.00 or more are shipped prepaid, smaller orders—add 55¢. California residents add Sales Tax... IC's shipped within 24 hours. P.O. BOX 41727 SACRAMENTO, CA 95841 916 334 2161

BABYLON ELECTRONICS

CIRCLE NO. 9 ON READER SERVICE CARD

CIRCUIT Collections: 20 useful circuits you can build. Includes schematics, parts list, description, \$3.98. RJE Company, 28 Park Street, Jamestown, N.Y. 14701.

DIGITAL panel meter sale. Big savings. Many models. Write Betz, Box 14942, Portland, Oregon 97214.

wanted Citizens Band

DEALER-DISTRIBUTORS

Send this ad with Letterhead to:

PAL ELECTRONICS CO.

2962 W. WELDON - PHOENIX, ARIZ. 85017

FOR A New Electronic Experience, learn to control your brainwaves. Aquarius Electronics, Box 962E, Albion, CA 95410.

SEND SASE for information on Shielded Ignition Systems described on page 80 of February PE. Summit Enterprises, 20 Eider St., Yarmouthport, Mass. 02675.

FREE Solar Energy Catalogue. Send Stamp. Centerline, 401U South 36th Street, Phoenix, Arizona 85034.

POPULAR ELECTRONICS

YOU CAN BE SURE OF GETTING THE BEST! ★★ ★★

FOR THE LEAST! — Save with our low prices & Volume Discount.

RESISTORS: 1/2, 1/4 watt— 5, 10%

Solid State Systems presents standard 5% and 10% tolerance Stackpole & Allen-Bradley type RCR hot molded fixed composition resistors which meet all requirements of MIL-R-3900B. These resistors have established reliability to 0.001% failure rate per 1000 hours of operation at maximum ambient temperature of 70°C as symbolized by the fifth color band on the body of the resistor.

All Resistors from TABLE I 4C
All Resistors from TABLE II 6C

PLEASE ORDER IN MULTIPLES OF 5 ONLY.

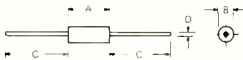

Wattage	Dimension in Inches			
	A	B	C	D
1/2	0.250-0.010	0.010-0.005	1.500-0.125	0.025-0.010
1/4	0.375-0.031	0.140-0.008	1.500-0.125	0.033-0.002

- Maximum Ambient Operating Temperature 70°C
- Available Values: All 84 standard 10%, and all 167 standard and 5% values from 2.7Ω to 22MΩ.
- Unexcelled low noise characteristics.
- Utmost uniformity in dimensions due to exclusive molding process.
- All leads tin plated to meet MIL-STD-20C, Method 208 requirements.
- Permanent color codes which are immune to scrubbing with all commercially used flux solvents

TABLE I: STANDARD 10% VALUES AND CATALOG NUMBERS

Resistance	Catalog Number	Resistance	Catalog Number	Resistance	Catalog Number	Resistance	Catalog Number
% Watt	% Watt	% Watt	% Watt	% Watt	% Watt	% Watt	% Watt
100	11 10207	12 10220	10K	11 10407	12 10420	11 10607	12 10620
120	11 12207	12 12220	12K	11 12407	12 12420	11 12607	12 12620
150	11 15207	12 15220	15K	11 15407	12 15420	11 15607	12 15620
180	11 18207	12 18220	18K	11 18407	12 18420	11 18607	12 18620
220	11 22207	12 22220	22K	11 22407	12 22420	11 22607	12 22620
270	11 27207	12 27220	27K	11 27407	12 27420	11 27607	12 27620
330	11 33207	12 33220	33K	11 33407	12 33420	11 33607	12 33620
390	11 39207	12 39220	39K	11 39407	12 39420	11 39607	12 39620
470	11 47207	12 47220	47K	11 47407	12 47420	11 47607	12 47620
560	11 56207	12 56220	56K	11 56407	12 56420	11 56607	12 56620
680	11 68207	12 68220	68K	11 68407	12 68420	11 68607	12 68620
820	11 82207	12 82220	82K	11 82407	12 82420	11 82607	12 82620
1000	11 10307	12 10320	100K	11 10507	12 10520	11 10707	12 10720
1200	11 12307	12 12320	120K	11 12507	12 12520	11 12707	12 12720
1500	11 15307	12 15320	150K	11 15507	12 15520	11 15707	12 15720
1800	11 18307	12 18320	180K	11 18507	12 18520	11 18707	12 18720
2200	11 22307	12 22320	220K	11 22507	12 22520	11 22707	12 22720
2700	11 27307	12 27320	270K	11 27507	12 27520		
3300	11 33307	12 33320	330K	11 33507	12 33520		
3900	11 39307	12 39320	390K	11 39507	12 39520		
4700	11 47307	12 47320	470K	11 47507	12 47520		
5600	11 56307	12 56320	560K	11 56507	12 56520		
6800	11 68307	12 68320	680K	11 68507	12 68520		
8200	11 82307	12 82320	820K	11 82507	12 82520		

TABLE II: STANDARD 5% VALUES AND CATALOG NUMBERS

Resistance	Catalog Number	Resistance	Catalog Number	Resistance	Catalog Number	Resistance	Catalog Number
% Watt	% Watt	% Watt	% Watt	% Watt	% Watt	% Watt	% Watt
100	13 10207	14 10220	10K	13 10407	14 10420	11M	13 10607
110	13 11207	14 11220	11K	13 11407	14 11420	11M	13 11607
120	13 12207	14 12220	12K	13 12407	14 12420	12M	13 12607
130	13 13207	14 13220	13K	13 13407	14 13420	13M	13 13607
140	13 14207	14 14220	14K	13 14407	14 14420	14M	13 14607
150	13 15207	14 15220	15K	13 15407	14 15420	15M	13 15607
160	13 16207	14 16220	16K	13 16407	14 16420	16M	13 16607
180	13 18207	14 18220	18K	13 18407	14 18420	18M	13 18607
200	13 20207	14 20220	20K	13 20407	14 20420	20M	13 20607
220	13 22207	14 22220	22K	13 22407	14 22420	22M	13 22607
240	13 24207	14 24220	24K	13 24407	14 24420	24M	13 24607
270	13 27207	14 27220	27K	13 27407	14 27420	27M	13 27607
300	13 30207	14 30220	30K	13 30407	14 30420	30M	13 30607
330	13 33207	14 33220	33K	13 33407	14 33420	33M	13 33607
360	13 36207	14 36220	36K	13 36407	14 36420	36M	13 36607
390	13 39207	14 39220	39K	13 39407	14 39420	39M	13 39607
430	13 43207	14 43220	43K	13 43407	14 43420	43M	13 43607
470	13 47207	14 47220	47K	13 47407	14 47420	47M	13 47607
510	13 51207	14 51220	51K	13 51407	14 51420	51M	13 51607
560	13 56207	14 56220	56K	13 56407	14 56420	56M	13 56607
620	13 62207	14 62220	62K	13 62407	14 62420	62M	13 62607
680	13 68207	14 68220	68K	13 68407	14 68420	68M	13 68607
750	13 75207	14 75220	75K	13 75407	14 75420	75M	13 75607
820	13 82207	14 82220	82K	13 82407	14 82420	82M	13 82607
910	13 91207	14 91220	91K	13 91407	14 91420	91M	13 91607
1000	13 10307	14 10320	100K	13 10507	14 10520	100M	13 10707
1100	13 11307	14 11320	110K	13 11507	14 11520	110M	13 11707
1200	13 12307	14 12320	120K	13 12507	14 12520	120M	13 12707
1300	13 13307	14 13320	130K	13 13507	14 13520	130M	13 13707
1500	13 15307	14 15320	150K	13 15507	14 15520	150M	13 15707
1600	13 16307	14 16320	160K	13 16507	14 16520	160M	13 16707
1800	13 18307	14 18320	180K	13 18507	14 18520	180M	13 18707
2000	13 20307	14 20320	200K	13 20507	14 20520	200M	13 20707
2200	13 22307	14 22320	220K	13 22507	14 22520	220M	13 22707
2400	13 24307	14 24320	240K	13 24507	14 24520		
2700	13 27307	14 27320	270K	13 27507	14 27520		
3000	13 30307	14 30320	300K	13 30507	14 30520		
3300	13 33307	14 33320	330K	13 33507	14 33520		
3600	13 36307	14 36320	360K	13 36507	14 36520		
3900	13 39307	14 39320	390K	13 39507	14 39520		
4300	13 43307	14 43320	430K	13 43507	14 43520		
4700	13 47307	14 47320	470K	13 47507	14 47520		
5100	13 51307	14 51320	510K	13 51507	14 51520		
5600	13 56307	14 56320	560K	13 56507	14 56520		
6200	13 62307	14 62320	620K	13 62507	14 62520		
6800	13 68307	14 68320	680K	13 68507	14 68520		
7500	13 75307	14 75320	750K	13 75507	14 75520		
8200	13 82307	14 82320	820K	13 82507	14 82520		
9100	13 91307	14 91320	910K	13 91507	14 91520		

ASSORTMENTS

Assortments of most wanted electronic components, Resistors and capacitors, are now offered in counts from one up to 10 each per value. Each assortment is neatly sealed in heavy plastic with 5 and 10 count assortments already separated by value. This should prove extremely valuable in keeping a close control over inventories. These assortments are ideal for use in R & D Laboratories, Schools, Laboratories, and for Experimenters. All components are brand new with full markings and all specifications listed in this advertisement. EACH ASSORTMENT OFFERS SUBSTANTIAL SAVINGS OVER INDIVIDUAL COMPONENT PRICES.

Catalog Number	Description of Assortment	Unit Price
15 01310	1 Each of 167 Standard 5%, 1/2 Watt Resistors	11.50
15 02310	2 Each of 167 Standard 5%, 1/2 Watt Resistors	21.50
15 05310	5 Each of 167 Standard 5%, 1/2 Watt Resistors	48.50
15 10310	10 Each of 167 Standard 5%, 1/2 Watt Resistors	95.00
15 01715	1 Each of 84 Standard 10%, 1/4 Watt Resistors	6.75
15 02410	2 Each of 84 Standard 10%, 1/4 Watt Resistors	15.30
15 05410	5 Each of 84 Standard 10%, 1/4 Watt Resistors	39.00
15 10410	10 Each of 84 Standard 10%, 1/4 Watt Resistors	79.70
15 01715	1 Each of 167 Standard 5%, 1/2 Watt Resistors	11.50
15 02410	2 Each of 167 Standard 5%, 1/2 Watt Resistors	21.50
15 05110	5 Each of 167 Standard 5%, 1/2 Watt Resistors	48.50
15 10110	10 Each of 167 Standard 5%, 1/2 Watt Resistors	95.00
15 01210	1 Each of 84 Standard 10%, 1/4 Watt Resistors	6.75
15 02210	2 Each of 84 Standard 10%, 1/4 Watt Resistors	13.50
15 05210	5 Each of 84 Standard 10%, 1/4 Watt Resistors	33.00
15 10210	10 Each of 84 Standard 10%, 1/4 Watt Resistors	69.00
15 01750	1 Each of 50 Type 5GA Ceramic Disc Capacitors	3.60
15 02750	2 Each of 50 Type 5GA Ceramic Disc Capacitors	6.75
15 05750	5 Each of 50 Type 5GA Ceramic Disc Capacitors	15.30
15 10750	10 Each of 50 Type 5GA Ceramic Disc Capacitors	30.70
15 01715	1 Each of 15 Type 5HK Ceramic Disc Capacitors	1.58
15 02715	2 Each of 15 Type 5HK Ceramic Disc Capacitors	3.15
15 05715	5 Each of 15 Type 5HK Ceramic Disc Capacitors	7.20
15 10715	10 Each of 15 Type 5HK Ceramic Disc Capacitors	13.50
15 01707	1 Each of 7 Type TG Ceramic Disc Capacitors	0.90
15 02707	2 Each of 7 Type TG Ceramic Disc Capacitors	1.71
15 05707	5 Each of 7 Type TG Ceramic Disc Capacitors	4.05
15 10707	10 Each of 7 Type TG Ceramic Disc Capacitors	7.65
15 01407	1 Each of 7 Type UK Ceramic Disc Capacitors	1.17
15 02407	2 Each of 7 Type UK Ceramic Disc Capacitors	2.16
15 05407	5 Each of 7 Type UK Ceramic Disc Capacitors	5.40
15 10407	10 Each of 7 Type UK Ceramic Disc Capacitors	10.80
15 01749	1 Each of 49 AXIAL Electrolytic Capacitors	10.00
15 02749	2 Each of 49 AXIAL Electrolytic Capacitors	19.00
15 05749	5 Each of 49 AXIAL Electrolytic Capacitors	48.00
15 10749	10 Each of 49 AXIAL Electrolytic Capacitors	84.00
15 01849	1 Each of 49 RADIAL Electrolytic Capacitors	10.00
15 02849	2 Each of 49 RADIAL Electrolytic Capacitors	19.00
15 05849	5 Each of 49 RADIAL Electrolytic Capacitors	48.00
15 10849	10 Each of 49 RADIAL Electrolytic Capacitors	86.00

DISC CAPACITORS

PLEASE ORDER IN MULTIPLES OF 10 PER ITEM.

5HK Sprague type 5HK ceramic disc capacitors offer high capacity in a minimum space. All type 5HK capacitors have a tolerance of 20%, +80%. Voltage rating is 1000VDC for values up to 10 and including 0.01µF, and 500VDC for 0.015µF and higher.

Catalog Number	Capacitance	Unit Price
71 10069	1000 pF	07
71 15069	1500 pF	07
71 20069	2000 pF	07
71 22069	2200 pF	07
71 33069	3300 pF	07
71 47069	4700 pF	07
71 50069	5000 pF	07
71 68069	6800 pF	07
71 10469	0.010 µF	07
71 15469	0.015 µF	07
71 20469	0.020 µF	09
71 25469	0.025 µF	09
71 40469	0.040 µF	17
71 50469	0.050 µF	21
71 10569	0.1 µF	32

5GA Sprague type 5GA ceramic disc capacitors have low self-inductance of sintered flat-plate design for high pass efficiency. All type 5GA capacitors have a tolerance of ±20%, and 1000VDC ratings.

Catalog Number	Capacitance	Unit Price
71 50069	5 pF	07

PREDETERMINED PROGRAMMABLE COUNTER

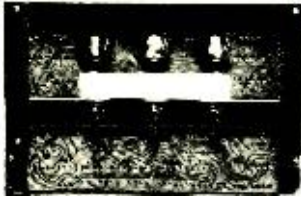

We have 3 models of a counter used by a large copying machine manufacturer. The number of copies desired is preset by dials, and the machine then makes this number of copies displaying the count on NIXIE tubes. When the preset number is reached, the counter stops the machine. The counters were removed from copiers, and replaced with newer

models. They all operate on input pulses, display the count, and close a set of contacts when the predetermined number is reached. Useful for many types of industrial counting, darkroom timing etc. All units have 3 BURROUGHS NIXIE tubes, type B5092A, which currently sell for \$17.25 ea. We supply operating instructions and some application data.

STOCK NO.P5265 (uses BEAM X switching tubes) \$13.95 (additional data supplied on models using BEAM X tubes).
STOCK NO.P5264 (module type switching) \$17.95
STOCK NO.P5231 (all solid state switching) \$19.95

10"x6 1/2"x5" Weight 8 lbs.



EXOTIC COMPUTER BOARD

One of the finest boards we have ever seen. 8 12-15 volt reed relays, LM 309 in heat sink, 11 trim pots, 5 different values, 2 optical couplers, ICs, 4 Op-Amps, bridge rectifier, 7 transistors, diodes, resistors and much more. Over \$150.00 worth of parts.

STOCK NO.P9226 8.95 ea. 2/17.00

TRIPLE REGULATOR BOARD +12 volts @ 200 ma. & tracking regulator, 0 to 5 volts 500 ma. 0.5% reg. with data. 5 1/2"x3 1/2"
STOCK NO.P9013 5.95 ea. 2/10.00

9 1/2"x10" 2Lbs.

Please include sufficient postage. Excess will be refunded. Send for our latest and largest catalog No.14, 64 pages.



DELTA ELECTRONICS CO.

BOX 1, LYNN, MASSACHUSETTS 01903
Phone (617) 388-4705

CIRCLE NO. 16 ON READER SERVICE CARD

CB SPECIALS

2SC517	4.75	2SC781	3.25	2SC1237	2.00	2SC1678	5.75
2SC710	.70	2SC799	4.25	2SC1239	2.80	2SC1679	5.75
2SC711	.70	2SC1013	1.50	2SC1243	1.50	2SC1957	3.50
2SC735	.70	2SC1014	1.50	2SC1306	5.25	2SD235	1.00
2SC756	1.50	2SC1017	1.50	2SC1307	6.25	MRF8004	3.00
2SC773	.85	2SC1018	1.50	2SC1377	6.75	4005	3.00
2SC774	1.75	2SC1173	1.25	2SC1449	3.50		

JAPANESE TRANSISTORS

2SA52	60	2SB370	1.10	2SC478	80	2SC829	75	2SC1509	1.25
2SA101	70	2SB379	65	2SC482	1.75	2SC833	70	2SC1569	1.25
2SA103	70	2SB380	70	2SC491	2.50	2SC838	70	2SC1756	1.25
2SA221	60	2SB405	1.00	2SC495	70	2SC839	85	2SD300	9.00
2SA473	85	2SB407	2.10	2SC497	1.60	2SC930	65	2SD45	2.00
2SA495	65	2SB415	1.05	2SC515	80	2SC945	65	2SD64	75
2SA497	55	2SB461	1.25	2SC535	95	2SC1010	80	2SD65	75
2SA505	65	2SB463	1.65	2SC536	65	2SC1012	80	2SD68	70
2SA562	70	2SB471	1.75	2SC537	70	2SC1013	1.50	2SD72	1.00
2SA607	2.25	2SB474	1.75	2SC563	2.50	2SC1014	1.50	2SD88	1.50
2SA613	1.00	2SB481	2.10	2SC564	70	2SC1018	1.50	2SD120	85
2SA643	65	2SB492	1.25	2SC568	70	2SC1030	3.25	2SD130	1.50
2SA647	2.75	2SB495	95	2SC582	85	2SC1051	2.50	2SD141	2.25
2SA673	85	2SB605	2.00	2SC591	2.50	2SC1061	1.65	2SD151	2.25
2SA679	2.25	2SB606	2.00	2SC605	1.00	2SC1079	3.95	2SD170	2.00
2SA682	95	2SC15	65	2SC619	70	2SC1096	1.20	2SD180	3.00
2SA699	1.30	2SC24	65	2SC620	80	2SC1098	1.15	2SD198	2.50
2SA699A	2.00	2SC32	65	2SC627	1.75	2SC1115	2.75	2SD201	2.50
2SA705	55	2SC33	65	2SC644	70	2SC1166	70	2SD218	5.00
2SA714	2.50	2SC41	4.00	2SC645	85	2SC1170	4.00	2SD235	1.00
2SA720	70	2SC49	80	2SC681	2.50	2SC1172B	4.25	2SD261	80
2SA733	65	2SC56	95	2SC684	2.10	2SC1173	1.25	2SD291	85
2SB22	65	2SC143	3.50	2SC687	2.50	2SC1213	75	2SD292	85
2SB54	70	2SC154	3.75	2SC696	2.35	2SC1226	1.25	2SD300	2.50
2SB56	70	2SC162	3.75	2SC710	70	2SC1237	2.00	2SD313	1.20
2SB77	70	2SC163	4.50	2SC711	70	2SC1239	2.80	2SD315	75
2SB128	2.50	2SC185	1.00	2SC712	70	2SC1293	85	2SD318	95
2SB135	95	2SC202	1.00	2SC713	70	2SC1308	5.00	2SD341	95
2SB152	4.50	2SC206	1.00	2SC732	70	2SC1317	60	2SD350	3.50
2SB172	55	2SC240	1.10	2SC733	70	2SC1325	5.00	2SD352	80
2SB173	55	2SC261	65	2SC735	70	2SC1347	80	2SD380	6.00
2SB175	55	2SC291	65	2SC739	70	2SC1377	6.75	2SD389	95
2SB178	1.00	2SC320	75	2SC756	1.50	2SC1383	75	2SD390	75
2SB186	60	2SC352	75	2SC774	1.75	2SC1393	60	2SD437	6.00
2SB187	60	2SC353	75	2SC775	2.00	2SC1409	2.75	2SD458	80
2SB235	1.95	2SC371	70	2SC778	3.00	2SC1410	2.75	2SD111	3.50
2SC303	85	2SC372	70	2SC783	1.00	2SC1446	1.25	2SD115	3.75
2SC324	1.00	2SC380	70	2SC784	70	2SC1447	1.25	2SK19	2.25
2B337	2.10	2SC387	70	2SC785	1.00	2SC1448	1.25	2SK30	1.25
2SC364	65	2SC394	70	2SC792	3.00	2SC1450	1.00	2SK40	1.60
2SC365	65	2SC458	70	2SC793	2.50	2SC1454	2.75	3SF11	3.14
2SB367	1.60	2SC460	70	2SC798	75	2SC1507	1.25	SG609	4.95

20% off on Replacement orders of 25.00 or more. Above is partial list of current stock available at drastic reductions. Send for complete list!
ALL PARTS GUARANTEED AND TESTED ON PREMISES
WRITE FOR FREE CATALOG AND LG. QUANTITY DISCOUNTS

1N270	06	2N630	3.10	2N1540	90	2N2325	2.10	2N3247	3.50	2N3856	20	2N4403	19
1N749 A	16	2N677C	5.00	2N1543	3.00	2N2326	3.00	2N3250	4.00	2N3866	90	2N4409	19
1N750 A	16	2N706	2.00	2N1544	80	2N2327	4.00	2N3375	4.95	2N3903	19	2N4410	19
1N751 A	16	2N706B	35	2N1549	1.05	2N2328	4.25	2N3393	19	2N3904	19	2N4416	75
1N914	06	2N711	35	2N1551	3.50	2N2329	6.00	2N3394	19	2N3905	19	2N4441	85
1N4148	06	2N711B	50	2N1552	3.50	2N2368	25	2N3414	22	2N3906	19	2N4442	90
1N4746	05	2N718	18	2N1554	1.75	2N2369	19	2N3415	25	2N3954	3.25	2N4443	1.25
1N4747	50	2N718A	25	2N1557	1.50	2N2484	20	2N3416	28	2N3925	4.50	2N4852	60
1N4749	50	2N720A	1.35	2N1560	3.00	2N2712	25	2N3417	30	2N3954	4.50	2N5061	25
1N5355	75	2N759A	90	2N1605	35	2N2894	40	2N3442	190	2N3954A	4.90	2N5064	40
1N5357 A,B	75	2N760	40	2N1613	30	2N2903	3.50	2N3553	1.50	2N3955	2.50	2N5130	19
1N5358 A,B	75	2N877	2.25	2N1671	1.00	2N2904	19	2N3563	18	2N3955A	2.90	2N5133	15
1N5359 A,B	75	2N894	1.75	2N1711	30	2N2904A	25	2N3565	18	2N3957	1.30	2N5138	15
2N173	2.00	2N918	19	2N1907	4.25	2N2905	19	2N3638	18	2N3958	1.20	2N5154	6.25
2N178	90	2N930	19	2N2060	1.90	2N2905A	25	2N3642	19	2N4037	60	2N5157	8.95
2N2327A	1.25	2N956	20	2N2102	40	2N2906	19	2N3643	15	2N4093	90	2N5198	3.85
2N2334	1.25	2N960	40	2N2218	20	2N2906A	20	2N3645	15	2N4124	18	2N5294	60
2N2336	90	2N962	40	2N2218A	25	2N2907	19	2N3646	10	2N4126	23	2N5296	45
2N238A	1.10	2N967	40	2N2219	20	2N2907A	25	2N3730	1.25	2N4141	23	2N5306	20
2N399B	90	2N1136	1.25	2N2219A	25	2N2913	75	2N3731	1.65	2N4142	16	2N5354	25
2N404	20	2N1137A	1.65	2N2221	19	2N2914	1.25	2N3740	1.00	2N4143	15	2N5369	20
2N443	1.05	2N1142	1.95	2N2221A	19	2N2916A	3.75	2N3771	1.90	2N4220A	90	2N5400	50
2N456	1.15	2N1143	1.75	2N2222	19	2N3019	1.25	2N3772	2.00	2N4234	1.25	2N5401	50
2N501A	35	2N1302	25	2N2222A	19	2N3053	19	2N3773	2.10	2N4235	1.60	2N5457	35
2N508A	35	2N1305	30	2N2270	30	2N3054	70	2N3819	25	2N4400	19	2N5458	35
2N512B	25	2N1377	1.25	2N2322	1.50	2N3055	75	2N3823	60	2N4401	19	2N5467	28.00
2N555	45	2N1420	1.80	2N2323	1.60	2N3227	2.10	2N3843	25	2N4402	19	C106B1	45
2N652A	90	2N1483	1.00	2N2324	2.00								

SILICON UNIUNIONS

2N2646	To-18	50
2N2647	To-18	65
2N6027 PUT	To-92	55
2N6028 PUT	To-92	75
2N1671	To-5	1.00
D5E37	To-18	4/1.00

INTEGRATED CIRC.

UA703C	40
CA3066	4.00
CA3068	6.50
MC1305	1.50
Replacement for Zenith	
221-36. 221-37. 221-39	3.50

RECTIFIERS

1N4001	10	100
1N4002	60	5.00
1N4003	70	6.00
1N4004	80	7.00
1N4004	90	8.00
1N4005	1.00	9.00
1N4006	1.10	10.00
1N4007	1.20	11.00

TRANSISTOR GRAB BAG—Germanium and Silicon small sigs and power transistors. Untested. 50/1.00 FAIRCHILD 9L00 IC's. prime units. 29
HOBBYISTS 16 Pin Digital IC- Untested .45 1.00 709C Hi-Perf. Op Amp 5 1.00
Fairchild 7400 IC- While They Last! 8 1.00 741C Hi-Perf. Op Amp 4 1.00



New-Tone Electronics
P.O. BOX 1738 A
BLOOMFIELD, N.J. 07003

TERMS Check or money order. COD's accepted. Include 10% for postage and handling. N.J. residents add 5% sales tax. Minimum order \$5.00

CIRCLE NO. 28 ON READER SERVICE CARD

POPULAR ELECTRONICS

C-MOS

4000AE	.26	.25
4001AE	.26	.25
4002AE	.26	.25
4004AE	5.83	5.82
4006AE	1.35	1.34
4007AE	1.49	1.48
4008AE	1.79	1.78
4009AE	.60	.59
4010AE	.59	.58
4011AE	.26	.25
4012AE	.26	.25
4013AE	.47	.46
4014AE	1.49	1.48
4015AE	1.26	1.25
4016AE	.56	.55
4017AE	1.20	1.19
4018AE	1.49	1.48
4019AE	.52	.51
4020AE	1.49	1.48
4021AE	1.34	1.33
4022AE	1.11	1.10
4023AE	.26	.25
4024AE	.90	.89
4025AE	.26	.25
4026AE	3.72	3.70
4027AE	6.09	6.07
4028AE	.98	.97
4029AE	1.27	1.26
4030AE	.44	.43
4033AE	3.01	3.00
4035AE	1.27	1.26
4040AE	1.43	1.42
4041AE	4.06	4.05
4042AE	.75	.74
4043AE	.60	.59
4044AE	.60	.59
4047AE	3.54	3.53
4048AE	1.43	1.42
4049AE	.52	.51
4050AE	.52	.51
4051AE	1.34	1.33
4052AE	1.34	1.33
4053AE	2.63	2.62
4056AE	3.43	3.39
4060AE	1.50	1.49
4066AE	.90	.89
4069AE	.78	.68
4071AE	.26	.25
4076AE	1.68	1.67
4081AE	.26	.25
4510AE	1.98	1.78
4516AE	2.88	2.78
4518AE	3.28	2.98
4520AE	1.88	1.68
4901AE	.43	.36
4911AE	.43	.36



WAVEFORM GENERATOR

XR205K KIT Only \$25.00
Here's a highly versatile lab instrument at a fraction of the cost of conventional unit. Kit includes two XR205 IC's, data & application notes, PC board (etched & drilled, ready for assembly) and detailed instructions.

7400N TTL

7400N	\$1.4	7444N	\$1.05	7496N	\$.85	74161N	1.28
7401N	.17	7405N	1.04	74100N	1.04	74162N	1.50
7402N	.14	7446N	1.10	74104N	1.25	74163N	1.48
7403N	.17	7447N	1.00	74105N	.45	74164N	1.70
7404N	.20	7448N	1.00	74107N	.40	74165N	1.78
7405N	.20	7450N	.15	74109N	.92	74166N	1.50
7406N	.35	7451N	.20	74110N	.72	74170N	2.60
7407N	.45	7452N	.20	74111N	.92	74173N	1.55
7408N	.18	7414N	.26	74114N	.92	74174N	1.20
7409N	.23	7455N	.37	74115N	.92	74175N	1.60
7410N	.18	7460N	.25	74118N	1.51	74176N	1.30
7411N	.27	7462N	.37	74121N	.50	74177N	1.50
7412N	.52	7464N	.37	74122N	.50	74180N	1.05
7413N	.65	7465N	.37	74123N	.90	74181N	3.20
7414N	.80	7470N	.60	74125N	1.05	74182N	.75
7415N	.37	7471N	.49	74126N	.64	74184N	2.90
7416N	.36	7472N	.33	74128N	.95	74185N	2.29
7417N	.37	7473N	.38	74132N	1.80	74188N	4.90
7418N	.17	7474N	.35	74136N	.92	74190N	1.49
7419N	.60	7475N	.60	74140N	2.50	74191N	1.49
7420N	.27	7476N	.45	74141N	1.19	74192N	1.40
7421N	.48	7478N	.55	74145N	1.08	74193N	1.29
7422N	.34	7480N	.60	74147N	2.90	74194N	1.35
7423N	.27	7481N	1.19	74148N	2.20	74195N	.80
7424N	.31	7482N	.90	74150N	.99	74196N	1.90
7425N	.52	7483N	.80	74151N	.84	74197N	.80
7426N	.20	7484N	3.02	74152N	1.50	74198N	2.00
7427N	.27	7485N	2.50	74155N	1.05	74199N	2.09
7428N	.36	7486N	.40	74154N	1.48	74200N	5.90
7429N	.32	7489N	2.40	74155N	1.08	74221N	1.75
7430N	.35	7490N	.60	74156N	1.18	74251N	1.75
7431N	.90	7491N	1.00	74157N	1.18	74278N	2.95
7432N	.16	7440N	.84	74158N	1.44	74279N	1.10
7433N	.95	7449N	.80	74160N	5.00	74293N	.95
7442N	.78	7494N	1.20			74298N	2.55
7443N	.95	7495N	.80				

DECODED READ/WRITE RAM

P1103	\$6.20
-------	--------

SCHOTTKY TTL

74S00N	.45	74S74N	1.30	74S158N	2.40
74S02N	.80	74S85N	6.10	74S161N	4.70
74S03N	.75	74S86N	2.70	74S174N	3.30
74S04N	.75	74S112N	2.20	74S181N	10.20
74S08N	.80	74S113N	2.50	74S189N	5.10
74S10N	.75	74S132N	3.60	74S194N	3.30
74S12N	.65	74S133N	.90	74S195N	3.40
74S20N	.80	74S138N	2.40	74S251N	2.40
74S30N	.80	74S139N	2.40	74S253N	2.40
74S32N	.80	74S140N	.90	74S257N	2.40
74S40N	.80	74S151N	2.40	74S258N	2.40
74S51N	.80	74S153N	2.40	74S260N	.90
74S64N	.80	74S157N	2.40	74S280N	5.70

LOW POWER TTL

74L00N	.34	74H00N	.34	74H53N	.36
74L02N	.34	74H01N	.34	74H54N	.36
74L03N	.39	74H04N	.38	74H55N	.36
74L04N	.39	74H05N	.37	74H60N	.36
74L10N	.34	74H08N	.40	74H61N	.36
74L20N	.39	74H10N	.36	74H72N	.36
74L42N	1.62	74H11N	.36	74H71N	.80
74L51N	.34	74H20N	.36	74H72N	.74
74L73N	.74	74H21N	.36	74H73N	.90
74L74N	.89	74H22N	.36	74H74N	.87
74L90N	1.62	74H24N	.36	74H76N	.80
74L93N	1.74	74H40N	.36	74H101N	.80
74L95N	1.62	74H50N	.36	74H102N	.80
93L00	1.50	74H51N	.36	74H103N	1.10
93L01	1.60	74H52N	.36	74H106N	.95
93L08	2.20				
93L09	1.80				
93L10	2.80				
93L11	4.20				
93L12	1.80				
93L14	1.70				
93L16	3.20				
93L18	3.50				
93L21	1.50				
93L22	1.80				
93L24	2.80				
93L28	3.70				
93L34	4.00				
93L38	4.20				
93L40	6.50				
93L41	6.50				
93L60	3.00				
93L66	2.70				

BIPOLAR MEMORY

C3101	6.50
P3101A	4.90
C3101A	7.30
P3101A	5.80
IM5501CDE	7.30
IM5501CPE	5.80
MM5560D	7.30
MM5560N	5.80
DM8599N	5.80
93403PC	5.80

TWO-PHASE MOS CLOCK DRIVER

MMH0026CN	\$5.50
-----------	--------

COMPUTER INTERFACE

DM8820N	2.40
DM8820AN	6.90
DM8830N	2.40
DM8831N	5.20
DM8832N	6.00
N8T26B	4.40
9600PC	1.30
9601PC	1.20
9602PC	2.10
9614PC	2.10
9615PC	2.40
9616DC	5.00
9617PC	3.50
9620PC	4.00
9621PC	4.00

PORTABLE 4 1/2 DIGIT MULTIMETER

FOR \$299. A 10 MHz COUNTER OPTION FOR \$50.

PULSE GENERATOR

Interdesign 1101: 0.1Hz-2MHz. 0.5V Output, var. width, line or battery operation. \$159.00

INTERSIL 8038 PRECISION WAVEFORM GENERATOR & VCO

For simultaneous sine, square and triangular waveforms <.001 Hz to 1MHz.

Part No	1-9	10 up
8038CCPD	\$4.50	\$3.70

DUAL LOW NOISE OP AMP

LM3331N: V_{io} = 6mV I_b = 1000 nA I_p = 1000 nA Noise = 1.5dB \$2.20

CALCULATORS (Limited Qty.) \$19.00

1024-BIT N-Channel RAM
2601-1 11.40
2601-2 11.40
2602B 8.00
2602-1B 8.00
2602-2B 8.00
MK4102P 11.40
7552-1CPE 8.00
7552-2CPE 8.00

DISPLAYS

OPCOA		
SLA11 Red	2.25	
SLA11 Green	3.50	
SLA21 Yellow	3.50	
SLA7 Red	1.60	
LITRONIX		
DL80 Red	6.00	
DL81 Red	6.00	
DL10 Red	6.00	
DL10A Red	4.00	
DL101 Red	4.90	
DL57 Red	9.90	
DL61 Red	12.00	
DL33 Red	4.00	
DL44 Red	6.00	
DL402 Red	4.00	
DL701 Red	3.40	
DL704 Red	2.25	
DL707 Red	2.35	
DL747 Red	2.50	
XCITON		
XAN72 Red	2.00	
XAN52 Green	2.00	

74LS

74LS00	.58	74LS76	.92	9300PC	1.00
74LS01	.58	74LS78	.92	9301PC	1.20
74LS02	.58	74LS107	.92	9303PC	1.50
74LS03	.58	74LS109	.92	9306PC	6.90
74LS04	.63	74LS112	.92	9308PC	2.50
74LS05	.63	74LS113	.92	9309PC	1.60
74LS08	.58	74LS114	.92	9310PC	1.50
74LS09	.58	74LS138	2.38	9311PC	2.30
74LS10	.58	74LS139	2.38	9312PC	2.30
74LS11	.58	74LS149	1.30	9314PC	1.30
74LS15	.58	74LS157	2.10	9316PC	5.00
74LS20	.58	74LS158	2.40	9321PC	1.20
74LS21	.58	74LS160	2.70	9322PC	1.30
74LS22	.58	74LS161	2.70	9324PC	2.50
74LS27	.64	74LS170	5.92	9328PC	2.50
74LS30	.58	74LS174	3.02	9334PC	2.95
74LS32	.64	74LS175	2.90	9338PC	3.00
74LS51	.58	74LS181	3.72	9340PC	5.00
74LS54	.58	74LS251	2.55	9341PC	4.10
74LS55	.58	74LS253	3.05	9342PC	1.15
74LS73	.92	74LS260	.58	9360PC	1.75
74LS74	.92			9366PC	1.75

INTERFACE MODULES

CY1010	Instr. Amp., Bipolar Input	29.00
CY1011A	Instr. Amp., Bipolar Input	49.00
CY1020	Instr. Amp., FET Input	34.00
CY1021	Instr. Amp., FET Input	49.00
CY2021A	DAC, 10 Bit, Low Drift	39.00
CY2218	DAC, 12 Bit, 2 Quad Multiplying	149.00
CY2237	DAC, 12 Bit, Low Drift	69.00
CY2735	DAC, 4 Digit BCD, Low Cost	79.00
CY3035	ADC, 8 Bit, Sect. Counting, Low Cost	89.00
CY3635	ADC, 3 Digit BCD, Sect. Count, Low Cost	119.00

LINEAR ICs

H=TO5	N=DIP	M=MINI-DIP	D=CER-DIP	K=TO3	
LM114H	3.00	LM311H	1.70	LM711CN	.90
LM300H	1.20	LM311D	1.90	LM715CH	4.30
LM300N	1.20	LM311M	1.75	LM715DC	4.60
LM301AH	.90	LM312H	2.60	LM723CN	.90
LM301AN	1.10	LM318H	2.70	LM723CH	7.50

ABOUT YOUR SUBSCRIPTION

Your subscription to POPULAR ELECTRONICS is maintained on one of the world's most modern, efficient computer systems, and if you're like 99% of our subscribers, you'll never have any reason to complain about your subscription service.

We have found that when complaints do arise, the majority of them occur because people have written their names or addresses differently at different times. For example, if your subscription were listed under "William Jones, Cedar Lane, Middletown, Arizona," and you were to renew it as "Bill Jones, Cedar Lane, Middletown, Arizona," our computer would think that two separate subscriptions were involved, and it would start sending you two copies of POPULAR ELECTRONICS each month. Other examples of combinations of names that would confuse the computer would include: John Henry Smith and Henry Smith; and Mrs. Joseph Jones and Mary Jones. Minor differences in addresses can also lead to difficulties. For example, to the computer, 100 Second St. is not the same as 100 2nd St.

So, please, when you write us about your subscription, be sure to enclose the mailing label from the cover of the magazine—or else copy your name and address exactly as they appear on the mailing label. This will greatly reduce any chance of error, and we will be able to service your request much more quickly.

ALTAIR 8800—Assembled, guaranteed—\$521. 168 Painter Road, Media, PA 19063.

ELECTRONIC COMPONENTS: Premium grade at minimum cost. Wide selection purchased from liquidating companies. Send 25 cents to Closeout Bulletin, 340 Vivian St., Longmont, CO 80501.

PLANS AND KITS

ATTENTION AUDIO FREAKS!! ... Audio Processing Circuits ... designs, kits, units. Laboratory tested designs for hobbyist through professional use—limiters, compressors, equalizers, phasers, mixers and more! Send now—\$1.00 (refundable) for complete catalog—CIRCUIT RESEARCH LABS, 3920 E. Indian School, Phoenix, AZ 85018.

AMAZING ELECTRONIC PRODUCTS—Pocket Laser, See-In-The-Dark, Scramblers, Penlight Strobe, Energy Devices, TV Disruptor, Many More, All New. Catalog \$1.00. INFORMATION UNLTD., West St., Milford, N.H. 03055.

FREQUENCY counter, Digital Clock, Logic Probe and more to come. Complete kits or PC Boards, reasonable priced full details \$3.00. Refundable. East Coast Electronics, 50 Scott, Hamburg, New York 14075.

CYCLOPS TV CAMERA KIT, featured on cover of February PE, available from CROMEMCO, 26655 Laurel, Los Altos, California 94022.

SAVE ELECTRIC POWER!

Save up to 80% electrical power with this unique, inexpensive, portable, permanent and legal method applicable for shops, homes, factories, businesses, farms, sites. 100% Refund Guaranteed if not scientifically sound or if it employs gimmicks.

Information \$1.00

CONSUMERTRONICS CO.

P.O. Box 1399 Alamogordo, N.M. 88310

NEW FROM EICO—Listen to official FCC-Licensed background music (SCA) on your FM radio without commercials. EC5000 Kit, \$12.95 Postpaid. M&K Electronic Corp., 135-33 Northern Blvd., Flushing, N. Y. 11354.

LEARN digital circuitry. Electronic game kits. Information 10 cents. NBL-E, Box 1115, Richardson, Texas 75080.

DIGITAL PLANS: Digital Thermometer, Digital Photographic Timer, Digital Combination Lock and more. Also P.C. Boards. Com-Tronics, 144 Clowerside Court, Buffalo, N.Y. 14224.

TESLA COIL—40" SPARKS! Plans \$7.50. Information 75 cents. Huntington Electronics, Box 2009-P, Huntington, Conn. 06484.

TOUCH SWITCH. Very reliable and versatile. Plans-applications. \$3.00. The Mail Shop, Box 1203, Spilwater, Okla. 74074.

ALTAIR 8800 Kits. Your assembled plug-in boards tested free. Midwest Electronics, Box 344, Henning, Minn. 56551.

CONSTRUCTION PLANS. Telephone, others. Catalog, Free Circuit. Alley Service, 233 Laurelton, Rochester, N.Y. 14609.

BURGLAR ALARMS

BURGLAR-FIRE alarm supplies and information. Free catalog. Protecto Alarm Sales, Box 357-G, Birch Run, Michigan 48415.

BURGLAR ALARM dialing unit automatically calls police. \$29.95. Free literature. S&S Supply, Box 12375C, North Kansas City, MO 64116.

GUARD Master Professional Wholesale Alarm Catalogue \$2. Mepco, Dept. A6, Box 28007, St. Louis, MO 63119.

BURGLAR-FIRE ALARM components, hardware. Free catalog. Information. Silmar, 133 S.W. 57 Ave., Miami, Florida 33144.

HIGH FIDELITY

DIAMOND NEEDLES and Stereo Cartridges at Discount prices for Shure, Pickering, Stanton, Empire. Grado and ADC. Send for free catalog. LYLE CARTRIDGES, Dept. P, Box 69, Kensington Station, Brooklyn, New York 11218.

LISTEN TO SPECTACULAR 4-CHANNEL SOUND!

Expand your stereo to quadraphonic Hi-Fi.

Build the VISTA Full Logic "SQ" Decoder.

Latest CBS licensed circuitry using 3 IC's to provide Full Logic and Wave Matching.

Exclusively ours. Kit SQ-1 \$40.00. Shipped prepaid in USA & CANADA.

Send for information.

PHOTOLUME CORPORATION

118 East 28th Street, New York, N.Y. 10016

WANTED

QUICKSILVER, Platinum, Silver, Gold, Ores Analyzed. Free Circular. Mercury Terminal, Norwood, Mass. 02062.

TUBES

RADIO & T.V. Tubes—36 cents each. Send for free Catalog. Cornell, 4213 University, San Diego, Calif. 92105.

RECEIVING & INDUSTRIAL TUBES, TRANSISTORS. All Brands — Biggest Discounts. Technicians, Hobbyists, Experimenters — Request FREE Giant Catalog and SAVE! ZALYTRON, 469 Jericho Turnpike, Mineola, N.Y. 11501.

TUBES receiving, factory boxed, low prices, free price list. Translertonic, Inc., 1306 40th Street, Brooklyn, N.Y. 11218A, Telephone: 212-633-2800.

TUBES "Oldies", latest. Lists free. Steinmetz, 7519 Maplewood, Hammond, Indiana 46324.

CASH PAID FOR OLD TUBES RCA45, RCA50, WE205B, WE252A, WE300B, WE350B, WE274A, and sound Hi-Fi equipment of Western Electric, Macintosh, Marantz, Leak, Quad, old and new types, Contact: M. Takabe, Room 1816, 303 Fifth Ave., NYC 10016.

ELECTRICAL SUPPLIES & EQUIPMENT

PLATING Equipment, Portable Platers, Supplies and "Know-How." Build your own tanks for nickel, chrome, etc. Easy-to-install PVC liners. Rectifier components—all sizes. Schematics, parts lists, formulas, operating instructions for all plating. Guaranteed to save you 25%-75%. Some good units for sale. Write for details. Platers Service Company, 1511-PE Esperanza, Los Angeles, Calif. 90023.

TAPE AND RECORDERS

RENT 4-Track open reel tapes—all major labels—3,000 different — free brochure. Stereo-Partl, 55 St. James Drive, Santa Rosa, Ca. 95401.

1930-1962 Radio Programs. Reels, \$1.00 Hour! Cassettes, \$2.00 Hour!... Mammoth Catalog. \$1.25. AM Treasures, Box 192F, Babylon, N.Y. 11702.

OLD RADIO SHOWS ON CASSETTES. \$1.50 per show. Catalog 25 cents. Radio Classics, Box 804A, Mattituck, N.Y. 11952.

MOVIE FILMS

8MM-SUPER 8-16MM MOVIES! Biggest Selection! Lowest Prices! Free Catalog! Cinema Eight, Box PE, Chester, Connecticut 06412.

GOVERNMENT SURPLUS

GOVERNMENT Surplus. How and Where to Buy in Your Area. Send \$2.00. Surplus 30177-PE Headquarters Bldg., Washington, D.C. 20014.

MANUALS for Govt Surplus radios, test sets, scopes. List 50 cents (coin). Books, 7218 Roanne Drive, Washington, D.C. 20021.

PERSONALS

MAKE FRIENDS WORLDWIDE through international correspondence. Illustrated brochure free. Hermes, Berlin 11, Box 110660/ZD, Germany.

INSTANT MEMORY. NEW WAY to remember. No memorization. Release "Photographic" memory. Forget nothing. Liberates extraordinary knowledge, talents. Immediate results! Free information. Institute of Advanced Thinking, Box 606-Dept. PE, Pacific Palisades, CA 90272.

INSTRUCTION

LEARN ELECTRONIC ORGAN SERVICING at home all makes including transistor. Experimental kit—trouble-shooting. Accredited NHSC. Free Booklet. NILES BRYANT SCHOOL, 3631 Stockton, Dept. A, Sacramento, Calif. 95820.

LEARN WHILE ASLEEP. Hypnotize! Strange catalog free. Auto-suggestion, Box 24-ZD, Olympia, Washington 98501.

DEGREE IN ELECTRONICS through correspondence. Free catalog. Grantham, 2000 Stoner Avenue, Los Angeles, California 90025.

INTENSIVE 5 week course for Broadcast Engineers. F.C.C. First Class license. Radio Engineering Incorporated, 61 N. Pineapple Ave., Sarasota, Florida 33577 and 2402 Tidewater Trail, Fredericksburg, VA 22401.

F.C.C. EXAM MANUAL

PASS FCC EXAMS! Memorize, study — Test Answers for FCC 1st and 2nd class Radio Telephone licenses. Newly revised multiple choice questions and diagrams cover all areas tested in FCC exams plus "Self-Study Ability Test." \$9.95 postpaid. Moneyback Guarantee.

(COMMAND PRODUCTIONS) P.O. BOX 26348-P
RADIO ENGINEERING DIVISION SAN FRANCISCO, CALIF. 94126

SCORE high on F.C.C. Exams... Over 300 questions and answers. Covers 3rd, 2nd, 1st and even Radar. Third and Second Test, \$14.50; First Class Test, \$15.00. All tests, \$26.50. R.E.I., Inc., Box 806, Sarasota, Fla. 33577.

FCC License, electronics design, satellite communications, through correspondence. Free catalog. Genn Tech, 5540 Hollywood Blvd., Los Angeles, CA 90028.

UNIVERSITY DEGREES BY MAIL! Bachelors, Masters, Ph.D's. Free revealing details. Counseling, Box 1162-PE7, Tustin, California 92680.

SELF-STUDY CB RADIO REPAIR COURSE. THERE'S MONEY TO BE MADE REPAIRING CB RADIOS. This easy-to-learn course can prepare you for a career in electronics enabling you to earn as much as \$16.00 an hour in your spare time. For more information write: CB RADIO REPAIR COURSE, Dept. PE075, 531 N. Ann Arbor, Oklahoma City, Okla. 73127.

UNDERSTAND DIGITAL ELECTRONICS—Calculators, Microprocessors, Clocks. New programmed learning courses. Design of Digital Systems, 6 volumes, only \$14.95. Digital Computer Logic, \$9.95. Both \$19.95. Unconditional refund if dissatisfied. Cambridge Learning, Box 428, FDR Station, New York, N.Y. 10022.

F.C.C. FIRSTPHONE—4 Tests, formulas, aids. Guaranteed! \$10. Engineer, DWR 570, Mars, PA 16046.

REAL ESTATE

BIG... FREE... CATALOG! 256 pages! Over 2,600 top values in 40 states coast to coast! UNITED FARM AGENCY, 612-EP, West 47th St., Kansas City, Mo. 64112.

RUBBER STAMPS

RUBBER address stamps. Free catalog. 45 type styles. Jackson's, Box 443G, Franklin Park, Ill. 60131.

7400N TTL

SN7400N	21	SN74151N	27	SN74151N	1.25
SN7401N	18	SN74152N	27	SN74152N	1.25
SN7402N	21	SN74154N	41	SN74154N	1.25
SN7403N	21	SN74155A	25	SN74155N	1.21
SN7404N	21	SN74160N	22	SN74160N	1.30
SN7405N	24	SN74170N	45	SN74170N	1.30
SN7406N	45	SN74171N	29	SN74171N	1.75
SN7407N	45	SN74173N	45	SN74173N	1.45
SN7408N	25	SN74174N	45	SN74174N	1.65
SN7409N	25	SN74175N	80	SN74175N	1.65
SN7410N	20	SN74176N	47	SN74176N	1.65
SN7411N	30	SN74178N	50	SN74178N	1.70
SN7412N	42	SN74179A	42	SN74179A	5.00
SN7413N	85	SN74183N	1.15	SN74170N	3.00
SN7414N	70	SN74185N	1.12	SN74172N	1.80
SN7416N	43	SN74186N	45	SN74173N	1.70
SN7417N	43	SN74188N	3.50	SN74174N	1.95
SN7418N	25	SN74189N	3.99	SN74175N	1.90
SN7420N	21	SN74190N	89	SN74176N	90
SN7421N	38	SN74191N	1.20	SN74177N	90
SN7423N	37	SN7492N	87	SN74180N	1.05
SN7425N	43	SN7493N	82	SN74181N	3.55
SN7426N	31	SN7494N	91	SN74182N	95
SN7427N	31	SN7495N	91	SN74184N	2.20
SN7429N	42	SN7496N	91	SN74185N	2.20
SN7430N	26	SN74100N	1.50	SN74187N	6.00
SN7432N	31	SN74107N	49	SN74190N	1.50
SN7437N	47	SN74121N	55	SN74191N	1.50
SN7438N	40	SN74122N	49	SN74192N	1.50
SN7439A	25	SN74123N	1.05	SN74193N	1.40
SN7440N	21	SN74125N	60	SN74194N	1.45
SN7441N	1.10	SN74126N	81	SN74195N	1.00
SN7442N	1.08	SN74132N	3.00	SN74196N	1.25
SN7443N	1.05	SN74141N	1.15	SN74197N	1.00
SN7444N	1.10	SN74142N	6.50	SN74198N	2.25
SN7445N	1.10	SN74143N	7.00	SN74199N	2.25
SN7446N	1.15	SN74144N	7.00	SN74200N	7.00
SN7447N	89	SN74145N	1.15	SN74201N	2.50
SN7448N	99	SN74148N	2.50	SN74284N	6.00
SN7450N	26	SN74150N	1.10	SN74285N	6.00

20% Discount for 100 Combined 7400's

HIGH SPEED		LOW POWER		SCHOTTKY	
SN74H00N	33	SN74L00N	33	SN74S00N	60
SN74H01N	33	SN74L02N	33	SN74S03N	60
SN74H02N	33	SN74L03N	33	SN74S04N	65
SN74H03N	36	SN74L04N	33	SN74S05N	1.05
SN74H04N	33	SN74L10N	33	SN74S10N	65
SN74H10N	33	SN74L20N	33	SN74S15N	65
SN74H11N	33	SN74L30N	33	SN74S15N	60
SN74H20N	33	SN74L42N	1.50	SN74S20N	60
SN74H21N	33	SN74L73N	69	SN74S22N	60
SN74H22N	33	SN74L74N	69	SN74S24N	60
SN74H30N	33	SN74L75N	79	SN74S64N	60
SN74H40N	33	SN74L75N	1.15	SN74S65N	60
SN74H50N	33	SN74L86N	69	SN74S12N	1.25
SN74H51N	35	SN74L90N	1.60	SN74S15N	2.50

CMOS

CD4000	39	74C10N	.65
CD4001	39	74C20N	.65
CD4002	39	74C30N	.65
CD4006	3.75	74C42N	2.15
CD4007	.55	74C73N	1.50
CD4008	.69	74C74	1.15
CD4010	.69	74C80N	3.00
CD4011	39	74C85N	2.20
CD4012	39	74C107N	1.25
CD4013	1.00	74C151	2.90
CD4016	1.00	74C154	3.00
CD4017	2.65	74C157	2.15
CD4019	1.15	74C160	2.25
CD4020	1.50	74C161	3.25
CD4022	1.50	74C163	3.00
CD4023	39	74C164	3.25
CD4024	1.95	74C173	2.60
CD4025	39	74C183	2.75
CD4027	1.15	74C190	2.75
CD4028	2.65	74C207	1.50
CD4029	3.95	74C209	.75

LINEAR

LM100H	15.00	LM1310N	2.95
LM106H	2.50	LM135	1.65
LM171H	7.75	LM141N	1.75
LM1712H	7.00	LM145C	65
LM300H	8.00	LM1496N	95
LM301H	3/1.00	LM1556V	1.95
LM301CN	3/1.00	LM2111N	1.95
LM302H	7.5	LM2901N	65
LM304H	1.00	LM3055N	65
LM305H	95	LM3900N	55
LM307CN	35	LM3905N	60
LM308H	1.00	LM5566N	1.85
LM308CN	1.00	MC555V	1.00
LM309H	1.10	LM7545N	49
LM309CN	1.15	LM7545CN	39
LM310CN	1.25	LM7555V	75
LM311H	90	LM7555N	1.25
LM311N	90	NE5388	45
LM318CN	9.50	NE566N	1.95
LM319H	1.30	NE567H	1.25
LM319D	1.00	NE567V	1.25
LM320K	5.135	LM7030N	45
LM320K-5.2	1.35	LM7099H	29
LM320K-12	1.35	LM7099N	29
LM320K-15	1.35	LM710N	79
LM323K-5	14.00	LM711N	39
LM324N	1.80	LM723N	55
LM339N	1.70	LM723H	55
LM340K-5	1.95	LM733N	55
LM340K-12	1.95	LM739N	129
LM340K-15	1.95	LM740N	3/1.00
LM340K-20	1.95	LM741CN	3/1.00
LM340To-5	1.75	LM741-14N	39
LM340To-6	1.75	LM747H	79
LM340To-12	1.75	LM747N	79
LM340To-15	1.75	LM748N	79
LM340To-24	1.75	LM749N	39
LM350N	1.00	LM1303N	90
LM351CN	.65	LM1304N	1.19
LM370N	1.15	LM1305N	1.40
LM370H	1.15	LM1307N	.85

8000 SERIES

8091	59	8552	2.49
8092	59	8523	3.00
8095	1.39	8230	2.59
8121	89	8263	7.00
8123	1.19	8267	4.00
8130	2.19	8280	7.50
8200	2.59	8281	8.50
8210	3.49	8288	1.15
8214	1.69	8520	1.29
8216	1.69	8551	1.65

* JAMES Summer Specials *

TTL IC'S		DIODES - TRANSISTORS				
7400	Quad. NAND Gate	6/51.00	IN751A	5.1	400M	7/51.00
7447	8CD. Seven Seg. Dec.	89	IN6053	15	400M	6/51.00
7490	Decade Counter	59	IN4002	100Piv	1 AMP	15/51.00
74100	4 Bit Bistable Lath	1.25	IN4003	200Piv	1 AMP	15/51.00
74150	16 Line 1 Mult.	1.00	IN4004	400Piv	1 AMP	15/51.00
74154	4-16 Line Decoder	1.00	IN4148 (N914)		1 W	20/51.00
			IN4735A	6.2	1 W	5/51.00
			2N3055	NPN		.79
LINEAR IC'S		NEW KITS				
LM301AN	OP AMP	4/51.00				
LM307H	Super Op Amp	4/51.00				
LM311 H	Hi perf. V comp.	75				
LM311 H	Hi perf. V comp.	75				
LM555V	Timer	.69				
NE565T	Phase Lock Loop	1.25				
NE567T	Time Decoder	1.25				
NE567V	Time Decoder	1.75				
LM723H	Volt. Reg.	2/51.00				
LM723N	Volt. Reg.	2/51.00				
8038	Function Generator	3.95				

4' POWER SUPPLY CORDS . . .

Black59¢ ea.



8' POWER SUPPLY CORDS

Black or Gray \$1.45 ea.



MULTIPURPOSE KEYBOARDS

20 Keys - Touch Tone
No schematic needed, (pop off) key tops.
This unit may be cut apart for smaller units.

1 - 4 - 5
\$3.25 ea. \$2.95 ea.



NEW PROTO BOARD-100

Here's a low cost, big 10 IC capacity breadboard kit with all the quality of OT Sockets and the best of the Proto-Board series . . . complete down to the last nut, bolt and screw. Includes: 2 OT-35S Sockets, 1 OT-35B Bus Strip, 2 5 way binding posts, 4 rubber feet; screws, nuts, bolts, and easy assembly instructions.

\$19.95

COMPLETE KIT



DISPLAY LEDS

CA	Common Anode	CC	Common Cathode
MAN 1	Com. Anod.	270	\$1.95
MAN 2	Com. Cath.	125	95
MAN 3	Com. Cath.	197	1.95
MAN 4	Com. Cath.	197	1.95
MAN 7	Com. Anod.	30	1.50
DL 33	Com. Cath.	125	1.95
DL 747	Com. Anod.	255	2.50

IC SOLDERTAIL - LOW PROFILE (TIN) SOCKETS

	1.24	25.49	50-100	1.24	25.49	50-100	
8 pin	\$2.22	20	18	24 pin	.68	.62	56
14 pin	26	23	21	28 pin	.81	.73	
16 pin	29	26	24	36 pin	1.10	.99	90
18 pin	46	41	37	40 pin	1.25	1.13	93
22 pin	.65	59	53				

SOLDERTAIL STANDARD (TIN)

14 pin	\$3.20	28	26	28 pin	\$.99	.90	.81
16 pin	33	31	29	36 pin	1.33	1.26	1.15
18 pin	42	39	37	40 pin	1.59	1.45	1.30
24 pin	59	54	54				

SOLDERTAIL STANDARD (GOLD)

8 pin	\$3.20	27	24	24 pin	\$ 1.70	.63	57
14 pin	35	32	29	28 pin	1.10	1.00	90
16 pin	38	36	32	36 pin	1.55	1.40	1.26
18 pin	52	47	43	40 pin	1.75	1.59	1.45

WIRE WRAP SOCKETS (GOLD) LEVEL # 1

10 pin	\$4.45	41	37	24 pin	\$1.05	.95	85
14 pin	46	42	38	28 pin	1.40	1.25	110
16 pin	55	50	45	36 pin	1.59	1.45	130
18 pin	75	68	62	40 pin	1.75	1.55	140

50 PCS. RESISTOR ASSORTMENTS \$1.75 PER ASS'T.

ASS'T. 1	5 ea:	10 OHM	12 OHM	15 OHM	18 OHM	22 OHM	27 OHM	33 OHM	47 OHM	56 OHM	1/4 WATT 5% = 50 PCS.	
ASS'T. 2	5 ea:	68 OHM	82 OHM	100 OHM	120 OHM	150 OHM	180 OHM	220 OHM	270 OHM	330 OHM	500 OHM	1/4 WATT 5% = 50 PCS.
ASS'T. 3	5 ea:	470 OHM	560 OHM	680 OHM	820 OHM	1K						1/4 WATT 5% = 50 PCS.
ASS'T. 4	5 ea:	3.3K	3.9K	4.7K	5.6K	6.8K	8.2K	10K	12K	15K	18K	1/4 WATT 5% = 50 PCS.
ASS'T. 5	5 ea:	22K	27K	33K	39K	47K	56K	68K	82K	100K	120K	1/4 WATT 5% = 50 PCS.
ASS'T. 6	5 ea:	150K	180K	220K	270K	330K	390K	470K	560K	680K	820K	1/4 WATT 5% = 50 PCS.
ASS'T. 7	5 ea:	1M	1.2M	1.5M	1.8M	2.2M						1/4 WATT 5% = 50 PCS.

Satisfaction Guaranteed. \$5.00 Min. Order. U.S. Funds.
California Residents - Add 6% Sales Tax
Write for FREE 1975 Catalog - Data Sheets .25¢ each

JAMES

P.O. BOX 822, BELMONT, CA. 94002
PHONE ORDERS - (415) 592-8097

IC'S EXAR KITS

FUNCTION GENERATOR KIT

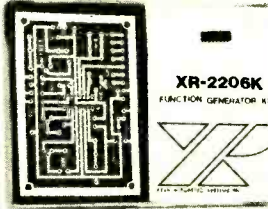

XR-2206K
FUNCTION GENERATOR KIT

features sine, triangle and square wave; THD 0.5% typ.; AM/FM capability

XR-2206KA

Includes monolithic function generator IC, PC board, and assembly instruction manual. **\$19.95**

XR-2206KB

Same as XR-2206KA above and includes external components for PC board. **\$29.95**

TIMERS

XR-555CP	Monolithic Timer	\$ 1.10
XR-320P	Precision Timer	1.55
XR-556CP	Dual-555 Timer	1.85
XR-2556CP	Dual Timing Circuit	3.20
XR-240CP	Programmable Counter/Timer	4.80

PHASE LOCKED LOOPS

XR-210	FSK Demodulator	5.20
XR-215	High Frequency PLL	6.60
XR-567CP	Tone Decoder (mini DIP)	1.95
XR-567CT	Tone Decoder (TD-5)	1.70

STEREO DECODERS

XR-1310P	PLL Stereo Decoder	3.20
XR-1310EP	PLL Stereo Decoder	3.20
XR-1800P	PLL Stereo Decoder	3.20

WAVEFORM GENERATORS

XR-205	Waveform Generator	8.40
XR-2206CP	Monolithic Function Generator	5.50
XR-2207CP	Voltage Controlled Oscillator	

BUSINESS OPPORTUNITIES

I MADE \$40,000.00 Year by Mailorder! Helped others make money! Free Proof. Torrey, Box 318-NN, Ypsilanti, Michigan 48197.

FREE CATALOGS. Repair air conditioning, refrigeration, Tools, supplies, full instructions. Doolin, 2016 Canton, Dallas, Texas 75201

NEW—FIRST OF ITS KIND SERVICE DEALERSHIP. Tired of punching a time clock? Sick of making money for someone else? Would you like an opportunity to work for yourself? Do you have a basic understanding of electricity or electronics? If you do, we will train you to repair micro-wave ovens. We specialize in the service and repair of micro-wave ovens. This is our only business. We are looking for people who want to invest in their own service business under our trade name. You will be authorized to do warranty work and service all brands. We furnish accounts and supply all parts. Part time to start. Protected Area. Investment required. Write: Micro-Ovens, Inc., 3383 E. Layton Avenue, Cudahy, WI 53110.

FREE BOOK "2042 unique proven enterprises." Work home! Hayling-B, Carlsbad, CA 92008.

P-2

wanted Citizens Band
DEALER-DISTRIBUTORS
Send this ad with Letterhead to:
[PAL] ELECTRONICS CO.
2962 W. WELDON - PHOENIX, ARIZ. 85017

MAILORDER MILLIONAIRE helps beginners make \$500 weekly. Free report reveals secret plan! Executive (1K7), 333 North Michigan, Chicago 60601.

PIANO TUNING LEARNED QUICKLY AT HOME! Tremendous field! Musical knowledge unnecessary. GI approved. Information free. Empire School, Box 450327, Miami 33145.

\$200.00 DAILY In Your Mailbox! Your opportunity to do what mail-order experts do. Free details. Associates, Box 136-J, Holland, Michigan 49423.

ELECTRONIC Assembly Business. Big profits. Start home, spare time. Investment, knowledge, experience unnecessary. Free illustrated literature. Barta, Box 248CT, Walnut Creek, Calif. 94597.

INVENTIONS WANTED

CASH-ROYALTIES for patented, unpatented inventions. Global Marketing Service, 139-P Lake Merced Hill South, San Francisco, California 94132.

INVENTORS: Protect your ideas! Free "Recommended Procedure". Washington Inventors Service, 422T Washington Building, Washington, D.C. 20005.

FREE PAMPHLET: "Tips on Safeguarding Your Invention." Write: United States Inventors Service Company, 708-T Carry Building, Washington, D.C. 20005.

Inventors Wanted

RECOGNITION, FINANCIAL REWARD, OR CREDIT for "inventing it first" may be yours! We'll develop your idea, introduce it to industry, publicize it, negotiate for Cash Sale or Royalty Licensing.

Send for **FREE INVENTORS KIT** Includes a Vital Information on Protection, Development, Marketing of your Invention • Important "Invention Record Form" • Directory of 500 Corporations Seeking New Products

RAYMOND LEE ORGANIZATION
230 Park Ave. No., New York, NY 10017
Please rush **FREE INVENTORS KIT A-139**

Name _____
Address _____
City _____ State _____ Zip _____

INVENTIONS IDEAS WANTED

Manufacturers Need New Products. Your invention, new product or idea developed for cash / royalty sales by Professional Organization.

"No Idea Is Too Small"*

Free Booklet: "How to Safeguard, Develop and Market Your Ideas to Industry"

LAWRENCE PESKA ASSOCIATES
500 Fifth Ave., Dept. MM, N.Y.C. 10036
Phone (212) 354-9696

A trademark of Lawrence Peska Associates, Inc.

MUSICAL INSTRUMENTS

UP TO 60% DISCOUNT. Name brand instruments catalog. Freeport Music, 455N Route 110, Melville, N.Y. 11746.

WHOLESALE! Professional Guitars, PA Systems, Ateck Speakers, 240W RMS Amplifiers. Free Catalog, Carvin, Escondido, Calif. 92028.

TREASURE FINDERS

FREE FACT-FILLED CATALOG! World's largest selection! Metal detectors starting at \$79.50. Two year guarantee! Three factories, U.S.-Canada. 1,200 dealers - Service Centers nationwide. Finest instruments at any price! Budget Terms. Dealer inquiries invited. Write: White's Electronics, Inc. Dept. PD5U, 1011 Pleasant Valley Road, Sweet Home, Oregon 97386.

TREASURE FINDER locates buried gold, silver, coins, treasures. 6 powerful models. Instant financing available. Write or call for free catalog. Phone (713) 682-2728 day or night. Dealer inquiries invited. Relco. Dept. AA20, Box 10839, Houston, Texas 77018.

REMAIL SERVICE

FAST CONFIDENTIAL, your mail received, forwarded from mini computer capital of the world. B.J., Box 441, Maynard, MA 01754.

HYPNOTISM

SLEEP learning. Hypnotic sound. 92% effective. Details free. ASR Foundation, Box 23429EG, Fort Lauderdale, Florida 33307.

FREE Hypnotism. Self-Hypnosis. Sleep Learning Catalog! Drawer H400, Ruidoso, New Mexico 88345.

AMAZING self-hypnosis record releases fantastic mental power. Instant results! Free trial. Write: Forum (AA7), 333 North Michigan, Chicago 60601.

INTEL 8008 8 BIT MICRO PROCESSING CHIP (with data book) \$49.50
2102-2-1024 BIT RAM \$6.95
1702A UV PROM \$24.00
MM5203 UV PROM \$24.00

MINIATURE TRIM POTS
5K, 10K, 25K, 100K.
\$.75 EA. 3/\$2.00

MULTI-TURN TRIM POTS
Similar to Bourns 3010 style 3/16" x 1/8" x 1 1/4" 50, 100, 2000, 5000, 10,000 ohms
\$1.50

LIGHT ACTIVATED SCR'S
TO-18 200V 1A
\$1.75

PRINTED CIRCUIT BOARD
4 1/2" x 6 1/2" single sided epoxy board, 1/16" thick, unetched
\$.50 ea. 5/\$2.20

MC14435 & MC1405L
A two piece 3 1/2 digit A/D converter system for panel meters and DVM'S with schematics
\$39.95

2N3820 P FET \$.60
TIS 73 N FET \$.50
2N4891 UJT \$.50
ER900 TRIGGER DIODES 4/\$1.00
2N6028 PROG. UJT \$.75

VERIPAX PC BOARD
This board is a 1/16" single sided paper epoxy board, 4 1/2" x 6 1/2" DRILLED and ETCHED which will hold up to 21 single 14 pin IC's or 8, 16 or LSII DIP IC's with buses for power supply connector.
\$5.25

RED/GREEN BIPOLAR LED \$1.30
MT-2 PHOTO TRANS \$.60
GREEN OR YELLOW LED \$.30
RED GAP OSL-3 LED \$.20
14 PIN DIP SOCKETS \$.40
16 PIN DIP SOCKETS \$.50
MOLEX PINS 100/\$1.00...1000/\$8.00

10 WATT ZENERS \$.75 EA
3.9, 4.7 DR 18V
1 WATT ZENERS 5.6, 10, 12, 15, 18, OR 22V \$.40 EA.

Silicon Power Rectifiers

PRV	1A	3A	12A	50A
100	.06	.14	.30	.80
200	.07	.20	.35	1.15
400	.09	.25	.50	1.40
600	.11	.30	.70	1.80
800	.15	.35	.90	2.20
1000	.20	.45	1.10	2.75

REGULATED MODULAR POWER SUPPLIES

+15VDC AT 100ma 115VAC INPUT \$24.95
5VDC AT 1A, 115VAC INPUT \$19.95
12V 6A \$24.95
IN 4148 (IN914) 1A/\$1.00

1103 1024 bit RAM \$4.75
NEC 6003 2048 bit RAM \$9.50
1101 256 bit RAM \$1.75
8223 PROM \$4.75
7489 RAM \$2.75

Terms: FOB Cambridge, Mass. Send Check or Money Order. Include Postage. Minimum Order \$5.00. COD'S \$20.00.

TRANSISTOR SPECIALS

2N6517 NPN Si TO-92 \$4/\$1.00
2N5086 PNP Si TO-92 \$4/\$1.00
2N4898 PNP TO-66 \$.60
2N404 PNP GE TO-5 \$4/\$1.00
2N3919 NPN Si TO-3 RF \$1.50
MPSA13 NPN Si TO-92 \$3/\$1.00
2N3767 NPN Si TO-66 \$.70
2N2222 NPN Si TO-18 \$5/\$1.00
2N3055 NPN Si TO-3 \$1.00
2N3904 NPN Si TO-92 \$4/\$1.00
2N3906 PNP Si TO-92 \$4/\$1.00
2N5296 NPN Si TO-220 \$.50
2N6109 PNP Si TO-220 \$.55
2N3866 NPN Si TO-5 Si RF \$.75
MJ2252 NPN Si TO-66 \$.90
2N3638 NPN Si TO-5 \$5/\$1.00
2N2218A NPN Si TO-5 \$4/\$1.00

CAPACITORS

35v at .47 UF TANT 5/\$1.00
35v at 6.8 UF TANT 3/\$1.00
20v at 150 UF TANT \$.40
6V 30 UF TANT \$5/\$1.00
12V 200 UF ELECT \$.30
200V 4.7 UF ELECT \$.30

CD 201 100x100 IMAGE SENSOR CHARGED COUPLE DEVICES USED IN SOLID STATE CAMERAS. WITH APPLICATIONS \$198.00

FPA 711-7 LEVEL Diode Array Optical Tape Readers \$5.95

Conductive Elastometer low profile calculator keyboard. A 2 3/4" x 3 1/4" x 1/2" flex key. 195K-6 keyboard having 0-9, *, +, -, x, =, /, K+C buttons with off, on switch. \$6.00

TTL IC SERIES

7400	30	7476	45
7401	17	7480	60
7401	17	7483	99
7402	17	7485	1.10
7403	17	7486	48
7404	21	7490	60
7405	20	7491	1.00
7406	35	7492	.75
7407	37	7493	.60
7408	18	7495	.80
7410	17	7496	.85
7411	27	8267	1.95
7412	45	74107	.40
7413	72	74121	.50
7416	37	74123	.90
7417	37	74125	.60
7420	17	74126	.64
7425	36	74150	.99
7426	27	74151	.85
7427	31	74153	1.05
7430	17	74154	1.48
7432	27	74155	1.05
7437	36	74157	1.18
7438	35	74163	1.49
7440	17	74164	1.70
7441	95	74165	1.78
7442	90	74173	1.55
7445	1.05	74175	1.60
7446	1.10	74177	1.50
7447	1.00	74181	3.20
7448	1.00	74192	1.40
7472	33	74193	1.29
7473	38	74195	.80
7474	35	74196	1.90
7475	60	75324	1.75
		75491	1.10

8038C IC VOLT CONT. OSC. \$4.40
5311, 5314 or 5316 CLOCK CHIPS \$5.00 ea.
CT7001 Calendar Alarm CLOCK CHIP \$6.75

C/MOS (DIODE CLAMPED)

74C02-\$.50 CD4019-\$.58
74C10-\$.50 CD4022-\$ 1.25
74C157-\$2.00 CD4023-\$.30
74C165-\$3.50 CD4024-\$1.00
CD4001-\$.30 CD4025-\$.30
CD4002-\$.30 CD4026-\$.67
CD4006-\$1.50 CD4027-\$1.20
CD4007-\$.30 CD4028-\$1.09
CD4009-\$.67 CD4029-\$1.42
CD4010-\$.67 CD4030-\$.30
CD4011-\$.30 CD4035-\$1.42
CD4012-\$.30 CD4042-\$.84
CD4013-\$.53 CD4046-\$2.55
CD4015-\$1.17 CD4047-\$3.10
CD4016-\$.63 CD4050-\$1.05
CD4017-\$1.34 CD4055-\$2.70

DO-33-A 3 DIG. LED ARRAY READOUT \$1.95
MAN-1, Red LED READ-OUT \$2.50
MAN-3 READOUT \$1.75
MAN-4 READOUT \$2.00
SLA 3 \$4.50

Full Wave Bridges

PRV	2A	6A	25A
200	.95	1.25	\$3.00
400	1.15	1.50	\$4.00
600	1.35	1.75	\$5.00

CHARACTER GEN
2516-64x6x8 \$9.95
CD 110 LINEAR 256 X1 BIT SELF SCANNING CHARGED COUPLED DEVISE, WITH OATA \$150.00

SANKEN AUDIO POWER AMPS

Si 1010 G 10 WATTS \$ 6.40
Si 1020 G 20 WATTS \$13.95
Si 1050 G 50 WATTS \$24.95

LINEAR CIRCUITS

LM 309K 5V 1A REGULATOR \$1.50
723-40 +40V REGULATOR \$.58
301748 HI Per Op Amp \$.30
LM 320 -5 or -15V REGULATOR \$1.75
LM 376 -V to 37V POS REG \$.58
741A or 741C OP AMP \$.31
709C OPER AMP \$.25
340T-5, 12, 15, 18, 24V POS. REG TO-220 \$1.75
101 OPER AMP, HI PERFORM \$.75
LM 308 OPER AMP, LOW POWER \$1.05
747-DUAL 741 \$.75
555 DUAL TIMER \$1.30
537-PRECISION OP AMP \$2.60
LM 3900-QUAD OP AMP \$2.40
LM 324-QUAD 741 \$.99
560-PHASE LOCK LOOP \$2.50
561-PHASE LOCK LOOP \$2.50
565-PHASE LOCK LOOP \$2.50
566 FUNCTION GEN \$2.50
567-TONE DECODER \$2.85
703-RF-IF AMP \$.41
LM 370-AGC SQUELCH AMP \$1.15
555-2 us -2 HR. TIMER \$.88
555 QUAD TIMER \$3.50
FCO 810 OPTO ISOLATOR \$1.35
1458 OPER AMP \$.95
1458 OP AMP \$.65
LM 380-2W AUDIO AMP \$1.39
LM 377-2W STEREO AUDIO AMP \$2.50
LM 381-STEREO PREAMP \$1.69
LM 382-DUAL AUDIO PREAMP \$1.69
LM 311-HI PER. COMPARATOR \$.95
LM 319-DUAL HI SPEED COMP \$1.15
LM 339-QUAD COMPARATOR \$1.45

TRIACS

PRV	1A	10A	25A	1.5A	6A	35A
100	.40	.70	1.30	.40	.50	1.20
200	.70	1.10	1.75	.60	.70	1.60
400	1.10	1.60	2.60	1.00	1.20	2.20
600	1.70	2.30	3.00			3.00

Send 20c for our catalog featuring Transistors and Rectifiers; 145 Hampshire St., Cambridge, Mass.

SOLID STATE SALES
P.O. BOX 74A
SOMERVILLE, MASS. 02143 TEL. (617) 547-4005

WE SHIP OVER 95% OF OUR ORDERS THE DAY WE RECEIVE THEM

JULY 1975

ADVERTISERS INDEX

READER SERVICE NO.	ADVERTISER	PAGE NUMBER
1	A.D.R. Audio Video	68
2	A.P. Products Incorporated	79
3	Adva Electronics	94
48	Allison Automotive Company	51
	Alpha Electronics	1
6	Altaj Electronics	87
7	Ancona Corp	95
8	B&K Precision Products of Dynascan	26
9	Babylon Electronics	88
	Bell & Howell Schools	18, 19, 20, 21
	CREI Capitol Radio Engineering Institute	52, 53, 54, 55
10	Circuit Design, Inc.	67
11	Cleveland Institute of Electronics, Inc.	70, 71, 72, 73
12	Clifford's Hi-Fi Wholesalers	84
14	Continental Specialties Corp	7
15	Crown	14
16	Delta Electronics Co	90
17	Delta Products, Inc.	15
18	Digi-Key Corporation	99
19	EICO	59
20	Edmund Scientific Co	100
5	Heath Company	5
21	Illinois Audio	84
22	International Electronics Unlimited	86
23	James	97
33	Johnson Co., E.F.	2
24	Lafayette Radio Electronics	77
25	McIntosh Laboratory, Inc.	69
26	MITS	25
27	Maxell Corporation	17
50	Mini-Micro Mart	94
	NRI Schools	8, 9, 10, 11
	National Technical Schools	80, 81, 82, 83
28	New-Tone Electronics	90
30	Pace Communications	69
31	Pace Communications	85
32	Phase Linear	63
34	Pickering and Company, Inc.	THIRD COVER
35	Poly Paks	93
36	Processor Technology Co	75
37	RCA Electronic Instruments	67
38	RCA Solid State	13
39	Radio Shack	SECOND COVER
40	SAE, Inc.	79
49	Sansui Electronics Corp	23
41	Solid State Sales	98
42	Solid State Systems, Inc.	89
43	Southwest Technical Products	6
44	Stereo Discounters	76
45	Teletronics Company of America	76
46	Tracy Design Corp.	90
47	Tri-Star Corporation	68
4	United Audio Products	FOURTH COVER

CLASSIFIED ADVERTISING 86, 88, 94, 96, 98, 99

JULY 1975

PRO SPORTS FILMS

OUT THEY GO! Brand new, lab fresh Super 8 B&W 200' NFL Films. Why wait? Order your choice of: Football Follies; Super Bowl 1969; Super Bowl 1972; or Super Bowl 1970 or '71 (Standard 8 only) at only \$4.95 each PPD while our stock lasts. ORDER TODAY! You save \$4.00 on every print you buy. Or choose others from Columbia or Castle catalogs (30 cents each). It's the chance of a lifetime! PRO SPORTS FILMS, Elect. Dept-7, Box 24-500, Speedway, Indiana 46224.

RECORDS

OLDIES: 45rpm. Free Catalog, Corny's Record Shop, Box 166TJ, Mason, Ohio 45040.

FREE RECORD COLLECTION Reviewers wanted. Anyone qualifies. We ship you new records to review. You pay postage. Records are free. Applicants accepted "first come" basis. Write: Entertainment Associates Rating Systems, Inc., Research PE, 6162 Washington Circle, Milwaukee, Wisconsin 53213.

EMPLOYMENT OPPORTUNITIES

ELECTRONICS/AVIONICS EMPLOYMENT OPPORTUNITIES. Report on jobs now open. Details FREE. Aviation Employment Information Service, Box 240E, Northport, New York 11768.

OVERSEAS EMPLOYMENT-TECHNICIANS Five years minimum experience required in the petrochemical, chemical, refining, or oil/gas industries for the following: (1) Marine Mechanical Repairman—Troubleshoot and modify equipment instruments aboard marine craft (2) Specialist Electrical Technician—valid FCC Radiotelephone License. 2nd class or better. Maintenance of various electronic equipment. (3) Electronic/Pneumatic Instrumentation Technician—package includes fantastic compensation, yearly paid vacations and family living. Rush resume for confidential review to Dan A. Redwine, Scientific Placement, Inc., Employment Service, 2700 S. Post Oak Road, Houston, Texas 77027. We will be in touch shortly if there is further interest.

TRANSMITTER SECTION HEAD required for Christian radio station. Applicant needs five years experience in performing and supervising high-powered shortwave broadcast operations. Experience in supervising and working with multinational staff desirable. Two-three year contract. Excellent fringe benefits. Written application to: Personnel Office, Radio Voice of the Gospel, P.O. Box 654, Addis Ababa, Ethiopia.

BOOKS AND MAGAZINES

FREE catalog aviation/electronic/space books. Aero Publishers, 329PE Aviation Road, Fallbrook, California 92028.

FREE book prophet Elijah coming before Christ. Wonderful bible evidence. Megiddo Mission, Dept. 64, 481 Thurston Rd., Rochester, N.Y. 14619.

POPULAR ELECTRONICS INDEXES. Detailed and complete subject indexes now available to both 1972 and 1973 magazines. Hundreds of subject references to help you quickly find that special project, article, or product test. 1972 and 1973 editions \$1.00 each. INDEX, box 2228, Falls Church, Va. 22042.

LOW & MEDIUM FREQUENCY RADIO SCRAPBOOK. Unique new handbook dedicated to the experimenter. Receivers, converters, coil winding, antennas, loops, the nonlicensed communication bands and the FCC rules. Over 100 pages chock-full of diagrams and data. Nostalgia for the oldtimers and an Introduction to radio communications for the newcomer. \$4.75. Cornell, 225 Baltimore Avenue, Point Pleasant Beach, N.J. 08742.

TOOLS

UNUSUAL Directory of companies offering thousands hand and power tools. \$2.00. Cash Industries, Box 4804PE2, Pittsburgh, Pennsylvania 15206.

MAGNETS

MAGNETS. All types. Specials-20 disc, or 10 bar or 2 stick, or 8 assorted magnets, \$1.00. Magnets, Box 192-H, Randallstown, Maryland 21133.

DO-IT-YOURSELF

TELEPHONES, ALL TYPES. Equipment, Supplies, Keyed, Regular, Decorator. Catalog 50 cents. Box 1654J, Costa Mesa, California 92626.

MISCELLANEOUS

WINEMAKERS: Free illustrated catalog yeasts, equipment. Semplex, Box 12276P, Minneapolis, Minn. 55412.

Quality Electronic Components

SPECIAL SAVINGS DISCOUNT ON LINEAR AND DIGITAL INTEGRATED CIRCUITS

Discount 4% from the total of your I.C. order if it exceeds \$25.00 based on single lot prices. 7% for \$50.00 or more, 10% for \$100.00 or more. Additional large quantity discounts offered.

TTL & CMOS INTEGRATED CIRCUITS											
7400N	25c	7445N	81c	7495N	90c	74193N	\$1.17	4027AE	67c		
7401N	25c	7446N	81c	7496N	81c	74198N	\$2.75	4028AE	\$1.09		
7402N	25c	7447N	81c	74107N	32c	74199N	\$2.75	4029AE	\$1.42		
7403N	25c	7448N	90c	74121N	38c	4003AE	30c	4030AE	50c		
7404N	25c	7450N	23c	74122N	45c	4001AE	30c	4033AE	\$1.67		
7405N	25c	7451N	23c	74123N	1.08	4002AE	30c	4034AE	\$3.34		
7406N	25c	7453N	23c	74141N	99c	4006AE	\$1.50	4035AE	\$1.42		
7407N	25c	7454N	23c	74150N	\$1.44	4007AE	30c	4036AE	\$1.67		
7408N	25c	7459N	25c	74151N	90c	4008AE	\$1.17	4041AE	92c		
7409N	25c	7460N	23c	74153N	81c	4009AE	67c	4042AE	84c		
7410N	25c	7470N	36c	74154N	\$1.44	4010AE	67c	4043AE	67c		
7411N	25c	7472N	36c	74155N	81c	4011AE	30c	4044AE	67c		
7412N	25c	7473N	32c	74156N	81c	4012AE	30c	4045AE	\$2.51		
7416N	25c	7474N	32c	74157N	72c	4013AE	53c	4046AE	58c		
7417N	25c	7475N	54c	74158N	\$1.53	4014AE	\$1.67	4050AE	58c		
7418N	25c	7476N	36c	74160N	\$1.26	4015AE	\$1.17	4051AE	\$1.50		
7420N	25c	7480N	72c	74161N	\$1.17	4016AE	63c	4052AE	\$1.50		
7421N	25c	7482N	72c	74162N	\$1.26	4017AE	34	4053AE	\$1.50		
7423N	72c	7483N	72c	74163N	\$1.26	4018AE	\$1.67	4054AE	\$1.67		
7426N	25c	7485N	\$1.40	74164N	\$1.35	4019AE	58c	4066AE	\$1.00		
7430N	25c	7486N	32c	74165N	\$2.45	4020AE	\$1.67	4071AE	30c		
7437N	25c	7489N	\$4.47	74166N	\$2.00	4021AE	\$1.50	4072AE	30c		
7438N	25c	7490N	50c	74175N	\$1.00	4022AE	\$1.25	4073AE	30c		
7440N	25c	7491N	81c	74176N	91c	4023AE	30c	4075AE	30c		
7441N	\$1.17	7492N	50c	74181N	\$2.25	4024AE	\$1.00	4081AE	30c		
7442N	65c	7493N	50c	74182N	90c	4025AE	30c	4082AE	30c		
		7494N	81c	74192N	\$1.26	4026AE	\$1.67				

LINEAR INTEGRATED CIRCUITS											
555V	MINIDIP	TIMER	82.5c	558V	MINIDIP	DUAL	AMP	75.0c			
565A	DIP	PLL	\$3.38	567V	MINIDIP	DECODER		\$3.38			
741V	MINIDIP	OP	AMP	50.0c	723A	DIP	VOLTAGE	REG.	82.5c		
748V	MINIDIP	OP	AMP	42.0c	747A	DIP	DUAL	AMP	97.5c		
L129	5 VOLT	REG.	\$1.80	LM3900	DIP	QUAD	AMP.	60.0c			
L131	15 VOLT	REG.	\$1.80	L130	12 VOLT	REG.	\$1.80				
				LM309K	5 VOLT	REG.	\$1.75				

MINIATURE ALUMINUM ELECTROLYTIC CAPACITORS

--- AXIAL LEAD TYPE ---											
-40°C to +85°C Tolerance: ±10 Plus 30% (ignore than 0.7 µF) ±16 plus 75% (0.7 µF or less)											
1 µF/50V	14c	12c	11c	33 µF/10V	15c	12c	11c	33 µF/10V	35c	25c	24c
2.2 µF/50V	14c	12c	11c	33 µF/25V	17c	13c	12c	33 µF/25V	44c	35c	32c
3.3 µF/50V	14c	12c	11c	47 µF/10V	17c	14c	13c	47 µF/10V	37c	30c	27c
4.7 µF/50V	14c	12c	11c	47 µF/25V	19c	14c	13c	47 µF/25V	49c	39c	35c
10 µF/10V	14c	12c	11c	100 µF/10V	19c	15c	14c	100 µF/10V	49c	39c	35c
10 µF/25V	14c	12c	11c	100 µF/25V	24c	18c	17c	100 µF/25V	59c	45c	55c
22 µF/10V	14c	12c	11c	220 µF/10V	34c	18c	17c	220 µF/10V	75c	60c	55c
22 µF/25V	15c	13c	12c	220 µF/25V	35c	24c	24c				

1 AMP SILICON RECTIFIERS

1N4001	50 PIV	12/51	100/56	1000/548	1N4005	600 PIV	8/51	100/59	1000/570
					1N4007	1000 PIV	6/51	100/511	1000/588

SILICON SIGNAL & SWITCHING DIODE

1N4148	(1N4148 equiv.)	12/51	100/57	1M/550	5M/520
--------	-----------------	-------	--------	--------	--------

MOLEX SOLDERCON I.C. TERMINALS

100/51	500/54	200/54	1000/58	2000/58	5000/538	20	50,000/5275
--------	--------	--------	---------	---------	----------	----	-------------

LED 7 SEGMENT DISPLAYS

DATALIT-704	\$1.00	DATALIT-707	\$1.50
-------------	--------	-------------	--------

MACHINE SCREWS, NUTS & LOCKWASHERS

2-56 1/4 Screw	90c/c	2-56 1/2 Screw	98c/c	6 AMP SPST. N.D. CONTACTS	
4-40 1/4 Screw	98c/c	4-40 1/2 Screw	76c/c	Call Voltage	1 10
6-32 1/4 Screw	92c/c	6-32 1/2 Screw	86c/c	5V	\$2.00 \$1.50
8-32 3/8 Screw	\$1.05/c	8-32 5/8 Screw	\$1.35/c	5V	\$2.00 \$1.50
2-56 Hex Nut	\$1.45/c	2 Lock Washer	45c/c	12V	\$2.00 \$1.50
4-40 Hex Nut	\$1.45/c	4 Lock Washer	45c/c	24V	\$2.00 \$1.50
6-32 Hex Nut	\$1.45/c	6 Lock Washer	45c/c		
8-32 Hex Nut	\$1.50/c	8 Lock Washer	45c/c		

DISC CAPACITORS I.C. SOCKETS

100 pf/500V	7c	5.5c	4.5c	3.6c	8 pin Solder	27c	21c
220 pf/500V	7c	5.5c	4.5c	3.6c	14 pin Solder	29c	23c
470 pf/500V	7c	5.5c	4.5c	3.6c	16 pin Solder	32c	25c
.001/500V	7c	5.5c	4.5c	3.6c	18 pin Solder	34c	26c
.0022/500V	7c	5.5c	4.5c	3.6c	24 pin Solder	54c	42c
.0047/500V	7c	5.5c	4.5c	3.6c			1 10
.01/500V	10c	7.5c	6.3c	5.0c	8 pin W.W.	38c	30c
.01/25V	5c	3.5c	3.0c	2.4c	14 pin W.W.	50c	39c
.022/25V	6c	4.0c	3.5c	2.7c	16 pin W.W.	54c	42c
.047/25V	9c	6.0c	5.3c	4.2c	18 pin W.W.	88c	68c
.1/25V	12c	9.0c	7.5c	6.0c	24 pin W.W.	99c	80c

1/2 & 1/4 WATT CARBON COMP. RESISTORS

5 each of the 85 standard 10% values (2.2-22M) 1/2 W Resistors (425 pcs.) Sorted by value \$12/5et 2.4 or \$11/5et 5.9 or \$10/5et.

5 each of the 70 standard 10% values (10-5.6M) 1/4 W Resistors (350 pcs.) Sorted by value \$12/5et 2.4 or \$11/5et 5.9 or \$10/5et.

SILICON TRANSISTORS

1N918	TO-106	21c	18.5c	16.5c	2N3645	TO-105	20c	17.5c	16.0c
1N938	TO-106	21c	18.5c	16.5c	2N3646	TO-106	22c	19.0c	17.5c
1N922	TO-106	21c	18.5c	16.5c	2N3904	TO-92	22c	19.0c	17.5c
1N2369A	TO-106	21c	18.5c	16.5c	2N3906	TO-92	22c	19.0c	17.5c
1N2907	TO-106	21c	18.5c	16.5c	2N4124	TO-92	22c	19.0c	17.5c
2N9712	TO-98	18c	16.0c	14.5c	2N4126	TO-92	22c	19.0c	17.5c
2N3911A	TO-98	22c	19.0c	17.5c	2N4401	TO-92	22c	19.0c	17.5c
2N3392	TO-98	22c	19.0c	17.5c	2N4403	TO-92	22c	19.0c	17.5c
2N3393	TO-98	22c	19.0c	17.5c	2N5087	TO-92	22c	19.0c	17.5c
2N3394	TO-98	22c	19.0c	17.5c	2N5089	TO-92	22c	19.0c	17.5c
2N3343	TO-106	20c	17.5c	16.0c	2N5129	TO-106	19c	17.0c</	

LIVE IN THE WORLD OF TOMORROW... TODAY!

And our FREE 180 PAGE CATALOG is packed with exciting and unusual values in electronic, hobby and science items — plus 4,500 finds for fun, study or profit... for every member of the family.

A BETTER LIFE STARTS HERE

TOTAL KIRLIAN PHOTOGRAPHY SET

Explore "aura" photography w/ superb new self-contained Kirlian Electrophotography Research Unit. Terrific value — introduced at \$99.95 (\$140 in Sept.)! Has everything but vinyl photo changing bag. Ideal for color or b/w 35mm. sheet or Polaroid film for photos up to 5x7" *all without camera or lens*. Variable voltage 12v to 32kv. Ultimate safety design—fully encased in plastic; patented electronics. Instrs.

No. 72,104AV... (3x5 7/8x7 7/8") \$99.95 Ppd.
 No. 42,240AV... (CHANGING BAG) \$ 6.50 Ppd.

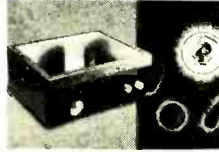

ELECTRONIC DIGITAL STOPWATCH: \$69.95

A price breakthrough! New pocket size 4 oz. timer acc. to ±2% of last digit (1/100 sec. increments). Compares with others twice the price! Instant error-free readouts to 9999.99 sec. (over 2 3/4 hr). Starts, stops re-starts (accumulates). Mechanical pushbutton & electrical remote on/off's w/any 3.5-150v AC/DC source. Plug-in jack. Incls. 9v batt. Solid state.

No. 1943 AV (2 1/4x4 1/4x7/8") \$69.95 Ppd.
 DELUXE 2 EVENT STOPWATCH (±0.01% OF LAST DIGIT)
 No. 1653 AV (PRICE UP IN SEPT.) \$120.00 Ppd.



FUEL MISER RECLAIMS HEAT

Save your 40% wasted heat to warm a basement, garage or rec room at no extra cost! Instead of going "up the chimney" it goes where you want it. Remove part of furnace exhaust pipe, slip Heat Exchanger in. At 125' fan automat. forces clean air through unit which heats to over 200°F. can be ducted to 20 ft. from unit. 110v AC. Inst.

No. 19,194AV (5" DIA.) Shpg. 17 lb. \$99.00 FOB
 No. 19,195AV (6" DIA.) Shpg. 17 lb. \$99.00 FOB
 No. 19,198AV (7" DIA.) Shpg. 17 lb. \$99.00 FOB



LOW COST 7X INFRA-RED VIEWER

For infra-red crime detection surveillance, security system alignment, I.R. detection, laser checking, nite wildlife study, any work req. I.R. detection & conv. to visible spectrum. Self cont. scope w/everything incl. I.R. light source. 6v or 12v power. 6032 I.R. converter tube. f/4.5 objective lens. adjust. triplet eyepiece. Focuses from 10' to infinity.

No. 1659AV (11x14 1/4x3") \$275.00 Ppd.
 WITHOUT LIGHT SOURCE
 No. 1648AV \$225.00 Ppd.



WHEN YOU COME TO PHILADELPHIA BE SURE TO SEE
FREE BICENTENNIAL LIGHT SHOW
 IN BARRINGTON, N.J. ONLY 10 MINUTES AWAY AT
EDMUND FACTORY STORE

3-CHANNEL COLOR ORGAN KIT

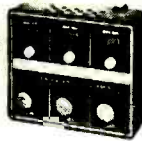

Easy to build low-cost kit needs no technical knowledge. Completed unit has 3 bands of audio frequencies to modulate 3 independent strings of colored lamps (i.e. "lows"-reds, "middles"-greens, "highs"-blues. Just connect hi-fi, radio, power amp etc. & plug ea. lamp string into own channel (max. 300w ea.). Kit features 3 neon indicators, color intensity controls, controlled individ SCR circuits; isolation transformer; custom plastic housing; instr.

Stock No. 41,831AV \$18.95 Ppd

AM RADIO FITS IN/ON YOUR EAR!

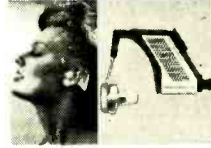

Wear it inconspicuously *everywhere*. listen as you work (lawn, yard, office), watch (game, beach) or wait. Instant music, news, sports. No gimmick-6/10 oz. technological wonder w/integrated circuit. 11 transistors, patented ferrite antenna/tuner/volume dial. Works best outdoors. Uses hearing aid batt. (incl.)-up to 100 hrs. playing. New batt. to slip in avail. at drug stores (about 50¢). No lengthy wires, bulky cases, or power-packed!

Stock No. 42,275AV \$14.95 Ppd.

KNOW YOUR ALPHA FROM THETA!



For greater relaxation, concentration, listen to your Alpha-Theta brainwaves. Ultra-sensitive electrode headband slips on/off in seconds—eliminates need for messy creams, etc. Atch'd to amplifier, filters brainwaves, signals beep for ea. Alpha or Theta wave passed. Monitoring button stimulates Alpha sound; audio & visual (L.E.D.) feedback. Reliable, easy-to-use unit comparable to costlier models. Completely safe. Comprehensive instruction booklet.

No. 1635AV (8 3/4" x 4"; 24 oz.) \$134.50 Ppd.
 DELUXE "ON" TIME MONITOR—Measures and records % LOW COST "STARTER" UNIT
 No. 1652AV (15 x 10 x 6") \$349.50 Ppd.
 No. 71809AV \$55.00 Ppd.
 DO-IT-YOURSELF KIT No. 61,069AV \$34.95 Ppd.

QUALITY DETECTOR UNDER \$40



New Edmund-developed, fully transistorized BFO unit capable of locating quarter at 18" — powerful 6-trans. oscillator-amplifier circuit. Easily compares to others priced 50% higher! Aluminum pole and housing—not plastic! 6" waterproof search coil (Faraday shielded to elim. outside interference), long 50-hr. battery

(9V) life; powerful 2" speaker; 1-knob on-off tune control. Perfect balance; lightweight (2 lbs.). Great buy!

Stock No. 80,222AV \$39.95 Ppd.
 DELUXE UNIT W/EAR PHONES, METER
 No. 80,134AV (11" coil) \$169.00 Ppd.

1 1/4" ASTRONOMICAL TELESCOPE



See moon craters, rings of Saturn, double stars. New equatorial mount. f/10, 1/4 wave mirror (Pyrex). Gives theoretical limit of resolution. Rack & pinion focusing. Aluminum tube, 6X finder, 1" F.L. 45X Kellner achromatic eyepiece and Barlow lens to double & triple power up to 135X. Free Star Chart plus 2 Books.

Stock No. 85,105AV (Shipping Wt. 42 lbs.) \$149.50 FOB
 1 1/4" WITH CLOCK DRIVE No. 85,107AV \$189.50 FOB
 6" REFLECTOR TELESCOPE (48X to 360X) No. 85,187AV \$249.50 FOB
 6" WITH CLOCK DRIVE No. 85,086AV \$285.00 FOB
 3" DELUXE REFLECTOR (30X to 90X) No. 80,162AV \$ 79.95 Ppd.
 STANDARD 3" REFLECTOR No. 85,240AV \$ 49.95 Ppd.



MAIL COUPON FOR GIANT FREE CATALOG!

180 PAGES • MORE THAN 4500 UNUSUAL BARGAINS

Completely new 1975 edition. New items, categories, illustrations. Dozens of electrical and electromagnetic parts, accessories. Enormous selection of Astronomical Telescopes. Unique lighting and ecological items. Microscopes. Binoculars, Magnifiers, Magnets, Lenses, Prisms. Hard-to-get surplus bargains. Ingenious scientific tools. 1000's of components.

EDMUND SCIENTIFIC CO.
 300 Edscorp Building, Barrington, N.J. 08007
 Please rush Free Giant Catalog "AV"

Name _____
 Address _____
 City _____ State _____ Zip _____

COMPLETE & MAIL WITH CHECK OR M.O.

EDMUND SCIENTIFIC CO. 300 Edscorp Building, Barrington, N.J. 08007

How Many	Stock No.	Description	Price Each	Total
<input type="checkbox"/>		PLEASE SEND GIANT FREE CATALOG "AV"		
<input type="checkbox"/>		Charge my BankAmericard		
<input type="checkbox"/>		Charge my Master Charge *		
Interbank No. _____				
My Card No. Is _____				
Add Handling Chg. \$1.00, Orders Under \$5.00, 50¢, Orders Over \$5.00				
I enclose <input type="checkbox"/> check <input type="checkbox"/> money order for TOTAL \$ _____				
Signature _____				
Card Expiration Date _____				
30-DAY MONEY-BACK GUARANTEE. Name _____				
You must be satisfied or return any purchase in 30 days for full refund. *\$15.00 minimum City _____ State _____ Zip _____				



The source of perfection in sound... tracks at one gram (or less) in stereo and discrete.

Frankly, perfection doesn't come easily.

Pickering's engineers pursued the idea of a totally new departure in cartridge design with all the zeal of true crusaders.

They had a reason . . . there was a demand for a pickup to play both stereo and discrete (as well as SQ and QS) with total and absolute precision at one gram.

That they succeeded is a remarkable achievement because this cartridge successfully tracks all types of records at forces even lighter than one gram. It is a real first to do it this accurately.

The Pickering XUV/4500Q possesses excellent performance characteristics that provide outstanding frequency response and separation beyond 50 kHz. These improvements make possible the most faithful reproduction of the 30 kHz FM-modulated material on discrete records. It is noteworthy that Pickering's exclusive, new design development, which provides superior 4-channel discrete performance, also greatly enhances the reproduction of stereo records.

The XUV/4500Q features Pickering's patented Quadrahedral® stylus assembly. The Quadrahedral stylus assembly incorporates those features that produce extended *traceAbility*™ for 4-channel as well as stereo. This means that it possesses not only superior performance in low frequency tracking, but also in high frequency tracing ability. When combined with the exclusive Quadrahedron™ stylus tip, a brand new shape, it can truly be called: "the Source of perfection in Sound", whether the playback requirement is stereo, SQ, QS or discrete 4-channel.

The specifications are so exciting that we hope you will write to Pickering and Company, Inc., Dept. PE 101 Sunnyside Blvd., Plainview, New York 11803 for further information.

 **PICKERING**
"for those who can hear the difference"

Introducing the 601. Dual's first medium-priced single-play turntable (fully automatic, of course.)

With the 601, Dual introduces its second fully automatic single-play turntable. Like the first, the electronic direct-drive 701, it shares several features with Dual's familiar multiple-play turntables, and offers a number of innovations as well.

The 601 drive system consists of an 8-pole synchronous motor, developed especially for this new model, and a precision-ground belt running directly from the drive shaft to a flywheel beneath the 12-inch dynamically-balanced platter. The motor's absolute speed constancy, its exceptional smoothness, and the isolation of the platter from the motor combine to reduce wow, flutter and rumble to an insignificant level.

The 601's 8 $\frac{3}{4}$ " tonearm is suspended in the same low-friction double gimbal as the more costly 701. Operation of the tonearm is optionally fully-automatic, manual, or continuous repeat.

Variable pitch-control is provided for both speeds, and an illuminated strobe is built into the chassis. The anti-skating system has separate calibrations for conical, elliptical and CD-4 styli.

The high level of performance and quality for which Dual turntables have been known for years is incorporated in the 601. Thus, music lovers who desire a single-play turntable in the medium-price range, with Dual precision and performance, now have it.



Dual

United Audio Products, 120 So. Columbus Ave., Mt. Vernon, N.Y. 10553
Exclusive U.S. Distribution Agency for Dual

CIRCLE NO. 4 ON READER SERVICE CARD

www.americanradiohistory.com