

BUILD AM RECEIVER USING 2 FET'S

POPULAR ELECTRONICS

MAY
1967

50
CENTS

EXTRA CONSTRUCTION
PROJECTS ISSUE

- Miniature Reverberation Outfit
- Transistor/Diode Tester
- Solid-State AF Meter
- Electronic Stethoscope
- Converting CB to Ham
- Branley Coherer

SPECIAL REPORT

- The FCC vs. The CB'er

PLUS

- Information Central, Foreign
Language Short-Wave Broadcasts,
Operation Assist, etc.



E0470 302572DAR3457HL015
L DARKNELL JR
3457 HOOVER ST
4
REDWOOD CITY CA 94063

You get more for your money from NRI—

America's oldest and largest Electronic, Radio-Television home-study school

Compare. You'll find—as have so many thousands of others—NRI training can't be beat. From the delivery of your first lessons in the remarkable, new Achievement Kit, to "bite size," easily-read texts and carefully designed training equipment . . . NRI gives you more value.

Shown below is a dramatic, pictorial example of training materials in *just one* NRI Course. Everything you see below is included in low-cost NRI training. Other major NRI courses are equally complete. Text for text, kit for kit, dollar for dollar—your best home-study buy is NRI.

**Available under
NEW GI BILL**
If you served since
January 31, 1955, or
are in the service,
check GI line in
postage-free card.

**ACHIEVEMENT
through
ELECTRONICS** nri

GET A FASTER START WITH NRI'S NEW EXCLUSIVE ACHIEVEMENT KIT

The day your enrollment is received your Achievement Kit will be on its way to you. It contains everything you need to make an easy, fast start in the Electronics training of your choice. This attractive, new starter kit is an outstanding, logical way to introduce you to home-study the way NRI teaches it . . . backed by a dedicated staff and the personal attention you should expect of a home-study school. It is your first special training aid . . . designed to make your adventure into Electronics absorbing, meaningful. Your Achievement Kit contains your first group of lesson texts; rich vinyl desk folder to hold study material; the industry's most complete Radio-TV Electronics Dictionary; valuable reference texts; lesson answer sheets; envelopes; pencils, pen; engineer's ruler—even postage. No other school has anything like it.

LEARNING BECOMES AN ABSORBING ADVENTURE WITH NRI TRAINING KITS

What better way to learn than by doing? NRI pioneered and perfected the "home lab" technique of learning at home in your spare time. You get your hands on actual parts and use them to build, experiment, explore, discover. Electronics come alive! NRI invites comparison with training equipment offered by any other school. Begin NOW this exciting, practical program. It's the best way to understand the skills of the finest technicians—and make their techniques your own. Whatever your reason for wanting to increase your knowledge of Electronics . . . whatever your field of interest . . . whatever your education . . . there's an NRI instruction plan for you, at low tuition rates to fit your budget. Get all the facts about NRI training plans; NRI training equipment. Fill in and mail the attached postage-free card today.

NATIONAL RADIO INSTITUTE, Wash-
ington, D.C. 20016.

OVER 50 YEARS OF LEADERSHIP



IN ELECTRONICS TRAINING

This is an example of material included in just one NRI course. Other courses are equally complete. But NRI training is more than kits and "bite-size" texts. It's also personal services which have made NRI a 50 year leader in home-study. Mail postage-free card today.

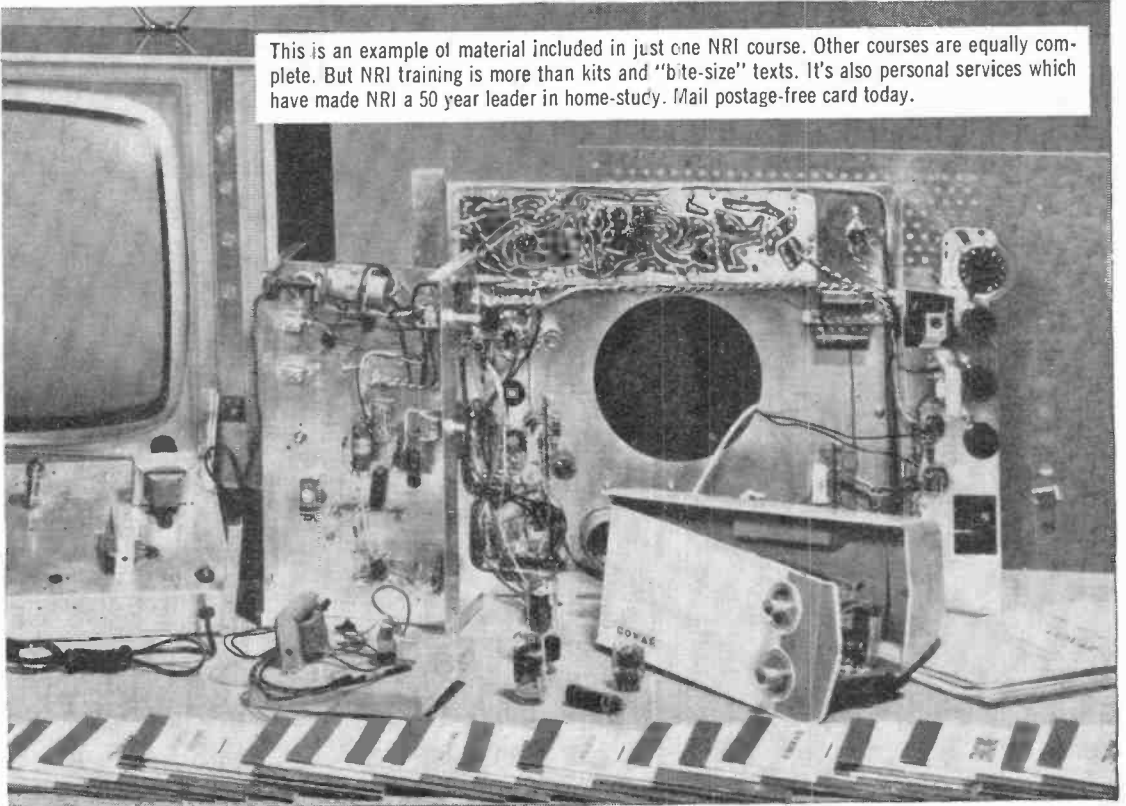

POPULAR ELECTRONICS

WORLD'S LARGEST-SELLING ELECTRONICS MAGAZINE

VOLUME 26

MAY, 1967

NUMBER 5

SPECIAL CONSTRUCTION FEATURE

- JACK ALTHOUSE 27 INTRODUCING . . . THE FET SET
A two-transistor receiver that will astound you

FEATURE ARTICLES

- ALEX. F. BURR 31 THE "PENNANT RACE" SPECIAL

- ERROL J. QUEEN 32 POPULAR ELECTRONICS "CALLITHUMP":
A DUBIOUS TALE

- JERRY KRUCZEK A DAY IN A 1985 SCHOOL

- SAL STELLA 33 THE "ELECTRONIC STETHOSCOPE"
Minute sounds and mechanical vibrations come in loud and clear

- ART TRAUFFER 40 STACKED-ANTENNA AM RADIO

- DANIEL MEYER 41 THE "MINI-VERB"
Half-pint reverberation unit for car or home

- HENRY B. DAVIS 47 THE COHERER
A detector that gave radio its start

- 50 MAKE YOUR OWN COHERER

- TUNING AND USING YOUR COHERER

- WALTER F. LANGE, W1YDS 51 AMATEUR RADIO FOR CB'ERS: PART I
How to convert CB transceivers to 10 meters

- T. V. CRANMER, K4MMB 59 LIQUID LEVEL INDICATOR FOR THE BLIND

- HANK BENNETT, W2PNA 61 SHORT-WAVE LISTENING
Broadcasting station news around the world

- 66 IT'S SPRING TUNE-UP TIME

- CHARLES D. RAKES 67 BREAKDOWN REVERSE VOLTAGE TRANSISTOR AND DIODE TESTER
Nondestructive "one-shot" scope technique

- WALT MILLER 72 THE ELECTRONICS COUNTERMAN

- WALT HENRY 73 ELECTRONIC FREQUENCY METER
It measures the voltages and tells you the frequency

- 78 FCC PROPOSES CB "TYPE ACCEPTANCE"
Manufacturers catch blame for CB conditions

- ROBERT P. BALIN 80 ELECTRONICS I.Q. QUIZ

- CHARLES J. SCHAUERS, W6QLV 81 INFORMATION CENTRAL

- BILL LEGGE 84 FOREIGN-LANGUAGE BROADCASTS TO NORTH AMERICA

- LOU GARNER 85 SOLID STATE

- ROBERT LEGGE 92 ENGLISH-LANGUAGE BROADCASTS TO NORTH AMERICA

- HERB S. BRIER, W9EGQ 93 AMATEUR RADIO
The fascination of amateur radio

- MATT P. SPINELLO, KHC2060 95 ON THE CITIZENS BAND
Club paper swap shop

DEPARTMENTS

- 8 LETTERS FROM OUR READERS
15 READER SERVICE PAGE
16 ELECTRONICS LIBRARY
22 NEW PRODUCTS
98 NEW LITERATURE
99 TIPS & TECHNIQUES
101 OPERATION ASSIST

POPULAR ELECTRONICS is indexed
in the Readers' Guide
to Periodical Literature

This month's cover photo by
Conrad Studios, Inc.

Copyright © 1967 by ZIFF-DAVIS PUBLISHING COMPANY. All rights reserved.

POPULAR ELECTRONICS, May 1967, Volume 26, Number 5. Published monthly at 307 North Michigan Avenue, Chicago, Illinois 60601. One year subscription rate for U.S., U.S. Possessions and Canada, \$5.00; all other countries, \$6.00. Second class postage paid at Chicago, Illinois and at additional mailing offices. Authorized as second class mail by the Post Office Department, Ottawa, Canada and for payment of postage in cash. Subscription Service: Portland Place, Boulder, Colorado 80302.

If You Service Citizens Radio Transceivers...

you should have

AN INTERNATIONAL

C-12B

FREQUENCY METER

Four Instruments In One

The C-12B is more than a frequency standard—it measures power output, measures AM modulation, and is a signal generator... all self contained in one convenient unit.

check these features!

- **Frequency Measurement** — Range 26.965 mc to 27.255 mc. Frequency stability $\pm .0025\%$ 32°F to 125°F; $\pm .0015\%$ 50°F to 100°F.
- **Power Measurement** — 0 to 5 watts, accuracy $\pm \frac{1}{4}$ watt.
- **Counter Circuit** — Frequency range 0 to 3 kc. Residual error 100 CPS @ zero beat.
- **AM Modulation Measurement** — Range 0 to 100%. Accuracy 3% @ 400 CPS @ 80% modulation.
- **Signal Generator** — Frequency range 26.965 mc to 27.255 mc. Low output 1 microvolt through special pick-off box furnished with meter. High output 100 microvolts through output jack.

- **Panel Controls** — Channel selector, 24 positions • "Hi-Lo" frequency adjust • RF level control • Modulation set • Power • Meter calibration adjust • Function selector, 7 positions • Modulation • RF • Deviation • Calibration • Battery Test "A" • Battery Test "B" • Battery Test "C".
- **Battery Power Required** — 1½ vdc @ 60 ma, 67½ vdc @ 5 ma, 9 vdc.

The C-12B is capable of holding 24 crystals and comes with 23 crystals installed. Everything you need including connecting cable, PK box, dummy load, and batteries.

Cat. No. 620-101.....\$300.00

Manufacturers of precision electronic products for home, industry and aerospace needs.

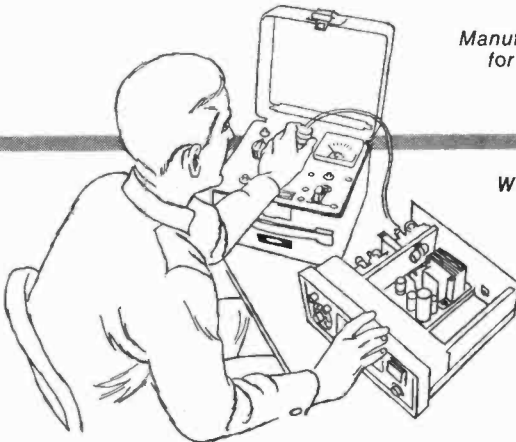
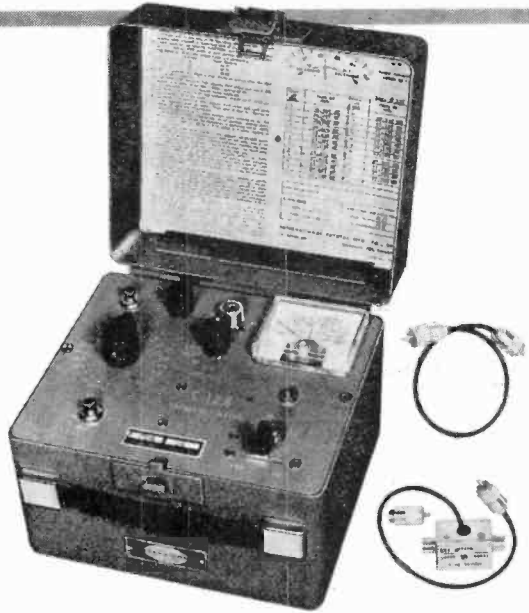

WRITE FOR COMPLETE CATALOG



CRYSTAL MFG. CO., INC.
18 NO. LEE OKLA. CITY, OKLA. 73102

CIRCLE NO. 13 ON READER SERVICE PAGE

When THIS Pioneer Speaks
...it's time to listen!

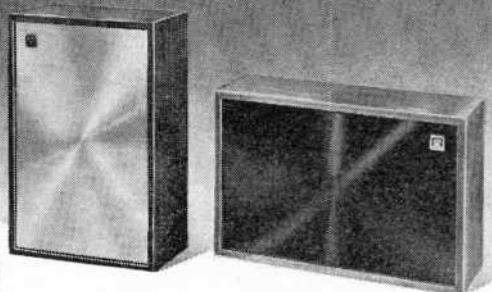

Model CS-24 PIONEER "Little Gem"
Full-Fidelity Compact
Slimline Speaker System

...an incredible value at \$27⁵⁰ ea.

Listen . . . to the outstanding beauty, clarity and definition of this *slimline* Pioneer CS-24 speaker system. It's the ideal system for high fidelity vocal reproduction and total musical enjoyment. The CS-24 has been the "HIT" of Hi-Fi shows wherever shown.

A remarkable engineering achievement in a system of this kind, the CS-24 is a dual cone 8" speaker system. Decorator styled in jewelry polished silver or black metal grille and framed in superbly finished matched wood grain cabinet. Whether wall or shelf mounted, Pioneer Model CS-24 enhances the appearance of any office, living room, den or kitchen.

Only the world's largest loudspeaker manufacturer can bring you such tonal pleasures at such an unbelievably low price of \$27.50 each, and guarantees it for 3 years, too. Size: 10 1/2" H. x 16 1/2" W. x 4 3/4" D.

**SPECIAL OFFER
TO POPULAR ELECTRONICS READERS!**

If not available at your nearest dealer you can order direct, and we will credit our nearest franchised dealer accordingly. Just complete coupon below and mail with your check to Pioneer. No COD's please.

— FILL OUT & MAIL TODAY —



PIONEER ELECTRONICS U.S.A. CORP.
140 Smith St., Farmingdale, N. Y. 11735
(516) 694-7720

Send me _____ Model CS-24 Speaker Systems @ 27.50 each
FOB Farmingdale, N. Y. I want the following finish

Silver Black. Check enclosed for \$ _____
(Add state/local taxes where applicable).

Name _____

Street _____

City/State _____ Zip Code _____

CIRCLE NO. 24 ON READER SERVICE PAGE

POPULAR ELECTRONICS

PHILLIP T. HEFFERNAN
Publisher

OLIVER P. FERRELL
Editor

ROBERT CORNELL, WA2HDQ
Managing Editor

JOHN D. DRUMMOND
Technical Editor

WILLIAM GALBREATH
Art Director

MARGARET MAGNA
Associate Editor

ALEXANDER W. BURAWA
Assistant Editor

ANDRE DUZANT
Technical Illustrator

NINA KALAWSKY
PATTI MORGAN
Editorial Assistants

H. BENNETT, W2PNA
H. S. BRIER, W9EGQ
L. E. GARNER, JR.

CHARLES J. SCHAUERS, W6QLV
M. P. SPINELLO, KHC2060
Contributing Editors

LAWRENCE SPORN
Advertising Sales Manager

ARDYS C. MORAN
Advertising Service Manager

ZIFF-DAVIS PUBLISHING COMPANY

Editorial and Executive Offices
One Park Avenue, New York, New York 10016
212 679-7200

Eastern Advertising Manager, RICHARD J. HALPERN

Midwestern Office
307 North Michigan Avenue, Chicago, Illinois 60601
312 726-0892

Midwestern Advertising Manager, JAMES WEAKLEY

Western Office
9025 Wilshire Boulevard, Beverly Hills, California 90211
213 Crestview 4-0265; BRadshaw 2-1161
Western Advertising Manager, BUD DEAN

Japan: James Yagi
Ishikawa Mansion
#4, Sakuragaoka
Shibuya-ku, Tokyo
462-2911-3

Circulation Office
Portland Place
Boulder, Colorado 80302

William B. Ziff, Chairman of the Board (1946-1953)

William Ziff, President

W. Bradford Briggs, Executive Vice President

Hershel B. Sarbin, Senior Vice President

Philip Sine, Financial Vice President

Walter S. Mills, Jr., Vice President, Circulation

Stanley R. Greenfield, Vice President, Marketing

Phillip T. Heffernan, Vice President, Electronics Division

Frank Pomerantz, Vice President, Creative Services

Arthur W. Butzow, Vice President, Production

Edward D. Muhlfeld, Vice President, Aviation Division

Irwin Robinson, Vice President, Travel Division

Ziff-Davis also publishes Airline Management and Marketing, Boating, Business & Commercial Aviation, Car and Driver, Cycle, Electronics, World, Flying, HiFi/Stereo Review, Modern Bride, Popular Aviation, Popular Photography, Skiing, Skiing Area News, and Skiing Trade News. (Travel Weekly is published by Robinson Publications, Inc., a subsidiary of Ziff-Davis Publishing Company.)

All subscription correspondence should be addressed to POPULAR ELECTRONICS, Circulation Department, Portland Place, Boulder, Colorado 80502. Please allow at least six weeks for change of address. Include your old address, as well as new-enclosing if possible an address label from a recent issue.

EDITORIAL CONTRIBUTIONS must be accompanied by return postage and will be handled with reasonable care; however, publisher assumes no responsibility for return or safety of art work, photographs or manuscripts.



Member Audit Bureau
of Circulations

POPULAR ELECTRONICS

50,000 Men Who Filled Out DeVRY TECH COUPONS

During The Past 36 Years,
Earned Diplomas As Qualified
Electronics Technicians

How about you? If 50,000 men found a DeVry Coupon to be a start toward a new, wonderful world — a world with money-in-the-pocket, job-progress, and a real future — How about you? For many of those men were once like you: looking for a good field to get into, or an escape from a get-nowhere, low-income job. Some of them had no previous technical experience or advanced education; others didn't realize they had a talent for electronics! They were astonished, that after completing a few of the interesting experiments and assignments, how simple it all seemed and how interesting. (Some tell us they hated to leave their desks to go to bed!) For DeVry Tech teaches by showing; you learn by doing. Maybe you can come to one of our 2 modernly-equipped resident schools, maybe you'll find it convenient to keep your present job and prepare at home. Thousands of our graduates did one or the other; all had the ambition to go through with it. How about you? Mail the coupon for details.

ACCREDITED MEMBER OF NATIONAL HOME STUDY COUNCIL

DeVRY INSTITUTE OF TECHNOLOGY • CHICAGO • CANADA

DeVRY INSTITUTE OF TECHNOLOGY

4141 Belmont Ave., Chicago, Ill. 60641, Dept. PE-5-X

Please give me your two free booklets, "Pocket Guide to Real Earnings" and "Electronics in Space Travel"; also include details on how to prepare for a career in Electronics. I am interested in the following opportunity fields (check one or more):

- | | |
|--|---|
| <input type="checkbox"/> Space & Missile Electronics | <input type="checkbox"/> Communications |
| <input type="checkbox"/> Television & Radio | <input type="checkbox"/> Computers |
| <input type="checkbox"/> Microwaves | <input type="checkbox"/> Industrial Electronics |
| <input type="checkbox"/> Automation Electronics | <input type="checkbox"/> Broadcasting |
| <input type="checkbox"/> Radar | <input type="checkbox"/> Electronic Control |

NAME _____ AGE _____

ADDRESS _____ APT. _____

CITY _____ ZONE _____ STATE _____

Check here if you are under 16 years of age.

HOME STUDY AND RESIDENT SCHOOL TRAINING

2096 AVAILABLE IN CANADA

5,000 FIRMS HAVE EMPLOYED DeVRY GRADUATES

Nearly every industry using electronics in many applications, employs DeVry trained men.

2,200 RESIDENT STUDENTS

Men 18-45, come to our Chicago or Toronto training laboratories, day-time or after work, to prepare for a job in electronics.

EMPLOYMENT SERVICE

Many graduates who started by clipping our coupon are now on the jobs we helped them get; many consult us regularly on technical problems. They are DeVry men! Clip that coupon and join them.

SCOTT

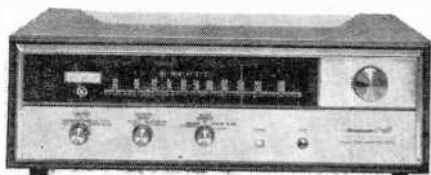

SCOTT'S NEW ONE-AFTERNOON TUNER KIT DELIVERS AMAZING FET PERFORMANCE

Now you can get factory-wired performance from a kit that takes only one afternoon to build! Scott's new LT-112B is the only kit with Field Effect Transistor circuitry*, enabling you to enjoy more stations more clearly. Interstation Muting Control effects complete quiet between FM stations . . . oscilloscope output allows laboratory-precise correction for multipath distortion.

"Scott's LT-112 . . . is one of the finest FM stereo tuners we have tested and it is easily the best kit-built tuner we have checked. . . . Because of its simple construction and trouble-free nature, it is a logical choice for anyone who wants the finest in FM reception at a most remarkable price." HiFi/Stereo Review.

LT-112B specifications: Usable sensitivity, 1.8 μ V; Cross modulation, -90 dB; Stereo separation, 40 dB; Capture ratio, 2.5 dB; Price, \$189.95.

*Patents pending

For complete information on the Scott LT-112B, send for your free copy of Scott's 16-page full-color illustrated Guide to Custom Stereo.

Scott . . . where innovation is a tradition



Prices slightly higher west of Rockies. Subject to change without notice.

CIRCLE NO. 29 ON READER SERVICE PAGE

LETTERS

FROM OUR READERS

Address correspondence for this department to:
Letters Editor, POPULAR ELECTRONICS
One Park Avenue, New York, N. Y. 10016

FOREIGN AID

I am very thankful to you for publishing my letter (November, 1966) regarding the difficulty in obtaining parts for projects here in India. Experimenters located all over the U.S.A. have written to me, offering me a variety of components. The writers included mechanical engineers, doctors, and students. I was really moved by this response and have deep feelings of satisfaction about the way



all of these Americans reacted so promptly to help someone in need. I am sending my correspondents Indian novelties and curios as gifts.

K. B. TENDULKAR
Bombay, India

PROPAGANDA: TWO VIEWPOINTS

In two years I have QSL'd almost 50 countries, and only Cuba and Red China have continued to send anything more than program schedules (without my asking to have propaganda discontinued). But from the information sent from these two countries, one feels like a cell mate to Fidel and Mao. I asked Havana to discontinue mailing but two months later, I received a listener-survey questionnaire; either they disregarded my plea, or U.S. customs haven't sent the note on yet. One of my friends has a simple solution—he sends anything besides the QSL received from a communist nation straight to the FBI office.

Prague discontinues all mailings if you don't write once a year (heard on their Listener's Mailbag Show). *Deutsche Welle* sends "Hallo Friends" and other publications to all listeners, but does ask in questionnaires if the listener wants them continued. *R. Nederland* sends a program schedule to all who write for QSL's or request a schedule (in several languages—I get Spanish and English); they will send almost anything but a windmill on request.

DOUGLAS B. MEYER, WPE2OUS
New Rochelle, N.Y.

CIRCLE NO. 7 ON READER SERVICE PAGE →

*A new dimension
in solid-state C.B.*

COURIER CLASSIC

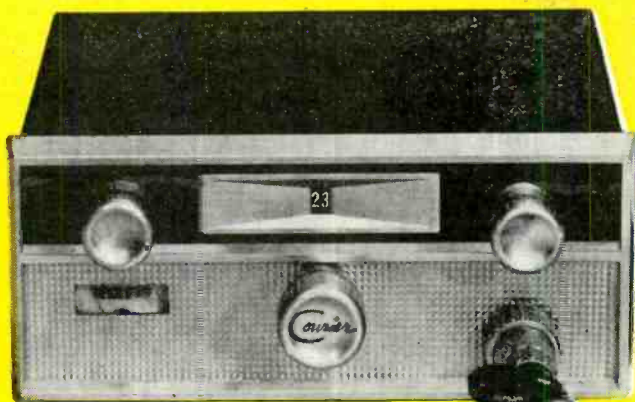

You are looking at the incomparable 23-channel Courier Classic—two years in development. Designed and engineered for total reliability, with years-ahead styling that sets a new standard of comparison. So advanced in performance, it required the creation of several new components by America's leading component manufacturers. With illuminated S meter. Illuminated channel selector. PA system. Auxiliary speaker jack. Single-knob tuning. Modulation indicator. DC cord. Exclusive Courier "Safety Circuit" to protect against mismatched antenna, incorrect polarity, and overload. The first transistor rig designed to help pierce "skip." Every known feature that could be built into a CB rig, in a compact 6½" W x 8½" D x 2½" H. Plus the industry's biggest guarantee—10 full years!

Just **\$189**
Complete with crystals
for all 23 channels.

 **COURIER COMMUNICATIONS, INC.**
A Subsidiary of
eci. electronics communications inc.
55 Hamilton Avenue, White Plains, New York

Yes! Tell me all about the new Courier Classic.

Name

Address

City County

State Zip

NOW: PACE 2-WAY RADIO IN YOUR \$ 69⁹⁵ CAR



USE THE NEW PACE "AUTOMATE" ALL SOLID STATE 5-WATT TRANSMITTER to call for help when you're in trouble • Receive messages over your AM car radio . . . and get assistance in a hurry • Communicate up to 10 miles even on a weak battery • Just flip on the transmitter switch, tune your car radio to 1505, pick up the microphone, and make a call • Takes no more current than an electric clock • 12 channels available for business or personal use • Write for complete information and the name of your nearest PACE dealer.

((P)) PACE

COMMUNICATIONS CORP.

24049 Frampton Ave., Harbor City, Calif. 90710

Export Div.: 64-14 Woodside Ave., Woodside, N.Y.

Also available in Canada

CIRCLE NO. 23 ON READER SERVICE PAGE

LETTERS *(Continued from page 8)*

Those SWL's who don't want any propaganda are missing half the fun. Whenever I write to a station, I ask them to send me some material about the station, country, or any other miscellaneous literature they wish. I have received all sorts of interesting information: from program schedules to post-cards, sports magazines to antenna construction pamphlets, and some propaganda—even from U. S. stations.

Whenever I "show off" my QSL's to people, I also show them my accumulated pile of literature; and they are sometimes more interested in the literature, especially the propaganda, than my QSL's! This propaganda also makes for very interesting discussions or reports in a history class. I don't believe any of this flow of foreign materials will jeopardize my future military service because I have had only one of my many packages opened—and that was because the original envelope fell apart!

Although I received quite a bit of propaganda from *Radio Havana*, Cuba, after asking for it, I now get only a program schedule about every five months. I have never received any propaganda from Moscow or Kiev in the U.S.S.R., or from Albania, and very little from W. Germany, Czechoslovakia, Hungary, Rumania, and Bulgaria. (I have received sports magazines from Czechoslovakia, and tourist information from Rumania and Bulgaria.) Communist China does send a lot of propaganda, however.

BOB HUBER, WPE3GUN
Wilmington, Del.

ANTI ANTI-SKATE

After reading your article on "The War on Skating" (September, 1966), I did some experimenting. When a record is played, the tone arm travels from the outer edge of the disc toward the center of the disc. If the tone arm is set on a grooveless disc, the same thing happens, but the tone arm travels far too rapidly. When an anti-skating device is

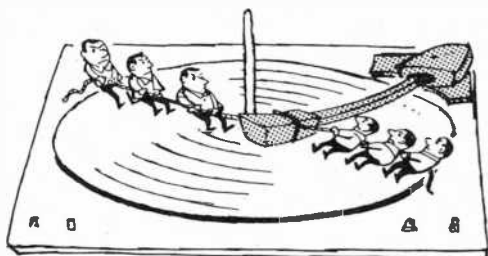

installed, the tone arm is reduced to a dead weight—it no longer moves over the record by itself. The stylus in the record groove is subjected to an opposite force. Side groove pressure has not been eliminated; rather, it has been transferred from the inner groove wall to the outer groove wall. In my opinion, the solution to the problem is not to eliminate

(Continued on page 14)

New Heathkit® AR-15 Solid-State Stereo Receiver

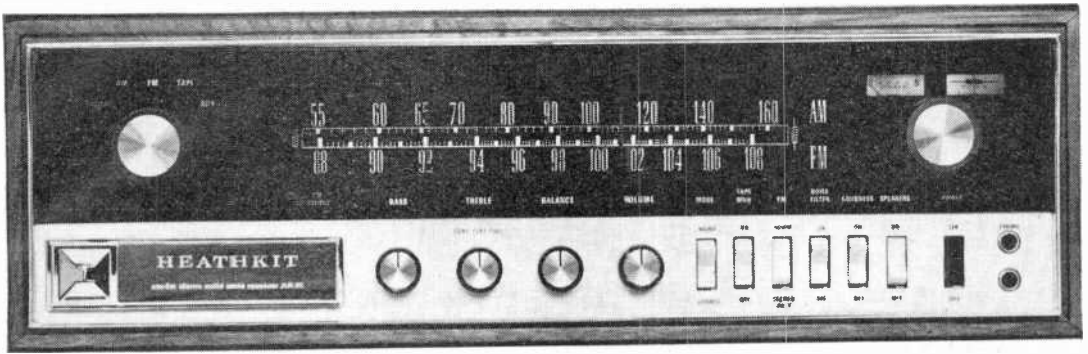

150 Watts . . . AM-FM Stereo . . . \$329.95†

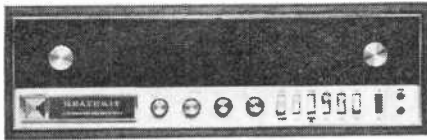

"Black Magic" Panel Lighting . . . A touch of the power switch and presto! . . . The black magic panel lights up with a slide-rule dial for easy tuning, and instant identification of all controls.

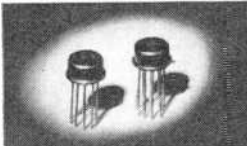

Integrated Circuits . . . two are used in the IF amplifier for hard limiting excellent temperature stability, increased reliability. Capture ratio is 1.8 db. Each IC is the size of a tiny transistor, yet each contains 10 transistors, 7 diodes, and 11 resistors.

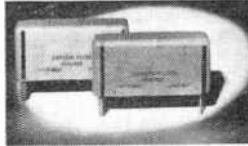

Crystal Filters . . . two are used in the IF amplifier to replace the usual transformers . . . Heath hi-fi exclusive. Provide near-perfect bandpass characteristics, (70 db selectivity) yet no adjustment is ever needed!

Now From The World's Most Experienced Solid-State Audio Engineers Comes The World's Most Advanced Stereo Receiver . . . The New Heathkit AR-15. There's nothing like it anywhere in the transistor stereo market place. Besides the use of space-age integrated circuits and exclusive crystal filters in the IF section, it boasts other "state-of-the-art" features like these:

150 Watts Dynamic Music Power . . . the highest power output of any transistor stereo receiver . . . delivers the coolest, most natural sound you've ever heard.

All-Silicon Transistor Circuitry . . . a total of 69 transistors, 43 diodes and 2 IC's for maximum reliability.

Positive Circuit Protection . . . four Zener diodes and two thermal circuit breakers protect the driver and output transistors from overload and short circuits of any duration.

Field Effect Transistor FM Tuner . . . cascode 2-stage FET RF amplifiers and an FET mixer provide high overload capability, excellent cross modulation and image rejection. Sensitivity 1.8 uv. Features 4-gang variable capacitor and 6 tuned circuits for extreme selectivity under the most adverse conditions. Completely shielded . . . completely assembled.

Two Calibrated Tuning Meters . . . for signal levels, for center tuning — doubles as a VOM for check-out during or after kit assembly. Plus automatic switching to stereo, transformerless design, filtered outputs and a host of other deluxe features. Full details in FREE catalog.

† Kit AR-15, (less cabinet) 28 lbs. \$329.95
AE-16, assembled wrap-around walnut cab., 7 lbs. . . . \$19.95

AR-15 SPECIFICATIONS — AMPLIFIER SECTION: Dynamic Power Output Per Channel (Music Power Rating): 8 ohm load; 75 watts. Continuous Power Output, Per Channel: 8 ohm load; 50 watts. Power Bandwidth For Constant 0.5% Total Harmonic Distortion*: 6 Hz to 25 kHz. Frequency Response (1 watt level): ±1 db, 6 to 50,000 Hz. ±3 db, 4 to 70,000 Hz. Harmonic Distortion: Less than 0.5% from 20 to 20,000 Hz at 50 watts output. Less than 0.2% at 1,000 Hz with 50 watts output. Less than 0.2% at 1,000 Hz with 1 watt output. Intermodulation Distortion (60 Hz, 6,000 Hz=4:1) Less than 0.5% with 50 watts output. Less than 0.2% with 1 watt output. Damping Factor: 45. Hum & Noise: Volume control at minimum position; —80 db. PHONO; Channel Separation: PHONO; 45 db. TAPE & AUX.; 55 db. Output Impedance (each channel): 4, 8 & 16 ohms. FM SECTION (Mono): Sensitivity: 1.8 uv*. Frequency Response: ±1 db, 20 to 15,000 Hz. Antenna: Balanced input for external 300 ohm antenna, unbalanced, 75 ohm. Volume Sensitivity: Below measurable level. Selectivity: 70 db*. Image Rejection: 90 db. IF Rejection: 90 db minimum*. Capture Ratio: 1.5 db*. AM Suppression: 50 db*. Harmonic Distortion: 0.5% or less*. Intermodulation Distortion: 0.5% or less*. Hum & Noise: 65 db*. Spurious Rejection: 100 db*. FM SECTION (Stereo/epic): Channel Separation: 40 db or greater. Frequency Response: ±1 db, 20 to 15,000 Hz. Harmonic Distortion: Less than 1% at 1,000 Hz with 100% modulation. 19 & 38 kHz Suppression: 55 db or greater. SCA Suppression: 50 db. AM SECTION: Sensitivity: 12 microvolts at 1,000 kHz. Image Rejection: 60 db at 600 kHz. 40 db at 1400 kHz. IF Rejection: 70 db at 1,000 kHz. Harmonic Distortion: Less than 1.5% at 400 Hz, 90% modulation. Hum & Noise: 45 db. Power Requirements: 105-125 or 210-250 volt 50/60 Hz AC. Dimensions: Overall, 16 1/2" wide x 4 3/4" high x 14 1/2" deep.

*Rated IHF (Institute of High Fidelity) Standards.



FREE CATALOG

Describes these and over 250 kits for stereo/hi-fi, color TV, amateur radio, shortwave, test, CB, marine, educational, home and hobby. Save up to 50% by doing the easy assembly yourself. Mail coupon or write Heath Company, Benton Harbor, Michigan 49022

HEATH COMPANY, Dept. 10-5
Benton Harbor, Michigan 49022

Enclosed is \$ _____, plus shipping.

Please send model (s) _____

Please send FREE Heathkit Catalog.

Name _____ (Please Print)

Address _____

City _____ State _____ Zip _____

Prices & specifications subject to change without notice. HF-201

CIRCLE NO. 12 ON READER SERVICE PAGE

Learn, Enjoy And Save . . . Build

Heathkit Rectangular Color TV's With Exclusive Self-Servicing



Kit GR-295
\$479⁹⁵*
 (295 sq. inch viewing area)



Kit GR-180
\$379⁹⁵**
 (180 sq. inch viewing area)

Exclusive Features That Can't Be Bought In Ready-Made Sets At Any Price!

All color TV sets require periodic convergence and color purity adjustments. Both Heathkit Color TV's have exclusive built-in servicing aids, so you can perform these adjustments anytime . . . without calling in a TV serviceman . . . without any special skills or knowledge. Just flip a switch on the built-in dot generator and a dot pattern appears on the screen. Simple-to-follow instructions and detailed color photos in the manual show you exactly what to look for, what to do and how to do it. Results? Beautifully clean and sharp color pictures day in and day out . . . and up to \$200 savings in servicing calls throughout the life of your set.

Exclusive Heath Magna-Shield . . . surrounds the entire tube to keep out stray magnetic fields and improve color purity. In addition, **Automatic De-gaussing** demagnetizes and "cleans" the picture everytime you turn the set on from a "cold" start.

Choice Of Installation . . . Another Exclusive! Both color TV's are designed for mounting in a wall or your own custom cabinet. Our you can install either set in a choice of factory assembled and finished Heath contemporary walnut or Early American cabinets.

From Parts To Programs In Just 25 Hours. All critical circuits are preassembled, aligned and tested at the factory. The assembly manual guides you the rest

of the way with simple, non-technical instructions and giant pictures.

Plus A Host Of Advanced Features . . . a hi-fi rectangular picture tube with "rare earth" phosphors for brighter, livelier colors and sharper definition . . . **Automatic Color Control** and **Gated Automatic Gain Control** to reduce color fading and insure jitter-free pictures at all times . . . deluxe **VHF Turret Tuner** with "memory" fine tuning . . . **2-Speed Transistor UHF Tuner** . . . **Two Hi-Fi Sound Outputs** for play through your hi-fi system or connection to the special limited-field speaker . . . **Two VHF Antenna Inputs** — 300 ohm balanced and 75 ohm coax . . . **1-Year Warranty** on the picture tube, 90 days on all other parts . . . plus many more deluxe features. For full details, mail coupon for **FREE Heathkit catalog.**

*Kit GR-295, everything except cabinet, 131 lbs. **\$479.95**

GRA-295-1, walnut cabinet (shown above) 56 lbs. . . 19" D. x 31" H. x 34½" W. **\$62.95**
 Deluxe contemporary walnut & Early American cabinets also available at \$94.50 & \$99.95

Kit GR-180, everything except cabinet, 102 lbs. **\$379.95

GRA-180-1, walnut cabinet (shown above) 41 lbs. . . 18¼" D. x 28¼" W. x 29" H. **\$49.95**
 Early American cabinet available at \$75.00

12" Transistor Portable TV — First Kit With Integrated Circuit

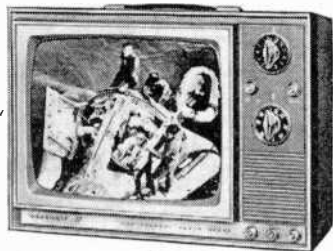

Kit GR-104
\$119⁹⁵

Unusually sensitive performance. Plays anywhere . . . runs on household 117 v. AC, any 12 v. battery, or optional rechargeable battery pack (\$39.95); receives all channels; new integrated sound circuit replaces 39 components; pre-assembled, prealigned tuners; high gain IF strip; Gated AGC for steady, jitter-free pictures; front-panel mounted speaker; assembles in only 10 hours. Rugged high impact plastic cabinet measures a compact 11½" H. x 15¾" W. x 9¾" D. 27 lbs.

Your Own Heathkit® Electronics!

60-Watt Solid-State Guitar Amplifier . . . All The Features Guitarists Want Most!

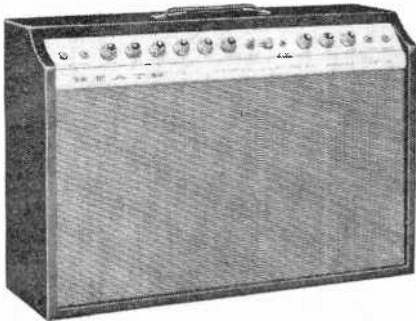

Kit TA-16
\$129⁹⁵

Worth \$300! Two channels, 4 inputs handle accordion, guitars, organ or mike. Variable tremolo & reverb. Two foot switches. Two 12" speakers. Line bypass reversing switch for hum reduction. Leather-textured vinyl cabinet of 3/4" stock. 28" W x 9" D x 19" H. Build in 12 hours. 52 lbs.

4-Speed Solid-State Portable Phonograph . . . Plays Anything From Beatles To Beethoven



Kit GD-16
\$39⁹⁵

Worth At Least 50% More! Assembles in 1 to 2 hours . . . just wire one small circuit board, mount the 4" x 6" speaker and plug in the preassembled changer! Features automatic mono 4-speed play; dual sapphire styli for 78's or LP's; 45 rpm adapter; olive and beige polyethylene over sturdy, pre-assembled cabinet; 117 v. AC operation. 25 lbs.

New Solid-State High Impedance Volt-Ohm-Milliammeter

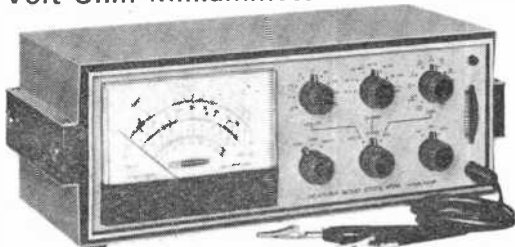

Kit IM-25
\$80⁰⁰ (Wired IMW-25 \$115)

Full scale ranges down to 150 mv & 15 ua, 10 ohms center scale; all-silicon transistors plus FET's; 6" 200 ua meter; ± 3% accuracy on DC, ± 5% on AC; 1% precision resistors; built-in 120/240 v. AC or battery power for portable operation; new unitized construction. 10 lbs.

New Low Price On Deluxe Transistor 10-Band AM /FM / Shortwave Portable . . . Save \$20!

Kit GR-43
Was \$159.95
Now
\$139⁹⁵

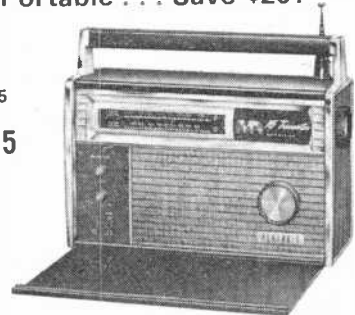

10 bands tune Longwave, AM, FM and 2 MHz to 22.5 MHz shortwave. Two separate AM & FM tuners and IF strips. 16 transistors, 6 diodes and 44 factory assembled and pretuned circuits. 4" x 6" speaker, earphone, time zone map, listener's guide. Build in about 10 hours. 19 lbs.

FREE

World's Largest Electronic Kit Catalog!



Describes these and over 250 kits for stereo/hi-fi color TV, amateur radio, shortwave, test, CB, marine, educational, home and hobby. Save up to 50% by doing the easy assembly yourself. Mail coupon or write Heath Company, Benton Harbor, Michigan 49022

HEATH COMPANY, Dept. 10-5
Benton Harbor, Michigan 49022
In Canada, Daystrom Ltd.

Enclosed is \$ _____, plus shipping.

Please send model (s) _____

Please send FREE 1967 Heathkit Catalog.

Name _____

Address _____

City _____ State _____ Zip _____

Prices & specifications subject to change without notice. CL-288



FULLY EQUIPPED FOR
IMMEDIATE OPERATION
ON ALL 23 CHANNELS

reach
way out
with

the NEW
Cobra CAM-88



23-CHANNEL CB
mobile and base station
AM TRANSCEIVER

GREATER RANGE POWER with the exclusive new DYNA-BOOST circuit that intensifies speech signals and extends the signal range.

The new Cobra CAM-88 is rugged, handsome and field proven. Compare it, feature for feature, with other CB equipment and you'll be convinced that the Cobra CAM-88 is by far the best.

Outstanding Features

- Fully-Equipped for Immediate 23-channel Transmit and Receive
- Double Conversion Superheterodyne Receiver
- Transistorized 117V AC/12V DC Power Supply
- Speech Compression with Switch
- Delta-Tune Fine Tuning
- Squelch Control and Standby Switch
- Illuminated Dual-Purpose Meter
Power-in (Receive)-Power-out (Transmit)
- Modulation Indicator
- Detachable Press-to-talk Microphone
- Convertible to a Public Address Amplifier

Carefully engineered design makes the Cobra completely reliable and easy to operate. Completely self-contained. No additional crystals needed. \$21495



DIVISION OF DYNASCAN CORPORATION
1801 W. BELLE PLAINE AVE. CHICAGO, ILL. 60613

Export: Empire Exporters, 123 Grand St., New York 13, U.S.A. Also available in Canada
CIRCLE NO. 2 ON READER SERVICE PAGE

LETTERS (Continued from page 10)

skating but to put it to controlled use. I feel that the tone arm could be damped just enough to allow the skating force to move the arm at the proper rate of speed. Then the stylus would be free to work on the "wiggles" in the disc without having to move the tone arm. Anti-skating devices defeat this ideal situation, and actually introduce another form of distortion.

STEVEN PAUGH
Audio-Visual Crew Chief
Portage Senior High School
Portage, Wis.

BACK ISSUES AVAILABLE

It is with great regret that I write this letter. Due to a space problem, I have to dispose of my back issues of POPULAR ELECTRONICS. I have all but ten issues from the first to the present one. Rather than have the junkman turn them into tinder, I would appreciate it if you would publish my name and address so that someone will have an opportunity to



make better use of them. The first person to send me \$20, plus postage, will receive them as soon as possible.

NORMAN ROSENSPAN
180 Lenox Rd.
Brooklyn, N.Y.

I have an almost complete set of P.E., from Volume 1, Number 1, to the present (it's minus two or three issues) that I would like to sell for \$20, plus shipping.

ELROY MAREZ
4039 Southmont Dr.
Montgomery, Ala. 36105

Volume 1, Number 1, to present (complete set). Price, open for bids.

ROMAN RUCINSKI
3832 Bristow St.
Detroit 12, Mich.

Think twice before you decide to sell your back issues, fellows. All copies prior to November, 1963, are out of print, as well as some recent ones. However, if you get any calls for individual issues you don't have, tell your correspondents to contact Ziff-Davis Service Division, 595 Broadway, New York, N.Y. 10012. Issues that sold on the newsstand for 35 cents will cost 50 cents; those that sold for 50 cents will cost 65 cents.

-50-

POPULAR ELECTRONICS

READER SERVICE PAGE

**You can get
additional information promptly
concerning
products advertised or mentioned
editorially
in this issue**

1

Circle the number on the coupon below which corresponds to the key number at the bottom of the advertisement or is incorporated in the editorial mention that interests you.

2

Mail the coupon to the address indicated below.

3

Please use this address only for Product Service requests.

**POPULAR ELECTRONICS
P. O. BOX 8391
PHILADELPHIA, PA. 19101**

Please send me additional information about the products whose code numbers I have circled

1 2 3 4 5 6 7 8 9 10 11 12 13 14 15 16 17 18 19 20 21 22 23 24 25
26 27 28 29 30 31 32 33 34 35 36 37 38 39 40 41 42 43 44 45 46 47 48 49 50
51 52 53 54 55 56 57 58 59 60 61 62 63 64 65 66 67 68 69 70 71 72 73 74 75
76 77 78 79 80 81 82 83 84 85 86 87 88 89 90 91 92 93 94 95 96 97 98 99 100

NAME (Print clearly) _____

ADDRESS _____

CITY _____ STATE _____ ZIP CODE _____

VOID AFTER JUNE 30, 1967

5



New Concord 300 Tape Recorder

unique portable with
automatic volume control and

reverse-a-track®

No need to flip reels or rethread! With special Reverse-A-Track, the unique Concord 300 records or plays continuously in both directions to give you up to 6 hours of uninterrupted operation on a standard 4" reel — almost 50% longer than studio type recorders using 7" reels! Among many advanced-design features, this 6¼ lb. solid state electronics unit also includes automatic volume control for voice recording... with switch-off when you want volume variation for recording music. Operates on batteries or house current. Concord-designed and quality-controlled for easy operation, optimum recording and reproduction quality and rugged reliability... and priced under \$130! See, hear this newest addition to Concord's complete line of audio and video tape recorders. Ask for a demonstration at your Photographic, Hi-Fidelity or Radio-TV dealer.

Or Write Dept. V-5.

The Signature of Quality

**CONCORD
ELECTRONICS CORP.**

AUDIO TAPE RECORDERS
VIDEO TAPE RECORDERS
CLOSED CIRCUIT TELEVISION
COMMUNICATIONS PRODUCTS

1935 ARMACOST AVE. • LOS ANGELES, CALIFORNIA 90025

CIRCLE NO. 6 ON READER SERVICE PAGE

ELECTRONICS LIBRARY

TV TROUBLESHOOTER'S HANDBOOK

Derived from material that has appeared in *Electronic Technician* magazine, this handbook is made up of service hints, circuit descriptions, production changes, field service notes, etc., for various makes and models of TV receivers which have been manufactured during the last four years. Although both black-and-white and color receivers are covered, emphasis is on the former—probably because there are more of them. The content is arranged by make and model for easy reference, as is the comprehensive index at the back of the book.

Published by Tab Books, 18 Frederick Rd.,
Thurmont, Md. 21788. Hard cover. 192 pages.
\$6.95.



MARVELS OF MEDICAL ENGINEERING

by Norman Carlisle and Jon Carlisle

The fantastic involvement of electronics in medical diagnosis and treatment is evident from this new book in the "Advances in Science Series." Written at an elementary level, but abundantly illustrated, this book is an up-to-date summary of how ultrasonics, laser beams, computers, microminiature radio transmitters, etc., assist doctors in saving thousands of lives. The book is factual and does not dwell on the "miraculous" or Sunday-supplement type of medical report.

Published by Sterling Publishing Company,
Inc., 419 Park Avenue South, New York, N.Y.
10016. Hard cover. 144 pages. \$3.95.



101 WAYS TO USE YOUR OSCILLOSCOPE, Second Edition

by Robert G. Middleton

Oscilloscopes have changed in the years since this book was first published: wide-band scopes are now standard equipment, and the triggered-sweep scope can be found in the better-equipped service shops. This well-known handbook has been updated to cover the newer scopes. Much of the book is related to testing TV receivers; trouble-shooting the various sections of both black-and-white and color sets is discussed in detail. The use of square waves to evaluate circuits and components is explained, and time-constant charts for some of the common circuits have been added.

Published by Howard W. Sams & Co., Inc.,
4300 West 62 St., Indianapolis, Ind. 46206. 192
pages. \$2.95.

—50—

Be the man who's always
first to say: "I've got
the answer right here!"



START USING THIS REMARKABLE

ELECTRONICS SLIDE RULE

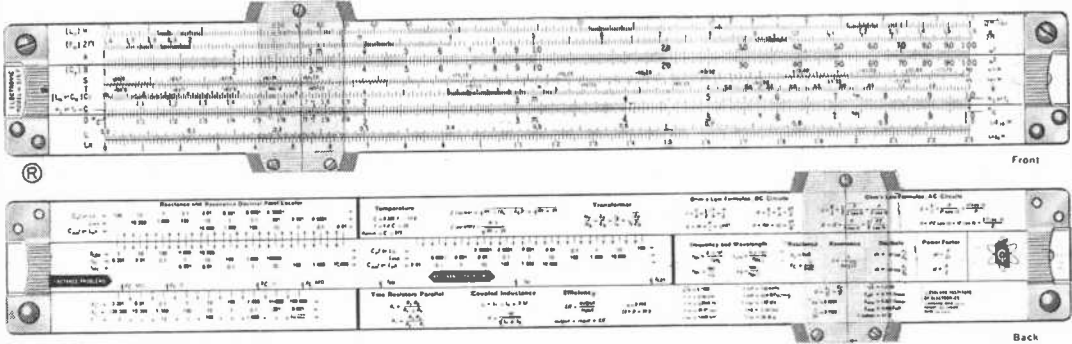

SOME DAY EVERYONE in electronics may have a slide rule like this. Till then, the man who uses one will seem like a wizard as he solves reactance and resonance problems in 12 to 20 seconds—without pencil and paper.

This is a professional slide rule in every detail, a full 10" long, made exclusively for Cleveland Institute of Electronics, to our rigid specifications, by Pickett, Inc. It can be used for conventional computation as well as special electronics calculations. All-metal construction assures smooth operation regardless of climate.

Handsome top-grain leather carrying case has heavy-duty plastic liner to protect slide rule; removable belt loop for convenient carrying. "Quick-flip" cover makes it easy to get rule in and out of case.

You also get four full-length AUTO-PROGRAMMED™ Lessons, which teach you how to use the special electronics scales on the slide rule. These lessons have been carefully designed to meet the same high educational standards as the electronics career courses for which our school is famous. Even if you've never used a slide rule before, you'll soon whiz through the toughest problems with this CIE rule.

Deliberately underpriced. Many men in electronics have told us that this unique slide rule, leather case, and 4-lesson course easily add up to a \$50 value. But we have deliberately underpriced it at less than \$25. Why? Our reason is simple: we are looking for men in electronics who are ambitious to improve their skills...who know that this will require more training. If we can attract you with the low price of our slide rule and course—and impress you with its quality—you are more

likely to consider CIE when you decide you could use more electronics training.

Send for free booklet. See for yourself why this amazing slide rule and course have made such a big hit with busy electronics men everywhere. No obligation, of course—just an opportunity to get in on the best offer ever made to people in electronics. Just mail coupon, or write Cleveland Institute of Electronics, Dept. PE-132, 1776 East 17th St., Cleveland, Ohio 44114.

CIE Cleveland Institute of Electronics
1776 East 17th Street, Cleveland, Ohio 44114

MAIL THIS COUPON FOR **FREE BOOKLET**

Cleveland Institute of Electronics
1776 East 17th Street Cleveland, Ohio 44114

Please send me without charge or obligation your booklet describing CIE Electronics Slide Rule and Instruction Course. ALSO FREE if I act at once: a handy pocket-size Electronics Data Guide.



Name _____ (please print)
Address _____
City _____ State _____ Zip _____



Accredited Member National Home Study Council
A Leader in Electronics Training... Since 1934

PE-132

CIRCLE NO. 5 ON READER SERVICE PAGE

NEW!

MASTER COURSE IN COLOR TV

WITH NTS COLOR KITS



Big 25" Color TV kits included in new Master Color TV program. You learn Color TV and keep the big new 25" color TV receiver you build with exciting kits we send you.

10 million homes in this country will have color TV by the end of 1967. This industry needs technicians as never before, and NTS-trained men can move quickly into the big money.

COLOR TV SERVICING BRINGS HIGH PROFITS.

New color sets need careful installation, precision tuning and skilled servicing. NTS home training can put you in this profit picture—prepare you for big pay, security, or start a business of your own.

LIFT OFF... To A "Space Age" Career In Electronics!

This is the "space age." It crackles with the excitement of new discovery, new opportunities—in communications, industrial electronics, computer technology, closed circuit TV, and many others. Automation has greatly expanded the need for skilled electronics technicians in thousands of manufacturing plants. Only the well trained man makes it big in today's expanding electronics market, and industry demands this kind of man... the NTS man. What does it mean for you? A lifetime career... not just a job! Pick your field, and let an NTS Project Method Program open up the wonderful opportunity-filled world of electronics to you.

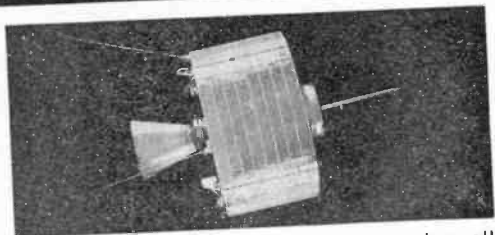

New Electronic developments are taking place all over the world, and your training brings top pay wherever you travel.

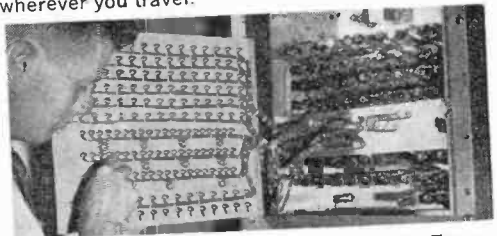

Train for a career in Electronic Controls, Transmitter Operation, or get your FCC License—a "must" in communications work. All included in your Master Program.

NEW "Project Method" CAREER KIT...

Fast, Easy Start To NTS Home Training

NTS introduces the NEW exclusive Project Method Career Kit—developed to help you move into your training program quickly. It is practical and convenient; together with the shop-tested Project Method lessons, this kit speeds you toward earning extra money within a short time.



Send today for the New profusely illustrated NTS Color Catalog. It shows you all the equipment and exciting kits you receive and keep. Describes in detail all the advantages of NTS Project Method Home Training—tells you everything you need to know to get started.

CLASSROOM TRAINING AT LOS ANGELES

You can take Classroom Training at Los Angeles in Sunny Southern California. NTS occupies a city block with over a million dollars in facilities devoted exclusively to technical training.



HIGH SCHOOL AT HOME



National offers accredited high school programs. Take only subjects you need. Study at your own pace. Everything included at one low tuition. Check special high school box in coupon for full information and FREE catalog.

NATIONAL TECHNICAL SCHOOLS
WORLD-WIDE TRAINING SINCE 1905
4300 So. Figueroa St., Los Angeles, Calif. 90037

MAIL REPLY CARD OR COUPON FOR NEW, FREE COLOR CATALOG AND SAMPLE LESSON.

You enroll by mail under NTS "No Obligation" plan. We have no salesmen: This means lower tuition for you.

Accredited Member National Home Study Council
Member: National Association of Trade & Technical Schools



10
TRAINING
PROGRAMS

NATIONAL TECHNICAL SCHOOLS
4000 S. Figueroa St., Los Angeles, California 90037

APPROVED
FOR
VETERANS

Please rush Free Color Catalog and Sample Lesson, plus detailed information on field checked below. No obligation.

- | | |
|--|--|
| <ul style="list-style-type: none"> <input type="checkbox"/> MASTER COURSE IN COLOR TELEVISION <input type="checkbox"/> COLOR TV SERVICING <input type="checkbox"/> MASTER COURSE IN ELECTRONICS-TV-RADIO plus ADVANCED TV and INDUSTRIAL ELECTRONICS <input type="checkbox"/> ELECTRONICS-TV-RADIO SERVICING AND COMMUNICATIONS <input type="checkbox"/> FCC LICENSE COURSE <input type="checkbox"/> RADIO SERVICING (AM-FM-TRANSISTORS) | <ul style="list-style-type: none"> <input type="checkbox"/> TELEVISION SERVICING (including color lessons) <input type="checkbox"/> STEREO, HI-FI and SOUND SYSTEMS <input type="checkbox"/> BASIC ELECTRONICS <input type="checkbox"/> ELECTRONICS MATH <input type="checkbox"/> HIGH SCHOOL AT HOME (Dept 205-57) |
|--|--|
- Name _____ Age _____
Address _____
City _____ State _____ Zip _____
- Check if interested in Veteran Training under new G. I. Bill.
 Check if interested ONLY in Classroom Training at Los Angeles.

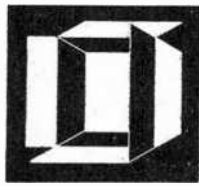

NEW PRODUCTS

Additional information on products covered in this section is available from the manufacturers. Each new product is identified by a code number. To obtain further details on any of them, simply fill in and mail the coupon on page 15.

"BOOKSHELF" FM STEREO RECEIVER

Said to be the first bookshelf-size solid-state hi-fi stereo receiver, the ADC 606 announced by *Audio Dynamics* measures only nine inches deep (17" wide and 5" high). It delivers 30 continuous watts per channel. Usable FM sensitivity is rated at 1.6 μ V; FM frequency response is virtually flat to 20,000 hertz; and the FM stereo separation is over 35 dB. Total harmonic distortion: 0.3%. Among the many front panel features of the ADC 606 are a "log scale" dial face, stereo indicator light, tape monitoring facilities, and a stereo headset outlet.



Circle No. 75 on Reader Service Page 15

"SILENT SECRETARY"

You simply place your telephone in the proper position on *Sonar's* Model JAM-2 "Silent Secretary" as shown, plug the latter into a 117-volt outlet, and the JAM-2 will answer your phone automatically. It will greet callers in your prerecorded voice, and record and store accurately all information received. Other things the "Silent Secretary" can do are take dictation, monitor calls, and inform callers where you can be reached in an emergency. It can be used as a paging system, and as a telephone amplifier. Completely solid-state, the JAM-2 is self-contained, lightweight, and portable. And it works 24 hours a day.



Circle No. 76 on Reader Service Page 15

"PROFESSIONAL" VTVM

Accurate measurements down to 0.01 volt are possible with EICO's Model 235 "Professional" vacuum-tube voltmeter. Operation of the instrument is made easier by the use of color coding to match the function and range switches with the arcs of the easy-to-read 6" meter, and by use of a dual-purpose a.c./d.c. "Uni-Probe." Both p-p and r.m.s. voltages are read on separate scales in seven overlapping a.c. ranges—up to 1500 volts r.m.s., 4200 volts p-p. Frequency response is 30 Hz to 3 MHz (to 250 MHz with optional probe). Measurements can be made from 0.01 to 1.5 kV in eight overlapping d.c. ranges—up to 30 kV with optional probe. The 11-megohm input makes for negligible loading.

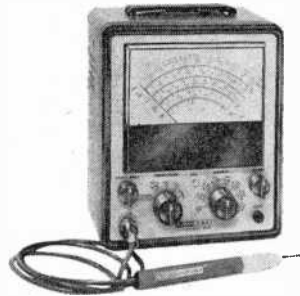

Circle No. 77 on Reader Service Page 15

SOLID-STATE STEREO FM TUNER

All-silicon transistors are used in the Knight Model KN-290 stereo FM tuner, now being offered by *Allied Radio*, for reliable performance. Features of the KN-290 include a built-in tuning meter, a f.c., a stereo indicator light, and automatic multiplex switching. Sensitivity is 1.5 μ V for 20 dB quieting; frequency response, 50 to 15,000 hertz \pm 1.5 dB; signal-

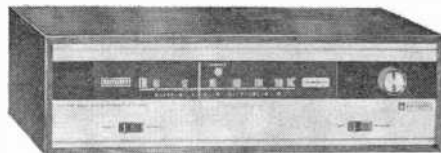

to-noise ratio, 55 dB; distortion, less than 1%. The KN-290 is compact—it measures 13" wide by 10" deep by 3 $\frac{3}{16}$ " high—and a handsome oiled walnut wood case adds just \$1 to the price of the tuner.

Circle No. 78 on Reader Service Page 15

"QUICK-GRIP" CB TRUNK MOUNT

No holes need to be drilled for a mobile CB antenna with the new type of trunk mount developed by *Antenna Specialists*, yet the setup looks like a conventional permanent antenna installation. The Model M-161 "Quick-Grip" mount consists of a specially designed clamp that slips over the edge of the trunk lid, and is locked in place on the underside of the lid. The mount is encased in an inverted cone-shaped chrome-plated housing that overlaps the edge of the trunk lid slightly, permitting the connecting cable to be snaked through to the trunk interior without showing. Surface marring is prevented by a rubber

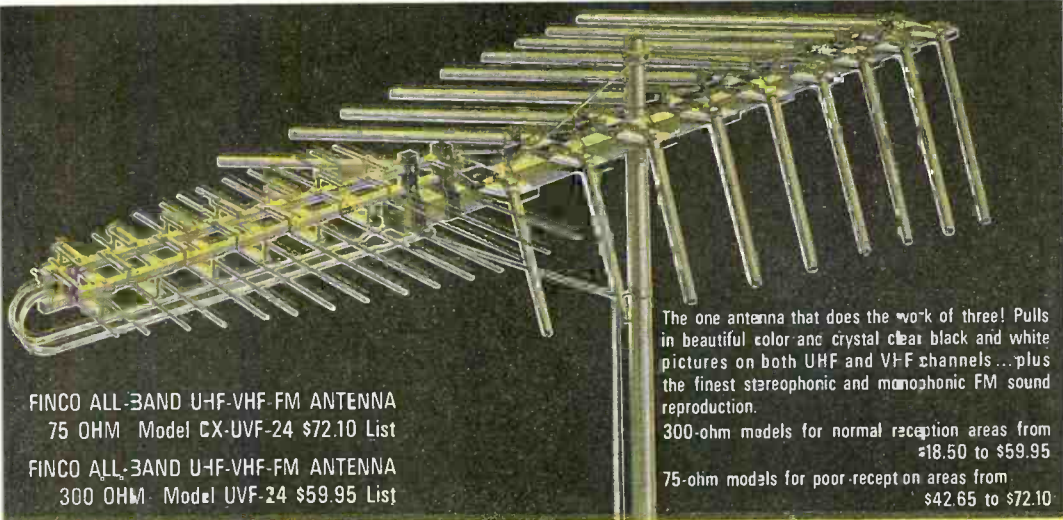

FINCO ALL-BAND UHF-VHF-FM ANTENNA
75 OHM Model CX-UVF-24 \$72.10 List
FINCO ALL-BAND UHF-VHF-FM ANTENNA
300 OHM Model UVF-24 \$59.95 List

The one antenna that does the work of three! Pulls in beautiful color and crystal clear black and white pictures on both UHF and VHF channels...plus the finest stereophonic and monophonic FM sound reproduction.
300-ohm models for normal reception areas from \$18.50 to \$59.95
75-ohm models for poor reception areas from \$42.65 to \$72.10

FINCO

introduces / 75-ohm COLOR VE-LOG ANTENNAS
FOR UHF-VHF-FM RECEPTION

Finco's Swept-Element Antenna challenges all competition. Its unique design assures the finest color and black and white TV reception—plus superb FM and FM Stereo tone quality.
300-ohm models for normal reception areas from \$16.95 to \$54.50
75-ohm models for poor reception areas from \$18.55 to \$62.80

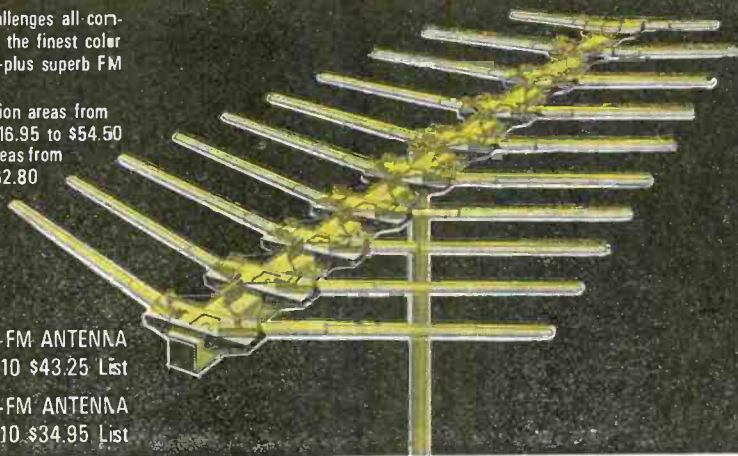

FINCO SWEEP-ELEMENT VHF-FM ANTENNA
75 OHM Model CXVL-10 \$43.25 List
FINCO SWEEP-ELEMENT VHF-FM ANTENNA
300 OHM Model VL-10 \$34.95 List

FREE! ALL FINCO CX-VL, CX-UVF AND UVF ANTENNAS COME WITH A FREE INDOOR SET-MOUNTED TRANSFORMER, VHF-UHF TRANSFORMER SPLITTER OR VHF-UHF SPLITTER.



THE FINNEY
COMPANY
34 West Interstate Street
Dept. PE, Bedford, Ohio

Send for free brochure
Name _____
Address _____
City _____ State _____ Zip _____

CIRCLE NO. 8 ON READER SERVICE PAGE

PRODUCTS (Continued from page 22)

grommet, which also keeps surface water from entering the housing. The "Quick-Grip" mount will accept any existing antenna with a $\frac{3}{8}$ "-hole requirement; adapters are available to accommodate other hole sizes.

Circle No. 79 on Reader Service Page 15

SOLID-STATE PRIVATE TONE CALLER

For use with *Lafayette* 12-volt solid-state CB transceivers, the new "Priva-Com III" transistorized private tone caller employs ceramic and resonant tuning fork circuitry instead of conventional reed relays. Features include: 9-transistor, 2-diode circuitry; simple to operate push-button switches for standby, normal, call and reset; volume control and indicator light. It is supplied with



mounting bracket, two plug-in tuning fork filters, and connecting cable with plug for the Lafayette HB-500A, HB-555, HB-525A, HB-600, and HE-20T. The "Priva-Com III" is compatible with the "Priva-Com IV," which is intended for use with Lafayette HB-444/25 and Comstat 25 units. There is also a "Priva-Com V" tone caller for tube-type transceivers.

Circle No. 80 on Reader Service Page 15

BEAM ANTENNA KITS

Interested in stacking CB beam antennas to obtain additional gain? *Mosley Electronics* has kits available which include two "Scotch-Master" beams, stacking harness, guy rope, boom, necessary hardware, and concise assembly instructions. The antennas in the STACK'IT 3, SKT-3 are 3-element beams; those in STACK'IT 4, SKT-4 have 4 elements; and those in STACK'IT 5, SKT-5 have 5 elements. Up to 13 dB gain, compared to a reference dipole, can be obtained.

Circle No. 81 on Reader Service Page 15

STEREO HEADPHONE CONTROL CENTER

Olson Electronics' Model PH-127 stereo headphone control center permits the use of two sets of stereo headphones, with a separate volume control for each. It comes with a 5' cable with a three-circuit plug to allow connection to your amplifier; this plug can be removed for connection to amplifiers that do not have a phone jack. The Model PH-127 measures 5 $\frac{1}{4}$ " wide by 3 $\frac{3}{4}$ " deep by 3 $\frac{1}{4}$ " high.



Circle No. 82 on Reader Service Page 15

COAXIAL SWITCH

A new single-pole, two-position coaxial switch for amateur radio and CB use is available from the *Gold Line Connector Company*. Designated as the Model 2 P, the switch has a current-carrying capacity of 9 amperes and a power-carrying capacity of 1000 watts. Clips and rotor contacts are silver-plated brass, and the switch is insulated with electrical grade laminated phenolic—which provides protection against voltage breakdown of critical parts to 1000 volts r.m.s.

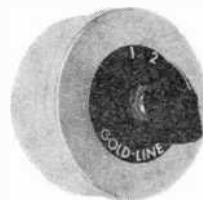

Circle No. 83 on Reader Service Page 15

PHILLIPS SCREW LAUNCHER

Starting Phillips screws in hard-to-get-at locations is said to be an easy matter with a new launcher tool made by *Vaco Products Company*. By means of a simple push-pull operation of a sliding aluminum sleeve which is part of the tool, the tough spring-steel blades of the launcher expand in the cross-slot of the screw head and grip it firmly. Screw removal is equally easy. The Phillips screw launcher is available in four lengths: 3, 5, 7, and 9 inches.

Circle No. 84 on Reader Service Page 15

CONTROLLED IMPEDANCE SPEAKER SYSTEM

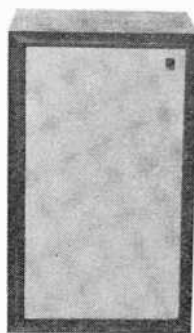

Since solid-state components are believed to give best performance over a narrow range of load impedance, *H. H. Scott's* new S-11 three-way speaker system has an impedance range carefully limited, by integrated engineering development of both speakers and crossover, for optimum performance with today's solid-state receivers and amplifiers. Measuring 24"

x 14" x 11 $\frac{1}{4}$ ", the S-11 system features a walnut-finish air-suspension type of enclosure.

Circle No. 85 on Reader Service Page 15

COAXIAL "CABLEMATCH"

Something new in coaxial cable has been put on the market by *JFD Electronics*. Called the "Color-Shield-82 Coaxial Cablematch," it is a low-loss 82-channel cable which comes with a 300-75 ohm matching transformer attached—the transformer ties directly to the 300-ohm output of the antenna. Available in three lengths (50, 75, and 100 feet), the cable is equally effective for color and black-and-white TV reception, VHF, UHF, and FM stereo.

Circle No. 86 on Reader Service Page 15

Squires Sanders

23'er



THE *different* KIND OF CB TRANSCIVER

The 23 channel all solid state 23'er is unique. Outstanding performance is engineered into its design . . . deep down inside where you have to look carefully. Take transistors for example . . . there are twenty-six (all silicon) — up to eight more than you see in the average 23 channel set. They give performance with a capital "P" . . . like the exclusive ignition noise silencer which operates as a second little receiver listening for ignition noise and chopping it out . . . and push-pull 100% modulation of the full 5 watt input . . . and an extra-sensitive receiver with superbly flat AGC that literally pulls the weak signals up out of the noise. The 23'er is different . . . and better. \$235 ready for mobile installation. Power Supplies for base station: Standard, \$19.95; Master (electronically regulated, with S meter) \$39.50.



If you are interested in limited channel capability, see the S-5-S, 5 channel twin to the 23'er. It has all of the bonus performance features of the 23'er for five channel operation. \$185 for mobile; use same power supplies. Set of channel 9 crystals included.

COMING SOON: The Modern Miracle in low cost 23 channel transceivers: S-S 23



See your dealer for details or write today to SQUIRES-SANDERS, INC., Box 319, Millington, N. J. 07946
CIRCLE NO. 33 ON READER SERVICE PAGE

Quick change artist

Here's the perfect blend of price, performance and versatility. The Johnson Messenger 100 offers a ready choice of mobile, portable and base operation to satisfy every communication need.

In your car the Messenger 100 features 6-channel operation, extremely low current drain, built-in PA system, and provisions for Tone Alert selective calling system.

The first quick change converts the Messenger 100 to field operation in just a few seconds. You simply add the accessory Power Pack and get up to 8 hours of oper-

ation on one charge. The nickel cadmium battery can be recharged several times—at any standard AC outlet.

The second quick change gives superb base station operation by adding an antenna and an AC power supply to the Messenger 100. Just plug it in and you're on the air. FCC type accepted and DOT approved.

Want to know more about our quick change artist? Ask for information on the Johnson Messenger 100. The coupon makes it easy.



Johnson's Messenger I, TWO, III, 100 and 300 are FCC type accepted and DOT approved. No other manufacturer gives you this assurance of quality and performance.



E. F. JOHNSON COMPANY

2432 Tenth Ave. S.W., Waseca, Minn. 56093

Providing nearly a half-century of communications leadership

Please send me information on the Messenger 100 and the complete Johnson CB line.

Name _____

Address _____

City _____ State _____ Zip _____

CIRCLE NO. 14 ON READER SERVICE PAGE

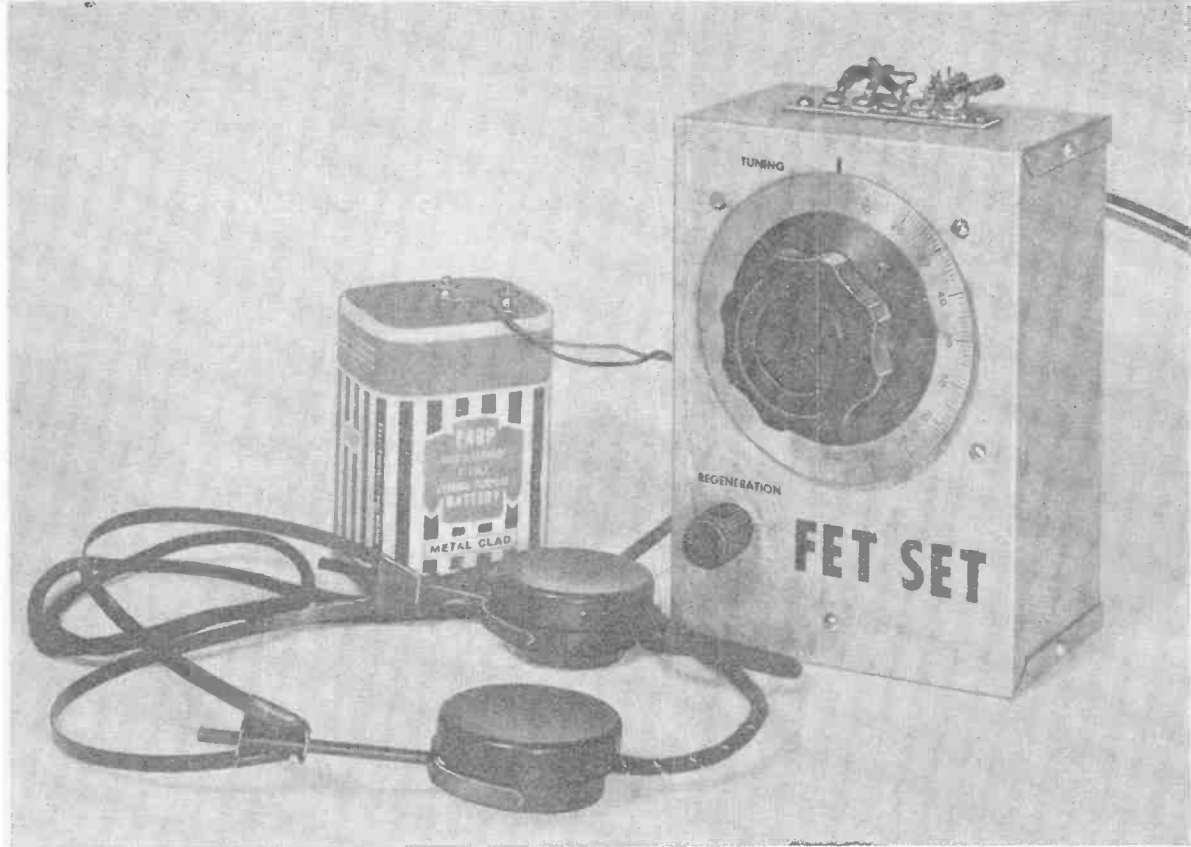

INTRODUCING THE FET SET

A RADIO RECEIVER WITH A
POWER DRAIN SO LOW
THAT IT PLAYS FOR A YEAR
ON A 6-VOLT BATTERY

WHAT IS a FET set? It is an ultra-modern version of the once-popular tube-type regenerative receiver, with the vacuum tubes directly replaced by field-effect transistors—the high-impedance solid-state devices that “think” and act like tubes. The FET set is battery-operated and able to pull in BCB DX stations with more selectivity and sensitivity than you would expect from such a simple circuit.

So, if you have an evening or two to spare, and the \$10-15 required for all the

By JACK ALTHOUSE

parts, you'll be in for a rewarding experience building the FET set. And you'll have the satisfaction of knowing that you are working with the very latest member of the transistor family—the FET.

How It Works. The theory of operation of the field-effect transistor is discussed in detail in the February, 1967, issue of POPULAR ELECTRONICS (page 47) and is summarized on page 30 of this issue.

The circuit for the FET regenerative receiver is shown in Fig. 1. Field-effect transistor $Q1$ functions as a regenerative detector in a Hartley circuit arrangement, while $Q2$ operates as an audio amplifier.

Signals at the antenna appear across $L1$, and the desired frequency selected by tuning capacitor $C1$ is induced in $L2$ and applied to the gate of $Q1$. Since the circuit is regenerative, a portion of the signal at the drain is fed back to

the gate. The amount of feedback is controlled by $C3$. The gate is self-biased by $R1$, bypassed by $C2$. Coil $RFC1$ eliminates r.f. from the output circuit.

The detected audio is developed across $R2$ and is coupled to the gate of $Q2$ through capacitor $C4$. Transistor $Q2$'s gate is returned to ground through $R3$, while $R4$, bypassed by $C5$, provides self-biasing for this transistor. The amplified audio at $Q2$'s drain is reproduced by the magnetic headphones.

Construction. The author's FET set is housed in a 7" x 5" x 3" aluminum box, with the tuning and regeneration controls mounted on the front panel. If you like this arrangement, begin construc-

tion by first laying out and drilling mounting holes for the tuning dial ($C1$), regeneration control ($C3$), and $L1$ - $L2$ coil form, and the circuit board, following the general arrangement shown in Fig. 2.

Then cut out a suitable sized slot through the top of the box to mount the terminal strip ($TS1$) that serves to connect the battery, headphones, and antenna to the receiver. Make sure there is enough clearance so that $TS1$'s terminals won't ground out against the chassis. Now lay the box aside temporarily.

Secure a 1"-diameter by 4"-long plastic or cardboard coil form and drill the holes called for in Fig. 3; two holes are required at each end of the $L1$ and $L2$ windings. Following the instructions giv-

PARTS LIST

- B1—6-volt lantern battery
- C1—Midget 409-pF variable capacitor (Allied Radio 43 A 3524 or similar)
- C2, C5—10- μ F, 10-volt miniature electrolytic capacitor
- C3—50-pF variable capacitor (Hammarbund MC-50-S or similar)
- C4—0.01- μ F paper capacitor
- L1, L2—See Fig. 3
- Q1, Q2—2N4360 p-channel FET (Fairchild)*
- R1, R2—22,000-ohm, 1/2-watt resistor
- R3—470,000-ohm, 1/2-watt resistor
- R4—10,000-ohm, 1/2-watt resistor
- RFC1—10-mH r.f. choke (National Radio R-50 or similar)
- TS1—5-lug terminal strip

- 1—Pair of magnetic headphones, 2000 ohms or higher
- 1—7" x 5" x 3" aluminum box (LMB TF-782 or similar)
- 1—2 1/2" x 3" perforated unclad circuit board
- 22—Push-in terminals (Vector T-28 or similar)
- Misc.—Coil form (4" long x 1" dia.), knobs (2), 1"-long 6-32 threaded spacers (2), 3/4"-long 6-32 threaded spacers (2), ground lugs (2), 6-32 x 1/4" screws (10), 6-32 nuts (2), #26 enameled wire, solder

*Available from Glassman Electronics, 20 Hampton Rd., Massapequa, N. Y. 11758, at \$1.25 each. Minimum order is \$5; postage paid in U.S.A.

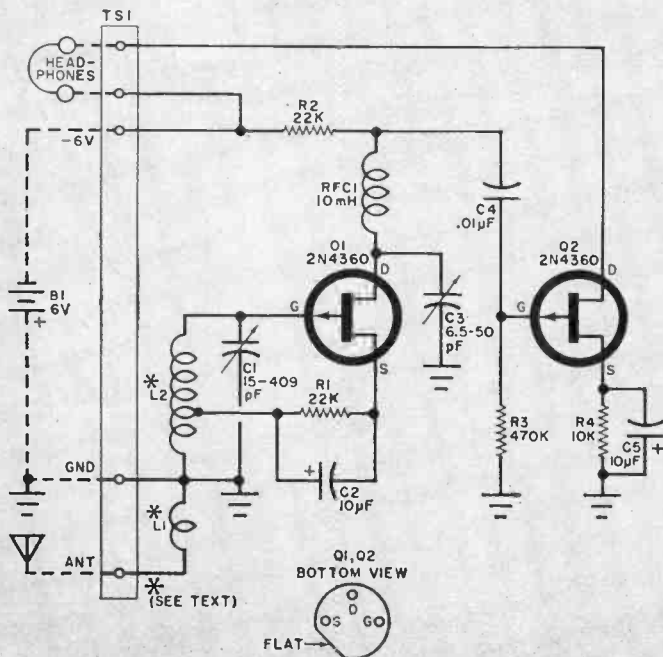

Fig. 1. This FET set schematic shows an updated version of one of the most popular radio receivers of the '30's—the regenerative receiver. Here, field-effect transistors are used to replace the once mighty vacuum tubes.

Fig. 3. To fabricate the antenna/oscillator coil (L1-L2), close-wind the indicated number of turns of #26 Formvar enameled wire on a 4" length of 1"-diam-eter polystyrene, phenolic or cardboard form.

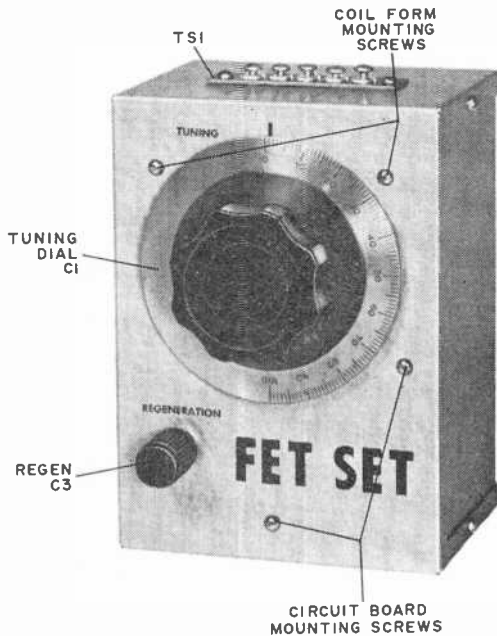
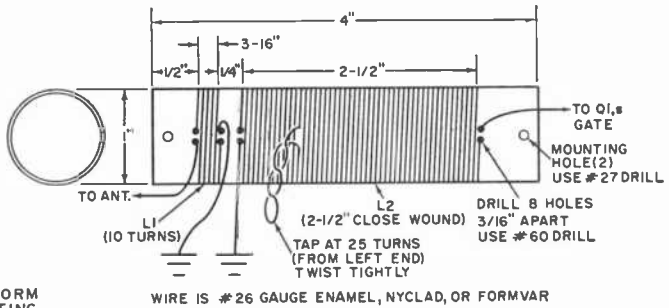

Fig. 2. Start construction by drilling holes in the aluminum box to accommodate the tuning dial shaft and regeneration control. Then drill mounting holes for the circuit board and coil form as shown here.

en in Fig. 3, wind L1 and L2 on the form. Thread the free end of each lead down through one hole and back up through the other to hold the wire in place. When winding L2, form a loop about an inch long and twist it together at the 25th turn from the left end; this is your coil tap. Finish winding the coil.

Now refer to Fig. 4 and install the coil in the box, using 1"-long threaded spacers to support it. Do not use any shorter spacers, since the coil must be kept at least this distance from the metal box. Mount the tuning (C1) and regeneration (C3) controls on the front panel and set the unit aside.

Using Fig. 4 as a guide, assemble the small parts on a 2 1/4" x 3" perforated circuit board. Flea clips can be used to

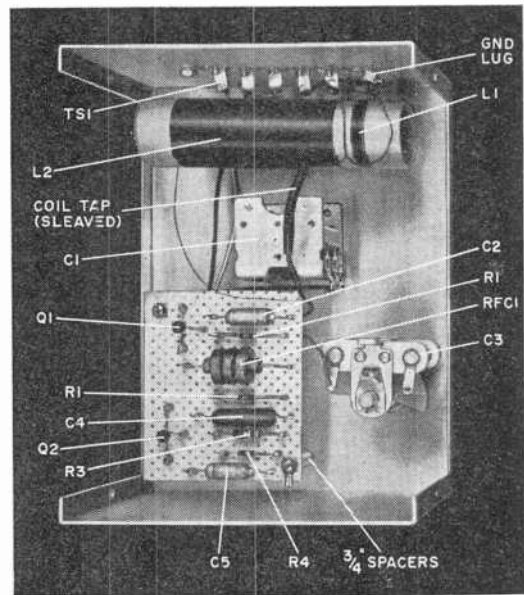

Fig. 4. The parts layout for the FET set is not critical, but the coil should be mounted at least 1 inch away from the metal box to avoid upsetting circuit Q. Mount the circuit board on 3/4" spacers.

interconnect the leads. Once completed, mount the board on two diagonally-placed 3/4" threaded spacers. Place a #6 grounding lug under the head of one of the mounting screws, and connect the common bus from the circuit board to this point.

Complete the remaining point-to-point wiring, using the schematic diagram (Fig. 1). After carefully checking your work, connect the battery (observe polarity), headphones, and antenna lead to TS1. As with any regenerative-type receiver, a good antenna and ground are a must. Use an inverted-L antenna—at least 75 feet long—placed as high as possible above the ground. The set's ground connection should be to a water-pipe.

Since no power switch is provided for the battery, you can only disconnect it by removing its leads from the terminal strip. However, if you use the recommended 6-volt lantern battery, you can get about a year's play out of the radio before having to change the battery. Of course, you can also use a regular 9-volt transistor battery if you wish, but this battery will not last nearly as long. Do not operate the FET set at potentials over 9 volts.

Be sure to use the recommended magnetic-type headphones and not a crystal type, since $Q2$'s drain current must return to the source through the headphones. Low-input headphones will not provide adequate volume.

Operation. To tune for a station, turn the *regeneration* control fully clockwise while setting your tuning dial. Then slowly turn the control counterclockwise to reduce the amount of regeneration until

the detector quits oscillating. At that point, your station will come in. Now retune the dial slightly to peak the station.

As you tune across the band, the regeneration control will have to be readjusted slightly. On strong local stations, it will have to be turned down considerably to act as a volume control.

Possible Modification. After you have become well acquainted with the operation of your FET set, you may want to change $L1$ to optimize it for your particular antenna, its location, and reception requirements. For example, if you are getting interference from a strong station over most of the band, remove three or four turns from $L1$. This reduces overloading while increasing the selectivity of the set. If you live in a poor signal area, you can increase the receiver gain by adding about five turns or so to $L1$, or making the antenna longer. -30-

HOW A FET OPERATES

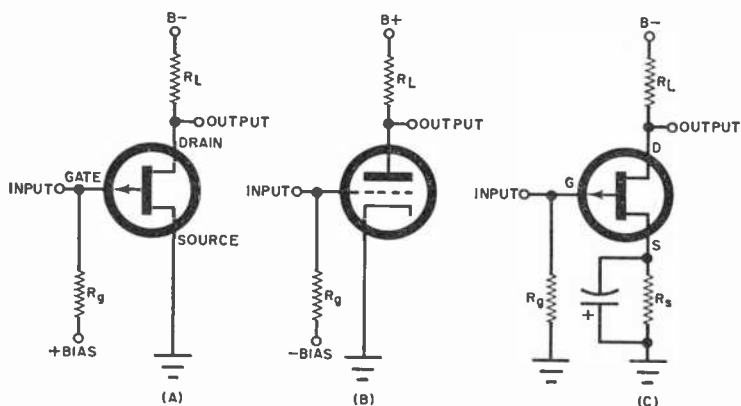

A field-effect transistor, variously called FET, JFET, IGFET and MOST or MOSFET, does not operate like a conventional bi-polar transistor. Rather, it controls current flow by means of an electrostatic field, and operates more like a vacuum tube—but requires no heater power. It has high-input impedance like a tube, and less circuit loading than a conventional transistor. Other advantages of the FET include lower inherent noise, and greater sensitivity to weak signals.

In the diagram above, observe the similarity between a p-channel FET amplifier (A) and

a comparable vacuum-tube amplifier (B). Note the difference in the polarity of the operating voltages. The vacuum tube always requires a plus (+) voltage on its plate, while the p-channel FET requires a minus (-) voltage on its drain, the corresponding electrode.

Observe, also, that the tube operates with a negative grid bias while the p-channel FET operates with a positive gate bias. To avoid the use of a separate bias supply, a self-biasing arrangement can be substituted as shown in (C). This is the scheme employed in the "FET SET" circuit.

FOUR-WAY
ADAPTER LETS
UP TO
FOUR PEOPLE
LISTEN TO
A TRANSISTOR
RADIO
AT THE SAME
TIME

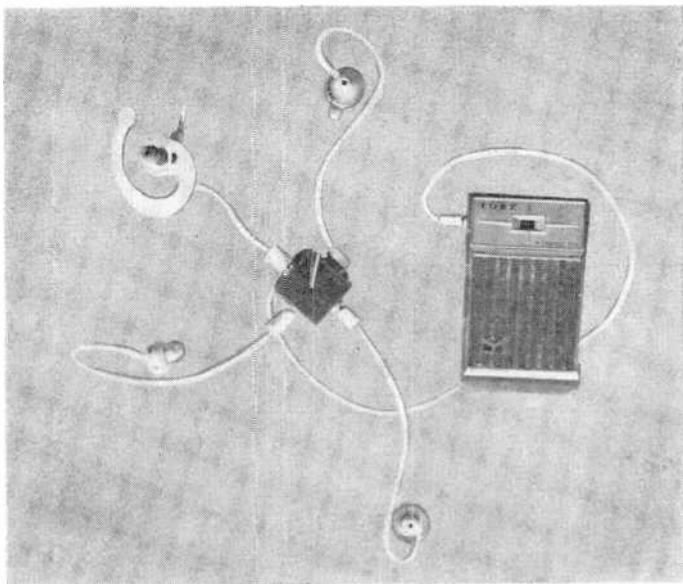

THE "PENNANT RACE" SPECIAL

DO YOU enjoy a good ball game more if, at the same time you are watching it in the ball park, you can hear the commentary on the plays and players over your transistor radio? If you do, you probably use the earphone rather than the speaker, so as not to disturb your neighbor. Since hardly anybody goes to a ball game alone, the fact that most radios have only one earphone jack presents a problem. You can solve the problem by making an inexpensive, easy-

to-build four-way earphone adapter.

The circuit for the adapter, shown in the diagram, is simple. You can mount the four miniature phono jacks on the sides of a small $1\frac{1}{8}'' \times 1\frac{1}{8}'' \times \frac{7}{8}''$ plastic box. Two of the jacks are open-circuit types, and two are closed-circuit types. This arrangement helps to keep the impedance of the earphones matched to the radio.

When one earphone is used, it should be plugged into one of the open circuit jacks. When two earphones are used, any two jacks will do—whichever way the sound is best. If both earphones match the radio individually, there will be a 2 to 1 mismatch—not enough to cause any trouble. If three earphones are used, one of the closed-circuit jacks should be left empty; the mismatch will then be less than 2:1.

When four earphones are used, they will be matched to the radio, but since the radio will be supplying so many earphones, the volume in each will be less than would ordinarily be the case. However, if the radio has a fresh battery, there will be enough reserve signal volume to supply everybody's needs.

—Alex. F. Burr

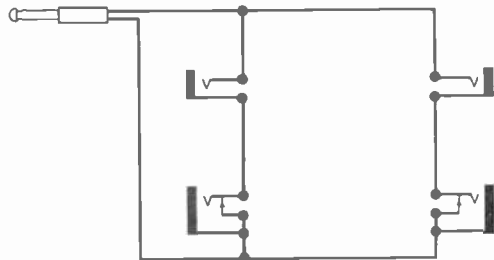

One to four earphones can be plugged into this transistor radio adapter. Use either open-circuit jack for one phone, any two jacks for two; do not use one of the closed-circuit jacks for three; use all jacks for four. You may have to turn up the volume control a bit to compensate for the split load.

POPULAR ELECTRONICS "Callithump"

A DAY IN A 1985 SCHOOL

A DUBIOUS TALE

ALTHOUGH history books are replete with accounts of the Spanish exploration of America, few books tell of a small colony that settled on the Scandinavian shores. This colony was called "El Ektrik."

The Spanish had chosen a poor site and the only means of survival was to harvest and live off the currants that grew in the surrounding forests. But this was not easy, for Norsemen raiding parties forced the colonists to fight for their crops. The colonists needed a battery of vaults to protect their harvest.

The currants were perishable, but the leader of the colonists, who had been schooled in England, had a good idea. "Let's store the 'arvest in our cool 'omes."

And so they did, with such success that in a few years the leader began to worry about the inadequate vaultage and the unpredictable alternating currant production.

Two brilliant El Ektricians, Al Gebra and Geo. Metry discovered that the vaultage required was proportional to the currant production and to the number of homes in the settlement. Thus, they convinced the leader of the colonists to pass a new law that enumerated the maximum number of homes per vault, or:

$$\text{vaultage} = \text{currant times 'omes}$$

Of course, you and I know that this law came down through the ages as 'omes law.

—Errol J. Queen

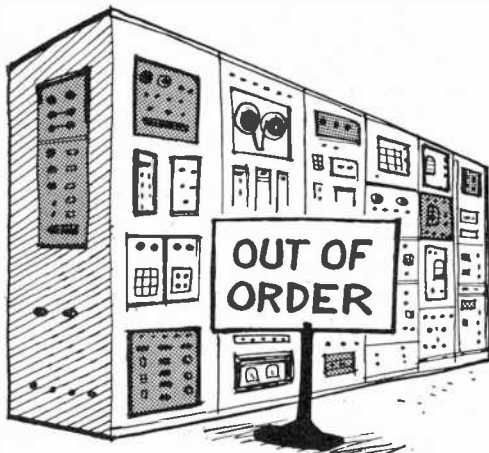

"**W**ELL, son," I said to my weary looking offspring, "it's a beautiful day, but you look like you had a rough one."

"Yeah, pop, it was pretty miserable. Those moving sidewalks between classrooms are on the fritz and I had to walk all over the building. And, when I finally got to my advanced bio-physics class, I found that the computer center had sent over a substitute teacher. A real cornball with field-effect transistors and all that old junk. I didn't know they kept anything older than large-scale IC's on the premises."

"I can see why you're tired," I commented in unfeigned understanding of his plight.

"That was nothing. You should have seen what I was stuck with in my astrophysics calculus class."

"What?"

"My ILLIAC Mark XXXV had to go for maintenance and I did all of my logarithms on an analog computer. I'll bet even you had it easier back in the 60's."

"We sure did," I answered, feeling a twinge of self-reproach. "The only things I remember breaking were pencil points. But, then, our math was so simple we always did it in our heads . . ."

"By the way, son," I added, "how are your grades this quarter?"

"Oh, they're okay. With my A-plus in muscular cytology and my B-minus in Babylonian cuneiforms, I'm a cinch to pass the fourth grade."

—Jerry Kruczek

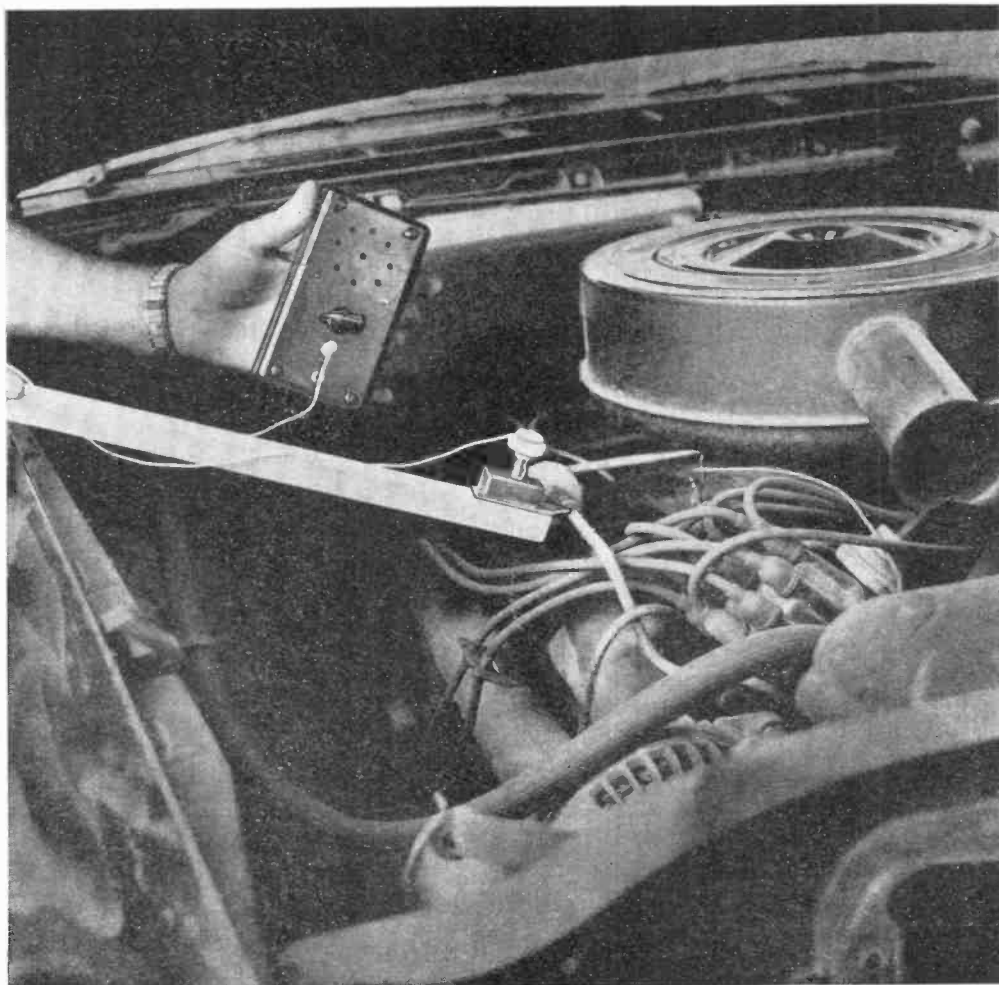

BUILD THE "ELECTRONIC STETHOSCOPE"

SOUND AMPLIFIER
HELPS PINPOINT TROUBLES
IN MACHINERY,
TRACK DOWN MECHANICAL
VIBRATIONS,
AND LISTEN TO
WEAK SOUNDS

By SAL STELLA

WITH THE "Electronic Stethoscope" to help sharpen your hearing, you can quickly trace a trouble in a car's engine to its source, locate a faulty bearing in an electric motor, or check the flow of liquids through pipes, feed lines, and valves. As a matter of fact, the applications of the unit are limited only by your imagination.

The stethoscope is used to amplify weak sounds or other mechanical vibrations. As the pickup end of the stethoscope approaches the sound source, the output "signal" from the pickup becomes stronger. Because the signal is strongest at the closest point to the source, it is

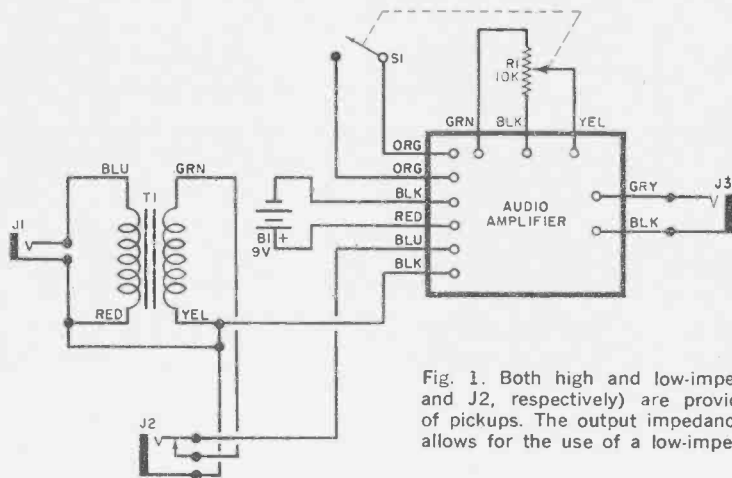

Fig. 1. Both high and low-impedance inputs (J1 and J2, respectively) are provided for a variety of pickups. The output impedance of 8 ohms (J3) allows for the use of a low-impedance headphone.

PARTS LIST

- B1—9-volt battery
- J1, J3—Miniature open-circuit phone jack
- J2—Miniature closed-circuit phone jack
- R1—10,000-ohm potentiometer (with switch)
- S1—S.p.s.t. switch (mounted on R1)
- T1—Impedance-matching transformer (Lafayette Radio Electronics 99 C 6034 or similar)
- 1—Five-transistor audio amplifier module (Lafayette Radio Electronics 99 C 9037 or similar)
- 1—Under-the-chin low-impedance dynamic headphone
- 1—High-impedance headphone for pickup—see text
- 1—Crystal or dynamic phono cartridge
- 1—5" x 3" x 2" (approx.) plastic or metal box
- Misc.—Sheet metal, wood, magnet, solder, flat piece of iron or steel, nuts, bolts, spacers, etc.

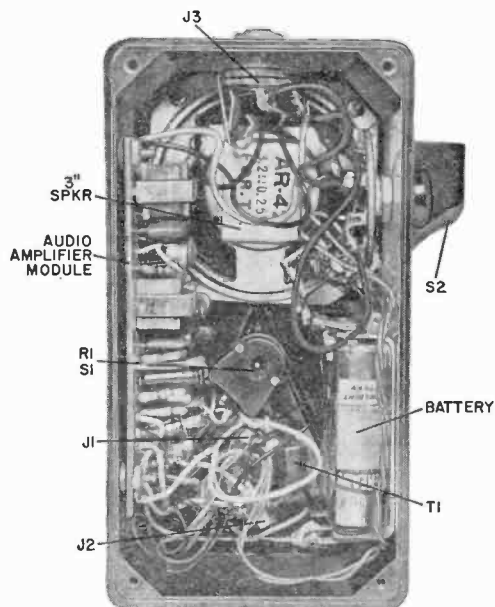

Fig. 2. A miniature 8-ohm speaker and a selector switch can be mounted on the case to provide a choice of either headphone or speaker output.

easy to pinpoint a noisy or defective mechanical component.

Construction time for the "Electronic Stethoscope" shouldn't be longer than three hours. And the cost of the unit is only about \$10—a considerable saving over the prices of many commercially available electronic stethoscopes.

How It Works. As shown in Fig. 1, the "Electronic Stethoscope" is built around an audio amplifier module. Power for the amplifier is supplied by a 9-volt battery, B1; potentiometer R1 functions as a volume control; and jacks J2 and J1 serve as inputs for a low- and a high-impedance

signal source, respectively. The purpose of transformer T1 is to match a high-impedance source to the amplifier's low-impedance input. In order to obtain a continuous circuit when the low-impedance input is not in use, J2 must be a closed-circuit jack.

The device used as a microphone to pick up sound is a small crystal head-

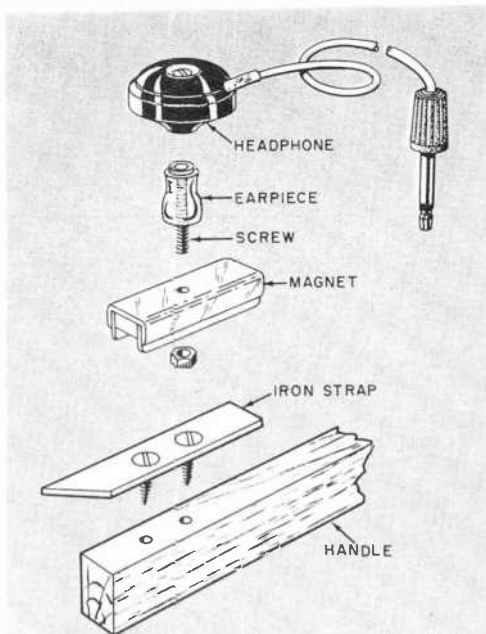

Fig. 3. The pickup should be mounted on a small but strong magnet. The probe consists of a wood handle with a flat piece of iron bolted to one end.

spacers or some washers to maintain a suitable clearance between the amplifier and case. Another small case can be used to store the pickups and magnets.

To make a hands-free mount for the sound pickup (microphone), attach the small headphone unit to a magnet. Cut the head off a 1½"-long #6 or #8 machine screw (whichever will make a better fit), and insert the screw into the earpiece as shown in Fig. 3. Secure it in place with a drop of cement. Bolt the earpiece assembly to the magnet, being careful not to overtighten it. The magnet shown can be obtained from most hardware and department stores.

You can make a suitable probe for getting into hard-to-reach places with the pickup by attaching a small flat piece of steel or iron to one end of a 24" x 1" x 1" piece of wood (see Fig. 3). The size of the metal is not important, but it should be large enough to accommodate the magnet. The end of the metal should be cut to a point to obtain maximum resolution of the trouble area.

An inexpensive crystal or ceramic phono cartridge connected to the ampli-

After finishing construction, label the controls and jacks. The magnets, pickups, headphones, etc., can be stored in a small plastic case when not in use.

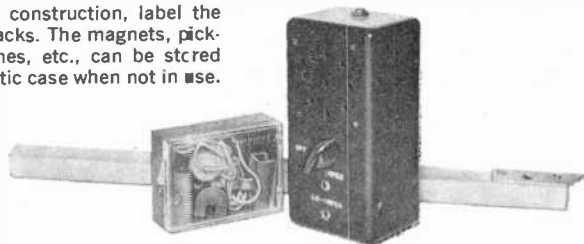

phone of the type used with pocket-sized portable radios. An old crystal or ceramic phono cartridge will make a relatively inexpensive mechanical vibration sensor. Sounds or other mechanical vibrations sensed by the pickup are amplified and fed through *J3* to a low-impedance under-the-chin headphone.

Construction. Either a plastic or a metal case measuring about 5" x 3" x 2" can be used to house the battery and amplifier module. Transformer *T1* can be mounted by soldering one of its mounting tabs to the outer conductor lug of *J2* as shown in Fig. 2. Use ½"-long

fier's high-impedance input can be used to pick up mechanical vibrations. Attach the cartridge to another long piece of wood to make a convenient probe.

If you attach a metal clip to the stethoscope, you'll be able to hang the unit on your belt. The clip can be made from a 1"-wide by about 3"-long piece of 22-gauge sheet metal that has been bent to a shape roughly resembling a money clip. In fact, you can use a money clip. Mount the clip on the back of the amplifier case.

With only a little practice, diagnosing mechanical troubles with the "Electronic Stethoscope" should be second-nature to you.

You can earn more money if you get an FCC License

...and here's our famous CIE warranty that you will get your license if you study with us at home

NOT SATISFIED with your present income? The most practical thing you can do about it is "bone up" on your electronics, pass the FCC exam, and get your Government license.

The demand for licensed men is enormous. Ten years ago there were about 100,000 licensed communications stations, including those for police and fire departments, airlines, the merchant marine, pipelines, telephone companies, taxicabs, railroads, trucking firms, delivery services, and so on.

Today there are over a million such stations on the air, and the number is growing constantly. And according to Federal law, no one is permitted to operate or service such equipment without a Commercial FCC License or without being under the direct supervision of a licensed operator.

This has resulted in a gold mine of new business for licensed service technicians. A typical mobile radio service contract pays an average of about \$100 a month. It's possible for one trained technician to maintain eight to ten such mobile systems. Some men cover as many as fifteen systems, each with perhaps a dozen units.

Coming Impact of UHF

This demand for licensed operators and service technicians will be boosted again in the next 5 years by the mushrooming of UHF television. To the 500 or so VHF television stations now in operation, several times that many UHF stations may be added by the licensing of UHF channels and the sale of 10 million all-channel sets per year.

Opportunities in Plants

And there are other exciting opportunities in aerospace industries, electronics manufacturers, telephone companies, and plants operated by electronic automation. Inside industrial plants like these, it's the licensed technician who is always considered first for promotion and in-plant training programs. The reason is simple. Passing the Federal government's FCC exam and get-

ting your license is widely accepted proof that you know the fundamentals of electronics.

So why doesn't everybody who "tinkers" with electronic components get an FCC License and start cleaning up?

The answer: it's not that simple. The government's licensing exam is tough. In fact, an average of two out of every three men who take the FCC exam fail.

There is one way, however, of being pretty certain that you will pass the FCC exam. And that is to take one of the FCC home study courses offered by the Cleveland Institute of Electronics.

CIE courses are so effective that better than 9 out of every 10 CIE-trained men who take the exam pass it...on their very first try! That's why we can afford to back our courses with the iron-clad Warranty shown on the facing page: you get your FCC License or your money back.

There's a reason for this remarkable record. From the beginning, CIE has specialized in electronics courses designed for home study. We have developed techniques that make learning at home easy, even if you've had trouble studying before.

In a Class by Yourself

Your CIE instructor gives his undivided personal attention to the lessons and questions you send in. It's like being the only student in his "class." He not only grades your work, he analyzes it. And he mails back his corrections and comments the same day he receives your assignment, so you can read his notations while everything is still fresh in your mind.

Mail Card for Two Free Books

Want to know more? The postpaid reply card bound-in here will bring you free copies of our school catalog describing opportunities in electronics, our teaching methods, and our courses, together with our special booklet, "How to Get a Commercial FCC License." If card has been removed, just send your name and address to us.

Matt Stuczynski,
Senior Transmitter
Operator, Radio
Station WBOE



"I give Cleveland Institute credit for my First Class Commercial FCC License. Even though I had only six weeks of high school algebra, CIE's AUTO-PROGRAMMED™ lessons make electronics theory and fundamentals easy. I now have a good job in studio operation, transmitting, proof of performance, equipment servicing. Believe me, CIE lives up to its promises."



Chuck Hawkins,
Chief Radio
Technician, Division
12, Ohio Dept.
of Highways

"My CIE Course enabled me to pass both the 2nd and 1st Class License Exams on my first attempt...I had no prior electronics training either. I'm now in charge of Division Communications. We service 119 mobile units and six base stations. It's an interesting, challenging and rewarding job. And incidentally, I got it through CIE's Job Placement Service."

Glenn Horning,
Local Equipment
Supervisor, Western
Reserve Telephone
Company



"There's no doubt about it. I owe my 2nd Class FCC License to Cleveland Institute. Their FCC License Course really teaches you theory and fundamentals and is particularly strong on transistors, mobile radio, troubleshooting and math. Do I use this knowledge? You bet. We're installing more sophisticated electronic gear all the time and what I learned from CIE sure helps."

ENROLL UNDER G.I. BILL

All CIE courses are available under the new G.I. Bill. If you served on active duty since January 31, 1955, or are in service now, check box on reply card for G.I. Bill information.

CIE Cleveland Institute of Electronics
1776 E. 17th St., Dept. PE-54, Cleveland, Ohio 44114

Accredited by the Accrediting Commission of the National Home Study Council, and the only home study school to provide complete coverage of electronics fundamentals plus such up-to-date applications as: Microminiaturization • Laser Theory and Application • Suppressed Carrier Modulation • Single Sideband Techniques • Logical Troubleshooting • Boolean Algebra • Pulse Theory • Timebase Generators...and many more.



Better than
9 out of 10
CIE men win
their "ticket"
the very first
time they try
(NATIONAL AVERAGE
IS ONLY 1 OUT OF 3)

Cleveland Institute of Electronics

WARRANTY

of success in obtaining a
Government FCC License

The Cleveland Institute of Electronics hereby warrants that upon completion of the Electronics Technology, Broadcast Engineering, or First-Class FCC License course, you will be able to pass the FCC examination for a First Class Commercial Radio Telephone License (with Radar Endorsement);

OR upon completion of the Electronic Communications course you will be able to pass the FCC examination for a Second Class Commercial Radio Telephone License;

AND in the event that you are unable to pass the FCC test for the course you select, on the very first try, you will receive a FULL REFUND of all tuition payments.

This warranty is valid for the entire period of the completion time allowed for the course selected.

G. O. Allen
G. O. Allen
President

BUILD A

STACKED-ANTENNA AM RADIO

TWO ANTENNAS CAN BE BETTER THAN ONE

By ART TRAUFFER

IT IS a well-known fact that you can increase a radio's sensitivity simply by using a better antenna. The technique of stacking two or more antennas in parallel is also well known. Since the ferrite loopstick has taken the place of outdoor antennas, particularly for local reception of AM broadcast programs, why not try stacking two loopsticks?

You can't just connect two loopstick antennas in parallel, however, because these antennas are also used to form the tunable tank circuit at the head end of the radio. When you connect two coils in

parallel, you decrease their total inductive reactance and shift the band of frequencies covered. But, with a little do-it-yourself activity, you can make them work for you. It is necessary only to double the inductive reactance of each antenna, so that the total reactance of the two when in parallel is the same as for the one that would ordinarily be used.

You can build a small two-loopstick radio in about an hour, and at a cost of less than \$5.00.

How It Works. The circuit shown here is that of a simple crystal type radio with one stage of amplification. Coils $L1$ and $L2$ act as the antennas, and connected across $C1$, they form a resonant circuit that can be tuned across the AM broadcast band.

When a signal is picked up by $L1$ and $L2$, it is detected by $D1$ and capacitively coupled to amplifier stage $Q1$. After amplification, the demodulated signal is fed to the headphones.

Power for the circuit is supplied by a $\frac{1}{2}$ - or 3-volt battery, $B1$. Resistor $R1$ provides forward bias for $Q1$, and allows it to operate as a simple Class A amplifier.

Construction. The best way to build this circuit is to breadboard it. Parts layout is not critical, except for $L1$ and $L2$ which must be mounted two or three inches apart and parallel to each other for best results.

The antennas, $L1$ and $L2$, are wound on $7\frac{1}{2}$ "-long by 0.33"-diameter ferrite rods using #24 enameled and cotton-covered wire. Wind 125 turns of wire evenly spaced along the length of the rods. Both coils must be wound in the same direction. As you wind $L2$, strip back the cotton and enamel insulation at several places along the rod and "break out" into small loops, to make the taps. Then use wax or coil dope to hold the wire in place.

No power switch is needed since all you have to do to break the circuit is unplug the headphones from the radio. However, if you decide to wire the headphones directly into the circuit, connect an s.p.s.t. switch in series with either connection to $B1$. Use the alligator clip to select the tap that gives you best reception.

PARTS LIST

$B1$ —1.5- or 3.0-volt battery
 $C1$ —10- to 365 pF miniature tuning capacitor
 $C2$ —10- μ F, 10-volt electrolytic capacitor
 $D1$ —1N34A diode
 $L1, L2$ —Antenna coils—see text
 $Q1$ —2N217 transistor
 $R1$ —220,000-ohm, $\frac{1}{2}$ -watt resistor
Misc.—Headphones, battery holder, hookup wire, etc.

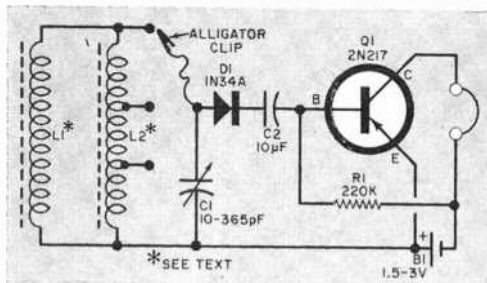

Stacked ferrite core antennas ($L1$ and $L2$) provide an AM radio with increased sensitivity to incoming signals. Since the antennas also form part of a tunable tank circuit, they must be specially wound.

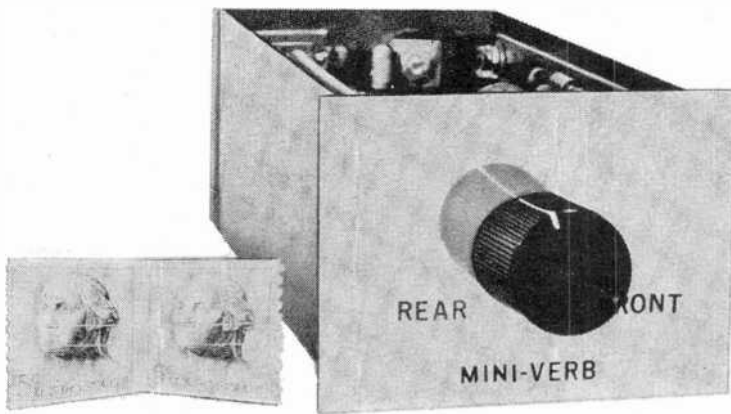

BUILD
THE

“MINI-VERB”

REVERBERATION systems are offered as “accessory” equipment with many cars, included in many high fidelity systems or electronic organs, and even in public address amplifiers. Reverb systems give music a warmer tone and add a feeling of spaciousness by simulating the reverberation—or echo—effect of large concert halls. A car—or even the average living room—is not big enough to have an audible natural reverberation. So adding electronic reverberation makes the reproduction more pleasant and gives a feeling of concert-hall space.

The “Mini-Verb,” an improved and updated version of the system described in *POPULAR ELECTRONICS*, Feb., 1966, was originally built for use in a car. It was miniaturized by using a smaller delay line than the one in the older system. However, it is also usable with your home hi-fi installation and can be hooked up to most stereo systems with little trouble. Quality and output power have been kept high in spite of the fact that the size has been brought down.

By **DANIEL MEYER**

IMPROVED AUTO REVERB
CIRCUIT USES NEW
MINIATURIZED UNIT;
SUITABLE FOR ATTACHMENT
TO STEREO HI-FI RIGS

A standard high-fidelity solid-state circuit is used in the amplifier. The transformerless class-B output stage will deliver at least 3 watts into a 3.2-ohm speaker with less than 1% distortion. Silicon transistors are used throughout for maximum temperature stability.

The small delay line reverb unit (Gibbs Type VII) makes possible a compact system that can be installed almost anywhere. The case measures 2" x 2 $\frac{3}{4}$ " x 6" and includes the fader control and power switch. If you have room in your

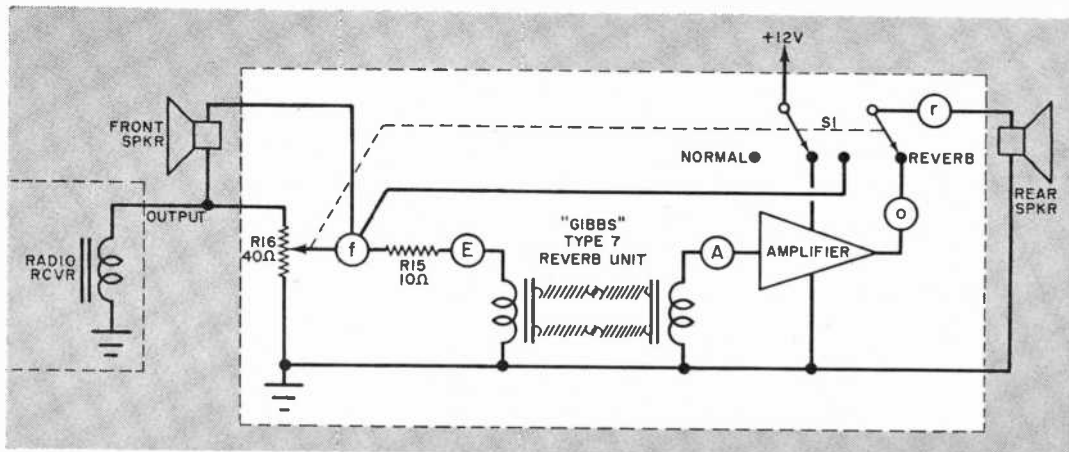

Fig. 1. In an automobile installation, reverberation is achieved by delaying and "verb'ing" the sound from the rear seat speaker. The delay of sound fools the ear into believing the sound is in a large concert hall.

PARTS LIST

C1, C7—10- μ F, 15-volt electrolytic capacitor
 C2—30- μ F, 6-volt electrolytic capacitor
 C3, C4—5- μ F, 15-volt electrolytic capacitor
 C5—200- μ F, 6-volt electrolytic capacitor
 C6—500- μ F, 25-volt electrolytic capacitor
 C8—100- μ F, 15-volt electrolytic capacitor
 D1, D4—1N645 silicon diode, 600-mW
 D2, D3—1N3754 single-ended diode (RCA)
 F1— $\frac{1}{2}$ -A Slo-Blo fuse
 Q1, Q2, Q3—MPS-3708 transistor (Motorola)
 Q4—MPS-3638 transistor (Motorola)
 Q5, Q6—TIP-24 transistor (Texas Instruments)
 R1, R3, R6, R10—4700-ohm, $\frac{1}{2}$ -watt resistor
 R2, R7—22,000-ohm, $\frac{1}{2}$ -watt resistor
 R4—1000-ohm miniature trimmer control (Malory MTC-1 or similar)
 R5—2200-ohm, $\frac{1}{2}$ -watt resistor
 R8—25,000-ohm, $\frac{1}{2}$ -watt resistor

R9—100-ohm, $\frac{1}{2}$ -watt resistor
 R11—1000-ohm, $\frac{1}{2}$ -watt resistor
 R12, R13—220-ohm, $\frac{1}{2}$ -watt resistor
 R14—470-ohm, $\frac{1}{2}$ -watt resistor
 R15—10-ohm, $\frac{1}{2}$ -watt resistor
 R16—40-ohm, 5-watt wire-wound potentiometer with slide actuator
 Rb—220-ohm, $\frac{1}{2}$ -watt resistor—see text
 S1—D.p.d.t. slide switch
 1—Gibbs Type VII reverberation unit
 Misc.—Case, printed circuit board, fuse holder, nuts, bolts, knob, wire, solder, etc.

A complete kit of parts including a special case is available from DEMCO, 219 W. Rhapsody, San Antonio, Texas 78216, for \$16.74 (postpaid). Prices of individual components are available on request.

car to mount a speaker selector switch, you will probably have enough room for the reverberation system.

How It Works. The heart of any reverberation system is the audio delay line. It consists of two electromagnetic transducers and a pair of different-diameter springs coupling them. Audio frequency signals drive the input transducer, which twists the springs slightly. This mechanical motion travels down the springs and creates an electrical signal in the output transducer. Not all the mechanical energy is reconverted to an electrical signal—some energy continues to travel back and forth and gradually decays, resulting in both a delay and a decay of the original sound, as with natural echoes.

The audio signal is split between the speakers through a fader control (R16)

and selector switch S1 (Fig. 1). When the selector switch is in *normal* position, the same signal is applied to both front and rear speakers. The fader serves as a variable divider to balance or shift the sound output from each speaker as desired. When the fader control knob is pulled out, S1 switches the power onto the reverb amplifier and connects the rear speaker to the amplifier's output.

The signal from the radio now drives the front speaker and the input transducer through R15. The output transducer of the reverb unit is connected to a high-gain amplifier (Fig. 2). The amplifier makes up the 40 to 45 dB loss in the delay line reverb unit. In this circuit, Q1 drives voltage amplifier Q2, which is directly coupled to a pair of complementary driver transistors, Q3 and Q4. The driver transistors drive the class-B output pair on alternate half cycles.

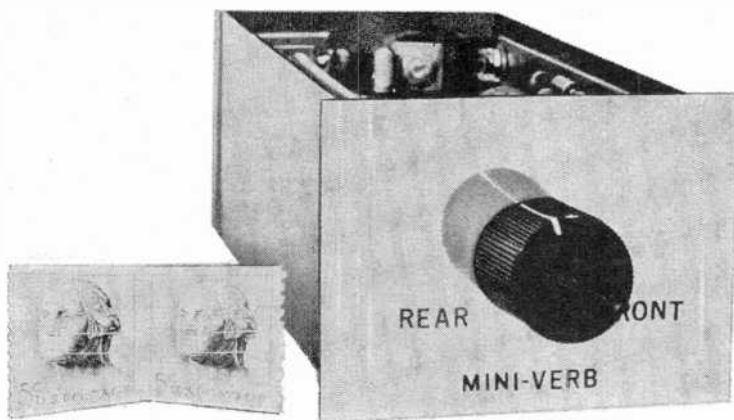

BUILD
THE

“MINI-VERB”

REVERBERATION systems are offered as “accessory” equipment with many cars, included in many high fidelity systems or electronic organs, and even in public address amplifiers. Reverb systems give music a warmer tone and add a feeling of spaciousness by simulating the reverberation—or echo—effect of large concert halls. A car—or even the average living room—is not big enough to have an audible natural reverberation. So adding electronic reverberation makes the reproduction more pleasant and gives a feeling of concert-hall space.

The “Mini-Verb,” an improved and updated version of the system described in *POPULAR ELECTRONICS*, Feb., 1966, was originally built for use in a car. It was miniaturized by using a smaller delay line than the one in the older system. However, it is also usable with your home hi-fi installation and can be hooked up to most stereo systems with little trouble. Quality and output power have been kept high in spite of the fact that the size has been brought down.

By **DANIEL MEYER**

IMPROVED AUTO REVERB
CIRCUIT USES NEW
MINIATURIZED UNIT;
SUITABLE FOR ATTACHMENT
TO STEREO HI-FI RIGS

A standard high-fidelity solid-state circuit is used in the amplifier. The transformerless class-B output stage will deliver at least 3 watts into a 3.2-ohm speaker with less than 1% distortion. Silicon transistors are used throughout for maximum temperature stability.

The small delay line reverb unit (Gibbs Type VII) makes possible a compact system that can be installed almost anywhere. The case measures 2" x 2 $\frac{3}{4}$ " x 6" and includes the fader control and power switch. If you have room in your

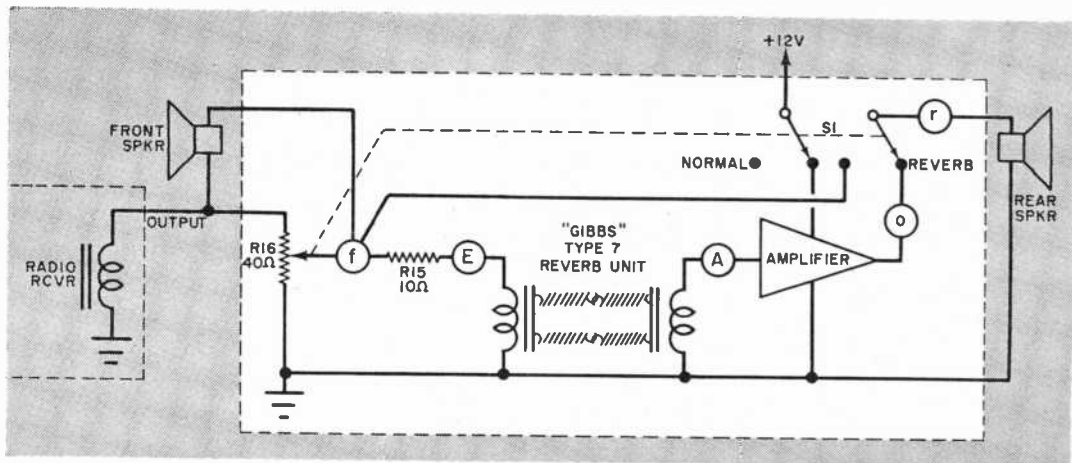

Fig. 1. In an automobile installation, reverberation is achieved by delaying and "reverb'ing" the sound from the rear seat speaker. The delay of sound fools the ear into believing the sound is in a large concert hall.

PARTS LIST

C1, C7—10- μ F, 15-volt electrolytic capacitor
 C2—30- μ F, 6-volt electrolytic capacitor
 C3, C4—5- μ F, 15-volt electrolytic capacitor
 C5—200- μ F, 6-volt electrolytic capacitor
 C6—500- μ F, 25-volt electrolytic capacitor
 C8—100- μ F, 15-volt electrolytic capacitor
 D1, D4—1N645 silicon diode, 600-mW
 D2, D3—1N3754 single-ended diode (RCA)
 F1— $\frac{1}{2}$ -A Slo-Blo fuse
 Q1, Q2, Q3—MPS-3708 transistor (Motorola)
 Q4—MPS-3638 transistor (Motorola)
 Q5, Q6—TIP-24 transistor (Texas Instruments)
 R1, R3, R6, R10—4700-ohm, $\frac{1}{2}$ -watt resistor
 R2, R7—22,000-ohm, $\frac{1}{2}$ -watt resistor
 R4—1000-ohm miniature trimmer control (Mal-lory MTC-1 or similar)
 R5—2200-ohm, $\frac{1}{2}$ -watt resistor
 R8—25,000-ohm, $\frac{1}{2}$ -watt resistor

R9—100-ohm, $\frac{1}{2}$ -watt resistor
 R11—1000-ohm, $\frac{1}{2}$ -watt resistor
 R12, R13—220-ohm, $\frac{1}{2}$ -watt resistor
 R14—470-ohm, $\frac{1}{2}$ -watt resistor
 R15—10-ohm, $\frac{1}{2}$ -watt resistor
 R16—40-ohm, 5-watt wire-wound potentiometer with slide actuator
 Rb—220-ohm, $\frac{1}{2}$ -watt resistor—see text
 S1—D.p.d.t. slide switch
 1—Gibbs Type VII reverberation unit
 Misc.—Case, printed circuit board, fuse holder, nuts, bolts, knob, wire, solder, etc.

A complete kit of parts including a special case is available from DEMCO, 219 W. Rhapsody, San Antonio, Texas 78216, for \$16.74 (postpaid). Prices of individual components are available on request.

car to mount a speaker selector switch, you will probably have enough room for the reverberation system.

How It Works. The heart of any reverberation system is the audio delay line. It consists of two electromagnetic transducers and a pair of different-diameter springs coupling them. Audio frequency signals drive the input transducer, which twists the springs slightly. This mechanical motion travels down the springs and creates an electrical signal in the output transducer. Not all the mechanical energy is reconverted to an electrical signal—some energy continues to travel back and forth and gradually decays, resulting in both a delay and a decay of the original sound, as with natural echoes.

The audio signal is split between the speakers through a fader control (R16)

and selector switch S1 (Fig. 1). When the selector switch is in *normal* position, the same signal is applied to both front and rear speakers. The fader serves as a variable divider to balance or shift the sound output from each speaker as desired. When the fader control knob is pulled out, S1 switches the power onto the reverb amplifier and connects the rear speaker to the amplifier's output.

The signal from the radio now drives the front speaker and the input transducer through R15. The output transducer of the reverb unit is connected to a high-gain amplifier (Fig. 2). The amplifier makes up the 40 to 45 dB loss in the delay line reverb unit. In this circuit, Q1 drives voltage amplifier Q2, which is directly coupled to a pair of complementary driver transistors, Q3 and Q4. The driver transistors drive the class-B output pair on alternate half cycles.

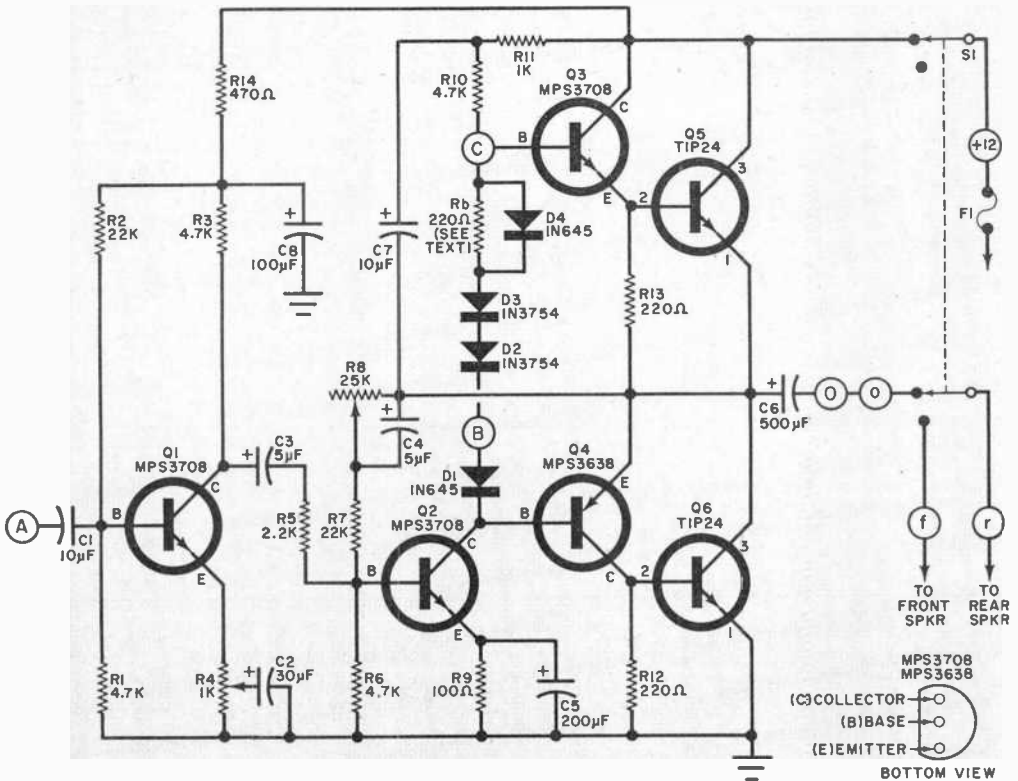

Fig. 2. Schematic diagram shows the simple solid-state high-gain amplifier required to compensate for the audio signal in the reverberation springs. The amplifier has a 3-watt output and is powered by 12 volts d.c.

The diodes between the base of Q_3 and the base of Q_4 provide a small forward voltage bias to prevent crossover distortion and also provide temperature compensation. Diodes D_2 and D_3 are in direct physical contact with the output stages, as shown in Fig. 3. Any heating which would increase output transistor idle current is quickly sensed by the diodes. The heat reduces the diode voltage drop, reducing the transistor forward bias and idle current.

The reverb system's gain is controlled by R_4 and the fader (R_{16})— R_4 for the coarse settings and the fader to make variations to suit the taste of the listener. The amplifier is efficient and draws only about 10 mA with no signal input. At full 3 watts output, the current is 0.4 to 0.5 ampere.

Construction. To make the system small but still easy to assemble, the amplifier is built on an etched board and the whole

system is housed in a specially designed case. (See Fig. 4). If you follow the instructions, there should be no construction problems.

Begin by mounting the power transistors and diodes in the rear of the case. Use a 6-32 x 1/2" screw, with a shoulder washer on the outside of the case and a mica spacer between the inside of the case and the transistor mounting flange. Be sure to coat both sides of the mica washer with silicone grease to insure good heat transfer.

The 1N3754 bias diodes are pushed into their clips and mounted with the same screw that holds the transistors. The diode leads are insulated from the case, so the clips can contact the transistor mounting tab. Turn the diodes so that the red cathode identification dots are opposite each other. Cut the lower leads and solder them together—cathode of one to anode of the other—as shown in Fig. 3. Mount the terminal strip next

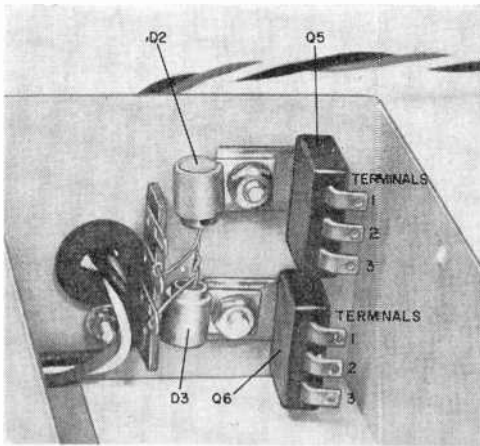

Fig. 3. The npn output transistors are of unusual construction and have not previously appeared in POPULAR ELECTRONICS projects. Each transistor is bolted to the chassis wall along with biasing diodes D2 and D3. You must follow this plan.

to the diodes and connect the remaining two leads to the center and lower lugs. Check for possible shorts between the transistors and case.

Now mount the fader control and reverb unit. Wire the leads for the front speaker, radio input, and ground to the fader control. Dress the wires behind the reverb unit and to the case bottom,

install the grommet, and bring the wires out through the grommet.

Mount the various parts on the circuit board (Fig. 5) as indicated by the printed part numbers (see p. 46). Be sure the electrolytic capacitors and diode are mounted with correct polarity. Solder leads to Q5 and Q6 as shown in Fig. 3. Connect wires to points +12V and *r*, for the power and rear speaker, and to *B* and *C* for the bias diodes. Use a piece of lamp cord or equivalent to wire the rear speaker.

Connect the ground side of the rear speaker to the board's ground strip near the output transistor connection. Do *not* attempt to use the frame of the car for the ground lead to the rear speaker—this can result in noise and even circuit oscillation. Connect a short piece of hook-up wire to point *f*. Connect the green lead from the reverb unit's output (red coil) to point *A* and the green lead from the input to point *E*. Be sure all wires and connections are soldered.

Mount the circuit board on the side of the case (Fig. 6) with 4-40 x 3/8" machine screws. Be sure the switch knob slides between the plates at the rear of the fader control. Use quarter-inch spacers between the case and the circuit board. Connect the wire from point *f* to the

Fig. 4 (below). Due to the intense interest in this project, the author in conjunction with POPULAR ELECTRONICS offers a special mounting case.

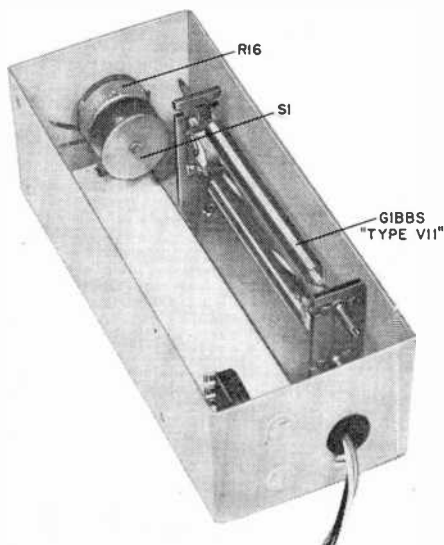

Fig. 5 (below). View of partially completed printed circuit board shows location of some of the components. The numbers alongside C6 pertain to connections to transistor Q6.

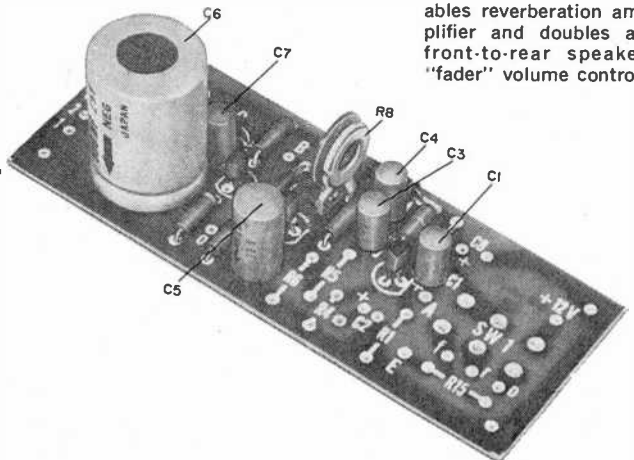

Fig. 6 (right). Photo of the completed unit. Push-pull control disables reverberation amplifier and doubles as front-to-rear speaker "fader" volume control.

arm of the fader control. Mount a soldering lug under the mounting screw at the bottom front of the board, and connect it to the black wires from the reverb unit coils and to the ground side of the fader control, using a short piece of bare wire.

Connect the leads from the board to the power transistors. The numbers on the board and the transistors must match: 1 to 1, 2 to 2, etc. Connect the wire from point *C* to the upper (unused) lug on the terminal strip. Install *D4* and *Rb* on the terminal strip and, observing polarity, the other end to *D3*'s anode. Connect a wire from point *B* to the cathode side of *D2* on the terminal strip. Connect a lead at +12V and run it out through the grommet in the rear of the case to the fuse holder. (This in-line type holder can be picked up at an auto supply house, and is used with a half-ampere Slo-Blo fuse.) Label the leads—to protect the transistors.

Installation. The circuit is designed to work with an ungrounded front speaker. If one side of your speaker is grounded at the speaker frame rather than at the radio, simply clip the ground lead and splice on a piece of wire for connection to the reverb unit. Be sure the car has

4- or 8-ohm speakers. (There are some 40-ohm systems around which require a matching transformer from the radio to the reverb unit.) Also, be sure the speaker is not "hot." Some speakers have 12 volts on the leads.

Connect the +12-volt lead from the fuse holder to the radio, or connect it to the accessories terminal on the ignition switch. Connect the ground lead to an unpainted screw or to some other point that you are sure is a good ground on the car's frame. Connect the lead from point *f* on reverb input to the front speaker. Run the two rear speaker wires to the rear speaker.

Turn the radio on, with the reverb unit knob pushed in. The control should vary the volume of the front and rear speakers as it is turned, with near-zero volume on the front speaker at the extreme rear position, and vice versa. Now pull the fader knob out. You should have about the same volume as before with *R4* set for full gain (the resistor is partially bypassed by *C2*). Sound will probably be best with a bit less volume on the rear speaker when the system is in the reverb position. Set the fader control in the center position and adjust *R4* for the most pleasing rear speaker level.

The reverb unit cover can be fastened under the dash with sheet-metal screws, or mounted through the dash and held by the fader control bushing.

Testing. The system will work quite well without exact circuit adjustments. You can, however, get lower distortion and slightly greater output if you have the proper equipment to make a few tests.

Resistor *Rb* is specified as 220 ohms. This is slightly lower than the best value but safe in all cases. A slightly higher value may reduce crossover distortion. To check for the proper value, connect a milliammeter (VOM) in the +12-volt lead. Short the meter leads and turn on the amplifier. Unshort the meter leads and read the idle current. Now short *Rb* with a clip lead and watch the meter reading. If it drops between 5 and 10 mA, the value of *Rb* is okay. If the drop is less, increase the value of *Rb* to 270 ohms, and check again. The initial current reading should not be more than 15

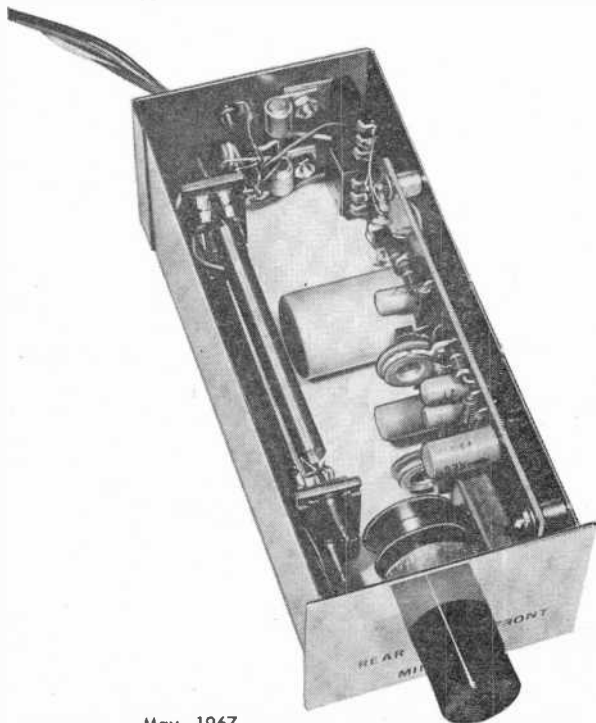

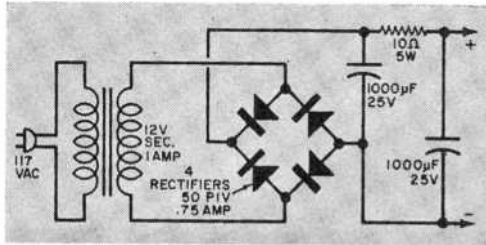

Fig. 7. This simple power supply will enable the builder to operate his Mini-Verb off the 117-volt a.c. lines. All components are easily purchased.

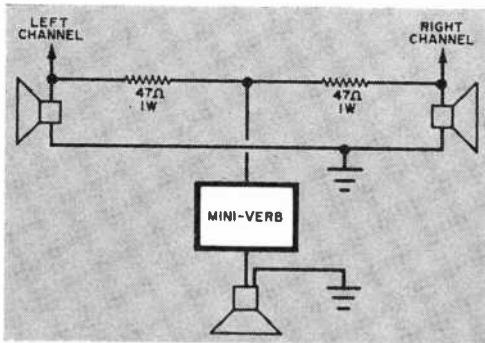

Fig. 8. Reverberation in your home calls for using the Mini-Verb as a third channel. Mixed signal from the right and left channels is derived as shown in this diagram. See text at right for more information.

mA, and R_b must not be increased past the value that gives a 10 mA increase in current.

You can adjust R_8 in either of two ways. If you have only a voltmeter, it can be set for a reading of +6 volts at the emitter (terminal 1) of Q_5 . If an oscilloscope and signal generator are available, drive the amplifier to full output (clipping level) with a 4-ohm load at about 1 kHz and adjust R_8 for symmetrical clipping of the observed waveform.

“Stationary” Applications. To use the “Mini-Verb” with your high fidelity system (or public address equipment), you will need a 12-volt power supply that can deliver 500 mA with good regulation and low hum. A typical circuit is shown in Fig. 7.

To use the “Mini-Verb” with your stereo system, follow the circuit of Fig. 8. (The resistors should be about 47 ohms, 1 watt; reduce the resistance if reverb volume is too low.) This circuit will give you a driving signal that contains information from both channels. Little separation remains in reverberation sound, so two channels are unnecessary in the reverb system. -30-

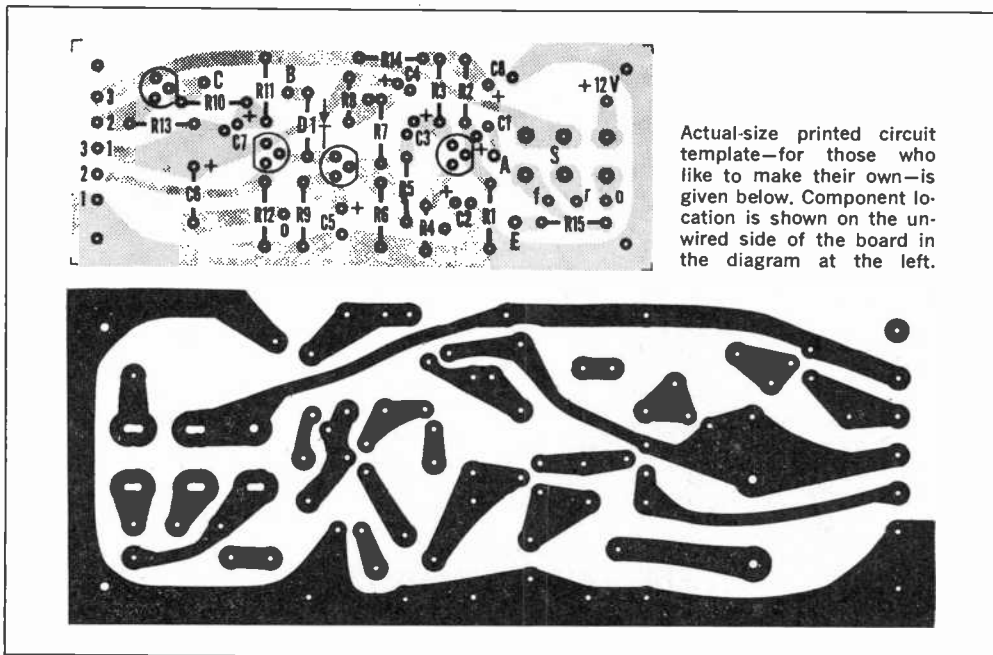

Actual-size printed circuit template—for those who like to make their own—is given below. Component location is shown on the unwired side of the board in the diagram at the left.

The "Coherer"

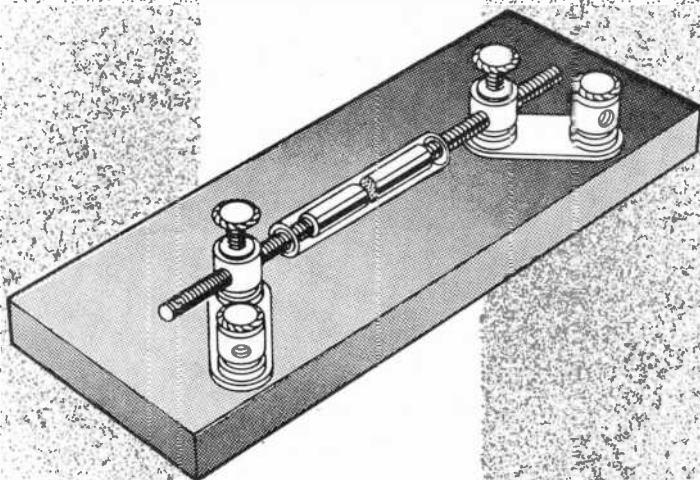

THE EARLY HISTORY OF RADIO COMMUNICATIONS AND THE MEN AND DEVICES THAT MADE IT POSSIBLE

By HENRY B. DAVIS

WHILE MOST HISTORY BOOKS date the birth of radio from Marconi's invention of wireless, this is only a half-truth. Like many scientific discoveries, the radio phenomenon was known as a "paper theory" many years before its actual existence was proven.

As early as 1845, Michael Faraday observed that the characteristics of light and electricity were basically similar. It was this observation that spurred James Clerk Maxwell, a brilliant British physicist, to dig deeper into the phenomenon.

In his paper "On A Dynamical Theory Of The Electromagnetic Field," written in 1864, Maxwell noted that a change in a magnetic field could bring about a change in an electrical field, and vice versa. This led to his conclusion that electromagnetic energy could be propa-

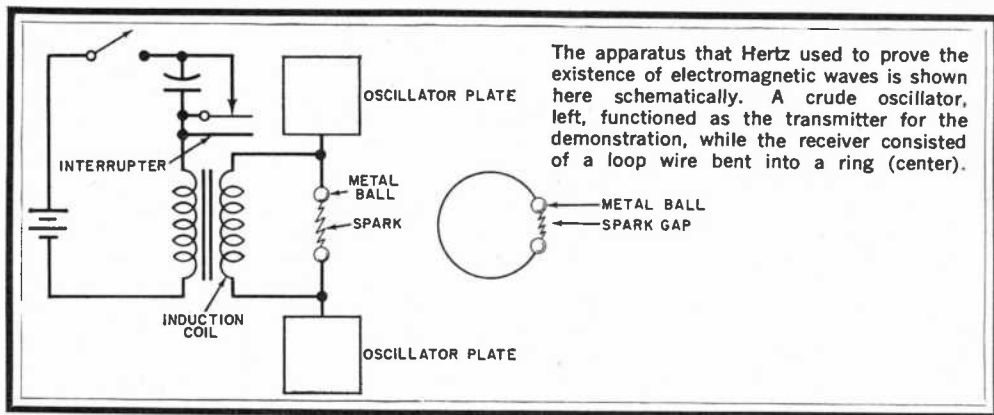

gated into space from a wire conductor, and that the energy traveled at the speed of light. He failed, however, to present physical proof of his theory.

In the years that followed, a great deal of scientific thought was given to Maxwell's theory. But it was 1887 before Heinrich Hertz, a German physicist, demonstrated a device which proved that the Maxwell theory was correct.

To generate electromagnetic energy (really radio waves), Hertz used a spark transmitter, operating around 4 meters (75 MHz). His "receiver" consisted of a length of wire with a small metal ball at each end; the wire was bent to form a ring with a small air gap between the metal balls. When the transmitter switch was thrown, the spark generated electromagnetic energy and this energy was induced into the wire "receiver," causing a spark to jump the gap between the receiver's metal balls. Thus, a spark produced by the transmitter induced a spark in the "receiver." No physical contact between the transmitter and the "receiver" existed.

Although the distance between the two units was limited to a few feet, it was soon learned that this range could be increased to about 50 feet simply by limiting the size of the "receiver" wire to the wavelength of the oscillator's frequency and carefully adjusting the gap between the metal balls at the wire's ends.

Hertz's demonstration encouraged new interest in electrical waves—which came to be called "Hertzian" waves. Attempts to conduct radio waves through earth and water were carried out. Then experi-

ments were made with large coils of wire to try and find a method of transmitting and receiving electromagnetic radiation by induction alone. But it was the introduction of the first sensitive radio wave detector—the "Coherer"—that made it possible to use radio waves as a means of demonstrating intelligent communications.

Back in 1850 the French scientist, Pierre Guitard, had discovered that dust particles in the air *cohered*, or collected together, when electrified. Later, in 1879, David E. Hughes, an American electrician and the inventor of the carbon microphone, while investigating the resistance properties of loose carbon granules, discovered that the granules *cohered*, going from a high-resistance to a low-resistance state, when a current was passed through them.

Dr. Edouard Branley, another French physicist, perhaps borrowing from Hughes' elementary discovery, built the first "Coherer." His Coherer consisted of a glass tube partially filled with iron filings and plugged with corks through which wire electrodes had been forced. In operation, the iron filings *cohered* when a strong radio signal was impressed across the electrodes. Branley did not use his instrument for the reception of radio waves, but he did find that the Coherer had to be tapped manually to *decohere* the filings in order to return the unit to a high-resistance condition.

A British physicist, Sir Oliver Lodge, was the first to use the Coherer in place of Hertz's wire loop, for the detection and pen recording of Morse code signals.

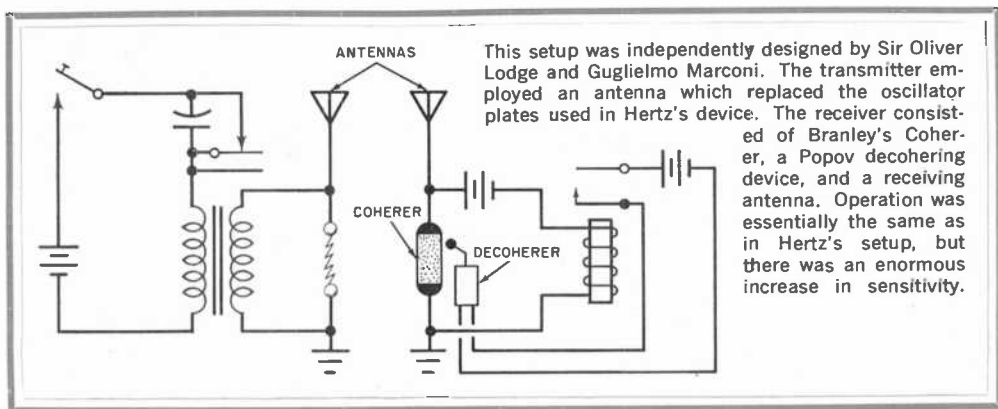

Because the Coherer had to be *decohered* after detecting each pulse of electromagnetic energy, it was suitable only for a Morse code type of communications setup. Sir Oliver, understanding this to be the case, used a “trembler” to *decohere* the iron filings.

In 1895, when the Russian physicist, Aleksandr Stepanovitch Popov, employed the armature of an electric bell to *decohere* the particles, practical transmissions of pulses at a reasonable rate of speed became possible. The bell did away with the need for necessarily slow manual *decohering*. But an even more significant achievement attributed to Popov is the fact that he was the first person to consider using an antenna with the Coherer circuit. The addition of the receiving antenna increased the radio range to more than 900 feet.

At this point, Marconi enters the picture. Sir William Crookes, in the British publication *Fortnightly Review*, predicted in 1892 that wireless [radio] telegraphy would replace all other means of rapid communications. It is likely that this prediction inspired Guglielmo Marconi, the Italian inventor, to make the dream come true.

Marconi took the crude Coherer Branley had designed and made improvements on it. He replaced the corks with silver plugs. And by using a mixture of silver and nickel filings in place of iron filings and evacuating the air from the tube, Marconi succeeded in producing a device many times more sensitive than the original Coherer.

With his own improved version of the

Coherer, the Popov method of *decohering*, and a receiving antenna, Marconi attained results that can be described as only slightly less than spectacular. Signals of from 2 to 9 miles were observed almost immediately, and by early 1901 the figure had increased to 200 miles. About the same time, at the suggestion of Sir Oliver Lodge, Marconi incorporated an “oscillation transformer” in his radio system which permitted the system to be tuned to a given resonant frequency.

Marconi's crowning achievement, however, came about when, on December 12, 1901, he succeeded in proving that radio waves could be intercepted around the curvature of the earth. On that day, he received a signal transmitted from England—some 2000 miles from where he waited on the coast of Newfoundland, Canada.

It is not really clear when radio was actually born. But it certainly was not in existence before Hertz demonstrated his apparatus, and just as certainly it came about not later than Sir Oliver Lodge's demonstration. Both of these events took place prior to Marconi's historic adventure into the new technology.

The achievements of these early pioneers were monumental considering the fact that most of the work was accomplished before the advent of the electronic amplifier. Just how incredible these achievements were can be fully realized only by building and using a Coherer yourself. The diagrams and text on the following page provide all the necessary details.

MAKE YOUR OWN COHERER

THE DRAWING at right is more or less self-explanatory. Most of the dimensions will depend on the materials you use, but keep the inner diameter of the glass tube down to about $\frac{3}{16}$ " and the lengths of the electrodes to about $\frac{1}{2}$ ". Also, file the ends of the electrodes opposite the screws at a slight angle to facilitate tuning.

Rub both electrodes in mercury until they take on a bright metallic coating, then attach the screws as shown. If you run into any problem trying to mate the electrodes to the glass tube, file or sand the electrodes down to fit before rubbing them in mercury.

Use a medium file to prepare a mixture of 5% silver and 95% nickel. Sift the filings through fine cheesecloth to remove

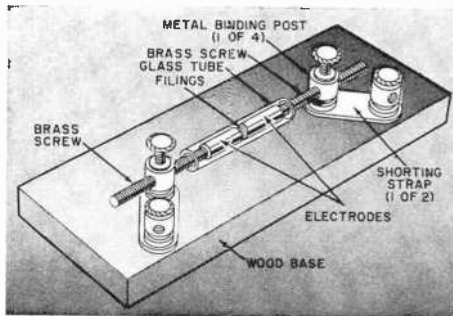

Parts must be solidly mounted on the wood base. Screw-type metal binding posts will facilitate easy mounting of the electrode assembly and will also provide convenient circuit connections.

all unwanted metal dust that might gum up the works.

Slide one of the electrodes into the glass tube. Pour just enough of the filings into the tube to fill the space about halfway when the electrodes are spaced $\frac{1}{16}$ " apart. Then assemble the unit. -30-

TUNING AND USING YOUR COHERER

AFTER ASSEMBLING the Coherer, connect it up as shown below (left). Use a relay that will pull in below 60 milliamps to prevent burning the filings or electrodes.

Decrease the spacing between electrodes until the relay pulls in, then slowly increase the distance between electrodes until the relay de-energizes. Do this several times until you have the Coherer set at the point just before the relay pulls in.

When properly adjusted, the Coherer should close the relay when a 1" spark coil is energized at a distance of 25 or more feet. For this test, no antenna should be connected to the Coherer. Between tests, tap the Coherer to get ready for the next pulse from the spark coil.

When you're satisfied that the Coherer is properly adjusted, tighten the screws on the binding posts connected directly to the electrode screws. Then connect your Coherer up to a circuit like that shown below (right), and it's ready for use.

A spark coil can be used for your experiments, but if you're planning any prolonged experiments, it is suggested that you use a high-voltage capacitor instead. The rapid discharge of the capacitor will have almost the same effect as that of the spark coil, and will not cause any interference on your neighbors TV's and radios.

You might want to experiment with the Popov method of decohering. If so, refer to the circuit on page 49. -30-

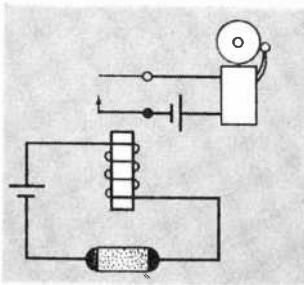

After tuning the Coherer, connect it up to a circuit like that shown at right, below. The circuit can be provided with a degree of selectivity if you tap the choke in several places. A decoherer can also be added.

The tuning circuit for the Coherer is shown at left. A relay that will draw no more than 60 milliamperes is needed to prevent damaging the filings.

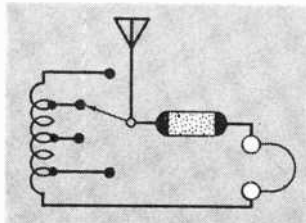

Amateur Radio for CB'ers

HOW TO CONVERT YOUR CB RIG TO TEN METERS
AS AN INEXPENSIVE START IN AMATEUR RADIO

By **WALTER F. LANGE**, W1YDS*

MISTER CB'ER, why not become a ham? This is an ideal time to get your license. Signals are popping in from all over the world on both the Citizens Band and the adjacent 10-meter amateur band. With sunspots on the increase, world-wide communication will soon be possible on these frequencies. But, as a CB licensee, you can only listen to DX (distant stations). Contacting—or even attempting to contact—DX stations is a violation of the FCC's CB rules. Qualifying as a ham—not a difficult process—makes it possible for the CB'er to engage in unrestricted DX communication. If you want to get in on the fun and adventure of amateur radio, start studying today for your General Class ticket.

In order to pass the ham license examination, you must have a basic knowledge of electronics and FCC amateur regulations, and be able to send and receive International Morse code. For some

people these requirements are a "breeze." For others a bit more study and practice is in order. For anyone, a little application of time and effort will certainly win the coveted license. Many teen-agers have passed the ham exam (there's no age limit), so surely *you* can do it! The American Radio Relay League, 225 Main Street, Newington, Conn. 06111, will be glad to fill you in on all the details.

As far as equipment goes, you are really lucky: most of your CB gear can be easily and inexpensively converted to 10 meters. In many cases, the cost of going from the Citizens Radio Service to amateur radio will be less than \$10, including a \$4 license fee and \$3 transmitting crystal.

Once you have received your General Class ticket, there are only two tasks you will need to perform in order to go on 10 meters: slightly reduce the length of your antenna elements and make a simple hookup conversion to your CB transceiver. Since antenna data is given

**Technical Staff, American Radio Relay League*



in several manuals and handbooks published by the A.R.R.L. and other organizations, the subject will not be treated here. However, the 10-meter conversion of a dozen popular CB transceivers will be described in detail, as there has been little information published on this topic.*

If you convert your CB transceiver to 10 meters, remember that the transmitter section cannot be legally returned and used on CB, unless the adjustments are made by the holder of a first- or second-class commercial license. Also, don't for-

get that it's against the law to use the transmitter portion of your converted CB transceiver on the air unless you have a General Class ticket. This is *very* important. Not only does the FCC chase bootleggers, but amateurs have their own lookouts. If they track down your illegal transmissions, you might as well forget about communicating by radio for many years to come.

**This article is an expanded version of the author's article published in QST, February 1967, page 20.*

CONVERSION DETAILS

In the material that follows are details on individual CB transceiver conversions. The units discussed are known to be in common use and are representative of the problems that may be encountered. Hams should find this material of interest if they are looking for an inexpensive 10-meter AM mobile transceiver.

EICO 770. The EICO Model 770 is an eight-tube CB transceiver designed for 117-volt a.c. operation. Only a new transmitting crystal and realignment are required to convert this unit to 10 meters. Set the channel selector switch in any position except the extreme counterclockwise spot. This latter position is for fixed-channel operation only.

The receiver is a single-conversion superhet with an i.f. of 1750 kHz. Begin the receiver alignment, once the main tuning capacitor has been set at maximum capacitance, by tuning oscillator coil *L6* (see Fig. 1), to 26.750 MHz or to a frequency 1.75 MHz below the low-frequency end of the desired tuning range. Turn the tuning capacitor to the center of its range and apply a 10-meter signal to the antenna connector. Tune grid coil *L4* and plate coil *L5* of the r.f. amplifier for maximum response. This completes the receiver conversion. The transceiver that was converted by the author tuned from 28.500 to 28.710 MHz after being adjusted as described above.

Before aligning the transmitter, replace the transmitting crystal, located next to the channel selector switch, with a third-overtone FA-5 type crystal whose frequency is in the 10-meter phone band. Next peak oscillator coil *L1*. Then alternately tune amplifier plate capacitor *C9* and loading capacitor *C10* for maximum output. Start with the plates of compression trimmer *C10* screwed down. Go back and forth between the two capacitors, gradually decreasing the capacitance of *C10* while peaking *C9*, until maximum output is obtained.

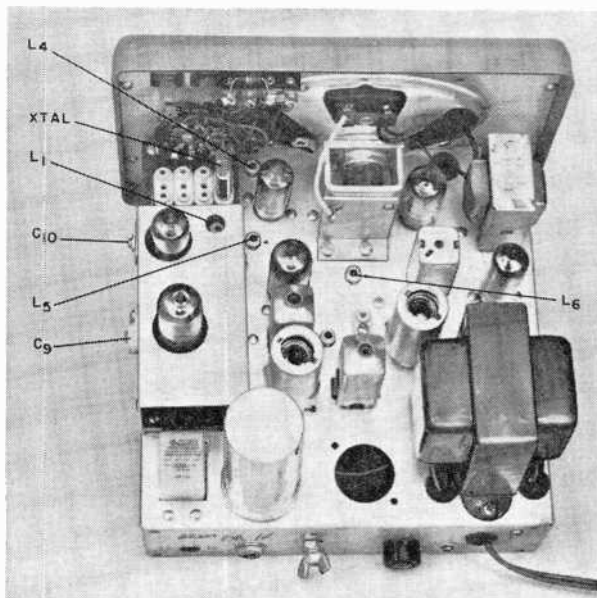

Fig. 1. The EICO Model 770 transceiver can be converted to 10 meters in a jiffy. This base station rig needs only a new crystal and r.f. alignment.

EICO 777. The EICO Model 777 CB transceiver is an eight-tube unit that can be operated from 117 volts a.c., 12 volts d.c., or 6 volts d.c. As with the Model 770, only a new transmitting crystal and realignment are necessary for the 10-meter conversion. Before aligning the receiver, put the *Tune-Xtal* switch in the *TUNE* position.

The receiver is a double-conversion superhet with a first i.f. of 1750 kHz and a second i.f. of 262 kHz. Start receiver alignment by fully meshing the plates of the receiver tuning capacitor. Adjust oscillator coil *L6* shown in Fig. 2 to 26.750 MHz or to a frequency 1.75 MHz below the low end of the desired tuning range. If you align the receiver for the bottom end of the phone band, it will cover from 28.500 to approximately 28.820 MHz. Using a signal in the middle of this range, peak r.f. amplifier grid coil *L4*. Then adjust the amplifier plate coil and the mixer grid coil (top and

General Instructions. Twelve different CB transceivers were converted by the author to 10 meters. They are typical examples of much of the CB gear that has appeared on the market during the past few years. Although the conversion details vary from transceiver to transceiver, there are several areas common to all.

All the transmitters and eleven of the

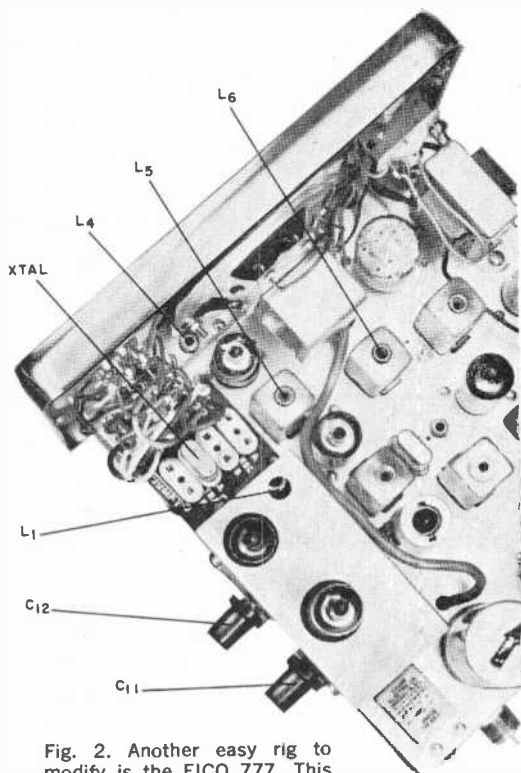

Fig. 2. Another easy rig to modify is the EICO 777. This transceiver has a dual power supply (12 and 117 volts). Replace the transmitting crystal and follow the simple alignment instructions given here.

bottom slugs of *L5*) for maximum response.

Start the transmitter conversion by replacing the transmitter crystal with a third-overtone FA-5 unit in the 28.5- to 29.7-MHz range. Tune oscillator coil *L1* and final plate and loading capacitors *C11* and *C12* for maximum output. Initially set compression trimmer *C12* at maximum capacitance. Then, after tuning *C11* for maximum output, decrease the capacitance of *C12* a little bit. Continue peaking *C11*

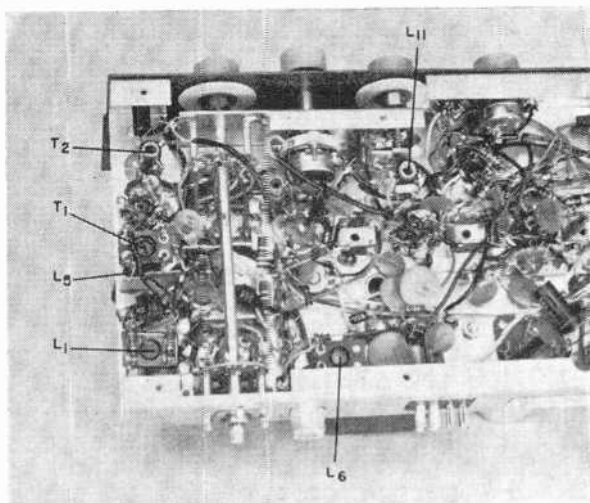

Fig. 3. To get the Hallicrafters CB-19 transceiver on 10 meters, you must remove 5-pF capacitor *C13* from the right side of the coil. Substitute a new crystal and this unit can be tuned on 10 meters.

and decreasing the capacitance of the loading capacitor until maximum output is achieved.

Hallicrafters CB-19. Designed to operate from either 117 volts a.c. or 12 volts d.c., the Hallicrafters Model CB-19 is a compact seven-tube CB transceiver. Before making any adjustments, put the *VFO-OFF* switch in the *VFO* position.

The receiver is a double-conversion superhet with a first i.f. of 1650 kHz and a second i.f. of 262 kHz. With the receiver tuning capacitor set at maximum capacitance, begin aligning the receiver by tuning oscillator coil *L11* (see Fig. 3) to 26.850 MHz or to a frequency 1.65 MHz below the bottom end of the desired tuning range. If you align the receiver for the low end of the phone band, it will cover from 28.500 MHz to approximately 28.860 MHz. With a mid-range signal applied to the antenna connector, peak the r.f. amplifier plate coil and the mixer input coil (top and bottom slugs of *T2*). Since the receiver's input coil *T1* is also the output inductor for the transmitter, align it when adjusting the transmitter section of the transceiver. Of course, if you only intend to convert the receiver, go ahead and adjust *T1* after modifying it as described below.

Before tuning the transmitter, remove 5-pF capacitor *C13* from across the two inside terminals of *T1*. Replace the transmitting crystal with a third-overtone FM-9 unit in the 10-meter phone band. The transmitter crystal board is located on top of the chassis at the rear near the power transformer. Tune oscillator plate coil *L1* for maximum output. Adjust the final by tuning *T1* with a screwdriver or alignment tool and varying the position of the output link *L5* with respect to *T1*. Alternately peak *T1* and move *L5* until maximum output is obtained. If necessary, adjust second harmonic trap *L6* for minimum interference to television Channel 2.

receivers must be realigned. To retune the transceivers, three alignment tools are needed. An ordinary screwdriver will handle all variable capacitor adjustments, and a GC Electronics No. 9302 3-in-1 hex core alignment tool will take care of most of the slug-tuned coils. The remaining coils, which have very tiny alignment slots, can be adjusted with a home-made alignment tool. A suitable tuning tool can be constructed by filing down a small screwdriver to the desired size.

The transceivers can be realigned without test equipment, but the job is rather tedious and time-consuming. A general-coverage short-wave receiver (3 to 30 MHz) and a grid-dip meter or signal generator will make receiver alignment easy. And an SWR bridge and dummy load are useful for transmitter tune-up.

During alignment, be very careful not to damage the tuning slugs or coil forms. Do not try to turn any core beyond the point where binding resistance is encountered. If you do, you will probably strip the alignment slot in the core. In most cases, it will then be impossible to replace the core without damaging the coil form itself. Also note that many of the coil forms are sealed with wax or other material; this gunk should be scraped away before any attempt is made to turn the slugs.

Hammarlund HQ-105TR. Of all the transceivers described in this article, the Hammarlund HQ-105TR is the easiest unit to convert. Actually the HQ-105TR is a general-coverage communications receiver with a CB transmitter installed in the same cabinet. Since the receiver section covers the entire 10-meter amateur band in its unmodified state, the only part of the transceiver that requires attention is the transmitter.

Replace the CB crystal shown in Fig. 4 with an FA-5 third-overtone unit in the 10-meter phone band. Peak oscillator coil *L8* and final amplifier tank *T11*. You can, if you wish, use the receiver's S-meter as an output indicator for these adjustments.

Heath MW-34. The Heath MW-34 CB transceiver is a nine-tube unit that can be operated from 117 volts a.c., 12 volts d.c., or 6 volts d.c. Realignment, a new transmitting crystal, and the substitution of a 15-cent capacitor are required to convert this unit to 10 meters. Before adjusting the receiver, set the channel selector switch in any position under **VARIABLE**.

Receiver Conversion. The CB receiver will be considered first. Converting your receiver will give you an opportunity to listen to 10-meter signals and get an idea of some of the interesting stations you might possibly work once you obtain your General Class license. Usually, this conversion consists of realignment only—so you can put your receiver on

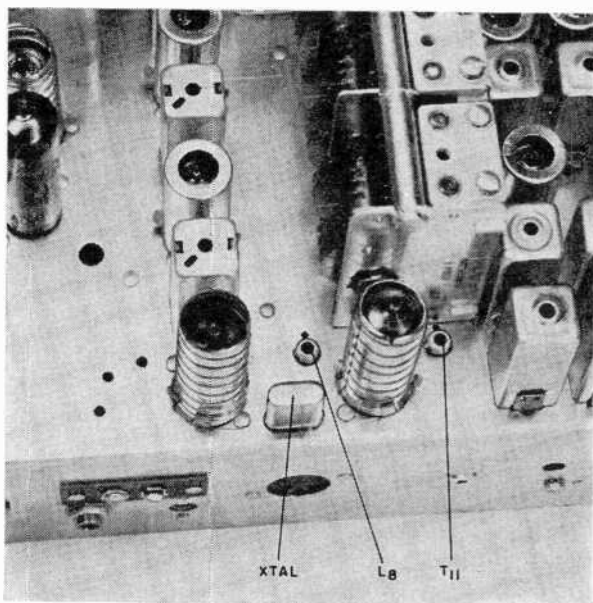

Fig. 4. Converting the Hammarlund HQ-105TR is simplicity itself. Besides changing the transmitting crystal, you only adjust two coils to get on 10.

The receiver is a single-conversion superhet with a 455-kHz i.f. Depending on which part of the band you wish to cover, set the oscillator above or below the desired tuning range. To tune the low end of the band, set the receiver tuning capacitor at maximum capacitance and adjust oscillator coil *L8* shown in Fig. 5 to 28.045 MHz. Your receiver will cover from 28.500 to about 28.945 MHz, the exact range depending on the setting of *C18*. Apply a mid-range 10-meter signal to the input of the receiver. Peak r.f. amplifier "antenna" coil *L1*. Then adjust the amplifier plate coil and the mixer grid coil (top and bottom of *L2*) for maximum response.

Start work on the transmitter by installing a new transmitting crystal in one of the crystal sockets next to the power transformer or the crystal socket on the front panel. Use a third-overtone FA-5 crystal in the 28.5- to 29.7-MHz range. Replace 2.2-pF capacitor *C49* across *L7* with a 1-pF disc ceramic or mica capacitor. See Fig. 6 for its location. Tune oscillator plate coil *L5* and driver plate coil *L6* for maximum output. Then peak final amplifier plate coil *L7*.

the 10-meter amateur band, and if you don't care for what you hear, you can tune it back to the Citizens Band. In those cases where components have to be removed or changed, make the necessary modifications before starting the realignment procedure.

The first step in realigning most of the receivers described in this article is to retune the oscillator coil to a higher frequency. In each case, this will permit the receiver to tune from 28.5 MHz, which is the bottom end of the 10-meter phone band, to some higher frequency (the range varies from transceiver to transceiver). Set the receiver tuning capacitor at maximum capacitance (CB channel 1 end of the dial) and adjust the oscillator coil until the difference between 28.5 MHz and the tunable oscillator frequency is equal to the receiver's first i.f. For example, if the receiver has a first i.f. of 1.75 MHz, the oscillator will be operating at 25.215 MHz when the receiver is tuned to CB channel 1 (26.965 MHz). To align the receiver for 28.5-MHz reception, tune the designated oscillator coil to 28.5 MHz minus 1.75 MHz, or a frequency of 26.75 MHz.

Once the oscillator has been adjusted, the receiver will tune on the average about 350 kHz of the 10-meter phone band. It's not possible to satisfactorily cover the entire band (with one excep-

tion) without making some elaborate and expensive modifications, including the installation of a new dial mechanism and tuning capacitor. Actually, there is no great disadvantage in this limited coverage, since most of the contacts you will be making, once you get your amateur license, will be on or near your transmitting frequency.

If you want to cover a different portion of the 10-meter band (other than the low end), it's easy to calculate a new tunable oscillator frequency. Simply subtract the first i.f. from the lowest 10-meter frequency you want to tune. For instance, if the lowest frequency you'd like to copy is 29.00 MHz and the first i.f. is 1.75 MHz, the tunable oscillator frequency will be equal to 29.00 minus 1.75, or 27.25 MHz.

There are several ways you can realign the oscillator. Probably the best method is to adjust the oscillator coil while listening to the oscillator signal on a calibrated general-coverage receiver. If you aren't able to get hold of a receiver, you can check the oscillator frequency with a grid-dip meter. A third technique is to adjust the oscillator coil until you hear the output from an r.f. signal generator tuned to 28.5 MHz. The output level of the generator must be turned up as the input stage will still be tuned to the Citizens Band.

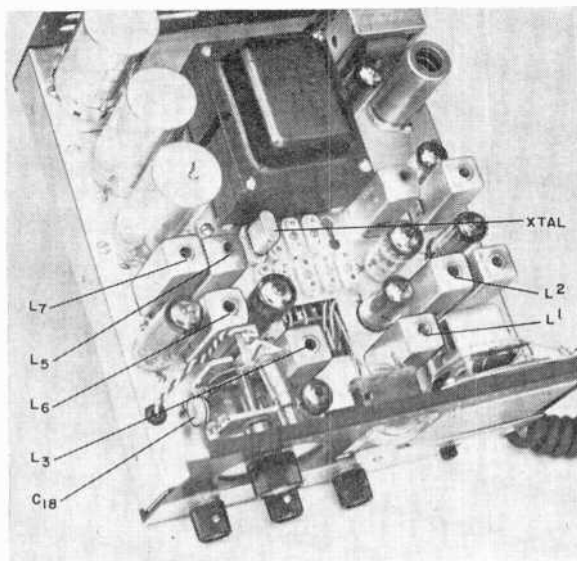
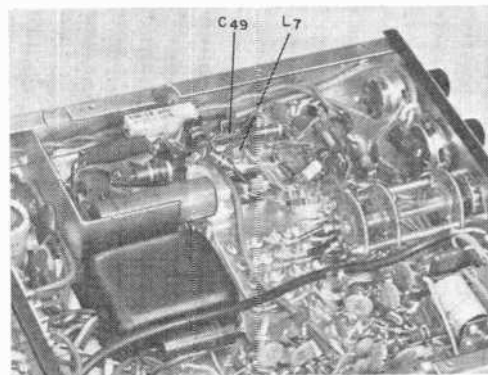
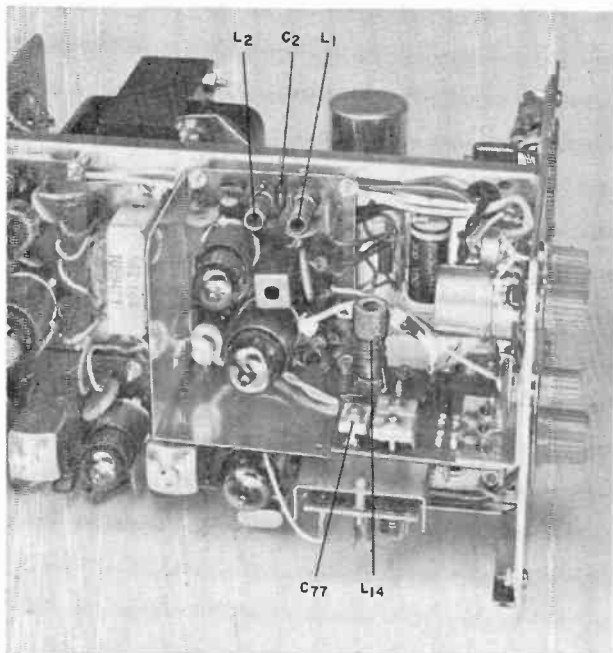

Fig. 5 and Fig. 6. The Heathkit MW-34 is another CB rig easily converted to 10 meters. You can use the panel-mounted crystal socket (Fig. 5, at left) or one of the seven sockets behind the panel for the new transmitting crystal. You must reduce C49 (Fig. 6, below) from 2.2 to 1.0 pF to enable the final amplifier to tune to the low end of 10 meters.



Once the tunable oscillator has been adjusted, the receiver's r.f. input stage can be aligned. There are several ways of doing this. One method is to apply a mid-range 10-meter signal (from a signal generator) to the receiver and tune all the input circuits for maximum response or best signal-to-noise ratio. A receiver adjusted in this manner will be most sensitive at the center of its tuning range, becoming less sensitive on either side. Another method is to stagger-tune the input circuits, which is accomplished by tuning, for example, the input r.f. coil to the low end, the mixer to mid-range, and the r.f. output to the high end. This procedure is repeated several times until the receiver appears to have the same sensitivity across its entire tuning range. A receiver so adjusted will not be as sensitive at mid-range as it would have been had it been tuned by the first method, however. Finally, the receiver can be adjusted without any test equipment at all, provided there is



International 50AN. The International Model 50AN CB transceiver is a nine-tube unit that will operate from 117 volts a.c., 12 volts d.c., or 6 volts d.c. Put the *Receive Selector* switch in the *TUNE* position.

The receiver is a single-conversion super-het with an i.f. of 10 MHz. Look at Fig. 7 and locate the circuit board on which *L14* and *C77* are mounted. Remove *C81*, an 18-pF capacitor in parallel with *L14*. No difficulty should be encountered, as there aren't any other 18-pF units on this board. Then, replace *C2*, the 18-pF capacitor located between *L1* and *L2*, with a 10-pF silver mica capacitor. Be careful not to burn the wires located between the board and the chassis when making this modification.

With the plates of the receiver tuning capacitor fully meshed, tune oscillator coil *L14* to 18.5 MHz. If this frequency can't be reached, tune *C77* as required. A receiver converted to the low end of the phone band will cover from 28.500 to approximately 28.905 MHz. To tune a different portion of the band, adjust the oscillator to a frequency 10 MHz below the bottom end of the desired tuning range. Finish the receiver alignment by applying a mid-range signal to the receiver and peaking double-tuned input circuit *L1-L2* and plate coil *L3* of the r.f. amplifier.

Replace the transmitter crystal, located above the *Transmit Selector* switch (see Fig. 8), with an FA-5 fundamental crystal whose frequency is half the desired output frequency. For example, if you want to transmit on 28.6 MHz, use a 14.3-MHz crystal. Tune oscillator-plate coil *L8* and final amplifier grid

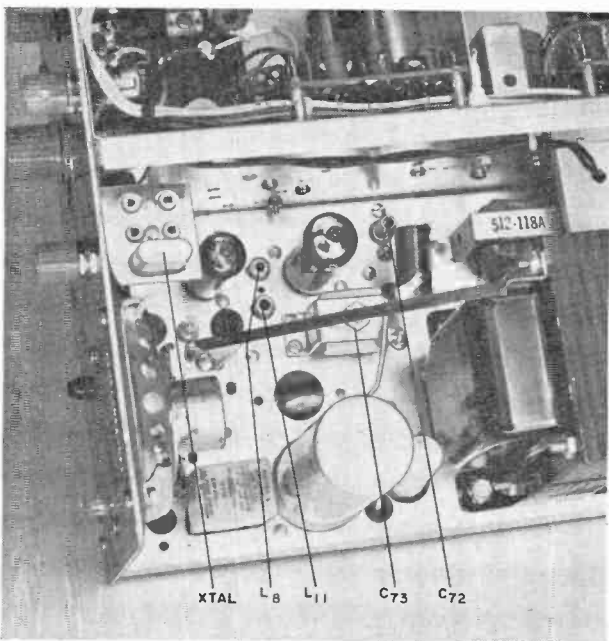

Fig. 7 and Fig. 8. Be careful when removing *C2* and *C81* from the circuit board of the International Model 50AN. In top view, *C81* has been removed from *L14*. Bottom photo shows crystal and coil locations.

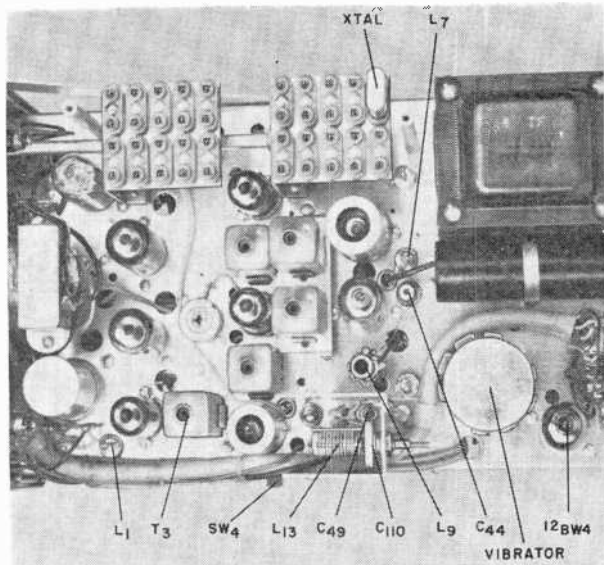

Fig. 9. Some instruction manuals for the Johnson "Messenger Two" refer to coil L13 as L113. In any case, they are the same. Before realigning this coil, remove the gunk that seals the core in place.

coil *L11* for maximum output. Starting with final loading capacitor *C73* at maximum capacitance, alternately decrease the capacitance of *C73* and peak plate tuning capacitor *C72* until the transmitter is fully loaded.

Johnson "Messenger Two." The Johnson "Messenger Two" is a ten-tube CB transceiver designed to operate from 117 volts a.c., as well as from 6, 12, or 24 volts d.c., depending upon the model. Only a new transmitting crystal and realignment are necessary to convert this unit to 10 meters. Make sure slide switch *SW4* on the side of the chassis is pushed to the rear; this control determines whether the receiver operates in the fixed or tunable mode.

The receiver is a single-conversion superhet with an i.f. of 455 kHz. Depending on which portion of the 10-meter band you want to cover, the oscillator may be set either above or below the desired tuning range. Before oscillator coil *L13* can be adjusted, some work must be done on it. Sufficient gunk has been used inside the form to make it impossible to tune the adjustment screw without breaking the form. To prevent the oscillator coil from being ruined, it is necessary to clean out the form and tune it from the inside. This method of tuning is possible because a grooved brass slug has been employed rather than one of ferrite or powdered iron.

Look at Fig. 9 and remove the 12BW4 and the vibrator at the rear of the unit, as well as the four screws which bolt the oscillator coil's supporting bracket to the chassis. Tilt the form slightly outward and clean out the gunk with a probe. A little alcohol might help to loosen the slug. Using a screwdriver inside

10-meter activity at the time you do the realigning—you simply tune the input circuits for maximum response to a 10-meter signal in the new range.

Only conversion information for tunable-receiver operation has been given below, since few amateur receivers are channelized. Once a CB receiver has been converted as described previously, its fixed-channel receiver facilities will no longer function on the Citizens Band even though they haven't been tampered with, since the receiver's input stage will have been tuned to 10 meters. If 10-meter fixed-channel operation is desired, the receiver crystals will have to be replaced with suitable crystals in the tunable oscillator range. Also, the fixed-channel oscillator coil will have to be retuned.

Transmitter Conversion. Do not convert your CB transmitter to 10 meters until after you have received your General Class license. Once you have your ama-

the form, carefully tune the slug in and out several times. After the core has been sufficiently loosened, replace the four bracket screws, vibrator, and tube. The adjustment screw may now be used to turn the core.

Set the receiver tuning capacitor at maximum capacitance and adjust *L13*, and *C110* if necessary, until the oscillator is tuned to 28.045 MHz. The receiver will now cover from 28.500 to 28.825 MHz. Set the receiver tuning capacitor at mid-range and apply an appropriate 10-meter signal to the antenna connector. Tune input circuit *L1* on the r.f. amplifier for maximum response. Also peak the r.f. amplifier plate coil and the mixer grid coil (top and bottom slugs of *T3*).

Remove the plastic crystal cover and replace the transmitter crystal with an FA-5 third overtone crystal in the 10-meter phone band. Peak oscillator plate coil *L7*. Then adjust final amplifier output network *L9-C49* for maximum output. Starting with loading capacitor *C49* at maximum capacitance, alternately decrease the capacitance of *C49* and peak *L9* until the amplifier is fully loaded.

Although the final uses a neutralizing capacitor (*C44*), no neutralizing adjustments are normally required. If the final amplifier happens to become unstable, it can be stabilized by adjusting *C44* until the grid voltage of the final amplifier stays constant, or nearly so, when *L9* is tuned through resonance. The grid voltage can be measured with a d.c. VTVM at pin 3 or pin 6 of the final amplifier by using an r.f. choke in series with the meter lead. If it becomes necessary to adjust *C44*, be sure to retune the output network after the amplifier is neutralized.

teur ticket, start the transmitter conversion by replacing the transmitter crystal with an appropriate unit for 10-meter operation. Although the replacement crystals listed are made by International Crystal Mfg. Co., other brands with the same mode, pin spacing, etc. can be employed. Next, make any component changes that are required. And before realignment is initiated, borrow or build an output indicator, such as an SWR bridge, and a 50-ohm, 5-watt (or more) dummy load.*

After the output indicator and dummy load have been attached to the transmitter, tune the oscillator coil for maximum output. Then open and close the microphone button or transmit switch a few times to be sure the oscillator always starts. If the oscillator stops working, detune the coil a little bit at a time until the oscillator operates every time the transmitter is turned on. Now ad-

**Your CB output meter will work on 10 meters without conversion.*

just the driver stage, if there is one, and the final amplifier stage for maximum output.

Check the modulation of the final amplifier. The output should increase with modulation. If it doesn't, go back and check all the circuits to be sure they are tuning correctly. A coil that appears to be on frequency may, in fact, be tuned only to a point of minimum or maximum inductance. If the stages are tuning as they ought to be, and the output drops when you talk into the microphone, perhaps the final amplifier is too heavily loaded for the amount of available drive. In this case, detune or unload the final amplifier until upward modulation is obtained.

Finally, it should be mentioned that, if you tune the transmitter for a frequency in the center of the transceiver's typical 350-kHz operating range, you will normally not have to readjust the transmitter for other frequencies in the same range.

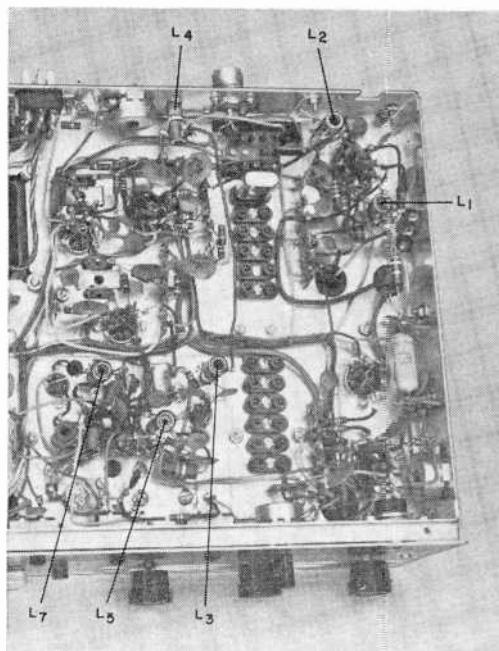

Fig. 10. It is really unnecessary to take the wrap-around cabinet off the Knight C-560—all of the adjustments required to convert this unit to 10 meters can be made through holes and removable panels.

Knight-Kit C-560. Designed to operate from 117 volts a.c. or 12 volts d.c., the Knight-Kit C-560 CB transceiver is one of the easiest rigs to put on 10 meters. In fact, all adjustments of this nine-tube rig can be made without removing the unit from its cabinet. This is possible due to the fact that there is a hole in the bottom of the case for each coil that needs to be retuned. For information purposes, the transceiver's innards are shown in Fig. 10. Before aligning the receiver, put the *Tune-Xtal* switch in the *TUNE* position.

The receiver is a single-conversion superhet with an i.f. of 1650 kHz. Set the receiver tuning capacitor at maximum capacitance and tune oscillator coil *L7* to 30.150 MHz. Note that the oscillator operates 1650 kHz *above* the desired tuning range. When tuned for the low end of the phone band, the receiver covers from 28.500 to about 28.820 MHz. Set the receiver tuning capacitor in the middle of its range and apply an appropriate signal to the antenna connector. Tune input and output coils *L3* and *L5* of the r.f. amplifier stage for maximum response.

Remove the crystal cover from the bottom of the transceiver and replace the transmitting crystal with a third-overtone FA-5 unit in the 10-meter phone band. Tune oscillator coil *L1* and final amplifier plate coil *L2* for maximum output. Adjust second harmonic trap *L4* for minimum interference to television Channel 2. This completes the rather simple conversion of the C-560.

(To be continued next month)

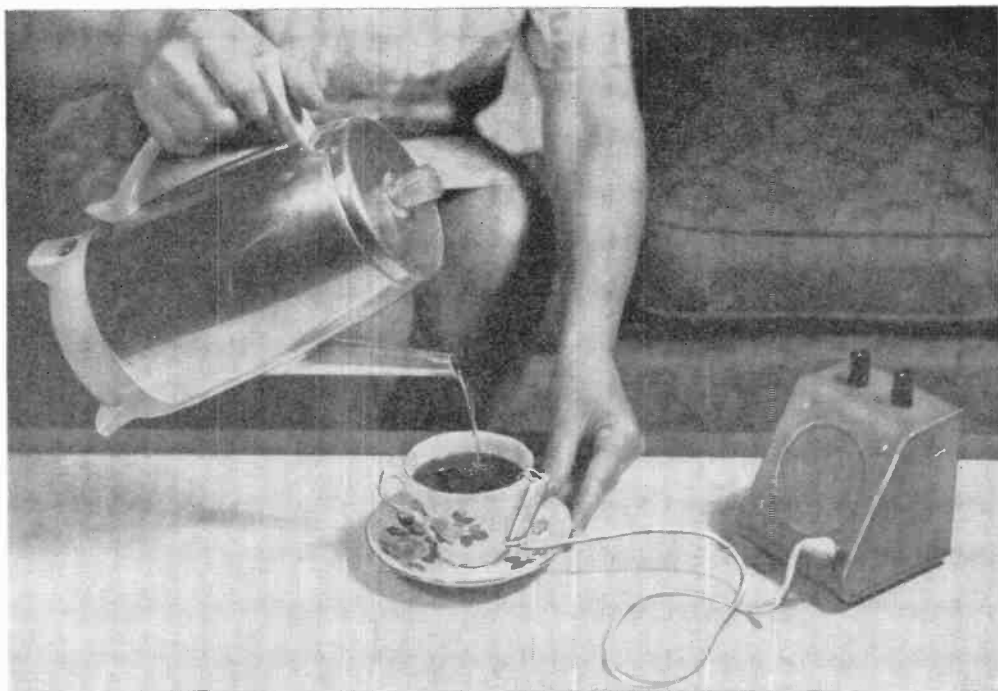

LIQUID LEVEL INDICATOR FOR THE BLIND

ELECTRONIC DEVICE LETS BLIND PEOPLE
POUR COFFEE, SOUPS, AND OTHER HOT
OR COLD LIQUIDS—WITH CONFIDENCE

WHEN YOU POUR steaming liquids into a cup or bowl, you know when to stop—unless you happen to live in the perpetual darkness of the blind. A continuity checker, rigged up with a suitable liquid-sensing probe which gives an audible signal when the cup is full enough, solves the problem admirably.

The simple neon lamp relaxation oscillator circuit presented here was devised by the author and has been used with much success by blind clients of the Bureau of Rehabilitation Services in Kentucky.* This level indicator is not only suitable for use with hot liquids, but with cold liquids such as milk or carbonated drinks—and even with spirits.

*The author serves as Director, Division of Services for the Blind, Bureau of Rehabilitation Services, Department of Education, Frankfort, Kentucky.

By **T. V. CRANMER**, K4MMB

The first circuit tested for this application was suggested by L. W. Butler of Milwaukee, Wisconsin. Mr. Butler used a single transistor in a conventional Hartley oscillator circuit with the sensing probe connected in the battery lead. This circuit worked well, but the audio level of the output was insufficient to permit its use in noisy surroundings.

Mr. Butler has since made a clever modification of a conventional pocket-size radio which gives a much better output. To make this modification, you need only feed the output from one side of the speaker transformer through a 100-pF capacitor through the probe to the center connection or wiper of the

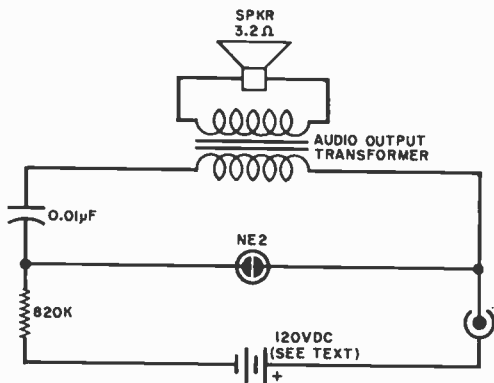

The value of the resistor can be either increased or decreased to respectively raise or lower the pitch or frequency of the tone heard at the speaker.

volume control. When the probe is in contact with a liquid, the feedback circuit is completed and the transistor radio goes into strong oscillation.

The neon oscillator circuit shown in the drawing has the advantages of low cost, high reliability, excellent output signal and negligible battery drain. Value of the resistor can be changed to vary the pitch of the sound output. Four small 30-volt batteries (Burgess U-240, or similar) can be used in series to power the circuit. The unit is housed in a 4" x 4" x 5" sloping panel meter case.

The probe can be made with a twin-lead Mosley 301 and 311 connector. One-half of the connector is attached to a flexible cord. A phono plug on the other end of the cord fits into a jack on the oscillator's case. The other half of the connector holds two horseshoe-shaped pieces of stainless steel rods having a diameter of about 0.050".

Suitable stainless steel wire for the probe can be obtained from dental supply stores. Two 2¼"-long pieces of this wire are needed. When each one is bent into the correct shape, the dimensions are: long leg, about ⅞"; short leg, about ¾"; crown (or width), about ½". You insert the short legs into the connector, and tighten the connector's setscrews. Then complete the assembly by plugging the two halves of the connector together.

This arrangement allows removal of the "business" end of the probe for occasional washing. In use, the probe is hung over the side of the cup or bowl.

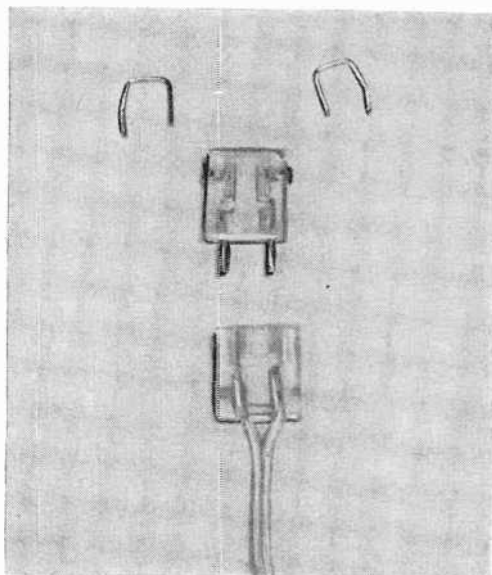

Two lengths of non-corrosive stainless steel wire make up the probe. These wires should be fitted into a suitable connector as shown and the whole assembly connected to two-conductor flexible wire.

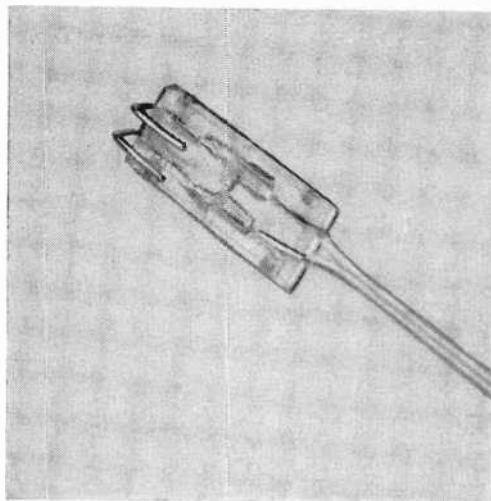

Some of the blind hams in Kentucky have built this equipment for themselves. There are many blind people, however, who have no technical background and would need help in building a liquid level indicator. If you have a blind friend, why not offer your assistance? Besides the satisfaction you would derive from such a gesture, you would help instill in your friend the one thing most needed by the handicapped—confidence.

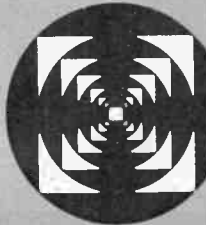

SHORT-WAVE LISTENING

By **HANK BENNETT**, W2PNA/WPE2FT
Short-Wave Editor

BROADCASTING STATION NEWS AROUND THE WORLD

THE SOVIET UNION has resumed full-time jamming of Red China's Russian-language broadcasts to Russia for the first time in two years—according to *Radio Liberty*, a privately owned organization which broadcasts in 17 languages to Russia. *Radio Liberty*, whose main studios are in Munich, Germany, stated that virtually all of the Communist Chinese broadcasts in the direction of Russia were affected. The Soviet Union's previous jamming campaign had ended soon after Nikita Khrushchev's fall from power in October, 1964.

A letter QSL from VSI8, Cable & Wireless, Mercury House, Grand Turk Island, notes that this station has a voice broadcast daily except Sunday at 1830 on 4560 kHz. Usually of 10-minute duration, the broadcasts cover local news and relay messages to the peoples of Turks & Caicos Islands. On Saturdays the transmissions run longer since there is a review of the week plus an occasional address by the Island Administrator. This station is listed as being 100 watts "on phone," which implies that it may also operate on CW at about 200 watts.

Radio 247, the British Broadcasting Corporation's answer to the pirate stations operating off the English Coast, was expected to begin operations "early in 1967," but plans now call for the new station to go on the air "when all of the pirate stations are silenced." *Radio 247*, with a tentative schedule of 0530-0200, will operate on 247 meters (1214 kHz). Future plans call for additional transmitters in the same service for coverage of the Midlands and southwestern portions of England.

All India Radio may be going commercial for the first time in its history. An Indian source has revealed that the Ministry of Information & Broadcasting has accepted the recommendations of the Chanda Committee relative to the introduction of commercial broadcasts on the station. These recommendations have been sent to the Cabinet for approval. If they are accepted by the Cabinet, the commercials will be introduced gradually through the "Vividh Barati" program.

The Swedish weekly publication *Vi* has a
(Continued on page 115)



John Zaharek, WPE1GUM (above), of Torrington, Conn., DX'es with a Lafayette HA-230 receiver. At the present time he has 44 countries verified (out of 64 logged) and 31 states and seven provinces verified. John's antenna is 100' long, 25' high.

As a retired seaman, Lester Nichols, WPE6IP, San Francisco, Calif., has the unique distinction of having visited most of the 20 countries he has verified to date. Lester's equipment includes a brace of E. H. Scott receivers, the SLR-F and the SLR-12-B, plus a Hallicrafters S-77A and a Drake SW-4.



**“Get more
education
or
*get out of
electronics***

...that's my advice.”

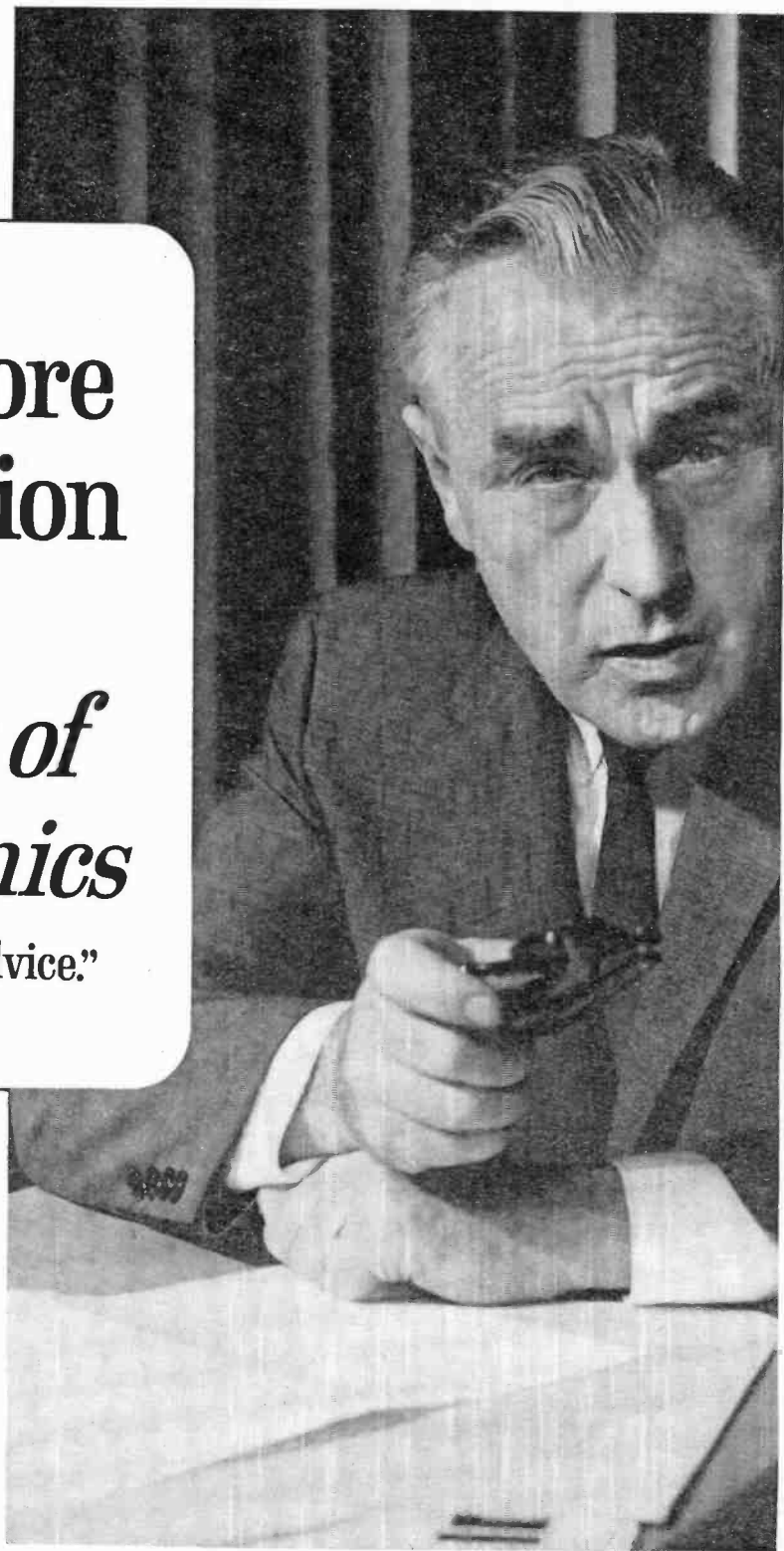



Ask any man who really knows the electronics industry.

Opportunities are few for men without advanced technical education. If you stay on that level, you'll never make much money. And you'll be among the first to go in a layoff.

But, if you supplement your experience with more education in electronics, you can become a specialist. You'll enjoy good income and excellent security. You won't have to worry about automation or advances in technology putting you out of a job.

How can you get the additional education you must have to protect your future—and the future of those who depend on you? Going back to school isn't easy for a man with a job and family obligations.

CREI Home Study Programs offer you a practical way to get more education without going back to school. You study at home, at your own pace, on your own schedule. And you study with the assurance that what you learn can be applied on the job immediately to make you worth more money to your employer.

You're eligible for a CREI Program if you work in electronics and have a high school education. Our FREE book gives complete information. Airmail postpaid card for your copy. If card is detached, use coupon below or write: CREI, Dept. 1205 E, 3224 Sixteenth Street, N.W., Washington, D.C. 20010.



The Capitol Radio Engineering Institute

Dept. 1205 E, 3224 Sixteenth Street, N.W., Washington, D.C. 20010

Please send me FREE book describing CREI Programs. I am employed in electronics and have a high school education.

NAME _____ AGE _____

ADDRESS _____

CITY _____ STATE _____ ZIP CODE _____

EMPLOYED BY _____

TYPE OF PRESENT WORK _____ GI BILL

- I am interested in Electronic Engineering Technology
 Space Electronics Nuclear Engineering Technology
 Industrial Electronics for Automation
 Computer Systems Technology

APPROVED FOR VETERANS ADMINISTRATION TRAINING

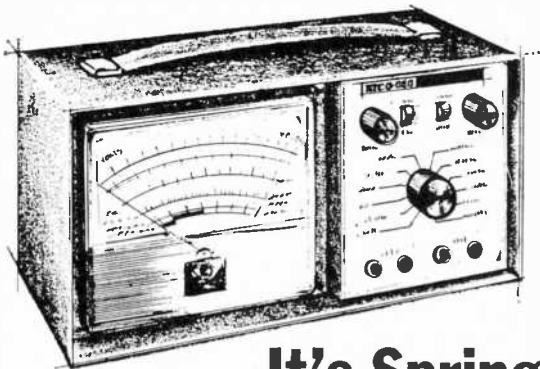

It's Spring Tune-Up Time

EICO*
AUTO ANALYZER KIT
CAN DIAGNOSE
ILLS OF YOUR OLD CLUNKER

If the above title sounds as if you've picked up another Ziff-Davis publication, CAR and DRIVER, don't be alarmed; you're still tuned to POPULAR ELECTRONICS. The month of May is usually associated with automotive spring tune-ups, and you can do the job easier and better with an electronic engine analyzer.

The EICO 888 "Solid State Universal Engine Analyzer" is a prime example of what you'll need to spot those ignition and carburetion problems. The 888 is sold as a kit for \$44.95, and a wired and tested model is available for \$59.95. The \$15 saving that results from wiring it yourself is worthwhile, since the kit can be assembled in about two evenings of casual soldering.

Of course, buying an engine analyzer presupposes that you know something about automobile engines, and know the difference between a needle valve and the alternator regulator. If so, be advised that the 888 reads dwell angle, r/min (two ranges—one range for setting the idle and the other range to check acceleration), voltage drop, alternator diode leakage, and spark output. It will also do some other things, like cutout relay checking, substituting a built-in capaci-



Control functions of the EICO 888 are grouped on the right-hand side of the sturdy instrument. The "FWD-REV" switch is for checking alternator diode leakage. The low voltage range (3.2 volts) comes in handy when you're looking for a voltage drop created by a poor electrical connection or excessive voltage drop across a cable.

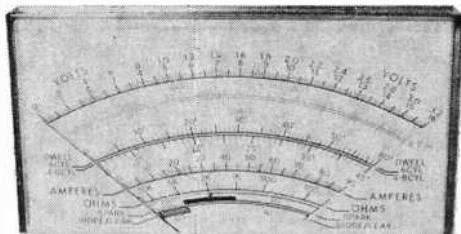

The multiple scales on the 888's meter may appear confusing at first, but the 6-inch breadth offers amazing readability even from three or four feet away. The scales are multi-colored.

tor for a possible defective "condenser" across the points, etc.

If you wire the kit, calibration is easy and direct (using either the 50- or 60-hertz a.c. power lines) because of a special probe supplied by EICO. In the POPULAR ELECTRONICS test, we found that the r/min calibration was slightly high at 500 r/min (our model read 520 r/min) and slightly low at 2500 r/min (our model read 2250 r/min).

We would be remiss not to compliment EICO on the inclusion of hundreds of car specifications in the 888 operating manual. This immediate, handy reference volume contains dwell, manual shift and automatic transmission idle specs on both American and foreign cars. —~~30~~

*EICO Electronic Instrument Co., Inc., 131-01 39th Ave., Flushing, N.Y. 11352.

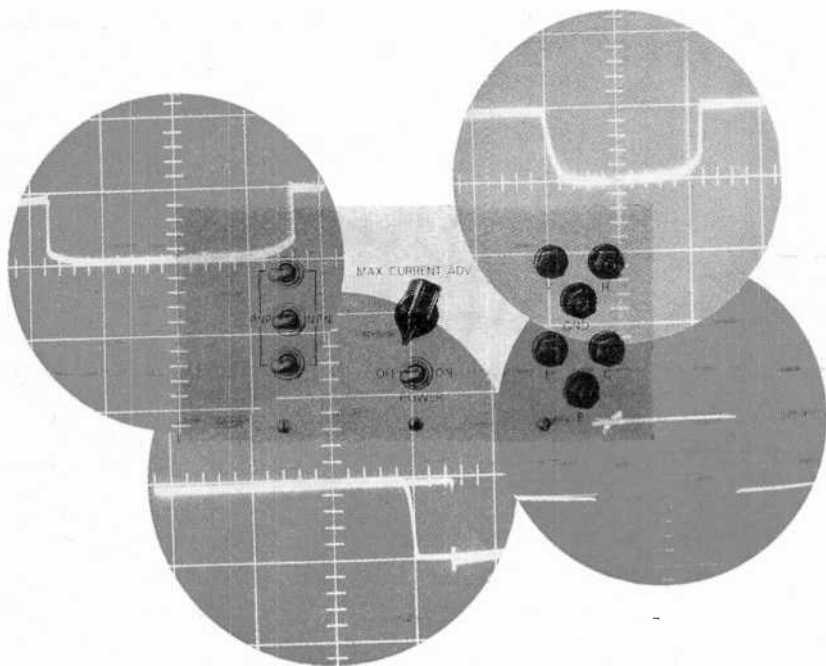

BREAKDOWN REVERSE VOLTAGE TRANSISTOR AND DIODE TESTER

FOR EACH different transistor parameter, there is a test procedure that can be set up and followed in order to predict a transistor's ability to live up to its specifications. While there are many different specifications for a transistor, not all of them must be up to par in any one application. For most applications, it is usually sufficient to know that a transistor will work in a given circuit, without being too concerned about the transistor's capabilities in excess of the circuit's requirements. Quite often you can take advantage of the commercially accepted tolerance of ratings by going through a batch of less expensive transistors and selecting those that will work in your circuit.

For example, if a transistor is rated to withstand a reverse voltage across the collector and base elements of, say, 100 volts, you wouldn't care whether or not the transistor breaks down at 75 volts when the most voltage it will see in a

NONDESTRUCTIVE
"ONE-SHOT"
SCOPE TECHNIQUE
USED TO
REVEAL SEVERAL
CHARACTERISTICS
AT ONCE

By **CHARLES D. RAKES**

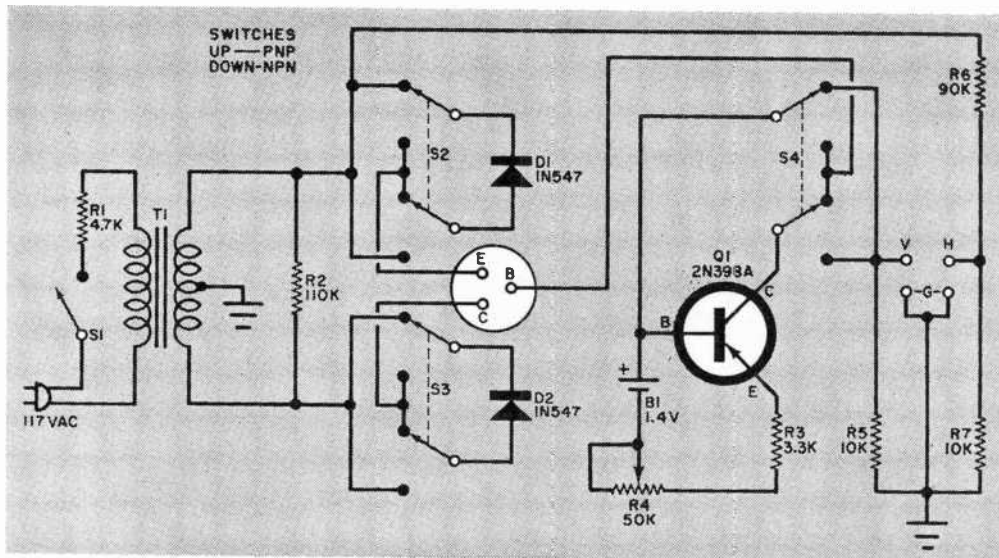

Fig. 1. Reverse voltage is applied alternately across the emitter-base junction and the collector-base junction of the transistor under test by the combined action of diodes D1 and D2 on the a.c. voltage from the transformer. Transistor Q1 acts as a current limiter. Potentiometer R4 can be adjusted to limit maximum current flow to a predetermined value. Zener diodes and other diodes as well as neon lamps can be checked out with this adapter. Output voltages are fed to an oscilloscope for interpretation.

given circuit does not exceed 9 volts. But you wouldn't want to put this transistor into a 90-volt circuit. By the same token, if the transistor checked out at 120 volts, there's no reason why you couldn't insert this component into a 110-volt circuit.

Many fine, inexpensive transistor testers are available that can predict gain and leakage, but none of them can tell you anything about the figure for reverse breakdown voltage. One way to check reverse breakdown voltage is to gradually apply an increasing amount of voltage until the transistor breaks down. Once you do that, you will know what the breakdown voltage is, and you will also have to junk the transistor. It's like testing a fuse to find out how much current it will take to make it pop. There is no trick to a destructive-type test and there is a point of no return that most of us would object to. The way to avoid destruction of solid-state components even in the presence of potentials in excess of the breakdown voltage is to limit the amount of current to prevent thermal runaway.

If you have an oscilloscope, you can take a page out of a transistor manufacturer's notebook; and if you build the simple, low-cost circuit presented here,

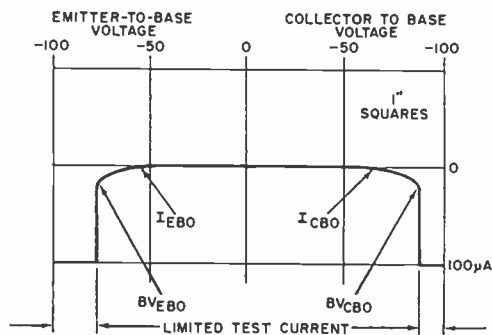

Fig. 2. Trace obtained when testing a good transistor can be analyzed as follows: left portion of curve shows what happens when reverse voltage is applied across emitter-base junction; right side indicates collector-base junction characteristics. Trace also shows cutoff and reverse current.

you can perform a non-destructive test to check both emitter-to-base reverse breakdown voltage, and collector-to-base reverse breakdown voltage. With this circuit, you will also be able to determine emitter cutoff current and collector cutoff current. All four of these parameters can be ascertained from a single scope trace, in a "one-shot" type of test. The procedure is rapid and lends itself to mass production techniques.

As a sort of bonus feature, this same

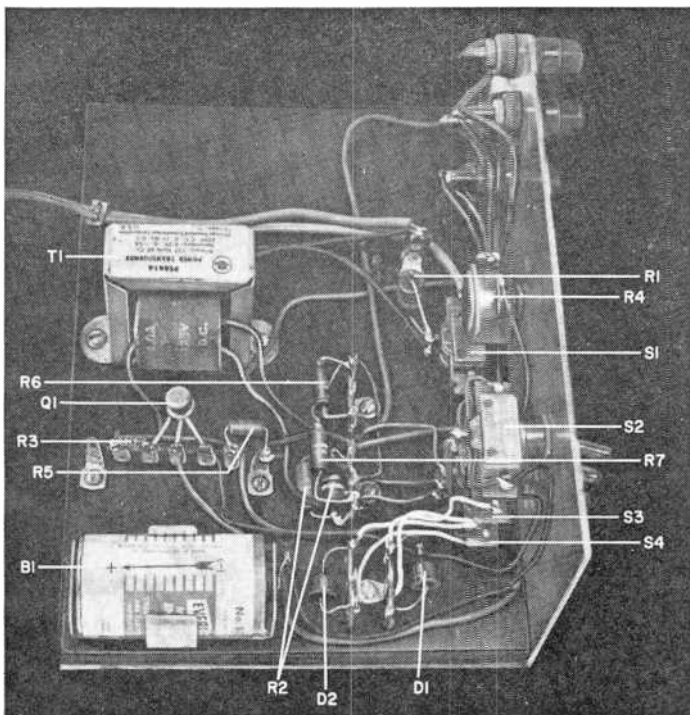

Fig. 3. Layout of components is not critical. Two resistors are shown connected in parallel to obtain proper value for R2. A 3-gang d.p.d.t. switch can be used instead of separate switches for S2, S3, and S4. Observe polarity of B1, D1 and D2.

PARTS LIST

- B1—1.4-volt mercury battery
 D1, D2—1N547 diode
 Q1—2N398A transistor
 R1—4700-ohm, 2-watt resistor
 R2—110,000-ohm, 4-watt resistor—see text
 R3—3300-ohm, 1/2-watt resistor
 R4—50,000-ohm potentiometer
 R5—10,000-ohm, 1/2-watt resistor
 R6—90,000-ohm, 1/2-watt resistor
 R7—10,000-ohm, 1/2-watt resistor
 S1—S.p.s.t. switch
 S2, S3, S4—D.p.d.t. switch
 T1—Power transformer: primary, 117 volts; secondary, 250 volts with center tap (Stancor PS8416, or similar)
 Misc.—Terminal strips, binding posts, chassis, hardware, etc.

test procedure will let you determine the zener voltage of zener diodes, the reverse breakdown voltage for low-peak-inverse-voltage diodes, and both the firing and holding voltages of neon lamps.

How It Works. With this test circuit, units under test are subjected to a maximum reverse voltage of about 100 volts. The "maximum-current" range is adjustable from approximately 20 μ A to 500 μ A. The amount of maximum current that

can be safely passed through the transistor under test depends upon the power that can be safely dissipated in the tested unit. If a large number of units are to be checked, the voltage and current limits can be grease-penciled on the oscilloscope screen for a quick go-no-go selection.

As shown in Fig. 1, switches S2, S3, and S4 are in the PNP position, and the anodes of diodes D1 and D2 are connected to the emitter and collector test jacks respectively. The base test jack is returned to ground through current sampling resistor R5.

The voltage developed across R5 is fed to the vertical input of the scope through test jacks marked V and G. The scope's horizontal sweep is controlled by the voltage that appears across the 10 to 1 voltage divider resistors R6 and R7 and which is fed out through the terminals marked H and G.

Emitter-To-Base Reverse Voltage. When the top of T1 goes negative with respect to ground, D1 conducts, and sends the emitter voltage (with respect to base) of the transistor under test in the nega-

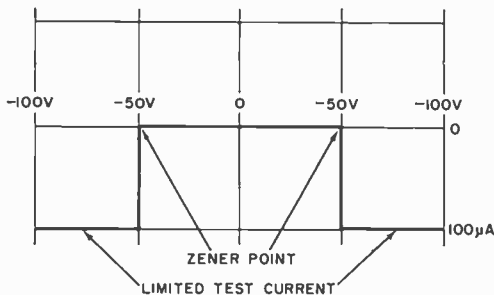

Fig. 4. Typical scope trace of good zener diode is shown here. Right half reveals same information as left half, and is actually redundant. Single-sided patterns can be just as easily obtained. See text.

tive direction and causes a downward deflection of the scope's trace when this voltage breaks through the emitter base junction. Keep in mind that this potential across the emitter and base is reverse voltage. Also, the voltage at the top end of $R6$ and $R7$ at this time is negative with respect to ground. As the voltage swings in the negative direction, the scope's spot travels from the center of the screen towards the left to display a horizontal trace.

The action of the scope's trace can be understood by an examination of Fig. 2. Note that as the negative horizontal voltage increases the reverse voltage across the emitter and base is also increasing, and at about 75 volts the curve drops sharply—this is the point of voltage breakdown.

During the time that the emitter-to-base-junction is subjected to this reverse

voltage, $D2$ blocks the collector current of the transistor under test and leaves the collector in an essentially open-circuited condition. This open-circuit condition satisfies one of the requirements for determining the specification for reverse voltage breakdown.

During the time that the applied voltage is in excess of the breakdown voltage, current is limited to prevent destruction of the component under test by the action of circuit $Q1$, $R3$, $R4$, and $B1$. Potentiometer $R4$ can be adjusted to increase or decrease the maximum current.

As the voltage across the secondary of $T1$ swings back to zero, the spot on the screen retraces its path, and returns to its central point on the zero reference line.

Collector-To-Base Reverse Voltage. When the polarity of the a.c. voltage across $T1$ reverses, a positive voltage appears across $R6$ and $R7$ and pulls the spot horizontally from the center of the screen to the right. The positive voltage on the cathode of $D1$ also blocks the emitter current of the transistor under test, effectively opening the emitter circuit. The negative voltage on the anode of $D2$ now completes the collector-to-base circuit through $Q1$. The trace on the right side of the scope indicates the collector-to-base reverse voltage breakdown. Here again the requirement for the third element in a transistor to be open-circuited when checking for reverse voltage breakdown is satisfied.

The same action takes place for an *npn* type of transistor except that the polarity of the reverse voltage is reversed and the deflection of the trace will be upward. Of course, switches $S2$, $S3$, and $S4$ are simultaneously flipped to the *NPN* position.

While the vertical deflection of the scope's beam is a function of the voltage drop across $R5$, the extent of this voltage drop depends upon the current through $R5$, the collector-to-base of $Q1$ and the transistor under test. If the vertical input of the scope is calibrated for 1 volt per inch, a 1-inch high trace represents $100 \mu\text{A}$ of current ($100 \mu\text{A} \times 10,000 \Omega = 1 \text{ volt}$).

The tilt on the left side of the trace (Fig. 2) shows emitter-to-base reverse

REVERSE VOLTAGE AND CURRENT CUTOFF PARAMETERS

BV_{CBO} : Collector-to-base d.c. breakdown reverse voltage with the emitter circuit open. Collector current (I_C) should be specified.

BV_{EBO} : Emitter-to-base d.c. breakdown reverse voltage with the collector circuit open. Emitter current (I_E) should be specified.

I_{CBO} : Collector d.c. current cutoff when the collector junction is reverse-biased with the emitter circuit open. Collector base voltage (V_{CB}) should be specified.

I_{EBO} : Emitter d.c. current cutoff when the emitter junction is reverse-biased with the collector circuit open. Emitter base voltage (V_{EB}) should be specified.

current while the tilt on the right side shows collector-to-base reverse current. In this idealized trace, reverse current becomes evident at about -60 to -70 volts, and increases gradually until the breakdown voltage point is reached. The breakdown point is also commonly referred to as the zener point.

(Note that the 0 to -50 volts per inch along the horizontal scale represents the inverse voltage across the transistor under test when the scope's horizontal input sensitivity (through the test circuit) is calibrated at 50 volts per inch. The voltage across the horizontal input has a linear relationship and is in step with the inverse voltage applied to the test transistor.)

Construction. Parts placement and layout is not critical. In Fig. 3, the test circuit is shown breadboarded on an $8\frac{1}{2}$ " x 6" piece of $\frac{3}{4}$ " plywood. The front panel is an $8\frac{1}{2}$ " x $4\frac{1}{2}$ " piece of 16-gauge aluminum. More compact construction can be obtained by using a 6" x 5" x 4" aluminum utility box. Ground only those points shown in the schematic (Fig. 1). Use spaghetti to insulate $Q1$'s leads.

A 2N398A transistor was chosen for $Q1$ because of its high collector-to-base reverse breakdown voltage rating. The transistor used in the project is rated at -105 volts, but actually checked out at -150 volts.

Although individual switches are used for $S2$, $S3$ and $S4$, you can substitute a suitable two-position rotary switch or stacked slide switch. The binding posts for the test transistor's connections and for the connections to the oscilloscope can be of any design. You may find it more convenient to add another ground post, or eliminate the terminals altogether and connect the leads that go to the scope directly to the circuit.

All parts used in the tester are standard. If you have any difficulty in locating a 110,000-ohm, 4-watt resistor for $R2$, you can connect two 220,000-ohm, 2-watt resistors in parallel.

Zener Diode Test. The curve shown for the zener diode (Fig. 4) can be obtained by connecting a jumper between the emitter and collector terminals (E and C) of the test circuit, and connecting the zener diode between one of these

terminals and the base terminal (B). The cathode lead of the diode goes to ground, and the switches are in the *PNP* position. If you reverse the diode's connections, and flip the switches over to the *NPN* position, the trace will go upward instead of downward. The test can be made either way.

If you do not use the jumper and connect only one side of the diode either to the emitter or the collector terminal, the left half or the right half of the trace will be obtained. Both halves of the trace contain the same information.

Neon Lamp Test. If a good neon lamp is connected between the base and collector test points, the curve shown in Fig. 5 will be displayed. Reading this curve is more or less self-explanatory. Here $S2$, $S3$, and $S4$ were set to the *PNP* position.

The accuracy of the test readings depends upon how accurately you calibrate the oscilloscope. Once the oscilloscope is correctly calibrated, no further scope adjustments are required.

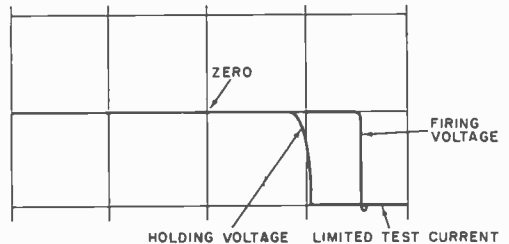

Fig. 5. Firing and holding voltage of a neon lamp can be predicted. If the scope's horizontal sweep is calibrated at 50 volts per inch, the neon lamp depicted here ignites at about 75 volts and stays lit until the potential drops to about 50 volts.

Scope Calibration. To adjust vertical sensitivity, apply a 1-volt peak-to-peak a.c. signal directly to the scope's vertical input, and adjust the vertical gain for a 1"-high pattern. This is all there is to the vertical calibration for a deflection of 100 microamperes per inch.

Horizontal sensitivity can be calibrated by applying a 5-volt peak-to-peak a.c. signal directly to the horizontal input terminals and adjusting the horizontal gain for a 1"-long trace. Because of the 10-to-1 voltage divider network in the test circuit, actual horizontal sensitivity will be 50 volts per inch.

THE ELECTRONICS COUNTERMAN

By WALT MILLER



"I foolishly suggested he try it out first—that was three days ago."

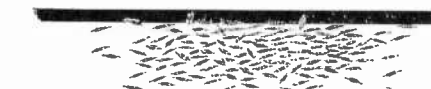

"Pardon the sneeze, Harry—I must be catching cold—you say there's a short count in that resistor order?"



"Nope, I can't sell it to you... a ham operator of your calibre deserves the quality and performance of this deluxe unit."



"We'll give you the best possible trade-in allowance on your old equipment—let's see, used copper wire is worth 30¢ a pound..."

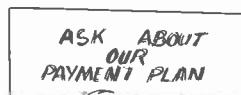

"Would you like to use our installment plan or do you prefer to take the receiver with you?"

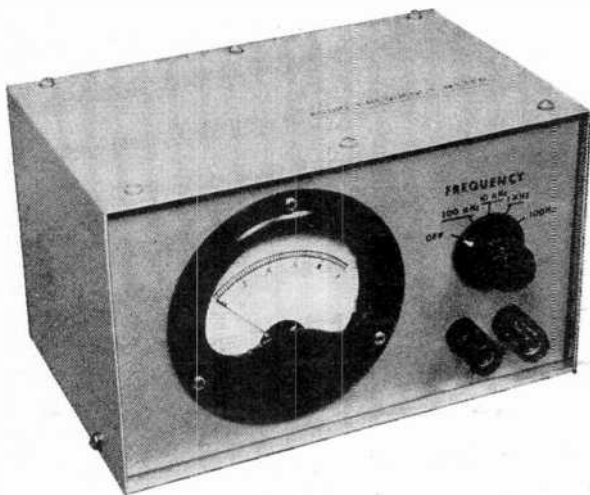

BUILD THE ELECTRONIC FREQUENCY METER

... AN IDEAL INSTRUMENT
FOR THE ACCURATE MEASUREMENT
OF AUDIO AND ULTRASONIC FREQUENCIES

By **WALT HENRY**

HERE'S AN ACCURATE, low-cost electronic frequency meter that's sure to delight the hearts of engineers, technicians, and experimenters alike. Direct reading, the instrument measures the frequency of audio and ultrasonic voltages from 100 hertz to 100 kHz, over wide ranges of input signal levels, and displays the frequency count on a front panel meter.

To measure an unknown frequency, you simply connect the signal source to the instrument's binding posts, rotate the frequency switch to the desired range, and presto! You read off the frequency from an expanded scale meter. Nothing could be simpler.

Fully transistorized and battery-operated, the audio frequency meter counts sine waves, square waves, or pulses. You can build it for less than \$30!

How It Works. The circuit (Fig. 1) consists essentially of a two-stage, high-gain squaring amplifier ($Q1$ and $Q2$), a regenerative switch ($Q3$ and $Q4$), a

single-stage meter amplifier/driver (*Q5*), and a milliammeter (*M1*).

An input signal at binding posts *BP1* and *BP2* is limited by diodes *D1* and *D2* before it is applied to the base of *Q1*, the first squaring amplifier. The limiter operates at signal levels between 0.5 volt peak-to-peak (0.17 volt, r.m.s.) and 85 volts peak-to-peak (30 volts, r.m.s.), thereby protecting the amplifier in the presence of large input signals, eliminating any need for an input level control.

Transistor *Q1* is biased by *R5* bypassed by *C3*, and its high-gain characteristics alternately drive *Q2* into saturation and cutoff, even with relatively low input signals. Thus, the waveform at the collector of *Q2* is essentially a square wave.

The square wave is then differentiated by the combination of resistor *R13* and capacitor *C4*, *C5*, *C6*, or *C7*, depending on the frequency range selected. The differentiator output is a series of alternately positive and negative spiked pulses that are applied across *D3* to trigger the multivibrator (*Q3* and *Q4*). The purpose of diode *D3* is to remove the negative portion of the pulses, so that only the positive spikes appear at *Q3*'s base.

In the absence of a trigger pulse, transistors *Q3* and *Q4* are in the saturated on state, and their output current biases *Q5* to off. When a trigger pulse arrives, however, *Q3* and *Q4* are turned off, the reverse bias on *Q5* is removed, and current flows from *Q5*'s collector through the meter. Once off, *Q3* and *Q4* remain off until the timing capacitor (*C8*, *C9*, *C10*, or *C11*) charges through its timing resistor (*R9*, *R10*, *R11* or *R12*) to turn on *Q4* again.

As *Q4* turns on, its collector current flows through the base of *Q3* and is amplified by this transistor. Amplification of *Q4*'s base current results in a further increase in collector current. Thus, a very fast regenerative switching action takes place as *Q3* and *Q4* turn on to discharge the timing capacitor and ready the circuit for the arrival of the next trigger pulse.

The current to the meter consists of a series of pulses at the collector of *Q5*. Pulse width will be constant on each range, but the higher the input frequency, the more pulses appear in a given time, and the average current is increased. The inertia of the meter move-

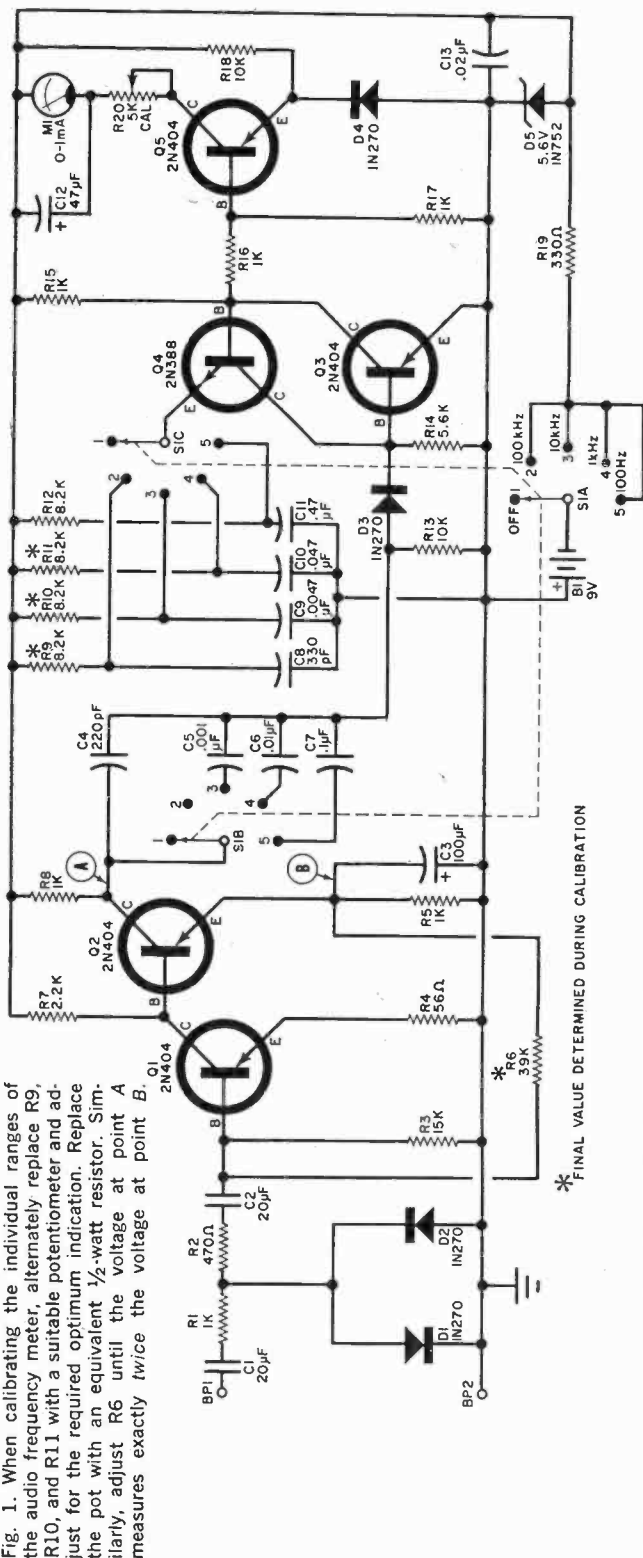

Fig. 1. When calibrating the individual ranges of the audio frequency meter, alternately replace *R9*, *R10*, and *R11* with a suitable potentiometer and adjust for the required optimum indication. Replace the pot with an equivalent 1/2-watt resistor. Similarly, adjust *R6* until the voltage at point A measures exactly twice the voltage at point B.

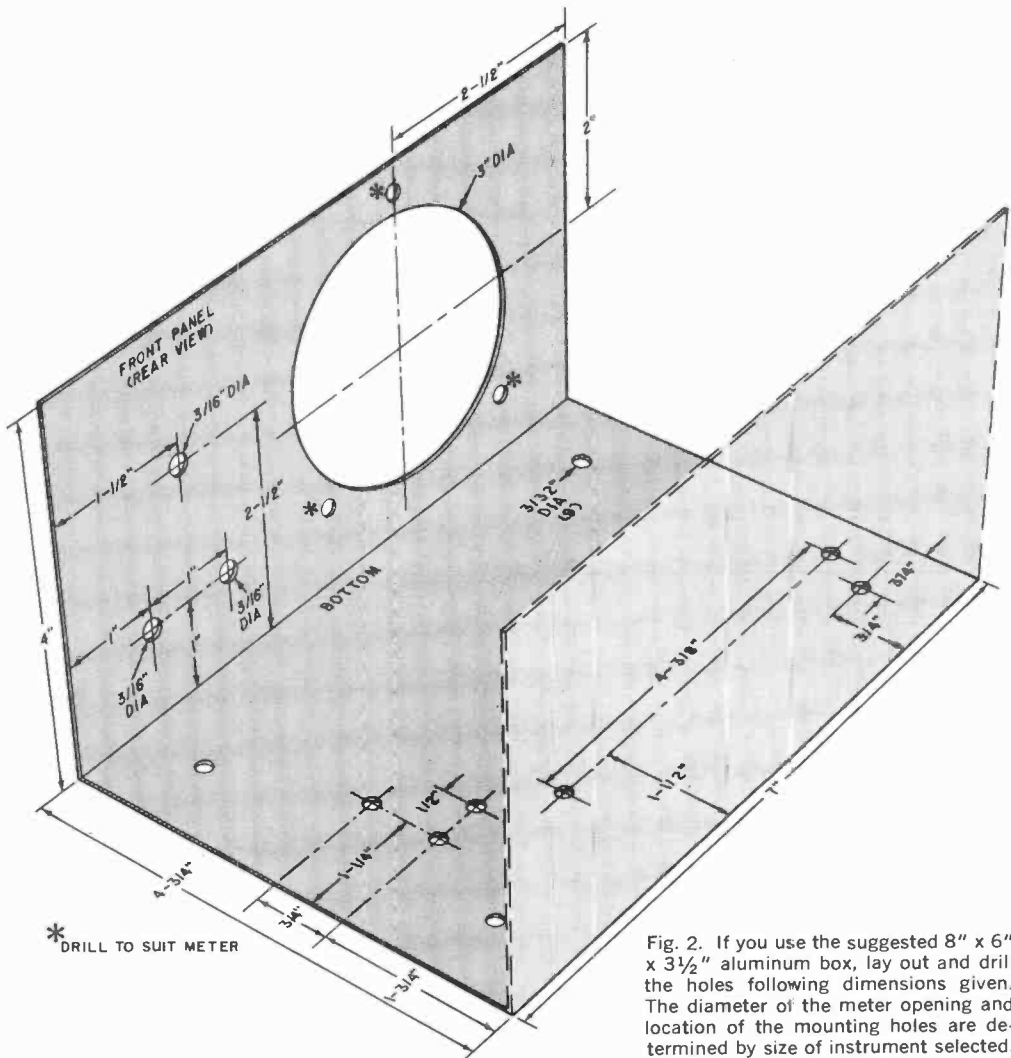

Fig. 2. If you use the suggested 8" x 6" x 3/2" aluminum box, lay out and drill the holes following dimensions given. The diameter of the meter opening and location of the mounting holes are determined by size of instrument selected.

PARTS LIST

B1—9-volt battery
 BP1, BP2—5-way binding post
 C1, C2—20- μ F, 30-volt non-polarized electrolytic capacitor (Cornell-Dublier BRNP 20-30, or similar)
 C3—100- μ F, 10-volt electrolytic capacitor
 C4—220-pF mica capacitor
 C5—0.001- μ F, 100-volt disc ceramic capacitor
 C6—0.01- μ F, 100-volt disc ceramic capacitor
 C7—0.1- μ F, 100-volt disc ceramic capacitor
 C8—330-pF, 100-volt mica capacitor
 C9—0.0047- μ F, 100-volt mica capacitor
 C10—0.047- μ F, 100-volt tubular capacitor
 C11—0.47- μ F, 100-volt tubular capacitor
 C12—47- μ F (or 50- μ F), 10-volt electrolytic capacitor
 C13—0.02- μ F, 100-volt disc ceramic capacitor
 D1, D2, D3, D4, D5—1N270 diode
 M1—0.1 mA milliammeter

Q1, Q2, Q3, Q5—2N404 transistor
 Q4—2N388 transistor
 R1, R5, R8, R15, R16, R17—1000 ohms
 R2—470 ohms
 R3—15,000 ohms
 R4—56 ohms
 R6—39,000 ohms—see text
 R7—2200 ohms
 R9, R10, R11, R12—8200 ohms—see text
 R13, R18—10,000 ohms
 R14—5600 ohms
 R19—330 ohms
 R20—5000-ohm potentiometer (Bourns 3067-S, or similar)
 S1—5-position, 3-pole rotary switch (Mallory 1325L, or similar)
 1—8" x 6" x 3/2" aluminum box
 Misc.—4-pin terminal strips (3), 4 3/4" x 2 3/4" perforated phenolic board, flea clips, battery holder, wire, solder, etc.

} All resistors
 } 1/2 watt, $\pm 10\%$

ment and the filtering action of *C12* cause the meter pointer to move smoothly rather than oscillate with the pulses. Potentiometer *R20* sets the basic calibration of the instrument.

Zener diode *D5* regulates the supply voltage so that an aging battery, for example, will not cause any abrupt change in the calibration of the instrument.

Construction. The ideal size enclosure for the radio frequency meter is an 8" x 6" x 3½" aluminum box. The meter, range switch, and input binding posts are mounted on the front panel, which can be laid out and drilled as shown in Fig. 2. The layout for the bottom plate shows mounting holes for four rubber feet, the battery holder, two terminal strips, and the phenolic circuit board which mounts the small parts.

A three-lug terminal strip, mounted on the range switch (see Fig. 3), serves as

potentiometers to achieve greater flexibility of adjustment during calibration. If you do use potentiometers, mount them on the circuit board instead of on the switch. Incidentally, the switch has five positions, although only four of these are used for range selection. The first position is your power on-off control.

Capacitor *C12* is mounted directly across the meter terminals; be sure to observe polarity. Except for input capacitor *C1*, coupling capacitor *C2*, resistors *R1* and *R2*, and diodes *D1* and *D2*—which are mounted on terminal strips—all other parts are assembled on a 4-¾" x 2-¾" perforated phenolic circuit board. Do not solder *R6* permanently in place at this time, since its value may have to be changed during calibration. Note that sockets are not required for mounting the transistors, although they were used in the author's model of the unit. Also, other high-gain, fast-switching transis-

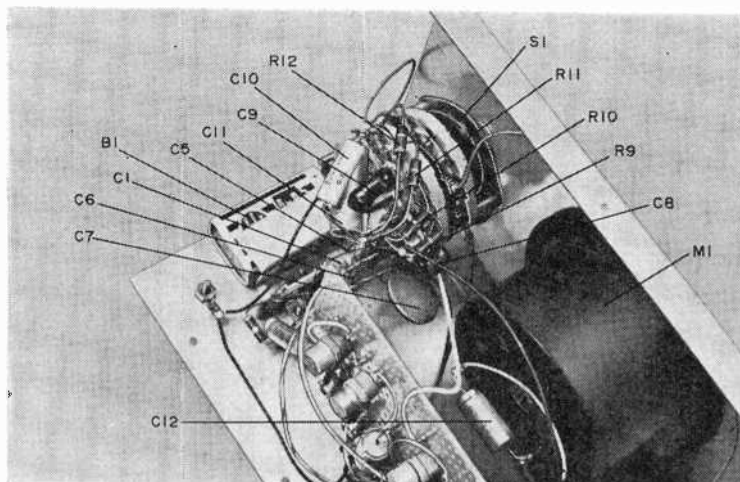

Fig. 3. The frequency-determining components can be assembled on the back of the switch, and the entire assembly mounted on the front panel.

connecting terminals for the timing resistors (*R9*, *R10*, *R11*, and *R12*) and capacitors (*C8*, *C9*, *C10*, and *C11*) as well as for the differentiator network capacitors (*C5*, *C6*, and *C7*), all of which are mounted on the back of the switch. However, the timing resistors should not be permanently connected to the switch until their final value has been determined during calibration.

A convenient, though more expensive, alternative is to replace the timing resistors with miniature-type 15,000-ohm

tors can be substituted for the types indicated.

After assembly, the board is mounted vertically on the chassis as shown in Fig. 4. But be sure to keep it at least a half-inch away from the back panel or other metal surfaces in order to minimize stray capacitance.

While, in general, the circuit layout is not critical, it is important that you isolate the leads to the amplifier input from those going to the meter, to prevent cross-coupling. Also, run ground leads

from the various points in the circuit to a single ground lug on the chassis. The lug can be secured under one of the screws.

Checkout And Calibration. After you have carefully checked all your wiring, insert the battery in its holder and turn the range switch to the 100-kHz position. The meter pointer should suddenly deflect up-scale and then settle down back to zero. With the positive lead of

be employed as a 60-Hz signal source.

The meter should give a reading when the test signal is applied to the binding posts. Adjust *R20* for a reading of exactly 0.6 on the dial. Thus, the range setting (100 Hz) times the meter reading (0.6) gives 60 Hz, the input frequency.

To calibrate the 1-kHz, 10-kHz, and 100-kHz ranges, you'll need an audio oscillator. However, to obtain an accurate calibration on each range, it will be necessary for you to adjust the value of the

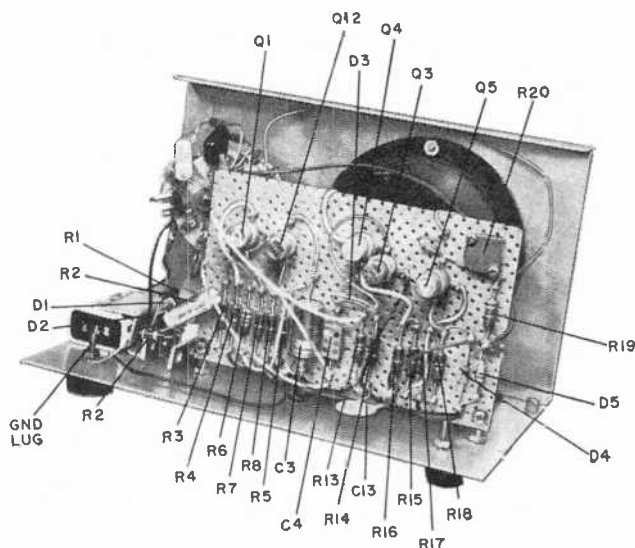

Fig. 4. When mounting the circuit board, position it at least $\frac{1}{2}$ " above bottom plate and away from back panel, to minimize stray capacitance.

your voltmeter at ground (chassis), measure the voltages at the emitter and collector of transistor *Q2*. Ideally, the voltage at the collector should be twice the voltage at the emitter, although in practice this ratio is difficult to achieve.

If this voltage ratio cannot be achieved, within reasonable limits, alternately lower and raise the value of *R6* as necessary. Once the final resistance value has been determined, solder this resistor in place permanently.

Now set the range switch to the 100-Hz position and connect a 60-Hz signal across the input binding posts. An accurately calibrated audio signal generator can be used as the signal source, but the signal amplitude should be at least 1 volt peak-to-peak (0.4 volt r.m.s.). A 6- or 12-volt filament transformer connected to the a.c. power line can also

timing resistor for each range. Thus, *R9* is adjusted for the 100-kHz range calibration, *R10* for the 10-kHz range, and *R11* for the 1-kHz range. If potentiometers are used in place of resistors, calibration will be quite simple.

Operation. To operate the audio frequency meter, simply connect the signal whose frequency is to be measured to the input binding posts. *Caution:* Since the input capacitor, *C1*, is rated at 30 volts, do not apply higher level signals to the instrument.

Turn the range switch clockwise from *off* until you get a meter reading between 0.1 and 1.0. The exact signal frequency is determined by multiplying the reading indicated by the setting of the range switch. After use, turn off the instrument to save the battery. -30-

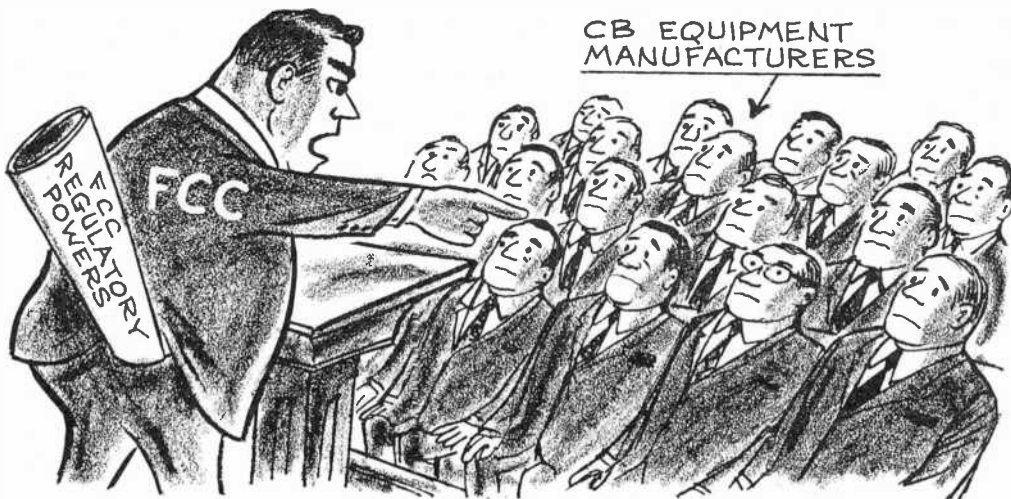

"SHAME ON YOU FOR MAKING THE CB MESS!"

FCC Proposes CB "Type Acceptance" Manufacturers Blamed for CB Malpractices

IN A sudden—but not unexpected—move, the Federal Communications Commission has proposed (Docket No. 17196) that at some not too-distant date all new CB transceivers be "Type Accepted." This announcement was made on February 17 at a meeting in Washington, D.C., called by the FCC to discuss the CB "mess" with CB equipment manufacturers.

Type acceptance is a formal FCC method of controlling the manufacture of transmitting equipment.* If the proposal becomes law, the FCC would check out the operating characteristics of sample CB transceivers submitted to the FCC by the manufacturers. Approval by the FCC would be required before a CB unit could be offered for sale to the general public.

With regard to CB equipment now in use, the FCC docket proposes that all transceivers have a five-year life, or amortization period. In addition, the new rule would allow a six-month period after finalization of the rule change wherein manufacturers of CB equipment could dispose of stock on hand that might not meet "type acceptance."

What New Equipment Will Be Like. One of the greatest surprises to the manufacturers

*Type acceptance is not something created just to bedevil CB'ers. Type acceptance of transmitters is presently required for all radio services except CB and ham radio.

attending the February meeting was the "specifications" for type acceptance. Practically all "frills" would be swept off the faces of the new CB transceivers.

The *ONLY* external controls accessible to the user would be: the a.c. or d.c. power plug, microphone connection, antenna connection, on-off switch and volume control, channel selector switch (with a maximum selection of 23 channels), transmit-receive switch, and a switch to enable the use of the modulator amplifier for public address.

Missing from CB transceivers under type acceptance would be the following typical controls: squelch (!), S-meter or any type of r.f. output meter/indicator, connections for selective calling, fine or "delta" tuning control, r.f. gain or tone controls, panel crystal socket, voice enhancement switch or control, earphone jack, etc.

Manufacturers were given until March 27 to file comments on the proposed docket. As this magazine went to press, no manufacturer had been able to formalize objections to some of the proposed changes.

The Manufacturers Did It. Attending the Washington meeting were representatives of practically all the major CB equipment trade papers. The FCC had called the meeting to discuss with equipment manufacturers improved compliance by CB users to the Part 95 CB Rules and Regulations.

As the 75 attendees of the meeting sat in

somewhat stunned silence, it was apparent that all of those present were being blamed for every ill to befall CB—including what the CB user says on the air and exactly how the CB'er uses his equipment! Although many of the attendees made various suggestions and offers of cooperation—if the FCC would provide guidelines—this part of the meeting accomplished little.

The Walkie-Talkie Gossip. Almost as an afterthought, the FCC announced at the Washington meeting that newspaper and magazine stories concerning an impending frequency change for the 100-milliwatt walkie-talkies were not true. Although the problem (if there really is one to begin with

—Ed.) of interference between the 5-watt CB transceivers and walkie-talkies is being studied, no "imminent" change in the appropriate Part 15 Rules and Regulations was foreseen.

Heath Asks for Kit Recognition. In a separate action, but noted by the FCC in the proposed type acceptance docket, the Heath Company has filed a petition requesting a special exception for CB gear assembled by kit builders. As implied above, the type acceptance proposal would eliminate all CB transceivers not produced under the direct control of a specific manufacturer. No allowance is made in the present proposal for CB transceiver kits. —30—

EDITORIAL COMMENT

In this latest "Proposal for Rules Making" to straighten out the "mess" on the CB channels, the FCC has backed itself into an unenviable position. CB is big business and the public has invested well over a half billion dollars in CB equipment. Industry figures show that twice as much money is spent on CB as on ham radio. CB—as we know it right at this moment—can never be disbanded by the FCC.

Isn't it time that the FCC took a long, hard, serious look at CB as it really is? Piecemeal legislation and rule changes cannot resolve the problems afflicting CB. The FCC has been victimized by its own poor planning and appalling disinterest in the wants or desires of hundreds of thousands of the very citizens it supposedly represents.

Continual "re-interpretations" of the CB rules will not solve the basic problem of how to "police" the CB'ers already on the air. Cer-

tainly the FCC doesn't seriously envision the day when CB will be legislated out of existence. What does the FCC think would happen to all that equipment? Wouldn't the "policing" problem become a national scandal if the CB rules were suddenly junked?

The CB equipment manufacturers did not "create" CB. In fact, for the most part, the equipment manufacturers have had little to do with or to say about the CB rules. It seems rather ironic that the FCC finds it apparently impossible to shoulder the burden of guilt for the so-called CB "mess."

Isn't it time the FCC recognized that there are only two feasible solutions to the CB problem? The FCC can either legislate the CB hobbyists to a new band of radio frequencies; or move the legitimate—but abused—CB user to a new, small business band.

OLIVER P. FERRELL, KOD3631



ELECTRONICS I.Q. QUIZ

By **ROBERT P. BALIN**

Each of the sketches (A-I) below can be directly associated with a single digit (1-9) that helps to describe its purpose, or interprets its function. For example, in the sample sketch (X), the silver band on the resistor indicates a tolerance of $\pm 10\%$. If you answer 9 out of 9, you're a genius; 7 correct answers is about average.

(Answers appear on page 104)

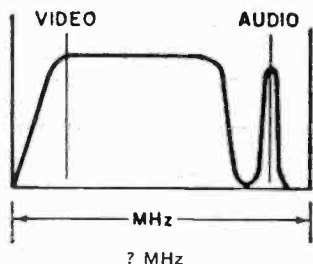

A



X

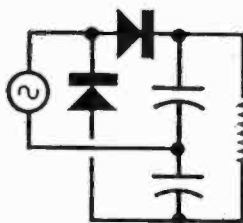

B

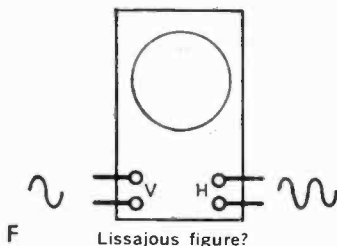

F

Lissajous figure?

1 _____

2 _____

3 _____



Morse code digit?

C

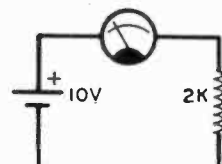

G

$I = ? \text{ mA}$

4 _____

5 _____

6 _____

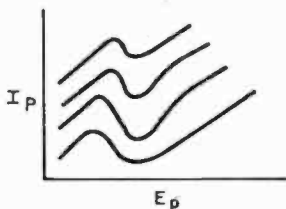

Tube type?

D



H

Binary readout?

7 _____

8 _____

9 _____

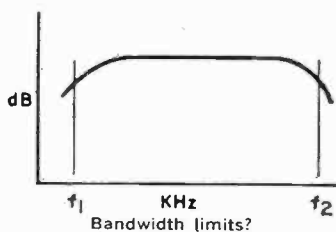

E

I

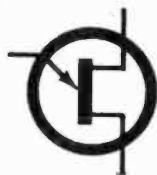

Number of junctions?

10 X



INFORMATION CENTRAL

By CHARLES J. SCHAUERS, W6QLV

JUST AS there is no 100% typical reader of POPULAR ELECTRONICS, there is no typical question being asked your *Information Central*. Questions that have been arriving at my desk range from the very simple to some of the most complex—as a matter of fact, they are occasionally so involved that an electronics research and development laboratory would have difficulty solving the problems.

I continue to be pleased by the very favorable response to this new department. To date, the majority of questions that I have received have been thoughtfully presented and appear to be sincere queries about perplexing problems. Although I conducted a column similar to this one for many years in a ham radio magazine, I freely admit that the POPULAR ELECTRONICS reader offers a much greater challenge.

Keep sending your questions to *Information Central*, % POPULAR ELECTRONICS, One Park Avenue, New York, N.Y. 10016. I want the editor to think that this department is a success!

Ferrite Beads. *I understand that ferrite beads can be used for r.f. decoupling, r.f. shielding, and even parasitic suppression. Do you have any information on them?*

Ferrite beads have not been used in too many ham applications, but they are amaz-

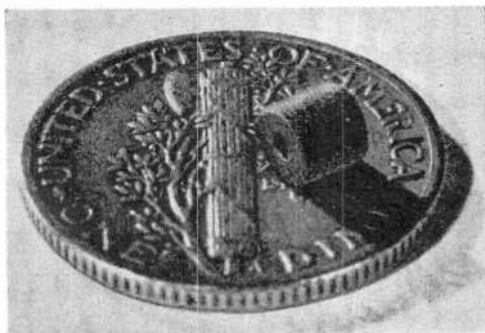

ing little devices. Each bead acts like an r.f. choke, and when strung on a connecting lead—say in a power supply or an audio circuit—it imposes a high impedance along the r.f. path. When there is an undesirable r.f. signal traveling along a low-impedance

path, the ferrite beads can do a remarkable job of “stripping” the hash. They can also be used in grid circuits of r.f. amplifiers to make neutralization easier or even to keep r.f. out of a high-gain audio circuit.

If you want to experiment with ferrite beads, write to Ami-tron Associates, 12033 Otsego Street, North Hollywood, Calif. A dozen or so beads will probably cost you about \$2.00.

TVI Elimination. *I have tried just about everything to eliminate the TVI caused by my ham rig on neighboring TV receivers, but there is still a little cross-hatching that defies all my efforts. I have a 3-element, 3-band trap beam antenna fed with 52-ohm coax. Is there any last-resort TVI elimination measure I could take?*

Each situation requires a different type of treatment, but there is one thing that has helped me. Try a 1:1 balun right at your antenna. The balun should be a 52-to-52-ohm unit and must be encapsulated against the weather and large enough in power-handling capacity to suit your rig.

Tape Recorder Hiss. *My solid-state tape recorder has developed an excessive hiss. This becomes unbearable when the tone control is turned into the treble range, and even when the volume is increased above average room level. Is there any kind of a filter that I could place between the tape recorder output and my speaker system?*

Rather than try to insert a filter, I would look for three possible causes of your problem. In order of likelihood, first I would make sure that the playback head was demagnetized. Some tape recorders need head demagnetization every five or six weeks, depending on use. A second possibility concerns the tweeter level of your speaker system. Has the level been changed or accidentally set too high? Finally, you might have a very noisy transistor in the playback amplifier, but this is very unlikely.

Van de Graaff Spheres. *I built a 300,000-volt Van de Graaff electrostatic generator for a Science Fair project, and I need a large aluminum sphere for the top of the column. I can't buy one and no one seems to advertise them. What do I do?*

You can buy spun aluminum spheres from Morris & Lee, 1685 Elmwood Ave., Buffalo, N.Y. 14207. This company specializes in Science Fair project materials and sells spheres (either copper or aluminum) at about \$1 per inch of diameter.

Generator Whine. *My car uses a regular d.c. generator (not an alternator) and the "whining sound" coming over my CB rig is driving me crazy. I have tried bypassing the generator leads, but this has provided only a partial solution to my problem. Is there any 100% foolproof method of eliminating the whine?*

I think so, but your letter doesn't indicate whether you used a coaxial capacitor in series with the armature lead to the generator. You must use a coaxial capacitor since the usual automotive type of capacitor is not too effective in suppressing this whine around 27 MHz.

If bypassing is not the answer, buy or build a wave trap and place it in series with the armature lead. The trap should be tuned to the CB channels that you want to hear.

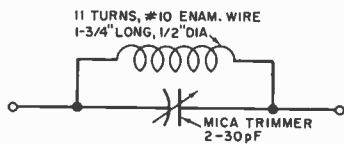

Allied Radio catalogs such a trap as 17A8512 (\$2.35) and Lafayette Radio Electronics has one under catalog number 99C6018 (\$2.49).

Some generators may require an additional 0.01- μ F metal-cased tubular capacitor from the hot brush of the generator to ground.

Hammarlund HX-500 VOX Hang-On. *My HX-500 transmitter has been exhibiting VOX relay hang-on. This is something new to me, so where should I look first to locate the trouble?*

User reports on this transmitter indicate that the condition can almost always be cured by merely replacing the 6U8 tube (V-8 on the schematic) with a quality 6U8A tube.

"Apache" Heating. *I am stationed in Germany with the Armed Forces and have my "Apache" TX-1 Heathkit transmitter on the air. The power transformer is really heating up. I am surprised that the 50-cycle current would cause this much heating. Is there anything I can do about it?*

This is strange, for I once operated an "Apache" transmitter on 50 cycles without undue heating. The 10-cycles difference can

cause overheating if the transformer is operated in excess of its ratings. Have you tried keeping your input down to a maximum of 110 volts? And how about the oscillator filament transformer. Does that heat up? If the filament transformer does not overheat, the problem could be in your power transformer, although I doubt it. There is also the possibility of getting a transformer wound for 50-cycle operation; there are many shops in Germany that can do this for you.

The "Official" Ten Code. *I know that CB'ers "lifted" the Ten Code from the police, but how much difference is there between the "Official" Ten Code and the code used by CB'ers?*

Actually, there is quite a bit of difference and if you're involved in emergency communications, be careful if you attempt to use the Ten Code. For example, 10-10 on CB means standing by, but the police signal means that a fight is in progress; 10-11 among CB'ers means speak slowly, but the police know that it means "dog case." In fact, a quick comparison between the CB Ten Code and the police "official" ten signals indicates that less than half of the police signals are applicable to CB and over two-thirds of the police signals are not the same as the CB Ten Code.

Tape Recorder Connection. *I have a medium-priced tape recorder with only a microphone input, and I would like to make tape recordings from my radio. What must I do?*

Locate the volume control in your radio and bring out a shielded lead (with appropriate microphone connector) with the center conductor in series with a 0.01- μ F ceramic capacitor attached to the top terminal on the control. Connect the shield to the bottom of the control.

SWL Receiver Improvements. *I have a \$60 short-wave receiver and I would like to improve the sensitivity so that I can hear some of the DX in the 16- and 19-meter bands.*

The SWL receiver that you have has no r.f. stage and would be vastly improved if you could add an outboard preselector or r.f. amplifier. Your best bet would be to build the nuvistor cascode preamplifier sold by AMECO as Model PCL-P. This unit includes a built-in power supply and sells for under \$35. Holstrom and Lafayette sold SWL'ing preselectors some years ago, but I no longer find them cataloged.

SB-33 Transistor Replacement. *I own a second-hand SB-33 transceiver which is giv-*

ing me excellent service except that the T6417, 2N1727 and 2N1867 transistors are below par. Are there any recommended substitutions?

All the transistors mentioned can be replaced by the Amperex 2N2672. Also, in your transceiver, the T6126 transistor can be replaced with a 2N1304 or 2N1700. A 2N1305 can be used to replace the T2515 transistor.

Aquarium Neon Noise. *I am positive that it is the neon bulbs in my aquarium heaters that are interfering with the radio reception. Is there anything I can do to eliminate this noise?*

Generally speaking, the elimination of neon fixture noise is difficult because of the lack of space in which to mount the necessary suppression components. However, try two 0.01- μ F ceramic capacitors tied in series across the heater a.c. line input. The center connection of the two capacitors should be grounded to the metal fixture frame.

If this doesn't work well enough, try the filter shown in the accompanying diagram.

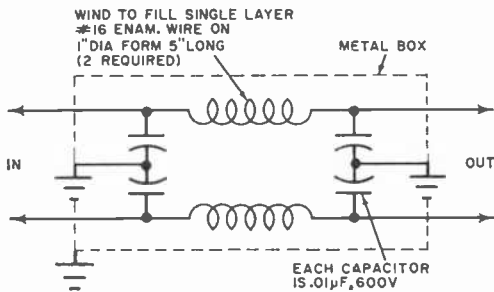

Mount the filter components in a small metal box and run an inconspicuous grounding lead between the aquarium heater metal fixture and the metal box. If this improves things, but does not completely eliminate all of the interference, try using some fine wire mesh copper screen to shield the neon bulbs in their metal enclosure. The screen will shield out the r.f., but allow the light to come through.

Do-Everything FET. *Is there any such thing as a universal field effect transistor? I am looking for a FET that will work in any frequency range from 1 Hz to maybe 400MHz. Any suggestions as to where I can obtain one.*

Yes, I would suggest that you try the 2N4416 FET made by Union Carbide. The manufacturer claims that it will replace 80% of all currently available FET's. For additional technical data, write to Untion, 365 Middlefield Rd., Mountain View, Calif. 94040.

EICO 753 Modification. *I have an early model of the 753 transceiver that I bought from a friend. I am experiencing the following difficulties: the set has a very low output and it is hard to adjust the final power amplifier bias, and there appears to be frequency instability with FM and chirping of my CW signal. Has any information been released on these problems?*

Yes. Your first problem will be solved if you replace the final amplifier 6DQ6B tubes with factory replacements. Your second problem can be resolved with the addition of a zener diode, a resistor, and a change in capacitor type and value if you have a vacuum-tube-operated VFO. A solid-state VFO with instructions for installation is available. However, I would suggest that you write to EICO, 131-01 39th Avenue, Flushing, N.Y. 11354 (Att.: Service Department) for exact modification information.

CB FM'ing. *I have a couple of popular CB rigs. One is my base station and the other two are mobiles. Oddly enough, one of the mobiles works fine, but the other has distorted modulation and FM'ing. What do I look for?*

If both of your mobile rigs are solid-state and one works, but the other doesn't, I'd suspect "downward" modulation. Some of the older transistorized CB outfits were notorious for their inability to maintain sufficient drive to the final amplifier. When the drive is low, the modulation peaks go down rather than up. Read the article in the April issue of POPULAR ELECTRONICS (page 72) on CB tune-ups. There's one CB rig that has a 6-watt output (illegal), but the modulation is all downward.

SWL'ing and BCI. *I have a National NC-121 receiver and the local broadcast stations (each a half-mile away on opposite sides of my location) produce harmonics all over the dial. Can I trap these stations out?*

There's no doubt you're suffering from r.f. saturation (probably in the a.c. power lines) and there's little you can do. Unfortunately, the NC-121 has no r.f. stage; unless you put in a selective (tunable) r.f. preselector and filter the a.c. lines, you're licked.

Tape Recorder Auto-Cueing. *How about some plans for automatically cueing my tape recorder?*

Sorry, Mister, but the first thing you need is a good tape recorder and your \$60 unmentionable is not in that ball park. To make auto-cueing work, you've got to record a tone signal between 16,000-17,000 hertz—your recorder would be lucky if it got close to 11,000 hertz.

FOREIGN-LANGUAGE BROADCASTS TO NORTH AMERICA

Prepared by **BILL LEGGE**

LANGUAGE	STATION	Time—EST	Time—GMT	Frequencies (MHz)
ARABIC	Beirut, Lebanon	9-9:30 p.m.	0200-0230	11.76
	Cairo, U.A.R.	6:30-7:30 p.m.	2330-0030	9.475
BULGARIAN	Sofia, Bulgaria	8-8:30 p.m.	0100-0130	9.70
CHINESE	Peking, China	8-10 p.m.	0100-0300	12.01, 15.095, 17.795
		10-12 p.m.	0300-0500	9.48, 12.01, 15.08
CZECH/SLOVAK	Prague, Czechoslovakia	8:30-9 a.m. (Sun.)	1330-1400	15.285, 17.825
		10-10:30 p.m.	0300-0330	5.93, 7.345, 9.55, 11.99
DANISH	Copenhagen, Denmark	8-8:45 p.m.	0100-0145	9.52
DUTCH	Brussels, Belgium	6:15-8 p.m.	2315-0100	11.85
	Hilversum, Holland	9:30-10:50 p.m.	0230-0350	9.59
FINNISH	Helsinki, Finland	7:15-10:10 a.m.	1215-1510	15.185
FRENCH	Brussels, Belgium	6:15-8 p.m.	2315-0100	11.85
	Lisbon, Portugal	9:15-10 p.m.	0215-0300	5.985
	Paris, France	7-7:30 p.m.	0000-0030	9.755, 11.845
	Rome, Italy	8:20-8:35 p.m.	0120-0135	11.81, 15.385
GERMAN	Vatican	8:10-8:25 p.m.	0110-0125	7.27, 9.645, 11.76
	Berlin, Germany	8:30-9:30 p.m.	0130-0230	9.73, 11.92
	Cologne, Germany	7-10 p.m.	0000-0300	6.10, 9.545, 11.795
		10 p.m.-1 a.m.	0300-0600	6.10, 9.64, 11.795
HUNGARIAN	Budapest, Hungary	7-7:30 p.m.	0000-0030	9.833, 11.91
		9-10 p.m.	0200-0300	9.833, 11.91
ITALIAN	Rome, Italy	5:30-8 p.m.	2230-0100	11.81, 15.385
JAPANESE	Tokyo, Japan	7:15-7:30 a.m.	1215-1230	9.505, 11.815
		8:30-9 p.m.	0130-0200	15.135, 15.235, 17.825
LITHUANIAN	Vilnius, U.S.S.R.	5:30-6:30 p.m.	2230-2330	9.745, 11.79
NORWEGIAN	Oslo, Norway	10-11:30 a.m.	1500-1630	15.175
		6-7:30 p.m.	2300-0030	11.85
PORTUGUESE	Lisbon, Portugal	7-9 p.m.	0000-0200	6.025, 6.185, 9.68
		9:45-11 p.m.	0245-0400	6.025, 6.185, 9.68
RUMANIAN	Bucharest, Rumania	6:15-7 p.m.	2315-0000	9.57, 11.94, 15.38
		10:30-11 p.m.	0330-0400	9.57, 11.94, 15.38
RUSSIAN	Moscow, U.S.S.R.	7 a.m.-12:30 p.m.	1200-1730	15.135
		6:30-7 p.m.	2330-0000	9.685, 11.955
		8:30-9 p.m.	0130-0200	9.685, 11.955
SPANISH	Buenos Aires, Argentina	8-9 p.m.	0100-0200	9.69
		11-12 p.m.	0400-0500	9.69
	Havana, Cuba	6 a.m.-4 p.m.	1100-2100	6.135, 15.30
		5-11 p.m.	2200-0400	6.135, 11.93
	Quito, Ecuador	6-9 a.m.	1100-1400	9.745, 11.915, 15.115
	7:30-9 p.m.	0030-0200	9.745, 11.915, 15.115	
SWEDISH	Stockholm, Sweden	8-8:30 p.m.	0100-0130	11.805
		11-11:30 p.m.	0400-0430	11.805
UKRAINIAN	Kiev, U.S.S.R.	6:30-7 p.m.	2330-0000	9.665, 9.685, 11.79
		7:30-8 p.m.	0030-0100	9.665, 11.79

SEMICONDUCTOR DEVICES must be sealed during production, against outside contamination, to insure consistent characteristics and long operating life. With present methods, these devices are first formed by vapor diffusion and alloying techniques on crystalline slices containing hundreds (or thousands) of individual units. Then the slices are cut up into separate devices, with each device (or IC) sealed individually by means of an epoxy plastic coating or a vacuum-tight metal container.

In contrast, a new production technique developed by Bell Telephone Laboratories (Murray Hill, N.J.) brings *batch* processing to the encapsulation (sealing) step, permitting thousands of devices to be sealed

simultaneously. This not only reduces production costs, but can result in smaller, more reliable devices. The hermetic seal is formed by applying a layer of silicon nitride along with beam lead contacts to the silicon dioxide layer of the semiconductor device.

Several steps are required in the new process. First, the silicon slice containing the devices is heated to 875° C. in a closed chamber containing pure hydrogen gas. Second, a mixture of two gases, silicon hydride and ammonia, is introduced into the chamber. When this mixture makes contact with the heated slice, the heat causes the two gases to react chemically to form a silicon nitride layer which adheres to the slice, forming a protecting barrier against the penetration of contaminating elements.

In order for the beam lead contacts to make electrical contact with the interior regions of the semiconductor devices, "windows" are opened in the silicon nitride coating by etching with boiling phosphoric acid. In an alternate method, the silicon nitride in the window area is anodized or converted electrolytically into silicon oxide.

The precious metal beam contacts are applied to the devices through the etched window openings. The contacts form a strong chemical bond with the silicon nitride layer, further sealing the contact areas. Afterwards, the slice may be cut into individual devices similar to the one in Fig. 1.

In preliminary tests of the new technique, epitaxial silicon transistors with the new seal were deliberately contaminated with metallic ions and then subjected to accelerated power aging. That is, they were operated with normal bias voltage but at a power level considerably above their ratings. Such a test accelerates failure by raising the transistor junction temperature to about 300° C. Although these tests are continuing, devices with the new seal have already exhibited a longer median life than conventional hermetically-sealed transistors.

Reader's Circuit. Are you one of that growing number of hi-fi enthusiasts who are experimenting with headphone reproduction of stereo program material? If so, you should be interested in the amplifier circuit

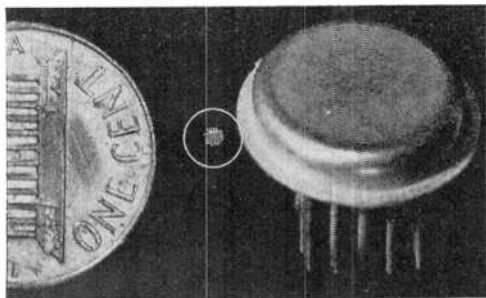

A new semiconductor encapsulation process developed by Bell Labs makes possible the fabrication of smaller IC devices (center) by eliminating the need for the hermetically sealed can at the right.

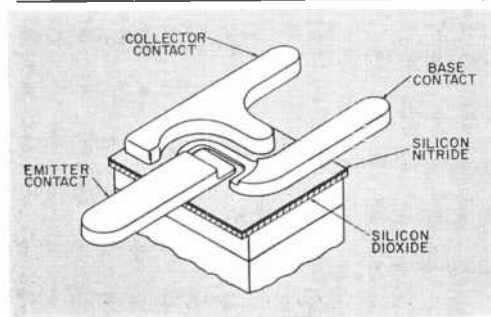

Fig. 1. A layer of silicon nitride is shown applied with beam lead contacts to a silicon dioxide layer during the sealing of a semiconductor device.

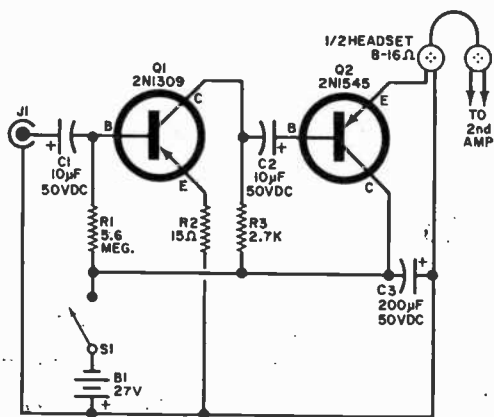

Fig. 2. This simple two-transistor amplifier circuit submitted by reader Christopher C. Hoffman provides ample power for low-impedance headphones.

shown in Fig. 2. Submitted by reader Christopher C. Hoffman (676 Yale Station, New Haven, Conn.), this simple circuit is designed to provide adequate drive for the popular low-impedance (8-16 ohms) dynamic headphones widely used for hi-fi listening.

The design features a pair of R-C coupled *npn* transistors, with *Q1* used as a common-emitter amplifier to provide voltage gain, while *Q2* serves as an impedance-matching emitter-follower power amplifier. The input signal at *J1* is applied to *Q1*'s base circuit through coupling capacitor *C1*. Base bias is supplied through *R1*, with emitter resistor *R2* providing stabilization, and with *R3* serving as the collector load.

The amplified signal at *Q1*'s collector is applied to *Q2* through interstage capacitor *C2*. The second stage, *Q2*, is operated without external base bias. Operating power is furnished by *B1*, controlled by s.p.s.t switch *S1*, and bypassed by *C3*.

Inexpensive parts are used in the circuit. Transistor *Q1* is a 2N1309, and *Q2* a 2N1545. All resistors are half-watters and the three capacitors are 50-volt electrolytic units. Jack *J1* is a standard phono type. Any toggle, slide, or rotary switch can be used for *S1*. A 27-volt power source (*B1*) is required; this can be either a line-operated d.c. power supply or three 9-volt batteries connected in series.

The amplifier can be assembled on a small chassis, a phenolic circuit board, or a suitably designed etched circuit board. Remember that for stereo listening you'll need two identical amplifiers. Heat-sink the output transistor (*Q2*) on a 2" x 4" light-gauge aluminum plate.

For maximum output volume when using headphones of average sensitivity, the am-

plifier should be driven with a moderate-level signal, such as might be obtained from an FM tuner or standard preamplifier. However, Chris reports that he has obtained adequate volume (without RIAA compensation, of course) by connecting his amplifier directly to the output of a magnetic phono cartridge.

Manufacturer's Circuit. Our reader mail clearly indicates a growing interest in line-operated transistor circuits. For, although batteries are relatively inexpensive, line operation is not only feasible at times, but actually preferable to battery power. A general-purpose line-powered audio amplifier circuit is illustrated in Fig. 3. Appearing in a General Electric (Semiconductor Products Department, Syracuse, N.Y.) Application Note, this amplifier can be used in a phonograph or intercom, or in the audio section of a radio or TV receiver.

Employing *npn* transistors, the circuit makes use of a direct-coupled design and is capable of delivering approximately 1 watt of audio power to a speaker load when driven with a 3-millivolt input signal. It has relatively low distortion and adequate frequency response, but is not intended for high-fidelity applications.

The input signal at *J1* is applied across gain control *R1* to the base of *Q1*, through capacitor *C1*. Transistor *Q1*, biased by *R2*, is hooked up as a common-emitter amplifier, with its amplified output signal developed across collector load *R3*, and direct-coupled to emitter follower *Q2*, serving as an impedance-matching device. Transistor *Q2*'s output, developed across emitter load *R4*, is direct-coupled to the base of power amplifier *Q4*. This stage is stabilized by unbypassed emitter resistor *R6*, while overall stabilization is provided by the feedback applied to *Q1*'s base through bias resistor *R2*.

Transformer *T1* matches *Q4*'s collector circuit to the low-impedance loudspeaker load. Capacitor *C2*, shunted by neon lamp *NE1* and the primary of *T1*, balances the overall frequency response by providing a high-frequency roll-off. Neon lamp *NE1* acts to short out inductive transient spikes which could damage *Q4*.

A conventional line-operated power supply, consisting of rectifier *D1*, limiting resistor *R7*, and filter capacitor *C4* is employed. Power is controlled by switch *S1*, while *C3* serves as a noise bypass across the line.

Transistor *Q3*'s role is an interesting one; observe that its collector is not connected at all. This device is hooked up to function as a zener diode rather than as a transistor. Together with series resistor *R5*, it main-

Fig. 3. Appearing in a General Electric Company Application Note, this audio amplifier, suitable for a phono or intercom, features line operation and can deliver 1 watt of audio power to a speaker.

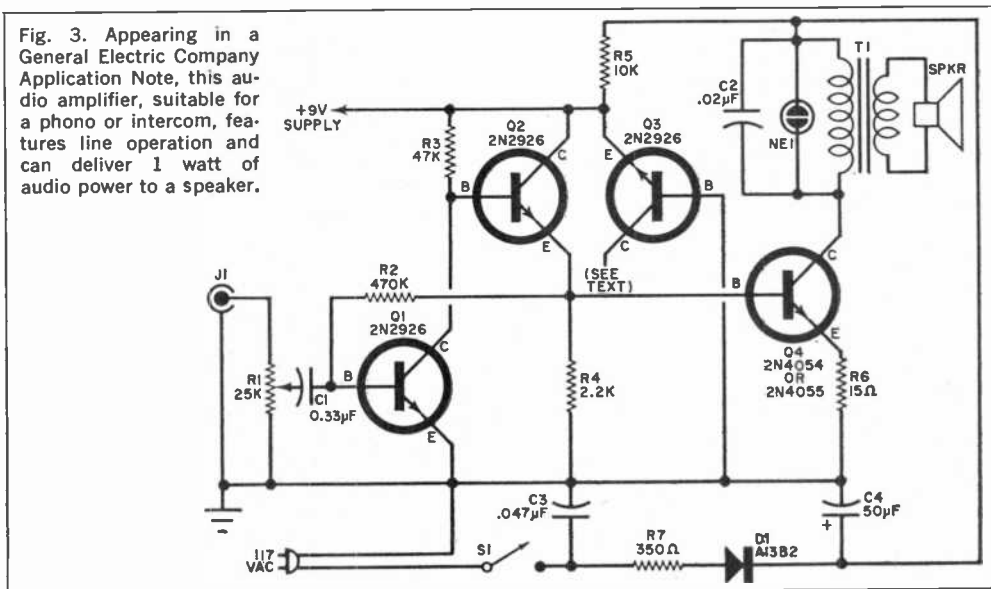

tains a 9-volt d.c. potential at the collector of Q_2 , and supplies this voltage to other parts of the circuit.

If preferred, you can substitute a low-wattage 9-volt zener diode for Q_3 . Transistors Q_1 , Q_2 , and Q_3 are 2N2926's and Q_4 is a 2N4054 or 2N4055 power unit which, according to GE, will be at their distributors in June. Diode D_1 is a A13B2 unit, but any standard type, such as a 1N4003 or 1N4004, can be used instead. Gain control R_1 is a conventional potentiometer with an audio taper; all resistors are half-watters except R_5 which is a 2-watt unit, and R_7 , which is rated at 5 watts. Capacitor C_1 is a low-voltage ceramic unit, C_2 and C_3 are 200-volt tubular paper types, and C_4 is a 150-volt electrolytic capacitor.

Neon lamp NE_1 is a NE-2H, selected to trigger above 90 volts. If preferred, a Ferroxcube No. E299DD-P340 voltage-dependent resistor can be used in place of the neon lamp. The output transformer, T_1 , should have a 2000-ohm primary, with its secondary chosen to match the voice-coil impedance of the speaker used. Input jack J_1 is a standard phono type, while S_1 can be any toggle, slide, or rotary s.p.s.t. switch. With one side of the power line connected directly to the amplifier's ground, as in a a.c./d.c. tube-operated receiver, a polarized line plug should be employed to minimize shock hazards which are inherent in line-operated power supplies of this kind. The use of an isolation transformer in the line is more desirable.

The builder can follow his own inclinations as far as assembly is concerned, using

either chassis or circuit board construction. Signal leads should be kept short and direct, of course, with the power supply circuit kept away from the input stage to minimize hum pickup. Although not specified in the GE Application Note, it would be a good idea to provide a small heat sink for Q_4 . And if substitute transistors are used for Q_1 and Q_2 , try adjusting R_2 's value, experimentally, for optimum performance.

The "Guesstimate" Game. Without counting the usual run-of-the-mill applications of solid-state devices in home entertainment equipment, what would be your guess as to the number of consumer products—intercom, burglar alarm, light dimmer, sewing machine control, garage door opener, etc.—in which solid-state devices are used? Would you say 100? How about 10?

If you'd like to play this guessing game, write a short letter or send us a postcard listing the different circuits in which you think these devices could be used or are being used. You'll see your name in print if you come up with the longest list of practical applications.

But don't pick applications that can be handled more economically by other techniques. An expensive electronic thermometer, for example, is hardly a practical application in non-critical areas where an old-fashioned mercury or alcohol type will do as well.

Product News. Three new series of digital and linear integrated circuit (IC) designer/
(Continued on page 105)

SOMEONE SHOULD DEVELOP AN EASY WAY TO LEARN ELECTRONICS AT HOME

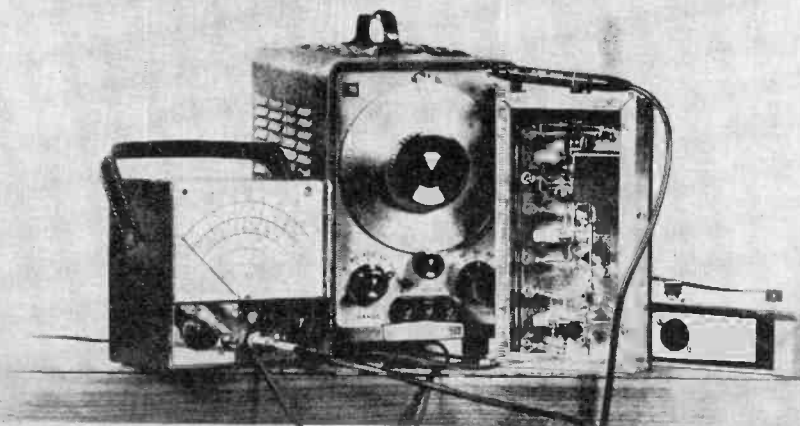

RCA INSTITUTES DID!

Here is a whole new approach to learning electronics at home! RCA Institutes, one of the nations' largest schools devoted to electronics, has developed a faster, easier way for you to gain the skills and the knowledge you need for the career of your choice. Here for the first time, is a student-proved, scientifically designed way to learn. If you have had any doubts in the past about home training in electronics—if you have hesitated because you thought you might not be able to keep up—or that electronics was too complicated to learn—here is your answer! Read how RCA Institutes has revolutionized its entire home training ideas!

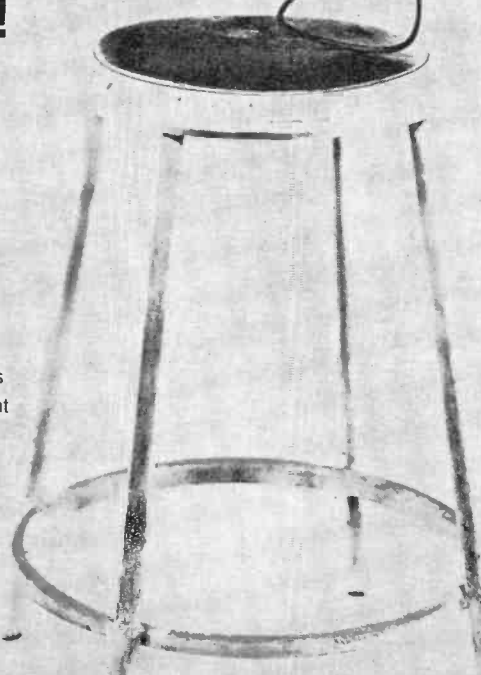

NEW CAREER PROGRAMS BEGIN WITH "AUTOTEXT" INSTRUCTION METHOD!

Start to learn the field of your choice immediately!

No previous training or experience in electronics needed!

With this new revolutionized method of home training you pick the career of your choice—and RCA Institutes trains you for it. RCA's Career Programs assure you that everything you learn will help you go directly to the field that you have chosen! No wasted time learning things you'll never use on the job! The Career Program you choose is especially designed to get you into that career in the fastest, easiest possible way!

And each Career Program starts with the amazing "AUTOTEXT" Programmed Instruction Method—the new, faster way to learn that's almost automatic! "AUTOTEXT" helps even those who have had trouble with conventional home training methods in the past. This is the "Space Age" way to learn everything you need to know with the least amount of time and effort.

CHOOSE A CAREER PROGRAM NOW

Your next stop may be the job of your choice. Each one of these RCA Institutes Career Programs is a complete unit. It contains the know-how you need to step into a profitable career. Here are the names of the programs and the kinds of jobs they train you for. Which one is for you?

Television Servicing. Prepares you for a career as a TV Technician/Serviceman; Master Antenna Systems Technician; TV Laboratory Technician; Educational TV Technician.

FCC License Preparation. For those who want to become TV Station Engineers, Communications Laboratory Technicians, or Field Engineers.

Automation Electronics. Gets you ready to be an Automation Electronics Technician; Manufacturer's Representative; Industrial Electronics Technician.

Automatic Controls. Prepares you to be an Automatic Controls Electronics Technician; Industrial Laboratory Technician; Maintenance Technician; Field Engineer.

Digital Techniques. For a career as a Digital Techniques Electronics Technician; Industrial Electronics Technician; Industrial Laboratory Technician.

Telecommunications. For a job as TV Station Engineer, Mobile Communications Technician, Marine Radio Technician.

Industrial Electronics. For jobs as Industrial Electronics Technicians; Field Engineers; Maintenance Technicians; Industrial Laboratory Technicians.

Nuclear Instrumentation. For those who want careers as Nuclear Instrumentation Electronics Technicians; Industrial Laboratory Technicians; Industrial Electronics Technicians.

Solid State Electronics. Become a specialist in the Semiconductor Field.

Electronics Drafting. Junior Draftsman, Junior Technical Illustrator; Parts Inspector; Design Draftsman Trainee Chartist.

SEPARATE COURSES

In addition, in order to meet specific needs, RCA Institutes offers a wide variety of separate courses which may be taken independently of the Career Programs, on all subjects from Electronics Fundamentals to Computer Programming. Complete information will be sent with your other materials.

LIBERAL TUITION PLAN

RCA offers you a unique Liberal Tuition Plan—your most economical way to learn. You pay for lessons only as you order them. No long term contracts. If you wish to stop your training for any reason, you may do so and not owe one cent until you resume the course.

VALUABLE EQUIPMENT

You receive valuable equipment to keep and use on the job—and you never have to take apart one piece to build another. New—Programmed Electronics Breadboard. You now will receive a scientifically programmed electronic bread-

board with your study material. This breadboard provides limitless experimentation with basic electrical and electronic circuits involving vacuum tubes and transistors and includes the construction of a working signal generator and superheterodyne AM Receiver.

Bonus From RCA—Multimeter and Oscilloscope Kits. At no additional cost, you will receive with every RCA Institutes Career Program the instruments and kit material you need to build a multimeter and oscilloscope. The inclusion of both these kits is an RCA extra.

CLASSROOM TRAINING ALSO AVAILABLE

RCA Institutes maintains one of the largest schools of its kind in New York City where classroom and laboratory training is available in day or evening sessions. You may be admitted without any previous technical training; preparatory courses are available if you haven't completed high school. Coeducational classes start four times a year.

FREE PLACEMENT SERVICE

In recent years, 9 out of 10 Resident School students who used the Free Placement Service had their jobs waiting for them when they graduated. And many of these jobs were with top companies in the field—such as IBM, Bell Telephone Labs, General Electric, RCA, and radio and TV stations and other communications systems throughout the world.

SEND ATTACHED POSTAGE PAID CARD FOR COMPLETE INFORMATION, NO OBLIGATION. NO SALESMAN WILL CALL.

**ALL RCA INSTITUTES COURSES
AVAILABLE UNDER NEW GI BILL.**

RCA INSTITUTES, Inc., Dept. PE-57
A Service of Radio Corporation of America
350 West 4th St., New York, N.Y. 10014



The Most Trusted Name In Electronics

ENGLISH-LANGUAGE BROADCASTS TO NORTH AMERICA

FOR THE MONTH OF MAY

Prepared by **ROBERT LEGGE**

TO EASTERN AND CENTRAL NORTH AMERICA			
TIME—EST	TIME—GMT	STATION AND LOCATION	FREQUENCIES (MHz)
7:15 a.m.	1215	Helsinki, Finland	15.185 (Tues., Sat.)
		Melbourne, Australia	11.71
7:45 a.m.	1245	Copenhagen, Denmark	15.165
6 p.m.	2300	London, England	9.58, 11.78, 15.30
		Moscow, U.S.S.R.	9.665, 11.715, 11.955
6:45 p.m.	2345	Tokyo, Japan	15.135, 17.825
7 p.m.	0000	London, England	9.58, 11.78, 15.30
		Moscow, U.S.S.R.	9.665, 9.685, 11.715
		Peking, China	15.06, 17.68
		Sofia, Bulgaria	9.70
		Tirana, Albania	7.263
7:30 p.m.	0030	Budapest, Hungary	9.833, 11.91
		Johannesburg, South Africa	9.675, 11.90
		Kiev, U.S.S.R.	9.665, 11.79
			(Mon., Thurs., Fri.)
		Stockholm, Sweden	11.805
7:50 p.m.	0050	Vatican	7.27, 9.645, 11.76
8 p.m.	0100	Berlin, Germany	9.73, 11.92
		Havana, Cuba	6.17, 11.76
		London, England	7.13, 9.58, 11.78
		Madrid, Spain	6.13, 9.76
		Moscow, U.S.S.R.	9.665, 9.685, 11.87
		Prague, Czechoslovakia	5.93, 7.345, 9.55, 11.99
		Rome, Italy	11.81, 15.385
8:15 p.m.	0115	Berne, Switzerland	6.12, 9.535, 11.715
8:30 p.m.	0130	Bucharest, Rumania	9.57, 11.94, 15.38
		Cairo, U.A.R.	9.475
		Cologne, Germany	9.64, 11.945
		Hilversum, Holland	9.59
9 p.m.	0200	Lisbon, Portugal	6.025, 6.185, 9.68
		London, England	7.13, 9.58, 11.78
		Moscow, U.S.S.R.	9.665, 9.685, 11.73, 11.87
		Stockholm, Sweden	11.805
9:30 p.m.	0230	Beirut, Lebanon	11.76
10 p.m.	0300	Bucharest, Rumania	9.57, 11.94, 15.38
		Budapest, Hungary	9.833, 11.91
		Havana, Cuba	6.135, 6.17
10:30 p.m.	0330	Prague, Czechoslovakia	6.095, 7.345, 9.55, 11.99

TO WESTERN NORTH AMERICA			
TIME—PST	TIME—GMT	STATION AND LOCATION	FREQUENCIES (MHz)
6 p.m.	0200	Melbourne, Australia	15.22, 17.84
		Tokyo, Japan	15.135, 15.235, 17.825
6:50 p.m.	0250	Taipei, China	15.125, 15.345, 17.72
7 p.m.	0300	Moscow, U.S.S.R.	15.14, 15.18, 17.76
		Peking, China	9.457, 11.82, 15.095
7:30 p.m.	0330	Stockholm, Sweden	11.805
7:45 p.m.	0345	Berlin, Germany	9.65, 11.92
8 p.m.	0400	Sofia, Bulgaria	9.70
8:30 p.m.	0430	Budapest, Hungary	9.833, 11.91
8:45 p.m.	0445	Cologne, Germany	9.735, 11.945
9 p.m.	0500	Berne, Switzerland	9.695, 11.715
		Moscow, U.S.S.R.	9.54, 11.755, 11.85

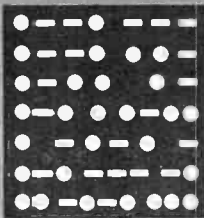

AMATEUR RADIO

By **HERB S. BRIER**, W9EGQ
Amateur Radio Editor

THE FASCINATION OF AMATEUR RADIO

WHAT IS THERE about amateur radio that attracts and holds the interest of such diverse personalities as Barry Goldwater, K7UGA; Andy Devine, WB6RER; the King of Bhutan; doctors; nuns; housewives; and people just like you and me? Well, for one thing, an amateur radio station presents an opportunity to make new friends in distant locations. For another, it attests to your ability as a communicator or as an electronics wizard of sorts, for each time you work another state or country it is renewed proof that you are a "master of the airways."

In addition, an amateur station in your home, car, boat, or aeroplane will let you rag-chew with other amateurs, participate

in contests, experiment with antennas and exotic forms of electronic communication, and relay messages for people, including those in the armed forces. If you are interested in any of the above, you are a potential radio amateur (assuming that you don't already have a license), and you can learn a lot more about this fascinating hobby by reading *POPULAR ELECTRONICS' Communications Handbook*, now available at most newsstands.

Then comes the moment of truth. Do you want to become an amateur enough to learn the code? If not, forget the whole idea, because the code is a permanent part of all amateur license examinations. Although learning the code is not really hard, there is

AMATEUR STATION OF THE MONTH



Don C. Miller, W9NTP, Waldron, Ind., operates on all amateur bands from 1.8 through 1296 MHz, and uses CW, RTTY, SSB and TV modes! Under special FCC authorization, Don keeps "slow-scan" TV and voice schedules on 14 MHz with U.S. installations in the Antarctica, and transmits normal wideband TV pictures on 432 MHz. (The insert picture is of Don's wife, Sue, W9CNW, transmitted by W9NTP on 14 MHz and tape-recorded by WA0NLQ in Colorado.) Equipment not built by Don includes E. F. Johnson "Ranger" and "6N2" and Hallicrafters HT-32 transmitters, National NC-303 and Hammarlund HQ-129A receivers. Don will receive a one-year subscription for submitting the winner for May in our Amateur Station of the Month photo contest. To enter the contest, send a clear picture of your station with you at the controls and some details on the equipment you use and your ham career to Amateur Radio-Photo Contest, c/o Herb S. Brier, Box 678, Gary, Ind. 46401.

no denying that it does take some intestinal fortitude to spend a half hour or so a day five to seven days for five weeks or so to bring your speed up to 5 wpm for a Novice or Technician license. (Don't worry about the 13-wpm General Class code test at this point; you will easily be able to increase your speed to that level while working the world with your Novice license.)

One good way to learn the code is to make friends with a ham or two and help them with their projects (like putting up an antenna, for example) in return for help with the code. Formal code classes sponsored by local radio clubs and recorded code courses available from amateur supply houses are also good.

Get a short-wave receiver capable of receiving amateurs as soon as you can. Eavesdropping on amateur phone conversations is lots of fun and will give you much useful information; and the receiver will give you almost unlimited opportunities for over-the-air code practice. While single-sideband (SSB) modulation, used by most amateur phone stations because of its superior "getting out" ability, is unintelligible gibberish on a conventional broadcast receiver, the chances are good that a receiver capable of receiving code signals will also receive SSB signals.*

**SSB modulation compares to conventional amplitude modulation (AM) used by broadcast stations and most CB transmitters about like a cup of regular coffee to a cup of instant coffee. Like the water that must be added to the instant coffee granules the receiver beat frequency oscillator (BFO) must be added to the SSB signal to make it intelligible.*

To receive an SSB signal, tune the receiver for the loudest gibberish from the loudspeaker. Then retard the r.f. gain (sensitivity) control and advance the a.f. gain (volume) control to keep the speaker signal at the desired level. Next, turn on the receiver BFO and adjust its pitch control until the sounds from the speaker become intelligible. (One setting of the pitch control is normally used to receive SSB signals on the 75-meter phone band, and a slightly different setting is used on the 40-, 20-, 15-, and 10-meter bands.)

The main factor in receiving SSB signals is precise tuning. Once the knack is acquired, most short-wave receivers with BFO's will do at least a passable job of receiving them, although not as good a job as a receiver specifically designed for SSB reception, of course.

"Short Skip" on Six. Starting around the first of May and continuing past Labor Day, experienced 50-MHz operators will be watching, morning, noon, and night, for the 50-MHz band to break open with strong signals from distances of 600 to 1000 miles and more. Whether you call the phenomena "short skip" or "sporadic-E propagation," the theory is that radiation from the sun produces intense patches of ionization in the ionosphere that reflect 50-MHz and even higher frequency signals (which usually sail uselessly into outer space) back to the earth hundreds of miles from the transmitter.

No one can yet predict when "short skip" (Continued on page 112)

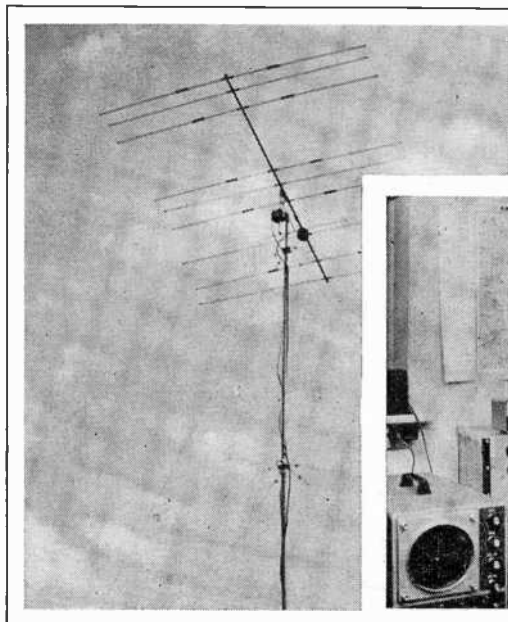

Jack Elias, WA3EVG, Philadelphia, Pa., concentrates on six and two meters. Included in the picture below are a Heathkit oscilloscope, a homebrew 2-meter transmitter, "Poly-Comm 6" transceiver, and a Hammarlund HQ-100 receiver. On the roof of the WA3EVG shack is a Hy-Gain DB-62 six-and-two-meter beam (photo at left).

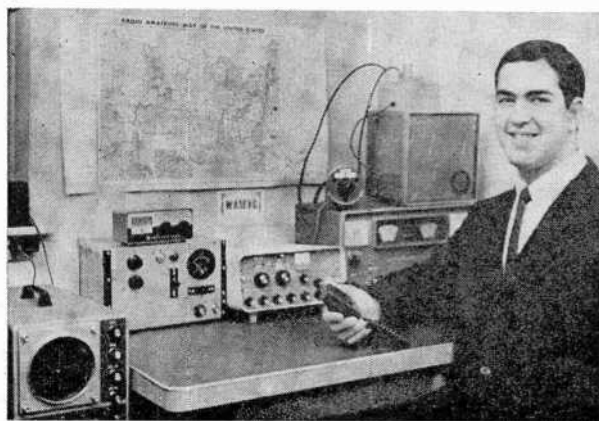



ON THE CITIZENS BAND

By MATT P. SPINELLO, KHC2060, C3 Editor

CITIZENS BAND CLUBS are always searching for ways and means to stimulate membership. On the other hand, individuals interested in CB radio or already licensed to operate, never seem to know where the nearest club is located, or how to find out more about nearby emergency teams and the requirements for membership.

Many clubs that have been printing a news sheet or multi-page club paper for several years have found that their publications do more than just serve as a news

CLUB PAPER SWAP SHOP

vehicle for the immediate club membership. Groups currently plagued with membership problems, organizing a new club, or trying to keep an existing club from falling apart, would do well to follow the printed examples set by some of the more successful CB newspapers.

We realize that it is not possible for a thousand clubs and the 20,000 new CB licensees joining the band each month to communicate directly, but there are ways in which the interested bystander or new CB'er can be introduced to the local or area club, and there are ways in which a club can promote the worthwhile aspects of the organization and establish a more solid rapport with local authorities.

For one thing, CB clubs interested in gaining the attention of non-member CB'ers should make it a point to distribute a supply of extra copies of the club publication to electronic sales centers, distributors, and dealers. Placing these publications on their counters will serve to stimulate both the interest of the newcomers and CB equipment business for the firm.

Secondly, as we have mentioned before in this column (October, 1966), a copy of the club paper should be sent to the news director of each radio and television station in the area, as well as to local newspapers. Area news media should be informed about worthwhile club activities by means of a press release, accompanied by a glossy photo if possible. Following through on these counts is the fastest route to attracting the attention of area authorities.

Then, make sure your publication contains the club name and address, the month and year of publication, and the editor's and/or officers' names and addresses. Too often CB sheets are written on a local level, without proper identification for recognition by CB'ers in other areas.

Finally, your OTCB Editor will be happy to serve as a CB "club paper swap shop." Those clubs currently publishing a news sheet should supply us with a monthly copy of the paper and indicate whether they are willing to swap publications with other clubs across the country. When a sizable list of would-be publication swappers has been compiled, we will forward a copy of the list to all interested groups who supply us with a self-addressed, stamped envelope.

This procedure can serve two purposes:



The CB publications shown here are but a handful of the newsworthy bulletins received by your OTCB Editor each month, and they represent a small portion of a large group of clubs that strive to bring their memberships the complete CB picture on a monthly basis. Each of these clubs is well known for numerous emergency assists in its own area.

swapping, say, 50 monthly copies of your club paper will move as many different CB publications from coast to coast. You will have spread your word to 50 areas, and at the same time obtained a good idea of how clubs in other areas operate, what their problems of organization are, and, in some cases, the solution to your own hang-ups. Moreover, the receipt of 50 different CB club papers each month should give your publication's editor at least 25 new ideas on how to better the publication, as well as how to profit from the mistakes of others.

In addition, you may be able to reprint some of the better articles from other club papers to fill in your own membership on the national scene. The process could, under practice and control, add up to the start of a national CB link through the printed word.

Skip To The Rescue. Ionospheric reflections tend to "skip" or bounce CB signals as far as 2000 miles at certain times of the year. The condition is normally highly undesirable since it can add air-traffic problems to an already CB-active area by almost doubling the number of stations that can be heard in the process of conversation.

But four hunters can be grateful for at least one bounce that paid off. Vernon Towne, of Plainwell, Mich., and three companions found themselves pretty well stranded on a muddy Mesa Mountain road near Durango, Colo., when their two-week hunting trip came to an abrupt halt via one broken front axle on Towne's pickup truck.

Towne's CB plea for help was received by a woman in Ohio. She called the Walbridge Post of the Ohio State Highway Patrol, the Walbridge Post called their Headquarters at Findlay, the Ohio Headquarters called the Colorado State Patrol at Denver, and Denver contacted the Durango Post. And before the four Michigan men had been towed to Durango for repairs, Towne's wife was receiving the news in Plainwell from another CB'er who had picked up Towne's CB call on her gear in Detroit.

Near Disaster Averted. One night a couple of months ago, David Johnson, Lemon Grove, Calif. (call-sign unknown), heard a weak call for help and immediately responded to it, asking for details while literally ringing up the Sheriff's Office with the other hand. The call came from a TV transmitter site high up on San Miguel Mountain. A TV technician had accidentally driven his jeep off the road and plunged 150 feet down a steep embankment.

The technician was injured, but managed to crawl back to the transmitter room only to find that the telephone service was dead. Repeated weak CB calls for help—between

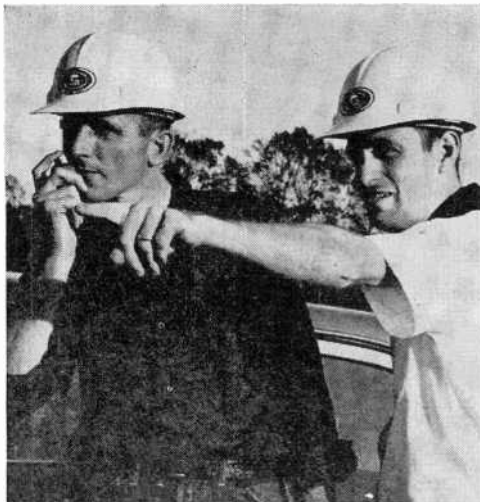

Emergency teams are always on the lookout for new members who can be trained to supplement their mobile search and rescue operations. The men shown here are members of the ALERT team in Baton Rouge, La., an organization that works closely with Civil Defense, Red Cross, and law enforcement agencies.

lapses into comas—were laughed at by dozens of CB'ers who thought someone was "putting them on." Three hours passed before Dave heard the call, at 2 a.m., and responded to it. Fortunately, the TV technician is now okay.

The moral of this story is obvious. A clear channel for emergency calls is needed. Sometimes I wonder how many lives would not have been lost, and how much damage could have been prevented, if CB'ers only had a clear emergency channel.

REACT Report. REACT (Radio Emergency Associated Citizens Teams) is doing its part by monitoring channel 9 twenty-four hours a day. A CB-equipped motorist can call "REACT control" in over a thousand communities on channel 9, and the chances are good that his call will be received by a REACT mobile or base station and the assistance required dispatched quickly.

Since its inception, this four-year-old organization—sponsored by the Hallicrafters Company—has rendered assistance in over 1,200,000 situations requiring emergency aid or road information; 72% of these emergencies involved motor vehicles and nearly a third of these involved accidents.

A new pocket-size folder listing the locations and membership of the currently existing 1185 REACT teams throughout the Western Hemisphere is available from REACT National Headquarters, 5th and Kostner Aves., Chicago, Ill. 60624. The aver-

(Continued on page 111)

Regency

ALL AMERICANS

all solid state

Regency *Charger*

12 channel CB Transceiver

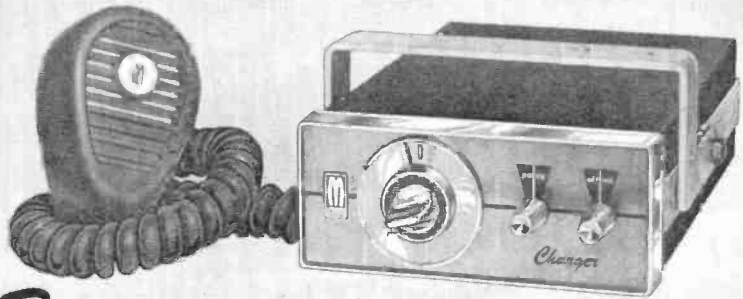

Regency *Bronco*

8 channel CB Transceiver

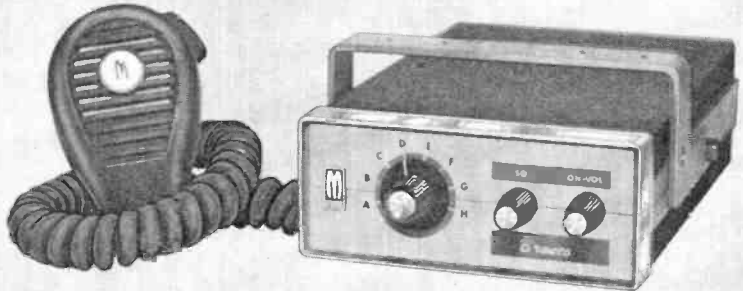

Where else 5 full watts ... for as low as

\$89⁹⁵

All silicon transistors
American made
1 year warranty

REGENCY ELECTRONICS, INC.
7900 PENDLETON PIKE
INDIANAPOLIS, INDIANA 46226

Slightly higher west of Rockies

CIRCLE NO. 32 ON READER SERVICE PAGE

NEW LITERATURE

To obtain a copy of any of the catalogs or leaflets described below, simply fill in and mail the coupon on page 15.

A total of 6600 cartridge listings are cross-referenced in *Sonotone Corporation's* 1967 replacement manual—some 900 more than in the 1966 edition. Once again, the data has been printed from a solid-state computer, and is arranged in two sections: Sonotone cartridges are related to competitive cartridges in Section 1, to phonographs in Section 2. The 32-page (8½" x 11") three-hole-punched manual carries a price of 50 cents, but is being offered free for a limited period only.

Circle No. 87 on Reader Service Page 15

Delmar Publishers, Inc., has available a comprehensive 8-page catalog describing electricity and electronics texts and work-text-books which can be used either in the classroom or for home study. Some of the titles

in the catalog include: Basic Electronics, Electricity I-IV, Alternating Current Fundamentals, Direct Current Fundamentals, and Basic Mathematics Simplified.

Circle No. 88 on Reader Service Page 15

Nine new dynamic electric power drills with machine-gun grip auxiliary handle are described in a 4-page, 3-color folder put out by *Wen Products Inc.* Detailed mechanical and electrical features of the four ¼", four ⅜", and a single ½" drill are provided.

Circle No. 89 on Reader Service Page 15

The 1967 full-line catalog released by the Distributor Division of *Clarostat Mfg. Co., Inc.*, features potentiometers, field-assembled controls, power rheostats, and resistors. Also covered in its 32 pages are sound system attenuators, precision decade boxes, shafts, bushings, etc. Complete technical specifications and dimensional information are included.

Circle No. 90 on Reader Service Page 15

Over 450 items are listed in *Robins Industries* new 24-page shopping guide for tape recordists and phono enthusiasts. A complete selection of recording tapes is fully described, as are tape splicers and other tape accessories, and phono care accessories and kits.

Circle No. 91 on Reader Service Page 15

At last—TTI removed the resistance to Electronics training at home!

New training method eliminates frustrations that slow down your progress—boredom, dry theory, lack of fun in doing, loss of interest or motivation

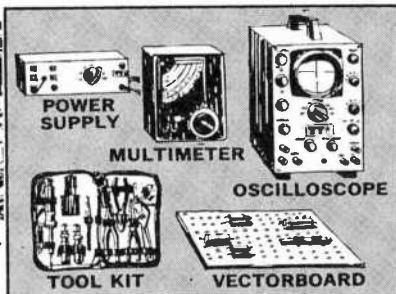

- No ordinary program—you set up a "learning laboratory" in your home. Step by step you build, test, trouble-shoot the circuits you are studying. Smooth-flowing series of 63 projects makes each principle crystal clear. (You build 4 radios, not just one!)

Industrial-quality vector board with unique solderless circuits lets you put together, prove, revise or expand, and dismantle each circuit. You get full set of tools, test instruments and materials, including resistors, capacitors, oscilloscope, milliammeter and multi-voltage power supply.

Program is conducted to level of Electronics Technician, most sought-after man in industry today. Approved by NHSC. It would take many pages of this magazine to tell story. Our 40-page booklet has it—send coupon now!



TECHNICAL TRAINING INTERNATIONAL, Dept. 1E7
10447 S. Torrence Ave., Chicago, Ill. 60617

Send Free booklet "Your Future in Electronics" and full information about today's most interesting and practical Electronics Training program.

name _____

address _____

city _____ state _____ zip _____

PARTS
METHODS
IDEAS
GADGETS
DEVICES

TIPS & TECHNIQUES

STRIPPED SCREW HOLES CAN BE BEEFED UP BY "STAKING"

Because of the stripping action of overtightened self-tapping screws, getting them to hold firmly in soft aluminum after they have been removed and replaced a few times can become a problem. You can use a larger screw, but this would necessitate using an even larger screw subsequently. However, there is a simple solution to the problem—at least temporarily.

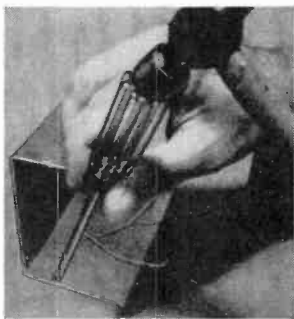

"Stake" the edges of the screw hole with a broad-bladed screwdriver or small dull chisel. All it takes is a few light taps with a hammer.

—Henry R. Rosenblatt

MAKE YOUR OWN WIRE PIGTAILS TO SIMPLIFY COMPONENT REPLACEMENT

If you don't have a supply of the commercially available pigtails ("Kwikette") made by Sprague, you can whip up a few of your own, minus the solder (the commercial units are coated with solder). A pigtail serves as a small coupler between the lead of an original component being replaced and the replacement component lead. To make one, you

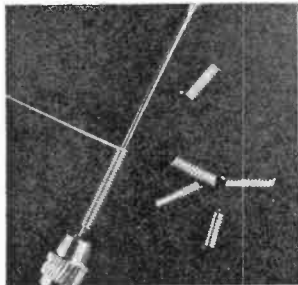

simply wind a short length of 22-AWG bare wire around a sewing needle or another stiff piece of wire of appropriate diameter. Make it loose enough to fit over the component leads easily. When replacing a

component on a printed circuit board, leave as much of the original component's leads as possible on the board. Solder the pigtail in place, but do not allow the old leads to

"IT'S FOR YOU... LONG DISTANCE"

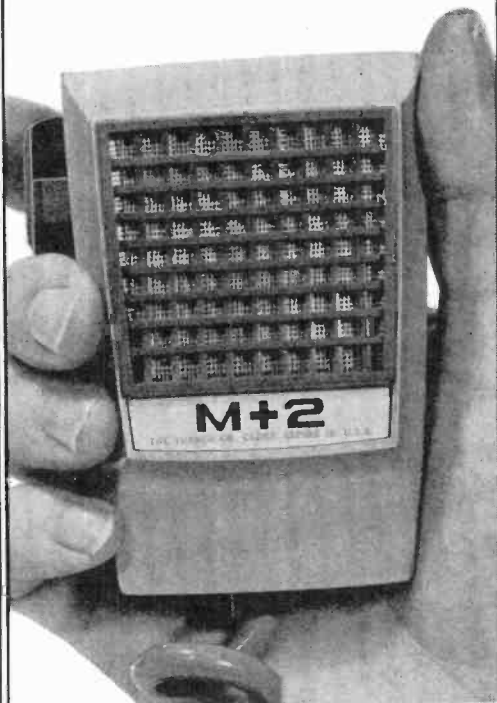

"Long distance", of course, is a relative term . . . but when you're talking about mobile microphones, the "long distance" a Turner M+2 can provide can be awfully important. Even at distances where you now need a telephone to contact your base station, the M+2 gives you additional output with a twist of the dial. (And the Turner +2 in your base station gives you the increased output you need to complete the communication circuit.)

If YOUR mobile rigs aren't performing the way they should, see your nearest CB dealer or distributor . . . let him show you why the Turner M+2/Turner +2 combination is — indeed — unique in its field.

THE TURNER MICROPHONE COMPANY
946 17th Street N.E.
Cedar Rapids, Iowa

In Canada: Tri-Tel Associates, Ltd.
Export: Ad Auriema, Inc., 85 Broad St., New York, N.Y. 10004

DYNACO

THE FINEST STEREO HI-FI
AT THE LOWEST COST



SCA-35
stereo amplifier-\$99.95

Get full information on Dynaco components and build-it-yourself kits for the cost-conscious perfectionist.

DYNACO, INC., 3912 Powelton Ave., Phila., Pa. 19104.

Please send complete information on
Dynaco high fidelity products to:

Name _____

Address _____

City _____ State _____

PE-567

CIRCLE NO. 34 ON READER SERVICE PAGE

BACK ISSUES AVAILABLE

Use this coupon to order back issues of POPULAR ELECTRONICS

We have a limited supply of back issues that can be ordered on a first-come, first-served basis. Just fill in the coupon below, enclose your remittance in the amount of 65¢ for each copy ordered.

ZIFF-DAVIS SERVICE DIVISION

Dept. BCPE, 589 Broadway
New York, New York 10012

Please send the following back issues of POPULAR ELECTRONICS. I am enclosing..... to cover cost of the magazine, shipping and handling.

Month Year

Month Year

Month Year

Name

Address

City

State Zip Code

Payment must be enclosed with order

TIPS

(Continued from page 99)

shift their position if they become momentarily desoldered. If possible, heat-sink the old component leads with a pair of pliers when applying heat. —Louis H. Phelps

PAPER-CLIP JIG HOLDS PRINTED CIRCUIT BOARD

Two large paper clips mounted on a suitable bracket can be used to support a printed circuit board and small components. Both sides of the printed circuit board are accessible for work at the flip of the clips. There's less chance of damaging the components and you can place a work light behind the board to help you trace out a circuit. The jig shown in

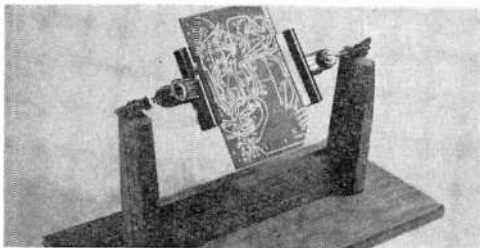

the photo can be duplicated for about \$2.00. The upright supports can be either wood or metal and, with a little ingenuity, can be made to adjust the height of the work. Slip wide rubber bands over the jaws of the clips to cushion the board. Here, each clip is bolted to an eye bolt which is held in place with a small compression spring. However, almost any other mechanically secure arrangement can be used. —David A. Reid

HOT KNIFE MAKES "COOL" CUTTING TOOL

The plastic boxes popularly used for small electronic projects have a nasty habit of cracking and deforming if slots are cut into them without special tools. One way to avoid making a mess is to use a tool that does not require much physical pressure to cut the slots. An "X-Acto" hobby knife blade (it doesn't have to be a new one so long as it has a clean edge) and a 150- to 240-watt soldering gun will do the trick. Bolt the knife blade to the soldering gun tip as shown in



the photo; use lock washers to hold the blade firmly in place. Before using the tool, allow the blade to heat up sufficiently to cut through the plastic when it is applied with a slight but steady pressure. After cutting out the slot, sand the edges of the slot smooth.

—Bruce Pelkey

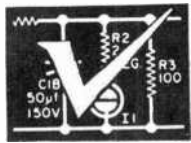

OPERATION ASSIST

Through this column we try to make it possible for readers needing information on outdated, obscure, and unusual radio-electronics gear to get help from other P.E. readers. Here's how it works: Check the list below. If you can help anyone with a schematic or other information, write him directly—he'll appreciate it. If you need help, send a postcard to Operation Assist, POPULAR ELECTRONICS, One Park Avenue, New York, N.Y. 10016. Give maker's name, model number, year of manufacture, bands covered, tubes used, etc. State specifically what you want, i.e., schematic, source for parts, etc. Be sure to print or type everything legibly, including your name and address. Because we get so many inquiries, none of them can be acknowledged. POPULAR ELECTRONICS reserves the right to publish only those items not available from normal sources.

Eveready Model 1 receiver, ser. W15574; tunes BC; has 8 tubes. **Atwater-Kent Model 20** receiver, ser. 336149; tunes BC; has 5 tubes. Schematics and operating manuals needed. (Tim Krichbaum, 634 Highland Ave., Mansfield, Ohio 44903)

Knight-Kit transmitter; 50 watts; 8 to 10 meters; has 5U4, 6AG7, 807 tubes. Operating manual needed. (Douglas Stivison, Knights of Airwaves Amateur Radio Club, Uniondale High School, Uniondale, N.Y. 11543)

Bell Model T-300 tape recorder. Source for capstan motor and springs needed. (Paul Taylor, 525 N. Middleton Rd., Media, Pa. 19063)

Webster Model 80-1 wire recorder, ser. 7846. Operating manual and source for recording wire needed. (Bob Mattingley, 618 Miller Ave., Sunnyside, Wash. 98944)

Philco Model 46-480 receiver; tunes BC, FM and s.w.; has 7 tubes. Schematic needed. (Jack Saint, 4415 Kiger St., Huntsville, Ala. 35805)

Zenith Model A600 "Trans-Oceanic" receiver; tunes 550 kHz to 18 MHz on 7 bands. Schematic and operating manual needed. (Rick Campbell, 564 Lincoln Ave., Lansing, Mich. 48910)

Globe Model HG303 transmitter; covers 80, 40, 20, 15, and 10 meters; has 2 tubes. Schematic needed. (David Gross, 31 Eaton Rd., Syosset, N.Y. 11791)

Hickok Model 540 dynamic mutual conductance tube tester, circa 1942. Schematic, operating manual, and information on updating equipment needed. (Dwight L. Roberts, 6826 Rosefield Dr., San Diego, Calif. 92115)

Ecco-Fonic Model 109B. Schematic needed. (C. R. Rader, 9608 Mellor, Wichita, Kan.)

Philco Model 50-3001 "Philco-Tropic" receiver, circa 1939; tunes AM and s.w. on 2 bands; has 5 tubes. Schematic and source for cabinet and power cord needed. (Richard Mote, 13703 River Forest, Corpus Christi, Tex. 78410)

Stromberg-Carlson Model 38-A receiver, circa 1928; tunes BC; has 9 tubes. Schematic and source for tubes needed. (Tom Harris, 99 Calif. Ave., Mill Valley, Calif. 94943)

RCA Model AR 88 receiver, circa 1944; tunes 550 kHz to 30 MHz. Schematic and operating manual needed. (Paul Jacobi, Oasis Oil Co. of Libya, Inc., Box 395, Tripoli, Libya, N. Africa)

RCA Model C11-1 receiver; tunes BC and s.w. on 3 bands. Source for power transformer needed. (Lannie L. Brown, Rt. 1, Valley View, Tex. 76272)

(Continued on page 102)

more power to you!

all your portable equipment always at your service

with the CRL-1200

RECHARGEABLE

POWER PACK

USE IT FOR:

CB & FM Radio
Portable TV
Photographic Equipment
Power Tools
Boating Equipment
Camping Equipment
or any 12-Volt Equipment



Centralab's POWER PACK works anywhere, at any time.

- Outperforms conventional battery systems because it works longer without recharging, and costs 1/10th as much per ampere hour.

- It switches easily from job to job and holds its power when not in use.

- Easily portable—weighs 9½ lbs., measures 8½ x 2¼ x 9 inches.

- Handsomely packaged in rugged leather case, complete with charger. \$49.95

P-6709



CENTRALAB

Electronics Division
GLOBE-UNION INC.

Distributor Division

Send me detailed literature and the name of my local dealer.

P. O. Box 591
Milwaukee, Wisconsin 53201

Name _____

Address _____

City _____ State _____ Zip _____ Code _____

CIRCLE NO. 4 ON READER SERVICE PAGE



NEW MOSLEY NOVICE

A completely Do-It-Yourself beam for 15 meters. Priced to fit your budget.

X-15 rated for Full Power (Novice or General). Readjust for 10 meters, if desired, when you become a General.

Please send FREE info. on X-15 Beam.

Name _____

Address _____

City/State _____

Zip Code No. _____

Mosley Electronics Inc. # 121

4610 N. Lindbergh Blvd, Bridgeton Mo. 63042

CIRCLE NO. 20 ON READER SERVICE PAGE

SAY YOU SAW

IT IN

POPULAR ELECTRONICS

GET INTO ELECTRONICS

V.T.I. training leads to success as technicians, field engineers, specialists in communications, guided missiles, computers, radar, automation. Basic & advanced courses. Electronic Engineering Technology and Electronic Technology curricula both available. Associate degree in 29 months. B.S. obtainable. G.I. approved. Start September. February. Dorms, campus. High School graduate or equivalent. Catalog.

VALPARAISO TECHNICAL INSTITUTE

DEPARTMENT PE, VALPARAISO, INDIANA



TRIK STIK UNIVERSAL ANTENNA



for CITIZENS BAND, Low and High BUSINESS BAND, MONITOR, CIVIL DEFENSE, AMATEUR, SWL, AIRCRAFT, TV and FM RECEPTION.

\$6.45

Free Literature. CUSH CRAFT, DEPT. TS
621 Hayward St., Manchester, N.H. 03103

ASSIST (Continued from page 101)

Packard-Bell Model 2602 receiver/phono/TV combo. Schematic needed. (David B. Holzinger, 4401 Bell Ave., Houston 23, Tex.)

Crosley Model 817 receiver. ser. 1402970; has 8 tubes. (Jack Mesaros, 132 South St., Jim Thorpe, Pa. 18229)

Potter Instrument Model 830 frequency counter. Schematic, operating and alignment instructions needed. (Sgt. Cecil R. Browning, RA 17298056, Co A 1st Bn, 48 Inf., APO, New York, N.Y. 09039)

Zenith Model G724 receiver, chassis 7G02, circa 1951; has 7 tubes. Schematic and other data needed. **Knight-Kit Model KG-400 stereo amplifier.** Schematic needed. (Robert Peterson, 9315 Latrobe, Skokie, Ill. 60076)

Sentinel Model 816C color TV receiver, ser. 50821. Source for 7-megohm, 2-watt ceramic wire-wound resistor or substitute for same needed. (C. W. Gordon, 305 Bettencourt St., Sonoma, Calif. 95476)

Hallicrafters Model S40 receiver; tunes 550 kHz to 44 MHz. Operating manual and schematic needed. (Paul Lee, Box 456, Morrisburg, Ont., Canada)

Heathkit Model 0-9 oscilloscope, circa 1954. Construction and operating manuals needed. (Peter Z. Simpson, 18 University Dr., Natick, Mass. 01760)

E. H. Scott Model CZC-46139 receiver, ser. 1088, circa 1942; tunes 0.53 to 15.6 MHz on 3 bands; has 11 tubes. Operating manual and alignment data needed. (Paul T. Judkins, 1200 Stuart Rd., Herndon, Va. 22070)

Precision Model 912P tube tester, ser. 9262. Operating manual, latest roll charts, tube listings, test data, and source for 9-pin tube adapter needed. (Wayne Weaver, Jr., Box 223, Haleyville, Ala. 35565)

GE Model CR05S oscilloscope. Schematic and operating manual needed. (John Neighbors, 5544 Fillmore Ave., Alexandria, Va. 22311)

Sonora Model NL-0101 organ. Schematic, service and instruction manual needed. (M. Strong, 114 Scott St., Massapequa, N.Y.)

Crosley Model 7H4 receiver, ser. K948739; tunes s.w. on 3 bands. Schematic, parts list, and source for parts needed. (Cliff Briere, Rt. 4, Box 283, Mechanicsville, Va. 23111)

Superior Model 670-A VTVM. Schematic and operating manual needed. (S. B. Stovall, 3054C McQueen St., Montgomery, Ala. 36107)

Radio City Products Model 446 multitester, series 8-2-40. Schematic needed. (Max Klingner, 855 E. 231 St., Bronx, N.Y. 10466)

McMurdo Silver "Masterpiece VI," circa 1938; has 20 tubes. Schematic needed. (George B. Publow, Box 590, Picton, Ontario, Canada)

Zenith Model 6S254 receiver, ser. R323058, circa 1933; tunes on 3 bands. Service manual needed. (Thomas K. McNally, Fine Rd., High Bridge, N.J. 08829)

Zenith Model 49CZ668 "Trans-Oceanic," receiver, circa 1949; tunes on 6 bands; has 5 tubes. Complete chassis needed. (Mac's Radio Service, 2769-J-Rodman Rd., Aberdeen Proving Ground, Md. 21005)

Weston Model 983 oscilloscope. Schematic and operating manual needed. **RCA Model T64 receiver.** Schematic needed. (Wilfrid N. LaChance, 286 N. Spring Garden St., Ambler, Pa. 19002)

Capehart Model 21M2 "Panamuse" receiver, ser. 75551, circa 1947; has 15 tubes. Schematic and alignment data needed. (G. R. Butler, 5388 Highland Rd., Cleveland 24, Ohio)

Superior Model TD-55 tube tester. Schematic and operating manual needed. (Dan Wischhoe, 814 13 St., Estherville, Iowa 51334)

Precision Model T60 tube tester. Roll chart and tube testing data needed. (Matthew J. Socha, Rt. 1, Box 420, Summersfield, Fla. 32691)

Continental Model TP-410 tape recorder, made in Japan; has 4 transistors. Schematic and operating manual needed. (Tarcizo Alves Batista, Centro Alte Moraes Rego (SN-20), Ministerio Marinha—Divisao Postal, Rio De Janeiro, Brasil)

GE Model E72 receiver, ser. 2243237; tunes 550 to 1600 kHz and 1.5 to 20 MHz; has 7 tubes. **Philco Model 90 superhet receiver** ser. 104529; tunes BC; has 9 tubes. Schematic, parts list, and alignment data needed. (Frank Brown, 51 Farnham St., Portland, Me. 04103)

Mosley Model CM-1 receiver, ser. 1430-3-62; covers 80 to 10 meters; has 5 tubes. Schematic and operating manual needed. (Gary McCorkle, Rt. 1, Box 75, Gatesville, Tex. 76528)

Emerson Model 109 receiver; tunes BC; has 4 tubes. Schematic and parts list needed. (Ed Kallin, 75 Tumblebrook Ln., W. Hartford, Conn.)

Atwater Kent Model 188; has 8 tubes. Schematic and source for parts needed. (Don C. Cox, Box 127, Welch, W. Va. 24801)

Stromberg-Carlson receiver, chassis 30317; tunes 550 to 1600 kHz and 6 to 18 MHz; has 9 tubes. Schematic, parts list, alignment data, and operating manual needed. (Bill Lockwood, 429 E. Grandview Blvd., Erie, Pa. 16504)

Hammarlund Model SP200 SX "Super Pro"; tunes 1250 kHz to 40 MHz. Schematic and operating manual needed. (Paul Dolengewicz, White Oak St., Middle Island, N.Y. 11953)

Majestic Model 7YR752 phono-receiver combo with wire recorder, circa 1946. Schematic and source for parts needed. (R.F. Hill, 386 Roosevelt Ave., Lyndhurst, N.J. 07071)

Somerset Model 5A receiver, circa 1924; tunes BC. Schematic and coil wiring information needed. (Pastor L.M. Schaeffer, Mortons Corners Rd., Springville, N.Y. 14141)

Hallcrafters Model CA2 "Skytone" receiver. Schematic and tube layout needed. (W. Gladman, General Delivery, Crofton, V.I., B.C., Canada)

Philco Model 41-280 receiver, circa 1941; tunes 540 kHz to 12 MHz on 3 bands; has 8 tubes. Operating manual and source for parts needed. (Dave Zawodny, 2330 Nebraska Ave., Toledo, Ohio 43607)

Rocket Model 8-HL TV receiver, circa 1962. Source for high-voltage transformer and other parts needed. (E.J. Bunker, 1804 Thornbury Rd., Baltimore, Md. 21209)

GE Model FE-51 receiver, circa 1946; tunes 540 to 1800 kHz and 5.6 to 19 MHz; has 5 tubes. Schematic and source for parts needed. (Lou Kurdziel, 28 Crosman Ave., Buffalo, N.Y. 14211)

Precise Model 300B oscilloscope, circa 1955; has 10 tubes and 7J1 cathode-ray tube. Schematic and operating manual needed. (John Albion, 3631 Cedar Hill Rd., Victoria, B.C., Canada)

Hallcrafters Model S-40 receiver, circa 1940; tunes 540 kHz to 44 MHz on 4 bands; has 8 tubes. Schematic and alignment data needed. (Jack Yeager, 7529 Baily Rd., Montreal, Quebec, Canada)

Sentinel Model 1U-816C color TV receiver, circa 1957. Source for horizontal output transformer #20E1208 needed. (Fred Cerne, 2809 S. Austin Blvd., Cicero, Ill. 60650)

Superior Instrument Model 85 "Dynamic" tube tester. Schematic and tube chart needed. (Frank Sheldon, 9303 107 St., Richmond Hill 18, N.Y.)

Motorola Model 65T21 receiver; tunes BC and s.w. on 2 bands; has 6 tubes. Schematic and operating manual needed. (Thomas Markos, 130 Marietta Dr., McKeesport, Pa. 15131)

Collins Model 310B exciter, circa 1948. Operating manual and parts list needed. (Curt Britton, 78 Laurel Ave., Bradford, Mass. 01830)

Zenith Model G500 "Trans-Oceanic" receiver, circa 1950; tunes BC and s.w.; has 5 tubes. Schematic and operating manual needed. (Don Hoefer, 1402 Mimosa Ln., Silver Spring, Md. 20904)

RCA Model 6BX672 receiver; tunes s.w. on 7 bands; has 5 tubes. Schematic, operating manual, and source for headphone and parts needed. (Allen Curtis, 1337 Brookline Rd., Cleveland Hts., Ohio 44121)

National receiver, type RCP, ser. 40; tunes 200 to 400 kHz and 1.3 to 30 MHz. Schematic and operating manual needed. (Alan S. Jenson, 721 Santa Rita, Sunnyvale, Calif. 94086)

Pilot Model T-500 receiver, circa 1946; tunes BC and s.w. Source for 4" speaker needed. (Arnold A. Pfeiffer, 66 Ridgeway Ave., Setauket, N.Y. 11785)

Pfanstiehl Model 34 receiver; has 7 tubes. Schematic of power pack needed. (Homer Madden, U.S. Lock #14, Box 58, Heidelberg, Ky. 41333)

(Continued on page 104)

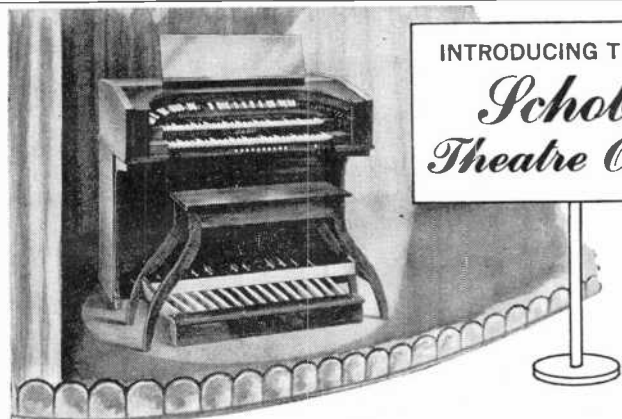

INTRODUCING THE NEW
Schober
Theatre Organ

The only
Theatre Organ
available in kit form
—for only \$1350.

Build it yourself and
save over 50%

Combination Action Ten buttons select preset combinations of stops—actually move the stop tablets as in pipe organs.

Percussion Eight percussion stops provide exciting realism. Celesta, harpsichord, piano, mandolin, xylophone, chrysoglott, orchestral bells, single or reiterating, are played just like the real thing—and sound that way—alone or along with regular organ stops.

Free Information. Send today for your copy of Schober's 16-page full-color booklet—plus free 7" recording.

THE *Schober Organ* CORPORATION
43 West 61st Street, New York, N.Y. 10023

The Schober Organ Corp., Dept. PE-23
43 West 61st St., New York, N. Y. 10023

- Please send me Schober Organ Catalog and FREE 7-inch "sample" record.
 Enclosed please find \$2.00 for 12-inch quality LP record of Schober Organ music. (\$2.00 refunded with purchase of first kit.)

Name.....

Address.....

City.....State.....Zip No.....

You've asked for it and here it is — the NEW Schober THEATRE ORGAN that you assemble yourself. For the first time in kit form, a real Theatre Organ with that rich, full, old time theatre pipe organ sound. You create the organ, then you create the music!

The Theatre Organ features special voicing, curved console design, two 61-note keyboards, 2-octave radiating pedal clavier, 8 octaves of tone distributed over 5 pitch registers (including a 1-foot register), 35 speaking organ stops, 8 realistic percussion stops, 4 couplers, and vibrato tablet—48 tablets in all. And all at a truly remarkable low price...you save over \$1,500 (well over 50%) from comparable theatre organs.

Just follow easy step-by-step instructions written in everyday language which anyone can understand. You'll have an unequalled pride when you're finished that only can come from assembling it yourself.

The Theatre Organ starts at \$1,350. This price includes a beautiful walnut console or you can save further by building your own from plans. Options available include combination action, genuine reverberation, percussion, and amplifiers and speakers.

CIRCLE NO. 28 ON READER SERVICE PAGE

Build your own
AUTO ANALYZER
—and **SAVE!**

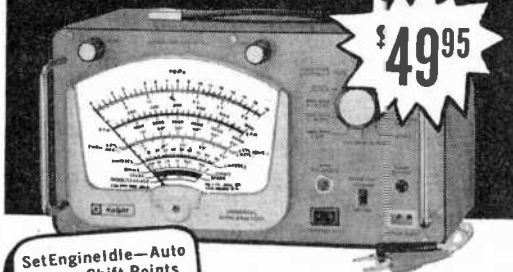

\$49⁹⁵

Set Engine Idle—Auto Trans. Shift Points

CHECK:

- Distributor wear
- Dwell angle
- Voltage regulator
- Condensers
- Point surfaces
- Coil resistance
- Ground circuits
- Alternator diodes
- Engine timing
- Spark output and much more!

WITH A **knight-kit**® FROM
ALLIED RADIO

Headquarters for Everything in Electronics
Save double on this famous Knight-Kit Auto Analyzer. Build it yourself and save factory assembly costs. Then use it for tune-ups and trouble-shooting to hold down car upkeep.

Write for special introductory offer
No Money Down • \$5 Monthly

ALLIED RADIO

Dept. P.O. Box 4398, Chicago, Ill. 60680
CIRCLE NO. 15 ON READER SERVICE PAGE

The Mellotone display has some sound ideas!

Acoustically-engineered fabrics to cover your speakers . . . decorating ideas for your high fidelity installation. See the Mellotone grille fabric display at your parts distributor.

Mellotone Inc.,
1220 Broadway,
N.Y., N.Y., 10001.

MELLOTONE

CIRCLE NO. 18 ON READER SERVICE PAGE

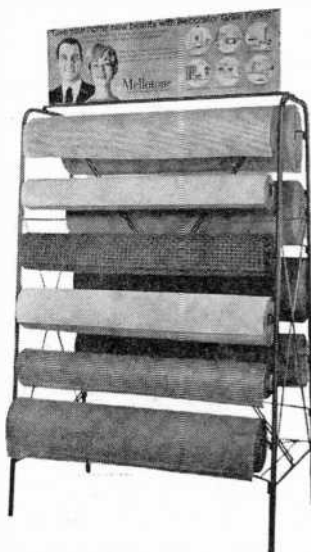

ASSIST (Continued from page 103)

Sonograph Model C4 receiver, ser. 605648; has 5 tubes. Schematic of amplifier section and source for parts needed. (Robert Stainer, Box 348, Oliver, B.C., Canada)

Hickok Model 530 tube tester. Operating manual needed. (R.L. Trott, 1690 Sharkey St., Tallahassee, Fla.)

Lysco Model 381 converter; covers 80 to 40 meters; has 3 tubes. Schematic needed. (Stan Putta, 1429 Lawn-dale, Racine, Wis. 53403)

Majestic receiver, ser. A 134128; tunes AM and FM, and 9.5 to 15.5 MHz; has 12 tubes. Schematic, alignment data, and photo of unit wanted. (Robert Blacka, 533 Levick St., Philadelphia, Pa. 19111)

Solar Model CF "Capacitor Exam-eter," ser. F-92206. Schematic and source for power transformer needed. (S.W. Wilkinson, 4124 E. Hastings St., Burnaby 2, B.C., Canada)

Simpson Model 300 tube tester. Schematic, operating manual, and tube chart needed. (Robert F. Eager, 1225 Saunders Settlement Rd., Niagara Falls, N.Y. 14305)

Kolster Model K-34 receiver, ser. 27101, circa 1925; has 7 tubes. Schematic and source for parts needed. (Jack Alexander, Jr., 10246 Woodbury, Apt. C, Garden Grove, Calif. 92640)

Bremer Tully Model 7DB-21 "Counterphase" receiver; tunes BC. Schematic and year of manufacture wanted. (Roy Filippo, 4712 Holladay Rd., Virginia Beach, Va.)

Packard Bell Model 651 "Stationized" receiver; tunes BC and 6 to 18 MHz; has 6 tubes. Schematic and alignment data needed. (Tom Carson, 7934 Amestoy Ave., Van Nuys, Calif. 91406)

RCA Model AVR-20A aircraft receiver, ser. 1849; tunes 2.3 to 6.5 MHz on one band; has 4 tubes. Schematic, operating manual, and parts list needed. (Michael G. Farrell, 1710 E. 4 St. #B, Long Beach, Calif.) **30**

QUIZ ANSWERS

(Quiz appears on page 80)

- 1 — I The unijunction transistor has but ONE p-n junction.
- 2 — B The voltage doubler output is approximately equal to TWO times its r.m.s. input.
- 3 — E Audio equipment frequency response is measured within the half-power point on the curve—read as THREE db down.
- 4 — D These curves, representing the characteristics of a tetrode (FOUR-element vacuum tube) plate, display a negative resistance region.
- 5 — G By Ohm's law, the current flowing in the circuit is FIVE mA.
- 6 — A Television channels are SIX-MHz wide.
- 7 — C This is the Morse code symbol for numeral SEVEN.
- 8 — F A figure-EIGHT (Lissajous) pattern on a scope indicates that the scope's horizontal input is being fed a sine wave having twice the frequency of the vertical input signal.
- 9 — H The "on" lamps are reading NINE in the binary number system.

SOLID STATE

(Continued from page 87)

experimenter breadboard kits are now available from Texas Instruments' distributors. Priced at \$49.50 apiece, each kit includes from four to eight IC's, breadboarding sockets, specification sheets, sample diagrams, application information, and service data, all designed to provide the engineer, student or experimenter with the essential components needed to check out and test basic IC applications.

A new silicon *n*p*n* transistor for UHF applications has been introduced by the International Rectifier Corp. (233 Kansas St., El Segundo, Calif. 90245). Designated as Type TR-24, the transistor is specifically designed for general replacement use in TV receiver UHF oscillators, FM converters, and other circuit applications in the 100-MHz range.

The Tor Manufacturing Co. (16329 E. Arrow Hwy., Irwindale, Calif. 91707) has introduced a series of four power transistor mounting kits. These kits, according to the manufacturer, will cover the hardware needs of over 80% of all standard transistor types. Each kit is individually packaged, and includes Teflon or mica insulating washers, bushings, screws, nuts, and solder lugs.

Transitips. It's no trick to convert a.c. line voltage to d.c. All that is needed is a diode rectifier. But the d.c. you get in this manner is not "pure." Rather, it is a pulsating unidirectional wave containing both a.c. and d.c. components. The a.c. component, commonly called *ripple*, will introduce intolerable hum into the equipment (amplifier, receiver, etc.) powered by the pulsating d.c., unless it is removed by a suitable filter.

A variety of techniques can be used to reduce the amount of ripple, some of which are shown on p. 110. In Fig. 4(a), a large value capacitor, *C1*, is used as a ripple filter. The a.c. input is rectified by diode *D1*, in series with limiting resistor *R1*, acting to control surge currents while *C1* is charging, and thus prevent *D1* from burning out. Typically, the value of *R1* is between 22 and 100 ohms, while *C1* may range from 50 μ F to as high as 5000 μ F, depending on the d.c. load.

A simple filter of this type is inexpensive and may even be mandatory where high currents are involved. However, it has poor d.c. regulation and is relatively inefficient. While satisfactory for moderate-gain or low-gain circuits, it is usually not suitable for high-gain amplifiers.

(Continued on page 110)

May, 1967

Thinking of college and a space age career?

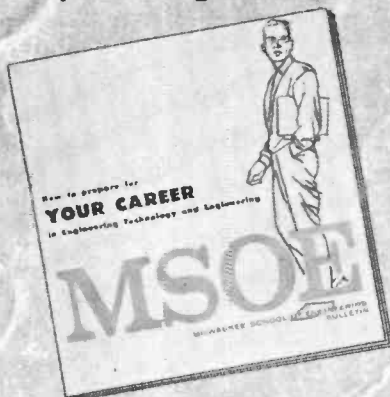

Send for this booklet on ENGINEERING TECHNOLOGY AND ENGINEERING

Learn how you can prepare for a dynamic career as an electrical or mechanical engineering technician or engineer in such exciting, growing fields as avionics, missiles, reliability control, fluid mechanics, data processing, metallurgy, microelectronics, and advanced aerospace research.

MSOE offers residence study programs leading to these degrees in engineering technology and engineering:

2 years — Associate in Applied Science

4 years — Bachelor of Science

Also get facts about scholarships and financial aids, job placement and other student services, plus photographs of MSOE technical laboratories and student activities. Courses approved for veteran training. For your copy, just mail the coupon — no obligation.

MSOE

Milwaukee, Wisconsin 53201

Milwaukee School of Engineering
Dept. PE-567, 1025 N. Milwaukee Street
Milwaukee, Wisconsin 53201

Please send the "Your Career" booklet.
I'm interested in

Electrical fields Mechanical fields

Name.....Age.....

Address.....

City.....State.....ZIP.....

CIRCLE NO. 19 ON READER SERVICE PAGE

MS-284

SOLD ONLY BY RADIO SHACK®

JETSTREAM™ 10-TRANSISTOR AIRCRAFT AND AM PORTABLE

Hear Pilot-Control Tower Transmissions!

Tunes Aircraft in Flight • Control Towers • Unicom • ILS • Approach Control • Omni-range • Radar Approach • GCA Systems • Standard AM Band, Too!

21⁹⁵

#12-626

Perfect for pilots, G.I.'s, stewardesses, travelers — at work, home, driving or flying. Has telescopic VHF antenna. Batteries included.



REALISTIC® 12" LP WITH 28 TIMED SOUND EFFECTS

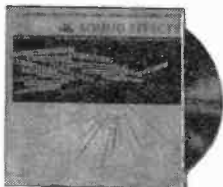

Only **1⁴⁹**

#50-1970

Playable Both Monaurally and Stereophonically!

Custom pressed in the U.S.A. by popular demand — for speaker testing, home movies, amateur theatricals! Compare our price!

SAVE \$20 ON 50-WATT SOLID STATE FM-STEREO RECEIVER!

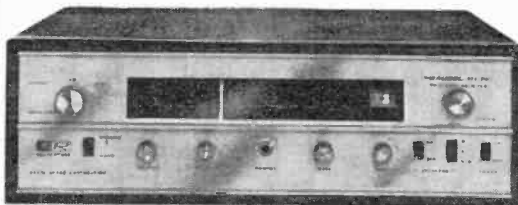

Our 1967 Cat. Price ~~\$189⁹⁵~~

- Automatic Stereo FM!
- Stereo Headphone Jack!
- Precise Tuning Meter!
- Smooth Flywheel Tuning!

169⁹⁵

NO MONEY DOWN.

Model STA-50T — made for us by one of America's leading names in solid state equipment! Get power, performance and value-plus! Features flexible remote/local/all-speaker switching; tape recorder input; automatic stereo FM with built-in line cord FM antenna. Sensitivity: 3 μ v. Response: 20-20,000 cps. Stereo separation: 30 db at 1,000 cps. With metal case. #31-2045. 60-Watt Model STA-60, with AM; 31-2060, Reg. 219.95, SALE 199.95.

SAVE \$5! 8-TRANSISTOR WALKIE TALKIES License-Free 100 MW

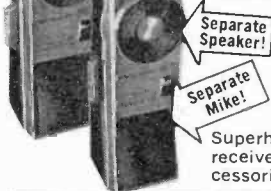

'66 Cat. Price: ~~\$199⁹⁵~~ **14⁹⁵** Each

Superhet, not super-regen! Send, receive to a mile or more! All accessories included. #21-1001

NOW — 145 RADIO SHACK STORES IN 31 STATES!

ARIZONA — Phoenix
 ARKANSAS — Little Rock
 CALIFORNIA — Anaheim, Bakersfield, Covina, Downey, Garden Grove, Inglewood, La Habra, Long Beach, Los Angeles, Mission Hills, Mountain View, Oakland, Pasadena, Pomona, Reseda, Sacramento, San Bruno, San Diego, San Francisco, Santa Ana, Santa Monica, Torrance, West Covina
 COLORADO — Denver
 CONNECTICUT — Hamden, Manchester, New Haven, New London, Orange, Stamford, West Hartford

FLORIDA — Jacksonville, Orlando
 GEORGIA — Atlanta
 ILLINOIS — Chicago
 KANSAS — Wichita
 LOUISIANA — New Orleans
 MAINE — Portland
 MARYLAND — Langley Park
 MASSACHUSETTS — Boston, Braintree, Brockton, Brookline, Cambridge, Framingham, Lowell, Medford, Natick, Quincy, Saugus, Springfield, Waltham, West Springfield, Worcester

MICHIGAN — Detroit
 MINNESOTA — Minneapolis, St. Paul
 MISSOURI — Kansas City, St. Joseph, St. Louis
 NEBRASKA — Omaha
 NEW HAMPSHIRE — Manchester
 NEW JERSEY — Pennsauken
 NEW MEXICO — Albuquerque
 NEW YORK — Albany, Binghamton, Buffalo, New York, Schenectady, Syracuse
 OHIO — Cincinnati, Cleveland
 OKLAHOMA — Oklahoma City, Tulsa

OREGON — Portland
 PENNSYLVANIA — Philadelphia, Pittsburgh
 RHODE ISLAND — Providence, East Providence
 TENNESSEE — Memphis, Nashville
 TEXAS — Abilene, Arlington, Austin, Brownsville, Corpus Christi, Dallas, Fort Worth, Houston, Lubbock, Midland, San Antonio, Sherman, Waco
 UTAH — Salt Lake City
 VIRGINIA — Arlington, Virginia Beach
 WASHINGTON — Seattle

SOLD ONLY BY RADIO SHACK®

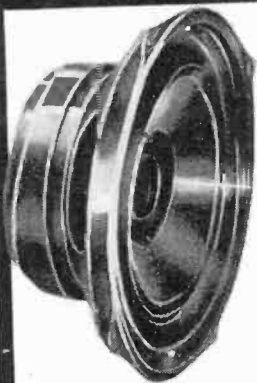

SUPER SPECIAL PURCHASE! HIGH-COMPLIANCE 4" SPEAKERS

For Acoustic Suspension Systems

Compare! Made in England by **EMI**

3⁹⁹
Ea.

Lots of 4-12	3⁷⁷ Ea.
Lots of 13-24	3⁵⁵ Ea.

Unbeatable low price! Use in custom hi-fi installations, as replacements in compact enclosures, or as extension speakers. Broad cone excursion; 13,000 gauss ceramic magnet; 50-15,000 cps response. Handles 15 watts music power. 8 ohms. #40-1908

Repeat of a Sellout! New Low Price!

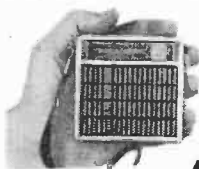

6-TRANSISTOR MICRO RADIO

The same miniature portable that sold at \$4.99! Only 2 1/2" square, 1 1/4" deep. Stunning black grain case, silvered front panel. #12-619

ONLY 4⁹⁹

DUOFONE™ HI-FI HEADPHONES



Wide-range dynamic (not magnet) headset; feather-light; cushioned earpieces. Stereo/mono switch in plug. Matches 4-16 ohms. #33-196

6⁹⁵

America's Only Switchable Stereo and Mono Headset!

5-WATT MOBILE CB TRANSCEIVER

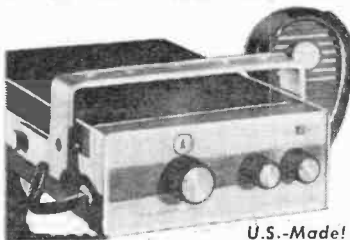

Model TRC-14

Only **79⁹⁵**

8-channel operation; 100% modulation; adjustable squelch; ANL; 13 transistors, #21-032

U.S.-Made!

DUAL-Z DYNAMIC MIKE, STAND



• 250 or 50K Ohms!
• New for 1967! **7⁹⁵**

'Realistic' desk mike with stand. 40-13,000 cps response; 360° swivel joint; black molded body, base. Output: -55 db. #33-934

CLOSEOUT! MINIATURE 1 1/2 VDC MOTORS

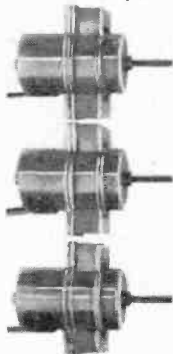

- Ideal for Hobbyists!
- Only 1 3/8 x 2 x 3/4"!

3 For 99^c

Lowest price we've seen for miniature motors! Operate from 1 1/2-12V flashlight battery; the greater the voltage, the greater the speed. Bronze bearings; 1/16" dia. shaft, 1/2" long. #273-232

MAIL THIS HANDY COUPON TODAY!

RADIO SHACK } East: 730 Commonwealth Ave., Boston, Mass. 02215 DEPT. QN
West: 1515 So. University Dr., Ft. Worth, Tex. 76107

- | | |
|---|--|
| <input type="checkbox"/> Send me FREE 1967 Radio Shack catalog. | <input type="checkbox"/> STA-60 AM/FM-Stereo Receiver, 31-2060 |
| <input type="checkbox"/> Aircraft/AM Radio, 12-626 | <input type="checkbox"/> 4" Speaker, 40-1908 |
| <input type="checkbox"/> Sound Effects Record, 50-1970 | <input type="checkbox"/> Micro-Radio, 12-619 |
| <input type="checkbox"/> Walkie-Talkie, 21-1001 | <input type="checkbox"/> Stereo/Mono Headphones, 33-196 |
| <input type="checkbox"/> STA-50T FM-Stereo Receiver, 31-2045 | <input type="checkbox"/> TRC-14 CB Transceiver, 21-032 |
| | <input type="checkbox"/> Dynamic Mike, 33-934 |
| | <input type="checkbox"/> Motors, 273-232 |

Please send me the items I have checked. I enclosed \$_____ plus \$1.00 to cover handling and postage anywhere in the U.S.A.; I understand any excess payment will be refunded promptly.

Name _____

Street _____

City _____ State _____ Zip _____

CIRCLE NO. 25 ON READER SERVICE PAGE

AM/FM VHF RECEIVERS

POLICE • FIRE • AIRCRAFT AMATEUR • GENERAL COVERAGE

The new 364C is a self contained highly sensitive receiver offering the user continuous AM/FM coverage from 26 to 54 and 88 to 174 MC in eight bands plus one band covering 15 meters. Features: superhet circuitry, full vision calibrated dial with vernier drive, speaker, power transformer, ready to use for 110/120 V AC.



364C
\$59.95



377A
\$22.50

377A Low cost tuneable transistor converter self contained battery for car use. Three types—low or high band police and fire or aircraft. Also complete line of crystal controlled converters and squelch units for monitoring police, fire, aircraft, etc. signals.

372B Level limiting is a necessity in recording. The 372B features low distortion and adequate dynamic range for any situation. Write for full details of this and other audio equipment.

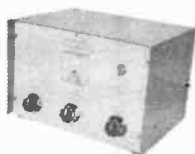

372B
\$99.95

KUHN ELECTRONICS

20 GLENWOOD CINCINNATI 17, OHIO

CIRCLE NO. 16 ON READER SERVICE PAGE

Audio-Color

Lets you see your music



ASSEMBLED
\$54.95

KIT FORM
\$44.95

\$5 DOWN — \$5 MONTH

Walnut finished cabinet included / Shipped REA Collect

Easy to build, easy to install. All transistor AUDIO-COLOR adds a visual dimension to musical enjoyment. A brilliantly moving panorama of color casts dancing images on a soft frosted screen, reflecting rising and falling volume with each beat of the music. Here's a truly unique and exciting new musical experience. Make check or money order to CONAR.

SEND FOR FREE CONAR CATALOG

CONAR

Division of National Radio Institute,
Dept. EA7C 3939 Wisconsin Ave.,
Washington, D.C. 20016

Where additional filtering is required, a resistor (R_2) or a choke can be connected in such a way as to form an a.c. voltage divider with the filter capacitor. Such an arrangement becomes a basic *L-type* filter, and is illustrated in Fig. 4(b). As before, d.c. is obtained from D_1 , in series with R_1 . The value of R_2 can range from as little as 50 ohms to as high as 10,000 ohms, depending on the load current and voltage requirements. In practice, however, both resistors are not used in an L-type filter, since a single resistor, either R_1 or R_2 , will suffice if its value is fixed at from 100 to, say, 2500 ohms.

An L-type filter is effective, but introduces a definite power and voltage loss, due to the IR drop across the series resistor. For a given applied a.c. input, the d.c. output can be raised appreciably by the addition of an input filter capacitor (C_2) shown by the dashed lines. This converts the arrangement to a pi-type (π) filter.

The voltage drop across R_2 can be considerably reduced if this resistor is replaced with an iron-core choke coil, L_1 , shown in Fig. 4(c). This type of filter is very effective and has been used extensively in vacuum tube power supplies. However, where low voltages and high currents are involved—as

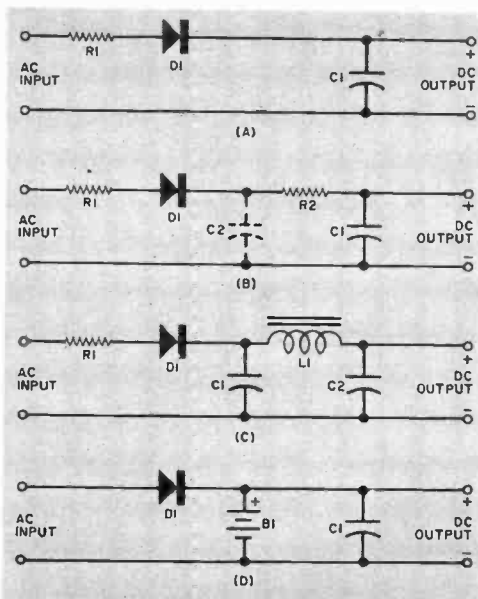

Fig. 4. Power supply ripple filters. (A) includes a large value capacitor, C_1 , in the output circuit. For additional filtering, a basic L-filter (B) can be formed by adding a resistor, R_2 , in the output circuit. To achieve greater d.c. output, resistor R_2 can be replaced with a choke, L_1 , having a capacitor on each side as shown in (C). Floating a battery, B_1 , across the line as in (D) obviates the need for either a coil or additional resistor.

is the case with many transistor circuits—the arrangement becomes impractical due to the physical size, and cost, of the choke needed for effective filtering.

A less popular, less expensive, yet extremely effective ripple filter is shown in Fig. 4(d). Here, a battery (*B1*) is floated across the d.c. line and a relatively small filter capacitor (*C1*) is used. With this arrangement, *R2* is no longer needed, since the fixed battery voltage prevents sudden current surges. In practice, *B1*'s voltage is slightly under the d.c. voltage supplied by *D1*. Thus, *B1* supplies relatively little current and, instead, acts very much as if it were a large filter capacitor. The life of the battery in this application approximates its normal shelf life.

Although half-wave rectifiers are featured in each of the circuits shown, full-wave rectifiers can be used in similar filter arrangements. Filtering action is much more efficient in full-wave rectifier circuits due to the higher ripple frequency involved.

That closes out this month's column. See you in June.

—Lou

ON THE CITIZENS BAND

(Continued from page 95)

age team has 31 members, the combined total membership being in excess of 37,000.

A REACT Assist.*As a monitor for Kanmo REACT Headquarters, Kansas City, Mo., Jan Orth, KNI0377, has handled the usual landline relays required at the scene of several accidents, aided in searches for lost persons, and even helped arrange transportation from a private airport into town to a chartered airline. But Jan admits that the most unusual call came from a physician who was mobile, en route from Cameron, Mo., to Kansas City.

Learning of the illness of one of his patients, the doctor ordered her admitted to Cameron County Hospital. In order to save time, he issued the following orders to Jan's monitoring station through his mobile CB radio while proceeding to the hospital:

. . . Symptoms—pneumonia and possible heart failure. Orders—oxygen, 4 liters; head of bed elevated 40 degrees; 600,000 units penicillin . . . immediate EKG (electrocardiograph), CBC (complete blood count) tonight; chest X ray on admission; for temperature above 101 degrees, 1 cc Dipherone . . .

Jan relayed the information to Kanmo REACT Headquarters, and it was relayed to the hospital from there.

May, 1967

The CB-20 "Reactor" is one of seven solid state CB transceiver brands on the market selling for less than \$100. Even if their specifications were comparable,*



doesn't it make sense

to buy yours from the company that has built more communications rigs by a country mile than all the others put together?



hallicrafters

A Subsidiary of Northrop Corporation

5th and Kostner Aves.
Chicago, Ill. 60624

*The CB-20's specs are a matter of conservative record: Channels: 5, crystal-controlled. Transistors: 12 plus 8 diodes, Zener voltage regulator. Sensitivity: One microvolt for 10 db S/N ratio. Audio power output: 3 watts. Power supply: 12 V. dc only. Modulation: high order. Microphone: push-to-talk ceramic. Maximum current drain: Receive, 0.75 amp.; Transmit, 1.4 amps. Dimensions: 7" x 6" x 2¼" LWH. Weight: 4 lbs. PS-20 AC pedestal power supply available as an accessory.

Export: Int'l. Div. Canada: Gould Sales Co.
CIRCLE NO. 10 ON READER SERVICE PAGE

111

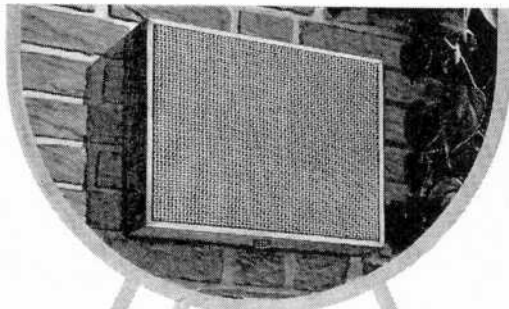

New

Patio

outdoor speaker
in timeless redwood
\$14.95 Audiofile net

- Silicone-treated speaker.
- 10-watt, full-range, 8-ohms.
- Handy, built-in volume control.
- Weather-resistant cane grille.
- 14" x 10½" x 3½" fits in any sheltered space.

Write for
FREE

Argos

CATALOG PRODUCTS COMPANY

Dept. C 600 So. Sycamore St., Genoa, Illinois 60135
CIRCLE NO. 1 ON READER SERVICE PAGE

Live Better Electronically With

LAFAYETTE RADIO ELECTRONICS

1967 Catalog 670 **FREE!**



**BETTER THAN EVER
512 Pages**

Stereo Hi-Fi • Citizens
Band • Ham Gear • Tape
Recorders • Test Equip-
ment • TV and Radio Tubes
and Parts • Cameras •
Auto Accessories • Musical
Instruments • Tools • Books

Featuring Everything in Electronics for
• HOME • INDUSTRY • LABORATORY
from the "World's Hi-Fi & Electronics Center"

LAFAYETTE Radio ELECTRONICS
Dept. IE-7 P.O. Box 10
Syosset, L.I., N.Y. 11791

Send me the FREE 1967 LAFAYETTE Catalog 670 IE-7

Name

Address

City State

Zip

(Please Give Your Zip Code No.)

CIRCLE NO. 17 ON READER SERVICE PAGE

Aid to Brazil? Artur Chamis, 2BX442, Brazilian CB operator, would like to correspond with U.S. CB'ers. He is specifically interested in learning more about how CB works in the U.S., as well as setting up club and network operations. A few well-printed CB club papers might prove quite helpful to Artur. Those interested in his cause should contact him at A. Eduardo Prado 383 C/8, S. Paulo, Brazil.

I'll CB'ing you,

-Matt, KHC2060

AMATEUR RADIO

(Continued from page 94)

will occur or for how long an opening will last, but in the United States the spring and summer months and the late forenoon hours (local time) are the most likely times. Just keep listening to the band as much as you can; and, even if you are using only a 5-watt transceiver and a simple antenna, you will end up with a lot of new states in your logbook before fall rolls around.

"Veishea" Contest. Out at Iowa State University, the Campus Radio Club, WØYI, and the Men's Residence Association Radio Club, WAØKHF, will jointly operate at least three rigs during "Veishea"—the nation's largest student-managed festival at which educational displays and entertainment are provided for thousands of people. WØYI and WAØKHF are offering a certificate to any amateur radio operator who works either or both stations on any amateur frequency.

Operation will be from 0000, May 5, through 0600, May 7, and it is suggested that you monitor the following frequencies: 3.780, 3.975, 7.055, 14.270, 21.410, 28.600, and 50.400 MHz. To obtain the certificate, send your QSL to WØYI (WAØKHF), Campus Radio Club, Electrical Engineering Bldg., Iowa State University, Ames, Iowa 50010. The QSL must include the date and time (in GMT) the contact was made and a full return address, and it should be sent within a week after the contest takes place so that the certificates can be processed and mailed before the end of the school year.

Coast Guard Cutter On the Air. Amateur mobile radio station WA5KSJ on the Coast Guard Cutter *Campbell* officially went on the air on February 2. Operating out of the ship's home port, Staten Island, N.Y., at that time, the station was expected to be used extensively on the *Campbell's* scheduled cruise to Ocean Station Echo, located

POPULAR ELECTRONICS

some 800 miles east northeast of Bermuda.

Due to the absence of mail for as long as 30 days while the cutter is out "on station," WA5KSJ plans to keep crew members in touch with relatives and friends at home through broadcasts to other ham stations in the U.S. and overseas. In one of the first "on-the-air" sessions, WA5KSJ made a loud-and-clear contact with a West German ham.

The station will also be used to receive and transmit distress broadcasts intercepted by other ham operators, and so assist the cutter in its mission of Search and Rescue.

NEWS AND VIEWS

During the big snow storm in Northern Indiana and Illinois in late January, hundreds of radio amateurs were busy handling vital communications. For example, Chicago TV station WFLD televised "live" reports on snow, road, and other emergency conditions from amateurs all over the Chicagoland area as the reports were received over the WFLD amateur radio club station, WA9RTP, located in the TV studios . . . Complicating conditions just south of the main snow belt, ice and freezing rain knocked out many miles of power and telephone lines, leaving amateur radio as the sole means of communications with many areas. "Ray" Lane, W9KXN, Clinton, Ill., for example, dispatched all railroad trains in and out of Clinton via amateur radio for several days; Pauline Course, WA9CNU, acted as his Chicago outlet.

To keep the record straight, although K3SIO reported from Asia in the December "News and Views" that WA8OBB/XV5 was active from Cam Ranh Bay, Vietnam, S/Sgt. George J. Wade, WA8PPQ, who operates MARS Station AB8AB in Quinhon, Vietnam, reports that K1YPE/XV5 is still the only officially authorized amateur station in the country. K1YPE, by the way, is William Porter, the U.S. Deputy Ambassador to Vietnam . . . Arthur Malatzy, WN2WFI, 83-19 141 St., Jamaica, N.Y., worked 27 states and Canada in 10 months as a Novice—not bad for a 40-meter dipole antenna strung along the baseboard in his apartment. A Heathkit DX-20 transmitter and a Lafayette HA-225 receiver took turns huffing and puffing on the antenna. Art has a Rag Chewers' Certificate and a 20-wpm code certificate on the shack wall, and when his General ticket (which is on the way) arrives, he plans to buy a WRL "Galaxy-V" transceiver . . . Dr. Carl W. Boyer, WA3EAW, 8304 20th Ave., Adelphi, Md., is another ham who has had excellent results with an indoor antenna. His was a 20-meter dipole tacked to the attic rafters while he was stationed in Hawaii and signing KH6FDG. This antenna, fed by a National NCX-3 transceiver, worked all over the Pacific and the United States on 20-meter SSB. Carl admits, however, that his present, home-brew, 2-element beam radiates better than an indoor dipole.

John W. MacMillan, VP1JM, P.O. Box 441, Belize City, British Honduras, is the answer to many amateurs' prayers. John, who works in a bank, QSL's 100% by airmail! And he claims that his returns are just about 100%, too; having a DX call does help. John uses an EICO 753 transceiver; it drives a WRL vertical antenna and has worked many U.S. stations and Canadians, and quite a bit of DX on 20-meter SSB—usually between 14.2 and 14.25 MHz. And he is going back to CW, part time at least, after neglecting it for several years . . . Scott J. MacGregor, WA7ECY, 495 NE Beech St., Gresham, Oreg., started his Novice career with a second-hand "Globe Scout" transmitter and a Hallicrafters S-118 receiver. Twenty states later, he had a Heathkit DX-60A transmitter and HR-10

Popular SAMS BOOKS



USE THIS HANDY ORDER FORM

RECENTLY PUBLISHED! TIMELY!

- Transistor Substitution Handbook.** *New 7th edition*—more complete than ever. Lists thousands of direct transistor substitutions—U.S., foreign (including replacements for Japanese types), both home entertainment and industrial. Order 20529, only \$1.75
- Slide Rule in Electronics.** Tells how to figure resistance, reactance, impedance, current and voltage relationships, etc. Order 20532, only \$4.25
- Troubleshooting with the Oscilloscope.** *Newly revised.* Explains clearly how to isolate electronic circuit troubles through waveform analysis. Covers testing of solid-state devices, use of triggered sweep scopes, etc. Order 20550, only \$3.95
- 101 Ways to Use Your Hi-Fi Test Equipment.** *Newly revised.* Explains proper use of these specialized instruments; gives test setups, procedures, and how to evaluate results. Order 20552, only \$2.95
- Basic Electricity & An Introduction To Electronics.** *Newly revised.* Clear coverage of electricity fundamentals, followed by an explanation of electronics basics. Ideal for home study. Order 20540, only \$3.95
- How To Read Schematic Diagrams.** Not only shows you how to read and interpret diagrams, but analyzes each component, its construction, and its circuit purpose and use. Order 20337, only \$2.25
- TV Servicing Guide.** Tells you how to apply proper trouble shooting procedures based on analysis of symptoms, illustrated by picture tube photos. Packed with troubleshooting and servicing hints. Order 20361, only \$2.50
- Color-TV Servicing Made Easy. Vol. 1.** Full explanation of color principles, circuitry, setup adjustments, and servicing of all color-TV sets. Takes the mystery out of servicing color-TV. Order 20135 \$3.25
- ABC's of Citizens Band Radio.** **NEWLY REVISED & UPDATED.** All you need to know about planning and setting up a CB 2-way radio system. Explains functions, principles, setup and operation, latest rules and regulations. Order 20019 \$2.25
- Transistor Ignition Systems Handbook, 20238** \$2.95
- TV Tube Symptoms & Troubles, 20476** 1.95
- Citizens Band Radio Handbook, 20101** 3.50
- 2nd-Class Radiotelephone License Handbook, 20316** 4.75
- Modern Dictionary of Electronics, 20151** 7.95
- Handbook of Electronic Tables & Formulas, 20230** 3.95
- Color TV Trouble Clues, 20520** 1.95
- Solving TV Tough-Dogs, 20403** 3.25

FAMOUS ABC'S BOOKS

- Lasers & Masers, 20262 \$2.25
- Electronic Test Probs., 20039 2.25
- Computer Programming, 20123 2.25
- Modern Radio, 20047 \$1.95
- Transistors, 20440 2.25
- Tape Recording, 20399 1.50

— HOWARD W. SAMS & CO., INC. —

Order from any Electronic Parts Distributor, or mail to Howard W. Sams & Co., Inc., Dept. PE-5 4300 W. 62nd St., Indianapolis, Ind. 46268

Send books checked above. \$ _____ enclosed.

Send FREE Sams Book Catalog.

Name _____

PLEASE PRINT

Address _____

City _____ State _____ Zip _____

CIRCLE NO. 27 ON READER SERVICE PAGE

**Discriminate Between
Desired Signal and
Unwanted Noise**

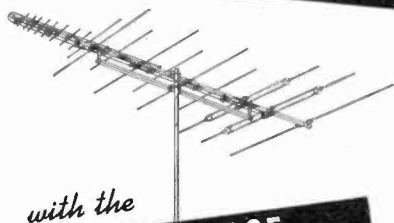

with the

**FREE SPACE
STANDING WAVE
MAGNETIC ANTENNA
UHF-VHF-FM-COLOR**

Investigate now!

S & A ELECTRONICS INC.

Manufacturers of the TARGET ANTENNA

228 W. FLORENCE STREET

TOLEDO, OHIO 43605

CIRCLE NO. 26 ON READER SERVICE PAGE

WORLD'S FINEST



**ERSIN
MULTICORE
5-CORE
SOLDER**

**NEW EASY
DISPENSER
PAK only 69¢**

**BUY IT AT RADIO-TV
PARTS STORES**

MULTICORE SALES CORP., WESTBURY, N.Y. • 11591

CIRCLE NO. 22 ON READER SERVICE PAGE



Lew Christie, WB6QQP, of Fontana, Calif., is another of the increasing number of hams who prefer CW to phone. Lew's record: WAS; WAC; 52 countries with less than 100 watts; and Idaho with 25 mW.

receiver; these carried him to 37 states, Japan, and New Zealand. Next came his General ticket and a Drake TR-4 transceiver; a Heathkit "Tower," used both at home and as a mobile for mountaintop operation; and a Heathkit HW-12A for 75-meter mobile work. Oh, yes, the states-worked total now is up to 47, and a tri-band beam is scheduled to take its place among the dipoles and verticals on his 80-acre antenna farm shortly . . . **Buzz Jehle, WN8TFJ**, 7275 Tangle Ridge, Cincinnati, Ohio, has worked one state for every watt of transmitter power—50 watts to a Johnson "Adventurer." His receiver is a Heathkit HR-10, and his antenna is a "ground plane" vertical. The band is 15 meters. Still to come are Buzz's General Class ticket and a QSL card from Asia for his Worked All Continents certificate.

Bill Pearl, WN6UYW, 8704 Rosewood Ave., Los Angeles, Calif., figures his amateur station cost him \$100—the best \$100 he ever spent. Half of it went for a used Hallicrafters SX-43 receiver, \$25 for a home-brew 50-watt transmitter, and \$25 for a Hy-Gain 18-V vertical antenna, wire, etc. Operating the 80-, 40-, and 15-meter Novice bands, Bill has worked 26 states and Japan in a month . . . **Chuck Starling, W9FTK/8**, says if you want some real high-speed code practice, listen to W1EIA and WINJM on 3637 and 7120 kHz, Sundays at 8:30 p.m. EST (0130 GMT, Mondays). Transmission speeds are 35 to 65 wpm! . . . **Wiley G. Clarkson, WA5OTR**, 1417 Hillcrest, Fort Worth, Texas, works all amateur bands from 80 meters through 2 meters. A Gonset GSB-100 AM/CW/SSE transmitter, a National NC-303 receiver, a Hy-Gain 14-AVQ vertical antenna, and an 80/40 meter "trap" doublet handle things up to 10 meters. A Hallicrafters SR-46 transceiver with matching VFO and a 5-element Cush Craft beam cover 6 meters, and a 75-watt home-brew transmitter and another 5-element beam cover 2 meters. Wiley is a member of Air Force MARS and of several amateur emergency nets . . . **Dave Gross, WN2ZQE**, 31 Eaton Rd., Syosset, N.Y., raised the very first station he called as a Novice. And in two weeks he has worked 15 states and three countries, all on 15 meters, with a "Globe Scout" transmitter, Lafayette HA-225 receiver, and a dipole antenna.

If there is some facet of amateur radio that you would like to have us discuss in this column, let us know what it is. And let us have your "News and Views," pictures, club newspapers, and information on any club code courses. Address your letters to: Herb S. Brier, W9EGQ, Amateur Radio Editor, POPULAR ELECTRONICS, P.O. Box 678, Gary, Ind. 46401.

73, Herb, W9EGQ

POPULAR ELECTRONICS

SHORT-WAVE LISTENING

(Continued from page 61)

news item claiming that the clandestine *R. Peyk-e Iran* (widely heard on 11,695 kHz) belongs to the Kurds in northern Iran. The station was attacked by Iraqi bombers and is reportedly located near the Iranian border. *R. Peyk-e Iran* is often jammed by a station which used to be known as the "Kiss Me Honey" station; some months ago the "Kiss Me Honey" recording was dropped for a Beatles recording of "Can't Buy Me Love," and lately they have been using a variety of pop records. The jamming station is also being reported on 9555 and 11,410 kHz, around 1400.

In the December, 1966, column, "466 Weaver St., Webster, N.Y." was listed as being an address to which reception reports for 4VEH (Cap Haitien, Haiti) might be sent. This is actually the address of the DX Stamp Service from whom mint (unused) stamps of many foreign countries can be purchased for return postage use.

CURRENT STATION REPORTS

The following is a resume of current reports. At time of compilation all reports are as accurate as possible, but stations may change frequency and/or schedule with little or no advance notice. All times shown are Greenwich Mean Time (GMT) and the 24-hour system is used. Reports should be sent to SHORT-WAVE LISTENING, P.O. Box 333, Cherry Hill, N.J., 08034, in time to reach your Short-Wave Editor by the fifth of each month; be sure to include your WPE identification, and the make and model number of your receiver.

Ascension Island—The government of this island recently issued a set of stamps of the 1d, 3d, 6d, and 1/6d denominations to mark the setting up of a BBC relay station here.

Brazil—*Emissora Rural, A Voz do San Francisco*, Petrolina, 5025 kHz, is the station being heard here from 2230 to 0203 s/off with native music and commercials. This 500-watt station evidently is the only one active on this channel; two other listed Brazilians are not being heard.

Ceylon—The Commercial Service of *R. Ceylon*,

Colombo, 9667 kHz, has a BBC news relay at 1300 with musical programs before and after the news.

Colombia—Station *HJGR, La Voz del Pueblo*, Pereira, is on 5997 kHz, where it suffers QRM from the *VOA* on 5995 kHz. It has the usual Latin American features and is audible around 0100 and later.

Congo (Democratic Republic)—*La Voix de la Fraternite Africaine*, Lumumbasi, has returned to 11,866 kHz, where it has been noted at 1820 with an ID. This station has Eng. news on Sundays at 1745-1755 followed by pop music and an Eng. period until 1827. Reports indicate that the Eng. period may vary as to time.

Costa Rica—*Esta Es Radio Popular*, San Jose, has been noted with many ID's around 0302 on 4780 kHz. Tune carefully; this station may drift in frequency.

Denmark—Copenhagen's current Eng. schedule reads: to N.A. at 0145-0215 on 9520 kHz, to the Far East at 0745-0815, to N.A. at 1245-1315, to S. Asia at 1445-1515, and to Africa at 1915-1945, all on 15,165 kHz. In addition, there is an Eng. test xmsn at 1015-1100, Saturdays only, on 9520 kHz. There are no Eng. xmsns on Sundays.

Ecuador—*HCOS4, La Voz del Rio Carrizal*, is a new station noted on 3569 kHz, with listener's request periods mostly, and with closing around 0330.

Ethiopia—Station *ETLF*, Addis Ababa, has Eng. for W. Africa at 1900-1945 on 15,115 kHz. It was also noted at the same time on 15,385 kHz, a new channel.

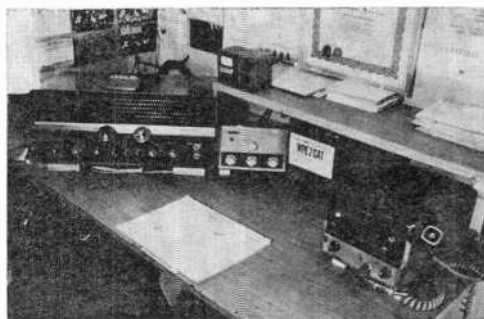

The listening post of Mel Granick, WPE2GAT, Laurelton, Queens, N.Y., contains a Hallicrafters S-108 receiver plus a Heath HD-11 Q-multiplier for SWL'ing, and a Johnson "Messenger II" transceiver for CB operation. His SWL record is 31 countries verified out of 36 heard (plus 4 out of 5 on the medium waves), and 24 states verified out of 25 logged.

Sonar SENTRY VHF MONITOR RECEIVERS

\$39⁹⁵

With Battery, Earphone, & Carrying strap less Crystals \$5.00 ea.

Model		
FR-103	FR-106	AR-107
150-175 MHz	25-50 MHz	Aircraft 108-136 MHz

LISTEN TO: POLICE, FIRE, AIRCRAFT & WEATHER REPORTS!

for Industrial, Commercial, Utility & Govt. Use

2 CHANNELS • BROADCAST BAND • CRYSTAL CONTROLLED

Designed and engineered for simplicity of operation, compact enough to fit a shirt pocket yet powerful enough to deliver a clear clean signal—it's dependable • Operates on two crystal controlled VHF channels plus broadcast band • Completely solid state for long life use • Visible battery indicator to show battery condition at all times • Built in antenna • 5 7/8" H x 2 1/2" W x 1 3/8" D. Wt. 11 oz.

SONAR RADIO CORP., 73 Wortman Ave., Bklyn, N.Y. 11207

Please send information on VHF Monitor Receivers. Dept. 536

Name _____

Address _____

City _____ State _____

POPULAR ELECTRONICS SUBSCRIBER SERVICE

Please include an address label when writing about your subscription to help us serve you promptly. Write to: Portland Place, Boulder, Colo. 80302

Change of Address:
Please let us know you are moving at least 4 weeks in advance. Affix magazine address label in space to the right and print new address below. If you have a question about your subscription, attach address label to your letter.

To Subscribe:
Check boxes below.

- New Renewal
 5 years \$20
 3 years \$13
 1 year \$5

Specify

- Payment enclosed
 —You get 1 extra issue per year as a Bonus!
 Bill me later.

← AFFIX LABEL →

If you have no label handy, print OLD address here.

state city address name

zip-code please print

name please print 0212

address

city

state zip-code



SEND FOR FREE NEW CATALOG AND TERMINAL SAMPLES
 VECTOR • 1100 FLOWER STREET, GLENDALE, CALIFORNIA

LEARN Electronics Engineering AT HOME

Fix TV, design automation systems, learn transistors, complete electronics. College level Home Study courses taught so you can understand them. Earn more in the highly paid electronics industry. Computers, Missiles, theory and practical. Kits furnished. Over 30,000 graduates now employed. Resident classes at our Chicago campus if desired. Founded 1934. Catalog. "Vets—write for information about G.I. Bill Training."

AMERICAN INSTITUTE OF ENGINEERING & TECHNOLOGY
 1137 West Fullerton Parkway, Chicago, Illinois 60614

Formosa—Voice of Free China, Taipei, noted on 15,125 kHz with Eng. news at 0257, an ID at 0301, Chinese music at 0309, a news review at 0322, and is heard well to close at 0348 now that Seoul has vacated the channel. This xmsn is dual to 7130, 15,345, 17,720, 17,780 and 17,890 kHz.

Germany (East)—R. Berlin International is noted on 21,560 kHz at 1325 with Eng. news, and from 1330 to 1355/close with dance music in the Africa service. The 6120-kHz outlet has also been logged at 0230-0300 to N.A. with news, music, discussion-type shows, and current event reports.

Guatemala—Station TGBA, R. Maya Barillas, Huehuetenango, 2360 kHz, may run past normal s/off time to as far as 0500 on special occasions. Their QSL indicates that the languages used for programming include Aguateca, Ixil, Quiche, Chuj, Mam, K'anjobal, and some Spanish.

Haiti—R. 4VEH, Inc., Cap Haitien, has been heard with a good signal at 2300-0305 (to 0335, Wednesdays and Fridays) in Eng. on 11,835 kHz (4VEJ); 9770 kHz (4VEH); and 890 kHz (4VE—a new station). Frequencies in use after 0130 include 6120 kHz (4VE), 2450 kHz (4VSO), and 1035 kHz (4VEF).

India—All India Radio, Delhi, has been operating in Eng. on 15,375 kHz from 1330 to 1500; news is aired at 1445. Two other channels have been reported for the first time: 7195 and 11,850 kHz, both with Eng. news around 0230-0240.

Italy—Rome is heard well on 9630 kHz in Eng. to N.A. from 0100 and in Spanish to Latin America at 0245-0330.

Kenya—Voice of Kenya, Nairobi, is definitely on 4934 kHz, and verified as such. They have Eng. news, closing at 0615, followed by a commercial-type program with some ads in Eng. but primarily in Swahili. Listen to 0400 for seven gongs at 7 a.m. their local time. Many listeners are confusing this station with Lagos, Nigeria, newly located on 4932 kHz, which opens at 0600 with a commercial service.

Korea (North)—R. Pyongyang continues to be heard well on 14,510 kHz from 2300 to 2350 s/off in Spanish to Latin America, dual to poorer 11,765 kHz. They announce another xmsn at 0100-0150 on the same frequencies. Also being logged is 6285 kHz, around 2330.

Korea (South)—A new frequency for Voice of Free Korea, Seoul, is 15,430 kHz, heard from 2245 to 2300 in Korean, at 0215-0230 in Spanish, to 0300 in native language (possibly Oriental), and at 0300-0400 in Eng. with news, commentary, pop Korean music, and "Korean Impressions."

Libya—Libyan Broadcasting & TV Service, Tripoli, was heard on 7165 kHz from 2146 to 2215 s/off with instrumental music, singing, news, and anmts in an all-Arabic xmsn.

Mongolian People's Republic—A registered letter from R. Ulan Bator gives this adjusted and corrected schedule for Eng.: at 2200-2300 on Mondays, Tuesdays, Thursdays and Fridays; and 1300-1450 on Tuesdays, Wednesdays, Fridays and Saturdays.

Mozambique—R. Clube de Mocambique, Lourenco Marques, has been found on a new frequency of 4860 kHz at various times between 2130 and 0400 with Eng. and Afrikaans commercial service; they may ID as "This is LM Radio." The dual channel on 11,780 kHz has also been noted from 0335 to 0445. R. Paz, Beira, 7205 kHz, has a Portuguese music program at 0415-0425; s/on is at 0400 with a chimes IS and singing by a choir.

SHORT-WAVE ABBREVIATIONS

anmt—Announcement	QRN—Station interference
BBC—British Broadcasting Corporation	QSL—Verification
Eng.—English	R.—Radio
ID—Identification	s/off—Sign-off
IS—Interval signal	s/on—Sign-on
kHz—Kilohertz	VOA—Voice of America
kW—Kilowatts	xmsn—Transmission
N.A.—North America	xmtr—Transmitter

RADIO BUCHAREST LETTERS CONTEST

Would you like to have a souvenir from Romania? An art album, collections of records, slides of picture postcards presenting the beauty spots of Romania? All you have to do is listen to Radio Bucharest at least 12 times before June 1, 1967, and send the station 12 reception reports of about 150 words each. Include in the reports—in addition to the usual data on reception conditions—comments on the programming, and suggestions for possible changes or improvements in the program material.

Netherlands—*R. Nederland*, Hilversum, has Dutch to the West Indies at 0000-0100 on 6200 kHz in parallel to 9630 kHz.

New Hebrides—*R. Port Vila* has been heard in Eng. and later in French on 3905 kHz until 0709/close. The signal is weak; QRM from ham operators is heavy.

Nicaragua—*R. Zelaya*, Bluefields, is now on 5950 kHz with Eng. at 1140-1204. Pop music is noted around 2355.

Pakistan—*R. Pakistan*, Karachi, is heard on 15,090 kHz at 1335-1350, and on 15,210 kHz at 1440 with music, at 1500-1515 with Eng. news, and to past 1530 with native-language programs.

Portuguese Guinea—*Emissora da Guine Portuguesa*, Bissau, is weak on 5041 kHz to 2300 s/off. Some monitors claim that membership in *R. Portugal's* DX Club seems to speed up a QSL considerably.

Somali Republic—Add 6107 kHz as being in use by *R. Mogadiscio* from 0330 s/on after the normal "A" running signal. They have native-language news at 0345-0355 followed by music. The QRM is very heavy and very selective tuning is required for this one.

South Africa—*R. South Africa*, Paradys, has Eng. from 0430 s/on on a new frequency of 7260 kHz.

Thailand—Bangkok is currently audible as early as 2350 with native music and Thai on 11,910 kHz. By 0030 they are generally "over S9," indicating that the new 100-kW xmtr is doing a good job. This would be a good time period for them to have Eng. to N.A.; undoubtedly they would draw a large response since their beam is on target and propagation conditions are good.

Tunisia—*R. TV Tunisienne*, Tunis, has been found on 6285 kHz at 2215 with the end of news in Arabic, followed by a talk in the same language. The signal is generally good.

Uganda—Being reported for the first time is the Blue Network of *R. Uganda*, Kampala, 7110 kHz, which was noted with a weak signal at 0650-0715, carrying instrumental music and talks in vernacular.

United Arab Republic—Cairo has been logged on two seldom-heard channels: 15,360 kHz from 2230 s/on in Arabic, and 9305 kHz from 0240 with Eng. talks and Arabic music until a 0300 clock strike.

Upper Volta—*Radiodiffusion de Haute-Volta*, Ouagadougou, is currently on 7230 kHz from 0600 s/on, with French music from 0630 to 0645.

Vatican City—*R. Vaticano* has Eng. at 1800-1812 on 11,700 kHz with church news.

Venezuela—*R. Barquisimeto* has reactivated the 9510-kHz channel: all-Spanish programming was noted at 0235, 0600, and 0800-1055, with talks and pop music. *R. Monagas*, Maturin, has opened operations on 11,770 kHz and is heard at 0005-0215 with sporting events; not known, as yet, is whether this is a change from or an addition to the normal 3325-kHz frequency. *La Voz de la Patria*, Caracas, has moved from 3305 to 4839 kHz, and is loggable from 0745 to 0809 s/off with Latin American music. However, they are still announcing, at press time, as being on 3305 kHz.

May, 1967

GET MORE ACTION WITH

MULTI-ELMAC
PRECISION MADE,
POPULAR PRICED
CB UNITS!

*** CITI-FONE SS \$16950**

FULL 23 CHANNEL
AC-DC Operation,
Illuminated Meter
& Channel Selector,
Triple Tuned RF,
"Noise Immune"
Squelch, Double
Tuned IF's, Ready to Operate



*** CITI-FONE 99 \$9950**

FULL 8 CHANNEL
AC-DC Operation,
Delayed AVC,
Electronic Switching,
2 Stage Pre-Amp
Illuminated "3"
Meter, Complete
with Crystal for 1 Channel



*** CITI-FONE II \$4995**

SOLID STATE
Transmitter-Converter

Contact 3 1/4 x
4 3/8 x 1 1/2, 9
Transistor, 2
Diodes, 3 Watt
Input (FCC Max.)
100% Modulation, 12 VDC
Operation, Complete with Crystal for
1 Channel



Please send further information on Citi-Fone SS , 99 , II

MULTI-ELMAC CO.

21470 Coolidge • Oak Park, Michigan 48237

NAME _____

ADDRESS _____

CITY _____

STATE _____ ZONE _____

CIRCLE NO. 21 ON READER SERVICE PAGE

FREE!

BIGGER... BETTER THAN EVER!



40th ANNIVERSARY 1967 CATALOG



YOUR BUYING GUIDE FOR:

- Stereo & Hi-Fi Systems & Components.
- Tape Recorders.
- Electronics Parts, Tubes, Tools.
- Phonos & Records.
- Ham Gear.
- Test Instruments & Kits.
- Cameras & Film.
- PA.
- Citizens Band.
- Radio & TV Sets.
- Musical Instruments.

**SEND FOR
YOURS TODAY!**

BURSTEIN-APPLEBEE CO.

Dept. PE 1012 McGee, Kansas City, Mo. 64106
 Rush me the FREE 1967 B-A Catalog.

Name.....

Address.....

City..... State..... Zip Code.....

CIRCLE NO. 3 ON READER SERVICE PAGE

IMPROVE MOBILE RADIO RECEPTION



'Filter out annoying ignition noise with SIGNAL SAVERS'

The signal comes through sharper, more clearly, when you ground annoying ignition interference. You extend reception range—even double it. Signal Savers place a blanketing shield around the sources of interference: distributor, coil, spark plugs, high tension leads... keep the noise out, let the signal come through. Guaranteed not to interfere with electrical or mechanical performance. Signal Savers are approved for original equipment installation by all leading automotive engine manufacturers. Write for information and name of nearby Signal Saver dealer.

*Signal Saver is a Hallett trademark

Hallett

Dept. PE-567, 136 N. Ash St., Inglewood, Calif. 90301

SOME DISTRIBUTOR AREAS OPEN!

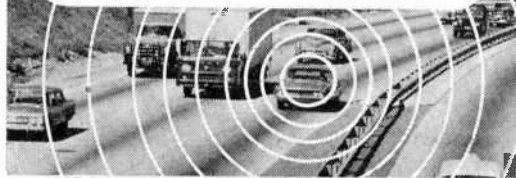

CIRCLE NO. 9 ON READER SERVICE PAGE

Zambia—Rarely heard on the West Coast is Lusaka on 4965 kHz with native-language programs overriding *R. Santa Fe* (Colombia) at 0500. According to some DX'ers, this phenomenon occurs only once or twice a year.

Clandestine—Many reporters are hearing a station in the 49-meter band (frequencies vary from 6100 to about 6140 kHz) with an ID of *Phoenix, Voice of International Waters on Radio Phoenix Six, The Call of the High Seas*. Most reports list it as being heard at 1700-2200 on Sundays only with pop records and frequent ID's. Two disc jockeys are on board, one named Don Stack. The station refers to "our Miami listeners." But other reports claim that the announcer stated that they were just off Atlantic City, N. J. Still other reports quote the announcer as saying they are anchored just outside the three-mile limit and can be seen from the beach (but the exact beach was not given—Ed).

Utility—If you hear CW beacon station RAB, Rabinal, Guatemala, on 1613 kHz, send your report to Pan-American Communications Department, Miami, Fla. 33159.

50

SHORT-WAVE CONTRIBUTORS

W. F. Mitchell (*WPE1FVW*), Revere, Mass.
Roger Camire (*WPE1GK*), Manchester, N. H.
Thomas Feeney, Jr. (*WPE1GZC*), Newport, R. I.
Douglas Grant (*WPE1GZQ*), Canton, Mass.
Arthur Delibert (*WPE2HJR*), Lynbrook, N. Y.
Stephen November (*WPE2HLS*), Bronx, N. Y.
William Graham (*WPE2LMU*), Binghamton, N. Y.
Kenneth Coyne (*WPE2LSI*), Long Beach, N. Y.
Robert Kaplan (*WPE2MIR*), Bronx, N. Y.
Bernard Greene (*WPE2MNI*), Brooklyn, N. Y.
John Sgrulletta (*WPE2NCF*), Bedford Hills, N. Y.
Roger Greene (*WPE2NFC*), Bronx, N. Y.
Elliott Feinberg (*WPE2NFG*), Brooklyn, N. Y.
Ira Schultz (*WPE2NGG*), White Plains, N. Y.
Jay Hans (*WPE2NGI*), White Plains, N. Y.
Alan Coles (*WPE2NUY*), Leonia, N. J.
Christopher Schminck (*WPE2OES*), Williamsville, N. Y.
Peter Macinta, Jr. (*WPE2ORB*), Kearny, N. J.
Bill Kushner (*WPE2ORR*), Port Washington, N. Y.
Bruno Colapietro (*WPE2OWO*), Endwell, N. Y.
Clifford Mass (*WPE2OWT*), East Meadow, N. Y.
Bernard Lansing (*WPE2PBA*), Rochester, N. Y.
Alan Farley (*WPE2PHL*), Highland Park, N. Y.
Bob Huber (*WPE3GUN*), Wilmington, Del.
Grady Ferguson (*WPE4BC*), Charlotte, N. C.
Chuck Edwards (*WPE4BNK*), Fort Lauderdale, Fla.
Dan Henderson (*WPE4GW*), Laurel, Md.
John Hoecker (*WPE4HYG*), Annandale, Va.
Paul Johnson (*WPE4ICW*), Virginia Beach, Va.
Bill Darkoch (*WPE5ELO*), Dallas, Texas
Trev Clegg (*WPE6FAF*), Fresno, Calif.
Bruce Fingerhood (*WPE6GPG*), Northridge, Calif.
John Sears, Jr. (*WPE7CNZ*), Bellevue, Wash.
Dave Borino (*WPE7EZ*), Cheyenne, Wyo.
Robert Eddy (*WPE8FOW*), Newport, Ohio
Bob Hagerman (*WPE8INH*), Hemlock, Mich.
Carl Durnavich (*WPE9IFO*), Riverdale, Ill.
Richard Luttrell (*WPE9ILD*), Jacksonville, Ill.
Steve Whitney (*WPE9ISE*), Madison, Wis.
A. R. Niblack (*WPE9KM*), Vincennes, Ind.
Mike Nielsen (*WPE9NY*), Orinda, Calif.
John Beaver, Sr. (*WPE0AE*), Pueblo, Colo.
Dave Lund (*WPE0AUO*), Sioux City, Iowa
Alan Braun (*WPE0EWW*), Prairie Village Kan.
Jack Perolo (*PY2PE1C*), Milwaukee, Wis.
Don Wright (*VE2PE1KZ*), Pierrefonds, Quebec, Canada
Leo Alster, Rahway, N. J.
David Alpert, Morton Grove, Ill.
Anthony Curtis, Centre Hall, Pa.
Jeffrey Dubin, Philadelphia, Pa.
Bruce Horlick, Los Angeles, Calif.
W. Keller, Hamden, Conn.
Don Kenney, Westminster, Calif.
David Palfrey, Kearny, N. J.
John Russell, Jr., Pequannock, N.J.
Christopher Schmandt, Philadelphia, Pa.
Lee Teegarden, Independence, Mo.
Radio New York Worldwide, New York, N. Y.
Radio Ulan Bator, Ulan Bator, Mongolian People's Republic
Sweden Calling DX'ers Bulletin, Stockholm, Sweden

POPULAR ELECTRONICS

ELECTRONICS MARKET PLACE

COMMERCIAL RATE: For firms or individuals offering commercial products or services. \$1.00 per word (including name and address). Minimum order \$10.00. Payment must accompany copy except when ads are placed by accredited advertising agencies. Frequency discount: 5% for 6 months; 10% for 12 months paid in advance.

READER RATE: For individuals with a personal item to buy or sell. 60c per word (including name and address). No Minimum! Payment must accompany copy.

GENERAL INFORMATION: First word in all ads set in bold caps at no extra charge. Additional words may be set in bold caps at 10¢ extra per word. All copy subject to publisher's approval. Closing Date: 1st of the 2nd preceding month (for example, March issue closes January 1st). Send order and remittance to: Hal Cymes, POPULAR ELECTRONICS, One Park Avenue, New York, New York 10016.

FOR SALE

FREE! Giant bargain catalog on transistors, diodes, rectifiers, SCR's, zeners, parts. Poly Paks, P.O. Box 942, Lynnfield, Mass. 01940.

GOVERNMENT Surplus Receivers, Transmitters, Snooper-scopes, Radios, Parts, Picture Catalog 25¢. Meshna, Nahant, Mass. 01908.

CANADIANS—GIANT Surplus Bargain Packed Catalogs. Electronics, Hi-Fi, Shortwave, Amateur, Citizens Radio. Rush \$1.00 (Refunded). ETCO, Dept. Z., Box 741, Montreal, CANADA.

WEBBER LAB'S Police—Fire Transistorized Converter kit 30-50mc. & 100-200mc. (1 mc. spread) \$5.00 each. 26-200mc. on broadcast band using any type radio, crystal controlled \$23.00 wired pp. tunable—crystal controlled \$11.00 kit. 72 Cottage Street, Lynn, Mass. 01905.

JAPAN & Hong Kong Electronics Directory. Products, components, supplies. 50 firms—just \$1.00. Ippano Kaisha Ltd., Box 6266, Spokane, Washington 99207.

CANADIANS, TRANSISTORS AND PARTS. Free catalogue contains reference data on 300 transistors. J. & J. Electronics, Dept. PE, Box 1437, Winnipeg, Manitoba.

INVESTIGATORS, FREE BROCHURE, LATEST SUBMINIATURE ELECTRONIC SURVEILLANCE EQUIPMENT, ACE ELECTRONICS, 11500-L NW 7TH AVE., MIAMI, FLA. 33168.

CB-WPE-QL CARDS. Same High Quality, Beautiful, Glossy multi-color cards. New LOW PRICES. 26 SAMPLES, 25¢. Dick, W8VXX, 19QA0625, Gladwin, Mich. 48624.

R.F. CONVERTERS. World's largest selection. Also CCTV cameras, etc. Lowest factory prices. Catalog 10¢. Vanguard 196-23 Jamaica Ave., Hollis, N.Y. 11423.

RECTIFIERS, transistors, other components. Catalog free. Electronic Components Co., Box 2902C, Baton Rouge, La. 70821.

TELEPHONE VOICE SWITCH: (LS-500). ACTUATES AUTOMATICALLY AND UNATTENDED ANY TAPE OR WIRE RECORDER. PICTORIAL INSTALLATION INSTRUCTIONS INCLUDED. \$23.75. POST PAID USA, WJS ELECTRONICS, 737 NORTH SEWARD, HOLLYWOOD, CALIF. 90038.

INVESTIGATORS: KEEP IN STEP WITH ADVANCEMENTS IN THE ART OF ELECTRONICS FOR THE PROFESSIONAL. SEND \$1.00 FOR EQUIPMENT BROCHURE, WJS ELECTRONICS, 737 NORTH SEWARD, HOLLYWOOD, CALIF. 90038.

BUG DETECTOR: WILL DETECT AND LOCATE SURREPTITIOUS TRANSMITTING DEVICES IN CONFERENCE ROOMS, HOME AND OFFICES, ETC. WRITE FOR DETAILS. WJS ELECTRONICS, 737 NORTH SEWARD, HOLLYWOOD, CALIF. 90038.

TRANSISTORIZED Products Importers catalog. \$1.00. Intercontinental, CPO 1717, Tokyo, Japan.

RADIO — T.V. Tubes—33¢ each. Send for free catalog. Cornell. 4213 University, San Diego, Calif. 92105.

DETECTIVES! Free Brochures! Electronic Surveillance Devices. SILMAR ELECTRONICS, 3476 N.W. 7th Street, Miami, Fla. 33125.

CIRCUIT Boards, Parts for "Poptronics" projects. Free catalog. DEMCO, Box 16297, San Antonio, Texas 78216.

ROCKETS: Ideal for miniature transmitter tests. New illustrated catalog, 25¢. Single and multistage kits, cones, engines, launchers, trackers, rocket aerial cameras, technical information. Fast service. Estes Industries, Penrose 18, Colorado 81240.

LOWEST Prices Electronic Parts. Confidential Catalog Free. KNAPP, 3174 8th Ave. S.W., Largo, Fla. 33540.

SURVEILLANCE EQUIPMENT—NEW HIGH PERFORMANCE SUBMINIATURE MODELS. ELECTRONIC COUNTERMEASURE DEVICES TO PROTECT PRIVACY. FREE DATA: SECURITY ELECTRONICS-PE, 15 EAST 43RD STREET, NEW YORK, N.Y. 10017.

CB-QL CARDS. New Designs, Record Books, Blabbermouth Awards, Gag Signs, Warning Decals, Novelties. Free Brochure. WOODY, 8474 Watson, St. Louis, Mo. 63119.

CRYSTALS . . . largest selection in United States at lowest prices. 48 hr. delivery. Thousands of frequencies in stock. Types include HC6/U, HC18/U, FT-241, FT-243, FT-171, etc. Send 10¢ for catalog with oscillator circuits. Refunded on first order. Jan Crystals, 2400F Crystal Dr., Fort Myers, Fla. 33901.

FREE ELECTRONICS (new and surplus) parts catalog. We repair multimeters. Bigelow Electronics, Bluffton, Ohio 45817.

NEW supersensitive transistor instrument detects buried gold, silver, coins. Kits, assembled models. \$19.95 up. Free catalog. Relco-A33, Box 10563, Houston, Texas 77018.

CONVERT any television to sensitive, big-screen oscilloscope. Only minor changes required. No electronic experience necessary. Illustrated plans, \$2.00. Relco-A33, Box 10563, Houston, Texas 77018.

ELECTRONIC Ignition Kits, Components, Free Diagrams. Anderson Engineering, Epsom, New Hampshire 03239.

COMPONENTS? Kits? Hardware? For catalogue write Trans-Vu-Pacs, Box 267, Chelsea, Mass. 02150.

DIAGRAMS—Radios \$1.00, Television \$2.50. Give make and model. Diagram Service, Box 1151PE, Manchester, Conn. 06042.

MUSIC LOVERS, CONTINUOUS, UNINTERRUPTED BACKGROUND MUSIC FROM YOUR FM RADIO, USING NEW INEXPENSIVE ADAPTOR. FREE LITERATURE. ELECTRONICS, 11500-Z NW 7th AVE., MIAMI, FLORIDA 33168.

GREAT BUYS Electronic Catalog 10¢. Relays, latching, sensitive, mercury, miniature, rotary switches, silicon rectifiers 750 PIV-750 MA 35¢, FERTIK'S, 5249 "D", Philadelphia, Pa. 19120.

MESHNA'S Transistorized Converter Kit \$5.00. Two models; converts car radio to receive 30-50mhz or 100-200mhz (one mhz tuning) Meshna, No. Reading, Mass. 01864.

CLOSED-CIRCUIT TV—Industrial, educational. Factory-direct prices. Write for particulars. ATV RESEARCH, Box 396P, Industrial Division, South Sioux City, Nebr. 68776.

110VAC 60cy from car generator. Powers lights, refrigerator, transmitter, receiver, etc. Simple, easy to convert. Plans, \$2.00. Tedco, Box 12098, Houston, Texas 77017.

TV CAMERA PLANS. Best available. Tube model, vidicon—\$3.00; transistor—\$5.00 (deductible). Flying spot scanner—\$2.50. **ATV RESEARCH**, Box 396P, So. Sioux City, Nebr. 68776.

HOBBYISTS, EXPERIMENTERS, Amateur Scientists, Students . . . Construction Plans—All complete including drawings, schematics, parts lists, prices, parts sources . . . **Laser**—Build your own coherent-light optical laser. Operates in the pulsed mode, the visible light range—\$6.00 . . . **Diode Laser—Invisible Light (infrared)** can be continuously modulated—\$3.00 . . . **Reverberator (Echo) Unit**—Build your own. Use with your automobile radio, home radio or hifi, electric guitar, etc.—\$3.00 . . . **Radar**—Build your own ultrasonic doppler radar. Detect motion of people, automobiles, even falling rain drops. Transistorized, uses standard small 9-volt battery—\$4.00 . . . **Long-Range "Sound Telescope"**—This amazing device can enable you to hear conversations, birds and animals, other sounds hundreds of feet away. Very directional. Transistorized. Uses 9 V battery—\$3.00 . . . Or send 25¢ coin or stamps for complete catalogue . . . **Technical Writers Group**, Box 5501, State College Station, Raleigh, N.C. 27607.

SEE YOURSELF ON TV! Exciting hobby lets you televise live pictures right in your own home. Kits from \$18.95 to \$149.50. Catalog 10¢. **ATV RESEARCH**, Box 396P, Amateur Division, South Sioux City, Nebr. 68776.

DIGITAL COMPUTER EXPERIMENTS! CIRCUIT DIAGRAMS using the **INEXPENSIVE ZN107** or Equiv. completely. **ASTABLE MULTIVIBRATOR; FLIP-FLOP; INVERTER-AMPLIFIER; SCHMITT TRIGGER.** 98¢ each; All four only \$2.98. Circuits, P.O. Box 671, Aurora, Colo. 80010.

OLD Radios. Old Tubes. State wants. Husband's collection. Stella Duea, Underwood, Minn.

EXPERIMENTERS Latest Transistorized Projects Catalog 10¢, Hazelton Scientific, Box 163, Hazel Park, Michigan 48030.

\$500,000.00 Inventory Late Electronics \$3500.00. Stanley Kluzek Company, Dawson, Illinois 62520.

SUDYMONT acoustic baffles. Plans \$5.95; Baffle \$26.95; with cabinet from \$39.95. Send speaker size. **SUDY-MONT**, 120 Liberty Str. NYC. 10006.

WE SELL CONSTRUCTION PLANS. AMAZING NEW SUPER HOBBY CATALOG 25¢. **TELEPHONE:** Answering Machines, Speaker-phones, Mobilephones, Automatic Dialers, Central Dial Systems, Phonevision, Legal Connectors, Laser Links. **TELEVISION:** Cameras, 3D Converters, Color TV Converters, Video Recorders, **HOBBYIST:** Teletypes, Electron microscopes, Tranquillizers, Private Eye Tail Transmitter. Plans \$4.95 each. Silent Listening Device **DYNAMITER** Plans \$8.50. **COURSES:** Detective Electronics \$22.50, Telephone Engineering \$39.50, Cryptographic and Security Electronics \$27.50. Don Britton Enterprises, 7906 Santa Monica Blvd., Hollywood, Calif. 90046.

DISCHARGE Ignition, PHOTOFLASH parts, kits. Free catalogs. **TRANSFIRE**, Carlisle, Massachusetts 01741.

JAPANESE or EUROPEAN DIRECTORY 200 firms \$1.00. **SURVEILLANCE EQUIPMENT**, wireless **SNOOPERMIKE** \$25.00, **SUBMINNIMIKE** 3/8 x 3/8 x 3/16 \$4.00, Brochure 25¢, **SIERRATRONICS**, Box 7497, Las Vegas, Nev. 89101.

TRANSISTORS—10¢ each, on circuit boards with other components. Minimum order \$2.00 ppd. L. Short, Box 332, Kennesaw, Georgia 30144.

NEW PRODUCT FOR ELECTRONIC TRANSDUCERS! One drop of force paint makes a transducer with **LITTLE** weight or volume. **AIR DRYING;** apply to any shape between conductive surfaces. **HUNDREDS** of transducers can be made from 1 oz. of fluid. A **DROP** of liquid will change resistance **THOUSANDS** of ohms; will operate relays, recorders, and solid state circuits **WITHOUT** amplifier. Price \$20.00 oz. **DEAN ELECTRONICS**, Box 9265, N. Hollywood, Calif. 91609.

FM WIRELESS MIKE—KIT OR FACTORY ASSEMBLED. Small compact unit incorporating latest advances in design and circuitry. 86-105 mc range. Kit includes Printed Circuit Board assembled and tested, internal **WIDE RANGE** dynamic microphone, Vinyl covered metal case—\$29.95. Complete unit—factory assembled and tested—\$39.95. **PMC Electronics**, 7815 Oxford Ave., Phila., Pa. 19111.

CLASSIFIED ADVERTISING ORDER FORM

Please refer to heading on first page of this section for complete data concerning terms, frequency discounts, closing dates, etc.

1	2	3	4	5
6	7	8	9	10
11	12	13	14	15
16	17	18	19	20
21	22	23	24	25
26	27	28	29	30
31	32	33	34	35

Words { @ 60¢ (Reader Rate) } = \$ _____
 { @ \$1.00 (Commercial Rate) }

Insert _____ time(s) Total Enclosed \$ _____

NAME _____

ADDRESS _____

CITY _____ STATE _____ ZIP _____

Signature _____

WORD COUNT: Include name and address. Name of city (Des Moines) or of state (New York) counts as one word each. Zone or Zip Code numbers not counted. (Publisher reserves right to omit Zip Code if space does not permit.) Count each abbreviation, initial, single figure or group of figures or letters as a word. Symbols such as 35mm, COD, PO, AC, etc., count as one word. Hyphenated words count as two words.

PE-567

SUBMINIATURE FM TRANSMITTER—1/2" CUBE with mike. Newest integrated circuit design, **LONG RANGE**. Write for further information. PMC Electronics, 7815 Oxford Ave., Phila., Pa. 19111.

PROTECT PRIVACY OF PHONE CONVERSATIONS—TELEPHONE SCRAMBLER SYSTEM. Safeguards vital information transmitted over the telephone. Small **PORTABLE** transistorized package. Write for detailed information. PMC Electronics, 7815 Oxford Avenue, Phila., Pa. 19111.

INTEGRATED CIRCUIT Experiment Kit, \$6.95, FET converts your VOM to 10 megohm input impedance. Plans, \$1.00. Others. Catalogue 25¢. **KAYE**, BOX 3932, Long Beach, California 90803.

QUALITY PRINTED CIRCUIT boards **AND** artwork. **SEMI-CONDUCTOR** curve tracer and wideband **EXPERIMENTERS** preamplifier. Construction plans and kits. **CATALOG** —25¢. Universal Development Company, Box 26, Dept. 1017, Oak Creek, Wisconsin 53154.

ELECTRONIC "SPY" DEVICES for home, office, and telephone. Latest Developments. Send \$1 for Brochure. Security Communications, 330 Casa Linda, Dallas, Texas 75218.

PLANS AND KITS

ALLWAVE RADIO KIT. Tube, transistor included \$5.00. Headset \$2.50. Ekeradio, Box 131, Temple City, Calif. 91780.

GIANT TESLA COIL—FORTY-INCH SPARKS! Complete plans \$5.00. Details, color photo 50¢ (deductible). Huntington Electronics, Inc., Box 9 Huntington Station, Shelton, Conn. 06484.

"CRYSTAL SET CONSTRUCTION" Handbook—50¢. Catalog. Laboratories, 12041-L Sheridan, Garden Grove, Calif. 92640.

BUILD A SOLO ORGAN, Reverb, other Projects. Free catalog. Solutron Company, 29641 Gilchrist, Farmington, Michigan 48024.

ACOUSTIC PRISMS AND EXPONENTIAL HORNS in compact 3-way systems. The ultimate in sound from small speakers. Blueprints and complete instructions for 5 unusual enclosures \$3.00. Solid State Acoustic Products, Box 2235, Yakima, Wash.

SHORTWAVE LISTENING

SWL PROGRAM GUIDE, listings by the hour, \$2.00. Better Shortwave Reception, \$3.40. Fun of SWling, \$1.00. **ALL** Books for SWLs. SWL Guide, 218 Gifford, Syracuse, N.Y. 13202.

EQUIPMENT

FREE ELECTRONICS catalog. Tremendous bargains. Send postcard. Electrolabs, Department C-677D, Hewlett, New York 11557.

HIGH FIDELITY

FREE! Send for money saving stereo catalog #P5E and lowest quotations on your individual component, tape recorder, or system requirements. Electronic Values, Inc., 200 W. 20th St., New York, N.Y. 10011.

Hi-Fi Components, Tape Recorders, at guaranteed "We Will Not Be Undersold" prices. 15-day money-back guarantee. Two-year warranty. No Catalog. Quotations Free. Hi-Fidelity Center, 239 (P) East 149th Street, New York 10451.

"LOW, Low quotes: all components and recorders. HiFi, Roslyn 9, Penna. 19001.

TAPE RECORDERS, Hi-Fi, components, Sleep Learning Equipment, tapes. Unusual Values Free Catalog. Dressner, 1523R, Jericho Turnpike, New Hyde Park, N. Y. 11040.

WANTED

CASH Paid! Unused tubes, electronic equipment. Barry, 512 Broadway, N.Y.C. 10012.

QUICKSILVER, Platinum, Silver, Gold. Ores Analyzed. Free Circular. Mercury Terminal, Norwood, Mass. 02062.

MILITARY SURPLUS EQUIPMENT NEEDED: ARC-34, ARC-38, ARC-44, ARC-52, ARC-54, ARC-55, ARC-66, ARC-73, ARC-84, ALSO ARN-14C, ARN-54, ARN-59. COLLINS 51X-2, 51V-3, 51Y-3, 51R-3, 17L-4, 17L-7, 618S-1, 18S-4. BENDIX TA-21, RA-21. APR-14, PRC-25, RT-66 THRU RT-70/GRC. APN-22, APN-117, APN-133. TEST SETS WANT WITH ARM, UPM, URM, USM, SG PREFIXES. TOP CASH DOLLAR PAID IMMEDIATELY. SLEEP ELECTRONICS CO., DRAWER 178-PE; ELLENTON, FLORIDA 33532, PHONE (813) 722-1843.

CRT Miniature—will swap ham tubes. Hergenhan, P.O. Box 98, Scotch Plains, N.J. 07076.

DO-IT-YOURSELF

BUILD your own directional antenna. Any frequency. Design chart \$1.00. Ghiringhelli, Box 102, Northvale, N.J. 07647.

TUBES

TUBE Headquarters of World! Send 10¢ for Catalog (tubes, electronic equipment) Barry, 512 Broadway, N.Y.C. 10012.

TUBES "Oldies", latest. Lists free. Steinmetz, 7519 Maplewood, Hammond, Indiana 46324.

FREE Catalog. Electronic parts, tubes. Wholesale. Thousands of items. Unbeatable prices. Arcturus Electronics ZD, 502-22 St., Union City, N.J. 07087.

RADIO & T.V. Tubes—33¢ each. Send for free list. Cornell, 4213 University, San Diego, Calif. 92105.

RECEIVING & INDUSTRIAL TUBES, TRANSISTORS. All Brands—Biggest Discounts. Technicians, Hobbyists, Experimenters—Request **FREE** Giant Catalog and **SAVE!** **ZALYTRON**, 469 Jericho Turnpike, Mineola, N.Y. 11501.

DON'T BUY TUBES—Radio, TV-Xmitting, special-purpose types until you get our price list! Lowest prices in U.S.A. 5,000 types—Guaranteed Brand New. Send postcard for TV—Special Purpose Price List. **UNITED RADIO COMPANY, P.O. BOX 1000, NEWARK, N.J. 07101.**

TAPE AND RECORDERS

BEFORE Renting Stereo Tapes try us. Postpaid both ways—no deposit—immediate delivery. Quality—Dependability—Service—Satisfaction—prevail here. If you've been dissatisfied in the past, your initial order will prove this is no idle boast. Free Catalog. Gold Coast Tape Library, Box 2262, Palm Village Station, Hialeah, Fla. 33012.

RENT 4-TRACK STEREO TAPES—Dependable service our keynote—**ALL MAJOR LABELS—FREE CATALOG** (48 States)—**TRIMOR** Company, P.O. Box 748, Flushing, N.Y. 11352.

STEREO TAPES. Save up to 60% (no membership fees, postpaid anywhere U.S.A.). Free 60 page catalog. We discount batteries, recorders, tape accessories. Beware of slogans "not undersold," as the discount information you supply our competitor is usually reported to the factory. **SAXITONE**, 1776 Columbia Road, Washington, D.C. 20009.

AUTOMATIC telephone connection for Concord and other transistorized recorders. **SURVEILLANCE** and Privacy Protection Devices. Free Data: Security Electronics-PER, 15 East 43rd Street, New York, N.Y. 10017.

TAPE transport. NAB recording studio quality. Build yourself for amazingly low cost. Detailed plans \$5.00. Free particulars. Pepke Laboratories; 309-B West 19 Street, New York, N.Y. 10011.

TAPE RECORDER SALE. Brand new, latest models. \$10.00 above cost. Arkay Sales, 1028-C Commonwealth Ave., Boston, Mass. 02215.

RENT Stereo Tapes—over 2,500 different—all major labels—free brochure. Stereo—Parti, 1616-PE Terrace Way, Santa Rosa, California 95404.

HI-FI Components. Tape Recorders, at guaranteed "We Will Not Be Undersold" prices. 15-day money-back guarantee. Two-year warranty. No Catalog. Quotations Free. HiFidelity Center, 239 (PT) East 149th Street, New York 10451.

RENT Stereo-8 CAR TAPES. 10¢/day. Send refundable \$10.00 deposit and name of first selection. Autotapes, Box 19086-D, Indianapolis, Ind. 46219.

INVENTIONS WANTED

INVENTIONS wanted. Patented; unpatented. Global Marketing Service, 2420-P 77th, Oakland, Calif. 94605.

INVENTIONS—IDEAS developed: CASH/ROYALTY SALES. Member: United States Chamber of Commerce. Raymond Lee, 130-GR West 42nd, New York City 10036.

PATENT SEARCHES \$6.00! FREE "INVENTION RECORD"/ Information. Miss Hayward, 1029HR Vermont, District of Columbia 20005.

INVENTORS! Sell your invention for cash or royalties! Our client manufacturers eagerly seek new items. Patented. Unpatented. Financial assistance if needed. 25 years proven performances. For free information, write Dept. 20, Gilbert Adams, Invention Broker, 80 Wall St., New York, N.Y. 10005.

INVENTORS! Don't sell your invention, patented or unpatented, until you receive our offer. Eagle Development Company, Dept. P, 79 Wall Street, N.Y., N.Y. 10005.

PATENT Searches including Maximum speed, full airmail report and closest patent copies, \$6.00. Quality searches expertly administered. Complete secrecy guaranteed. Free invention Protection forms and "Patent Information." Write Dept. 9, Washington Patent Office Search Bureau, 711 14th Street, N.W., Washington, D.C. 20005.

INVENTORS. We will develop, help sell your idea or invention, patented or unpatented. Our national manufacturer clients are urgently seeking new items for outright cash sale or royalties. Financial assistance available. 10 years proven performances. For free information, write Dept. 41, Wall Street Invention Brokerage, 79 Wall Street, New York, N.Y. 10005.

INVENTORS! Outright cash sale or royalties for your inventions. Patented. Unpatented. Active demand from our client manufacturers. Financial assistance available. Write Dept. 35, United States Invention Brokerage, 78 Wall Street, New York, N.Y. 10005.

INVENTORS Needing Help with any problem, financial, development, securing manufacturer, obtaining patent. Write the organization that delivers action and results—not promises. Pioneer Invention Service, Dept. 79, 150 Broadway, New York, N.Y. 10038.

REAL ESTATE

FREE!!! Illustrated SUMMER catalog! Describes hundreds of farms, ranches, homes, businesses, vacation, retirement and waterfront properties coast to coast! Specify type property and location preferred. Zip code, please. **UNITED FARM AGENCY**, 612-EP West 47th St., Kansas City, Mo. 64112. PLaza 3-4212.

CANADIAN VACATION LANDS: Full price \$385.00. 40 acres, \$10 month. Suitable cottage sites, hunting, fishing, investment. Free information, Land Corporation, 3768-P, Bathurst, Downsview, Ontario, Canada.

PERSONALS

INVESTIGATORS, FREE BROCHURE, LATEST SUBMINIATURE ELECTRONIC SURVEILLANCE EQUIPMENT. ACE ELECTRONICS. 11500-K NW 7th Ave., MIAMI, FLA. 33168.

BORROW \$1,205 AIRMAIL! Repay \$47 for 36 months. State licensed. Postal Finance, Dept. 84-A, 200 Keeline Building, Omaha, Nebraska 68102.

BILL PROBLEMS? Poor credit no trouble. Not a loan company. Send for free application. Nationwide Acceptance, Dept. PE, 930 F St. N.W., Washington, D.C. 20017.

INSTRUCTION

LEARN While Asleep, hypnotize with your recorder, phonograph. Astonishing details, sensational catalog free! Sleep-Learning Association, Box 24-ZD, Olympia, Wash. 98501.

LEARN ELECTRONIC ORGAN SERVICING at home all makes including transistors. Experimental kit—trouble-shooting. Accredited NHSC. Free Booklet. **NILES BRYANT SCHOOL**, 3631 Stockton, Dept. A, Sacramento 20, Calif. 95820.

FCC License in 6 weeks. First Class Radio telephone. Results Guaranteed. Elkins Radio School, 2603B Inwood, Dallas, Texas 75235.

ASSOCIATE Degree in Electronics Engineering earned through combination correspondence-classroom educational program. Free brochure. Grantham Technical Institute, 1505 N. Western Ave., Hollywood, Calif. 90027.

HIGHLY—effective home study review for FCC commercial phone exams. Free literature! Cook's School of Electronics, P.O. Box 517, Monticello, Ky. 42633.

HIGH SCHOOL DIPLOMA at home. Qualified instructors. Send age, highest grade completed, for free details. No salesman. **SOUTHERN STATES ACADEMY**, Professional Bldg., Dept. 5, Decatur, Ga. 30000.

FIX ANY TELEVISION RECEIVER. Become expert repairman on Black/White, Color sets. "Work bench" method used by thousands of "pros". Write specifying black/white, color. National Technical Research Labs, 6440 S. Western Avenue, Whittier, Calif.

REI First Class Radio Telephone License in (5) weeks Guaranteed. Tuition \$295.00. Job placement free. (KANSAS CITY) R.E.I., 3123 Gillham Road, Kansas City, Missouri, Telephone WE1-5444. (SARASOTA) R.E.I., 1336 Main Street, Sarasota, Florida 33577. Telephone 955-6922.

HIGHLY EFFECTIVE home study course in Electronics Engineering Mathematics with circuit applications. Earn your Associate in Science Degree. Free Literature. Cook's Institute of Electronics Engineering, P.O. Box 517, Monticello, Ky. 42633. (Established 1945.)

REPAIRS AND SERVICES

TV Tuners rebuilt and aligned per manufacturers specification. Only \$9.50. Any make UHF or VHF. We ship COD. Ninety day written guarantee. Ship complete with tubes or write for free mailing kit and dealer brochure. JW Electronics. Box 51C, Bloomington, Indiana 47401.

COMPLETE Tuner Service \$8.95. Send tuner or write for free mailing kit to Midwest Tuner Repair, P.O. Box 892A, Bloomington, Ind. 47401.

GOVERNMENT SURPLUS

JEEPS Typically From \$53.90 . . . Trucks From \$78.40 . . . Boats, Typewriters, Airplanes, Electronics Equipment, Photographic Equipment, used. 100,000 Bargains Direct From Government. Complete Sales Directory and Surplus Catalog \$1.00 (Deductible First \$10.00 Order). Surplus Service, Box 820-J, Holland, Mich. 49424.

BOOKS

FREE CATALOG. Adult Books. **POSTAL PE**, 2217 Lackland, St. Louis, Missouri 63114.

FREE Book. Prophet Elijah Coming Before Christ. Wonderful Bible Evidence. **PE Megiddo Mission**, Rochester, New York 14619.

FREE catalog 950 aviation/electronic/space books, Aero Publishers, 329PE Aviation Road, Fallbrook, California 92028.

MAGAZINES

"**JAPANESE Electronics Industry.**" Monthly Magazine. Sample \$1.00. Subscription \$10.00. "Oriental Electronics Directory." 200 Firms. \$2.00, Dee, Box 211, Beverly Hills, Calif. 90213.

AUTHORS' SERVICES

AUTHORS! Learn how to have your book published, promoted, distributed. **FREE booklet "ZD,"** Vantage, 120 West 31 St., New York 10001.

HYPNOTISM

FREE Hypnotism, Self-Hypnosis, Sleep Learning Catalog! Drawer H400, Ruidoso, New Mexico 88345.

"**FEMALE HYPNOTISM**" Exposed, explained! "Secret Method"—they never know! \$2, rushed. Guaranteed! Isabella Hall, Silver Springs, Florida 32688.

"**HYPNOTIC CANDLES.**" How to use candles to induce hypnotic trance. \$1.00. Refund if unsatisfied. Elton's, Box 19012-PE2, Indianapolis, Indiana 46219.

FEMALE HYPNOTISM! Easily! Instantly! Secret Nerve Centers! \$2.20. Brugenheimer Publishers, Box 158-E30, Lexington, Mass. 01801.

HYPNOTIZE FEMALES! — Unnoticed! Instantly! Nerves! Exciting! Send \$2.25. Research Enterprises, 29-SN21 Samoset, Westburn, Michigan 48101.

HOW I PUT myself in a trance. \$1.00. Refund if unsatisfied. Elton, Box 19012-PE3, Indianapolis, Indiana 46219.

PRINTING

EMBOSSSED business cards, \$2.99—1,000, free samples. Gables—405T Clifton, Glenshaw, Pa. 15116.

RUBBER STAMPS

RUBBER ADDRESS STAMP \$1.50. SIGNATURE \$2.88. FREE CATALOG. JACKSON PRODUCTS, 1433 WINNE-MAC, CHICAGO, ILL. 60640.

PHOTOGRAPHY—FILM, EQUIPMENT, SERVICES

MEDICAL Film—Adults Only—"Childbirth"—1 reel 8mm \$7.50—16mm \$14.95. International-E, Greenvale, L.I., New York 71548.

SCIENCE Bargains—Request Free Giant Catalog "CJ"—148 pages—Astronomical Telescopes, Microscopes, Lenses, Binoculars, Kits, Parts. War surplus bargains. Edmund Scientific Co., Barrington, New Jersey 08007.

EMPLOYMENT OPPORTUNITIES

SERVICE Managers and Repair Technicians required for a fast expanding company manufacturing hearing aids of the highest quality. Must have practical experience with transistors and amplifiers. Take advantage of this excellent opportunity for employment with steady increases in salary and extra benefits. Apply to: American Oticon Corp., Box 1511, Union, N.J. 07083.

CORNELL
TUBES
1 YR. GUARANTEED
30 DAY MONEY BACK
YOUR ORDER FREE!
CORNELL ELECTRONICS CO.
4219 UNIVERSITY SAN DIEGO CALIF. 92106

SEND FOR FREE CATALOG

RENT SAM'S PHOTOFACTS \$1.25

1. Send \$3.00 deposit
2. Use & keep 5 days
3. Return for refund

BUSINESS OPPORTUNITIES

INVESTIGATE Accidents—Earn \$750 to \$1,400 monthly. Men urgently needed. Car furnished. Business expenses paid. No selling. No college education necessary. Pick own job location. Investigate full time. Or earn \$6.44 hour spare time. Write for Free literature. No obligation. Universal. CZ-5, 6801 Hillcrest, Dallas, Texas 75205.

VENDING Machines—No Selling. Operate a route of coin machines and earn amazing profits. 32-page catalog free. Parkway Machine Corporation, 715PE Ensor Street, Baltimore, Md. 21202.

FREE CATALOGS. Repair air conditioning, refrigeration. Tools, supplies, full instructions. Doolco, 2016 Canton, Dallas, Texas 75201.

I MADE \$40,000.00 Year by Mailorder! Helped others make money! Start with \$10.00—Free Proof. Torrey, Box 318-N, Ypsilanti, Michigan 48197.

FREE Book "990 Successful, little-known Businesses." Work home. Plymouth 145Y, Brooklyn, N.Y. 11218.

PIANO TUNING learned quickly at home. Tremendous field! Musical knowledge unnecessary. GI Approved. Information free. Empire School of Piano Tuning, Box 327, Shenandoah Station, Miami, Florida 33145.

\$200.00 DAILY in Your Mailbox! Your Opportunity to do What Mailorder Experts do. Free Details. Associates, Box 136-J, Holland, Michigan 49423.

HELP WANTED—Freelance photographers urgently needed. Make extra money. Write Williams, Box 74607-PE, Hollywood 90004.

LEARN TECHNICAL WRITING—at home. High paying prestige careers not requiring college. Growing demand, all industries for tech writers now. Low monthly tuition. Easy to understand. **FREE** career book, sample lesson. **APPROVED FOR VETERANS.** American Technical Writing Schools, Dept. PEC-57, 5512 Hollywood Blvd., Hollywood, Calif. 90028.

ELECTROPLATING Equipment and supplies. All types for home workshops and industrial. Send \$1.00 (refundable) for equipment guide formulas, operating data, catalog. HBS Equipment Division 90, 3543 East 16th, Los Angeles, California 90023.

RAISE RABBITS for us on \$500 month plan. Free details. White's Rabbitry, Mt. Vernon, Ohio 43050.

STAMPS

FREE Wonderful New United States Catalog! Postage and Airmails Complete. 786 Illustrations. Special offers, Bargains Galore—Everything! Send Today. H. E. Harris, Dept. FC-1, Boston, Mass. 02117.

EDUCATIONAL OPPORTUNITIES

WANTED! TV—Radiomen to learn aircraft electronics servicing. Numerous job openings everywhere. Write: Academy Avionics, Reno/Stead Airport, Reno, Nevada 89506.

LEARN WHILE ASLEEP. Miraculously build Mind Power, achieve Self-Confidence, improve Health, gain Success. Method 92% effective. Details free. ASR Foundation. Box 7021 Henry Clay Sta., Lexington, Kentucky 40502.

CORRESPONDENCE COURSES—B.Sc., Engineering, Electronics. Catalog \$1. Canadian Institute of Science & Technology, 263H Adelaide St., W., Toronto.

EMPLOYMENT INFORMATION

FOREIGN and USA job opportunities available now. Construction, all trades. Earnings to \$2,000.00 monthly. Paid overtime, travel, bonuses. Write; Universal Employment, Woodbridge, Connecticut 06525.

FOREIGN EMPLOYMENT. Construction, other work projects. Good paying overseas jobs with extras, travel expenses. Write only; Foreign Service Bureau, Dept. D, Bradenton Beach, Florida 33510.

"JOBS! NATIONWIDE OPPORTUNITIES. ENGINEERS, TECHNICIANS. COMPLETE LIST, REVISED MONTHLY. \$1.00. BOX 9946, WASHINGTON, D.C. 20015.

MOVIE FILMS

SUPER 8 . . . REGULAR 8mm—YOUR ACTION SPORT IN SPECTACULAR COLOR! WRITE FOR CATALOG. SPORT-LITE FILMS-PE, 20 North Wacker Drive, Chicago, Illinois 60606.

MISCELLANEOUS

WINEMAKERS: Free illustrated catalog of yeasts, equipment. Simplex, Box 7208, Minneapolis, Minn. 55412.

LEMURIAN VIEWPOINT—Thought-provoking discussions of Universal Truth, man's purpose on earth, reincarnation, and subjects from Lemurian Philosophy. Send for FREE copy. Lemurian Fellowship, Dept. 648, Ramona, California 92065.

BEERS, PEACH BRANDY, WINES—Strongest Formulas, \$2.25. (complete brew supplies hydrometers catalog 10¢) —Research Enterprises, 29-D Samoset, Woburn, Mass. 01801.

STAMMER — Stutter — No More. (Dr. Young.) Write: Gaucho, Box 9309-E8, Chicago 60690.

MONEY—WE PAY \$10 hr. for NOTHING but your opinions, written from home about our clients' products and publications, sent you free. Nothing to buy, sell, canvass, or learn. No SKILL. NO GIMMICKS. Just honesty. Details from RESEARCH, ZD2, Box 669, Mineola, N.Y. 11501.

STOP BURGLARS THE EASY WAY!! Affix authentic "Protected by Electronic Sentry Alarm" Decals to auto windows, doors & windows of home, retail stores, vending machines, etc. Whether you have an alarm or not—thieves stay away! Only \$1.00 for each set of two. J. Ross, 80-34 Kent St., Jamaica, N.Y. 11432 Dept. PE.

ELECTRONICS MARKET PLACE classified advertising remains your best bet for outstanding mail order responses. More than 400,000 monthly buyers of POPULAR ELECTRONICS read these pages thoroughly as they eagerly await the offerings they know are found only in ELECTRONICS MARKET PLACE each issue. They read and they buy because they know they can rely on the products and services advertised in the pages of their favorite magazine. You can increase your mail order response substantially by running a low cost ad (\$1.00 per word—minimum \$10.00) in these columns. Forward advertising copy with your payment today in order to be certain of inclusion in the next issue—July (Closing May 1st, on sale June 20th). Send to: Hal Cymes, Classified Advertising Manager, POPULAR ELECTRONICS, One Park Avenue, New York, New York 10016.

POPULAR ELECTRONICS

MAY 1967

ADVERTISERS INDEX

READER SERVICE NO.	ADVERTISER	PAGE NO.
15	Allied Radio	104
	American Institute of Engineering & Technology	116
1	Argos Products Company	112
2	B & K	14
3	Burstein-Applebee Co	118
	Capitol Radio Engineering Institute, The	62, 63, 64, 65
4	Centralab	101
5	Cleveland Institute of Electronics	17
	Cleveland Institute of Electronics	36, 37, 38, 39
	Conar	110
6	Concord Electronics Corp	16
	Cornell Electronics Co	123
	Cush Craft	102
	DeVry Institute of Technology	7
34	Dynaco, Inc	100
7	E.C.I. Electronics Communications Inc	9
11	Electro-Voice, Inc	FOURTH COVER
8	Finney Company, The	23
9	Hallett	118
10	Hallcrafters	111
12	Heath Company	11, 12, 13
13	International Crystal Mfg. Co., Inc	5
14	Johnson Company, E.F.	26
16	Kuhn Electronics	110
17	Lafayette Radio Electronics	112
18	Mellotone Inc	104
19	Milwaukee School of Engineering	105
20	Mosley Electronics, Inc	102
21	Multi-Elmac Co	117
22	Multicore Sales Corp	114
	National Radio Institute	SECOND COVER, 1, 2, 3
	National Technical Schools	18, 19, 20, 21
23	Pace Communications Corp	10
24	Pioneer Electronics U.S.A. Corporation	6
	RCA Electronic Components and Devices	THIRD COVER
	RCA Institutes, Inc	88, 89, 90-91
25	Radio Shack	106, 107, 108, 109
32	Regency Electronics, Inc	97
26	S & A Electronics Inc	114
27	Sams & Co., Inc., Howard W	113
28	Schober Organ Corporation, The	103
29	Scott	8
30	Sonar Radio Corp	115
33	Squires Sanders	25
	Technical Training International	98
31	Turner Microphone Company, The	99
	Valparaiso Technical Institute	102
	Vector Electronics	116
CLASSIFIED ADVERTISING 119, 120, 121, 122,		123, 124



Service your Color TV customers with confidence...
with RCA HI-LITE picture tubes!

Customer satisfaction... and consequently your service reputation... can very often depend on the quality of the replacement parts you use. When it comes to replacement picture tubes, you can depend on an RCA HI-LITE for picture brightness and color fidelity at its finest. Install them and you literally "up-date" your customer's set with the same quality... the same tubes... that go into today's original equipment sets.

Enjoy the confidence of offering the finest. Rely on RCA picture tubes to protect your service reputation. They are designed to protect the biggest reputation in the Color TV industry

RCA Electronic Components and Devices, Harrison, N. J.



The Most Trusted Name in Electronics



If you like
big speakers,



listen
to the mammoth
little E-V SEVEN!

(E-V) The E-V SEVEN is the small speaker for people who don't really want a small speaker. Built in the shadow of one of the biggest speakers of them all (the vast Patrician 800) the E-V SEVEN refuses to sound as small as it is.

But why does an E-V SEVEN grow up when it's turned on? Our engineers point to years of painstaking exploration in the byways of sound. They'll patiently explain the virtues of our low

resonance 8" woofer and 3 1/2" cone tweeter with symmetrical damping (an E-V exclusive). They may even mention—with quiet pride—the unusual treble balance RC network that adjusts E-V SEVEN response more smoothly than any conventional switch or volume control.

But when it comes to describing the sound, our engineers prefer to let the E-V SEVEN speak for itself. And while they'd be the last to suggest that the E-V SEVEN

sounds just like speakers many times larger (and costing much more) they treasure the pleased look of surprise most people exhibit when they hear an E-V SEVEN for the very first time.

If you have just 19" of shelf space, 10" high and 9" deep ... and have \$66.50 to invest in a speaker, by all means listen carefully to the E-V SEVEN. It might well be the biggest thing to happen to your compact high fidelity system!

high fidelity systems and speakers • tuners, amplifiers, receivers • public address loudspeakers
microphones • phonograph needles and cartridges • organs • space and defense electronics

ELECTRO-VOICE, INC., Dept. 574P, 630 Cecil Street, Buchanan, Michigan 49107

Electro-Voice

CIRCLE NO. 11 ON READER SERVICE PAGE