

THE PROFESSIONAL MAGAZINE FOR ELECTRONICS AND COMPUTER SERVICING

ELECTRONICTM

Servicing & Technology

May 1995/\$3.00

Camcorder Servicing

Troubleshooting Techniques

Tools & Toolcases Showcase

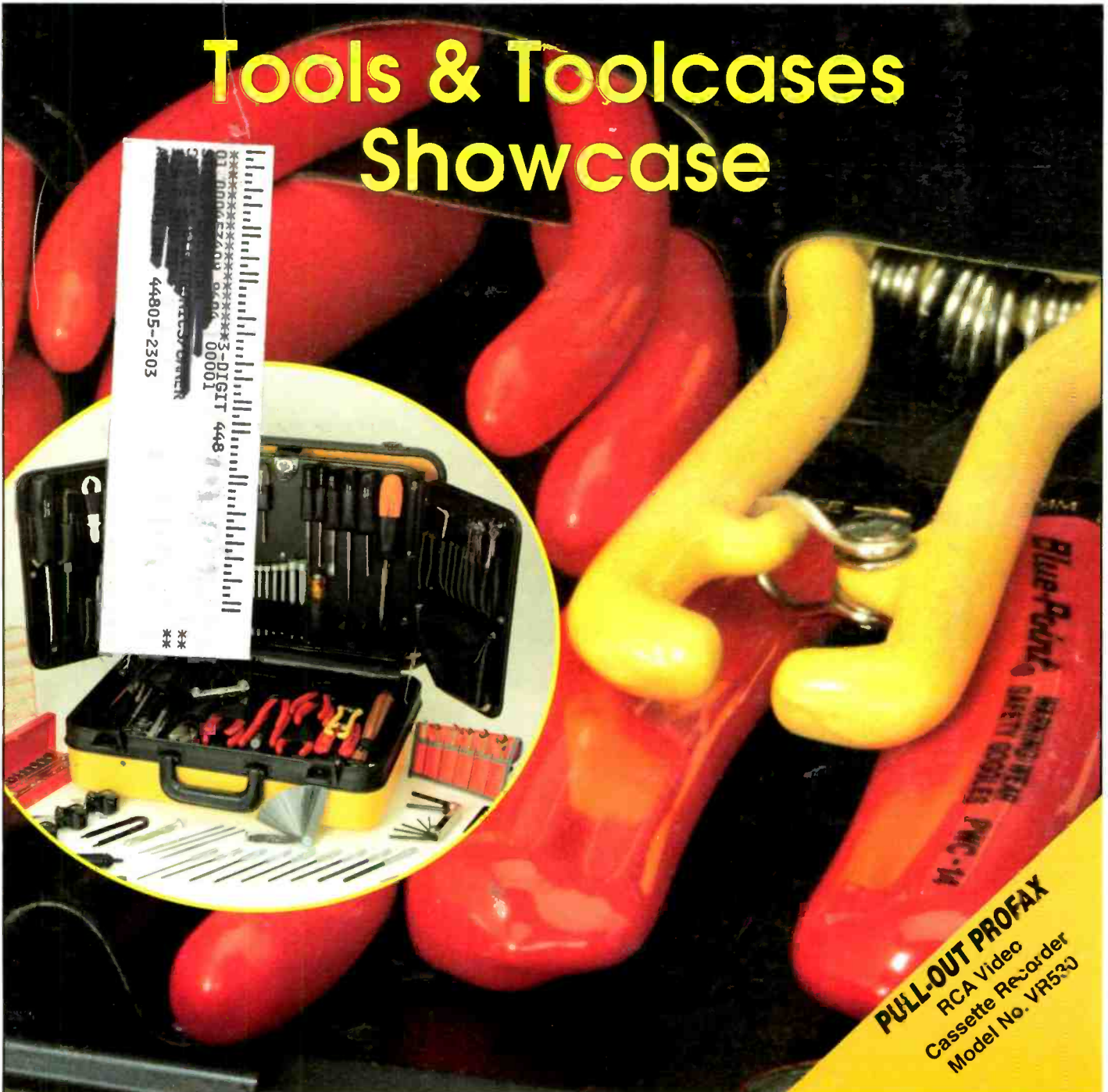

PULL-OUT PROFAX
RCA Video
Cassette Re-corder
Model No. VR523

In The Field



At The Test Rack

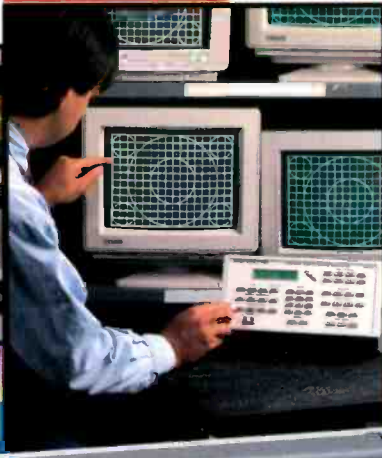

On The Bench



New-
It's Portable
& Affordable!

CM125 "Pix Pak"™ Computer Monitor Signal Generator

The new CM125 "Pix Pak" Computer Monitor Signal Generator provides you with full computer monitor testing capabilities on the bench, in the field or wherever you service and test computer monitors. The new "Pix Pak" provides you with a fully programmable RGB scan frequency and pixel generator (video bandwidth to 125 MHz and 2048 x 2048 pixel resolution) plus, a complete set of troubleshooting and performance testing video patterns to help you identify all types of monitor defects.



To find out more on how the new CM125 "Pix Pak" Computer Monitor Signal Generator will enhance your servicing operation, simply call **1-800-SENCORE** today.
(736-2673)

SENCORE

3200 Sencore Drive, Sioux Falls, SD 57107
Direct (605) 339-0100 Fax (605) 339-0317

Circle (119) on Reply Card

The ECG® Semiconductor Master Guide. The Last Word In Replacements.



In the 16th edition ECG® Semiconductor Master Replacement Guide: 4,100 devices, 14,000 more crosses for over 276,000 total. Plus, nearly 200 new linear ICs, transistors, diodes, rectifiers, gas-filled surge suppressors for Industrial and Entertainment applications. At 900 Philips ECG distributor locations, or call 1-800-526-9354.



Philips ECG



PHILIPS

Circle (34) on Reply Card

Put Industry's Best Semiconductor Cross Reference On Your Screen.



ECG® INSTANT CROSS™ Version 2.0 for PC. Contains expanded data base of 16th edition Master Guide 212R: over 276,000 Industrial and Entertainment part numbers crossed to 4,100 ECG replacements. Includes product index, device descriptions, case styles, special notes. At 900 Philips ECG distributor locations, or call 1-800-526-9354.



Philips ECG



PHILIPS

Circle (35) on Reply Card

13 New Advanced Chemicals, All CFC/HCFC Free, All From Philips ECG.



Advanced Chemicals for the Electronic and Electrical industries. The ECG® line features application tailored flux removers, electronics washes, degreasers, contact cleaners, head cleaners, circuit refrigerants, dusters, lubricants and more. 13 are new and CFC/HCFC free. Ask for new full-line catalog at 900 Philips ECG distributor locations, or call 1-800-526-9354.



Philips ECG



PHILIPS

Circle (36) on Reply Card

28 Ways To Get Good Readings At A Great Price: ECG® Test Equipment.



Products include full-function digital and analog multimeters, AC clamp-on current meters, capacitance meters, digital thermometers, logic and oscilloscope probes, infrared RC testers. The value leader in performance, dependability and extra features. Ask for a catalog at 900 Philips ECG distributor locations or call 1-800-526-9354.



Philips ECG



PHILIPS

Circle (37) on Reply Card

Mobile Electronics Show for 1995

The mobile electronics industry will be rolling into Philadelphia in full force to participate in the 1995 Mobile Electronics Show (MES). Sales of exhibit space have already surpassed all records, including last year's high of 77,000 net square feet. Currently 77,900 net square feet have been sold. The mobile electronics industry, estimated at \$5.5 billion level in 1994, includes car audio, security, mobile office, paging, cellular, radar detection, vehicle navigation and intelligent transportation system products and accessories for those products.

"It is going to be an outstanding Show," said Robbi Lycett, show manager. "It is clear that this segment of the consumer electronics industry is in a time of growth, and that is reflected in our success with MES." Lycett added, "This year we have added some new attractions such as the Intelligent Transportation System Pavilion and the Innovations '95 exhibit."

The mobile electronics industry, including aftermarket autosound equipment sales, domestic factory-installed autosound, and aftermarket vehicle security sales totaled an estimated \$5.5 billion in 1994. It is expected to increase in 1995 to more than \$5.7 billion.

The industry estimates that sales in all categories will demonstrate growth in the coming year. For example, in 1994 sales of aftermarket autosound equipment totaled \$1.95 billion, up 22 percent over 1993. Sales in 1995 are expected to grow an additional 9 percent, and pass the \$2 billion mark.

Notably, in-dash CD players top the list for anticipated autosound purchases in the next year with nearly 8 percent of all U.S. households indicating they are likely to make such a purchase. Consumers age 30 and under are the most likely group to purchase aftermarket CD players for their cars.

EIA submits new proposal to FCC on TV-cable interface: a descrambling-only interface

The Electronic Industries Association's

Consumer Electronics Group (EIA/CEG) announces that it has submitted a new proposal to resolve the dispute over the interface that Congress required by the Federal Communications Commission (FCC) between televisions, VCRs and cable. The proposal calls on the FCC to adopt a Decoder Interface designed to simply accommodate descrambling of cable signals, and to promote the competitive supply of set-top boxes.

The consumer electronics and the cable industries have reached an impasse over previous design proposals that would allow consumers to have access to the features offered by TV and VCR manufacturers and cable providers.

When the cable and electronics industries had agreed on all elements of a Decoder Interface making cable boxes obsolete, the cable industry insisted on an infrared bypass which would allow cable systems to circumvent the interface and interfere with TV set and VCR functions.

"Our primary objective has always been to adhere to the will and intent of the Cable Act," said Gary Shapiro, group vice president of EIA's Consumer Electronics Group. "Simply stated, consumers deserve to have access to all of the features in their TVs, and not all of them can do that now. Congress acted to change this. For example, cable providers scramble their signals, and that means consumers have to rent a decoder box, provided by cable companies to descramble signals. Unfortunately, that also means consumers have to use more than one remote control device: one to access TV's, or VCR's features and one to access cable programming. Our proposal achieves compatibility by designing a standard interface for descrambling modules and it opens all other features, including set-top boxes themselves, to competition. This proposal achieves the Act's intent, and the FCC's goal, of providing flexibility and maximum access to product and cable features for consumers. That's a win-win situation for both parties, and consumers."

Section 17 of the Cable Act directs the FCC to adopt regulations that allow con-

sumers to take full advantage of the features and functions of their TVs and VCRs when using cable service. In addition, the Act says that consumers should be allowed to enjoy all of the programming available to them on their cable service, while promoting commercial availability of set-top boxes and remote controls. As important, the Act also spells out there should be an allowance for a secure cable signal.

A Decoder Interface that is designed to accommodate the descrambling of cable signals will accomplish each of these goals, and will also allay cable's concerns that the Decoder Interface standard not constrain its ability to provide subscribers with new and innovative services through competitive means.

Today's TVs and VCRs offer a broad array of features, like picture-in-picture, stereo sound, picture enhancement, timed-delay recording, and on-screen program guides that consumers have repeatedly asked for through their purchases. Under the NCTA proposals TV-VCR features could be circumvented and rendered useless.

"We've spent several months developing a system that in the end became too technologically complicated for both sides to agree. This latest proposal simplifies everybody's access to features, maintains a competitive marketplace, and allows for the security of programming. It's a simple solution to a very delicate situation, and we hope the cable industry will concur. NCTA's concurrence will go a long way to help move this issues to closure with the FCC," concluded Shapiro.

EIA is the 71-year-old Arlington, Virginia-based trade association representing all facets of electronics manufacturing. EIA's Consumer Electronics Group represents U.S. manufacturers of audio, video, home office and home automation products, mobile electronics, multimedia, and accessories.

Regional training dates announced by electronic installers association

The Custom Electronic Design and In-

Installation Association (CEDIA) announced regional training dates for 1995. According to Randy Wilson, chairman of the organization's Education Committee, training will be held in these cities:

San Francisco, CA — May 7-8

Indianapolis, IN — June 4-5

Training will cover all aspects of custom design and installation, and will cost \$50.00 for CEDIA members and \$75.00 for non-members. For more information, call 1-800-CEDIA 30.

Projection and other large-screen TVs showed strength in February, but caution over inventories continues to blur video sales picture

Both projection and large-screen, direct-view televisions posted solid gains last month, but in several other video hardware categories the sales-to-dealers situation remained mixed.

Data gathered by the Electronic Industries Association's Consumer Electronics Group (EIA/CEG) indicate that while total sales of color TVs declined fractionally in February, sales of large-screen, direct-view models—those with screen sizes 27 inches and larger—expanded 10 percent. For their part, projection TVs enjoyed a 14 percent increase in February. Also on the plus side, laserdisc players showed considerable strength, jumping more than 52 percent in February, relative to February

“What appears to be happening in the marketplace is an effort on the part of some retailers to re-balance higher inventories that resulted from over-optimistic Christmas sales expectations,” said Gerald M. McCarthy, president Zenith Sales Company and chairman of EIA/CEG's video division. “Once that near-term adjustment takes place, however, there's every reason to believe that the long-range growth trend will resume and even produce some new industry records.”

EIA/CEG recently predicted that based on a still-expanding economy and results of intent-to-buy surveys, color TV sales are likely to reach record levels in 1995. Among the hottest categories will be

direct-view models measuring 30-inches and larger, which last year grew 33 percent. Other video hardware categories reporting sales decreases in February included color TV/VCR combinations, VCR decks and camcorders.

Sales of TV/VCR combos dropped 8 percent in February to 114,000 units, and on a year-to-date basis number 205,000 units, nearly 13 percent below January-February 1994.

VCRs slipped 4.6 percent in February to approximately 750,000 units, year-to-date. Sales of VCR decks now stand at some 1.4 million units, 8 percent behind last year's pace. Within that category, however, February sales of stereo VCRs which represented one of every three VCRs sold—grew 8 percent.

Sales of camcorders declined more than 14 percent in February to some 139,000 units, as both compact and full-size models reported decreases. For the first two months of 1995, camcorder sales totaled approximately 332,000 units, nearly 4 percent below the 346,000 units sold during the January-February period a year ago.

The 14 percent growth in projection television in February was the 19th consecutive monthly gain for that product. Sales of projection TVs in the 50 to 54-inch category jumped 24 percent in February, and accounted for 42 percent of monthly sales.

EIA lauds Energy's action to re-examine proposed TV energy limits

The Electronics Industry Association's Consumer Electronics Group (EIA/CEG) hailed the announcement in February by the Department of Energy to re-evaluate its data used to regulate energy consumption levels of TVs. The action means the Department would evaluate data from televisions with current features. It also means the Department acknowledges using flawed data to study TV performance.

In March of 1994, the U.S. Department of Energy issued a proposed regulation

that would establish energy consumption limits for television receivers. The standard would place a limit on the energy consumption of television sets manufactured or sold in the United States. This standard was based on a featureless, nine-year-old TV set.

Under the Energy Policy and Conservation Act, the Department of Energy must set energy conservation standards for certain household appliances, such as water heaters, furnaces, ovens, and others. The Department has no mandate to establish an energy standard for television receivers. Instead, Congress has authorized the Department of Energy to exercise discretion whether a standard for TVs is appropriate.

According to the EIA, there are other reasons that the DOE TV energy limits proposal should be abandoned:

- The Justice Department said that imposing stringent requirements on manufacturers, at a minimum, would be a tremendous burden on manufacturers and ultimately the consumers.

- TVs use less energy than a 100 watt light bulb, and in terms of energy conservation have become 300% more efficient in the past 20 years.

- The proposal would force U.S. television manufacturers to eliminate features that enhance the performance, usefulness, and convenience of the product.

- Features eliminated by the regulation would inevitably be available to consumers via separately-powered devices (such as cable boxes). Ironically, the separate power supplies needed for these add-on devices will use more energy than would be the case if these same features are integrated into the television. The net effect of the proposed rule would increase, not decrease, overall energy consumption.

- Set manufacturers work hard to make products more efficient so they throw off less heat - which causes products to break.

- Consumers value features like stereo sound and closed captioning, which require modest energy usage.

- The marketplace works. This is unnecessary government regulation.

Magnetic recording principles: Video

By Lamar Ritchie

Articles in the January and February issues described, in general, the principles of magnetic recording, and provided specific details on audio recording as well as recording of video, with some detail on each of the popular consumer video formats: VHS, Beta and 8mm.

This article will provide further details on video recording. We will briefly discuss the circuits and methods for VHS and Beta only, but the 8mm will be similar.

Azimuth recording

For the standard audio, to prevent crosstalk between channels, guard bands on the tape are used. Earlier machines used guard bands between video tracks to prevent crosstalk between them. In order to reduce tape consumption, VHS and Beta machines do not use guard bands. In fact, at slower tape speeds, the video tracks may actually overlap somewhat.

One technique that is used to minimize crosstalk at the higher luminance FM frequencies is to use azimuth recording techniques. Azimuth means the vertical angle of the head gap. The two video heads are given opposite azimuth. This video is illustrated in Figure 1.

For VHS, as shown, the head azimuths are + and -6 degrees. For Beta, these azimuth angles are + and -7 degrees.

As the heads are alternately switched in they will create video tracks in which alternate tracks have the opposite azimuth. An adjacent track then will have the wrong azimuth for the video head. It will "straddle" the magnetic poles on this track, causing it to cross north and south regions at the same time, producing cancellation for this signal.

This method works for the higher frequency FM signals but not as well for the lower frequencies at which the color is recorded. The longer wavelengths produce longer magnetic poles on the tape,

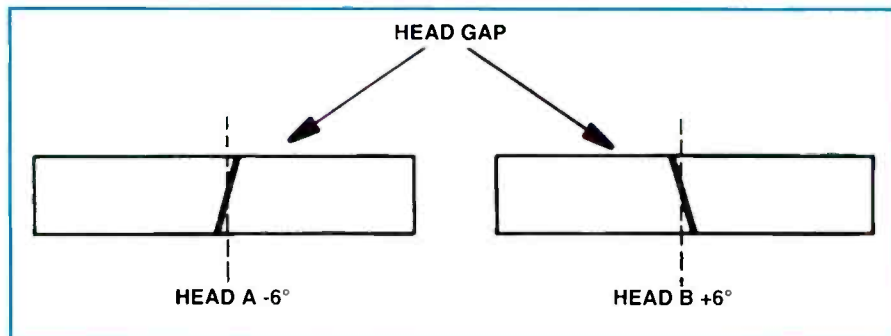

Figure 1. Azimuth recording techniques, the placing of the two video heads at slightly different angles to the tape path, minimizes crosstalk at the higher luminance FM frequencies.

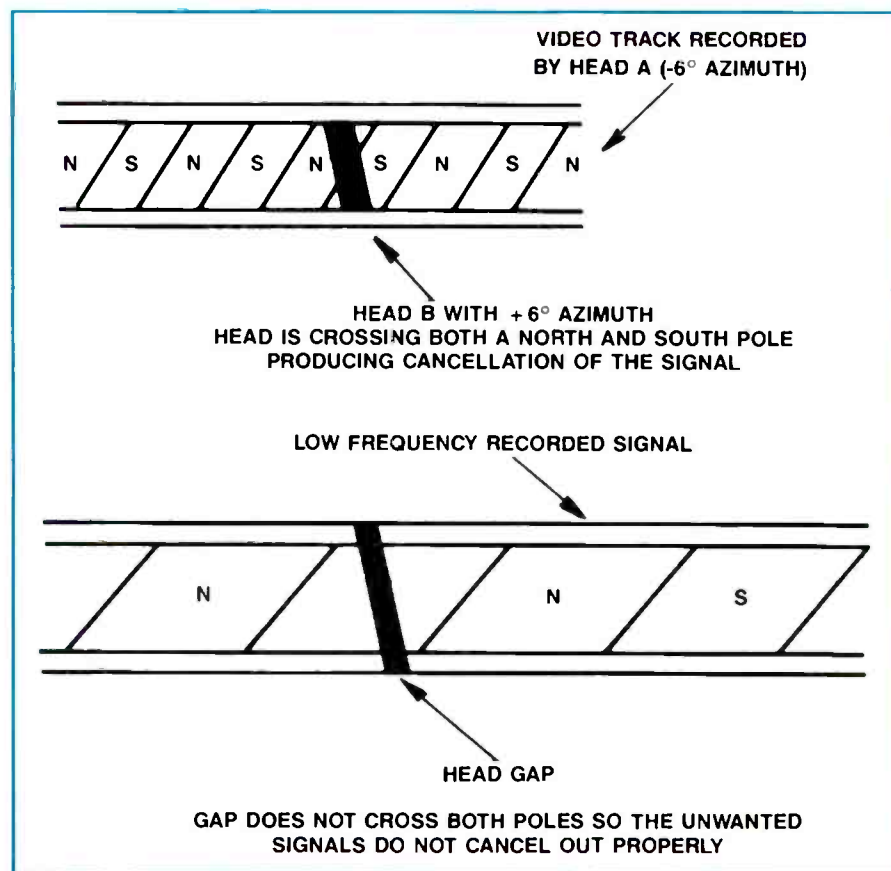

Figure 2. Longer recorded wavelengths produce longer magnetic poles on the tape. In this case, the magnetic head gap can still be within a single recorded magnetic pole, causing crosstalk.

and the gap can still be within a single pole. Figure 2 illustrates this concept.

For standard play speed in VHS machines, the tracks have a small amount of separation, so this does not produce much

of a problem. It is not as much of a problem with Beta machines because the frequencies are a little higher and tape speeds are a little faster. There is more of a problem at the LP and SLP (EP) speeds on a

Ritchie is an electronics instructor at Kentucky Tech. Hazard Campus.

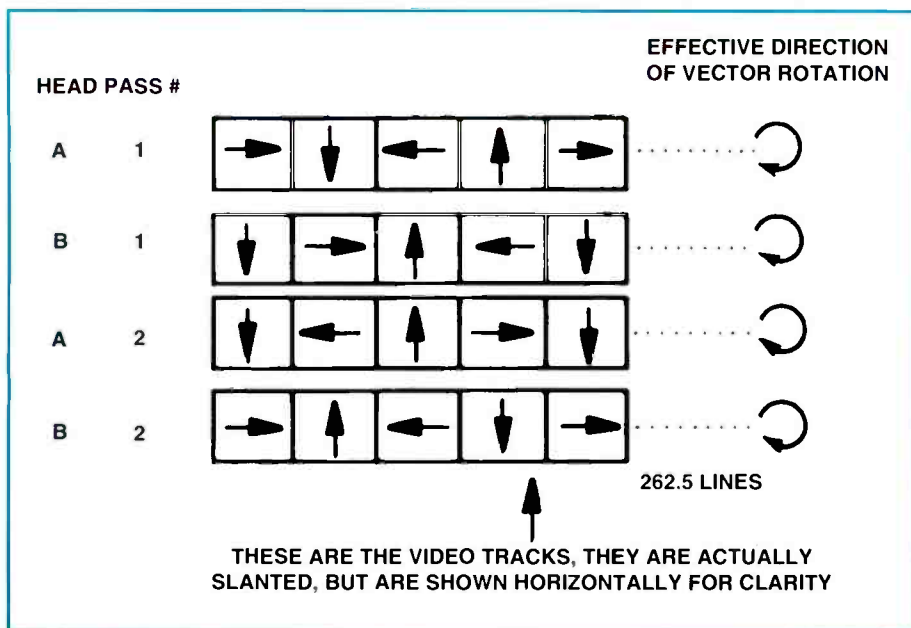

Figure 3. At the lower chroma frequencies a vector rotation scheme is used to eliminate crosstalk.

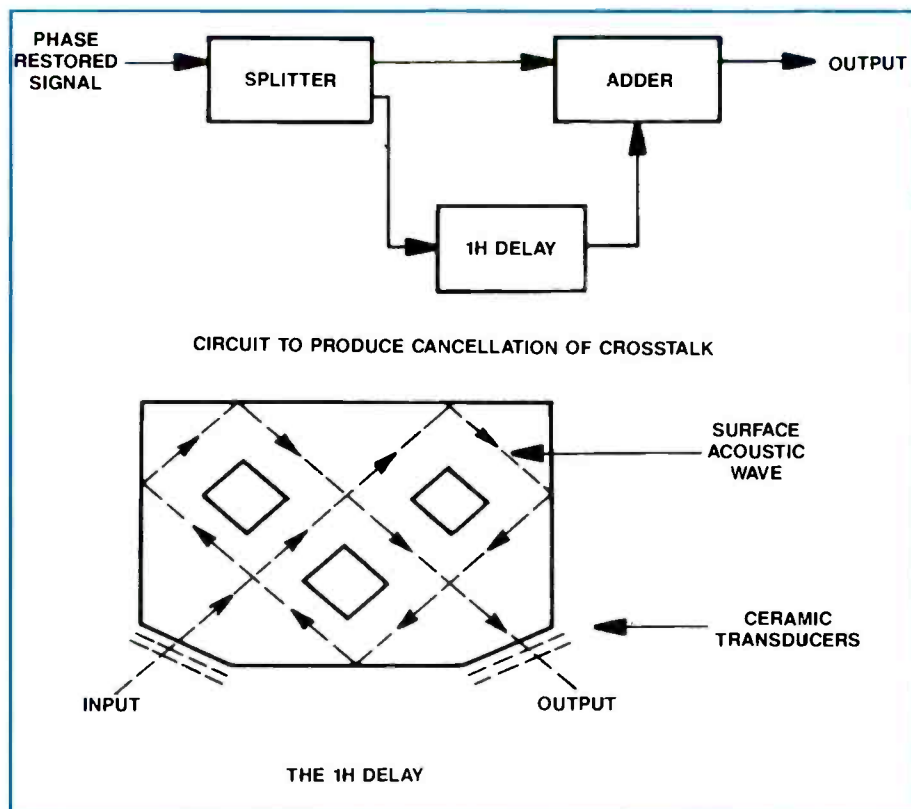

Figure 4. In the vector rotation scheme, cancellation is achieved by adding the signals from each horizontal line to the signals of the previous horizontal line by using a 1H delay line.

VHS machine. The tracks can actually overlap at the slower speeds.

Beat frequencies

There are actually two problems at the lower frequencies. In addition to the low frequency crosstalk for the FM luminance, there will be "beat" frequencies

developed between the main signal picked up by a head and the crosstalk frequencies from an adjacent track. The beat frequencies have no true azimuth and will appear in both channels.

One way to minimize the beat is to "line up" the tracks so that all horizontal sync pulses and video line information is at the

same place on each track. Since the information is very nearly the same for successive fields, there would be little beat difference between them.

The original SP speed was engineered to be the correct speed at which the tracks lined up perfectly. Perfect alignment also occurs at 1/3 this speed (SLP/EP), but not at 1/2 this speed (LP). At the LP speed, the video sync tips are in the middle of the horizontal scanning line for adjacent tracks and greatly worsen the beat problem.

FM interleaving

As a further method to eliminate the beat problem, FM interleaving is used. As you may know from the study of color TV principles, interleaving was used for the color subcarrier to reduce beat interference. The monochrome video information occurs mostly in clusters of energy at multiples of the horizontal scan rate. To accomplish this interleaving for the luminance FM, the frequencies for one channel (for one of the heads) is raised by 1/2H, or 7,867Hz.

At the lower chroma frequencies, azimuth recording does not help to reduce crosstalk. Instead, a vector rotation scheme is used. What is done, in effect, is to advance the phase of channel 1 by 90 degrees each horizontal line, while delaying the phase of channel 2 by 90 degrees each horizontal line. Circuits within the color section of the VCR accomplish this (Figure 3).

Each of the boxes with an arrow represents one horizontal line. The arrows indicate the phase of the chroma signal for each line. During playback, the circuits reverse the phase angles, effectively rotating the vectors the opposite way to restore the proper phase.

To understand how this works, look at pass number 1 of head A. The crosstalk component that is picked up is that recorded by head B. In playback, as the vectors are rotated the opposite way, the information for each horizontal line will be brought back into phase. However, any crosstalk is being rotated the wrong way and will end up shifted 180 degrees each horizontal line, producing cancellation.

To produce the cancellation, the signals from each horizontal line are added to the signals from the previous horizontal line by using a 1H delay line (delays by 63.5µsec) as shown by Figure 4.

Since the main signals are in phase for

each line, they add and the output is doubled. The crosstalk components, however, are 180 degrees out of phase, so these components cancel.

The delay device

The 1H delay device is normally a surface acoustic wave (SAW) device. At the speed of electrical conduction (nearly the speed of light) it would be difficult to get a 1H delay. The SAW device uses transducers to change the electrical signal to a surface acoustic wave, as shown in the Figure. The 1H acoustic delay is also used to separate the color from the luminance for the record circuits.

Recall that the color is interleaved with the luminance. If the output is connected with the polarity to cause the color signals to be in phase, then the luminance will be out of phase, and cancel. The reverse is also true.

This circuit is called a "comb filter" because its output frequency response will look like a comb (see Figure 5) as the frequencies are alternately in phase and out of phase.

As mentioned before, the color signal will have "jitter" components. The color playback circuits must restore the color to 3.58MHz and remove the jitter components. A generic block of these circuits is as shown in Figure 6.

The frequencies in the figure are the "rounded" values that are normally used.

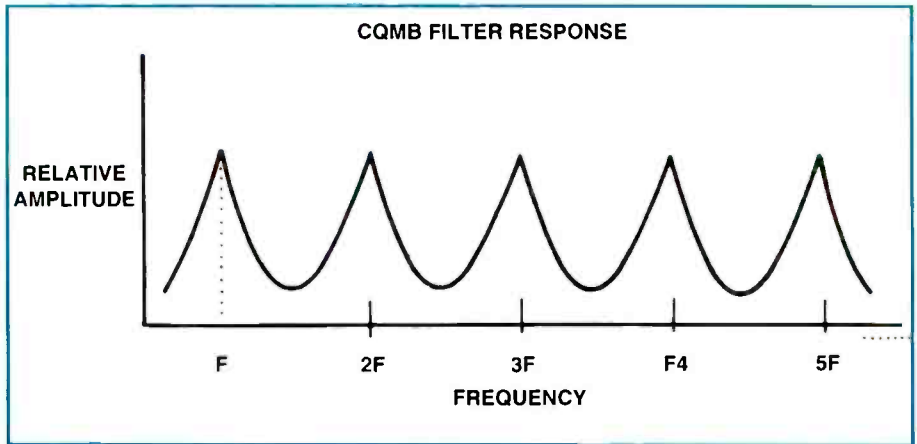

Figure 5. The 1H acoustic delay provided by the SAW filter is also used to separate the color from the luminance for the record circuits, using a device called a comb filter.

The actual frequencies are:

4.27MHz (4.2679MHz)

4.2MHz (4.2089MHz)

688KHz, the Beta frequency, is actually 688.37KHz, 629KHz, The VHS color frequency, is actually 629.37KHz.

The 629KHz frequency in a VHS machine is sometimes referred to as the 40-FH signal, because it is equal to 40 times the horizontal scan rate:

$$40 \times 15.734\text{Hz} = 629.24\text{KHz}$$

A frequency used to rotate the vectors by 90 degrees is the 160FH signal. This frequency is used in a circuit called the 4-phase logic circuit.

$$160 \times 15,734\text{Hz} = 2.52\text{MHz} (2.517482\text{MHz})$$

This is four times the converted color frequency and when divided by 4 in the color sequencer circuits will equal the color frequency.

The playback signals

During playback, two signals are produced by the heads, the FM luminance and the color sidebands. These signals are very low amplitude: only about 10mV or so. The signals are coupled to the rotary transformer winding mounted in the bottom of the rotor via wires from the head cylinder. From there, they couple into the rotating winding of the rotary transformer. Induction couples these signals into the stationary winding of the transformer mounted

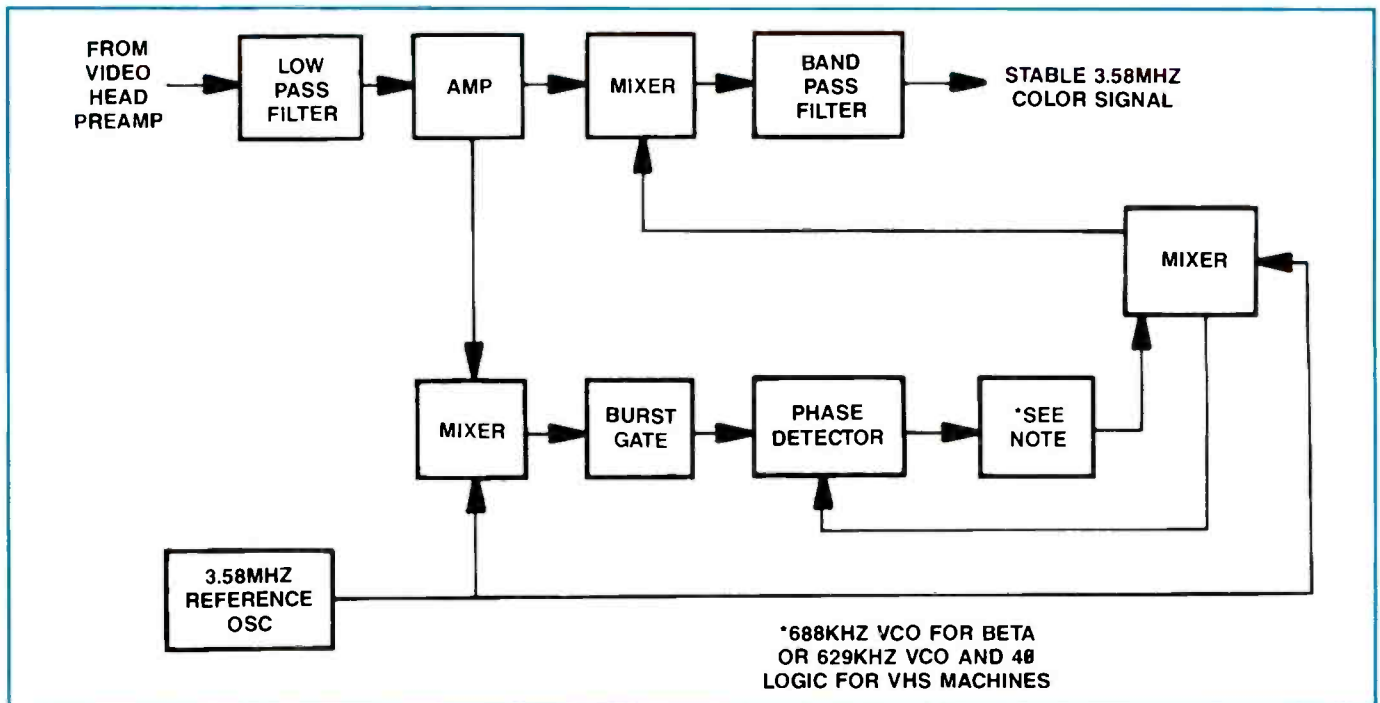

Figure 6. The circuits shown in this block diagram restore the color to 3.58MHz and remove the jitter components from the playback signal.

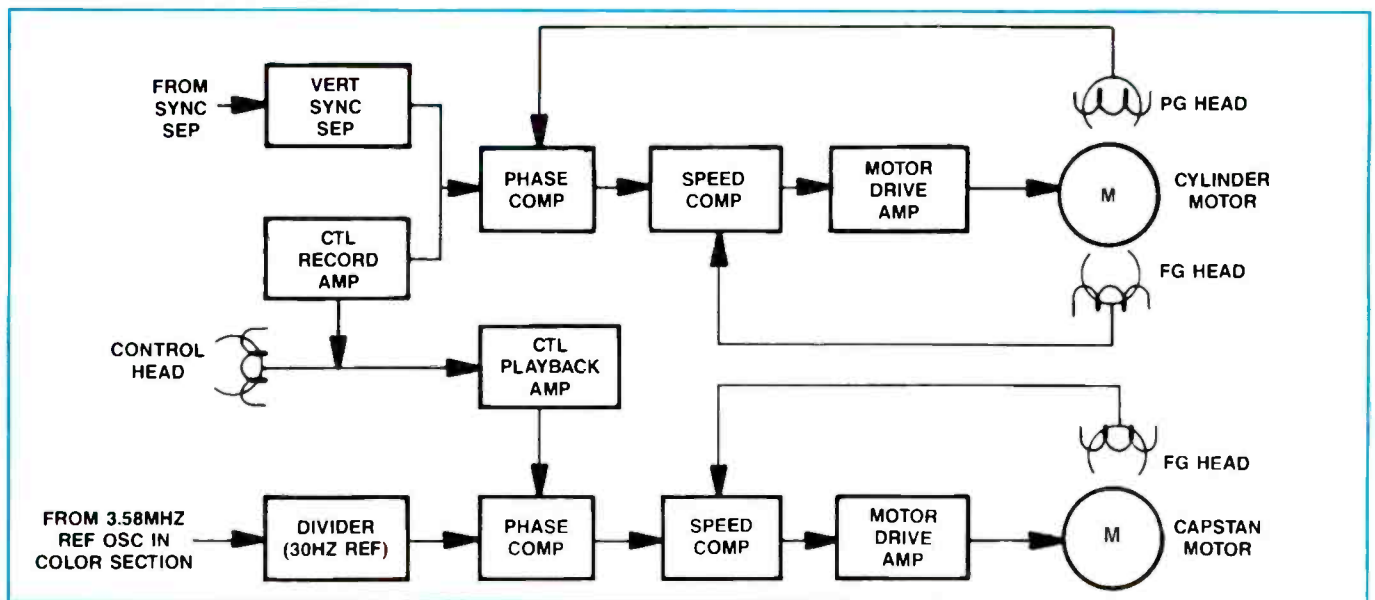

Figure 7. A simplified block diagram of the VCR servo circuits.

on the lower cylinder. The signals are then coupled into a head preamp.

The head preamp

The head preamp may be physically mounted to the head's base, or lower cylinder structure. This allows for the shortest connections possible and offers less chance of picking up stray magnetic fields, causing noise in the signals. The preamp may also be located on the main PCB, with shielded coax cable connections from the heads. In either event, the head preamp will be well shielded to prevent noise pickup.

The main component of the head preamp will usually be an IC, containing the preamplifier, filters to separate the luminance FM and chroma signals, and the head switching circuits.

The inputs to the head preamp will be the signals from the two heads, the dc power supply voltage, typically 5V, and a 30Hz square wave (the head switching pulse) from the servo circuits. The outputs from the head preamp will be the chroma signal and FM luminance signal. Using bandpass filters, the chroma signal will be routed to the color circuits, just described, and the FM luminance will be routed to the luminance circuits. Typically, these circuits are known collectively as the Y/C circuits, or Y/C section of the VCR.

The luminance circuits contain the FM demodulator for playback of the signals, and the FM modulator for recording of the signals. These are typically within a single IC in modern VCRs, with built in

switching circuits to select record or playback, using a digital control signal from the syscon (system controller).

The video output from the FM demodulator is fed to both the video output jacks, and the video input of the RF modulator. The RF modulator contains the circuits to generate and modulate the carriers to enable the playback signals to connect to a standard television, on either channel 3 or 4 (switch selectable).

Of course, the chroma and luminance signals and frequencies just described cannot be obtained unless the servo circuits are operating properly. These are the circuits that control both the speed and positioning of the scanner rotation and tape movement.

The servo circuits

The servo circuits for a VCR are responsible for a number of functions:

- Precise positioning of the video heads as they rotate. This is known as the cylinder or drum servo.
- Precise control of tape speed, synchronized with the rotation of the head cylinder, to insure that the head is allowed to precisely follow the video tracks. This is called the capstan servo.
- Generation of the 30Hz head-switching pulse.
- Fine adjustment, to allow for slightly different track length, width, and positioning for recordings made on different machines: the "tracking control."

A simplified block diagram of the servo circuits is shown in Figure 7.

To provide such precise control, the servo circuits must know the position of both the capstan motor and the cylinder motor at all times during their rotation. This is accomplished by using reference generators in each. The reference generators are pickup coils that have voltages induced into them by magnets or loops mounted within the structures. These coils generate pulses that correspond to position as they rotate. The cylinder must have two pulse generators. One generator generates a 30Hz pulse corresponding to the time when one head is leaving the tape and the other is entering the tape. This is called the head PG (pulse generator) pulse.

However, for precise control of positioning during the video tracks, this frequency is not high enough. A second generator generates an FG (frequency generator) pulse for this purpose. The exact frequency being used for phase control here, may vary from one machine to the next, but will be a multiple of 60Hz.

The capstan reference generator

The capstan reference generator produces a capstan FG pulse. It is well to point out here that the FG pulses are not really pulses, they are sine waves. The servo circuits will precisely control the frequency and phase of these sine waves by controlling the currents delivered to the motors.

(Continued on page 71)

Camcorder electrical adjustment

By the ES&T Staff

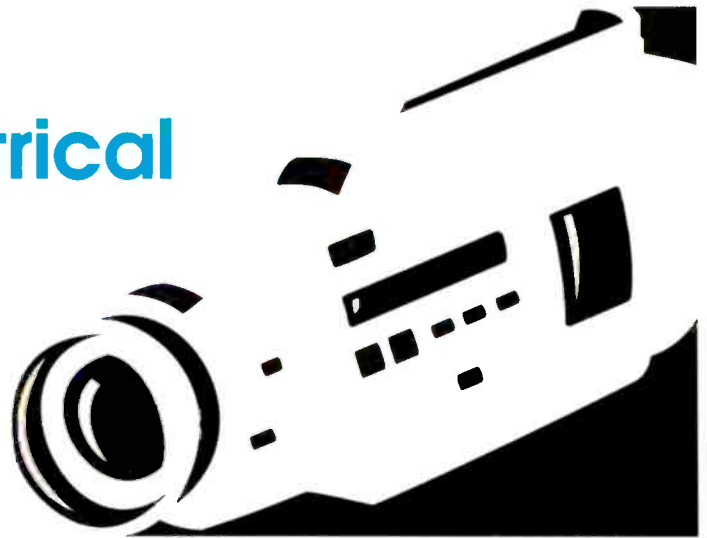

The digital revolution has wrought many changes in the way consumer electronics products operate. When you tune a modern radio, you no longer rotate the dial and watch the meter to find the best reception. You push a button and the radio's tuned to the exact station frequency. With CD players, you slide a disk into the player then select a track, or program the unit to play tracks in whatever order you choose, then you just sit back to listen to digitally encoded music. It's no longer necessary to carefully cue the tone arm, or do any of those other things you once had to do using vinyl disks.

Digital adjustments

The introduction of digital circuitry has, in some ways, made things both more difficult and easier for service technicians. For example, while the micromini-

aturization of components used in camcorders has made them difficult to see and even more difficult to handle, the digital nature of those components has made it possible to make adjustments to the camera's operation without ever taking the cover off, or without ever turning a single wiper of a single pot. By changing the data stored in an integrated circuit in the camcorder, it's possible to adjust such characteristics as black level, sync level, burst level, and autofocus level.

Making adjustments

Modern camcorders are controlled by microprocessors. Microprocessors are really pretty much microcomputers that are capable of performing only a limited set of functions. In older electronics products, when the voltages that control the functions of the product vary as the prod-

uct ages, they are adjusted by changing the value of an adjustment potentiometer. In modern products, such as a camcorder, the voltages that control those functions are derived and adjusted digitally. The microprocessor establishes the value of those voltages based on data stored in a memory module. The value that is output from the microprocessor in digital form is converted by a digital to analog (D/A, or D-to-A) converter into those voltages (Figure 1).

As the characteristics of the components being controlled by those voltages change with age (let's say that the recorded picture on the tapes recorded by the camcorder are beginning to look smeared during playback), the technician needs to adjust the voltage that controls that characteristic. Since the value of that control voltage depends on a set of information

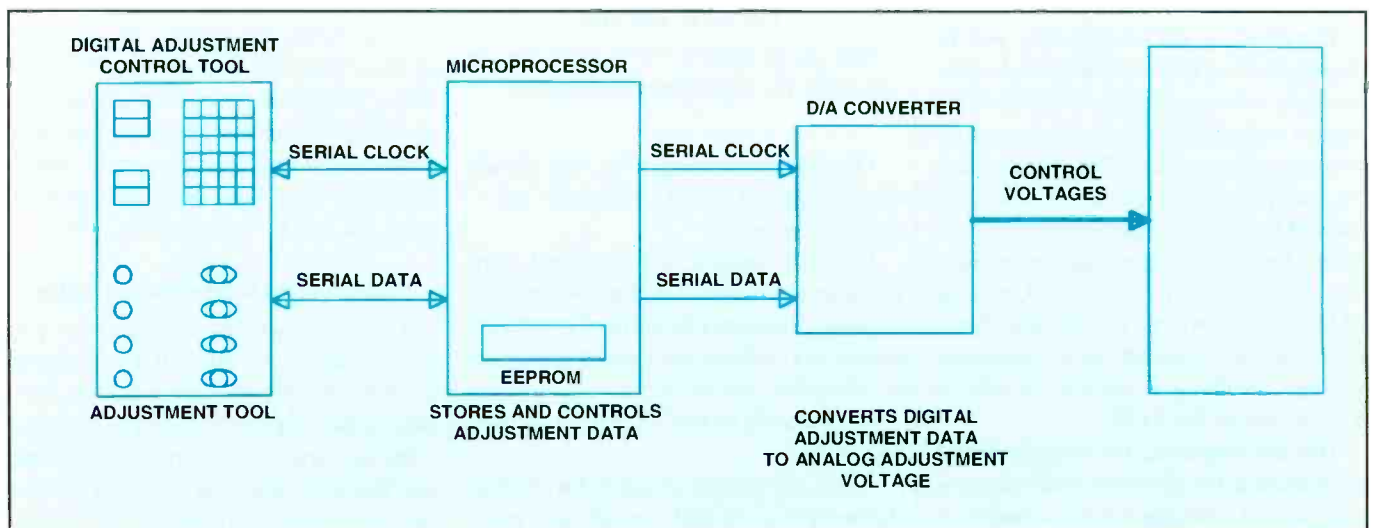
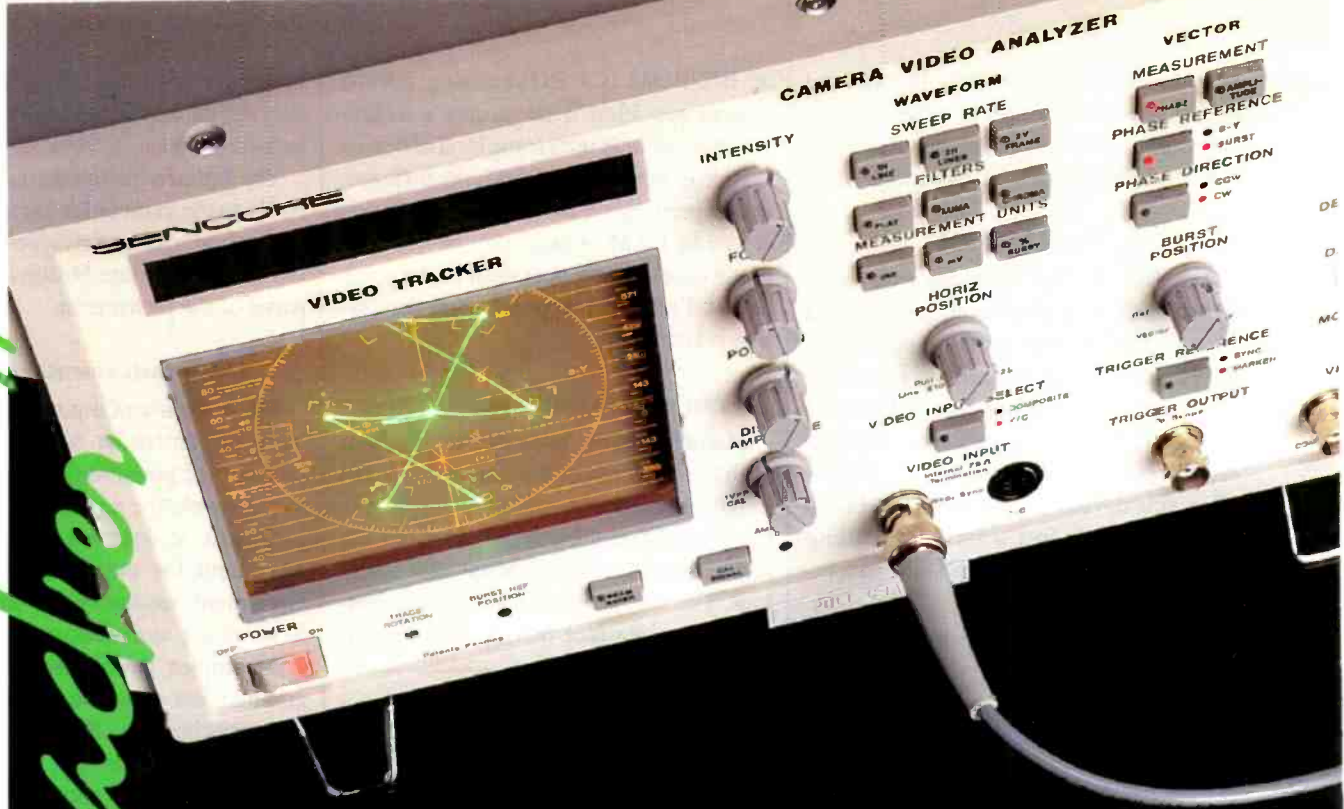

Figure 1. The digital adjustment tool allows technicians to adjust the camcorder's characteristics without even removing the cover from the unit.

CAMERA VIDEO ANALYZER™

"Video Tracker"



"If Only I Could..."

Only one instrument provides you with everything you need to analyze and troubleshoot cameras and camcorders. So, whether you're just getting started or are a seasoned professional, the exclusive digital analyzing tests of the CVA94 "Video Tracker" will help you better service all types of consumer camcorders.



Call 1-800-SENCORE and ask how the CVA94 will benefit your service center. We'll show you what the CVA94 can do for you and provide you with business building ideas to help ensure you a profitable year.

**Call 1-800-SENCORE.
(736-2673)**

SENCORE
3200 Sencore Drive, Sioux Falls, South Dakota
Direct 605 339-3100 Fax 605 339-0317

Free **Camcorder 10 Point Test
Procedure To The 1st 100 Callers!**
Circle (109) on Reply Card

stored in a memory module, he needs to update that information to adjust for the new condition. Camcorder manufacturers provide technicians with ways to do that.

The EEPROM

The data that the microprocessor uses to establish the control voltages is stored in an EEPROM (electrically erasable programmable read only memory). In the system shown in Figure 1, the EEPROM is actually in the same package as the microprocessor. As the term EEPROM implies, this device is a ROM, or read only memory. That's just a little misleading here, as the data within the ROM can actually be changed.

However, for all intents and purposes,

an EEPROM is a ROM during normal system operation. That is, until a technician deliberately uses some kind of device to reprogram the EEPROM, the information is permanent; unlike the information stored in RAM, which may be changed many times during operation of the product, and which disappears once the system is turned off.

Two ways to make adjustments

Manufacturers provide technicians with two methods of making adjustments to the camcorder by changing the data in the EEPROM; a computer assisted adjustment system, and a digital adjustment tool. The computer assisted system consists of an interface box, a cable to con-

nect the box to the computer, a cable to connect the box to the camcorder, and the software, on floppy disk.

The digital adjustment tool connects directly to the camcorder via a special connector, and adjustments are made by pressing the appropriate buttons on the front panel of the instrument.

Other instruments required

While the use of digital data for adjustment of camcorder function eliminates mechanical potentiometers and the need to get inside the camcorder to make adjustments, it does not eliminate the requirement for the other tools and test equipment familiar to consumer electronic servicing technicians. The camcorder is a complex device that requires a full complement of test equipment.

According to Thomson Consumer Electronics service data, in addition to the digital adjustment tools, also necessary for proper adjustment are: oscilloscope, DVM, frequency counter, vectorscope, light meter, tripod, color monitor, lighting, charts, and a few other items.

Hexadecimal representation

The data stored in the EEPROM is in digital form. Each individual data location consists of eight bits. One unit of data could be represented by a series of eight individual binary bits. Using binary data to represent the data would be cumbersome, and could lead to errors, so the camcorder electrical adjustment system uses hexadecimal numbers instead. Assume that the data stored at position 0,0 in the EEPROM is 4E. Each of those hexadecimal digits represents four binary digits. The hexadecimal number 4 is represented as 0100 in binary (it's equivalent to 4 in decimal). The hexadecimal number E is represented as 1110 in binary (it's equivalent to 14 in decimal). Thus if you could actually see into the EEPROM, you would see that the data stored in the eight-bit data word in position 0,0 of the EEPROM is 01001110.

More to come

This article merely touches the surface of electrical camcorder adjustment in order to introduce some of the concepts of electrical adjustment. In future issues, we'll consider some of these steps in greater detail. ■

ES&T Calendar

May 7-8, 1995
CEDIA Regional Training
CEDIA (Custom Electronic Design & Installation Assn.)
San Francisco, CA
1-800-CEDIA30

May 17-18, 1995
Systems Support Expo
World Trade Center
Boston, MA
10:00 am to 5:00 pm daily
Fax: 207-846-0657

May 19-20, 1995
ETA Annual Convention
Philadelphia Wireless Technical Institute
Philadelphia, PA
Electronics Technicians Association
317-653-8262

June 4-5, 1995
Regional Training
CEDIA (Custom Electronic Design & Installation Assn.)
Indianapolis, IN
1-800-CEDIA30

June 17-19, 1995
CES Specialty Audio & Home Theater Trade Show
EIA/CEG
Chicago, IL
703-907-7600

July 31-August 5, 1995
National Professional Electronics Conference
Arlington, VA
National Electronics Service Dealers Association
817-921-9062

October 26-27, 1995
Systems Support Expo
Moscone Center
San Francisco, CA
10:00 am to 5:00 pm daily
Fax: 207-846-0657



Soldering tips

By Don D. Doerr

A recent article in ES&T recommended cutting chips from a board (rather than desoldering), and soldering the new components to the old pins, because it isn't possible to remove through-hole chips from a multilayer circuit board safely. I have repaired thousands of multilayer boards and have found that multilayer boards are usually easier to work on and have less chance of being damaged by desoldering (than single or double-sided circuit boards), because of the eyelets that go through the board to connect the layers. The important thing is to practice on scrap boards until you feel comfortable enough to safely remove the parts without damaging the board.

These misconceptions about chip removal on multilayer boards and SMT (surface mount technology) boards are kept alive by manufacturers who don't want competition in the repair of their own boards. One well-known manufacturer for example, charges an average of about \$900 for a system board exchange, yet most techs say it is not worth doing board repair. One has to ask, at what point does it become worth doing? The following are some tips for removing chips from a through-hole circuit board.

Choosing and using a soldering iron

Make sure you are using a regulated soldering iron with the proper sized tip for the connections you are trying to heat. A good regulated soldering iron will have a heat adjustment. For removing most chips you should set your soldering iron at about 620F to 700F. Don't believe anyone who tries to tell you this is too hot. Most damage to circuit boards is done by inexperienced people afraid to use enough heat to do the job properly. Using a higher temperature allows you to heat

Doerr is President of National Advancement Corporation, a Santa Ana, CA based company that specializes in Advanced PC, Macintosh, Printer and Network maintenance training and author of the book, "Servicing PC-based Equipment", published by Prentice Hall. Doerr is also Spokesman for NAPCO (National Association of PC Owners) a non-profit organization dedicated to improving the quality of service to the PC industry. He can be reached at (800) 832-4787.

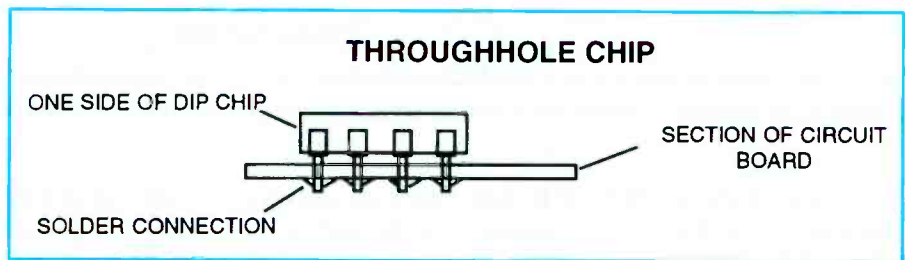

Figure 1. If you use the proper techniques, it is possible to safely desolder a through-hole component, even from a multi-layer circuit board.

the connection faster and remove the heat faster. More important than the heat is how long it is applied to the connection. Never leave the soldering iron on a connection for more than three seconds. Always keep the tip of the soldering iron clean and well tinned with solder. If the heat is not transferring well to the connection, try applying a small amount of solder to the tip.

Desoldering the defective component

When the heat is applied to a connection and the solder starts to melt, carefully push the pin of the chip into the center of the hole with the tip of the soldering iron, being careful not to push down with the iron, as this could damage the run. Then use a plunger type solder sucker to remove the solder from the lead. If the solder does not come out of the connection, always re-solder the connection before attempting to desolder the connection a second time. Whether or not the solder comes out of the connection, always remove the heat from the connection and allow to cool for a few seconds before reapplying heat.

Removing the desoldered device

After the solder has been removed from all pins on the device in question, use a probe, (such as a small jeweler's slotted screw driver), to wiggle each pin one at a time (from the solder side of the board). This procedure will tell you if the pin feels loose or if another attempt is required. Next, from the component side of the board, use the same screw driver to push each pin inward toward the center of the chip. As you push, the pin will usually

make a snapping sound indicating it is now loose. Be careful not to push too hard. When all of the pins feel loose, the chip can be easily lifted from the board. Never force the chip off the board.

Installing the new component

From either side of the board, apply the soldering iron to the edge of each connection (not the center as this will cause the solder to fill the hole) to melt the solder, opening the hole. Now you are ready to install the replacement chip. Make sure that the pin 1 orientation is correct before you start to solder. Flow solder into each connection on the new chip. Again, never leave the heat on a pin for more than three seconds. Flux remover can be sprayed or brushed onto the board to remove the excess flux, making it easier to inspect your work. Practice this procedure on bad boards until you feel comfortable about removing chips without damaging the board.

Dealing with surface mount devices (SMDs)

Replacement of SMDs will require some investment. There are several companies that make hot-air soldering tools for SMD components. These range in price from about \$600 for the Leister or Hakko hand-held units to over \$20,000 for a fully loaded station with high resolution cameras and displays. Additionally, you will need to purchase different heads for different shaped chips. Costing between \$150 and \$250 each, these heads are expensive. You will probably need about six heads to replace almost any chip you will encounter, for a total minimum

EXAMPLES OF SMD CHIPS

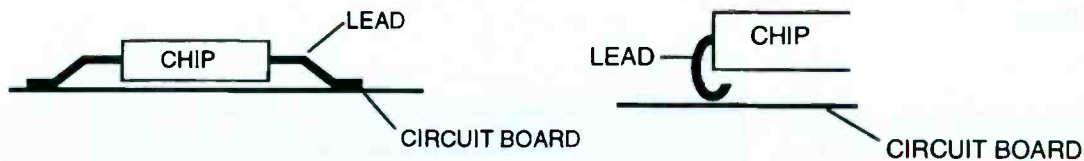

Figure 2. The best way to replace SMDs is using a hot air system to heat all the pins at one time.

investment of about \$1800. This may sound expensive, but it is a one time investment that will be recouped after just a few board repairs.

Some manufacturers sell soldering irons with replacement tips designed to spread the heat across all the pins of a surface mount device at one time. These products are inexpensive, but it is nearly impossible to get good heat transfer to all pins simultaneously, making it very easy to pull a run on the board. The best way to replace SMDs is using a hot air system to heat all the pins at one time. The individual heads are made to concentrate the heat on the pins of only the chip being replaced. When the solder starts to melt, the chip can be easily lifted off the board.

Installing the replacement SMD

After the component has been removed, it is important to tin the pads on the board before attempting to install the replacement. Applying some liquid flux to the area will aid in this process. After fluxing the area, apply a small amount of solder to all of the pads using a regular pen-type soldering iron. Being careful not to push down with the soldering iron, lightly slide the iron across the pads while applying a small amount of solder to the iron. You should see that the pads have been tinned with no solder bridges between pads. The flux will keep the solder from sticking anywhere except to the pads where it is desired. If you do get solder bridges between pads, you have used too much solder. Remove the excess solder, reapply flux to the area, clean the soldering iron tip, and try again.

Installing the replacement component

Once the pads are properly tinned with no solder bridges, apply more flux to the pads and you are ready to place the new chip on the board. It is not necessary to

have the chip perfectly lined up as long as the leads are touching their respective pad without making contact with adjacent pads. With the chip in position, turn down the air flow on the hot air unit so it will not move the chip. Slowly lower the unit into position over the chip. When you see the solder start to melt, lightly tap on the circuit board. You should notice the component settle into place. Then remove the heat immediately. If the chip is slightly out of position, the skin effect of the solder will pull it into position. Use some flux remover to clean up the area, inspect for solder bridges and you're done.

Get some practice first

After practicing on a scrap board for an hour or so you should be able to replace almost any SMD in less than five minutes. After training thousands of techs how to perform this procedure, I find that they are always amazed at how simply these procedures can be completed. You will find that it is a little more difficult to line up the pins when dealing with fine pitch chips. When dealing with these components, you may want to tack down two connections on opposite sides of the chip using a pen type soldering iron to help hold the chip in place. This will keep the hot air from moving the chip. This is where the big difference between spending several thousand or several hundred dollars on this equipment will show up. The more expensive units have X-Y controls that allow the user to move fine-pitch parts into position with much higher accuracy. The high-resolution cameras (microscopes), also make it much easier to deal with these smaller parts.

Rethinking board repair

For many years, it has been the conventional wisdom among computer servicing technicians that, "computer boards

are not worth fixing". More recently, however, there seems to be a new sentiment growing among field technicians and their managers. This new attitude probably has come about because servicers and their customers pay such high prices to the manufacturers for board exchanges and repairs.

Obtaining documentation and replacement parts

Many computer manufacturers attempt to keep the revenues to themselves by refusing to release parts and documentation. This will stop a lot of people from attempting board repairs. But, there are other sources for these parts. Anyone who has not done board repair would be surprised to find out how cheap most of the chips are for these boards. For example, most of the 7400 series chips used for bus latches and buffers cost less than a dollar each. On most of the newer boards these digital ICs are being replaced by the large-scale-integration (LSI) chips such as Chips & Technologies, Suntac, or Symphony to name a few. These chips and all of the proprietary (i.e. IBM, Compaq, Apple, etc.) chips are readily available for \$10 to \$30 each.

Most of the newer boards, in addition to the processor (which is usually socketed), have one to four of these surface mounted components. This makes it pretty easy to ascertain the cause of a problem, especially if you have a good ROM-Based diagnostic such as the RACER or PHD cards by Ultra-X. Even if you guess, you have a 25% chance or better of picking the right chip.

Now you may be wondering why, if doing board repair presents such a great opportunity, why haven't you heard about it before. The companies that specialize in board repair (fourth party services) report that if they do not make at least

\$300 an hour for their time repairing a product, they move on to other products. At \$900 per board (Compaq's average board exchange price) you don't have to repair many boards per day to make a good living. If you found a gold mine how quick would you be to tell the whole world its location?

Efficiency is the key to success

If your expectations of doing board repair includes tracing signals using a scope and schematic, you are probably wondering how you can fix more than a couple of boards per day. Efficiency is the key to success and there are many aspects to that efficiency that will be covered in later articles. One important step is keeping a database of symptoms and fixes (including make and model) for every repair completed which will greatly reduce the amount of troubleshooting required. Since about 90% of problems on any product are repeat problems, keeping records of repairs you have made is a requirement for an efficient repair facility. Once a technician becomes familiar with the workings of a board and its failure modes, most repairs can be completed in under 15 minutes.

Making the transition

Many of the readers of this magazine are owners of consumer electronics service centers. They understand, better than most, the truth in that statement about documenting repeated problems. They also are among a dying breed of individuals who have a background in electronic troubleshooting and repair. Because of their background they don't adhere to the board-swap mentality. The skills of these individuals also translate directly to the repair of many problems in printers, monitors, and power supplies; and with very little training they can be servicing system boards and other logic boards.

Many consumer electronics service centers have taken the step of repairing computer modules with great success. The volume of business and the amounts people are willing to spend on computer servicing is a welcome relief from the conditions that prevail in servicing of consumer products. In future articles we will discuss the opportunities that exist for these entrepreneurs, what is required to get started, where to get the parts, how to generate business, how to find the niche markets, and how to service efficiently. ■

Cordless

POWER

& Precision

Perfect for the bench top or out in the field

High capacity batteries and high efficiency tips let you solder longer without recharging. And a unique, isolated-tip design eliminates electrical leaks and damage.

A complete line of irons along with job-matched tips means you'll find the iron that's perfect for your job. Write or call for more information or "where to buy".

ISO-TIP®

WAHL CLIPPER CORPORATION
2900 Locust Street • Sterling, IL 61081
(815) 625-6525 • Fax: (815) 625-0091

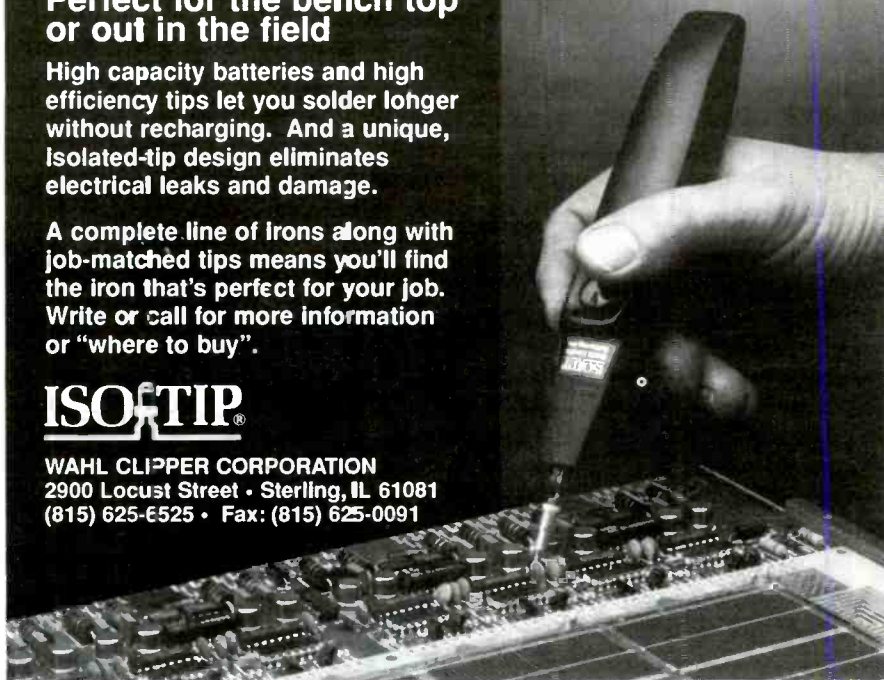

Circle (45) on Reply Card

Troubleshooting tips

Camcorder "DEW" indication

RCA models PRO883HB, PRO930, PSC10 and PSC20HB

Remains on constantly

(Adapted from Thomson Technical Information)

In some of these camcorders, even when there is no excessive moisture in the unit, the on-screen display (OSD) may show the indication "DEW" and the tape will not record, play, fast forward or rewind. In most cases of this problem, the dew error conditions will not clear spontaneously, so the camcorder will remain unusable. If the case is removed for servicing, the problem will disappear, and the camcorder will work properly again; for a period of time. Unfortunately, the problem will usually return in a few days or weeks.

The cause of the problem is that PG902 and CN902, the two-pin connector and socket associated with the dew sensor element are developing intermittent high resistance connections. To cure the problem, cut the two-pin connector (CN902) off of the cable

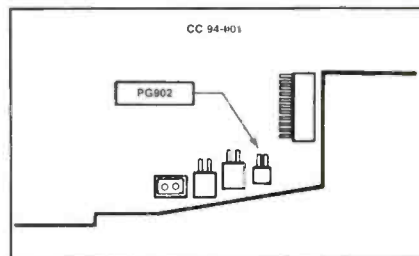

from the dew sensor element and remove the mating socket (PG902) from the main circuit board (see the drawing for the location of the socket). Solder the two wires (red and brown) from the dew sensor element directly to the main circuit board. The polarity of the two wires does not matter. You will have to add an extension to each of the dew sensor wires in order to make this connection.

(Continued on page 32)

Servicing vertical foldover problems

By Homer L. Davidson

Foldover is a form of distortion that can be caused by malfunctions in either vertical or horizontal circuits. Overlapping of the picture at the top or bottom of the TV screen is called vertical foldover. In foldover, one portion of the picture overlaps another portion of the picture, accompanied by distortion. Vertical foldover can occur at the top, middle or bottom of the raster.

The most common form of foldover is insufficient picture height with a half inch or so of foldover in the middle of the screen. When foldover occurs at the top of the picture, it may be accompanied by black and white lines. Excessive height at the bottom of the picture may result in overlapping of the picture or vertical foldover. In some cases the bottom area of the picture may be raised up and there will be a black area at the bottom.

The cause of vertical foldover

Vertical foldover is caused by defective components in the vertical output, bias or feedback circuits. Often, a leaky or open electrolytic capacitor, a change in the resistance of a resistor in the feedback circuits, or a defective transistor or IC component is the cause of foldover. In older TVs a transistor or leaky coupling capacitor to the vertical yoke winding may be the cause of vertical foldover. Feedback resistors or electrolytic capacitors can also cause vertical foldover.

Accurate voltage measurements and oscilloscope tests can help locate the defective component. Excessive vertical foldover cannot be corrected by adjusting the vertical height and linearity controls.

If you encounter a TV set that has a vertical foldover problem, check the vertical output transistors to see if they are leaky, and check bias resistors to see whether their value is significantly different than the specified values. Check to see if the voltages on the bottom vertical output

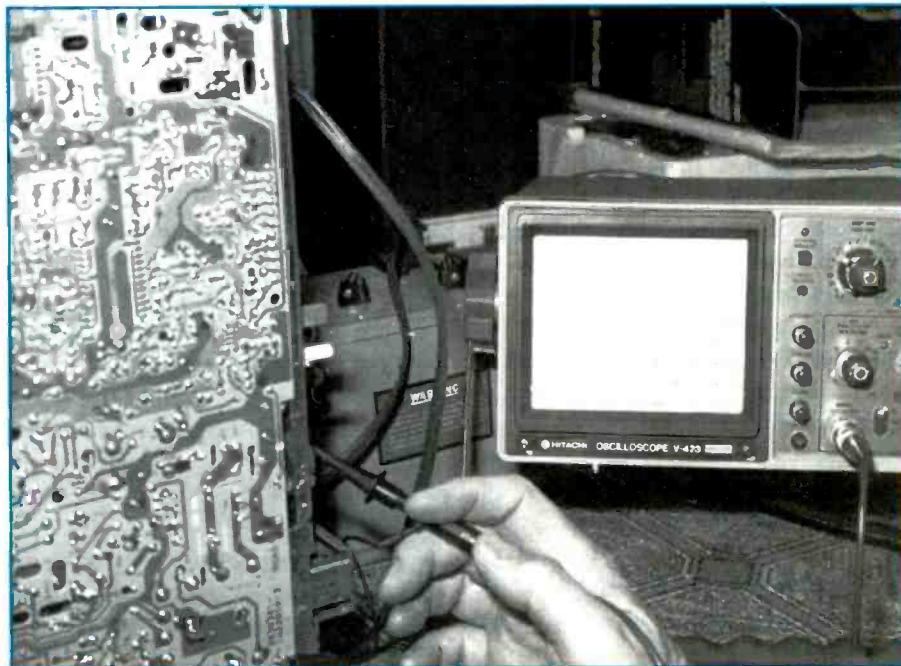

Figure 1. If the problem is vertical foldover, check the waveforms at the input of the vertical deflection IC, and the output of the deflection IC to the vertical yoke winding.

transistor are according to the specifications in the service manual.

It may be necessary to replace both vertical output transistors in order to solve a foldover problem. Although the oscilloscope cannot pinpoint the defective component, observation of the input and output waveform can help the technician determine if normal sweep is present (Figure 1).

Injection of a normal waveform into the input terminal of the vertical output IC can help to determine if the foldover problem is caused by a defective IC or problems in the output feedback circuits. Vertical linearity or foldover problems can be caused by problems in the vertical feedback and bias circuits.

A suitable diagnostic procedure is to shunt all electrolytic capacitors in the output and feedback circuits one at a time. If shunting these electrolytic capacitors does not produce any improvement in the problem, you can be almost certain that it will be necessary to replace the vertical output IC to solve the foldover problem.

Careful resistance measurements in the bias and feedback circuits can turn up a leaky capacitor or resistor that may be causing foldover. Remove one end of the resistor to isolate it from the remainder of the circuitry for accurate tests. In many cases you will find that the defective resistor has increased in resistance.

Transistor output foldover problems

In early TV chassis with transistors in the vertical output circuits vertical foldover may be caused by a defective transistor, an electrolytic coupling capacitor, bias diodes, or a change in resistance of the feedback resistor. In many cases measurements will show that the voltages at the terminals of the vertical output transistors are incorrect when the TV set exhibits foldover.

In a Sharp C-1551 portable with a foldover line at the top of the raster, full vertical sweep could not be obtained (Figure 2). In this case, the voltages at the terminals of the top output transistor (Q504) had increased by 5.6V. Voltages at the

Davidson is a TV servicing consultant for ES&T.

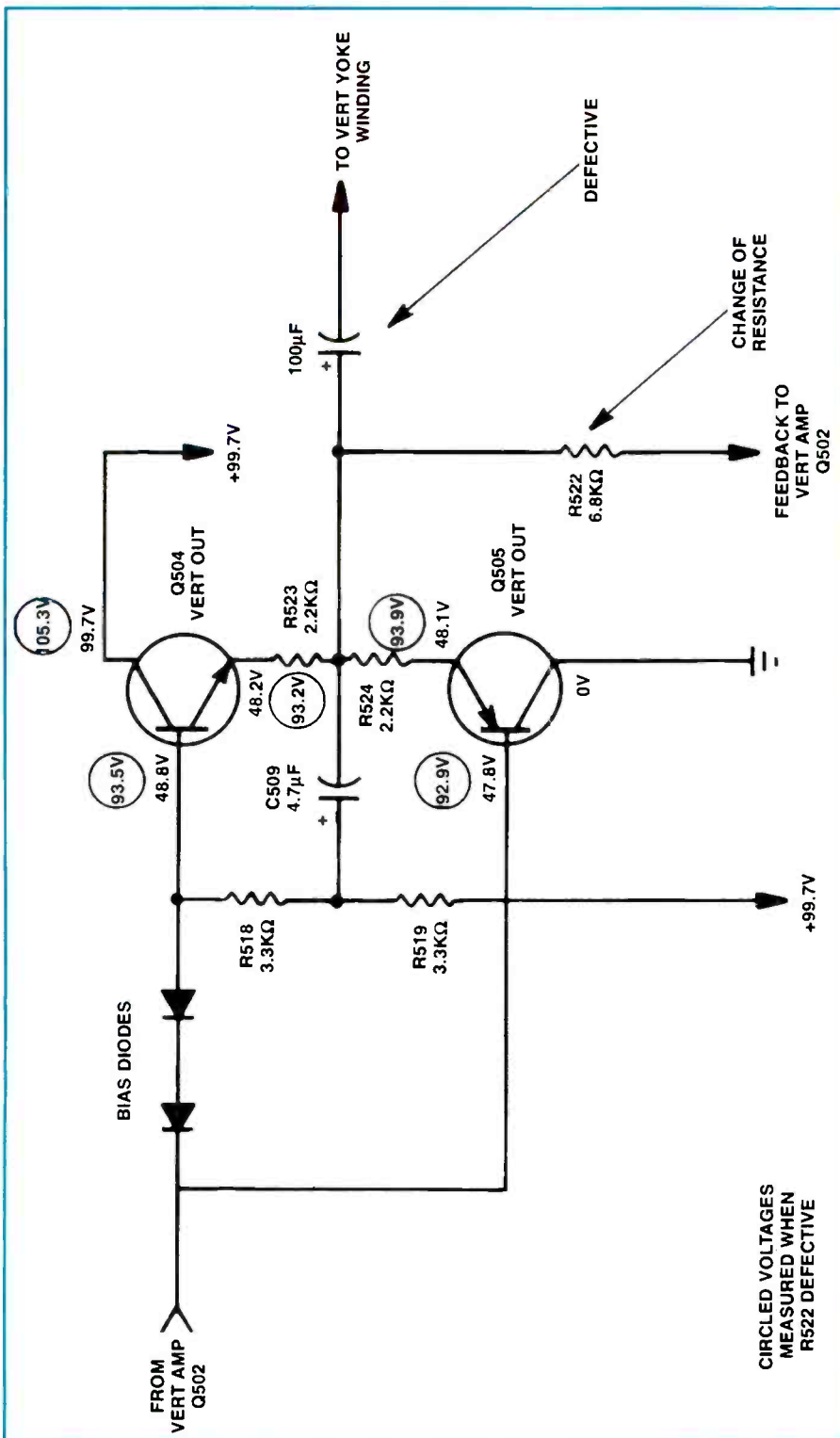

Figure 2. When vertical foldover was the problem in a Sharp C-1551 set, replacement of the 100μF yoke coupling capacitor and feedback resistor R522 (6.8K) restored normal operation.

bases of both output transistors were almost twice their specified values. At first I suspected that Q504 was leaky, since voltages on all three terminals of that transistor were close to the same value. When tested in-circuit, Q504 appeared normal. I decided to remove the transistor for out-of-circuit tests. The transistor appeared normal out of circuit. These tests are not

conclusive, because a transistor may be intermittent under load, or its characteristics can change when heat is applied to remove it from the circuit.

Because the symptom pointed to Q504, even though it seemed to test good, I replaced this 2SC1448A transistor with an SK3054 universal transistor. The symptom remained. I checked all bias re-

sistors, and they were normal. A measurement of the resistance of feedback resistor R522 (6.8KΩ) in the circuit revealed that this value was higher than normal. I disconnected one end of R522 in order to measure it free from the influence of other resistances that might be paralleling it. The value of this resistor had increased to 15.58KΩ, so I replaced it. I replaced the vertical coupling capacitor as well, since in some sets has caused foldover problems. This cured the foldover problem at the top of the picture.

One-half-inch foldover problem

The picture on the screen of a General Electric 19PCF set had shrunk to a very small height. When the vertical hold control was adjusted, the picture expanded to two inches with a half inch foldover in the center. Readjustment of the height control did not increase the height of the raster. Because the symptom was insufficient height, both output transistors were checked in the circuit (Figure 3), but both tested good.

A measurement on Q601 indicated high collector voltage (85V). Usually this voltage measures around 65V, measured at the 116V source through R647 (1.5-KΩ). The voltage between base and emitter on both transistors measured 0.6V. Since these transistors are NPN types, these forward bias measurements indicated that both transistors were normal. A quick look at the IC waveform at pin 1 of IC501 with the oscilloscope showed that this was normal at 0.7V, indicating that the foldover problem must be caused by a malfunction somewhere in the vertical output circuits.

Since a defective electrolytic capacitor or a change in feedback resistors can also cause foldover, I shunted each of the capacitors, one at a time, by turning off the set, clipping a new capacitor across the suspected one in the set, then turning on the set again to observe the results. When I clipped a new 22μF capacitor across capacitor C614, there was no change in the picture. When C425 was shunted with a 100μF electrolytic capacitor, however, the vertical sweep returned to full deflection, and the center foldover problems had disappeared.

Sharp 19J63 and 19J65 foldover problems

When you encounter a TV set with a

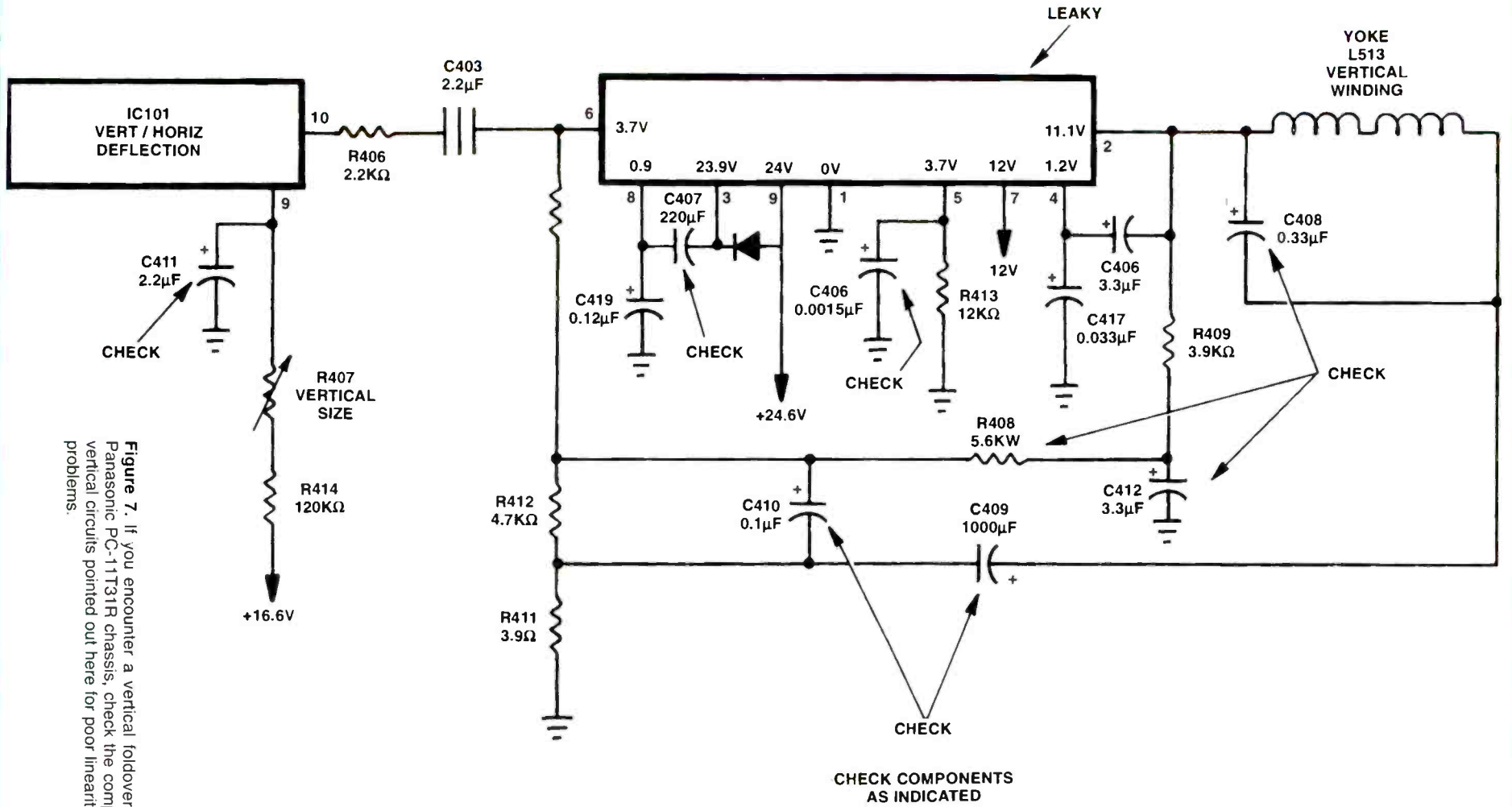

Figure 7. If you encounter a vertical foldover problem in a Panasonic PC-11T31R chassis, check the components in the vertical circuits pointed out here for poor linearity and foldover problems.

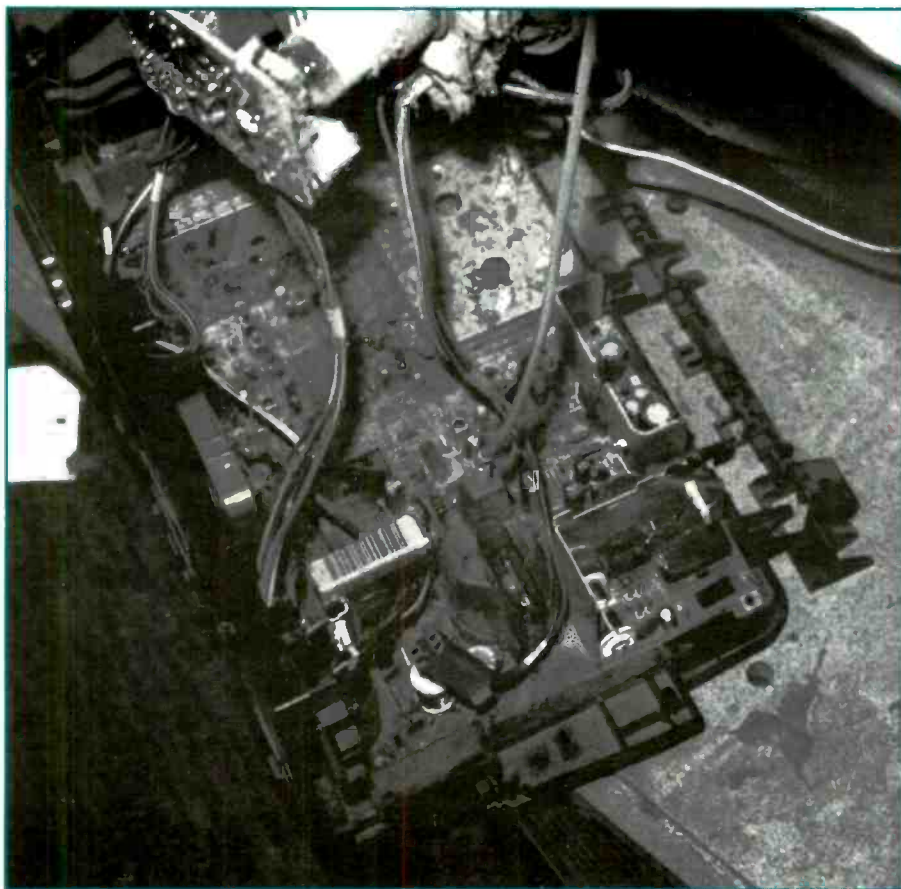

Figure 8. When you don't have a schematic diagram available and you want to locate the vertical output IC, look for an IC mounted on a large heat sink.

with the oscilloscope. Check the waveform at the IC terminal that connects to the yoke winding. Start with the yoke and trace pc wiring back to the output pin. Improper waveform at this output pin may indicate a defective IC, improper voltage sources, or a defective component tied to each pin terminal.

Next check for one or two voltage sources feeding the vertical IC from the low-voltage power supply. The highest voltage is the voltage supply pin. A 24V to 25V source powers the vertical output IC component. Scope the input terminal which is usually a sawtooth or negative pulse (0.9V to 1.5V).

You can signal trace the vertical circuits with one of the latest TV schematics, that includes a vertical output IC. Most of the latest vertical IC output circuits are just about the same and any schematic can be used to signal trace, observe waveforms and measure voltages.

Notice that the vertical yoke winding ties directly to pin 4, with the return winding through a 680 μ F electrolytic capacitor and a 3- Ω resistor to common ground (Figure 9). Besides the 680 μ F capacitor, check 2.3 μ F, 1 μ F, 0.033 μ F, 100 μ F, and 470 μ F capacitors any time you happen to

Clean Up Your Benchttop Cleaning With the Money-Saving Trigger Grip.

Component-level repair is the toughest job in the electronic industry, and the loss of the CFC solvents made it even tougher. So take a look at your cleaning procedures – they're costing you money you don't have to spend.



◀ *Here's what you'll find:*

"Dip-and-brush" cleaning with dirty solvents. Using too harsh a solvent and melting soft components. Using too mild a solvent and wasting

hours cleaning. Complaints about residues, smells and slow drying. Out-of-date safety sheets. And more.

So when you clean, call Micro Care. Our non-CFC aerosols offer you more choices for cleaning fluxes, oils and inks. Plus our benchttop tools enforce proper cleaning procedures that will save you time and money. Faster, safer, better, cheaper: that's cleaning the Micro Care way.



The Trigger Grip system controls solvent use, improving quality while standardizing the cleaning process.



For Clean, Clean Boards

MICRO CARE CORPORATION 1-800-638-0125 34 RONZO ROAD BRISTOL, CT 06010-7792 USA • 203-585-7912 • FAX 203-585-7378

Prottek 2MHz
Function Generators
You Can Count On!

- Seven frequency ranges • 100: 1 frequency control on each range • Four digit LED frequency readout
- VCF input • Variable DC offset

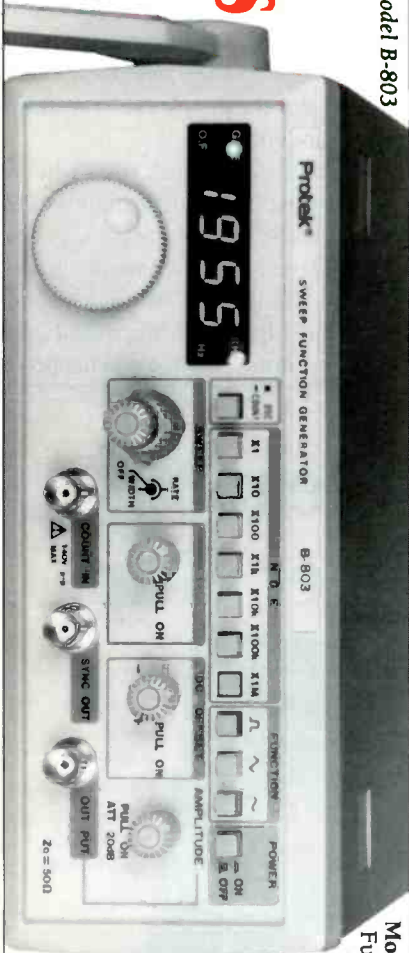

Model B-803

Model B-803 - 2MHz Sweep
 Function Generator/Counter \$320

Model B-801 - 2MHz Sweep
 Function Generator \$239

Model B-810 - 10MHz Sweep
 Multifunction Generator/
 Counter \$775

Other Models Available



154 Veterans Drive
 Northvale, New Jersey 07647
 Tel: (201) 767-7242
 Fax: (201) 767-7343

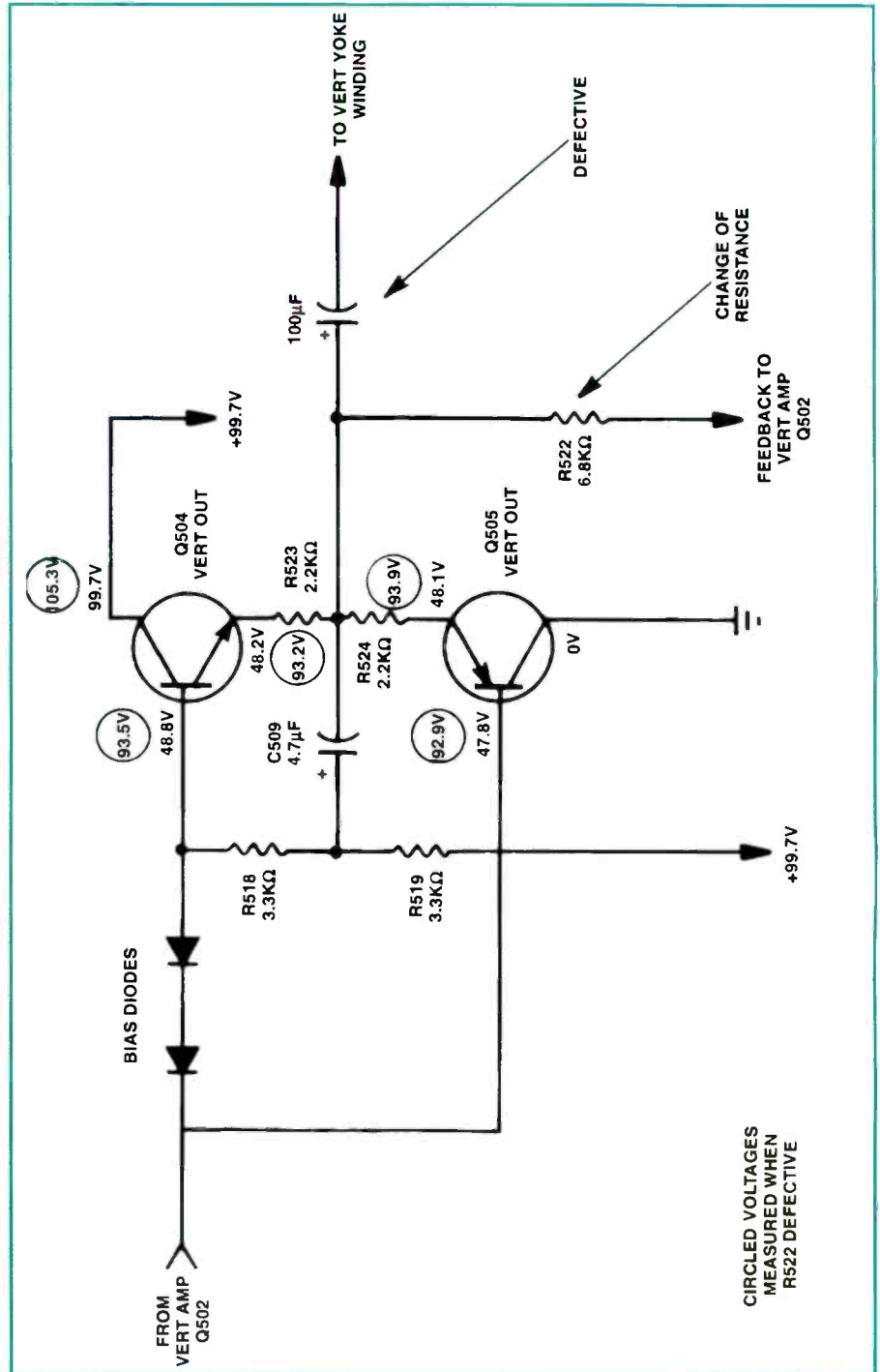

Figure 9. When the problem is poor linearity accompanied by vertical foldover, check all electrolytic capacitors in the vertical output IC circuits.

encounter poor vertical linearity and fold-over problems.

Conclusion

Whenever the problem is vertical fold-over, carefully observe waveforms into and out of the vertical output IC to determine if the IC is defective, or if the problem is caused by other components that are defective. Remember that vertical

foldover is caused by problems that occur in the vertical output, feedback and bias circuits of the set.

Shunt electrolytic capacitors in the vertical output and feedback circuits to check for open conditions. Carefully measure resistances across electrolytic capacitors to determine if capacitors are leaky. Measure the voltage source to the supply pin on the output IC to determine if the voltage is as specified.

Troubleshooting techniques

By the ES&T Staff

One of the things that makes the troubleshooting of consumer electronics products so interesting, is the variety of ways in which troubleshooting can be accomplished. Sometimes, the troubleshooting procedure can be performed in a straightforward manner, but in some cases the job is made easier by employing a few tricks of the trade.

The old light bulb trick

Let's say you have a TV set that has an internal short or heavy overload. It was originally brought into the service center with a blown fuse. You've replaced the fuse, but every time you turn the set on, it just blows another fuse. You've checked resistances around the power supply, and the horizontal and vertical outputs, but everything checks out okay. You'd really like to get the set operating so you can perform some voltage checks, but the set refuses to cooperate.

One simple method that can be used in a situation such as this, is to place a standard 100W light bulb in series with the hot side of the power line. Then when the power is applied to the set, the light bulb will limit the current to the set enough to keep the fuse from blowing. This will give you enough time to make a few voltage measurements. In addition, the light bulb itself will serve as a diagnostic device. If the bulb is dim, you'll know that the overload isn't severe. If the bulb is bright, then you'll know that the overload is heavy, possibly a short circuit.

Check those connectors

In products, such as computers that employ plug-in circuit boards, cable connectors and other non-soldered joints, intermittent problems as well as complete failure can frequently be traced to a bad connection where two circuit segments plug together. Aging, oxidation, or compression of the metal in the connectors can all cause a plug-in connection to fail. When you're faced

with a computer or other product using plug-in connections, and it's exhibiting problems, it could save some time and effort to start by checking any of those plug-in connections.

For example, let's say that a disk drive isn't operating properly. With the unit turned off, disconnect the cable from its connector and inspect the connector for signs of oxidation. If it looks like there might be a little discoloration of the surface of the metal on the connector, plug it in and unplug it several times. The rubbing of metal against metal may be all it takes to clean the surface and restore proper operation. If the metal looks seriously discolored from oxidation, rub a pencil over the contacts to brighten it up, or spray it with a contact cleaner/lubricant/deoxidizer. In many cases this will solve the problem. If it hasn't solved the problem, you've only lost a couple of minutes, and now you're pretty sure that the connectors are working, and you can look elsewhere.

Have a system floppy disk handy

When you're servicing computers, it may happen that you're called upon to service one that has a problem with the hard drive, or associated circuits that will make it impossible to get the computer booted up and running. Because such problems will crop up from time to time, whenever you go on a computer service call you should always have both a 5-1/4-inch and a 3-1/2-inch floppy disk that have the operating system on them.

To prepare these disks, simply take unformatted floppy disks, or disks for which you have no further use, and format them with the /s switch. In other words, place the disk in the drive and type, FORMAT /S A: (or B:, depending on the drive designation). Formatting the disks using the /s switch places a copy of the operating system on the disk. Then, if you're ever faced with a computer that can't boot from the hard drive, you can put one of the disks in whichev-

er floppy drive the computer looks at to find a bootable floppy disk. Once the computer is running, you can use your diagnostic software and test equipment to locate the problem source.

Signal substitution

Sometimes when you're faced with a problem such as, absence of a TV picture because there's no horizontal output, you don't know if the problem exists because the output circuit isn't operating, or if the problem is occurring due to an earlier stage not providing the necessary drive signal. One way to track this problem down is to connect the drive signal from the output stage and substitute a known good signal from a signal generator. Look at the schematic and see what the drive signal looks like. What is the amplitude? What is the waveshape? What is the frequency? Once you have determined these parameters, turn off the set, disconnect the drive source from the output circuit by desoldering, connect the signal generator to the input connections of the output circuit and turn the set back on. If you get some kind of raster on the screen, you know you need to concentrate on the circuits ahead of the output section. If there's still no picture of any kind, concentrate your troubleshooting efforts on the output section.

Using a substitute power supply

Sometimes, the problem in a TV set will be isolated to a malfunction in an oscillator circuit. If you're servicing a set and have pretty much concluded that the problem is with the oscillator, but you don't know if it's the oscillator components or if the oscillator supply voltage source has a problem, you can substitute a known-good power supply voltage from a bench power supply. Disconnect the set. Discharge any large capacitors in the area of the circuit where you'll be working. Disconnect the TV's power supply from the suspect circuit.

Connect the substitute bench power

Troubleshooting tips *(from page 21)*

TV audio drops out while in the SAP mode

RCA models CTC186, CTC187 (Adapted from Thomson Technical Information)

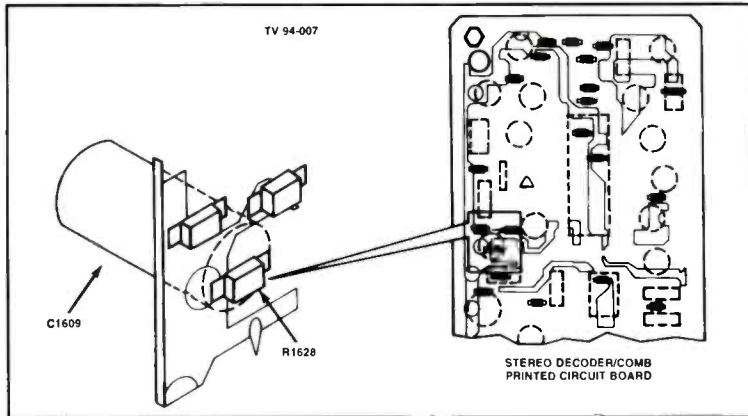

In some of these sets, the second audio program (SAP) noise detector is triggered by high-level stereo L-R signals, momentarily switching from the SAP signal to stereo and back to SAP when the signal level decreases.

To cure this symptom, remove capacitor C1609 located on the stereo decoder circuit board and replace it with a 47uF, 25V capacitor, (Thomson stock number 193043). Add a 100kΩhm

surface-mount device (SMD) resistor (R1628), (Thomson stock number 192084), across the leads of C1609 on the copper side of the stereo circuit board. See the diagram for the location of C1609 and R1628.

These changes were incorporated into production sets with serial numbers 429000000 and higher, so the problem should not be experienced with those units. ■

supply, turn it on and adjust the output voltage to the correct voltage. Now observe the waveform at the oscillator output. If you observe a waveform that's fairly close to the one shown in the documentation, you've isolated the problem to the power supply section. If the oscillator fails to produce any waveform, the problem is most likely in that circuit. Perform further voltage, resistance and component substitution checks until you've tracked down the faulty component(s).

Documentation

One of the best troubleshooting techniques is to keep a record of problems and their solutions every time you run across something new. Then categorize and catalog them in an orderly manner. Now, when you encounter a problem, you can refer back to your notes and find out what the solution was the last time. Even better, many of the manufacturers, and several independent services, offer catalogs of common problems and their solutions. By using your own experience, as well as the experience of other servicing technicians and the manufacturer, you multiply your troubleshooting power. ■



Fox International

23600 Aurora Road • Bedford Hts., Ohio 44146

OVER 3 MILLION PARTS IN STOCK



Why Call Multiple Distributors For All Your Parts Needs?
"With One Call You Get It All"

CALL ONE NUMBER
FOR ALL YOUR PART NEEDS

800-321-6993

We Are Not A Broker WE STOCK PARTS
Call Us With Your Backorder List Today!!!!

Circle (25) on Reply Card

Improve Your Form.

3/5 Part

A continuous feed form used for customer COD service, parts/accessory sales receipts, and warranty billing. Includes technician hard copy and set tag. Available in 3-part (N3CS) and 5-part (N5CS) format.

5 Part

A continuous feed 5-part (N5CN) form for warranty billing that does not include a set tag.

Discounts Carbonless NESDA Forms are available to NESDA members at additional savings. For pricing information and samples, contact Moore Business Products at the number below.

The NESDA Form

Moore Business Products
(800) 433-5557

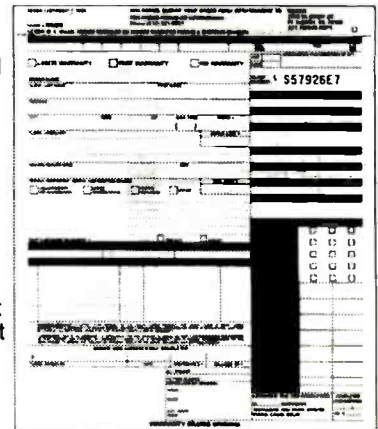

★ ★ ★ SHOWCASE OF TOOLS & TOOL CASES ★ ★ ★

Tentel

4475 Golden Foothill Pky.
El Dorado Hills, CA 95762
Phone: 916-939-4005
800-538-6894
Fax: 916-939-4114

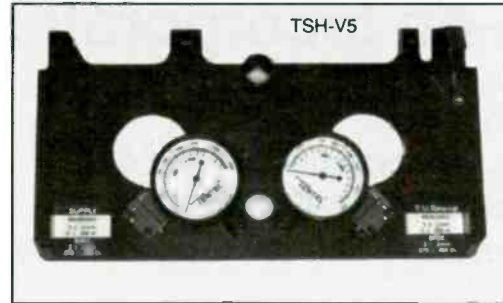

Over 90% of VCR and camcorder problems are due to mechanical malfunctions. Mechanical components fail due to wear, oxidation, and abuse. There are literally dozens of mechanical parameters in a typical machine. These mechanical problems can be categorized as 1) carriage alignment, 2) tape hold back tension, 3) guide and reel table heights, and 4) video head wear problems. Most TV shops only guess about VCR problems since they have thousands of dollars in electronic testing equipment but virtually nothing for the critical mechanical VCR parameters.

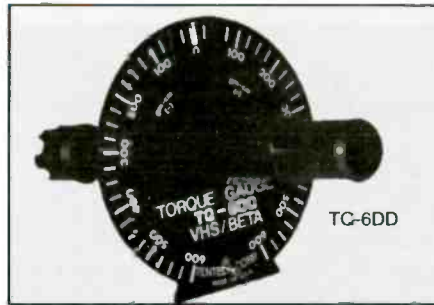

Tentel manufactures the only universal test instruments to provide fast, accurate measurement of these mechanical tests. Elimination of guessing provides better

repairs without costly and embarrassing call backs, while actually cutting down the time spent on VCR service.

Tentel has been providing test instruments to the video repair and maintenance marketplace for over 22 years, and is rec-

ognized throughout the world as the leader in supplying easy to use powerful test instruments for the mechanical measurements on video transports. Over 70,000 TENTEL test instruments are in use for testing and repairing video transports.

IMAGINE THE BEST VCR TEST INSTRUMENTS!

These are EVEN BETTER!

Our biggest challenge is trying to communicate how these VCR test instruments will actually help your business, by allowing better VCR repairs.

It's interesting how the veterans of *trial and error* VCR repair, *suddenly* become our BEST supporters. If you're ready to try these gauges in your own shop, with a 100% money back guarantee, it's time to call. STOP guessing and wasting valuable service time by continuing to perform TRIAL and ERROR VCR repairs. The RIGHT tools make any job easier to do; these ARE the RIGHT tools for VCR repair! EVERY VCR service manual shows a method of performing these critical tests which cause the majority of VCR problems. **These are the ONLY Universal** gauges for tape tension, guide heights, torques, video head wear, reel table heights, and other critical mechanical tests.



4475 GOLDEN FOOTHILL PKWY. 800-538-6894 / 916-939-4005
EL DORADO HILLS, CA 95762

24 hour FAX line: (916) 939-4114

Snap-on Incorporated

2801 80th Street
 Kenosha, Wisconsin 53141-1410
 Headquarters: 414-656-5200
 (Check phone book for local offices)

Since 1920, when we first developed the interchangeable socket wrench, Snap-on Incorporated became recognized as the industry leader in providing the finest quality hand tools and equipment for the professional service technician. In the 1920's we pioneered direct sales and service to customers right at their places of business, while providing credit programs so they could purchase the tools that would build their businesses. We still do that today.

Snap-on Incorporated is the world's premier manufacturer and distributor of hand and power tools, wheel alignment and service equipment, tool storage and diagnostic equipment and electronic service tools for the professional technician. Now in our 75th anniversary year, we lead the market in product quality, personal customer service and design innovations.

With more than 15,000 products in our line, we offer the variety, styles and innovative products to handle the kinds of jobs facing professional automotive and industrial technicians as well as electronic service and repair. Such products include our Flank Drive® and Flank Drive® Plus Wrenching Systems, Counselor® II Digital Oscilloscope (the industry's best selling scope) and Stork® pliers. Our line of electronic service tools is extensive: pliers, insulated tools, strippers, cutters and crimpers and Electrosets® that consist of self-contained cases and pallets filled with tools for specialized uses. These sets range from a general basic set to Field Engineer's Set, Journeyman's Set, Electro-mechanical Set and Clean



Room Set. Each set can be modified and customized by the user with tools most needed for specific jobs.

The entire Snap-on service network is based on a national distribution network made of regional customer service centers, distribution centers and branch offices located

in principal cities throughout North America. To back up our products we run our own service centers, so when things need to be fixed, they are fixed right. You can depend on Snap-on for quality products and commitment to dependable service where and when you need it.

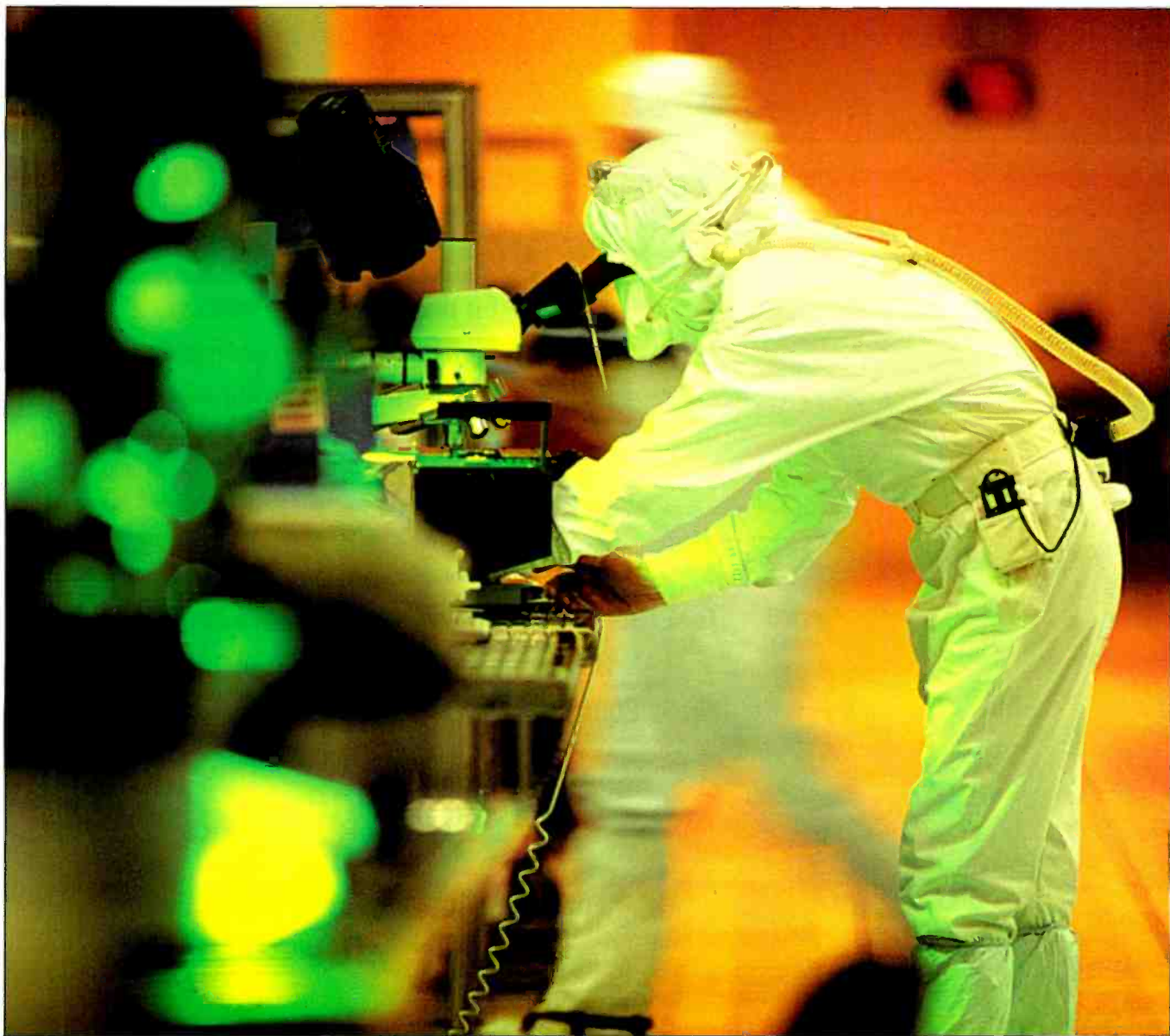

LET'S GET TECHNICAL.

The work you do may be complicated. But finding the right tools and equipment is simple. Just talk to a Snap-on Industrial Tool Specialist.

Whether you're dealing with highly sensitive medical equipment or sophisticated electronics to office machine maintenance, Snap-on has the custom tools you need. Packaged the way you need them. And if we don't already make it, our Specials Division can design and build it especially for you.

You see, when you invest in Snap-on, you get more than the ultimate tools. You get the ultimate in fast, personal service. You don't

just deal with a warehouse or catalog salesperson. You team up with a Snap-on tool and equipment specialist who's linked directly to our entire engineering and manufacturing staff.

Which means you get a free design engineer. As well as faster response. Faster turnaround. And faster solutions.

So for the hardest working, longest lasting, and most accurate tools and equipment you can buy, talk to a Snap-on Industrial Tool Specialist. No one else can offer you the experience, the knowledge and the reputation for quality that we can. Technically speaking, of course.



Snap-on®

THE TOOLS OF AMERICAN INDUSTRY.

Circle (76) on Reply Card



TRACK RECORD.

To stay on the fast track to success,
you need high-performance equipment.

At Specialized Products Co., we make sure you *always* come in first.

Our inventory of over 10,000 products is constantly being expanded and updated with the very latest tools, testers and cases. This huge selection, combined with our competitive pricing and speedy overnight delivery, helps you turn in a winning performance. Year after year.

At Specialized Products Co., you're always first!

Tool Kits • Foam-Filled Cases • Service Tools • Cable Testers

LAN Test Equipment • Electronic Test Equipment

Static Control Products • Connector Tools & Equipment

Fiber Optics Equipment



For a Free Copy of Our Latest Catalog,
Call 1-800-866-5353

© 1995 Specialized Products Co. Inc.



Circle (47) on Reply Card

Specialized Products Company

3131 Premier Drive
Irving, TX 75063
1-800-866-5353
Fax 1-800-234-8286 (24 hr)



Specialized Products Company's 30th anniversary marked by tremendous growth. Specialized Products Company, an international supplier of specialized tool kits and test equipment, is backed by a 30-year history of growth and prosperity. Its success is marked by keeping pace with technology and market demands. As it celebrates its 30th anniversary, SPC continues to expand its product selection and prosper through its commitment to superior service to its specialized customers.

SPC was founded in 1965 in Dallas, Texas, to distribute Mil Spec coatings and adhesives to the local electronics manufacturing and defense contracting community. Around 1970, product lines were expanded to include a wide variety of production tools and equipment. In the mid 1970's SPC became one of the first suppliers of standard electronic-type tool kits to OEM and third-party maintenance organizations. Late in the 1970s SPC began offering test equipment as an adjunct to its rapidly growing tool kit businesses. At that time, computer field engineers were the primary customers.

In 1979 SPC refocused its marketing plan to sell to the service professional exclusively by catalog. By 1985 this catalog also served telephone installers (as a result of telephone deregulation), and by 1988 the customer base was extended to include data communications specialists. Today, product lines also supply cable installers, LAN/WAN managers, biomedical engineers, telecom integrators and virtually anyone else involved in installing and/or repairing any type of technology.

During the 1980's SPC became one of the nation's largest and best known suppliers of tools, tool kits and test equipment and over 100 standard tool kits. This thriving company expects to reach \$50 million in sales within three years.

SPC's own line of tool kits is designed for a variety of specialized needs. As-

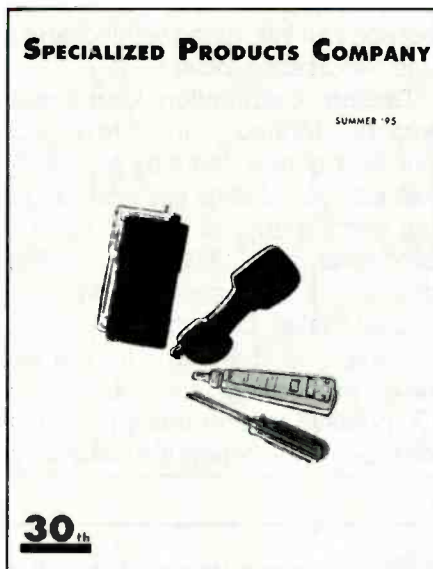

sorted tool case and pallet styles and materials are stocked with high-quality, name-brand tools. Any tool kit may be modified to suit a customer's specific application or budget. Specified tools can be added or deleted from a standard kit at no extra charge. The resulting modified tool kit usually can be shipped the same day it is ordered. When an organization supplies tool kits to a national service group or has unique requirements, custom tool kits can be built from scratch to any customer's exact specifications. A competitive quote is usually available within 24 hours.

This 30-year-old company sells almost exclusively in the service arena. From basic cable installation to board level component repair, SPC offers a wide range of products to accommodate virtually any service-related requirement. In the 1970s that mainly referred to the mainframe/mini-computer companies along with their third-party maintenance organizations. Service today runs the entire gamut of PC repair, LAN management, satellite com-

munications, desktop video and everything in between.

In 1994 SPC sold products to over 35,000 different customers. A typical SPC customer today is anything but typical. The past 10 years have seen the emergence of self-maintainer customers and in-house service groups. On any given day SPC sells to banks, insurance companies, RBOCs, fast food restaurants, hospitals, airlines, etc. These customers can be marketed effectively via catalogs because of their diverse locations and relatively frequent purchasing habits.

This successful company mails over a million catalogs a year. They are recognized and accepted within the industry as the standard by which all competitive publications are measured. SPC's catalog efforts are unique because all catalogs are produced in-house. A state-of-the-art production facility takes a project from conception to film all under the same roof. This capability allows for both cost effectiveness and high response to changes in products and prices.

Specialized Products Company is dedicated to offering the fastest turnaround in the industry. Ninety-eight percent of all orders are shipped the same day they are received (typically for overnight delivery). SPC utilizes three order centers (Dallas, Texas; Nashua, N.H.; and Anaheim, Calif.) for inbound calls. Toll-free phone and FAX numbers simplify and speed up the ordering process. The toll-free technical support line currently handles almost 50 calls each day. Its commitment to selling quality products and providing speedy service has earned SPC numerous awards for quality from such customers as Texas Instruments, MCI, Abbott Laboratories and Loral Aerospace. As it enters its fourth decade in business, SPC continues to strive for a level of service unmatched in the industry. Call (800) 866-5353 to request a free SPC catalog.

Dalbani Corporation

4225 N.W. 72nd Ave.
Miami, FL 33166
1-800-325-2264
Fax: 305-594-6588

Dalbani Corporation is a national and international distributor of high quality electronics components and parts, servicing the wholesale, retail and manufacturing industry.

Since finding the parts you need should not be a major task, Dalbani Corporation maintains a huge stock of the most popular parts as well as those parts that are hard to find. Our extensive inventory of over 22,000 different items reflects our commitment to our customers, anticipating their needs and offering the lowest prices available for the best quality merchandise.

Dalbani Corporation also carries a

full line of coaxial tools, crimping tools, wire strippers, pliers, ratchet crimpers, computer maintenance tool kits, VCR service tool kits, along with soldering and desoldering tools.

Dalbani Corporation keeps customers informed of the latest introductions of new items by publishing two full-line catalogs per year including catalog supplements, seasonal brochures, and notifications of sales promotions and specials. The multi-lingual Sales Department coupled with the state-of-the-art computerized order processing, enables Dalbani Corporation to offer prompt and efficient service to benefit the customers:

Monday through Friday 9:00 a.m. to 7:00 p.m. East Coast Time. A toll-free number (1-800-DALBANI/1-800-325-2264) for the U.S.A. and Canada is available, in addition to a 24-hour fax line (Fax: 305-594-6588).

Dalbani Corporation offers many shipping options (UPS Red, Blue, Orange & Ground, FEDEX, etc.). Orders received by 3:00 p.m. Eastern Time are air freighted the same day, and most other orders are shipped within 24 hours. CODs, company checks and cash, and most major credit cards (Visa, Mastercard, Amex & Discover) are accepted. There is a \$20.00 minimum order.

Our Customer Service Department is available to help answer customers' product related questions during normal business hours.

Dalbani Corporation will meet your company's needs: Wholesale, retail and manufacturing. For more information and to receive a free full-line catalog, call toll-free 1-800-325-2264.

DALBANI

VCR ALIGNMENT TOOL KIT

- 7 Assorted head & guide aligners
- VCR Head puller
- Retaining ring remover
- Spring hook
- Micro screwdriver
- Hex key set
- Fitted vinyl
- Soft zippered case
- 3 Reversible screwdrivers
- (Small-Flat-Phillips)
- Dimensions: 9 1/2"(W) X 12 1/4"(L)



\$29.95

ONE YEAR
Made in Japan
WARRANTY

VCR HEADS



24-0150	GOLDSTAR	413050A	\$14.99
24-2550	JVC	PDM2008A	14.99
24-2550	JVC	PDM2008F5	14.99
24-1750	ORION	1590D00002	16.50
24-0775	PANASONIC	VEHS-0095	14.99
24-0800	PANASONIC	VEHS-0115	14.99
24-0900	PANASONIC	VEHS-0385/0191	14.99
24-1200	PANASONIC	VEHS-0077	28.00
24-1375	PANASONIC	VEHS-0146	28.00
24-2000	SAMSUNG	6900-370-011	14.99
24-2625	SHARP	DDRMU0004E10	35.00
24-2100	SONY	DRS84R	14.99
24-2300	TOSHIBA	70321991	14.99

4225 N.W. 72nd Ave. • Miami • Florida • 33166
Tel. : (305) 716-1016 • Fax : (305) 594-6588

Receive a free catalog with your first order

Call **1-800-325-2264**

SHIP UP TO 5 lb. FOR ONLY \$3.95 / 2nd DAY

\$20.00
MINIMUM ORDER

Prices are valid through June 30 / 95

We carry over 14,000 original I.C and Transistor in stock

SEMICONDUCTORS

29¢ Minimum 10 pieces per Item



Low Frequency Power Transistors

(AF driver, VCBO : 180V, 1.5A, 100 hFE)
BD-135 (PNP-Si) Repl. ECG : 373
BD-136 (NPN-Si) Repl. ECG : 374

(Voltage Regulators) Repl. ECG N°

7805 (Pos VR, 5V, 1A)	960
7806 (Pos VR, 6V, 1A)	962
7809 (Pos VR, 9V, 1A)	1910
7812 (Pos VR, 12V, 1A)	966
7818 (Pos VR, 18V, 1A)	958
7824 (Pos VR, 24V, 1A)	972
7905 (Neg VR, 5V, 1A)	961
7906 (Neg VR, 6V, 1A)	963
7912 (Neg VR, 12V, 1A)	967
7915 (Neg VR, 15V, 1A)	969
7918 (Neg VR, 18V, 1A)	959
7924 (Neg VR, 24V, 1A)	971



Up to **60% Off**
On all replacement

FLYBACK TRANSFORMERS

63-0425	CURTIS-MATIS	471-05200	\$19.00
63-0196	DEAWOO	DCF-1577	11.50
63-0286	EMERSON	04-321-4003	12.50
63-0189	GOLDSTAR	154-074R	12.50
63-460	GOLDSTAR	154-122E	11.99
62-850	HITACHI	243-4391	16.50
62-860	HITACHI	243-4401	13.99
62-490	PANASONIC	TLF-14617F	14.50
62-601	PANASONIC	TLF-14706F	19.95
63-0475	RCA (original)	1455864-501	19.95
63-0160	SAMSUNG	FCC-1414AL	11.50
63-0203	SAMSUNG	FCK-1414AL	11.50
63-810	SHARP	RTRNF-0003CEZZ	12.50
63-0126	SHARP	RTRNF-0011PED	12.50
63-840	SHARP	RTRNF-0015CEZZ	12.50
63-0112	SONY	1-439-254-13	12.50
63-0170	SONY	1-439-254-00	12.50
63-0113	SONY	1-439-273-00	15.99
63-0346	SONY	1-439-235-00	17.00
63-0346	SONY	1-439-235-11	17.00
63-0346	SONY	1-439-235-21	17.00

HOT PRICES ON POPULAR SEMI'S (Minimum 10 pieces per Item)

BU-208	\$1.49	2SD-1398	1.49	STK-4273	6.49
2N-3055	0.99	2SD-1426	1.69	STK-5481	7.99
2N-3773	1.49	2SD-1427	2.25	TA-7777	6.95
2SD-871	2.29	2SD-1650	1.69	TDA-2005	1.99

Circle (48) on Reply Card

★ ★ ★ SHOWCASE OF TOOLS & TOOL CASES ★ ★ ★

Jensen Tools

7815 South 46th Street
Phoenix, Arizona 85044-5399
Phone: 602-968-6231
Fax: 602-438-1690

In addition to over 100 tool kits developed for use in electronics, telecom, computer, facsimile, copier, fiber optics and many other areas. Jensen provides custom tool kit service to meet any individual need or application.

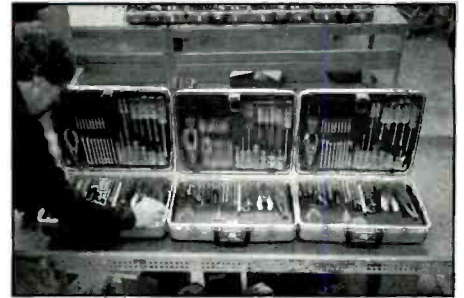

Jensen Tools Inc. is the foremost catalog supplier of tool kits and cases to the electronics industry. For more than 30 years, Jensen has been the leading source for these items plus tools, test instruments and other products and equipment needed by technicians & service personnel in electronics and communications.

Jensen Tools is part of Stanley Mail Media™, a division of The Stanley Works®. Stanley, founded over 150 years ago, is one of

the most recognized and trusted names for tools and hardware.

In addition to standard tools Jensen carries specialized and hard-to-find items, some of which are exclusive to this source. And all Jensen brand hand tools are guaranteed for life.

Jensen customer benefits include a full satisfaction guarantee, free technical support and free shipping to any location in the United States.

The company publishes and dis-

tributes full-color catalogs several times a year to customers and prospects in all 50 states, Canada, Central and South America, Great Britain and other countries around the world.

**For more information
and a free
Jensen Tools catalog,
call 800-426-1194 or
Fax your request to
800-366-9662.**

Your Best Source for Electronic Servicing Products

- Meters, Oscilloscopes & Other Test Equipment
- Wire & Cable ● Crimpers & Strippers
- Connectors ● Static Control Devices
- Solder/Desolder Tools ● Power & Hand Tools
- Tool Kits/Cases/Shipping Containers

Many major manufacturers represented: Stanley, Fluke, Tektronix, AMP, Xcelite, Weller, Wavetek, Harris-Dracon, 3M, and many, many more!

As a customer, you are always assured of the very best customer service, free shipping, prompt delivery, technical support and a lifetime guarantee on all Jensen hand tools.

For your free catalog: **Call: 800-426-1194**
Fax: 800-366-9662



JENSEN TOOLS INC.

7815 South 46th Street, Phoenix, Arizona 85044-5399
Phone: 602-968-6231 Fax: 602-438-1690



Andrews Electronics

P.O. Box 914, Santa Clarita, CA 91380-9014

800-289-0300 Fax: 800-289-0301

What is the most important quality that you as a servicer look for in a distributor? An extraordinary supply of parts on hand or superior service? By itself, either would be practically useless. Welcome to Andrews Electronics, the best of both worlds! We are the most well-stocked wholesale distributor of our kind, with over 250,000 line items in our warehouse and an average fill-rate of over 90%! Over an acre of floor space filled

with parts, all in one location, makes us the largest supplier in America for the majority of the manufacturers that we represent. In addition to being the foremost O.E.M. parts supplier in the country, we also carry many of the tools and supplies necessary to get the job done. Our newest addition is **Den-On Instruments**, manufacturer of the popular and portable SC-7000 desoldering and SMD removal tool. The line also includes

soldering equipment and the new SD-2000 SMD rework station. **Hoza** makes a wide variety of technical tools (Pliers, drivers, cutters, etc.), soldering and desoldering instruments, and tool kits (general or specific, such as the S-7000 VTR alignment tool kit). We also represent **Xcelite** (makers of almost every type, size, and shape of every technical tool imaginable). **Weller** (has the widest possible variety of soldering guns, stations, irons, tips, and accessories), and **GC** (tools, service aids, chemicals, and more!). In conjunction with all these tools, you'll find **Multicore** brand solder, **Solder-Wick** solder removal braid, and a full line of service chemicals from **Four Star**, **Zenith**, and **GC**! You now have even more reasons to make us your "one-stop shopping" distributor. Another outstanding reason is our service. Our dealer order desk has recently been expanded to an unbelievable **30 available sales representatives**! You now have a 99.9% chance of speaking to them rather than voice mail during office hours. We've built our reputation on a very simple philosophy...service. Not very fancy, but pretty effective. Our constant growth attests to it. You see, all of our policies that have been developed over the years have been based on that one simple thought: "How may we better serve the industry?" How about: 16 major brands to save you time, frustration, and money with "one-stop shopping."

Orders placed before 2:30 PST are routinely shipped the same day.

A freight program that offers free or discounted shipping.

No minimum orders and no handling charges. Automatic backorder reports with ETA's mailed bi-weekly.

A fast, highly-efficient research department, second to none.

A program that converts make/model/descriptions to part numbers instantly for the majority of research requests.

24-hour toll-free phone and fax order lines. Over 80 full-time employees waiting to serve your needs.

Our newest feature is an online system that allows select customers to directly access our computer! This program offers the widest possible range of servicing including:

Placing orders that are automatically prioritized and will accept multiple purchase order numbers, research, etc., Viewing previous orders, access to our model file, enabling customers to perform the majority of their research immediately.

Viewing backorders with eta's, part inquiry for pricing and availability that also provides information on substitutes and allows partial part numbers to be entered.

In case you've heard this elsewhere before, now's the time to let us prove it to you. By investing a mere two minutes of your time, you can discover what thousands of others have: that there is a difference. When you place your next order with your local supplier, check the availability of all the items. Then call or fax Andrews and check our stock levels. We believe you'll be pleasantly surprised! Wouldn't getting those extra units repaired a week or two sooner be good for your reputation? Sure it would! And we can help! After all is said and done, it is performance that counts. We know that your ability to perform your job depends on how well we perform ours. Our regular office hours are from 8:15 to 4:45 PST and we're closed for lunch between 12:00 and 12:30. When you think of electronic parts ... think of Andrews.

SAVE TIME, MONEY, AND FRUSTRATION WITH...

ONE-STOP SHOPPING!!!

There is **ONLY ONE** place to call!

PHONE: 800-289-0300 or FAX: 800-289-0301

WITH OVER 1/4 MILLION LINE ITEMS, ALL IN ONE LOCATION!

YOU WOULD HAVE ONLY:

- ◇ One purchase order to generate (no minimums) ◇ One invoice to pay
- ◇ One shipment to receive (averaging a 90+% fill-rate)
- ◇ One backorder report to reconcile
(automatically mailed bi-weekly with ETA's)

FACTORY AUTHORIZED FOR 16 MAJOR BRANDS!

SONY PANASONIC JVC
SHARP PROSCAN* AIWA
ZENITH QUASAR DELCO
TOSHIBA SCOTT HITACHI
TECHNICS RCA* EMERSON
GE*

We also offer: A **FREE** or **DISCOUNTED FREIGHT** program, **SAME DAY SHIPPING** for orders in by 2:30 P.M. (P.S.T.), **NO HANDLING CHARGES**, and the finest **RESEARCH** department anywhere!

FOR THE MOST PARTS AND THE FASTEST SERVICE...

COUNT ON  **andrews electronics**

P.O. Box 914, Santa Clarita, CA 91380-9014

INQUIRES: 805-257-7700 or FAX 805-295-5162

* PREMIER DISTRIBUTOR

Circle (22) on Reply Card

Hytec Dealer Services, Inc.

4548 Parkbreeze Ct.
 Orlando, FL 32808
 Phone: 800-883-1001 • 407-297-1001
 Fax: 407-297-4310

Hytec Dealer Services began operation in 1981 as a division of one of the largest office equipment dealers in the southeast U.S. After becoming an independent corporation in 1985, Hytec quickly established itself as the preeminent repair center in North America for office equipment circuit board repair on copiers, facsimiles, typewriters and laser printers.

Office equipment dealers and OEMs around the world recognize Hytec for its consistently high-quality repair work and its expertise in a variety of areas. Customer service has been a major focus since the earliest

days of Hytec. The business of circuit board repair requires quick response by the vendor and Hytec has maintained an adequate and attentive customer service staff to solve dealer problems that otherwise might have resulted in lost accounts.

Board repair services offered have expanded through the years to include CANON, SHARP, MINOLTA, RICOH, SAMSUNG and BROTHER office equipment, among many others. Many of Hytec's repair lines are offered through direct authorization by the OEM. Hytec remains the exclusive OEM authorized facility for sev-

eral equipment lines, including CANON MICROGRAPHICS, SHARP COPIERS, BROTHER TYPEWRITERS AND FACSIMILE and SAMSUNG FACSIMILE. New repair services are always being added and, for 1995, Hytec is pleased to announce the addition of board repair services for the Ricoh/Savin copier line.

Other services offered include a complete variety of technician tools and accessories. Complete tool kits and cases from Platt Case Co. and Howe Industries, meters from Wavetek and Fluke, service vacuums from 3M and assorted other accessories allow individual technicians and service departments to utilize Hytec as a true "one-stop" shop for their service needs.

A complete catalog featuring all of Hytec's products and services is available free of charge by calling a Hytec account rep at 800-883-1001.

NORTH AMERICA'S LARGEST AUTHORIZED

Office Equipment & Circuit Board Repair Center

**COMPLETE
MACHINE REPAIR**

Facsimiles	Laser Printers
Personal Copiers	Typewriters

- ▶ FAST TURNAROUND
- ▶ GENUINE OEM PARTS
- ▶ FACTORY AUTHORIZED
- ▶ BEST PRICING AND QUALITY
- ▶ COMPONENT LEVEL REPAIR

THERMAL FAX REPAIR ONLY \$35.00 (Plus Parts)

**QUALITY
SERVICE PRODUCTS**

THE HYTEC STANDARD TOOL KIT

Choice of two case styles -
6" deep Polyethylene hard case with 2 pallets
or
5 1/2" deep large zippered case

~~\$199.00~~
\$129.00

(Add \$36.00 for hard case pictured)

MENTION THIS AD FOR A 5% DISCOUNT

4548 Parkbreeze Ct. Orlando, FL 32808
800-883-1001 Fax: 407-297-4310

CALL FOR OUR LATEST CATALOG
AND REPAIR LISTINGS -

1-800-883-1001



Poway, CA 92064-6810
Phone: (800)779-8170
Fax: (800) 779-8171

Time Motion Tools provides one-stop shopping for all your hi-tech electronic needs. For over 30 years, we have met the field service needs of electronics and communications professionals in the United States and abroad. Our catalog features Custom Tool Kits, Test Equipment, Voice and Data Communications, Lan Equipment, Telecommunications and Computer Equipment, ESD Products, Maintenance and Repair Tools, and Shipping Containers.

Specializing in custom tool kits designed to your individual needs, **Time Motion Tools** offers a diverse selection of quality kits and cases

ideal for working on a wide range of equipment. Save valuable time, effort and money by allowing **Time Motion Tools** to build your personalized tool kit. Call our toll-free number today. Our friendly order desk is open from 6 AM- 4:30 PM Pacific time.

Time Motion Tools also provides a full line of test and communications equipment from such reputable manufactures as Fluke, Extech, Amp, Harris-Dracon, Wavetek, Goldstar, and many more. **Time Motion Tools** is committed to providing you with the highest quality products along with unmatched



customer service. Quality and conformance to your requirements is a known fact with us. Call today for your free full-color catalog! (800) 779-8170.

For a complete product listing call (800) 779-8170 and ask for your free Time Motion Tools 1995 master catalog.



Quality Field Service Tools And Tool Kits

- ▶ FAST FRIENDLY SERVICE
- ▶ SAME DAY SHIPMENT
- ▶ TEST & REPAIR SOLUTIONS



12778 Brookprinter Place • Poway, CA • 92064
 Phone: (800) 779-8170 or Fax: (800) 779-8171
New Customer Service Hotline: (800) TMT-0303



Successful Servicing

Diversity and specialization is survival at certified radio

By Ron C. Johnson

We all know that in the consumer electronics servicing industry the expression "survival of the fittest" is not just an empty cliché. And nowhere is this more true than in Edmonton, Alberta, Canada. In Edmonton, like everywhere else, the face of business is changing, especially in the electronics field. Servicing businesses have had to innovate to survive.

Edmonton, with a population of about eight hundred thousand people, is the capital city of the province of Alberta and serves a large geographical area. Alberta is noted for its oil and gas production as well as its lumber, pulp and paper, petrochemicals and farming. Also noteworthy is the climate, with warm summers and relatively long, cold winters.

Certified Radio, the focus of this article, has two locations in Edmonton and has been in business since 1948. Certified started out in two-way radio sales but eventually moved into automotive radio and stereo sales and service. For a number of years, its bread and butter has been service to Ford, GM and Chrysler auto stereos and radios. The company has grown to over fifty employees, with a service department of seven technicians.

Diversification

Today Certified is diversified. They repair VCRs, televisions, car stereos, camcorders, microwaves and other consumer electronics products, while also branching out into a variety of other areas.

"We do all kinds of service work, but it's getting more and more difficult to make it pay," says Murray Cusack, Certified Radio's service manager. "We've been doing automotive radios for years, including installations. We eventually got into other aspects of vehicle electrical systems like power locks and windows, cruise control installations and repair, and even the in-dash electronics."

Certified's showroom bears testimony to the diversity of the products they sell and service. Custom speaker boxes for high end custom stereo systems, power antennas, radar detectors, security systems and a device that helps out during the long, cold winters: remote car starters.

"The remote starters are a popular item these days," says Cusack. "They allow you to start your vehicle while you're still indoors and have it warmed up by the time you go outside."

In a climate where winter can last from the end of October until March, the convenience of a remote starter is worth the price tag for many customers.

"Remote starters are great in the summer too," Cusack says.

"They will start the vehicle and turn on the air conditioner to cool down the vehicle before you get in."

Johnson is a journeyman electronics servicing technician and an instructor of technology at the Northern Alberta Institute of Technology in Edmonton, Alberta, Canada.



Figure 1. Certified Radio started out in two-way radio sales, but has expanded into other sales and service.

And speaking of air conditioning, Certified services vehicle air conditioning systems as well. With fourteen installer/service personnel on staff between two locations and a total of seven automotive bays, they can put through a lot of vehicles on a good day. In addition to their service and installation, Certified Radio has several other departments designed to provide a well rounded set of services to the customer. They now retail pagers, cellular radios, trunk racks, and mobile public address systems. Another division wholesales many installation parts and materials to other similar companies, especially smaller operations in remote centers around the province. Their home and business automation and security division custom designs, sells and installs security systems.

Overcoming problems

Despite all this variety, service still remains an important part of their business. Cusack explained some of the problems they have confronted in service and how they manage to overcome them.

"Today it's really difficult to make service pay," says Cusack.

"It used to be that there were a lot of service centers and a lot of guys who were trained, but not to the level that they have to be trained now. Now you have to have an incredibly skilled person to be able to service products economically and to make it worthwhile for the customer to pay for it."

Certified Radio prints fliers that list the types of service they do, including an offer to service VCR's for \$49.95 plus parts.

"These days you can buy a new VCR for under \$200," says Cusack, "so it makes it hard to repair one inexpensively enough



Figure 2. Certified Radio's bread and butter has been auto radio and stereo service.

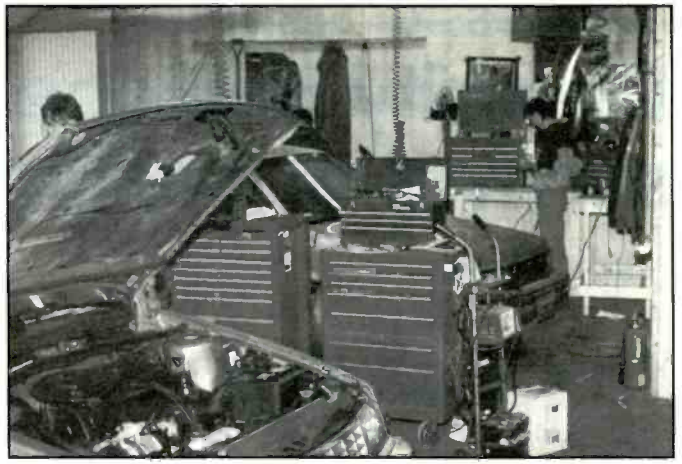

Figure 4. Certified Radio has even branched into auto air conditioning service.



Figure 3. In Edmonton, Alberta, Canada, the winters are long and cold. Certified Radio sells and installs a lot of remote starters for people who want their cars to be warm when they get in.

to make any money on it. If you spend more than an hour or so on the repair it isn't worth it. We've had to put the technicians on piece work for the last several years so the guys that work fast can make more money and we can make a profit on repairs too. We also get the technicians more involved in finding their own parts rather than having someone doing that full time."

Servicing in Edmonton has some unique problems that come with the climate. Not only are the winters cold, (temperatures sometimes dip as low as -40F), but they are dry as well.

"Because it is colder there's less humidity," says Cusack. "That causes more static. You get lots of extra repairs because people walk across the carpet and touch their stereo, a spark jumps, and that damages the circuitry. We used to get lots of calls to service products for electrostatic discharge problems. We still do but with everything using remotes now, that's reduced the problem."

An organized service center

Certified's service center is well organized by most standards. Behind the front counter, a staging area contains customers' equipment stacked on shelves waiting for repair, waiting for

pick-up, or waiting for parts. Upstairs, near the actual service area, a library of manuals and service literature is organized near the parts department. The availability of parts and service literature is another problem area in servicing these products.

"When it comes to repairing, this isn't like the automotive industry," says Cusack. "They (the consumer electronics service field) don't have a very good parts inventory control system available. And there are getting to be so many different machines. You can't keep up with the documentation. Besides that, when you do order parts, you don't know what to tell the customer about delivery. Suppliers won't tell you when the parts will come in. They don't know themselves."

So how does a company like Certified manage to keep on doing service?

Specialization with generalization

"Well, it's becoming a very difficult business to make money at," according to Cusack. "The pricing of stereo products has come down so much everybody is looking for the lowest price. Also, parts are hard to find. There are so few stocking parts distributors, even for the brand names. And yet Certified Radio seems to be successfully coping with these challenges. Cusack comments on their approach to business.

"We have had several people involved in the company and each one has an area of specialty, but we can all move around and do different things too. As a company, we specialize in the kind of electronic consumer item that has to be installed in vehicles, but can't be done by the average do-it-yourselfer or the local garages or car dealers because their rates are too high. Also, the mass market stores don't have the people or expertise to do the work efficiently."

Find a niche, do it better

So what is the key to a successful future for companies like Certified Radio? Judging by their history, it would appear that the ability to adapt to current market trends is one important ingredient. Another is to keep looking for ways to be efficient. But perhaps the most important, the one that Certified Radio seems to have proven over almost forty years, is to work hard at finding a profitable niche and attempting to do it better than anyone else. ■

What Do You Know About Electronics?

Motor speed control

By Sam Wilson

Correction of an error

Last month, I made up a problem to demonstrate the importance of noise voltage. After I made the calculation with the numbers I made up, I felt the value of the noise voltage was too low to demonstrate the point I wanted to make. I began changing values and reworking the problem. I was focusing on the problem instead of the reason for the problem!

The reason for the problem was to demonstrate the importance of noise voltage. After I got the value of noise voltage I wanted, I forgot to go back and change the values in the problem. The calculation was correct. The problem stated in the article was wrong, because it did not have the values shown in the calculation.

By the time I realized what I had done it was too late to make the change in the article. I decided to do the logical thing and blame Norma. For a week I got very small portions at mealtime. (And people keep asking me how I lost so much weight!)

Noise vs bandwidth

The noise problem in last month's WDYK, demonstrated that a wide band

Wilson is the electronics theory consultant for ES&T.

of frequencies results in a higher noise voltage than a narrow band of frequencies. That is a correct interpretation, but, in the calculation the bandwidth is *not* the range of frequencies between the half power points. Instead, it is the range of frequencies between points where the amplitude is constant, or, very nearly constant. That is a small difference in most applications but it should be noted.

Radio Shack?

I got a very professional letter from a teacher in Georgia. One of his students bought an infrared detector at Radio Shack. It changes color when exposed to IR light. The student would like to know how it works. So would the instructor. So would I. If any reader can help, please jump in. I'm hoping to hear from you.

Examples of motor controls

I searched through my files for motor controls and came up with a few for you to look at. You will remember that control of the *speed* of a permanent magnet (PM) dc motor is accomplished by controlling the *voltage* across the motor armature. So, automatic speed controls are

usually voltage regulators. The relationship between speed and armature current is not just for PM motors. It also applies to shunt motors if the shunt current is constant. So, you control the speed of the PM motor by controlling the voltage across the armature, and letting the current fall where it may. If you use a voltage-regulated power supply you will get a constant-speed motor. As always, you must be careful not to exceed manufacturer's specifications. If you want to control the *torque* or *output horsepower* of a PM motor, you need to control the *current* delivered to the motor armature. In that case, you are not concerned with the voltage across the motor.

Speed and torque of a dc motor are tradeoffs. That is illustrated by the graph in Figure 1. Observe that the highest torque occurs with the lowest speed. That is one reason why industry uses dc motors in many of their systems. It is hard to get an ac motor that will deliver high torque at low speed if it is the same size as a corresponding dc motor. If the requirement is high torque and low speed, and the logical power source is ac, the designer may resort to the use of gears or belts. If you have ever had to change the speed on a

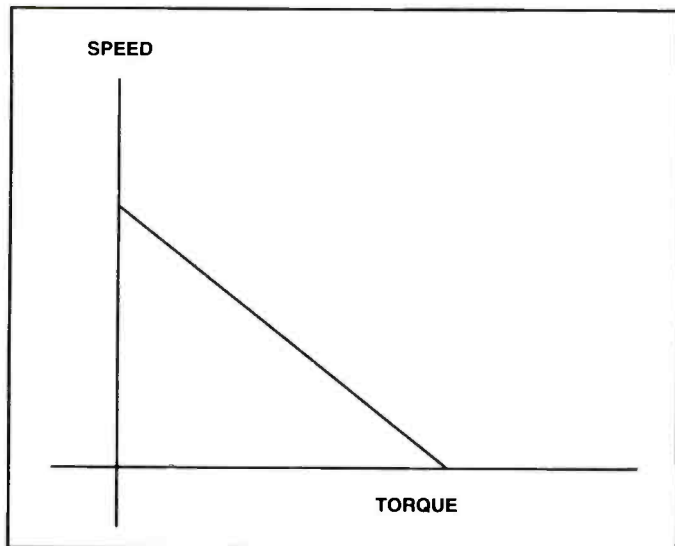

Figure 1. Speed and torque of a dc motor are tradeoffs. The highest torque occurs with the lowest speed.

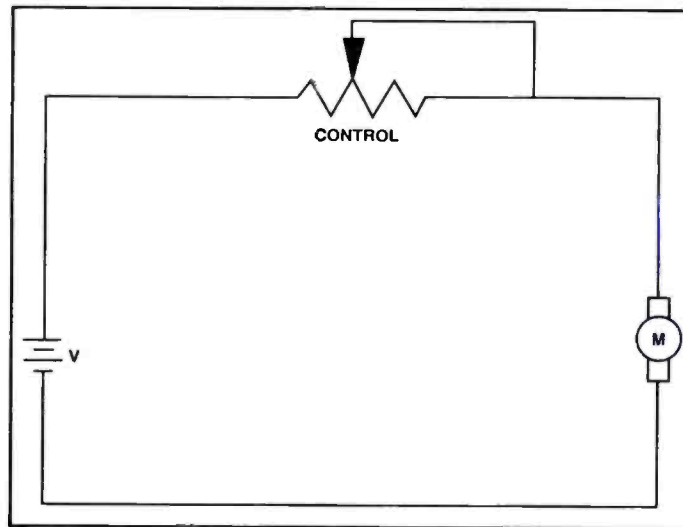

Figure 2. A simple open-circuit motor torque control; also called a manual control. Since a rheostat is used it is obvious that the current, and therefore the torque, is being controlled.

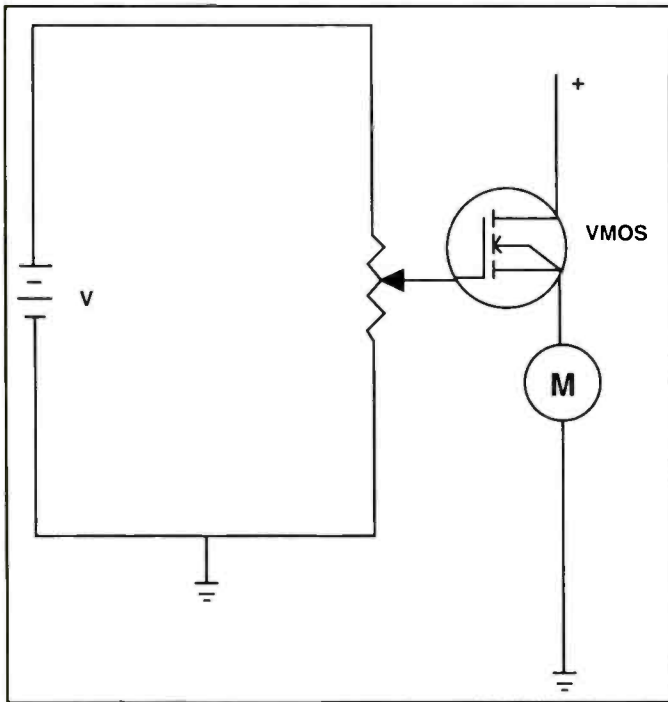

Figure 3. This is a more efficient open-loop system, using a power amplifier to control the current to the motor. The power VMOS transistor controls the source-to-drain current using voltage rather than current.

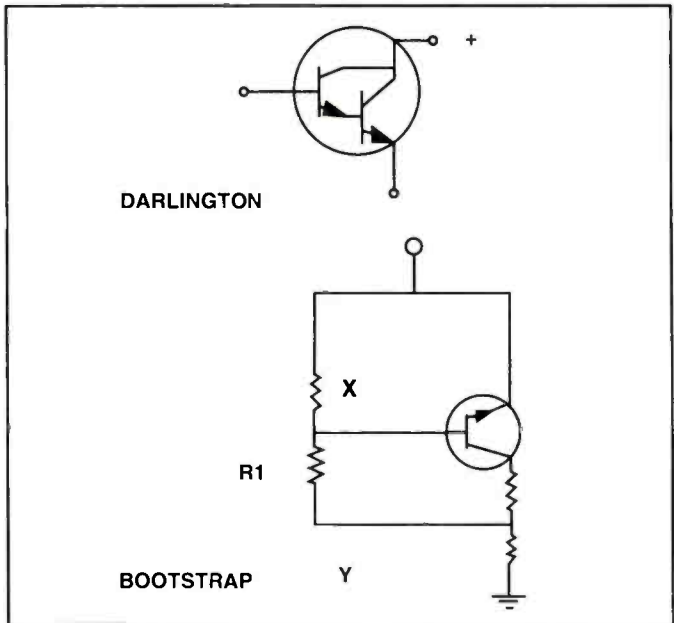

Figure 4. Some bipolar transistor circuits are designed to minimize the amount of input power needed to control current. The Darlington amplifier, also called a beta-squared amplifier, controls the power delivered by Q2 by using an amplifier to deliver its base current. The bootstrap circuit delivers a feedback voltage in sync with the input signal. Not much current is flowing through R1.

drill press that operates with an ac motor, you most likely changed a belt from one pulley to another.

Open loop torque (and horsepower) controls

In this discussion, I am limiting the controls to those used for low-horsepower applications. Very large motors require additional starting circuitry. That is because the armature current can become very high at startup. That high current occurs because there is no counter voltage developed in the armature to limit current when the motor armature is not turning. The starting circuit allows the operator to start the motor slowly, and run it up to speed. Figure 2 shows a simple open-circuit motor torque control. It is also called a manual control. Since a rheostat is used it is obvious that the current, and therefore the torque, is being controlled (remember, rheostats control current and potentiometers control voltage).

Of course, if the motor is under mechanical load, an increase in torque there will produce a corresponding change in the speed of the motor. However, you are controlling current because you want to control torque and output power—not speed. Since torque is your main interest in this application, you do not concern yourself with speed.

The type of control used is always a matter of what you want the motor to do. The rheostat control wastes power in heating the resistor. That is power the motor doesn't get. If power loss is not a primary concern the rheostat control does very well.

A more efficient system

A more efficient open-loop system, uses a power amplifier to control the current to the motor. The example shown in Figure 3 uses a power VMOS transistor for control. It is ideal because the gate uses voltage, not current, to control the source-to-drain current. Any device that needs current to control current, such as a bipolar transistor, requires input power, and that is power wasted in the system.

Having said that, I want to explain that there are bipolar transistor circuits designed to minimize the amount of input power needed to control current. Two examples are shown in Figure 4. The Darlington amplifier is also called a beta-squared amplifier. It controls the power delivered by Q2 by using an amplifier to deliver its base current. The bootstrap circuit delivers a feedback voltage in sync with the input signal. Since the voltage at points X and Y are nearly the same, there is not much current flowing through R1. If you have an input voltage (at X) that

does not produce a corresponding large current, it follows that the signal is looking at a high impedance. Either of the circuits in Figure 4 can be used for efficient motor torque control. The power control shown in Figure 3 was also used with vacuum tubes for the same reason. In fact, the characteristics of those two circuits are exactly the same.

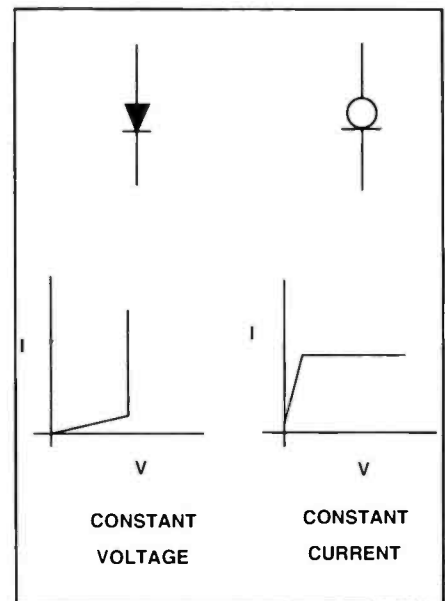

Figure 5. A constant-current supply can be used to regulate motor torque. The control device is a power amplifier (Q1). Forward bias for Q1 is obtained by the current through R1.

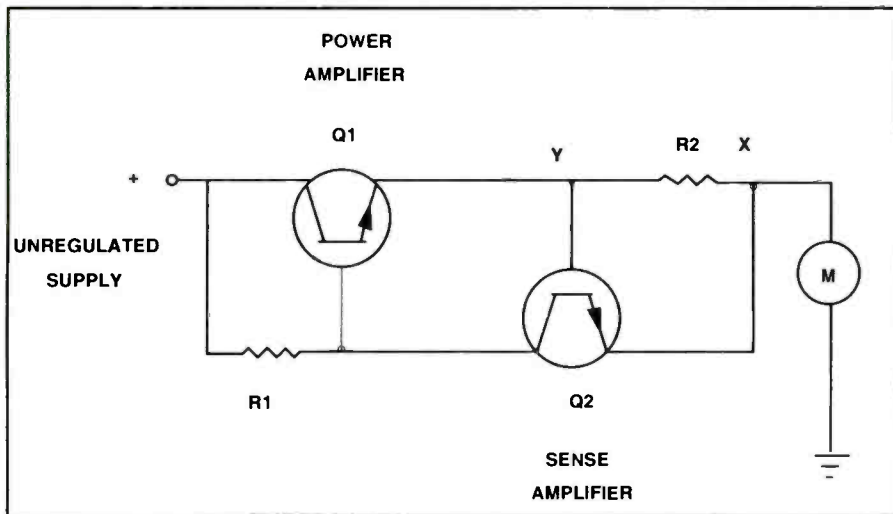

Figure 6. This is a more elaborate constant-current control. The motor armature current is sensed by a series resistor. The output of the sense resistor is a voltage that is compared with a dc torque voltage control.

The open-loop controls shown in Figures 3 and 4, do not use feedback circuitry to maintain a constant armature current at a constant value. A change in the mechanical load, therefore, will cause the amount of torque delivered by the motor to change. Constant-current power supplies in Figure 5 shows a constant-current

diode compared with a constant voltage (zener) diode.

These very simple devices are not normally used by themselves to control motor speed or torque because the amount of power they can handle is limited. However, they are commonly used as references in regulated supplies. Neither of

the diode circuits is capable of producing tight regulation. In power supply speak, the expression for tight regulation is "stiff regulation".

Figure 6 shows an example of a constant-current supply that can be used to regulate motor torque. As you might expect, the control device is a power amplifier (Q1). Forward bias for Q1 is obtained by the current through R1. Transistor Q2 controls most of the current through R1. Base bias for Q2 is obtained by the voltage divider comprised of Q1 and R2.

Suppose the current through the load resistance, R_L , starts to increase. That makes point Y more positive with respect to point X, so Q2 conducts harder through R1. The base voltage (and current) of the power amplifier is lowered and the conduction through Q1 decreases back to where it belongs. The opposite action occurs if the current through the load resistance starts to decrease. The voltage across R_L is not a factor in this constant-current regulator.

A more elaborate control

Figure 7 shows a more elaborate constant-current control. The motor armature current is sensed by a series resistor. The output of the sense resistor is a voltage that is compared with a dc torque voltage control. That voltage can be obtained with a variable resistor that allows the operator to control the motor torque. It can also be obtained from a stable voltage reference. In either case, the output of the summing amplifier will be a voltage that compares the sense voltage with a reference voltage. The output of the sense amplifier controls a voltage amplifier, and the output of that voltage amplifier is delivered to a power amplifier. The current through the power amplifier is also the current through the armature.

Observe that the armature current and motor torque, are actually controlled by a closed-loop voltage control. The difference between this circuit and a voltage-regulated circuit, is that a power amplifier is used to deliver the controlling current. Closed-loop voltage regulators do not use an output power amplifier. In the next issue we will look at some speed controls, and if space permits we will get into stepping motors. From this point we will concentrate more on circuitry. However, it will be necessary to discuss the true theory of operation for stepping motors. ■

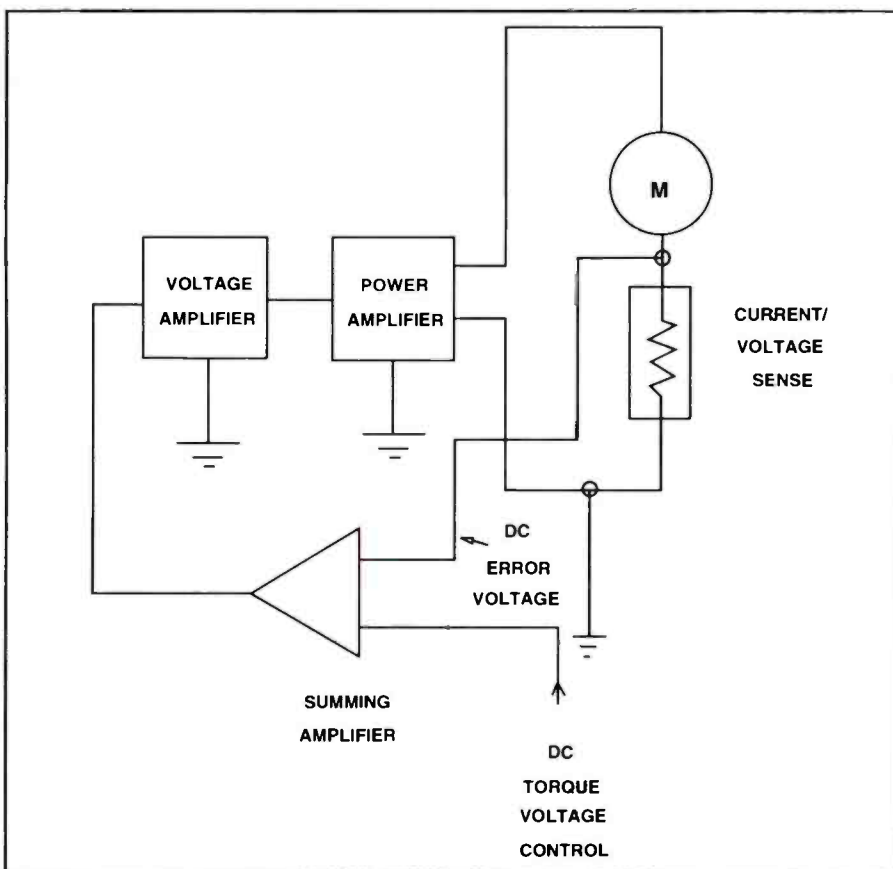
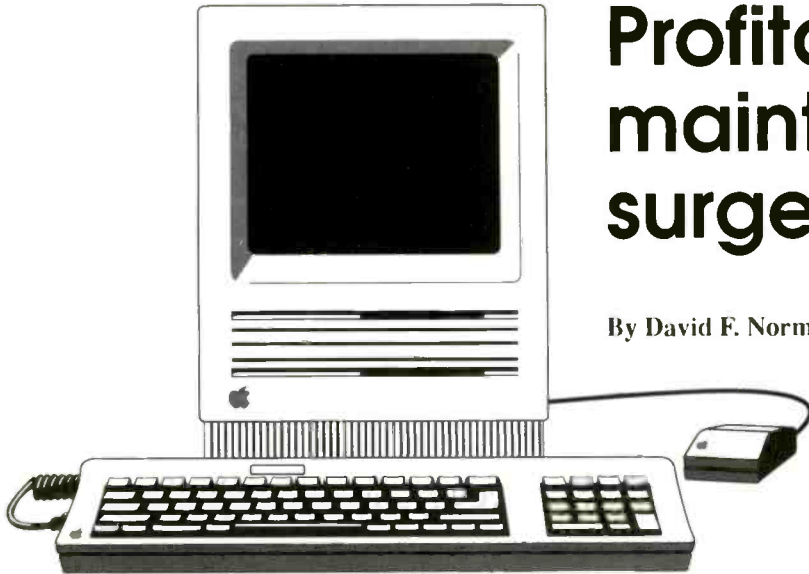

Figure 7. This is a more elaborate constant-current control. The motor armature current is sensed by a series resistor. The output of the sense resistor is a voltage that is compared with a dc torque voltage control.



Profitable preventive maintenance and surge protection

By David F. Norman

Everyone knows that new computers are obsolete before you can get them unpacked, hence, preventive maintenance on personal computers is often neglected. That's a shame. Servicing technicians often miss easy lucrative work by not asking for customers' computer maintenance. A well maintained computer causes the user fewer problems, and produces a better output than a neglected computer. In most cases the work involved in computer maintenance is much easier than cleaning VCR heads and pays about the same.

Preventive maintenance is also an excellent opportunity to sell simple accessories. Anything that you can do to help your customer stay up and running enhances your reputation as a servicing facility, interested in service; a situation so rare nowadays that it is almost always appreciated. Here is a step-by-step procedure to get you started.

Following a preventive maintenance routine

First, and always, be certain that the customer has a recent backup of all critical files. A full backup is great, but the important thing is to protect irreplaceable files. The next step is to power down the unit and remove the cover. Use the same type of vacuum cleaner you would use for other electronics gear. Remove all dust

and look for droppings that might be from mice or roaches, and other signs of varmint burglary. If pests can get into a computer, they will, and they can definitely cause damage. They leave their little corrosive sign all over the PCB. If you see signs of such an entry, close up any holes by using proper slot covers or duct tape. Don't cover any ventilation openings though, you'll do more harm than good.

Clean connections, heads

Using grounding procedures, carefully remove and replace each adapter card several times. This helps insure clean connections. Avoid touching the plated contacts. After each card has been worked carefully a few times, re-install all cards and tighten them down. Replace any missing screws. The subtle vibration in a computer can loosen connections over several months or years. Use a wet-type floppy cleaning disk and clean each drive at least twice. If the customer has had problems reading known good disks on a particular drive, you may have to get more aggressive.

Most floppy drives have three tiny screws which hold a cover in place over the movable heads. If a drive persists in not reading known good disks, remove the offending drive's cover plate. This will expose the head and its rails to view. Insert the cleaning disk and carefully move the head manually over its full limit of travel. As you move the head add a fin-

gertip's pressure to the head slightly pressing the heads into the cleaning disk. Repeat this procedure a couple of times. Give the drive a few seconds to evaporate the chemical cleaner and try to read a disk again. If you are successful, button the drive up and move on.

If your cleaning efforts are not successful, you have two options. Either replace the drive with a new drive, or remove it for disassembly and bench cleaning. In most cases replacement is the most economical route to take. The customer may have an unused drive—especially in a networked system—that you can swap for the defective drive. Reconnect everything and power the system up to make certain it is working as it was before you started. Now comes the interesting part.

Defragmenting the hard drive

Few computer users regularly check and defragment their hard disks. This can mean a lot of scattered files adversely affecting disk access. Using Norton Utilities or the Defrag program included with DOS 6.xx, run a full disk optimization on each hard disk in the computer. This can take an hour or more, so start it and move to the next computer. Take pains to insure that power is not accidentally interrupted during the disk optimization process. With some defragmenters, data is lost if power is interrupted. Connecting the computer via a UPS (Uninterruptible Power Supply) during defragmentation is a good

Norman is an independent servicing technician and a computer and security consultant.

way to preclude this type of data loss.

If your customer does not have his system protected by a UPS on each computer, this is a perfect opportunity to demonstrate the benefits of emergency power. Just don't do it on a unit engaged in a critical operation such as optimization. If the battery happens to be down or something is not connected right, you'll look bad.

Printer maintenance

After each unit is cleaned and optimized, you can move on to the customer's printer(s). In most cases merely remove the dust and spilled toner, lightly lube the rails on a dot matrix, clean the corona wires on a laser printer and you are done. If the customer is running a network, power down the system and remove, tighten and replace network cable connectors. Power up the system, check to see that everything is sanitary, and look to see that each computer and each telephone line connected to a computer is surge protected.

Surge protection

Basically there are two sources of power surges; defined as a condition such that line voltage exceeds a safe level for the equipment. If a system is close to an operation with large electric motors, the voltage of the power line supplying that system may exceed safe levels when the motors are kicked off. At the instant of power removal, large electric motors can act for a few milliseconds as generators due to hysteresis or energy stored in the motor's windings.

The farther the computer system is from the power lines supplying the motors the less pronounced the effect will be. One place to expect this problem is in an office attached to a machine shop. This surge is very different from the brownout or lowered voltage caused by motors starting. A UPS can protect against brownout, which can cause loss of data. Seldom is there physical damage to a computer.

The other major cause of power surges is lightning—sometimes miles away. If your service area is subject to lightning strikes, your customer needs something more than a dime store surge protector.

Inexpensive protectors

Inexpensive surge protectors work by

clamping voltage at a preset level. A solid state device shorts the over-voltage to ground. Then you throw the surge protector away and replace it with another. At \$6.00 to \$20.00, the price is cheap, right? Wrong.

Most inexpensive surge protectors trip too slow and at too high a voltage. By the time the surge is shunted, the damage has been done. Most protectors of this type do not react until voltage is several hundred volts—far too late to save most electronic equipment. There is another choice.

Higher quality protection

Most better UPS, provide solid state switching to block surges in a nanosecond or two. Others do not. Also subject to lightning are telephone lines, which most UPS and surge protectors do not protect. Remember this. Unless every line coming into a system is protected against over-voltage, nothing is protected. Each computer could be fully protected and if one phone line is not protected, guess where the over-voltage will enter the system. Panamax, of San Rafael, CA, manufactures a complete line of active surge suppression equipment. This is not the only such company but it is one with which I have personal experience. A year or so ago, my father in Central Florida replaced his third television set in as many years. This time the dealer suggested the product to prevent further losses. The salesman told my father about the equipment guarantee which comes with the unit. Stated simply, the guarantee covers not only the protector, but all equipment properly connected to the protector. The conditions are simple and reasonable and, frankly, sound too good to be true.

After installing the unit on his entertainment system, my father soon decided that he had a bargain. Over the next two weeks, the protector switched off the system several times, usually before anyone was aware that lightning was even close.

At the time, I was living in the South Plains of Texas, a place also noted for thunderstorms. I contacted the company and received a unit designed for computer systems and including two-line telephone protection. This unit comes with four ac outlets and a two-line telephone inlet and outlet. I made certain that every-thing in my network lab—three comput-

ers, two modems, and a laser printer were protected.

We left Texas soon after and I never had a chance to see the protector do its thing until lately in Bakersfield, CA, where I now reside. During the past Christmas season, my protector tripped three times: once when the power flickered brightly and went out, and; twice more when there was no indication of power anomaly.

Another neat thing about this system is that it kicks off on low voltage as well. If you use both a UPS and the circuit protector connected ahead of the UPS, it is hard to lose either data or equipment. Most UPS can use a little extra protection. Low voltage is not very likely to damage a PC but it can wreak havoc in high-voltage circuits in laser printers and monitors. ■

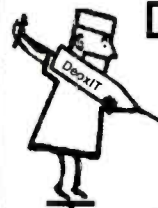

Is there a long lasting solution for improving the performance and reliability of switches and connectors?

See DeoxIT on page 67

ISCET VCR

Cross Reference

VCR Model Number Cross Reference
and VCR Parts Cross Reference

5th Edition. Contains both model- and parts- number cross references for more than 1,700 models and almost 5,000 parts. **\$29.95**
Plus shipping \$3.00

One 3 1/2" disk, or
 Two 5 1/4" discs.
Version 6.0, for IBM PC AT/XT or compatibles. Requires hard drive and DOS 2.1 or greater **\$69.95**
Plus shipping \$3.00

Special Combo Offer.
Your choice of discs, plus 5th Edition VCR Cross Reference. **\$95.00**
Plus shipping \$3.00

Allow 4-5 weeks delivery when using personal checks or VISA and MasterCard. Money orders and cashiers checks processed immediately.

Amount _____ VISA MasterCard
Card No. _____ Exp. _____
Name _____
Business _____
Address _____
City _____ State _____ Zip _____
Phone _____ Member ISCET NESDA

Texas residents multiply dollar value x 7 1/4% for taxes.
Foreign shipments please add international postage.
Send ISCET, 2708 W. Berry St., Ft. Worth TX 76109

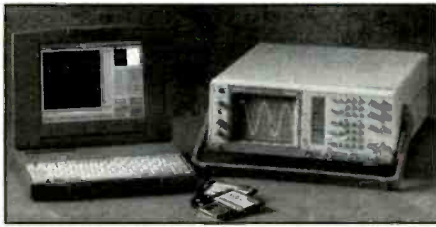

Optional interfaces

Fluke corporation offers optional interfaces for its CombiScope series of oscilloscopes, a combination of a digital storage oscilloscope (DSO) with built-in analog scope.

The 60 MHz PM 3335 is now available with an optional bi-directional RS-232-C interface for hard-copy output and remote control. A second low-cost option is the RS-232-C interface in combination with the company's AnyWave 2.0 software package and a serial communication cable.

Circle (65) on Reply Card

MicroFinish slotted screwdrivers

Willi Hahn Corporation, introduces a new range of screwdrivers. Screwdriver handles have a positive gripping "non slip

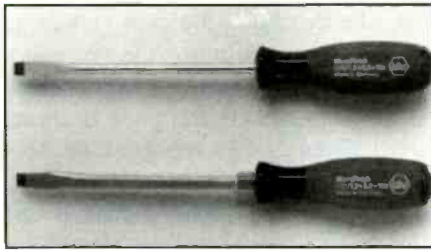

surface" which improves power transmission and allows maximum force and comfort even with dry, oily or wet hands.

The handles are made from cellulose acetate. Which eliminates the risk of sharp/foreign objects becoming embedded in the handle as can happen with soft rubber two component handles. The handles are impact resistant, oil and grease resistant, cadmium free, and have good insulating properties.

These screwdrivers feature chrome-vanadium-molybdenum hardened and tempered tool steel blades for exceptional tool life, wear resistance and high torque performance (RC58-60).

Circle (66) on Reply Card

Dual time-base scope with cursors and readouts

B+K's Model 2260 oscilloscope offers cursors and readouts, 60MHz bandwidth, 1mV per division vertical sensitivity, V-mode triggering for viewing two signals unrelated in frequency, main and delayed time bases and a built-in component tester for testing resistors, capacitors, coils, diodes, and a wide variety of other semi-conductors and components.

Digital readouts display volts per division (either channel), seconds per division, and important operating mode information such as ADD, UNCALibrated, Probe Attenuation, MAGnification, Delay Mode, Delay Time, Component Test, and XY

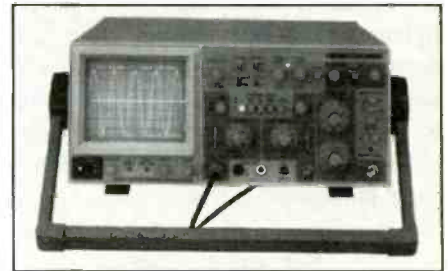

PROMPT® Publications *ff* Howard W. Sams *ff* PROMPT® Publications

ONE IS BASIC

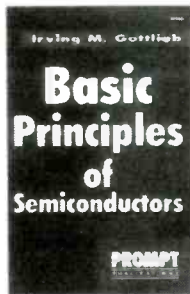

Basic Principles of Semiconductors

by Irving M. Gottlieb

Provides an excellent introduction and reference into the fundamentals of semiconductors.

\$14.95

Paper/161 pp/6 x 9/Illustrated
ISBN#: 0-7906-1066-3

ONE IS ADVANCED

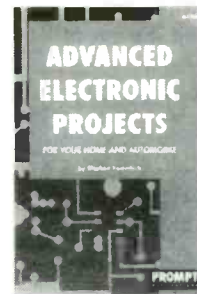

Advanced Electronic Projects

by Stephen Kamichik

Gain valuable experience by building these advanced projects for your car and home.

\$18.95

Paper/160 pp/6 x 9/Illustrated
ISBN#: 0-7906-1065-5

WHICH ARE YOU

Your Information Source

800-428-7267

for the Electronics Industry

Call now for the name of your

nearest PROMPT® distributor.

Mode. Cursors measure voltage differences, time differences, and frequency.

The user can select from 23 calibrated sweep time ranges on the main time base and 19 calibrated ranges on the delayed-sweep time base. Each sweep time range is fully adjustable between calibrated ranges. A X10 magnifier is provided to allow closer examination of waveforms, while maintaining display calibration.

Other features include front panel x-y operation, z-axis input, variable holdoff, channel 1 output on the rear panel (e.g., for input to a frequency counter), signal delay line, beam finder, single sweep operation, and a bright CRT with illuminated internal graticule.

The oscilloscope comes complete with two new 10:1 probes, instruction manual and schematic diagram.

Circle (67) on Reply Card

Heavy duty multimeter Works without batteries

Extech's heavy duty "No-Bat" multimeter is powered by a custom capacitor charged by applying its tests leads to an ac or dc source. The meter measures ac (2 to 750V), dc (200mV to 1000V), ac/dc

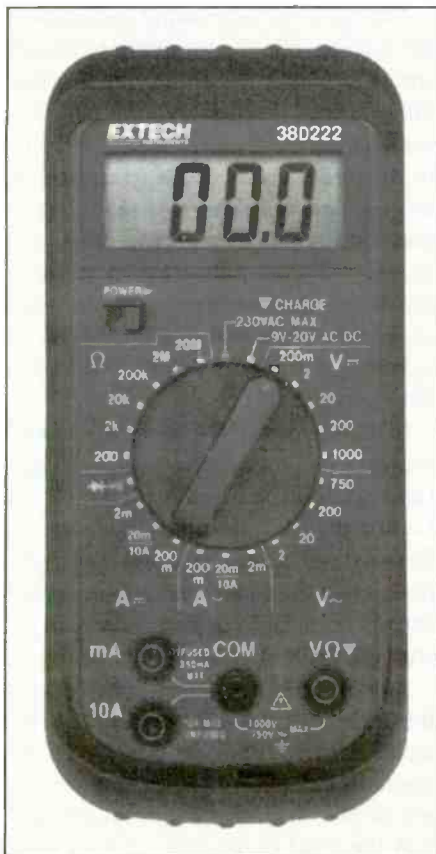

Circle (69) on Reply Card

current (2mA to 10A), and resistance (200Ω to 20MΩ) and includes audible continuity and 1mA diode test. The meter operates for more than two hours after a three minute charge. "Low Battery" and "Full Charge" indication keeps user fully informed.

Circle (68) on Reply Card

Computer monitor signal generator

Sencore's new model CM125 "Pix Pak" Computer Monitor Signal Generator is an easy-to-use, programmable, portable, RGB generator.



The generator is a fully programmable scan frequency and pixel resolution RGB generator with video bandwidth to 125 MHz and 2048 x 2048 pixel resolution. The unit is compatible with TTL, analog, and ECL video types and has 100 monitor setup memory locations (43 preprogrammed for flexible testing and fast setup. Plus, the outputs are completely protected to prevent damage from defective computer monitors-preventing costly downtime.

A complete set of video patterns helps simplify computer monitor testing and troubleshooting. The product provides patterns that dynamically test the operation of a computer monitor while exposing monitor defects that point toward the faulty circuits. A special pattern sequence feature allows automatic cycling of the video patterns several times a minute to prevent phosphor burns during burn-in testing. The user can effectively test the new power management systems (green monitors) by simulating the monitor's step-by-step shutdown action.

[Continued from page 65]

CONTACT CLEANERS ARE NOT CREATED EQUAL

DeoxIT™

- Improves Conductivity
- Reduces Noise & Distortion
- Deoxidizes, Cleans & Protects
- Reduces Intermittents
- Reduces RFI, Wear & Abrasion

Even the finest equipment cannot guarantee noise-free operation. One "dirty" connection anywhere in the signal path can cause unwanted noise, distortion and signal loss. Considering the hundreds (if not thousands) of connections in electronic equipment today, it's only a matter of time before they begin to fail.

Use what the Manufacturers Use!



Available in Environmentally-Safe Spray, Wipes, Pen, Precision Dispensers & Bulk Containers

Some film deposits are effectively removed with "wash-type" cleaners such as contact/tuner cleaners, degreasers, alcohols and other solvents. Oxides and sulfides, however, become an integral part of the contact surface and cannot be removed by ordinary contact cleaners.

DeoxIT dissolves oxides and sulfides that form on metal surfaces, removing these sources of resistance. This restores the contact's integrity and leaves a thin (organic) layer that coats and protects the metal.

DeoxIT's advanced formula contains deoxidizers, preservatives, conductivity enhancers, arcing and RFI inhibitors and anti-tarnishing compounds that significantly increase the performance and reliability of electrical components and equipment.

DeoxIT provides long-lasting (1-10 years) protection, reducing the expense of repeated cleaning with expensive and aggressive ozone-depleting solvents.

DeoxIT outperforms & outlasts all other contact cleaners.

Non-flammable, Safe on Plastics & Environmentally-safe.

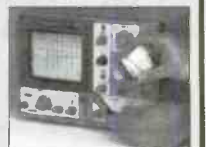

CAIG PRODUCTS... USED BY THOSE WHO DEMAND THE BEST!

Ampex	Federal Express	Honeywell	Switchcraft
Boeing	General Electric	McIntosh Labs	Tektronix
Diebold Inc.	John Fluke Mfg.	Motorola	Texas Inst.
Dolby Lab.	Hewlett Packard	Nakamichi	Xerox Corp.



CAIG
LABORATORIES, INC.

16744 West Bernardo Drive
San Diego, CA 92127-1904
TEL: (619) 451-1799
FAX: (619) 451-2799

1-800-CAIG-123

Circle (24) on Reply Card

Leadership: a rare and valuable commodity

By ES&T Staff

Social leadership

"In Search of Leaders," an article in the January/February edition of *Beyond Computing magazine* speaks about a growing trend in the information technology industry. More and more, searches for information technology managers, center on the need for leadership. The type of leadership required by the industry does not necessarily involve the ability to inspire or the strength of one's personality. Today's managers are expected to have "people skills, business sense, and an ability to make a difference in the way that the business operates." In short, managerial leadership involves a focus on human resources and the capability to link those resources with the goals and strategy of the company.

The extremes

The past two articles on leadership have been an attempt to set the end-points for a linear scale of managerial leadership. At one end of the scale, transactional leadership involves an ongoing exchange between the leader and the follower. At the other end of the scale, ethical or moral leadership involves stewardship, self-constraining responsibility, and equity.

The next few articles about leadership will look at some remaining leadership styles and consider how those styles fit between the two end-points. Not surprisingly, each style takes on characteristics of the two base types. Certainly, some type of ongoing exchange between leader and follower may have roots in stewardship, responsibility, and equity. Yet, each style also has specific characteristics that warrant inspection.

Social leadership

Traditional wisdom tells us that managers should remain somewhat distant from their employees. In this vein, close relationships between managers and em-

ployees create an environment where one may take advantage of the other.

Nevertheless, many leaders assert that a "family atmosphere" in the workplace can propel the organization toward extraordinary achievements. This type of social leadership builds supportive relationships that, in turn, build both personal and organizational vitality. As the individuals in the organization share goals and goal-setting on the professional level, they care more about each other. Thus, instead of merely belonging to a team, each individual in the organization becomes a part of something more significant and larger.

By definition, social leadership involves a variety of forces that bring people together in a number of settings. In our previous discussions about TQM and leadership, the term "organizational culture" became more familiar. Let's take another quick look at the definition:

An organizational culture is the collective values and beliefs of an organization's members that develops over a number of years and is passed on to new members. In some cases, the organizational culture is reflected in the symbols used by an organization, its rhetoric, and the actions of its members.

The organizational culture

Social leadership recognizes the power of an organizational culture and attempts to shape that power into a resource for the organization. Sometimes, studies of organizational cultures will disclose that individuals who lack formal titles often carry a great deal of informal power. In some cases, a social leader may wish to preserve distinctions that have evolved through the culture. In others, a social leader who also has become a change-agent may disturb the organizational culture for the purposes of achieving change. In either case, the leader must have the ability to gain the consensus of the group while working towards acceptable goals.

Achieving consensus

How does a social leader achieve consensus? Part of that skill hinges on the ability of the leader to build the self-esteem of everyone involved in the organization. After all, leadership itself is based on self-confidence. The building of employee self-esteem in the organization allows leaders to begin the successful, responsible empowerment of their followers. As the organization reaches the point of total self-confidence and empowerment, the desire for strength, achievement, adequacy, freedom and appreciation become satisfied. In addition, a "social interest" where the striving of individuals becomes identified with the striving of the group builds throughout the organization.

Empathy

The other side of creating consensus in the organization, is the ability to nurture empathy within the organization. Many times, a leader must have the ability to walk a mile in the shoes of another. That is, the leader must be able to understand the feelings of another and see the organization from the perspective of another. In every way, the ability to achieve empathy moves the organization toward ethical or moral leadership. Empathy allows us to begin to treat others as we would like to be treated.

In one chapter of the book, "*The Leadership Challenge*," U.S. Army Major General John H. Stanford and Vince Lombardi, the one-time coach of the Green Bay Packers, talk about the need for encouraging love throughout organizations. Stanford equates success in life with the ability to stay in love.

To Stanford, "Staying in love gives you the fire to really ignite other people, to see inside other people, to have a greater desire to get things done than other people. A person who is not in love doesn't feel the kind of excitement that helps

them to get ahead and lead others and to achieve."

Lombardi says, "Mental toughness is humility, simplicity, Spartanism. And one other, love. I don't necessarily have to like my associates, but as a person I must love them. Love is loyalty. Love is teamwork. Love respects the dignity of the individual. Heartpower is the strength of your corporation."

The ability to love may seem far removed from the business world. However, when we look back at Stanford's and Lombardi's words, the underpinnings of social leadership become evident. Encouragement often occurs through the social recognition of employees. Again quoting from "The Leadership Challenge," "as we give encouragement, we give heart. When we give heart to others, we give love." Without love and the selflessness that accompanies love, it becomes impossible to build self-esteem or achieve empathy. And, it becomes impossible to maintain transactions within the context of moral leadership.

A few suggestions

Building self-esteem, achieving empathy, and discovering love within your organization may be as difficult as it would seem. This simple formula may help:

- Schedule Celebrations—Some organizational values or events warrant specific celebrations. The recognition of innovations, milestones, and service builds morale, and encourages togetherness, responsibility, and leadership.

- Lead By Example—Make your stand on personal and organizational values clear to everyone. Use imagination when rewarding others and let others know that it's okay to laugh, have fun, and enjoy each other's company.

- Build Social Support—Increased social interaction increases the commitment of everyone to the standards of the group. As the group vision becomes aligned with the vision of the leader, the organization achieves synergy. Social support also allows individuals to avoid the common effects of workplace stress.

- Add Heart — Put your heart into your business and the business into your heart. The love that you show for your business, and for others will build into a passion for leadership. ■

To Order Back Issues

Send \$3.50 Per Issue

When ordering back issues include the following information: Name, address, city, state & zip. Please make a list of the issues you're requesting. When paying by credit card send the number along with the expiration date. Check, Money Order, Mastercard, VISA, Discover and AMEX accepted.

Complete your collection today.

1-800-853-9797

or Fax 1-516-681-2926

Electronic Servicing & Technology
76 North Broadway, Hicksville, NY 11801



Obtain required certification...
Enhance your career potential...
Improve your earning power...

Prepare Yourself to Pass The Communications Licensing and Certification Exams!

Give yourself the competitive edge it takes to succeed in the expanding world of communications.

Use [Communications Licensing and Certification Examinations The Complete TAB Reference](#) to "prep" yourself in a wide range of electronics subjects and concentrate on the areas where you need to "brush up."

[Practice Tests for Communications Licensing and Certification Examinations](#) provides you with full-length practice tests that cover virtually every subject needed to master the actual test.

Much more than just a textbook, this set provides a focused review of the material you need to know. Fill out and return the coupon, or call, toll-free 1-800-822-8158 —

now — for this extraordinary study reference set.



Get a TAB Electronics brief bag, absolutely free!



TAB Electronics
P.O. Box 182606
Columbus, OH 43271-3033

Satisfaction Absolutely Guaranteed

We're so sure that you'll be satisfied with your selection, we'll even pay the postage if you decide to return it.

YES! Please rush my 2-volume set (#587064-9). Payment of \$69.90 (plus \$6 S&H and applicable sales tax) is enclosed. I understand that if I purchase this set now, I will receive a TAB Electronics brief bag, absolutely free.

PAYMENT METHOD:

Check or Money Order Enclosed Please charge my credit card:
 MasterCard VISA Discover American Express

Account No. _____
Expiration Date _____
Signature _____

Name _____
Address _____
City _____ State _____
Zip _____ Phone () _____

FOR FASTEST RESPONSE ON CREDIT CARD ORDERS CALL, TOLL-FREE, 1 800 822-8158, 24 hours a day!

Key - SP55E4A

Test Your Electronics Knowledge

By Sam Wilson

1. Refer to the relaxation oscillator in Figure 1. To decrease the output frequency you should move the arm of R

- A. Toward X
- B. Toward Y

2. Which of the waveforms in Figure 2 should you get at point Z in Figure 1?

- A
- B
- C
- D

3. Which of the following is a circuit that converts dc to ac?

- A. Converter
- B. Rectifier
- C. Oscillator
- D. Transformer

4. Which of the following is used to suppress parasitic oscillations?

- A. Bead ledge
- B. Hot carrier diode
- C. High-pass filter
- D. Ferrite bead

5. Gain-bandwidth product is a

- A. Current
- B. Voltage
- C. Frequency
- D. Time unit

6. What r-f frequency corresponds to a wavelength of 2 meters?

7. At what point on a sinewave current is the current changing at the greatest rate?

- A. When the current is maximum
- B. When the current is minimum

8. What is the term in color theory that includes both hue and saturation?

- A. Brightness
- B. Chrominance
- C. Balance
- D. Color

9. A sinewave is applied to the input of a Schmitt trigger. The output is a

- A. Sine waveform
- B. Square waveform
- C. Pulse
- D. Sawtooth waveform

10. Complete this truth table for a NAND gate:

A	B	L
0	0	-
0	1	-
1	0	-
1	1	-

(Answers on page 72)

Wilson is the electronics theory consultant for ES&T.

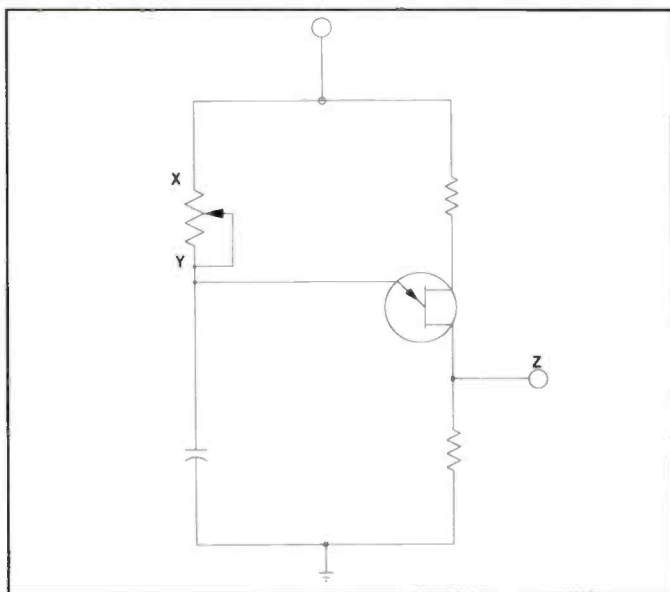

Figure 1.

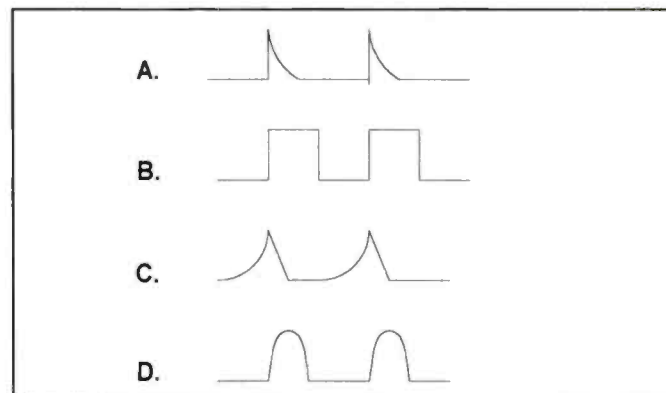

Figure 2.

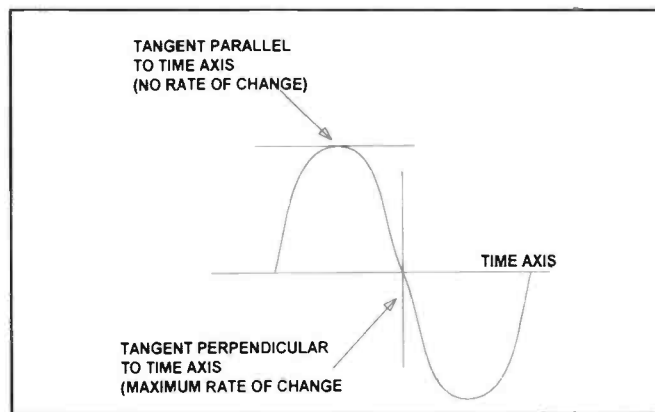

Figure 3.

Magnetic Recording

(from page 11)

The speed of the capstan motor will be controlled by comparing the 30Hz control track pulses with a 30Hz signal derived by dividing the 3.58MHz signal from the color section. The control track pulses are obtained from the control track head which is positioned on the same physical mount as the audio head.

During record, the control track pulses were derived from the vertical sync and recorded along the edge of the tape. The capstan rotation being much slower than the cylinder rotation, the 30Hz control track pulses are sufficient for phase control (precise positioning) of the capstan movement also.

The vertical sync is the reference used for speed and phase control of the head cylinder. The sync is multiplied in frequency and fed to the phase and frequency comparison circuits of the cylinder servo section.

Motor drive

As an interface between the servo circuits and the motors themselves, motor drive amplifiers (MDAs) are used to provide sufficient current to operate the motors. The motor drive amplifiers are higher power hybrid IC's (transistors on older types) that receive a control voltage from the servo. The amplifiers drive the motors to a speed that is proportional to the servo control voltage. For the capstan motor, a dc motor can be used, with the MDA supplying a dc current, the amplitude of which is controlled by the servo.

For the cylinder motor, a dc motor is not sufficient to allow the precise control needed. A multi-pole ac motor is used. Typically this motor will have three pairs of poles and use three-phase ac. The servo circuits or the drive circuits for the cylinder will vary the frequency of the voltages applied to this motor. Three voltages, 120 degrees out of phase, are developed by the circuits. This true rotating field allows much more precise positioning during the cylinder's rotation.

Precise tracking

For more accurate tracking, most modern VCRs also use multi-pole motors and ac servos for the capstan.

To allow for precise tracking, the control head must be in precisely the right

position along the tape path. To allow for correct "centering" of the head. A mechanical adjustment is provided to move it laterally a small amount. This is usually done with a conical shaped threaded nut that, as it is threaded up or down, displaces the head one way or the other. Electrical adjustments are sometimes provided on the main PCB to center the tracking. On some units there is an adjustment for each tape speed.

The system controller

To precisely control all the functions of a VCR, a microprocessor is used. This is a dedicated microprocessor called a system controller. This circuitry is sometimes referred to as the SYSCON. Controlling the necessary functions of a VCR is quite complicated, and the controller has many functions. Refer to the simplified block shown in Figure 8.

Of course, one function of the system controller is to invoke the functions selected by the user (play, record, etc.). To accomplish this the control panel switches are usually arranged in a matrix having rows or columns that are scanned by the controller. Matrixing allows for less PCB wiring and fewer connections. The controller will thus have "scan data" outputs and inputs.

A single encoded data line is usually provided from an IR receiver to allow remote control of the VCR. The transmitter generates different data codes depending on which key function is pressed. The syson decodes the transmitted data.

The controller has outputs to control the motors that load the cassette tape, thread the tape or turn the reel drive motor forward or reverse. Outputs tell the servo section when to start rotation of the cylinder and capstan.

Many machines were made with separate capstan motors, reel drive motors, cassette loading motors and tape threading motors. Some VCRs have mechanical assemblies that allow some motors to have more than one function. In many newer machines a single motor, the capstan motor, performs all of these functions. The mechanical arrangements that allow multiple functions from one motor are quite complex.

Switches and sensors

In order for the controller to "know" what function is being performed and

when the motor has completed performing that function, mechanical switches can be used. One such multi-position switch may be referred to as the "mechacon" switch. Alignment of this switch position is sometimes referred to as control timing adjustment.

Switches may be provided to indicate the position of the cassette tape as it loads as to when a tape has been inserted, when it is fully loaded or fully ejected. The mechacon also provides for some protection of the heads, circuits and tape.

The dew sensor

One type of protection that is provided is to insure that the tape cannot contact the rotating cylinder when dew has formed on the cylinder. The moisture would fill in the air grooves on the cylinder, causing the cylinder to "grab" the tape. To determine when this condition exists, a "dew sensor" is used. The dew sensor is a small element whose conduction increases when its layers of wiring become moist. When the dew sensor signals to the controller that there is moisture present, the controller causes all tape motion functions to be inoperative.

The reel sensor

If, for any reason, the take up reel could not take up the slack as the capstan's pinch roller pulls the tape from the supply reel, the tape would spill out inside of the machine. This would ruin the tape and possibly cause other serious damage. A protection circuit is therefore provided for this condition by means of a "reel sensor."

In present day VCRs, this sensing is provided by putting mirrored stripes on the bottom surface of the take up reel. An infrared LED shines upward toward the reel. Positioned alongside it, also pointing toward the reel, is a photo detector. As the reel turns, the light will alternately be absorbed and reflected back to the detector, producing square output pulses if the reel is turning. The controller senses whether these pulses are present or not. If no pulses occur within 1 to 3 seconds, STOP mode is initiated by the controller. The reel sensor itself usually has both LED and detector mounted in the same package, being a single component with four lead connections.

The reel sensor has a second function: to supply pulses as the reel turns for the tape counter.

Test Your Electronics Knowledge

Answers to the quiz

(from page 70)

1. B - Moving the arm toward Y increases the resistance of the time constant circuit, and therefore, increases the time constant. That increases the time for one cycle and lowers the frequency.

2. A - You get an output only during the time the capacitor is discharging through the UJT.

3. C - That is one definition of an oscillator.

4. D - A ferrite bead acts like an inductor. It opposes the high frequency parasitics.

5. C - The gain (no units) times the frequency (Hertz) is a frequency. Gain-bandwidth is a value supplied by the manufacturer for its transistor. It is the frequency at which a transistor beta is equal to unity (1.0).

6. 50 MHz - Remember the basic equation:

distance equals rate x time.

The distance in the equation is the distance the radio wave travels during one cycle. The rate is three-hundred thousand meters per second and T is the time for one cycle.

$$6 \text{ meters} = 300,000,000 T$$

$$\text{so } T = 6/300,000,000 = 0.02 \mu\text{sec}$$

$$T = 1/f = 1/0.002 \times 10^{-6} = 50 \text{ MHz}$$

7. B - See Figure 3 - The rate of change is equal to the angle a tangent to the curve makes with the time axis. At the maximum current the tangent is parallel to the time axis, so, the rate of change of current is 0. At the point where the current is 0 the tangent is maximum.

8. B - (by definition)

9. B - It is one of the things a Schmitt trigger does.

10.	A	B	L
	0	0	1
	0	1	1
	1	0	1
	1	1	0

End of tape sensor

Sensors are provided to tell the controller when the tape has reached the end of its travel. If the end of the reel did not signal the system to stop, the tape could be stretched or broken when it reached the end. A second purpose of the EOT (end of tape) sensors is to trigger the automatic rewind function on all VCRs. Some EOT sensors also have an auto-repeat function. A third function is to provide sensing as to whether the cassette has dropped properly into position after the cassette load operation.

For use by the EOT sensors, all tapes have a clear leader strip attached to each end. An infrared LED (in older machines, an incandescent lamp) is positioned in the center of the tape transport such that it will protrude through a hole in the center of the cassette. There is a small hole in the cassette, just inside the tape cover, through which the infrared light from the LED can shine. On each side of the transport, at the same level as the hole in the cassette, is a photodetector (normally a phototransistor).

The left detector is called the supply sensor, the right one the take-up sensor. If the end of the tape is reached, the light will shine through the clear strip and strike the sensor. This output voltage change will be sensed by the controller. When the tape is inserted, if the level of at least one of the sensors does not change, the controller "knows" that the tape cassette has not dropped into position.

Tuner and demodulator

All consumer VCRs contain a tuner and RF demodulator to provide recording capabilities for off the air and cable signals. The tuner is usually of a type identical to that found within a color TV. An RF demodulator is a circuit that amplifies the video IF frequencies supplied by the tuner and converts them to baseband video and audio. It contains video IF amps, video detector and FM sound detector. These signals connect to either a line/tuner switch of some kind, or through contacts of the video and audio input jacks.

The switch or contacts provide selection of the input signals to be recorded. Most jacks are connected such that if external video or audio sources are plugged in, the connections are broken from the RF demod providing automatic selection.

The tuner and demodulator may be integrated into a single unit in some VCRs.

RF switching

Switching must be provided at the RF output to select whether the modulator in the VCR, or the TV signal leads are is connected to the output. This switching is done electronically in modern VCR's using a control voltage and switching diodes. Some VCRs have a separate RF switch, a small shielded unit with the RF in and RF out external connections, an internal connection from the modulator, and an output to the VCR's tuner. This switch has a switching voltage connection for the selection. A VCR/TV switch on the front panel provides control, through the system controller. In addition, in most units the controller automatically switches to the VCR position when PLAY is selected.

In many VCRs the modulator and RF switching are integral. For the integral modulator/RF switch, there are the two external RF in and out connections, audio and video inputs, an output to the tuner (shielded RF cable), power supply voltage (B+) input and switching input. Sometimes the B+ voltage and switching voltage are the same voltage, this voltage energizing the modulator and causing the VCR to switch from the RF input to the modulator input.

Performance options

Of course there are many options available for VCR's, and many circuit variations. One type of circuit being used on some machines is called an HQ (high quality) circuit. This is simply a way of sharpening up the edges of objects in the playback, giving more apparent detail. The HQ circuitry uses a "crispened comb filter" to emphasize the high frequency components of the video.

Many higher quality machines use more than two video heads. The four head machine uses only one set of two heads at a time. Another set is provided because of a compromise that must be made for having three operating speeds. The wider the video tracks, the more induced signal the heads will have. The tracks could be wider at faster tape speeds, but at slower speeds this might cause too much overlapping of tracks. For a machine to acceptably play all three speeds, the heads must be no wider than allowed for the SLP

Save time...make more money

...with the new

SOURCE BOOK

by Thomson

VCR/Camcorder SOURCE BOOK

VCR/Camcorder

RCA



PROSCAN

SK Series

KEY ITEMS CROSS REFERENCE

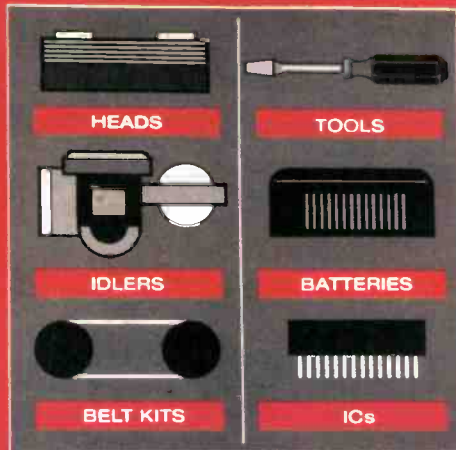

Exact Replacement Semiconductors
OEM Replacement Parts
Universal Replacement Parts

THOMSON CONSUMER ELECTRONICS

Now available...a single guide to help you find your exact or universal parts...fast!

Our new cross reference source book for VCRs and camcorders combines our most popular cross reference information into one easy-to-use volume.

One book...filled with 320 information packed pages on VCR and camcorder key items, universal parts ...and much more.

The Technician's New Friend

Contact your TCE Parts Distributor for your complimentary copy. Order Publication Number 1J9780

Here's what the new guide contains:

- OEM Replacement Parts
- Universal Replacement Parts
- Exact Replacement Semiconductors
- Camcorder Batteries
- Flameproof Resistors
- and much more

THOMSON CONSUMER ELECTRONICS

Circle (93) on Reply Card

Now you can concentrate on your work without worrying about adjusting the scope.



Introducing the new Fluke PM 3380A CombiScope™ with Autoranging.

Now there's a better, faster way to get the measurements you need, and at a much lower cost.

Think about it! A 2-channel, 100 MHz analog/digital oscilloscope that lets you concentrate on the problems you have to solve rather than on constantly readjusting the time base and attenuators to get a good view of the signal.

How can that be? Autoranging. A unique feature that automatically scales signals and puts them in the picture, letting you probe around the circuit with ease. Even when an unexpected event sends your signal off-screen, Autoranging brings it right back.

- Autoranging
- 18 automatic measurements
- Analog scope built in
- On-probe switch for mode changing
- Trigger view: Almost another channel
- True digital peak-detection
- Glitch triggering
- Video line counter and TV trigger
- Oversampling digital peak detection
- Waveform processing and mathematics
- Closed-case calibration
- 3-year warranty parts and labor
- 5 year CRT warranty
- Exceptional value at **\$3,495.00**

This Fluke scope has an impressive array of intuitive and intelligent features usually found in scopes of twice the price. And all are contained in one compact unit that will give you years of dependable service.

Call **1-800-44-FLUKE** today and see how easy it can be to put this scope to work for you.

©1994 Fluke Corporation, P.O. Box 9090, M/S 250E, Everett, WA, USA 98206-9090. U.S. (206) 356-5400. Canada (905) 890-7600. Europe (31 40) 644200. Other countries (206) 356-5500. All rights reserved. Ad No. 00691

FLUKE®