

THE MAGAZINE FOR CONSUMER ELECTRONICS SERVICING PROFESSIONALS

# ELECTRONIC<sup>TM</sup>

Servicing & Technology

APRIL 1989/\$2.50

Understanding DSO accuracy and measurement performance

Distributors' Showcase • What's in a Name?

## Waveform Analysis With Professional-grade Oscilloscopes

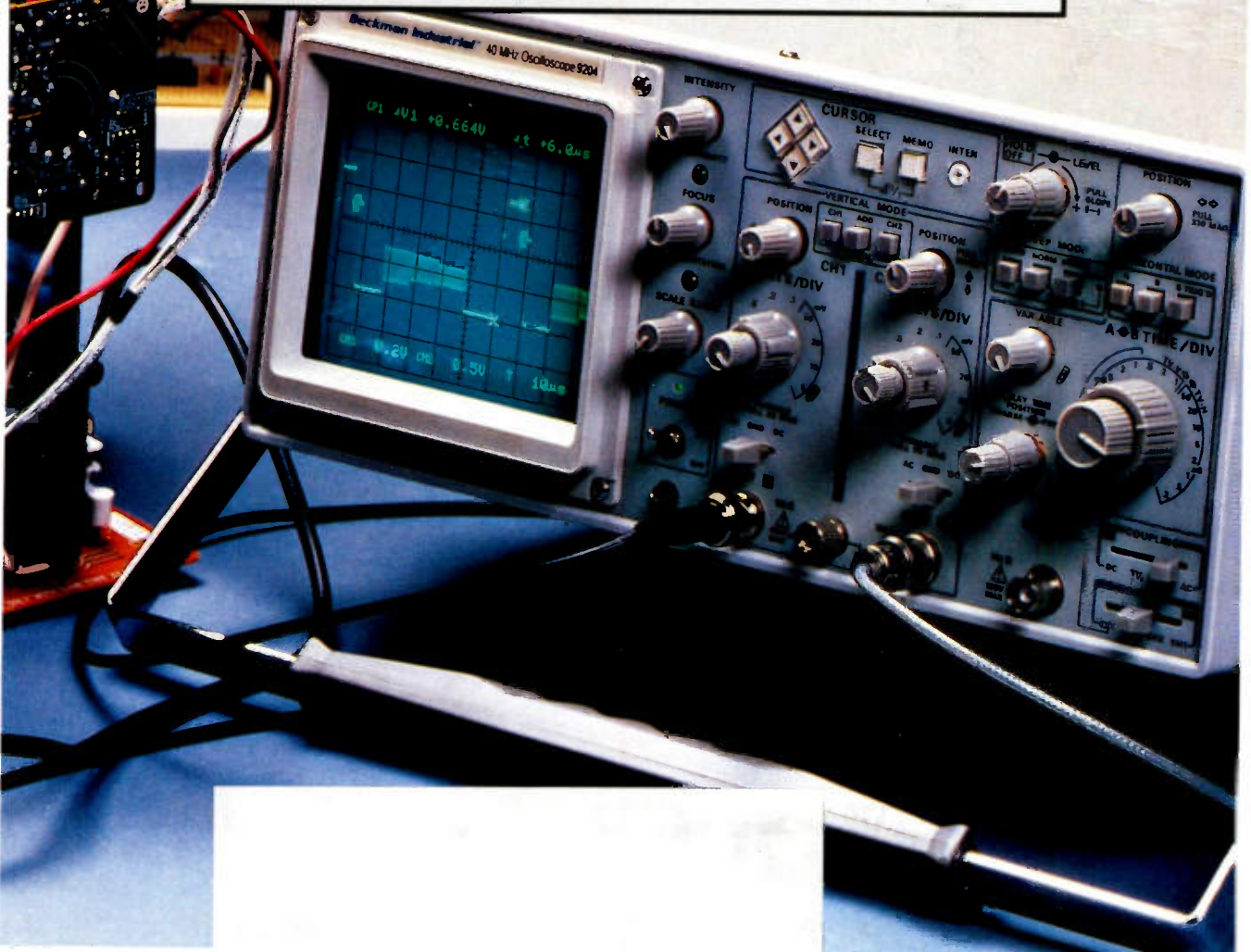

**Dynamically Analyze Stereo Audio Power Amplifiers In Less Than 1/2 The Time You Now Take, With Superior Accuracy And Reduced Measurement Errors, To A Full 500 Watts (250 Watts/Channel) And To IHF/EIA\* Specifications.**

**New!**



**With The Completely Integrated PA81 Stereo Power Amplifier Analyzer**

**Introductory Price  
\$1995!**

**Now Test To A Full  
5,000 Watts With  
Optional Accessories!**  
Call For Details

Presenting the missing link in audio service. The ALL NEW PA81 is designed to pinpoint hard to find problems in stereo and monaural audio power amplifiers, in a fraction of the time you now take.

- Twin Autoranged Wattmeters Make The Job A Snap.
- Built-In IHF/EIA testing components at your fingertips to make your job easy and your work accurate.
- Monitor sound quality at all times to prevent backtracking.
- RMS and dB audio signal tracing ability lets you tie down troubles in any driver stage.
- Prevent amplifier damage, plus monitor intermittents.
- "Audio Line" tests ensure that the component signals to the amplifier are "OK".
- Stereo separation tests to 126 dB to speed AM, FM and Stereo TV work.

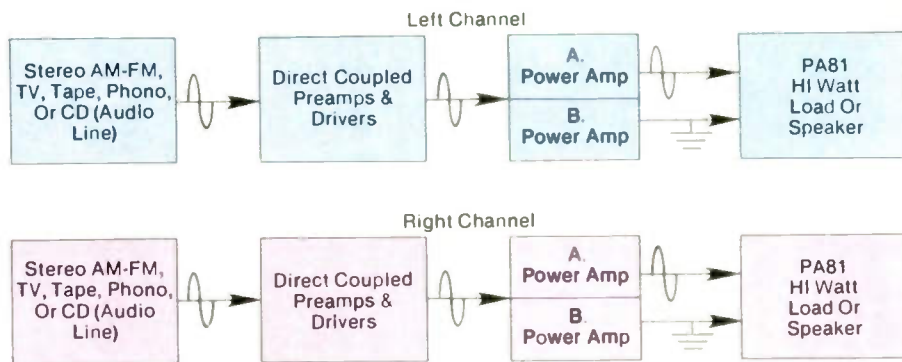

*Walk troubles out of any power amplifier stage, step by step, with the PA81.*

\* IHF - Institute of High Fidelity  
EIA - Electronics Industry Association

**Call or Write For A 10 Day  
Videotape Preview**



Circle (1) on Reply Card

**SENCORE**  
3200 Sencore Drive Sioux Falls, South Dakota 57107

**Call 1-800-843-3338**

**In Canada Call 1-800-851-8866**



# EXPAND YOUR CAREER HORIZONS...

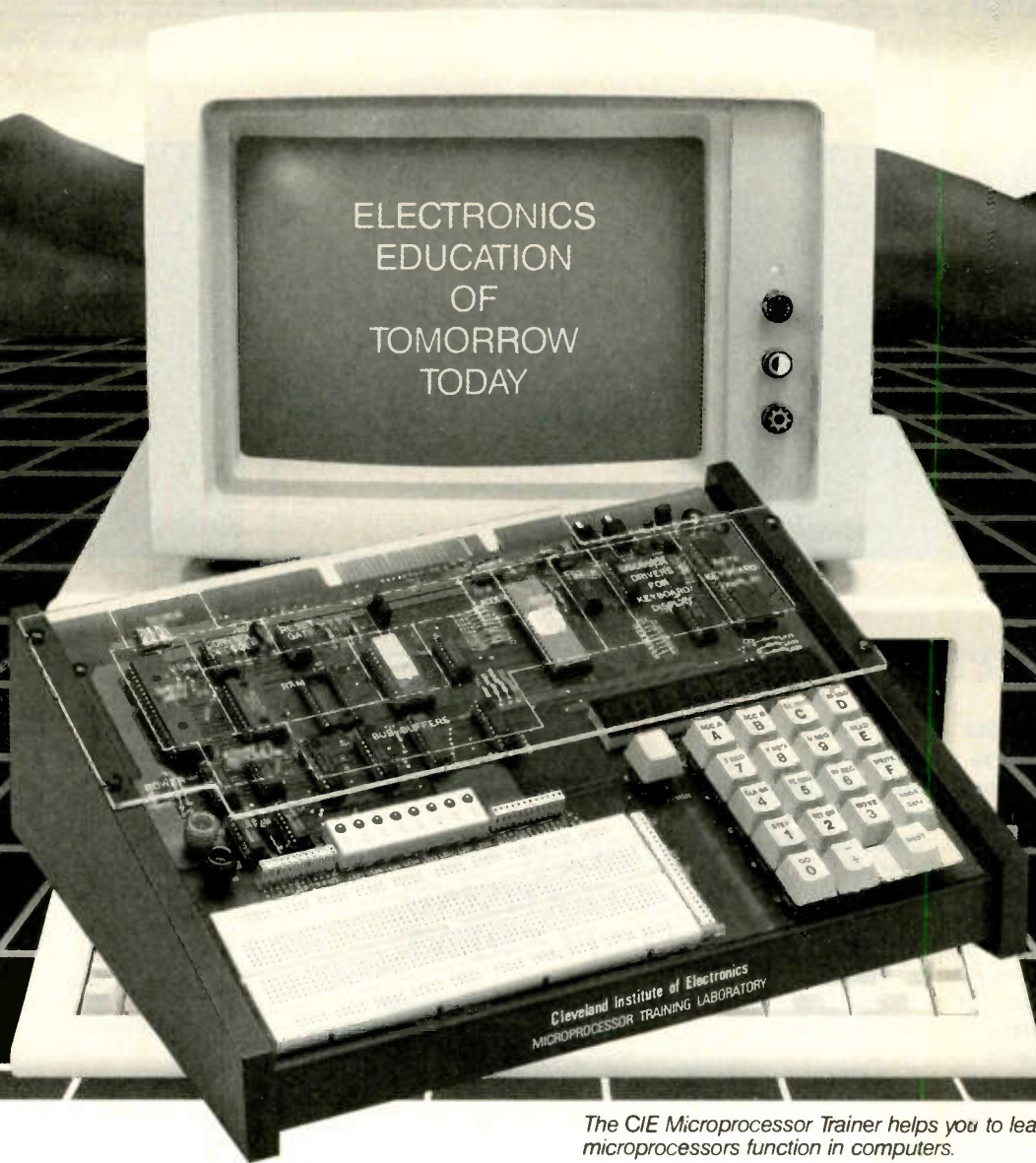

The CIE Microprocessor Trainer helps you to learn how circuits with microprocessors function in computers.

## START WITH CIE.

Microprocessor Technology. Satellite Communications. Robotics. Wherever you want to go in electronics... start first with CIE.

Why CIE? Because we're the leader in teaching electronics through independent study. Consider this. We teach over 25,000 students from all over the United States and in over 70 foreign countries. And we've been doing it for over 50 years, helping thousands of men and women get started in electronics careers.

We offer flexible training to meet your needs. You can start at the beginner level or, if you already know something about electronics, you may want to start at a higher level. But wherever you start, you can go as far as you like. You can even earn your Associate in Applied Science Degree in Electronics.

Let us get you started today. Just call toll-free **1-800-321-2155** (in Ohio, 1-800-362-2105) or mail in

the handy reply coupon or card below to:  
Cleveland Institute of Electronics,  
1776 East 17th Street, Cleveland, Ohio 44114.

### **CIE** World Headquarters

**Cleveland Institute of Electronics, Inc.**  
1776 East 17th Street • Cleveland, Ohio 44114

Please send your independent study catalog.  
For your convenience, CIE will try to have a representative contact you — there is no obligation.

Print Name \_\_\_\_\_

Address \_\_\_\_\_ Apt. \_\_\_\_\_

City \_\_\_\_\_ State \_\_\_\_\_ Zip \_\_\_\_\_

Age \_\_\_\_\_ Area Code/Phone No. \_\_\_\_\_

Check box for G.I. Bill bulletin on Educational Benefits

Veteran  Active Duty **MAIL TODAY!**

Just call toll-free **1-800-321-2155** (in Ohio, 1-800-362-2105)

Circle (3) on Reply Card

AES-34



Page 12



Page 20

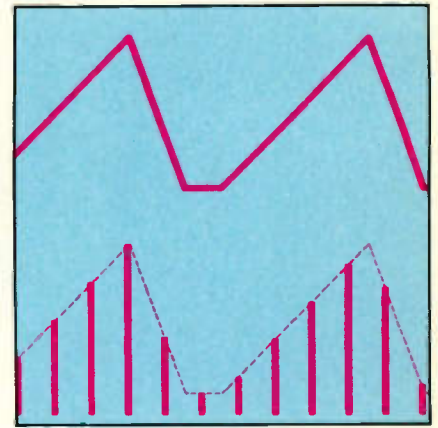

Page 42

## FEATURES

### 12 Streamline your TV servicing: Waveform analysis with professional-grade oscilloscopes

By John R. Albright

Look on any electronics servicers bench and you'll see an oscilloscope. Basic equipment, right? Well, the lowly oscilloscope just keeps getting better. With waveform analysis capabilities, the new breed of oscilloscopes can help you service TVs faster and more accurately.

### 20 An infrared remote-control tester

By Steven Chisarick, CET

Infrared remote controls are almost guaranteed to go out because of all the unplanned trips they take from coffee table to floor. This simple, easy-to-build tool lets you find the bad connections that are bound to occur.

### 42 Understanding DSO accuracy and measurement performance

By Brad Harris

Sure, a DSO can help you streamline your troubleshooting — storing correct waveforms, freezing single-shot waveforms, measuring with cursors and capturing glitches or spikes. But you can't just grab

any DSO off the shelf and expect it to be perfect for the way you use a scope. You have to understand how the scope works and what the specs mean before you can choose the features you need.

## SPECIAL ADVERTISING SUPPLEMENT

### 21 Distributors Showcase

So you need a waveform analyzer. You've studied the specs, you know what you want, now you just choose the distributor at random because they're all the same, right? Not so fast — Does this company have the item in-stock? What's the company's return policy? What kind of ordering options do you have? Is there a toll-free phone number? What kind of warranty does the company offer? Well, to help you answer some of those questions, we'd like to introduce a few companies that may be able to help you get that analyzer faster and easier.

## DEPARTMENTS

### 4 Editorial

Hope for better days?

### 6 News

### 10 Business Corner

Dealing with customer complaints

### 16 Test Your Electronics Knowledge

### 18 Technology

### 28 Computer Corner

Erratic problems? Check the cable

### 31 Profax

### 50 Troubleshooting Tips

Sony model KV2670R, chassis SCC548C

### 52 Books

### 54 Products

### 57 Literature

### 58 What do you know about electronics?

What's in a name?

### 60 Audio Corner

Servicing the compact disc player — Part VII

### 62 Video Corner

Making and using VCR test cassettes

### 64 Readers' Exchange

### 68 Advertisers' Index

## ON THE COVER

Precise waveform analysis used to require specialized, high-end laboratory instruments that were out of reach for most electronics servicers. With cursors and numeric readout, however, oscilloscopes are now putting waveform analysis within the servicer's grasp.

The magazine for consumer electronics servicing professionals

**ELECTRONIC**  
Servicing & Technology



# LEADER

CARVER DENON harman/kardon  HITACHI  
NEC ONKYO  PIONEER  SANSUI  
SHARP SONY  TEAC YAMAHA

## These leaders specify Leader.

When servicing electronics, depend on Leader for your test equipment needs.

Leader meets the standards of so many, because we set such high standards in design.

Equip your bench with our standard test equipment as required by manufacturers. Leader continually consults manufacturers and their service facilities to determine what products and features you'll need. The unique features on Leader equipment help you work smarter and increase efficiency.

SEE LEADER INSTRUMENTS AT ELECTRO '89, BOOTHS 1663-1667

You'll find hard-to-beat capabilities and value throughout the Leader line.

See all there is to Leader's leadership, and benefit from our more than 34 years of experience. Phone now to discuss your equipment requirements, for a copy of our catalog, and for the name of your nearest "Select" Leader Distributor. All Leader equipment is backed by a TWO-YEAR WARRANTY, and factory service on both coasts.

Call toll-free  
**1 800 645-5104**  
In NY State  
**516 231-6900**

Leader Instruments Corporation  
380 Oser Avenue, Hauppauge, New York 11788  
Regional Offices:  
Chicago, Dallas, Los Angeles, Boston, Atlanta  
In Canada call Omnitronix Ltd. 416 828-6621

**LEADER**  
FOR PROFESSIONALS WHO KNOW  
THE DIFFERENCE

1. LCG-400S NTSC Pattern Generator
2. LVS-5850B NTSC Vectorscope
3. LDC-823S 250-MHz Frequency Counter
4. LMS-238 TV Stereo Generator
5. 3216 AM/FM Stereo Generator
6. LHM-80B High Voltage Meter

7. LSW-333 TV Sweep Generator
8. LAG-126S Audio Generator
9. LMV-185A AC Millivoltmeter
10. LFM-39A Wow & Flutter Meter

11. LDM-171 Distortion Meter
12. LTC-906 Transistor Checker
13. LDM-853A Digital Multimeter
14. LPS-152 DC Power Supply
15. LPM-8000 Laser Power Meter
16. LBO-2060 CRT Readout Oscilloscope

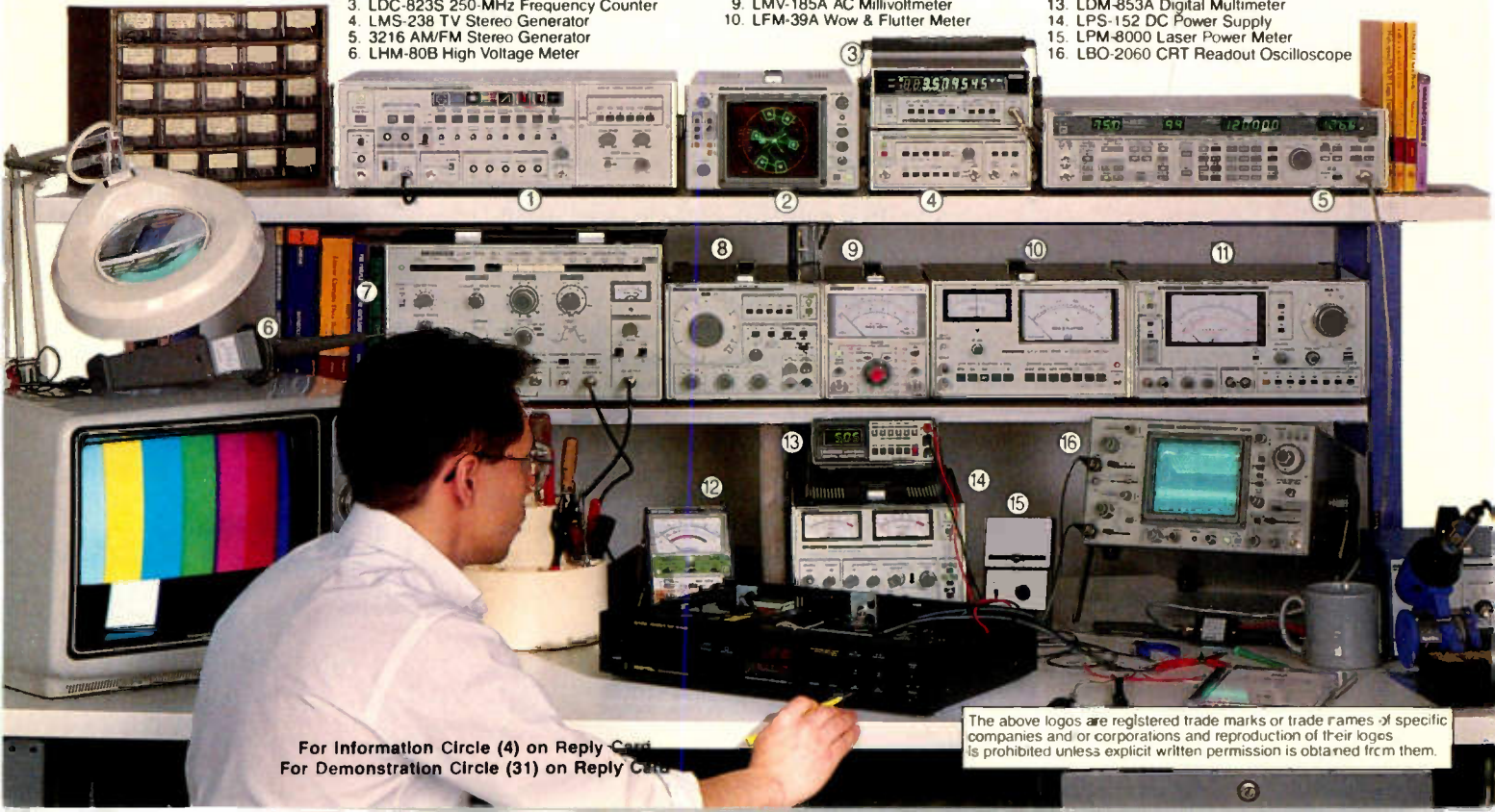

For Information Circle (4) on Reply Card  
For Demonstration Circle (31) on Reply Card

The above logos are registered trade marks or trade names of specific companies and/or corporations and reproduction of their logos is prohibited unless explicit written permission is obtained from them.



# Hope for better days?

The subject of high-definition TV (HDTV) seems to be receiving increasing play these days. Just a few weeks ago there was a multipage article in *Business Week* about it, and today I read an Associated Press article about it. The latter article stated that Zenith and AT&T are teaming up to produce complex HDTV equipment.

By combining AT&T's integrated-circuit technology with Zenith's television expertise, the companies hope to develop equipment for evaluating and demonstrating Zenith's existing high-definition TV transmission system.

Something is going on in the consumer-electronics industry, and it bodes well for electronics servicing. Is it possible that the downtrend that has been in effect for so long might be slowing and that consumer-electronics servicing could be in for an upsurge?

It's really too early to tell, but let's at least take a look at the signs that seem to be holding out some hope. For starters, let's take a look at how the problem evolved.

In its infancy, television, from the point of view of the consumer, was an expensive proposition. A TV set cost a lot of money, but it was fascinating, seductive and beguiling because it represented a window on the world that had theretofore not existed. Even though the technology was, relatively speaking, crude and the picture available was poor by today's standards, it was such a wonder that people were willing to spend a lot of money to own a TV set. They were also willing to spend significant sums to keep their expensive TV sets working. Of course, in the days of tube-type TVs, that was often. Furthermore, most repairs were pretty simple to handle. If worse came to worse you could just test every tube in the set and replace any that were suspect.

Then several things happened: Televisions gradually became more reliable and much less expensive, and people, no longer fascinated by the mere fact that they could receive pictures in their

homes from long distances, began to expect much more for less. They received good color pictures and poor sound in programming that was noted neither for its technical achievements nor for its content. Most people were content to watch insipid TV on inexpensive sets. Because of the sets' low cost and the constant technological upgrades, owners would rather buy a new set than have an old one fixed.

All of those changes led to hard times for servicing companies.

The tide may have turned. People are beginning to realize that TV technology is capable of much better picture and sound than is generally available today. They want it, and they seem willing to pay for it. People are now paying for premium programming, and they want high-quality sets with good picture and sound to watch it on. People are also buying high-quality VCRs and camcorders. At \$500 to \$1,500 for one of these products, they are willing to pay a few hundred dollars to have them fixed. Already, VCR cleaning is a lucrative business for many servicing companies.

Satellite TV seems to be another indicator that people are increasingly willing to spend great sums of money to get a good-quality TV picture. Now that the scrambling shakeout has taken place, manufacturers, dealers and program providers are concluding that many people want satellite TV delivery, and they are willing to pay for the hardware, the descrambler and the monthly cost of keeping the descrambler receiving the premium channels.

HDTV, if it materializes, should accelerate this trend.

Unless I'm missing something, it seems that the demand for servicing of all of these new, costly products has to increase, and that has to be good news for electronic servicing technicians. Let's hope it's not too long in coming.

*Nils Conrad Penam*



# Cursors To Cure Measurement Curses.

Beckman Industrial  
Introduces The Series 9000.  
Speed, Accuracy, Performance  
And Value.

Presenting a new family of quality  
oscilloscopes with professional features.  
Choose from six models with frequency  
ranges of 20, 40 and 60MHz.

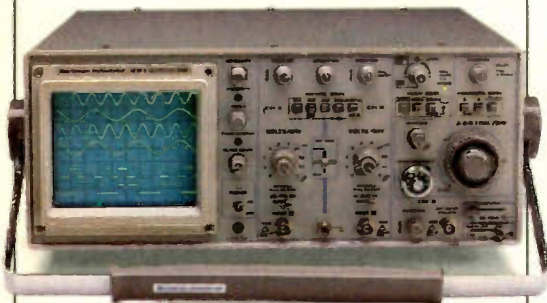

Model 9106,  
60MHz,  
3 Channel,  
Dual Sweep  
(A & B).

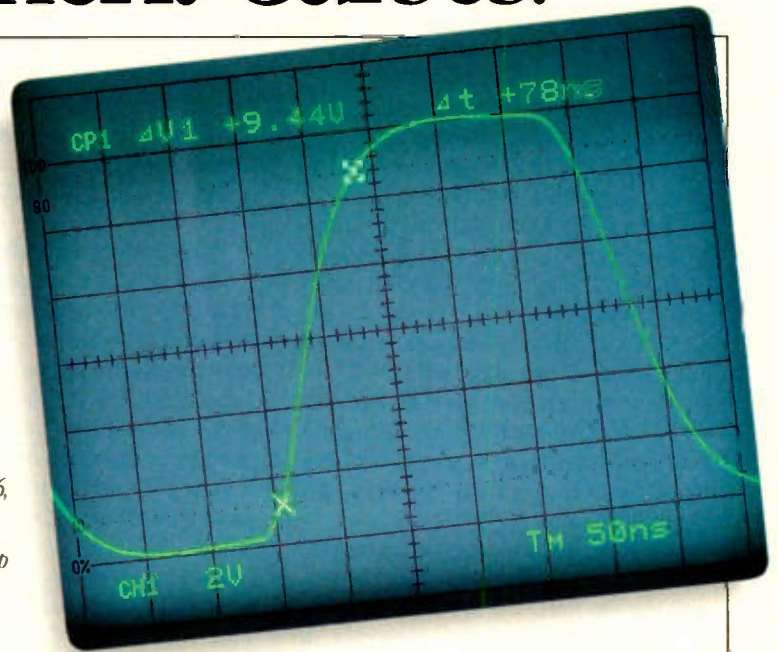

Independent cursors and  
on-screen readouts make  
waveform measurements  
fast and accurate.

Five of six models feature two  
independently-adjustable time bases. Built-  
in intensity modulation allows you  
to select a small section of a main  
waveform for closer examination.  
This feature is ideal for measuring  
pulse rise times or checking sync pulse  
amplitudes in composite video signals.

## Cursors And On-Screen Readouts.

Two sets of independent cursors are  
featured on Models 9202 and 9204. Simply  
position the cursors on the waveform and  
you instantly have accurate on-screen  
numeric readouts of amplitude, time,  
frequency, duty cycle and phase shift. A  
separate frequency counter is unnecessary.  
Interpolation is eliminated. You save time.  
Improve accuracy.

## Solid Design.

The Series 9000 features a low-  
profile cabinet, logically grouped controls,  
camera-mount CRT bezel and graticule  
illumination for waveform photography.  
Most models feature a three year warranty.

The Series 9000 Oscilloscope. Only  
from Beckman Industrial. Finally, the  
affordable cure for measurement curses.



Model 9204, 40MHz,  
On-Screen CRT Readout.

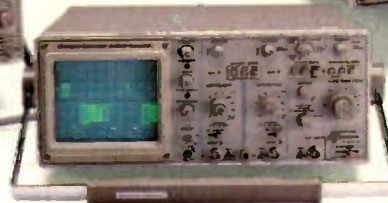

Model 9104, 40MHz,  
2 Channel, Dual Sweep (A & B).



Model 9022, 20MHz,  
2 Channel.

FEATURES	9106	9104	9204	9202	9102	9022
Max Frequency	60MHz	40MHz	40MHz	20MHz	20MHz	20MHz
Input Channels	3	2	2	2	2	2
Dual Sweep (A & B)	•	•	•	•	•	
CRT Readout			•	•		
Cursor Readout			•	•		
Switchable X1/REF/X10 Probes	2	2	2	2	2	2
Warranty	3 year	3 year	3 year	3 year	3 year	1 year
Price	\$1,290	\$950	\$1,095	\$865	\$700	\$550

## Beckman Industrial™

Beckman Industrial Corporation  
Instrumentation Products Division  
A Subsidiary of Emerson Electric Company  
3883 Ruffin Road, San Diego, CA 92123-1898  
(619) 495-3200 • FAX (619) 268-0172 • TLX 249031



## EIA makes proposal for U.S. competitiveness

U.S. competitiveness would be most effectively addressed by a combination of broad-based economic policy measures and industry-specific policies designed to promote investment throughout the U.S. economy, according to a report sent to Congress by the Electronic Industries Association (EIA).

The report, titled "Consumer Electronics, HDTV and the Competitiveness of the U.S. Economy," offered seven policy initiatives:

- Reduce the U.S. dependence on foreign capital by cutting the deficit, and increase the national savings rate.
- Shift federal spending to educational and worker training programs with emphasis on commercial sciences and technology.
- Stimulate investment by changing the tax laws.
- Make the R&D tax credit permanent.
- Fund public/private consortia to develop generic technology.
- Relax antitrust restrictions on cooperative R&D activities to allow joint production.
- Press for greater access to foreign markets.

The report also presented three recommendations on HDTV:

- Policies should promote, not impede, the expeditious adoption of transmission standards.
- Any public funds for the development of HDTV should be focused on generic technological products that will benefit a large number of industries.
- The involvement of companies with technological know-how should be obtained. Any consortia must draw on the best technological resources available and may include, as appropriate, U.S.-based, foreign-owned, multinational companies.

For a copy of the report, contact the EIA's HDTV Information Center, 1722 Eye St., N.W., Washington, DC 20006; 202-457-4992.

## NASD holds service-management school

The 30th annual School of Service Management (SSM), held Jan. 28-31 by the National Association of Service Dealers (NASD), attracted 135 service business owners/managers from 29 states and Canada. Topics discussed in-

cluded negotiating skills, preparing a financial plan, planning for the future, hiring and firing, profitable product refurbishing, service contracts, computer and home office product servicing, and an explanation of laws important to service-business owners.

For more information about the SSM, contact NASD at 10 E. 22nd St., #310, Lombard, IL 60148; 312-953-8950.

## NAC offers PC-support class

National Advancement Corporation (NAC), a company that specializes in PC technical training, will begin offering a hands-on class on PC support. The 3-day class, titled "First-Line PC Support," is designed for the person who provides help on-site or by phone. It also targets PC users who would like to be more self-sufficient when their systems fail.

The class focuses on problem-solving with DOS, hard-disk format and software issues, use of software and firmware diagnostics, use of tools and programs that can prevent breakdowns, fault isolation skills and easy solutions to problems that might have generated a service call in the past.

Contact NAC at 2730-J S. Harbor, Santa Ana, CA 92704; 714-754-7110.

## ISCET honors electronics technicians

Electronics technicians were honored nationally on March 7 with the celebration on National Electronics Technicians Day. The day recognizes the role of electronics professionals as a human technological resource to the nation. It also recognizes the role of the certification program, which is sponsored by the International Society of Certified Electronics Technicians (ISCET). President George Bush saluted the high standards of performance and excellence maintained by professional technicians and by ISCET in its years of distinguished service to the electronics industry. He paid tribute to the vital part that electronics technicians play in helping to assure the country's continued technological and economic leadership as a formidable international competitor.

March 7 was set aside as a national testing day for certification of electronics technicians. For more information, contact ISCET at 2708 W. Berry St., Fort Worth, TX 76109; 817-921-9101.

The magazine for consumer electronics servicing professionals

# ELECTRONIC

Service & Technology

Electronic Servicing & Technology is the "how-to" magazine for technicians who service consumer electronics equipment. This includes service technicians, field service personnel and avid servicing enthusiasts who repair and maintain audio, video, computer and other consumer electronics equipment.

## EDITORIAL

Nils Conrad Persson, *Editor*  
 Carl Babcoke, *Consumer Servicing Consultant*  
 Tom Cook, *Senior Managing Editor*  
 Alisa Carter, *Associate Editor*  
 Pamela S. Fleener, *Editorial Assistant*

## CONSULTING EDITORS

Homer L. Davidson, *TV Servicing Consultant*  
 Christopher H. Fenton, *Circuit Fabrication Consultant*  
 Victor Meeldijk, *Components Consultant*  
 Kirk G. Vistain, *Audio Consultant*  
 Sam Wilson, *Electronics Theory Consultant*

## ART

Kevin Callahan, *Creative Director*  
 Barbara Miles, *Graphic Designer*

## BUSINESS

Cameron Bishop, *Group Vice President*  
 Eric Jacobson, *Group Publisher*  
 Greg Garrison, *Sales Manager*  
 Marcia Durrett, *Marketing Director*  
 Evelyn Hornaday, *Promotions Manager*  
 Kelly Hawthorne, *Promotions Coordinator*  
 Dee Unger, *Advertising Business Manager*  
 Catherine Grawe, *Advertising Coordinator*

## ADVERTISING

Regional advertising sales offices are listed in classified pages.

## ADMINISTRATION

R.J. Hancock, *President*  
 Chuck Rash, *Corporate Circulation Director*  
 Jane J. Powell, *Circulation Director*  
 Jo Ann DeSmet, *Fulfillment Manager*  
 Barbara Clare, *Reader Correspondent*



Member, Audit Bureau of Circulation



Member, American Business Press



Member, Electronic Servicing Dealers Association

## CORRESPONDENCE

Editorial, advertising and circulation correspondence should be addressed to: P.O. Box 12901, Overland Park, KS 66212-9981 (a suburb of Kansas City, MO); 913-888-4664. Home office fax: 913-541-6697. Home office telex: 42-4156 INTERTEC OLPK

**SUBSCRIPTION PRICES:** one year, \$19.49; two years, \$32.98 in the USA and its possessions. Foreign countries: one year, \$23.49; two years, \$36.98. Single copy price: \$2.50; back copies, \$3.00. Adjustment necessitated by subscription termination to single copy rate. Allow 6 to 8 weeks for new subscriptions.

**PHOTOCOPY RIGHTS:** Permission to photocopy for internal or personal use is granted by Intertec Publishing Corp. for libraries and others registered with Copyright Clearance Center (CCC), provided the base fee of \$2 per copy of article is paid directly to CCC, 21 Congress St., Salem, MA 01970. Special requests should be addressed to Eric Jacobson, publisher. ISSN 0278-9922 \$2.00 + 0.00

Electronic Servicing & Technology (ISSN 0278-9922) is published monthly for \$19.49 per year by Intertec Publishing Corp., 9221 Quivira Road, Overland Park, KS 66215. Second-class postage paid at Shawnee Mission, KS and additional mailing offices. POSTMASTER: Send address changes to ELECTRONIC SERVICING & TECHNOLOGY, P.O. Box 12960, Overland Park, KS 66212.

©1989 All rights reserved.





# There is no smarter choice than Philips ECG.

## Keep equipment in top shape with Philips ECG's top of the line Audio/Video products.



The best performance from any piece of equipment. The line-up that delivers it looks like this:

- To measure and adjust frequency response of audio tape decks, the AR20 frequency response cassette
- To accurately adjust audio tape running speed and record/playback head alignment, the AR30 speed and adjustment cassette
- To observe tape travel path in the VCR, the Video tape path view cassette
- To measure torque in play or fast forward/rewind modes, the Video torque meter cassettes

Contact your Philips ECG distributor or call 1-800-225-8326. It just might be the smartest call you make all week.

Circle (6) on Reply Card

The Smart Choice.  
**Philips ECG**

A North American Philips Company

## Philips ECG's Cable Converter brings in the signal loud and clear!



- The TV 2000 adapts any TV set to cable ready
- Remote control adjusts volume, turns TV on/off, has direct channel selection and channel stepping
- Receives up to 139 VHF, UHF and cable channels
- Separate video and audio outputs for direct connection to VCR and stereo systems
- Stores up to 12 user-selected channels for quick selection

Contact your Philips ECG distributor or call 1-800-225-8326. It just might be the smartest call you make all week.

Circle (32) on Reply Card

The Smart Choice.  
**Philips ECG**

A North American Philips Company

## Philips ECG's Master Guide gives you all the replacement semiconductor information you'll ever need.



For speed, accuracy and ease-of-use, nothing beats the Philips ECG® Master Guide!

- Contains technical data for 4000 Philips ECG semiconductors that replace over 240,000 industry part numbers
- Contains the most accurate cross-references available.
- New edition has 13,000 additional cross-references and 230 new devices

All this, all in one book. Contact your Philips ECG distributor or call 1-800-225-8326. It just might be the smartest call you make all week.

Circle (33) on Reply Card

The Smart Choice.  
**Philips ECG**

A North American Philips Company

## Philips ECG's PR60 & PR200: The smart answer to your scope probe needs.

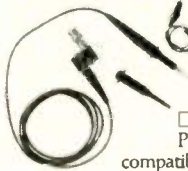

Whether you're an engineer, technician or a hobbyist, we've got the popular scope probes you're looking for. Each features X1 and X10 attenuation, a switchable ground reference, and 360° rotatable ground clip.

- The PR60 has a 60 MHz bandwidth, the PR200 has a 200 MHz bandwidth and both are compatible with most popular oscilloscopes
- Both models are supplied with a retractable hook. The PR200 also comes with an IC tip, BNC adapter and insulating tip

Contact your local Philips ECG distributor or call 1-800-225-8326. It just might be the smartest call you make all week.

Circle (34) on Reply Card

The Smart Choice.  
**Philips ECG**

A North American Philips Company

## ECG® DM-76 Auto-Ranging Digital Multimeter: The smart choice for value!

ECG DM-76 Multimeter is accurate, priced right and packed full of features. Here's what you get:

- Auto or manual range selection
- 0.5% basic accuracy
- 3½ digit LCD with range indicator
- Data hold
- 20 megohm full scale
- Transistor hFE
- Diode V<sub>F</sub>
- Audible continuity test

Accuracy! Value! All the features you need! Contact your ECG products distributor or call 1-800-225-8326. It just might be the smartest call you make all week.

Circle (35) on Reply Card

The Smart Choice.  
**Philips ECG**

A North American Philips Company

## Ensure pinpoint accuracy with the ECG® DM-410 Multimeter.

The ECG DM-410 4½ digit multimeter ensures a level of accuracy that's hard to beat! And it's loaded with features:

- 0.05% basic DC accuracy
- 7 functions, 26 ranges
- Data hold
- 10 amps AC/DC
- Audible and visual continuity tests
- Measures down to 0.01 ohms
- RF shielded
- Diode test

Contact your ECG products distributor or call 1-800-225-8326. It just might be the smartest call you make all week.

Circle (36) on Reply Card

The Smart Choice.  
**Philips ECG**

A North American Philips Company

# Digital scopes with a

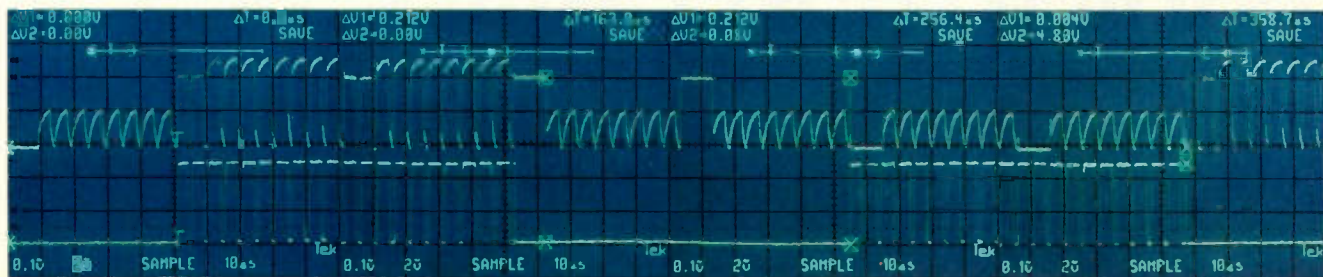

## Give up real-time capability for storage? Not with Tek!

That's because analog capability is integral to low-cost Tek digital storage oscilloscopes. So you need only one instrument to make all your measurements efficiently. With no trade-offs.

It's another Tek advantage: analog and digital in one familiar, affordable package.

Select either mode at the push of a button.

With digital storage you can capture events which are difficult if not impossible to see on conventional scopes.

Pre and post trigger events. Fast transients.

Single-shot events.  
Elusive glitches.  
Low-speed phenomena.

*Four screen photos spliced end to end illustrate the benefit of full four-screen capture using the 2230's 4K record length.*

Any waveform can be viewed for as long as you like. Or stored in 4K of memory for later analysis or comparison to other waveforms. And if there's a question about a digital measurement, just push a button for real-time display analysis.

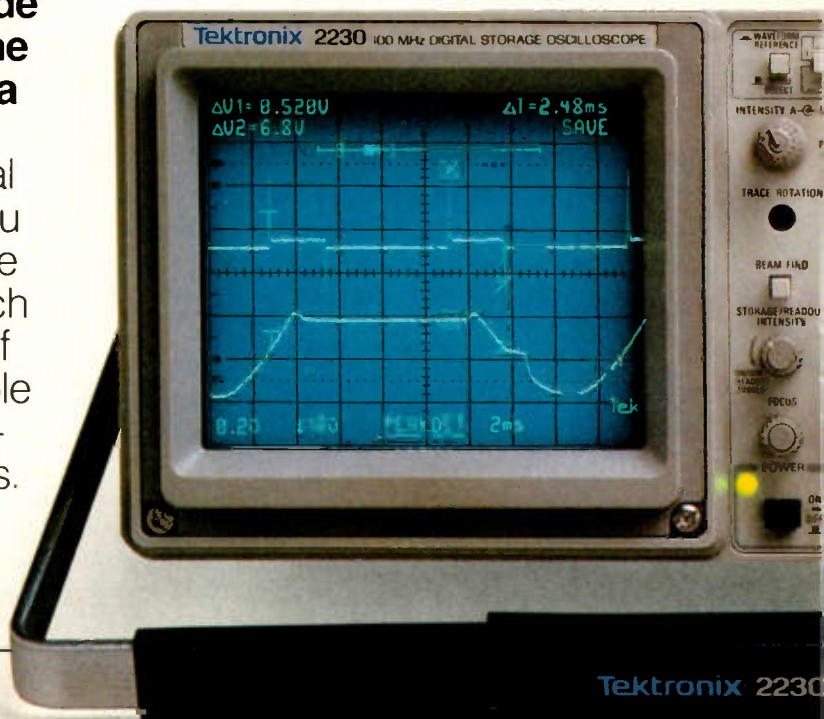



# real-time advantage.

## The affordable portables.

These are the world's best-selling digital storage oscilloscopes. And with the new 20 MHz Tek 2201 joining the family, there's now an even better selection—in bandwidth, performance and price.

Select for advanced features such as 100 ns glitch capture at any sweep speed, CRT readout, measurement cursors, multiple acquisition modes and hardcopy output, plus optional GPIB or RS-232-C interfaces and software.

These scopes are perfect for first-time digital users. And seasoned operators will appreciate even more their versatility, convenience and value. All backed

Features	2230	2221	2220	2210	2201 <sup>NEW</sup>
Bandwidth	100 MHz	60 MHz	60 MHz	50 MHz	20 MHz
Max. Sampling Speed	20 MS/s	20 MS/s	20 MS/s	20 MS/s	10 MS/s
Vertical Resolution	8-12 bits	8-10 bits	8 bits	8 bits	8 bits
Record Length	1K/4K Selectable	4K	4K	4K	2K
Glitch Capture	100 ns	100 ns	100 ns	No	No
CRT Readout/Cursors	Yes	Yes	No	No	No
GPIB/RS-232-C Options	Yes	Yes	Yes	No	RS-232-C Hardcopy
Warranty	3-years on labor and parts including CRT				
Price	\$4995	\$3995	\$2995	\$2395	\$1495



*Each scope offers a range of capabilities you'd expect to find only in much more expensive instruments.*

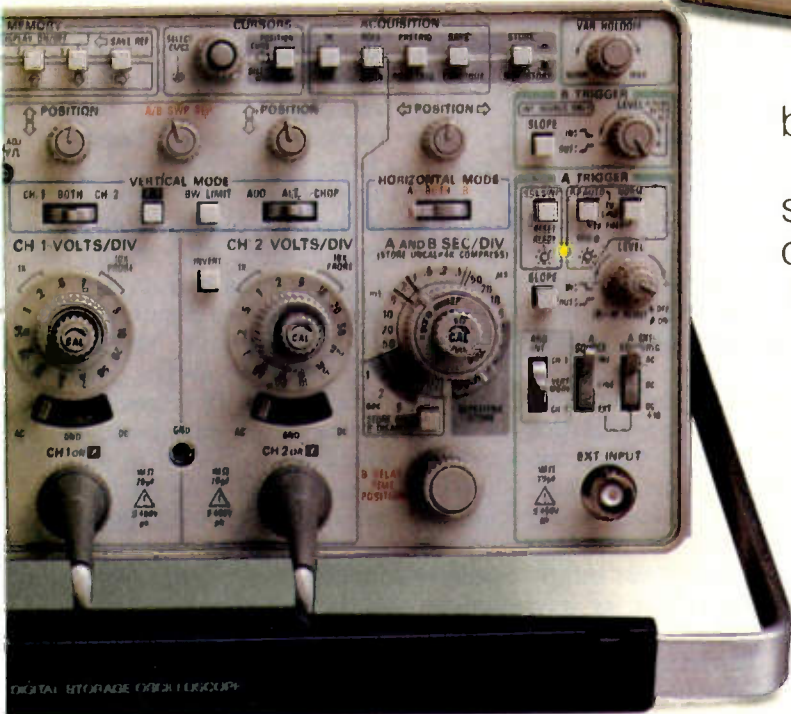

by Tek quality and a 3-year warranty. Discover the potential. Let Tek show you what you're missing... without making you give up analog to see it. That's the real-time advantage of Tek digital storage.

For easy ordering or more information call Tek Direct:

# 1-800-426-2200



**Tektronix**  
COMMITTED TO EXCELLENCE

Circle (7) on Reply Card



# Dealing with customer complaints

By William J. Lynott

If you do much business reading, you are undoubtedly aware of a new family of books available today. I'm talking about all those books that attempt to analyze the reasons why some businesses are so successful while others barely stay alive or even fail.

The trend probably got started with the publication of the excellent Peters/Waterman work, "In Search of Excellence." Since that book was published in 1983, a long string of others have followed. Some are quite good; others are not so well done. But I've noticed one important thread of continuity that runs through all of them.

Without an exception that I could find, every one of these authors attributes outstanding business success, at least in part, to management's understanding of the value of customer satisfaction. As one author described the philosophy of an extremely successful company and its employees: "An almost fanatic dedication to keeping customers happy."

The shrewdest service dealers I know have come to understand that all this talk about customer satisfaction is not just window dressing. There is, in fact, a direct and dramatic connection between financial success in business and an unrelenting policy of customer satisfaction.

There is no room for question about that. It is now so well-documented that even the best business schools in the country are teaching it.

But you don't have to spend time in the classroom to learn it. All you have to do is remember that keeping customers pays off on the bottom line. And nowhere is this more true than in the service business.

But what does it take to keep customers happy?

I've never met a service dealer yet (and I know hundreds) who didn't openly proclaim unshakable belief in the importance of customer satisfaction. After all, it would sound pretty silly for someone in the service business to say he didn't care about his customers.

I can tell you, though, that in the real world, only a small percentage of service dealers are truly willing to do whatever it takes to win back an unhappy customer. In actual practice, most service executives have developed negative attitudes about complaining customers, and these attitudes are clearly reflected in the attitudes of their employees. The most unfortunate part of all this is that almost no one — even the worst offenders — recognizes this situation in his own business.

The fact is that resolving most customer complaints calls for an investment: always an investment in time and usually an investment in money. This is where so many opportunities are lost.

All major studies of customer complaints that I've seen show several important facts. First, only a tiny percentage of unhappy customers ever bother to complain to the offending company. Some experts feel that as few as 1% of dissatisfied customers ever register their complaints. That means that those customers who do tell you about their problems are providing extremely valuable feedback about what's happening out there.

Second, recent studies are now showing that customers with complaints that are fully resolved to their satisfaction *become better customers of the company than they were before the incident that triggered their complaint*. As you might expect, unresolved complaints usually result in permanent loss of that customer's business.

Now consider the cost of obtaining a new customer. If you haven't done it before, a look at this cost for your business may startle you. To get an idea,

divide your total advertising expense for a year by the number of *new* customers that can be attributed to your advertising (exclude any customers that came to you by referral). If you don't have the records to support this type of analysis, keep this figure in mind: Separate industry studies indicate that it costs approximately five times as much for a business to obtain a new customer than it does to keep a present customer.

By now you've got the idea. Your present list of customers is one of your most valuable business assets, perhaps the most valuable of all. Each and every customer on your list adds to that value, so doing everything within reason (and sometimes beyond reason) to keep a customer from straying to your competitor is nothing more than sound business practice.

None of this is schoolbook theory. It is simple business economics supported by the experiences of countless successful business persons. To put it simply, there is no better insurance policy against business failure than a long list of happy customers.

Unless a service dealer clearly understands the forces that are at work when a customer complains, he is likely to balk at the costs involved in settling some tough complaints. After all, the expense for doing a repair over again or in some other way giving a customer something that doesn't appear "justified" is real and immediate. The reward for doing it is usually delayed for a while and is hard to measure directly.

That's why so many people in the service business miss out on the unqualified success that comes to those who will go to almost any length to satisfy a customer. The rewards may be a little slow in coming, but they do come. And they are very real.

You may want to keep all this in mind when you are dealing with your next "unreasonable" customer.

ES&T

Lynott is president of W.J. Lynott, Associates, a management consulting firm, and publisher of the Service Dealer's Newsletter.



# GoldStar

## THE GOLD STANDARD IN PRECISION ELECTRONICS

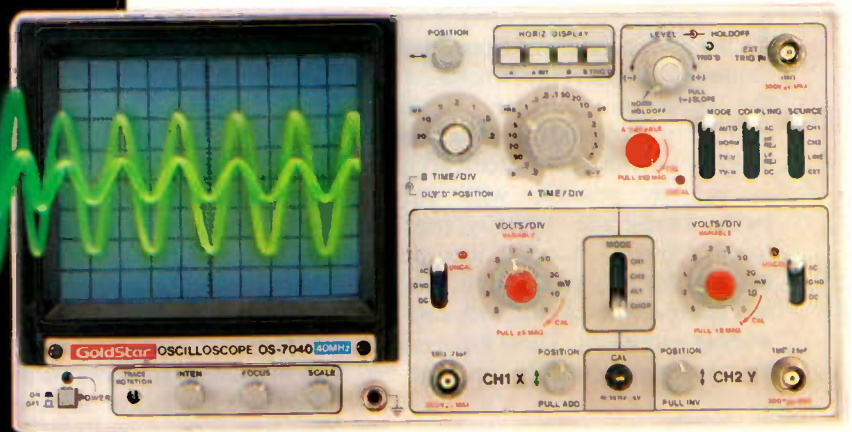
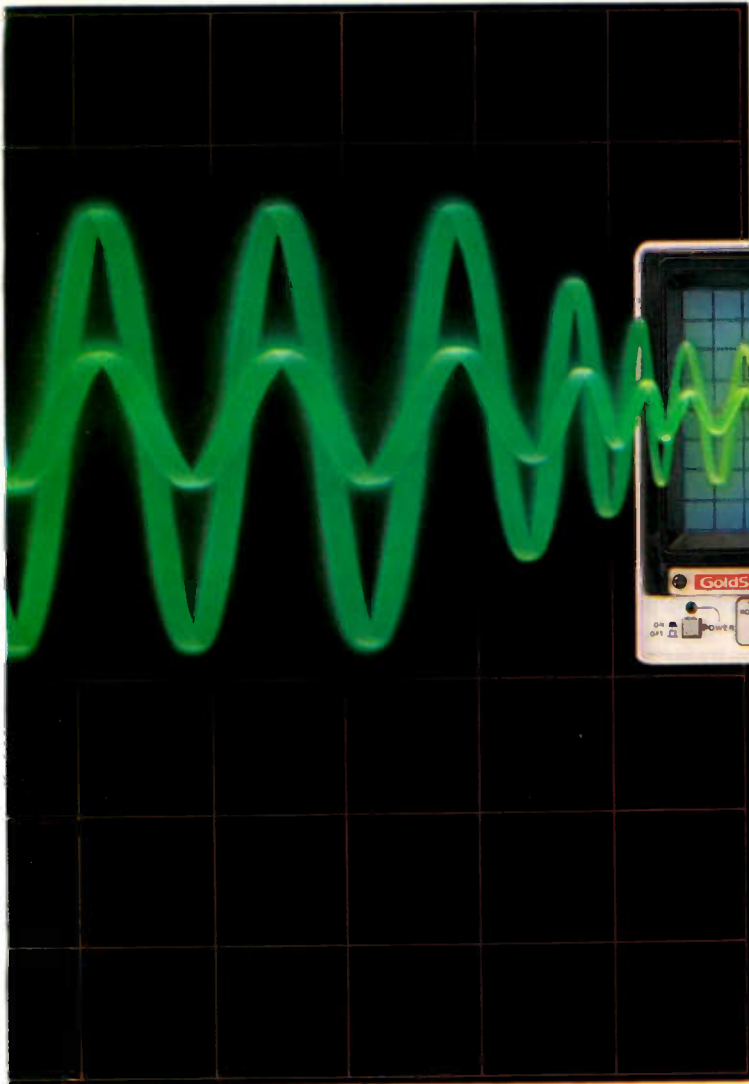

### Model OS-7040

- 40MHz Dual Trace.
- Delayed Sweep.
- TV Sync. Separation circ. it.
- High Sensitivity X-Y mode, Z-axis (intensity modulation)

Precision. The essential quality for all measuring and testing instruments. Goldstar. The name that has come to mean value in over 80 countries around the world.

Goldstar Precision manufactures a complete line of reliable measuring and testing instruments, including:

- oscilloscopes
- function generators
- analog multimeters
- power supplies
- signal generators
- digital multimeters
- frequency counters

In the field or at the bench, these instruments offer the precision technology you need. And the value you've come to expect from Goldstar. Goldstar measuring and testing instruments. Precision at the right price.

### Model OS-7020

- 20MHz Dual Trace.
- TV Sync, Separation circuit.
- High Sensitivity X-Y mode, Z-axis (intensity modulation)



## GoldStar Precision

13013 East 166th Street, Cerritos, Ca. 9071  
 Tel.: (213) 404-0101 Tlx.: (910) 583-5719 LGILA  
 Fax.: (213) 926-0849, 404-0132

Circle (8) on Reply Card

LUCKY GOLDSTAR



Streamline your TV servicing:

# Waveform analysis with professional-grade oscilloscopes

By John R. Albright

In the past, precise waveform analysis required specialized instruments such as the spectrum analyzer. However, relatively sophisticated waveform analysis — with microsecond accuracy — is now possible with only a professional-grade oscilloscope. The latest “smart” scopes incorporate features that help you capture, measure and interpret waveforms with ease and without guesswork. These features used to be found primarily on high-end

laboratory instruments such as waveform analyzers.

The new scopes are particularly useful for examining microsecond timing relationships. For example, in video applications, critical timing relationships include intervals between horizontal trace and retrace or sync and color burst. Other examples include VCR head-switching and blanking times. Accuracy in microsecond ranges generally is needed for these measurements. However, consistent accuracy in these ranges with a conventional scope is difficult because you must estimate the magnitude and duration of waveforms

visually. In the new scopes, visual estimation and interpolation are eliminated: Removable cursors provide on-screen readouts of amplitude and time values.

## Features of conventional scopes

You'll need a good working understanding of the limitations of conventional scopes to appreciate the new enhancements. The basic function of any oscilloscope is to display variations in voltage over a time base. The result is shown as a curve, or *trace*, on a graphic coordinate grid (also called a *graticule*) on the face of a CRT. The vertical dimension, or Y axis, is the voltage component; the horizontal dimension, or X axis, is the time base, which proceeds from left to right.

An oscilloscope is a passive test instrument, measuring voltages within powered circuits. To conduct certain types of waveform analysis, a separate signal generator or video analyzer may be used to inject test signals.

Scopes for service applications generally have been available in single- and dual-channel models. A single-channel scope can accept the input and display the trace from one source. A dual-channel scope can display two signals on two traces at the same time.

With a conventional scope, the actual measurement of the waveform must be done visually by the operator. You must count the graticule divisions along the trace and multiply by the time base setting to measure the time interval. The TIME/DIV control determines the value of each increment on the X axis of the display. Typical sweep ranges are 0.05 $\mu$ s to 0.5s per division.

To get voltage readings, you must estimate the height of a portion of the trace and multiply by the voltage range you have selected. The VOLT/DIV control determines the value of each increment on the Y axis of the display. On

Albright is product manager of service test instruments at Beckman Industrial, Instrumentation Products Division.

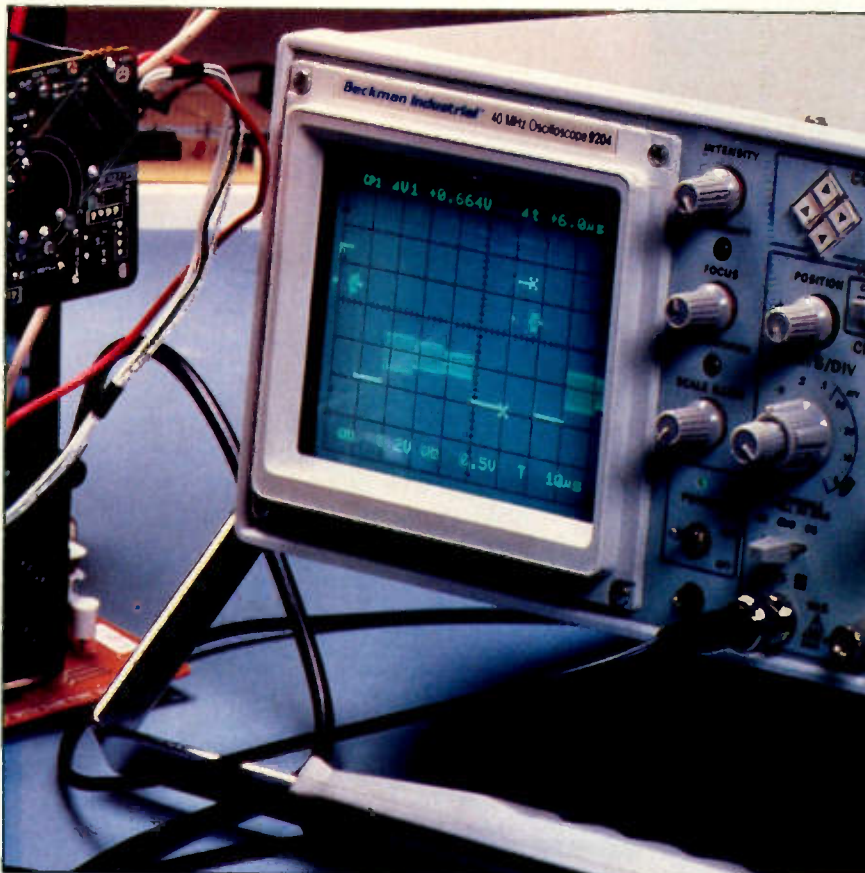

Modern oscilloscopes with cursors and numeric readout allow sophisticated waveform analysis of waveforms without other test equipment. This makes troubleshooting easier and more precise.



a dual-channel scope, two controls will be found, one for each source/channel. Typical ranges are 5mV to 5V per division.

It's the process of visual estimation and interpolation that makes it difficult to obtain consistently accurate readings with conventional scopes, especially when you're working in microsecond ranges, where even apparently small increments can make a big difference. It's also tricky to isolate portions of a waveform for close-up examination. For this purpose, oscilloscopes with two independently adjustable sweep generators are useful. A small section of a waveform can be selected for closer examination by adjusting the channel B sweep-time and delay-time controls while observing an intensified portion of the waveform. The intensified section can then be expanded across the screen with the press of a button. This kind of close-up examination is very useful for measuring pulse rise times and details of composite video signals, such as horizontal sync or color bursts.

A basic characteristic of all scopes that affects price is *bandwidth*, or the range of frequencies to which the scope can respond. Wideband scopes with bandwidths of 100MHz or greater are relatively expensive, but may be necessary for some RF applications and for analysis of high-speed digital circuits.

#### Working smarter with the new scopes

The new scopes remove the potential inaccuracies and guesswork of using a conventional scope by incorporating advanced features previously found only in waveform analyzers. These advanced waveform analysis features include:

- selection and comparison.
- numeric measurement and display.
- waveform photography.
- calculations and conversions.
- other modes and capabilities.

Each of the new scopes offers a different set of features to address specific sets of application requirements.

**Selection and comparison.** A major challenge with conventional scopes is just being able to home in on the portion of the waveform, or trace segment, that you want to examine. To facilitate comparison of waveforms, modern scopes all have dual-channel capability. Some can display and manipulate multiple traces in three channels.

**Numeric measurement and display.** Selection and comparison are enhanced with on-screen numeric readout features on some of the new models. With an innovative set of cursor controls (see the photo top right), you can move pairs of markers on the screen to indicate specific portions of traces for measurement. The marker or *cursor* on the left side is called the reference cursor; the one on the right is the delta cursor.

The reference cursor is placed at the most negative value at the beginning of a time interval. The delta cursor is moved to the maximum vertical position and rightmost time. Once a portion of a trace has been selected in this way, the scope presents a numeric readout of corresponding parameters along the top of the screen. For the portion of the trace selected, the display shows time (in seconds) and amplitude (in volts) of the trace between the cursors. Or, at the press of a switch, the numeric readout format may be changed to show frequency in hertz. The display also may show phase shift in degrees or duty cycle in percent. The front-panel settings of VOLTS/DIV and TIME/DIV are shown at the bottom of the screen.

To facilitate comparisons further, a memory function permits storage of two pairs of cursors. Each cursor in each pair can be moved separately, or the pair can be manipulated together, in eight

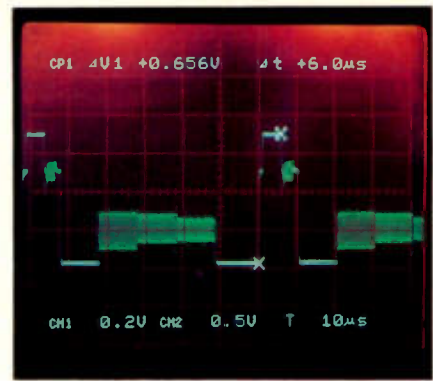

On-screen cursors and numeric readout on some of today's oscilloscopes allow a technician to determine amplitude and time information on a waveform with precision. Illuminated graticules provide an improved graphic representation of the waveform's parameter.

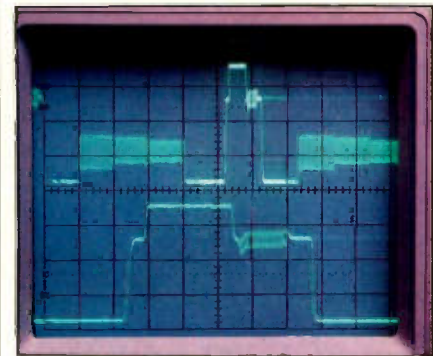

A dual-trace oscilloscope with dual time base allows the operator to observe both the waveform and an expanded portion of it for more detailed analysis.



Waveform photography, made easier with a camera bezel on the scope, makes it possible to save waveform information for further study or future reference.

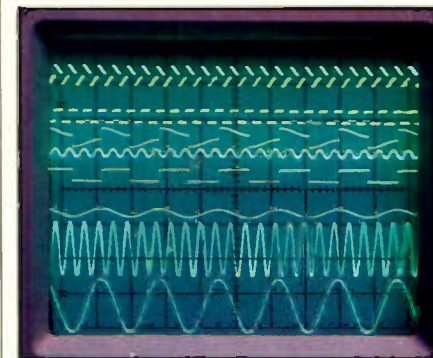

A three-channel scope allows simultaneous display of eight different traces.



different directions. This scheme represents an advance over previous on-screen cursor systems, which used dashed lines as markers. With two pairs of X symbols for selecting reference and delta points, it becomes possible to take simultaneous readings of either voltage and time or voltage and frequency.

**Waveform photography.** Cursor control and on-screen numeric readout have an important side benefit — greatly increasing the information that can be recorded through waveform photography. Without on-screen numeric display, a photograph would show only the trace itself (or pair of traces). You would then have to record your estimated measurement by marking it manually on the border or on the back of the photograph. To fully document the photograph, you would also have to record the VOLT/DIV and TIME/DIV settings. With the new on-screen display features, all these parameters will be shown in the photograph.

Other features that make it easier to photograph the CRT include special camera-mount CRT bezels, which are standard with the new scopes. In the past, only laboratory instruments provided built-in camera-mount hardware.

Photography is an excellent way to capture and analyze transients. This approach is facilitated by a single-sweep mode that captures one-shot events. You can also be sure that the graticule on the screen will show up in the photograph. The graticules on the new scopes are etched on the inside of the screen faceplate. Illumination of the graticule is variable so that you can achieve just the proper exposure.

Manufacturers apparently have believed that service technicians are less

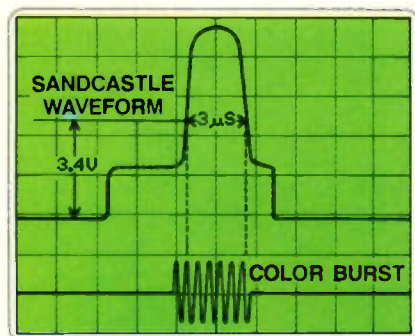

**Figure 1.** With an ideal sandcastle waveform, if the sandcastle timing is to spec and the pulse width is  $3\mu\text{s}$ , the  $3\mu\text{s}$  should bracket most of the burst signal.

interested in waveform photography than are the users of high-end laboratory oscilloscopes. However, it may just be that photography has been used more rarely in service applications simply because it's been cumbersome and inconvenient. With the new scopes, there's no reason not to keep a permanent record of problematic waveforms for future reference.

**Calculations and conversions.** The benefits of microprocessor control in the new scopes, of course, are readily apparent in the models that have the on-screen numeric readout feature. With this numeric readout, interpolation is eliminated entirely. Furthermore, the ease of precise cursor positioning means that you can be sure that the measurement reflects a specific segment of the trace.

The internal microprocessor is also used for conversions from time to hertz, as well as calculations of phase shift and duty cycle.

**Other modes and capabilities.** As mentioned previously, one new scope model offers three separate channels. This scope can actually display up to eight traces simultaneously.

Scope triggering, so crucial to achieving stable displays, has also been improved significantly. Selection of trigger mode determines what condition starts the horizontal sweep to display the voltage waveform. The trigger signal can be from an external source or can be derived from the input channels (internal triggering). An automatic mode displays a base line even without a signal

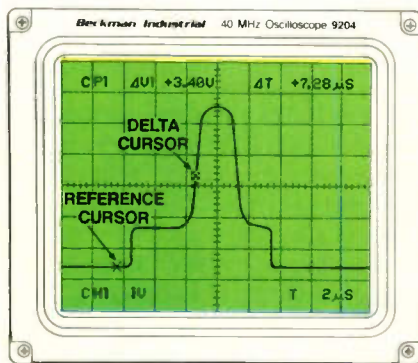

**Figure 2.** To assure that the sandcastle is operating at spec, you must measure the pulse width at a specified amplitude (3.4V in this case). The reference cursor should be at the leftmost point on the baseline. The delta cursor should be positioned on the left slope of the trace until the on-screen numeric display shows 3.4V.

being present. In normal mode, triggering level is continuously adjustable through both positive and negative slopes of a signal. Selectable trigger coupling includes special settings needed in some applications, such as ac, dc, AC-LF Reject and TV. A variable hold-off control can be used to obtain a stable display when you are measuring periodic or complex signals.

Of particular interest to video technicians, a special TV trigger coupling mode uses a sync separator circuit to lock in on the horizontal or vertical sync pulses in a composite video signal. Horizontal or vertical sync selection is done automatically with the TIME/DIV adjustment.

An auxiliary signal output (channel 1 output) is available for convenient connection of frequency counters, recorders or other instruments to the scope. This feature lets you use just a single set of probes in the circuit and reduces clutter on the bench.

Finally, the new scopes are available in multiple bandwidths, at prices that are competitive with conventional oscilloscopes intended for service applications. Bandwidths of 20MHz, 40MHz and 60MHz are available, and a 100MHz model is expected to be announced later this year.

#### Application: analyzing the sandcastle waveform

An example of a complex waveform that can be analyzed much more readily with the new scope technology is the sandcastle pulse (see Figure 1), which is common in color TV circuitry. You would want to study this waveform if you noted no color signals at the outputs of the IC that controls

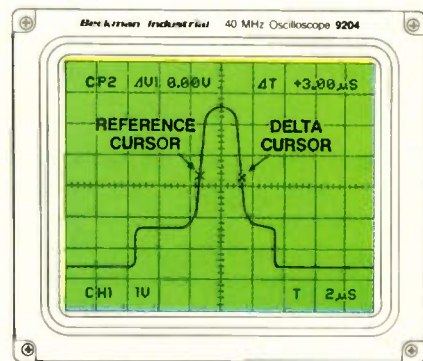

**Figure 3.** To measure the pulse width, you would move the reference cursor to the 3.4V point, then move the delta cursor to the lagging edge of the pulse. The on-screen time reading corresponds to the pulse width.



luminance/chroma. Because the sandcastle is a complex signal of only  $11\mu\text{s}$  duration, it's very difficult to troubleshoot with a conventional scope.

The sandcastle can be at the root of the color problem because it is so critical to the proper operation of the color IC. The sandcastle signal is an input to the IC that is a composite of three separate parameters: flyback pulse, delayed horizontal sync pulse and vertical blanking pulse. The IC separates the pulses. Horizontal blanking is derived from the flyback pulse for the output buffer amplifiers. Color burst is separated from the "back porch" of the horizontal blanking interval by the delayed sync pulse. Vertical blanking is provided by the sandcastle's vertical pulse. If the parameter of any of these pulses are only slightly off spec, problems can arise.

Troubleshooting the sandcastle is straightforward with one of the new scopes that has cursor control and on-screen numeric display. To assure that the sandcastle is operating at spec, you must measure the pulse width at a specified amplitude, as in the following example, in which the set manufacturer specifies measuring the pulse width at 3.4V.

Once you have the sandcastle trace on the display, you direct the reference cursor to the leftmost point on the baseline with the cursor control buttons (arrow keys). You then position the delta cursor on the left slope of the trace until the on-screen numeric display shows 3.4V. The correct positions of the reference and delta cursors are shown in Figure 2. To measure the pulse width, you can use the second set of cursors, as shown in Figure 3. You move the reference cursor to the 3.4V point, then move the delta cursor to the lagging edge of the pulse. The on-screen time reading corresponds to the pulse width, which should be  $3\mu\text{s}$  at this point.

If the sandcastle timing is to spec, the  $3\mu\text{s}$  should bracket most of the burst signal. This relationship can be verified by viewing the burst signal with channel 2.

If any characteristics of the sandcastle pulse are shown to be incorrect with this procedure, you can expand and analyze segments of the trace using the B time base. Of course, if there are any anomalies in the trace, you must go back to the circuit that generates the sandcastle and continue your analysis there.

**ES&T**

# Hot line.



Call PTS 800 Express toll free. Order direct from the world's largest inventory of quality replacement parts for T.V.'s and VCR's. One convenient source. All makes. All models. Quality backed by the industries best warranty. Just say "charge it". Call today to order or to receive your free replacement parts catalog.

**NEW**  
**DTS™ 800 EXPRESS**

**1-800-333-PTS1**



Circle (9) on Reply Card

# Test your electronics knowledge

By Sam Wilson, CET

1. Which of the following statements is correct?

- A. Choose an antenna with a very high antenna resistance in order to get low noise delivered in a receiver.
- B. The amount of noise power delivered to a receiver is not affected by antenna resistance.
- C. Choose an antenna with a very low antenna resistance in order to get low noise at the input of a receiver.

2. Which of the following statements is correct?

- A. The greater the bandwidth, the greater the noise power delivered to a receiver.
- B. The greater the bandwidth, the lower the noise power delivered to a receiver.

3. The crystal-controlled frequency of  $f$  in Figure A is 2.7MHz. If  $N1$  equals 9 and  $N2$  equals 3, what is the output frequency at VCO?

*Wilson is the electronics theory consultant for ES&T.*

4. Name two motors that have speeds directly related to the frequency of the applied power.

5. In which of the following types of circuits would you expect to find a startup circuit?

- A. Power amplifier
- B. Armstrong oscillator
- C. Hall effect sense circuit
- D. Power supply

6. Which of the following vacuum tubes has an undesirable negative resistance characteristic?

- A. Tetrode
- B. Nuvistor
- C. Frame grid pentode
- D. Beam power amplifier

7. Which of the following would be useful for defeating an AFC circuit?

- A. High-power amplifier
- B. Low-pass filter
- C. Voltage amplifier that uses long tail bias
- D. A dc power supply

8. Which of the following is true?

- A. Using the proper circuitry, you can get a sine wave out of a Class B amplifier.
- B. A Class B amplifier has a high output distortion. It cannot be used to obtain a sine wave voltage.

9. In a series L-R circuit, doubling the resistance of R will:

- A. double the time constant of the L-R combination.
- B. not affect the time constant of the L-R circuit.
- C. reduce the time constant of the L-R circuit to half its original value.

10. Which of the following is the way more playing time is obtained for a given VCR tape system?

- A. The speed of the heads is increased.
- B. The speed of the heads is decreased.
- C. The speed of the heads is not changed to get more playing time. The speed of the tape is changed.

*Answers are on page 64.*

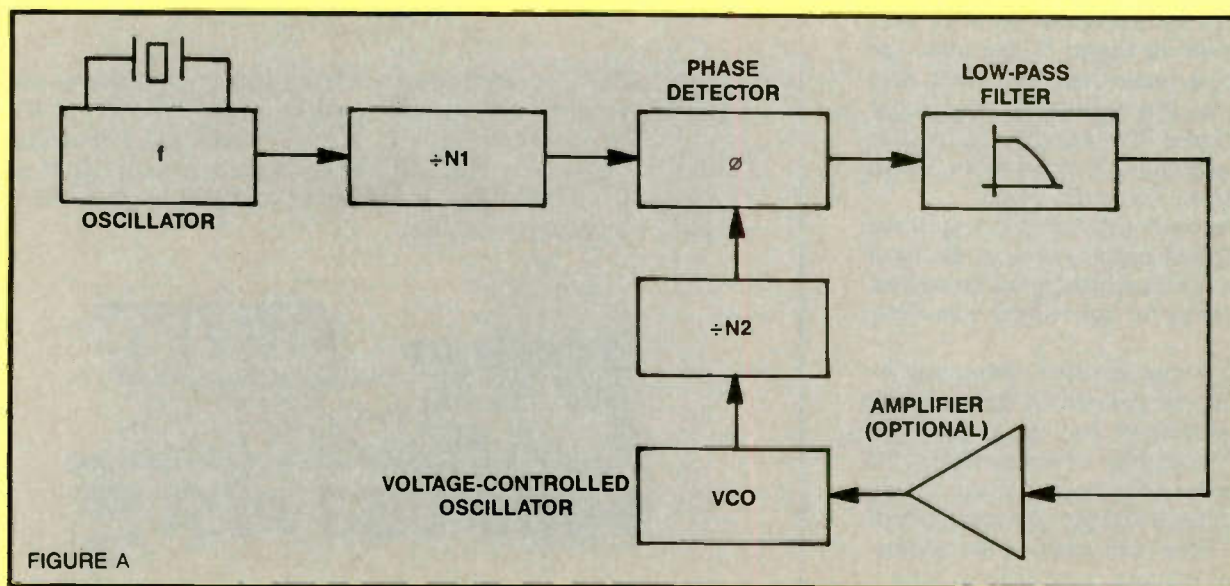

FIGURE A



## HIGH PLACES



## TIGHT SPACES



# No matter where you go, Tek's new 222 is a perfect fit.

Introducing Tek's new 222 Digital Oscilloscope. Weighing in at under 4.5 pounds, the new Tek 222 is an ultra-portable, 10-MHz digital storage scope that's perfect for service applications. So tough, rugged, and totally self-contained, it can go just about anywhere. And it's incredibly easy to use—even in extreme conditions.

Extraordinary capability and reliability at a great price. The 222 is a dual-channel scope that can measure a wide variety of electronic instrumentation and circuitry. It has rechargeable on-board batteries with a floating ground to 400 volts, and meets tough environmental standards.

Plus, the 222 lets you pre-define front-panel setups, and call them up with a single button in the field. You can also save waveforms in the scope's memory, then transfer them to a PC for analysis and hard-copy output when you get back to the shop.

Best of all, the 222 is yours for only \$2350. And that includes Tek's remarkable three-year warranty on parts, labor, and CRT.

Get one to go! Pack a handful of power with you wherever you go. To order your 222, or for a free brochure, contact your local Tek representative or authorized distributor.

In a hurry? Call  
1-800-426-2200.



Circle (10) on Reply Card



# A magneto-optic mass storage system

Canon U.S.A. has announced the full-scale production of a high-speed writing, erasing and transferring magneto-optic (M-O) mass storage system for advanced computer work stations. The system includes disk drive and cartridge media, and shipments already have been made to its first OEM customer. The system has been used in the recently introduced NeXT computer, in which the M-O drive takes the place of the conventional floppy disk drive and magnetic hard disk.

## The media

The M-O system's media, which the company calls "exchange coupled" or "Canon EC type," is produced with proprietary technology involving continuous thin-film, multilayered processing. The media — two M-O layers composed of rare earth/transition metal amorphous alloy — is based on a concept that separates contradictory functions into two layers. The first layer provides high-speed writing and erasing. Information recorded on the first layer is transferred to the second layer, which provides good reading performance.

## Specifications

In addition to its media being

erasable, the system's disk drive has a rotation rate of 3,000rpm, which can be reached using a middle-powered diode laser of 35mW that assures both long life and low cost compared to higher-powered diode lasers. This fast rotation rate boosts high throughput erasing, reading or writing.

The magnetic strength of the media is at least 20 times higher than that of magnetic hard disk and tape recording media, according to the company. The Canon media provides data integrity for more than 10 years without rewrite of data.

## Advantages of the system

The rapid growth of desktop publishing, engineering workstations and 32-bit CPU technology has created a huge demand for a mass storage system that fulfills such requirements as random access, removable media, high storage capacity and low bit cost. Floppy disks and magnetic tapes have some limitations: Floppy disks fail for limited memory capacity and are vulnerable to environmental conditions; magnetic tape doesn't permit random access.

In addition to having optical disk storage densities about 10 times those of magnetic hard disk storage, the M-O

system's reading, writing, erasing and rewriting functions are not impaired by dust or scratches on the disk surface. Therefore, the media cartridge can be easily removed from the drive and transferred without special handling.

Other storage approaches, such as compact disc, laser disk and CD-ROM, offer read-only capability. Although write-once, read-many (WORM) storage has been commercialized, acceptance has been limited to applications involving archiving and filing of documents.

## Potential applications

Canon anticipates many applications for its M-O system, including use as a system disk for computers (already a reality with the NeXT application); for electronic document filing and medical image filing; as a buffer for image processing; as storage for CAD/CAM systems; as a video disk, digital audio disk (DAD) or electronic album; and as a replacement of magnetic tape.

More than 1,000 patents have been applied for on the media technology, and several basic patents for the media have been allowed in seven countries. To assure efficient and low cost media production, Canon had to design and build its own mass-production equipment. It also developed all of the other related technologies within the company, including the optical head, drive mechanism and disk controller.

Canon will market the entire M-O mass storage system and media to original equipment manufacturers for high-performance personal computers and workstations, or it will sell only the media to existing M-O drive manufacturers.

Components of the Canon M-O rewriteable mass storage system include an OM-500D disk drive unit, an OM-C10 SCSI controller and an OM-X131/132 disk cartridge. The 132 has two formatted sides or a 512MB capacity; the 131 has one formatted side or 256MB.

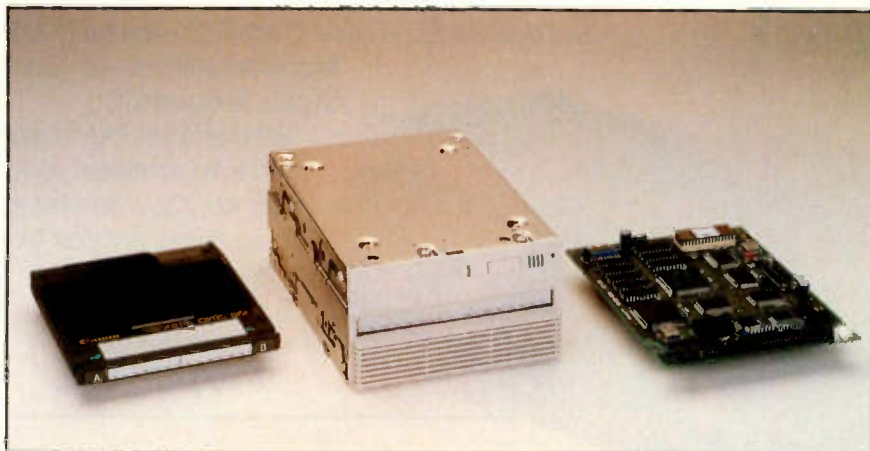

The magneto-optic rewriteable mass storage system includes a disk cartridge, a disk drive unit and an SCSI controller. Some advantages of the system are an erasable disk cartridge, a 3,000rpm rotation rate and a 10-year data integrity.



DO IT BY THE BOOK!

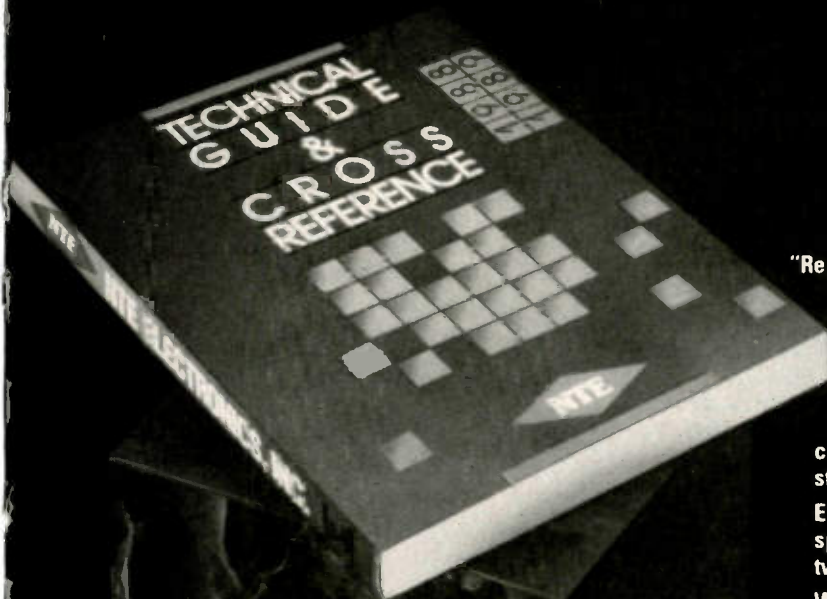

"Replacitivity" is the science of getting things up and running again. And nothing helps accomplish it faster, easier and with more confidence than the new 1988-1989 NTE Technical Guide and Cross Reference — now the standard directory for technicians everywhere! It lists more than 230,000 original devices cross-referenced to 3,400 top of the line NTE universal replacement parts. Semiconductors, flameproof resistors, capacitors, wire ties, and static control products.

Each is quality tested to assure it meets or exceeds OEM specifications. And all NTE parts are backed by an exclusive two-year warranty.

Whether you order 1 or 100 NTE parts you'll discover they are readily available, limiting downtime to a minimum.

For your copy of the 1988-89 NTE Technical Guide contact your local NTE distributor, or simply fill in the coupon below and send it to us today with a check or money order for \$3.25 each.

**NTE**

**NTE ELECTRONICS, INC.**

A WORLDWIDE REPUTATION FOR QUALITY, SERVICE AND VALUE

For the name of your nearest NTE distributor, call NTE toll free:  
Outside NJ 1-800-631-1250 • Inside NJ 1-800-624-2624

Please rush me \_\_\_\_\_ copies of the 1988-89 NTE Technical Guide and Cross Reference manual at \$3.25 each. I have enclosed my check or money order for a total of \$ \_\_\_\_\_

Name \_\_\_\_\_

Company \_\_\_\_\_

Address \_\_\_\_\_

City \_\_\_\_\_

State \_\_\_\_\_ Zip \_\_\_\_\_

Mail to: NTE, 44 Farrand Street, Bloomfield, NJ 07003

ES&T 4/89

Circle (11) on Reply Card



# An infrared remote-control tester

By Steven Chisarick, CET

If you need a simple tool for testing infrared remote-control units, try this project. You can use all Radio Shack parts for under \$10 (not including the housing), or you can use parts from your stock or junk, which would be even cheaper.

U1 is a high-gain amp that will amplify low-level digital pulses. Q1 drives the speaker or an LED.

To use the unit, align the remote control with the IR detectors and press any function key on the remote control. You will hear pulses in the speaker from the code generated by the pushed key.

Most of the problems you'll encounter in remote controls are caused by bad connections that occur when the remote is dropped. Once you find the bad connections, the remote can be repaired easily.

## Parts list\*

Part description	Radio Shack part number
Q1, MPS2222A NPN transistor	276-2009
Infrared photo transistor	276-145
U1, 741 op-amp	276-007
0.1 $\mu$ F, 50V capacitor	272-1069
220k $\Omega$ , 1/4W resistor	271-1350
1k $\Omega$ , 1/4W resistor	271-1321
3.3k $\Omega$ , 1/4W resistor	271-1328
1M $\Omega$ , 1/4W resistor	271-1356
8 $\Omega$ , 2-inch speaker	40-245
printed circuit board	276-150
9V, EV216 battery	23-464
SPST switch	275-603

\*One of each part on the list

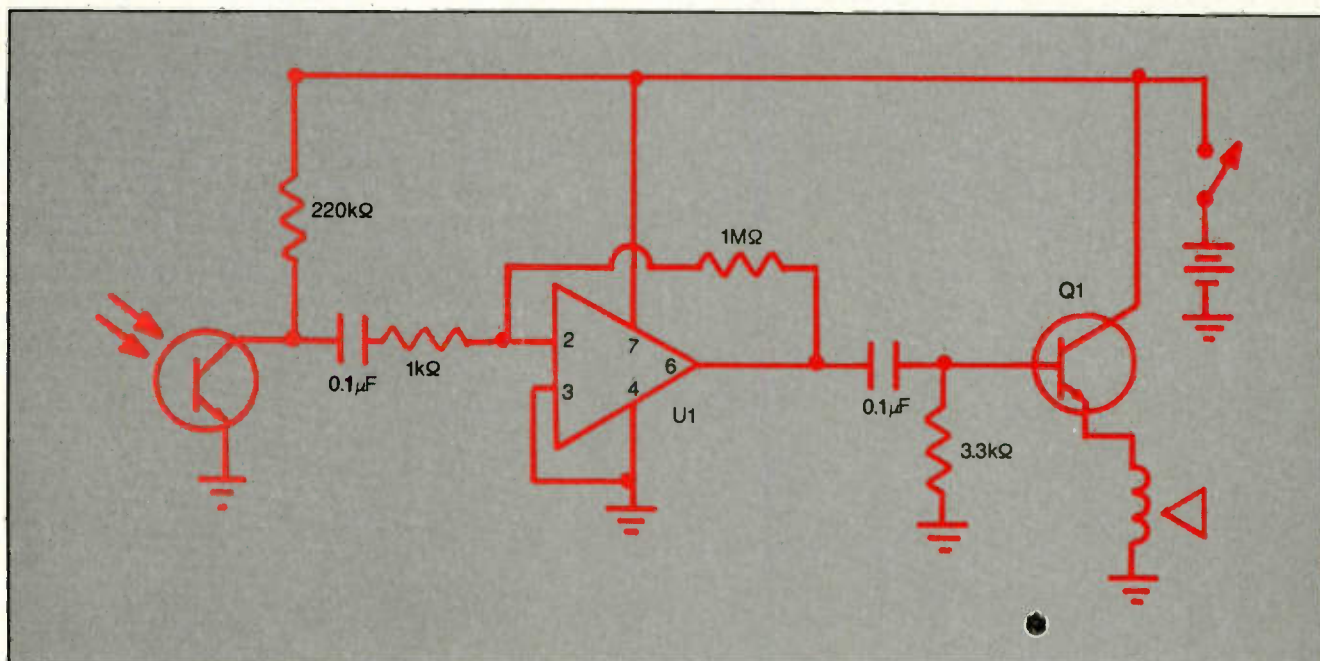

Figure 1. This tool for testing infrared remote-control units uses U1, a high-gain amp that will amplify low-level digital pulses, and Q1, which drives the speaker or an LED. To use the unit, align the remote control with the IR detectors and press any function key on the remote control. You will hear pulses in the speaker from the code generated by the pushed key.

ES&T

# Distributors' SHOWCASE

Deciding on a distributor with whom to do business is a lot like deciding on any other kind of business relationship. Whether you choose to do all of your business with a local distributor, almost all of your business with a mail order firm, or some reasonable combination of the two, it makes sense to choose your distributor(s) carefully.

As you may already have found out, distributors are not all alike, any more than restaurants or retail stores are all alike. Most distributors are well-stocked and well-organized; they can help you with special requirements and help you do research on finding the correct part. On the other hand, some are not. Some mail-order distributors can take your order in a number of ways, including mail, telephone (some with 800 numbers), fax, etc.; some cannot. Some distributors charge a reasonable amount of money for shipping and handling; some appear to charge more than is reasonable. Some distributors will send your order right away even before your check clears, some will wait until your check clears, and some will keep your money well beyond the point when they should have shipped your product.

## Details to consider

You probably shopped carefully when you bought your house and your car. You're probably a careful shopper when it comes to buying other consumer goods. You should also be a careful shopper when choosing a distributor.

Here are some of the things you should consider when settling on a distributor. Some of these considerations apply only to the local distributor, and some apply only to mail order, but it would be a good idea to keep them in mind any time you're thinking about doing business with a new company.

These items are not listed in any particular order, for the simple reason that their order of priority or importance depends upon your particular wants and needs. Put them in order of importance for yourself.

- Do the distributor's facilities or literature give the general impression of competence and order?
- Do the distributor's prices seem reasonable and in line with what other companies charge?
- Does the distributor seem to have most items in stock, or do many of them go on back-order?
- Does the distributor seem to have a broad line of products, or will you have to find other sources of supply for many of your needs?
- Does the distributor specialize in any kinds of products that you will need?
- What kind of payment options does the distributor offer: open order account, credit card, COD, check?
- How soon after receipt of an order does the distributor ship?
- Does the distributor add a shipping surcharge or a handling charge?
- Does the company have a toll-free number?
- Does the distributor offer such ordering options as fax and telex, and does the company offer such computer ordering options as MCI Mail, Compuserve and EasyLink?
- What is the distributor's return policy?
- Are all of the distributor's policies well-documented, or do you have to guess at them? Or do they differ depending on the company's whim?
- What kind of warranty, if any, does the distributor offer?
- Is the catalog, if one exists, clear and easy to understand?
- Is there a minimum order amount, and if so, is it reasonable?
- What kind of shipping options

are available: mail, UPS, Federal Express?

- What kind of special services, such as assembling cables, does the company offer?
- What research services does the distributor offer to help you find the part you need?

## Proceed with caution

Most distributors of replacement parts for consumer-electronics products are hard-working, well-organized, ethical companies who will bend over backwards to help you obtain the correct replacement for a faulty component. It's not always easy to locate the good ones and avoid the ones that will give you problems. One approach when you're considering ordering products from a new distributor is to start out with a small order and see what kind of response you get. If the service you receive is not what you'd like, try someone else. There's nothing worse than not getting the products you ordered or being hit with exorbitant freight charges.

We're interested in hearing from you if you've found any distributors to be either particularly good or particularly bad. Please let us know about your experiences.

## The showcase

Although you can choose from dozens of distributors, both local and national, the following Distributors' Showcase, a special advertising supplement, features company profiles along with advertisements from six distributors who chose to advertise in this supplement. These distributors provide a variety of replacement parts, tools and test equipment, and offer a varied menu of special services. If you need information regarding other distributors that are not listed in this issue, please refer to the March 1989 Buyers' Guide.



# Distributors' SHOWCASE

Contact East catalogs have become standard technical references for anyone servicing, testing or assembling electronic equipment. More than an ordinary catalog, Contact East catalogs give up-to-date technical and



new-product information. Test instruments, tool kits and a full range of technical supplies are all shown in full color with detailed descriptions and pricing.

**Same-day shipment.** Delivery delays represent a big "hidden" cost, often exceeding any price savings. For years, Contact East customers have benefited from their same-day shipment program. Because of a huge inventory of more than 10,000 items and a fast computer order-processing system, 92% of the orders placed by 3 p.m. are shipped before 5 p.m.

**Big price savings.** Contact East is a leading national distributor. The company's volume purchases allow it to buy at the lowest costs. These big price savings are then passed on to the customers. Discounts of up to 25% off manufacturers' list prices are not uncommon.

**Product quality.** A wide selection of quality, brand-name merchandise is offered by Contact East. Most products are made in the United States.

**Technical assistance.** A staff of product managers is always available to answer your application questions and recommend solutions to process and engineering problems.

**Custom tool kits.** Contact East can custom-design and assemble tool kits to meet the individual needs of the customer. Custom kits provide you with the right task-specific tools to do your job. Contact East has the experience with kit design and assembly, plus an extensive knowledge of tools and test instruments, to design a kit for your needs.

**Ironclad guarantee.** If you're not 100% satisfied with your purchase from Contact East, you have up to 45 days to return the merchandise for a full refund, credit or replacement.

**Twenty-six years of service.** Customers around the United States have come to depend on Contact East. For more than 26 years the company has shown its commitment to service excellence, quality products and competitive pricing.

## SAME DAY SHIPMENT

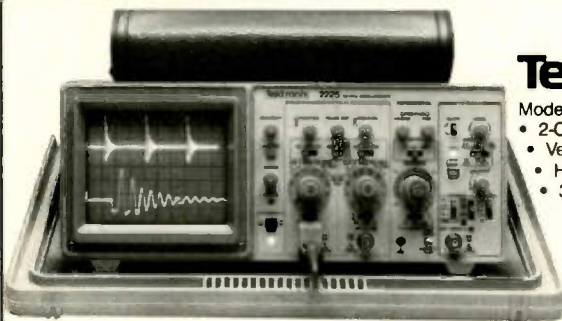

### Tektronix

Model 2225 50 MHz Oscilloscope

- 2-Channel
- Vertical magnification to 500  $\mu\text{V}/\text{div}$
- HF+LF reject on trigger
- 3-year warranty

Reg. ~~\$1095~~  
Special  
**\$1049.00**

### FLUKE

Model 77  
3 1/2 Digit DMM

- Auto/manual
- 0.3% DC accuracy
- Touch-hold function
- Analog bar-graph display
- 10A & 300 mA range
- 3-year warranty

Reg. ~~\$159~~  
Special  
**\$139.00**



### Weller

Model WTCPS  
Soldering Station

- Controls temperature at 600°F, 700°F, 800°F
- Safe, low voltage, closed loop design
- Pilot-light/switch, burnproof cord
- Soldering stand can be remotely placed

Reg. ~~\$121.70~~  
Special **\$99.00**  
with 700° tip



## Spring Specials

TO ORDER CALL: **1 800-225-5370**

In Massachusetts (508) 682-2000 8 a.m. to 5 p.m. EST

Use your **VISA, Master Card** or **AMEX**  
Add \$6.25 for packing and guaranteed delivery.  
Offer expires May 31, 1989



**FREE Contact East Catalog** contains thousands of products for testing, repairing & assembling electronic equipment. To get your free catalog, circle the reader service below or call **508-682-2000**.

**contact east** Willow St. So. PO Box 786 North Andover, MA 01845

Circle (13) on Reply Card

# Joseph Electronics

# Distributors' SHOWCASE

Joseph Electronics warehouses and distributes product lines in more than 150 categories featuring more than 100 leading, recognized, national brands. In most cases, the company will ship within 24 hours, directly from stock.

Included are a great variety of test instruments, amplifiers, battery chargers, cable, capacitors, connectors, cleaners, controls, diodes, electronic hardware, filters, kits, lamps, meters, plugs, receivers, relays, semiconductors, speakers, switches,

ments. Joseph can provide custom production to exact requirements. The company has the expertise, equipment and personnel to do work economically that many large companies cannot do. Many companies cannot meet the same time sched-

ules. Pre-production samples are provided in a matter of days. Other services include custom cable assemblies, custom field-service tool and instrument kits, custom battery assembly for a variety of applications, and PC board work.



tool cases, tools, transformers, video systems, wire and wiring accessories and more. Their computerized system enables Joseph Electronics to meet your needs for quality, service, price and technical support and counsel. The entire organization is devoted to providing customers with the highest level of service, top-quality products and the best support after the sale.

To better serve its customers, Joseph Electronics maintains an outside sales force to call upon customers, a telemarketing staff to answer questions, and retail salespeople to serve you on-site. In addition, the company has a value-added service department to function as an extension of customers' engineering, purchasing, assembly and quality-control depart-

## FREE! New 528-page Electronics Catalog



**This is your most complete  
reference of electronic products...  
one catalog; one source!**

Request Joseph's FREE 528-page "Industrial Products Catalog." FREE with any order or if requested on your company letterhead. (Otherwise, \$4.95 to cover catalog and shipping costs.)

Catalog features over 150 product categories; more than 100 leading national brands.

**Joseph**  
ELECTRONICS

8830 N. Milwaukee Ave., Dept. F  
Niles, IL 60648 • 312-297-4200

**FAX: 312-297-6923**

**ORDER DEPT. Toll free**

**800-323-5925**

**ORDER DEPT. In Chicagoland**

**312-297-4200**

Circle (14) on Reply Card



# Distributors' SHOWCASE

MCM Electronics is a company of dedicated people committed to offering only the best electronic parts, components and service to the customer.



Because needs in the electronic industry are constantly changing, MCM Electronics continually and thoroughly researches the market and reacts to the market's changing needs. MCM is constantly in touch with national and

international manufacturers to bring the commonly used and the hard-to-find products to its customers. In fact, more than 500 new items were introduced in its latest catalog.

The sales/customer service department has been thoroughly trained to answer all calls on the toll-free lines promptly and efficiently. These representatives are professionals who can provide immediate information on stock availability and pricing. They are available Monday through Friday, 7 a.m. to 8 p.m. EST, and Saturday, 9 a.m. to 5 p.m. EST. Orders can also be placed after hours with a national, toll-free number, ensuring service 24 hours a day, seven days a week. Technical questions about a particular product can be answered by MCM's highly trained electronics technicians, who are available to provide the answers the customers need.

The company's Distribution Center

houses an enormous inventory of parts and components. Every order is pulled and double-checked to strive for timely and error-free shipment. Because more than 11,000 of the items in the catalog are in-stock and ready for shipment, orders are shipped within 24 hours.

Even though most orders are shipped by UPS, MCM offers a broad range of shipping options. Customers can establish Net 30 accounts or have their orders shipped COD, charged to MasterCard or Visa, prepaid or picked up at the Distribution Center's Will Call area. There is a \$20 minimum for COD, checks and open accounts, and a \$25 minimum for MasterCard and Visa orders.

For more information and a free catalog subscription, call 800-543-4330. (In Canada, call 800-824-9491; in Dayton, OH, call 434-0031.)

## Fill'er - Up!

### With MCM Electronics Your FULL SERVICE Electronic Parts Supplier

**High-Quality Products** are *all* you'll find in MCM Electronics' giant catalog. Never any "low-test" items to "knock" down our reputation — or yours!

**A Huge Assortment** of over 11,000 items keeps you "on the road" to success, whatever your needs may be!

**Great Values** on every item, with a commitment to quality.

**Exceptional Service** means we'll keep you "pumped-up" with all the help you need... *when* you need it!

For Your **FREE** subscription to our MCM Electronics Catalogs and Flyers

## CALL TOLL-FREE 1-800-543-4330

...or write...

**MCM ELECTRONICS**  
650 CONGRESS PARK DR.  
CENTERVILLE, OH 45459-4072  
A PREMIER Company

**SOURCE NO. ES-44**

Circle (15) on Reply Card

# Parts Express

# Distributors' SHOWCASE

Parts Express, a full-line distributor of electronics parts and accessories, is geared toward the consumer electronics repair industry, manufacturing design and engineering, and the technical hobbyist. The company stocks an extensive line of speaker drivers and accessories for replacement, plus one of the largest selections of semiconductors in the country. The company offers a free 100-page catalog listing more than 5,000 popular items, and its extensive computer inventory-control system allows it to monitor each item and ensure that it is in stock when you need it.

With both overseas and domestic sources for parts and an aggressive new-product research team, Parts Express keeps in touch with the needs of the industry. The company can supply replacement parts for the newest TVs, VCRs and stereos as they are introduced to the market, and it can special-order non-stocked items for volume users.

The company prides itself on being

flexible, and it makes every effort to accommodate special requests. The company normally ships within 24 hours, and most orders received before 1 p.m. EST are shipped the same day. And unlike some companies, Parts Express' service doesn't stop there. The company understands that you aren't always sure what you're getting when you order from a catalog, so it has taken the risk factor out of mail-order. If you are not 100% satisfied with any item you've purchased, you can return it within 15 days for a refund. No questions asked, no restocking fee.

Parts Express can offer a money-back guarantee because it honestly doesn't think you'll have to use it. On-staff quality-control technicians extensively test and evaluate products before adding them to stock. The company won't sell any item that its technicians wouldn't use themselves.

Call Parts Express at 800-338-0531 for your free issue of the 1989 catalog. They even pay for the phone call.



## OUR NAME SAYS IT ALL !

When we say Parts Express, we mean it! Most orders that we receive before 1:00 are shipped out the same day. And, 99% of all orders are shipped out within 24 hours. You can count on it! Our in-stock ratio is one of the highest in the industry.



### PARTS IN STOCK

Our extensive computer inventory control system allows us to monitor each and every line item in inventory to ensure that the item you need is in stock when you need it.



### FAST SHIPPING

Our order packing department is experienced at making sure that you order arrives fast and accurately. They pride themselves on quick order processing and few mistakes.



### FRIENDLY SERVICE

Our knowledgeable salespeople will do everything they can to answer questions and courteously take your order when you call. We also have experienced technicians on hand if you should need additional technical assistance.



### QUALITY

At Parts Express we know the importance of quality parts. We won't sell anything that we wouldn't use ourselves. You can rest assured that we stand behind what we sell. Our 15 day, no quibble guarantee is proof positive of this.

Parts Express International Inc.  
340 E. First St.  
Dayton, Ohio 45402

Local Phone: 1-513-222-0173  
FAX: 1-513-222-4644

CALL  
TOLL FREE

**1-800-338-0531**

Circle (16) on Reply Card



# Distributors' SHOWCASE

## Techni-Tool



Techni-Tool is the largest distributor in the field, offering more than 18,000 items in stock. With such an inventory, the company can usually ship your order within 24 hours, directly from stock. If a customer needs same-day service, that kind of service is also available.

Because of Techni-Tool's broad inventory, you can find almost everything you might need in its catalog, and most items are available immediately because the company's modern, computerized facility makes it easy to search and find the items to fill your order. This quick service and ability to fill almost any order completely saves you the time and extra cost you might otherwise spend looking for other sources.

Because of the quality of the company's merchandise, you are assured of buying a tool that will do what it was designed to do for a long time.

Because Techni-Tool has more than 28 years of technical expertise and a competent, friendly staff dedicated to servicing customers promptly and efficiently, you can be sure that your technical questions will be answered.

And they guarantee your satisfaction. The 850 manufacturers provide expressed warranties for quality and workmanship of their specific product lines. Techni-Tool further backs these warranties. If within seven days you are dissatisfied with any product purchased, you may return it for a full refund.

## Free Catalog

**Tool Kits & Cases, Tools, Clean Rooms, Telco Equipment, Test Equipment, Static Control Products, MRO Products**

Techni-Tool's latest **FREE CATALOG** includes the biggest and best selection of top-quality items to be found anywhere! The catalog presents more than 18,000 items from over 850 fine manufacturers. You will find tools and accessories for electro-mechanical assembly and maintenance, electronics, telecommunications, field service, and computer maintenance, plus ESD products, clean room supplies, and tools for SMT applications. And you get **ONE-STOP SHOPPING & convenient 24-HOUR SERVICE**. Call, FAX, Telex or write for your **FREE CATALOG**.



**TECHNI-TOOL** inc.

5 Apollo Road, P.O. 368, Plymouth Meeting, PA 19462 U.S.A.  
(215) 825-4990 Sales 941-2400 Fax No. (215) 828-5623

Circle (17) on Reply Card

# U.S. Instrument Rentals, Inc.

# Distributors' SHOWCASE

U.S. Instrument Rentals, a part of U.S. Leasing and wholly owned by Ford Motor Company, was founded in 1974. The company's \$220 million inventory includes more than 5,000 products from more than 170 manufacturers. These products include analyzers, generators, oscilloscopes, meters, recorders, power sources, components, counters and more. A separate division of USIR, USL Data Systems, serves the computer-product needs of the company's customers. From PCs to laptops to printers, the latest technology is immediately available. USLDS also offers a full range of backup systems, power modules and storage systems, video display terminals, plotters and accessories.

This inventory is housed in the company's International Distribution Center in Dallas. This state-of-the-art warehousing facility also contains the company's Calibration Lab and Repair/Maintenance/Refurbishment departments. The Calibration Lab is fully audited for compliance with MIL standards (including MIL-STD 45662A) and is monitored by an in-house quality assurance manager. By combining its warehouse with its labs, U.S. Instrument Rentals is able to reduce the time it takes to prep a customer order and get it on its way. By operating this facility around the clock, the company cuts down that time even further.

In most cases, equipment available for shipping in the warehouse can be picked, calibrated, tested, packed and delivered within 24 hours of order acceptance. By locating this distribution center on the grounds of the Dallas/Fort Worth International Airport, the company has reduced the amount of time it takes to get shipments to the appropriate carriers. This move also allows the company to process orders later into the evening and still get them out for delivery the next day.

USIR also guarantees delivery of product to your door. If the company fails to meet an agreed-upon delivery date, it will deduct 50% from your first invoice.

By offering the customer a wide range of financial options for acquiring the equipment they need, U.S. Instrument Rentals is able to satisfy the needs of virtually all customers. Customers with short-term requirements will find renting a sound solution. Leasing offers greater flexibility

than a purchase by allowing you to tailor your monthly payment, assigning an end-of-term buy-out option that suits the need, provides complete service and calibration, and can even provide the means to upgrade to the latest technology as it becomes avail-

able. USIR also sells used and pre-owned equipment at better prices than new equipment. All used and pre-owned equipment is maintained by USIR and is refurbished and repaired as necessary, and it comes with a 30- to 90-day warranty. **ES&T**

## Instrumentation. Cover to Cover.

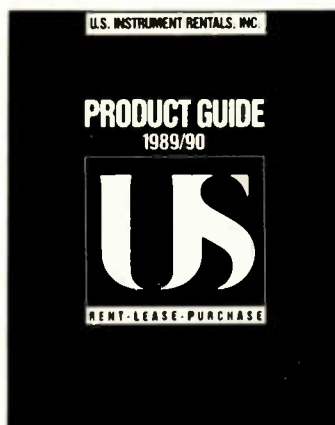

**800-824-2873**  
**RENT-LEASE-PURCHASE**

With the new 1989/90 Product Guide from U.S. Instrument Rentals that's exactly what you get. This hardbound guide is packed with over 5000 products from more than 170 major manufacturers. Browse through our comprehensive product sections—analyzers, counters, oscilloscopes, microprocessor development systems, computer products, power sources, generators, telecommunications products—and more!

The detailed product descriptions, product photos, and unbiased, thorough product comparison charts help speed your product decisions, and provide you with a valuable reference tool you'll come to rely on. We're sure you'll find this to be the most complete, authoritative guide to instrumentation available.

Call or write for your free copy, and let our 1989/90 Product Guide begin working for you.

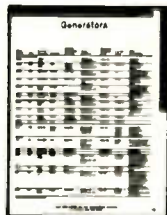

Product Specification Charts



Detailed Product Descriptions with Photos



Unbiased Manufacturer's Comparison Charts

**United States Instrument Rentals, Inc.**



A U.S. Leasing Company  
2988 Campus Drive  
San Mateo, CA 94403  
800-824-2873

Circle (18) on Reply Card



# Erratic problems? Check the cable

By Conrad Persson

There are few servicing calls more frustrating than one for an intermittent or erratic problem. If you're going to be servicing computers, get prepared to face a lot of them. The reason is simple: The system is complex. The complexity exists not only because of the hardware, which creates enough problems, but because of the software as well.

Sometimes the hardware problems alone are enough to cause you to pull

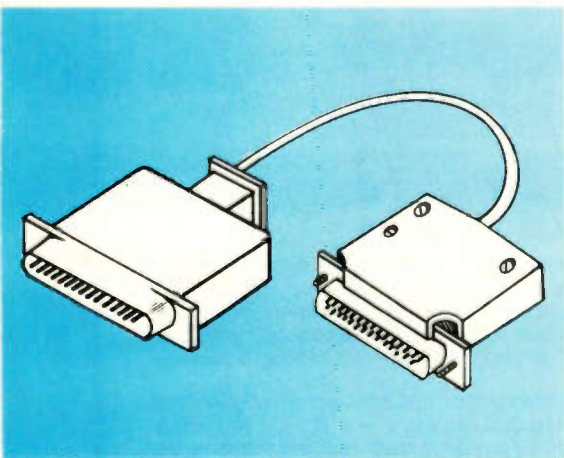

**Figure 1.** The computer-to-printer cable has a DB25 connector at one end and an Amphenol connector on the other.

your hair out, however. Here's a problem that I just finished working on. I have an IBM AT compatible computer and a Panasonic KXP-1124 printer. I was using the computer with a word processor package. The interface is a Centronics parallel connection.

The problem was very strange. I was able to print out 40 pages of copy from a self-documenting shareware program

that I'm considering purchasing. The system printed it out twice, all 40 pages of it, with nary a burp or a hiccup. I used a simple word processor program to print out a page or two of other copy with no glitches.

But every time I loaded up the more powerful word processor and tried to print out a document, I got a PRINTER ERROR indication, and somewhere down in the printout the printer would fail to advance the paper. The result was lines that printed over one another. In one case, the paper failed three times in a row to advance and I wound up with four lines of type, one on top of the other. Then everything straightened back out, and the remainder of the document printed with no further problem.

I hasten to add that it's not the software. I have known it to work just fine on other systems. For some reason, the combination of the computer I own, the printer, the software and the interconnections teamed up to cause this erratic problem.

I called the computer shop and described the problem to the salesperson/technician from whom I bought the system. After listening to a detailed account of when the problem occurs and when it doesn't occur, he suggested that it might be a cable problem. He told me about a similar case that he had been called in on. The computer would print page after page of type without a burp, then a couple of lines would pile up or a line of asterisks would print. Then the printer would go along on its merry way and print the remainder of the document. Or sometimes, and this has happened on rare occasions to me, the printer would just stop.

He told me that he spent several hours playing with the printer, trying first one

thing and then another with the computer and the software, all to no avail.

Finally, with no alternatives left, the technician decided to try replacing the cable. The problem disappeared and hasn't returned. To this day no one knows the exact nature of the cause of that problem. It may have been a pin that wasn't quite the correct diameter, a poorly made connection or maybe a fault in the conductor itself. The technician has now changed his approach to such problems. If it's an intermittent and there doesn't appear to be any logical cause of the problem, one of the first things he does is replace the cable. It turns out that cable faults are quite common in personal computer installations, and swapping cables is a prudent diagnostic step.

I decided to take his advice and stopped by the store to replace the cable. While I was there, I discussed several alternatives in case the new cable didn't do the trick. Because the problem seemed so erratic, I couldn't believe the cable could be the cause.

The technician was absolutely right. After I installed the new cable, the problem just stopped.

Upon further reflection, the fact that the cable was at fault was entirely reasonable. There are more than 30 connectors in the cable, and the power level that each connector handles is a few milliamps at about 5V. All it would take would be a little oil from someone's finger, a pin with a slightly smaller diameter than specification, or a spring-type connector without the right amount of spring.

Any time you run into problems in computer-to-peripheral interfaces that you can't explain and can't seem to correct, try a new cable.

Persson is editor of ES&T.



GE 1VCR2002X SERVO SCHEMATIC DIAGRAM

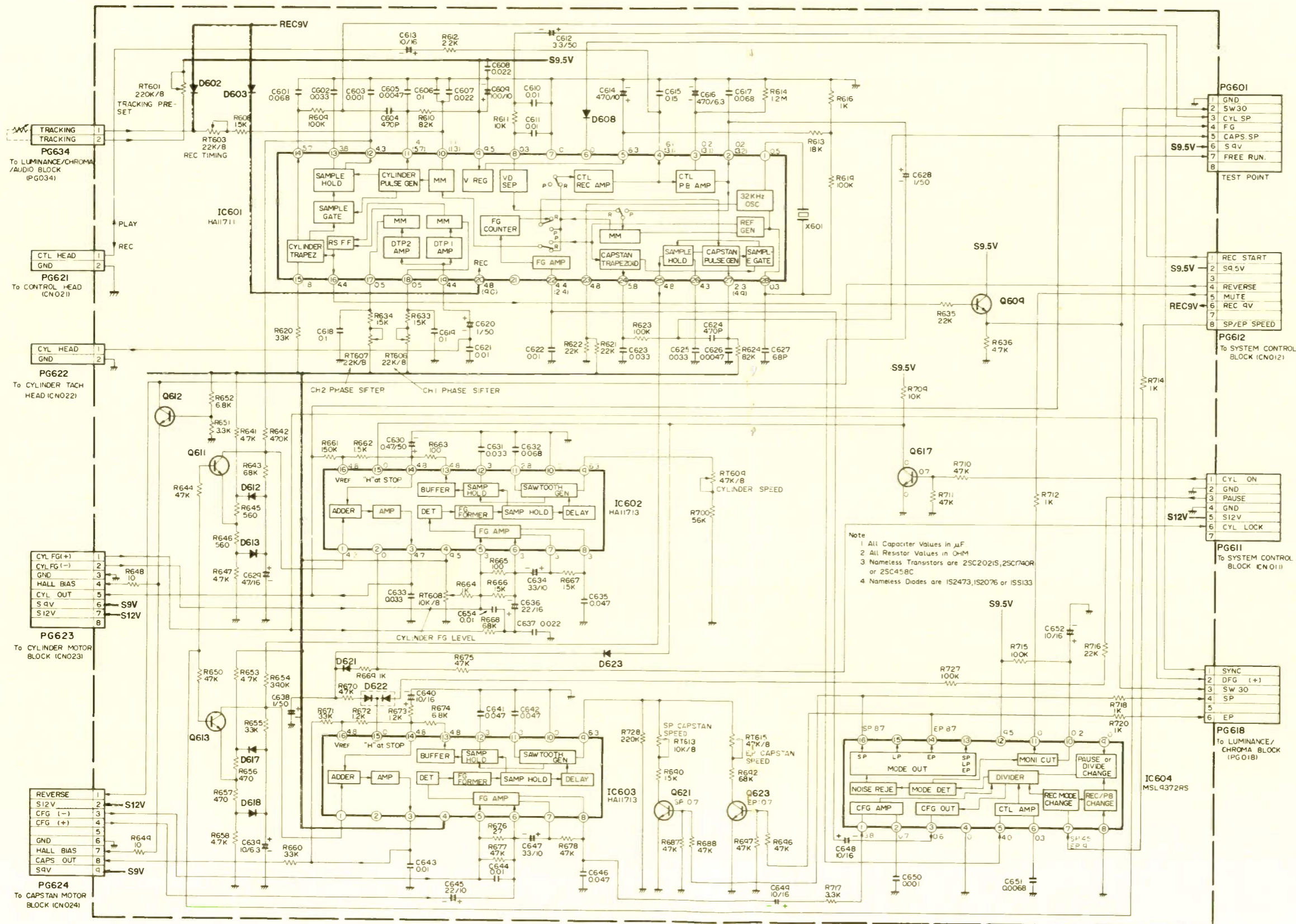

Product safety should be considered when component replacement is made in any area of a receiver. Components marked with a ! designate sites where safety is of special significance. It is recommended that only exact cataloged parts be used for replacement of these components.

Use of substitute replacement parts that do not have the same safety characteristics as recommended in factory service information may create shock, fire, excessive x-radiation or other hazards.

This schematic is for the use of qualified technicians only. This instrument contains no user-serviceable parts.

The other portions of this schematic may be found on other Profax pages.



Product safety should be considered when component replacement is made in any area of a receiver. Components marked with a ! designate sites where safety is of special significance. It is recommended that only exact cataloged parts be used for replacement of these components.

This schematic is for the use of qualified technicians only. This instrument contains no user-serviceable parts.

Use of substitute replacement parts that do not have the same safety characteristics as recommended in factory service information

may create shock, fire, excessive x-radiation or other hazards.

The other portions of this schematic may be found on other Profax pages.

GE 1VCR2002X LUMINANCE/CHROMA SCHEMATIC DIAGRAM

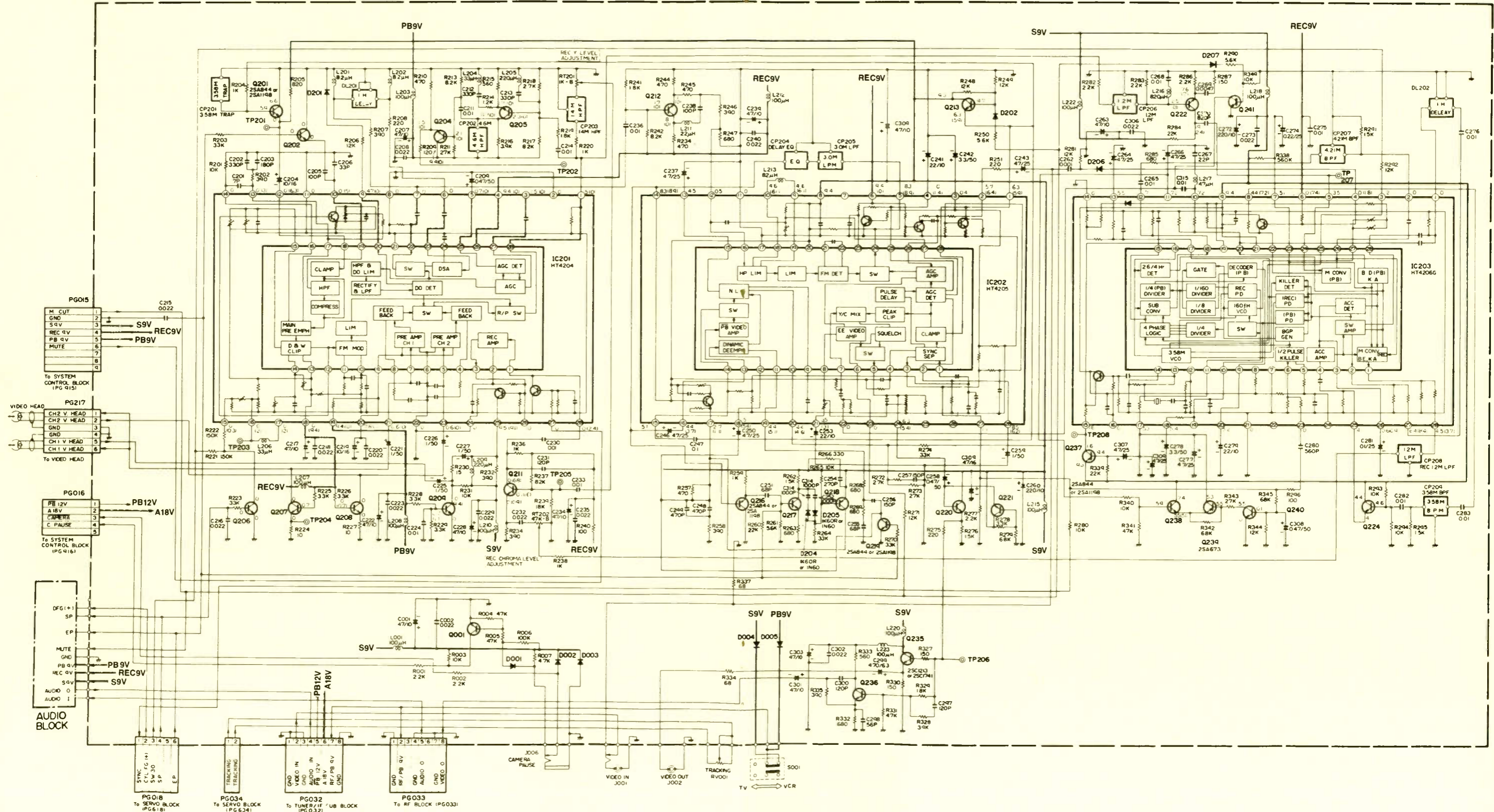



### GE 1VCR2002X SYSTEM CONTROL SCHEMATIC DIAGRAM

Product safety should be considered when component replacement is made in any area of a receiver. Components marked with a ! designate sites where safety is of special significance. It is recommended that only exact cataloged parts be used for replacement of these components.

This schematic is for the use of qualified technicians only. This instrument contains no user-serviceable parts.

The other portions of this schematic may be found on other Profax pages.

Use of substitute replacement parts that do not have the same safety characteristics as recommended in factory service information may create shock, fire, excessive x-radiation or other hazards.

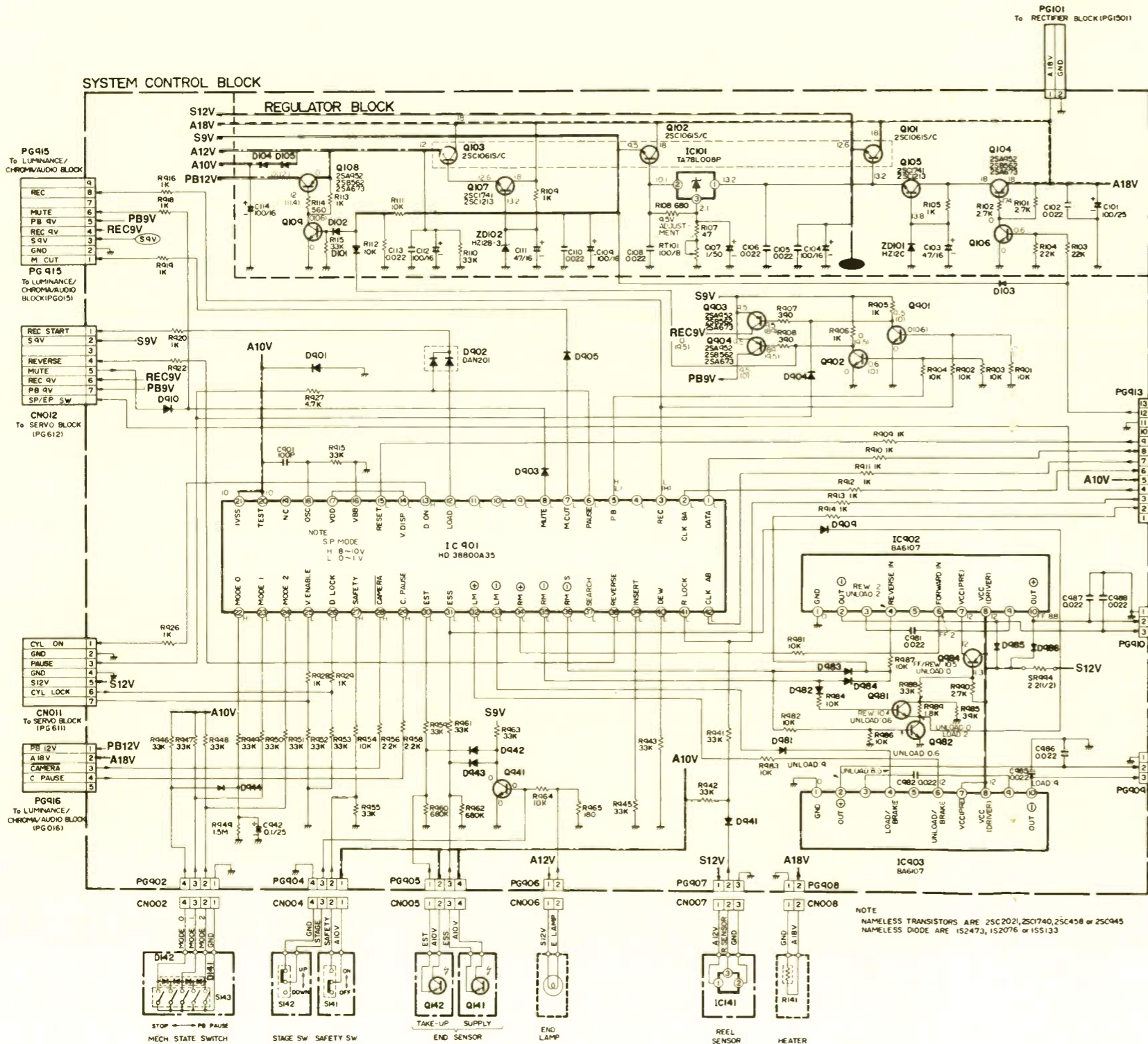

### GE 1VCR2002X SYSTEM CONTROL SCHEMATIC DIAGRAM

Product safety should be considered when component replacement is made in any area of a receiver. Components marked with a ! designate sites where safety is of special significance. It is recommended that only exact cataloged parts be used for replacement of these components.

This schematic is for the use of qualified technicians only. This instrument contains no user-serviceable parts.

The other portions of this schematic may be found on other Profax pages.

Use of substitute replacement parts that do not have the same safety characteristics as recommended in factory service information may create shock, fire, excessive x-radiation or other hazards.

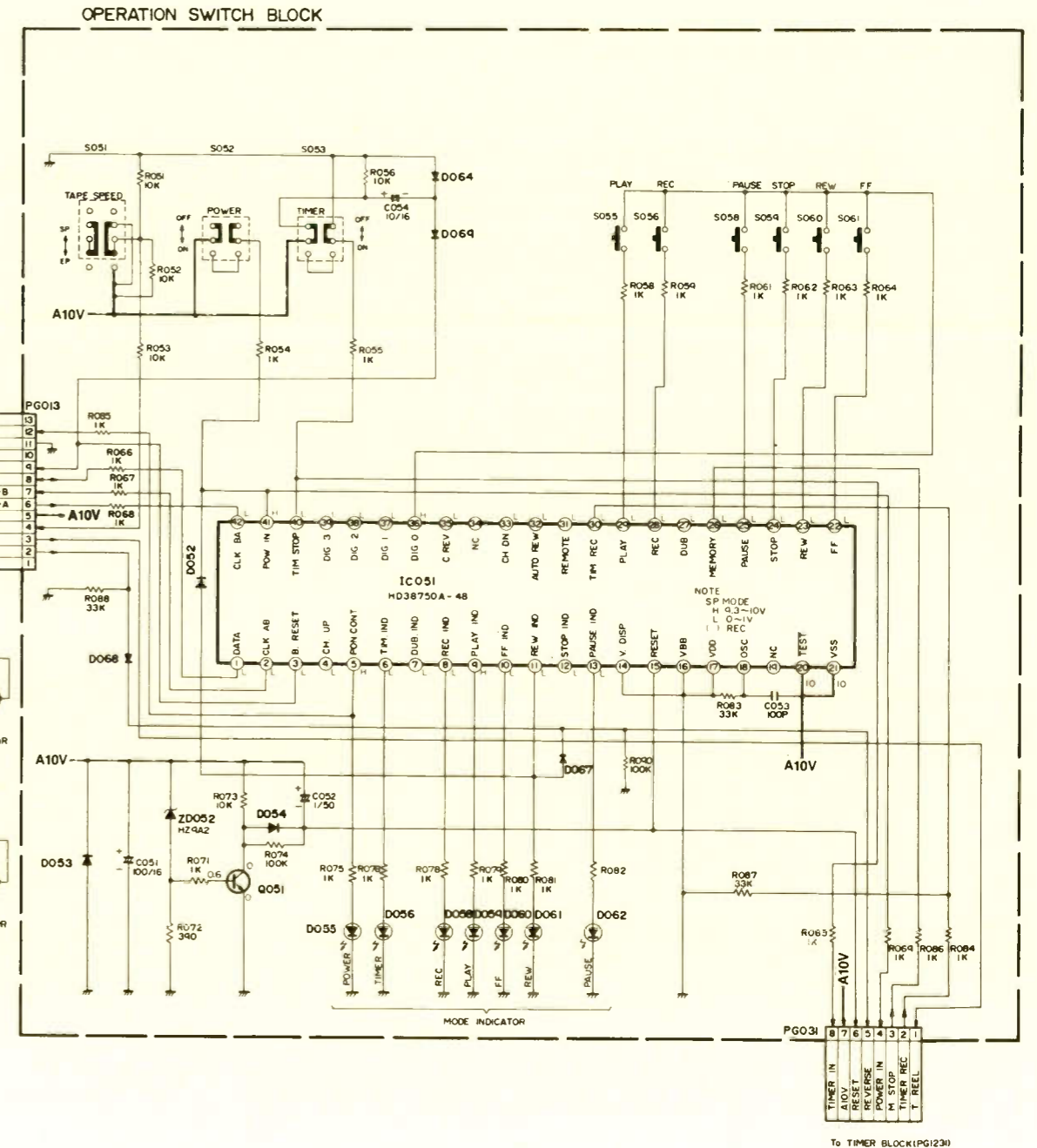



Product safety should be considered when component replacement is made in any area of a receiver. Components marked with a ! designate sites where safety is of special significance. It is recommended that only exact cataloged parts be used for replacement of these components.

Product safety should be considered when component replacement is made in any area of a receiver. Components marked with a ! and shaded areas of the schematic diagram designate sites where safety is of special significance. It is recommended that only exact cataloged parts be used for replacement of these components.

Use of substitute replacement parts that do not have the same safety characteristics as recommended in factory service information may create shock, fire, excessive x-radiation or other hazards.

This schematic is for the use of qualified technicians only. This instrument contains no user-serviceable parts.

The other portions of this schematic may be found on other Profax pages.

Use of substitute replacement parts that do not have the same safety characteristics as recommended in factory service information may create shock, fire, excessive x-radiation or other hazards.

This schematic is for the use of qualified technicians only. This instrument contains no user-serviceable parts.

The other portions of this schematic may be found on other Profax pages.

April 1989

Schematic

GE 1VCR2002X VHS VCR ..... 3044

Hitachi CT1955 color TV ..... 3045

HITACHI CT1955 BASIC CIRCUIT DIAGRAM

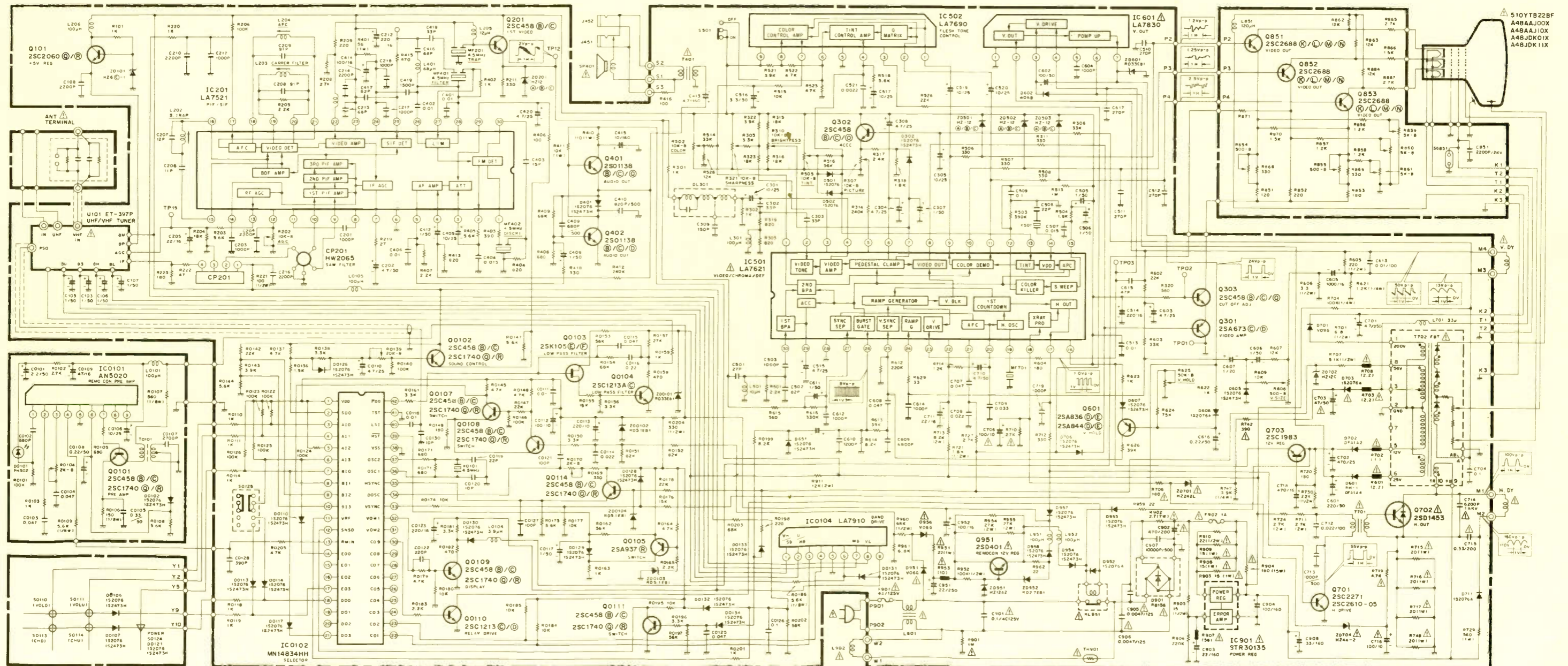



**When you come up with  
a superior product,  
people talk.**

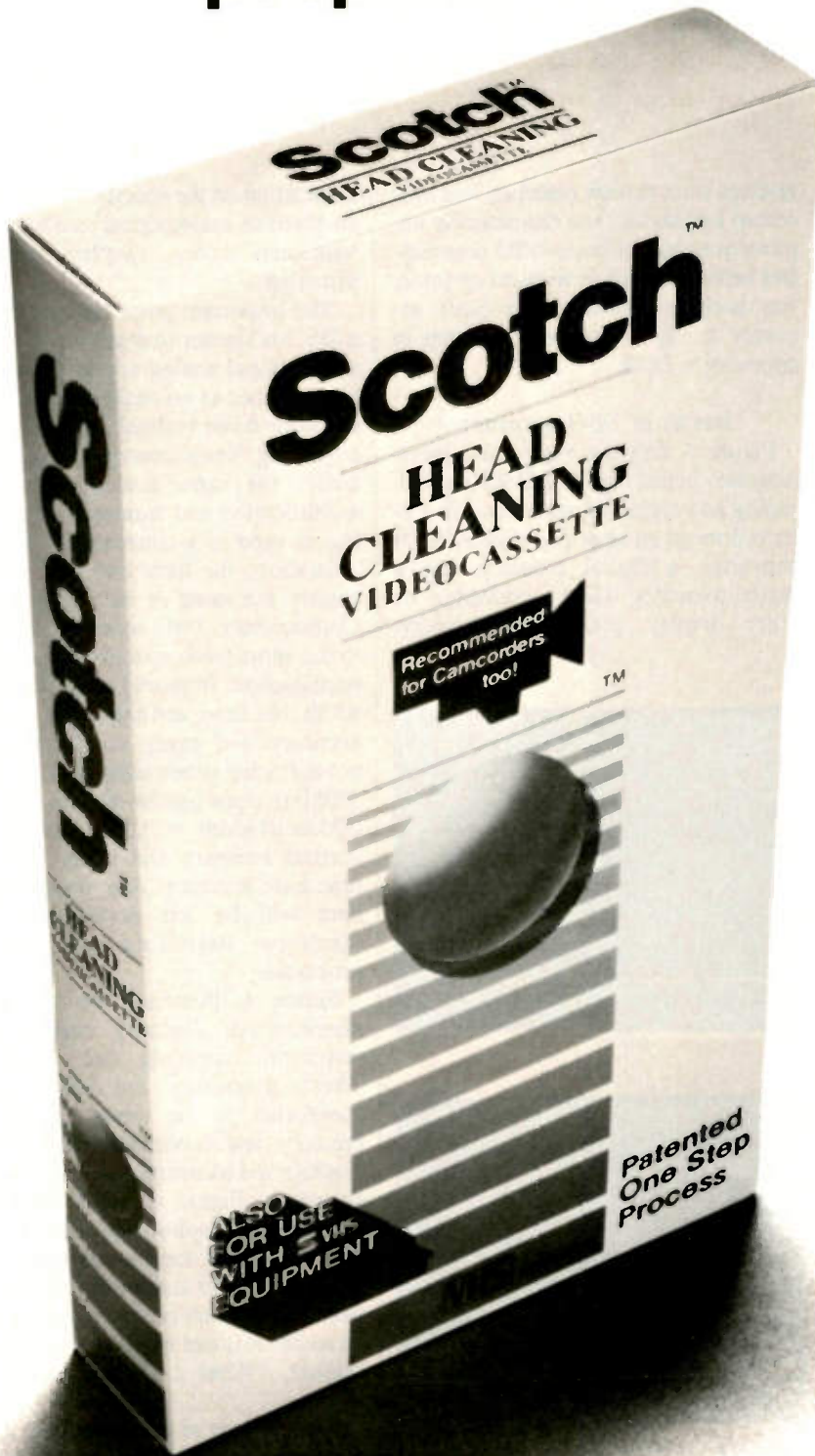

**“This is the first head cleaning system I feel confident I can recommend.”**  
*George Bluze, CET/CSM, Largo, FL*

**“We sell it and recommend it.”**  
*Don Erwin, CSM, San Diego, CA*

**“Protects my customers' investment and my reputation.”**  
*Art Nelson, CET, Milwaukee, WI*

**“It works better than traditional wet or dry methods.”**  
*John Sperry, CET/CSM, Lincoln, NE*

**“A quality product and safe to use.”**  
*Bill Warren, CET/CSM, Knoxville, TN*

**“Great product...it's safe and effective.”**  
*George Weiss, CSM, Chicago, IL*

NESDA experts agree the best solution to cleaning video recorder heads is the simplest. Unique to its category, the Scotch™ Head Cleaning Videocassette is the only recorded magnetic tape-based head cleaning cassette.

**“It's effective, it's safe and it's economical.”**  
*As featured in the Advance Technology Nov./Dec. '87 supplement*



# Understanding DSO accuracy and measurement performance

By Brad Harris

Digital storage oscilloscopes (DSOs) can simplify a wide range of troubleshooting and servicing problems. For example, waveforms from a known-good unit can be stored in digital memory and recalled to the screen for quick comparisons in troubleshooting. Single-shot waveforms, such as SCR-regulator start-up signals, can be frozen on-screen for detailed analysis. Waveforms can be measured faster and easier with cursors or push-button measurements. (See Figure 1.) And DSOs can even reveal things about waveforms that would be missed with a conventional analog scope: elusive noise glitches or switching spikes that disrupt digital circuitry. (See Figure 2.)

However, just as in the case of analog scopes, a wide range of DSOs is available on the market. Picking the right DSO for your test and measurement needs depends on understanding DSO specifications. The first feature to consider is the critical issue of basic DSO accuracy. What is it? How does it affect your measurements? Then there are

Harris is product marketing manager of portable digital oscilloscopes at Tektronix.

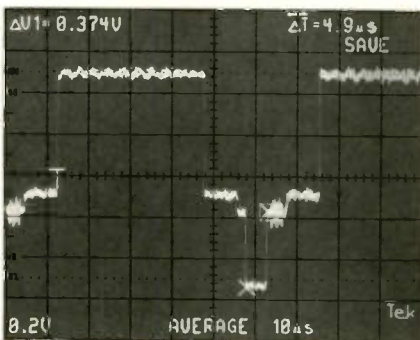

Figure 1. A DSO can freeze any waveform on-screen, making it easier to see and to measure waveform details. Measurement cursors, shown on this display as Xs, can be easily positioned anywhere on the waveform for direct screen readouts of voltage and time differences (V and T) between cursor locations.

features such as peak detection and long record lengths that can dramatically improve your use of basic DSO accuracy. But before looking at features or price, you need to establish your basic accuracy needs as the first key step in choosing a DSO.

## Basics of DSO accuracy

Figure 3 shows a basic DSO block diagram. In this case, the DSO has both analog and digital signal paths. The latter is through an analog-to-digital (A/D) converter, a digital memory and a digital-to-analog (D/A) converter or other display generation circuitry.

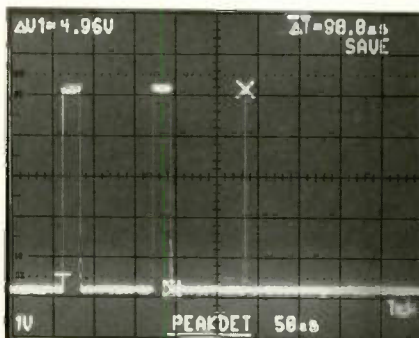
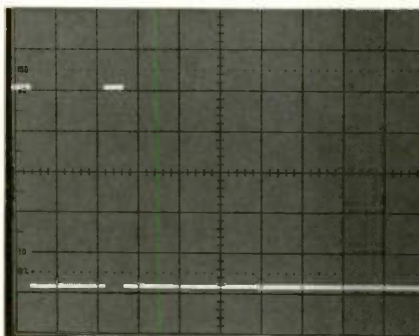

Figure 2. With a scope using typical troubleshooting settings, narrow glitches are too dim to be seen and will be missed (Figure 2a). A DSO with peak detection will show that a potentially troublesome glitch exists (Figure 2b).

Depending on the specific DSO model, an alternate analog signal path for a conventional scope display may be provided.

The important point for now is that a DSO is similar in many respects to a conventional analog scope. It uses the same probes as an analog scope. It has the same basic vertical, horizontal and triggering setup controls. And it requires the same analog signal pre-amplification and front-end conditioning as used in a conventional scope.

In short, the front end of a DSO is exactly the same as an analog scope. Consequently, DSO accuracy is subject to the same basic specifications of any oscilloscope: front-end amplifier bandwidth, rise time, and amplitude and time accuracy. For many consumer product-servicing needs today, this means a 100MHz input bandwidth (rise time =  $0.35/\text{bandwidth} = 3.5\text{ns}$ ), 2% or 3% vertical accuracy and better than 1% time-base accuracy. Any compromises here will be felt downline in the waveform digitizing and storage processes.

Figure 4 illustrates the two basic elements in digitally capturing a waveform: sampling and digitizing. These processes are what allow waveforms to be stored in digital memory and reconstructed for DSO displays and measurements such as was shown in Figure 1. This waveform storage and display capability is particularly useful for closely examining low-repetition or single-shot signals that would be difficult or impossible to view on a conventional oscilloscope (see the sidebar, "What a DSO Can Do for You").

The amount of measurement detail available from a stored waveform depends on the processes illustrated in Figure 4. Figure 4a shows an analog waveform presented to the D/A by the DSO's front end. As illustrated in Figure



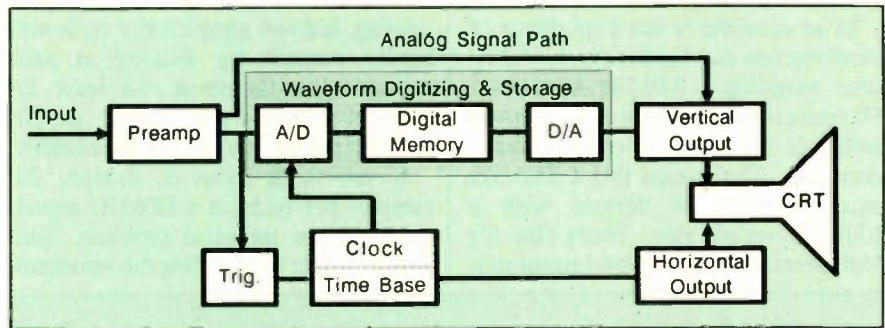

**Figure 3.** In many respects, a DSO is similar to a standard oscilloscope. Some DSOs even have an alternate analog signal path that allows them to be used also as a conventional oscilloscope.

4b, the amplitude of the waveform is sampled at equally spaced points in time. As each sample is taken, it is held briefly while being converted to a digital value for storage in digital memory. The result of this digitizing is illustrated in Figure 4c.

How closely the digital values follow the actual waveform depends on two factors: *sample spacing*, which is a function of sample clocking rates, and *sampling method*. The closer the samples are on the waveform, the finer the horizontal (time) resolution.

In the same manner, the closer the digital levels, the finer the vertical (amplitude) resolution. This factor depends on the number of bits used in the A/D. For example, a 6-bit digitizer provides 64 distinct levels for representing amplitude. A 7-bit digitizer has twice the resolution with 128 distinct amplitude levels, and an 8-bit digitizer doubles that again with 256 levels.

The 1/256 resolution of an 8-bit A/D converter allows measurement of amplitude differences as small as 0.391% of the signal amplitude. However, this value should not be confused with accuracy. Remember, the front-end accuracy of most scopes and DSOs runs from 1% to 3%. The DSO's A/D by itself cannot improve on that basic amplitude accuracy. Consequently, paying more for 9-bit or 10-bit digitizing is resolution overkill for most servicing applications.

Figure 5 provides further illustration of the effects of waveform sampling and digitizing. If you compare Figure 5a to Figure 4c, you can see the effect of increasing digitizing resolution by one bit. The improvement is most noticeable on the second cycle of the sawtooth waveform, which has more timing offset from the equally spaced sample points.

Now, compare the further improvement obtained in Figure 5b by increas-

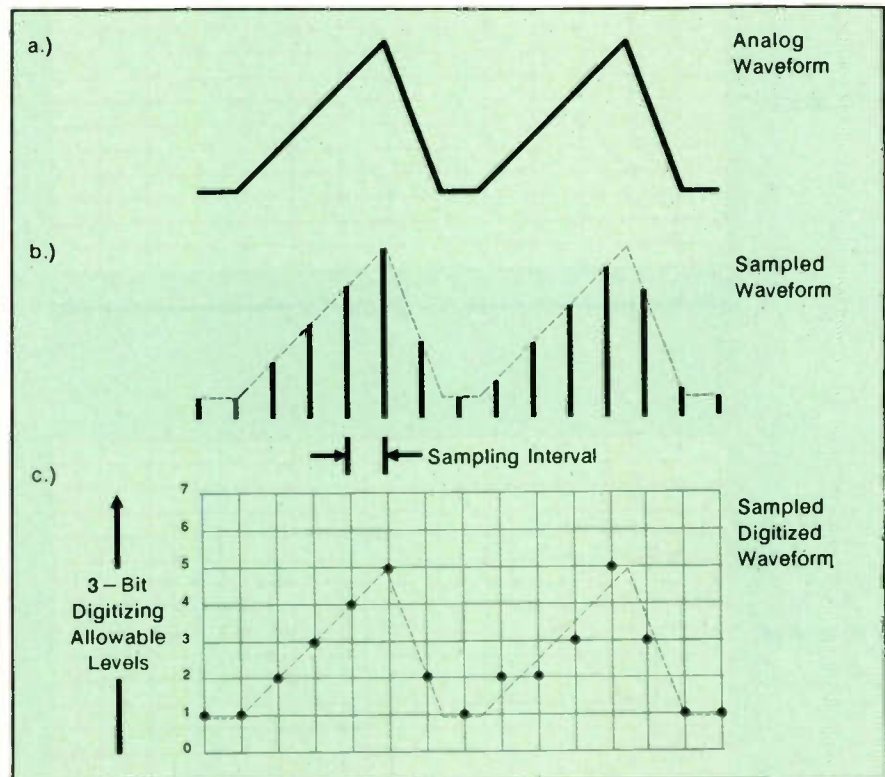

**Figure 4.** The basic processes in digitally representing an analog waveform (Figure 4a) include sampling the waveform at equally spaced time intervals (Figure 4b) and converting these samples to discrete values for storage in digital memory (Figure 4c).

ing the number of samples on the waveform. With more samples at closer intervals, the location of the second peak becomes better defined. (DSOs that provide peak detection will always capture peaks, even on the slowest sweep speeds.)

In actual practice, DSOs usually provide a minimum of 256 vertical levels (8 bits) and 512 or more sample points. This resolution is substantially more fine-grained than what is illustrated in Figures 4 and 5. In fact, it is so fine-grained that the displayed sample dots appear to define a continuous waveform. On most DSOs, this resolution is further enhanced by connecting the dots with straight lines, creating what is

called a vector display from a dot display.

#### The importance of sample rate

As mentioned previously, most DSOs provide 8-bit digitizing. However, there are a variety of other major distinctions between the various 8-bit DSOs on the market today. One of the basic distinctions is a specification typically referred to as *useful storage bandwidth*.

Useful storage bandwidth is further specified as single-shot bandwidth and equivalent-time bandwidth. To understand what these mean and what their importance is in waveform measurements, let's take a closer look at the sampling process.



As an example of the importance of sampling rate and bandwidth, let's consider sampling a 100MHz sine wave. Theoretically, two samples per cycle are sufficient to mathematically define a sine wave. That means that a 100MHz bandwidth can be defined with a 200MHz sample rate. That's fine for mathematics and higher level signal pro-

cessing, but two samples per cycle are hardly enough for looking at and measuring a waveform. At least 10 samples per cycle are needed, and 20 samples per cycle would be even better.

If you think about it, though, 20 samples per cycle on a 100MHz signal does raise a technical problem. You would have to be sampling the waveform

and performing A/D conversion at a 2GHz rate. Doing that in real time requires some expensive technology.

To solve the problem economically, sampling can be done in what is called an *equivalent-time mode*. The basic concept is illustrated in Figure 6.

In Figure 6, sampling is being done at some reasonably achievable rate, say 20MHz. When the waveform to be acquired triggers the DSO, several samples are taken over the duration of the waveform. The next repetition of the waveform triggers the DSO again, and several more samples are taken at different points on the waveform. Over many repetitions, the number of stored samples can be built up to be equivalent to a high rate of sampling — for example, a 2GHz equivalent-time sample rate. This rate is just what is needed to provide plenty of samples for high-resolution definition of a waveform.

There are several cautions you should be aware of here. One DSO manufacturer might consider it prudent to provide 2GHz equivalent-time sampling for a 100MHz equivalent-time bandwidth. Another might skimp and decide that half as many samples are enough. So, what you have are two 100MHz DSOs with maybe a slight price difference, but one provides twice the sampling coverage for the same waveform.

An even bigger performance difference can show up in the real-time sampling rate specification and the corresponding single-shot bandwidth performance. To understand this, take a look at Figure 6 again. Notice that the high equivalent-time sample rate (and bandwidth) depends on building up samples on multiple sweeps of a repetitive waveform. Now, think about what happens if you have to capture an entire waveform with one sweep (single-shot mode). If sampling is done at a slow, real-time rate, say 1MHz, you'll get a lot fewer samples on the waveform than a sampler running at a real-time rate of 20MHz. For a "100MHz" DSO, that's 20 times the difference in single-shot performance.

Even if you are not concerned with capturing single-shot waveforms, real-time sample rate can still turn out to be a critical performance issue. To see how, consider the repetitive waveform situation of Figure 6 again. Now think about a 1MHz real-time sample rate vs. a 20MHz real-time sample rate. With the 20MHz rate, you get 20 times as many samples on each sweep, which means

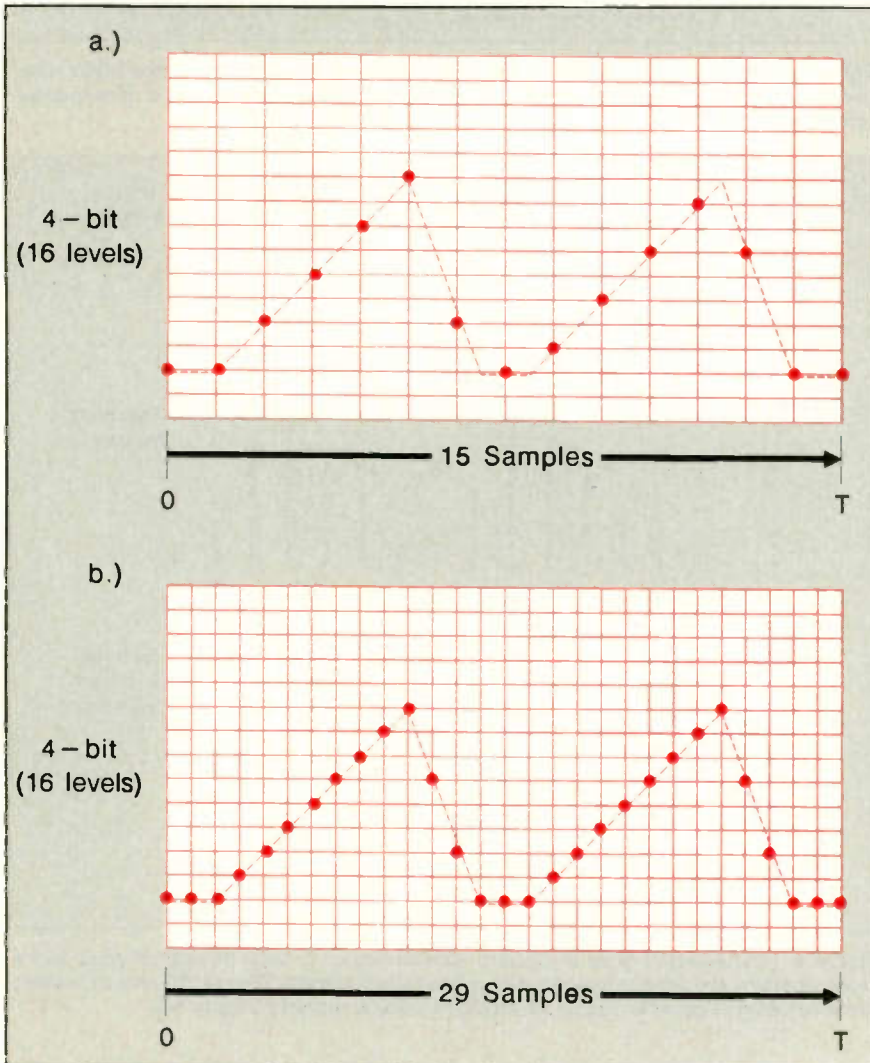

Figure 5. The amount of waveform detail captured by digitizing depends on how closely digital levels and digital samples are placed. Notice how doubling the number of samples improves the definition of the corners on the second cycle of the sawtooth wave.

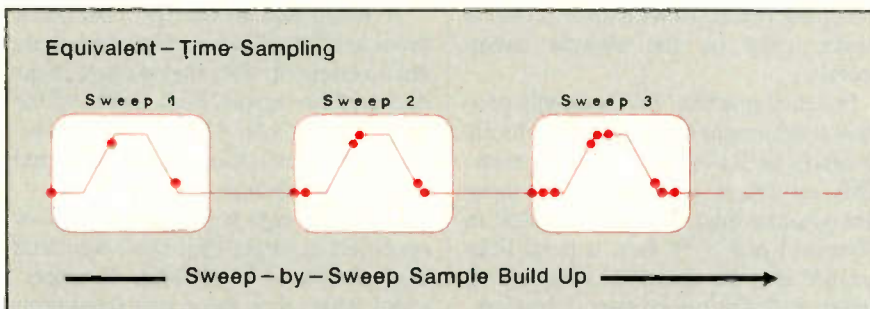

Figure 6. Equivalent-time sampling is often used to provide high-bandwidth capture. This process is done by sampling at a low rate and building up sample density over multiple repetitions of the waveform.



## What a DSO can do for you

An example of the usefulness of DSO waveform storage and display can be taken right from the pages of **Electronic Servicing & Technology**. On page 18 of the July 1986 issue (see "Servicing Sharp High and Low Voltage Circuits"), Homer L. Davidson discusses the difficulty of measuring critical parameters on the sawtooth triggering waveforms used in SCR regulation of certain TV power supplies.

"Assume a source of a 15,734Hz sawteeth and something like a scope to view them," the article states. "However, no service scope can do what we specify, so instead imagine an observation point with the individual sawteeth passing slowly one by one (or stopped with one) and expanded wide enough to permit a close and accurate visual examination of one tooth at a time." Davidson goes on to discuss specific voltage measurements on an individual cycle. Then he concludes, "Well, at least those voltages could be measured if we could stop one cycle and measure it."

With a DSO's waveform digitizing and storage, any waveform can be stopped on-screen and held steady for detailed measurement. This feature is particularly useful for low-repetition waveforms, such as those often encountered in tape, CD and computer disk-drive alignment procedures. On a conventional scope, these low-rep waveforms appear as flashing displays that make measurements difficult. Storing these waveforms with a DSO results in clear, stable displays, making it quicker and easier to obtain precise and accurate measurements.

The process of making measurements is also easier with a DSO. Measurement cursors, shown as Xs or crosses on the display, can be moved to any pair of points on a waveform. The voltage and time differences between cursors is automatically displayed on the DSO screen, allowing you to see amplitude and time measurements directly without counting display divisions or worrying about scale factor multiplications.

Still other DSO features include peak detection to catch noise that would otherwise be missed, signal averaging to remove noise on low-level signals, pre-triggering to show what is happening before waveform trigger points, and enveloping modes to record the effects of long-term changes, such as circuit drift or jitter.

DSOs can even be hooked up to personal computers, which allows standard waveforms to be captured and stored on computer disks as "service waveform libraries." These library waveforms can then be loaded back into DSO memory for use as comparison standards in complex troubleshooting or alignment procedures.

a fully sampled waveform is acquired and displayed 20 times faster. In short, with faster sampling, you get a faster display update rate.

Display update rate becomes critical when you are tracking waveform changes. For example, if you turn a potentiometer to adjust circuit levels or timing, you'd like to see the signal changes updated as quickly as possible on the DSO display. If the display doesn't track the changes quickly, you



Shown here:  
Model SP100  
Switchable 1X-10X **\$43.**

## TPI Probes Last Longer, Cost Less

Unique flexible cable and superior strain relief give longer life and easier, more comfortable handling

Order from these distributors:

- ACTIVE
- ALLAN CRAWFORD ASSOC.
- ALLIED ELECTRONICS
- CALCOTRON
- CONTACT EAST
- EIL INSTRUMENTS
- ELECTRA TEST
- ELECTRONIC PARTS CO.
- ELECTROTEX
- JENSEN TOOLS
- JOSEPH ELECTRONICS
- MARSHALL INDUSTRIES
- MC MASTER-CARR
- METERMASTER
- RADAR ELECTRIC CO.
- SOUTHEASTERN ELECTRONICS
- SPECIALIZED PRODUCTS CO.
- TECHNI-TOOL
- WESTCON INC.
- WM. B. ALLEN

**TEST  
PROBES, INC.**

**TPI**

9178 Brown Deer Road, San Diego, CA 92121  
Call Toll Free for information and free catalog:  
1-800-368-5719  
1-800-643-0382 in CA

Circle (20) on Reply Card



**Table 1  
A DSO check list**

<b>What amplitude accuracy do your measurements usually require?</b>	.....% vertical amplifier
<b>What's the amplitude of the smallest signal that you need to measure?</b> For measurement accuracy and resolution, the signal should cover at least three vertical divisions on the DSO display. Divide your answer by three, and enter the result to the right.	.....volt/div vertical sensitivity
<b>What kind of time accuracy do you usually need for rise time, pulse width and other timing measurements?</b>	.....% time base
<b>What's the frequency or rise time of the fastest repetitive signal that you need to look at?</b> For non-sinusoidal signals (sawtooth, square wave, etc.), the bandwidth of your scope or DSO should be at least five times greater than the frequency of the signal you wish to measure. Thus, you should multiply your answer by five and enter the result to the right. If rise-time measurements are your greatest concern, use the following equation to compute the necessary DSO bandwidth from the fastest rise time ( $T_r$ ) that you typically measure:  $BW = 0.35(5 \times T_r)$	.....MHz equivalent-time bandwidth
<b>Do you ever need to capture single-shot waveforms?</b> If so, what kind of time resolution do you need for reasonable definition or measurement of the signal? For example, you will probably need at least 10 sample points to adequately define a pulse's rise time (for example, 10 samples on a $1\mu s$ rise time provides a 100ns resolution). Once you've determined your single-shot resolution needs, compute the reciprocal ( $1/\text{resolution}$ ) to find the DSO's necessary real-time sample rate.	.....MS/s real-time sample rate
<b>When measuring a signal's amplitude, width, and rise or fall time, do you ever have to change time-base settings to make all of the measurements? (Enter Yes or No.)</b>	.....4,096-point records
<b>Do you use your scope to troubleshoot digital circuits or to detect narrow glitches seen as noise spikes? (Enter Yes or No.)</b>	.....peak detection
<b>Do you need to look at or measure fast-changing or complex waveforms (for example, video signals)? (Enter Yes or No.)</b>	.....high update rate or analog operation
<b>Do you need to make accurate timing and amplitude measurements? (Enter Yes or No.)</b>	.....waveform-based cursors

wind up over-adjusting the potentiometer. The faster the DSO's real-time sample rate, the faster the display update rate and the easier it is to track waveform adjustments.

In cases where you are using the fastest sweep speed on a DSO, high-speed sampling still may not provide as quick a display update as you'd like. Then you probably need the real-time update rate of a conventional analog scope. That's why some DSOs offer the additional analog signal display path shown in Figure 3. This feature gives you the advantages of a conventional scope in the same package with a DSO.

Record length is still another factor that determines how well a DSO can

represent waveforms and, in turn, how easy the DSO is to use. Referring back to Figure 5, the two waveforms illustrated there have record lengths of 15 and 29 samples, respectively, over the duration ( $T$ ) of their display. In actual practice, DSOs provide much longer record lengths. Records of 512 samples are a minimum, and 1,024 samples are more typical.

To get a feeling for the effects of record length, consider a DSO operating at a sweep speed of  $5\mu s/\text{division}$ . For a 10-division display, that's  $50\mu s$  record duration. With 512 samples, the last 12 samples usually extend beyond the last division, giving 500 samples per display or 50 samples per

division. This corresponds to a time resolution of  $0.1\mu s$ . With a 1,024-point record (100 points/division), you get twice the resolution ( $0.05\mu s$ ) for the same waveform display. With a long record of 4,096 points, you get four times the resolution of a 1,024-point record.

Another advantage of a longer record is that you can see more of the waveform without sacrificing resolution. It's like having four 1,024-point displays tied together end to end. This is illustrated in Figure 7 and is particularly useful for making high-resolution measurements on long duration waveforms, such as digital pulse trains. With a shorter record length, you'd be forced to expand



## Peak detection reveals troublesome glitches

With a conventional analog scope, trouble-causing noise glitches may never be seen. Even a DSO can miss narrow glitches if the DSO doesn't have a peak detection feature.

Without peak detection, troublesome noise glitches might be captured if the DSO happens to be sampling when the glitch occurs. The chances of that can be pretty slim, however. For example, a 100ns glitch could easily fall between the 1,000ns sample spacing of 1MHz sampling.

On the other hand, 20MHz sampling would ensure at least one sample on glitches as narrow as 100ns. For this to occur, the DSO must continuously sam-

ple in a 20MHz peak-detect mode on even the slowest sweep speeds. This process will produce far more samples than can ever be displayed. However, by retaining only the maximum and minimum valued samples over the desired sample intervals, 100ns peak detection can be achieved on even the lowest sweep speed of the DSO.

This peak detection process is illustrated to the right, and Figure 2 in the main article shows the result on an actual DSO display. Without this kind of peak detection and display capability, troubleshooting intermittent or random faults in digital circuitry becomes a hit-and-miss situation.

When not operating in a peak-detect mode, a DSO samples at a rate required to fill a complete record over the length of time defined by the time/division setting. For example, a DSO with a 1K record length (or 100 sample points per division) need only sample once every 10µs or 0.1MS/s when operating at a 1mS/div time-base setting (1mS/div ÷ 100 samples/div = 10µs/sample). Peak-detect mode allows samples to be taken at a maximum sampling rate (for example, 10MS/s) with minimum and maximum values found saved as the displayed samples. In this way, glitches as narrow as 100ns are captured.

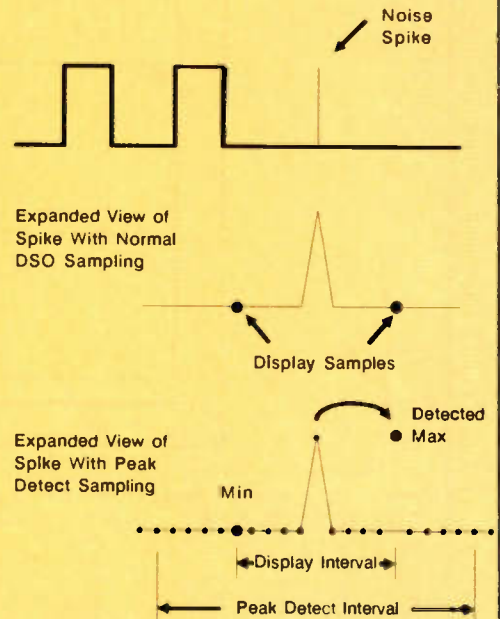

## Excellent reliability and operational simplicity in a high-performance scope.

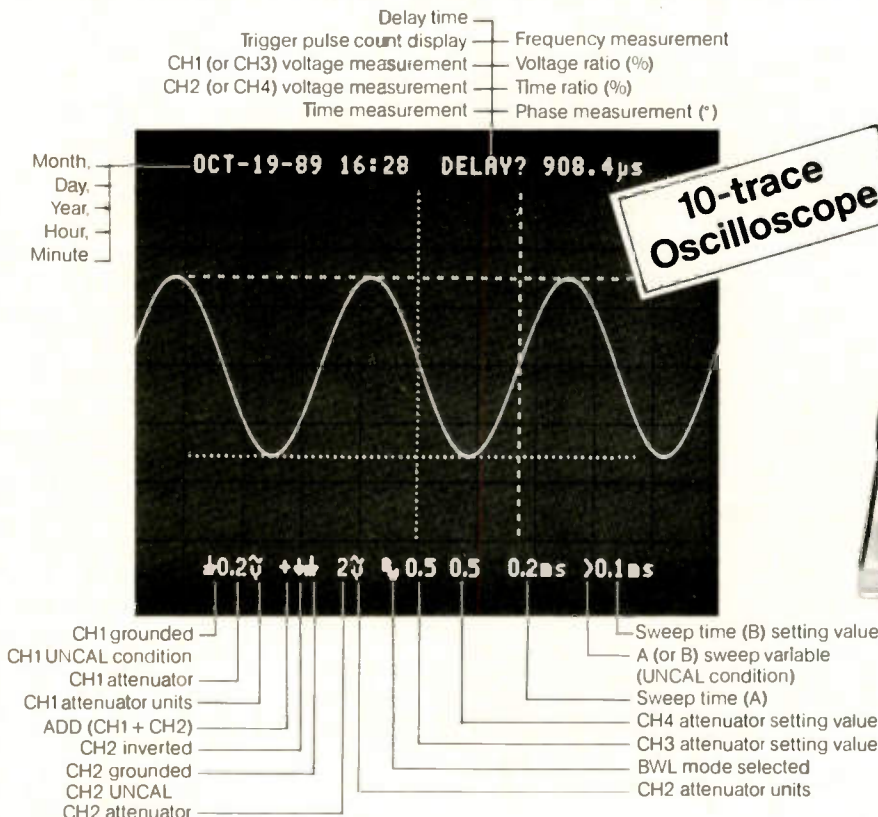

### CS-6020...150MHz 4-channel, 10-trace oscilloscope.

- A trigger counter function for analyzing complex digital and video signals.
- Bright CRT readout—all essential information on a single screen.
- Cursor functions—provides a digital readout of voltage, time, voltage ratio, time ratio, frequency, and phase differences.
- Logic control for functionality and high reliability.
- B sweep variable for fine adjustment of delayed sweep.

For more information, contact your Kenwood Distributor or call Kenwood today!

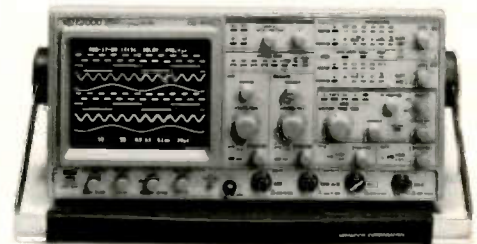

## KENWOOD

KENWOOD U.S.A. CORPORATION  
Communications & Test Equipment Group  
2201 E. Dominguez St., P.O. Box 22745  
Long Beach, CA 90801-5745  
Telephone (213) 639-4200

See us at EDS '89 Booth Nos. 513-515

Circle (21) on Reply Card



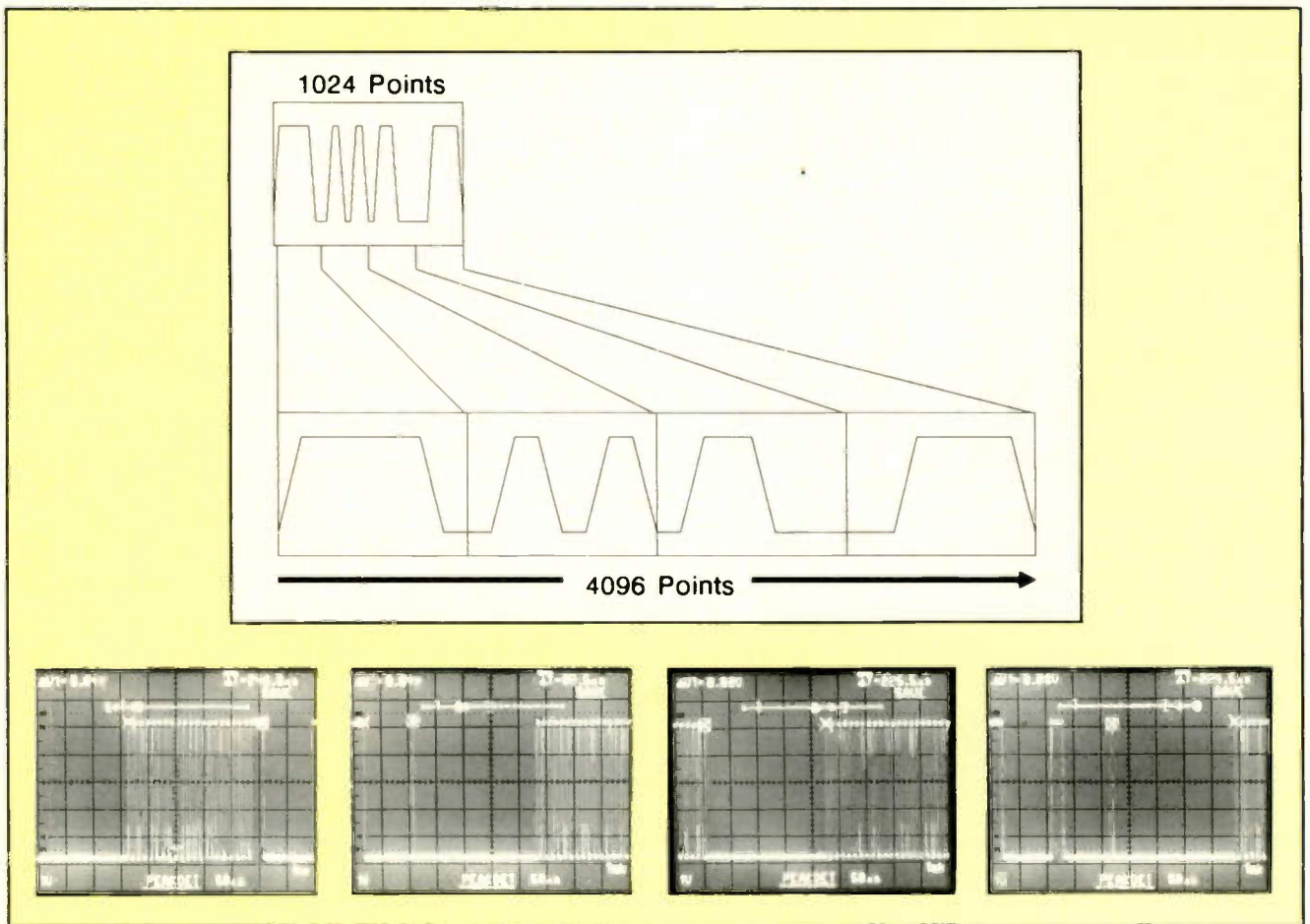

Figure 7. Record length determines how much detail you get to see on a given waveform. The difference is shown here with the same waveform captured in a 1,024-point record and in a 4,096-point record corresponding to four end-to-end screen displays.

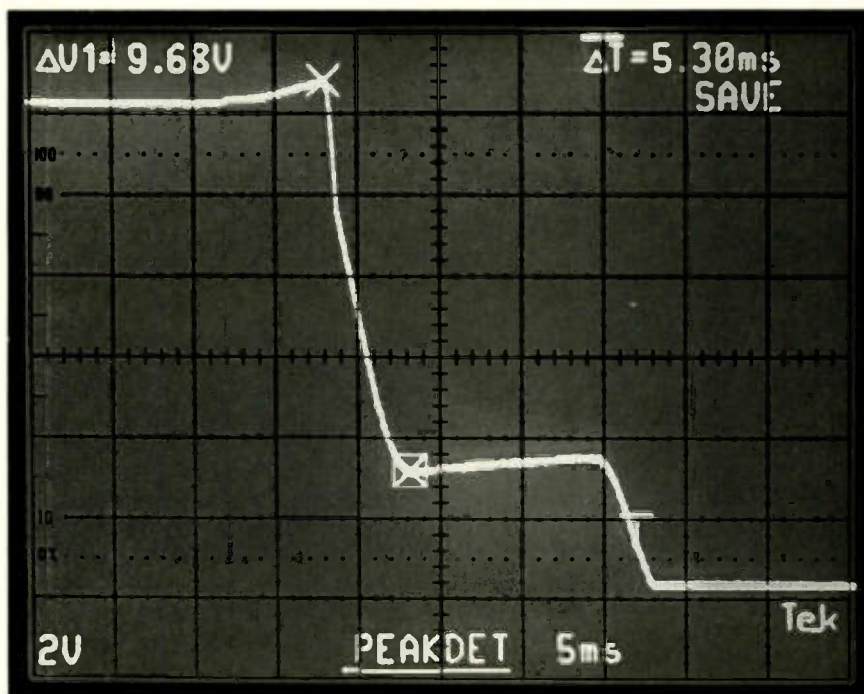

Figure 8. Pre/post trigger adjustment allows you to determine how much of the waveform is captured prior to and after the trigger point (T on the waveform). This adjustment is useful for finding fault conditions leading up to a failure or circuit-breaker trip.

the display on each pulse to get the same resolution for rise-time and width measurements.

#### Seeing things other scopes miss

Beyond record length, there are many other DSO features that can help you focus on selected portions of waveforms. Some of the most important of these include pre-triggering, post-triggering and peak detection.

Pre- and post-triggering are fairly easy concepts to implement digitally. Essentially, these features determine how much of the waveform is captured before and after the trigger point. This is illustrated in Figure 8, which shows a waveform captured with pre/post triggering set for half a screen.

Pre-trigger is particularly useful for tracing problems that occur before the symptom. For example, a circuit breaker in a TV set keeps tripping. It would be nice to be able to see what is happening in the power supply or elsewhere just before the breaker trips. To do this, simply set the DSO to trig-



# CES YES!



Say yes to CES® and discover *all* the latest trends and top-selling products. It's where 1400 exhibitors showcase more than 95 different consumer electronics product categories!

**Pre-register Now. Take advantage of the advance complimentary registration and save the \$25 on-site fee.**

Mail this completed form to Consumer Electronics Shows, % CompuSystems, Inc., P.O. Box 6579, Broadview, IL 60153-6579. To obtain your badge by mail, we must receive this form no later than May 5, 1989. Attach your business card for proper verification and prompt processing. If we receive this form after May 5 and before May 22, 1989, you may pick up your badge at the "Advance Registration Pick-Up" Desk in the Main Registration Area of McCormick East and McCormick North. Two forms of ID will be required. Registration Forms received after May 22 will not be processed. Please register on-site after paying \$25.

To register more than one qualified individual, please duplicate this Advance Registration Form and attach business cards. Complete Show information, including housing form, will be sent separately.

**1989 International Summer Consumer Electronics Show®**

Saturday, June 3 through  
Tuesday, June 6, 1989  
Chicago, Illinois USA



The Consumer Electronics Shows are sponsored and produced by the Electronic Industries Association Consumer Electronics Group.

Please check only one badge category:

- 1  Retailer
- 2  Distributor
- 3  Dept./Chain Store Buyer
- 4  Prom./Catalog Buyer
- 5  Manufacturer's Rep
- 6  Manufacturer
- 7  Institutional Buyer
- 11  Adv./Mktg./PR/Consultant
- 12  Financial/Market Analyst

Name \_\_\_\_\_

Company \_\_\_\_\_

Street \_\_\_\_\_

City \_\_\_\_\_ State \_\_\_\_\_ Zip \_\_\_\_\_

Phone \_\_\_\_\_ Last four digits of your Social Security Number \_\_\_\_\_ 126  
(for internal use only)

\*Only 21 characters including spaces will appear on your badge.

For the trade only. No one under 18 years of age will be admitted. Over-the-counter sales are not permitted. For exhibit sales information please call (202) 457-8700.



# Troubleshooting Tips

ger off of the circuit breaker and select full pre-trigger for the display. This allows you to see a full screen of waveform information before the trigger point. When full pre-trigger is combined with a long record, such as the one shown in Figure 7, you can see everything from power-on all the way through the fault condition.

Peak detection is another equally useful feature for troubleshooting faults in digital circuits. For example, a digital TV tuner inexplicably changes channels or a digitally controlled volume level jumps up or down. These and other logic faults can be caused by occasional noise spikes generated within the TV set or picked up from outside sources. The trouble is, you'll rarely see these glitches on a conventional oscilloscope or even on most DSOs.

With a conventional scope, you might be able to catch some glitches by using a fast sweep speed and turning the display intensity way up. But this isn't the usual mode of operation during general troubleshooting. Consequently, problem glitches are often missed when you're troubleshooting intermittent logic faults. This situation was illustrated in Figure 2, which shows a DSO's peak detection capturing a glitch that's invisible on a conventional scope display.

## A DSO checklist

Beyond sampling rate, record length, pre/post triggering and peak detection, there are many other features offered by DSOs. For example, some DSOs have a signal-averaging feature that can be used to reduce noise on repetitive waveforms. Not only does averaging make it easier to measure low-level signal parameters, but it can actually improve the vertical resolution of the DSO. An 8-bit DSO (256 digital levels) can become a 10-bit DSO (1,024 digital levels) if signal averaging has been properly implemented in the DSO.

But before worrying about any of these more advanced features, you need to answer some basic questions about your DSO needs. The key questions to consider are listed in Table 1. By answering these questions, you can define your basic DSO needs. And when you begin to compare your answers to the corresponding specifications for different DSO models, you'll begin to see some major performance differences between DSOs that you might have thought were about the same except for price.

**ES&T**

**Symptom:** No picture, no raster, good sound

**Set ID:** Sony model KV2670R, chassis SCC548C 26-inch pix tube

**Photofact:** 2347-2

When this set was brought in, the symptom was no picture and no raster, but the sound was OK. My first thought was that high-voltage might be absent, so I hooked up the high-voltage probe. The reading was 27kV, which should be adequate for normal operation. I then took a look at the CRT heater. It was lit and appeared normal.

Still suspecting something at the picture tube, I took voltage readings at all of the connections at the CRT socket. All of these voltages seemed to be within the normal range. My next step

was to check out the condition of the CRT. When I hooked the CRT up to the tester, I got readings that indicated that there were no short circuits within the tube, and emission on all three guns was within spec.

My next step was to check the connector that supplies the operating voltages to PCB-C (the CRT circuit board). This PC board contains the CRT socket; the red, green and blue color drivers and output circuits; plus the VM drivers and outputs. The 976V boost voltage and the 197V and 9.2V supplies were all within tolerance. Failing to isolate the source of the problem up to this point, I decided to turn the brightness control up full, but found that the owner had already done that.

My next troubleshooting step was to

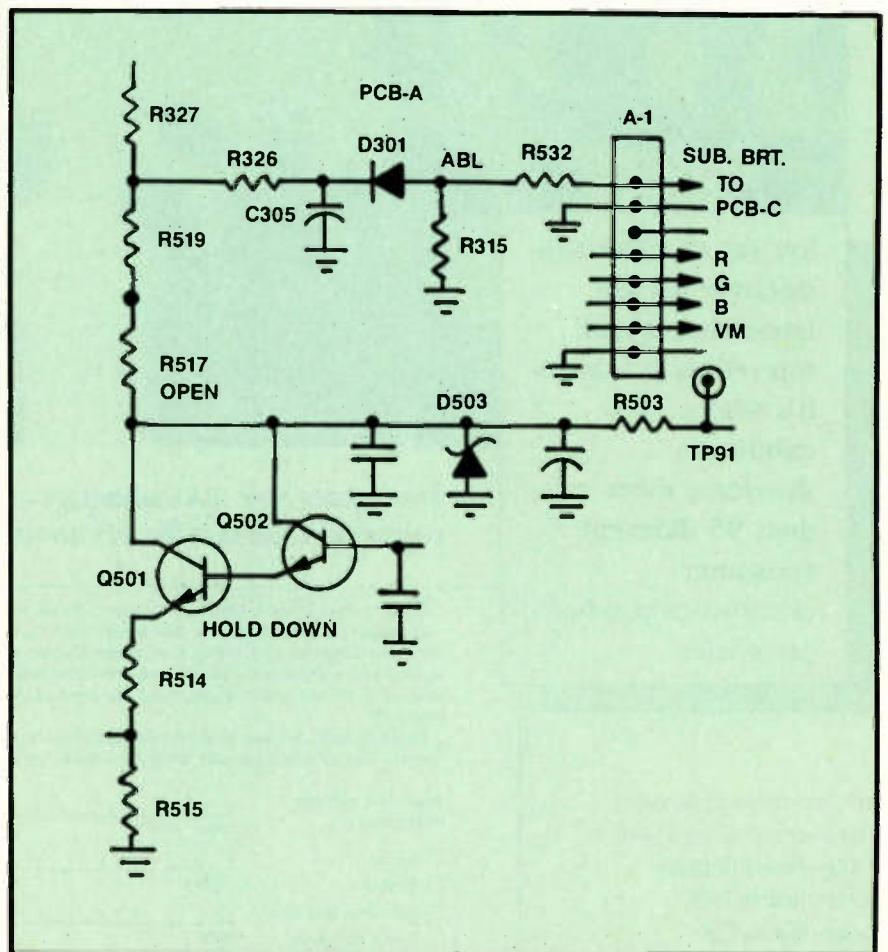

Figure 1. In this set, R517 was open, causing the voltage at the collectors of the output transistors to be about 50V higher than the specified value and near the source voltage. This schematic diagram has been redrawn from the Sams Photofact schematic in order to show the relationships of the circuit segments, which are connected by virtue of their being connected in common to the 24.9V source (Circuitrace number 3).



check the adjustment of the master screen control (RV-701) on the same PC board. Turning this control up resulted in a dim raster but with no video and no color. I thought that if I could determine why the video and color were missing, I'd have a solution to the problem.

Because the PCB-C is located conveniently on the CRT socket, I decided to check it out first, looking for more brightness. To pursue the video and other brightness circuits, I would have to pull the main chassis. I checked the physical appearance of the red, green and blue output and driver transistors, then checked the voltages at all pins of each transistor. All of these voltages were in the normal range, except at the collectors of the output transistors. These were about 50V higher than the

specified value and near the source voltage, which led me to believe that there might be an open circuit in the base or emitter circuit of one of the output or driver transistors. Nothing on PCB-C seemed to be open or defective in any way.

At this point, I turned to the main chassis, PCB-A, by picking up the line leading from PCB-C marked "Sub Brt" and tracing it to PCB-A connection block A1. This line leads to the ABL circuit on the main circuit board. I started by checking the ABL diode, D301, then the filter circuit R326, C305 and R315 associated with D301, still looking for an open circuit. Everything checked out OK.

Then, while trying to determine which path to take from this point, I quickly checked a couple of the resistors

adjacent to the ABL circuit, and there it was. R517 in the collector circuit of the hold-down transistors was open (Q501 and Q502 hold-down). The next question that occurred to me was, "What caused the problem?" A check of all components leading to this circuit turned up no defects. A new R517 corrected the problem. Video and brightness both returned in abundance. A long bench test confirmed that this was the only problem. This is one of many very small resistors in this set. It may have been that it carries more current than was intended by the designers, or that a defect showed up only after it was in service for some time.

**Edwin J. Glatzel**  
Severna Park, MD

**ES&T**

## HOLD IT ANYWHERE YOU WANT IT!

PanaVise electronic work holding systems allow you to position, tilt and rotate your projects without removing them from their holding devices! With over 30 years experience and made-in-USA quality, PanaVise ensures reliable, long-lasting service.



**MULTI-PURPOSE WORK CENTER:** Self-Centering Extra Wide Opening Head (opens to 9"), famous "split ball" Standard Base (moves in three planes), and convenient Tray Base Mount (with parts wells) handle difficult to hold items with ease! Model #350.

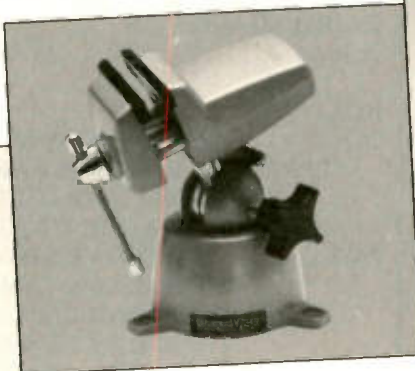

**STANDARD PANAVISE:** Our most popular vise, the Standard PanaVise is an extremely versatile, useful workbench tool. Jaws open a full 2.25" and the patented "split ball" base tilts, turns and rotates through three planes. One convenient control knob locks work into any position! This durable, all-purpose mini-vise stands about 6" tall and will deliver years of rugged service. Model #301.

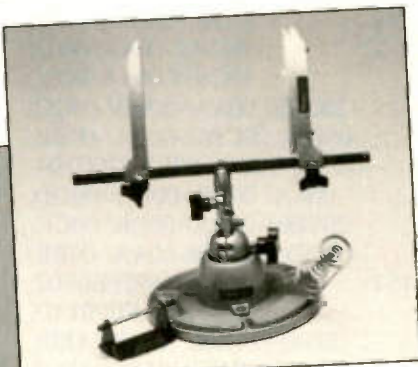

**ELECTRONIC WORK CENTER:** A complete combination to make work areas more efficient and manageable! Circuit Board Holder gently, but firmly, holds PCB's up to 12" wide. Add our Standard Base (moves in three planes), Tray Base Mount (with parts wells), and Solder Station (self-centers wire and holds iron at perfect angle) for a great combo! Model #324.

**PANAVISE**

See your local electronics supplier or contact PanaVise for the source nearest you:  
PanaVise Products, Inc., 2850 E. 29th Street,  
Long Beach, CA 90806; (213) 595-7621



# Books/Photofact

## PHOTOFACT

### EMERSON

2636-1 ..... ECT2500D  
 2640-1 ..... PC-6  
 2641-2 ..... M2550RD/RDA  
 2642-1 ..... M1375R/RA  
 2643-1 ..... MS2580RD/RDA  
 2645-1 ..... ECR1350,  
 ECR1350 (SUFFIX A)  
 2647-1 ..... ECR2100, ECR2100  
 (SUFFIX A/B)  
 2648-1 ..... MSI980R

### GE

2630-1... 8-2559A01 (CH. ALDX110)  
 2633-1... 8-2562A01, 8-2564A01,  
 8-2569A01 (CH. ALEDX110)

### HITACHI

2628-1 ..... CT2076B, W

### JCPENNEY

2631-2 ..... 685-4221M, 685-4222M,  
 685-4224M

### MAGNAVOX

2629-1 ..... (CH. 19C801-00BB,  
 19C802-00AA/B002,  
 19C803-00AA/B002,  
 20C802-00AA/-00BB/-00CC/  
 -00DD, 20C803-00AA/-00BB/  
 -00CC/-00DD/-00EE, 20C804-  
 00AA/-00BB/-00CC/-00DD,  
 20C805-00AA/-00BB/-00CC/  
 -00DD, 20C806-00AA/-00BB)  
 2646-1 ..... EMN692PE01/02,  
 RG4474AK01/02/03,  
 RG4549AK01, RG4812AK01,  
 RG4816PE01, RG5940AK01/02/03,  
 RG5946PE01/02/03, (CH. 25C806-  
 00AA/BB/CC/DD/EE, 25C807  
 00AA/BB/CC/DD/EE, 25C808-  
 00AA/BB/CC/DD/EE/FF, 25C809  
 00AA/BB/CC/DD/EE, 25C810-  
 00AA/BB/CC/DD/EE/FF, 25C816  
 00AA/BB/CC/DD/EE, 25C817-  
 0AA/BB/CC/DD/EE, 25C818  
 00AA/BB/CC/DD/EE, 26C805-  
 00AA/BB/CC/DD, 26C807  
 00AA/BB/CC/DD/EE/FF/GG/HH,  
 26C808-00AA/BB/CC/DD, 26C809  
 00AA/BB/CC/DD, 26C814-  
 00AA/BB/CC, 26C816-00AA/BB/CC,  
 26C817-00AA, BB, CC, DD, EE, FF)

### MITSUBISHI

2623-1 ..... CS2013R, CS2014R

### PANASONIC

2622-1 ..... CTJ2065R, PC-21P65R  
 (CH. AEDP157, YAEDP157)  
 2631-1 ..... CTJ-1900, -1, PC-20P01  
 (CH. P151/SI, LP151/SI,  
 YP151/SI)  
 2634-1 ..... CTJ-2780R, CTJ-2788R  
 (CH. AEDP134/GL6S,  
 AMEDP134/GL6S)  
 2635-1 ..... CTJ-2560R/80R,  
 PC-26P80R (CH. ADP128/GL6S  
 YAEDP128/GL6S)

### PHILCO

2638-1 ..... R5883WAK01,  
 R5885WPE01, R6980WAK01/02,  
 R6982WPE01/02 (CH. 25C601,  
 26C606)  
 2645-2 ..... R3340A

### QUASAR

2621-1... WP3931BW/W, YP3931BW  
 (CH. C149, LC149, YC149)  
 2624-1... TL9839BP, TL9932BW/CW,  
 TU9810BU/CU, YT9810BU,  
 YT9820BK (CH. ADC130,  
 AEDC130, YADC130)  
 2625-1 ..... TT6267BW-1  
 (CH. AEDC175)  
 2632-1 ..... TP2157CC/CE/CH/CR,  
 YTP2157CE (CH. AGC159,  
 YAGC159)  
 2648-2 ..... WU9610BU, WL9618BP

### RADIO SHACK

2638-2 ..... CM11 (26-1024)

### RCA

2621-2 ..... EPR350E-1/E-2/W-1/W-2,  
 EPR355W-1, EPR358AR-1/WR-1,  
 EPR359DR-1, EXR345ER-1,  
 EXR350E-1/E-2 (CH. CTC135D)  
 2622-1 ..... FMR550WR/555WR/  
 565WR/566WR/720WR,  
 GMR851PR/885CR/855HR/  
 859PR/860TR/868PR  
 (CH. CTC130B)  
 2626-1 ..... CSM055  
 2632-2 ..... 1986 USA E,T  
 (CH. CTC131M)  
 2644-1 ..... FMR460WR/461WR/  
 468WR/488TR (CH. CTC120C)

### SEARS

2623-2 ..... 564.42871750  
 2636-2 ..... 564.42822750/51  
 2637-1 ..... 562.42251650  
 2639-1 ..... 564.40454850  
 2640-2 ..... 564.40653850  
 2641-2 ..... 564.48013850/51

2643-2 ..... 564.42903850  
 2644-2 ..... 564.42954850  
 2646-2 ..... 564.48127850  
 2647-2 ..... 564.42071850

### SONY

2625-2 ..... KV-27TS20/21/22/  
 (CH. SCC-A05P-A/Q-A/R-A,  
 SCC-A50G-A)  
 2626-2 ..... KV-27TX10/11/12  
 (CH. SCC-A05S-A/T-A/U-A,  
 SCC-A50H-A)  
 2627-1 ..... KV-20TS10/11/12/13  
 (CH. SCC-A05Y-A,  
 SCC-B55A-A/B-A/C-A)  
 2634-2 ..... KV-1927RA  
 (CH. SCC-A81M-A)  
 2637-2 ..... KV-20TR10/11  
 (CH. SCC-A05L-A/A05M-A)

### SYLVANIA

2633-2 ..... RLF351AK01,  
 RNF357PE01/02, RNF358AK01/02,  
 RNF372AK01/02, RNF375HP01/02,  
 RNF378PE01/02,  
 RNF610CH01/02, RNF980AK01/02,  
 RNF981AK01/02, RNF982AK01/02  
 (CH. 25C802-00AA/CC/GG/HH,  
 25C803-00AA/BB/CC, 25C805  
 00AA/BB, 25C819-00AA/BB/CC,  
 26C801-00AA/CC/EE/FF/KK,  
 26C802-00AA/BB/CC, 26C803-  
 00AA/BB/CC, 26C810-00AA/BB/CC,  
 26C811-00AA/BB/CC, 26C812-  
 00AA/BB/CC, 26C813  
 00AA/BB/CC/DD, 26C815-00AA/  
 BB/CC/DD/EE/FF, 26C818  
 00AA/BB/CC)  
 2639-2 ..... CXF165WA01/02,  
 RFX155WA01/02, RFX169WA01  
 (CH. 19C710/11/16)  
 2642-2... RKE192SL01/02/03,  
 RKE198SL01, RKF192CH01/02,  
 RKF194CH01/02, RKF195CH01/02,  
 RKF198CH01/02, RXE188 (CH.  
 19C601, 20C602/3/5/8/9)

### TOSHIBA

2624-2 ..... CF917, CTC917C  
 (CH. TAC8720, TAC8725)  
 2627-2 ..... CF2038, CX2158C  
 (CH. TAC8800, TAC8805)  
 2628-2 ..... CF2048, CX2168C  
 (CH. TAC8801, TAC8806)  
 2629-2 ..... CF2638, CF2648,  
 CX2838C, CX2848C, CX2858C  
 (CH. TAC8810, TAC8815)  
 2630-2 ..... CX2078, CX2178C  
 (CH. TAC8802, TAC8807)  
 2635-2 ..... CF2028 (CH. TAC8733)



**Survey of Wages, Benefits, and Working Conditions in the Service Industry, by the publishers of Service Dealer's Newsletter; Lynco Publications; 20 pages; \$39.95.**

This year's edition provides statistics for the industry by product categories: home appliances/TV; heating/cooling/refrigeration; office equipment/computers; heavy machinery; and medical/scientific. Information on wages and benefits, labor charges, employee benefits, operating methods, profit margins and the use of computers is included. A total of 484 service companies contributed to this data.

Lynco Publications, 615 N. Easton Road, Suite 200, Glenside, PA 19038; 215-886-3646.

**Electronics: A Survey, 3rd edition, by Robert Boylestad and Louis Nashelsky; Prentice-Hall; 684 pages.**

This text concentrates on the most important concepts of a broad range of subjects dealing with electrical engineering technology. The topics include dc and ac networks and

machinery; magnetics; basic electronic devices; electronic and integrated circuits; multi-stage and large signal amplifiers; communications; control systems; digital fundamentals; analog circuits; power supplies and electronic instrumentation.

Prentice-Hall, Prentice-Hall Building, Englewood Cliffs, NJ 07632.

**Handbook of Home Security Electronics, by Harry L. Helms; Prentice-Hall; 107 pages.**

This handbook describes all major types of electronic security devices and hardware and shows how to integrate them into a comprehensive system for total, effective protection. The book gives the strengths and weaknesses of the devices, including how they work, how to design them into a complete system, and how to install and service the system. Testing, troubleshooting, repair techniques and schematic diagrams are also included.

Prentice-Hall, Prentice-Hall Building, Englewood Cliffs, NJ 07632.

**Servicing Personal Computers, 2nd edition, edited by Michael Tooley; CRC Press; 258 pages; \$39.95.**

This manual covers the principles and practice of PC servicing and includes numerous circuit and block diagrams. Software diagnostic routines have been included with listings and actual screen dumps. A new chapter on the IBM PC, AT, XT and compatibles is provided. CRC Press, 2000 Corporate Blvd., NW, Boca Raton, FL 33431; 800-272-7737.

**Newnes Audio and Hi-fi Engineer's Pocket Book, by Vivian Capel; CRC Press; 190 pages; \$19.95.**

This book presents a concise collection of practical data for anyone working on sound systems. The topics covered include microphones, gramophones, CDs, tape recording, high-quality radio, amplifiers, loudspeakers and public address. A section is also provided on acoustics.

CRC Press, 2000 Corporate Blvd., NW, Boca Raton, FL 33431; 800-272-7737.

**ES&T**

**Come Out of the Dark.**

Light your way with the 100-page desktop guide to the electronics industry, the 1989 Professional Electronics Yearbook, just one of many "enlightening" benefits available from NESDA. For an order form, and more information about NESDA, just send the following:

Name \_\_\_\_\_

Address \_\_\_\_\_

City \_\_\_\_\_ State \_\_\_\_\_

Zip \_\_\_\_\_

Phone \_\_\_\_\_

National Electronics Sales &

**NESDA**

Service Dealers Association

2708 W. Berry St.  
Ft. Worth TX 76109  
(817) 921-9061

\*One of a series.

**NEW** **TECHNICIANS' TIME SAVER**  
**VHS VU-THRU**  
**DIAGNOSTIC TOOL**

The new VU-THRU is a clear jig that allows operation of a VHS machine as if there were a tape in it. It lets you instantly see the problem. Cuts diagnostic time to a minimum.

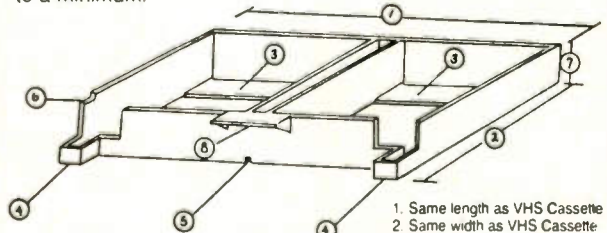

1. Same length as VHS Cassette
2. Same width as VHS Cassette
3. See thru area contact switches
4. Stop points
5. Centering key slot
6. Door switch relief
7. Same height as VHS Cassette
8. Tape pick up finger clearance

ONLY ... **\$14.95**  
each plus shipping

Call Toll FREE ...

**1-800-558-9572**

In Wisconsin 1-800-242-9553

Ask for your FREE copy of our 1989 Catalog with over 12,000 electronic parts and accessories.



**PRIME**  
**ELECTRONICS CO.**



P. O. Box 28 • Whitewater, Wisconsin 53190

Circle (23) on Reply Card



## Digital storage oscilloscope

Tektronix's 4½-pound hand-held DSO, the Tek 222, offers 10MHz, dual-channel performance, automatic set-up and digital save/recall. Other features in-



clude glitch capture up to 100ns, a 10MS/sec sample rate and an RS-232-C interface.

Circle (76) on Reply Card

## Tool kit

The model 71A103 compact tool kit from HMC is made of waterproof, stain-resistant Cordura nylon, and includes 24 brand-name tools essential for equipment troubleshooting and repair. The kit includes a soldering iron, an adjustable



wrench, Phillips and slotted screwdrivers, a wire stripper, a cutting plier and more. The case is small enough to be carried in a briefcase.

Circle (77) on Reply Card

## Coax cable stripper

The CST PA 1241 precision coax cable stripper from Paladin can accommodate cable from 0.100-inch to 0.315-inch diameter and has a roller sup-



port to reduce friction. Features include an adjustable stop for reproducible cutting force and a cam wheel for precise location of the cable. The design reduces hand pressure by up to 50%.

Circle (78) on Reply Card

## Software

The CService version 5.1 software from America West C&E can be used for invoicing, accounts receivable, inventory, equipment maintenance history and tracking technician efficiency, work tickets and maintenance contracts. The invoicing section is interfaced to inventory and will close out the work ticket and credit the hours to the technician's file. Inventory allows for up to nine shop locations.

Circle (79) on Reply Card

## Solderless breadboards

Cheneko Products is offering a new series of solderless breadboards, the X-tra Edge. The series features an extra multi-purpose edge panel for organizing and mounting components that do not fit into the normal DIP spacing solderless breadboard socket connections. The X-tra Edge breadboards are available in four sizes, ranging from 4.3''x 7.4'' to 9.7''x 7.4''.

Circle (81) on Reply Card

## Maintenance kit

Contact East is offering a PC and peripherals maintenance kit that includes a special combination wire cut-

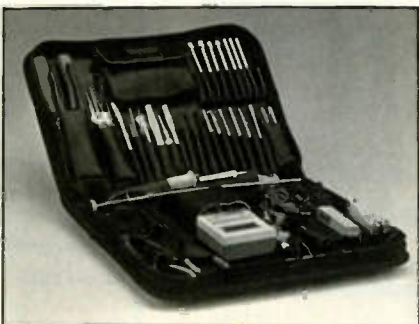

ter; a stripper and crimper for common RS-232 U-barrel; connector pins; memory chip and RS-232 pin inserter/extractors; miniature wrenches and more. Optional accessories are available, including a 3-digit meter. A service kit, which contains all that the maintenance kit does and more, is also available.

Circle (82) on Reply Card

## Audio/visual electronics program

Bergwall Productions has released #878 *Troubleshooting the IBM PC II*, a 5-part audio/visual training program. The electronics program will instruct the student/trainee in the analysis of the fault and the proper steps that should be taken to isolate the given problem. A study guide provides learning objectives, pre-tests, post-tests and a glossary.

Circle (83) on Reply Card

## Static protection covering

The Charge-Guard 8100 surface-covering material, available from 3M, transforms conventional work benches, tables, shelves and floors into static-protective surfaces. The covering consists of three layers: an outer static-dissipative layer, an inner conductive layer and a bottom layer with a pressure-sensitive adhesive. A ground cord and a 1MΩ current-limiting resistor are included.

Circle (84) on Reply Card

## Product line

EMCO Electronics has introduced its DM series. The product line includes the DM-80, which has a 3¾-digit autorange with 3,999 counts; the DM-3650 DMM with 3,999 counts; and the DM-3900 DMM with 1,999 counts. All three units test ac-dc volts, current, resistance and frequency. The DM-3650 also tests capacitance; the DM-3900 has high tach, low tach and dwell.

Circle (85) on Reply Card

## Computer care kit

The model CCK 100 Universal Computer Care Kit, available from Scooter Products, features a battery-operated mini-vacuum cleaner. The vacuum includes four attachments to accommodate hard-to-reach areas. Also featured in the kit are 3½- and 5¼-inch disk drive cleaning diskettes, a miniature utility



brush and anti-static cleaning solution.

Circle (86) on Reply Card

### Logic analyzer

*Global Specialties'* LA-1610 logic analyzer can display 256 contiguous events occurring on 16 channels of an oscilloscope. The model features optional inversion of incoming data and front-panel push buttons to set the trigger word. The unit can run on its internal clock (with four selectable speeds from 1.25MHz to 10MHz) or an external clock.

Circle (87) on Reply Card

### Oscilloscope

The Philips PM 3308 100MHz digital storage oscilloscope from *John Fluke Mfg.* features an electroluminescent screen that can display four traces simultaneously, extensive cursor measurements and a battery-backed 180Kbyte



RAMdisk. Its non-volatile memory can store up to 100 waveforms and set-up menus. The scope also features autoset, a 100MHz bandwidth, a 40MS/s sampling rate on one channel, 8Kbyte acquisition, and GPIB and RS-232 interfaces.

Circle (88) on Reply Card

### Pocket torch

The pocket-size Blazer Micro Torch from *Jensen* delivers an adjustable flame from 800°C to 1,300°C. The torch, equipped with a Piezo ignition system, requires no lighter or matches to start and features a protective safety cap, windshield and detachable base. The Blazer burns butane lighter fuel and is refillable.

Circle (89) on Reply Card

### Digital multimeter and buffer

*Brunelle Instruments* has introduced its model 4090 digital multimeter, which is computer-compatible via the model 270 buffer. When interfaced, the multimeter and buffer can measure resistance, temperature, humidity, light levels, rpms and ac/dc volts and amps. Readings can be transferred directly to the computer or printer. The DMM also features transistor and diode test.

Circle (90) on Reply Card

### Satellite protection system

The SATT PRO II-36, available from *Electronic Specialists*, is an in-home satellite protection system for receiving and control equipment. It provides six filter/suppressor-protected ac sockets; 8-line control cable protection; TVRO and TV VHF/UHF cable protection.

Circle (91) on Reply Card

### Surge protectors

*Panamax* has announced an improvement in all its surge protectors. The devices now provide a lower clamping level — 240V — and "fail-open" circuitry, which will stop any current from passing through the protector to the connected equipment if the suppression circuitry is damaged. The appearance of the protectors has been redesigned as well.

Circle (92) on Reply Card

### Dual iron and dual station holders

*CooperTools* has introduced the Weller DPH-2 dual iron holder and the Weller SH-2 dual soldering station holder. The dual iron holder can be assembled to fit three different iron combinations. The dual soldering station holder can accommodate any combination of Weller EC, WTCPS and WTLE series of soldering stations.

Circle (93) on Reply Card

### Breakout box

The SmartCableMaker II breakout box from *IAM* senses line levels, evaluates transmission and reception signals and instantly makes the proper connection for any RS-232 device. A 7-position dip switch is included for non-standard applications, and a plotter interface connection ensures compatibility for all types of devices. A graphic display of the connections

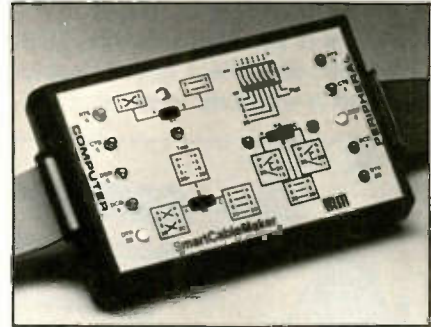

allows the user to replace the unit with a flat cable.

Circle (94) on Reply Card

### Disk drive exerciser

The model 103E disk drive exerciser from *AVA Instrumentation* can exercise all sizes of floppy drives and all Apple drives. It can also exercise any tape drive with a floppy interface and any Winchester drive with the ST506/412 or the ESDI interface. The unit uses an LCD display, is user-programmable and has a battery-backed memory.

Circle (95) on Reply Card

### Soft-side tool kits

*Hand Tool Industries'* has introduced a stock line of soft-side zipper-type tool kits. The kits are designed for technicians who service telephone systems and equipment, copiers and other business machines, computers and other data processing equipment.

Circle (96) on Reply Card

### Videotape winder/cleaner

The model V-0755 videotape winder/cleaner from *Ambico* allows rewinding, fast-forwarding and safe

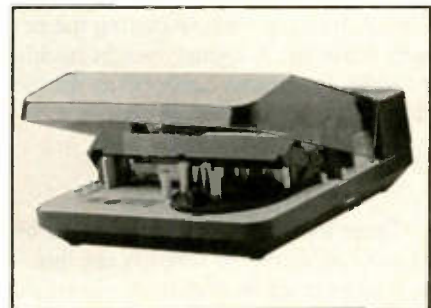

cleaning for VHS videotapes. The device rewinds or fast-forwards a T-120 tape in less than 3 minutes. The cleaning function uses a safe wet system.

Circle (97) on Reply Card



**Temperature controller**

*Hot Tools* has introduced the Dial-Temp controller, which makes electric-heated tools with fixed temperatures ad-

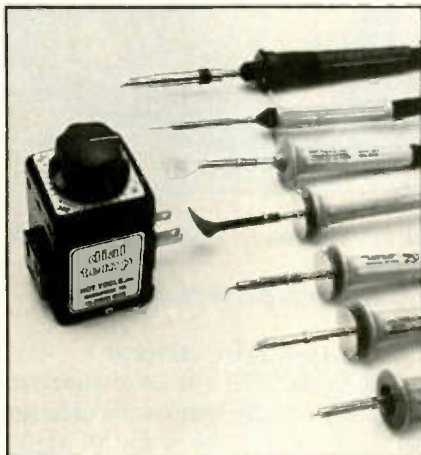

justable from 150°F to full heat. The controller plugs into ac wall outlets and accepts tools ranging from 15W to 1,600W.

Circle (98) on Reply Card

**Heat shrinkable tubing**

The STK-100 heat shrinkable tubing from *The Eraser Company* contains an assortment of different sized pieces of flexible, flame-retardant polyolefin shrink tubing. When heat above 120°C is applied to the tubing, it will shrink to approximately half its original diameter to conform to the object covered.

Circle (99) on Reply Card

**Wrist straps**

The Ultra Comfort Aid wrist strap from *Semtronics* features a pull-through tab that allows the operator to adjust the size of the strap without cutting the excess material. A lighter-weight buckle provides continuous conductivity for the user whether open or closed.

Circle (100) on Reply Card

**Extraction tools**

Three tools have been introduced by *Jonard Industries* to simplify the insertion and extraction of delicate electronic components. The S-42 plier, lamp cap extractor and the S-339 switchboard lamp extractor feature dielectric insulation. The S-340 extractor, tweezer type is for extraction of miniature and micro-miniature lamps, caps, numeric in-

dicators, miniature PC-type components, flat packs and ICs.

Circle (101) on Reply Card

**Overhead ionizer**

The A60420 overhead mounted ionizer from *Desco* is completely self-contained and plugs into a 110Vac outlet. The autobalanced ionizer, which doesn't require an external power supply, covers a 2'x4' area and has three built-in fans.

Circle (102) on Reply Card

**Patching modules**

*Beckman Industrial* has introduced its 701 and 702 EasyPATCH Quadverters. Each module has four connectors located on separate sides of the case, which provides simple and fast data communications interfacing, and includes jumper wires. The 701 allows RS-232C patching between DB25 Centronics, DB9- and DB15-configured datalines. The model 702 allows patching between DB25, DB9, DB15 and DB37 RS-449 connectors.

Circle (103) on Reply Card

**Hard-shell cases**

SpaceCase, available from *Matrix Enterprises*, is a component system that uses the same components with different sizes of plastic sheet to build hard-shell cases from 90 cubic inches to 10 cubic feet. The kit is made from polycarbonate components and ABS plastic sheet, and includes a bonding agent and step-by-step instructions for assembly.

Circle (104) on Reply Card

**Frequency counters**

*Goldstar Precision* has introduced its new line of frequency counters, which feature three frequency ranges. The models FC-7011 and 7012 have a range of 1Hz to 100MHz; models FC-7051 and 7052 range up to 550MHz; and models FC-7010 and 7102 have a range to 1GHz. All counters offer 8-digit LED displays, measured data-hold, and gate times of 0.01, 0.1, 1 and 10 seconds.

Circle (105) on Reply Card

**Hand tools**

A line of more than 250 hand tools is available from *Ideal Industries*. The line includes professional quality pliers, screwdrivers, hammers, wrenches, knives, saws, electronic screwdrivers



and cutters. All tools are backed by a lift-time warranty. Accessories, including pouches, belts, keys, and levels, are also available.

Circle (106) on Reply Card

**Tool kit**

The BALLDRIVER hex driver assortment tool kit (model no. BSX 8S. Cat. #10632) is now available from *Bondhus*. The kit includes a size range of small-inch dimension tools required for maintenance, repair and assembly, including eight precision-sized fastening tools. A companion Metric Pouch Set (model BSX 6mm Cat. #10686), which contains six precision-sized metric tools, is also available.

Circle (107) on Reply Card

**Workbench**

The *Tennsco* Technical Workstation features a heavy-duty steel frame with concealed fasteners; a slip resistant, adjustable footrest; comfort-radius edging; and adjustable glides for a level work surface. Optional features include a static-controlled work surface; an 8-outlet, 15A, 115V power rail; and instrument shelf and drawer units. Several sizes and colors are available.

Circle (108) on Reply Card

**Electronic pliers**

*Stanley-Proto* has introduced its electronic pliers, which provide exact control and extended life through its welded compression springs and superior box-joint. The pliers' induction heat treating process maintains sharp cutting edges. The tool is available in six types of cutting heads and five holding jaw styles.

Circle (109) on Reply Card

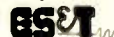



# Literature

## Tool/test instrument catalog

Contact East is offering its 132-page 1989 General Catalog, which contains voice/data communications test instruments, 2-way radios, oscilloscopes, static protection products, soldering supplies, test equipment, precision hand tools, tool kits and more.

Circle (125) on Reply Card

## Safety standard catalog

The January 1989 Catalog of Standards for Safety has been released by Underwriters Laboratories. This updated catalog includes 77 revised UL standards; 542 standards are published. The catalog also includes 10 new proposed first editions.

Circle (126) on Reply Card

## Product catalog

The 1989 White Brochure from Best Power Technology is filled with charts, graphs and information on the company's products and services. The 36-page catalog details power problems and explains how Best's Ferrups and

Micro-Ferrups units protect equipment and data from damage. All who request the catalog will be added, free of charge, to the subscriber list for Horizons.

Circle (127) on Reply Card

## Test equipment catalog

Fluke and Philips have published their 1989 test and measurement equipment catalog. The 520-page catalog integrates the product lines of both companies into 16 categories. Nineteen new products and 19 new service programs are listed, in addition to the more than 650 products previously available.

Circle (128) on Reply Card

## Product catalog

Budget Electronics has released its catalog #3087, which features the majority of its products. All items in the catalog are stocked by standard industry part numbers rather than replacement part numbers. Every item in the catalog is stocked except close-out and reordered products.

Circle (129) on Reply Card

## Surge protection booklet

KeyTek Instrument Corp. is offering a 20-page introductory guide to surge protection and testing. The material is keyed to both technical and non-technical personnel. A question-and-answer format covers the causes of transient spike voltage and current surges on both power and data lines and discusses the problems they create in today's computers and other microelectronic systems.

Circle (130) on Reply Card

## Soldering system brochure

A 4-page brochure from Hexacon Electric describing the 1002 PBS temperature-controlled power boost system is now available. The brochure analyzes the problems involved in hand-soldering multi-layer boards with heavy ground planes, discusses incorrect techniques used in the process, and explains the correct technique and tool for the job.

Circle (131) on Reply Card

**ES&T**



# Plug in!

## To the NESDA system.

**YOUR BUSINESS** is in the world's fastest changing industry. If you're not careful, you could find your business in the dark.

But, you don't have to stay there.

Through a system of local, state, and regional groups, the National Electronics Sales & Service Dealers Assn. (NESDA) keeps members up-to-date with the fast pace of advancing technology while offering:

- ◆ Managerial and technical training.
- ◆ Business contacts.
- ◆ Technical and management certification.
- ◆ Information on new products.
- ◆ Legislative activities that affect the industry.

Don't be left in the dark. Let the NESDA system work **FOR YOU!**

---

For more information and an application, write to:  
 NESDA, 2708 W. Berry St., Ft. Worth, TX 76109; Ph (817) 921-9061

Name \_\_\_\_\_

Bus. Name \_\_\_\_\_

Address \_\_\_\_\_

State \_\_\_\_\_ Zip \_\_\_\_\_ Phone \_\_\_\_\_

Member of State  Local  Assn.

# Presenting an affordable Light Box System.



Model TR100 CB Camera Light Box with (2) transparencies

- (2) 3200° Kelvin Lamps (meets mfr. spec.)
- 1-year conditional guarantee
- Transparencies mounted in acrylic with optical scratch-resistant surface
- 11-step gray scale transparency
- 7-Bar color transparency
- All orders are shipped within 72 hours, U.P.S.

The method most manufacturers recommend

**\$799**

**NOTRONIX** (313) 939-2740

P.O. Box 77103 • Sterling Hts., MI 48077

Circle (24) on Reply Card



# What do you know about electronics?

## What's in a name?

By Sam Wilson

This is an article about a unit of measurement that has no real meaning and has been denounced by leading engineers. Nonetheless, it lives on.

This subject is usually covered in college texts using some very sophisticated math. However, we have been carrying on a series of networks without math, and this is a continuation of that series.

Consider the sine wave voltage and current in Figure 1. Because they are in phase, it follows that the circuit is pure resistance — that is, there is no inductance and capacitance. For the purpose of this discussion, the circuit is a single resistor.

If you multiply the voltage at any instant ( $V_i$ ) by the current ( $I_i$ ), you get the value of power at that instant ( $P_i$ ).

If you multiply all of the instantaneous voltages and currents, you will get the power wave shown in Figure 2.

Observe that the power wave goes through two cycles for every one cycle of voltage and current, and that the power is always positive. According to the power waveform, the resistor heats and cools at a rate that is double the rate of the voltage and current. Of course, it doesn't really get cold and hot that often; it heats to the average value of the power wave.

The power waveform is a sine wave,

Wilson is the electronics theory consultant for ES&T.

so the average value is half-way between the peaks. The broken line in Figure 2 shows the average power. Remember, that broken line represents the true power being dissipated.

Figure 3 shows the same illustration with the rms values of voltage and current marked. They are shown as straight lines parallel to the zero volts and amps line. In other words, they are dc values.

You would expect that to be the case because the rms value is the value of dc that could be used to replace the ac waveform and still get the same heating effect.

If you multiply the rms voltage by the rms current at any instant of time, you get the average power:  
rms voltage  $\times$  rms current = average power

Not too many years ago, someone decided that multiplying rms voltage by rms current gives rms power. Never mind that the term rms power has no physical meaning. Never mind that the product is known by every technical person to be average power.

The unfortunate thing is that the people who determine such things accepted the idea of rms power, so you see this unit of measurement used as a method of rating amplifiers.

### Learning from history

I don't know of anything I disliked in

school more than history. It was bad enough having to study it, but when I learned that a lot of it was incorrect I learned to hate it all over again.

There was the George Washington cherry-tree hoax. It never happened. The Newton apple-tree story isn't true. Columbus didn't discover that the world is round...and so on.

There is a saying that those who fail to study history suffer to repeat it. Let me tell you something: Those who have to study history do a lot of suffering too.

There is an exception — the history of technology. You can learn a lot of electronics by going over some of the things that were done in the past.

For example, have you ever heard of a wobulator? Sweep generators have been with us longer than you may think. Wobulators were early versions. A tunable sine-wave oscillator was the basic circuit. First you tuned a variable capacitor to set the center frequency. Then you pushed a button and a motor vibrated one of the capacitor plates to continually change the distance between the plates. As the distance between the plates varied, so did the oscillator frequency.

I found a device called a tuning wand in a 1955 book called *Elements of Radio Servicing*, by Marcus and Levy. The tuning wand was made with a fiber rod that had a brass tip at one end and a steel tip at the other end. A voltmeter or scope was used to measure the secondary output of a tuned transformer. You inserted one end and then the other into the tuned circuit. The setup is shown in Figure 4.

Both ends should detune the circuit and lower the output. If the output increases when one end is inserted and decreases when the other end is inserted, the circuit is not properly tuned.

This handy device works for any tuned circuit, not just tuned transformers.

And here's some fascinating information about batteries. I once took a course called "Humanities." It was about the history of culture. Part of it dealt with the history of technology.

As with other histories, there wasn't

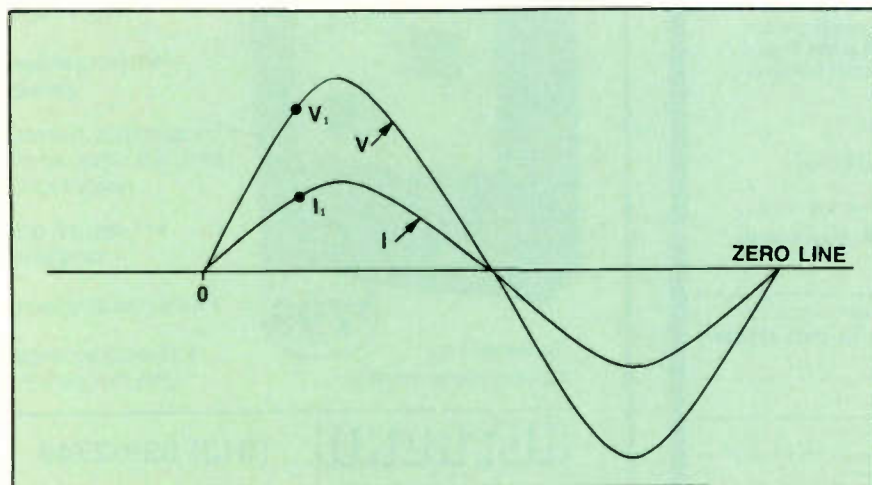

Figure 1. Because the sine wave voltage and current are in phase, it follows that the circuit is pure resistance.



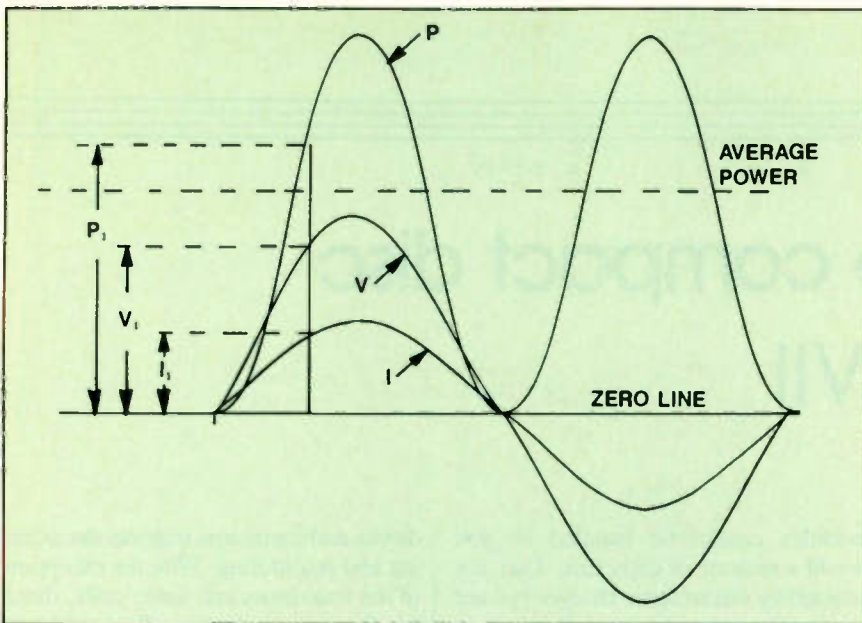

Figure 2. If you multiply all of the instantaneous voltages and currents in Figure 1, you will get this power wave. The broken line shows the average power.

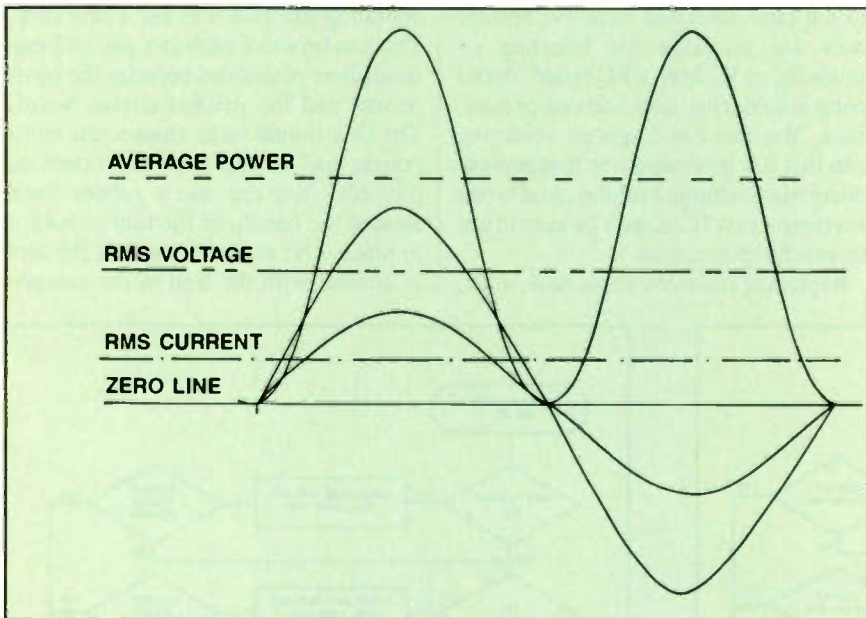

Figure 3. The rms values of voltage and current are shown as straight lines parallel to the zero volts and amps line. In other words, they are dc values.

much care taken with facts. The book starts the history of electricity with Galvani (1737-1798). The real story is that Egyptians made batteries in the time when the pyramids were being built. Some of these batteries have been recovered by archaeologists. The batteries were crude by today's standards.

These batteries were used for electroplating jewelry, examples of which have also been found.

In addition to the batteries and jewelry, there is a mystery about the pyramids that has never been solved. It was told to me by a graduate student. In a room where electroplating was done there were no smoke smudges on the ceiling, such as would have been made by torches used for light. There

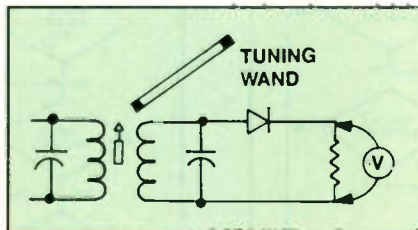

Figure 4. An early tuning wand was made with a fiber rod that had a brass tip at one end and a steel tip at the other end.

were no windows in this room and only one door.

The question is: How were they able to see what they were doing? A related question: When archaeologists figure out the answer, is it going to kill our favorite Thomas Edison story? **ES&T**

## LEARN VCR

### CLEANING/MAINTENANCE/REPAIR

EARN UP TO \$1000 A WEEK, WORKING PART TIME FROM YOUR OWN HOME!



Secrets Revealed!

NO Special Tools or Equipment Needed.

EARN UP TO \$60 AN HOUR AND MORE!

THE MONEYMAKING OPPORTUNITY OF THE 1990's

IF you are able to work with common small hand tools, and are familiar with basic electronics (i.e. able to use voltmeter, understand DC electronics)...

IF you possess average mechanical ability, and have a VCR on which to practice and learn...then we can teach YOU VCR maintenance and repair!

**FACT:** up to 90% of ALL VCR malfunctions are due to simple MECHANICAL or ELECTRO-MECHANICAL breakdowns!

**FACT:** over 77 million VCRs in use today nationwide! Average VCR needs service or repair every 12 to 18 months!

Viejo's 400 PAGE TRAINING MANUAL (over 500 photos and illustrations) and AWARD-WINNING VIDEO TRAINING TAPE reveals the SECRETS of VCR maintenance and repair - "real-world" information that is NOT available elsewhere!

Also includes all the info you'll need regarding the BUSINESS-SIDE of running a successful service operation!

#### FREE INFORMATION

CALL TOLL-FREE 1-800-537-0589  
Or write to: Viejo Publications,  
3540 Wilshire Bl., STE 310  
Los Angeles, CA 90010, Dept. EST

Circle (27) on Reply Card



### Your Ticket To

# SUCCESS

Over 25,000 technicians have gained admittance worldwide as certified professionals. Let your ticket start opening doors for you.

IS CET offers Journeyman certification in Consumer Electronics, Industrial, Medical, Communications, MATV, Radar, Computer, and Video. For more information, contact the International Society of Certified Electronics Technicians, 2708 West Berry St., Fort Worth, TX 76109 • (817) 921-9101

Name \_\_\_\_\_  
Address \_\_\_\_\_  
City \_\_\_\_\_  
State \_\_\_\_\_ Zip \_\_\_\_\_

\_\_\_\_\_ Send material about IS CET and becoming certified.

\_\_\_\_\_ Send one "Study Guide for the Associate Level CET Test" Enclosed is \$5 (+ \$1 postage).



# Servicing the compact disc player—Part VII

By Martin Clifford

This is the seventh part in a series on servicing compact disc players, based on *The Complete Compact Disc Player* by Martin Clifford (published by Prentice-Hall). Part VI discussed how flowcharts can streamline diagnosis. This part will finish up that discussion and begin looking at audio circuit failure.

### Data processor failure

For the most part, the data processor (Figure 1) is made up of ICs. The IC

Clifford, a free-lance writer, has published more than 75 books on electronics.

modules cannot be handled as you would a resistor or capacitor. They are affected by electrostatic charges and are also temperature-sensitive. It is best to avoid touching the terminals on the IC with your fingers or with any tools that do not have insulated handles. Special tools are available for inserting or removing an IC from a PC board. Avoid using a soldering iron without precautions. You can use a special soldering iron that has grounded tips that prevent electrostatic charge buildup. And when inserting a new IC, always be sure to use an exact replacement.

Replacing resistors, capacitors, coils,

diodes and transistors requires desoldering and resoldering. With the exception of the transistors and some coils, these are 2-terminal devices. It should not take more than about five seconds to desolder each terminal. A good operating practice is to use a heat sink. This can be a tool such as a pair of long-nose pliers positioned between the component and the printed circuit board. The sink should be as close to the component and as far from the board as possible. You can use a rubber band around the handle of the tool to hold it in place. Use as much metal of the tool in contact with the lead of the compo-

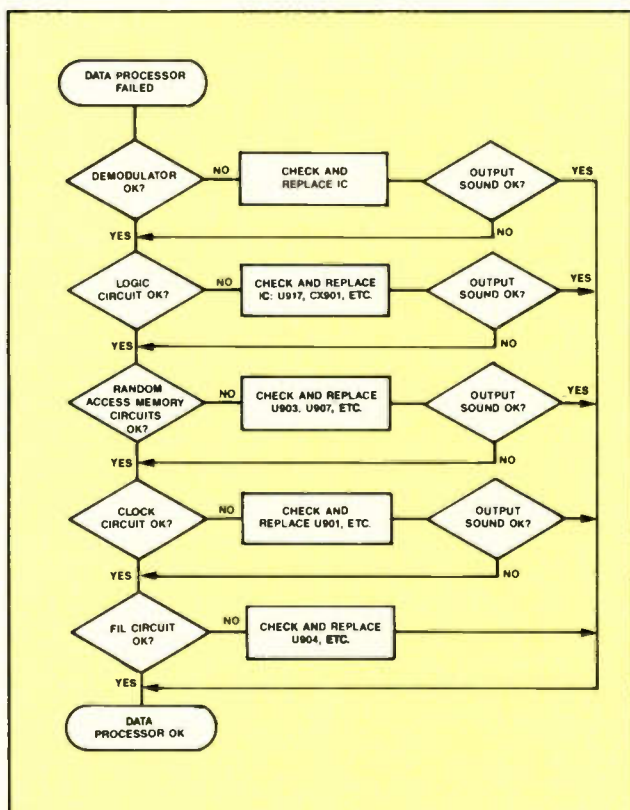

Figure 1. Flowchart for data processor failure. (Courtesy of Kyocera International.)

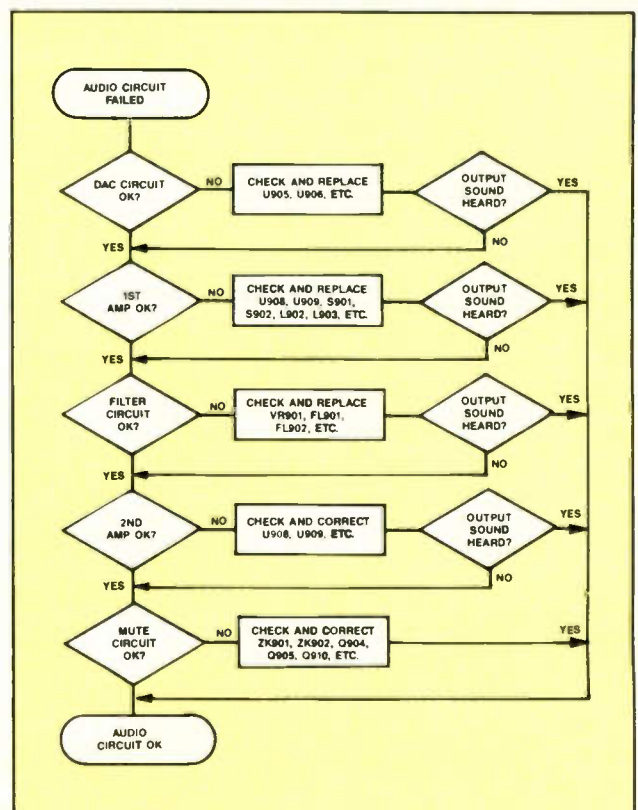

Figure 2. The flowchart for audio circuit failure shows the chain of servicing events, from the digital-to-analog converter to the audio output. In this case, it would involve checking the filters as well as the integrated circuits containing audio amplifiers. (Courtesy of Kyocera International.)



ment as possible. And be careful when applying the soldering iron to the PC board — it can also be damaged by too much heat.

### Sound problems

For CD players, the name of the game is audio, and audio problems negate the very purpose of a CD player. However, audio circuit failure does not necessarily mean a complete absence of sound. A stereo system has two sound output channels, left and right, and there is always the possibility that just one of these channels has been affected.

The chain of servicing events, as in-

dicated in the flowchart (Figure 2), involves moving step-by-step from the digital-to-analog converter to the audio output. In this case it would involve checking the filters as well as the integrated circuits containing audio amplifiers.

There is always the possibility that lack of sound may be caused by factors outside the CD player. The audio connecting cables and the hi-fi amplifier that follows may be at fault. Plug in a pair of headphones — if you get sound output, trouble external to the CD player may be indicated. Use a spare speaker and try connecting it to the audio out-

put terminals of the player. The sound will be weak, but at least you will know that audio exits at the output.

### Making adjustments

To get optimum functioning from various systems, every CD player requires various adjustments, including the correct adjustment of various mechanisms or vertical, focus offset, balance, disc motor, radial gain, pulse width, phase-lock-loop and output level, feed motor gain and servo adjustment.

It should not be necessary to make these adjustments because they are done at the factory. Furthermore, the adjustments are held in place by lock screws. (See Figure 3.) Under conditions of extreme and repeated vibration, however, these screws may become loose. This condition is more likely to occur with portable and auto CD players.

An improper adjustment can mean an inoperative CD player or one that works poorly or intermittently, giving symptoms of some defect. Adjustments are made using a scope and/or a voltmeter to make sure the waveforms and voltages correspond to those suggested by the manufacturer.

The adjustment screws are Allen set screws and require the use of an Allen wrench. To determine whether the screw needs some rotation, insert the wrench and try turning it gently. If the screw is firmly in position, it is unlikely that any adjustment is required. If the screw appears to be loose and turns easily, it might well need attention. If you have determined that you must turn the screw, be sure to loosen the associated locking screw first.

Next month, we'll continue our discussion of sound problems with some specific problems that can occur.

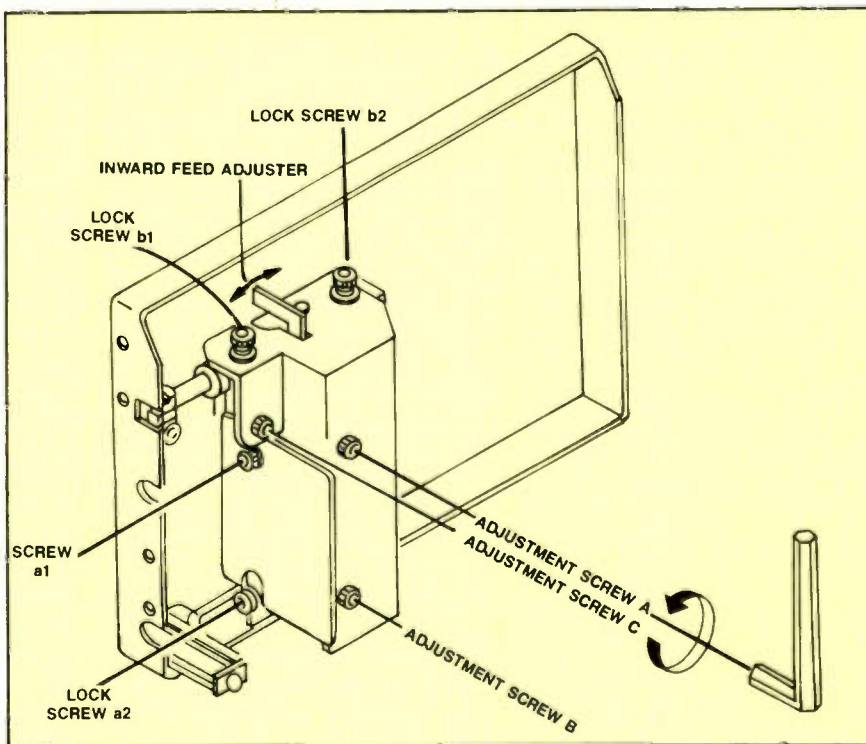

**Figure 3.** It should not be necessary to make operating adjustments because they are done at the factory and are fastened by lock screws. Under conditions of extreme and repeated vibration, however, these screws may become loose.

# Making and using VCR test cassettes

By Stephen J. Miller

**These two test cassettes, simple to make by modifying ordinary videocassettes, will help you diagnose VCR problems and avoid causing problems in servicing.**

Has this ever happened to you? In the customer's presence, you insert a tape into his VCR to verify the complaint, press PLAY and the machine runs only briefly. When you press EJECT, you find the tape is a mangled mess, and you have egg on your face. If so, or if you're concerned that this could happen, then you need my patented "clicker" test shell. This device is a videocassette that has been altered to produce a clicking noise with a frequency that is directly proportional to spindle velocity. With this device, you can establish the presence or absence of both supply and take-up reel torque without even remov-

ing the VCR cover. This device is not available in any store, but I'll tell you how to make your own for free.

### Using a clicker cassette

To make your own clicker cassette, select a damaged tape from your scrap pile. If the tape is mangled but not broken, then fast forward or rewind to the middle of the tape. Remove the screws from the bottom, place the cassette spindle-side down on the bench, and remove the top half. Inside you will find that each reel has a cogged outer edge that contacts a locking mechanism (see Figure 1). This is to prevent freewheeling of the reels whenever the cassette is removed from the VCR. When the tape is inserted into the VCR,

a post extends up into the cassette from the bottom and disengages these locking levers.

To fashion a clicker tape, you have to remove the disengaging lever. First, cut the videotape so that each reel can rotate independently. Then, using cellophane tape, secure the loose ends of the videotape to the reels so that they cannot unravel. Next, remove the disengaging lever, usually an L-shaped piece of black plastic, but leave in place the two locking levers that contact the cogs. Once this lever is removed, the take-up reel should click as it is turned forward, and the supply reel should click when it is turned backward. You will notice several metal and plastic tape guides in the cassette. They are no longer necessary, so they can be removed if you wish. Now replace the top half, invert the shell, install the screws, apply black tape over the end sensor holes under the door (see Figure 2), and the job's complete.

After damaging good tapes on untested machines, I have made it a habit to install the clicker tape first. In fast forward and rewind, the tape should make a rapid clicking noise; in play, you should hear a slower clicking sound. Most important, the unloading process should give a rapid clicking sound, signaling sufficient torque to rewind slack tape back into the cassette. With the clicker tape, I can instantly get some idea of the relative reel torques without even removing the VCR's cover. If the VCR passes this test, I can safely install a good tape to observe the symptoms.

Miller is a senior bench technician for a Lancaster, PA, repair company.

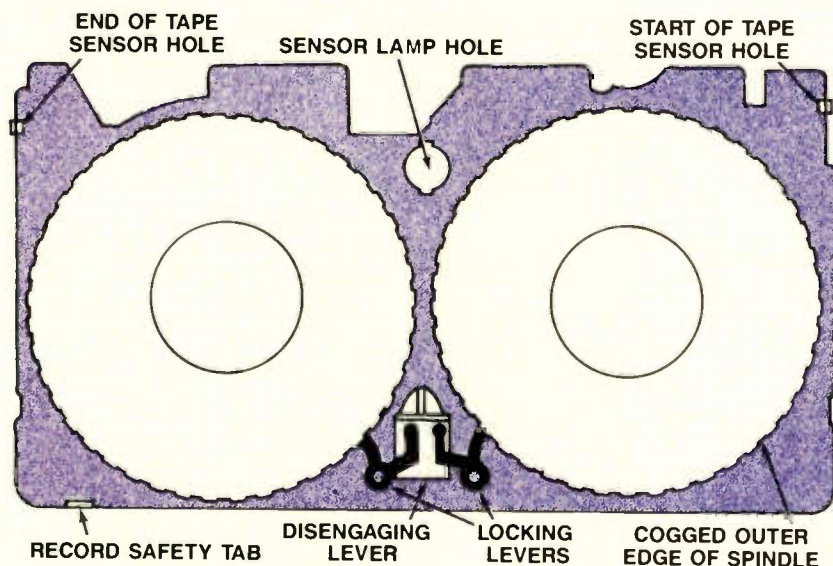

**Figure 1.** A clicker tape — a videocassette that has been altered to produce a clicking noise with a frequency that is directly proportional to spindle velocity — can establish the presence or absence of both supply and take-up reel torque.

**Using an empty shell**  
My other test shell I call "empty"



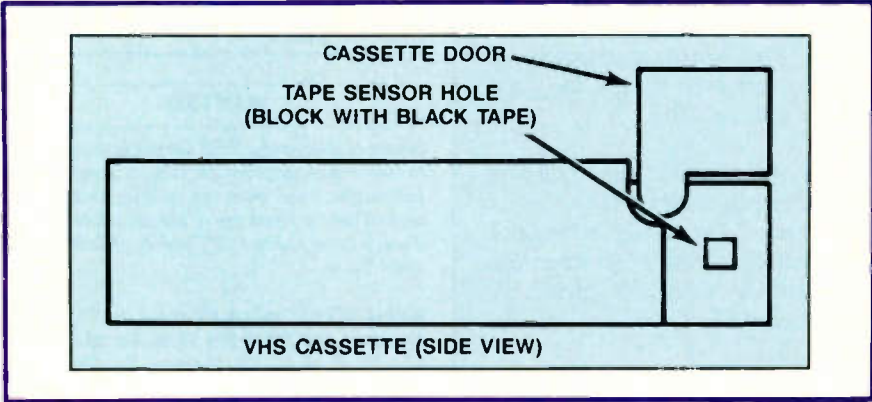

**Figure 2.** To make the clicker tape, cut the videotape so that each reel can rotate independently. When the disengaging lever is removed, the take-up reel should click as it is turned forward, and the supply reel should click when it is turned backward. Black tape over the end sensor holes completes the job.

because it contains nothing at all. I simply removed the screws from the bottom of the cassette, separated the two halves, dumped the entire internal contents in the trash and reassembled the cassette housing. I then carefully cut out and discarded the clear plastic windows on the top of the cassette and taped over the end sensor holes. With this shell in a machine, I can place either my torque gauge or my finger directly onto the spindles to check the torque and braking forces applied in the various modes. Problems caused by stuck brakes, worn idlers, worn back-tension bands and other mechanical problems are easy to diagnose in this manner. You can check many operations using this type of test shell without worrying about tape jamming or damage to the cassette. After performing any mechanical alignment or cam gear work, I always use the empty cassette to dynamically test the mechanism.

Both of these test shells have a large variety of uses. For example, by loading the empty cassette into the carriage assembly before removing that assembly, you make the VCR believe a cassette is loaded, allowing you to observe the mechanism's operation with neither a cassette nor the carriage obscuring your view. End-of-tape sensor operation can be checked by removing the tape covering the sensor holes.

Another use for the empty shell is spin-drying the video heads after cleaning. Video heads, still damp with cleaning solution, will often stick to the tape, wrap it around the head cylinder and create a real mess. Briefly running the empty shell in the machine spin-dries the heads and avoids this problem.

These test shells have been very helpful to me. Give them a try.

Next month, we will explore the facts and fallacies of alignment tapes.

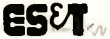

## C\$ERVICE® Service Shop Computer Software

A computer software package that is written specifically for the service & repair industry

- Invoicing—T&M Contract/Rentals
- Customer Files
- Technician Efficiency
- Work Ticket Log/Tracking
- Accounts Receivable—Monthly Statements
- Inventory—Shop/Service Vans
- Maintenance History
- Interface to Peachtree Accounting System
- Unique On-Line Support From Our Technical Department

All programs are fully interfaced. Multiple companies, multiple shop locations. Available for IBM & compatibles. Demonstration program available for evaluation.

### America West C&E, Inc.

311 Washburn Drive  
Rock Springs, WY 82901  
307-382-5663

Circle (26) on Reply Card

## ATTENTION TECHNICIANS

- ★ JOB OPENINGS
- ★ MONTHLY TECHNICAL TRAINING PROGRAM
- ★ BUSINESS MANAGEMENT TRAINING
- ★ LOW COST INSURANCE
- ★ CERTIFICATION
- ★ TECHNICAL SEMINARS

All of this in a nonprofit international association for technicians

FIND OUT MORE:



604 N. Jackson St.  
Greencastle, IN 46135  
317/653-8262

## Answers to the quiz

Questions are on page 16.

1. C — Any resistance across the antenna terminals will cause noise to be injected into the system.

2. A — The amount of noise power in a system increases as the bandwidth of the system increases.

3. 0.9MHz — N1 divides the oscillator frequency of 2.7MHz by 9. This 0.3MHz signal is applied to the phase detector input. The frequency applied to the feedback input of the phase detector must also be 0.3MHz. This frequency is multiplied by N2 to arrive at the required VCO output frequency, 0.9MHz.

$$2.7 \div 9 = 0.3\text{MHz}$$

$$0.3 \times 3 = 0.9\text{MHz}$$

4. Synchronous motors — the type used in electric clocks — and stepping motors. Both turn at a rate determined by the frequency of input power.

5. D — A startup circuit (sometimes called kickstart) is needed with a scan-derived power supply. Power for the supply comes from the flyback transformer, which, in turn,

gets its energy from the output of the horizontal stage. However, the horizontal stage can't operate without the supply voltage, so a startup circuit is necessary.

6. A — The negative resistance occurs when a lot of secondary electrons from the plate go to the screen. This causes a reduction in plate current even though the plate voltage is increasing.

7. D — A dc power supply can be used to substitute for the output of the FM detector. The oscillator frequency should be controllable when the dc substitute voltage is varied. A simplified AFC circuit is shown in Figure B.

8. A — The trick is to feed the pulsing output to an L-C tank circuit. The L-C tank circuit oscillates and produces the output sine wave.

9. C — The equation is  $T = L/R$ .

10. C — Slowing the tape puts the tracks closer together. That, in turn, puts more tracks on a given tape.

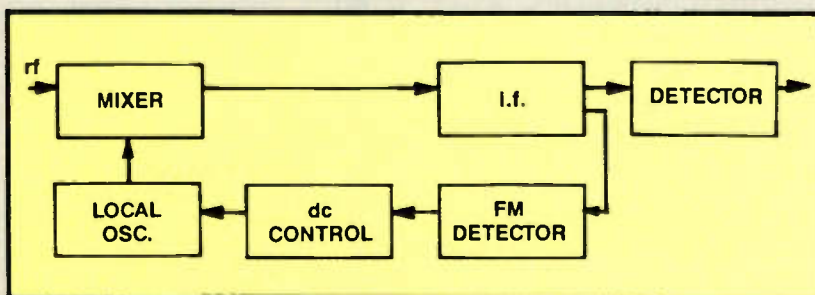

FIGURE B

**Editor's Note:** Readers' Exchange items are published in the order they are received. We are happy to offer this service at no charge to you, our readers, but we ask that:

- Items are typed (or legibly written).
- You include your name and address on the same page as your ad (envelopes and contents are often separated). Please also include your telephone number (specify if you don't want it published). Using your peel-off label or a return label is a good idea.
- You limit any ad to no more than three items. If space demands, ads will be edited to roughly four lines in the magazine.
- Mail to: Readers' Exchange, Electronic Servicing & Technology, P.O. Box 12901, Overland Park, KS 66212.

Please remember that ES&T is in production six weeks to two months ahead of publication date. To get your ad in the May issue, for example, you should get your ad in by the last week in March.

### WANTED

Source of inexpensive VHS alignment tools/gauges or your equipment: tension, torque, master plane, reel height, head wear, etc. Willing to trade off ease of use for lower price. *Michael Roberge, 66 Thrush Drive, Milton, VT 05468; 802-893-6765 after 5 p.m.*

Knight KG-637 sweep generator, 83YX137 AF generator and B&K 606 Dyna Jet tube tester. *Charles T. Huth, 229 Melmore St., Tiffin, OH 44883; 419-448-0007.*

Operating manual for an RCA Junior volt ohm test VTVM; an operating manual for a Hickok model 800 tube tester. Will buy or copy and return. *Steve's Radio Service, P.O. Box 168, Wickes, AR 71973.*

VHS tapes on color TV repair; a VCR VHS training course; a good used Sony number 520 BR 22 picture tube. *James Gregorich, 117 N. Second St., Virginia, MN 55792.*

Sencore SC61 oscilloscope. Must be in good condition. *Sal Cribari, 1312 Well Drive, Camp Hill, PA 17011; 717-763-1855.*

Schematic for model 700 Honeywell Stroboscan electronic flash. *Robert Miller, Rt. 1, Box 223, Anadarko, OK 73005; 405-247-6553.*

B&K scope, working or repairable, models 1435 or 1479B; good, used Fluke digital bench meter; old B&K and Leader test equipment catalogs, 1965-1985; old B&K model 1431 scopes, working condition or any condition for parts. Will pay a reasonable price. *Mike Shelton, 2708 May Drive, Burlington, NC 27215; 919-227-2908 after 7 p.m.*

NRI Professional model 35 signal tracer and NRI model 114 R-C tester. *William P. Jarvis, 1214 Fifth Ave., Beaver Falls, PA 15010; 412-846-7735.*

Cathode ray tube for Tektronix type 502 A dual-trace scope, part number 154-246. *David Dolecheck, 582 Long Drive, Sheridan, WY 82801; 307-674-8287.*



A recent TV-servicing course by NRI, CIE, etc.; Panasonic TLF 14712F flyback. *Ed Herbert, 410 N. Third St., Minersville, PA 17954.*

Manual and connector for TEI Electronics model 49-250 car subwoofer system; address/phone number for TEI Electronics. *William J. Byerly III, P.O. Box 605, Fernandina Beach, FL 32034; 904-277-2994.*

Service manual, drive belt set for Sony TC-161. *Jim Farago, P.O. Box 6313, Minneapolis, MN 55406.*

Schematic for Zenith SN2311W (Sams 2097-2), copy or original; Zenith 9-160-OJ module; Panasonic TLF14617F flyback. State price and condition. *S. Tanenbaum, 4 Jarvis Court, Erial, NJ 08081; 609-627-3606.*

Good tube tester to test early radio tubes from the 1930s. *Rick Yerke, P.O. Box 392, Moscow, PA 18444; 717-842-4857.*

Flyback transformer for Boardmoor TV, part number 09270776M or TCF-II. State price. *George Saylor, 2319 Parrish St., Philadelphia, PA 19130.*

Sony model TC-K45 tape deck and Pioneer PD5010 CD player — both for parts. *Ken Weber, 1249 Bellaire Blvd., Bellevue, NE 68005.*

RCA model WV-98C volt ohmyst in A-1 condition, complete. *Paul Capito, 637 W. 21st St., Erie, PA 16502.*

Akai model M-10 reel-to-reel tape recorder for parts. *James Modesitt, Rt. 3, Box 33, Weston, WV 26452; 304-269-5013.*

B&K 470 or 467 model in good condition, with manual, chart, connections, sockets. *Pedro Martinez, 721 W. Illini St., Phoenix, AZ 85041; 602-243-6236.*

Schematic and/or service manual for TV-sweep generator, Electroteck model SMG-39, to copy or buy. Will pay charges plus fee. *George Popdavid, 1255 Shadyside Ave. SW, Canton, OH 44710; 216-452-2710.*

A readable schematic and, if possible, a pictorial showing the location of the ICs, transistors and other components for a Majestic model MCR-5000 auto radio. This set was manufactured in Van Nuys, CA. *W.W. Ellett, 10023 Estrella Drive, La Mesa, CA 92041.*

Solid-state VHF and/or UHF FM transceivers, FM scanning radios and VHF pagers, any condition. *Jerry's Radio Service, 409 S. Oklahoma St., Shamrock, TX 79079; 806-256-2405.*

Tektronix "XYZs of Oscilloscopes" training package; Tektronix K501 tilt pedestal; 100MHz X1, X10 oscilloscope probe. Trade with Keithley 130A multimeter or EICO model 30A4 analog multimeter, or pay cash. *Osman Yilmaz, 150 E. 39th St., New York, NY 10016; 212-684-4680.*

Schematics for Seville model 661C color TV and televideo model TV1-920C "dumb terminal"; source for GE EP77X55 flyback (original part

number is EP36X345) and the 0.047 $\mu$ F, 2,400Vdc capacitors used in GE projection TVs. *Don Selliff, Rt. 1, Box 237A, Apple Grove, WV 25502.*

Tube-type radios manufactured in the 1930s and made with blue, peach, green or silver glass mirrors. Will pay up to \$1,000 depending on style and condition or will pay \$50 finder's fee. *Doug Heimstead, 1349 Hillcrest Drive, Fridley, MN 55432; 612-571-1387.*

Schematic for a model G30 Pico RF signal generator and a model 3230 JC Penney radio and tape player; an IC transceiver with power supply or Kenwood transceiver with power. *Ralph Dorough, 117 Pecan St., Terrell, TX 75160; 214-563-7105.*

VHS tapes on advanced VCR computer and color TV repair — will loan my tapes for yours; test equipment — Sencore SC61, VA62, VC63, NT64, EX231, LC76. Simpson 260 VOM. *Van Waldrop, P.O. Box 1832, Drexel, NC 28619; 704-433-8773.*

Sencore VA-48 in any condition. Call anytime. *Beaverdam Electronics, Rt. 1 Box 176, Beaverdam, VA 23015; 804-449-6907.*

A good used Sharp flyback transformer #F112ICE-S. Will pay up to \$30. Write first. *Weiss Radio & TV, 61187 Co Rd T, Moffat, CO 81143; 719-256-4262.*

Schematic and information on a tour sound product, power system module 242S stereo Sound Master stereo 850 SC — will pay cost for copies; a UTC audio XFMR type A-21 — what is availability and cost? *Arthur R. Vickery, P.O. Box 742, Torrington, CT 06790.*

A recent TV servicing course by NRI, CIE, etc.; a Panasonic flyback transformer #TLF14712F. *Ed Herbert, 410 N. Third St., Minersville, PA 17954.*

Tandberg model 64 reel-to-reel tape deck for parts. *Norman Rubin, 66 Dawn Drive, Churchville, PA 18966; 215-887-2196.*

KRK 237A tuner for RCA color; Sams Photofact for RCA CTC93 chassis, pix tube 19VJUP22. Reasonable. *4366 Eastport Drive, Bridgeport, MI 48722.*

Need help on Admiral ET3RA ETS (1667-1). Is there a circuit description available or a repair or exchange shop? *L.E. McHenry, 6225 N. 20th Lane, Phoenix, AZ 85015; 602-249-2325.*

Schematic diagram for Kawasho model 3713 13-inch color TV. *Voglers TV, Box 95, Sommers Road, North Branch, NY 12766.*

Old magazines on tube projects, radio electronics, popular electronics, radio TV experimenter; radio and TV tubes, new and used, boxed or not. *Greg Hingle, Rt. 2, Box 584, Port Sulphur, LA 70083.*

Sencore FS 134 field strength meter. State condition and price. *Ed Schultz, P.O. Box 234, Estes Park, CO 80517; 303-586-4588.*

Suppliers address for new dual-type tuning controls used on Kenwood FM/AM model TK-140X

solid-state stereo receiver. *Joseph J. Kasnic, 1001 East Ridge St., Conway, PA 15027-1003; 412-869-5474.*

Sencore MUI50 tube tester. Supremes TV -1, -2, -4, -27 manuals; Sams TR-82 Photofact. *Charles T. Huah, 229 Melmore St., Tiffin, OH 44883; 419-448-0007.*

European auto radio factory service manuals, prior to 1965 for Becker, Blaupunkt, Pyle, Condor, etc.; also buying these radios. *Wilford Wilkes, Box 103, Brisbin, PA 16620; 814-378-8526.*

## FOR SALE

Marantz model 22 receiver. 40W stereo amp. AM/FM with service manuals. excellent condition. \$50 plus shipping; Leader DDM 4-digit digital meter for the bench. \$50 plus shipping. *Harry Hoffman, 2743 Ocean Ave., Brooklyn, NY 11229; 718-891-8010.*

B&W model 177 voltohmmeter. \$85. Will ship UPS-COD. *Alex R. Minelli, 718 Michigan St., Hibbing, MN 55746; 218-263-3598.*

Simpson VTVM 312. \$60; Eico 0-24V battery eliminator and charger. \$35; Eico 324 signal generator. \$25. Add shipping. *M.E. Andrews Jr., Box 91, Exeter, RI 02822.*

Old radio tubes (used), magazines, transistors, parts for radios and TVs, diagrams on radios and TVs, Sams Photofacts, car radios and radios for sale. *Florian A. Rogowski, 25103 Cunningham, Warren, MI 48091.*

30MHz scope. \$300; 80MHz quad. \$600 negotiable; 10MHz single. \$125; Sencore flyback ringer. \$75; Sencore Cricket X-STR tester. \$60; Leader dot generator. \$70; Sencore CB-41 tester. \$50; RCA 3-inch scope. 5.5MHz. \$50. All in excellent condition. *Ralph Bianco, Boulevard Radio & TV, 1431 Robinson Ave., Havertown, PA 19083; 215-446-4519.*

Sencore VA62 universal video analyzer. VC63 VCT tester accessory. NT64 pattern generator. ES231 expander jack. complete with manuals and cables. \$3,000. *Craig Schwan, 20432 Hollywood, Harper Woods, MI 48225; 313-772-8345.*

Voltmeters. Sencore FE160 and B&K 177, both for \$50 plus shipping; Data Mate 80 microfiche machine. \$75; Sams Quickfacts, four-volume. \$15 each; B&K 1246 pattern generator. \$180; B&K 466 tester/rejuvenator picture tube. \$150; Sams Photofact, 44 sets, #485-#1553 and #2227. \$3 each or \$125 for all. Add shipping. *Sal Cribari, 1312 Well Drive, Camp Hill, PA 17011; 717-763-1855.*

Sencore CR70. \$595; Sencore VA-48. \$495; Sencore CA-55. \$195; Soar model MS-6050 oscilloscope, dual-trace. 60MHz. \$595. All in excellent condition. *Duane Conger, 4321 Herrick Lane, Madison, WI 53711; 608-238-4629 or 608-276-3832.*

Astatic LS tone arms, radio and TV tubes, power  
*Continued on page 66.*



## Readers' Exchange

and signal transistors. No reasonable offer refused. Dick Yasko, Fremont TV & Electronics, 407 E. Main St., Fremont, WI 54940; 414-446-2239.

Heath model IG-28 color bar generator, excellent condition. \$50. D. Walters, 13314 Lake George Lane, Tampa, FL 33618; 813-968-5030.

Sencore SC-61 waveform analyzer, excellent condition. DP-226 direct probe included. \$2,400 plus shipping. Jens Clark, P.O. Box C, Charlottesville, VA 22903-0517; 804-979-0187.

Sams AR manuals, \$3 each; 17-inch vintage Bakelite Motorola TV, set up to operate TV tuners during rebuilding. \$30; 50+ unused B&W CRTs, 9-inch through 24-inch. \$10 each or take all for \$50; 100 TVs to restore or for parts — free if you take them all. Jim Farago, P.O. Box 6313, Minneapolis, MN 55406.

284 Sams Photofacts between #219 through #1298, \$60 plus shipping and handling. L. Huel Hill, 288 Mayflower St., Mobile, AL 36609; 205-344-1611.

B&K 1570 A 80MHz quad-trace oscilloscope, \$800; B&K 1822 175MHz universal counter, \$350. Both are in excellent condition. Ron Grega, 107 Ridgeview Drive, Dunmore, PA 18512; 717-347-6842.

Large quantity of factory service manuals for most major manufacturers (VCR, TV, camera). \$5 each; many factory parts in original boxes, all 1986 or newer. Perfect Video, P.O. Box 74, Largo, FL 34649.

Sams Photofacts, #800-#2292, includes metal files, \$2,500 or best offer. Add shipping. Calvin Boddie, 660 E. Yucca St., Oxnard, CA 93030; 805-486-1071 after 4 p.m.

Triplers, modules, flybacks, etc., up to 50% off guaranteed. G. Barzily, 84-39 120th St., Queens, NY 11415; 718-847-7965.

Sencore model DVM microranger, used very little. \$600. A. Alessi, 29 Cross St., New Windsor, NY 914-562-9152.

New Diehl Mark V, \$350; used Diehl Mark IV, \$250. Free Diehl shopowner newsletters, \$32 value, with order. Add \$10 shipping. Please call first. Geo Reed, 817 Underhill Ave., Mamaroneck, NY 10543; 914-381-5436.

Eico 20MHz dual-trace scope with component tester, no probes, \$95; B&K 1570A quad-trace, dual-time base scope, two 1x10 probes, current price is \$1,464, \$750; B&K 1805 80MHz multi-function frequency counter with period and total, \$125; B&K 820 capacitance meter, 0.1pF to 1F, \$85; B&K 520B transistor tester, in- and out-of-circuit, out-of-circuit leakage test, \$150. All items in excellent condition with manuals and probes where applicable. Orland Lynd, 2300 Harvard Way #124F, Reno, NV 89502; 702-825-6157 evenings.

Sencore LC 53 capacitor and coil analyzer, \$400; Sencore TF 46 transistor tester, \$150; Sencore SG 165 audio analyzer, \$300; Zenith 800-1080 test jig and 24 adapters, \$200. Excellent condition. George M. Kelnhofer, 9025 N. 70th St.,

Milwaukee, WI 53223; 414-355-6946.

Hitachi V-203F oscilloscope, in perfect condition, 20MHz, dual trace with delayed sweep, X-Y mode, CH 1 output, in original box, with manual and two factory 10:1 probes, paid \$650 new, will sell for \$425 or best offer. Breit Batko, 4392 Cheryhurst Drive, Stow, OH 44224; 216-688-7008 or 216-688-2451 days.

Sencore SG-165 stereo analyzer, mint condition, with operator's manual and all cables and accessories, solid \$700 or will trade for mint-condition Kenwood TS 140 S transceiver and power supply. Alan Seiferl, 705 S. 25th St., South Bend, IN 46615; 219-232-6883.

Hitachi V-422 oscilloscope, used three times, cost \$700, will sell for \$500; B&K 2831 DMM, like new, \$200; V-7 vectorscope, \$250; good used picture tubes of various sizes, \$20. Add shipping. Worth Hitchcock, Tri-City TV, Rt. 3, Box 186, Birch Tree, MO 65438; 314-292-3281.

Sencore TP212 10kV transient protector probe, excellent condition, \$15. Stanley Todorow, G8468 Belle Bluff Drive, Grand Blanc, MI 48439; 313-695-0271.

Color bar generator, \$10; Jackson 800 color bar/pattern generator, \$10; B&K 1075 analyst with slide and probe, \$35; Knight-Kit KG-635 scope (CRT good), \$20; RCA WR-69A sweep generator, \$35; RCA WR-70A marker adder, \$35; RCA WR-99 marker generator, \$15; RCA WG-295C video multimeter, \$15; RCA WG-304B RF modulator, \$15; Accurate 156 genometer, \$10; 7-inch reels of Ampex 641 audio recording tape, 20 cents each. Please include shipping costs with order. Don Setliff, Rt. 1, Box 237A, Apple Grove, WV 25502.

TV tubes and parts. Send SASE. Mike Shelton, 2708 May Drive, Burlington, NC 27215; 919-227-2908 evenings.

NRI digital electronic servicing course with scope and discovery lab, \$700; Heath Zenith microprocessor trainer (3400-A) and course, includes interfacing and applications course, complete, \$400. J. Kostalek, 3141 Ludwick Drive, Warren, OH 44485; 216-898-4145.

Two Sears (Hitachi) CED videodisk players, both with visual fast and normal search, stereo output model \$60, standard model \$50. Louis Yadevia, 601 Church Lane, Upper Darby, PA 19082; 215-622-2573.

Tektronix equipment: model 7603 lab scope with 7A18A-7D15-7B53A plug-ins; 12 TM 500 plug-ins (DM501A-DM505-DC508-DC505A-PS503A-FG50-1A-FG504-AM501-AM502-SC503-SG503-SG505); TM501-TM504-TM504-TM515 power modules; largest lab cart with two instrument trays. Never used, mint condition, in original boxes. Total retail is \$34,637, will sell all for \$16,000. John L. Wingfield, P.O. Box 685, Ceclaredge, CO 81413; 303-856-6341.

Tandy Color Computer III with disk drive, seven game cartridges and five game disks, including Flight Simulator II, \$125 plus shipping. George

Saylor, 2319 Parrish St., Philadelphia, PA 19130.

Sencore SC61 in original shipping box with manual and cables, \$2,100; Sencore CG25 in original box, \$100. Both in excellent condition. Add shipping. C. Johnson, 2384 Shadow Hill, Riverside, CA 92506; 714-684-5583.

Two Beckman 300 digital meters, excellent condition, \$55 each; temperature assembly converter, never used, \$15; Pacer-amp dc clamp-on ammeter, new price is \$400, only asking \$125. Money order or bank check only. Mike Shelton, 2708 May Drive, Burlington, NC 27215; 919-227-2908 evenings.

Realistic DX160 solid-state communications receiver, 150kHz to 30MHz in five bands with separate bandspread dial, \$100 (includes prepaid UPS in continental U.S.); slightly used genuine Amphenol S0239 chassis-mount UHF connectors, 50 cents each plus postage or 12 for \$5 (includes prepaid UPS); new genuine Amphenol PL239 plugs, 75 cents each plus postage. Donald H. Nash, 1444 Pulaski St., Port Charlotte, FL 33952; 813-629-3934.

Tektronix 545 scope, dc-30MHz with vertical amp plug-in and manual, works well, \$220 plus shipping; Tektronix 531A scope with vertical amp plug-in and manual, works well, \$175 plus shipping; other scope available. Robert Gardiner, Box 130EA, Leonardtown, MD 20650; 301-475-8539.

Test equipment (Sencore, B&K and more), TV modules, ECGs, VCR parts, components, Sams and more. Channel Electronics, Rt. 206, Andover, NJ 07821; 201-383-5565.

B&K model 467 CRT restorer/analizer, \$300; B&K model 1248 digital color generator, \$195; EICO model 944 flyback, XFMN and yoke tester, \$95. All are in excellent condition and include manuals. Xiong Seng, 120 Bigelow Lane #G, St. Paul, MN 55117; 612-489-4850.

Sams #2082 to #2228, never opened, \$6 each; Jackson 648-1 tube tester, \$200; Hickok 6000A tube tester, \$150. Prepaid shipments only. SASE for other items. R. Walthers, 5921 Velma Ave., Las Vegas, NV 89108.

Heathkit IO-4555 10MHz scope, \$150; Heathkit SG-5240 pocket color-bar generator, \$75; Heathkit IG-4505 scope calibrator, \$40; Heathkit IG-5257 TV post marker/sweep generator, \$75; Sencore PS-163 dual-trace scope, \$200; TS-51QA/U signal generator, 10-420MHz, \$150; Ramsey DM-700 DMM, \$75; Ramsey CT-500 freq. counter, 600MHz, \$90; Apple MacIntosh 128K computer with external 400K floppy drive, \$800. Add shipping. Paul McCain, P.O. Box 542, Bynum, AL 36253; 205-238-1823 after 6 p.m. CST.

Two file drawers of Sams Photofacts from #700 through #1100, \$50 for all; Heathkit TS-3 TV alignment generator (no manual), \$35; Heathkit IM-12 harmonic distortion meter (no manual), \$35. Add shipping. Kenneth Miller, 10027 Calvin St., Pittsburgh, PA 15235; 412-242-4701.

Sencore VC63 VCR test accessory with manuals, like new, never used, \$350. Clarence G. McKee,



9516 Zion Road, Rives Jct., MI 49277;  
517-569-3139.

Sacrifice from a business — Sencore test equipment, like new: VA-62 video analyzer, VC-63 VCR test accessory, NT-64 pattern generator, EX231 expander, \$2,600; SC-61 waveform analyzer, \$2,000; 1655 B&K ac power supply, \$475; LOG688 Leader portable color pattern generator with acc., \$350; 6206B HP dc power supply, \$300; 120B HP single-trace scope, \$200. *Thomas Solak, 2507 N. Major, Chicago, IL 60639; 312-745-9595.*

Hitachi V-4236 scope, \$650; B&K 820 capacitance meter, \$175; B&K 1211A color pattern generator, \$150. All items new. *Vogler's TV, Box 95, Sommers Road, North Branch, NY 12766; 914-482-5295 after 5 p.m. EST.*

Color TV for parts for Admiral, RCA, GE, Motorola, Quasar, Zenith, Wards, Philco and Sears. Tell us what you need, and give us the model number or chassis number. *David C. Merrill, 1123 Knollwood Ave., Jackson, MI 49203; 517-787-4873 or 517-789-6919.*

B&K 2040 CB signal generator and B&K 1040 CB Service Master, \$350 plus shipping; B&K frequency counter and power supply. *Frank Brewster, Jr., P.O. Box 615, Baxter Springs, KS 66713; 316-856-3220 after 6 p.m.*

Radio and TV parts, text books, service manuals, magazines, new standard brand tubes in manufacturers' cartons, 90% off list price. Send large SASE for list. *M. Seligsohn, 1455 55th St., Brooklyn, NY 11219.*

Electronic trade magazines dating from early 1960s to present: PF Report, Electronic Technician/Dealer and Electronic Servicing & Technology. Make offer. *Elmer J. Alderman, Rt. 2 Box 139, Madison, NC 27025.*

Sencore SC-60 Widebander scope with manuals, original box and new probes, excellent condition, \$650. *Gary Knutson, 1205 Caledonia St., La Crosse, WI 54603; 608-784-1730 days.*

Three Heathkit electronics courses: electronic communications, semiconductor solid-state and test equipment, all brand new with wired trainer and all parts for the experiments, \$250; more than 23 electronics books, brand new condition, \$100 for all. *Daniel Seidler, 3721 W. 80th St., Chicago, IL 60652; 312-284-8221.*

Bafco 916A 2-channel sweep frequency response analyzer. Cost \$11,800, unused, asking \$3,500 or best offer. *Gene Larson, 2600 Arville #A-11, Las Vegas, NV 89102; 702-364-4617.*

Sencore VA-48, excellent condition, \$495 obo; Sencore DVM37 multimeter, excellent condition,

\$195 obo; Sams TV schematics #1100-#1500 and misc., \$200; misc. equipment and tubes, send SASE for list or call evenings. *Ace Electronics, N. 6717 Calispel, Spokane, WA 99208; 509-467-2575.*

MAC 17 1W translator TV chan 6 yield chan 11 with Raytheon line regulator, B/T chan 6 pre-amp, stainless steel housing, good working system. Make offer. *Ed Schultz, Box 234, Estes Park, CO 80517; 303-586-4588.*

Sencore VA62 with NT64 and VC63 in original box with all manuals, \$3,000; new B&K model 467 CRT restorer/analyzer with Dandy Daptor and manuals, \$400. *William Woody, Woody Electronics, Rt. 1 Box 733, Burnsville, NC 28714; 704-682-6228.*

Two Beckman #300 digital meters, excellent condition. \$55 each; temperature assy. converter, never used. \$15; Pacer-Amp clamp-on ammeter, dc, new price is \$400, only asking \$125. Money order or bank check only. *Mike Shelton, 2708 May Drive, Burlington, NC 27215; 919-227-2908 evenings.*

Sencore equipment: 1-year old, like new. SC-61, VA-62, VC-63, NT-64, EX-231, \$5,250; SG-165, \$895. *Angelo Russo, Tes Marketing, 3800 Lucius Road, Columbia, SC 29201; 800-553-5332.*

**ES&T**

## Classified

Advertising rates in the Classified Section are \$1.65 per word, per insertion, and must be accompanied by payment to insure publication.

Each initial or abbreviation counts as a full word.

Minimum classified charge \$35.00.

For ads on which replies are sent to us for forwarding (blind ads), there is an additional charge of \$40.00 per insertion to cover department number, processing of replies, and mailing costs.

Classified columns are not open to advertising of any products regularly produced by manufacturers unless used and no longer owned by the manufacturer or distributor.

### FOR SALE

VHS-VCR Repair Solutions Volumes I, II, III, IV. Each contains 150 symptoms and cures, cross reference chart, free assistance. Each \$11.95, any two \$19.95, any three \$29.95, all \$39.95. Eagle Electronics, 52053 Locks Lane, Granger, IN 46530. 01-89-TFN

TV/VCR TUFF TIPS listed by mfg. & model. Over 400 tips. \$21.95. TV Tips only \$11.95, VCR Tips only \$13.95. VCR CROSS-REFERENCE listing for electronically similar manufacturers, RCA, GE, Sylvania, Panasonic, Quasar, Magnavox, Philco, & J.C. Penney, \$19.95. TV/VCR FAILURE HISTORIES. Multiple cures for most problem areas. Send \$7.95 with mfg. and model number. Money will be refunded with free sample if model is not on database. Add \$1.50 postage and handling. TECH CURES, 4825 Fredericksburg Road, San Antonio, Texas 78229. 12-89-TFN

TV TROUBLESHOOTING: 300 PROBLEMS/SOLUTIONS. 3 VOLUME SET. NOTHING OLD LISTED. \$12.00 PER SET OR \$5.00 PER VOLUME. JONES, BOX 702, NICEVILLE, FLORIDA 32578 01-89-TFN

TV TOUGH DOGS: 300 symptoms and cures. Send \$8.95 to DAVID TV, 11772 Old Fashion Way, Garden Grove, CA 92640. 10-87-Tfn

PHOTOFACTS: Folders under #1400, \$4.00. Above #1400, \$6.00. Sent same day first-class postpaid. Loeb, 414 Chestnut Lane, East Meadow, NY 11554. 3-89-3t

REDUCED 75%, Diehl Mark V scanner \$249, Diehl Mark III scanner \$99. New. 2805 University Ave., Madison, Wis. 53705, 608-238-4629. 3-89-1fn

SONY-TRINITRON Rebuilt Picture Tubes are now available. All tubes shipped U.P.S. No Charge. We buy all Sony duds. Rochester Kinescope, 716-235-0750. 3-89-1fn

PHOTOCOPIER REPAIR: High profit, easier and less tools required than TV/VCR repair; Troubleshooting, tech tips, parts markup, more. Illustrated, \$24, or send for information. A-1 Electronics and Photocopier Repair, 5615 Deer Creek Drive, Ferndale, WA 98248. 3-89-2t

SENCORE EQUIPMENT FOR SALE: SC-61 oscilloscope \$2,200; SG-165 Stereo Analyzer \$900; PR57 Variable Isolation Transformer \$350; DVM37 Ohm-Volt-Amp Meter \$250. Call 402-352-5317. 4-89-2t

SHOP SERVICE MANAGEMENT PROGRAM: Basic language printout and documentation supports GW,M,O basic and compatibles. You get Symptoms and Cures, Inventory, Pricing, Invoicing, Year End Totals, Telephone Directory, Mark-up Percentages, System Maintenance, Expense, Serial Number, Purchase Orders and Schematic Logs all on line. 80 or 40 column versions. Custom programming available. \$25. Sigma Engineering, Box 24759, Baltimore, Maryland 21220. 4-89-1t

ELECTRONIC COMPONENTS. Free 192 page catalog including capacitors, resistors, relays, connectors, soldering equipment and supplies. MOUSER ELECTRONICS, 1-800-992-9943. 4-89-1t

SENCOR SC61 oscilloscope, like NEW original box \$1985.75. Write 110 Van Sant Road, Kaispell, MT 59901, or (406) 755-2681 evenings. 4-89-1t

### WANTED

TUBES WANTED - We buy all types of receiving tubes - particularly need radio and audio tubes. Must be new in original boxes unless very early balloon shape. Send us your list for our bid. Antique Electronic Supply, 688 W. First St. Tempe, AZ 85281. FAX 602-894-0124, Phone 602-894-9503 02-89-3t

NRI COURSE in Electronics with TV Training—Jack Moghadam, 1215 Prospect Street, Ann Arbor, MI 48104. Phone 313-761-7833 or 971-4146. 4-89-1t

NEED WIDTH COIL for Electrohome Color Monitor G07—Part #C30262A. Jacks TV, Phone (616) 894-4762. 4-89-1t

### SERVICES

SPEAKER REPAIR. 4"-18" Speakers reconed. Cross-over parts. Urban Audio, 119 7th St. NW, North Canton, Ohio 44720, (216) 497-9932 6pm-9pm EST. 4-89-1fn

### BUSINESS OPPORTUNITIES

TV, VCR, APPL. SALES, SERVICE AND RENTAL BUSINESS WITH 3 STORES \$25,000 buys service department and you manage \$100K in rental contracts for commission. Or will sell all stores for \$250K. Financing available for qualified buyer. Located in Northern Virginia. Call after 7:00 p.m. est. 703-972-7027 01-89-TFN

BUSINESS FOR SALE: Audio/video repair. Excellent warranties. Purchase test equipment etc. (approx. \$22,000), no Blue Sky. Located western Colo-Blue Skies—Owner retiring. Electronic Service, 211 S. 15th, Grand Junction, CO 81501. 4-89-1t

**A MUST FOR THE TV TECHNICIAN**

UNIVERSAL CRT ADAPTER. Don't buy another socket for your CRT Tester! Join 10,000 satisfied buyers & WIN the Socket War! **GUARANTEED** to fit your tester. Test/clean/restore ALL Color, B/W, Projection. \$59.95 cod. Complete Patented Kit, with sockets & setup Book.



**FREE CALL 1-800-331-9658**  
**DANDY MFG. CO./RANDALL ELECTRONICS**  
 (918) 682-4286, 2323 Gibson St., Muskogee, OK 74403

Circle (28) on Reply Card

**HAND REMOTE REPAIR**  
**LA GUARDIA ENT**  
 5882 Rich Hill Way  
 Yorba Linda, CA 92686  
 (714) 579-1276

90 Day Warranty  
 New Battery Included

- Call for pricing
- 24 hr. turnaround time
- Return freight pre-paid

Circle (29) on Reply Card

**Tech's Guide To Pricing**  
 updated new 5th edition... a framework for setting rates that apply to Hi-Tech products... a formula that guarantees SUCCESS!  
 Call Toll Free for details **1-800-228-4338** 8/5 CST

**NEW**

Circle (30) on Reply Card

**Moving?**

Take us with you.

Just peel off your subscription mailing label and attach it to the address change card inside this issue. Please allow 6-8 weeks to process your address change.

**Ad Index/Hotline**

Company	Page Number	Reader Service Number	Advertiser Hotline
Abatron Electronics	21	12	
American West C & E, Inc.	63	26	307/382-5663
B & K Precision Dynascan Corp.	IBC	2	312/889-1448
Beckman Industrial Corp.	5	5	619/495-3200
Cleveland Institute of Electronics	1, IFA-IFB	3	800/321-2155
Consumer Electronics Show	49		202/457-8700
Contact East	22	13	800/225-5370
Dandy Mfg. Co.	68	28	800/331-9658
ETA	63		
Goldstar Precision	11	8	213/404-0101
Iscet	59		
Joseph Electronics	23	14	800/323-5925
Kenwood Test & Measuring Instruments	47	21	213/639-4200
Laguardia Enterprises	68	29	714/579-1276
Leader Instrument Corp.	3	4,31	800/645-5104
MCM Electronics	24	15	800/543-4330
Nesda	53,57		
NTE Electronics, Inc.	19	11	800/631-1250
Panavise Products, Inc.	51	22	213/595-7621
Parts Express Int'l., Inc.	25	16	513/222-0173
Philips ECG	7	6,32,33	800/225-8326
Prime Electronics	53	23	414/473-4727
PTS Corp.	15	9	800/333-PTSI
Sencore, Inc.	IFC	1	800/843-3338
Sperry Tech, Inc.	68	30	800/228-4338
Techni-Tool	26	17	215/825-4990
Tektronix, Inc.	8-9,17	7,10	800/835-9433
Tektronix, Inc.	8A-8B		800/835-9433
Tektronix, Inc.	16A-16B		800/835-9433
Test Probes, Inc.	45	20	800/368-5710
Tronix, Inc.	57	24	313/939-4710
U.S. Instrument Rentals	27	18	800/824-2873
Viejo Publications	59	27	800/537-0589
Zenith	BAC		
3M Magnetic Media Group	41	19	

**ADVERTISING SALES OFFICES**

**ELECTRONIC**  
*Servicing & Technology*

**KANSAS CITY, MISSOURI**  
 Greg Garrison, Sales Manager  
 P.O. Box 12901  
 Overland Park, KS 66212  
 Phone: (913) 888-4664  
 Fax: (913) 541-6697  
 Telex: 42-4156 INTERTEC OLPK

**OXFORD, ENGLAND**  
 Nicholas McGeachin  
 Roseleigh House, New Street  
 Deddington, Oxford OX5 4SP  
 Phone: (0869) 38794  
 Telefax: (0869) 38040  
 Telex: 837469 BES G

**TOKYO, JAPAN**  
 Mashy Yoshikawa  
 Orient Echo, Inc.  
 1101 Grand Maison  
 Shimomiyabi-Cho, 2-18  
 Shinjuku-ku, Tokyo 162, Japan  
 Tel: 03-235-5961  
 Telex: J-33376 MYORIENT

**FREWVILLE, SOUTH AUSTRALIA**  
 John Williamson  
 Hastwell, Williamson, Rep. Pty. Ltd.  
 109 Conyngham Street  
 Frewville 5063  
 South Australia  
 Phone: (08) 79 9522  
 Fax: 08 79 9735  
 Telex: AA87113 HANDM





# DOLLAR FOR DOLLAR, THE BEST 60 MHz SCOPE

When you're looking for the best value in a 60 MHz dual-trace scope, look no further than B&K-PRECISION. The new Model 2160 gives you a wide range of high-end features and performance at a price that's \$100 or more below competition.

The 2160 will keep you well informed with 1 mV per division vertical sensitivity, alternate triggering for viewing two signals unrelated in frequency, dual time base and a unique curve-trace style component tester for out-of-circuit tests on a variety of components.

Select from 22 calibrated sweep time ranges on the main time base and 19 on the delayed-sweep time

base. For even closer examination and measurement of waveforms, switch on the X-10 magnifier.

To keep pace with your varied applications, the 2160 also offers front panel X-Y operations, Z-axis input, a channel 1 output for driving a frequency counter, and a signal delay line to catch fast input signals. The B&K-PRECISION 2160 comes complete with two 10:1 probes and a detailed instruction manual.

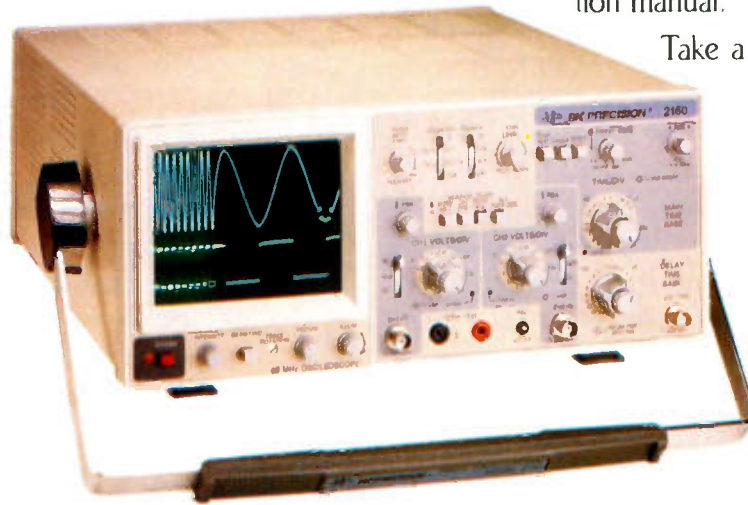

Take a close look at the 2160 and you'll see why it's the industry's best value. For immediate delivery or more information, contact your local distributor or B&K-PRECISION.

## \$1045

GET THE  
**MAX**  
FOR YOUR  
DOLLAR



### BK PRECISION

MAXTEC INTERNATIONAL CORP.

6470 W. Cortland St. • Chicago, IL 60635 • 312-889-1448

International Sales, 6470 W. Cortland St., Chicago, IL 60635

Canadian Sales, Atlas Electronics, Ontario

South and Central American Sales, Empire Exporters, Plainview, NY 11803

Circle (2) on Reply Card

**For your own reputation  
and in your customers' best interest  
always insist on**

**Genuine Zenith**  
**Remanufactured Replacement Parts**  
**Reconditioned and Serviced for Reliability**  
**by Zenith People**  
**as Knowledgeable and Dedicated as**  
**Those Who Made the Originals!**

One of the easiest, fastest, and surest ways for you to preserve the pedigree and maintain the quality of the Zenith products you service is with genuine Zenith replacement parts.

And at no time is this more critical than when you replace the more sophisticated components like modules, tuners, channel selectors and sub-assemblies.

Your participating Zenith parts distributor will supply you with a replacement remanufactured, reconditioned and serviced for reliability by Zenith people as dedicated and knowledgeable as those who made the original.

Equally important, the replacement module or sub-assembly you receive in exchange from your Zenith parts distributor

will most likely incorporate any Zenith factory-made modifications in effect at the time of remanufacture.

And nowhere else but in a participating Zenith parts distributor's Exchange Program can you get assurance that a replacement incorporates Zenith factory updates!

To learn the location of the Zenith R&R Exchange Counter in your area, write on your company letterhead and we will help you locate one that's nearby.

Risking an exchange for a Zenith replacement anywhere else doesn't make sense. Not when factory-fresh replacement modules and sub-assemblies are so readily available thru a Zenith parts distributor's Exchange Program! Write now!



The quality goes in before the name goes on.\*