

ELECTRONICTM

Servicing & Technology

MARCH 1982
\$2.25

Why a video technician needs a scope

Microprocessor: revolutionizing electronics

RR 1 BOX 3089
MILFORD PA 18337
A18337-----LP01 0890 SEP84 ESQ
0 01 C 0 090080
JOE LUP0 JR



COMPUTERS:
The changing image

The Tools.



**Boker, Crescent,
Lufkin, Nicholson, Plumb,
Weller, Wiss, Xcelite.**

The right tool makes the job easier.
And Cooper makes the right tool for the job.
Whether you're making or mending, cutting or joining,
striking, measuring or stripping, there's a Cooper tool that's
just right. Don't take chances on tools. Specify Cooper
and get 'em right the first time!

from Cooper The Toolmaker.™



The Cooper Group

BOKER® CRESCENT® LUFKIN® NICHOLSON® PLUMB® WELLER® WISS® XCELITE®
P.O. Box 728, Apex, North Carolina 27502. Tel: (919) 362-7510. Telex: 579497

Circle (1) on Reply Card

ELECTRONIC

Servicing & Technology

Editorial, advertising and circulation correspondence should be addressed to: P.O. Box 12901, Overland Park, KS 66212-9981 (a suburb of Kansas City, MO); (913) 888-4664.

EDITORIAL

Bill Rhodes, *Editorial Director*
 Nils Conrad Persson, *Editor*
 Carl Babcoke, *Consumer Servicing Consultant*
 Rhonda Wickham, *Managing Editor*
 Tina Thorpe, *Associate Editor*

ART

Dudley Rose, *Art Director*

CIRCULATION

John C. Arnst, *Director*
 Evelyn Rogers, *Manager*
 Dee Manies, *Reader Correspondent*

ADMINISTRATION

R. J. Hancock, *President*
 Cameron Bishop, *Publisher*

ADVERTISING

Greg Garrison, *National Sales Manager*
 Jeanette Staley, *Production Manager*
 Mark Raduziner, *Marketing Coordinator*

Regional advertising sales offices listed near Advertisers' Index.



Member, Audit Bureau of Circulation



Member, American Business Press

ELECTRONIC SERVICING & TECHNOLOGY (USPS 462-050) (with which is combined PF Reporter) is published monthly by Intertec Publishing Corp., P.O. Box 12901, 9221 Quivira Road, Overland Park, KS 66212-9981. Second Class Postage paid at Shawnee Mission, KS 66201. Send Form 3579 to P.O. Box 12901, Overland Park, KS 66212-9981.

ELECTRONIC SERVICING & TECHNOLOGY is the "how-to" magazine of electronics. It is edited for electronic professionals and enthusiasts who are interested in buying, building, installing and repairing home-entertainment electronic equipment (audio, video, microcomputers, electronic games, etc.).

Subscription prices to qualified subscribers: one year \$15, two years \$26, three years \$34 in the USA and its possessions. Foreign countries: one year \$20, two years \$30, three years \$40. Single copy price \$2.25; back copies \$3.00. Adjustment necessitated by subscription termination to single copy rate. Allow 6 to 8 weeks delivery for change of address. Allow 6 to 8 weeks for new subscriptions.

PHOTOCOPY RIGHTS: Permission to photocopy for internal or personal use is granted by Intertec Publishing Corp. for libraries and others registered with Copyright Clearance Center (CCC), provided the base fee of \$2 per copy of article is paid directly to CCC, 21 Congress St., Salem, MA 01970. Special requests should be addressed to Cameron Bishop, publisher.

ISSN 0013-497X/81 \$2



INTERTEC PUBLISHING CORP.

©1982 All rights reserved.

Compare the best.



We'd like you to compare Keithley's new Model 179A general purpose bench TRMS multimeter to its closest competitor.

	4 1/2-digit resolution	5 full functions	10uV sensitivity	TRMS	DCV accuracy	Field installable battery pack	Input protection on Ω	Size of digits	Display	20A capability	IEEE-488 option	PRICE:		
179A	✓	✓	✓	✓	0.04%	✓	1000V	NO	.56"	LED	✓	✓	\$359	
8050A	✓	✓	✓	✓	0.03%	NO	500V	✓	.50"	LCD	NO	NO	NO	\$369

Dollar for dollar, feature for useful feature, we think our new 179A gives you more common sense utility for your money. What do you think?

- I'd like a closer look at the 179A. Please call me to arrange a demo.
- Please send the new Keithley handheld, portable and bench meter catalog including the complete 179A specs.
- I'm interested in other Keithley products.
- High resolution and Systems DMMs.
- Keithley Scientific Instruments.

Name _____ Title _____

Company _____ Phone _____

Address _____

City _____ State _____ Zip _____

MAIL TO:

KEITHLEY

Keithley Instruments, Inc.

28775 Aurora Road/Cleveland, Ohio 44139-9990/(216) 248-0400

Circle (11) on Reply Card

March 1982 *Electronic Servicing & Technology* 1

The how-to magazine of electronics...

ELECTRONIC

ES&T
Servicing & Technology

March 1982
Volume 2, No. 3



A Commodore engineer designs a complex semiconductor chip. See story on the Commodore PE1 on page 51. (Photo courtesy of Commodore Computer Systems.)

- 6 From the staff**
Keeping with the changes in the industry, **ES&T** introduces a new editor.
- 14 The computer in your life**
By Carl Bentz
The jobs for a home computer are limited only by your desires and your creativity.
- 18 Microprocessor...revolutionizing electronics**
By John E. Cunningham
Some of the most elementary concepts in microprocessor operations are explained in this article.
- 25 Why a video technician needs a scope**
By Jim Smith
A vicious circle of problems keeps many technicians from using their scopes.
- 30 The field strength meter—a smart idea for the full-service TV shop**
By Carl Bentz
A better understanding of FSM equipment will help the technician provide diagnostic services.
- 36 How to choose the right interactive video equipment**
With the movement of computers out of the elitist category, interactive video has become a popular way to present material.
- 43 Protecting the microprocessor/minicomputer**
By David Kemp
Sophisticated electric equipment requires electrical power free of interference.
- 46 Understanding and troubleshooting shutdown and startup circuits**
By Greg Carey
An overview of the scan-derived power system helps explain how problems may develop.
- 51 Computer stars in band**
By John O'Brien
The percussion and backup vocals for this band are provided by a Commodore PET computer.
- 52 Learning to talk computer**
By Carl Bentz
Programming can be learned with a self-teaching course, such as this one from Heathkit-Zenith.



Page 14

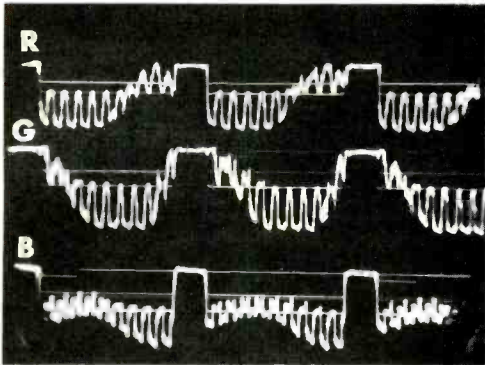

Page 25



Page 43

DEPARTMENTS

- 4 Electronic Scanner
- 7 Association News
- 8 Calendar of Events
- 12 Troubleshooting Tips
- 13 Quick Quiz
- 42 Symcure
- 56 New Products
- 64 New Literature

Reach for reliability.

Solve over 178,000 solid state replacement problems using 1800 SK and KH types. RCA's new Replacement Guide puts the reliable answers at your fingertips.

From foreign to domestic components, RCA simplifies just about any replacement application, including integrated circuits, high-voltage triplers, rectifiers, thyristors and transistors. The guide uses a convenient dual numbering system, which

matches the right SK replacement to your consumer or MRO/Industrial needs. For example: SK3444/123A.

Pick up your copy of the 1982 RCA SK Replacement Guide. Nothing puts reliability within easier reach. See your RCA SK Distributor, or send a check or money order for \$2.25 to: RCA Distributor and Special Products Division, P.O. Box 597, Woodbury, N.J. 08096.



25th Consumer Electronics Show sets all-time record

Attendance at the 1982 International Winter Consumer Electronics Show (CES) soared to 67,782, a record for any of the 25 International Consumer Electronics Shows held in Las Vegas and Chicago, according to Jack Wayman, senior vice president, Electronic Industries Association's Consumer Electronics Group, sponsors and producers of the show.

"This show was simply incredible, considering the state of the general economy," said Wayman. "It is a clear indication that consumer electronics is the growth industry of the 80s. Consumer electronics products and technology have captured the interest and at-

tention of the American public and our industry is enjoying a popularity high."

This Winter CES was busy on many fronts besides the more than 900 exhibits, which occupied 532,000 net square feet in the Las Vegas Convention Center, Hilton Hotel and Jockey Club. On day 4, traditionally a light day, the Personal Computer/Video Games Conference was crowded and the daily Export Seminars attracted a substantial attendance each day.

Spring courses offered by Integrated Computer Systems

Three courses by Integrated Computer Systems, "Digital image processing and analysis," "Digital filters and spectral analysis" and "Speech synthesis and recognition," are being offered this spring in Boston, Los Angeles, San Diego, San Francisco and Washington, DC. The courses, priced at \$795 each, are available on-site at special request.

For more information, contact Ruth Dordick, Integrated Com-

puter Systems, 3304 Pico Blvd., P.O. Box 5330, Santa Monica, CA 90405, 1-213-450-2060.

Final 1981 sales figures confirm banner year for video

The American consumer's love affair with the new world of video is reflected in final 1981 industry sales figures, compiled by the Marketing Services Department of the Electronic Industries Association's Consumer Electronics Group.

Sales to retailers of color TV receivers topped 11 million for the first time, reaching 11,157,334 units in 52 weeks of 1981, an increase of 2.4% above the 10,897,080 units sold in the 53 weeks of EIA/CEG's 1980 marketing calendar.

Why did video sales perform so well during a general economic recession? Jack Wayman, senior vice president of the Electronic Industries Association's Consumer Electronics Group, said, "the industry's steady stream of new technologies, resulting in new pro-



**The new
1982 RCA SK
Replacement Guide.**

**RCA SK Replacement
Solid State**

ducts that inform, educate and amuse, have become the most popular way for consumers to spend their disposable income. Also, the consumer recognizes the fact that consumer electronics products have barely budged in the Consumer Price Index in the past 14 years and offer a genuine value when compared to the staggering increases experienced generally in prices of all goods and services."

Demand for low-cost test instruments increases

As electronic equipment and microprocessors become more pervasive, the need for electronic instruments to service and test that equipment has increased. According to Dataquest, \$4,240 million worth of test equipment will be sold in 1983. The test equipment market, however, is not just getting larger. Oscilloscopes are a good example. The market for low-cost oscilloscopes, for example, is expected to grow from \$26.1 million in 1974 to \$171.5 million in 1984 according to Dataquest. New

users entering the electronic market and new applications, particularly for the low-cost, easy-to-use instruments, are continually being uncovered.

Tektronix opens national marketing center

Tektronix has opened its new direct-order channel—a toll-free number for lower priced instruments and accessories.

The National Marketing Center, based in Beaverton, OR, is intended to expand customer service and address the growing purchasing needs of news electronics purchasers.

By calling 1-800-547-1512, customers will reach experienced sales engineers, who will provide immediate technical consultation, applications assistance, and answers to a wide variety of measurement and safety problems. The center will be staffed from 5 a.m. to 8 p.m. EST.



Coming in the April

ELECTRONIC
Servicing & Technology

Audio noise reduction and masking. The Dynamic Noise Reduction System described in this article can save circuit board space and cost because of the few additional components required.

A new experience: The Ampex Museum of Magnetic Recording. This permanent historic equipment display tells the story of an industry that dates back to the 19th century.

Servicing excessive high-voltage, part 2. Operation and servicing of high-voltage regulators on solid-state color TV receivers are explained.

From the staff...

Several months ago, we announced and launched a "renewed" magazine. We took the old **Electronic Servicing** and gave it a facelift. The name was revised to more accurately reflect the state of electronics today. Design and graphics were totally revamped to improve readability and give it a contemporary appearance. Even the new logo was developed to reflect the fact that this is a technical, electronic-oriented magazine.

In addition to that, we expanded the editorial format and, as promised, have already begun to bring you more articles, more pages, more pictures, more graphs and more schematics. In general, more magazine for your money.

Now, we have taken another step in our renewed commitment and investment in **Electronic Servicing & Technology**. The initial success of this new program has made it necessary to add another highly experienced editor.

It is with a great deal of pleasure that we announce the addition of Conrad Persson as editor of **ES&T**.

Conrad holds a bachelor of science degree in electrical engineering and has served in several engineering and publishing capacities. They include: U.S. Air Force Communications Officer; engineer for the Safeguard Missile Systems Project; Western Electric plant electrical engineer; associate editor of Design News magazine and most recently, editorial director for

Actuator Systems and *Plant Electrical Systems* magazines.

Bill Rhodes, **ES&T** editorial director and Carl Babcoke, consumer servicing consultant will continue to write and contribute extensively to the magazine.

In fact, the addition of Conrad means that Bill and Carl will both have more time to spend working on articles and subjects in their specialties, and less time working on the day-to-day operation and direction of **ES&T**.

The editorial team of Persson, Rhodes and Babcoke gives **ES&T** what we consider to be the most experienced, technically knowledgeable editorial staff of any magazine in the industry.

Their combined experience in electronics, electrical engineering, technical servicing, maintenance and publishing will greatly enhance and strengthen the editorial package presented each month. It will also make **ES&T** an even more valuable source of technical data, servicing tips and how-to articles for you.

The major steps in the "renewal" of **ES&T** are now complete. Judging from the overwhelming number of positive responses we have received from you, it's working.

Thank you for your patience and support. As they say, keep those cards and letters coming.

Cameron Bishop
Publisher

The rate of change of electronic technology in our time has been so great that it can be considered a revolution. Although it had its roots in the Edison phonograph, the development of the vacuum tube and other events right around the turn of the century, the growth of consumer electronics really began in the 1920s with the development of radio broadcasting. At intervals followed hi-fi, video and stereo.

Today the pace of change is frantic. Electronics manufacturers have provided the world with computers affordable to almost anyone who wants one, home videotape and disc, satellite earth stations, video text and more. Even more startling developments include wristwatch-size televisions, hand-held computers with main-frame capacity, electronic mail and high-definition television.

In the midst of this state of events, **Electronic Servicing & Technology** could pursue no other course than to change with the technology that is so vital to its readers. It is no longer sufficient to publish articles relevant only to service work on the bench. In fact, part of the reason so many service technicians have fallen on hard times is that in the rush of events, it has been nigh impossible to keep pace. The changed format and content of **ES&T** are designed to keep readers abreast of these developments so that they can

capitalize on the service needs of consumers.

This does *not* signal a reduction in the content of hard service articles and tips. With more pages to work with, we intend to bring you not only this new type of information alerting you to technological developments, but *more* pages of what you have traditionally come to expect from **ES&T**.

We also intend to add more readers. Many technicians turned to servicing work as a natural consequence of their interest in electronics as a hobby. We plan to make **ES&T** attractive to others who have an interest in electronic devices and systems. By increasing our circulation, we will be able to bring you more pages, more articles, more tips, more color and more of everything you need to know about electronics.

Change is the essence of growth, and changes you have seen in **ES&T** and the changes to come are evidence of the growth of this magazine. As changes occur in the world of electronics/servicing, **ES&T** has made the commitment to change, to grow, in order to keep pace with them.

Nils Conrad Persson
Editor

ES&T_{inc}

Service Fast and Profitably with Simpson Professional Test Instruments



An Instrument for Every Service Need and a Full Line of Accessories at Your Local Simpson Distributor...

ASK FOR
FREE CATALOG



SIMPSON ELECTRIC COMPANY
853 Dundee Avenue, Elgin, IL 60120 (312) 697-2260

Circle (6) on Reply Card



EIA/CEG forms new planning committee

John McDonald (Casio) was elected chairman of the Personal Electronics Division of the Electronics Industries Association's Consumer Electronics Group at its board of directors meeting, January 9 in Las Vegas.

Authorized by the board last year, the CEG Personal Electronics Division has now been activated, and under the leadership of McDonald will be responsive to the needs of member companies, which will include manufacturers of personal computers, calculators and electronic games. The CEG Staff is ready to support the new division with marketing statistics, engineering standards, govern-

ment liaison, industry development programs and other requirements.

An additional action taken by the CEG board of directors was the adoption of a position supporting selection (by the Federal Communications Commission) of one system for AM stereo and one system for Teletext and Multi-Channel Sound, as opposed to the so-called competitive marketplace approach under which consumer response would determine which system or systems should prevail.

Radio Club gives Busignies award to Forster of ITT

The Radio Club of America, the pioneer radio communications society of the United States, has presented its new Henri Busignies Memorial Award to William H. Forster, vice president and product group manager for telecommunications and electronics of International Telephone and Telegraph Corporation.

In announcing the new annual award for, "substantial contribu-



tion to the advancement of electronics for the benefit of mankind," the Radio Club honors one of its most illustrious directors, Dr. Henri Busignies, ITT chief scientist emeritus, who died recently.

The award will go to Mr. Forster in recognition of his work in coordinating international research, for personal contributions in radar, television and communications system design, and for semiconductor component development.



CALENDAR OF EVENTS

March

19-21

Computer Fair, Civic Auditorium, Brooks Hall, San Francisco, CA. For more information call (415) 851-7075.

23-25

Southcon/82 Show and Convention, Sheraton Twin Towers Hotel, Orlando Hyatt Hotel and Holiday Inn International Drive, Orlando, FL. Call (800) 421-6816 for more information.

April

14-18

Electronic Home Entertainment Show, Arlington Park Race Track Exposition Hall, Chicago. Contact Expo Management Inc., Suite S2-132 Arcade, The Apparel Center, Chicago, IL 60654, 1-312-329-1191.

23-25

Hamvention '82, Dayton Hara Arena, Dayton, OH. For more information call (513) 277-5314.

29-May 1

1982 Electronic Distribution Show and Conference, New Orleans Hilton, New Orleans, LA. Contact David L. Fisher, Electronic Industry Show Corp., 222 S. Riverside Plaza, Suite 1606, Chicago, IL 60606, (312) 648-1140.

May

10-12

The 32nd Electronic Components Conference, Sheraton Harbor Island Hotel, San Diego, CA. Contact program chairperson D. J. Bendz, IBM Corp., Dept 649/014-4, 1701 North St., Endicott, NY 13760.

11-15

National Association of Television & Electronic Servicers of America (NATESA) 31st Annual Convention, Indian Lakes Resort, Bloomingdale, IL. Contact Frank J. Moch, 5930 S. Pulaski Rd., Chicago, IL 60629, 1-312-582-6350.

18-20

Northcon/82 Show and Convention, Seattle Center Coliseum, *(Continued on page 11)*

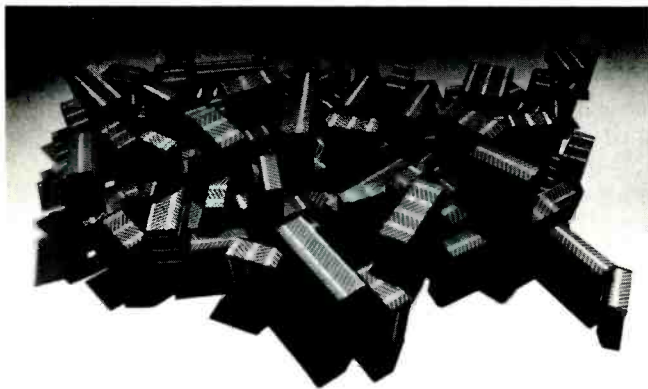

Coast to coast, one box stands out at over 1400 locations.

In the past five years PTS has grown from 40 to over 1400 locations nationwide. That means there's a PTS Distributor or Servicenter near you, where you'll find quality rebuilt tuners and modules.

And you'll like the convenience of picking up all

the brands you need in one stop.

How many electronics rebuilders make modules and tuners available at over 1400 locations?

Only One.



PTS CORPORATION

For the name of the PTS Distributor or Servicenter nearest you write PTS Corporation, P.O. Box 272, Bloomington, IN 47402

Circle (4) on Reply Card

Symcures Wanted

Electronic Servicing and Technology

needs a broader variety of television Symcures. Especially needed are reports of Quasar, General Electric, Sylvania (or Philco), Sony Sears and Magnavox.

Please give the brand, model number, Photofact number, a brief description of the symptoms, a rough hand-drawn schematic of the area containing the defect, and a short description of the cure (including whether the defective component was open, leaky, shorted or intermittent).

ES&T editors will adapt the material to the Symcure format and have Photofact-style schematics prepared.

Send seven Symcures each time. Only six will be published, but the extra gives the editor a spare for one already printed in the past (or otherwise not suitable to the format). \$30 will be paid for each page of six actually published (remember to include full name and address).

Send each group of seven potential Symcures to:

Symcure Department
Electronic Servicing and Technology
P.O. Box 12901
Overland Park, Kansas 66212

Calendar

(From page 8)

Seattle, WA. Call (800) 421-6816 for more information.

25-27

Electro '82, Hynes Auditorium, Boston, MA. For more information, call (800) 421-6816.

June

6-9

Summer CES '82, McCormick Place, Chicago, IL. Contact Consumer Electronics Shows, Two Illinois Center, Suite 1607, 233 North Michigan Avenue, Chicago, IL 60601, (312) 861-1040.

7-10

National Computer Conference '82, Astro Arena, Houston, TX. For more information call (703) 558-3600.

August

2-7

Joint convention of NESDA, ISCET, The Texas Electronics Association, the Louisiana Electronic Service Dealers Association, and Television Service Association of Arkansas. At the Hilton in New Orleans, LA. Contact The National Electronic Service Dealers Association, 2708 West Berry St., Ft. Worth, TX 76109, (817) 921-9061.

September

14-16

Wescon '82, Anaheim Convention Center, Anaheim, CA. For more information call (800) 421-6816.

October

11-13

EIA Fall Conference, Century Plaza Hotel, Los Angeles, CA. For more information contact the Electronic Industries Association, 2001 Eye Street N.E., Washington, D.C. 20006.

November

30-December 1-2

Midcon, Dallas Convention Center, Dallas, TX. For more information, call (800) 421-6816.

ES&T

COMPLETE TEST EQUIPMENT SERVICE.

**We pick it up.
We fix it fast.
We deliver it back
or
We service on-site.**

We handle calibration, repair, maintenance, and modification. We've been providing this service for 20 years—at fair rates. Today we service more than 7,500 pieces of equipment annually.

Padded van, no shipping container required . . .
Emergency 24-48 hour service . . . Certificate of calibration (NBS traceable) . . . Automatic recall notification . . . Scheduled preventive maintenance and calibration . . . Mil-Spec compliance . . . Estimates before servicing.

Equipment acting up? Call (201) 757-3730.

Lockheed Electronics

Instrumentation Measurements Laboratory
1501 U.S. Highway 22 C.S. #1, Plainfield, New Jersey 07061

Circle (13) on Reply Card

Our lowest price solder extractor isn't cheap.

People get suspicious when they see "lowest priced." Especially in a precision piece of equipment. They immediately think it's garbage.

Despite the reasonable price our EX-525 gives you vacuum by an oilless, piston pump, not diaphragm. It easily removes components from double sided and multi-layer PC boards. The EX-525 comes with a great technical manual and 2 year warranty.

The EX-525 is inexpensive, but it isn't cheap.

**AUTOMATED
PRODUCTION
EQUIPMENT**

142 Peconic Avenue
Medford, New York 11763 - U.S.A.
(516) 654-1197 • TWX: 510-228-2120

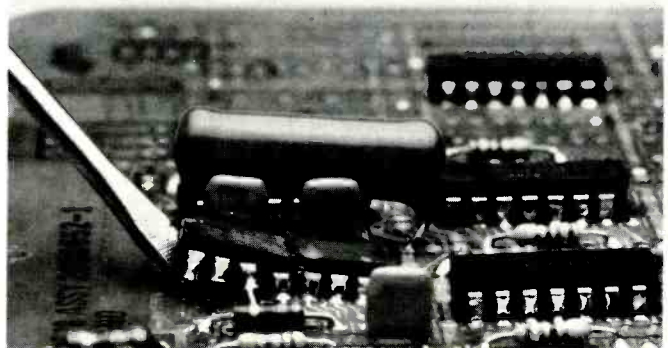

Circle (5) on Reply Card

TROUBLE-SHOOTING TIPS

Picture has no height Magnavox T974-07 (Photofact 1305-1)

Most symptoms of no vertical deflection in older tube sets are easily eliminated by replacement of the vertical oscillator/output tube. However, a new 6LU8 tube did not restore vertical sweep to this Magnavox color receiver.

Except for the tube, the two next suspects should be the coupling capacitor between the oscillator plate and the output

grid, and the output-tube cathode resistor. The C508 coupling capacitor was not shorted, leaking or open, but the R515 560Ω cathode resistor was open. Replacement of this 2W resistor restored some height, but the linearity control had no effect when adjusted, and the height control had little action.

Voltage measurements failed to uncover any obvious defects except the output cathode voltage was +28V instead of the normal +21V. However, that discrepancy could have been caused by improper adjustment of the linearity control.

Convergence problems have been known to affect height or linearity, so I connected a crosshatch generator and examined the convergence, finding it was poor. Open or shorted C295 cathode bypasses sometimes cause simultaneous height and con-

vergence problems but this one had been tested already.

My scope showed excessive amplitude of the output-tube cathode signal, indicating a loss of load in the convergence system. Ohmmeter tests in the vertical-

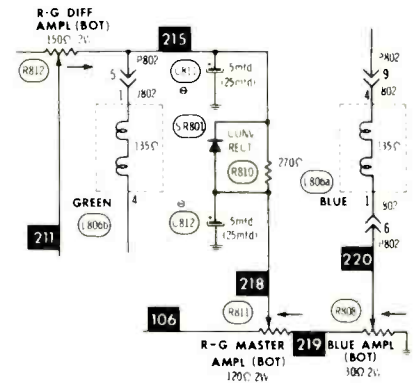

vergence circuit identified an open R811. Installation of a new R811 allowed adjustments for linear height, but the height control had insufficient range.

Next, I remembered that some color receivers obtain a positive voltage for the horizontal-output-tube suppressor grid (snivet eliminator) from the cathode of the vertical-output tube. Photofact 1305-1 confirmed that this Magnavox T974 used this method. When I installed a new 6JE6 horizontal-output tube, the height control provided more than enough variation.

As a crosscheck, the cathode of the vertical-output tube was tested. The dc voltage now was about +19V (previously +28V) and the ac waveform measured a normal 12VPP (previously 34VPP).

This repair was confusing because it involved three vertical components (6LU8 vertical tube, R515 cathode resistor and R811 convergence control) and also the 6JE6 horizontal-output tube. However, it does illustrate the wisdom of using test equipment to measure the various signals and voltages, rather than merely replacing suspected components without any proof.

Phillip M. Jones, CET
Martinsville, VA

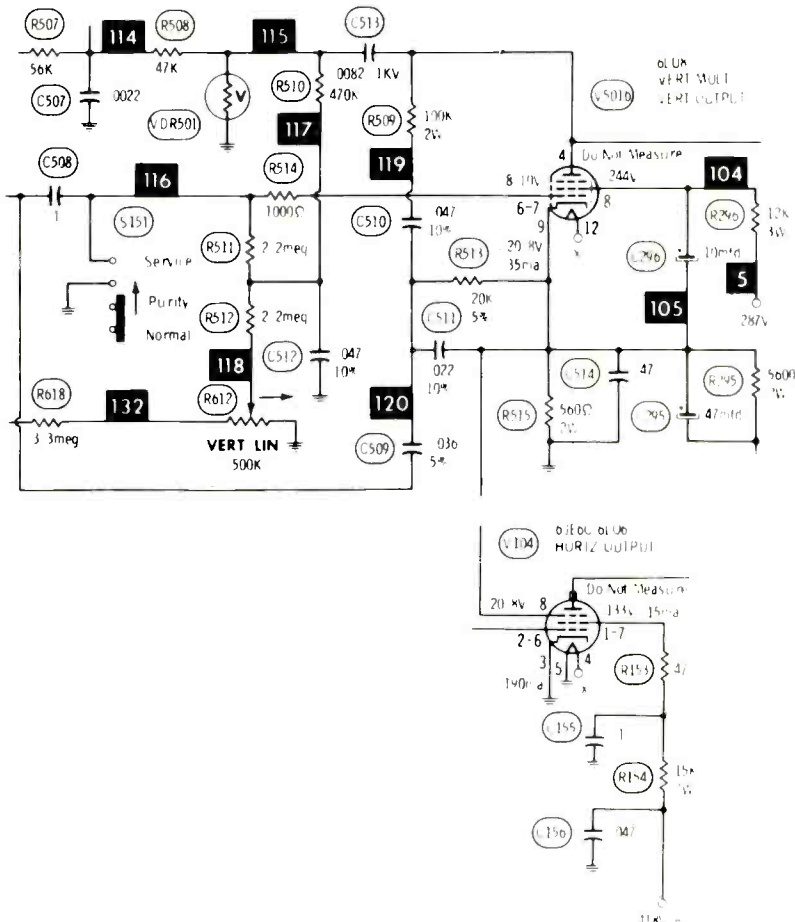

**Intermittent narrow width
Zenith 19GC45**
(Photofact 1546-2)

According to the customer, the Zenith would operate normally for about an hour before the picture narrowed to about 8 inches. About a half hour later, the picture width returned to normal.

I monitored the base-drive signal at output transistor Q202. After about 45 minutes, the scope showed a distorted base waveform and the picture narrowed. The B+ supplies had nominal voltages.

The 9-90 horizontal-oscillator/driver module was replaced, but the problem returned during the next heat run. However, heat appeared to be responsible for the erratic operation, so I used canned coolant spray on all components around the output stage after the picture narrowed next time. When the spray reached R224 (the 1.5Ω base-return resistor for Q202), the width increased instantly. Alternate heating and spraying of R224

proved it was thermally intermittent, and installation of a new resistor cured the erratic width.

After the erratic R224 was removed from the receiver, the resistance was measured while

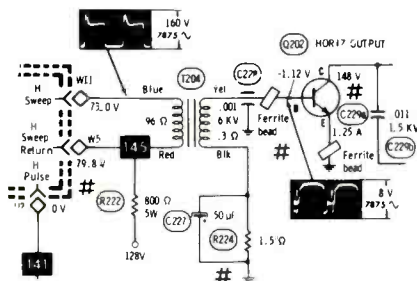

heat was applied. The resistance increased to about 12Ω.

Coolant spray is recommended for most cases involving intermittent faults caused by heat rise.

James O. Arnold
Neitzke TV Service
Bay City, MI



Troubleshooting Tips wanted

Electronic Servicing and Technology

needs additional consumer-product Troubleshooting Tips. Most types of case histories are suitable, especially those with unique, puzzling or misleading symptoms.

List the brand, model and Photofact number followed by a narrative telling the original conditions or symptoms, the various troubleshooting steps, and the components replaced to restore the original performance. Please include a simple hand-drawn schematic of the stage that has a defect.

\$5 will be paid for each Troubleshooting Tips published. Your name and city will be listed, unless you ask to remain anonymous.

Send all Troubleshooting Tips to:

Troubleshooting Tips
Department
Electronic Servicing and
Technology
P.O. Box 12901
Overland Park, KS 66212

Quick Quiz

Test Your Electronic Knowledge
by Wayne Lemons, CET

Three 12V light bulbs of the same type are connected as shown in the schematic. Bulbs B and C are in series across 12V, so each has about 6V. Current in bulb B is exactly equal to the current in bulb C, of course. Bulb A is in series with a silicon diode that allows current flow through bulb A only half of the time (during positive peaks).

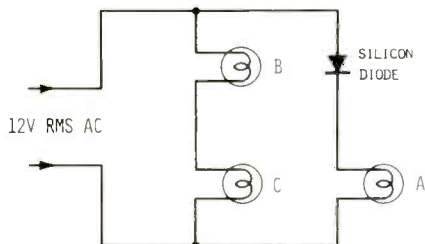

Which of these statements is true:

- (1) All bulbs have the same brightness.
- (2) Bulbs B and C are slightly brighter than bulb A.
- (3) Bulbs B and C are much brighter than bulb A.
- (4) Bulb A is slightly brighter than bulbs B and C.
- (5) Bulb A is much brighter than bulbs B and C.

(Answer on page 54)

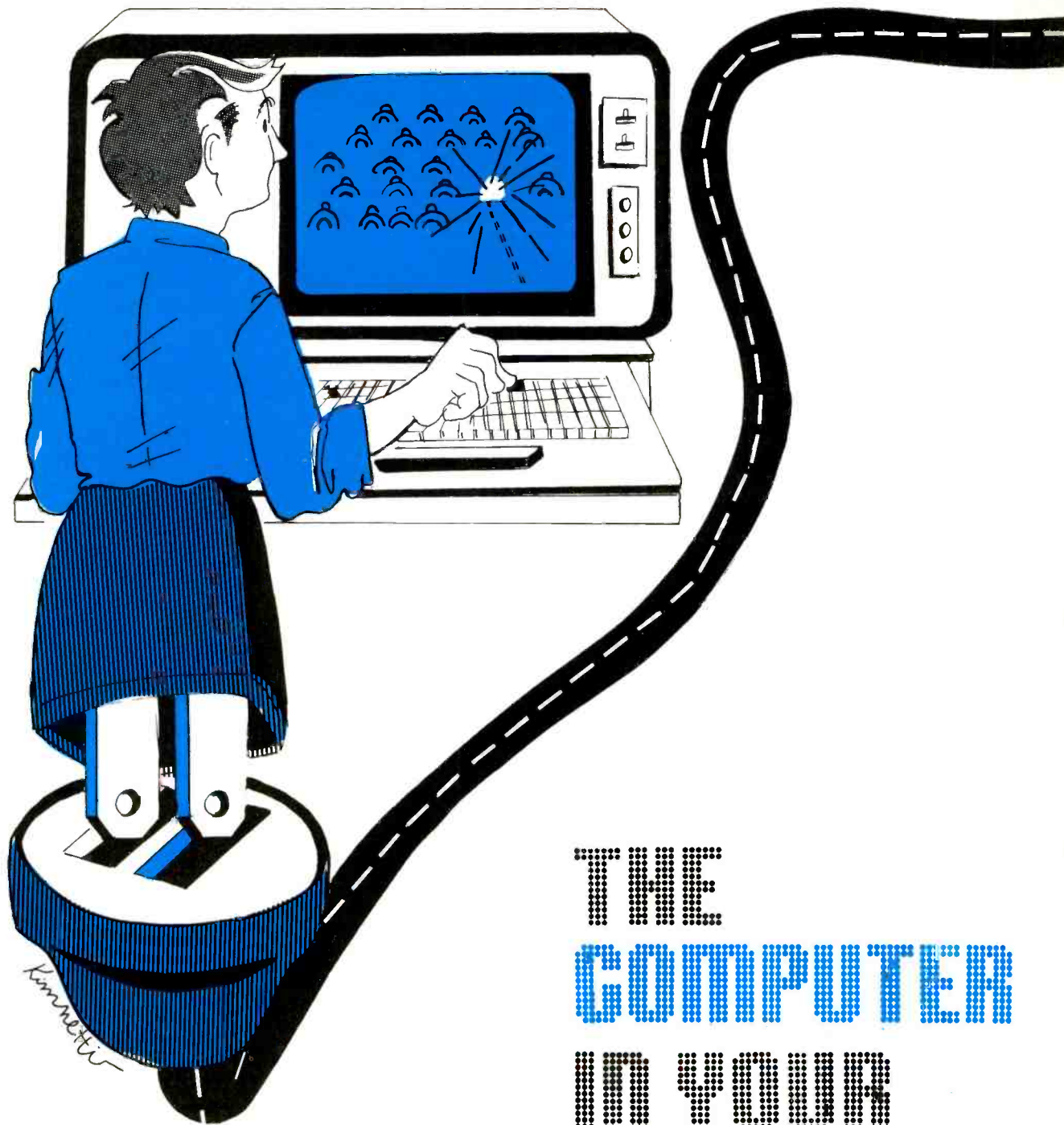

THE COMPUTER IN YOUR LIFE

The "new math" appeared on the scene not too many years ago. Touted by educators as *the way* to prepare young people for the coming age of computerization, new math was *not* all new. Admittedly, many parents could no longer help their children with homework. If they tried, the comments were often, "You can't do it that way, Dad!" The resulting parental fury did cause a change in approach after a short time toward more "traditional" arithmetic. But the issue had been presented and would never disappear.

Oddly enough, new math used the same old numbers. The same arithmetic operations—addition, subtraction, multiplication and division—still worked. The only real difference

By Carl Bentz, technical writer

was how one talked about those calculations. New words burst into view. There were now inequalities and intersections or unions of sets joined with binary number systems, bases, exclusive and inclusive ORs. Those of us who were able to adapt would have to wait a few years to realize exactly how the concepts of new math might be used.

Computers were being used at that time. Most of them, though, were found in large businesses, and our interaction with them was to try to straighten out billing errors in our charge accounts. Engineering companies hired programmers to tell their super-calculators how to figure stress analyses, to design buildings or to optimize a communications system across the United States. NASA and the Pentagon used computers extensively to keep track of a myriad of calculations and pieces of information needed for early space flights and strategic defense. These systems were large, costly to operate and expensive to lease or purchase. They could do thousands of calculations within the blink of an eye. Their abilities, once instructed by a good programmer, quickly paid for their expense.

The home computer

Today one of the fastest growing marketplace items is the home computer. Adding up to hundreds of thousands of dollars per month in gross sales, small businessmen are raking in the cash as the "mania" to own a computer spreads. Not only are microprocessor-controlled systems used in our automobiles, coffee pots, sewing machines and televisions, but the names of Apple, Atari, Commodore, IBM and Xerox, to mention only a few, belong to manufacturers of equipment that can literally take control of our lives if we let them, ease daily drudgeries and print out the latest stock market and new information for particularly interesting market issues or a given football team! Price tags generally start at about \$400 and soar upward into the tens of thousands of dollars. Although many of the systems are advertised as hobbyist-oriented, others are suggested as personal and small business systems.

What can you do with a home computer? Remember the blockbuster movie *2001: A Space Odyssey*? As explained by author Arthur C. Clarke, the computer in control of the spaceship was advanced beyond present day machines that even its name was anachronistically advanced a step ahead of a well known company IBM. HAL had complete control of the spaceship and the entire voyage. For visual impact, HAL's memory was contained in an immense vault. Of course HAL's mind had the knowledge of human existence *in toto*. It would be up to the embryonic form of mankind, backed by the computer, to recreate life as we know it after the destruction of the Earth!

Fortunately the tasks and size of today's home systems are not quite that immense. Yet, thousands of pieces of information can be available almost instantaneously in a desktop package. The jobs and projects of a home computer are limited by your heart's desires and by the far-reaching edges of your creative ingenuity.

Practical, yet entertaining

There are many practical uses for home computer equipment. The family bank account can be easily kept on a day-to-day basis, with checks and deposits kept on an audiocassette or floppy disc for end-of-the-month reconciliation. With a little more effort, income tax records and forms can be prepared. Without any calculations involved, data storage possibilities of a computer can aid our existence. Telephone numbers of people important to us, companies, emergency organizations or clients; favorite recipes; a



personal classical music record library; personal property inventory-type listing – these are simple projects that may be displayed quickly by a menu-type format.

Home systems may also provide family entertainment. A logical outgrowth of the Atari home systems was the Atari CX2600 game computer. Plug-in cartridges have been developed for both the computer systems as well as the game. The popularity of the CX2600 depended upon the lack of programming necessary for its use. However, with a logical approach to a programmable home system, any assortment of games could be developed and refined. Perhaps they will not all present the fine visual displays of

spacecraft capable of blasting asteroids and UFOs out of hyperspace, but they are certainly capable of providing many hours of mind-improving projects including chess and assorted number games. Even children can easily be taught to use these systems for fun and educational benefit (learning can be fun with a computer merely because it is different). A bowling league secretary can keep the entire season's scores, averages and team payment records available at a moment's notice. A budding author has a "word processing" system to aid in making error-free manuscripts for publishing inquiries. Data can be processed in any way, shape or form imaginable.

Almost every computer system available can display its efforts on an integrated CRT monitor screen or, with an inexpensive TV modulator, on the home TV receiver. Not only does the visual presentation provide exciting color, the sound portion of the signal may also be programmed. Voices, music and exotic sounds of the spheres can be designed with appropriate programming instructions. There is literally no limit to what you could do with the proper programming for a home computer.

Ultimately...

Perhaps the ultimate goal is to let a home computer run your home and life. Why not make your own "HAL" create an environment for you. With appropriate sensors and equipment interfacing, there is no reason why a computer cannot control the temperature and humidity of your home. Using indoor and outdoor sensing devices and linking circuitry to the furnace, air conditioner, humidifier and dehumidifier, your home can stay within preset comfort ranges. Economy may be designed into the system by appropriate control if you are not at home. The lawn and garden may be tended by the same system, constantly checking on soil moisture and starting the sprinkler system as required.

Complete home security of house and property may be monitored and controlled. Intrusion of the property may result in notification of the proper authorities. The garage door opener can be linked with the computer to disarm the burglar alarm system as you approach your driveway. Internal and external lighting may be arranged to discourage intruders. And during your out-of-town ventures, the computer may be asked to dispense pet food at the appointed times. Coffee may even be programmed to be freshly brewed for your return.

Complete communications can also be handled by your home system. Not only could the system take care of telephone messages, but also it could, by means of TouchTones, handle many projects by remote control. If information for a project or instructions for the computer can be encoded into

tones, the computer can conceivably field the project for you. For a few extra dollars, voice recognition will let you talk to your machine. The language may be a bit limited, but within its intelligence the capabilities are astounding.

Amateur radio operators have already found computers easily adaptable to some of their operations. Keyboards and high-speed printers have replaced the outmoded Teletype and Western Union machines that bounced around their shacks.



They can receive one message while composing an answer, send typewriter artwork from one station to another and handle emergency communications from disaster areas as "hams" have always done. Morse code characters may be instantly converted into printed materials, relieving the operator of the need for high speed code reading. Code, as communications engineers will tell you, will ultimately get the message through even in the worst of conditions of static and manmade noise, which can disrupt all voice communications.

But what can you do with a home computer? Well, how is your imagination? And how is your bankroll? The possibilities are only limited by both.

ES&T_{inc}

YES, WE HAVE THE LATEST EDITION

More than 4,500 old and new parts, both foreign and domestic are all cross-indexed so you can find what you need... fast! Now more than 195,000 cross references! For your latest copy of the best Guide yet, see your local GE Distributor. He'll also supply the parts you need... fast.

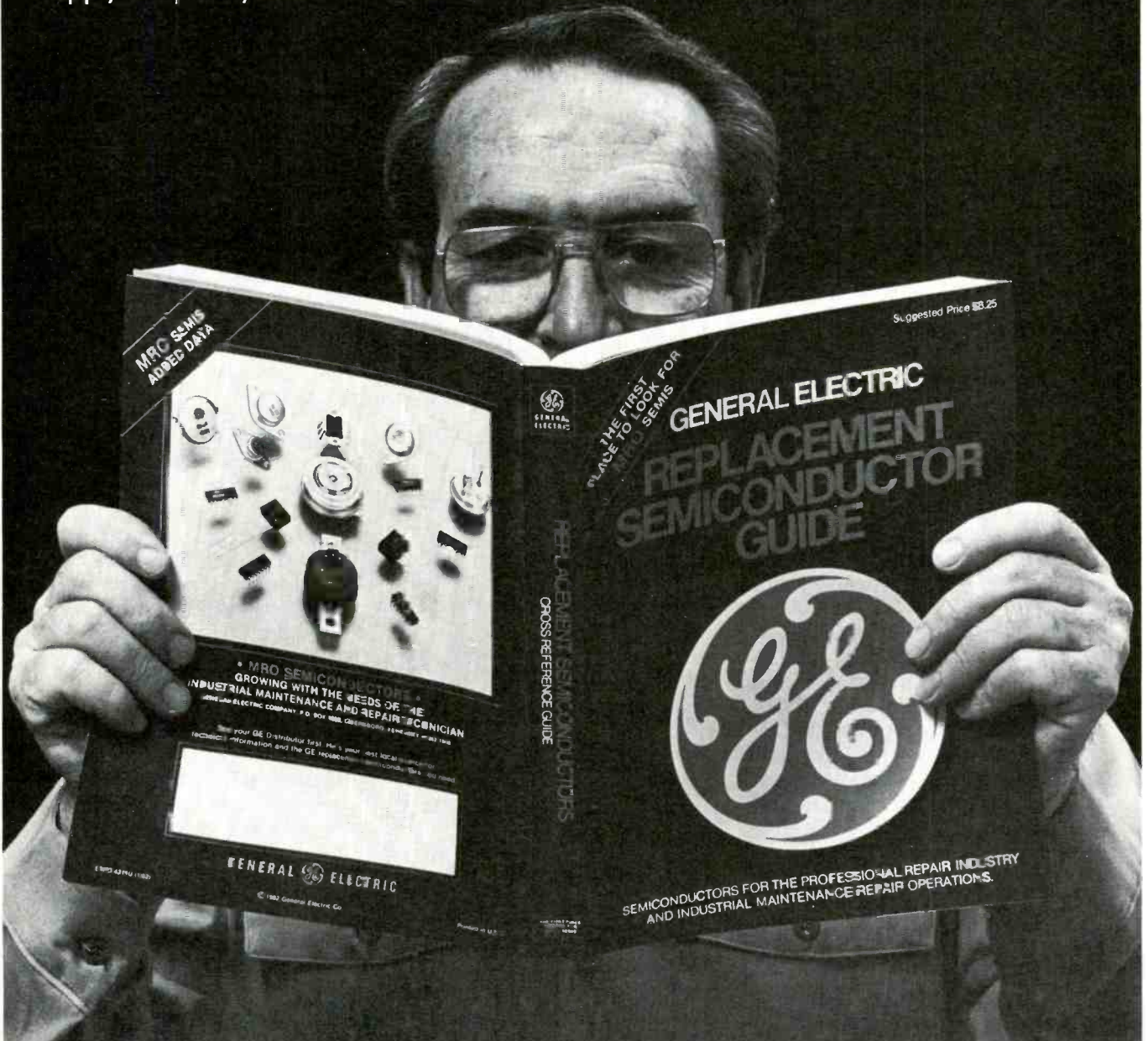

General Electric makes finding the right part easy.

Tube Products Department • General Electric Company • Owensboro, KY 42301

GENERAL  ELECTRIC

© 1982 GENERAL ELECTRIC COMPANY

Circle (12) on Reply Card

March 1982 *Electronic Servicing & Technology* 17

MICROPROCESSOR: revolutionizing electronics

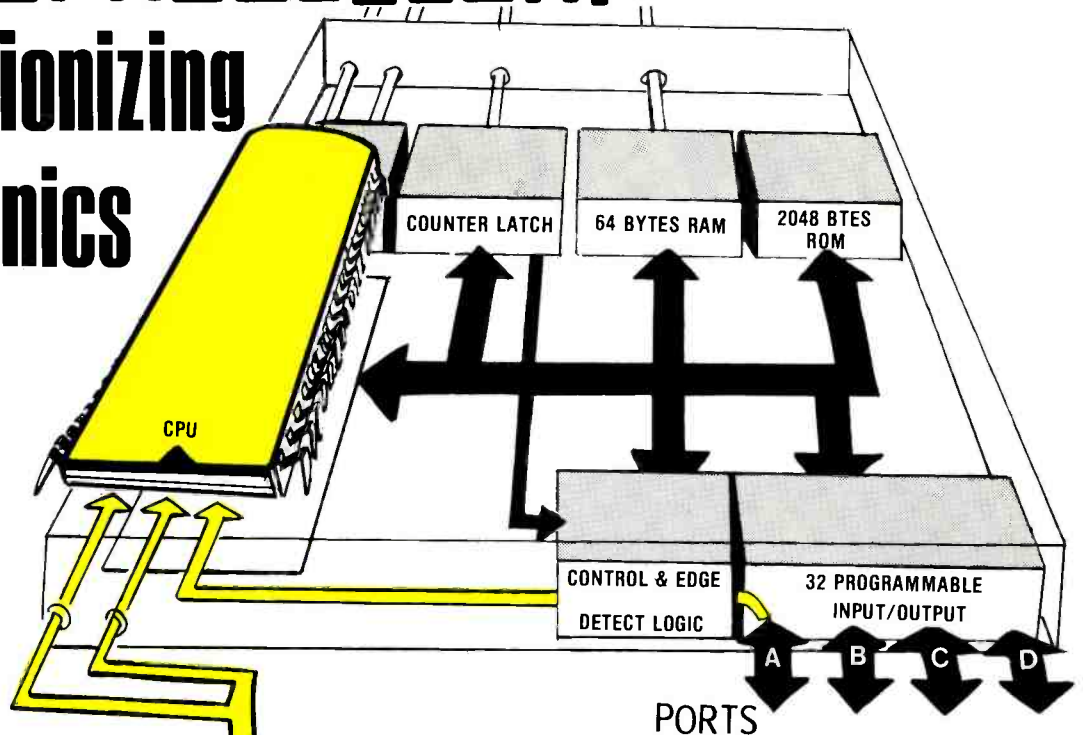

By John E. Cunningham

In 1968, a company called Viatron worked on a digital computer to rent for \$40 per month. The computer was based on a 4-bit microprocessor that the company was developing. Unfortunately, Viatron was plagued by financial problems and subsequently went bankrupt.

The microprocessor as it is now known was introduced by Intel, a West Coast company specializing in semiconductor devices. Today there are over two dozen manufacturers offering microprocessors. Moreover, several instruments, including oscilloscopes and digital voltmeters, are now using microprocessors as essential components.

In addition to its commercial use, the microprocessor has given birth to a new hobby—amateur microcomputers. Thousands of enthusiasts are building their own computers either from components or from kits.

When the microprocessor was first introduced, the price per unit was several hundred dollars. Now they are available for as little as \$20 each and many manufacturers agree that further price reductions are just around the corner.

What is a Microprocessor?

Perhaps the simplest description of a microprocessor is that it is a single integrated circuit containing all of the control and processing sections of a digital computer. But that definition does not explain why it is such a revolutionary development. For instance: Why should a digital computer improve such instruments as oscilloscopes and digital voltmeters?

The question arises because to most of us, a digital computer is a device that can perform mathematical calculations, keep records and make out pay checks. Many large digital computers are used in this way, but the digital computer is also capable of acting as a controller. It is as a controller that the microprocessor shows the most promise.

A modern digital system consists of many functional blocks, such as gates and flip flops, that perform simple logic functions. The overall operation of the system depends on the selection of these units and how they are connected. It is now possible to perform many logic functions in a single, large-scale integrated circuit that contains hundreds, or even thousands of logic elements.

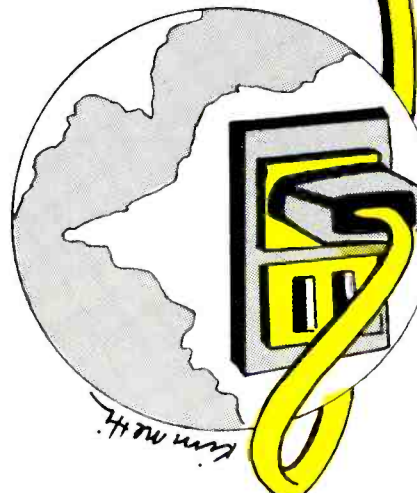

Such integrated circuits are called memories. By controlling the information that is put into the memories, we can determine what logic functions the system will perform.

If there were some way of using memories to control the operation of a system, we could build a universal system. The function that the system would perform would depend on how we put information into the memory. The microprocessor makes this universal system possible. Instead of designing a system with gates and flip flops, we can design it by programming our microprocessor and memories to perform the same function that a system using gates and flip flops would perform.

The microprocessor approach has many advantages. Techniques of programming memories have been highly developed by the digital computer people, so setting the proper program into a memory is straightforward. Furthermore, design changes can be made by merely changing the program, rather than changing the wiring and interconnections in the system. A system that is based on a microprocessor might be said to have a wiring diagram that we can change without actually disturbing a single connection. All of the

changes can be made in the information that we store in the memories.

Limitations

Although it will be used in a very large number of applications, the microprocessor is not the answer to all digital design problems. Two principle limitations involve size of the system and the required speed of operation. Many digital systems consist of only one or two simple integrated circuits. Obviously, nothing would be gained by replacing such a simple system with a microprocessor. It has been estimated that a system must use between 50 and 100 ordinary small scale integrated circuits before it is economically worthwhile to replace it with a microprocessor-based system. However, as the cost of microprocessors continues to drop, the economies will become more tangible.

The other limitation of the microprocessor is its speed. The microprocessor is simply not as fast as its older brother, the regular digital computer. For this reason, microprocessors will probably not be used to handle large amounts of data in very short periods of time as full sized digital computers do. Other than these two limitations,

the microprocessor-based system will do anything that either a digital computer or a system made up of discrete logic elements will do.

Terminology

It isn't easy for the technician or engineer who has had only a casual exposure to computers to understand how a microprocessor can perform all of the functions that have, until now, been performed by more conventional electronic systems. There are two reasons for this.

In the first place, in a conventional electronic system the function that the system will perform is determined primarily by how all of the components in the system are tied together. A digital voltmeter uses nearly the same types of components as a frequency counter. Whether the device using these components happens to be a digital voltmeter or a frequency counter depends primarily on how the components are wired together. By contrast, the components in many microprocessor-based systems are connected in the same way. The function that the system will perform depends on the information that is stored in its memory circuits.

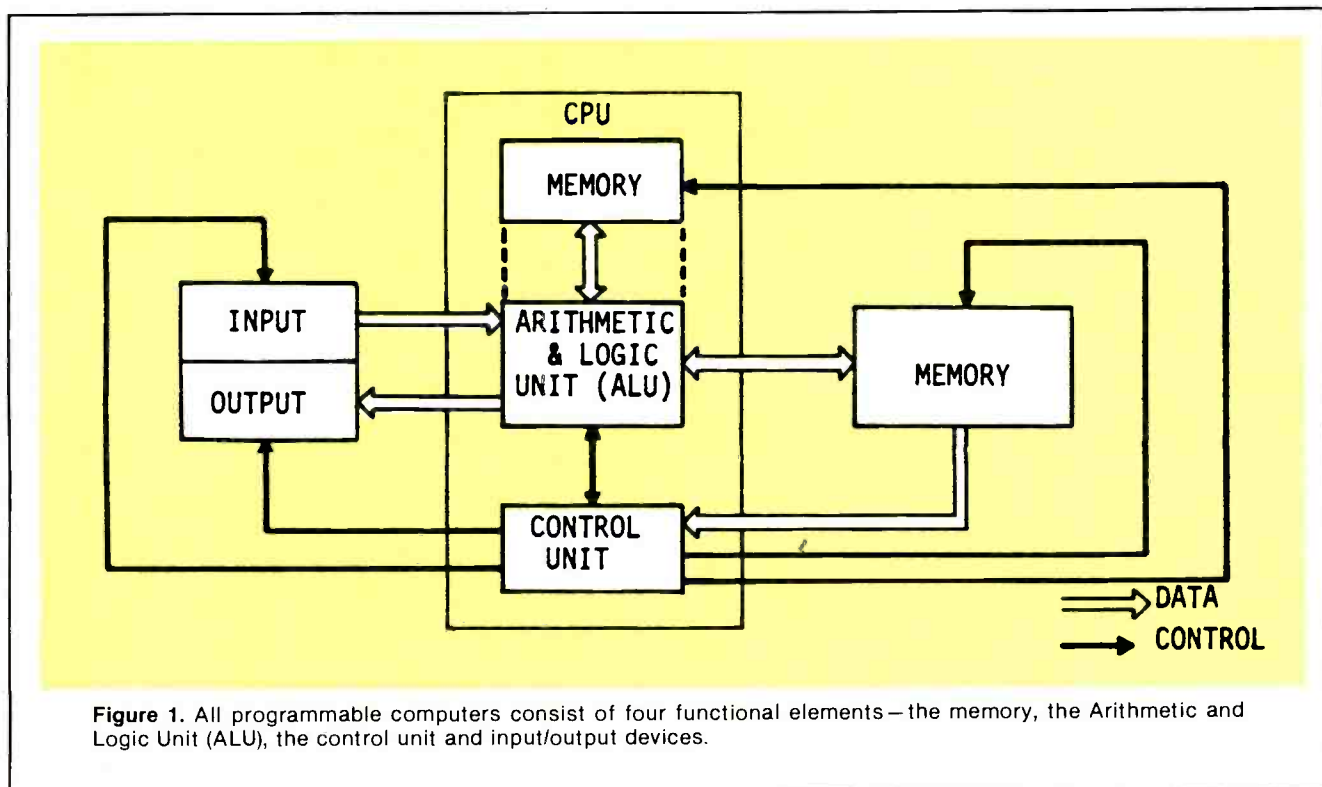

Figure 1. All programmable computers consist of four functional elements—the memory, the Arithmetic and Logic Unit (ALU), the control unit and input/output devices.

Microprocessor

Another problem facing the engineer or technician who is tackling microprocessors for the first time is the terminology. It is about as hard to read a kindergarten book as to read an engineering text if they are both written in a language with which you are not familiar.

Two of the terms used in connection with microprocessors and computer-based systems are hardware and software. Hardware isn't bad because it usually refers to physical devices such as integrated circuits, readouts and interconnecting wires. The term software is more confusing, however. It describes such things as numbers and instructions that have no physical existence, but are stored in hardware, such as semiconductor memories. The program or set of instructions that tells a computer what to do is called software.

Basic elements

All programmable computers consist of four functional elements. The memory, as its name implies, stores data. The data that is stored in the memory may consist of the actual numbers that the computer works with, or it may consist of numbers called instructions that tell the rest of the computer what to do.

In microprocessors, the memories are semiconductor devices that may be of two types. The Read Only Memory, or ROM, has information put into it that cannot be readily erased. Instructions that do not change are usually stored in ROM. Another type of semiconductor memory is called the Random Access Memory, or RAM. You may either write data into a RAM or read data out of it depending on control signals. RAM is usually used for temporary storage of data or instructions that are likely to be changed.

The most flexible type of semiconductor memory is the Read/Write Memory or Random Access Memory, RAM. With the RAM, data storage is not permanent. The user can place data into the memory. This is usually called writing data into the memory. He can also read out data that is stored in a memory.

The second basic element of a

computer is called the Arithmetic and Logic Unit, or ALU. It can perform simple arithmetic operations such as adding two numbers and comparing one number with another to see which is larger. Complex mathematical or control operations are performed by a series of very simple operations.

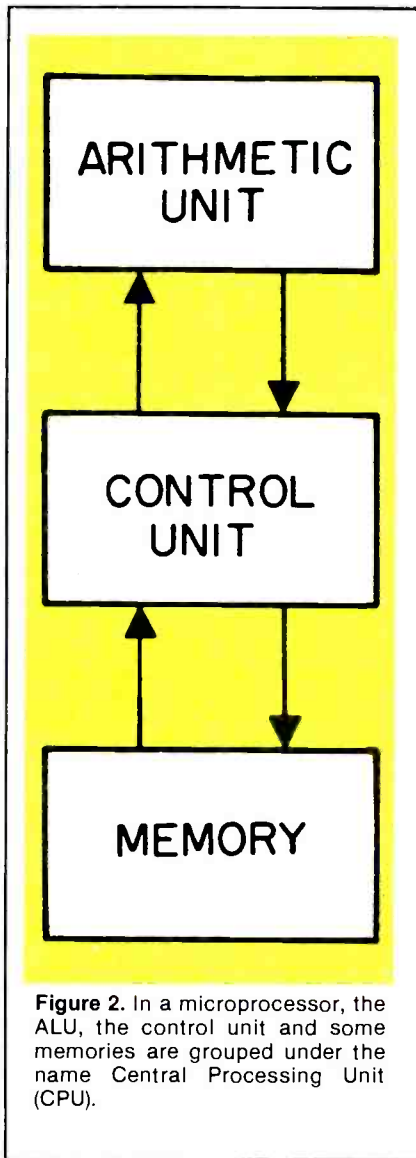

Figure 2. In a microprocessor, the ALU, the control unit and some memories are grouped under the name Central Processing Unit (CPU).

The next element of the computer is called the control unit. This element is often called the brain of the computer because it coordinates the operation of all the other elements of the computer in an orderly sequence. The control unit gets its instructions from a memory. A sequence of instructions is usually called a program.

The control unit is synchronized by a clock signal that keeps all the elements of the computer operating with the proper timing sequence.

The three elements described so

far constitute the basic computer, but to make any practical use of it, we must have a way to put data into it and take other data out of it. This is accomplished by input/output devices. An input or output device may take on a wide variety of forms. It might be as simple as a switch or a light, or as complex as a keyboard or printer. In any case, the function of the input/output devices is to get information such as data and instructions into the computer to get the results out into the world where they can be used.

In a microprocessor, the ALU, the control unit, and some memories are grouped under the name Central Processing Unit, or CPU. As shown in the accompanying illustrations, separate memories or separate parts of a memory are used for storing programs and data.

Computer operation

One of the reasons that computer operation is baffling to the beginner is that a computer performs all operations by sequentially performing many very simple steps. One way to explain computer operation is to use an analogy consisting of a man with a calculator, a pad of paper and a pencil. The man is analogous to the control unit of a computer. The calculator is analogous to the ALU, and the pencil and paper are comparable to the memory circuits.

Let's use this analogy to see how we would write a program for adding the number 2 to the number 3. The first thing we need is a set of instructions. These must be stored in memory, so we will write them on a piece of paper. A computer has no judgment other than what we program into it, so we must be careful to include all of the necessary steps.

The following list shows the steps necessary to add the number 2 to the number 3 using a simple calculator: 1) Press the clear key; 2) Enter the first number into the calculator; 3) Press the "+" key; 4) Enter the second number into the calculator; 5) Press the "=" key; 6) Read the total and write it down.

To find any of the above instructions all we have to do is go to the proper line. The number of the line is called the "address" of the in-

struction. For example, 3 is the address of the instruction "Press the = key." Looking at the list of instructions, we see the numbers we are to add are not specified, so we will take another piece of paper and write the numbers: A. 2 and B. 3.

These numbers are the numerical data that we are going to work with. To get the number 2, we have to go to line A, so we can say that line A is the address of the number 2.

Now we can write a program for adding 2 and 3. The program will have three different steps: 1) We must get, or fetch, the instructions; 2) We must get, or fetch, the data or numbers that we are going to add; 3) We must act on, or execute, each instruction.

The program will have many

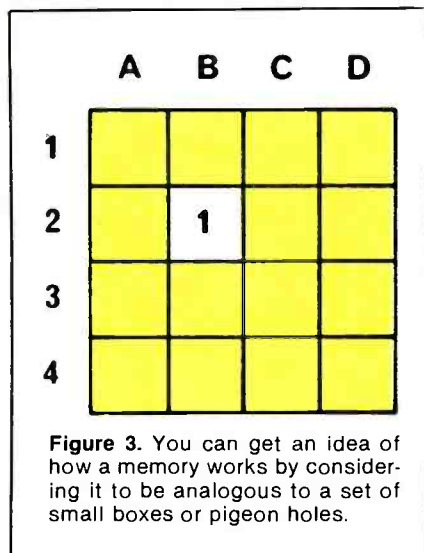

more steps than we might suspect, because the computer has to be told every step that it must perform. It doesn't do any reasoning on its own. The steps of the program will look something like this:

1. Fetch the instruction on line 1. (This instruction is to press the clear key on the calculator.)
2. Execute this instruction. (Actually press the clear key.)
3. Fetch the instruction on line 2. (This instruction tells us to enter the first number, but it doesn't tell us what the number is.)
4. Fetch the number on line A. (Now we find that the first number is on line A. (Now we find that the first number is 2.)

5. Execute the instruction on line 2. (This means to actually press the 2 key on the calculator.)
6. Fetch the instruction on line 3.
7. Execute the instruction on line 3. (Actually press the + key.)
8. Fetch the instruction on line 4. (This tells us to enter the second number, but it doesn't tell us what the number is, so we have the next step.)
9. Fetch the number on line B. (Now we know the second number that we want happens to be 3.)
10. Execute the instruction from line 4. (Actually press the 3 key.)
11. Fetch the instruction on line 5.
12. Execute the instruction on line 5. (Actually press the = key.)
13. Fetch the instruction from line 6.
14. Execute the instruction from line 6. (Actually read the total 5 and write it down. Strictly, we should also say where it is to be written. For example, on line C of the second piece of paper.)

In this analogy the calculator, the human operator, the pencil and the paper are hardware. The instructions, numbers and the program are software.

Now we have a reasonably close approximation of a computer program. It points out that although a computer works fast, time is required for each step. Thus when working complicated problems, the speed of the computer is important.

Memory

In any computer system, all data is represented by binary numbers. A binary number is one that only has two possible values, 0 and 1. In a microprocessor system, a 1 is represented by the presence of some voltage, frequently +5V, and a 0 is represented by the absence of a voltage.

The reason for using binary numbers is that it is much easier to build an electronic system that can distinguish the presence of a voltage from the absence of a voltage than it is to build a system that can distinguish one value of voltage from another.

Voltage determines logic

The binary number system is very easy to use. In most microprocessors the data representing numbers is carried on eight lines. Each of these lines will either have a voltage or it won't. If a voltage is present, the line is said to be carrying a logic 1. If there is no voltage present the line is said to be carrying a logic zero.

The following tabulation shows the logic levels on the eight lines (usually called a bus) of the microprocessor can be used to represent decimal numbers.

- 00000001 = 1
- 00000010 = 2
- 00000011 = 3
- 00000100 = 4

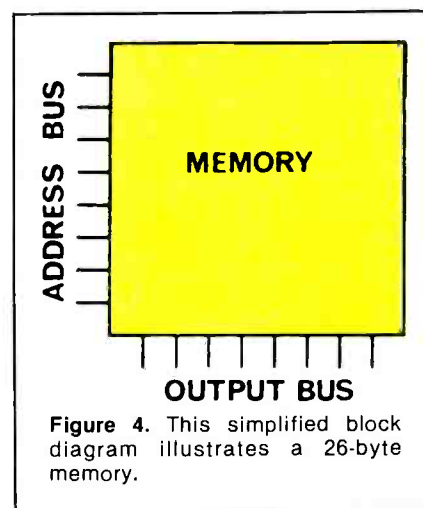

The bit and the byte

The voltage, or absence of a voltage, on each of the eight lines of the bus is called a "bit" of information. Thus the eight line bus can carry eight bits of information at any one time. The use of collections of eight bits of data is so common that it has been assigned a special name—the "byte." A collection of eight bits of data is called a byte of data in microprocessor work.

Data is carried on the bus one bit after another. At one instant the levels on the bus might be 00000010, representing the decimal number 2. At an instant later, the line levels might be 00000100, which represents the decimal number 4. This type of data transmission is usually called "bit parallel, byte serial," transmission. The reason is that eight bits are carried in parallel at one time

Microprocessor

and the bytes are carried one after another.

In most systems, bytes of data can travel in both directions on the bus. Sometimes data is fed into the microprocessor and at other times data is being fed out of the microprocessor.

In order for the microprocessor to be able to work with the digital data, we must have some place where we can store it. The devices that are used to store digital data are called semiconductor memories.

Semiconductor memories

You can get an idea of how a memory works by considering it to be analogous to a set of small boxes or pigeon holes. The illustration shows a set of 16 boxes, any one of which may contain either a logic one, or nothing, which is the same as a logic zero. Each box is specified by the letter which identifies which column it is in and a number that designates which row it is in. In the figure there is a 1 in the box designated as B2. The designation B2 is called the *address* of the particular box that contains the 1.

Microprocessor memories are usually organized so that each address applies to eight boxes where one byte of data can be stored.

In the illustration is a simplified block diagram of a 256-byte memory. It is arranged internally so that at each address there is an 8-bit byte of data. Just what the data happens to be depends on what is stored at what particular address. The memory has an 8-line address bus.

By placing logic ones and zeroes on these address lines we can specify 256 different addresses in the memory. When a particular address is specified by the signal on the address lines, the information stored at the particular address will appear on the output bus.

Using the microprocessor

To use the microprocessor effectively, one must combine the skills of the hardware designer and the computer programmer. The computer programmer works with instructions rather than with circuits. One of the tools that he uses frequently is the *flow chart*, which

is a list of the functions that the computer must perform. The flow chart is to the programmer much the same as the block diagram is to the engineer or technician working with regular electronic equipment.

Flow chart symbols

Several different symbols are used in flow charts, but all you have to know to get a good insight into the matter is the meaning of the three symbols shown in Figure 5. The first symbol that looks like a rectangle with rounded ends is used to mark the start or end of a program. This seems trivial, but you must realize that a computer won't do anything until it is told to start. By the same token, it has no way of knowing when it has completed its task unless it is told to stop. In any complete flow chart, start and stop operations will be designated by this symbol.

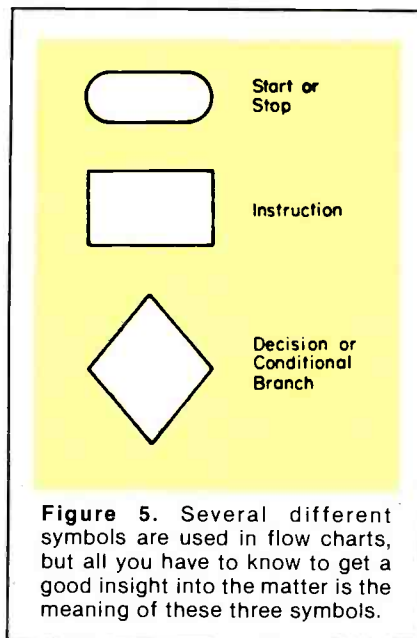

Figure 5. Several different symbols are used in flow charts, but all you have to know to get a good insight into the matter is the meaning of these three symbols.

The second flow chart symbol is a rectangle and represents one or more instructions that the computer must follow. In a detailed flow chart there will usually be a rectangle for each instruction. In a more general flow chart, a single rectangle may represent a whole set of instructions. Again, this is analogous to the block diagram. A detailed block diagram will show a block for each functional unit in a system. A more general block diagram may use one block to represent an entire subsystem such as a digital readout.

The last symbol in Figure 5, the

diamond shape, is representative of what distinguishes a software-based system from a hardware-based system. It represents a point in the program where the system must make a decision. The decision is based on something that the system can easily determine. For example, it may compare two numbers to determine which is larger. If one number is larger, one set of instructions will be followed, if the other number is larger, a different set of instructions will be followed.

Using the flow chart

A simple example of the use of a flow chart is shown in Figure 6. Here we have a rudimentary program for a microprocessor system that is designed to control the speed of a motor. The first block represents the beginning of the program. It means that the microprocessor must be told to start and signals must be provided to be sure that all of the registers and other stages of the microprocessors are in some known condition. For example, all of the registers may have to be set to zero before the program is started. This process is sometimes called *initialization*.

The next block tells the microprocessor to get a signal, probably from a digital tachometer, to determine the actual speed of the motor. Following this, the actual speed of the motor is compared with some binary number in the memories that specifies what the speed of the motor really should be.

Decision-making

Now we come to the first major *decision point* or *conditional branch* in the program. This is represented by the diamond, which asks the question, "Is the actual speed of the motor what it should be?" If the answer is "Yes", the program branches to the right and leads to the stop symbol indicating that there is nothing for the processor to do. If the answer is "No", the program proceeds to the next diamond, which asks the question "Is the motor speed higher than it should be?" If the answer to this question is "Yes" the processor provides a signal that will slow the motor down.

After this we have what is called

a loop in the program. The loop back to the first decision point allows the processor to again check the motor speed to be sure that it has been slowed down enough. A similar decision point asks whether or not the speed of the motor is too slow. In each case, when the processor finds that the speed of the motor is correct, it branches to the symbol marked stop.

The flow chart of Figure 6 is over-simplified. Each of the rectangles may actually represent several instructions and decisions that might be needed to make the processor perform the intended function. These are not shown on an overall system flow chart because they are internal instruc-

in a more conventional system. Figure 7 shows a conventional AND gate of the type that might be used in a digital system. The output of the AND gate is high when and only when both of the inputs—lines A and B—are high. If either or both of the inputs is low, the output will be low.

Figure 8 shows a flow chart of a program that will enable a microprocessor to perform the same function as the AND gate of Figure 7. The first instruction given to the processor is to check to see if line A is high or low. If this line is low, the output must also be low, so the instruction is to set the output at a low level. If line A is high, the output may be either high or low, depending on whether

If the entire system were enclosed inside a box, the observer would have no way of knowing whether the box contained an actual AND gate or a software system that duplicated the function of an AND gate.

Duplicating logic elements

The reader will find that after a little thought he can sketch out flow charts of programs that will duplicate the function of any logic element such as NAND, OR and NOR gates. Now it becomes clear that with the proper program a microprocessor-based system can be made to do anything that could be done with a system made up of regular digital integrated circuits.

Of course, if the system were to perform the function performed by a system that conventionally would be made up of a large number of integrated circuits, there would be a large number of steps in the program. The program required to make a microprocessor perform some particular function is usually stored in a read-only memory, or ROM.

Realizing that the flow chart is comparable to a block diagram, together with the fact that the instructions represented by the flow chart are actually stored in a semiconductor memory, we know that we can change the function of a system by merely changing the instructions stored in its memory.

Machine language

So far all of the instructions that we have discussed have been expressed in words. Obviously, the microprocessor does not understand spoken English. The actual instructions that are contained in the memory are expressed in a series of binary digits, each of which is either a one or a zero. For example, the number 00101100, when applied to the microprocessor, might tell it to add one number to another. An instruction expressed as a string of binary digits is said to be stated in *machine language*. This is the form in which the instructions are actually stored in the memory and is the only language that the microprocessor can understand.

Each different microprocessor has what is called an *instruction set*. This is simply a list of strings of binary digits that the processor

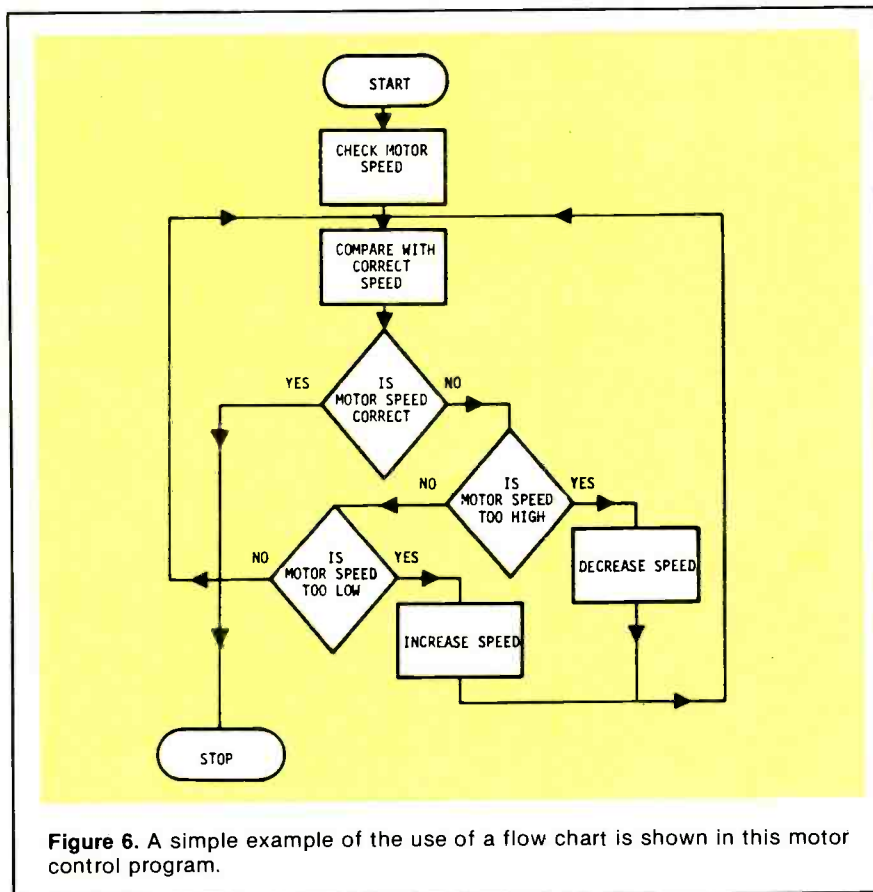

tions and decisions that are made inside the equipment without any input from the real outside world. They would, however, be shown on a detailed flow chart.

The AND gate

This gives a general idea of how a program is set up, but still leaves several questions. It still isn't clear just how a computer can duplicate the operations that are performed

line B is high or low.

Therefore, if the processor finds that line A is high, it is instructed to see if line B is also high. If it is, the next instruction is to set the output to a high level. If line B is low, the output will be set to a low level. A careful examination of this simple program will show that the microprocessor, when following the program, will behave exactly like an AND gate.

Microprocessor

can understand and which will cause it to perform a particular operation. One of the principal differences between the microprocessors available commercially is in how elaborate an instruction set is available.

When designing a system with conventional integrated circuits, it is possible to make a system that will perform any desired function using only NAND gates. In many instances, an impractically large number of NAND gates would be required, but it is nevertheless possible. In the same way, a microprocessor that has only a very simple instruction set can be made to do anything that a more elaborate unit will do. The price that is paid is that the machine with a simple instruction set will require more time and more memory to perform a given function than a unit with a more powerful instruction set.

A typical microprocessor may be able to recognize and act on more than a hundred different instructions. These range from simple logic operations such as AND and OR to more complex operations such as deciding whether a number is less than, equal to or greater than some specified number.

As far as the microprocessor is concerned, it must receive all instructions in machine language, which as we have seen, consists of a string of binary digits. This is fine for the processor, but it is extremely difficult for the human programmer. It is nearly impossible to remember number sequences that are made up of eight or more 1's and 0's.

The first thing that is done to

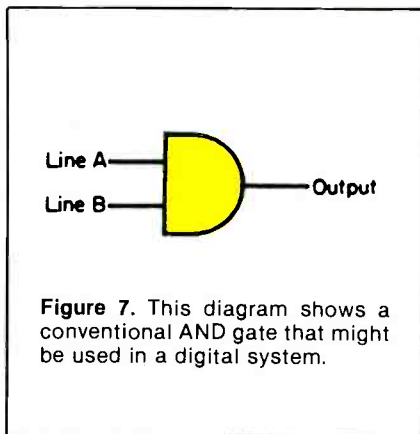

make things easier for the human programmer is to use some number system other than the binary system. A common system used for this purpose is the hexadecimal system which is a number system based on the number 15, instead of on 2 as in the binary system, or 10 as in the decimal system.

The hexadecimal system is shown in the following table where it is compared with the decimal and binary systems.

Decimal Number	Binary Number	Hexadecimal Number
0	0000	0
1	0001	1
2	0010	2
3	0011	3
4	0100	4
5	0101	5
6	0110	6
7	0111	7
8	1000	8
9	1001	9
10	1010	A
11	1011	B
12	1100	C
13	1101	D
14	1110	E
15	1111	F

11	1011	B
12	1100	C
13	1101	D
14	1110	E
15	1111	F

Assembly language

Another step that is taken to simplify life for the programmer is to express the various instructions in what is called assembly language. Assembly language consists of a series of usually English letters that are easy to remember. For example, the instruction requiring the machine to perform an EXCLUSIVE OR logic operation might be expressed in assembly language as EOR.

Languages are available that express instructions in English words. These higher level languages are very easy to use, but require more translation in the system.

ES&T

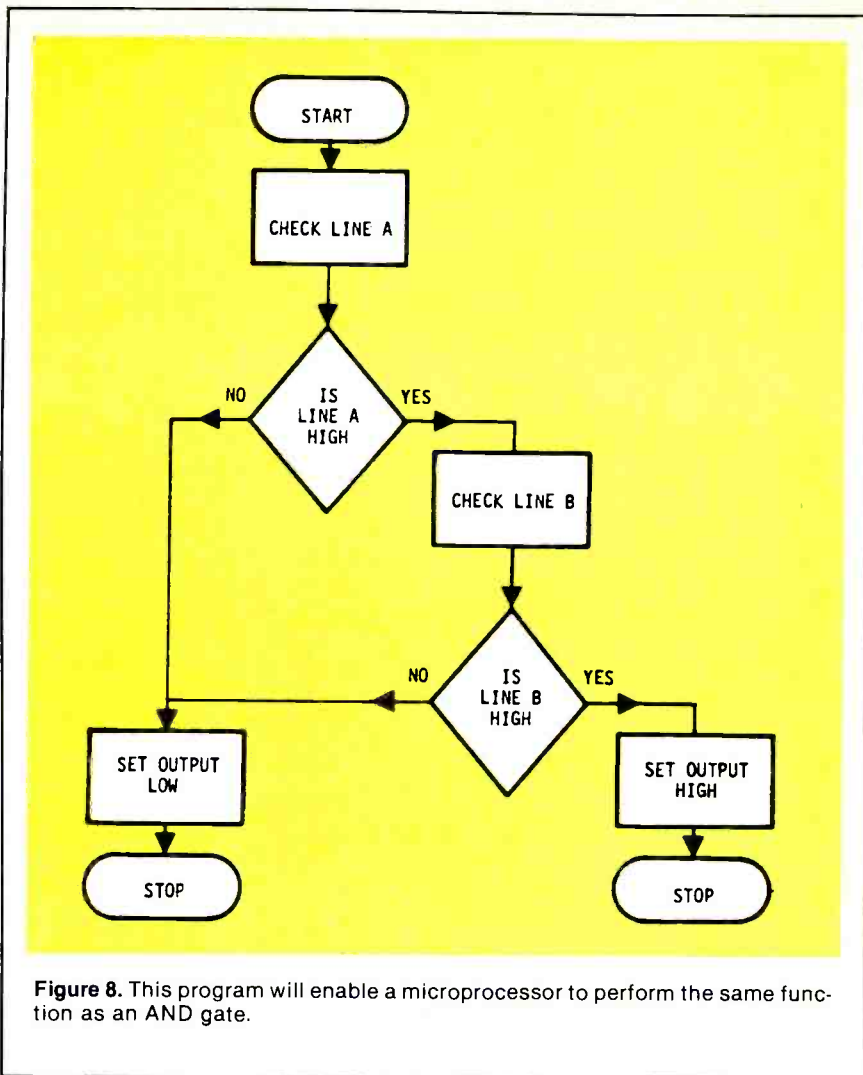

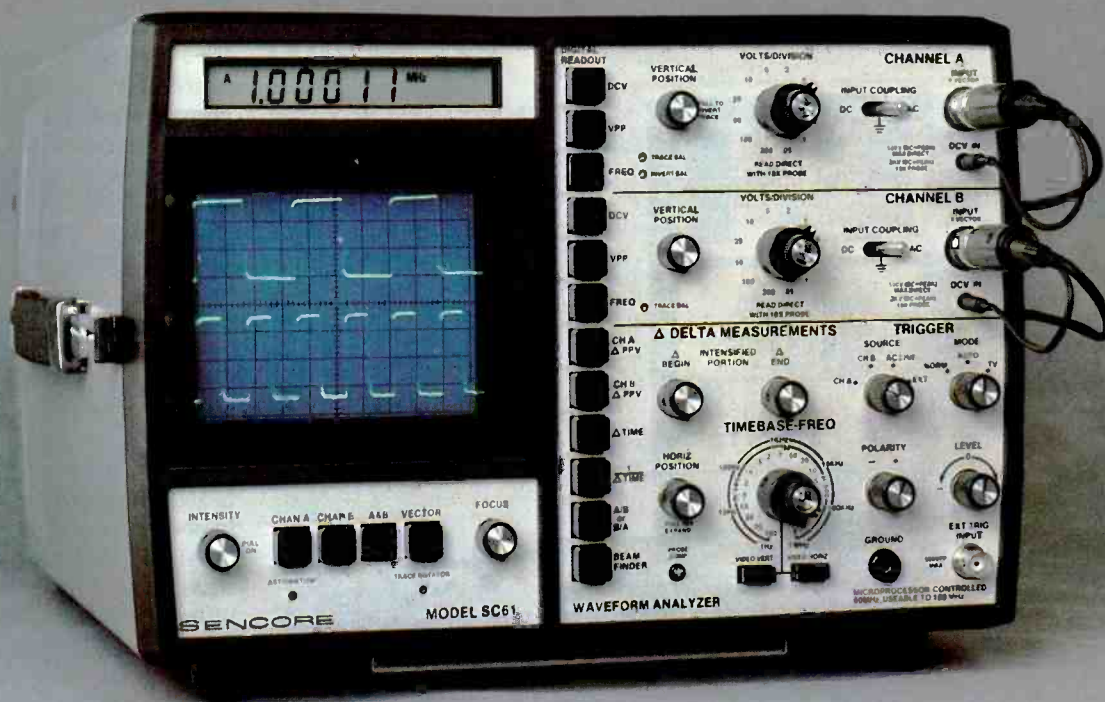

The SC61 waveform analyzer.

Why a video technician needs a scope

By Jim Smith, Sencore

Why do you think that the average industrial technician uses his oscilloscope every single day, often more than a voltmeter; while over half of the oscilloscopes in TV and video service shops sit and gather dust?

Does the industrial technician work with more complex circuits? Not really. Television has kept pace with technology as we moved from tubes, to transistors, to integrated circuits, to microprocessors.

Does the industrial tech have more varied types of circuits to work with? This is not the case either because most industrial

technicians work on only a few types of circuits while the TV tech may be working on 10 or 20 different brands, all with different circuit designs and problems.

Does the industrial technician have to be more efficient in his or her job? Again, the opposite is more likely because the service technician is only paid to service the most sets per day possible while the industrial technician is paid the same no matter what type of work he is doing.

What accounts for the difference? We have found three traits common to video techs that only use their scope a couple of

times a week. These three traits form a rather vicious circle, in that one trait perpetuates the other, and so on. Let's first look at the cause of the vicious circle in an overview and then see more details of what we mean.

Three primary traits

Trait #1: Technicians only use a scope occasionally because they find other methods are more efficient.

Reasons:

1. They think of a scope only as a last resort.
2. They invent other methods of troubleshooting so they don't have to use their scope.

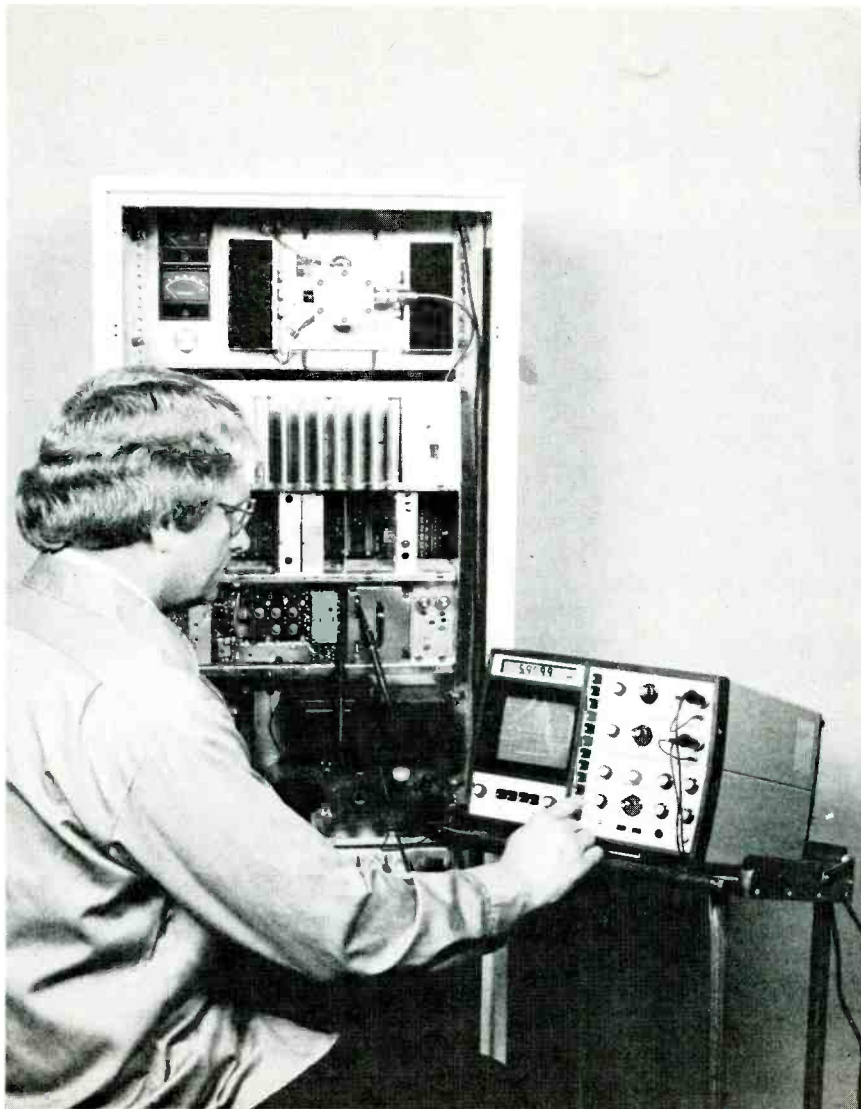

The SC61 in operation.

3. Because they are more comfortable using other methods, they use them more often and become most proficient at them.

How do we break this part of the vicious circle? The only way is to force ourself to use our scope more often. But we will only add to our frustration if the scopes are difficult to use.

Trait #2: Because the technicians use their scope so seldom, they are not familiar with its operation.

Reasons:

1. One primary reason for not using their scope more often is the difficulty in set-up and operation.
2. Most scopes, especially lab-type scopes that would be

necessary for today's circuits, Are extremely difficult to operate.

How do we break this part of the vicious circle? By purchasing a scope that is easy to operate with minimum set-up time and fewest user controls.

Trait #3: Because they are not sure of oscilloscope operation, they are not sure what the waveforms are telling them.

Reasons:

1. Inexperience in scope use.
2. Not familiar with scope controls.

How do we break this part of the vicious circle? By learning the basics of scope use, and by purchasing a video-oriented scope that is easy to use and set up.

10 key video waveforms

Video waveform analysis can be the difference between repairing two sets a day and repairing four or six sets per day. Why is it then that so many video techs only reach for their scope as a last resort? Perhaps the main reason is that, instead of using video waveforms as signals to determine where a defect is, many technicians see the waveforms on schematics only as signs of confusion.

In order to alleviate some of the confusion regarding video waveforms, we have selected and photographed the 10 key video waveforms found in every color receiver. In order for you to have a better understanding of what to look for in a good waveform, we have included an example of a bad waveform for comparison. The numbers on each waveform correspond to the numbers on the block diagram to allow you to relate the waveforms to schematics. Three basic rules for waveform analysis follow the waveforms.

The vicious circle

The three primary traits in the vicious circle of why video techs don't use their scope have been described.

The problem gets worse as each day goes along. At the same time, technological changes keep making the scope a more important tool. There are three major changes that have taken place recently that make an oscilloscope essential for efficient servicing: the integrated circuit, the microprocessor, and most important of all, the single-board unitized chassis.

Integrated circuits and microprocessors were, at first, part of exchangeable modules. If you suspected that the IC was the problem, you simply changed the entire module and sent the circuit back to the manufacturer for the actual troubleshooting. The manufacturer then found the actual problem, repaired the module, and put the repaired circuit into their exchange stock until you or some other technician had troubles with that same board.

Now that is changing. Most manufacturers have decided that it

is time for the service technician to find the actual problem. All circuits are on one large board, and the cost of stocking or exchanging the entire "mother board" has all but ruled out board swapping. So, once again, we must act as technicians to get the receiver working. We must be able to locate the actual problem and change only those components that are defective.

Unfortunately, dc voltage measurements only take us a short way into the circuits. Many problems are related to the signals, not the bias voltages. Signal injection helps, but only takes us to the main block rather than to the component level. An oscilloscope let us go that extra step to see what the response of the IC is to the correct input signal.

With a scope it is possible to measure the peak-to-peak amplitudes of the signals coming into the various IC or conventional circuits to see if they are too low for the circuits to respond. We can compare the timing of different signals to their references to make sure they are timed correctly. Then, we can trace each signal, stage by stage, combining signal tracing with signal injection for peak efficiency.

Up to this point, we have limited our discussion to scope usage in modern conventional circuits. But, what about modern digital circuits?

Digital circuits

A typical modern receiver may have everything on one board so it is impractical to change modules. Many modern tuner and remote control circuits are 100% microprocessor controlled so a typical 10MHz scope won't show any glitches that may cause these circuits to malfunction. We must be able to view the critical fifth harmonic to determine the leading edge of the square waves and to look for glitches. This means to effectively troubleshoot the receivers we need a 50MHz scope. But digital circuits in modern receivers are not only used in the tuner. Many sets have a digital horizontal and vertical oscillator that will cause poor sync if there is an extra little "glitch" on the

waveform. Even a 30MHz scope will miss some of these glitches and changing the chip will not correct a problem if it is caused by an external glitch. Where can we turn for help?

To stay competitive in the con-

Chronology of digital circuits in use in video receivers

Year

- 1973 Admiral introduces first digital tuner.
- 1975 Magnavox introduces Star system, digital tuning system.
- 1976 GTE Sylvania introduces digital countdown circuits in sync section.
- 1977 Every major manufacturer introduces digital tuner.
- 1978 Zenith introduces digital countdown circuit in sync section.
- 1979 Every major manufacturer incorporating digital countdown circuit in sync section

temporary video profession, a scope is needed that shows all the details in modern digital circuits. You need a scope you can trust. You need a scope that is easy to learn and easy to use so you don't fear the scope more than the circuit problem. You need a scope that is specifically designed for video servicing because the composite video signal is the most difficult signal for any scope to lock onto the CRT. In short, you must break the vicious circle of scope inefficiency to survive.

Breaking the vicious circle

Now that we have learned how the vicious circle starts and perpetuates, we can find ways to break it. Of the three ways to break the circle, which would be the easiest? To force yourself to use your scope more often? To learn the basics of scope operation? Or, to purchase, a video-oriented and easy-to-use scope with minimum set-up time and adjustments?

It would seem most logical to purchase a video-oriented scope with minimum user controls. Why? Because if you tried to force yourself to use a scope that was difficult to operate, you would only become more frustrated, and waste more time. And even if you learned the basics of scope operation, if you were using a scope that was difficult to use, you still wouldn't solve the problem.

Your future depends on it

It's easy to see that IC technology and the single-board unitized chassis have made the need for a video servicing scope more urgent than at any time in the past. The vicious scope circle taught us too well how to change tubes and how to change modules. Many of us even believed the old myth that said, "An IC will never go bad." But each of these "shortcuts" have come back to haunt us. Tube circuits now have multiple problems that simply changing the tubes will not correct. Many modules are no longer available, but the customer still wants the receiver repaired. And, of course, ICs do go bad. We have gotten lazy, and now our very future depends on being able to isolate the circuit problems with good old-fashioned technical knowledge. An oscilloscope, such as the Sencore SC60 "Widebender," can become the best troubleshooting weapon in your technical arsenal, if you will take the time right now to break some of your old "component swapping" habits.

If you are like many technicians, you are probably asking yourself, "How can I think of buying a 60MHz scope now when I can't even run that \$300 scope that is on my bench?" The answer is simple: Even though the Widebender is a true 60MHz scope, it is actually easier to operate than most 3 to 10MHz scopes. The SC60 Widebender is the scope you'll need to break this vicious cycle, and start ensuring your future now. We will show you more on how you can break this circle, in subsequent parts in this series, all of which will be critical if you plan to continue profitably in the video service business in the future.

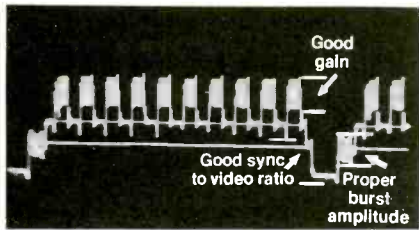

Figure 1a. Good video detector waveform showing normal gain, sync pulse and burst.

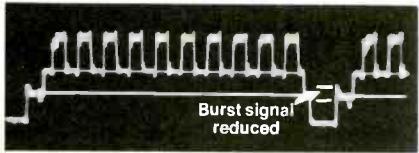

Figure 1b. Symptom: No color. Waveform: Note lack of color burst indicating loss of high frequencies in IF stages or detector.

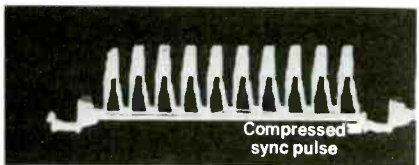

Figure 1c. Symptom: Bending or pulling at top or bottom. Waveform: Improper sync to video ratio caused by compressed sync pulse at detector.



Figure 1d. Symptom: Ringing or ghosting. Waveform: Video detector waveform showing ringing in IF stages or detector.

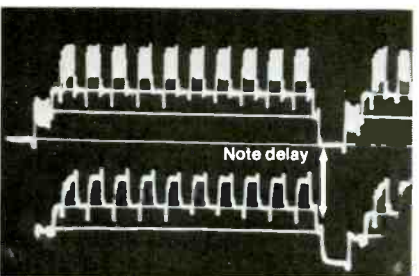

Figure 2a. Video detector (top) compared to output of good delay line (bottom).

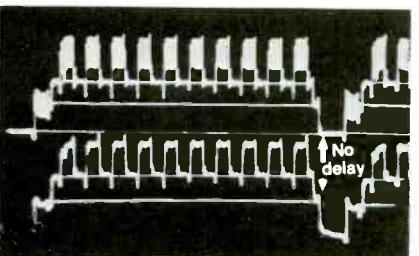

Figure 2b. Symptom: Picture detail ghosted to right of color. Waveform: No delay across delay line.

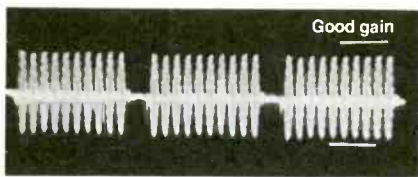

Figure 3a. Good bandpass amplifier output with normal gain.



Figure 3b. Symptom: No color. Waveform: Reduced gain at output of bandpass amplifiers.

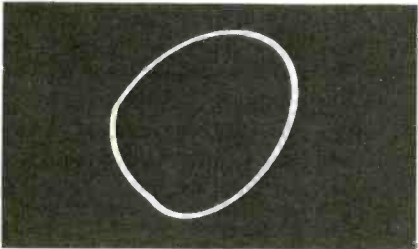

Figure 4a. Phase shift network good showing proper phase relationship.

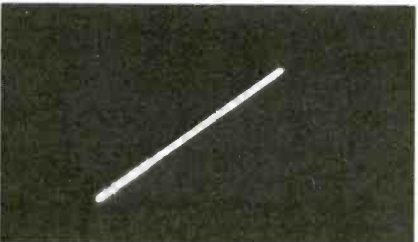

Figure 4b. Symptom: Incorrect tint. Waveform: Note lack of phase shift on demodulator input waveforms. This would result in no control of tint and only one color on screen.

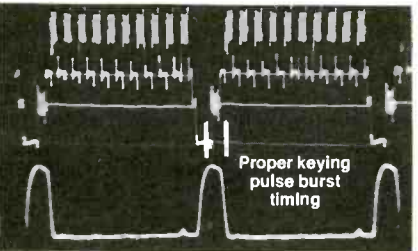

Figure 5a. Burst gate showing proper timing relationship between burst signal and keying pulse.

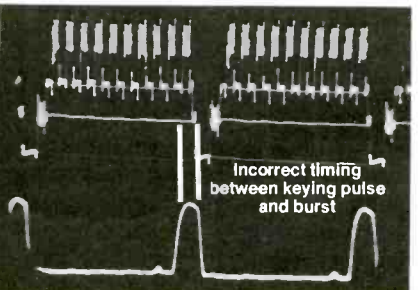

Figure 5b. Symptom: No color sync. Waveform: Note mistiming of burst and horizontal keying pulse.

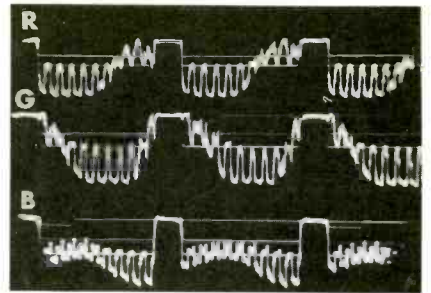

Figure 6. Output of R, G, B amplifiers showing proper phase relationship.

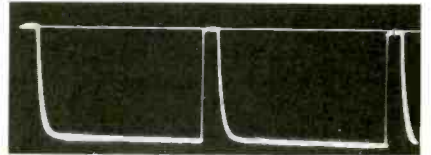

Figure 7a. Horizontal sync separator output at horizontal rate good.

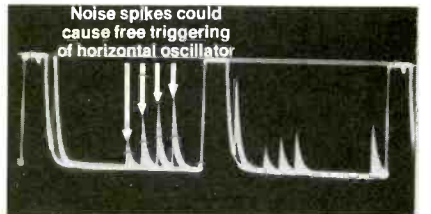

Figure 7b. Symptom: Unstable horizontal sync. Waveform: Horizontal sync output of sync separator with video present causing false triggering of horizontal oscillator.

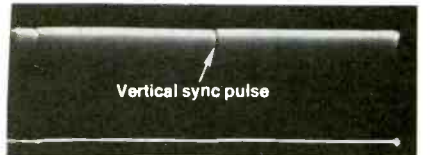

Figure 7c. Vertical sync separator output at vertical rate good.



Figure 7d. Symptom: Rolling. Waveform: Vertical sync output of sync separator with vertical sync pulses not present.

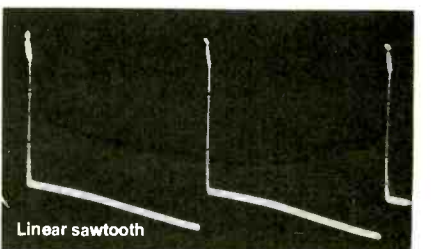

Figure 8a. Vertical output waveform with good linearity.

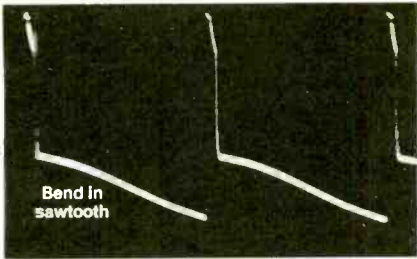

Figure 8b. Symptom: Poor vertical linearity. Waveform: Vertical output waveform showing bending or non-linearity on sawtooth waveform.

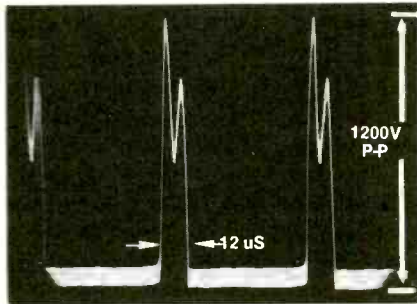

Figure 9. Collector of the horizontal output transistor shows 1200V peak-to-peak spike. Should be 12 μ S wide.

Basic rules for waveform interpretation

1. Whenever you are lost,

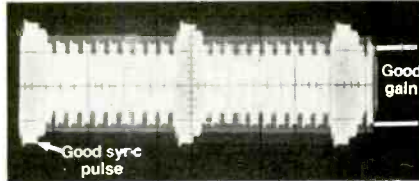

Figure 10a. Video IF waveform with good gain and symmetry

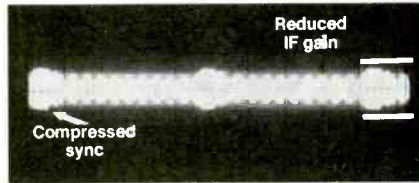

Figure 10b. Symptom: Weak picture, no color, poor sync. Waveform: Video IF waveform. Note reduced amplitude and compressed sync.

go back to the video detector for comparison.

The video detector waveform is used to reference all other circuits. Analyze the sync, color and video portions of the composite signal to make sure the problem is not actually in the tuner or IF stages.

2. Analyze the peak-to-peak first, the overall waveshape second, and the smaller detail last.

Most problems result in a loss of amplitude, so the P-P gives the greatest clue as to circuit operation. If the peak-to-peak is correct, look at the overall waveshape to see if there is severe distortion or clipping. Minor waveform distortion rarely causes circuit problems, so use it only in those few cases where it is needed.

3. When you are lost in the schematic, work backwards.

Many schematics do not show where the input and output pins of integrated circuits are located. Simply move to the following stage input (using the block diagram for reference if necessary) and trace the signal back to the IC to identify the output pin.

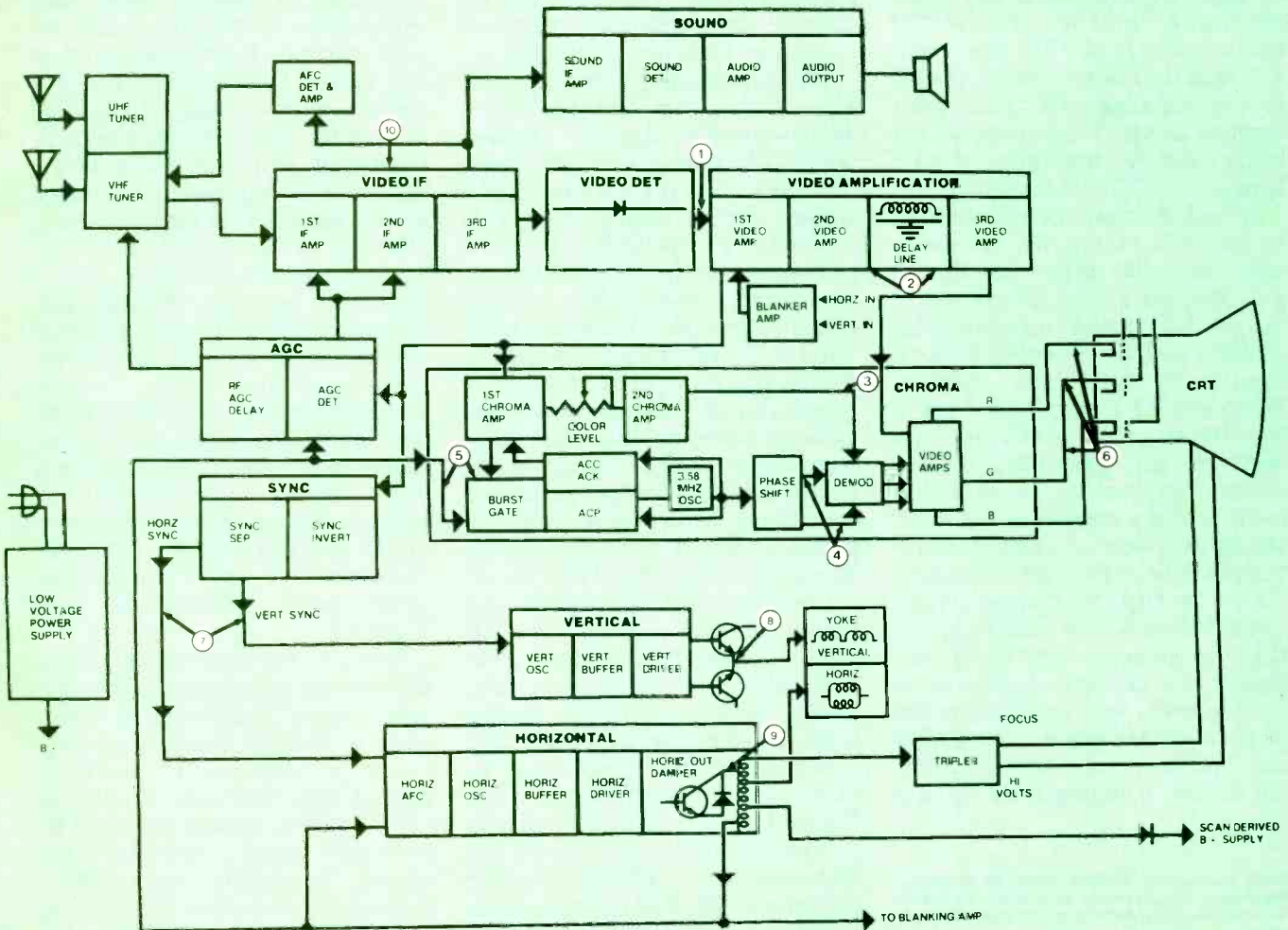

The field strength meter — a smart idea for the full-service TV shop

By Carl Bentz

A field strength meter (FSM) is not a new idea. FSM equipment has been in use in several forms for years. Yet during six years recently spent as a customer service and line maintenance technician for a cable TV system, I found many local TV service personnel almost completely unaware of the value of a high quality field or signal strength meter. A better understanding of FSM equipment will help the TV service technician to provide diagnostic and repair services to the TV receiver owner using simple antennas, CATV hookups or TVRO installations.

A field strength meter is related to the well known RF voltmeter with one major difference. The input circuitry of the RF voltmeter or an RF probe for use with VTVMs and oscilloscopes is not a frequency selective device. Whatever RF energy is present in the circuit under measurement is detected and presented by the meter movement. The measurement shows a composite of all RF across the response band of the input circuitry or the probe circuit.

For many purposes such measurements are sufficient—if the frequencies involved are known, for example. But to solve trouble areas such as interference or poor picture quality in a CATV installation, a more specific metering device is required. By making

the input circuitry frequency selective, the FSM becomes a tuned RF voltmeter, ready for searching out individual frequencies. Circuit Q of the tunable input must be relatively high, the selectivity bandwidth narrow enough to allow separation of measurement between TV visual and aural carriers. Even the concentration of energy in the TV channel signal from the reference subcarrier should be detectable.

The tuning range of the FSM should be reasonably wide. Measurements may be needed across the entire VHF TV spectrum as well as the UHF band. If a service group wishes to provide complete TV servicing to their customers, then many of the intermediate frequencies become equally important. Even tunability into the TV IF frequencies of 41 to 47MHz can prove of great value. A quick scan of the many radio services provided in the VHF spectrum alone, many of which could create interference under proper conditions, shows how potential problems might exist in a cable-connected home. (See Table 1)

The simplest FSM consists of a tuned RF tank circuit. The RF signals coupled into the tank from a signal source—antenna system, CATV outlet or TVRO tuning head—are detected by a diode that provides the current necessary to cause meter deflection. (See Figure 1.) The concept is similar to a crystal radio receiver with the earphones replaced by a meter movement. The higher frequencies involved with television, however,

require a great deal more sophistication. For proper measurements the input circuitry must provide an impedance match, usually 75Ω .

Input signals of interest may differ significantly, in level as well as frequency, so a switched input attenuator network is needed. Attenuators of known value (and reasonable accuracy) should be used, allowing the measurement to be more than mere relative figures. Very low signals might be of interest, so a carefully designed, fixed-gain amplifier block is included in the equipment. A meter driver amplifier is also provided, allowing calibration of the meter against a known reference. As the technician searches through frequencies, audio detection can often provide answers and identification. Either an audio amplifier/speaker system or at least an earphone jack is of value. Cases arise when the baseband video signal is important to solution-finding. For those cases a video output used with an oscilloscope or video monitor can offer useful information. (See Figure 2.)

Several manufacturers make field strength measurement equipment. Jerrold Electronics Company is perhaps the most widely known for equipment for relatively critical measurements needed in CATV system maintenance and installation trouble-shooting. Accuracy, portability and battery powering with built-in ac powering in some models result in high

Bentz, currently a technical editor for Broadcast Engineering, was employed as a service technician with Telecable Corporation (Overland Park, KS) for six years.

prices. Just as with any product, however, the quality of the product will depend upon the cost. Cheap gets cheap! For people interested in purchasing FSM equipment, the best suggestion is to buy under an "on-approval" agreement. Be ready to spend \$100 to \$1000 for a good meter. Yet, the investment should pay for itself once the service group is known to provide complete service.

An even greater asset to reading the available signals and to see sources of potential interference is the spectrum analyzer. Using an RF detection system tuned simultaneously with the sweep of an oscilloscope, the display will show spikes across the swept RF band wherever RF carriers are found. With expanded sweep scales it is even possible to detect

the type of modulation placed on the carrier. With careful observation, even the degree of modulation is measureable with a high quality spectrum analyzer. The costs to most TV servicing groups, however, is prohibitively high.

With an idea of the operation of the FSM equipment, some comments are in order on the use of the meter. First, on a typical home TV installation, the meter may be used to properly align the antenna to the most centrally located station. Some conditions, however, might preclude that approach. In any case, with the FSM attached to the 75Ω down lead from the antenna, using a matching transformer in reverse if twinlead is installed, the antenna may be turned to receive the greatest amount of signal from the station

of interest.

A rule of thumb for TV reception as followed by CATV technicians is that the signal at the television antenna terminals should be between 0 and 10dBmV. (0dBmV is 1mV applied across a 75Ω impedance.) Most of the modern TV receivers have tuners that may easily handle signals of much less strength. Too little signal will cause a snowy quality in the received picture. Oddly enough, too much signal can cause a similar problem. The FSM allows the technician to determine the signal strength at the receiver end of the antenna feed line and make proper adjustments.

It is possible that the signals from several local stations may vary greatly, perhaps above and below the 0 and 10 limits. The TV

Table 1.

Frequencies involved in Television

Frequencies of radio services

CATV Subband Channels

41-47MHz-Television IF

54-60MHz - Channel 2
60-66MHz - Channel 3
66-72MHz - Channel 4

76-82MHz - Channel 5
82-88MHz - Channel 6

88-174MHz - CATV Midband Channels

174-180MHz - Channel 7
180-186MHz - Channel 8
186-192MHz - Channel 9
192-198MHz - Channel 10
198-204MHz - Channel 11
204-210MHz - Channel 12
210-216MHz - Channel 13

216MHz - CATV Super Band Channels

27MHz area
28-30MHz
30-50MHz

50-54MHz

72-76MHz

88-108MHz
108-118MHz
118-132MHz
132-144MHz

144-148MHz
148-174MHz

216-220MHz

220-225MHz

- Citizens Band
- Amateur Radio
- Public Safety, Public Service, Paging, Business Two-way, and Industrial
- Amateur Radio
- Land Fixed and Mobile Services, Aeronautical Navigation
- FM Broadcast
- Aeronautical Navigation
- Aeronautical Communications
- Land Fixed and Mobile Services
- Amateur Radio
- Land Fixed and Mobile Services, Public Safety, Public Service, Paging, Mobile Telephone, Two-way Business Services.
- Land Fixed and Mobile Services
- Amateur Radio

The RF spectrum from below VHF television to above, showing some of the possible sources of interfering signals to television reception with simple antenna installations as well as CATV hookups.

Field strength meter

set age system was included to alleviate just that problem. On the other hand, if the signals are all quite strong and well above the 10dBmV level, some type of fixed pad attenuator is a logical solution to bring the signal strength at the receiver into the 0 to 10dBmV range. The technician should keep in mind that if 75Ω down lead is used to bring signals into the

allow further information to be gleaned, assuming the operator uses proper radio protocol and identifies his station. Even an illegal CB or amateur operator can sometimes be tracked down, just by listening to the chatter for a few minutes to see if he makes any references to his location.

Dealing with cable TV installations presents new problems. The TV technician should not attempt to repair the cable system. CATV

strength of all received channels. There should be less than 6dBmV variance between all channels from 2 through 13. Any difference in channel levels significantly greater than that should be noted and later be relayed to the CATV operators. Such variation indicates a suck-out of frequencies, usually caused by a poor connection within the cable equipment or a fault in the integrity of the cable materials. Staples through the

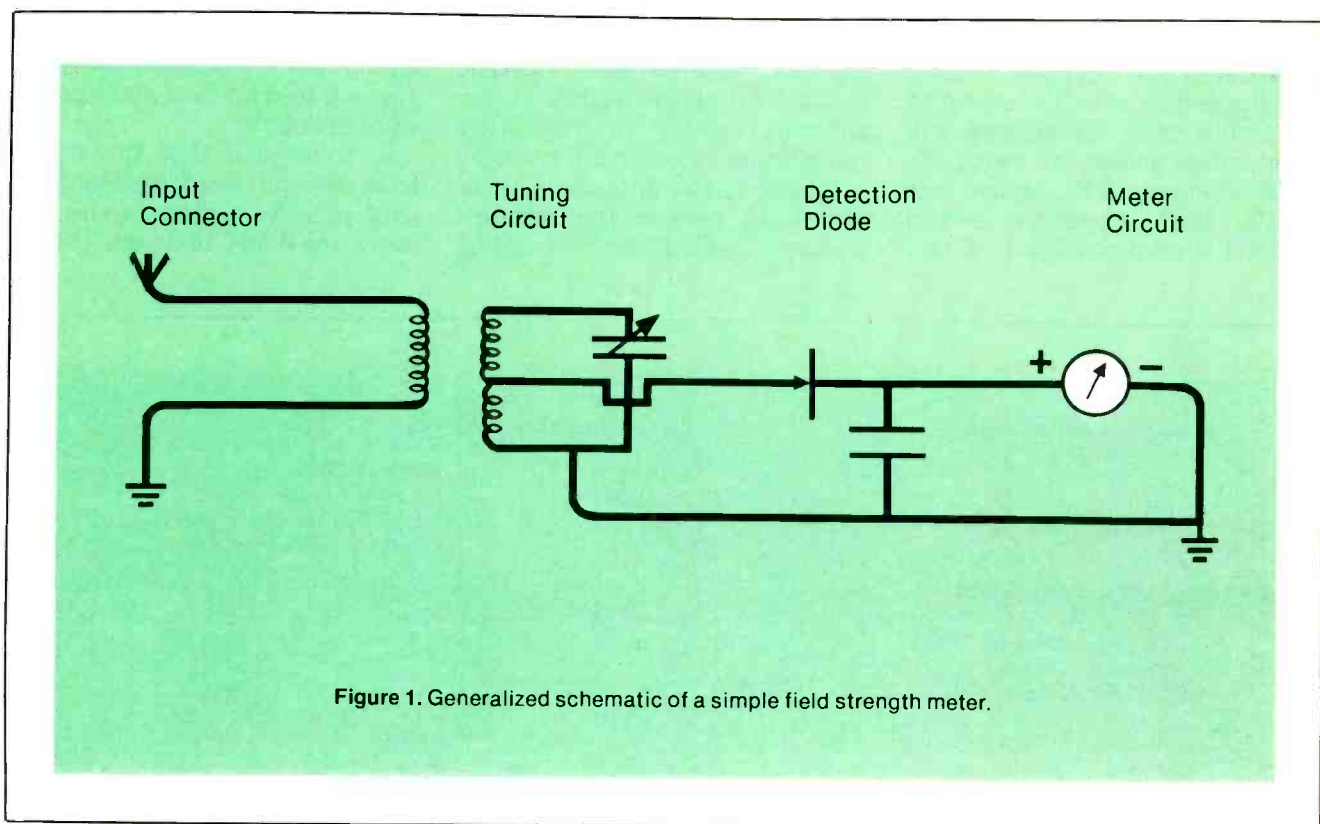

house from the antenna, a matching transformer is probably used in order to get the signal into the tuner. Although most newer sets include a built-in transformer, the quality is often questionable and an external unit would be preferred for a nominal added cost. The 75-to-300Ω transformer is also a voltage step-up device, increasing the signal voltage by a factor of four.

If a customer complains of an intermittent interference, the field strength meter may be attached to the down lead, and the interference may be located and the frequency checked. Knowing the frequency is a part of identifying the culprit. If the offending signal is an audio modulated service signal, the audio detector will

companies have plenty of technicians for that purpose, but the knowledgeable TV service technician can help the cable technician and vice versa. Cable TV can malfunction, of course, but it may also cause TV receiver problems that have been dormant since the set was constructed. Bad baluns, missing tuning strips, and misaligned adjacent channel adjustments can become painfully obvious at times, when they would have gone unnoticed with only the frequency-spaced local channels. Comments on the subject of CATV faults vs. receiver faults will appear in future issues.

When the complete TV service technician encounters a CATV installation, the first thing he should do is measure the relative signal

drop cable on the back of the house (where aerial installations are allowed), squirrel damage to the cable at the pole line, or pets chewing on the cable are all possible causes of one or more channels on a CATV system. If all signals are low, similar causes may be the explanation. If all signals are high, the cable operators should be notified to check their amplifier chain for misadjustment.

Contrary to advertisement, weather will have a significant effect on how cable television operates. Beyond blackouts caused by electrical storms, signals will drop in hot weather because impedance of the cable material increases with heat. Extremely cold climactic conditions will cause the signals to rise dramatically. In

theory, the amplifiers used along the pole line will have automatic gain controls to even out the variations, but theory tells us to expect the unexpected. The FSM has aided in locating the source of a possible problem and should also have increased the customers' opinion of the TV service technicians integrity.

Just as with a simple antenna installation, CATV may have interference. The causes are multi-

to look into a TVRO system installation. The complaint is based on a continued degradation of the pictures coming from satellite transmissions. Most customers who can afford the TVRO installation will have studied up on the cause of a general problem such as this, but the complete TV service center should be aware of ways to monitor such problems. Generally the TVRO receiver system will have a 70MHz output. While

for best reception. If repointing does not improve the reception, electronics more than likely are the cause of the complaint and the customer can be advised accordingly. Perhaps physical damage to the antenna has occurred as a result of weather or vandalism, because errors in antenna curvature can cause poor satellite reception. In a new TVRO installation, should the complete TV service group desire to enter that

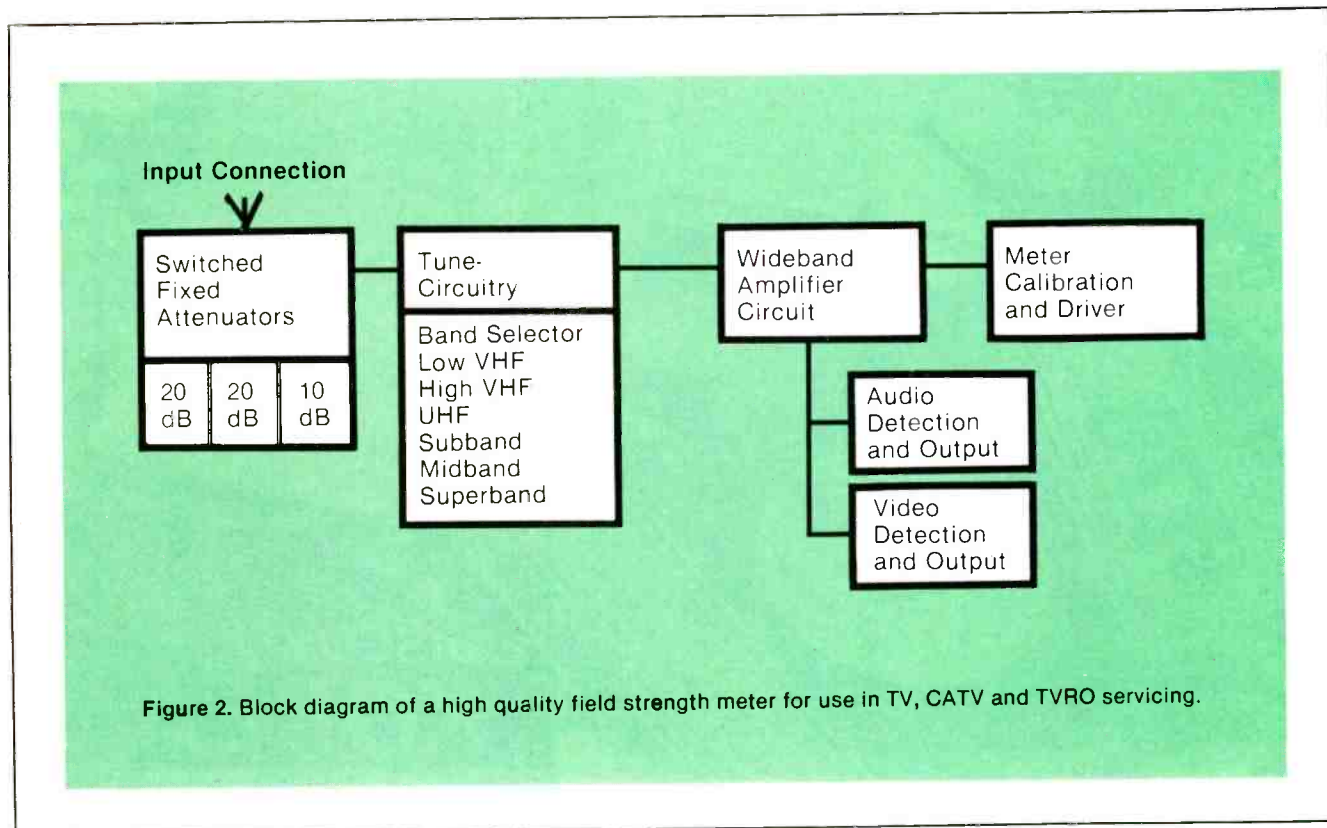

Figure 2. Block diagram of a high quality field strength meter for use in TV, CATV and TVRO servicing.

ple. On systems that only deal in VHF channels 2 through 13, for example, one signal greatly larger than the others may cause interference on all channels. The FSM can help to locate that signal. The technician should search throughout the spectrum, because non-TV signals significantly greater in strength could result in the problem. Public service signals can easily leak into a poor connection or a cable shield break and cause problems, particularly on systems where midband (between channels 6 and 7) frequencies are tuned with a converter. A malfunctioning transmitter could also produce signals that fall within the normal channel ranges. The FSM helps to locate such discrepancies.

Finally, suppose you are called

monitoring with the FSM, the technician can easily check to see if the antenna aiming calibration has perhaps changed. The satellites do wander in their orbit and it is entirely possible that when the installation was made, the satellite was at one end of its typical figure-8 orbital movement. As it moves to the other end of the pattern, the received signal will appear to drop, causing noisy pictures to result. On the ground the antenna footings may have changed due to settling of the earth. A properly installed earth station TVRO antenna will not have that problem occur usually, but anything is possible.

The FSM provides a means to check out the possible need of "recalibrating" antenna pointing

facet of the industry, the FSM is invaluable in the first alignment of antenna aiming.

The FSM allows the TV service technician another way of looking at conditions of the signal. No receiver can deal with a poor quality signal properly, and attempts on the part of the technician to offer receiver repair when unwarranted only causes poor opinions from the customer. The FSM can help locate the cause of poor reception by determining if there is sufficient signal or if there is an interfering signal causing the complaint. The costs, even though high, can be offset by an improved reputation as a complete TV service facility.

ES&T



Two ways to find replace

When you think about the number of new electronic gizmos that come off the boat every year, it's staggering.

If you happen to be a repairman, it's enough to drive you crazy. It seems there's absolutely no way for you to keep on top of all those new electronic components required.

But don't worry. There's a very easy way to keep up. Get a Sylvania ECG®

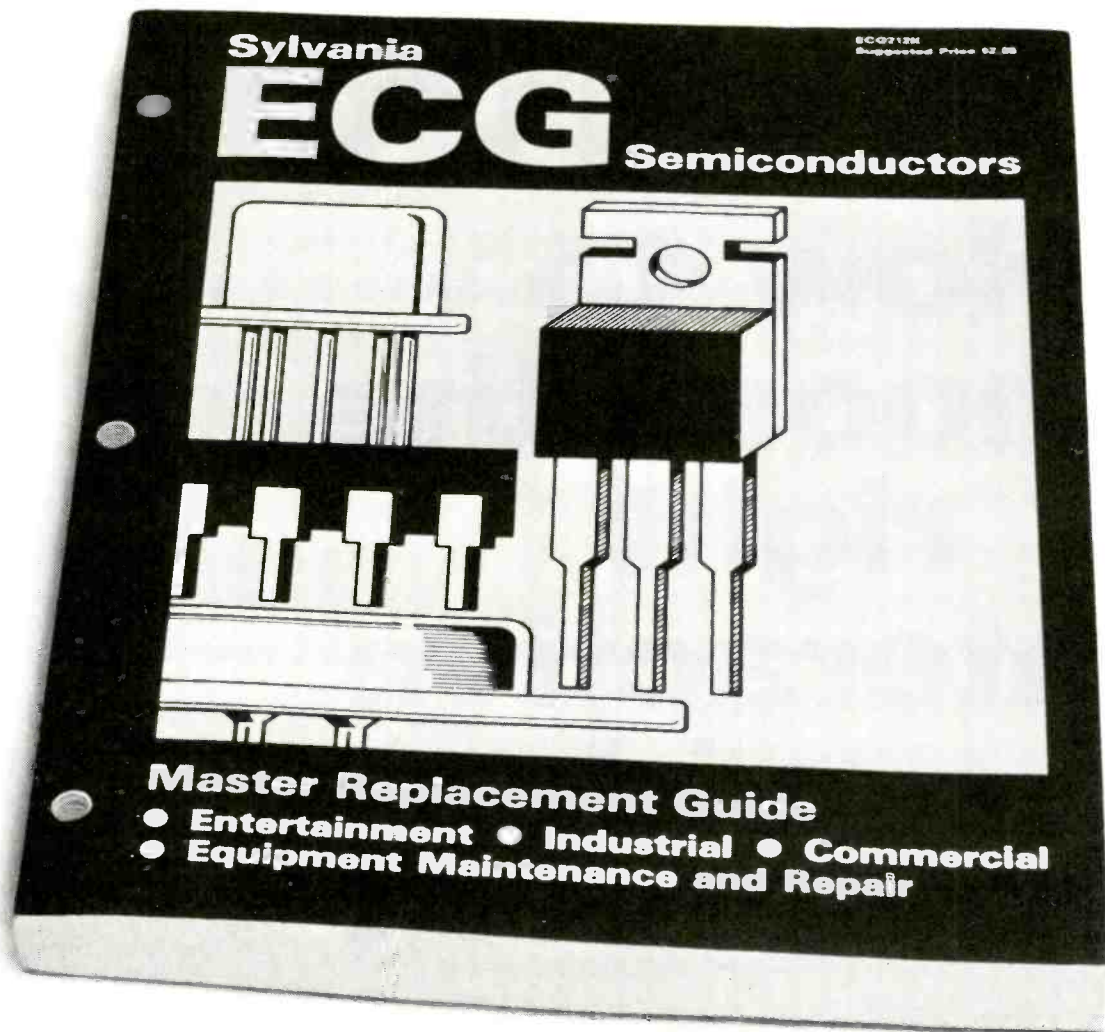

ments for foreign parts.

Master Replacement Guide from your Philips ECG distributor.

It cross references more than 170,000 industry part numbers to over 2,500 ECG devices including most of the hard-to-find foreign parts.

You get concise descriptions on each with clear illustrations of packaging and circuit diagrams. And, you have the full technical resources of Philips at your

disposal for any tricky replacements you might have questions about.

What's more, the ECG parts you receive are of the highest quality. Specifications on these devices are equal to, and usually exceed, those of the original part. To maintain quality and performance levels, all of the ECG's are checked in accord with military standard testing procedures.

But the best part is that you don't have to go every which way to get them. You just go to your nearest ECG distributor. "For your nearest ECG distributor, please call 1-800-225-8326; in Mass., call 1-800-342-8736."

Philips ECG

A North American Philips Company

Circle (14) on Reply Card

How to choose the right interactive video equipment



Courtesy Sony Video Communications, New York, NY.

Interactive video is the joint product of two technologies, each of which has developed rapidly over the past two decades: video and computers.

Broadcast television has long been recognized as an effective means to reach a mass audience. The size of the audience justifies large expenditures to create a professional-looking (if often simplistic) content. However, broadcast television is all 1-way, from the network or station to the viewer. The viewer is entirely passive—he has no control over what is seen or when, and he can't interact.

With the introduction of low-cost portable video equipment, such as the first Sony open-reel recorders of the 1960s, the user took the first steps toward control of the programming. This movement gained speed and momentum

with the introduction of the U-matic in the early 1970s, and the Betamax in the mid 1970s. Both U-matic and Betamax have enabled many organizations to create their own programming, for use when and where it's needed by their viewers.

But video programs still had to be made for the common denominator of a group, albeit for a smaller group than for broadcast. Viewed individually or alone, a video program still had parts that, for many viewers, were (a) already known, (b) too simple, (c) too complex, or (d) not relevant to their interest.

Sony took steps to improve this situation several years ago with the introduction of remote control units that accessed specific parts of a program. These control units have become more sophisticated. And this sophistication was en-

abled by the adoption of microprocessors.

This leads us to the second technology. In the past 20 years, computers have been moved out of the huge, expensive, elitist category and into everyday use in all parts of our lives. Computer power has dropped tremendously in price, while advances in software have greatly facilitated the writing of computer programs so that even school children can be programmers after a few days' exposure.

Efforts to use computers for instruction led to the emergence of what came to be called Computer-Aided Instruction, or CAI. CAI is highly interactive—the viewer or learner must respond to questions or choices in order to proceed through the material. In this sense, each separate viewer creates his own “path” through the material, as he makes responses or choices different from other persons. This is in contrast to regular video programs, where everyone has to follow the one path laid out by the producer without variations.

But CAI had several drawbacks. First, it typically relied on connection with a mainframe computer, and neither the connections nor the mainframe have been as reliable or as easily accessible as many users would hope. Second, CAI had very poor graphics; the material was presented primarily as text, with line drawings used for illustrations. Third, creation of material required a rather high level of computer expertise, which often meant bringing in a programmer who was remote from the material, and effectively separated the course creator from his intended final product and inhibited the widespread creation of

materials.

Now with interactive video, the best of these two technologies have been made to complement each other. Excellent graphics and visual impact of video are retained and versatility and responsiveness are achieved with computer power. The usage of VTRs currently in the field is improved by teaming them with computers. Sony is able to expand the uses of video by using the relatively new technology of the videodisc.

But what about the computer expertise that CAI requires? Do I have to become a computer expert—or hire a programmer—to get into interactive video?

The best answer to this is that different organizations have different needs. Rather than try to get everyone to fit their needs to one product, Sony makes a range of products to match a range of needs.

You can see how Sony is applying this approach to interactive video in Figure 1. On the vertical axis, we'll put "computer power" going from low to high. On the horizontal axis, we'll put "ease of random access and still frame," going from low to high. Computer power is what gives you simple or complex paths through an interactive program, while random access and still frames provide the visual part of an interactive program.

In the area at the lower left, where we have low computer power and low random access, we can put bare VTRs, producing regular video programs. In the lower right, we can put consumer laser videodiscs; these have no computer power, but the capability for manual random access and unlimited still frame.

In the middle, we put Sony's remote control units such as the

RX-353 and our Video Responder, both of which have some computer power that drives the VTRs they are tied to, to yield an interactive video program. While you can search a segment on tape, it may take several seconds to find the segment. With VTRs, you can hold a single still frame for several minutes, and although the more you use the single frame the more you wear down the tape, many needs can be satisfied by this level of performance.

Sony's industrial videodisc has more (or at least more flexible)

comprehend at an average pace and some understand the material very quickly. With a conventional program, the producer must create *one* sequence that tries to accommodate these differences. And, short of complete post-testing of all viewers, the producer doesn't really know who or how many actually understood the material. Typically, a large part of a group of viewers will not sufficiently understand some or all of the required content of a regular program. This may be caused by many things, such as a content

The usage of VTRs currently in the field is improved by teaming them with computers.

computer power built into it and, as a laser-based system, it has rapid random access and infinite still-frame capabilities. In the upper regions with high computer power, you can use external computers to create complex paths. Computers will drive a VTR (upper left) or a laser videodisc (upper right) to supply the visual portion of your program.

Is all this effort worth the trouble? What interactive video gives you is more effectiveness and more versatility.

Improved effectiveness

In any normal group of users or viewers, some of them are slow to comprehend the material, some

level that is too difficult or too simple or a portion that isn't relevant.

With interactive video, you can set up alternative paths through the material that match the differences in your viewing group. Now, you can be much more certain that 100% of your viewers understand 100% of the required contents.

The alternative paths themselves, and the increased assurance of everyone understanding all of the necessary contents, occur because each viewer is now required to respond to questions or make choices in order to proceed through the material. Viewers no longer have the option of going to sleep once the program starts;

Interactive video

they must pay attention to get to the end of an interactive program. You now have a built-in way for each viewer to customize the program to his or her own level—and this same way also ensures understanding by a higher percentage of the viewing group. This is improved effectiveness.

Also, adoption of superior training techniques now becomes feasible with interactive video. Immediate direct feedback has been shown to be an effective training method—yet in a typical classroom setting, each person may receive only a few direct feedbacks per hour—and none with a regular video program. This feedback can be greatly increased with interactive video. A well regarded format for immediate feedback is in a simulation, where a situation that the viewer/learner must really face is more or less duplicated. With the visual impact and fast response of interactive video, these simulations can be quite realistic. They can be anything from a job interview to an aircraft landing to an equipment operating procedure.

Interactive video's central characteristic of alternative paths means that each viewer must go through the program individually. This not only means customizing the program for each person, but also means freeing the individual to experiment, to make mistakes—even make mistakes repeatedly, without fear or embarrassment. A particular viewer or learner might not ask a question in class, or even when talking with a peer, instructor, supervisor or salesperson, because of this fear of looking stupid. And persistent requests for clarification can become irritating. But asking a machine the same question several times, or answering it wrong, is not

threatening. It frees the learner to proceed at his or her own pace and style.

Improve efficiency

Effectiveness means achieving the desired results. Efficiency means achieving the results with the least total resources.

With a conventional program, all of your viewers watched all of the material whether they all needed to or not. If the level of the program was set for the novice or slow learner, you wasted the time of the average and expert viewers. Conversely, if you made the program content appropriate for the expert or fast learner, the novices and average viewers didn't understand it. Now, one interactive video program can be set up to cover these multiple requirements. Experts or fast learners can save time by zipping through the material; and even average viewers will find some segments that they already know and can concentrate on those they don't. Novices or slow learners can take *their* time to fully understand the material.

Of course, you could make several separate regular programs to meet the differences in your group. But you may incur additional production costs in doing so, and you will very likely incur more duplication costs for the additional programs. And how would you determine who sees which version? Finally, how would you ensure that each viewer, even assuming he or she got the proper version, really paid attention and understood the material?

With interactive video, these separate programs can be thought of as combined into one. You may need to provide additional material as review for the novices and slow

learners, but you will also be able to make multiple use of some or most other portions—jumping over some details and not others, as indicated by the responses and choices each viewer makes.

Program copying costs should be less than if several programs were made. And the built-in questions or choices mean that as each viewer determines what he or she sees, you have assurance that they have paid attention and understood.

Interactive video enables improved efficiency by saving the time of a significant portion of your viewing group, and by combining multiple purposes in a single program.

Versatility

We have talked here of interactive video being used in a training situation. But the same ideas apply for sales aid or catalog situations—the user gets more precisely the information needed by way of alternative paths chosen through his or her own responses. There is a wide spectrum of applications for interactive video.

Not only can you better meet the differences *within* a group of viewers, you can use the same visuals for very different purposes with *different* groups of viewers.

For example, auto companies are using the same interactive video program to train sales staff and as a point-of-purchase demonstration tool with customers. The sales staff is given questions that they must successfully complete, while the customers are shown a menu (a table of contents) listing the various parts and aspects of a car. The customer chooses what feature he or she wants to see.

It may be possible to use a program on time management in four

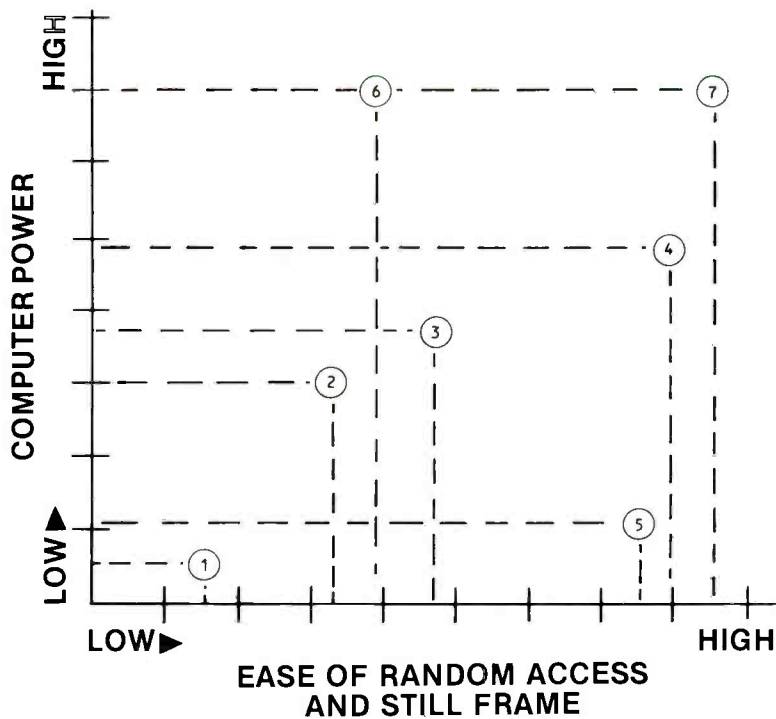

Figure 1. Ease of random access and stillframe can be combined with computer power. 1 = basic VTR, 2 = RX with "intelligent" VTR, 3 = responder with "intelligent" VTR, 4 = Sony industrial laser videodisc, 5 = consumer laser videodisc, 6 = microcomputer plus VTR, and 7 = microcomputer plus laser videodisc.

or five different ways. In a linear playback form, the program may be a good tool for presenting *concepts* to supervisors and motivating them to use the concepts. Then with interactive video questions, we can obtain *verification* that a subordinate has watched the entire program and comprehended what was said. Now the vice president of human resources may want to know if he should spend lots of money on a company-wide training program, but he isn't sure what kind of

reception it would receive. Putting different questions with the same program, we can now ask the viewer's opinions about the utility of the training—now we are getting *market research*.

Another way to use the material is as the basis for a *simulation*, perhaps with a written workbook to tie it closely to the setting at the company. Finally, we might achieve *time compression* by again changing the questions, and asking them before a segment. Those who know the material finish

quickly and save time.

What's what?

Interactive video isn't simply a matter of videotape or videodisc. It's a matter of matching the characteristics of two different technologies to your application. Let's look at each product and list advantages and disadvantages.

VTRs have the advantages of record capability and fast, economical duplication in small numbers. There is also a large base of installed equipment, so many users may not have to spend anything on equipment to get their messages out. VTRs by themselves seem to be most appropriate for motivational content, where assurance of understanding isn't critical. The cost of media may be reduced through recycling tapes.

Consumer laser disc's key advantage is low equipment cost. There is almost no wear on the laser disc, and frame-accurate access is limited to what you can do by manually stepping through the program—there isn't a built-in computer. The access time isn't as fast as with industrial units, and the player isn't as sturdy.

The Sony RX system retains the fast duplication and recycling advantages of basic VTRs, while adding the branching capability that is the first step into real interactivity. Slower access time and limited still-frame capabilities should be considered relative to the job you want the machine to do.

The Sony Responder takes the features of the RX and adds further interactive capability through a counter that takes the viewer to a review segment after some wrong answers, and by providing for multiple answers, figures and words as responses. The segments

Interactive video

are basically sequential. User performance can be tracked with the printer. Control data are systematically encoded with the Sony Cue Programmer. Again, depending on your application, slower access time and tape wear may be disadvantages.

The Sony Industrial disc player's prime advantages are instant and precise access, unlimited still frame, no disc wear and flexible computer programming and compatibility. Such programming features as increment and decrement registers, jump, go to, interrupt, skip and review give considerable latitude for program design. However, you should consider these aspects relative to your application. Several weeks are required for outside duplication. No recycling of discs is possible. There is no recording capability and you will have the expense of buying playback equipment.

Use of a microcomputer with either a VTR or a disc player will boost equipment costs. But the great flexibility of computer programming, combined with sizable memory capacity and a wide range of response types all make possible any number of intriguing applications. You have to be prepared to make an investment not only in equipment but in people who have some computer training to create the programs.

Of all the comparisons to be made between VTR and videodisc, the most elusive is that of media cost. It's not accurate to say point-blank that cassettes cost less than discs or vice-versa. There's no magic point at which one becomes less expensive than the other. It depends on the different aspects of the way you're using interactive video.

First of all, when you're talking

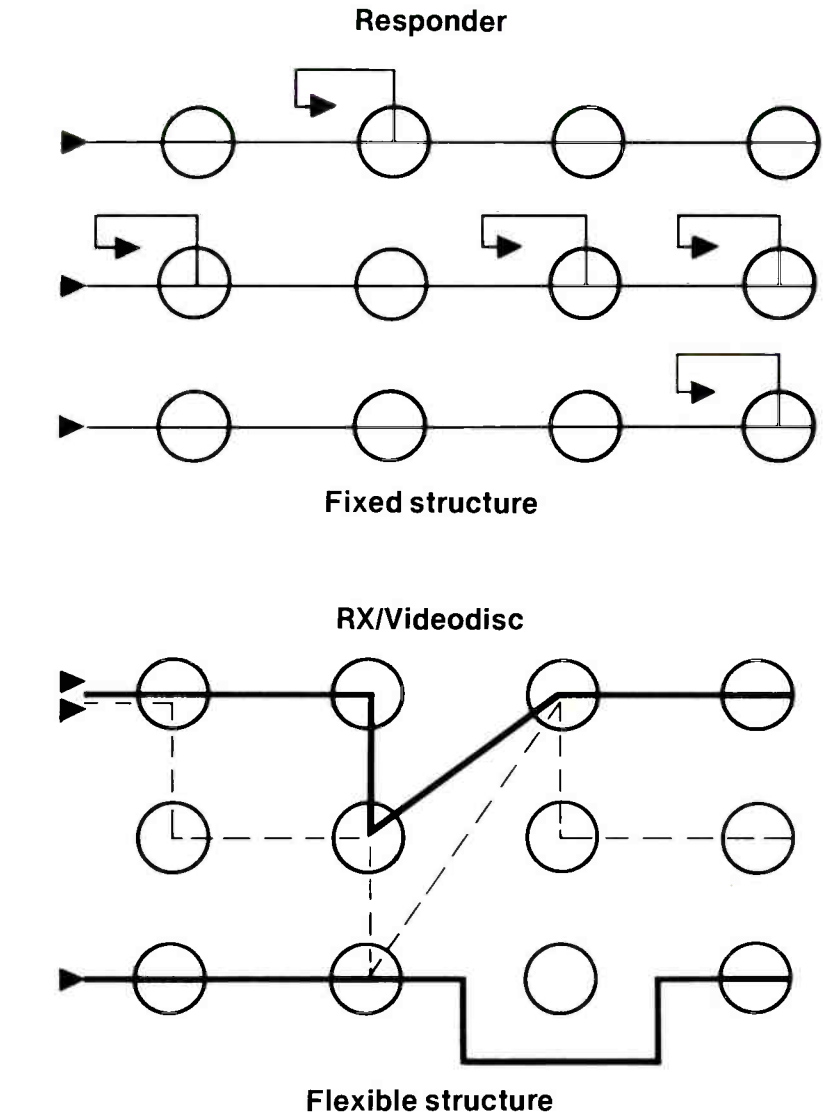



Figure 2. Interactive video lets you program fixed or changeable learning paths.

to someone about production costs, it's important to distinguish between program production and program duplication. No matter which medium you use, program production costs are likely to be much greater than duplication costs.

By the time you figure in salaries, overhead, equipment amortization, tape stock, talent payments and divide by the number of copies you want, you come up with a number that's a lot higher than the cost of duplication alone—perhaps



10 times higher—for either medium.

The difference between tape and disc duplication is significant and interesting. When you duplicate a tape, you do it on VTRs. The more copies you want, the more time it takes—or the more VTRs you need. The cost per copy remains basically the same, whether you make 10 copies or 100. With disc, on the other hand, you use a different process. First you have to make a master, using expensive mastering equipment. Count on a mastering price somewhere between \$1500 and \$2500 per program. But after that's over, you can knock out copies quickly and at a pretty low cost. So the first copy costs whatever the mastering price is plus the cost of one disc, then you simply add the cost of a disc for each subsequent copy.

Much depends on your particular application. You might decide to recycle tape to cut down costs. You might play a program so many times that you wear out the tape (in which case you'd have been better off with a disc). You may have a medical, military or aviation application in which you need the advantages of an industrial videodisc system so much that just one copy—expensive as it may be—is justified.

There isn't a single formula that can be applied to determine whether tape or disc is better for you. Many factors concerning your usage pattern will take precedence over just duplication cost.

We can use these comparisons to see what's involved in interactive video, and to figure out what level of equipment you should be using.

Interactive video can be implemented on either VTR or videodisc, depending on the requirements of your application.

The amount of computer power you choose depends on your application too.

Say you have one audience, and you want to get messages to that audience quickly. For this you may not need interactive video, unless you want to ensure that everyone in the audience understood the information. For a straight motivational or communications message, regular VTRs would fit your needs. If you want to ensure understanding, and you don't care about speed of access, and you won't use many still frames, then maybe the Responder or RX units are best for you.

On the other hand, what if you wanted to train your salesman on a new product, provide competitive comparisons, and at the same time have promotional material to show clients? You can do all of this with one program, along with a little computer power. The competitive comparisons may be in text or chart form, for which one still frame may suffice. Laser videodisc's precise still frame capabilities are appropriate for this job. And when you're showing demonstration material to a customer, you probably want instant access. Again, you want laser videodisc—and the Sony industrial videodisc, with its small, built-in computer is likely what you need.

If you're working in the medical field or in aviation, you may want to provide realistic simulations. It's better for your people to make a mistake in simulation, and learn the right way, than to make a mistake in a live situation with a patient or an aircraft. Simulations usually take a lot of computer power, which puts you way up at the top of the chart and means you probably have to go to an external

computer. The computer still drives the VTR or disc to provide the visual information and impact.

If you've followed us so far, you realize that the kind of equipment you need depends on the job you need to do. Answering these questions may bring you closer to understanding the dimensions of the job and help you select the equipment that's right.

1. Do you need the added capability of recording at each field location where playback equipment is located?
2. What is your expected number of copies per program?
3. Does your need justify even a limited number of copies?
4. What is your allowable turn-around time for duplication?
5. What is the "shelf life" of your program? How long before it'll be outdated?
6. Do you need to recycle your tape stock to cut down on costs?
7. What is the frequency of use for most of your programs?
8. How much "branching" could your material fruitfully use?
9. What access time can you allow to reach a desired segment or frame?
10. Can your content fruitfully use a large number of single still frames?
11. Is your content so confidential as to require in-house duplication?

These questions are just a start. Additional assistance in determining what equipment best meets your needs can be obtained by contacting Sony Video Communications, 9 West 57th Street, New York, NY 10019.

ES&T_{AV}

Chassis – Sylvania E51 and E53
PHOTOFACT – 2009-2 and 1988-3

1

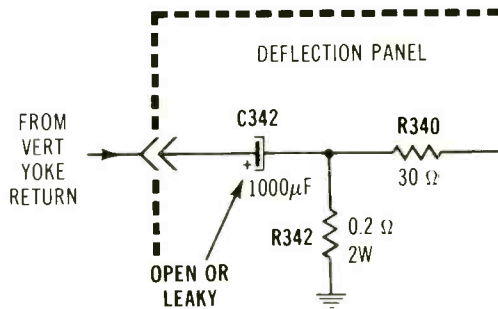

Symptom – Vertical-sweep foldover
Cure – Check capacitor C342, and replace it if leaky or low capacitance

Chassis – Sylvania E51 and E53
PHOTOFACT – 2009-2 and 1988-3

2

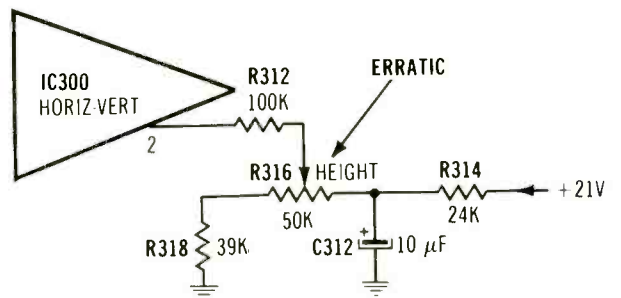

Symptom – Unstable vertical height
Cure – Check height control R316, and replace it if resistance is erratic

Chassis – Sylvania E51 and E53
PHOTOFACT – 2009-2 and 1988-3

3

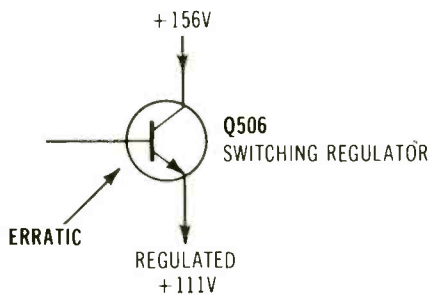

Symptom – Vertical jitters
Cure – Check regulator Q506 by replacement

Chassis – Sylvania E48
PHOTOFACT – 1884-2 and 1846-2

4

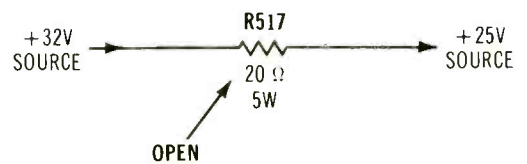

Symptom – No picture and no raster
Cure – Check resistor R517, and replace it if open

Chassis – Sylvania E48
PHOTOFACT – 1884-2 and 1846-2

5

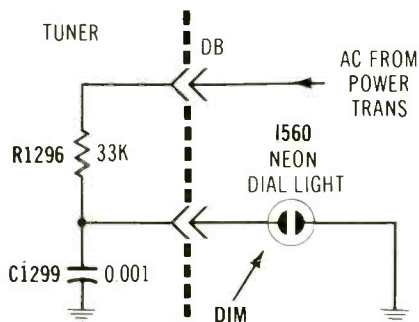

Symptom – Dial lamp is dim
Cure – Check 1560 neon-type dial lamp by replacement

Chassis – Sylvania E48
PHOTOFACT – 1884-2 and 1846-2

6

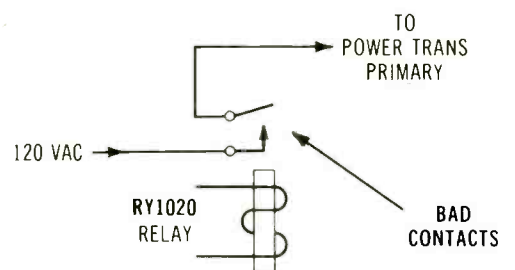

Symptom – No sound and no raster
Cure – Check relay RY1020, and replace it if the contacts are open

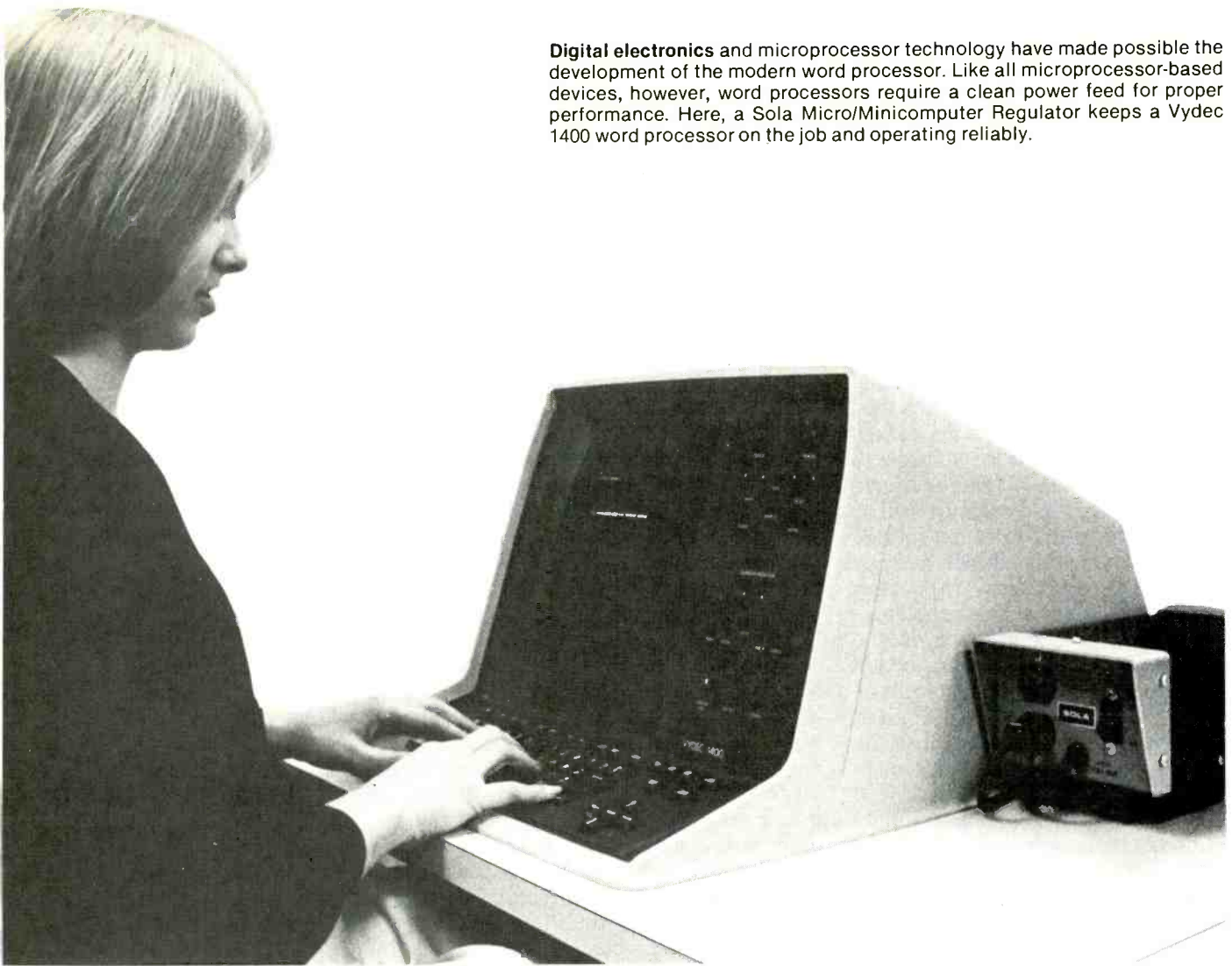

Digital electronics and microprocessor technology have made possible the development of the modern word processor. Like all microprocessor-based devices, however, word processors require a clean power feed for proper performance. Here, a Sola Micro/Minicomputer Regulator keeps a Vydec 1400 word processor on the job and operating reliably.

Protecting the microprocessor/minicomputer

By David Kemp, marketing manager,
Sola Electric, a unit of General Signal

The recent growth in small, microprocessor-based electronic equipment has spurred the development and introduction of an array of portable power protection equipment designed to help the new electronics operate properly. Sophisticated electronic equipment such as word processors and microcomputers—even electronic cash registers—all require electrical power that is both reliably stable and relatively free of interference or electrical noise.

Power protection equipment is designed to “clean up” raw, incoming ac power, making it suitable for use by the electronic system.

To choose among the many different kinds of power protection devices available, however, it is first necessary to understand some of the basic concepts of power line conditioning.

Basic functions of line conditioners

Electronic equipment has a cer-

tain tolerance to voltage variations but, beyond a certain point, malfunctions will occur. The following summarizes some of the most important functions that may be performed by a power protection device to help stabilize line voltage. An individual unit may provide all of the features below, or it may be designed to perform only one of these functions, providing partial protection.

Line voltage regulation. Commercial utilities attempt to supply

Protection

and maintain power at an average or "nominal" voltage—usually 120Vac. When measured at any particular point on the line, however, electrical power is rarely found at nominal voltage. Voltage level will be affected by distance from the generating station, resistance losses along the length of the conductor and other factors. In addition, line voltage frequently swings well above or below nominal for short periods of time. Transients, as these high speed voltage spikes and dips are called, can momentarily raise voltage 10 times or more. Longer term voltage surges and sags, as well as brownouts, can also cause voltage to deviate from nominal ratings. Transient voltages represent about 20% of power line problems.

Line voltage regulation is the capability of a power protection device to maintain output voltage at a steady or regulated level, despite voltage fluctuations on the input line. A line conditioner's regulation capability is described in terms of its ability to hold voltage at its output within a certain percentage of nominal for fluctuations over a given input voltage range (e.g., $\pm 5\%$ regulation for an input voltage range of $+8 - 20\%$). *Brownout protection* is a term used to describe effective line regulation, even when the utility drops line voltage to brownout levels over an extended period of time. About 10% of power problems are caused by brownouts.

Noise attenuation. Electrical noise can be defined as high voltage, high frequency interference on the ac line. Noise is an extremely common phenomenon and accounts for roughly 65% of the problems on an ac line. There are two types of noise—common mode and transverse mode—and both must be "attenuated" or filtered out by a line conditioner for proper electronics operation.

Attenuation is measured in decibels with 120dB representing just about the upper limit of attenuation possible today.

Line frequency regulation. Certain types of electronic equipment such as magnetic disc drives are sensitive to variations in the fre-

quency of electrical power. This equipment can malfunction if frequency deviates too far from the normal 60Hz (60 cycles per second). Normally, line frequency is not a problem except in certain types of mobile emergency generating equipment. The utilities are required to hold frequency within 3.001% of nominal. Some line conditioners, however, do offer frequency regulation and, like voltage regulation, this is expressed in terms of a percent deviation from nominal at the output for a given input range.

Distortion protection. Harmonic distortion is similar to electrical noise, but occurs at lower frequencies. Certain kinds of power protection equipment will remove distortion from the line while others, because of their design, can actually add distortion to the line.

Blackout protection. Blackouts total about 5% of the problems on a power line. Until just recently, blackout protection was available only in large and expensive power protection systems designed to guard data processing centers and other large mainframe computer installations. Today, however, the ability to supply uninterrupted power, even during total line loss, is offered by some portable protection equipment.

Alternatives

In comparing different types of power protection equipment, it should be remembered that some

are designed to provide more protection than others. A certain unit may offer noise attenuation but not regulation, while another may furnish regulation but not brownout protection. As the term is commonly used, however, a true line conditioner should provide, as a minimum, line voltage regulation and attenuation of both common- and transverse-mode noise.

Passive filter. A passive filter is an economical, easily installed device. Its function, however, is limited to noise attenuation over a certain band of frequencies to which the filter is tuned. It provides no line regulation, no transient suppression, and no protection from noise or distortion at frequencies outside its rejection band. Because of these limitations, a passive filter is rarely used by itself in critical electronics installations.

Ultra-isolation transformer. This device is a simple transformer incorporating electrical insulation and electrostatic shielding between its windings. Its function is to protect against line-to-ground leakage, one form of which is common-mode noise. The design provides good common-mode attenuation up to 120dB but it will not suppress transverse-mode noise. The ultra-isolation transformer provides no line regulation or brownout protection. It will not clip overvoltage transients, nor will it boost under-voltages to useable levels. For this



The Micro/Minicomputer Regulator continuously regulates output voltage and attenuates both common and transverse-mode noise. The unit provides a clean, stable power feed to ensure reliable electronics operation.

reason, the ultra-isolation transformer does not truly fit the definition of a line conditioner.

Electronic tap changer. The electronic tap changer essentially is a transformer with multiple taps on the secondary side. Electronic control circuitry senses fluctuations in input voltage and responds by firing Triacs to switch transformer taps and adjust output voltage. Thus, line voltage regulation is not smooth and continuous, but in steps ranging from ± 3 to $\pm 7\%$.

Tap changers offer good operating efficiencies in excess of 90% and provide good attenuation of common-mode noise (up to 120dB). They provide little transverse-mode noise suppression, however, and no protection from line frequency variation. Tap changers also offer no distortion protection; in fact, the design can actually add up to 2% additional distortion to the line. In some electronic tap changers, the Triacs are coupled directly to the power supply line. This creates the potential for erratic Triac behavior caused by incoming transient spike and voltage dips.

Constant voltage transformer. The constant voltage transformer is a true line conditioner in that it furnishes line regulation and full noise attenuation. It is basically a transformer-like device that contains no moving parts and requires no maintenance. It inherently provides current-limiting, which protects the electronic system from overloads and short circuits, an adjusts or regulates output voltage continuously and steplessly. And, because of its built-in storage capacitors, it can maintain full regulated output for up to $3\mu s$ of total line loss.

Recent modifications to the basic design provide the extra-high noise rejection required by microprocessor-controlled equipment. Called the Micro/Minicomputer Regulator, the unit is a portable, plug-in design in ratings from 70VA to 2000VA. It offers noise rejection levels of 60dB for transverse-mode and 120dB for common-mode noise. Regulation holds output voltage within 3% of normal levels during line-voltage swings as wide as 15% above or below normal.

Brownout protection is also an inherent benefit of the design.

Even in severe brownouts, with voltage drops as low as 65% of rated voltage, this unit still holds output to within 10% of nominal. This is within the operating tolerance range of most types of electronic equipment. The unit does not provide frequency regulation, but does offer excellent protection from line distortion, limiting harmonic distortion at its output to less than 3%.

Mini UPS system. Until recently, an uninterruptible power source (UPS) was available only in large, expensive models for use with large-scale electronic systems. With the present boom in low-power electronics, however, a portable, plug-in Mini UPS has been developed for use with mini- and microcomputers, word processors, electronic cash registers, intelligent terminals and other small systems. The Mini UPS functions much like its larger counterpart to provide 100% protection from all power problems, including blackouts. In the event of primary line failure, the unit draws on a

electronics, the Mini UPS is available in ratings of 400VA and 750VA.

The unit continuously operates between the primary line and electronic load. In a rectifier stage, incoming ac is converted to dc to power the inverter and keep the standby battery fully charged. The dc power is then reconverted to ac in the inverter stage for output. If utility power fails, the inverter continues to operate, drawing power from the battery reserve to maintain output with no power break or interruption whatsoever.

Because the Mini UPS is always on-line, full advantage can be taken of its voltage regulation and noise filtering capabilities. Output voltage is maintained within 3% of nominal voltage without discharging the battery, despite input voltage swings of up to 20%. Output frequency is regulated to $\pm 0.5\text{Hz}$; harmonic distortion is held to less than 5% at the output.

For small systems, the Mini UPS represents the ultimate in power protection—full line conditioning

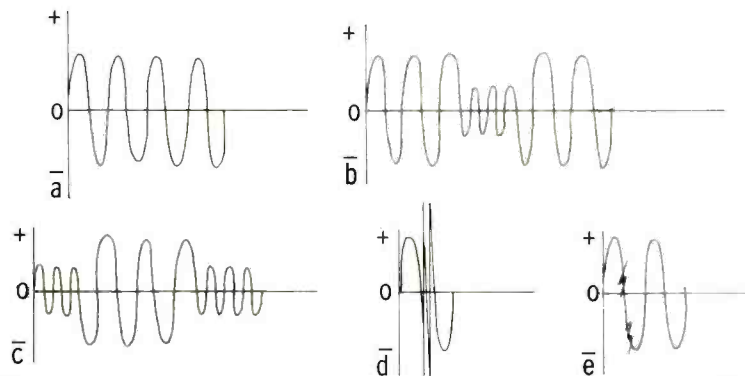

Figure 1. (a) A clean, constant ac waveshape—normally generated at 60Hz. (b) Transient voltage drop or, (c) voltage surge can be caused by turning on and off of electrical equipment, utility network switching or capacitor discharge. (d) A voltage spike can cause voltage to suddenly increase tenfold and drop off just as quickly. Lightning hits and arcing are frequent causes of voltage spikes. (e) Electrical noise can be caused by any motor-operated device or even radio/TV transmissions.

battery reserve to maintain uninterrupted power to the load.

The entire system is self-contained in a single enclosure. Its battery is a sealed, maintenance-free lead-acid type capable of supplying up to 20 minutes of reserve power. Should additional reserve time be required, an auxiliary battery pack is available that plugs into a receptacle at the back of the Mini UPS to provide up to 60 minutes additional battery reserve. Sized for use with small

plus standby battery reserve for blackout protection.

Purchasing power protection for small systems is a matter of degree—units are available to provide a range of functions from simple filtering to the total protection of a Mini UPS. Ultimately, the selection of power protection equipment will depend as much on the importance of the electronic system as on the user's budget.

ES&T_{inc.}

Understanding and troubleshooting shutdown and startup circuits

By Greg Carey,
Chief field engineer

Almost all modern TV receivers develop low voltage to run all of the circuits in the receiver (except the horizontal output stage) from special windings on the flyback transformer. There are many reasons for using this "scan-derived" power, but the main reason is increased efficiency for less power consumption. Rather than cover the variations found in the different makes and models of receivers, we will examine what is common to different circuits so we have a universal starting point.

Let's look at an overview of the scan-derived power system to better understand how to isolate the problems it may develop. First, let's divide the system into its three main sections: The regulated dc source, the output transistor regulator and the scan-derived voltage source. The block diagram is shown in Figure 1.

The first section is a simple dc power supply connected to the ac line. This is either a full or half-

wave power supply made up of simple power rectifiers and electrolytic capacitors. Notice that this supply is connected directly to the ac line, requiring the use of an isolation transformer to allow other test instruments to be safely connected to the receiver chassis. The output of this section is typically between 140 and 170Vdc. It cannot be used to directly power other circuits, however, because its output voltage varies with different ac input voltages.

The output of the unregulated supply is then fed to a dc regulator. Some regulators use a conventional pass-transistor and zener reference. Others, such as found in RCA chassis including CTC 87, 88, 93 and 97, use a special oscillator running at 15.7KHz, which controls a silicon-controlled rectifier (SCR) in series with the horizontal output transistor. The results of either type of regulator are the same: a constant dc voltage is produced to feed the horizontal output transistor, which in turn, keeps the 25 to 35KV high voltage constant for different line voltages and different flyback

loads. So far, however, we have only supplied power to the output transistor. How is the rest of the receiver powered?

The flyback transformer in modern "scan-derived" receivers is even more important than in the past. This transformer still supplies the high voltage needed to operate the CRT and supplies keying pulses to vertical stages such as the AGC of the color stages. But now the flyback also develops the dc voltages needed by all other circuits in the receiver. A typical flyback transformer may have a low voltage winding to power the IF, video, color and sound stages, and a higher voltage winding to power the vertical and video output stages. A special fast-acting rectifier diode and small filter network produce well-filtered dc for these other stages. There may be some regulation on the low voltage supply, although the regulator supplying the horizontal output does a good job of regulating these supplies, too.

The horizontal oscillator is also powered from the flyback output. We have our own little "catch 22" condition. There is no low voltage unless the horizontal output is operating; the horizontal output will not operate without a horizontal oscillator signal; and the horizontal oscillator gets its power from the flyback. We have either invented perpetual motion, or have skipped something. As it turns out, there is one more stage needed to get this whole loop started in the first place.

Kick and trickle start circuits

The horizontal oscillator needs a starting voltage. There are two types of starters: A kick-start and a trickle apart. The type of starter used depends on whether the entire chassis is connected to the ac line directly (as with Admiral chassis) or whether the chassis is electrically isolated from the hot ground by the flyback transformer (as in RCA).

The "kick" start circuit used in RCA chassis supplies a small amount of voltage to the horizontal oscillator for just a few seconds after the receiver is turned on. This small power supply has its

own ac line isolation transformer to prevent electrical connection between the isolated chassis and the ac line. The primary of the transformer is connected between the unregulated B+ and a large electrolytic capacitor returned to "hot" ground. The transformer supplies an output only during the time the capacitor is charging. If the horizontal oscillator has not started by the time the capacitor is fully charged, the power supply loop is not completed and the receiver dies.

The second type of starting circuit is much less complicated because there is only one ground. A large ohmage resistor is simply connected between the unregulated B+ line and the

horizontal oscillator. The resistor will not supply enough current to operate the receiver, but will allow the oscillator to operate. The flyback output supplies power to the horizontal oscillator as soon as the horizontal oscillator has started, closing the power loop.

It is important to remember that there are two types of starting circuits because each will give a different symptom when we get to the safety shutdown circuits. The kick-start system only allows the oscillator to start once each time the receiver is turned on. You may hear a short audio rushing sound, or the crackle of high voltage when the receiver is first turned on, but there will be complete silence after that. The second type of starting

circuit, on the other hand, will allow the set to restart each time the shutdown circuit activates, resulting a "putt-putt-putt" sound as the audio and high voltage circuits are alternately turned on and off. These conditions provide a valuable troubleshooting clue we will use later.

Loops for safety

The shutdown circuits prevent the receiver from operating with unsafe conditions that either produce excessive X-radiation or are stressing expensive componets in the horizontal output stage. There are three basic types of shutdown circuits used. Some receivers use only one of these circuits, while others have all three types.

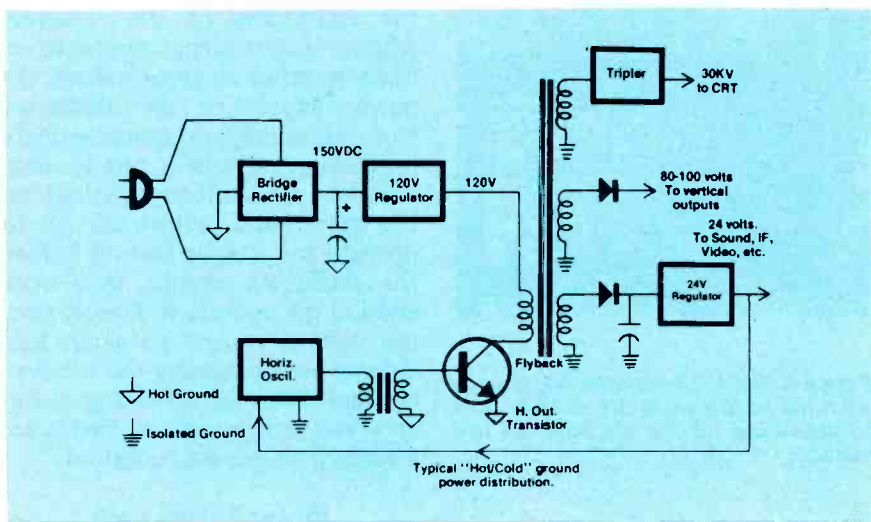

Figure 1. The horizontal oscillator, output stage and flyback form a closed loop to generate the low voltages needed by the receiver.

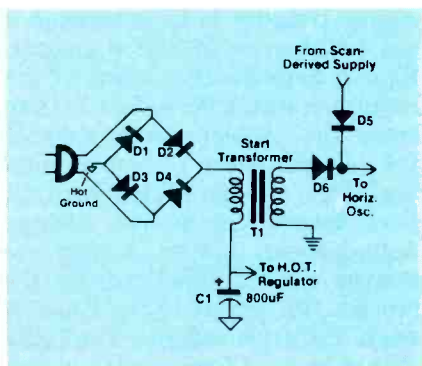

Figure 2. RCA's "kick start" circuit supplies low voltage B+ through the starting transformer only while the 150V filter capacitor charges. Diodes D5 and D6 prevent the start-up supply and scan-derived supply from interacting.

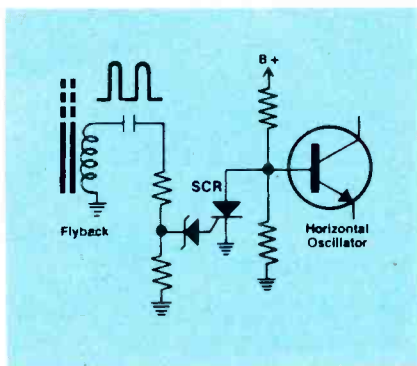

Figure 3. A typical shutdown circuit. If the pulses from the flyback are large enough to cause the zener diode to conduct, the SCR turns on, shorting out the horizontal oscillator.

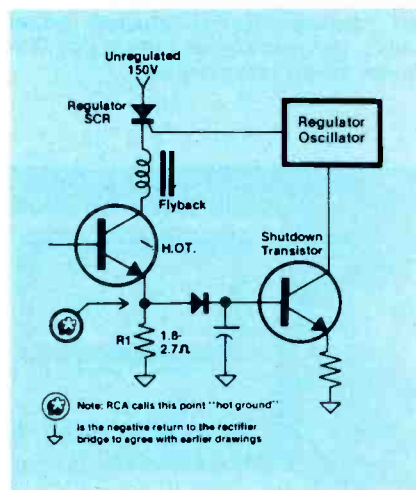

Figure 4. Increased emitter current in the output transistor causes a higher voltage drop in R1, causing the diode to conduct, turning on the shutdown transistor and killing the regulator oscillator.

Shutdown and startup

Killing horizontal oscillator

The most common type of shutdown circuit simply kills the signal running from the horizontal oscillator itself, or the output of the oscillator may be shorted to ground, preventing the signal from reaching the output stage. The circuit is activated by a pulse from the flyback transformer. This pulse will be below a given amplitude when everything is operating normally. The pulse will be too large if some condition causes the receiver to develop excessive high voltage. A level detector, triggered by the flyback pulse, turns on an SCR or transistor in the oscillator (or driver stage) to

kill the oscillator signal.

Kill output power supply

A second type of protection circuit senses the amount of current in the emitter of the horizontal output transistor. The circuit interrupts the regulated dc (by stopping the separate regulator oscillator used in these chassis) if the voltage across a small value resistor in the emitter circuit is too high. The receiver shuts down when the regulated supply is interrupted because the power supply loop is broken.

Horizontal frequency shift

RCA uses a third type of protec-

tion circuit (such as the CTC97 and similar chassis) that does not result in complete shutdown, but pulls the horizontal oscillator off-frequency to reduce the high voltage to a safe level. The circuit is triggered from any of three inputs; a sample of the 180Vdc supply, a sample of the CRT screen grid and focus voltages, and a sample of a pulse from a separate winding on the flyback transformer. The horizontal hold control has no effect if the circuit is activated.

Power supply or shutdown loop?

Figure 9 shows a functional analyzing troubleshooting guide (flow chart) for isolating shutdown and power supply problems with the PR57 ac Powerrite and the VA48 TV and Video Analyzer.

Notice that the first step is using the symptoms of the receiver, when it is first turned on, to determine whether to troubleshoot the power supply or the shutdown loop. Generally, a power supply problem results in a totally dead receiver. A shutdown problem, on the other hand, allows the set to operate for a split second before the shutdown circuits take over and kill the operation. Simply turn the volume control to about half volume before turning the receiver on, and listen for a rushing sound or a "put-put" symptom. Either indicates a shutdown condition.

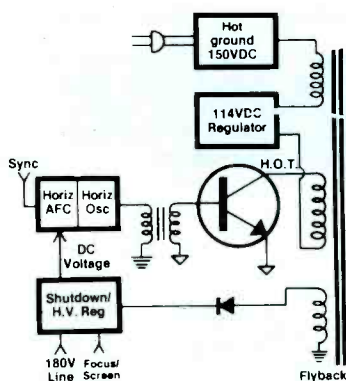

Figure 5. RCA chassis CTC97 and similar chassis have a third safety circuit that throws the horizontal oscillator off frequency if the detected flyback pulse, focus or screen voltages or 180V power supply is too large.



Figure 6. The PR57 isolates the chassis from the ac line while the VA48 is used to substitute for the scan-derived low voltage.

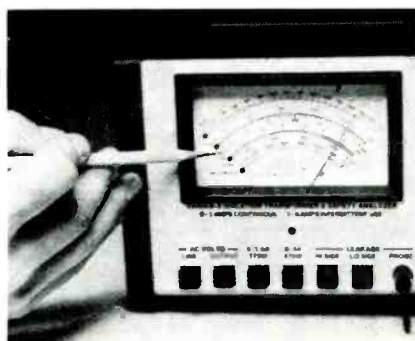

Figure 7. The current drawn by the receiver should be monitored on an ac current meter. High current consumption indicated problems in the output or flyback stages.

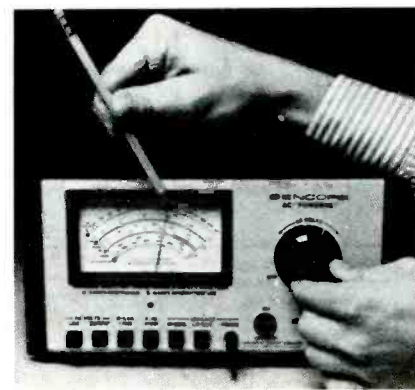

Figure 8. Reducing the applied ac voltage to 90V allows the startup circuits and unregulated power supply to operate, but reduces the output of the regulated supply below the normal output level.

Power supply path

The first step in isolating power supply troubles is to determine if the problem is in the regulator. Simply measure the output of the regulator with a dc voltmeter, and trace the problem back towards the ac input if the voltage is missing. If the voltage is present, your next suspect is the low voltage scan-derived power supply or startup circuit. Substitute for the low B+ Sub supply of the VA48 to see if operation returns. The PR57 should be used for isolation in this case.

If the receiver still does not operate, you know the problem is in the horizontal stages. Use the same VA48 troubleshooting procedures as in a conventional receiver to isolate the trouble.

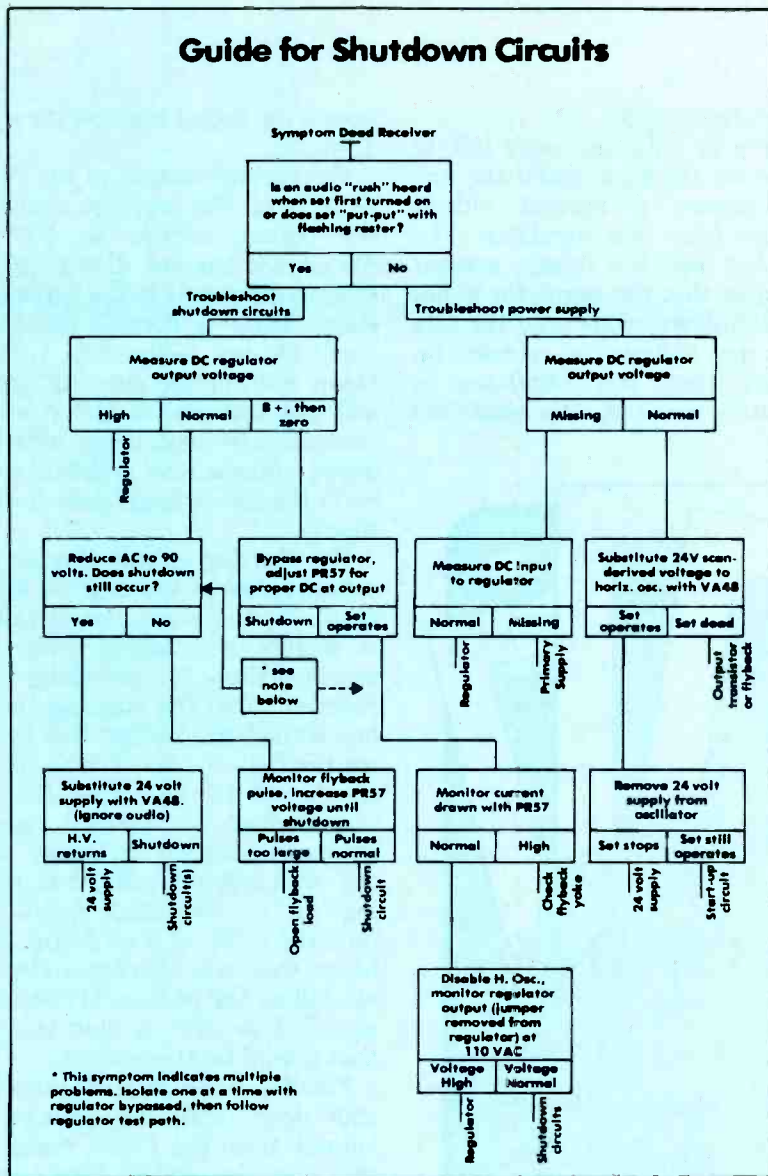

Figure 9. Functional analyzing troubleshooting guide for shutdown circuits.

If the receiver operates with the substitute voltage applied, leave the set turned on and disconnect the substitute dc voltage from the VA48. The scan-derived power supply is providing power if the set continues to operate without the external voltage, indicating the problem is in the start-up circuit. If, on the other hand, the set stops operating without the externally applied dc voltage, you know that the scan-derived power source is the problem.

Shutdown path

The shutdown path is a little more involved because there are several things that may be triggering the shutdown. The three most common problems are a defective

regulator, a defective shutdown circuit or a bad component in the horizontal output stages.

The first troubleshooting step is to measure the dc voltage at the regulator output. It is recommended that you use a meter such as the Sencore DVM37 with the TP212 Transient Protector Probe, or the DVM56 Microranger with the TP222 Transient Protector Probe because there may be high voltage spikes returning from the collector of the horizontal output transistor in some receivers.

A higher-than-normal voltage at the regulator output simply indicates a defective regulator. A normal voltage indicates problems elsewhere. A voltage of zero, however, requires an explanation

because it would seem that this is a power supply problem.

A zero voltage (after the original rushing sound) indicates that the regulator is putting out a voltage for a short period of time, and then shutting down. The next step in the flow chart indicates that the regulator should then be bypassed with a clip lead to break the regulator shutdown loop in order to locate the actual cause of the shutdown. It is recommended that you remove the regulator SCR or transistor from the circuit to prevent possible damage to the regulator itself.

You must carefully follow these steps to prevent damage to the receiver with the regulator bypassed:

1. Before turning on the set, adjust the output of the PR57 for 90V, using the ac output meter function.

2. Connect your dc voltmeter (with the TP212 or TP222 Protector Probe) to the bypassed regulator output.

3. Turn on the set and observe the dc voltage reading.

4. Slowly increase the voltage output knob on the PR57 until the meter connected to the regulator shows the normal dc output voltage.

Immediately switch the function of the PR57 to monitor the output current. If the measured current is higher than the normal current for the receiver, immediately turn the PR57 switch off. High ac current consumption indicates a problem, such as a shorted turn in the flyback, is responsible for the original shutdown condition. You may cause damage to the horizontal output transistor if the overload is allowed to continue. If, on the other hand, the current is normal, you must then determine whether the problem is in the regulator or the shutdown circuit itself.

To do this, start by disabling the horizontal output circuit by any of the following methods:

1. Remove the horizontal output transistor.
2. Pull the horizontal module, or
3. Disable the horizontal start-up circuit.

Shutdown and startup

Then, disconnect the jumper across the regulator transistor or SCR after reconnecting it to the circuit, and return the voltage output of the PR57 to the normal operating voltage. Finally, turn on the receiver and measure the regulator output. If it is higher than normal, suspect a bad regulator. If it is normal, troubleshoot the shutdown sensing and

switching circuits.

There is only one path left to follow on the flow chart: the one that shows a normal output voltage from the regulator. The fact that there is a voltage present indicates that the regulator is not in a shutdown mode, and the fact that the voltage is correct indicates that the regulator is operating correctly. We must then

isolate the actual cause of the shutdown.

The variable output of the PR57 helps here. We begin by reducing the output voltage to 90V to reduce the current drawn by the other components in the horizontal stage below a normal shutdown level. Do not reduce the voltage below 90V, or the starting circuit will not operate. If the receiver continues to shut down with reduced voltage, the problem could be in the low voltage scan-derived supply.

The starting circuit may be the actual cause of the original audio rush, but the scan-derived supply is simply not taking over the responsibility of powering the receiver after the start-up circuit has activated. Confirm this by using the Bias and B+ Sub Supply in the VA48 to substitute for the scan-derived low voltage supply. Proper operation indicates that the scan-derived voltage is missing. If, on the other hand, the receiver still shuts down, you know that the shutdown circuits are killing the horizontal oscillator signal. This path is then the one that should be troubleshot.

Finally, if the receiver does not shut down with the reduced ac voltage from the PR57, there are two possible causes. First, there may actually be a condition in the receiver that is leading to too much high voltage. This is confirmed by using your oscilloscope to measure the output of the flyback winding that is monitored by the safety shutdown circuits while the output of the PR57 is increased to the normal operating voltage. If the pulse becomes larger than the normal level shown on the schematic, you know that there is a high voltage problem, such as an open flyback load. If, on the other hand, the pulses do not exceed the normal level, and shutdown is occurring, you know that the shutdown sensing circuit is tripping too early, and must be corrected. *Never send a receiver to a customer with the shutdown circuits disabled, as severe damage to the receiver or excessive X-radiation may result.*



**You could be
making extra cash...**

**...and have the personal satisfaction
and prestige of having your work
published in a national magazine.**

Electronic Servicing & Technology, the new magazine for the electronics of today and the future is in need of technical servicing articles on audio and video consumer electronic products.

As a professional electronics technician, you could be making extra cash by submitting articles for publication to ES&T. You may think, "I know my stuff, but I'm no writer."

No problem.

Our expert staff will polish your original material and graphics into a finished product with your byline.

This is your opportunity to earn extra money, and also benefit your fellow technicians with your own expertise.

For more details, write or call:

DO IT NOW!

Bill Rhodes
Editorial Director
Electronic Servicing & Technology
P.O. Box 12901
Overland Park, KS 66212
(913) 888-4664

ES&T

COMPUTER STARS IN BAND

By John O'Brien

A recent electronic music festival in Philadelphia featured several bizarre bands, but it wasn't a guitar or a keyboard that stole the show — it was a computer!

The event was the second annual Festival of Performing Philadelphia Electronic Musicians at Temple University, and the Computer was a Commodore PET used by a band called the "Rubberheads." The Commodore PET was the first microcomputer introduced by Commodore Business Machines Inc. and is still one of their most popular small computers.

George Kuetemeyer "plays" the computer and other assorted electronic instruments for the Rubberheads, whose other members include singer/songwriter Scott Lomba on guitar, Mike Gunning on guitar and Jeff Lomba (Scott's seven-year-old son) on keyboards. Kuetemeyer usually uses the PET for a base and percussion effect and sometimes even hooks up a voice synthesizer for back-up vocals.

Kuetemeyer says that the voice effect is a real crowd pleaser. He programs the computer so that keys can be assigned a specific word. He can then push a key at the appropriate time in a performance for the desired effect. For example, he can assign the B key on the computer keyboard to say "baby, baby." Then, when the

singer says "baby," Kuetemeyer pushes the B key and the computer backs up the singer for an amazing effect. A "star" though it may be in the Rubberhead's act, Kuetemeyer admits that the PET "is not quite ready for lead vocals."

Kuetemeyer, who coincidentally works in the service department at a computer store (A. B. Computers in the Philadelphia suburb of Colmar) started playing electronic music with a home-built analog sequencer.

"It was fun but at that time still impractical for use in performances," said Kuetemeyer. "Now the effects I create with the microcomputer would be impossible with the sequencer."

Using the PET allows Kuetemeyer to store music on tape and play up to a 40-note sequence. Kuetemeyer's PET is hooked to a variety of electronic gadgets including an analog and percussion synthesizer. The computer is used to initiate sound events and provides the analog synthesizer with pitch information. A special sequencer program turns the PET into both a drummer and a bass player for the group.

Kuetemeyer chose the PET over other computers for a variety of reasons. "The PET is all-in-one including a CRT so I don't have to drag a television around," he said.

Other features that he enjoys include the built-in tone generator and CB2 sound that enable him to program in BASIC, yet another

benefit of the PET because many other microcomputers use far more complicated and time-consuming machine language.

Although he has been pleased with the PET, Kuetemeyer is still experimenting with different ways to get a new or better sound, even to trying to use a Commodore VIC 20 in its place. The VIC 20, which is the first full-featured color computer for less than \$300, can be hooked to any color television according to this innovative musician. "The VIC and a small 5-inch television can be packed into a briefcase, making it even more portable than the PET."

Kuetemeyer noted that another advantage of the VIC is on-board sound generation with four "built-in" voices. Three of these "voices" are for tones while the fourth is a "white noise" generator that helps create the sound effects for the VIC's video games.

Computers have entered virtually all areas of everyday life, and music may well be the next field where they make their mark, despite the fact that some people resent computers being used in the arts. They believe that they replace man's creativity, and that taped or preprogrammed music takes something away from a live performance. Artists such as Kuetemeyer, however, would argue this point, because although the music can be taped, it is manipulated at a live performance for a sound that is always unique and fresh. The computer can actually add to creativity by allowing the storage of an endless selection of variations of music on tape or disk.

In offices, homes, and schools, computers have and are continuing to revolutionize the way we work, live and learn. The use of microcomputers is becoming so widespread that a boy in the first row pointed at the computer being used by the Rubberheads onstage and said aloud in amazement, "Hey Mom, we have a computer just like that in school!"

ES&T



Musician George Kuetemeyer poses with the Rubberheads' drummer and bass player — a Commodore PET.

Learning

to talk

computer

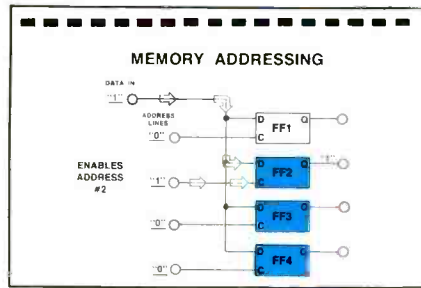

By Carl Bentz

So you finally convinced the family to let you buy a personal computer system to help around the house. Now all you have to do is make it do what you said would be possible. Although most system manufacturers do offer software (programs) for various home, personal and small business needs, there will always be aspects that you will want or need to change. You must learn to program your own computer. The sales person you dealt with should be able to point you toward a user group for the machine you bought. With advice from group members and manuals included with your computer you will find yourself writing programs soon.

A more generalized education

in programming can be acquired with a self-teaching course available from Heathkit. Designated the EE-3401 Microprocessor Self-Instruction Course, this Heathkit/Zenith effort provides a better understanding of computer operation. Ideally you will also get the ET-3400A Microprocessor Trainer and eventually the ETA-3400 Accessory. Doing so will provide you with a working system, albeit a limited one. Along with ten instructional units and reference materials, the package includes two cassette tapes and flipchart materials with a special group of components that may be used for experimentation with the trainer kit.

The Heathkit/Zenith EE-3401 Microprocessor Self-Instruction Course includes two cassette tapes and flipchart materials, some of which are shown here.

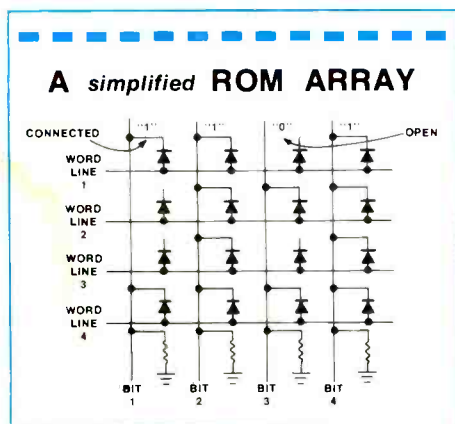
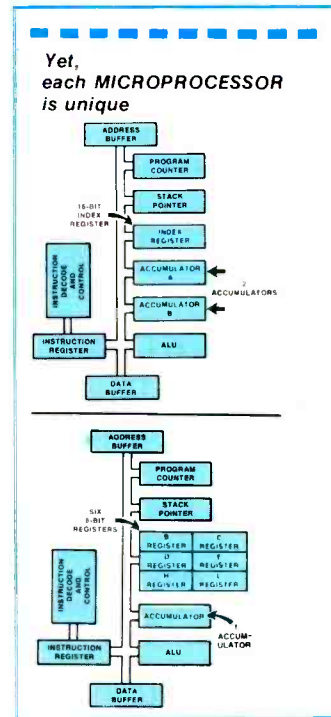
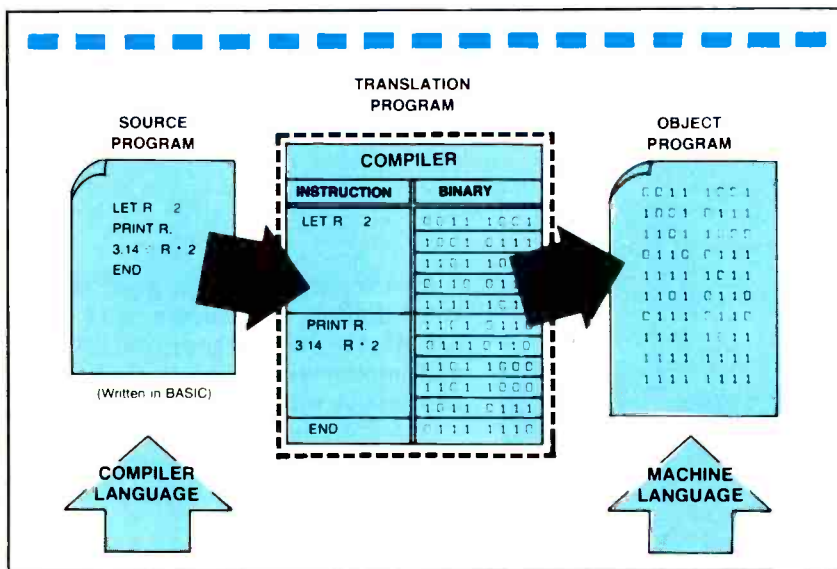

As you begin your education in programming, a manual such as the Heath/Zenith course will give a better understanding into the *why* than many systems programming reference guides. Interfacing (connecting the computer to the outside world) for various input and output devices (or other computers) involves three sections of the EE3401 course.

The course covers topics such as flow charts, machine language, assembly language, compiler language, binary systems and arithmetic operations.

Should you want your personal system to work for you around the house, the subject of interrupts is useful. An interrupt is a system by which the

computer may be told that it should stop doing whatever is currently in progress, check out what just happened outside and then act accordingly. Once the new project is completed, it may return to the original process.

Programming your personal computer is not difficult. It does require a logical approach to every problem to be handled, however, and for most people that is where the difficulty arises. Familiarization with the programming language to be used only takes time. Being logical is a constant learning process. Unfortunately if you're going to talk computer, that's one thing you'll have to learn.

ES&T

Answer to Quick Quiz

(from page 13)

by Wayne Lemons

Which bulb is brightest? An off-the-cuff answer might be that all three will have the same brightness (answer 1), because bulb A has power for half the time, while the other bulbs have half the voltage all the time. This sounds logical.

Then a perceptive technician will remember the 0.6V to 0.7V drop across a silicon diode, and that this voltage is subtracted from the positive peak that produces current. Therefore, the answer changes to number 2.

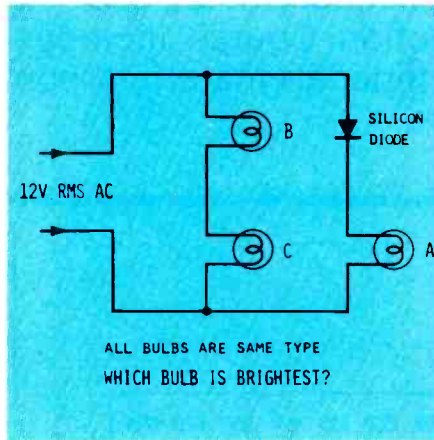

Both answers are based on Ohm's Law and diode action. However, one important basic has been overlooked: resistance of a light bulb changes with the applied voltage. The resistance variation is non-linear. Internal resistances of bulbs B and C are much higher with 6V applied than with 12V applied. Therefore, the current is decreased greatly.

The only correct answer is number 5 (bulb A is much brighter than each of the series-wired bulbs).

Quick Quiz...In depth

By Carl Babcoke, CET

These details prove the facts

The circuit of Quick Quiz #1 was tried with 4W, 120V bulbs and with automobile turn-indicator bulbs (Figure 1). The 120V bulbs had non-coiled filaments and showed bulb A about twice as bright as bulbs B and C. The 6V coiled-filament bulbs produced less difference, but again bulb A was much brighter than the other two (Figure 2).

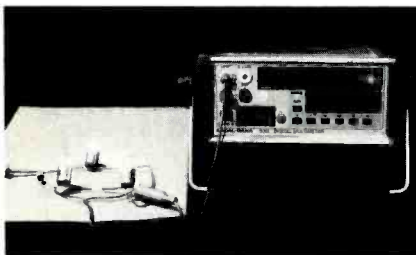
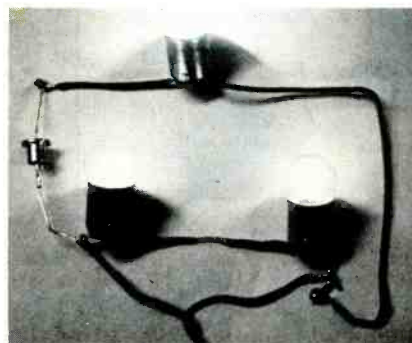

Figure 1 Three automotive-type bulbs were wired temporarily as shown in the schematic. The meter shown is a Racal-Dana 5½-digit model with True RMS voltage readings. A good 3½-digit DMM having average-responding ac voltages calibrated in RMS values was also used. True RMS readings provide better accuracy with non-sinusoidal waveshapes. Unfortunately, the specs did not say whether the ac-current readings were True RMS or average. Therefore, scope waveforms provided the most accurate answer in this case.



(A)



(B)

Figure 2 Comparative brightnesses of the three bulbs are shown in these photographs. (A) A normal-exposure photograph shows the wiring and components but does not reveal brightness differences of the bulbs. (B) A darker photograph proves bulb A is much brighter than the other two.

An excellent scope, a good service digital multimeter and a 5½-digit laboratory digital multimeter were used to find out why bulb A was brighter.

Unfortunately, a comparison of voltages and currents measured by digital multimeters (Table 1) was not conclusive.

Better results were obtained from waveforms of a dual-trace scope. Figure 3 shows the 12V-source versus the bulb-A waveforms. As expected, only the positive-peak amplitude (less about 0.6V drop in the silicon diode) was applied to bulb A. Therefore, the applied *peak* voltage was less than half the supply voltage. There was no proof in this test.

A comparison of the *peak-voltage* waveforms of bulb A versus bulb C (Figure 4) finally solved the mystery. Peak-to-peak voltages of the two waveforms were nearly identical (Figure 4A). That is interesting, but does not prove anything because the bulb A voltage and current are dc while the bulb C voltage and current are ac (Figures 4B and 4C). The dc power is obtained from zero voltage to maximum positive (or negative) versus zero current to maximum positive (or negative) current. The ac voltages and

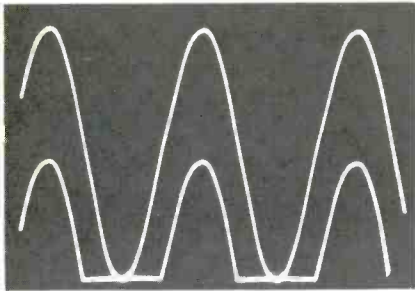

Figure 3 The largest amplitude waveform (sinewave) is the 12V RMS input voltage, and the half-wave waveshape is the voltage waveform across bulb A. The bulb-A waveform was exactly half of the input waveform less about 0.6V drop across the diode. Normal current flowed through bulb A during these positive peaks, but no current flowed during the negative peaks. Therefore, the brightness should have been 50% of that obtained direct from the 12V supply.

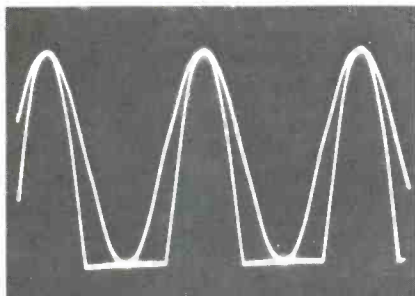
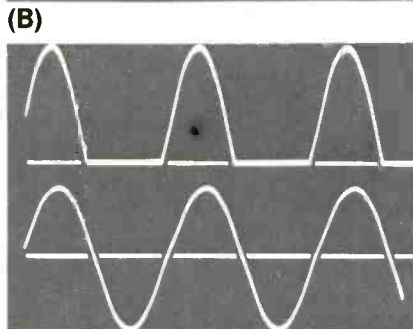
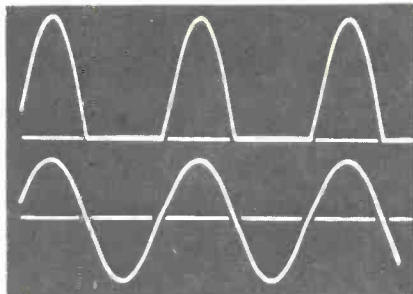

Figure 4 (A) A comparison of the bulb C sinewave and the bulb A positive-peak waveform shows they have almost identical amplitudes in peak-to-peak voltage. **(B)** Zero-voltage lines have been added by the scope to the bulb-A waveform (top trace) and the bulb-C waveform (bottom trace). The bulb-A waveform has slightly higher amplitude than the other, although an optical illusion makes the sine wave appear to be taller. **(C)** The top trace shows bulb A current, and bulb C current is shown by the bottom trace. Zero-voltage lines have been added by the scope to both waveforms.



power (for resistive linear loads) are obtained from the zero-voltage point at the center to each peak in turn.

Another important point to remember is that with a resistive linear load, doubling the voltage also doubles the current, giving four times the wattage. Therefore, only a small increase of voltage and current through bulb A has the effect of a much larger increase of power, which determines bulb brightness. Aiding this power gain is the bulb effect that reduces the bulb resistance when the power is increased. Therefore, with bulbs for loads, two separate gains of power (and consequent brightness) are obtained from a moderate original increase of voltage. Study the Figure 4 waveforms with these thoughts in mind.

Voltages and currents of three bulbs

Bulb	5½-digit RMS V	3½-digit average V	average current
#A	6.10V	6.12V	0.345A
#B	5.93V	5.91V	0.393A
#C	6.06V	6.04V	0.393A

Note: Voltage source was 12.03V RMS.

Table 1 Two acV digital multimeters gave these readings of the three bulbs. Rapid variations of the line voltage prevented using full accuracy of either meter. Analysis of these figures is inconclusive. Bulb A has slightly higher

voltage but lower current than the series bulbs. Meters are not accurate when the waveshapes are non-sinusoidal or phase shift between voltage and current is present.

**People
of all ages die of
heart disease
and stroke.**

Give the gift of love.



**American Heart
Association**

WE'RE FIGHTING FOR YOUR LIFE

NEW PRODUCTS

Modulation meter

The 8210 modulation meter, from *Boonton Electronics Corporation*, automatically calibrates both AM and FM channels each time power is applied. As a result of this self-calibration, AM accuracy is 1% of reading, from 10% to 90% AM, for carrier frequencies from 2MHz to 520MHz and modulation frequencies of 50Hz to 5kHz. FM accuracy is also 1% of reading for deviations up to 150kHz, carrier frequencies of 2MHz to 1.5GHz, and modulation rates of 50Hz to 5kHz. Modulation frequencies from 30Hz to 15kHz are accepted on both AM and FM channels with degraded accuracy.

Tuning and leveling are fully automatic with the 8210. The instrument acquires the largest signal present at the input connector and adjusts its local oscillator



Circle (15) on Reply Card

and measurement channel gain to indicate the fully calibrated AM or FM on a 3½ digit display. Selectable 3kHz and 15kHz loss-pass filters are standard, as is a 750µs de-emphasis switch.

Cassette deck cleaner

Allsop Inc. has introduced a new version of its audiocassette deck cleaner.

The new Allsop 3 Ultraline cassette deck cleaner model #71300 becomes the company's basic audiocassette cleaner. The Allsop 3 uses a dual gear-driven

wiper arm that cleans an area 50% larger than previous Allsop cleaners.

The dual gear-drive assures uniform performance, even in three motor decks, and decks with take-up reel sensors.



The new virgin wool felt pads are encased in precision-molded cartridges, making replacement of the capstan, pinch roller and head cleaning felt pads quick and simple.

Circle (17) on Reply Card

Sweep function generator

Exact Electronics Inc. has announced the release of a new 20MHz 100,000:1 LOG sweep function generator with frequency markers.

The model 528W has a frequency range of 0.001Hz to 20MHz and produces sine, square, triangle, positive square and negative square waveforms from the main generator. The auxiliary ramp is also available through the main output amplifier.

In the sweep mode, the ramp generator is used to internally sweep the main generator up or down linearly (up to 1000:1) or logarithmically (up to 100,000:1). The start and stop frequencies are independently settable and both may be easily set and measured using the RUN/HOLD and TRIGGER/HOLD positions of the ramp mode switch. The main generator



frequency can be manually swept linearly up to 3 decades or logarithmically up to 5 decades using the start frequency outer dial. A VCF input allows external control of frequency over a 5-decade range in the log mode and a 3-decade range in the linear mode.

Circle (20) on Reply Card

Wiring and crimping tool

Vaco Products Company's #1963 wiring and crimping tool crimps non-insulated and insulated terminals, strips 22-10 gauge wire, cuts wire with an end-position nose cutter, and slices six popular sized bolts.

Features include cushion grip



Circle (18) on Reply Card

handles, clearly marked gauge settings and a black oxide finish for resistance to rust and corrosion.

Cable/connector combinations

Shure Brothers Inc. has announced that six different types of Shure microphone cable/connector combinations are now available, each packaged in colorful and informative display packs.

The display card in each package is printed with illustrations and descriptions of all six of the Shure cable/connector combinations available in pre-packaged form so



consumers may select exactly which combination best suits their needs. Information on each combination includes type of microphone connector, type of equipment connector, type of cable jacket, cable length and number of conductors.

Circle (19) on Reply Card

Projection television

Kloss Video Corporation introduced a new video projection system at the 1982 Winter Consumer Electronics Show in Las Vegas. Called the Novabeam model two, the new portable video projector, intended for use in a darkened room, produces a bright, clear, 5-foot color TV picture on any flat white wall, without the special curve projection screen required by previous projection systems.

Controlling ambient room light allows a 5-foot flat image appearing 4-feet from the projector that can be watched at full picture brightness from any point in the room.

The Novabeam model two



weighs about 60 pounds and is smaller than most 19-inch color portables. It is a video projection monitor with direct video and audio inputs for any program source with video and audio outputs, including VCRs, component TV tuners and videodisc players. The monitor design eliminates the cost of a TV tuner, and permits the greatest flexibility in the viewer's choice of program sources and video accessories.

Circle (21) on Reply Card

TV wire dispenser

New from Channel Master is the Feeder-pak Professional TV Wire Dispenser. Consisting of a compact carton that eliminates the need for setup, tensioning devices or dereeling stands, the Feeder-pak dispenser feeds wire out quickly, smoothly and cleanly from a



non-rotating coil. The wire will not run-on, tangle, loop or kink, and payout stops as soon as you stop pulling.

The dispenser cartons protect wire stock from dirt and damage and when empty, fold up easily for quick disposal.

Circle (22) on Reply Card

Printed circuit board holder

O.K. Machine and Tool Corporation introduces its versatile printed circuit board holder, PCBH-10. Ideal for work on either side of printed circuit boards, this PCB holder has a recessed base for mounting in a vise, or may be af-

fixed directly to a workbench by using the two screws supplied. Self-adjusting jaws hold any size PC board for stuffing or soldering.

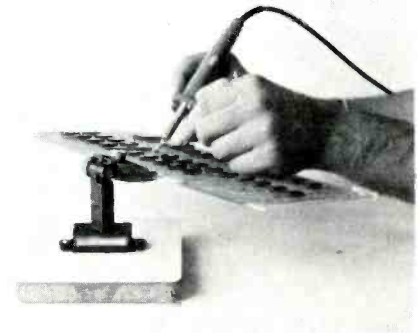

For maximum flexibility and convenience, the board can flip over more than 180 degrees, rotate a full 360 degrees, and stop in any position.

Circle (23) on Reply Card

Parabolic satellite antenna

Downlink Inc. unveiled the home satellite TV Skyview III parabolic antenna and the Skyview III system at the Winter Consumer Electronics Show in Las Vegas.

The Skyview III antenna is a 10-foot fiberglass parabolic designed for low-cost shipping and assembly. It can be shipped anywhere by air freight (the largest piece is 4' x 5'), transported by ordinary pickup truck and hand-carried by elevator to the roof of hotels, office buildings, etc. No training or special tools are required for assembly, according to Downlink.

The antenna also has better protection against wind (125-mile load rating), rough handling and weather than conventional aluminum construction, according to the manufacturer. The antenna weighs 530 pounds, including mount.

Circle (24) on Reply Card

Frequency sweep generator

Leader Instruments Corporation recently introduced a new test instrument for accurate audio frequency equipment evaluation. The unit, designated the model LSW-115 is an audio sweep/marker generator with response curve storage. The com-



For the man that would rather fix it himself – **Technical Publications has service manuals designed for you!**

SES-13 Small (Air Cooled) Engines Service Manual. \$9.95 (336 pages). You can service your own engines on lawnmowers, tractor sprayers and other power equipment. Special section on fundamentals, troubleshooting, preventive maintenance. Step-by-step instructions.

WLMS-1 Walking Lawnmower Service Manual \$7.95 (128 pages). The **complete** guide to the care and repair of your walk-behind, push-type lawnmower. Exploded views and diagrams.

CSS-6 Chain Saw Service Manual. \$8.95 (over 300 pages). Here's everything you need to know to tear down, repair, reassemble and adjust most popular chain saws. A truly **complete** chain saw manual.

GSM-1 Small AC Generator Service Manual \$7.95. A brand new manual that contains maintenance, service and troubleshooting procedures, as well as wiring schematics for most generator models. Covers electrical powerplants under 8kW that generate alternating current and are driven by air cooled engines.

OS1-8 Outboard Motor Service Manual Volume 1 \$8.95 (236 pages). Covers motors below 30 hp.

OS2-8 Outboard Motor Service Manual Volume 2 \$8.95 (232 pages). Covers motors with 30 hp and above. Both Volumes 1 and 2 provide detailed fundamentals on periodic servicing.

Put these books to work on your own equipment... (Or service outside equipment for profit!)

- Small (Air Cooled) Engines Service Manual
- Walking Lawnmower Service Manual
- Chain Saw Service Manual
- Small AC Generator Service Manual
- Outboard Motor Service Manual (Vol. 1)
- Outboard Motor Service Manual (Vol. 2)

Remittance must accompany orders of less than \$25.00. **Postage paid when payment accompanies order.** Allow four weeks for delivery.

How to send money: The best way to send money is your own personal check, post office money order, express money order or by bank draft or check. DO NOT SEND CURRENCY OR STAMPS.

- Check Money Order Enclosed
- Ship C.O.D. (No C.O.D.s outside of U.S.)

Missouri and Kansas Residents add 4% sales tax.
 Tennessee Residents add 6% sales tax.

Write for a free catalog covering our entire line of service manuals and wheel-type tractor service manuals.

VISA MASTERCHARGE
 Credit Card Number _____
 Expiration Date _____

Please Print:

Name _____

Street _____

City _____

State _____ Zip _____

Signature _____

**Technical
 Publications**

Division
 Intertec Publishing Corp.
 P.O. Box 12901, Dept. ES
 Overland Park, KS 66212
 (913) 888-4664

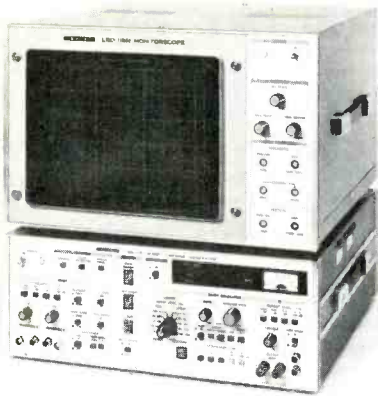

The monitor is designed to display the logic status of any device or combination of devices that have TTL, CMOS or compatible signal levels. The LCD screen instantly displays the logic status of each pin in any ROM, RAM, microprocessor or MSI/LSI chip.

The LM-4 can also be wired into a computer bus when fitted with two optional 16-pin IC test clips for comparison testing between known, "good" ICs and questionable ICs. It can also be used as a clip-on display for micro, mini



and special-purpose computers during testing, set up troubleshooting and design.

Circle (28) on Reply Card

Digital multimeter accessories

The *John Fluke Manufacturing Company Inc.* has announced the availability of four new accessories for their low-cost digital multimeter line: two high-frequency ac probes, a 6kV high-voltage probe and a touch-hold probe that saves DMM readings.

The 83RF and 85RF RF probes provide a dc output for high-frequency ac inputs from 0.25V to 30V rms. Therefore, they can be used with virtually any Fluke dc voltmeter. The 83RF's rated bandwidth is 100kHz to 100MHz. The specified frequency response is $\pm 1.0\text{dB}$, 100kHz to 100MHz. Accuracy is $\pm 1.0\text{dB}$ above 1V input, $\pm 1.5\text{dB}$ below 1V input.

The 85RF is an extended-frequency version of the 83RF with a

bined sweep generator and detector provides a stable display by using digital storage technology.

The unit is designed primarily for use in observing the frequency response characteristics of a wide range of audio equipment. It uses a digital waveform storage system to provide stable displays at single or slow sweep rates, eliminating CRT blooming problems often associated with high persistence phosphors. Response curves may be reproduced on an X-Y recorder, where hard copy is required, or on any X-Y module.

Circle (25) on Reply Card

Satellite TVRO

Comtech Data Corporation has designed a new satellite TVRO receiver. Designated the RCV 650,



it is patterned after the popular RCV 550. Features include down-converter mounts at the antenna, self-contained DC block, separate LNA power supply, LED channel readout, digital channel select and remote control capability.

Circle (27) on Reply Card

Logic monitor

The LM-4, a 40-channel logic monitor specifically designed to simultaneously monitor up to 40 pins of a DIP IC, has been introduced by *Global Specialties Corporation*.

APPLIANCE REPAIR BOOKS



Thirteen Handbooks written in easy-to-understand language by experts in the service field with illustrations and diagrams! Acclaimed by instructors and professionals alike! How to diagnose and repair air conditioners, refrigerators, washers, dryers, ranges, microwave ovens, dishwashers, vacuum cleaners, electrostatic air cleaners, RV gas appliances, hair dryers, motors, water heaters, coffeemakers, can openers, floor polishers, steam irons, food mixers, lawn care appliances, electric knives, electric and digital clocks and many others. Also fundamentals of solid state, setting up a shop, using test instruments and more. Only **\$2.65 to \$4.90 ea.**

SEND FOR FREE PRICE LIST

Gamit, Dept. ES

110 W. St. Charles Road,
Lombard, Illinois 60148

Circle (7) on Reply Card

It's no puzzle to order Oelrich Service Forms



For TV-radio and two-way radio service—legal forms for Calif., Florida and Utah. Now at parts jobbers or write for cat. B64.

OELRICH PUBLICATIONS

4040 N. Nashville Ave., Chicago, IL 60634
Now call toll-free! 800-621-0105

Circle (8) on Reply Card

Your ad gets quick results. Advertise in classifieds.

bandwidth of 500MHz. Frequency response is $\pm 0.5\text{dB}$ from 100kHz to 100MHz, $\pm 1.0\text{dB}$ from 100MHz to 200MHz and $\pm 3.0\text{dB}$ from 200MHz to 500MHz. Accuracy is $\pm 0.5\text{dB}$ for inputs $\geq 0.5\text{V}$, $\pm 1.0\text{dB}$ for inputs less than 0.5V.

For users who need to make high-voltage measurements, the 80K-6 high-voltage probe extends the voltage measurement capabilities of any Fluke ac/dc multimeter to 6000V dc or peak ac. Accuracy is $\pm 1.0\%$, dc to 500Hz and $\pm 2.0\%$, 500Hz to 1kHz.

Circle (26) on Reply Card

VHS tape

Prompted by the growing demand among professional videographers for improvements in 1/2-inch video picture quality, *US JVC Corporation* is introducing High Grade (HG) VHS videotape. The tape, available in 60 and 120 formats, provides better picture



and sound than conventional VHS tape, according to Dan Roberts, Professional Video Division manager.

The video signal-to-noise ratio of HG tape is +2.5dB, 3dB greater than conventional VHS videotape. The color signal-to-noise ratio also shows a gain of 3dB, to +2.8dB. Because of these dramatic improvements, HG video recordings are, in many instances, comparable to recordings produced on 3/4-inch equipment and tape.

HG videotape's improved audio characteristics result from an increase in sensitivity to +0.3dB. Higher overall magnetic energy improves both recording and playback on the sound track.

Circle (29) on Reply Card

Anti-static spray

Chemtronics Inc. has announced the availability of Static Free, anti-



static spray for use in the computer room.

Static electricity can degrade system performance resulting in costly downtime," stated Louis Friedman, Chemtronics vice president. "Years of exhaustive tests have resulted in a uniquely effective product that neutralizes and eliminates static electricity throughout the computer room environment."

Static Free, which neutralizes static build-up generated by friction and low humidity conditions, is safe for use on plastics, paper, cloth, rubber coatings and finishes. It may be used to eliminate static and its accompanying dust and dirt on data entry terminals, visual display terminals, magnetic tape and disc drives, computer printers and decollators, CRT screens, disc surfaces and anywhere else static build-up is a problem.

Circle (30) on Reply Card

Digital multimeter series

A. W. Sperry Instruments Inc., a national marketer of electrical/electronic test equipment, has designed the AWS Easy-Meter

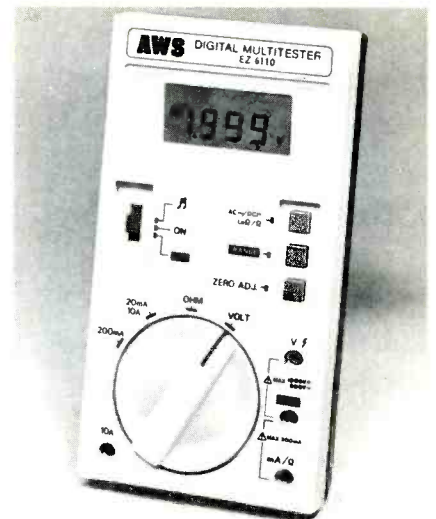

series of hand-held digital multimeters.

Features include autoranging on volts and ohms, 3 1/2-digit display, 10mm-high numerals, automatic indication of units and signs, autopolarity, overrange indication, safety fused on Ohms and mA, low battery warning, audio tone continuity buzzer (EZ-6100 and 6110), normal and low power ohm ranges, range hold (EZ-6100 and 6110), shock-resistant ABS plastic housings, pocket size and up to 300 hours continuous use.

Circle (31) on Reply Card

3-inch color television

Matsushita Electric Industrial Company Ltd. has developed a color TV set using a newly designed 3-inch color picture tube. The new model, TH3-W3V, is small and portable (4.5"x3.4"x9.2"), lightweight (3.3 lbs.), and power consumption is rated at 9.5 W.

Because the new model is equipped with video input/output terminals, it can operate as a color video monitor for personal viewing or a video tuner when connected to a video camera and a portable



VTR, respectively. The television operates on ac power, car batteries and on optional rechargeable batteries for viewing at home, in a car or boat, or any outdoor setting.

Circle (32) on Reply Card

Tear gas dispenser

The S34 Burglarmist tear gas dispenser has been announced by *Mountain West Alarm*. This type of burglar deterrent is of special interest to gun and jewelry stores, owners of remote houses and other high security risks. To date, Burglarmist has stopped every



break-in where used, according to the manufacturer.

On alarm, the protected premises immediately become uninhabitable, before property is removed or damage is done. The compact (2"x2"x7") package contains 4 ounces of humane, non-lethal tear gas that protects up to 2000 square feet of enclosed area.

The basic mechanical model operates when 5 ounces of pull is applied to the trigger line. Other models available can be activated by 6 or 12Vdc. A 20-second delay model is also available.

Circle (33) on Reply Card

Circuit board holder

The *Fraser Co. Inc.* has announced the availability of a new printed circuit board assembly holder, the Wybar model WY-10.

The WY-10 is a compact, self-contained, bench-mounted fixture for the production assembly and soldering of components onto printed circuit boards.

The board holder uses a main frame on which spring-loaded, grooved guide rails slide, enabling different-sized circuit boards to be mounted quickly and precisely. All adjustments are made by the use of thumbscrews; no tools are re-

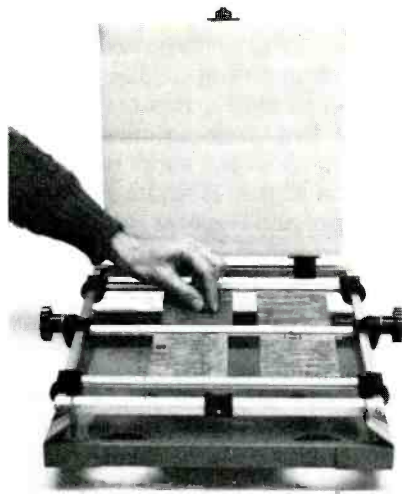

quired. The spring-loaded guide rails mean that once the fixture is set for a certain size board, no further adjustments are required for repetitive use. After the insertion of components into the PC board already in the fixture, a hinged, foam-lined lid incorporated in the unit is lowered and secured over the PC board. The whole frame, including the lid, is then rotated 180° to expose the underside of the printed circuit board for the cutting of component legs and hand soldering.

Circle (41) on Reply Card

Conductive tote boxes

For complete protection of static sensitive PC boards and devices from electrostatic discharge, *C. R. Daniels Inc.* now offers stackable Dandux conductive tote boxes in a variety of convenient sizes.

Daniel's high-density polyethylene conductive totes have a surface resistivity less than 30,000 Ω /sq. Volume resistivity is less than 3000 Ω /cm. For maximum protection against electrostatic discharge, snap-in lids made from low-density conductive polyethylene are available to create a Faraday cage.

Solidly constructed, modular totes feature bottom corner lugs that permit safe, secure stacking with or without snap-in covers. Boxes without lugs are also available if storage space limitations are not a problem.

Circle (38) on Reply Card

ES&T

NATIONAL ELECTRONIC

NESDA

SERVICE DEALERS ASSOCIATION, INC.

Your **KEY** to **SUCCESS**

NESDA OFFERS

- A National Certification Program
- National Recognition
- Government Representation
- Business Contacts
- Purchase Discounts
- Low Bankcard Rates
- Educational Materials
- Industry and Business Information

PLUS

- A Subscription to "ServiceShop" Magazine and Yearbook

Please send more information about:

NESDA, 2708 West Berry St.
Ft. Worth, TX 76129

name _____

address _____

city _____ state _____ zip _____

business _____

FREE CATALOG

Burglar/Fire Alarms



Controls • Wireless Components
• Ultrasonic • Microwave • Infrared • Sirens • Bells • CCTV
• Locks • Safes • Fire Systems

Mountain West Dept. ES-3

4215 N. 16th St. Phoenix, Ariz. 85016 800-528-6169

Circle (9) on Reply Card

**Want
MORE Information
on Advertised
Products?**

Just refer to the
Bingo #
beneath each
ad. Circle the
appropriate
number on the
Reader Service
Card in the
back of this
issue. **Complete
the remaining
information and
mail!**

**NEW
LITERATURE**

A new 64-page Industrial Tubes Product Guide, TPG-200L, featuring data on the design and per-



formance characteristics of the complete line of RCA Industrial Tubes is now available.

A publication of **RCA's Distributor and Special Products Division**, the new product guide features a ratings-and-characteristics section that groups tubes by major product application, a replacement directory that matches industry tube types with direct or similar type RCA replacements and a reference material section that contains additional technical data and supply sources for associated tube components.

Circle (38) on Reply Card

Continental Resources has issued its 1982 Electronic Instrumental Rental Catalog. The release of this 64-page, more than 1500-item catalog, comes with Continental's 20th year of operation in its field.

The catalog, with its extensive

listings of analyzers, generators, meters, oscilloscopes, recorders and telecommunications equipment, expands its inventory even further this year to include updated models by such manufacturers as Fluke, Hewlett-Packard, Tektronix and General Radio. Also listed is a wider selection of CATV products, microprocessors, diagnostic emulators and test sets. All items appear with full specifications and monthly rental rates, and are available for immediate delivery. Instruments are fully tested, calibrated and guaranteed to meet manufacturers' specifications, while adhering to all NBS certification regulations.

Circle (39) on Reply Card

The Immunized Computer discusses ac power line problems and the ways to correct these problems to ensure stable ac power.

The publication, from **Gould**, includes a brief discussion on problems, causes and solutions, along with an estimate on the total cost for the solution.

Circle (40) on Reply Card

ITT Pomona Electronics has published a 108-page catalog of test accessories for use in electronic equipment.

The 1982 Pomona Electronics catalog includes more than 450 black and white photographs and 30 drawings of such test ac-

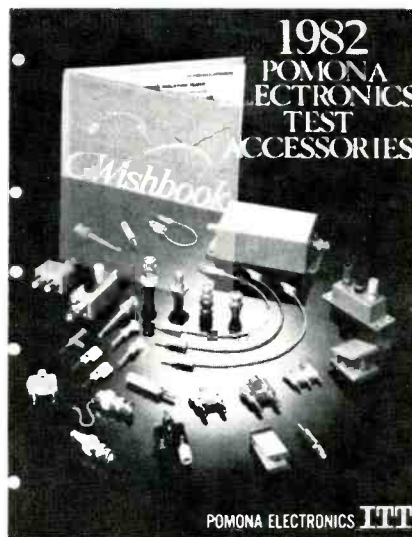

cessories as banana plugs, jacks and patch cords; phone tip jacks, plugs and connecting cords; test clips, probes and holders, binding posts, black boxes and sockets.

Also included in the catalog is an order form for special request quotations; assembly procedures for BNC and triaxial cables; metric and temperature conversion charts; cable and wire description charts; and electrical data.

Circle (41) on Reply Card

A new 160-page catalog of professional hand tools and occupational protective equipment is now available from **Klein Tools**.

This special 125th-anniversary



edition of the Klein catalog contains a huge selection of general-purpose and specialized tools and protective equipment for electrical and electronic workers; linemen, telecommunications installers, miners and industrial maintenance and iron workers.

Catalog #125 is organized for easy reference and fully indexed both alphabetically and by product catalog number. All tools and equipment are illustrated with photographs and drawings. Many illustrations use enlarged section views for added clarity of special features.

Circle (42) on Reply Card

The Rush Wire Stripper Division of the **Eraser Company** has published a new catalog on their

line of wire-stripping equipment for use in the electrical and electronic industries.

The 36-page catalog outlines technical specifications and operating details on a complete range of wire preparation equipment. The Rush line includes automatic wire cutters, strippers and twisters, which can be bench-mounted for production as well as a full line of hand tools and accessories. The catalog also contains a tear-out instruction form for free sampling services.

Circle (43) on Reply Card

General Instrument Corporation's CATV and MATV Antennas catalog is available through the company's TACO Division, describing the full range of J-series, C-series and broadband parabeam antennas available, including the new cantilever-mounted models.

The 15-page catalog details electrical and mechanical specifications, performance characteristics, construction features and applications of the antennas for UHF, VHF and FM reception. Black and white photographs support the descriptive copy for each model and illustrate the construction of each with and without the optional cantilever mount.

Circle (44) on Reply Card

A. W. Sperry Instruments Inc., marketer of portable electrical and electronic test equipment, has issued a new short form catalog

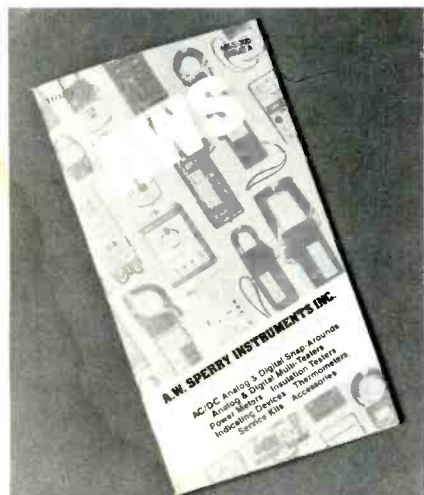

featuring the full line of AWS instruments.

The new catalog (MES-300—Issue A) contains detailed specifications on the A. W. Sperry line of digital and analog snap-around ammeters, digital and analog multi-testers, power meters, insulation testers, voltage indicators, thermometers, and accessories. The accompanying price sheet (RPL-18C—Issue C) lists the suggested trade prices along with instructions on how to purchase A. W. Sperry instruments.

Circle (60) on Reply Card

A new edition of the annual **Consumer Electronics Service Technician Replacement Parts Handbook** has been published by the Parts Subcommittee of the **Electronic Industries Association's Consumer Electronics Group Service Committee (EIA/CEG)**.

Prepared for the exclusive use of the servicer, the 65-page booklet offers a comprehensive inventory control and ordering system, including necessary forms and order sheets. It also provides a list of locations where parts are available for the consumer electronics products of EIA/CEG member companies.

Circle (45) on Reply Card

A new 8-page short-form catalog describing 37 new products is available from **ILC Data Device Corporation**.

Technical data and specifications for analog-to-digital, digital-to-analog, synchro-to-digital and resolver-to-digital converters are noted. Other products listed include data bus products, sample/hold and track/hold amplifiers, control transformers, industrial products and synchro instruments.

Circle (46) on Reply Card

A 4-page catalog giving complete details of its new line of microprocessor crystals is available from **Capar Components Corporation**. In addition to the frequency, load capacitance, drive

ATTENTION TECHNICIANS

- ★ JOB OPENINGS
- ★ MONTHLY TECHNICAL TRAINING PROGRAM
- ★ BUSINESS MANAGEMENT TRAINING
- ★ LOW COST INSURANCE
- ★ CERTIFICATION
- ★ TECHNICAL SEMINARS

All of this in a nonprofit international association for technicians

FIND OUT MORE:



R.R. 3 Box 564
Greencastle, IN 46135

ES&T

classified

ads

are well-read.

Use them at a

low-cost

insertion.

level and maximum effective resistance of each crystal the company manufactures, the catalog gives suggested applications for each and information on cross-referencing their crystals with those of other major manufacturers.

The catalog also gives standard specifications for the line, with information on how to obtain tighter specifications, as well as special frequencies.

Circle (48) on Reply Card

Weico Wire & Cable, manufacturer of cable, braid, wire and tubing products, is offering a new Belden/Weico Cross-Reference Guide featuring the full line of Weico wire and cable products and their Belden equivalents.

The Belden/Weico Cross Reference Guide is a comprehensive listing of cable, braid and wire available from the two companies. The cross reference consists of a

2-color, 2-column chart listing Belden part numbers and the corresponding replacement Weico part number. Equivalents are easily found by locating the required wire type and, opposite it, the equivalent type. Part numbers are listed numerically for easy location.

Circle (49) on Reply Card

Exact Electronics Inc. has released a catalog that covers a complete line of function generators, sweep generators, materials test generators, current and voltage calibrators, IEEE-488 programmable signal sources, pulse generators and associated accessories.

The catalog contains complete information on options, rack-mounting, worldwide sales and service centers and ordering. Thorough specifications on each model offered are included, along with a convenient model-vs.-

EXACT
electronics, inc.

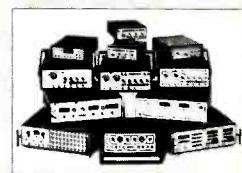

OUR 2nd Year

features instrument selection chart.

Circle (58) on Reply Card

A concise overview of variable persistence oscilloscope technology is covered in a new application note from **Hewlett-Packard**. Application Note 314, with 10

ELECTRONIC
Servicing & Technology

is Available in
MICROFORM

FOR INFORMATION
WRITE:

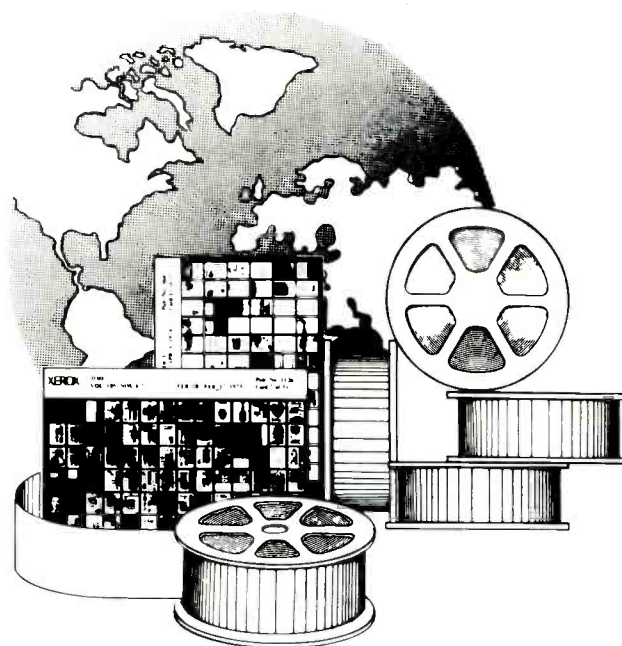

University Microfilms International

300 North Zeeb Road
Ann Arbor, Mich. 48106
U.S.A.

18 Bedford Row
London, WC1R 4EJ
England

drawings, diagrams and graphs, provides discussions on:

- Monitoring a microprocessor data bus line
- Comparing variable persistence scopes with digital storage and conventional oscilloscopes
- Step-by-step analyzing of the storage process, erasure techniques and methods of achieving fast stored writing speed.

Circle (55) on Reply Card

RCA Distributor and Special Products Division has revised and updated its *Cross Reference of TV Modules* for RCA TV chassis by dividing it into two volumes, for easier use.

Volume I (Form 1F4786 REv. 9/81) covers older color chassis CTC46A through CTC92W and b&w chassis KCS176 through KCS203V. It is intended that this volume be retained by service dealers because it will not be re-

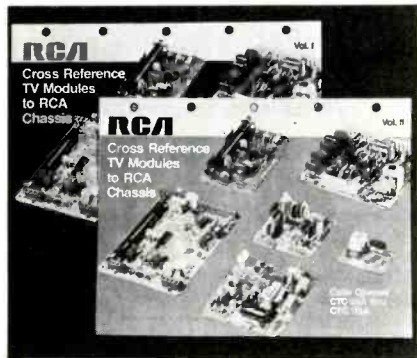

printed. Volume II (Form 1F6870) covers color chassis CTC93A through CTC115A and will be updated in the future as required.

Both volumes cross reference the modules in three different listings: stock number to module designation, module designation to stock number, and chassis to circuit.

Circle (65) on Reply Card

Personal Computer Products Inc. is offering *The Personal Computer and Calculator Catalog* for 1981/1982. The catalog, designed for the industrial/professional user, displays a limited selection of personal computers for the business market.

The models described include

personal computers, program-mables, scientifics, business/financial, printer/display and accessories. Several companies' products are included.

Circle (66) on Reply Card

A free 144-page catalog of hard-to-find tools for electronic assembly and precision mechanics is available from **Jensen Tools Inc.**

Major categories covered are micro-tools, test equipment,

JENSEN 1981-82 CATALOG



soldering equipment, tweezers, screwdrivers, cutters, drafting supplies, power tools and a complete line of tool kits and tool cases. Many of the tools are illustrated with full-color photographs.

Circle (50) on Reply Card

A 44-page catalog giving complete details of its line of capacitors and resistors is now available from **Capar Components Corporation.**

In addition to describing numerous new capacitor and resistor products, the catalog details the extended range of the company's lines of electrolytic, film and ceramic capacitors, as well as their design engineer kits, consisting of selected capacitances and voltages of various types of capacitors.

Circle (59) on Reply Card

ES&T

**Now, more than ever
... Men who KNOW say...**



IS THE ANSWER

**HELP NATESA HELP YOU
BY DOING YOUR PART**

Are YOU the operator of an ethical, professional caliber tv-radio-home electronics service business?

Write for details on how you can gain great benefits and participate in the destinies of this great industry.

NATESA
5930 S. Pulaski Road
Chicago, Illinois 60629

SAVE TIME

For fast, accurate service, please remove the Peel-Off Label (which is used to address your magazine) and affix it to the Reader Service Card, the Address Change Card, or to any correspondence you send us regarding your subscription.

THE MARKETPLACE

Advertising rates in the Classified Section are 50 cents per word, each insertion, and must be accompanied by cash to insure publication.

Each initial or abbreviation counts a full word.

Minimum classified charge \$10.00.

For ads on which replies are sent to us for forwarding (blind ads), there is an additional charge of \$3.00 per insertion to cover department number, processing of replies, and mailing costs.

Classified columns are not open to advertising of any products regularly produced by manufacturers unless used and no longer owned by the manufacturer or distributor.

For Sale

FREE

THE GREAT ELECTRONIC THINGS & IDEAS BOOK!

HUNDREDS OF UNUSUAL PARTS, GADGETS & IDEA ITEMS. UNAVAILABLE IN STORES OR CATALOGS ANYWHERE! Bargain prices on everything! New items in every issue! Rush postcard for your copy!

ETCO ELECTRONICS
Dept. 311
Plattsburgh, N.Y. 12901.

Circle (10) on Reply Card

AUTOMOBILE RADIO and tape replacement parts: Delco, Chrysler, Philco-Ford, Motorola, Panasonic and many others. Large inventory. Laran Electronics, Inc., 3768 Boston Road, Bronx, NY 10469. (212) 881-9600, out of New York State (808) 223-8314. 5-79-tf

TV & RADIO TUBES, 36 cents EA!! Free color catalog. Cornell, 4221 University, San Diego, California 92104. 8-76-tf

ELECTRONIC SURPLUS: CLOSEOUTS, LIQUIDATIONS! Parts, equipment stereo, industrial, educational. Amazing values! Fascinating items unavailable in stores or catalogs anywhere. Unusual FREE catalog ETCO-011, Box 762, Plattsburgh, N.Y. 12901. 6-78-tf

SCRAMBLED TELEVISION, encoding/decoding. New book. Theory/circuits. \$9.95 plus \$1 shipping. Workshop, Box 393ES, Dept. E, Bethpage, N.Y. 11714. 7-80-tf

PRINTED CIRCUIT boards from your sketch or artwork. Affordable prices. Also fun kit projects. Free details. DANOCINTHS INC. Dept. ES, Box 261, Westland, MI 48185. 5-81-tfn

PICTURE TUBE REBUILDING EQUIPMENT capable of producing four high quality tubes per day (WILL TRAIN TO OPERATE). Call or Write Atoll Television, 6425 Irving Park, Chicago, Illinois 60634, ph. 312-545-6667. 10-81-6t

RADIO-TV TUBES INCLUDING ANTIQUES! Many tubes thought to be obsolete are still being manufactured. Write for free discount price sheet of over 1,800 types. Electronic Parts Co., 1015 S. Escondido Blvd., Escondido, CAL 92025, (714) 741-2300. 1-82-6t

FOR SALE (Cont.)

PICTURE TUBE REBUILDING EQUIPMENT—Three Welch 1402 vacuum pumps, three diffusion pumps, one 5KW Bombarder, Pierce, Route 4, Box 255, Enterprise, Ala. 36330. 3-82-3t

USED COLOR TV YOKES removed from working chassis. Send complete information including mfg. part numbers. Enclose certified check or money order for \$24.50 plus \$7.00 postage and handling. Maurer TV, 29 South 4th St., Lebanon, PA 272-2481. 3-82-1t

THREE TYPES OF DECODERS. Details, stamp. Trojan Enterprises, 2920 Shelby, Indianapolis, Indiana 46203. 3-82-1t

INDIVIDUAL PHOTOFAC T FOLDERS under 1100. Postpaid \$3.00. Loeb, 414 Chestnut Lane, East Meadow, NY, 11554. 3-82-3t

GUIDE TO FINDING SERVICING INFORMATION—\$2. Useful in locating hard-to-find diagrams and data. Free catalog describes our ten publications; Sams, Supreme and Rider manuals; lots more. ARS Electronics, 646 Kenilworth Terrace, Kenilworth, Illinois 60043. 3-82-1t

Business Opportunity

TV TECHNICIAN! Increase your income up to \$60,000 yearly. Rent-lease-sell TVs new-used, even from comfort of your home. Basic Preliminaries \$4.00. Perrys TV Systems, 1467 Hwy. 90 West, Milton, FL 32570, 904-994-0068 12-81-tf

COMPUTERIZE YOUR ENTIRE TV OPERATION. GL-AP-AR-INV. Tubes—Parts—Customer—Vendor & TV rental files-programs. Start small & add to later. For Apple TRS80-NEC-Heath-Zenith. Free details. Perrys Computer Systems, 1467 Hwy 90 West, Milton, FL 32570. 904-994-0068. 11-81-tf

SOUTH FLORIDA TV SERVICE business for sale. Established same location over 20 years. Buy inventory and phone number and move right in. P.O. Box 159, Boynton Beach, Fl. 33435. (305) 734-6121. 2-82-2t

Help Wanted

TV and 2-way Technicians wanted. \$15K to \$22K per year. Benefits include employee stock purchase plan, in the largest Retail Service Center in Northwest Kansas. Friendly community, good schools, short drive to the Rockies. Equal Opportunity Employer. Miller's Electronics Inc., Goodland, KS 67735. 913-899-2386. 10-81-tfn

GET COMPLETE DETAILS

about the products
advertised or described
in this issue.

Use Free Inquiry Card.

ADVERTISERS' INDEX

Reader Service Number	Page Number
5 Automated Production Equipment Corp.	11
1 The Cooper Group	IFC
ETA	65
10 ETCO	68
7 Gamit Enterprises	61
12 General Electric Tube Products Div.	17
11 Keithley Instruments Div.	1
13 Lockheed Electronics	11
9 Mountain West Alarm Supply	63
NESDA	63
NATESA	67
8 Oelrich Publications	61
4 PTS Corp.	8
14 Philips ECG	34-35
RCA Distributor & Special Products	4-5
13, 14 Sencore, Inc.	BC
6 Simpson Electric Co.	7
2 Zenith Radio Corp.	IBC

ELECTRONIC

Servicing & Technology

Advertising Sales offices

NATIONAL SALES MANAGER

Greg Garrison
P.O. Box 12901
Overland Park, KS 66212
Phone: (913) 888-4664

LONDON, ENGLAND

John Ashcraft & Co.,
John Ashcraft
12 Bear Street, Leicester Square
London WC2H 7AS, England
Phone: 930-0525 Telex: 895-2387

AMSTERDAM, Holland

John Ashcraft & Co.
John J. Lucassen
Akerdijk 150A
1171 PV-Badhoevedorp, Holland
Phone: 0-2968-6226 Telex: 18406 HARKE NL

TOKYO, JAPAN

International Media
Representatives, Ltd.
Sumio Oka
2-29, Toranomon 1-chome
Minato-ku, Tokyo 105, Japan
Phone: 502-0656

NORWOOD, AUSTRALIA

Williamson & Associates Pty. Ltd.
P.O. Box 419
Norwood S.A. 5067, Australia
Phone: 42-7074

TAIPEI, TAIWAN. R.O.C.

Antony Liu
Long Life Advertisement Agency Co.
P.O. Box 17-134
Taipei, Taiwan. R.O.C.
Telephone: (02) 561-6629
Cable: Photop Taipei

a line of antennas as strong as its name
in time for your peak selling season

ZENITH

CHROMATENNA II T.M.

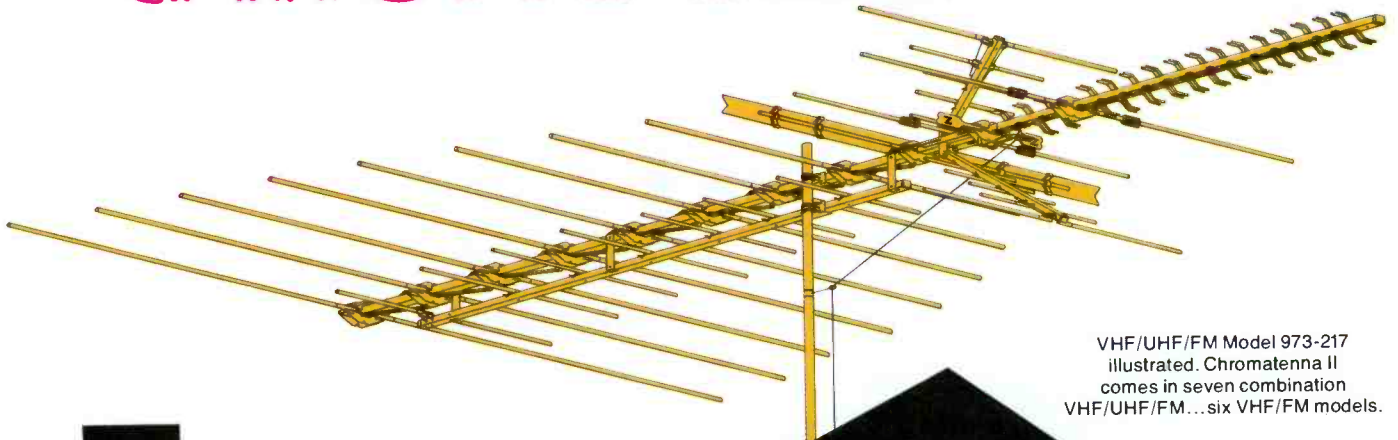

VHF/UHF/FM Model 973-217 illustrated. Chromatenna II comes in seven combination VHF/UHF/FM...six VHF/FM models.



Transmission Line Termination bleeds off static charges thru antenna system ground. Terminal stub improves front to back ratio on lower channels.



Aluminum Construction of all key metal parts works to eliminate rusting — provides long life. **Golden-Color Alodine Finish** is conductive — helps improve electrical performance!



High-Impact Plastic Insulators double-lock each element to the boom for extra bracing and durability.



FM Block reduces FM gain up to 12dB. Remove to receive full FM gain.



Wide-Spaced, Heavy-Duty Feed Lines help prevent shorting from heavy build-ups of snow or ice.



Dual Isolator Bars insure no loss of UHF to VHF signal transfer. (Combination models only.)



Strain Relief Insulator accommodates either 300-OHM twin-lead, Foam lead or Coax downlead.



U-Bolt Mounting provides a larger clamping area; larger locking nut with teeth an integral part assures a more rugged U-BOLT arrangement.



Corner Reflector Bracket enlarged and re-located in most models.



Optional Break-away UHF Wing Directors provide maximum gain of standard UHF channels with optional coverage of Hi UHF channels and translator frequencies when broken off. (Combination models only.)



Zenith Dipole on UHF. (Combination models only.)



VHF Colinear Directors provide extra signal boost on both low and high band VHF.



Proximity Spaced Signal Balancer (2 elements) provides automatic taper control of periodic driver, improves impedance matching and signal leveling on both Lo and High band channels. Improves Channel 7 pattern.



Loading Straps — metal plates close to first VHF element insulators provide compensation for Lo and High band by tuning the first driven element with extra capacity.



Rugged 1" Square Boom provides extra strength compared to many round-type booms.



Sleeved Elements of heavy-duty construction afford extra bracing and protection.



Hi-Bracket with angled ends for added strength.

Zenith has quality easy-to-install antenna kits — UHF only, VHF YAGI and Stereo FM antennas as well as a complete line of reception aid equipment. See your Zenith distributor for news of his exciting money-making programs and Catalog No. 902-2019!

ZENITH
The quality goes in before the name goes on®

Zenith Radio Corporation / Service, Parts & Accessories Division / 11000 Seymour Avenue / Franklin Park, Illinois 60131

Circle (2) on Reply Card

Now Cut Your TV-VCR Service Time Absolutely In Half.

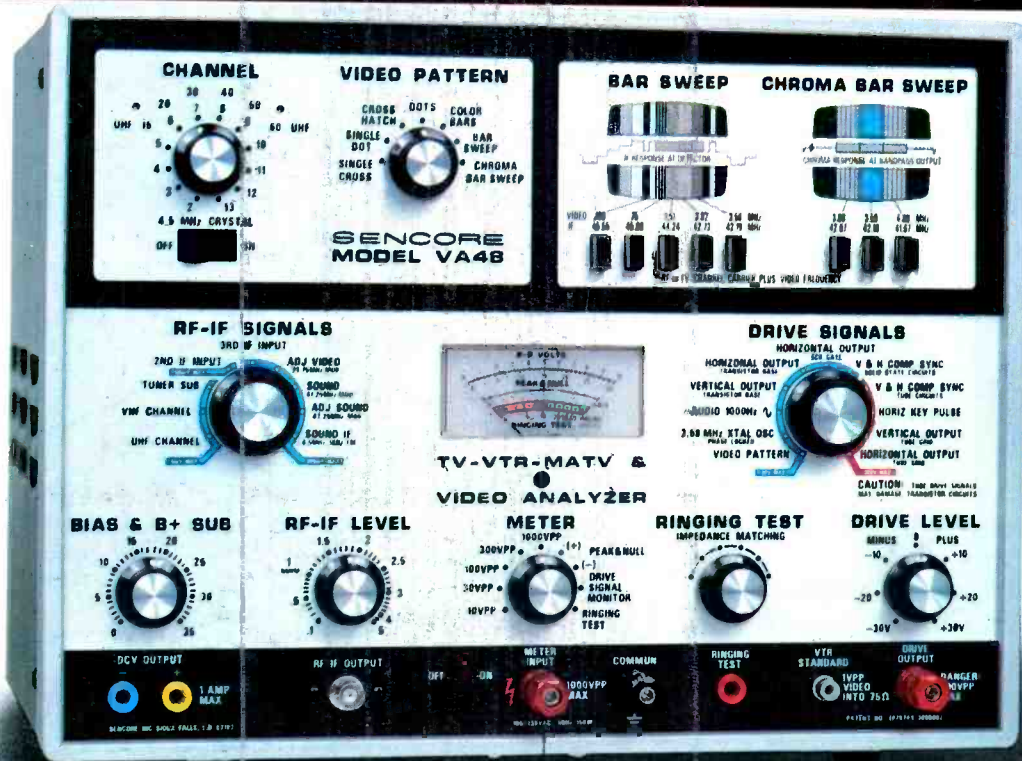

\$1395

It's a fact. You WILL cut your service time in half with a Sencore VA48 Video Analyzer. Over 1500 VA48 owners nationwide report an average time savings of 54%! These techs quickly and easily learned the VA48's Signal Substitution Method of troubleshooting. It's the key to DOUBLING your service output.

How it works. Our double-patented Signal Substitution Method lets you inject known good signals from the VA48 into any stage of a TV or VCR. If you get a good picture, you know everything is working from that point forward. You back up stage by stage until the defect appears on the

screen. You then know you are injecting into the defective stage. It's just that simple, and only the VA48 provides ALL signals necessary to inject from antenna to CRT. It literally cuts your service time in HALF.

The new industry standard. 22,000 VA48 users know this video analyzer is the new standard of the industry. So do manufacturers who are specifying the VA48's patented Bar Sweep patterns on their schematics. Look in Sams Photofact schematics. The VA48 Bar Sweep is there, too.

We DOUBLE Guarantee the VA48. We're so sure you'll cut your

TV-VCR service time in half, we offer your money back in 30 days if you're not absolutely satisfied. PLUS, when you call now, you'll receive a FREE copy of Bob Goodman's new \$18.95 best seller, "Practical TV Troubleshooting With A Video Analyzer." It's yours to keep FREE regardless.

Call toll free. Call now to order or to talk about the VA48 features with a qualified Sencore engineering representative.

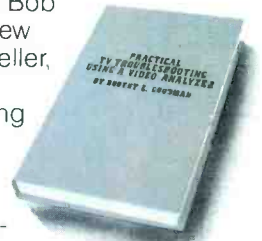

SENCORE

3200 Sencore Drive, Sioux Falls, SD 57107 605/339-0100 TWX: 910-660-0300

For More Information or To Order Phone Toll-Free **1-800-843-3338**

In Alaska, Hawaii, and Canada, phone collect: 605/339-0100

For Information Circle (13) on Reply Card
For Demonstration Circle (14) on Reply Card