

For industrial maintenance and consumer servicing professionals

August 1981  \$2.25

# Electronic Servicing

**1982  
consumer  
electronics**



**The industrial  
technician of  
the future**



**NEW!**

**WP-709.  
Double-slot  
Supplyst™  
power supply.**

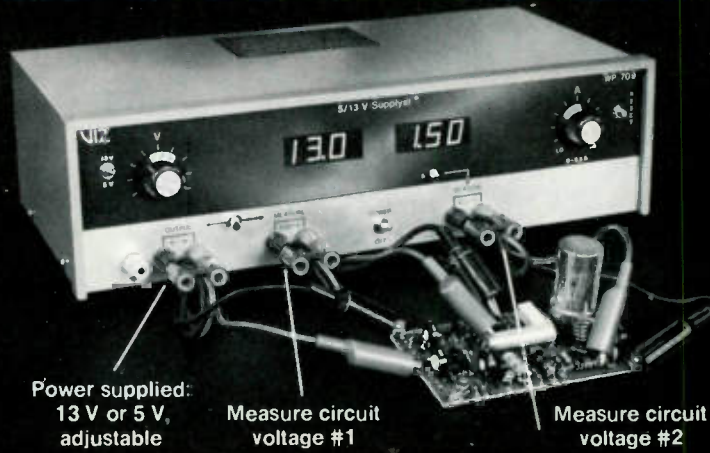

Power supplied:  
13 V or 5 V,  
adjustable

Measure circuit  
voltage #1

Measure circuit  
voltage #2

Outputs: 5V or 13V DC,  
adjustable  $\pm 1\frac{1}{2}$ V  
Zero to 7.5 amp, each voltage.

Two LED displays,  
monitor V or A—  
or two DC voltmeters  
Adjustable current limiting

Only  
**\$299.75.**

# DC power to test logic or mobile equipment. Another VIZ Value

## HERE'S REAL PRECISION

Select the precise voltage you want: 5V or 13V, adjustable  $\pm 1\frac{1}{2}$ V at each range. Output is laboratory quality. Ripple less than 10mV, peak to peak. Regulation better than 0.1%.

## HERE'S REAL POWER

Up to 7.5 amp. at each voltage—

plenty for computer circuits, PA systems, mobile transmitters, autos, boats, planes.

## HERE'S REAL CONVENIENCE

Front panel controls for instant voltage adjustment and precise fine adjustment to within 0.1V. Two 3-digit LED displays permit continuous

monitoring of both voltage and current during use. Current limiting control with instant pushbutton reset.

The WP-709 is like two precision power supplies for a price less than you might pay for one—PLUS two digital DC voltmeters.

## VIZ Supplyst™

power supplies with digital displays of voltage and current



**WP-705 \$289.95**

Single output  
0-50VDC, 0-2A.



**WP-707 \$374.75**

Dual output  
Two 0-25VDC, 0-2A.

Fully regulated, adjustable current limiting power supplies, PLUS two built-in digital DC voltmeters in a single quality unit. Digitally monitor output voltage or current, or two external voltages.

**WP-706 \$295.95**

Single output  
0-25VDC, 0-4A.



**WP-708 \$424.95**

Triple output Two 0-20VDC, 0-2A.  
One 5VDC, 0-4A.



## VIZ DC power supplies

Fully regulated, continuously adjustable voltage outputs with short circuit protection. Analog meters and overload indicators.



Dual WP-702A Two 0-20VDC, 0-200mA **\$150.75**

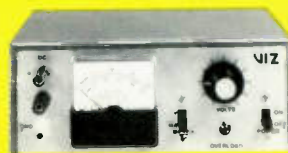

Single WP-703A  
0-20VDC, 0-500mA **\$107.00**



Single WP-704A  
0-40VDC, 0-250mA **\$117.55**

### VIZ RELIABILITY

VIZ is a 50 year-old company. Our instruments are fully warranted, parts and labor, for a year. All items tested to NBS standards. We offer service and parts availability for a minimum of ten years. Over 15 repair depots in U.S.A.

Want full technical details and a demonstration? Call toll-free. 1-800-523-3696, for the VIZ distributor nearest you

# VIZ

**Look to VIZ for value, quality, availability.  
Over 70 instruments in the line—PLUS full accessories.**

VIZ Mfg. Co., 335 E. Price St., Philadelphia, PA 19144

Circle (1) on Reply Card



## Electronic Servicing

Editorial, advertising and circulation correspondence should be addressed to: P.O. Box 12901, Overland Park, KS 66212 (a suburb of Kansas City, MO); (913) 888-4664.

### EDITORIAL

Bill Rhodes, *Editorial Director*  
Carl Babcoke, *Consumer Servicing Consultant*  
Rhonda Wickham, *Managing Editor*  
Lynn Chamberlain, *Associate Editor*

### ART

Dudley Rose, *Art Director*

### CIRCULATION

John C. Arnst, *Director*  
Evelyn Rogers, *Manager*  
Dee Manies, *Reader Correspondent*

### ADMINISTRATION

R. J. Hancock, *President*  
Cameron Bishop, *Publisher*

### ADVERTISING

Greg Garrison, *National Sales Manager*  
Mary Birnbaum, *Production Manager*  
Mark Raduziner, *Marketing Coordinator*

Regional advertising sales offices listed near Advertisers' Index.

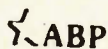

Member, American Business Press



Member, Audit Bureau of Circulation

ELECTRONIC SERVICING (USPS 462-050) (with which is combined PF Reporter) is published monthly by Inter-tec Publishing Corp., P.O. Box 12901, 9221 Quivira Road, Overland Park, KS 66212. Second Class Postage paid at Shawnee Mission, KS 66201. Send Form 3579 to P.O. Box 12901, Overland Park, KS 66212.

ELECTRONIC SERVICING is edited for technicians who repair home-entertainment electronic equipment (such as TV, radio, tape, stereo and record players) and for industrial technicians who repair defective production-line merchandise, test equipment, or industrial controls in factories.

Subscription prices to qualified subscribers: one year \$12, two years \$19, three year \$24 in the USA and its possessions. Foreign countries: one year \$17, two years \$27, three years \$35. Subscription prices to all others: one year \$25, two years \$50 in the USA and its possessions. Foreign countries: one year \$36, two years \$72. Single copy price \$2.25; back copies \$3.00. Adjustment necessitated by subscription termination to single copy rate. Allow 6 to 8 weeks delivery for change of address. Allow 6 to 8 weeks for new subscriptions.

**INTERTEC PUBLISHING CORP.**  
©1981 All rights reserved.

Our new model 128 has a beeper and a whole lot more. After you've seen it we think you'll agree that this is the best all around field service DMM available. It beeps on all three functions—V,  $\Omega$  and A—and on all ranges for each function. Applications are virtually unlimited. It "displays" a standard digital readout, an audible tone for rapid over/under checks and an over/under arrow.

# The sound choice.

Unique 128 design enables you to verify forward conduction and reverse blocking of semiconductor junctions, test LEDs and check multiple junction components. Even with the beeper on, the 128 maintains 10M $\Omega$  input resistance. You can calibrate both the beeper threshold and the A/D without disassembling the instrument.

The 128 is human engineered with a large, 0.6" display, rugged ABS case and display window, 350-hr battery life and overload protection.

Much less versatility can cost much more than \$139.

The 128 is the sound choice because it's the smart buy. Contact your local Keithley representative or distributor.

Nothing less than the best.

## KEITHLEY

Keithley Instruments, Inc.  
28775 Aurora Road/Cleveland, OH 44139  
(216) 248-0400 / Telex: 98-5469

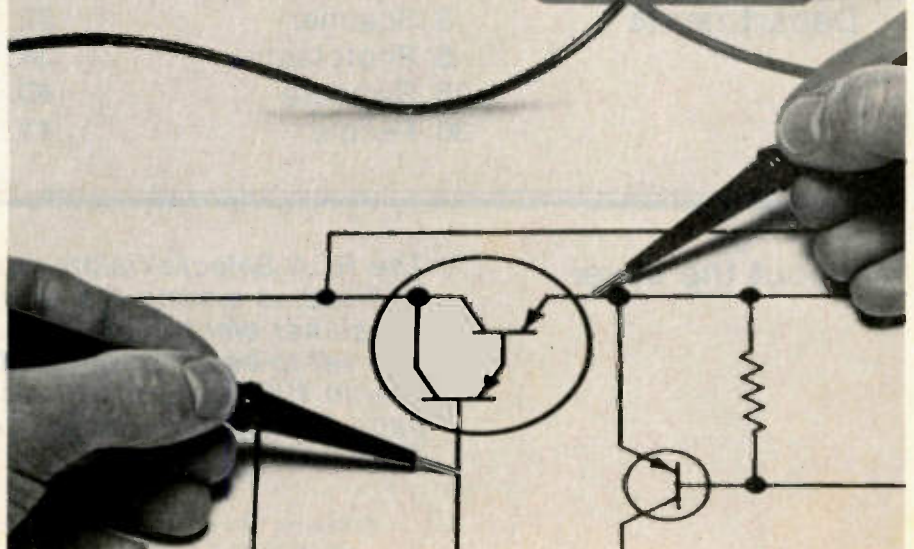
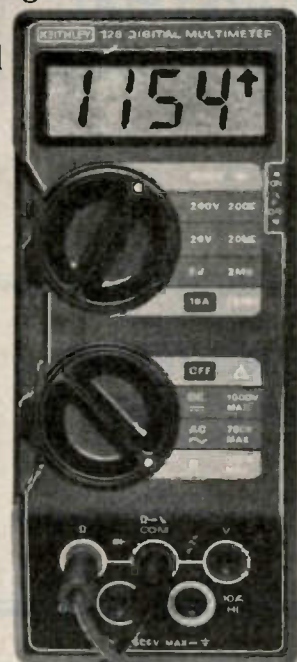

Circle (2) on Reply Card



# Electronic Servicing

August 1981 □ Volume 31, No. 8

---

## INDUSTRIAL MRO

### 18 Logic analysis techniques for testing digital circuitry

*By Pat Whitty and John Huber*

Logic analyzers, used to service micro-processors and microcomputers, are emerging as the oscilloscope of the digital equipment world.

---

## CONSUMER SERVICING & INDUSTRIAL MRO

### 22 The industrial technician of the future

*By John E. Cunningham*

Digital and optics technology, among others, will be standard fare for the electronics technician of the future

### 27 Reports from the Test Lab

*By Carl Babcoke, CET*

The Keithley model 135 and the Triplet model 3450 digital multimeter are discussed.

---

## CONSUMER SERVICING

### 6 What's new in 1982 consumer electronics

*By Carl Babcoke, CET*

Trends in 1982 home-entertainment products are discussed, along with sales and technical information from major manufacturers.

---

## Departments

3 Scanner	32 Reader's exchange
5 Photofacts	34 Product report
25 Symbure	40 Test equipment
30 People	41 Catalogs & literature

---

## About the cover

*The RCA SelectaVision videodisc player, model SFT-100, is among the recent additions to the consumer electronics field. For more about new and yet-to-be-released products, see, "What's new in 1982 consumer electronics" starting on page 6. Photo courtesy RCA Consumer Electronics Division.*



# electronic scanner

## EIA/CEG issues consumer study

Recently, Jack Wayman, senior vice president, Electronic Industries Association/Consumer Electronics Group, announced the availability of Phase I of an audio consumer market study titled, "Purchase and Ownership Patterns of Home and Car Audio Equipment," an EIA/CEG - commissioned, \$100,000 study conducted by Market Facts Inc., a consumer research organization.

Phase I of the study is based on the findings from a 25,000 consumer mail panel household survey with 68.8% response and covers a broad range of product ownership patterns. Three product categories are targeted, namely home, personal and car audio. Copies of Phase I are available for \$35.00 each to cover printing and handling from the EIA Marketing Services Department, 2001 Eye Street NW, Washington, DC 20006. Telephone (202) 457-4955.

## Videodisc study finds real user requirements

Strategic Inc. has announced the release of the third in a series of reports covering the developing optical storage system (videodisc) industry. The report reveals that potential users rank the technology's high density and low media costs as their primary reasons for wanting to purchase units. Also, random access, long media life, digital and video capabilities and high data transfer rates were ranked in descending importance.

The results are based on 30 in-depth interviews with prospects for optical storage systems for archival and computer storage systems applications.

The report also details the diversity of applications for which the videodisc is immediately usable, ranging from the entertainment production industry, through the data processing/data storage industries, and through real estate and government data collection.

Explosive developments in the

consumer and institutional videodisc player markets are covered, and an assessment of the impact of optical storage systems on competing products, especially magnetic and photographic, is provided.

The report also examines recent setbacks in the industry. For example, RCA, which recently introduced its \$499 CED product for the consumer and home market, is believed to have abandoned its efforts to secure commercial orders for its laser optical data recording system, despite work on models for the military establishment.

## General Instrument wins \$5 million contract

General Instrument Corporation (GRL-NYSE) has been awarded a \$5 million contract by the Witwatersrand Association of Racing Clubs in Johannesburg, South Africa, to install a computerized parimutuel wagering system to serve the four major racetracks in the Transvaal region of South Africa.

The contract provides for an Am-Tote 300 Sell/Pay Totalisator System to be delivered in January 1982. The computerized system will include 250 TIM 360 betting terminals.

The South African contract represents the firm's seventh major overseas contract for on-track wagering systems in the last several years. This rapidly developing international market is expected to exceed \$100 million during the next few years.

## Study projects video recorder sales increase

The U.S. market for professional videotape recorders will enjoy a healthy 14% growth rate through the '80s, and will accumulate total sales in excess of \$2 billion through 1989, according to a soon-to-be-released study, "Video Recorders, U.S. Market Opportunities," from Strategic Inc. The TV broadcasting sector, which represents the lion's share of the current market at a whopping 43%, will grow at a modest 9% rate over the next 10

years.

The industry sector represents 22% of the market, but by the end of the decade will surpass the broadcast sector. Representing 31% of the 1989 market, the business and industry sector will grow at a fast 22% annual rate. This increase surpasses the growth rates in all other market sectors: institutions, cable TV (CATV), production houses, and TV broadcasting.

CATV comes in second after business and industry in terms of growth, the report shows. Expanding yearly at a 21% rate, nearly as fast as the business sector, CATV will grow to nearly twice its present size by 1989. At the end of the decade, it will represent 10% of the total market as compared to its present 6% slice.

By comparison, production houses will maintain their current 14% relative market standing, despite a healthy 13.6% annual growth rate. The report reveals that institutions will increase their relative market standing by 1% by the end of the decade, expanding from 16% in 1980 to 17% in 1989. Strategic predicts a 15% growth rate annually for this sector, despite restrictive budgets on public and private educational facilities.

In the fastest growing market sector, industrial television, business firms are only now beginning to realize the vast potential for corporate communications made possible by television. As stated in the report, there are 1000 industrial TV production studios operating in the United States and the total is rising rapidly.

Strategic states that "business firms in the United States are expected to produce more TV programming for internal use during the current year than all TV networks combined." At the center of the production facilities are video recorders and cameras.

In the CATV market sector, the report projects that nearly all CATV facilities of 3500 subscribers or more will have a production facility requiring a video recorder and camera in the coming 10 years. The



## Scanner

same is true for institutions such as schools and colleges which, while hampered by lack of funds, will make substantial purchases nonetheless. A key sector element of this market is medical institutions, which will continue to aggressively use television as teaching and communications media.

The report sees 1-inch helical-scan recorder replacing the 2-inch quad machines as the prime component of professional video production. Institutions and industrial firms will be heavy users of 1/2-inch recorders, the report says. In addition, Strategic also foresees the emergence of a new 1/4-inch recorder in the mid '80s. Finally, videodisc recorders, the study shows, can be expected to do well, with sales growing at a fast 23% clip.

One product expected to suffer in the decade is the 2-inch quadplex recorder which will lose to the helical-scan equipment. A second to feel the pinch is the 3/4-inch video recorder whose sales will be slowed by one-inch and half-inch equipment.

The soon-to-be-released report sells for \$1500. For more information, contact Mrs. Alenne Glock, Customer Support, Strategic Inc., 4320 Stevens Creek Boulevard, Suite 215, San Jose, CA 95129, (408) 243-8121.

### Tandy Corporation records sales increase

Tandy Corporation has announced that consolidated sales for May 1981, were \$135,908,000, an increase of 28% over the May 1980 sales of \$105,919,000. Tandy's U.S. Radio Shack division recorded a 29% gain to \$111,511,000 during May 1981 from \$86,324,000 in May 1980. Sales of U.S. Radio Shack stores in existence more than one year rose 16% during May 1981.

### Workman Electronics purchases UTR assets

Workman Electronic Products has purchased certain assets of UTR Electronics.

UTR will continue the Atlanta

operation as a division of Workman Electronics. All orders and shipping will be handled out of the Atlanta plant. All personnel will remain except Carl Jackson, president of UTR, who will remain on a consulting basis.

### Brownell Electro opens new unit

The Instruments and Controls Division of Brownell Electro has opened a new stocking facility in Raleigh, NC.

This warehouse will carry the full Brownell line-up of industrial control devices and electrical/electronic test instrumentation products, and will serve the Eastern North Carolina and Southeastern Virginia marketing areas.

For more information, contact: Mike Kelly, 5245 North Boulevard, Raleigh, NC 27604; (919) 876-6524.

### Robinson Nugent announces 4-cent dividend

The Board of Directors of Robinson Nugent Inc. (OTC symbol: RNIC) has declared a cash dividend of 4 cents per share, payable July 27, 1981, to shareholders of record July 7, 1981.

The dividend represents the sixth consecutive semi-annual cash dividend since the company became publicly owned in October 1978.

Robinson Nugent is headquartered in New Albany and has additional manufacturing facilities in Dallas. The company designs, manufactures and sells components for electromechanical interconnection systems such as televisions, test instruments and computers and for many areas of communications. Its customers include both domestic and foreign manufacturers.

### Service to analyze Japanese market

Quantum Science will provide market impact analysis, Japanese market analysis and evaluation of key Japanese suppliers in the MAPTEK (Management Action Program in Technology) Japan Client Service.

The Japanese, who have already

established a strong presence in the U.S. and European information systems and services market, are expected to be stronger in the future with the evolution of direct marketing distribution channels and further development of technologies such as VLSI, fiber-optics, video compression, speech recognition, non-impact printing, displays and teleconferencing speech recognition and facsimile. As data processing and office automation merge into departmental information systems, Japanese companies will be able to obtain a greater market share because of these factors.

A need exists for understanding the underlying reasons for the Japanese companies' success in the '70s and how the U.S., European and Japanese companies can benefit from their mutual and individual strengths through licensing, joint ventures, OEM and other types of cooperative relationships. IBM, Xerox and Siemens are major companies that have already adopted this strategy.

Major emphasis of the MAPTEK Japan Program will be a multidisciplinary analysis of Japanese companies and their participation in all of the converging computer, office and communications markets.

### H.H. Smith headquarters nears completion

New facilities measuring 62,000 square feet are under construction in Manasquan, NJ, for Herman H. Smith Inc., a North American Philips Company and a major manufacturer of electronic components and hardware.

Richard Laken, company president, reports that newly designed, automated equipment is being developed for the headquarters facility in order to speed production while assuring a high level of quality control.

Laken also said that the new facilities will accommodate more than 500 employees. The site, 65 miles south of New York City, represents Phase II of Smith's recently instituted "Project Update." □



# photofact<sup>TM</sup>bulletin

<b>SANYO</b> Chassis A2T-78NOO/83NOO .....	1998-1
<b>SEARS</b> 564.48310050/360050/410050 .....	1998-2
<b>AOC</b> Chassis 4M46-1B2/2B2/1D5/2D5, 6M46-1D1/2D1 .....	1999-1
<b>GE</b> Chassis EM-A .....	1999-2
<b>EMERSON</b> RED5670 .....	1999-3
<b>HITACHI</b> Chassis NP9X-L .....	2000-1
<b>SEARS</b> 564.44150050/4200050 .....	2000-2
<b>REALISTIC</b> 12-1524 (Chronomatic 219) .....	2000-3
<b>SEARS</b> 564.41810050 .....	2001-1
<b>WARDS</b> GGY-17460A,B/65A,B/70A,B .....	2001-2
<b>ZENITH</b> R425 .....	2001-3
<b>CITEK</b> Chassis ECC-20346 .....	2002-1
<b>ZENITH</b> M1310A,C/382W/72OW,M331OC .....	2002-2
<b>REALISTIC</b> 12-1526 (Chronomatic 218) .....	2002-3
<b>RCA</b> Chassis CTC101A (1981 Prod.) MSC008A Rev C. ....	2002-4
<b>SEARS</b> 564.42360050 .....	2003-1
<b>SHARP</b> 13E21/25 .....	2003-2
<b>SYLVANIA</b> MY0170WH/78W .....	2003-3
<b>HITACHI</b> CT1306 .....	2004-1

## Would you pay \$20 a month for a highly skilled technician?

Here's your opportunity!

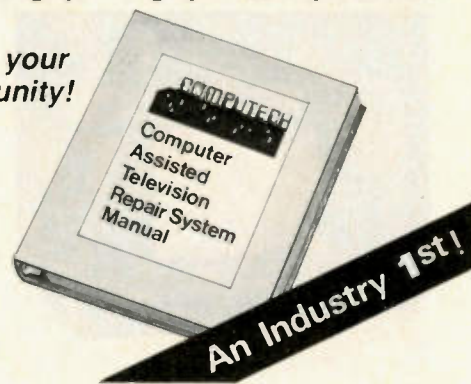

Our exclusive COMPUTECH manual is an organized, easily accessible source of solutions to those frustrating "tough-dog" service problems. Most importantly, this manual is expanded and updated each month to keep you in step with the rapidly changing television industry.

COMPUTECH can save hours of frustrating and unprofitable diagnostic time!

- approximately 6500 symptoms and solutions to "tough-dog" problems.
- indexed numerically by SAMS number.
- symptoms listed alphabetically for faster access.
- monthly updating provided.
- contains step-by-step procedures to locate the most difficult problems.
- standardizes your trouble shooting techniques.
- excellent training aid.
- saves YOU time and guesswork.

Over the past two years "COMPUTECH" has combined hundreds of hours of experience by professional technicians with the unique advantage of a computer to produce an attractive, easy to read, 8½"x11" binder that contains the type of information needed to make TV servicing faster, easier, and more profitable.

**COMPUTECH — AT TODAY'S PRICES...  
YOU CAN'T AFFORD NOT TO!**

COPYRIGHT © 1980

Call us direct (801) 277-2655  
or mail this coupon today.

<b>COMPUTECH</b> 4685 Holladay Blvd. Salt Lake City, Utah 84117 Phone (801) 277-2655	ES-2
Please send my COMPUTECH manual on the following basis:	
<input type="checkbox"/> A trial issue for \$24.95 plus postage and C.O.D. charges.	
<input type="checkbox"/> My yearly subscription updated monthly on the basis of \$20.00 per month plus postage and C.O.D. charges.	
<input type="checkbox"/> Or, my yearly subscription for \$240.00 which includes all monthly updating and postage.	
Name _____	
Service Company _____	
Phone _____	
Address _____	
City _____	State _____ Zip _____



Circle (3) on Reply Card



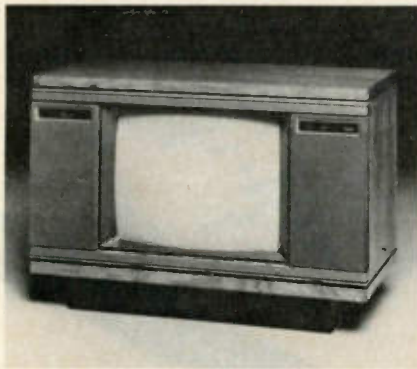

Figure 1 General Electric's top of the 1982 line is model 25-EM-2870P.

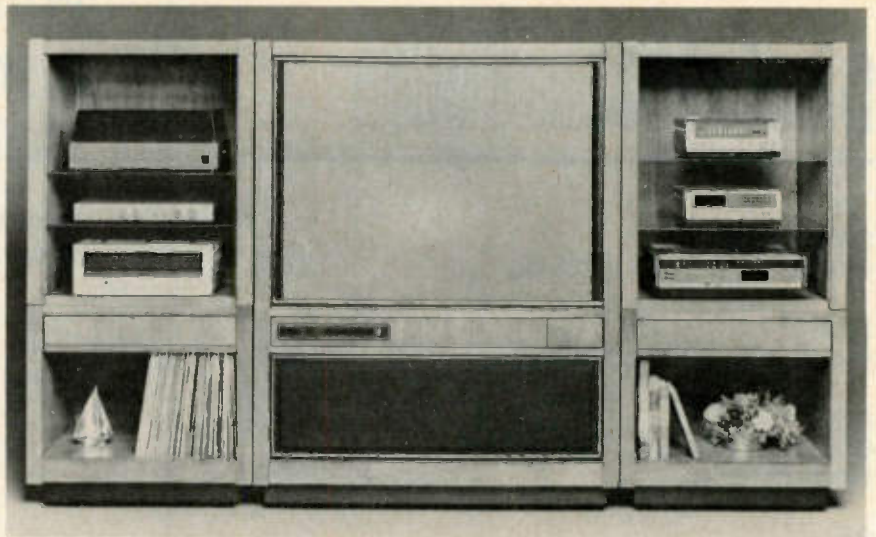

Figure 2 The General Electric projection television is model 45-EP-2000P Widescreen-4000 Home Television Center.

# What's new in 1982 consumer electronics

By Carl Babcoke, CET  
Electronic Consultants

Several trends are apparent in home-entertainment products, as indicated by information received from national manufacturers about the 1982 lines.

## Industry trends

Synthesized-frequency tuning using a crystal oscillator as frequency reference in phase-locked-loop (PLL) systems is standard now for all but the price leaders in most TV lines. These PLL systems are given various names, such as *quartz* (referring to quartz crystals), computer controlled or microprocessor controlled. This excellent frequency stability of PLL systems eliminates any need for fine-tuning adjustments or AFT, except for non-standard or drifting-frequency signals such as converted CATV channels or video games. Many of these digitally controlled tuning systems offer digital channel readouts, either with panel displays or inserted into the picture.

A definite trend is shown for add-

ing CATV (cable) channels. This is a valuable feature for viewers on cable systems, because the use of cable company converters prevents operation of remote controls.

Often the quartz-tuning PLL systems are teamed with infrared-carrier remote controls. Both usually are digital and therefore compatible. In these systems, nothing moves except the push-buttons that activate the functions.

Remote-control signals sent as pulses of infrared light are far less susceptible to false triggering than were the older supersonic audio versions.

As an estimate, remote controls are available in 30% to 40% of these new lines and probably represent 20% to 30% of the sales volume. *Service organizations should recognize the potential repair business possible from this area.*

Projection TV receivers are now offered by all major manufacturers. Most have all the best features of the line along with improved brightness and sharpness from three picture tubes. Only high price limits the sales potential. This can be a

profitable area for TV servicers. Complete training, however, is absolutely necessary. Some models have row after row of convergence controls, for example.

Videocassette recorders continue to be high-volume sellers. Every major manufacturer has several, including new portable models. Excellent color cameras also are available.

Videodisc popularity is just beginning. A possible deterrent is the lack of compatibility in playing the discs. There are two basic systems (laser-lighted photo cell vs. capacitance variation) with various types being offered or promised in the future. Philips/Magnavox laser (Magnevision) was the first type introduced. Several manufacturers are offering variations of the basic RCA Capacitance-Electronic Disc (CED) which was introduced by RCA in the fall of 1980.

Detailed schooling is strongly recommended for technicians of both videodisc players and videocassette recorder/players. They are far more complex than any color television, because they have





Figure 3 Model 1CVP-2020X is General Electric's first portable videocassette recorder.

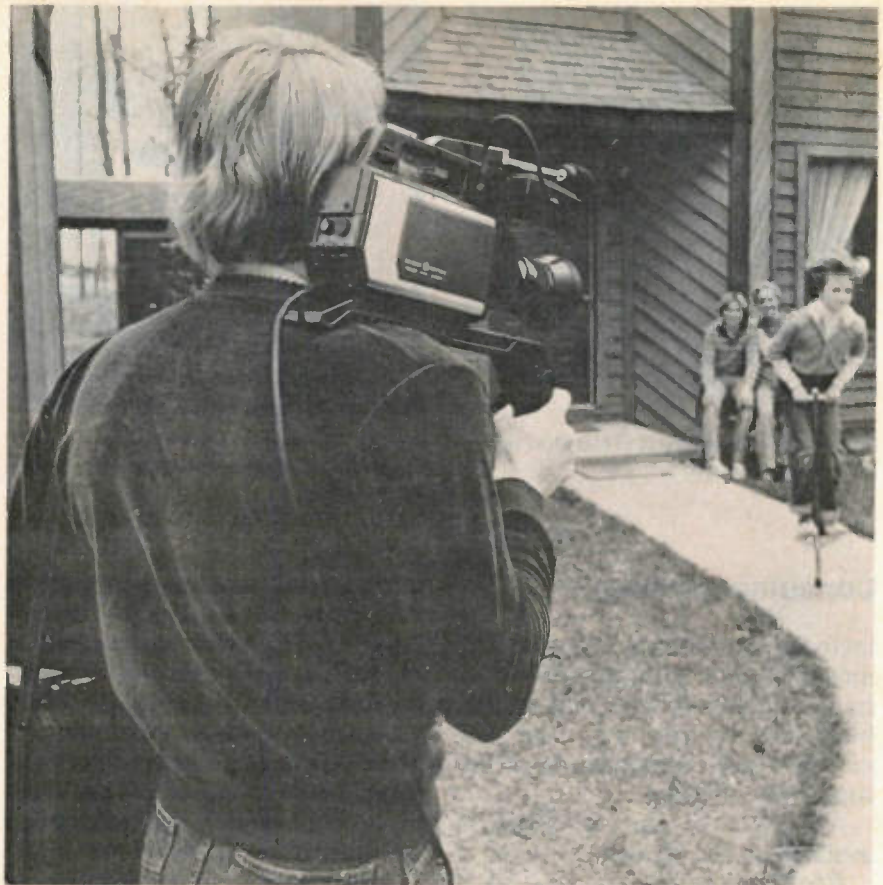

Figure 4 General Electric model 1CVC-2030E color video camera is portable.

sophisticated mechanical systems added to complicated correction and control circuits. All servicers of these products should prepare in advance of need.

Sophisticated audio products are strongly represented in many new lines. This is a comparatively recent development. Cassette recorders appear to be more popular than 8-track, although 8-track machines and tapes remain available.

Color TV continues to produce the largest sales-dollar volume. The distinction between various home-entertainment products, however, is rapidly dissipating. Many TV receivers now have stereo high fidelity amplifiers and speakers in anticipation of videodisc stereo sound and the possibility of TV-multiplex stereo sound. TV receivers often are used as displays for computers and video games.

Videocassette recorders can record TV programs for playback over the family's TV receiver at a later time or date. Videodiscs allow libraries of movies and concerts to be built up for use anytime. Cable systems bring choices of 20 to 35

programs.

Perhaps in the distant future, the promised home computer will control and regulate heating, air conditioning and all home-entertainment equipment.

One point is certain: These new high-technology products are complicated. Therefore, technicians will be compelled to acquire advanced training to stay abreast of new developments.

Descriptions and pictures of the 1982 lines of TV sets, videodisc players, videocassette tape recorders, radios and various audio products are given here, with the national manufacturers listed in alphabetical order.

#### General Electric sales features

In the 1982 line, General Electric offers eight monochrome TV receivers from 12 inch to 19 inch, and 31 color receivers, including two 10 inch, three 13 inch, two 17 inch, six 19 inch and 18 25 inch, plus one projection model, described separately. Top of the 25-inch line is model 25-EM-2870P (Figure 1) which has all the deluxe features

plus dual-channel Performance Sound II system giving hi-fi reproduction of TV monaural sound or true stereo from external videodisc player or FM tuner. (Two other 25-inch models feature Performance Sound without the stereo capability.)

VIR-controlled color is offered in 21 models. When the station does not broadcast VIR signals, the receiver switches automatically to Color Monitor in all but four models. All but five color receivers have quartz-stabilized electronic tuning.

Tuning of the midband CATV (cable) channels is included in 13 color models, providing 91 channels. Operation on both midband and superband cable channels provides 105 channels in 10 models.

Infrared-carrier remote control is available in about 42% of the GE line with scanning type in 7 models and dual-mode type in 10 models. Dual-mode remote allows scanning up and down, or random-access selection by keyboard.

Digital channel readouts are provided in 25 models. Other features



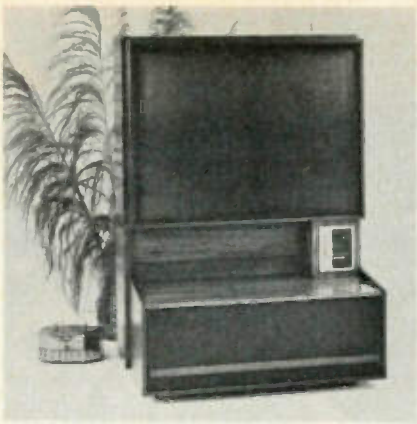

Figure 5 The Magnavox projection television is model 8505.



Figure 6 Model 7600 is the latest Magnavox Odyssey<sup>2</sup> Computer Home Video Game.



Figure 7 Magnavox model 8005 is the Magnevision videodisc player with remote control.

## Consumer products

include: room-light sensor (21 models); tone controls (five with treble, three with bass and treble); black-matrix picture tube (29 models); and self-regulating power supply (21 models).

A variety of cabinet styles is available in the 25-inch consoles.

**Projection television**—GE's Widescreen Home-Video Center has been improved by a comb filter, giving 15% better sharpness than last year, and a 10W per channel stereo amplifier (monaural for television, stereo for external FM tuner or videodisc), driving two 8-inch woofers and two 2-inch tweeters. Model 45-EP 2000P (Figure 2) has all top features, such as VIR/Color-Monitor color control, dual mode remote control for 105 channels, large calculator-type channel numbers, input/output and external-speaker jacks and a sharpness control.

**Videocassette tape recorders**—Three VHS-type VCRs are in the 1982 GE line. Model ICVP-2020X (Figure 3) is GE's first portable. It features 2-, 4- or 6-hour record/playback times. A companion tuner/timer can program the recording of eight different TV shows for up to two weeks.

Model 1VCR-2002X is a basic 2- or 6-hour recorder with a single-program timer. The full-featured model 1VCR-2014W operates in 2-, 4- or 6-hour times with special effects in the 2- and 6-hour modes. All functions can be controlled by a wireless infrared remote control.

**Color camera**—Easier to use than most movie cameras is the model ICVC-2030E (Figure 4) which fea-

tures a sensitive f1.4, 6-to-1 zoom macro lens that focuses to less than 2 inches. This video camera has an automatic-iris control, a fade-in/fade-out control, and an automatic white-balance control. The electronic viewfinder can be adjusted for right-eye or left-eye viewing, and the built-in microphone can be extended on the boom.

**Videodisc**—General Electric is expected to release its own *non-grooved* capacitance system (VHD for Very-High-Density) in January 1982. The VHD system is said to give advantages of both laser and capacitance systems while providing all the fast search and other special effects.

### Magnavox sales features

Magnavox's new Star tuning system is available in 19-inch and 25-inch color TV models. The Star system features an infrared remote transmitter and these functions:

- *on-screen time and channel displays.* The numerals disappear a few seconds after each channel selection.
- *superband CATV (cable) operation.* 105 channels are provided, including 35 cable channels for those with cable connections.
- *all-new 19-button remote transmitter.* This is a slim-line hand unit that controls all TV functions.
- *a choice of random-access or Favorite-Station modes.* In addition to the usual random-access tuning method, the tuner can be programmed for as many as 10 favorite stations, thus allowing fast 1-button access.
- *alternate-channel button.* When pressed, this button changes tun-

ing to the channel previously selected. A change between any two stations can be made by one press of one button.

- *remote-controlled voice/hi-fi button.* One push changes from narrow-band sound to hi-fi response, or back again.

Balanced Star models each have two 7W amplifiers that drive 6-inch woofers and 2-inch tweeters. When the program is in stereo (for example, when playing a Magnavision stereo videodisc), it can be reproduced in full stereo. When viewing standard monaural TV programs, a matrix type of simulated stereo is provided.

Seven new Star-system Touch-Tune models are offered during the remainder of 1981.

Four new portable TV receivers are offered in the Magnavox line. Three portables are black and white types, including a portable 5-inch model (3910) with AM/FM radio and operation from line voltage or 12V auto cable. The color portable is model 4012 with a 9-inch screen and a 82-channel thumb-wheel tuning dial.

Several new 19-inch table-model color sets (including model 4263) and the 5040 series of 25-inch consoles feature an expanded system of remote control that can tune 105 channels including 35 cable channels. Other features are green LED channel readouts that are easier to read, and a 16-button slim-line remote transmitter for infrared operation.

Almost 50 models are in the complete Magnavox line of TV receivers.

**Projection TV**—Model 8505 is the first projection-type color TV





Figure 8 Maganavox model 2072 has top-of-the-line audio features.

from Magnavox. Rear-screen projection of the 50-inch screen is employed (Figure 5). Three 55° sweep-angle picture tubes are supplied for increased brightness, contrast and sharpness without requiring a darkened room. Specifications call for a brightness of 56fL.

Model 8505 has all the advanced features previously listed for the *balanced* Star models plus more audio power and larger speakers. The high-resolution comb filter makes possible picture resolutions of 330 lines for TV reception or 410 lines for direct video.

*A giant leap in video games*—Maganavox has offered video games since 1972, but no longer are the games confined to simple bouncing balls with sound beep. Today's Odyssey<sup>2</sup> Computer Home Video Game System (Figure 6) has a 49-character keyboard, with two hand controls, and is operated internally by a microprocessor. More than 35 educational, sports and arcade games can be played without extra controls. The games are determined by plug-in cartridges. One cartridge even teaches computer theory.

*Magnavision videodisc player*—Model 8005 videodisc player (Figure 7) has a new infrared hand-held remote control that allows armchair control of most Magnavision special effects. To prevent picture deterioration if any special effect (except picture search) is accidentally engaged, a new special-effects-defeat function operates during playing of CLV (extended-play) discs. Special effects provided by the remote transmitter include fast and slow forward, still frame, frame-by-frame forward and reverse, search



Figure 9 This Philco 13-inch has micro-computer tuning and remote control.

forward and reverse, and indexing for frame and chapter.

Magnavision was the first videodisc system. It uses a laser and an optical system to read coded patterns in the disc. None of these components touch the disc. Therefore, picture quality from the disc is not degraded by minor scratches, dust or fingerprints on the surface.

*Audio and radio lines*—Maganavox has introduced more than 30 new audio and radio products, including three portable radios, three clock radios, eight tape and radio/tape recorders, four compact music systems, three component audio systems, one compact bookshelf audio system, three console stereos and three Balancer speaker series.

Model 2072 component audio system is shown in Figure 8.

#### Philco TV sales features

Since acquisition by the N.A.P. Consumer Electronics Corporation, the Philco TV line has received extensive redesign, including a new chassis and a completely restyled 19-inch portable TV line.

The Philco 1982 line consists of three 13-inch portables (Figure 9), six 19-inch models, and 15 25-inch color consoles (Figure 10). One feature of all new 25-inch models is the Philco Color-Rite II system of automatic color control. Eleven models have the new push-button Computer-Command tuning system that combines a frequency synthesizer with a micro-computer control. Four consoles with Computer Command carry suggested list prices ranging from \$740 to \$750. The cabinets come in Contemporary, American Colonial, Early American

## ESR METER

checks electrolytics  
IN-CIRCUIT and is TV shop  
FIELD-TESTED:

The most fantastic instrument I've ever bought—Billings, Mt. Used it 3 months; it only missed once—Marinette, Wis. (Typical). Squeal & no sync: 3 bad caps in B+ & AGC; Many Thanks—Taos, N.M. Please ship another; very satisfied—Glen Rock, Pa. It's fantastic—St. Joseph, Mo. Please rush; heard good reports—Hicksville, N.Y. One tremendous meter—Alexandria, Minn. Send your Super meter; heard about it—N. Olmstead, Ohio. Love that ESR Meter—Acton, Mass. Used it intensively for 30 days; it's been 100% effective—Pittsburgh, Pa.

Ideal for preventive maintenance: measures electrolyte dryness & shows up intermittent opens.

60-day Satisfaction Guarantee.

Send check or M.O. or call  
(313) 435-8916 for COD

Or write for free brochure to:

*Creative Electronics*

ESR Brochure \$ 99.00  
1417 N. Selfridge postpaid  
Clawson, Mich. 48017 USA & CAN.

Circle (4) on Reply Card

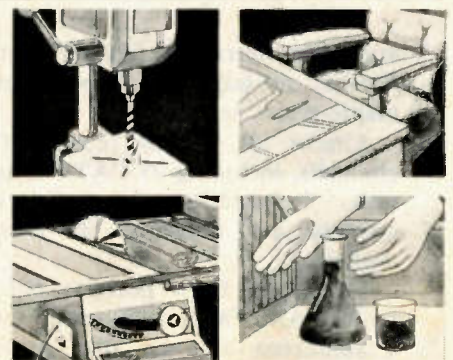

## Can you pick out the greatest employee health hazard?

If you picked one of the machines you're wrong. It's the desk and the swivel chair that have been called the greatest occupational health hazard of modern times. Why?

Because they keep us sitting on the job — with no exercise — no chance to keep physically fit. So our bodies grow soft. We are more susceptible to disease. And industry loses billions in lowered productivity, chronic fatigue, absenteeism, early retirement.

Your company probably can't do away with the desk and chair. But, like over 400 other companies in America, it can provide direction and opportunity for employee fitness. A room for calisthenics, an area for running or jogging, bicycle racks and showers.

For more information about a fitness program for your company write:  
Employee Fitness, Washington, D.C. 20201.



President's Council  
on Physical Fitness  
and Sports.

ENERGY FOR AMERICA - IT COMES FROM EXERCISE



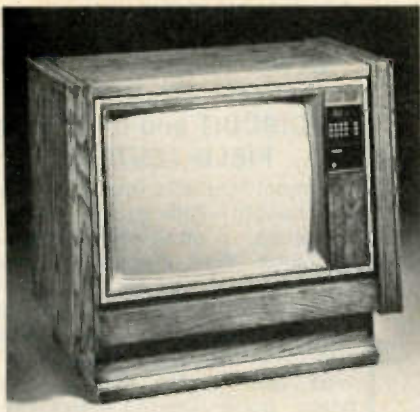

Figure 10 Four Philco 15-inch consoles have top features in furniture-style cabinets.



Figure 11 Quasar model XP-3234TA is a 12-inch monochrome television.



Figure 12 Quasar audio line features mix-and-match components for flexibility.

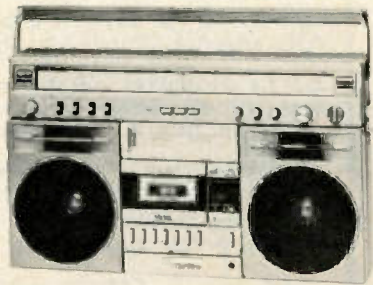

Figure 13 Quasar model GX-3661 is a large AM/FM cassette portable.



Figure 14 Model VH-5610TW is Quasar's top videocassette recorder with wireless remote control.



Figure 15 Top of the 1982 RCA Television line is ColorTrak model GFR-1001R.

## Consumer products

and Mediterranean styles with finishes of oak, pine, pecan and maple-grain, respectively.

Almost all models receive 105 channels, including 23 CATV channels. Infrared remote-control systems are available in many models.

The 5-inch B&W portable has a built-in AM/FM continuous tuning, a sunscreen and an auto power cable. It can operate from four power sources: 12Vdc from the audio power cable; nine "D" cells; ac-line power; or an optional rechargeable power pack.

Seven stereo consoles and two compact models were recently introduced. Features, which vary with the model, include 8-track tape player, cassette play/record deck, automatic record changer and AM/FM stereo radio.

### Quasar sales features

The Quasar color TV line introduced last May emphasizes three areas of technological improvement; picture quality, sound upgrading and better tuning.

Dynacolor-Plus provides a tinted

screen to increase contrast and reduce the effects of glare. The Supracolor system continues to be included in some models. It has some features of Dynacolor and Dynacolor-Plus, but does not have the room-light sensor.

Six of Quasar's new color receivers have Dynacolor-Plus, 28 have Dynacolor, and four have Supracolor.

The audio system improvement is called Audio-Spectrum Sound III, featuring a stereo amplifier that provides simulated stereo with present monaural TV broadcasts. However, true hi-fi stereo (as from videodiscs) can be reproduced in full stereo. This feature is in four Quasar models.

Four types of phase-locked-loop quartz-stabilized tuning are offered. Compu-Search has 4-button panel tuning. It is offered also with remote control. Compu-Matic allows the viewer to digitally program any desired channel. A remote-control version is available.

Forty-three models are featured in the new Quasar color TV line: three 10-inch, including a portable that operates from auto-battery or ac-line power; three 13-inch; two 15-inch; 10 19-inch; two 25-inch

table models; and 23 25-inch consoles (13 have remotes).

Quasar's 45-inch model PR-4800TP projection TV is being continued, because it remains on back orders because of strong demand.

Black-and-white TV models continue to sell well, according to Quasar. Four new B&W models (including XP-3234TV shown in Figure 11) have been added, giving Quasar a total of eight B&W models ranging from 5 inch to 19 inch.

An expanded line of audio products is offered for the second year. The foundation of the line is two "stacked" components that give the look of separate power amplifier, pre-amp, tuner and cassette deck, although all of these are actually combined in the single component (Figure 12). A choice of three turntables is offered, along with a rack to hold the main component and a turntable. There is a choice of two speaker systems. These eight items can be arranged in 12 different ways to satisfy most customer's desires.

Topping the AM/FM/cassette line of personal portables is model GX-3661 (Figure 13), which has four speakers, a quartz-locked digital clock/timer, and alarm. All four models have internal



microphones, stereo-balance controls, a tape-counter readout, auto stop, tape-travel pause and 1-touch recording.

Five new videocassette recorders, two new video cameras and many accessories have been added to the Quasar line. These compatible accessories allow dealers to assemble customized packages. Most videocassette recorders offer 6-hour recording and picture search. Model VH-5610TW (Figure 14) is Quasar's top of the VCR line, having special effects, a 105-channel tuner and a new 13-function wireless remote control.

Quasar also offers seven new microwave-oven models.

### Technical information

Quasar Company offers for a small fee a 16-page technical training booklet that gives details of the 105-channel Compu-Matic tuning system, Audio Spectrum Sound II and Dynafilter, which has a comb filter for separating chrominance from luminance. The booklet, number 68P71535A39, can be ordered from Quasar.

### RCA sales features

RCA's 1982 line of TV receivers is divided into three categories. XL-100 models are the value line. ColorTrak models have more features and improved performance, while the new ColorTrak-2000 series has the highest technology, described in the

technical comments.

Two 13-inch, three 19-inch, and four 25-inch models, each carrying an open list price, make up the XL-100 line.

Twenty models are offered in the ColorTrak line. These range from two 9-inch models first offered in February 1981 to many newly introduced 25-inch models. All models 13 inches or larger have cable-ready tuners for direct access to all 82 VHF/UHF TV channels plus 23 CATV channels.

Twenty models of the ColorTrak line comprise the RCA top-of-the-line color receivers. Five 25-inch models have ChanneLock Keyboard/Scan direct-access tuning from 10-digit front panel keyboards with LED channel readouts. The other 16 models offer a variety of cabinet styles and the new ColorTrak-2000 6-function Infrared Remote Control system that permits reception on 57 CATV channels plus the conventional 82 TV channels. (Figure 15). Other features include Detail Processors, Automatic Sharpness Controls, ColorTrak automatic color, high fidelity speakers and separate bass and treble controls.

*Two special TV receivers*—Model PFR-100 is a large-screen (50 inches diagonally) projection TV (Figure 16) that supplies 27kV to three 7-inch picture tubes (red, blue and green). Light from each CRT passes through a lens to a front-silvered mirror, and then on to an alumin-



Figure 16 RCA TV model PFR-100R has a 50-inch front-projection screen.

## APPLIANCE REPAIR BOOKS



Thirteen Handbooks written in easy-to-understand language by experts in the service field with illustrations and diagrams! Acclaimed by instructors and professionals alike! How to diagnose and repair air conditioners, refrigerators, washers, dryers, ranges, microwave ovens, dishwashers, vacuum cleaners, electrostatic air cleaners, RV gas appliances, hair dryers, motors, water heaters, coffeemakers, can openers, floor polishers, steam irons, food mixers, lawn care appliances, electric knives, electric and digital clocks and many others. Also fundamentals of solid state, setting up a shop, using test instruments and more. Only \$2.65 to \$4.90 ea.

SEND FOR FREE PRICE LIST

Gamit, Dept. ES

110 W. St. Charles Road,  
Lombard, Illinois 60148

Circle (5) on Reply Card

It's no puzzle  
to order Oelrich  
Service Forms



For TV-radio and two-way radio service —  
legal forms for Calif., Florida and Utah.  
Now at parts jobbers or write for cat. B64.

OELRICH PUBLICATIONS

4040 N. Nashville Ave., Chicago, IL 60634  
Now call toll-free! 800-621-0105

Circle (6) on Reply Card



FREE CATALOG

HARD-TO-FIND PRECISION TOOLS

Lists more than 2000 items: pliers, tweezers, wire strippers, vacuum systems, relay tools, optical equipment, tool kits and cases. Send for your free copy today!

JENSEN TOOLS INC.

1230 SOUTH PRIEST DRIVE · TEMPE, ARIZONA 85281

Circle (7) on Reply Card

Put your  
money where  
your Heart is.



American  
Heart  
Association

WE'RE FIGHTING FOR YOUR LIFE



## Consumer products

ized fiber glass screen where the colors are combined into a picture. Theater movies usually reflect 16fL from the screen, while the RCA projection system produces about 120fL. A darkened room is not required for good viewing.

Other features include an infrared remote-control system, providing direct access or channel scanning. Illuminated channel numbers are provided under the screen. A Detail Processor with comb filter provides excellent picture sharpness.

Inputs are provided for external audio or video signals. External speakers can be connected, substituting for the two tweeters and two 5-inch woofers inside the cabinet.

ColorTrak model VFM-575 Video Monitor is a 19-inch table model color receiver with circuits and plugs for connection of one or two external video sources such as video games, computers, videocassette recorder, videodisc machine or video camera, direct to the video circuits. Thus, the sharpness and color quality is improved over the customary method of applying a video-modulated RF signal to the antenna terminals of a standard color TV.

**Video recorders**—RCA offers three 6-hour videocassette recorders. Model VEP-150 is a portable recorder with provisions for operation on the internal rechargeable battery, an optional dc-power cord from a 12V car battery, or an optional supply from either a TEP-1400 tuner/timer or a PDP-500 adapter/charger.

SelectaVision-250 features high-speed Picture Search, internal tuner, clock/timer, tape counter and audio dubbing. SelectaVision-650 has all the features listed for model 250, plus total remote control of stop action, slow motion with slide control down to 1/30 normal speed, double speed, single-frame advance, channel change, pause/still for deleting material, tape rewind, fast forward, play and record. A new wireless infrared remote control is available for model VFT-650 (Figure 17).

Several optional color video cameras are available for live recording with any of the RCA videocassette recorders. Model CC011 camera (Figure 18) has the

greatest number of features, including a Newvicon camera tube that is sensitive to low-light levels but without burning from strong light, a 8:1 power-zoom lens and an automatic fade control.

**SelectaVision VideoDisc**—Model SFT-100 videodisc player provides up to two hours of TV viewing on a single disc. Operation is simple. The sleeve containing a CED disc slides into the machine and the sleeve is removed, leaving the disc inside the player. Visual search both forward and backward is possible at about 16 times normal speed. Rapid access gives faster search without a picture but with the normal playing time at each instant indicated in minutes by an LED display. A pause button allows temporary cessation of playing. The LED digital display indicates the elapsed playing time in minutes and also shows the load/unload, pause, or end-of-disc condition. A modulated carrier from the player is connected to the antenna terminals of a TV receiver used as a monitor or display.

An extremely small diamond stylus follows the disc groove, but the stylus is not vibrated by undulation of the groove, as the case with phonograph records. Instead the stylus correctly positions the capacitance pickup electrode.

### RCA TV technical features

ColorTrak-2000 chassis CTC111 is the all-new TV chassis in the 1982 RCA line. It has several interesting features, including Auto Peaking. Many other models allow the viewer to adjust picture sharpness with a variable-peaking control. The drawback is that large variations of sharpness during individual programs require the viewer to readjust the control many times.

In the CTC111, however, U701 and the auto-peaking circuitry automatically maintain whatever picture sharpness was previously selected by viewer adjustment of the Auto-Peaking control.

The circuit has a peak detector to measure the amplitude of high frequencies in the video signal, because a sharp picture has increased high frequency levels. The customer-operated sharpness control varies a dc voltage in the peak detector. A special delay line (not the video delay line or the comb-filter delay device) feeds video signals of various amplitudes and phases into

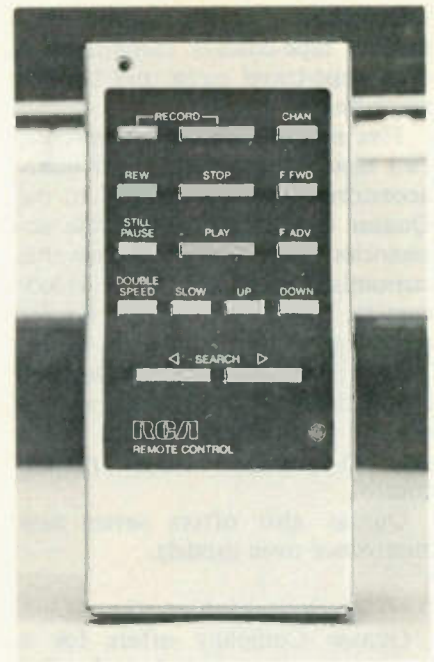

Figure 17 A new wireless remote-control hand unit comes with RCA's VFT-650 videocassette.

inputs of a differential-amplifier stage, which cancels all signals that are present at both inputs.

Output of the differential-amplifier stage is the peaking-correction signal, which is summed with two more signals in a transistor whose output is the desired peak luminance. Following amplification, a sample of peaked luminance is sent to the conventional video stages, while another is supplied to the auto-peak detector. Therefore, the total circuit is a closed loop which operates to vary the picture sharpness (either harder or softer) until it conforms to the quality selected by the viewer's adjustment of the front-panel sharpness control.

Volume and tone quality of the CTC111 audio has been improved by several alternate modes. Separate bass and treble controls are supplemented by loudness compensation according to the Fletcher-Munson curves of human hearing. At quiet volume adjustments, the bass and treble frequencies are amplified more than the middle frequencies.

Some models offer Dual-Dimension Audio (on PW-2200 board). DDA provides a quasi-stereo 2-channel audio output that is amplified by an external hi-fi system. Stereo simulation is provided by different peaks and valleys in frequency responses of the two





**Figure 18** RCA model CC-011 color video camera features a non-burning Newvicon camera tube.



**Figure 19** Sylvania's 50-inch projection Superscreen color television (model LSA-5000) features rear-screen projection with a black-matrix screen.



**Figure 20** Model CLA-580AR from the Sylvania Designer Collection II has Super-sound.

channels.

Hi-Feature Audio permits a choice of audio modes. Monaural is single-channel sound, Dual-Dimension is simulated 2-channel stereo, and External provides full stereo from external stereo audio sources.

A surface-acoustic-wave (SAW) filter is employed in the IFs. It is similar to the SAW filter used in CTC107, CTC108 and CTC109 chassis. These filters cannot be aligned in the field, but they do not drift and never require alignment.

A new U700 chrominance/luminance integrated circuit is used in the CTC111. It first was introduced in the CTC108 chassis. The former clip-out kit for adjusting red and green offset has been replaced with variable controls that allow easier adjustments.

The Exclusive Detail Processor continues to feature a CCD Comb Filter plus Vertical Peaking to provide sharper detail and reduced interference between luminance and chrominance signals.

All ColorTrak-2000 models incorporate the MST-007 Multiband Tuner which covers up to 127 channels. These 127 channels do not require an external converter, and they can be tuned by the infrared remote-control system. MST-007 has five tuning bands. Standard channel frequencies are frequency-synthesized for stability, but the

AFT system can search up to 2MHz on each side of these assigned frequencies for variant carriers, such as video games or converted cable channels.

The 1982 RCA TV line includes these color chassis numbers: CTC107; CTC108; CTC110; CTC111; and CTC115, used in 9-inch models, RCA's smallest. New remote-control systems are CRK29, a 6-function infrared type, and CRK28, another infrared type with 17 functions.

#### Sylvania sales features

N.A.P. Consumer Electronics Corporation has announced a Sylvania projection TV receiver (Figure 19) that is said to provide better contrast under bright ambient lighting. This Sylvania Superscreen has a projection screen with principles similar to those of black-matrix picture tubes.

Three projection picture tubes operate through the optical system to produce images with 330 lines of resolution for TV reception or 410 lines of resolution for direct video. Black striping on the screen minimizes ambient light, thus increasing the brightness and contrast.

Other features are a comb filter for sharper pictures and reduced interference between luminance and chrominance signals; an infrared-carrier remote control system; Quick View looks between any two

stations; cable-ready tuning of 105 channels, including CATV; a micro-computer-controlled tuning system; and Favorite Station scanning of any 20 channels after pre-programming.

**1981 color TV line**—A total of 29 models comprise the new Sylvania color TV line. Features include a micro-computer tuning system, cable-ready midband and superband CATV cable channels, and a comb filter in many models.

Thirteen 25-inch receivers have infrared remote control, as have three 13-inch portables and one 19-inch table model. All have Sylvania GT-Matic color system and Dark-Lite-100 black-matrix picture tubes. Thirteen of the 25-inch consoles have the micro-computer push-button-tuning system, as described for the projection model. The internal memory of the micro-computer fine tunes each channel precisely. These models also have comb filters, audio-output jacks and remote control with Quick-View.

The Designer Collection II Series has five models with favorite-station scan. Two models have Supersound with sealed speaker baffles (Figure 20).

**Stereo systems**—A feature of two stereo systems is a 2-speed, belt-driven, automatic record changer with ceramic cartridge. The wide-dispersion speaker system has two





Figure 21 A combination 5-inch portable B&W television with AM/FM radio is model MQ-9014GY from Sylvania.

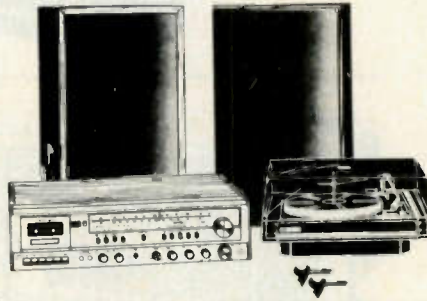

Figure 22 One of the several Sylvania AM/FM-stereo audio combinations is model CP-0666.



Figure 23 Zenith Panorama (model SN-2539X) television has the contemporary look.

## Consumer products

8-inch woofers and two 2½-inch tweeters. A cassette tape player/recorder is included. Other features are: speaker-selection switches; and auxiliary audio inputs for connecting TV sound, videocassette recorder audio, or videodisc audio to the internal speaker system.

Another model has a Sylvania AM/FM-stereo radio receiver with compensated loudness circuitry and an AM-signal-strength/FM-tuning meter. A second AM/FM-stereo receiver has the turntable and control module on top of the unit behind tinted glass doors.

Three horizontal models feature AM/FM-stereo radio, a 3-speed record changer with ceramic cartridge, a cassette tape recorder/player, and an 8-track tape player. Two models have a wide-dispersion speaker system with two 2½-inch tweeters and two 8-inch bass woofers. A third console has two 8-inch duocone full-range speakers.

The two remaining new consoles have an AM/FM-stereo radio, a 3-speed automatic record changer, and a cassette tape player/recorder. The speaker system has two 6-inch duocone full-range speakers.

### Zenith sales features

Zenith color TV receivers for 1982 total 56 models, in these categories:

- four portable 13-inch sets, one

with remote control;

- three 17-inch table models, one with remote control;
- 11 19-inch table models, four with remote control;
- six 23-inch consoles, one with remote control;
- 31 25-inch table and console models, 19 with remote control (Figure 23); and
- one 45-inch projection color TV console with remote and Space Phone.

**Tuning**—Electronic tuning is included in more than 92% of the 1982 Zenith models. There are many versions, such as single-knob, keyboard Touch Command manual or remote channel selection.

The 38 cable-compatible models have a new quartz-crystal-controlled system that eliminates fine-tuning adjustments. A computer seeks and locks the frequency. These cable-compatible models can receive 42 channels in the cable mode.

**Remote control**—Four systems of remote control are offered in the Zenith line. Computer Space Command-5000 with Advanced Space Phone is in the projection TV. Computer Space Command-4000 with Advanced Space Phone has all the usual remote-control functions plus facilities for dial-out phone calls. Other systems are the Computer Space Command-3000 and the Computer Space Command-1800.

All receivers with remote controls have the new Time-Control Pro-

grammer, which can be adjusted to turn the receiver power on or off once during each 24-hour period.

Space Phone last year allowed incoming phone calls to be received through the TV receiver by operation of the remote-control unit. Advanced Space Phone for 1982 handles incoming phone calls, but also can originate calls by the digital push-buttons on the remote hand unit. As the number is being dialed by the remote push-buttons, the number appears on the TV screen. Volume adjustments of the receiver also vary the volume of the incoming phone voices. A mute button provides privacy for outgoing voices when desirable. It is not necessary to operate the regular telephone for these calls. When the Advanced Space Phone is in use, the TV picture remains on the screen, but the program audio is replaced by the incoming phone voice. A microphone in the TV cabinet picks up the outgoing voices.

**Projection TV**—Model SN-4545P projection TV has a 45-inch screen illuminated by three picture tubes for increased brightness. These CRTs have self-converging guns. The furniture-styled cabinet (Figure 24) has the appearance of a console stereo, but when a remote control button is pressed, internal motors lift the cabinet top and the screen is raised to normal viewing height.

All of the deluxe features are provided in the projection chassis, including video and audio input jacks





Figure 24 Zenith's model SN-4545P is a projection TV with a 45-inch screen that is hidden when not in use.

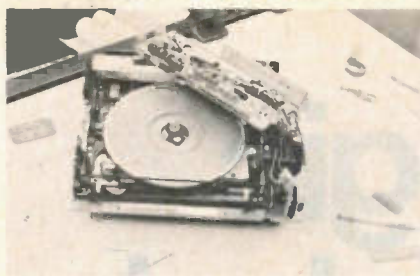

Figure 25 Model VP-2000 is Zenith's new CED-type videodisc player.



Figure 26 Smallest TV in the 1982 Zenith line is the 5-inch television portable called Explorer.

that allow monitoring of videocassette playbacks, home computers, videodisc playback, video cameras and home-type video games, without requiring an external modulator for antenna connections. This provides increased sharpness for those functions.

**Videodisc player**—Zenith model SN-4545P (Figure 25) plays video and audio of all Capacitance-Electronic-Disc (CED) type videodiscs. Each disc plays two hours—60 minutes on each side. No videodisc machine can record programs.

Many movies, both classic and current, are available.

**Small portable TV**—Tiniest of the Zenith line is the Explorer (Figure 26). It has a 5-inch B&W screen, an AM/FM radio, and a digital clock with adjustable alarm. The clock/timer is powered separately from the TV by an AA battery, and the display is LCD for good visibility in bright lighting. A sleep switch automatically turns off the receiver after 59 minutes.

Two tuners provide 82-channel reception. Operation is possible on four power sources: 120Vac; 12Vdc from auto or RV plug; six "D" batteries; or an optional rechargeable battery pack.

Standard equipment includes an earphone, an ac-adaptor cable, one clock battery, and a Vdc cable for autos. An S-057 rechargeable battery pack is optional. The weight with "D" batteries is 7½ pounds.

**Stereo cassette receivers**—Zenith

introduced two low-profile AM/FM-stereo receivers. Model MC-6190 has a quartz synthesized tuner with digital readout, signal seeking and up/down manual scan, presets for five AM or five FM stations, LEDs for recording-level indicators, Dolby noise reduction, soft-touch cassette control, and many other advanced features. Model MC-6170 has many of the same features, less the synthesized tuning and digital readout.

Other models are MC-6020 with 8-track tape playback/recorder, Series 1 and Series 2 integrated stereo systems. Three record changers and turntables are offered, along with five types of speakers.

**Radios**—For 1982, Zenith offers one FM/AM portable radio, four FM/AM multiband, four FM/AM portable cassette radios, one FM/AM table radio and five FM/AM electronic digital clock radios.

**Videocassette recorders**—Zenith has announced two new models. VR-9775 is a front-loading model that matches the Video Hi-Tech line, while VR-9800 is the new Zenith portable videocassette recorder. The VR-9800 can be operated in the field from rechargeable batteries. Accessories for home use are the VRT-9850 timer/tuner or the VRT-9852 ac-supply/battery-recharger.

**Technical features**—System-3 continues as top of the Zenith color line. This is the triple combination

of the Tri-Focus in-line picture tube, the Triple-Plus modular chassis with Peak-Resolution Picture (PRP) circuit (comb filter), and Color Sentry automatic-color control. The PRP circuit was analyzed in the April 1981 issue of **Electronic Servicing**.

Zenith's Beta-type videocassette recorder will be available in a new model about September 1981.

Video Hi-Tech describes three models having audio and video input jacks that allow video devices—cameras, videodisc players, videocassette recorders, or video games—to be connected direct to video and audio stages, thus bypassing the bandwidth restrictions of the RF, IF and detector stages. Sharper pictures and quieter sound are obtained from these video monitors. Two modular 19-inch table models and the projection console have this feature.

High-performance TV audio is offered in some receivers. These six receivers have a 4-speaker complement of two woofers and two tweeters with crossovers. The receivers also have audio-output jacks to allow listening on external hi-fi sound systems. Fourteen other models have audio-output jacks.

Also available are televisions with additional audio amplifiers and separate control centers. The amplifier is rated at 10W with less than 2% distortion, and the control center includes separate bass and treble controls with a voice/music filter switch. □



# Logic analysis techniques for testing digital circuitry

---

By Pat Whitty and John Huber,  
Tektronix Inc., Beaverton, OR

To meet the complex digital development and service requirements of the microprocessor and microcomputer design engineer and to complement the traditional oscilloscope with increasing versatility, capability and applicability, logic analyzers have evolved as important test instruments.

These instruments do for the analysis of complex digital equipment what the oscilloscope has long done for real-time signal analysis — provide views of multiple sequential data channels even if the data are nonrecurring, provide true simultaneous acquisition of multiple data channels, and provide data sequence displays that occur *before* a trigger.

## Logic analyzer origins

The logic analyzer was introduced in 1973 almost simultaneously by Hewlett-Packard and Biomation. These first logic analyzers were of two distinct types: one a *timing* analyzer, the other a *state* analyzer.

The Hewlett-Packard analyzer, the 1601L, was a state device with 12 parallel channels. Biomation's 810D was the first timing analyzer with eight parallel acquisition channels and 256 bits of memory per channel.

The timing analyzer is used for hardware debugging, from the design prototype to servicing the customer's instrument. With the asynchronous clocking technique, a fast pulse can be sampled and displayed with high resolution in a timing diagram format.

The state analyzer is used from the software/firmware development stage through the integration stage, and even as a field service tool at the customer's installation. State analyzers use a synchronous clocking technique to allow the capture of data flowing in step (sync) with the clock of the system under test. The information can be formatted and stored to be viewed in binary, hex or octal.

From these roots, the logic analyzer has rapidly become the primary digital analysis tool for the digital engineer. According to Galen Wampler of Dataquest, a Menlo Park, CA, market research firm, demand has exceeded all forecasts. Annual sales have averaged more than a 75% increase in each of the last three years, establishing an in-



stalled base valued at \$115 million. Sales in 1984 are projected to reach \$200 million.

### Logic analyzer internal characteristics

In a digital system design cycle there are three major components; software development, hardware development, and hardware/software integration. In this third phase, logic analyzers play a significant role in smoothing out the aberrations of integration.

Figure 1 shows the basic internal parts of a logic analyzer used for parallel data acquisition.

The input section is multichannel, and varies in size from 4 to 48 channels. The memory section is a block of random access memory for temporary storage of data coming into the analyzer via the input port. The memory is configured for N bits per channel, and ranges from 64 to 1024 bits.

The trigger/control section consists of clocks, memory control lines and set-up parameters that enable logic analyzers to acquire data at the proper speed, load it correctly into memory and properly display the acquired data. By using qualifiers for trigger or clocks, the triggering capabilities of the logic analyzer can be enhanced. More sophisticated triggering is generally needed for debugging software and firmware, while word recognition plus qualifiers are usually all that is required for hardware debugging.

The trigger/control section also provides control over the display of the acquired data, while the display section allows the user to select the way the acquisition memory is to be viewed.

The data formatter section (Figure 2) enhances the capabilities of the basic logic analyzer. The formatter block decodes the data in the acquisition memory into hexadecimal, octal, binary, GPIB or possibly  $\mu P$  mnemonics for display.

Logic analyzers provide different levels of capability in the five basic sections. They address a wide range of user needs, and most offer optional capabilities for particular applications.

The capability exists in various logic analyzers for IEEE-488 con-

trol and RS232-C data acquisition and control for transferring data to and from peripherals or a central computer.

Most analyzers use a probe pod, which allows the selection of different probe tips to be connected for ease of data acquisition. The probing capabilities are further enhanced

by the use of variable or fixed logic thresholds.

### Types of logic analyzers

The microprocessor and its peripheral integrated circuit families allow the logic analyzer to perform parallel timing, parallel state, serial state or signature analysis.

The Basic Logic Analyzer

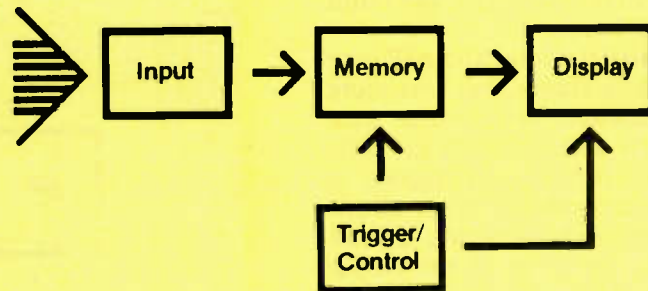

Figure 1

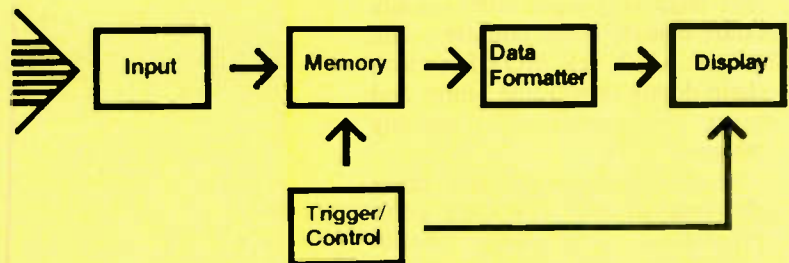

Figure 2

Parallel Timing

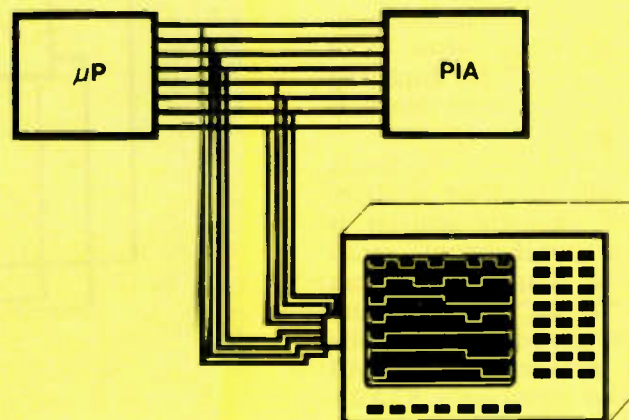

Figure 3



## Logic analysis

The parallel timing analyzer is shown in Figure 3. It has multiple inputs, and displays the data as a timing diagram. The data is not real-time data but represents the logic level of the input channels at the time of the sampling clock edge.

Timing analyzers are used for hardware applications in which their high speed asynchronous data acquisition can determine intermittent or incorrect transitions in a digital circuit. Timing analyzers range from 10MHz to 200MHz and fulfill most user needs.

The parallel state analyzer (Figure 4) is usually slower, but uses more input channels. Because the state analyzer is used primarily for software and firmware debugging, it runs synchronously with the circuit under test and, therefore, doesn't need the resolution of the timing analyzer. State analyzers display the data in the user's format, hex, binary, octal, GPIB or as  $\mu P$  mnemonics.

The triggering capabilities usually include delays, event counters, and the basic AND, OR, NOR functions to help debug subroutine jumps and returns and general programming problems.

The serial state analyzer takes logic analysis into the data communications environment. Serial analysis uses only one channel and stores data one bit at a time. The control parameters allow character trigger schemes, delay triggering, bits per character selection, and synchronous or asynchronous clocking.

The state table displays the data in ASCII and can even include parity error indication. Most serial analyzers use a CRT for displaying the data. A typical serial display is shown in Figure 5.

Signature analysis is the newest mode to join the logic analyzer family. The signature analyzer is basically a synchronous serial analyzer with a special algorithm built in to "format" the data input.

Signatures can be taken manually or in an automatic mode. All signatures are based on a START input and a STOP input signal.

Variable threshold probing is provided to take signatures for dif-

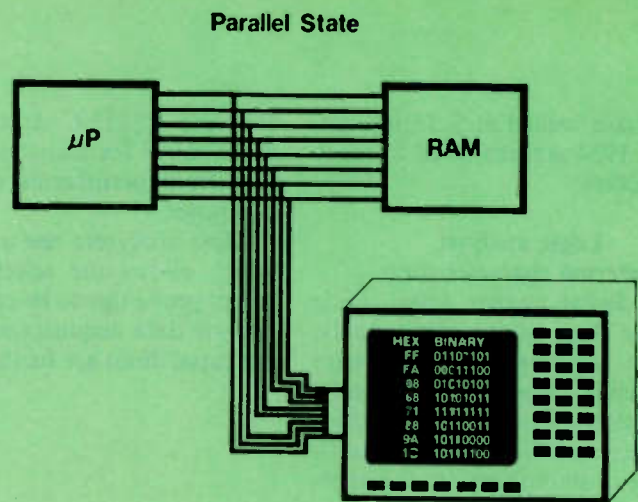

Figure 4

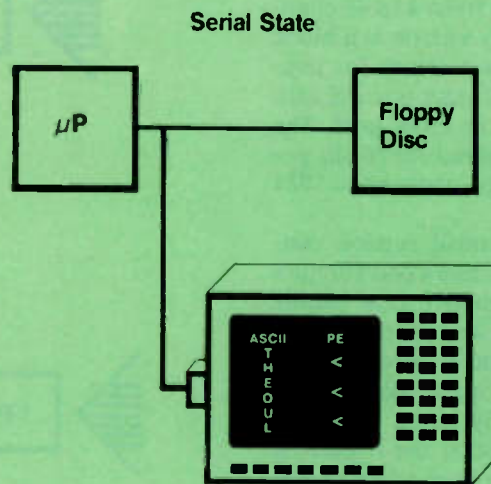

Figure 5

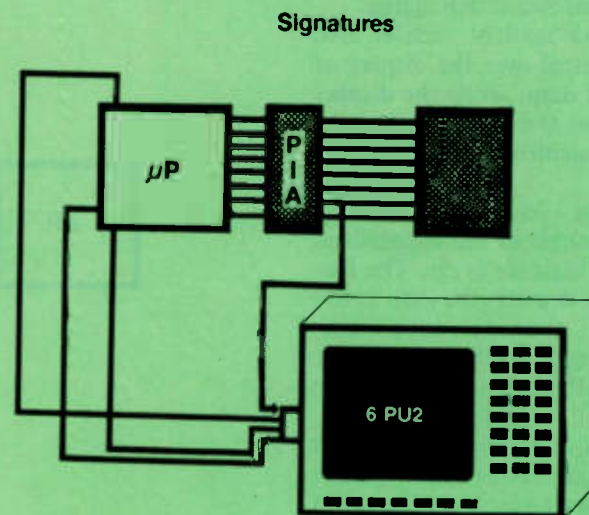

Figure 6



ferent logic families. Most signature analyzers use a standard CRC algorithm developed by Hewlett-Packard to produce their signatures. Displays range from seven segment LEDs to CRTs with menus. The readout is a 4-digit pseudohexadecimal code (Figure 6) following a 0-9 ACFHPU pattern.

### Applications

When considering applications for logic analyzers, remember that logic analyzers are not just for design. With new compact packaging, logic analyzers are rugged and portable and are being used more in service and manufacturing.

Hardware applications use timing diagram displays to track down intermittent pulses in digital circuits. Microprocessor timing relationships provide an ideal example for a timing analyzer application.

Inside a microprocessor-controlled system are many precisely timed events. When monitoring I/O activity, multichannel data acquisition with the logic analyzer provides an easy means for finding problems. When the data acquisition is confined to the synchronous domain of the CPU, the analysis task becomes a state analyzer function. But when a problem occurs outside of the PIA (Peripheral Interface Adapter), then the timing resolution needed is provided by asynchronous sampling. This is necessary because the activity outside the PIA is asynchronous to the CPU.

When debugging software, the parallel state analyzer is most useful. The capability to see up to 48 channels simultaneously yields a variety of debugging techniques. The ability to read data formatted into the user's "language" provides a convenient method for tracing program flow throughout a digital circuit.

Because the logic state analyzer allows monitoring of all 16 address lines plus control lines, address bus problems occurring during the software/hardware integration can be resolved quickly and efficiently. When an engineer needs to trigger on a 16-bit address and then view 8 or 16 lines of data to determine if every event occurred correctly, he can be in trouble using an oscilloscope. A logic analyzer allows

him to view all 16 address lines plus the 8 or 16 data lines to determine where the problem areas lie.

State analyzers normally run in sync with the circuit being tested. This allows valid address range recognition and event counting, which lets the engineer follow subroutine jumps and returns.

Some logic analyzers have a reference memory which allows the user to uncover intermittent problems. By loading known good data into the reference memory and then putting the logic analyzer into the "RESTART IF" mode, the analyzer will take a new acquisition, compare the contents of the acquisition memory to the reference memory and, if they are equal, the analyzer will start another acquisition cycle. If the two memories are not equal, a problem has occurred. The analyzer will then stop and display the last data acquired. By using the comparison feature, the user can pinpoint the exact problem area in the circuit.

This mode, known as "babysitting," can be set up to run during a weekend. When the engineer returns on Monday morning, he can see that the intermittent problem occurred. Some analyzers record the number of resets made to help isolate the problem.

The state analyzer allows tracing of a complete algorithm in a new or old circuit. Some of the analyzers give  $\mu$ P disassembly capability for certain popular microprocessors. This makes using the state analyzer much more simple. Connect 16 lines to the address bus and/or data bus, and the user gets a display of the opcode used for his application. By using the qualifier inputs, data can be captured in Write/Read, Direct Memory Access, or even interrupts. With the high speed analyzers, the user can monitor address bus multiplexing on RAMs.

Clock qualifiers offer selectivity when storing data. For example, while monitoring I/O activities, if the RD (Read) line is used as the clock qualifier, the logic analyzer will acquire data only when the read line is true (low). By using the clock qualifiers, memory depth available in the analyzer is used.

Glitch detection capability has been a prime factor in establishing

the logic analyzer into design and test engineering. A first-order glitch is defined as two transitions during a sample interval. Second-order glitches are defined as three transitions during a sample interval. The ability to latch glitches down to 5ns in width proves useful in determining system or circuit bugs.

A combination timing/state analyzer can lend itself to process control debugging on large or small systems. Verifying that A/D conversions are taking place correctly with no glitches and following the data through the circuitry is a common application. Combining a serial state analyzer with this application allows the user to monitor I/O operations via an RS232-C bus and can help isolate design errors between the CPU and a disc unit.

For communications between peripherals, a serial data analyzer is the ideal tool. It allows the user to detect random bit patterns either synchronously or asynchronously from 0 to 19.2 kilobaud. These bits are stored into memory for later analysis. Most serial state analyzers use RS232-C protocol.

Disc I/O activity to and from a CPU can be verified for floppy discs and even high-speed multiple disc systems.

For systems' characterization, the signature analyzer is essential. Characterizing a complete system provides an easy means of debugging the most complex digital problems. Even a power supply can be signed to allow the detection of unwanted noise spikes.

Using signature analysis allows someone who knows little about the system to debug a complex system.

Signature analyzers, a tri-stated bus or line can be characterized to determine its condition. By breaking connection with the outside world on a tri-state line, the user can determine where a fault may lie.

### A final word

Many have referred to the logic analyzer as the oscilloscope of the digital domain. Its use is expected to increase in design, service and manufacturing environments. The applications are limited only by the capabilities of the analyzers and the imagination of the people using them. □



---

# THE INDUSTRIAL TECHNICIAN OF THE FUTURE

By John E. Cunningham,  
Cleveland Institute of Electronics

Sooner or later, most electronics technicians wonder what electronics technology will be like in the future. The state of the electronics art is changing so rapidly that both electronics equipment and the operations performed by the technician will certainly change drastically in the not-so-distant future.

Sometimes this wonder changes to worry when prophets of doom predict that equipment will be designed so that electronics technicians will no longer be needed, even though all past efforts to eliminate the technician have failed.

Even though forecasting the future is risky, there are signs that strongly indicate what some of the trends will be.

## Digital equipment

Digital items are daily appearing on the market, and there is no indication that the trend is letting up. The result is that the cost of digital components is dropping and this, in turn, is leading to even more applications.

Some of these advances occur so fast that they pass right by the technician. Low-cost watches and calculators are good examples. The price erosion in these fields has happened so fast that the items have become expendable before the electronics technician has had time to learn to handle them. Other items are priced so that maintenance service will be required for many years.

The microprocessor in particular is being used with all types of equipment; according to many of the experts, the invasion has just started. The technician will find before many years that the majority of items that show up on the workbench contain microprocessors.

## Optics

With the exception of a few telephone companies that have ex-



perimented with fiber-optic transmission, optical techniques have not appeared in most electronic equipment until recently. Now fiber-optics are being used to carry signals between units of digital equipment, and electro-optic devices are actually being used to process signals. There are many advantages to electro-optics, and again devices using optical technology will soon appear on the bench for repair.

### The whole spectrum

At one time, an electronics technician could afford to specialize in the low end of the electromagnetic spectrum. Much of the higher portion of the spectrum wasn't used. But the advent of TV and 2-way radio soon forced the technician to the VHF and UHF regions.

Now it is hard to find a portion of the spectrum that isn't commercially used. Even home entertainment equipment is using microwaves for distribution of pay TV, and the FCC has approved experimental direct broadcast from geostationary satellites to home antennas. In the near future, the electronics technician will find that the technology of any portion of the spectrum cannot be neglected, whether he specializes in home entertainment equipment or industrial maintenance.

### Required skills

Few of the skills that have been passed on from one generation of technicians to another have truly become obsolete. Certainly, troubleshooting ability will be required. This isn't an easy skill to define, but it is easy to recognize. Undoubtedly it is based on a solid knowledge of electronic principles. But there is more—there is the almost intuitive knowledge of how electronic circuits fail.

Troubleshooting in just-created equipment will require new skills,

but the need for the traditional skills will be present for a long time. As long as electronic components are connected together, there will be defective connections. Furthermore, many of these will continue to be intermittent.

New skills required will be hard to predict until the new equipment arrives. With the advent of the microprocessor, the technician must learn to apply his troubleshooting ability to signals that occur in the form of several separate bits on a bus-type structure. This will require a new way of thinking.

Certainly tracing optical signals will require new and unfamiliar techniques. Microwave signals will also present new problems and require new skills.

Probably the most drastic change in skills that will be required will be at least a passing knowledge of software and computer programming. When much of the modern microprocessor-based equipment fails, there is no way to determine in advance whether the fault is a good old-fashioned component or connection failure, or a program fault. The troubleshooter must have enough skill in each area to solve the problem.

Mastering software troubleshooting skills sounds more difficult than learning a foreign language. Really, things aren't that bad.

A programmed system can be thought of as performing the same functions as earlier, more conventional systems. The difference is that the system has a wiring diagram that can be changed periodically by whatever is stored in its memory. If a cell in a memory or a connection fails, the problem can be thought of as a sudden change in the wiring diagram that causes it to no longer perform properly. A component failure in a conventional system does the same thing—changes the wiring diagram of the system so that

it no longer performs correctly. Because the technician has proved to be quite competent in the latter case, there is no reason why, with a little more knowledge, he can't develop a similar capability with programmed systems.

There is another factor working in favor of the technician. When complex digital systems were first introduced, it was nearly impossible to get the systems operating properly before they left the factory, and even harder to troubleshoot if they failed. This was not in the manufacturer's best economic interest, and many companies failed for this reason, even though their products served useful purposes. Now an important part of these systems' design is features that will make them easy to de-bug at the factory. These same features also make the product easier to troubleshoot.

A typical example of this is a process called "signature analysis." Products are designed so that when they are working properly, there are certain known signals available at various points. These signals are different than those of the past, but signal tracing skills can be converted and applied to the new equipment.

Everything that the manufacturer does to make his equipment easier to de-bug at the factory will in some way help the technician to troubleshoot it when it fails.

### Test equipment

Again, the VOM and oscilloscope will probably always be needed, although the newer versions will undoubtedly have features that will make them easier to use. There will also be a need for completely new equipment. Fortunately, test equipment manufacturers have recognized this need and realize that unless they keep up with the demand, they will soon be out of business.

At first, the new test equipment



## The industrial technician of the future

may be expensive compared to more conventional instruments, but the equipment that is to be repaired will also be more expensive.

The complexity of digital equipment is already spawning many instruments. For example, in signal tracing a digital instrument, one may need to know the signal that is present on a bus consisting of 16 separate wires. This signal may be checked with a voltmeter or a logic probe, but 16 separate measurements must be made. If the trouble is intermittent, the signal on one of the bus wires may change before the last of the 16 voltages is measured. A new logic analyzer may be clipped on so that it contacts all 16 wires simultaneously and measures their logic states. Furthermore, it will reduce this signal, consisting of 16 highs or lows, to a hexadecimal number that consists of only four digits and that can be easily read.

As equipment development proceeds, new test equipment must also be developed. Test equipment manufacturers are constantly working on methods of simplifying and reducing the cost of the instruments. There will soon be affordable versions of instruments that now cost many thousands of dollars.

### Required knowledge

Additional knowledge will be needed to work with more complex equipment. Predicting what this new knowledge will be is indeed difficult. Educators and engineers do not have a good track record in this area.

When the transistor came into common use, almost every engineer and educator predicted that before a technician could work on transistorized equipment, he would first have to become thoroughly familiar with crystal structures and their impurities, as well as the various theories of conduction by holes and electrons. These subjects were

taught religiously, and indeed, they are nice to know, but technicians seldom make practical use of these theories.

Similarly, when digital systems first appeared, it was felt that every technician needed a thorough knowledge of Boolean algebra. Again the subject was taught thoroughly, and again it is a nice subject to know, but even fewer technicians use it.

A recent trend in educational institutions seems to indicate that a technician should study the same subjects as an engineer, but simply not as much of it. History doesn't bear this out, and this principle doesn't seem to be considered in other fields. Automotive mechanics are not taught the design intricacies of the internal combustion engine.

Undoubtedly, when the new devices first appear, technicians will be taught all about them in some impractical way. The electronics technician, however, will use only the knowledge that he needs to make a living. The more practical educators are already looking at the new fields from this point of view.

A few facts have become obvious. The technician of the future must have a broader knowledge of the principles of physics. He must know more about how software operates. He must become familiar with test equipment as it appears.

Educators, as well as test equipment manufacturers, will soon find themselves facing hard times if the education they provide doesn't help the technician make a living. Technicians of the future will find courses that contain what they must know.

Some of this vital knowledge will be completely unfamiliar, but a properly educated technician will not need to go back to school when a new development appears. If his background in fundamental principles is adequate, he will be able to

pick up on new developments and to understand them.

### New horizons

Each development will bring change. The transistor has made the ordinary AM radio expendable, because it is usually more economical to discard than to repair. The same is true of some calculators and watches. On the other hand, solid-state developments have also brought new products such as electronic games, home computers and industrial controls that are far too expensive to discard. Here the technician not only finds additional work, but usually finds that he can charge a higher fee for his efforts.

Another field where the requirement for electronics technicians is increasing rapidly is in industry. The state-of-the-art in electronics is expanding faster than the supply of engineers who must convert these developments into practical products.

For many years, the claim in industry has been that many engineers are "underemployed." In addition to their engineering duties, they were busy performing many duties that could have been performed as well or better by an experienced technician. The engineer performed these duties because the time was available.

The shortage of engineers, which shows no sign of letting up in the near future, will force employers to use them to perform duties that require all of their knowledge and skill. The skilled electronic circuits and components tasks and testing must be turned over to the technician.

The electronics technician will still be with us in the future. He will have a broader base to his knowledge. The technician will have sharper skills, and undoubtedly, he will be much better paid. □



Chassis — Sylvania D16  
PHOTOFACT — 1325-2

1

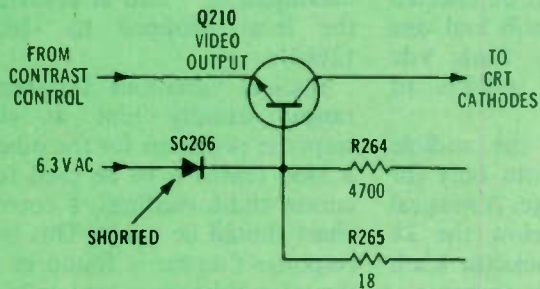

**Symptom** — No raster, but service line is normal  
**Cure** — Check diode SC206, and replace it if shorted

Chassis — Sylvania D16  
PHOTOFACT — 1325-2

2

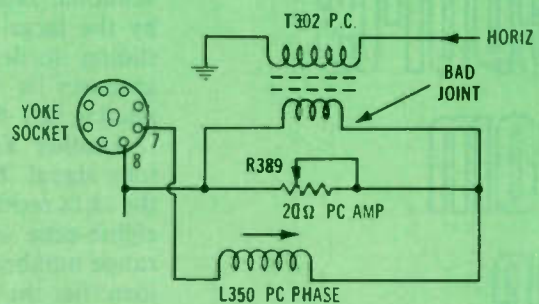

**Symptom** — Erratic lack of height at bottom of picture  
**Cure** — Check T302 connections, and resolder any bad joints

Chassis — Sylvania E20  
PHOTOFACT — 1595-1

3

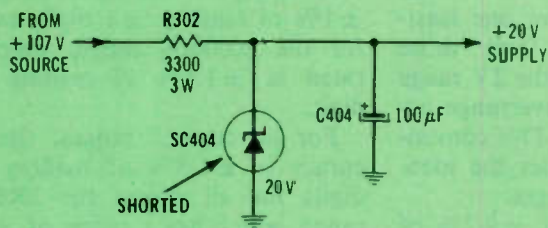

**Symptom** — No sound and no raster  
**Cure** — Check zener diode SC404, and replace it if shorted

Chassis — Sylvania E20  
PHOTOFACT — 1595-1

4

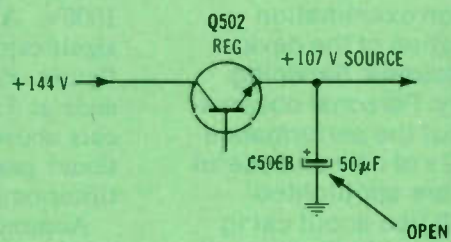

**Symptom** — Excessive high voltage followed by shut-down  
**Cure** — Check filter capacitor C506B, and replace it if open

Chassis — Sylvania E21  
PHOTOFACT — 1587-1

5

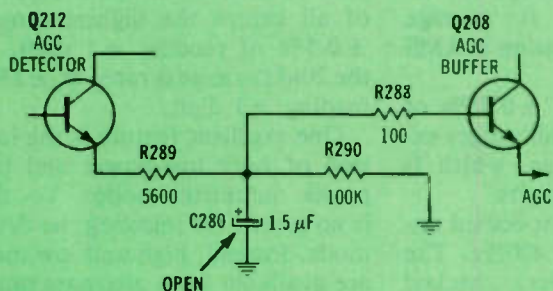

**Symptom** — Some picture instability, and scanning line pairing  
**Cure** — Check AGC capacitor C280, and replace it if open

Chassis — Sylvania E21  
PHOTOFACT — 1587-1

6

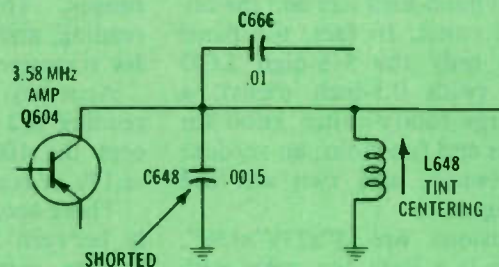

**Symptom** — Faces are green  
**Cure** — Check capacitor C648, and replace it if shorted



# Reports from the test lab

Each report about an item of electronic test equipment is based on examination and operation of the device in the **Electronic Servicing** laboratory. Personal observations about the performance and details of new and useful features are spotlighted, along with tips about using the equipment for best results.

By Carl Babcoke, CET

## Triplet model 3450 DMM

Two features of the Triplet model 3450 digital multimeter are the small hand-held size and the uncluttered panel. In fact, the panel contains only the 3½-digit LCD readout (with 0.5-inch digits), a single large rotary-switch knob for all ranges and functions, an ac/dc  $\Omega$  sliding switch, and two test-lead jacks (Figure 1).

Dimensions are 3"x5½"x1½". The case is a dark tan color with readout panel and selector knob of light tan. The weight is 10 ounces. A single alkaline battery supplies power for about 200 operating hours. A weak battery activates the readout's low-battery indication

when about eight hours of operation remain.

Twenty-four ranges in five conventional functions can be selected by the large rotary knob and one sliding ac/dc  $\Omega$  switch. Basic Vdc accuracy is rated at  $\pm 0.2\%$  of reading  $\pm 1$  digit.

Another feature is the audible tone signal that functions only for the 2k  $\Omega$  resistance range. A musical eighth-note symbol below the 2k range number on the selector knob identifies the audio-tone response.

Automatic functions include auto zeroing, auto polarity-indication on dc, auto weak-battery indication and auto decimal, moved by the range switch. The range-selector knob is color coded for convenience to the operator.

## Vdc specifications

The five Vdc ranges are  $\pm 200\text{mV}$ , 2V, 20V, 200V and 1000V. All ranges have one least-significant-digit less than those figures. For example, the 2V range ends at 1.999V, and overrange occurs above that point. This conventional practice simplifies the identification of DMM ranges.

Accuracy is rated at  $\pm 0.2\%$  of reading  $\pm 1$  digit for all ranges except the 1000V range, which is rated at  $\pm 0.75\%$   $\pm 1$  digit. Input impedance is 10M  $\Omega$  on all ranges. Maximum safe input voltage is 1000Vdc or a dc and peak-ac total of 1000V.

## Vac specifications

Five Vac ranges are supplied; 200mV, 2V, 20V, 200V and 1000V. Input impedance is 10M  $\Omega$  for all ranges. The circuit is average reading, and the calibration is RMS for sinewaves.

Accuracy is rated at  $\pm 0.75\%$  of reading  $\pm 2$  digits for all ranges except the 1000Vac range, which is  $\pm 1\%$  of reading  $\pm 2$  digits.

These accuracies are specified only between 50Hz and 400Hz. The sample meter, however, checked better than that on the two ranges tested for frequency response. On the 2V range, -1dB (about -11%) occurred at 4700Hz, while -6dB was at 42kHz for tests made at 1.6V RMS.

Test results of the 20V range were

surprising, because the readings *increased* at higher audio frequencies. The gradually rising response gave a maximum of +5dB at 28kHz, then the level dropped to -1dB at 126kHz.

Radical variations between two ranges usually hint at similar response problems for the others. If a 3450 DMM is to be used for accurate audio readings, a correction chart should be made. This lack of response flatness is found in many digital multimeters, especially those with op-amps in the Vac system.

## Current specifications

Maximum-current ranges of 2mA, 20mA, 200mA and 2000mA are supplied for both ac and dc power. A minus sign is shown before the digits for negative currents, but no sign shows for positive current or ac current.

Accuracy for the dc mA ranges is  $\pm 1\%$  of reading  $\pm 1$  digit, except for the 2000mA range, which is rated at  $\pm 1.5\%$  of reading  $\pm 1$  digit.

For ac current ranges, the accuracy is  $\pm 1.5\%$  of reading  $\pm 2$  digits for all except the 2000mA range, which has a rating of  $\pm 2\%$  of reading  $\pm 2$  digits.

Voltage drop across the meter is about 200mV for all ac and dc ranges. Protection is furnished by a 2A fuse. Measurements of audio current should include corrections for frequency response.

## Ohmmeter specifications

A full complement of six resistance ranges covers 200  $\Omega$  full scale to 20M  $\Omega$  full scale. Accuracy of all except the highest range is  $\pm 0.5\%$  of reading  $\pm 1$  digit, and the 20M  $\Omega$  range is rated at  $\pm 1\%$  of reading  $\pm 1$  digit.

One excellent feature is the inclusion of both low-power and high-power ohmmeter modes. Yet there is no switch for selecting the desired mode. Instead, high and low modes are available from alternate ranges. Those ranges printed in black on the selector knob should produce some conduction in diode or transistor junctions when forward biased. This is handy for testing semiconductors out of circuit. Ranges





**Figure 1** Triplet model 3450 digital multimeter features the essential five functions with more than adequate ranges, plus features such as an audio-response resistance indication and a color-coded selector knob. Simplified controls allow rapid operation with few measurement mistakes. The function-and-range switch has a large knob that turns off the power when fully rotated clockwise. A time-saving convenience is the deletion of all but two test-probe jacks.

Triplet resistance range	Test lead voltage without diode	Triplet diode-resistance reading	Voltage across diode
200 $\Omega$ (green)	+ 2.71V	Overrange	0.598V
2k $\Omega$ (black)	+ 2.71V	1.071K	0.586V
20k $\Omega$ (green)	+ 0.296V	Overrange	0.283V
200k $\Omega$ (black)	+ 0.968V	66K	0.373V
2M $\Omega$ (green)	+ 0.284V	1.57M	0.178V
20M $\Omega$ (black)	+ 0.667V	2.02M	0.159V

**Figure 2** All six resistance ranges were evaluated during tests of a silicon diode. A second DMM, having 22M  $\Omega$  input resistance on Vdc, was used to record the voltages of columns two and four. The 22M  $\Omega$  load reduced the true voltages, but they can be obtained by Ohm's Law calculations. According to the open-probe voltages, only the 20k  $\Omega$  and 2M  $\Omega$  ranges are low-power types. This is important during tests of circuits that include transistors and diodes.

printed in green should *not* cause any significant junction conduction, for testing circuits than include junctions.

Readings made by the sample DMM, however, showed several discrepancies from those specifications. During testing of a normal silicon diode monitored by another DMM having 22M  $\Omega$  input resistance, the Figure 2 readings were obtained.

The 200  $\Omega$  range has sufficient voltage at the tested diode to cause conduction, but the resistance that results is larger than the 199.9  $\Omega$  full-scale reading. Therefore, over-range indication is activated, even though this range actually operates in the high-power mode.

#### Audio-tone operation

An audio tone that indicates circuit conduction can be helpful when a technician must watch the test probes and not the meter readout. Triplet model 3450 audio tone operates only on the 2k  $\Omega$  range. The tone, from a rear-mounted transducer, sounds when a re-

sistance of 1000  $\Omega$  or less is across the test leads. When continuity first is established, the tone begins immediately, then it continues for about a half second before it is stopped by the meter circuit. In other words, the tone faithfully follows separate and repeated *short* bursts of continuity. But the tone cannot be sustained more than the half second even when the continuity is permanent. When the test probes are permanently shorted together, the tone begins instantly and lasts for a half second before it is eliminated. The next continuity activates the tone again.

After the tone stops but while the continuity persists, the digital readout will show, in due time, the exact resistance reading.

This operation is excellent for indicating the precise beginning of continuity, and for showing any opens or erratic continuity during the half second of tone. But it cannot identify any opens or erratic continuities that occur after the half second has expired. A constant tone is necessary for that test.

Because the audio tone operates on the 2k  $\Omega$  range, it can also be used for in-circuit testing of diodes and transistors without watching the readout.

#### Accessories

Accessories available for Triplet model 3450 include three types of protective cases, a 6kV probe, a 20A shunt, a clamp-on ammeter adapter, three types of test leads, and a wire-type tilt stand. This stand is a simple "U"-shaped insulated wire that holds the meter securely on any flat surface. It is highly recommended.

#### Comments

Model 3450 digital multimeter from Triplet packs many helpful features into a small package. Accuracy of the sample was good compared to other meters of higher rated accuracy (such as 4½-digit models).

The few controls and simple layout of the DMM should reduce measuring mistakes to a minimum. In actual operation, model 3450 was found to be easy and fast to accurately operate.



## Test lab

### Keithley model 135 4½-digit DMM

The Keithley line of laboratory test equipment has been expanded by the addition of model 135 digital multimeter, a 4½-digit LCD-display DMM of improved accuracy. Basic Vdc accuracy is rated at  $\pm 0.05\%$  + 1 digit.

The circuitry provides automatic zeroing, automatic polarity for dc reading, automatic decimal placement and automatic overrange indication. Any readout in excess of 19999 produces the overrange indication, consisting of a blinking 1 followed by 4 zeros. This applies to voltage, current and resistance readings. A *BAT* symbol appears in the upper left corner of the display when about 10% of the battery life remains. All panel numbers and words are covered by plastic to prevent removal or smearing during normal wear and tear. Colors of the instrument case range from tan to dark brown.

Height of the LCD digits is 0.6 inch (most DMMs have 0.5-inch LCD digits) for better readability.

A single 9V battery is used. An alkaline battery should operate the meter for 100 hours or more. An on/off switch is located on the cabinet's right side.

#### Rotary selector switches

Design and location of the two rotary knobs (range switch at top and function switch below) allow convenient operation in two ways. When the meter is lying on its back or on its tilting bracket (optional), the knobs can be turned by the fingers of either hand on the center bar. If the DMM is held in the left hand, the knobs can be rotated by the left thumb against notches around the knob's perimeter (Figure 1). Both rotations are possible when the DMM is fastened inside its optional carrying case.

#### Dc-voltage specifications

Four ranges of dc-voltage readings allow measurement between 0.1mV and 1000V, either positive or negative at 10M $\Omega$  input resistance. The 2V and 20V ranges have accuracy ratings of  $\pm 0.05\%$  + 1 digit, while the 200V and 1000V ranges are rated at  $\pm 0.1\%$  + 1 digit. The highest range does not stop or overrange at 1000V (it ac-



Figure 1 Keithley model 135 features high accuracy with a 4½-digit LCD display using large 0.6-inch digits. Basic Vdc accuracy is  $\pm 0.05\%$  + 1 digit. Range and function knobs can be rotated by the left thumb when the meter is held by the left hand, or the knobs can be rotated by the center bar with either hand.

tually is a 1999.9V range), but that is the highest voltage the meter can handle safely.

#### Ac-voltage specifications

Basic accuracy of  $\pm 1\%$  + 15 digits is specified for the four ac-voltage ranges. These are identical to the four Vdc ranges, except the highest safe voltage is limited to 750V RMS because of the peak voltage.

Input impedance is 10M $\Omega$  for all Vac ranges. Each range has a different frequency response, although special compensation networks and linear rectifiers in the ac-to-dc converter provide a flatter frequency response than that of most digital meters. The sample model 135 meter tested -1dB at about 75kHz on the 2V range and -1dB at about 135kHz on the 20V range. This is excellent performance for a digital multimeter.

#### Dc and ac current specifications

Because of the accuracy and high linearity of these ranges, only two 3½-digit current ranges are provided. One has a resolution of 0.1mA and a nominal full-scale rating of 20mA (although it will read higher before the protection diodes limit the accuracy). The higher range is rated at 10A, but the instrument will

tolerate higher current for a time.

Accuracy of the 20mA range is  $\pm 0.5\%$  plus 2 digits for dc power or  $\pm 1.5\%$  + 15 digits for ac. Accuracy rating of the 10A range is  $\pm 1\%$  + 2 digits for dc power or  $\pm 1.5\%$  + 15 digits for ac.

Five test-lead banana jacks are supplied. Voltage and resistance tests are made with the common and V- $\Omega$  jacks. The 20mA current ranges use the common and 20mA jacks. But two others (10A LO and 10 HI) are used for the 10A ranges.

#### Resistance measurement specifications

Five decades ranges cover 2K $\Omega$  to 20M $\Omega$  full scale with accuracies of either  $\pm 0.2\%$  + 2 digits or  $\pm 0.25\%$  + 5 digits, depending on range.

These are high-power resistance ranges with about 2.5V across an open circuit. A silicon diode tested 1.4182K $\Omega$  (1,418.2 $\Omega$ ) on the 2K $\Omega$  range, or 4.483K $\Omega$  (4,483 $\Omega$ ) on the 20K $\Omega$  range.

#### Accessories

Optional accessories include a soft carrying case with stand (highly recommended), a high-voltage probe, 50A current shunt, spare-parts kit, RF probe, clamp-on current probe and two types of test leads.

#### Comments

Keithley model 135 gave excellent performance during all lab tests. Readings appeared and stabilized rapidly — faster than most digital multimeters — and often only one transient reading was seen before the final readout. Only the normal bobble (one or two number variation of the least-significant digit) was noted. This allowed the full 4½-digits to be used for more measurements.

Advantages of the extra digit were noted for all readings that did not begin with a 1. Another advantage was the more detailed readout for voltages above 200V. Three-and-a-half digit meters display only whole volts, such as 262V, while the 135 showed tenths of a volt, as in 262.7V.

In some ways, the Keithley model 135 portable DMM has a higher accuracy than many large bench-type units. □



# Special Inventory Clearance Offer...

Get all 5\* great books for

**\$10.00**  
(a \$25.00 value)

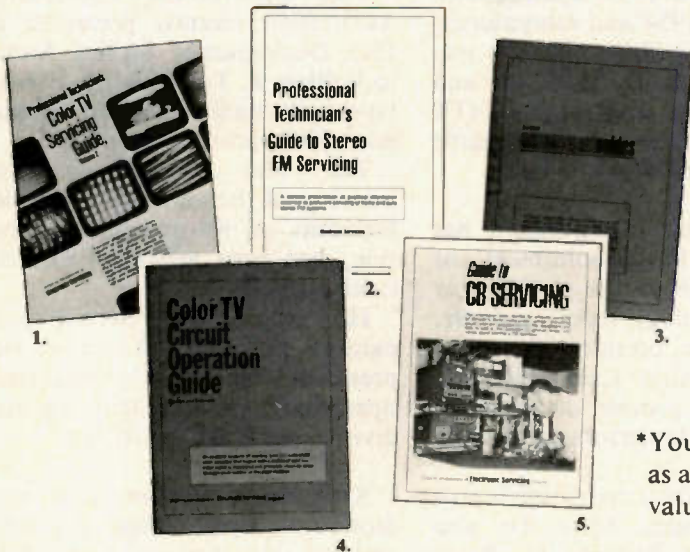

**Electronic Servicing** brings you 5 of its most popular reference guides for a fraction of their original value...

- Color TV Servicing
- Better Management
- Stereo FM Servicing
- Color TV Circuit Operation

plus:

\*You get "Guide to CB Servicing" FREE as an extra bonus for ordering this valuable set of reference manuals.

*For a limited time* **Electronic Servicing** is offering this complete package of 5 reference guides for one low price

**1. COLOR TV SERVICING GUIDE Volume 2**

Fourteen chapters explain many repairs of color TVs from the tuner to the deflection yoke. Included are photos of trouble symptoms from the screen of the picture tube, transistor tests, case histories of typical repairs, explanations of scan rectification, and descriptions of essential tools and techniques.

**3. BETTER MANAGEMENT GUIDES**

Practical information about bookkeeping and accounting procedures, service labor pricing, technician incentive programs, methods for increasing shop productivity, and how to get the most from your insurance dollars, plus a checklist for evaluating your own business management techniques.

**2. PROFESSIONAL TECHNICIAN'S GUIDE TO STEREO FM SERVICING**

A concise presentation of practical information essential to proficient servicing of home and auto stereo FM systems.

**4. COLOR TV CIRCUIT OPERATION GUIDE**

An in-depth analysis of existing tube and solid-state color circuitry that begins with a review of how the color signal is developed and proceeds stage by stage through each section of the color receiver.

*Order your set today for only \$10.00 by sending in this coupon:*

**5. Your FREE bonus:**

**"Guide to CB Servicing"**



The information most needed for efficient servicing of Citizen's Band transceiver radios; including circuit analysis, suggestions for test equipment and advice about CB business.

**Electronic Servicing**

P.O. BOX 12901, DEPT. GG, OVERLAND PARK, KS 66212

Please send me Electronic Servicing's 5 reference guides at the price of only \$10.00 for the complete set.

Name \_\_\_\_\_

Company \_\_\_\_\_

Address \_\_\_\_\_

City \_\_\_\_\_ State \_\_\_\_\_ Zip \_\_\_\_\_

Signature \_\_\_\_\_

Charge to my  VISA or  MasterCard # \_\_\_\_\_  
or  I have enclosed my check for \$10.00

Make checks payable to: Electronic Servicing



# people in the news

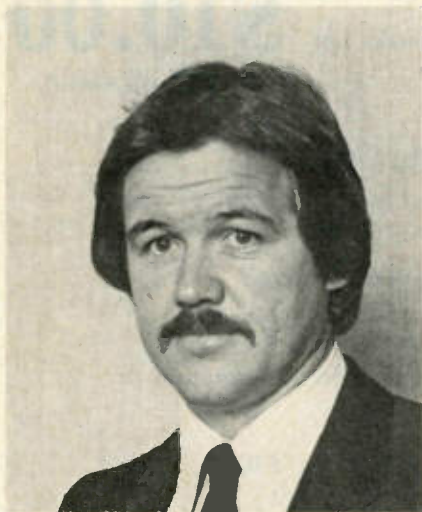

Midland International Corporation has announced the promotion of **Jerry McCoy** from central regional sales manager to national sales manager, consumer products division.

McCoy has been with the consumer products division of Midland for the past six years. His first position with the company was as warranty service manager, from which he was promoted to customer service manager and then to central regional sales manager.

**Henri Busignies**, chief scientist emeritus of International Telephone and Telegraph Corporation, an inventor, a scientist, and an authority on radio navigation and radio direction finding, died June 19 in Antibes on the French Riviera. Death was due to a heart attack.

Busignies held more than 140 patents in the air navigation, radar, and communication fields and was associated with the ITT System for more than 50 years.

He joined the ITT System in November 1928, as an engineer in the corporation's Paris laboratories, and he retired from active service on February 28, 1975, maintaining his active interest in the scientific progress of the corporation.

Since 1941, when he participated in the founding of ITT Laboratories, Dr. Busignies played a major role in the growth of ITT's U.S. activities. He became technical director of the laboratories in 1949,

vice president in 1953, executive vice president in 1954 and laboratories' president until 1960, when he was advanced to vice president and general technical director of the ITT parent corporation. He became senior vice president in 1965.

Lam Research Corporation has announced the appointment of **Steve Y. Muto** to vice president of process technology, reporting to **Dr. David K. Lam**, president.

Before joining Lam Research, Muto was a process development engineer for Hewlett-Packard, Palo Alto.

Holding patents on materials process technologies, Muto has also published his findings in major trade journals. In his position at Lam Research, he will work toward developing various process technologies for the firm's AutoEtch 480 plasma etching system.

Digital Pathways Inc. has announced the appointment of **John R. Anderson** to vice president of marketing and sales, a new position. He reports to **Dr. Mel Schwartz**, president.

Before joining Digital Pathways, Anderson was director of international operations for Racal-Vadic Inc., a modem and telephone peripheral manufacturer based in Sunnyvale, CA. In this capacity, he managed all marketing/sales activities outside the United States and Canada.

**Ed Weisl**, vice president of sales for the last 14 years at Mura, has joined BP Electronics.

In his new position, Weisl will be responsible for the expansion of the product line concentrating on the six major areas of auto speakers and accessories; audio devices, hardware and accessories; CA/MATV devices and accessories; components, tools and miscellaneous hardware; replacement antennas; and economy test instruments. At the same time he will also seek to expand and define a strong national distributor program.

The Electronic Industries Association recently presented its 1981 Distinguished Service Award to **William F. Tait** of RCA. Presentation was made during the association's 1981 spring conference.

Tait, who currently serves as treasurer of the association and vice president of its government division, has been active in EIA activities since 1973.

He joined the RCA Service Company in 1959 and will retire as vice president for RCA's marketing operations, government systems division, effective this month.

Klein Tools announces the promotion of **Alan W. Sipe** to western regional sales manager. Sipe joined Klein Tools in 1978 as district manager in the western Pennsylvania area. Responsibility includes supervision of all Klein's district managers in fourteen southwest and western states; including Hawaii, Alaska and the western provinces of Canada.

**William L. Tenney** has joined B&K Precision as west coast regional sales manager. Previously, Tenny was marketing manager for AMSCO/Turner Instruments.

Empire Scientific Corporation announces the appointment of **Rick Pere** as regional manager handling the eastern portion of the United States. Pere has an extensive background in retail sales.

Keithley Instruments has announced the appointment of **Tom Hayden** as national distributor manager for the firm's instruments division. Hayden will administer distribution of hand-held and bench digital multimeters to the MRO and industrial marketplace.

Gast Manufacturing Corporation has appointed **Siegfried Pudell** export products engineer. His duties will include supervising engineering requirement coordination of Gast compressor, vacuum pump and air motor products in European markets.



**James A. Slattery** has been named vice president, engineering, for the Indium Corporation of America. Slattery's new duties include responsibility for the engineering programs and activities for the electronics materials company. He will also be responsible for the company's research and development program.

Slattery has been a development engineer with Indium since 1976. Prior to joining Indium, he was a chemical engineer with Sperry Univac.

**Mark Raduziner** has been hired as marketing coordinator for Intertec Publishing Corporation's electronics magazines. The announcement was made by **Cameron Bishop**, group publisher.

Raduziner previously served as a communications associate with McMartin Industries, a broadcast equipment manufacturer, in Omaha, NE.

In his new position, Raduziner will work to improve advertiser services, and will coordinate marketing, sales activities, and sales promotion functions.

**Carl Bentz** has been hired to the new position of technical editor for Intertec Publishing Corporation's electronics magazines. The announcement was made by **Cameron Bishop**, electronics group publisher.

Bentz holds an FCC 1st class license, and joins the company with a background in TV engineering technology and cable engineering. He previously served as a staff engineer with KCPT-TV, Kansas City, MO, performing functions that included engineering maintenance, design and on-air programming.

He also has done extensive tracking of FCC issues and record keeping for both the KCPT and KUDL stations, and has edited and rewritten sections of the FCC rule book pertaining to engineering. Bentz has also served as a technical writer for aviation navigation electronics instruction manuals.

In this new position, Bentz will coordinate and advise on all technical aspects of the magazines.

**Kevin M. Finn**, general manager of the TRW semiconductor division, has been named a vice president of TRW Inc. He remains head of the division.

Finn joined TRW in 1968 as a project manager for microwave components. He later was plant manager of TRW's semiconductor operations in Bordeaux, France, advancing through the company to become division general manager in January 1979.

GC electronics division of Wallace Murray Corporation announces senior personnel appointments as follows: **Vere L. Hageman**, named director of product development, a position that will involve the design and development of new products for the industrial/MRO, service and consumer markets; **Thomas P. Giovingo**, succeeding Hageman as market analyst, with responsibility for analyzing current marketing strategies and developing ideas for new markets and products; **Robert C. Reynolds**, promoted to sales administrator overseeing all internal sales and order processing; and **Raymond D. Camacho**, marketing manager, who will add to his present duties as new product manager, the supervision of art, advertising, marketing and customer service.

**Herbert C. Klapp** has been appointed manager of marketing communications for Switchcraft, a new position.

Klapp is responsible for planning and administering national advertising, sales promotion and public relations for Victor Business Products. Previously, he held similar management posts at the Admiral group of Rockwell International, Wheel Horse Products and Whirlpool Corporation.

Also at Switchcraft, promotions include the appointment of **Keigh Bandolik** as distributor marketing manager.

Bandolik, who previously served as assistant manager of distribution products, joined Switchcraft in 1978.

**Andrew F. Durette** has been advanced to executive vice president of Cherry Semiconductor Corporation and **Frank Thalhauser** has joined the firm as manager of product engineering. Durette had been vice president of engineering. In his new position he assumes responsibility for all engineering and manufacturing activities. He joined the firm in 1973. Thalhauser was formerly a product manager with Texas Instruments.

**James A. Welz** has been appointed assistant product manager for electrical products in National-Standard Company's wire products group. Welz, in this new position, will be responsible for the sales and marketing of CopperPly wire and other new and existing products relating to the communications industry. He was formerly with Phillips Industries.

**Charles Round** is the new sales manager for distribution and OEM sales at University Sound. Most recently manager for OEM accounts at University, Round has also served as product manager for Altec Lansing and University Sound. His involvement with new product development will continue in the new position.

**Elizabeth Swain** has been appointed director of human resources at Digitran. Her prior experience includes managing industrial relations at BASF Video and positions in personnel with Abbot Laboratories and Analytical Systems Inc. She succeeds **Harry H. Cochran**, who retired in May after 15 years' service.

US JVC Corporation has named **Dan Roberts** as division manager for Professional Video. In his new position, Roberts will direct all product and market development and all sales and marketing strategies.

Also named: **John Brown**, as national government marketing manager. Brown will direct sales of professional video equipment to the General Services Administration.



# reader's exchange

**Needed:** Set-up chart for a Sencore TransiMaster transistor tester/signal generator, model TR110. Will pay reasonable fee for copy or will copy original and return at own expense. *Daniel Martinez, 310 E 115 St., #11-D, New York, NY 10029.*

**Needed:** Sencore ringer flyback and yoke tester, and B&K 520 transistor checker. *James E. Gregorich, 117 Second St. North, Virginia, MN 55792.*

**Needed:** Sam's Photofacts TR-82 and TR-85, and Supremes service manual volume R-6. *C. T. Huth, 146 Schonhardt, Tiffin, OH 44883.*

**Needed:** Schematic and service information for a miniature Sinclair Microvision TV, 1 $\frac{3}{4}$ " screen, model MTV-1, made May 1978. Also need a source of 7800 ICs. *Steve Elosh Jr., 231 Gladstone, Campbell, OH 44405.*

**Needed:** Good, used RCA 137801 yoke from a KCS 190D chassis. *Mike's Repair Service, P.O. Box 217, Aberdeen Proving Ground, MD 21005.*

**Needed:** Audio output transformer, part #95-1698-A, for old tube-type Zenith AM-FM stereo phonograph console, chassis #7G30 (amplifier). *William M. Suhy, 456 Burritt Ave., Stratford, CT 06497.*

**Needed:** Schematic and information on type of diodes used in power supply of RCA solid state scope model WO-505A. Will buy or copy and return. *Jerry Meives, 1712 Cplumet, Beloit, WI 53511.*

**Needed:** Sencore #YF33 ringer, variable line voltage transformer and Philco stereo power transformer #32-8924-1. *D. B. Fritz, 3210 St. Lawrence Ave., Reading, PA 19606.*

**Needed:** One copy of Ghirardi's Radio Troubleshooters Handbook. *F. M. Jones, 247 51st Ave., Bellwood, IL 60104.*

**Needed:** Number and lineup of the 4 output transistor for an AM/FM Multiplex stereo receiver, made in Japan for Maximas Sound Corporation, 5 South St., Garden City, NY. *Joseph Pino, Pino's Appliances, 501 Auburn Ave., Swedesboro, NJ 08085.*

**Needed:** Schematic for Monarch stereo amplifier, model No. SA-40A. Will buy or copy and return. *Vic Schwartz, 7512 Marie St., Columbia, SC 29209.*

**Needed:** Two control knobs from front of Admiral nine inch b&w. Model No. PN904. Listed Sams No. 803. *Jiraneck, Farmington, IA 52626.*

**Needed:** Schematic for Juliette solid-state stereo eight track AM/FM, AFC multiplex 3-way power radio. No

other information available. *David Fagan, 3103 S. Helena, Aurora, CO 80013.*

**Needed:** Schematic and manual for Tektronix type No. 512 oscilloscope. *Al Shur, Box 493, Cardiff, CA 92007.*

**Needed:** Good used or new 520KB22 and 320AWB22 picture tubes. Send cost detail to *H. Geller, 12622 N.E. 3rd St., Bellevue, WA 98005.*

**Needed:** Wiring diagram for Bell and Howell AM/FM radio model 2399A. Will buy or copy and return. *Andrew Horeczko, 1600 W. 22nd St., San Pedro, CA 90732.*

**Needed:** Any CATV or MATV technical manuals or design manuals. Will buy or copy and return. *Ronald R. Crow, 1510 Oddfellow, Apt. 10, Conroe, Texas 77301.*

**Needed:** Schematics and operating instructions for the following instruments. Will buy or copy and return. B & K model 1246 digital IC color generator; EICO model 221 VTVM; EICO model 366 sweep generator; Heathkit model V-7A VTVM; Heathkit model C-3 condenser checker; Heathkit model IG-102 RF signal generator; Heathkit model RF-1 RF signal generator; Heathkit model IG-62 color bar dot generator; Superior Instruments model TV-50 genometer-frequency generator. *John Marsh, 55963 Onaga Tr., Yucca Valley, CA 92284.*

**Needed:** Schematic for AKAI solid-state stereo tape recorder model No. M-10. *William Hennen, 324 Forest Ave., Aurora, IL 60505.*

**Needed:** Schematic for Benjamin model 1045 AM/FM stereo receiver. Firm no longer in business. Will buy or copy and return. *K. Bandusch, 7441 N. Maplewood, Chicago, IL 60645.*

**Needed:** Service information for Sharp SKC1950 chassis, manufactured for K Mart. Will buy or copy and return. *Andy Duli, 1 Boulder Drive, Pittsburgh, PA 15239.*

**Needed:** CRT for B/K 1075 Analist and/or information on dim TV screen displays. Would also be interested in a whole 1075 for parts. *Bob Mendall, RFD #2, Coopers Mills, NE 04341.*

**Needed:** Heath digital course and trainer, Heath microprocessor course and trainer, and B&K 530. *Hughie G. Bates Jr., Rt 6, Box 630, Biloxi, MS 39532.*

**Needed:** Schematic and parts layout from Sams MHF-19 for Lafayette Radio stereo receiver. *Richard Wright, 324 Dillon Dr., Virginia Beach, VA 23452.*



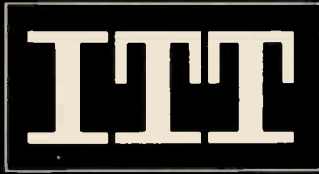

**Burlington**

*Campbell Soup Company*



**AT&T**

bloomingdale's



MASSACHUSETTS MUTUAL  
LIFE INSURANCE COMPANY

SPRINGFIELD, MASSACHUSETTS 01111



# Lots of smart companies have high blood pressure control programs.

## What about yours?

Uncontrolled high blood pressure is a national health problem. About 26 million workdays and billions of dollars are lost each year because of it.

But high blood pressure can be easily detected *and* controlled. Proper treatment, every day, can prevent heart failure, kidney disease, stroke and premature death caused by high blood pressure.

Many companies, large and small, have successful on-the-job high blood

pressure programs for their employees and management. Look into it. You can save time and money. And protect your employees' health. To find out the whole story write:

Ms. Judie LaRosa  
Worksetting Programs Coordinator  
National High Blood Pressure Education Program  
Bethesda, MD 20205

**High blood pressure.  
Treat it and live.**

National High Blood Pressure Education Program, National Heart, Lung, and Blood Institute, U.S. Department of Health and Human Services



## Time delay relay

A digital, solid-state time delay relay that can be inspected at a glance is available from *Exton Instrument*. Called INSTA-CHECK, it shows the operational status immediately, insuring trouble-free operation in industrial control applications.

The module is equipped with a clock timing LED that flashes at a



rate proportional to the delay period. For example, two seconds ON equal a two-hour delay period. This feature permits adjustments to be made quickly and accurately for time delay periods as long as 16 hours.

The time delay relay is also equipped with an output relay indicator LED that shows the time cycle is completed. In addition, it has an output relay override switch that actuates downstream equipment without affecting the time delay period. This helps streamline system setup and troubleshooting operations.

INSTA-CHECK handles all normal timing relay functions. Its basic design incorporates a CMOS divider chain with all components derated for long life.

Circle (50) on Reply Card

## Function generators

*B&K Precision* announces the addition of three function generators to its growing line of test instruments. They are the model 3030

high performance 5MHz sweep/function generator with LIN/LOG sweep; the model 3025 low distortion 5MHz sweep/function generator; and the model 3015 com-

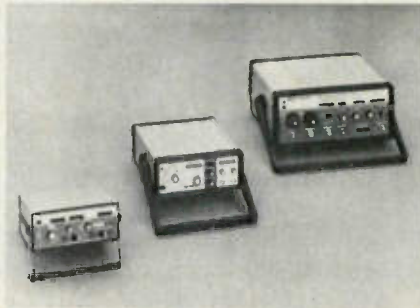

compact 200kHz sweep/function generator with LIN/LOG sweep.

Model 3030 provides frequency coverage from 0.001Hz to 5MHz in eight ranges. Dial frequency accuracy is  $\pm (1\% \text{ rdg} + 1\% \text{ fs})$  up to 1MHz. Sine wave distortion is less than 0.5% from 1Hz to 100kHz.

The model 3025 sweep/function generator is a versatile signal source with an extremely wide frequency coverage. The high frequency limit extends to 5MHz, which allows the 3025 to be a useful signal source in evaluating many rf and i-f circuits.

The model 3015 sweep/function generator is a compact instrument, considering its capabilities. Designed principally for audio and ultrasonic applications, the instrument covers a frequency range of 2Hz to 200kHz in three ranges, with each range providing 1000:1 frequency control.

Circle (51) on Reply Card

## Speed-wrap tool

The G200/R3278 speed-wrap tool from *O.K. Machine and Tool Corporation* is designed to produce solderless wire wrapped connections

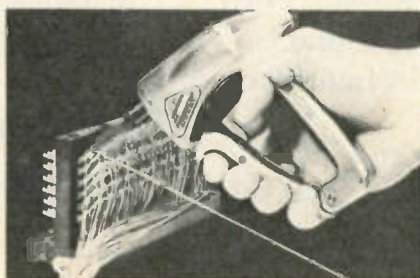

by merely squeezing the trigger. The hardened steel working parts ensure long life and trouble-free service. Enclosure in Lexan housing makes the tool lightweight. The tool is designed for production line and field service use in the electronic, telecommunications and appliance industries, for 22-30 AWG.

Circle (54) on Reply Card

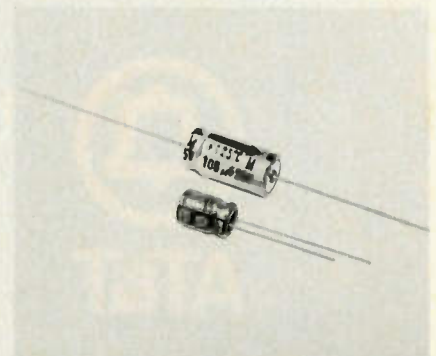

## Electrolytic capacitors

A family of high-temperature, industrial grade, miniature aluminum electrolytic capacitors is available from the Electronic Components Division of *Panasonic Company*.

Designated as 3H Series, the units offer a wide temperature range, including high-temperature operation (-40 to 125°C), a wide range of capacitance (1 to 1000 $\mu$ F), close capacitance tolerance ( $\pm 20\%$ ), rated working voltage range of 10 to 63Vdc, low leakage current (0.002CV or 2 $\mu$ A, whichever is greater), good low-temperature stability, and load life of 1000 hours at 125°C or 2000 hours at 105°C under full-rated voltage.

Available with radial or axial leads, the 3H Series high-temperature capacitors are suited for a variety of industrial and automotive applications at elevated temperatures. Also, the 3H Series capacitor offers good high-frequency performance and stable dissipation factor at temperatures of 25°C and higher.

The 3H Series capacitors offer relatively small size. A 1000 $\mu$ F, 10WVdc unit is only 0.63"x1.299", while a 1 $\mu$ F, 63WVdc capacitor is 0.248"x0.472".

Circle (53) on Reply Card



### Padlocks

*Klein Tools Inc.* announces the addition of a full line of top quality padlocks. The padlocks cover a



broad range of styles and sizes. All of these locks have 5-pin, pick-resistant tumblers, solid, 1-piece cases and hardened steel shackles. Self-locking shackles have a hardened steel ball at both heel and toe to resist forcing. All locks are available keyed differently or keyed alike at no extra charge.

Circle (55) on Reply Card

### Home satellite TV system

*Downlink* has available a line of low-cost home satellite TV receivers, a hobbyist's satellite TV system and a modular parabolic antenna.

The receivers make it possible to own a home satellite TV system with 12-foot antenna, 120° LNA, D-2X receiver, RF modulator and cables. The Skyview I system is a completely turnkey system.

For hobbyists who prefer to build or buy their own antenna, the company has introduced the EP-2000 electronics package, offering all the electronics needed to watch satellite TV except for the antenna.

And for those who prefer the parabolic antenna over the spherical, Downlink has the Skyview III modular fiberglass parabolic antenna.

Circle (56) on Reply Card

### Cordless telephone

*Electra Company* has introduced a microprocessor-based cordless telephone, the FF-4000, with software that makes possible many features previously unavailable. This state-of-the-art cordless phone, designed by Electra, will be manufactured in its Cumberland, IN, facility.

The custom microprocessor and software make possible many other features. The user can choose rotary pulse or pure tone activated dialing, making the telephone capable of full central telephone equipment interface. Features offered by the phone company such as call waiting, call forwarding, 3-way calling and speed calling can be used. A special "hook" key is provided to facilitate



use of these features. The FF-4000 also has automatic dialing capability, which means the user can store up to three numbers in memory and dial any one of them just by pushing a button. The auto dial feature is protected against temporary power outages by means of an easily changeable 9V battery. Also included is a security system that is programmable by the owner to prevent unauthorized usage of the system.

The clear, clean audio response of the unit is made possible by departures in standard circuit design. Unlike conventional systems, which use 1.7/49MHz duplex transmission, the FF-4000 offers the first 49/49MHz approach. This not only frees the system from most common electrical interference, but also makes an extended range of up to 1000 feet possible.

Circle (58) on Reply Card

NATESA  
5908 S.  
Troy  
Chicago  
IL 60629



### ARE YOU A PRO?

...the not for profit association championing independents' right to compete, and delivering valuable benefits continuously since 1950.

- LEADING SPOKESMAN
- TRADE INFORMATION DISPENSER
- WATCHDOG
- LOBBYIST
- YARDSTICK OF STANDARDS
- CONSUMER RELATIONS
- COUNSELOR
- PROBLEM SOLVER

We are not freeloaders. So our check for \$60.00 dues is attached. As our special premium, please ship the indicated \$15.00 Manual.

- Practical Business Manual  
- OR -  
 Service Contract Manual

This space contributed as a public service.



### MARY HEALY HAS SOMETHING TO SING ABOUT.

Nineteen years ago, Mary Healy had a success she'll never forget: recovering from cancer. She and almost 2 million others are living proof that your contributions are important. As important as life itself.

**CANCER CAN BE BEAT.**

American  
Cancer Society



## Products

### Synthesized scanner

*Electra Company* has announced its Bearcat 100 hand-held portable scanning radio. Fully synthesized, it requires no crystals. The unit is contained in a 3"x7"x1 1/4" case.

The unit has 16 channels with extended frequency coverage. Power



consumption is kept extremely low by using a liquid crystal display and several low power integrated circuits.

The radio produces audio power output of 500mW, and produces 1W when used with the accessory ac adapter included in the package. The unit has patented track tuning, selectivity of better than 50dB down, and sensitivity of less than 1mV on all bands and all channels.

Company engineers devised a frame made of high strength, heavy-duty aluminum that acts as a structural element and provides shielding for the internal circuitry. The radio has chrome-plated keys for functions that are user controlled, such as lockout, manual stepping of all 16 channels and automatic scan. Even search is provided, both manual and automatic.

The unit operates on 6 AA batteries and has a battery low LED indicator to signal when to recharge.

The unit's wide frequency coverage includes all public service bands (low, high, UHF and "T" bands), both 2m and 70cm amateur bands, plus military and federal land mobile frequencies. The unit has direct channel access and a built-in automatic scan delay.

Circle (60) on Reply Card

### 50 channel scanner

*Regency Electronics Inc.*, has introduced the D810 scanner. The D810 has 50 channels covering eight bands and eight separate direct access bands.

The direct access keys allow the user to hear preprogrammed channels to the most common public service frequencies for police, fire, emergency, weather, aircraft, mobile telephones, marine and even FM music broadcasts with the touch of a button. Fifty programmable channels are included so that the user may choose from among his favorite frequencies for the normal scanning mode.

The D810 has a permanent memory which allows programmed frequencies to be stored for up to



nine years without battery backup. Other features include search, priority channel, digital clock, count, scan delay, dual scan speed, dual level display, backlit keyboard and LED indicators for the direct access channels.

Circle (63) on Reply Card

### Earth station products

*Blonder-Tongue Laboratories Inc.* is introducing a line of satellite TVRO earth station products for the MATV market.

This product line, designed to interface with existing MATV systems, consists of: three antenna systems (3.0m, 3.65m and 4.6m); three low noise converters; a low cost earth station receiver and mounting tray; two foundation pier kits, and a 4.6m pressurization kit.

The 3.0m antenna system (model 6001) consists of six precision stamped aluminum panels, bolted together to form a parabolic surface of revolution, dual polarization focal point feed and mount. This design provides a low shipping

volume and easy handling during installation.

The mount provides coverage of geosynchronous satellites located along the orbital arc from 91° to 136° west longitude from anywhere



in the contiguous United States. The model 6002 antenna system combines the 3.0m antenna with a 0.65m extender ring for increased gain.

The 4.6m antenna system (model 6003) utilizes a high efficiency Cassegrain design, substantially reducing satellite terminal costs by providing performance comparable to larger antennas. The 12-panel main reflector is paraboloidal and uses a shaped subreflector to focus the incoming signal to a receive-only feed horn. The design provides high gain while meeting FCC sidelobe requirements.

The model 6008 earth station receiver and models 6004, 6005 and 6006 low-noise converters (LNC) are used in combination to enable satellite signals to be carried from the earth station antenna to the receiver over low cost, UHF-type coaxial cable. A low noise converter (a combination of a low-noise amplifier and block downconverter) is mounted at the antenna.

Circle (62) on Reply Card

### Mica capacitors

A virgin ruby mica, high temperature (300°C) line of capacitors is available from *KD Components*. These "High Temp" capacitors are available in a broad selection of capacitance and voltage values. They feature a temperature coefficient of  $\pm 10\text{ppm max.}$ ; welded, pure nickle leads; 1000M $\Omega$  insulation resistance (0.01mf) and virgin ruby mica elements. Moisture protection is insured by special encapsulation.

The capacitors' design allows



them to be installed in jet engine enclosures, geothermal wells, and rocket and nuclear applications, to name only a few.

The capacitors are available in ranges from 10pf to 0.25mf and 100 to 2000WVdc, tolerances as low as



$\pm 1\%$ , temperature range  $-55^{\circ}$  to  $300^{\circ}\text{C}$ .

Circle (61) on Reply Card

### 100K joystick pots

Radio Shack, a division of Tandy Corporation, is offering an addition to its Archer line of electronic component parts for amateur and professional circuit builders. This addi-

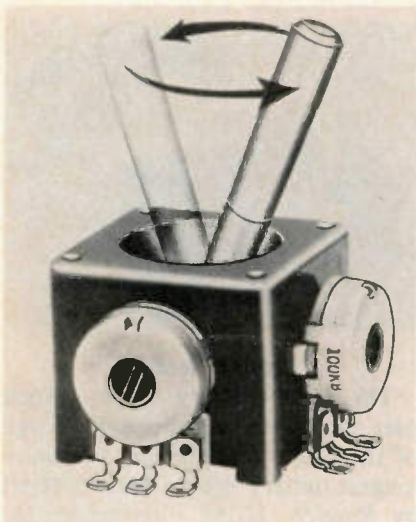

tion is a joystick-controlled pair of 100K  $\Omega$  linear-taper potentiometers.

This compact (1-7/16 inch square) joystick control is intended for a variety of applications, including video games and computer peripherals; robotics; radio-controlled model cars, boats and planes; stereo and recording controls and more. It has smooth action over a  $30^{\circ}$  displacement from cen-

ter in all directions. The 1-inch-long control shaft has a removable (threaded) tip for easy attachment to plumb-weights in pendulum applications. Mounting screws are included.

Electrically, each of the potentiometers outputs a resistance proportional to the joystick's positional displacement along each of two perpendicular axes; these analog signals can easily be digitized and used as inputs to a variety of equipment or devices.

Circle (64) on Reply Card

### Converter

A low-cost fiber-optic instrument that converts standard multimeters into fiber-optic power meters has been introduced by FOTEC Inc.

Called the FOTEC C Fiber-Optic Converter, the instrument can be used with any multimeter or voltmeter to measure basic fiber-optic system parameters such as fiber attenuation, connector or splice loss, source power coupled into fibers, or signal level at the receiver.

Although designed with the requirements of laboratory fiber-optic measurements as a guide, FOTEC C is also suitable for field service of fiber optic installations.

The converter can measure signals in the range of less than 20nW to



over 2mW of optical power with an accuracy of  $\pm 5\%$ , and with any signal frequency from dc to hundreds of megahertz. It can be used with sources in the 400 to 1100nm range, and is easily recalibrated for various source wavelengths.

The output is a linear dc signal calibrated as 1V/ $\mu\text{W}$  or 1V/mW on two switchable ranges. When used with a  $3\frac{1}{2}$ -digit DMM, for example, it gives 1 $\mu\text{W}$  resolution on the milliwatt range and 1nW resolution on the microwatt range.

Circle (65) on Reply Card

## NATIONAL ELECTRONICS SERVICE DEALERS

Are you standing idly by while ideas that can be money in your pocket fly away?

Membership in NESDA is one of those ideas.



### WHAT DO YOU GET FROM NESDA?

1. Insurance
2. Special Bancard Rates
3. ServiceShop Magazine
4. Electronic Service Industry Yearbook
5. Service Industry Information
6. Legislative Programs with State and National Government
7. Advocate for Better Warranty Practices
8. Business Information



Don't let your bucks get lost in the shuffle.

Send in your check today.



On the bottom line it will mean extra \$\$\$ in your pocket.

### JOIN NESDA

And Your State Association  
Send for more information:  
NESDA, 2708 W. Berry St.  
Fort Worth, TX 76109



**Even employees who have been with you for years can still learn something new.**

Tell them about Direct Deposit. It's a quick, dependable way to have their Social Security or other Government payments sent straight to their personal checking or savings account. For more information write: Dept. of Treasury-OPRS B3, Annex 1, Room 226, Washington, D.C. 20226.

## DIRECT DEPOSIT

A Public Service of This Magazine, Cards & The Advertising Council

United States Treasury



# test equipment report



## Micro-system troubleshooter

The *Fluke 9010A* micro-system troubleshooter represents a new concept in troubleshooting. With the population explosion of micro-processor-based circuits in terminals, business machines, mini-computers and other electronic instruments, a need for a simple and efficient digital service tool has been created—one that the 9010A fulfills.

The 9010A will troubleshoot the entire 'kernel' (power supply, clock, bus, RAM, ROM, I/O) of the micro-system automatically, through the  $\mu$ P socket, usually in less than 5 minutes, and will post results on a 32-character alphanumeric display.

The 9010A includes an algorithm that automatically examines and defines all digital locations and functions of the micro-system kernel from a working board using its "learn" mode. It then stores this data in its memory for the day's work or on a minicassette for permanent storage. Thus failures occurring in bus-connected devices outside of the microprocessor may be found by a fast and totally self-contained test program, put to work the same day the instrument is received.

The 9010A has other testing algorithms for working outside the kernel, where peripheral devices such as character generators, keyboards, readouts and other controls reside. The 9010A's keyboard includes grouped troubleshooting key functions for automatic patterns and digital exercises that are selected at the keyboard in an on-line, interactive manner by the operator.

Circle (70) on Reply Card

## Bus-bar snap-around

*A. W. Sperry Instruments Inc.* announces the introduction of its bus-bar snap-around. It is the first of the Snap-10 series and is designated Model SPR-1030.

The snap-around is designed and engineered for 3-inch bus-bar measurements and for use on round cables up to 2 15/16 inches OD. The unit features rotary scale for easier readings, with continuous duty for every range.

Five current ranges up to 1000A (ac) and three voltage scales up to



750V ac (self-contained) are available. The unit comes with a 1-piece Ohmprobe for both ohms and continuity testing. FS accuracy is  $\pm 3\%$  on signals from 50-400Hz. The snap-around weighs 24 oz. and measures 11 3/8"H x 4 1/4"W x 1 3/4"T.

Safety features include shock resistant ABS plastic housings, twist and lock threaded voltage leads, fully insulated jaws, plus the ability to withstand overloads.

Circle (71) on Reply Card

## Scope for power engineers

*Marconi Instruments* has designed Powerscope specifically to requirements of the electrical and power engineering field. Four channels are provided, each with a high voltage differential input, capable

of directly accommodating voltages associated with 600V, 3-phase power lines or 600V dc supply



systems. The common mode voltage of each input has been designed so that at a sensitivity of 100mV p-p/cm, a common signal to both inputs of each channel can be up to 350V RMS or  $\pm 500$ Vdc. Circuit loading has been designed to be very low with  $1M\Omega$  each side to the oscilloscope ground without probes and  $5M\Omega$  with the addition of high voltage accessory probes.

Circle (72) on Reply Card

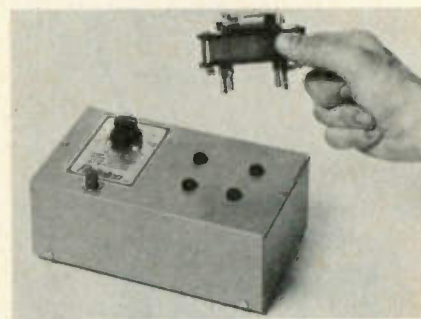

## Battery tester

The BT-1 battery tester, which uses controlled and timed discharge of the battery for testing to assure longest battery life, is being offered by *Ratelco*. Using interchangeable battery adapters, the unit points out unusual or improper operating conditions where the battery charging procedure does not permit the battery to attain its maximum capability.

Input power for the tester is 120Vac, 60Hz and 12W. The unit tests rechargeable batteries from 1.25 to 24V and 2A hours of capacity.

Circle (73) on Reply Card



# catalogs literature

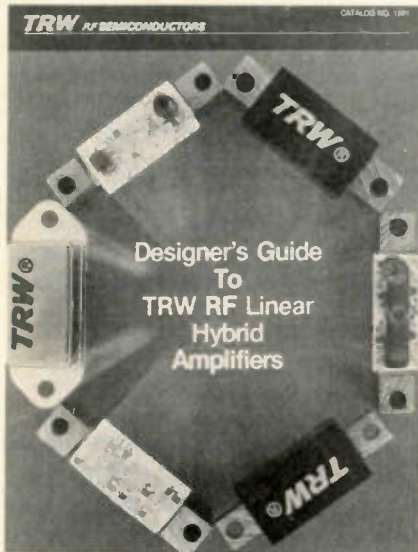

A new comprehensive *Designer's Guide to TRW RF Linear Hybrid Amplifiers* has been published by TRW RF Semiconductors.

Catalog number 1981 describes in detail the construction and performance of 14 medium-power, broadband gain amplifiers designed for use in a variety of applications.

Each device is fully characterized through tables, graphs and engineering drawings. There are sections on interpreting specifications, design and manufacturing, and hermetic packages and hi-rel screening, plus conversion charts on power levels and impedance matches. In addition there are four full-length technical articles by TRW RF semiconductor engineers.

Circle (74) on Reply Card

**Electronic Industries Association** has revised RS-390 to reflect changes in test procedures occurring since publication of RS-390 in 1971. RS-390-A, *Standard Test Procedure for Noise Margin Measurements for Semiconductor Logic Gating Microcircuits*, defines the dc (steady-state) noise margin and the ac (transient) noise margin of semiconductor logic gating microcircuits, and describes the procedures used to measure these

parameters. Standardization of the definitions and test procedures promotes both interchangeability of elements by test specification and improved understanding between manufacturers and users. Different test procedures, correlated to give equivalent results to those outlined, may be necessary for automatic testing at volume production, per EIA.

Circle (75) on Reply Card

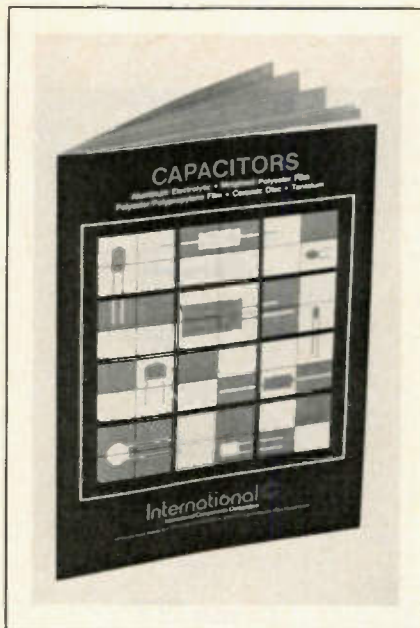

A 16-page catalog describing the company's full range of capacitors is available from **International Components Corporation**.

Seventeen capacitor series are described, including various aluminum electrolytic, metalized polyester/polypropylene film, ceramic disc and tantalum types. Details include specifications, configurations and dimensional drawings, performance curves and the available values for each type.

Circle (76) on Reply Card

**ITT Components** has published a 48-page catalog of electromechanical relays. Featured are 30 black-and-white photographs of sub-miniature PC board, miniature telephone PC board, instrumentation and communication, and in-

dustrial relays. Also included are 46 graphs of operating ranges, life curves, time values and perfor-

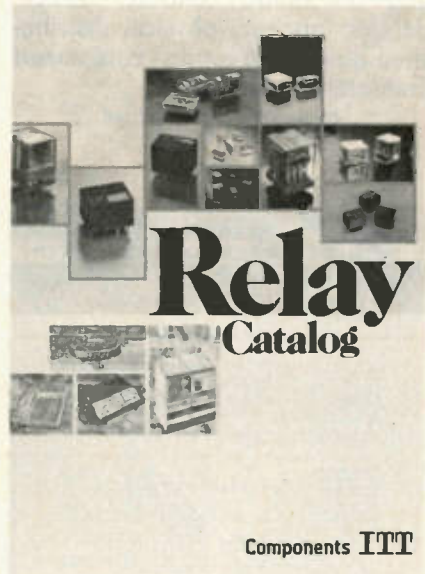

mance curves, plus wiring diagrams, drill plans and specification information for contact, coil and general data.

Circle (90) on Reply Card

The **FCC Commission**, through its consumer assistance and information division, Office of Public Affairs, has released a publication, *UHF Television Comparability*, containing six guidelines for significantly improving UHF television reception. Proposed by the FCC's UHF comparability task force, the guidelines can, in many cases, also help consumers improve reception on VHF television.

Circle (77) on Reply Card

The **American National Standards Institute** has issued its *1981 Catalog of American National Standards*. The 206 page publication lists more than 10,000 current standards approved by and available from the institute. The standards listed provide dimensions, ratings, terminology, symbols, test methods, performance and safety requirements for materials, equipment, components and products in a







showing connecting compatibility with similar products. Information also is included about Tini Q-G miniature connectors and accessories; Q-G audio connectors including a variety of panel and wall plate receptacles, adapters, inserts and accessories; Slim-Line audio connectors and accessories; various other microphone connectors, CB connectors, phono plugs and jacks; and ac receptacles for electrical/electronic applications.

Circle (86) on Reply Card

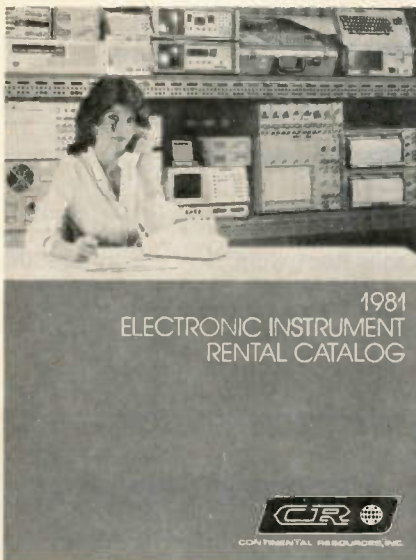

Continental Resources Inc. has just published its new 1981 *Electronic Instrument Rental Catalog* which contains descriptions of more than 1500 electronic test instruments available for monthly rental. The 64-page catalog offers full specifications and monthly rates for latest model test and measurement equipment from leading manufacturers. Included are oscilloscopes, recorders, logic analyzers, microprocessor test systems, power meters, X-Y plotters, function generators, frequency synthesizers and telecommunications test sets. Descriptions and monthly rates for such popular computer peripherals as line printers, CRTs and modems are also offered.

Circle (87) on Reply Card

Multicore Solders has issued a 1981 edition of its *Selector Guide*. This is a short form, quick reference

guide to the complete Multicore line of solders, fluxes and chemicals.

The 4-page brochure describes



basic features of each category of products and lists in tables all products within the category. The tables include such information as: characteristics, formulations, uses, variations, alloys where applicable, MIL and government approvals, and ordering data.

Circle (88) on Reply Card

PRICE LIST, KL, MINIKEY Low Profile Keyboards

ALL	QUANTITY	UNIT PRICE	DISCOUNT	NET PRICE
<b>6 KEY</b>				
F	100	\$12.00	10%	\$10.80
R	100	\$12.00	10%	\$10.80
<b>12 KEY</b>				
F	100	\$18.00	10%	\$16.20
R	100	\$18.00	10%	\$16.20
<b>16 KEY</b>				
F	100	\$24.00	10%	\$21.60
R	100	\$24.00	10%	\$21.60
<b>20 KEY</b>				
F	100	\$30.00	10%	\$27.00
R	100	\$30.00	10%	\$27.00

DIGITRAN

A new price sheet retroactive to Nov. 1 on 56 low-profile keyboards has been issued by **Digitran**.

The two-color, one-page sheet, number 1-0076B, shows prices and quantity discount rates for 6-, 12-, 16- and 20-key KL Minikey keyboards.

Circle (89) on Reply Card

# WHY YOU SHOULD MAKE A CORPORATE CONTRIBUTION TO THE AD COUNCIL

The Advertising Council is the biggest advertiser in the world. Last year, with the cooperation of all media, the Council placed almost six hundred million dollars of public service advertising. Yet its total operating expense budget was only \$1,147,000 which makes its advertising programs one of America's greatest bargains... for every \$1 cash outlay the Council is generating over \$600 of advertising.

U.S. business and associated groups contributed the dollars the Ad Council needs to create and manage this remarkable program. Advertisers, advertising agencies, and the media contributed the space and time.

Your company can play a role. If you believe in supporting public service efforts to help meet the challenges which face our nation today, then your company can do as many hundreds of others—large and small—have done. You can make a tax-deductible contribution to the Advertising Council.

At the very least you can, quite easily, find out more about how the Council works and what it does. Simply write to: Robert P. Keim, President, The Advertising Council, Inc., 825 Third Avenue, New York, New York 10022.

**Ad Council** A Public Service of This Magazine & The Advertising Council.

The cost of preparation of this advertisement was paid for by the American Business Press, the association of specialized business publications. This space was donated by this magazine.



# themarketplace

Advertising rates in the Classified Section are 35 cents per word, each insertion, and must be accompanied by cash to insure publication.

Each initial or abbreviation counts a full word.

Minimum classified charge \$3.00.

For ads on which replies are sent to us for forwarding (blind ads), there is an additional charge of \$3.00 per insertion to cover department number, processing of replies, and mailing costs.

Classified columns are not open to advertising of any products regularly produced by manufacturers unless used and no longer owned by the manufacturer or distributor.

## For Sale

**PICTURE TUBE REBUILDING EQUIPMENT** capable of producing four high quality tubes per day (WILL TRAIN TO OPERATE). Call or Write Atoll Television, 6425 Irving Park, Chicago, Illinois 60634, ph. 312-545-6667. 4-81-6t

**AUTOMOBILE RADIO** and tape replacement parts: Delco, Chrysler, Philco-Ford, Motorola, Panasonic and many others. Large inventory. Laran Electronics, Inc., 3768 Boston Road, Bronx, NY 10469, (212) 881-9600, out of New York State, (808) 223-8314. 5-79-tf

**TV & RADIO TUBES**, 36 cents EA!! Free color catalog. Cornell, 4221 University, San Diego, California 92104. 8-76-tf

**ELECTRONIC SURPLUS: CLOSEOUTS, LIQUIDATIONS!** Parts, equipment stereo, industrial, educational. Amazing values! Fascinating items unavailable in stores or catalogs anywhere. Unusual FREE catalog. ETCO-011, Box 762, Plattsburgh, N.Y. 12901. 6-78-tf

**SCRAMBLED TELEVISION**, encoding/decoding. New book. Theory/circuits, \$9.95 plus \$1 shipping. Workshop, Box 393ES, Dept. E, Bethpage, N.Y. 11714. 7-80-tf

"**SUPREME Radio - Television Diagram manuals** discounted 60%. Free information. SASE. Supreme, 1760 Balsam, Highland Park, IL 60035." 8-81-1t

**FOR SALE - PS29 Pushbutton Oscilloscope** 2 probe. All leads included. Used only 10 hrs. \$500. Arthur Annucci - 2122 West Saug Rd., Saugerties, N.Y. 12477. 8-81-1t

**FOR SALE:** Zenith sales and service shop near major highway complete with truck. 5 minutes to beach in Los Angeles area. \$25,000 plus inventory. Call Jim at 213-375-2233. 8-81-3t

**FOR SALE:** Model 1474 B&K dual trace 30MHz oscilloscope with probes, good condition, \$575.00. Mike Tucker, 1712 Meadowview Dr., Statesville, N.C. 28677, Phone 704-876-1666. 8-81-1t

**RECONDITIONED ROTORS** for TV, FM, CB antennas. Tele-Comm, Box 2910, Champaign, IL 61820. 8-81-4t

**OSCILLOSCOPES: SPECIAL SALE-HP & TEK 50MHZ DUAL TRACE**, \$595. Reg. \$695. Limited Quantities. Reconditioned, calibrated, guaranteed, free cat. A-OK ELECTRONICS, 1445 NW 9th St., Homestead, FL 33030, (305) 247-6349. 8-81-3t

## For Sale (Cont.)

**FREE**

**THE GREAT ELECTRONIC THINGS & IDEAS BOOK!**

HUNDREDS OF UNUSUAL PARTS, GADGETS & IDEA ITEMS UNAVAILABLE IN STORES OR CATALOGS ANYWHERE! Bargain prices on everything! New items in every issue! Rush postcard for your copy!

**ETCO**

ELECTRONICS  
Dept. 311  
Plattsburgh, N.Y. 12901.

Circle (8) on Reply Card

**PRINTED CIRCUIT** boards from your sketch or artwork. Affordable prices. Also fun kit projects. Free details DANOCINTHS INC. Dept. ES, Box 261, Westland, MI 48185. 5-81-1fn

## Wanted

**MIRROR IN THE LID**, and other PRE-1946 Television sets wanted for substantial cash. Also interested in 12AP4, MW-31-3 Pre-War picture tubes, parts, literature on Pre-War Television, Arnold Chase, 9 Rushleigh Road, West Hartford, Conn. 06117 (203) 521-5280. 2-81-7t

**DESPERATELY NEED:** Information on "Telicon" projection TVs from 1947, RCA "Test Lamp" for 1940's projection TVs, Arnold Chase, 9 Rushleigh Road, West Hartford, Conn. 06117 (203) 521-5280. 2-81-7t

**TUBE TESTED WANTED**, old Navy Weston or similar for 872A Rectifiers, Call 800-525-2424, Bill Lambert, Denver. 8-81-2t

## Business Opportunity

**TV TECHNICIAN!** Increase your income up to \$60,000 yearly. Rent-lease-sell TVs new-used, even from comfort of your home. Basic Preliminaries \$4.00. Perrys TV Systems, Hwy 181, Box 142, R1, Bremen, KY 42325. 12-80-tf

**ESTABLISHED TV-STEREO REPAIR SHOP** in beautiful Black Hills of South Dakota, main street location. Good steady business, excellent library equipment and inventory, priced right, terms available. Call 605-347-4243. 6-81-3t

## To get more information...

on items advertised or described in this publication, use the Reader Service Card.

As a free service for our readers, we forward your inquiry to the product's manufacturer. Reader Service Card is pre-addressed.

# advertisers' index

Computech .....	5
Creative Electronics .....	11
ETCO .....	44
Gamit Enterprises .....	13
Jensen Tools Inc. ....	13
Keithley Instruments .....	1
Natesa .....	37
Nesda .....	39
Oehlich Publications .....	13
Viz Mfg. ....	IFC
Zenith Radio Corp. ....	BC

## Electronic Servicing

### Advertising Sales offices

**NATIONAL SALES MANAGER**  
Greg Garrison  
P.O. Box 12901,  
Overland Park, KS 66212  
Phone: (913) 888-4664

**LONDON, ENGLAND**  
John Ashcraft & Co.,  
John Ashcraft  
12 Bear St., Leicester Square  
London, WC2H 7AS, England  
Phone: 930-0525 Telex: 895-2387

**AMSTERDAM, HOLLAND**  
John Ashcraft & Co.,  
John J. Lucassen  
Akerdijk 150A  
1171 PV-Badhoevedorp, Holland  
Phone: 0-2968-6226

**TOKYO, JAPAN**  
International Media  
Representatives, Ltd.  
2-29, Toranomom 1-chome,  
Minato-ku, Tokyo 105, Japan  
Phone: 502-0656

**NORWOOD, AUSTRALIA**  
Williamson & Associates.  
John Williamson  
No. 2 Edmund St.  
Norwood, S.A. 5067, Australia  
Phone: 42-7074



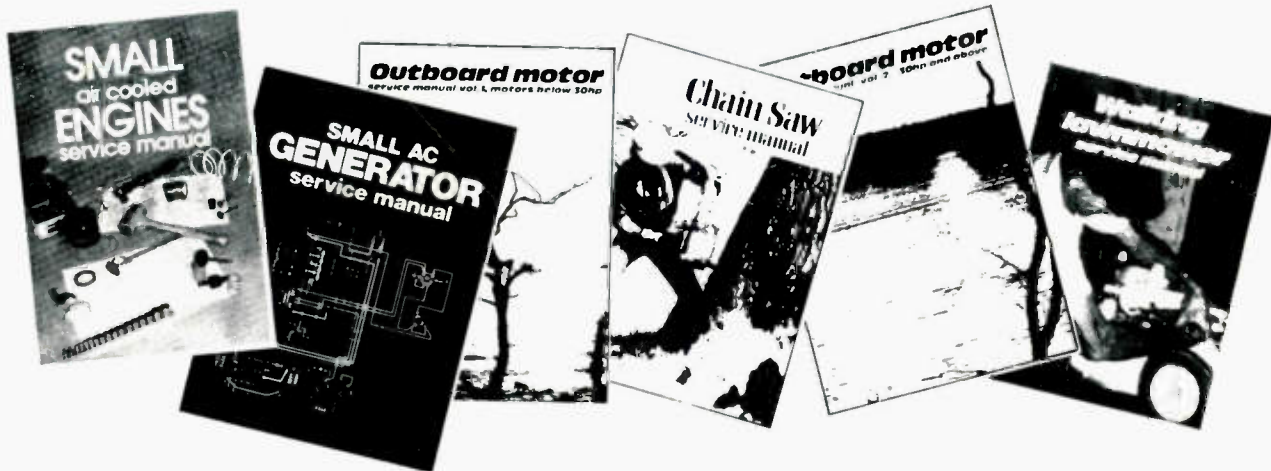

For the man that would rather fix it himself—  
**Technical Publications has  
 service manuals designed for you!**

SES-13 Small (Air Cooled) Engines Service Manual. \$9.95 (336 pages). You can service your own engines on lawnmowers, tractor sprayers and other power equipment. Special section on fundamentals, troubleshooting, preventive maintenance. Step-by-step instructions.

WLMS-1 Walking Lawnmower Service Manual \$7.95 (128 pages). The **complete** guide to the care and repair of your walk-behind, push-type lawnmower. Exploded views and diagrams.

CSS-6 Chain Saw Service Manual. \$8.95 (over 300 pages). Here's everything you need to know to tear down, repair, reassemble and adjust most popular chain saws. A truly **complete** chain saw manual.

GSM-1 Small AC Generator Service Manual \$7.95. A brand new manual that contains maintenance, service and troubleshooting procedures, as well as wiring schematics for most generator models. Covers electrical powerplants under 8kW that generate alternating current and are driven by air cooled engines.

OS1-8 Outboard Motor Service Manual Volume 1 \$8.95 (236 pages). Covers motors below 30 hp.

OS2-8 Outboard Motor Service Manual Volume 2 \$8.95 (232 pages). Covers motors with 30 hp and above. Both Volumes 1 and 2 provide detailed fundamentals on periodic servicing.

**Put these books to work on your own equipment...(Or service outside equipment for profit!)**

- Small (Air Cooled) Engines Service Manual
- Walking Lawnmower Service Manual
- Chain Saw Service Manual
- Small AC Generator Service Manual
- Outboard Motor Service Manual (Vol. 1)
- Outboard Motor Service Manual (Vol. 2)

Remittance must accompany orders of less than \$25.00.  
**Postage paid when payment accompanies order. Allow four weeks for delivery.**

*How to send money: The best way to send money is your own personal check, post office money order, express money order or by bank draft or check. DO NOT SEND CURRENCY OR STAMPS.*

- Check Money Order Enclosed
- Ship C.O.D. (No C.O.D.s outside of U.S.)

Missouri and Kansas Residents add 4% sales tax.  
 Tennessee Residents add 6% sales tax.

Write for a free catalog covering our entire line of service manuals and wheel-type tractor service manuals.

VISA       MASTERCARGE  
 Credit Card Number \_\_\_\_\_  
 Expiration Date \_\_\_\_\_

Please Print:

Name \_\_\_\_\_

Street \_\_\_\_\_

City \_\_\_\_\_

State \_\_\_\_\_ Zip \_\_\_\_\_

Signature \_\_\_\_\_



Division  
 Intertec Publishing Corp.  
 P.O. Box 12901, Dept. ES  
 Overland Park, KS 66212  
 (913) 888-4664



# a line of antennas as strong as its name in time for your peak selling season

## ZENITH

# CHROMATENNA II

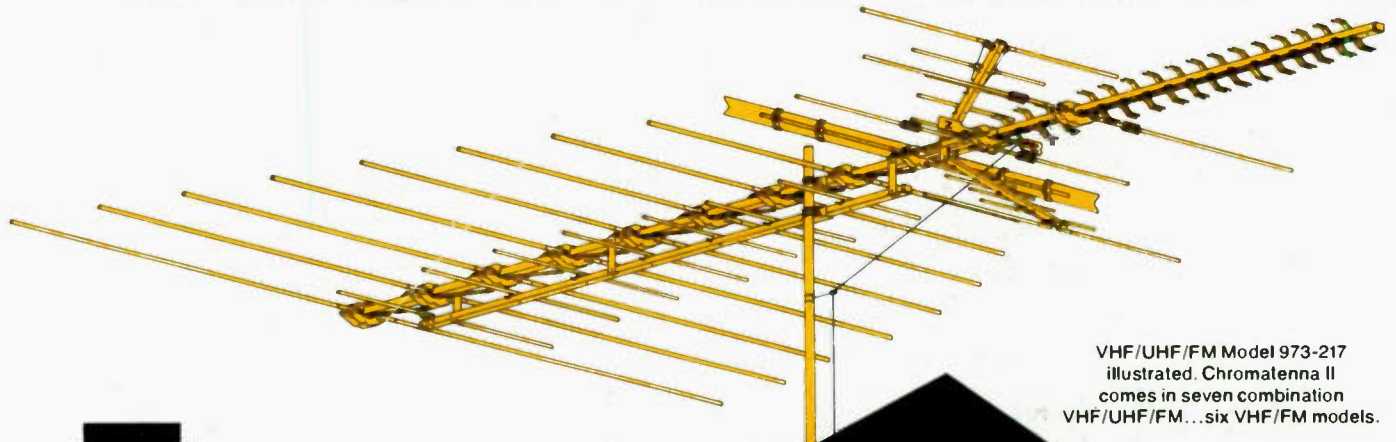

VHF/UHF/FM Model 973-217 illustrated. Chromatenna II comes in seven combination VHF/UHF/FM...six VHF/FM models.



**Transmission Line Termination** bleeds off static charges thru antenna system ground. Terminal stub improves front to back ratio on lower channels.



**Aluminum Construction** of all key metal parts works to eliminate rusting—provides long life. **Golden-Color Alodine Finish** is conductive—helps improve electrical performance!



**High-Impact Plastic Insulators** double-lock each element to the boom for extra bracing and durability.



**FM Block** reduces FM gain up to 12dB. Remove to receive full FM gain.



**Corner Reflector Bracket** enlarged and re-located in most models.



**Zenith Dipole on UHF.** (Combination models only.)



**VHF Colinear Directors** provide extra signal boost on both low and high band VHF.



**Loading Straps**—metal plates close to first VHF element insulators provide compensation for Lo and High band by tuning the first driven element with extra capacity.



**Wide-Spaced, Heavy-Duty Feed Lines** help prevent shorting from heavy build-ups of snow or ice.



**Dual Isolator Bars** insure no loss of UHF to VHF signal transfer. (Combination models only.)



**Strain Relief Insulator** accommodates either 300-OHM twin-lead, Foam lead or Coax downlead.



**U-Bolt Mounting** provides a larger clamping area; larger locking nut with teeth an integral part assures a more rugged U-BOLT arrangement.



**Optional Break-away UHF Wing Directors** provide maximum gain of standard UHF channels with optional coverage of Hi UHF channels and translator frequencies when broken off. (Combination models only.)



**Electrically Matched Terminals With Stainless Steel Screws** eliminate mismatch...protect against rusting, and provide positive electrical contact with improved no-strip stainless steel serrated washers for the take off terminals.



**Proximity Spaced Signal Balancer (Z elements)** provides automatic taper control of periodic driver, improves impedance matching and signal leveling on both Lo and High band channels. Improves Channel 7 pattern.

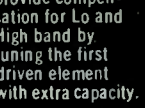

**Rugged 1" Square Boom** provides extra strength compared to many round-type booms.



**Sleeved Elements** of heavy-duty construction afford extra bracing and protection.

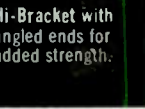

**Hi-Bracket** with angled ends for added strength.

Zenith has quality easy-to-install antenna kits—UHF only, VHF YAGI and Stereo FM antennas as well as a complete line of reception aid equipment. See your Zenith distributor for news of his exciting money-making Fall programs and Catalog No. 902-2019!

## ZENITH

The quality goes in before the name goes on®

Zenith Radio Corporation/Service, Parts & Accessories Division/11000 Seymour Avenue/Franklin Park, Illinois 60131

Circle (9) on Reply Card