

Electronic Servicing

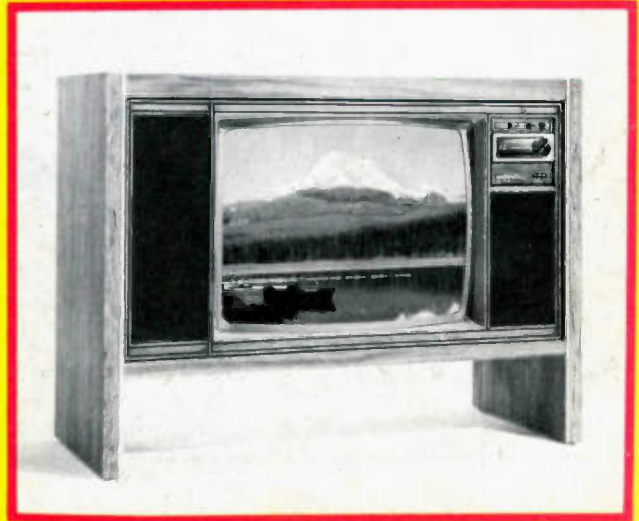

1981 TV receivers

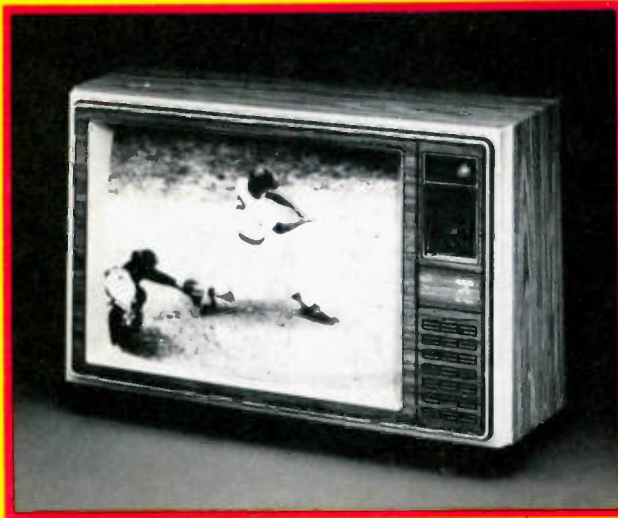

Semiconductor source guide

RCA vertical sweep



**Services
for MRO**

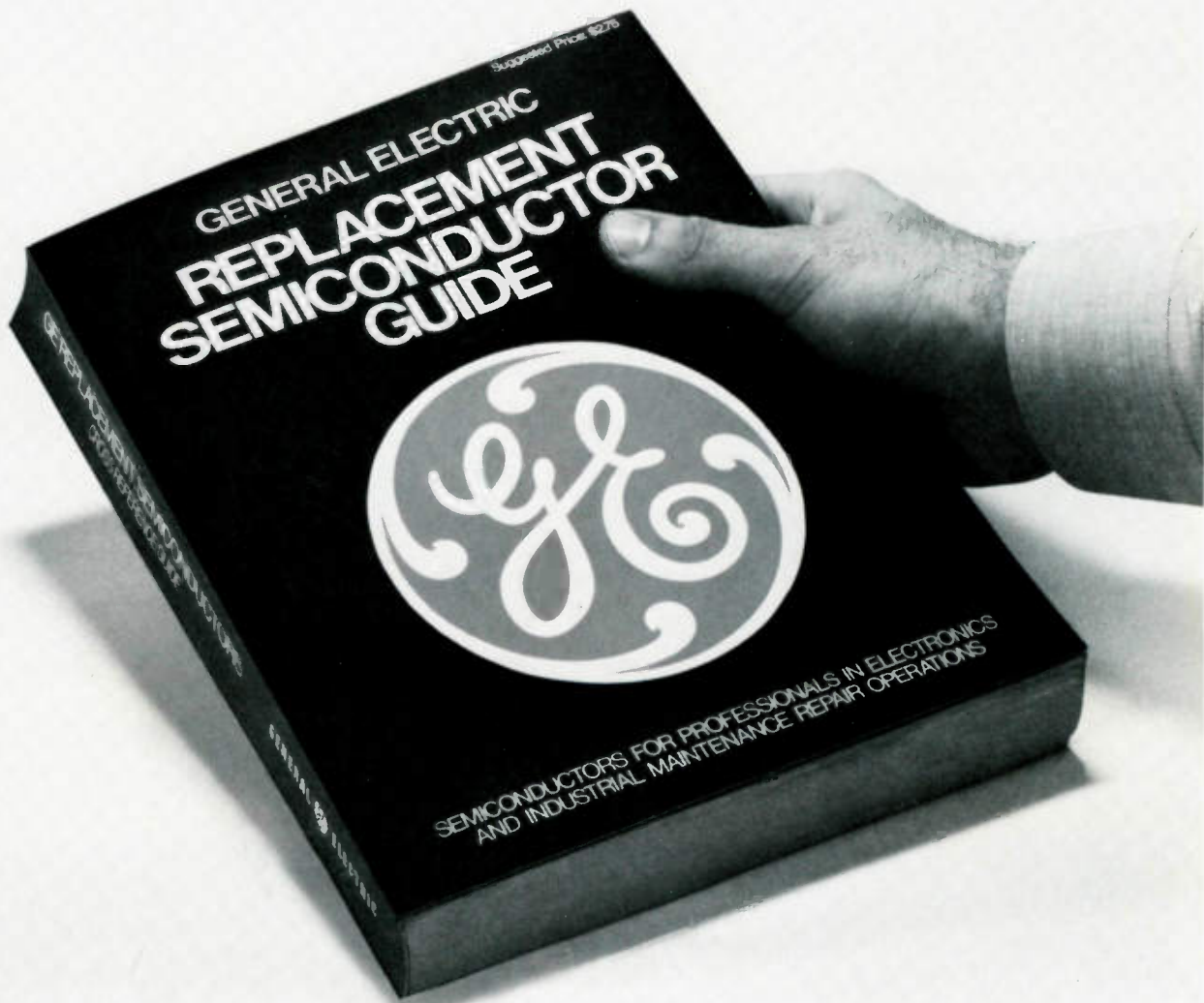

Solid State Replacements Start with the GE Book of Industrial MRO Knowledge.

We have added over 90 pages of MRO types and related information. And we have presented ICs in easier-to-use fashion than ever before. The latter are now shown in chart form and are grouped under various application headings—such as Preamps—in descending order of power dissipation.

As before, our unique parts ID numbering system tells you at a glance almost all you need to know when making a replacement.

Thus, GE5ZD3.3 stands for a 5-watt, 3.3-volt zener diode by General Electric.

Keeping up with the industry is how General Electric helps you stay in touch. With technical literature like this updated Semiconductor Guide...and with the replacement parts you need for the equipment you service.

For your copy of the book you asked us to publish again, see your authorized GE distributor today.

Tube Products Department—Owensboro, Kentucky 42301

GENERAL  ELECTRIC

Electronic Servicing

Editorial, advertising and circulation correspondence should be addressed to P.O. Box 12901, Overland Park, KS 66212 (a suburb of Kansas City, MO); (913) 888-4664.

EDITORIAL

Bill Rhodes, *Editorial Director*
Carl Babcoke, *Consumer Servicing Consultant*
Kevin Klous, *Managing Editor*
Mary Thornbrugh, *Associate Editor*

ART

Dudley Rose, *Art Director*
Linda S. Franzblau, *Graphic Designer*

CIRCULATION

John C. Arnst, *Director*
Evelyn Rogers, *Manager*

ADMINISTRATION

R. J. Hancock, *President*
George Laughead, *Publisher*

ADVERTISING

Greg Garrison, *National Sales Manager*
Dee Unger, *Production*

Regional advertising sales offices listed near Advertiser's Index.



Member,
American Business Press



Member,
Audit Bureau
of Circulation

ELECTRONIC SERVICING (USPS 462-050) (with which is combined PF Reporter) is published monthly by Intertec Publishing Corp., 9221 Quivira Road, Overland Park, KS 66212. Controlled Circulation Postage paid at Shawnee Mission, KS 66201. Send Form 3579 to P.O. Box 12901, Overland Park, KS 66212.

ELECTRONIC SERVICING is edited for technicians who repair home-entertainment electronic equipment (such as TV, radio, tape, stereo and record players) and for industrial technicians who repair defective production-line merchandise, test equipment, or industrial controls in factories.

Subscription prices to qualified subscribers: 1 year—\$12, 2 years—\$19, 3 years—\$24, in the USA and its possessions. All other foreign countries: 1 year—\$15, 2 years—\$25. Subscription prices to all others: 1 year—\$25, 2 years—\$50, in the USA and its possessions. All other foreign countries: 1 year—\$34, 2 years—\$68. Single copy price \$2.25; back copies \$3.00. Adjustment necessitated by subscription termination to single copy rate. Allow 6 to 8 weeks delivery for change of address. Allow 6 to 8 weeks for new subscriptions.



INTERTEC PUBLISHING CORP.
© 1980. All rights reserved.

Next month in

Electronic Servicing®

Industrial Maintenance

- Digital probe roundup
- Using probes in the field

Consumer Servicing

- Digital troubleshooting methods
- RCA vertical sweep, part 2



Thordarson replacement flybacks & yokes fit exactly

Thordarson flybacks and yokes are exact replacements . . . from mounting holes to wiring color code. Engineered and built better than the original you replace. Satisfy more customers with superior Thordarson performance. Buy from your Thordarson distributor.

THORDARSON

Thordarson Meissner, Inc.
Electronic Center
Mt. Carmel, Illinois 62863

Circle (3) on Reply Card

August 1980 *Electronic Servicing* 1

Electronic Servicing®

Industrial MRO

12 Semiconductor source guide
Descriptions of many available semiconductor sources are provided with reader service numbers.

16 Reports from the test lab
By Carl Babcoke, CET
The Keithley model 130 digital multimeter is featured.

18 Special meters and calibration services for MRO and Industry
By Gary Spencer, CAM/IPC Instrumentation
A case study of CAM/IPC Instrumentation and the equipment used in their facility to MRO customer needs.

Consumer Servicing

21 1981 consumer electronic products
A preview of some of the products available for 1981.

28 RCA CTC99 vertical sweep, part 1
By Gill Grieshaber, CET
Operation of countdown digital circuitry is explained.

Departments

4 Electronic Scanner	37 Troubleshooting Tips
6 Letters to the Editor	39 Readers Exchange
7 People in the News	40 Product Report
8 News Feature	42 Test Equipment
27 Symcure	

About the cover

Four 1981 TV receivers are shown: (Clockwise, from upper left) General Electric, Magnavox, RCA and Zenith. Graphic design by Linda S. Franzblau.

CASH IN ON SAMS FREE BOOK OFFER!

With your order of \$20 or more, you can select a FREE BONUS BOOK... value up to \$5.95. Take advantage of this money-saving, limited time offer on Sams Special Projects Books. Build your \$20 order from the current, popular titles listed below. Free Bonus Book selections are indicated by an asterisk (*). Mix or match the books you want... then indicate your free book selection on the order form.

AUDIO

- TAPE RECORDING FOR THE HOBBYIST—4th Edition.**
Cassettes, eight-track, open reel, and home video tape. Covers taping broadcasts, live sound, special effects and editing. #21348. \$4.95
- STEREO HIGH-FIDELITY SPEAKER SYSTEMS.**
Covers a broad range of stereo speaker systems. Includes shopping tips for equipment best suited to your needs. #24514. \$5.95.
- * **LISTEN TO RADIO ENERGY, LIGHT, AND SOUND.**
Hear fascinating, exciting new sounds through inexpensive amplifiers. #24525. \$5.95. BONUS BOOK SELECTION.

ELECTRONICS

- LED CIRCUITS AND PROJECTS.**
Covers all kinds of LED applications—from digital display and logic tester probes to communications systems and travel aids for the blind. #24006. \$5.25.
- * **ELECTRONIC CIRCUITBOOK 1: PROJECT CONSTRUCTION.**
Covers various kinds of electronic circuits and projects that can be made with them. #21241. \$3.25. BONUS BOOK SELECTION.
- * **INTRODUCTION TO RADIO ASTRONOMY.**
Explains how to construct several low-cost radio telescopes that are suitable for observation of solar phenomena, galactic noise and intergalactic signal sources. #21246. \$4.50. BONUS BOOK SELECTION.
- * **ELECTRONIC CIRCUITBOOK 5: LED PROJECTS.**
Instructions for making four-layer diode pulser, avalanche transistor pulser, high-circuit LED pulser, amplitude-modulation voice transmitter and receiver, and solid-state oscilloscope. #21311. \$3.75. BONUS BOOK SELECTION.
- BUILD-IT BOOK OF SAFETY ELECTRONICS.**
Contains ideas for building several novel projects to protect your home, family, and car. #21334. \$3.50.
- BUILD-IT BOOK OF HOME ELECTRONICS.**
Put solid-state devices and ICs to work in your home. Includes 13 interesting projects you can build. #21409. \$3.50.
- BUILDING AND INSTALLING ELECTRONIC INTRUSION ALARMS.**
Written for the novice who wants to install a security system in his home... and the technician who wants to enter the lucrative field of security electronics. #21465. \$4.95.
- UNIQUE ELECTRONIC WEATHER PROJECTS.**
You can build projects to measure temperature, wind speed, and direction, barometric pressure and construct a thermostat "with a brain" to help conserve energy. #21484. \$7.95.
- PRACTICAL LOW-COST IC PROJECTS—2nd Edition.**
Presents complete parts lists and schematic diagrams for 38 different, easy, low-cost integrated circuit projects. #21599. \$4.50.

- INTEGRATED CIRCUIT PROJECTS—2nd Edition.**
IC projects that are useful, fun to build, and educational. All projects have been tested and debugged. #21616. \$5.50.
- ELECTRONIC TELEPHONE PROJECTS.**
15 projects that can extend the capabilities of your present telephone. #21618. \$6.50.
- 99 PRACTICAL ELECTRONIC PROJECTS—2nd Edition.**
Choose from audio amplifiers, test equipment, photography projects, or automobile devices. Many can be built for less than \$10. #21635. \$4.95.
- SIMPLE IC TEST INSTRUMENTS YOU CAN BUILD.**
31 practical instruments and test accessory circuits you can inexpensively and easily build from scratch. #21683. \$4.95.
- ONE EVENING ELECTRONIC PROJECTS.**
Even beginners can build electronic projects with this book. Simple tools and readily available components can result in an evening of fun and useful projects for the house, garage, workshop, or office. #21699. \$5.95.

COMPUTERS

- GETTING ACQUAINTED WITH MICROCOMPUTERS.**
Written especially for engineers, technicians, scientists, and others who need to know about microcomputers. Self-instructional. #21486. \$8.95.
- GUIDEBOOK TO SMALL COMPUTERS.**
A must for anyone thinking about buying a small computer. Introduces small computers, software, and hardware. Surveys 21 currently popular systems. Includes a directory of small computer manufacturers. #21698. \$4.95.

ENGINES

- UNDERSTANDING YOUR CAR.**
Not a fix-it-yourself guide! Instead, this book explains problems so that they can be described to a mechanic. #21623. \$8.95.
- DIESEL ENGINE MAINTENANCE.**
Explains proper maintenance procedures for the popular, new diesel engines. #21620. \$6.95.

ENERGY

- ENERGY SAVING HOME IMPROVEMENTS.**
Outlines conservation projects, including furnace efficiency, insulation, and solar collectors. #21605. \$7.95.
- SOLAR HEATING.**
Sound facts about heat transfer and heat retention. Includes examples of use and many illustrations. #21621. \$6.95.

Sams BOOKS

Circle (4) on Reply Card

SAVE 10% ON THESE BRAND NEW TITLES!

- AUTOMOTIVE TUNE-UP AND EMISSION CONTROL.**
A do-it-yourself guide for many servicing and adjustment procedures which can be performed by the average person. #21712. SAVE 10%... ONLY \$8.95.
- ELECTRONICS FOR THE BEGINNER.**
No previous electronics knowledge is needed to build exciting projects like crystal sets, transistor radios, IC amplifier, CB and aircraft tuners, hi-fi am tuner, shortwave receiver, and many more. 100 illustrations and step-by-step instructions make it fun and simple. #21737. SAVE 10%... ONLY \$6.25.
- YOU AND YOUR TELEPHONE.**
The complete telephone book. With this book, you can determine the best telephone system, accessories, and services for your needs... and determine whether you should buy and install your own equipment, or rent it from your local phone company. #21744. SAVE 10%... ONLY \$4.45.
- 101 WAYS TO USE YOUR VOM, TVM, AND DVM—3rd Edition.**
Gives both common and uncommon uses of the volt-ohm-meter and vacuum-tube voltmeter. Covers equipment checks, ac and dc voltage tests, dc current tests, ohmmeter tests, signal-tracing tests, alignment applications, and color tv tests. Includes numerous illustrations and diagrams. #21756. SAVE 10%... ONLY \$5.95.

ORDER FORM

HOWARD W. SAMS & CO., INC.
4300 West 62nd Street, P.O. Box 7092
Indianapolis, Indiana 46206
(317) 298-5400

Indicate quantity in boxes above and complete order information below. Return entire ad with order.

Sub Total _____

Add local sales tax (where applicable) _____

TOTAL AMOUNT _____

My total exceeds \$20! Please send me my FREE BOOK.

*FREE BOOK Selection:

Title _____ # _____

- PAYMENT ENCLOSED (save postage and handling costs)
- CHECK MONEY ORDER
- MASTER CHARGE VISA AD027

Interbank No. (Master Charge) _____

Account Number _____

Expiration Date _____

Minimum Credit Card Purchase \$10.

Name (print) _____

Signature _____

Address _____

City _____ State _____ Zip _____

Prices subject to change without notice.
Offer expires 12/31/80

EIA/DPD program dates set for 1980-81

The return of Jack Berman, a series of debates, and a Distributor of the Year contest are among the programs scheduled for the 1980-81 Central Region meeting season of the Electronic Industries Association, Distributor Products Division.

Berman's presentation on creative selling, a follow-up to last year's *Left-brain Right-brain* seminar, will be held September 9 at the Fountain Blue Restaurant, Des Plaines, IL. A political debate designed to explore important issues as a prelude to Election Day '80, is also scheduled.

Three DPD programs for next year will feature debates: November 11, *The Great Debate*—sales representatives vs. factory direct; January 20, conflicting views of the economic outlook for the '80s; and February 19, limited line distribution vs. multiline distribution.

The two spring 1981 meetings—March 31 and June 2 at the Como Inn—will involve a Distributor of the Year contest. EIA/DPD members will nominate their candidates, and three finalists will be invited to each meeting to speak to Central Region members. The Distributor of the Year will then be elected and presented with an award at the 1981 golf outing. Time and place will be determined at a later date.

For more information about DPD programs, contact the Central Region office: 222 South Riverside Plaza, Chicago, IL 60606; (312) 648-1600; or the national office, 2001 Eye Street, N.W., Washington, DC 20006; (202) 457-4900. 457-4900.

EDS attendance up

Verified registration statistics show that customer attendance at

the 1980 Electronic Distribution Show significantly exceeded the 1979 EDS count. Not only advance registration, but actual attendance in Las Vegas was logged in the verification process. The total number of customer companies (distributors and sound contractors) that attended EDS '80 was 1384, compared to 1140 for EDS '79. The total number of customer personnel attending was 2545 for EDS '80, 575 more than were at EDS '79. Both counts are verified by at-show badge pick-up. This was the largest attendance for an EDS in Las Vegas since NEWCOM '75.

These figures compare total attendance of distributors and sound contractors, because the two groups were not separated in the 1979 count. However, the 1980 badging process did allow the Show Corporation to separate the two. The results of that count reveal that 1179 distributor companies and 2220 distributor personnel attended EDS '80; both of these counts of distributors alone exceeded the EDS '79 all-inclusive count.

Sound contractor company and personnel attendance at EDS '80 was 400% more than the estimated sound contractor attendance at EDS '79, due to the success of the first National Sound and Communications Conference, held in conjunction with EDS '80. There were 325 individuals from 205 companies in Las Vegas with Sound Contractor badges.

EDS '80 exhibitors will receive copies of the complete 1980 EDS attendance roster. The roster contains the names and addresses of all the electronic distributor and sound contractor companies and individuals that preregistered for and/or attended the show, including identification of those whose attendance was verified. The roster also includes information on the distributor's area of specialization,

estimated annual volume of sales and the verification process used to establish the distributor's status.

NATESA headquarters relocated

Effective August 1, 1980, NATESA headquarters will be located at 5930 S. Pulaski Rd., Chicago, IL 60629; (312) 582-6350.

Plans announced for Atlanta EDS

Plans have been confirmed that the 1981 Electronic Distribution Show will be held on May 5th, 6th and 7th at the Atlanta Hilton Hotel, according to Lewis Shuler, Dixie Electronics, president of the Electronic Industry Show Corporation.

Exhibits will be housed in two levels of the Atlanta Hilton, the Galleria and the Salon, Shuler said, with conference facilities and meeting rooms adjacent to the Salon. In addition, hotel suite participation will be available at the Atlanta Hilton, and Hyatt Regency and Marriott Hotels. Exhibits will open at 9 AM on each of the three days of the Show, remaining open until 5:30 PM on Tuesday and Wednesday, but closing at 3:30 PM on Thursday.

The EDS is operated by the non-profit Electronic Industry Show Corporation under the joint sponsorship of Electronic Industries Association / Distributor Products Division, Electronic Representatives Association, and National Electronic Distributors Association.

David L. Fisher, EDS executive vice president, said that the formal announcement and invitations to exhibit will be sent to manufacturers by mid-September. For more information contact: David L. Fish-

er, 222 South Riverside Plaza, Chicago, IL 60606. Telephone: (312) 648-1140.

New national trade association announced

The formation of a new trade association for sound contractors and electronics systems contractors was announced by Robert F. Ancha, Ancha Electronics, the group's president pro tem. To be known as the National Sound and Communications Association, the new group is being formed to provide a vehicle for evaluation, analysis, communication, and exchange of ideas on matters of common interest to sound and electronics systems contractors; to conduct marketing conferences for such contractors; and to engage in other activities to foster better business practices for sound and electronics systems contractors. The formation of the association is an outgrowth of the First National Sound and Communications Conference, held in May in Las Vegas in conjunction with the Electronic Distribution Show.

An industry mailing will soon be made soliciting memberships from eligible companies. Dues for each member company for the next year have been set at \$10 per employee, with a minimum of \$100 per company and a maximum of \$200. Eligible companies are those that sell and install sound and communications equipment and electronics systems as part of the regular course of their business. In addition to public address, intercom, and related sound systems, the association also hopes to attract installers of telephone interconnect equip-

ment, burglar and fire alarm systems, CCTV and security systems, Ancha said.

For more information about the association, contact: Robert Ancha, Ancha Electronics, 189 Gordon St., Elk Grove Village, IL 60006, (312) 437-7712, or the association offices, 222 S. Riverside Plaza, Suite 1606, Chicago, IL 60606, (312) 648-1140.

Production of RCA videodisc players to reach 500,000

RCA expects to reach an annual production capacity of more than 500,000 videodisc players by the end of 1981, along with a growing capacity for manufacturing preprogrammed discs, Roy H. Pollack, executive vice president, said.

Previewing RCA's SelectaVision videodisc player, which will be introduced nationally in the first quarter of 1981, Pollack emphasized that RCA is confident it has developed "the most cost-effective system for a videodisc market."

Pollack said RCA's videodisc system was designated as the capacitance electronic disc (CED) system. The CED designation is expected to be used for informational identification on all players and discs compatible with the RCA capacitance system. He said RCA expects additional international firms to announce their intention of adopting its capacitance videodisc system.

Agreements have been reached with CBS and Zenith Radio Corporation that are expected to result in the two firms entering the videodisc business next year with products based on RCA's CED system.

Pollack said RCA expects to sell 200,000 players and more than two million discs bearing its own brand in 1981.

DON'T LET INFLATION BLOW IT!



Use your
"Dollars and Sense"
Send for this free booklet,
and information on how
to obtain bulk copies.



George W. Hayden
The Advertising Council
825 Third Avenue, New York, N.Y. 10022

Please send me a free copy of "Dollars and Sense," and information for ordering bulk copies.

NAME _____

TITLE _____

ORGANIZATION _____

STREET _____

CITY _____

STATE _____ ZIP _____

SIGNATURE _____



A public service message of The Advertising Council and The U.S. Departments of Agriculture, Commerce, Labor and Treasury. Presented by this magazine.

Letters should be addressed to
The Editor, Electronic Servicing
P.O. Box 12901
Overland Park, KS 66212.
Please include company affiliation.

To the Editor:

I have read and enjoyed your articles for years. Now I am having a problem with 60Hz hum in an RCA CTC52F color TV. The black bar is horizontal across the picture and it slowly moves upward. At maximum brightness, the black bar is not very noticeable but it appears as a band of snow or grain pattern. Can you help me?

Dale S. Webster
O'Fallon, IL

Mr. Webster:

Our workload does not permit detailed answers to individual servicing problems. However, this suggestion might be helpful to others also.

Perhaps the hum bars are not caused by 60Hz or 120Hz hum in the B+ or directly injected into the video stages. Another possibility is rectifier radiation, sometimes called *silicon-diode bars*. These are different from true hum bars—which have rounded edges—by the sharp top and bottom edges (sometimes with a black line). It is not clear whether the diodes actually radiate a signal or if the diodes interfere with the signal ground thus causing a sudden change in TV-carrier level.

In either event, the bar edges occur during the beginning and ending of power-supply-diode conduction.

The picture shows a case of diode-radiation bars. One horizontal bar is clearly visible about a third from the bottom and the other is dimly seen near the top of the picture. One bar is produced by TVs having a single diode. Two bars (120Hz) are formed by TVs with doublers, bridges or any other power supply that rectifies both

peaks.

Usually these bars are stronger when the TV signal comes from the receiver's monopole or rabbit-ear antenna. Connecting to an outside antenna often eliminates the bars. Also, try soldering a short-lead 0.001 μ F capacitor across each power-supply diode. Try other power-supply bypasses on an experimental basis, and test the performance after each capacitor is added.

If these actually are hum bars, then a scope should be used to locate the point where the hum enters the video signal. We hope these suggestions will be helpful.

To the Editor:

I wish you would print articles about infrared radiation or any experimental infrared circuits for hobbyists.

Louis Bargas
Cottonwood, CA

Mr. Bargas:

Sorry, but our area is the servicing of commercially made equipment. However, GE and others have TV remote control equipment using infrared. Perhaps you could get ideas from these circuits.

To the Editor:

Regarding the letter of Tom Seller in the May 1980 issue, I have some advice for him. Enclosed is a copy of the GE troubleshooting chart for model JA, which is similar enough to the YA chassis to be helpful. Please send him the chart.

Also, I would advise Tom to check carefully Y701 damper and Y704 boost diode in addition to C701, C702 and C704. These capacitors are connected across the horizontal-output transistor. If the TV works for a short time but then stops, one of the capacitors probably is open. This increases the pulse amplitude at the output collector, which de-

stroys the transistor and blows the fuse.

One YA chassis blew the 1A fuse immediately when power was applied. Placing a jumper across the fuse caused the 4A fuse to blow. At the time, I didn't have the flow chart and went around in circles disconnecting and testing. Finally, I disconnected the yoke and found it was the trouble source. Although both horizontal and vertical windings tested exactly right, there was a dead short between them!

I suggest you print the full address of the letter writers so others could reply directly. The technique of connecting a 100W light bulb across the open fuse terminals or operating at reduced line voltage has been a lifesaver for me many times.

Bill Suhy
Stratford, CT

Mr. Suhy:

Thank you for the good advice. We will send Mr. Seller the chart. Also, we are planning to cover the subject in a later issue.

To the Editor:

I need a heavy-duty cart to transport large consoles. You had a product report in the February 1977 issue of one by Professional TV Service that seemed appropriate. Can you supply me with the name, address and phone number of any company that manufactures a similar unit? Conventional two-wheel trucks are not always adequate for large consoles.

Thomas Sullivan
Mr. Fix-It Electronics
PO Box 10331
Fort Wayne, IN 46851

Mr. Sullivan:

Your request will be brought to our reader's attention because we are not aware of such a unit at this time. □

people in the news

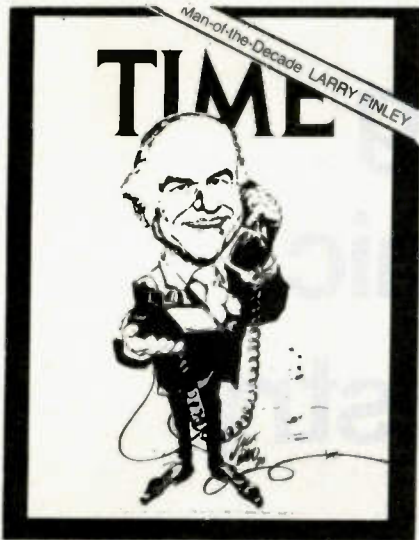

Finley named ITA Man of the Decade

Larry Finley, vice president, Events/Membership of International Tape/Disc Association (ITA) has been awarded the 1980 ITA/*Time Magazine* "Man of the Decade" Award.

Finley saw a need for a trade association to focus on what was then a relatively new world of tape and home video. He informed hundreds of companies of this need and formed what is today the largest international association in the audio/videtape and disc industry, ITA.

Earlier in his career, Finley was one of the first to become involved in prerecorded tape production. As head of the International Tape Cartridge Corporation, he helped pioneer the introduction of the 8-track cartridge. This development was extended in 1968 when he became president of the North American Leisure Corporation, a firm involved in producing prerecorded audiotapes.

The Antenna Specialists Co. has appointed Charles E. Darrow to the new post of product marketing administrator. Formerly he was vice president of operations at Dentron Radio Corp.

Glenn DeBella has been named general manager of Narda's Pacific Coast Operation. DeBella was previously general manager, amplifiers for Avantek.

Jack Roseman, former president of On-Line Systems, has been appointed president of United Computing International, a subsidiary of United Telecommunications, Inc. □

GET 10 TIMES MORE RFI PROTECTION WITH A LINDGREN "DEI" SCREEN ROOM

Lindgren's double-electrically-isolated (DEI) screen rooms offer 120 dB RF attenuation of electric and plane waves from 14 KHz to 1 GHz... up to 10 times more shielding than any other type of screen room.

This patented design keeps your design/test area interference-free despite rising ambient RFI levels. You get shielding equal to conventional solid-sheet-metal enclosures without sacrificing the see-through, hear-through and lighter-weight advantages of screen.

DEI design is superior because inner and outer screens of 0.011" dia. 22 x 22 bronze mesh are electrically separated, except for a single grounding point. Doors feature separate inside and outside RF seals on all four edges, with a single handle that assures an RF-tight closure by applying cam pressure at three points.

Built of panel modules, Lindgren RF enclosures can be moved, expanded or reshaped easily. Our patented over-apping pressure joints maintain full shielding integrity no matter how many times they're reassembled.

For more details, ask for our technical catalog on RF enclosures.

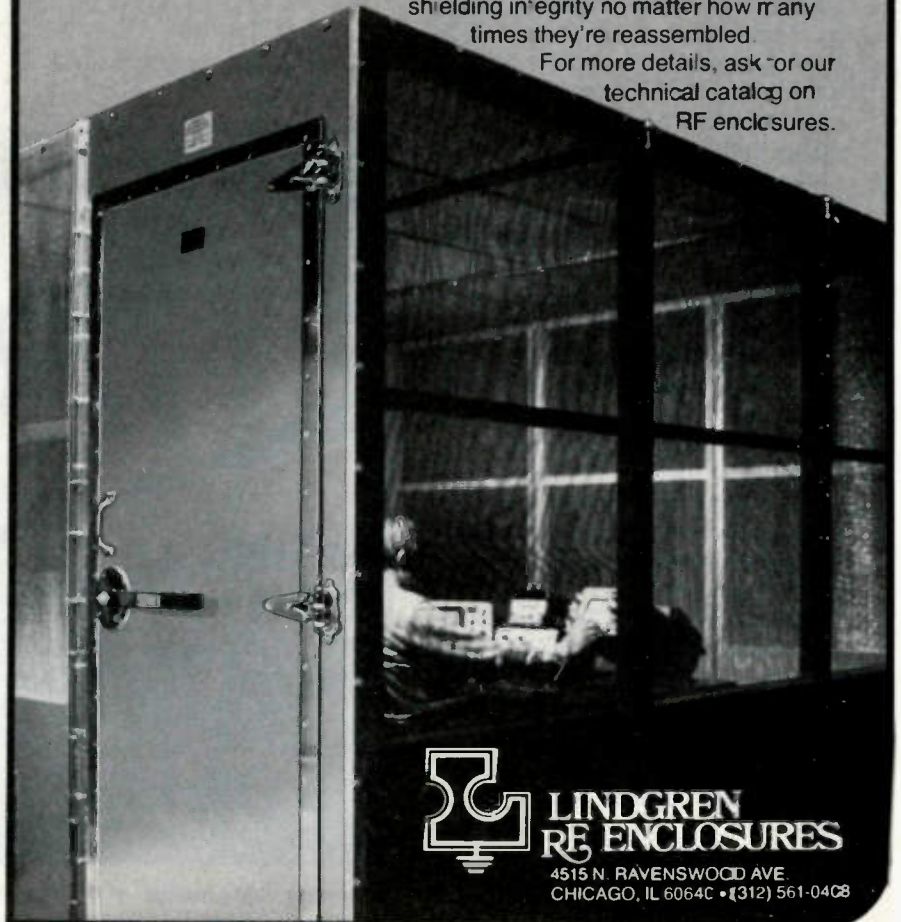

 **LINDGREN
RF ENCLOSURES**
4515 N. RAVENSWOOD AVE
CHICAGO, IL 60640 • (312) 561-0408

Circle (5) on Reply Card

Franchising the electronic servicing industry

If entrepreneur David J. Hagelin fulfills his plans, the franchised electronics servicing industry may be the next major entry onto the American business scene.

Hagelin saw an opportunity in this area and he took it. A former publisher of *ET/D* magazine, Hagelin is the man behind Tronics 2000, a Bloomington, IN, firm that is introducing a new franchising concept to the consumer electronic service industry.

"In my travels," Hagelin said, "I found great concern on the part of the independent dealers regarding the major challenges in the years ahead as the field becomes more complex and diverse.

"In large part, we knew it was an identity problem. But it wasn't until the fall of 1979 that the franchise concept crystallized."

Hagelin formed Tronics 2000 with Roland F. Nobis, president and founder of PTS Electronics, a company known for rebuilding tuners and modules.

"The purpose of Tronics 2000," said Hagelin, "is twofold, to ensure the survival and growth of the electronics service industry, and to instill in the consumer's mind the idea that Tronics 2000 stands for both quality service and convenience."

As electronic equipment becomes more complex, greater pressure is placed on the skills of service

technicians. Local shops are faced with maintaining a viable organization financially and technically, neither of which is easy. The concepts put forth by Tronics 2000 may offer solutions to both problems through financial manage-

ment, technical training, group advertising and volume purchasing.

"The concept," said Hagelin, "makes eminent sense. Built on a system of master and individual franchisees, our design nurtures the balance between the independence



Observing the grounds of Tronics 2000, are (l. to r.) Roland Nobis, secretary, and David J. Hagelin, president. University Electronics is in the background.

of the individual franchisee and the entire nationwide network. Our thrust is not in starting new service operations but in *organizing* and *supporting* existing service operations."

Hagelin projects a large network of franchisees, making it possible for the public to get reliable, convenient service at equitable prices. He said the Tronics 2000 concept could be "the shot in the arm the electronics service industry needs."

Selection of key people for regional franchises, a comprehensive public communications program, and the establishment of an adequate technical training program are all formidable tasks the growing firm faces. Hagelin is confident that all problem areas have been considered and solutions worked out.

"We are seeking the best of the best," Hagelin said. "What we are offering is the chance for growth and prestige, identification with a top-flight national organization, and the chance to keep constant pace with today's changing electronic advances—all while remaining a respected independent business person within the local community."

"The consumer electronics service industry is one of the largest industries left unfranchised in the United States," Hagelin said. "There are 200,000 to 210,000 service technicians, most operating in independent operations throughout the country. And today, independent operations, no matter what the industry, often mean consumer mistrust.

"In the eyes of today's consumer, bigness and quality often go hand in hand. By advertising a national organization, we'll be able to give the consumer a sense of confidence, while the franchisee will have the assurance of being backed by the integrity and expertise of a national network of franchised service facilities."

Hagelin said that one potential benefit for franchisees would be the

chance to branch out into other areas of electronic service work. With the rapid growth in electronic products, the successful can service other products in addition to television.

The nationwide Tronics 2000 system will be marketed through 340 exclusive territories sold to master franchisees, said Hagelin. These territories will include geographic areas with a population of at least 600,000, and plans call for the development of approximately 20 ultimate franchise units within each of these areas. The master will cost \$10,000 for 10 years with two five-year renewal options. Individual franchisees will pay the master franchisee a one time \$5000 fee plus a continuing royalty and service fee that will be split 50-50 with Tronics 2000. The individual franchisees will have three five-year terms.

"We will be seeking a high level of quality in our ultimate franchisees," Hagelin said. "Franchisees must either be established businesses or set up to begin a service business with adequate resources. In addition, they must be technically qualified, with all local or state licenses obtained."

Master franchisees will be trained in an intensive program in Bloomington, IN. Tronics 2000 will provide operating manuals for the individual franchisee and intensive instruction and the opportunity for hands on help in the actual shops.

Available expertise will include public relations, advertising and marketing as well as business management and volume buying benefits.

"Initially," said Hagelin, "we will be working with major manufacturers to assure our people of the most up-to-date technical expertise." He said that some type of "hot line" arrangement for quick answers to tough servicing problems was also being planned.

Tronics 2000 is also introducing with each franchise a 120-day guarantee on all work done. □

If I haven't got cancer by now I'll never get it. I just don't want to know. No one in my family ever had cancer anyway. My husband told me not to worry. I was going to go but I remembered the goldfish needed feeding. It was raining out, and I was afraid I'd get sick on the way. I overslept and missed my appointment. Who cares. I don't have a doctor. I feel fine. I missed the bus. The canary got out so I chased it around for hours. I forgot. I had to get a haircut. The kids wanted ice cream first. The traffic was terrible. The weather was great so I played golf instead. I'm not sick, ever. I don't have the money right now. If cancer's in the stars, it's in the stars. I went to the doctor's on the wrong day. I went to the wrong doctor's. Maybe next week I'll make it. It's against my religion. I'm not need to lose a few pounds first. I'm too busy right now. I don't want to fail apart without me. My father-in-law is a doctor's and he lived until he was 90. I don't like to think about it. Nothing's wrong with me. I'm not cold. I'm not care. I thought I should go home and fix dinner. I never heard of Mr. boss wouldn't give me the day off. I don't want to eat sale on linens I couldn't miss. I don't want to rattle. No one in my family ever had cancer. I'm not afraid of cancer. I lost a button that was on a football game on. By the time they find it I'll be in the doctor's office. I was doing laundry. I forgot to wash my clothes for a day in my life. Cancer of the what? Doctors are boring. In my business I need every hour. I don't want to miss a day. I couldn't care less. But I don't want to miss a day. I forgot bridge club meeting. I don't want to miss my office is too far away. I forgot to cash a check. My dog was lost, and I had to find it. It was hunting season. My clothes were at the laundry. I feel great. It upsets me to talk about it. The kids would rip the house apart if I went out. I don't know why. If I haven't got cancer by now I'll never get it. I just don't want to know. No one in my family ever had cancer anyway. My husband told me not to worry. I was going to go but I remembered the goldfish needed feeding. It was raining out, and I was afraid I'd get sick on the way. I overslept and missed my appointment. Who cares. I don't have a doctor. I feel fine. I missed the bus. The canary got out so I chased it around for hours. I forgot. I had to get a haircut. The kids wanted ice cream first. The traffic was terrible. The weather was great so I played golf instead. I'm not sick, ever. I don't have the money right now. If cancer's in the stars, it's in the stars. I

Stop excusing your life away.

Everyone has an excuse for not seeing their doctor about colorectal cancer. However, every year 52,000 men and women die of colorectal cancer in this country alone. Two out of three of these people might be saved by early detection and treatment. Two out of three.

So what is your excuse? Today you have a new, simple, practical way of providing your doctor with a stool specimen on which he can perform the guaiac test. This can detect signs of colorectal cancer in its early stages before symptoms appear. While two out of three people can be saved. Ask your doctor about a guaiac test, and stop excusing your life away.



American Cancer Society

THIS SPACE CONTRIBUTED AS A PUBLIC SERVICE.

Semi-conductor source guide

The demand for semiconductor replacement parts has given rise to many catalogs of cross-referenced parts. A brief description of some of these sources follows. Books, catalogs and cross-reference pamphlets are included.

Some cross-reference materials are free, but most are available for a small fee. To receive additional information, circle the appropriate number on the readers service card.



Aertech Industries

Catalog 0979 shows the Aertech line of diodes in 50 pages. Listed diodes include tunnel, Schottky barrier, PIN, NIP and step-recovery types. Applications cover consumer products, computer, radar, electronic warfare, satellite, telemetry and telecommunications. A cross is included between the Aertech AHR series and the industry Hewlett-Packard devices.

Circle (20) on Reply Card

D.A.T.A. Inc.

The D.A.T.A. electronics book information series is the most extensive index to semiconductor devices and specifications. It consists of an 18 title semiconductor/IC selection system involved in the R&D, design, engineering, and purchasing or high-technology electronic components.

The book series includes *Transistors, Discontinued Transistors, Diodes, Discontinued Diodes, Thyristors, Discontinued Thyristors, Microcomputers, Digital ICs, Linear ICs, Interface ICs, Memory ICs, Discontinued ICs, Power Semiconductors* and *Application Notes*. Each book includes a master index of devices, manufacturers and detailed technical sections that tabulate characteristics, connections and outline drawings for devices.

A valuable source of semiconductor data, these books often may be found at distributors and at manufacturers' regional offices.

Circle (21) on Reply Card

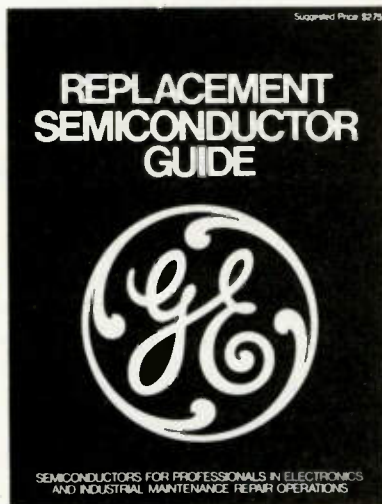

General Electric

General Electric *Replacement Semiconductor Guide* no. ETRM-4311T has 546 pages of technical information about semiconductors and an extensive cross-indexing system. Products include silicon and germanium transistors, diodes, rectifiers, voltage regulators, MOV, focus resistor assemblies, transient protectors, ICs, SCRs and triacs. The suggested price is \$2.75.

Circle (22) on Reply Card

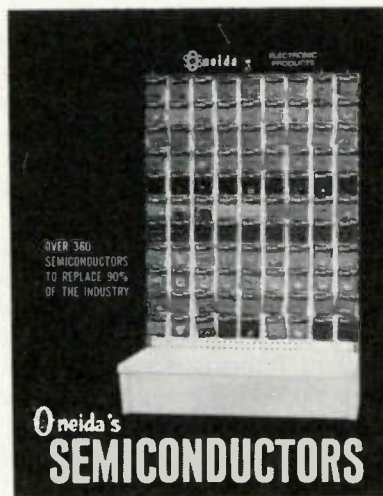

Oneida Electronics

Oneida's short-form catalog lists more than 360 semiconductors to replace 90% of the industry's components. Listed are: transistors, Zener diodes, rectifiers, thyristors, audio power amplifiers, triacs, diodes and rectifier stacks. Also included is a solid-state replacement cross for some common tubes.

Circle (23) on Reply Card



Radio Shack

Semiconductor Replacement Guide catalog no. 276-4003 from Radio Shack has 88 pages of specifications about Archer display devices, ICs, diodes, transistors, SCRs, triacs, optoelectronic devices and general information. Also, there are about 200 unnumbered pages that cross-index 100,000 semiconductor substitutions. The suggested price is \$1.99.

Circle (24) on Reply Card

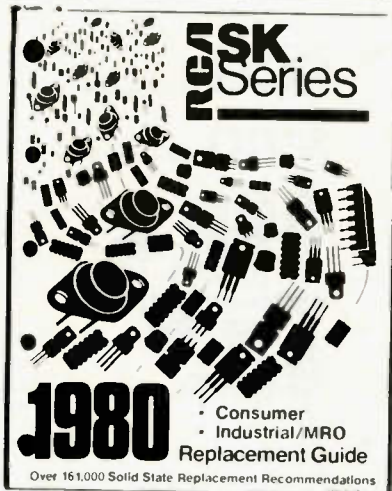

RCA
 Publication SPG-202Y is the RCA SK-series 1980 Replacement Guide and has 370 pages of semiconductor information for rectifiers, diodes, thyristors, transistors and integrated circuits. About 250 pages of cross-indexing includes a replacement directory of SK vs. GE and ECG numbers.

Circle (25) on Reply Card



Intended for use by plant engineers and technicians engaged in maintenance and repair operations on electronic equipment, RCA manual 1K636 includes abridged data for a wide variety of JEDEC and commercial devices to meet MRO replacement needs. The manual also includes a cross-reference of more than 4000 additional JEDEC and commercial types that they replace.

Circle (26) on Reply Card

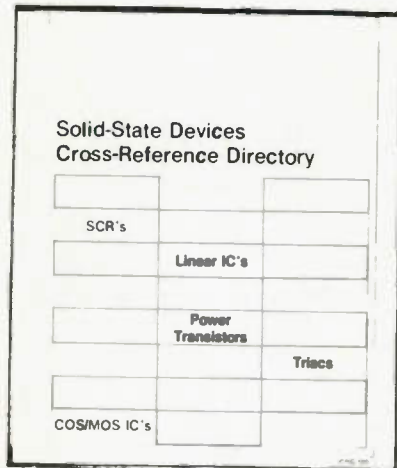

The CRG-100 solid state devices cross-reference guide provides a quick reference to a wide variety of industry solid state devices that can be replaced by RCA types. Linear and digital ICs, power transistors, SCR's and triacs are included.

Circle (27) on Reply Card

RCA Permacolor TV Antennas

Solid Connections Solid Pictures Solid Profits

The best possible TV reception in almost any area. That's what your customers will get with RCA's Permacolor Outdoor TV Antennas. One of the reasons is the use of solid, riveted connections of flexible aluminum — from elements to feed line. These permanent connections provide a positive electrical path for the signal to flow. There's no chance of interruption . . . overcoming a major problem found in other antennas. Plus polypropylene insulators and a weather-resistant blue and gold polyester finish contribute to Permacolor's remarkable performance and long life.

With RCA Permacolor, you can offer your customers a complete line of outdoor TV antennas, including 75

ohm and 300 ohm antenna kits. The RCA name and tradition will assure your customers that the highest quality and performance are built into RCA Permacolor. And they're right. Permacolor brings in a better TV picture for your customers. And a better profit picture for you.

For full information, see your RCA Antenna Distributor or write to: RCA Distributor and Special Products Division, Deptford, N.J. 08096, Attn: Sales Promotion Services.

RCA 
Permacolor

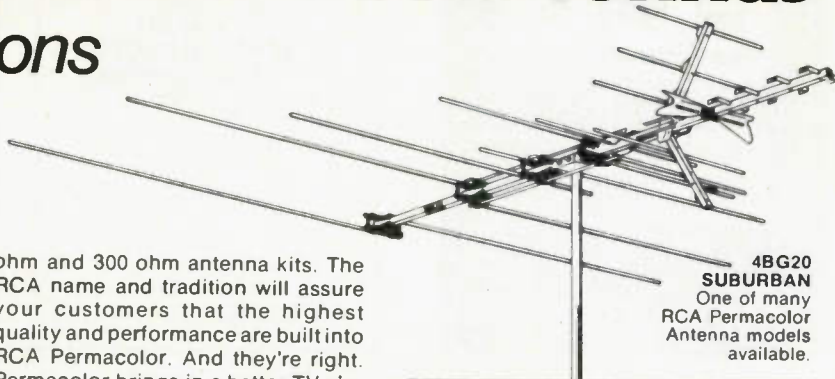

**4BG20
 SUBURBAN**
 One of many
 RCA Permacolor
 Antenna models
 available.

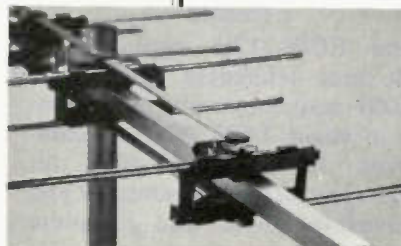

SOLID FEED LINE. Solidly riveted connections of flexible aluminum provide a positive path for the signal to flow from the elements to the receiver with virtually no chance of interruption . . . an RCA exclusive.

Semiconductors

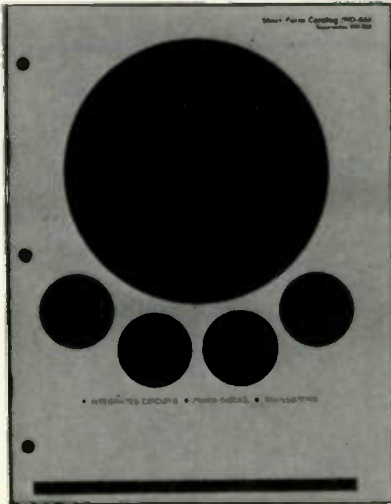

Sprague

The Sprague IND-844 semiconductor catalog describes the firm's line of ICs, Zener diodes and transistors with a comprehensive index to usage by applications: drivers, displays, switches, logic circuits, amplifiers, sensors, choppers and triggers. Included is a cross-reference from in-house marked devices to registered transistors.

Circle (28) on Reply Card



ST-Semicon

A 24-page catalog is available from ST-Semicon. A variety of rectifiers are described, such as SCRs, avalanche silicon bridge rectifier assemblies, special application single-phase bridges, silicon replacements for tube rectifiers, microwave-oven diodes, high-voltage rectifiers, high-surge rectifiers, zener regulators and selenium rectifiers. Cross-references are included.

Circle (29) on Reply Card



Sylvania

Sylvania ECG-MRO-3 is a 210-page replacement guide with cross-referencing of transistors, diodes and rectifiers, zeners, industrial rectifiers, SCRs, triacs, optoelectronic devices and linear and digital ICs. Selected specially for the industrial MRO market, 10,000 parts are cross-referenced. New sections cover R F and Bi-Polar transistors.

Circle (30) on Reply Card

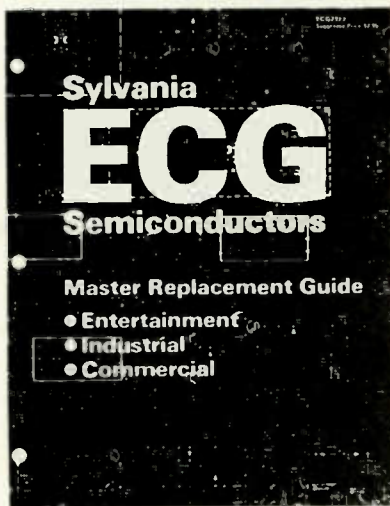

Sylvania

The ECG-212-J replacement guide cross-references more than 153,000 manufacturer's part numbers to about 2,500 ECG semiconductors. The 352-page guide includes entertainment, industrial and commercial parts, and complete data sections.

Circle (31) on Reply Card

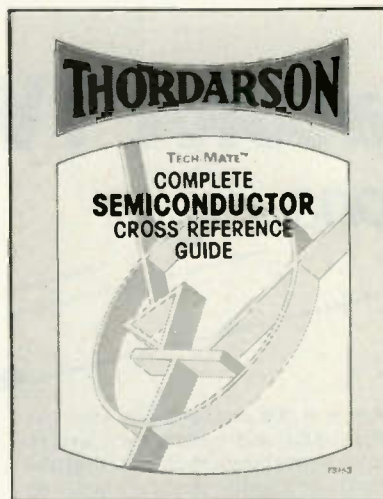

Thordarson

Tech-Mate Complete Semiconductor Cross-Reference Guide no. TSH-3 from Thordarson has technical tips, product data and cross-reference information for transistors, SCRs and SCSs, thyristors, diodes and rectifiers, zeners, voltage multipliers and ICs. Universal replacement semiconductors cover service requirements for more than 100,000 devices.

Circle (32) on Reply Card

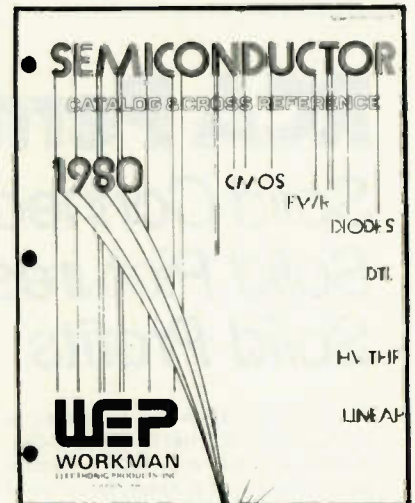

Workman

The Workman X80 catalog has 218 pages and more than 160,000 listings of semiconductors, including PNP and NPN silicon and germanium transistors, HV triplers, switching transistors, RF transistors, color TV ICs, zener diodes and silicon diodes. One new device is the Sil-Pad that replaces mica insulators under power transistors without requiring silicone heat-transfer compound.

Circle (33) on Reply Card



Zenith

Specifications of Zenith universal-replacement semiconductors, a competitive cross-reference to GE, RCA and Sylvania, and a full cross-index for industry numbers are in the *Zenith Universal Semiconductors* publication no. 902-1894-A. Covered are transistors, integrated circuits, rectifiers and diodes, germanium general-purpose diodes, silicon UHF mixer diodes, varicaps, SCRs, HV rectifiers, zener diodes, HV triplers and selenium rectifiers.

Circle (34) on Reply Card

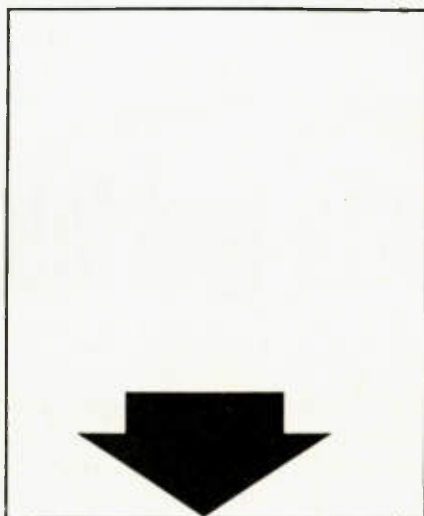

Other sources

In response to the ES request for semiconductor cross reference guides, many manufacturers sent short-form catalogs describing product lines. To receive information concerning product description, performance data and other ordering information, use the reader service card.

CODI

The CODI brand of rectifier bridges and discrete diodes are described in a *Product Summary* folder with additional specification sheets. Diode types include zener, temperature compensation, variable capacitance, forward-bias voltage-regulator, ultra-low leakage diodes, and sharp-knee low-noise zener diodes. Silicon rectifiers and bridges are available in most ratings.

Circle (35) on Reply Card

Semicoa

Included in the *Condensed Transistor Catalog* (20 pages) from Semicoa are specifications for NPN and PNP silicon power transistors, UHF and VHF transistors, general purpose transistors, high-speed logic switches, core drivers plus differential and dual amplifiers.

Circle (36) on Reply Card

RSM Sensitron

A 12-page specification booklet is offered by RSM Sensitron. It covers power rectifiers, bridge rectifiers, three-phase bridges and NPN silicon power transistors.

Circle (37) on Reply Card

Semikron International

Semikron International offers a 38-page *Condensed 1980 Catalog* featuring physical and electrical specifications for diodes, rectifier bridges, high-voltage diodes, MOV transient protectors, heat sinks and SCR thyristors. □

Circle (38) on Reply Card

ESR METER

checks electrolytics
IN-CIRCUIT and is TV shop
FIELD-TESTED:

The most fantastic instrument I've ever bought—Billings, Mt. Used it 3 months; it only missed once—Marinette, Wis. (Typical). Squeal & no sync: 3 bad caps in B+ & AGC; Many Thanks—Taos, N.M. Please ship another; very satisfied—Glen Rock, Pa. It's fantastic—St. Joseph, Mo. Please rush; heard good reports—Hicksville, N.Y. One tremendous meter—Alexandria, Minn. Send your Super meter; heard about it—N. Olmstead, Ohio. Love that ESR Meter—Acton, Mass. Used it intensively for 30 days; it's been 100% effective—Pittsburgh, Pa.

Ideal for preventive maintenance: measures electrolyte dryness & shows up intermittent opens.

60-day Satisfaction Guarantee.

Send check or M.O. or call

(313) 435-8916 for COD

Or write for free brochure to:

Creative Electronics

ESR Brochure \$ 99.00
1417 N. Selfridge postpaid
Clawson, Mich. 48017 USA & CAN.

Circle (6) on Reply Card

REBUILD YOUR OWN PICTURE TUBES?

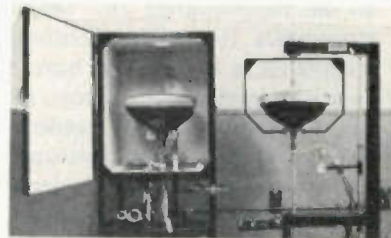

With the Lakeside Industries precision picture tube rebuilding unit, you can rebuild any picture tube, be it black and white or color or 20mm or etc. We offer you the most revolutionized precision equipment of our modern times. This unit is easy to operate and requires only 4 x 8 ft. of space. You can rebuild the finest tube available. The picture will be clear and sharp. Your cost to rebuild a color tube is \$5.50. Your cost to rebuild a black and white tube is \$2.15.

Profit? Imagine building four color tubes per day and if you sold these tubes for \$60.00 each. Total income \$240.00. Total cost \$26.40. Net profit \$213.60. Multiply this figure by five days per week. Your profit \$1,068.00 per week. Cut this figure in half! Build and sell only two color tubes per day. Your profit \$534.00 per week. Facts are facts, figures do not lie.

For further information, please send your name and address to Lakeside Industries, 4071 N. Elston Ave., Chicago, Illinois 60618. Phone: (312) 583-6565.

P.S. No salesman will call.

Circle (7) on Reply Card

Reports from the test lab

Each report about an item of electronic test equipment is based on examination and operation of the device in the **ELECTRONIC SERVICING** laboratory. Personal observations about the performance, and details of new and useful features are spotlighted along with tips about using the equipment for best results.

By Carl Babcoke, CET

With the introduction of the model 130 digital multimeter (Figure 1), another manufacturer of precision laboratory equipment has offered popular-priced multimeters to the maintenance and consumer-electronics industries. Keithley Instruments is reported to have made extensive preference surveys to find out the features most needed, and then combined these features with control and panel layout selected by human-engineering principles. The result is an accurate and attractive unit that is easy to operate.

Features and readout

Except for the larger size, the 3½-digit liquid-crystal display (LCD) readout is conventional. However, those readout digits are 0.6-inch high. They are easier to read at a distance than meters that have 0.5-inch displays (Figure 2).

The circuitry and LCD readout provide automatic dc polarity, automatic zeroing, automatic decimal placement, and automatic overrange indication. During overrange conditions, the display shows a non-blinking 1 and a decimal; the

three least-significant digits are blanked and cannot be seen. A low-battery symbol (BAT) appears in the upper-left corner when the battery has approximately 10% of its life remaining. A single 9V battery powers the meter. It is rated at 100 hours for a zinc-carbon or 200 hours with an alkaline battery.

Legends on the panel are printed on the reverse side of the protective panel overlay. The LCD and circuit board, mounted to the impact-resistant case, are cushioned if the meter is dropped.

Selector switches

One convenience feature is the arrangement of function and range selector knobs. The knobs can be rotated by either hand placed on the combination center bar and pointer. Or they can be rotated by a left thumb when the meter is held in the left hand (Figure 1). This adjustment by thumb can also be done with the meter in its opened carrying case.

Power is controlled by an on-off switch on the right side of the meter. All functions are protected against overloads to the extent detailed in the instruction book. A 2A fuse protects the millampere-current range. Make certain that *only* those two are used for the 10A range. For other current ranges, the meter common and mA jacks are to be employed.

Model 130 provides 29 ranges in the standard five functions.

Dc voltage specifications

Five ranges of dc voltage provide readings between 0.1mV and 1000V at 10MΩ input resistance. Each range ends at one count below the marked value. For example, the 2Vdc range reads to 1.999V and overranges when higher voltages are applied. Accuracy is rated at

±0.5% of reading + 1 digit. However, the rating applies to the first year. A comparison with five other digital meters indicated an accuracy that was much better when new.

Dc current

Five dc-current ranges have full-scale readings from 1.999mA to 10A. The 10A range requires the use of two separate test-lead jacks



Figure 1 The range switch (top) and the rotary function switch (bottom) of the Keithley model 130 digital multimeter can be rotated by either hand. When the meter is lying down, it is easier to rotate them with the fingers of the right hand on the raised bar in the knob's center. When the meter is held in the left hand, as shown, notches around the knobs permit rotation of the switches with the left-hand thumb.

and a range setting shared with the 20mA position.

Accuracy of the three lowest current ranges is $\pm 1\%$ of reading + 1 digit, and the 2000mA and 10A ranges are rated at $\pm 2\%$ of reading + 1 digit. A 2A fuse protects all but the 10A range. It is designed to tolerate 20A for up to 15 seconds.

Ac voltage specifications

The ac-voltage ranges are the same as listed before for dc voltages, except the top range should not have more than 750V peak-switched applied to it. Input impedance is $10M\Omega$ for all acV ranges. The ac conversion is average-responding and calibrated in RMS for sine waves. Accuracy for one year is $\pm 1\%$ of reading + 5 digits.

For ac readings, bandwidth must be considered. Keithley specifications for model 130 are for rated accuracy between 45Hz and 500Hz. However, response tests showed the sample meter had better bandwidth. The response measured -1dB at 11kHz and -6dB at 38 kHz. This is not flat, but it is better than many

other DMMs that also have $10M\Omega$ input resistance. Model 130 should be suitable for all power and audio measurements except precise audio-frequency response runs.

Ac current

Ac current ranges are identical with the ranges for dc current, except the accuracy of $\pm 2\%$ of reading + 5 digits. Frequency response should be the same as for ac-voltage measurements.

Resistance measurements

Five resistance ranges are decaded from 200Ω full scale to $20M\Omega$ full scale with an accuracy of $\pm 0.5\%$ of reading + 1 digit.

Open-probe voltage during resistance tests measured +1.203Vdc, which is approximately midway between the voltages of other models having a choice of high power and low power. The $20K\Omega$ range is marked with a diode symbol, indicating it should be used for testing solid-state devices. A silicon diode tested overrange on the 200Ω range, $1.7K\Omega$ on the $2K\Omega$ range, $7K\Omega$ on the $20K\Omega$

range, $40K\Omega$ on the $200K\Omega$ range, and only leakage resistance on the $20M\Omega$ range.

Accessories

Many accessories are available for Keithley model 130 including: a soft leatherette carrying case with stand for bench use (Figure 3 and Figure 4); a high-voltage probe (40KV); RF probe; clamp-on ac-current probe; and several types of test-probe sets.

Comments

Keithley model 130 performed perfectly during all tests. No instability was encountered when it was operated close to the horizontal sweep section of color TVs. The DMM seems to fulfill the stated Keithley intention of producing an accurate, rugged, stable, easy to calibrate (or repair) portable multimeter at a reasonable price. Model 130 sells for \$99 with test leads and instruction book. □

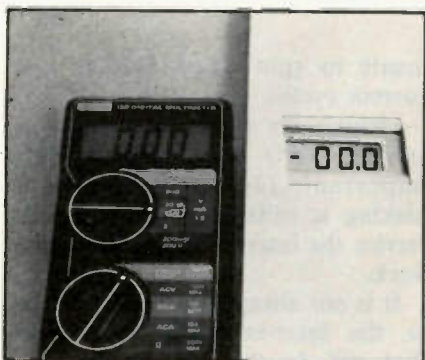

Figure 2 Larger size of the Keithley digital readout (at left) is compared to the usual 0.5-inch digits. All of the other DMM except the readout has been masked by cardboard.

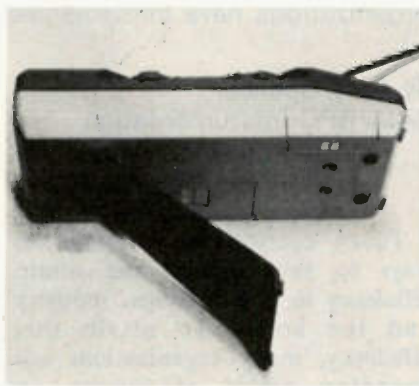

Figure 3 Included with the optional soft case is a large thumb nut and a plastic tilt stand that can be fastened to the model 130 case when it is operated without the case on a bench.



Figure 4 Protection and convenience are afforded by the soft-type zipper-operated carrying case. A large thumb nut holds the meter inside the case (if desired) during operation. A pouch in the lid provides ample space for storage of test probes when the case is zipped shut.

Special meters and calibration services for MRO and industry

Equipping an MRO shop to serve industrial customers is a specialized undertaking. Each shop must be instrumented specifically to meet its service needs. The final list of equipment required may range from a simple continuity checker to a host of sophisticated modern test and measurement instruments. In addition, special instruments or circuits may be needed to meet a particular shop's needs.

Because every MRO shop must be individually equipped, no *general* shopping list can be used to describe a *typical* shop. However, looking at selected shops designed to serve specific MRO needs can be informative.

In the following article, the author briefly describes how his organization provides special meters and calibration services to industry and MRO customers. He also describes some of the equipment used in their facilities to meet MRO customer needs. In future issues, **Electronic Servicing** will present additional case studies of MRO service facilities to illustrate how other organizations have implemented their special shops.

By Gary Spencer,
CAM/RPC Instrumentation

Today everyone is looking for ways to save money and attain efficiency in MRO shops, industry and the home. To attain this efficiency, many organizations are spending a lot of money on recording instruments to obtain a print-out showing when their electrical usage goes up or down. Others use analog or digital instru-

ments to spot check voltage and current cycles.

Picking the right instruments to service MRO equipment is very important. Just as important is picking a reliable organization to service the instruments need in your work.

It is not always the highest-priced or the least-expensive instrument that will do the job. Analyze the specifications on available types to choose an instrument that will do all that is needed at an acceptable cost. Be aware of the serviceability

of that instrument and where to send it when service is needed.

The first place to go for service is an authorized service center. The service center should guarantee that it has the parts needed and the knowledge to work on the instrument and that it will be returned in a reasonable amount of time. Sending the instrument back to the factory is not always the best choice.

There are numerous instrument service centers throughout the United States that perform repair and calibration. One such center is CAM/RPC Instrumentation in Pittsburgh. Of the 18 instrument and meter manufacturers that CAM/RPC handles as a distributor, nine have appointed CAM/RPC as their authorized repair or modification center.

The management at CAM/RPC Instrumentation thinks the growth of the company is because of the fast, efficient service it performs for MRO and industrial customers. It carries a large stock of replacement parts for most of the popular instruments it sells and customers have found comparable attention to quality and service for instruments that CAM/RPC does not sell.

Technicians at CAM/RPC are quality-conscious, which allows CAM/RPC to give a one year warranty after a thorough quality control inspection has been done on instruments serviced. The standards used to repair and calibrate the customer's instruments are traceable to The National Bureau of Standards and are open for review by customers at any time.

The Instrumentation Division of CAM/RPC is also an authorized modification center as well as a distributor of many panel-meter manufacturers. The customer can have non-stock scales (dials) made up with special colors or logos on



Skilled technicians modify instruments to meet customer's needs.



Special equipment is used to print custom dials for modified instruments.

Accurate Standards

When meters or instruments are calibrated for customer's accurate use, reference standards and precision measurements are required. In the CAM/RPC calibration facilities, the calibration standards are traceable to the National Bureau of Standards to assure rigorous calibration reference. In addition, the following instruments provide accurate measurements:

RFL Model 8296 AC/DC Calibration standard.

Accuracy: $\pm .05\%$ DC, $\pm .08\%$ AC
10 MV to 1400 VAC & VDC
10 A to 14 Amps AC & DC
10 Milliohms to 10 Megohms

Yokogawa Model 2861/2862 DC Calibrator.

Accuracy: $\pm .07\%$ to $\pm .3\%$
Depending on range

Yokogawa Model 2858/2859 AC Calibrator.

Accuracy: 1 to 1000 VAC
10mA to 50 Amps AC

Simpson 2600 AC/DC Calibrator.

Accuracy: $\pm .5\%$
1.6 A to 1600 Amps AC & DC
1.6 to 1600 VAC & DC
1 Ohm to 100 Megohm



Calibration of custom instruments is crucial to accurate performance, and custom dials must be carefully ruled.



Repairing meters and industrial equipment requires well-instrumented facilities.

Servicing Special Meters

In the building and repairing of special meters for industrial customers, skilled technicians, specialized equipment and monitors are required. The following is a list of the equipment used by CAM/RPC in serving its industrial clients with up-to-date meters:

- 2 RFL Magnet Treater Model 990
- 1 RFL Magnet Charger Model 107A
- L & N Kelvin Bridge Model 4288-2
- B. Grauel & Co. Flatbed Press

- 3 Simpson 464 $\pm .1\%$ to $\pm .5\%$ Accuracy
- 1 Simpson 360 $\pm .25\%$ to $\pm .5\%$ Accuracy
- Weston 433 AC Ammeter $\pm .75\%$ Accuracy

the dials or just black and white dials. The scale department is set up to do one dial or hundreds at reasonable prices with quality that will match that of the factory-run dial.

As expected of any viable organization, CAM/RPC has expanded its MRO and industrial services to meet its growing list of client needs. Recently added to its services has been an electronic calibration and repair department that performs fast, reliable service to instruments such as Tektronix and Hewlett-Packard oscilloscopes, power supplies and digital instruments.

But the MRO and industrial client needs are constantly changing as technology advances, continually putting manufacturers and service organizations under pressure for new equipment and innovative services. CAM/RPC thinks its biggest growth during the next few years will be in the sales of cost-efficient test equipment to the MRO market along with repair and calibration of the equipment.

Experience shows it is not uncommon to save up to 60% of replacement meter cost by having repairs made by a reliable, regional organization specializing in serving MRO and industrial clients. But cost of replacement/repair must be balanced against downtime if an instrument is critical in a plant or production operation. A reliable service department can tell how long it will take to repair and/or calibrate the instrument or meter. If the wait time is acceptable, the problem is resolved. If time is crucial, new equipment might be purchased or rented until the original equipment is back in operation. If new equipment must be purchased, consider repairing the used item and keeping it on the shelf for emergencies. □

1981 Consumer electronic products

Most manufacturers of consumer electronic products have announced their 1981 products. Manufacturers have provided information highlighting the following products.

General Electric

Color televisions, from 10-inch *Portacolor* models to the giant *Widescreen-1000* home television theater, are offered by General Electric. Improved sound quality is provided in the *Performance Sound Series* of 19- and 25-inch color receivers. At the top of the line are two high-style 25-inch consoles with internal 10W audio amplifiers and speaker systems, each consisting of two 9-inch oval woofers and two 2-inch round tweeters. Separate bass and treble controls are provided.

For customers who prefer listening to TV sound through their own amplifier/speaker systems, GE has eight new models with an audio output jack controlled by a front panel switch.

All electronic-tuning models can now receive nine midband cable-TV channels in addition to 82 standard UHF/VHF channels. Retained is the one-knob frequency-synthesis tuning system for all 82 channels. No fine tuning, setup or channel tabs are needed. Channel numbers are displayed on a digital readout.

Remote models include a programmable-scan infrared-carrier system that can be user-programmed to eliminate unwanted channels during scanning. GE has continued the use of its random-access programmable-scan system.

A new Energy-Conscious EM chassis uses 20% less operating power than a similar previous

model, provides a cooler chassis and features a new in-line auto-convergence picture tube.

Two types of color-correction systems are offered. One is VIR Broadcast-Controlled Color; the other is Color Monitor, a color-averaging system.

Technical features—The EM chassis for 25-inch televisions has a regulating power transformer. Chassis EC-D has two regulators in the negative leg of the line-rectified supply for the horizontal-output transistor. Chassis AC-C for 13-inch and 17-inch, AB-C for 10-inch, EC-N and EC-P for 19-inch models

have more sweep-rectified supplies, a start-up circuit, no regulation of the output power, a new ferroresonant regulator (tuned saturable reactor) for CRT heater, and +15V and +20V supplies.

All models feature a countdown system of obtaining vertical-sweep drive. No horizontal or vertical hold controls are needed.

Hitachi

Model CK-200 is a 5-inch color portable with *Channel Search* electronic tuning, quick-start picture and sound, and power from 120Vac, 12Vdc with adapter in car or nine D cells. Model CT-989



General Electric Model 25EM1850K

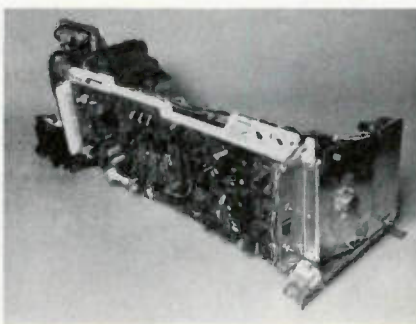

General Electric's EM chassis

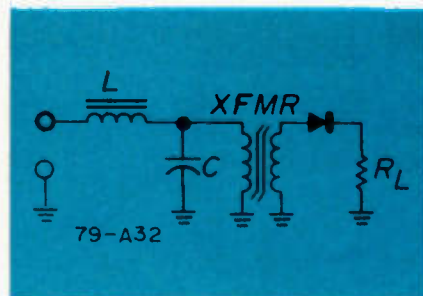

GE chassis EC-N and EC-P
(Courtesy of General Electric)

1981 products

features random-access keyboard tuning, random-access infrared remote control, VIR color control, digital channel indicator, light sensor, and earphone and recording jacks.

SAW filters are used to replace IF tuning. Pincushion-free deflection yokes eliminate pincushion distortion. The horizontal output transistor and damper are combined in one case. Power from the ac line has been reduced to 72W or 78W, depending on the model.

Magnavox

Six new color receivers have been added to the Magnavox line, and six current models have undergone cosmetic or feature improvements. All color receivers (except two 13-inch and three 19-inch leaders) have totally electronic tuning.

Three 25-inch model consoles in contemporary, early American and Mediterranean styles have a voice/music tone control, two 5¼-inch speakers and a 7W RMS amplifier.

Two 19-inch models have larger audio amplifiers and new tone controls for improved sound.

Models 8370, 8371 and 8372 are six-hour portable VCR systems. One model has a separate ac power unit; the other models have a recorder and tuner unit with electronic tuning. Model 8372 can be programmed for recording as many as seven programs on different channels up to 14 days in advance.

The *Magnavision* videodisc player is sold in 16 markets, including St. Louis, Tampa, Denver, Detroit, Portland, Cincinnati, Kansas City and Knoxville.

The *Performing Arts Center* houses a three-CRT 50-inch projection television with microprocessor *Touch-Tune* tuning system for 82 UHF/VHF channels plus eight midband cable channels, a six-hour videocassette recorder, a deluxe color video camera, *Magnavision* videodisc player, a *Touch-Tune* 19-inch color TV, the *Odyssey-2* video game and a quadramode component audio system with rec-

ord changer, eight-track and cassette tape recorders and a pair of *Tricooustic Projection* speakers.

Panasonic

Color TV models from 10-inch to 25-inch diagonal picture-tube sizes are in the new Panasonic line. Features of the 25-inch top-of-the-line consoles include *ColorPilot* electronic color control, an electronic synthesizer tuner with direct-access keyboard, two built-in speakers and a 100-degree in-line tripotential picture tube for sharper focus. Other models have one-knob or two-knob selection of VHF and UHF channels.

Three models have been added to the *Outsider* line of portable b&w televisions, including one with a pop-up viewing screen.

Panasonic also has many models of thin radios, portable radio/cassette combinations and clock radios. Model RC-6800 is unique because of an electronically generated voice that calls out the time automatically at 1-, 15-, 30- or

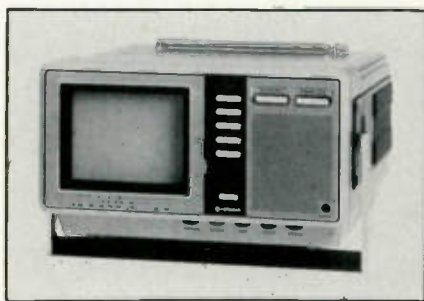

Hitachi model CK-200

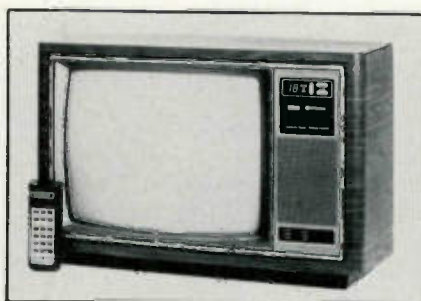

Hitachi model CT-989



Magnavox model 2070

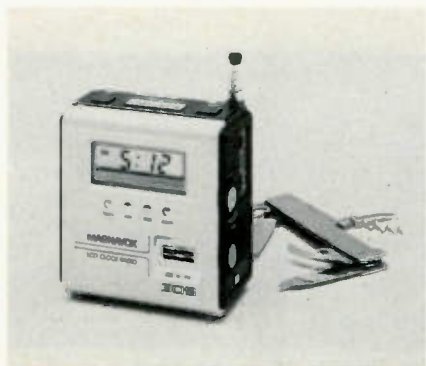

Magnavox model 309



Magnavox Performing Arts Center

60-minute intervals, in addition to a digital time readout. An internal battery prevents incorrect time and alarm settings during power failures.

Some Panasonic component stereo systems have *Power Touch* motor-driven controls that reduce the force required while allowing mode-to-mode direct switching and also have a single button for cassette recording. *LED Active Tuning* has two green arrows and a red circle above or below the tuning indicator. During tuning, the green arrows indicate the need for left or right rotation for proper tuning. When the best signal is tuned, the red circle lights. These LEDs replace two meters.

Philco

Twenty color televisions make up the Philco 1981 line. There are three 19-inch, two 21-inch 14

15-inch and one home-entertainment center. Included are 15 models with push-button electronic tuning and six models with infrared remote control for scan tuning.

The push-button tuner system has a crystal-reference PLL frequency-synthesis operation.

A battery-operated 5-inch b&w television and five 12-inch portable b&w televisions have been added to the line. Three videocassette recorders, including one programmable portable, are part of the 1981 line. Sixteen stereo systems are offered. All have an AM/FM-stereo radio receiver.

Quasar

Four Quasar Flagship line color televisions feature 105-channel direct-access synthesized tuning, multi-function remote control, the *Dynafilter* (comb filter) for better resolution and *Audio Spectrum*

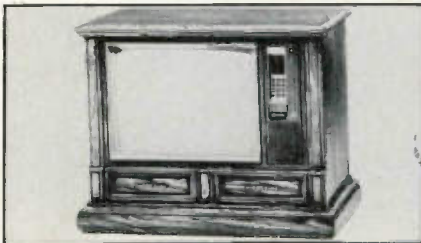

Panasonic model CT-5032



Panasonic talking AM/FM clock radio

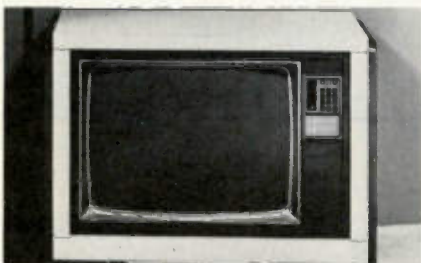

Philco model C3890MWHR



Philco model V1715 VCR

Quasar model TL9988SP

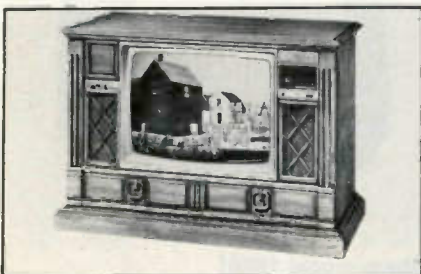

Quasar rear-projection model PR-4800



endeco soldering & desoldering equipment

SOLDERING IRONS



Pencil style. Safety light. Two heats — 20w and 40w. 6 tips. Unbreakable handle. 2 and 3 wire neoprene cords.

DESOLDERING IRONS



Pencil style. Safety light. Some operate at 40w, idle at 20w. 8 tip sizes. 2 and 3 wire neoprene cords.

SOLDERING & DESOLDERING KITS



Everything needed to solder or desolder or both. All in a handy lifetime metal box with hasp.

See your distributor or write...

Enterprise Development Corp.

5127 E. 65th St. • Indianapolis IN 46220
PHONE (317) 251-1231

Circle (8) on Reply Card

APPLIANCE REPAIR BOOKS



Thirteen Handbooks written in easy-to-understand language by experts in the service field with illustrations and diagrams! Acclaimed by instructors and professionals alike! How to diagnose and repair air conditioners, refrigerators, washers, dryers, ranges, microwave ovens, dishwashers, vacuum cleaners, electrostatic air cleaners, RV gas appliances, hair dryers, motors, water heaters, coffeemakers, can openers, floor polishers, steam irons, food mixers, lawn care appliances, electric knives, electric and digital clocks and many others. Also fundamentals of solid state, setting up a shop, using test instruments and more Only \$2.65 to \$4.90 ea.

SEND FOR FREE PRICE LIST

Gamit, Dept. ES

110 W. St. Charles Road,
Lombard, Illinois 60148

Circle (9) on Reply Card

1981 products

Sound-II with an 8W amplifier, two bass speakers and two tweeters.

Other models cover all CRT sizes and cabinet styles in b&w and color.

Model PR-4800 projection color television is the top of the Quasar TV line for 1981. Three six-inch projector tubes operate at 30kV to produce a brightness level of 80 foot-Lamberts (25% more than previous Quasar models) in the 45-inch rear-projection television. Horizontal-resolution sharpness is enhanced by a Quasar *Dynafilter*, a comb filter. The infrared direct-access remote system can tune in 105 channels. At the console, 82 TV channels and 23 cable channels can be tuned with the 105-channel synthesizer system. The projector television is equipped for future stereo with two 10W amplifiers that have balance, bass and treble controls. A video camera, videocassette tape or videodisc player can be connected directly to the video circuit for 450-line resolution.

RCA

Technology is emphasized in the new RCA line. Remote control is provided in 22 of the 43 models. Most models have a cable-ready tuning system for direct access to all VHF and UHF channels and 23 cable channels, including 12 regular VHF and 11 mid-band channels. A 75-ohm connector is provided in all these color receivers.

RCA's *Detail Processor* (CCD type of comb filter) is found in 20 1981 models, compared with five last year. An advanced type of *ChanneLock Keyboard/Scan Control System* combines scanning with direct touch-button access to 82 VHF and UHF TV channels.

Model VEM-575 is a unique combination of wide-bandwidth TV receiver (with a comb filter and vertical peaking) and a maximum-bandwidth video monitor. Provisions are made for connecting one or several of these *Video Monitors*. VCRs and videodisc players are required to include a tiny transmitter modulated by video and sound signals. In the conventional TV

receiver, the process is reversed. The video (including color) and audio signals must be regained by demodulation. Degradation of quality (video especially) is inevitable. When model VEM-575 receives video and sound signals *directly* from VCR, videodisc or video camera, the full bandwidth is available.

Technical changes—A new XL-100 color chassis is CTC109. It is similar to CTC108 (introduced several months ago), but there are differences. Regulated B+ is +123V (CTC108 has +118V) and the maximum CRT current has been increased from 1.3mA to 1.5mA. Rectified and filtered B+ from line power is applied only to the regulator and the horizontal-output transistor. The "hot" supply is not eliminated by the on/off switch. Instead, +150V is supplied *constantly* to the regulator. When

the receiver is turned off, the switch contacts apply saturation bias to the regulator oscillator transistor. This drops the B+ at the regulator output to zero. All other receiver power comes from the horizontal-output stage, so removing regulated power to the output transistor kills all TV functions (except the remote control). Standby power with the receiver turned off is said to be 7W.

Allowing the ac power to reach the bridge rectifier at all times brings a problem with automatic degaussing. In the CTC109 chassis, this is solved by adding a relay. Its field is energized from the +26V, which is missing when the TV is off, and the contacts close to apply ac power to the degaussing coil when the TV is on.

Pulse-code modulation of a 40kHz supersonic carrier operates the remote-control functions. Highs and lows of digital logic are transmitted to the TV receiver over

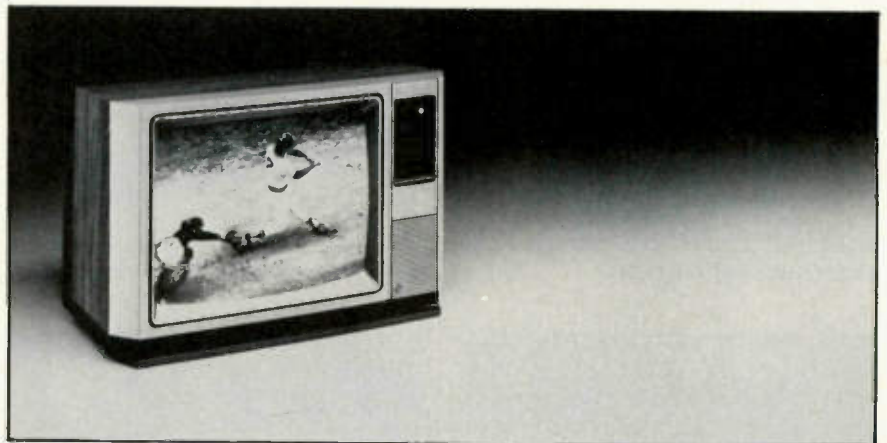

RCA model VEM-575



RCA model GER-770R

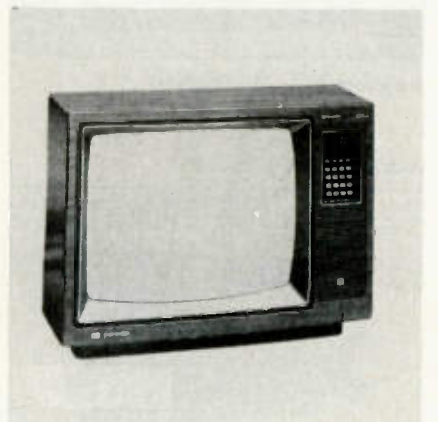

Sharp model 19E91

an infrared beam from LEDs. This provides better noise immunity. A logic low is transmitted by 16 LED pulses of the 40kHz carrier, and a logic high is signaled by 64 such pulses. A preamble is transmitted before the commands so the receiver can be certain the signal is valid. A maximum of 32 commands can be given by the five-bit function code, although this system uses only 17.

The CTC101 chassis is used in 22 of the new models. It is identical to the CTC99, except the CTC101 has the comb-filter and vertical-peaking system (*Detail Processor*).

Sharp

Sharp Electronics offers its first color TV line manufactured in the United States. Ten models are being introduced, and most models feature *Sigma-4000* chassis and wood-grained cabinets. The line consists of five 19-inch, four 13-inch

models and one 9-inch model.

Sharp's top-of-the-line television is model 19E91, a 19-inch with a *Linytron-Plus* in-line one-gun picture tube, *Sigma-4000* chassis, a quartz-PLL synthesized electronic varactor tuner covering 12 VHF channels (factory set) and 8 UHF channels, a 24-function direct-access infrared remote control, LED channel readouts, cable jack, *Automatic Color System* and rapid-on picture and sound.

Model 13E39 is the 13-inch model with the most features, including a *Sigma-4000* chassis, *Linytron-Plus* picture tube, a five-function remote system with up/down scanning, an electronic varactor tuner for up/down channel scanning, cable and earphone jacks, illuminated channel indicators, rapid-on picture and sound, and the *Automatic Color System* for single-knob color adjustments.

Two b&w televisions, models

3S62 and 3S66, have been added to the portable line.

Sylvania

The 1981 Sylvania line has 44 television receivers consisting of three 13-inch sets, five 19-inch models, three 21-inch *Little Giant* sets, 32 25-inch receivers and one home entertainment center. The 25-inch models are *Supersets*, and 24 of these have an audio output jack, 16 have remote control and three include *Supersound*.

Many of these have the new *GT-2000* chassis that has lower power consumption resulting in reduced internal heat. Twenty-nine *Supersets* and one home-entertainment center feature the new quartz-locked push-button tuning system that allows direct access to 82 TV channels.

An infrared remote system is included in 16 models. The infrared beam has pulse-coded signals that are immune to false triggering and make possible 16 commands.

Three *Supersound* models feature a separate built-in audio amplifier and a two-way speaker system. Separate cut/boost controls are provided for tone adjustments. Some other models have audio output jacks that permit external amplification of the TV sound through customers' hi-fi equipment.

Three VCRs have also been added to the Sylvania line. All can record or play up to six hours per cassette. Model VC3100 can be programmed 14 days in advance. It has electronic tuning and video scan that shows the picture at nine times the normal speed. Portable model VC4515 features freeze-frame and frame-by-frame advance in the six-hour mode. Remote control allows pause, still frame and frame advance.

Sylvania technical features—Two new *GT-Matic* chassis (E51 for 25-inch and E53 for 19-inch) have a voltage regulator that operates by switching dc power on or off as needed. Televisions with E40 chassis continue to use a voltage-regulating power transformer, and those with E20 chassis have a series voltage-drop regulator. The switch-

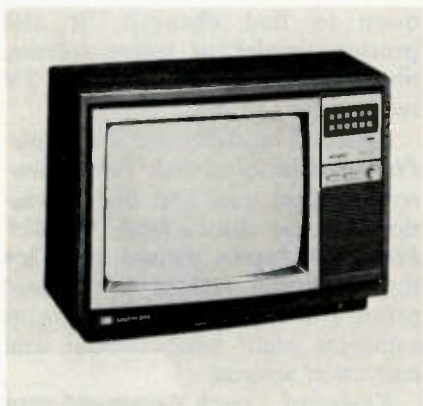

Sharp model 13E39



Sylvania *Supersound* color receivers

Sylvania external amplifiers/speaker unit

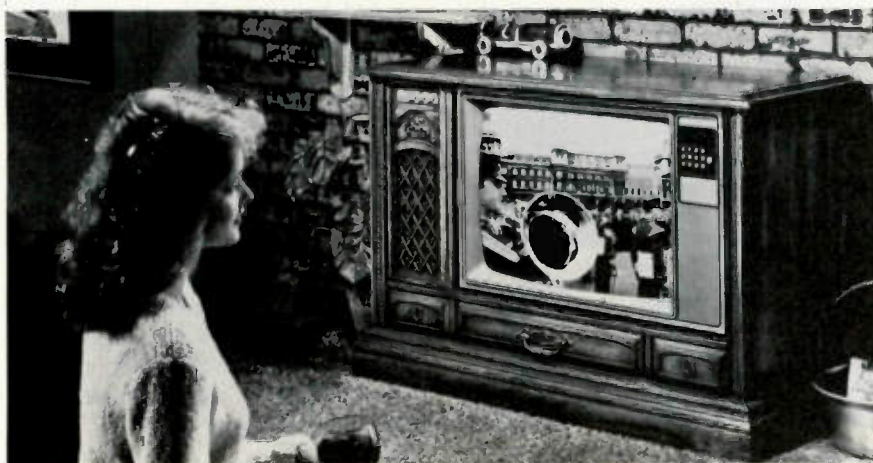

1981 products

ing regulator generates less heat from lower power dissipation. B+112V is obtained from bridge rectification of line voltage. All other B+ voltages are produced by rectification of horizontal-sweep power.

Two SCRs provide shutdown-type protection against overvoltage and overcurrent. If shutdown occurs because of a temporary overload, the TV can be brought back to operation by turning it off for one minute and then switching it back

on. Both hot and cold power supplies are provided. All ICs (except audio output and vertical output) plug into individual sockets, as also do the regulator and horizontal-output transistors.

Zenith

Zenith's line of 1981 color-TV receivers has 55 models in picture tube sizes ranging from 13 to 25 inches.

Thirty-two new models have PRP, a comb filter for separating

luminance and chrominance signals that provides about 25% more picture bandwidth.

Computer Space Command 3500 with *Space Phone* operates as an extension phone and remote control. When the TV receiver is connected to a conventional telephone line, incoming phone calls can be answered through the TV receiver. Pressing the hand transmitter *Space Phone* button silences the TV sound and allows the caller's voice to be heard from the TV speaker. A microphone in the television transmits the viewer's voice over the phone line. *Space Phone* circuitry switches automatically between talking and listening to prevent acoustic feedback. When the call is finished, a push on the same *Space Phone* button restores TV audio. Four 25-inch and one 19-inch table model have the *Space Phone* feature.

Space Command 2500 has a keyboard type of direct access. *Space Command 1600* scans up or down to find channels. It also provides louder or softer volume, mutes the sound and turns the TV receiver on and off.

System-3 receivers use the *Triple-Plus* chassis. *Electronic Power Sentry* furnishes load and line regulation with less chassis heat. The *Tri-Focus* 100-degree picture tube has three focusing actions to increase picture sharpness. *Color Sentry* combines eight color control and correction actions.

Keyboard Touch Command uses a microprocessor that stores channel-frequency information for recall when desired. Fine tuning is not needed because of the phase-locked loop operation.

Some 25-inch consoles have a four-speaker sound system, two woofers and two tweeters. Four *Royalty Sound* series receivers have an additional audio amplifier and controls. The amplifier is rated at 10W, and the audio-control center has detented bass and treble controls plus a voice/music switch. Audio-output jacks are supplied in 21 25-inch and five 19-inch models. This permits TV sound to be heard over any external hi-fi or sound system. □

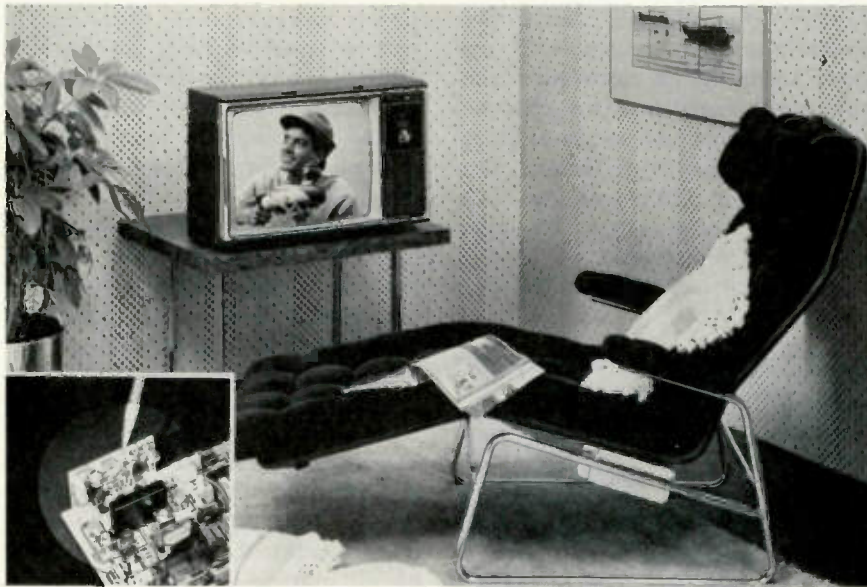

Zenith model M1938W

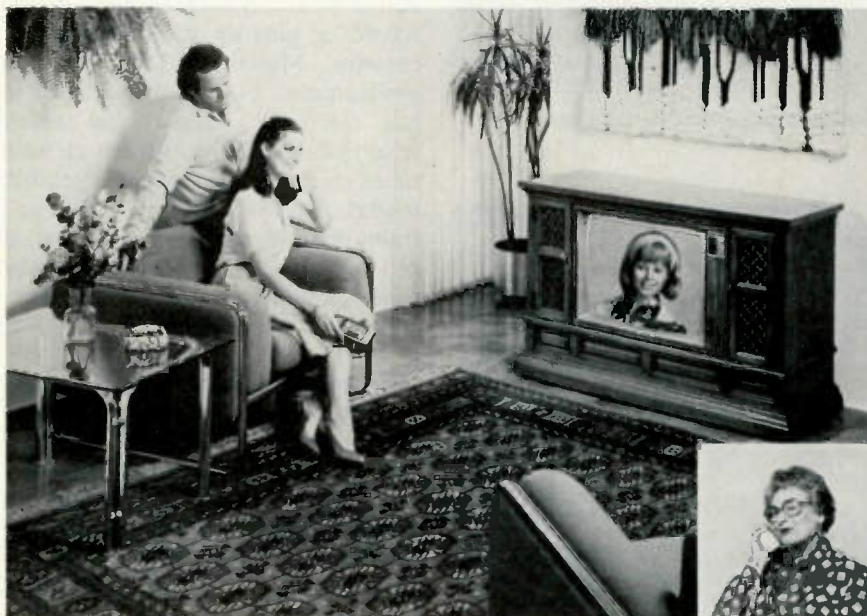

Zeniths Computer Space Command 3500 remote control

Chassis—Magnavox T985/T986
PHOTOFACT—1696-1

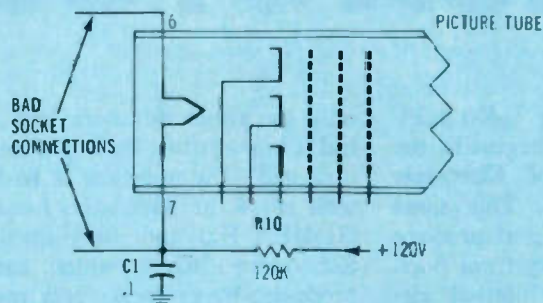

Symptom—No raster, no picture, but HV is normal
Cure—If the picture-tube heaters are not lighted, repair or replace CRT socket

Chassis—Magnavox T985/T986
PHOTOFACT—1696-1

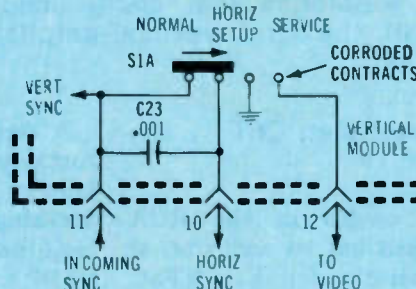

Symptom—Horizontal cannot be locked; vertical locks normally
Cure—Check for corroded contacts in S1A service/normal switch

Chassis—Magnavox T985/T986
PHOTOFACT—1696-1

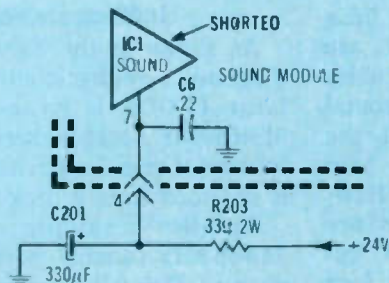

Symptom—No sound, R203 overheats only when the sound module is plugged in
Cure—Check IC1 (perhaps by replacement) for internal short or leakage

Chassis—Magnavox T985/T986
PHOTOFACT—1696-1

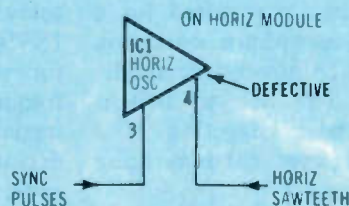

Symptom—Horizontal cannot be locked; vertical locking is normal
Cure—If pins 3 and 4 have proper waveforms, replace IC1

Chassis—Magnavox T985/T986
PHOTOFACT—1696-1

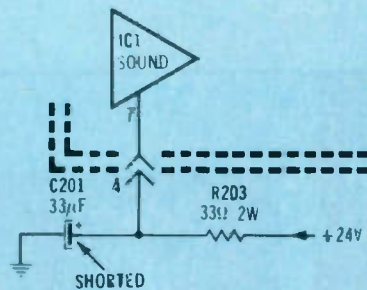

Symptom—No sound, R203 overheats whether or not sound module is plugged in
Cure—Check capacitor C201, and replace it if shorted.

Chassis—Magnavox T985/T986
PHOTOFACT—1696-1

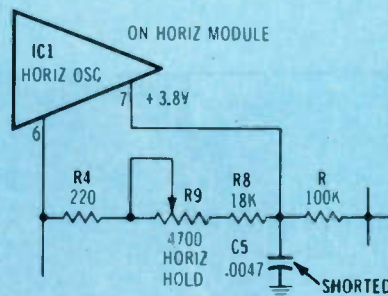

Symptom—No high voltage or horiz sweep
Cure—Check C, on horizontal module, and replace it if shorted

RCA CTC99

Operation of countdown digital circuitry is explained in detail, followed by a discussion and waveforms that clarify unique features of the first vertical-amplifier stages.

By Gill Grieshaber, CET
Gill's Color TV

Vertical sweep in the RCA CTC99 chassis has no oscillator. If the composite video has NTSC sync, the circuits sense the coincidence between the vertical sync (reference) and a pulse obtained by counting down from the horizontal frequency. If the composite video sync does not have the NTSC ratio between horizontal and vertical, the digital circuit automatically switches to a vertical-drive signal that is in-phase with the vertical sync in the video. Eight consecutive vertical fields of coincidence or non-coincidence are required for a change from countdown operation (NTSC signal) to direct-sync mode, or vice versa. This delayed switching prevents false triggering of a model change from random noise pulses.

Therefore, most of the vertical circuitry merely amplifies this drive signal while correcting the yoke-current linearity automatically. In other words, *changes of vertical-sweep linearity or height have no effect on the vertical frequency.* There is no vertical-hold control. Also, the negative feedback action corrects the vertical linearity; no linearity control is needed or provided.

A description of the U400 horizontal-drive operation begins in the January 1980 issue of **Electronic Servicing** on page 28. This same U400 has the dividers that produce NTSC vertical frequency from horizontal frequency, the internal circuitry for detecting NTSC sync, and switching between countdown and sync operation.

Figure 1 shows the location of U400 IC on the CTC99 chassis.

NTSC requirement

Under the NTSC color TV system, there are 262.5 horizontal-deflection lines across the TV screen for each vertical field. For b&w television, the frequencies are 15,750Hz for horizontal and 60Hz for vertical. The color horizontal frequency is 15,734.4Hz and the vertical-sweep frequency (to four decimal places) is 59.9406Hz. However, the exact frequencies are determined by the oscillator's frequency stability, which can vary slightly. *The important specification is the 262.5 ratio between the two;* and no variation or tolerance is allowed. Sync generators in TV networks and stations use digital countdown circuits from a single stable source to ensure this exact ratio.

There is a slight problem. Present-day digital dividers can divide

only by whole numbers; the extra half horizontal line cannot be obtained. The solution is to begin with twice the horizontal frequency (31,468.8 Hz) and then divide by 525 (twice 262.5), which can be produced by dividers. This method is used in all TV-receiver countdown systems introduced so far.

The U400 internal operation cannot be examined and the waveforms cannot be photographed. Therefore, the following information has been developed from the block diagram and basic information published by RCA.

U400 operation

As shown in the Figure 2 block diagram, a voltage-controlled oscillator (VCO) is sync-locked to 31,468.8Hz (double horizontal frequency). Drive for horizontal sweep is obtained from a divider.

Another sample of the 31,468.8Hz (double horizontal frequency) Drive for horizontal sweep is obtained from a divider.

Another sample of the 31,468.8Hz VCO output is used as clock pulses to increment (cause to count upward) the 10-stage counter. At certain counts, the 10-stage counter produces positive pulses (highs). Finally, it is reset to zero, which initiates the next vertical field and counts upward again.

Figure 1 Integrated circuit U400 produces drive pulses for horizontal and vertical sweep. It is located on the CTC99 chassis below the CRT base socket.

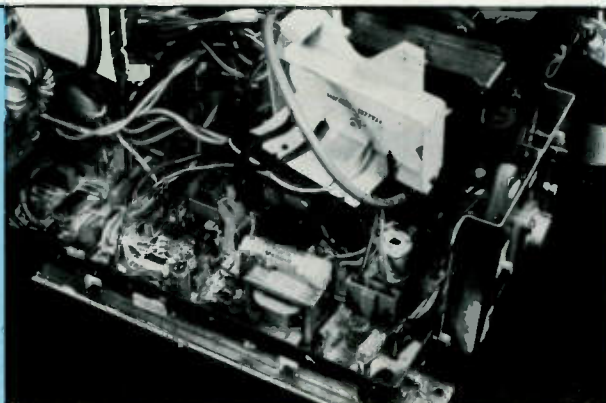

vertical sweep

Part 1

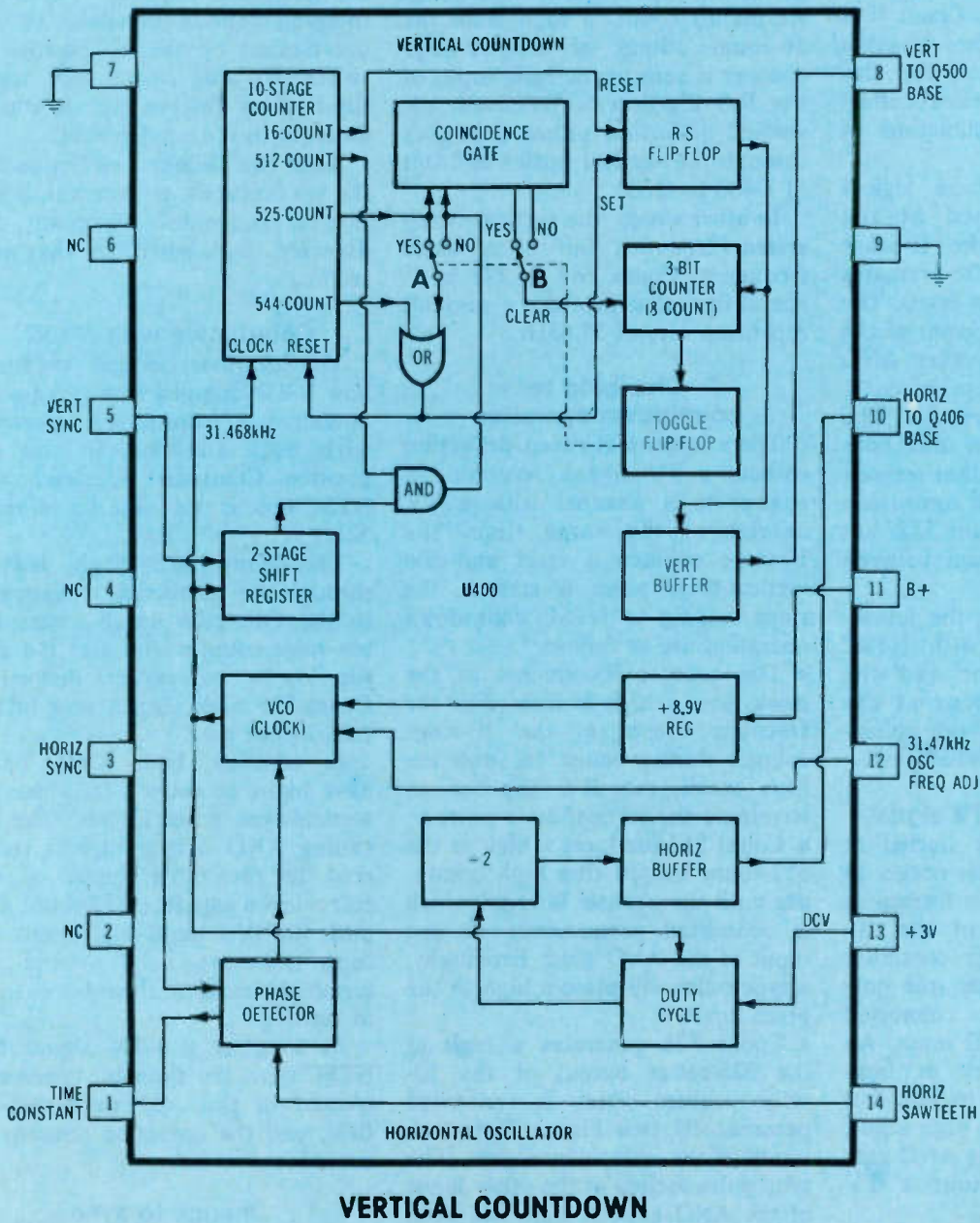

Figure 2 Refer to this block diagram of digital circuits inside U400 while reading the explanation of sync-control vs. digital-countdown operation of the vertical-deflection drive signal.

Vertical sweep

This operation continues constantly.

Because the VCO operates at twice horizontal frequency, count 525 of the 10-stage counter corresponds to 262.5 count of the NTSC system. It is the beginning of the next vertical field. (Actually, the rising edge of count 525 triggers the instantaneous change to count zero. In that sense, count 525 and count zero are the same.)

Count 0 of the 10-stage counter is the beginning of the vertical-drive pulse and count 16 is the end, regardless of the mode. Count 0 is the first one after the 10-stage counter is reset. Watch for this information of the vertical-deflection pulse in the explanation of each mode.

At clock pulse 512, a logic-1 digital high is formed at the 512-count output of the 10-stage counter (this one pulse remains high until the counter is reset). The high is delivered to one input of the AND gate, while the other AND input has a low except when a vertical-sync pulse arrives. The AND output remains low until both inputs are high. Notice that *triggering during direct-sync operation cannot occur before count 512*, but it can occur at any count between 512 and 544.

Keep in mind during the following explanations that with NTSC signals the 525 count and the vertical-sync pulse occur at the same time. If they are not coincident, the signal is not NTSC.

Operation with no TV signal

If the explanation is started at count 17, the next action occurs at count 512 when a high is formed at the 512-count output of the 10-stage counter. This high continues until the counter is *reset* (the only one to do so), and it is connected permanently to one AND input. An AND must have highs at both inputs to have a high output, but sync furnishes the other high input, and there is no sync. The AND gate has no function without a TV signal.

The counter continues to count upward, developing a high at the 525-count output that is connected permanently to one input of the coincident gate. But the gate cannot function since the other input comes from the AND gate that is

triggered by sync (there is none). Therefore, the usual actions do not terminate the count, and the 10-stage counter operates until it reaches 544, where a high is developed at the 544-count output. This output is connected permanently to one OR input, so the OR output goes high and accomplishes two things. First, it is applied to the *set* input of the R-S flip-flop where it starts the vertical-deflection pulse. Also, it is delivered to the 10-stage counter *reset* input, clearing the count to zero. Immediately, the counter continues incrementing. At the 16 count, a high from the 16-count output of the 10-stage counter is sent to the *reset* input of the R-S flip-flop to terminate the vertical deflection pulses that goes through the vertical buffer and out of U400 to Q500.

In other words, the vertical-sweep system free-runs but at a lower frequency. Count 544 is 272 horizontal lines that provides a vertical-repetition rate of 57.85Hz.

Changing to countdown operation

There is vertical-sweep deflection without a TV signal. Assuming a change to a channel with a TV carrier at the same time, the 10-stage counter is reset and the vertical-drive pulse is started, the steps leading to NTSC countdown operation are as follows:

- The counter increments at the clock rate. A high is formed at the 16-count output of the 10-stage counter during count 16, and the high resets the R-S flip-flop to terminate the vertical-drive pulse.

- Count 512 produces a high at the 512-count output (the high continues until the counter is reset) which is connected permanently to one input of the AND gate. Eventually, a sync pulse will place a high at the other input.

- Count 525 generates a high at the 525-count output of the 10-stage counter which is connected permanently (see Figure 2) to one input of the coincidence gate. The sync pulse arrives at the other input of the AND gate. A high has been waiting at the first input, so the AND gate output goes high. This output is connected permanently to the other input of the coincidence gate, and it has a 525-count high at the first input, so it outputs a high on the *no* line to the three-bit

counter. Therefore, the three-bit counter (which was not used during the operation without a TV signal) is not cleared.

- At the same time, the high from the AND output travels through the *no* section of the A switch and to the OR input causing a high at the OR output which *resets* the 10-stage counter and *sets* the R-S flip-flop to initiate another vertical-sweep pulse (the pulse is ended by the next count 16).

- This vertical field was triggered by vertical sync. Seven more identical fields are required before the three-bit counter overflows (it was not cleared by the *no* position of switch B) and causes the toggle flip-flop to reverse the A and B switches to the *yes* positions.

After the switches are toggled to the *yes* positions, the vertical deflection is controlled by count 525 directly, as shown in the next section.

Countdown with NTSC

The previous section explained how U400 changed from sync-pulse operation to countdown operation with both switches in the *yes* position. Continued operation with NTSC sync is the same up to count 525.

The count-525 high travels through the *yes* section of switch A to the OR gate which *resets* the ten-stage counter and *sets* the R-S flip-flop to start vertical deflection. Count-525 high also is sent to the coincidence gate.

In addition, both AND inputs have highs at count 525 when the vertical-sync pulse arrives. The resulting AND output high is delivered to the other input of the coincidence gate (the 525-count also pulls the first input high), and the high thus produced at the *yes* terminal clears the three-bit counter to zero.

As long as the TV signal has NTSC sync, the three-bit counter is *cleared* in this way each vertical field, and the operation remains in countdown mode.

Change to sync operation

Operation with NTSC sync has changed both switches to the *yes* positions and vertical sweep is initiated by count 525. These are the steps during the change to sync operation:

- The countdown continues as before up to count 512. A sync pulse that arrives after count 512 *but not at count 525* activates the AND gate with highs at both inputs and the output. The output high is delivered to the *no* input of the coincidence gate. But the other input has a high only at count 525. There is no coincidence, so the gate produces a high at the *no* output. The three-bit counter is *not cleared* and it continues to count. After seven more identical fields, it will change the switches from *yes* to *no*.
- Count 525 produces a high at the 525-count output of the 10-stage counter. The high travels through the *yes* contacts of the A switch to one input of the OR gate, causing the OR output to produce a high that *clears* the 10-stage counter and *sets* the R-S flip-flop (beginning the vertical-drive pulse).
- Therefore, *vertical deflection is obtained, but it is not locked with the picture at this time.*
- After seven more identical fields, during which the three-bit counter is *not cleared*, the three-bit counter overflows thus changing the state of the toggle flip-flop and reversing the switches to the *no* position.

Sync operation

With the switches in the *no* position, continuing operation has these steps:

- The AND output is connected to one OR input by the *no* position of switch A.
- When the sync pulse arrives after the 512 count, both AND inputs have highs so the AND output goes high. This high travels through the *no* section of the A switch to one OR input. The resulting high at the OR output starts the R-S flip-flop, which begins the vertical-deflection pulse and also resets the 10-stage counter to begin a new vertical field.
- There is no coincidence between count 525 and the vertical sync at the AND output, therefore the coincidence gate produces a high on the *no* line to clear the three-bit counter and prevent it from activating a change of switching via the toggle flip-flop.

Therefore, the vertical-sweep is locked properly, and the U400 operation remains in the sync-pulse mode with the internal switches in the *no* positions until the input

signal changes to another with NTSC sync.

Transient out-of-lock condition

During each eight vertical fields that are necessary to change from one mode to another, the picture is out of vertical lock. The changeover requires eight fields, or about 1/7 second.

In the RCA CTC99, the out-of-lock condition is not displayed on the screen because the video is blanked during (and for a short time after) each channel selection.

Vertical amplification and waveform shaping

Although it might seem a simple matter for the remainder of the vertical circuit merely to amplify the vertical-drive signal coming from pin 8 to U400, the circuit action actually is quite complex. Figure 3 shows the complete vertical-deflection circuit including the yoke, dc voltages, waveforms and their amplitudes. Additional dc waveforms and base-to-emitter waveforms are added where necessary to clarify the circuit operation.

Q500 operation

Waveforms W1, W2 and W3 trace the integration of vertical-sync pulses that enter U400 at pin 5. Unexpectedly, the dc voltage at pin 5 changes according to the type of signal received. In countdown operation on a TV station using the NTSC system, the pin 5 voltage was zero. When color bars from a generator were viewed, the dc voltage was about -0.06V. Tuning to a channel without a signal gave a reading of +0.3V, which is the value specified on the service data.

Figure 4 shows expanded-width versions of W3 and W4. Vertical sync at pin 5 is revealed by the top trace to have a much different waveshape than the usual one in sweeps where the sync merely locks an oscillator. The lower trace is the vertical-drive pulse leaving U400 at pin 8 (compare it with W4). It is negative-going and (as predicted) has a width of 16 clock pulses or eight horizontal lines.

On its trip to the base of Q500 switch transistor, the drive pulses are reduced in amplitude by R502 and R501. Also the reference point at Q500 no longer is ground but a

HOW TO GET BETTER MILEAGE FROM YOUR CAR...

Obey the 55 mph speed limit.



Keep your engine tuned.

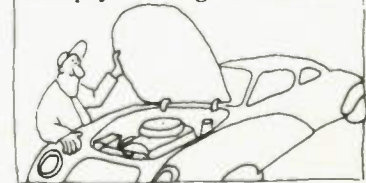

Avoid hot rod starts.



Drive at a steady pace.

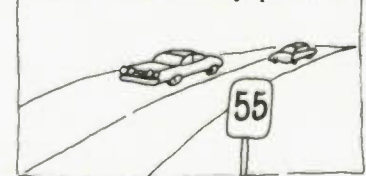

Don't let the engine idle more than 30 seconds.



And when buying, don't forget the fuel economy label is part of the price tag, too.



For a free booklet with more easy energy-saving tips, write "Energy," Box 62, Oak Ridge, TN 37830.

ENERGY.
We can't afford to waste it.

U.S. Department of Energy

Vertical sweep

parabolic waveform (along with +12.6V from the output stage) produced by yoke current passing through C505. When scoped to ground in the usual way, the W5 through W9 waveforms include large amplitudes of parabola. For example, the base signal of Q500 is

returned to ground through R502, C500 and U400 pin 8. But the emitter is connected to the parabola at C505. Therefore, the Figure 5 top-trace B/E waveform of Q500 shows some parabola. But the C/E waveform (bottom trace in Figure 5) has no parabola.

Also, Q500 appears to have no forward bias, since base and emitter have the same dc voltage, and

there is no resistor from base to B+. The Figure 5 waveforms show that the parabolic part moves the zero-voltage line (top trace) nearer the center. Therefore, there are 0.7V negative pulses below the zero line. These pulses saturate Q500 since it is a PNP type.

C501 is paralleled across collector and emitter. Therefore, the C/E waveform (Figure 5 lower trace) is a

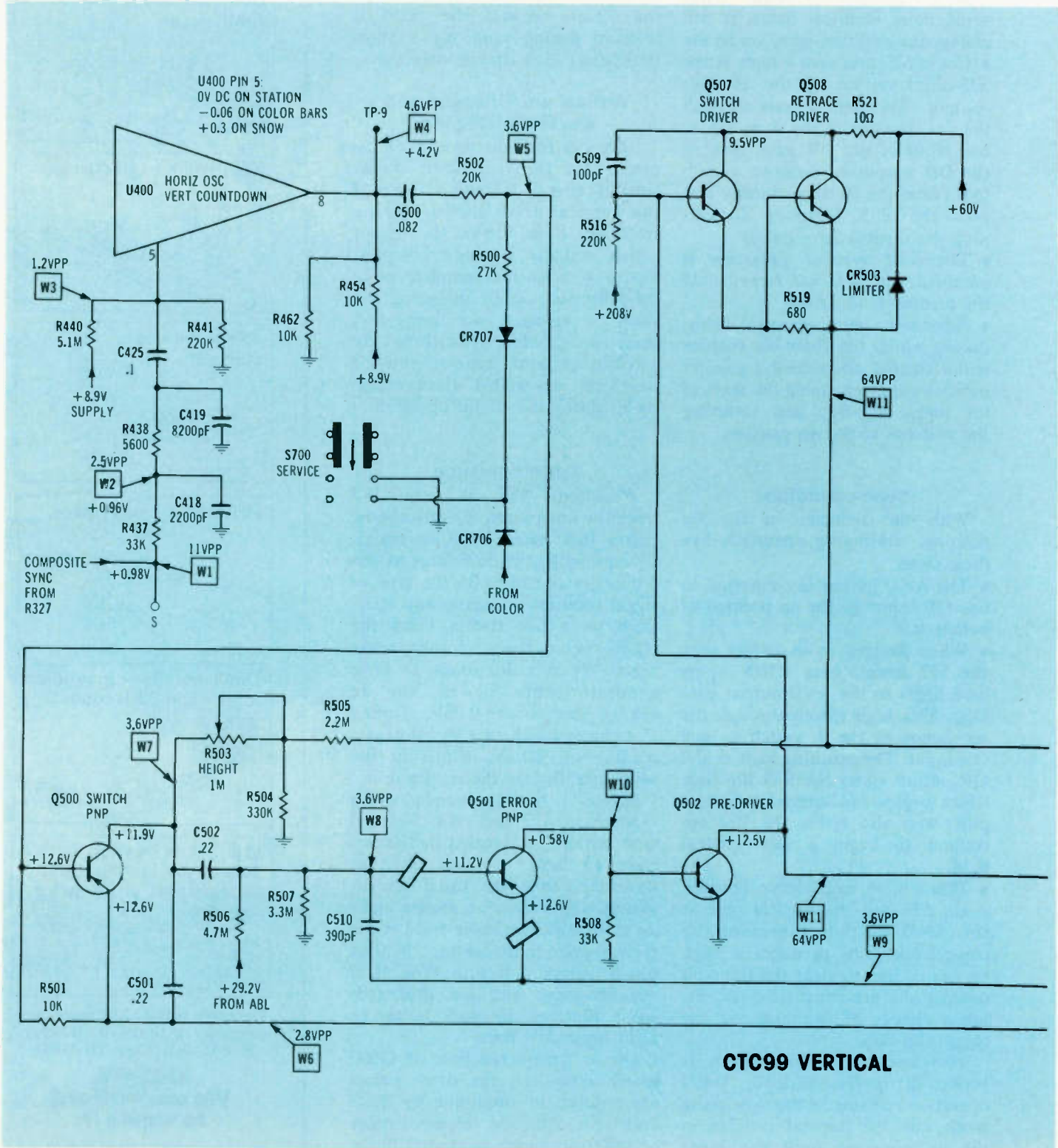

CTC99 VERTICAL

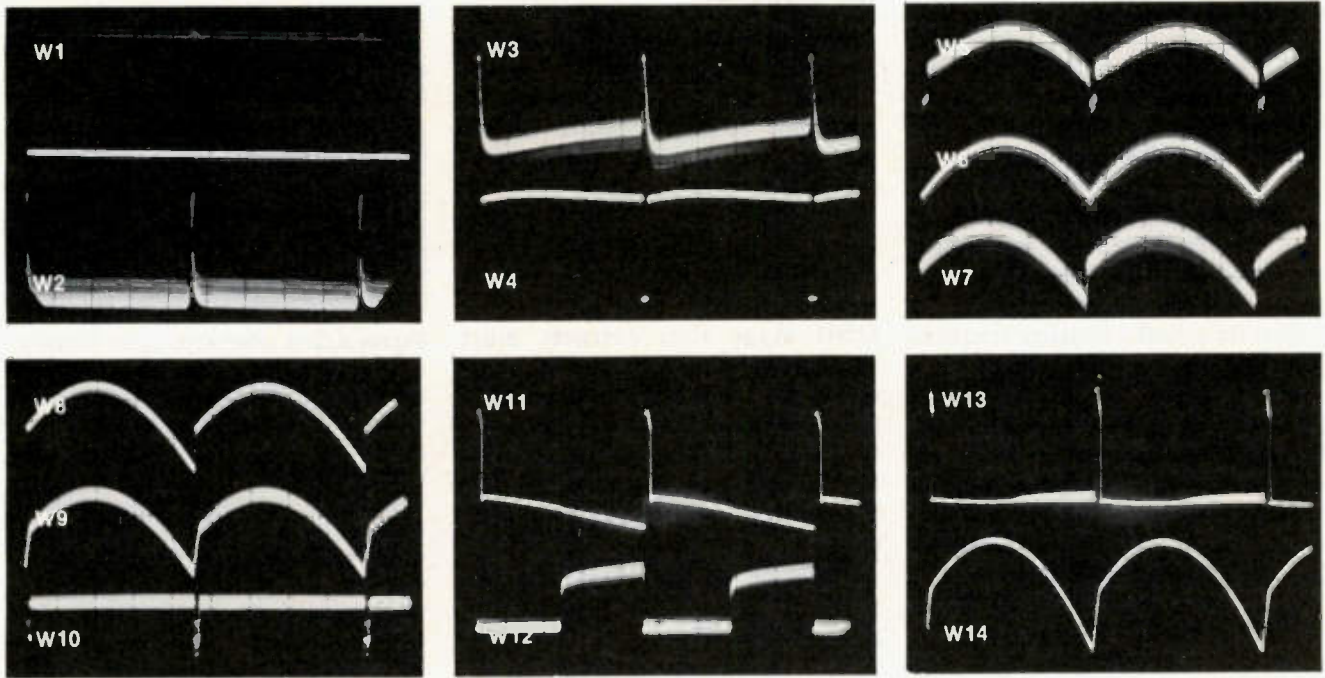
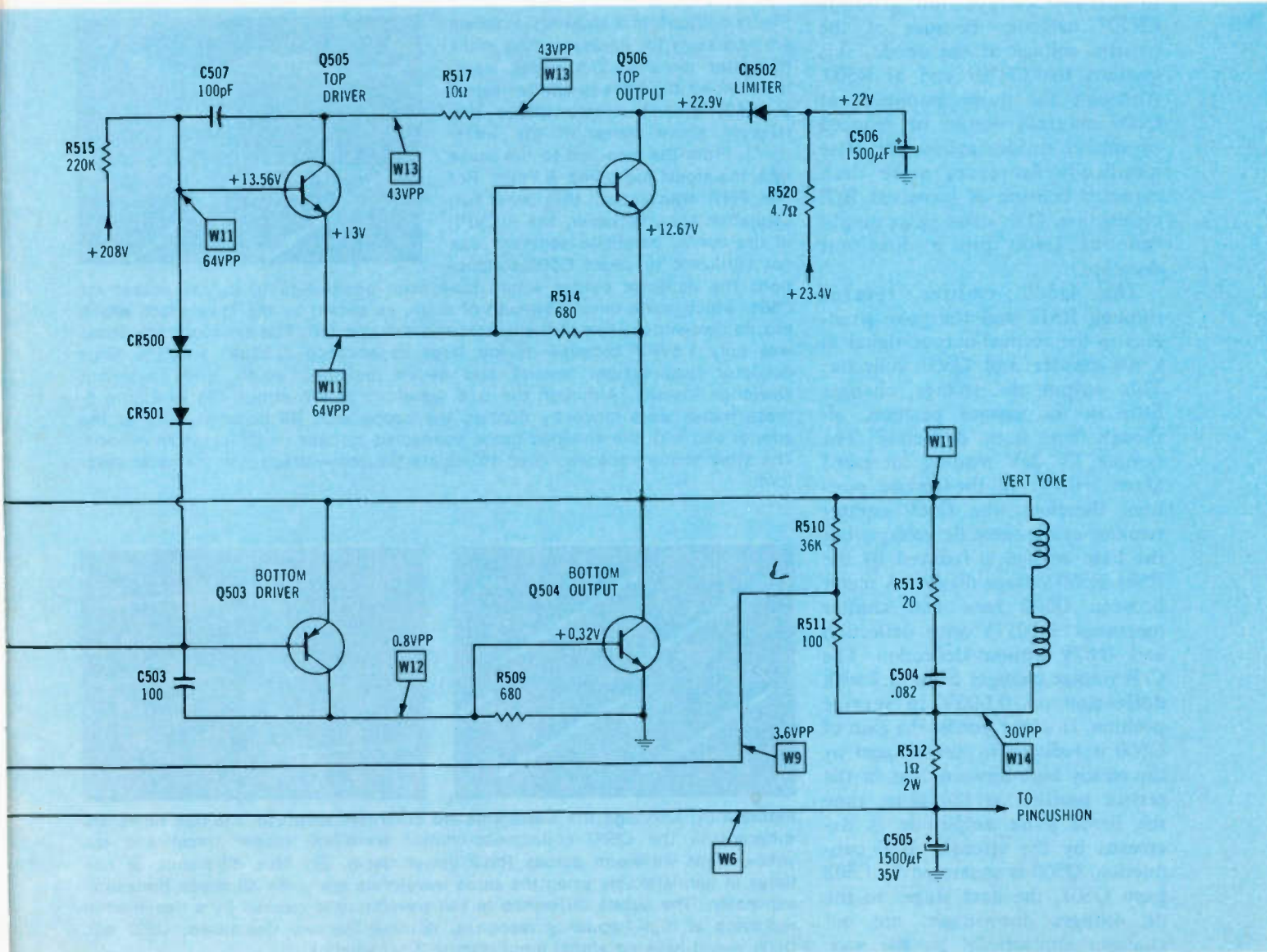

Figure 3 The vertical-sweep system in the RCA CTC99 color receiver, includes the U400 countdown IC, the amplifying and linearity-shaping circuitry and the vertical-yoke windings that are driven by the circuits. All waveforms were scoped with ground as reference.



Vertical sweep

linear sawtooth with zero voltage at the upper tips. Measured from the emitter, the collector is negative.

Retrace time in waveforms

In Figure 3, several waveforms are called W11. However, there are minor differences between some. A deliberate rolloff of higher frequencies from C503, C507, C504 and others provides a slower retrace time at the vertical yoke. The Figure 6 waveforms show the faster retrace time across C501 compared to the yoke-current retrace. This is shown also by base W8 and emitter W9 waveforms in Figure 3.

Service-switch operation

Another interesting thing about the Q500 stage is the method of killing vertical sweep in the service position of S700. Pulling out S700 to the service position grounds CR707 cathode. Because of the positive voltage at the anode, this grounds the CR707 end of R500. Although the pulse amplitude at Q500 naturally would be reduced by voltage divider action, the base amplitude decreases more than expected because of increased B/E conduction. (The drive pulse amplitude at U400 pin 8 does not decrease.)

The Q500 emitter returns through R512 and the yoke windings to the vertical-output signal at Q506 emitter and Q504 collector. This output dc voltage changes little in the service position, although there is no deflection. The sample TV dcV reading increased about +0.1V. In the service position, therefore, the Q500 emitter remains at the same dc voltage, but the base voltage is reduced by the R501/R500 voltage divider. A meter between Q500 base and emitter measured +0.017V with deflection and -0.67V without deflection. The C/E voltage changes from -0.7 with deflection to -0.005V in service position. In other words, the gain of Q500 is reduced to almost zero by the steady high forward bias in the service position at the same time the input pulse amplitude is decreased by the stronger B/E conduction. Q500 is separated by C502 from Q501, the next stage, so the dc voltages downstream are not changed appreciably. By the way,

the Q500 base is sensitive to capacitance loading in the normal position of the service switch. Excessive test-lead and meter capacitance causes a flutter in the picture that resembles a fast vertical roll.

Part 2

The subjects next month will be explanations and waveforms of the Q501 stage that corrects most vertical non-linearity, the mysterious Q507/Q508 retrace stage (that seems to duplicate Q505/Q506, or do nothing, depending on the viewpoint) and coverage of the remaining vertical-deflection circuitry.

Finishing the RCA CTC99 series will be circuit waveforms and photographs from the TV screen that illustrate many possible defects in the vertical-sweep system. □

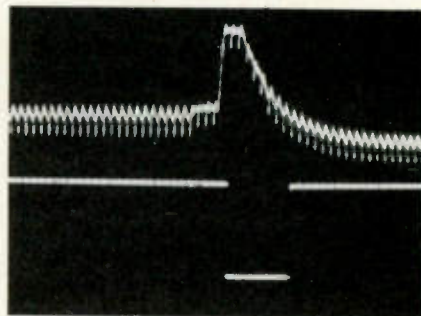

Figure 4 One integrated sync pulse at U400 pin 5 is shown by the upper waveform. The leading edge rises faster than the same edge in integrated vertical-sync pulses of older televisions. Lower trace shows one negative-going vertical drive pulse at U400 pin 8. It is eight horizontal lines wide. The dual-trace waveforms were widened by operating the scope at 1mS/div and X5 magnification. The smaller pulses on the upper trace are horizontal-sync pulses. In conventional waveforms, these pulses cause wide base lines.

Figure 5 Waveforms showing dc levels are necessary for understanding many transistor circuits. The upper waveform shows the base-to-emitter signal at Q500 plus the zero-voltage line (slightly above center of the waveform). From the zero line to the pulse tips, the signal measured -0.7VPP. For the PNP transistor, this was full saturation bias. However, the -0.2VPP of the curved parabolic segment was not sufficient to cause Q500 conduction.

The collector output would have been positive-going pulses except for C501, which made linear sawteeth of them, as shown by the lower trace which has its zero-voltage line at the waveform's extreme top. The sawtooth amplitude was only 1.5VPP because of the large capacitance (0.22 μ F) and the large collector load (height control and series resistor), which gives excellent sawtooth linearity. Although the B/E waveform is W5 minus W6 in Figure 3, these traces were made by floating the scope with its common lead at the emitter and with the shielded probe connected to base or collector as needed. The other scope trace was used to supply the zero-voltage line for each waveform.

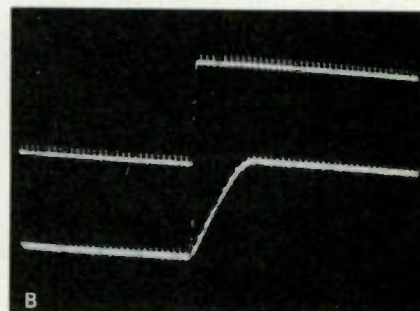
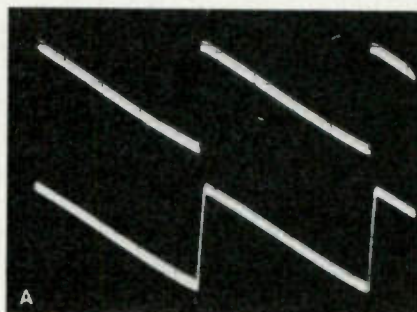
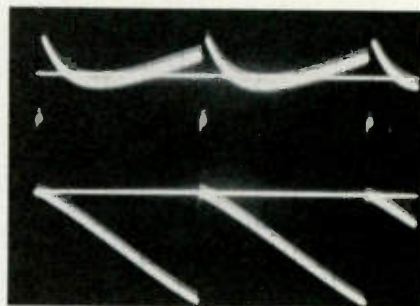

Figure 6 (A) Although the waveforms are otherwise identical, the rise times are different in the Q500 collector-to-emitter waveform (upper trace) and the yoke-current waveform across R512 (lower trace). (B) This difference of rise times is unmistakable when the same waveforms are given X5 scope horizontal expansion. The subtle difference in the waveforms is caused by a designed-in reduction of high-frequency response. Without the two rise times, Q507 and Q508 would have no signal input (Figure 3 schematic).

troubleshootingtips

Chattering relay RCA CTC81A (Photofact 1572-2)

When the brightness was turned down for a dim picture, the sound was clear, and the color picture was excellent without hum bars. However, turning the brightness up to normal produced a chattering in K201, the overvoltage relay.

Here is the proper operation of K201:

- One set of K201 contacts disconnects the B+ power from the horizontal-output stage until the supply rises nearly to +170V during turn-on.
- When energized, the K201 coil receives about +30V from R203 and R213. Both sets of contacts close, applying power to the horizontal-output stage and shorting across the positive-temperature resistor RT202 that is in series with the primary of T201, the regulating-type power transformer.
- Although the collector-emitter junction of Q201 parallels the relay coil, the transistor draws no current and does not reduce the coil voltage during normal operation.
- If the +39.8V supply rises to +43V or higher for any reason, zener diode CR205 passes current to the base of Q201, the protect transistor.

• Q201 C/E current reduces the K201 coil voltage, forcing the contacts to open. This stops the horizontal sweep and high voltage so the television is not operable until the defect causing the high supply voltage is repaired.

Therefore, *either* a reduction of the +173V momentarily below the value where K201 de-energizes or current through Q201 must be responsible for the relay chatter (rapid on/off operation).

First, I measured the supply voltage and the Q201 base voltage. These are found at cathode and anode of CR205. Q201 had some base voltage, and the +39.8V supply measured +43V. After making several other tests that proved nothing, I scoped the various positive-voltage power sources. C206B, the output filter capacitor of the +172V supply, showed a large signal at high brightness.

Replacement of the entire C206 multiple-capacitor can restore normal operation at all brightness levels. But the question remained: Why did an open filter cause the relay to chatter?

Regardless of the precise reason, it proved again the value of the old saying, "When in doubt, scope the power-supply voltages."

Ralph J. McGinty
Leonardville, KS

Editor's Note: When the filter capacitor that bypasses the horizontal-output supply voltage is open, hum usually is *not* produced (unless it comes from insufficient filtering of the vertical supply). However, the dc voltage at an open output filter capacitor (such as C206B) decreases to almost zero volts each time the output transistor or tube draws current. This produces a large 15,734Hz waveform with 60Hz variations (from video and retrace) at the open capacitor.

Larger output current for a bright picture reduces the instantaneous dc voltage below the relay hold-in point, and it opens the contacts which removes the horizontal-output current, eliminates the ripple, and allows the dc voltage to increase thus energizing the relay again. Therefore, the relay continuously opens and closes the contacts during high brightness.

It is more difficult to explain the higher +39.8V supply voltage, because the power transformer regulates all ac secondary voltages. Perhaps the rapid shorting of RT202 which is synchronized with the +172V load change produces transients that increase the dc voltage before the regulation can act. In any event, the Q201 collector current and the C206B ripple (either separately or together) reduce the relay coil voltage.

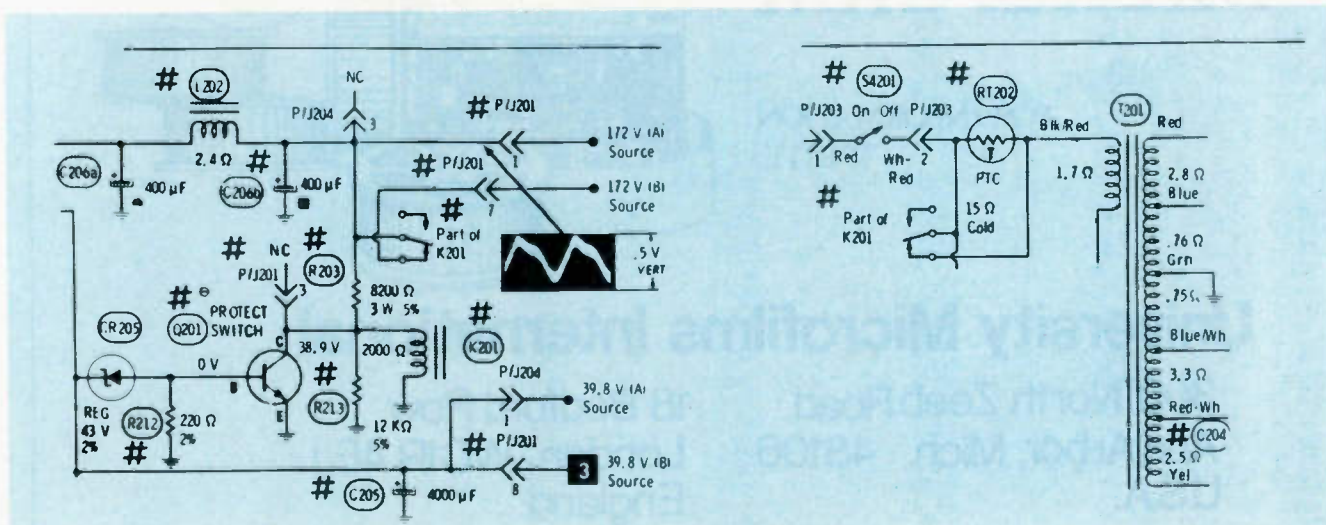

Black corner
Hitachi CA568
 (Photofact 1854-1)

The Hitachi color TV had been in another shop for about four months after it was knocked from the TV stand. When power was turned on, one section near the lower-left corner of the screen was dark. Because the picture tube had been changed previously, I was certain the dark corner was caused by blanking problems.

While scoping the blanking waveforms, I found an additional ground, but the dark corner remained. This time the rep said to send him the chassis. After it was returned, the dark corner was still visible, but the rep stated it was not seen on the test setup.

Therefore, if the chassis was perfect, the problem must be in some component outside the chassis. When the yoke was unplugged, the wrong pulses disappeared. A careful examination of the yoke revealed a broken ferrite core, with one section displaced about 1/4 inch. Evidently, the broken section un-

balanced the magnetic fields, allowing horizontal pulses to enter the vertical circuit.

A new yoke eliminated the dark spot. Since that time, I have seen the same type of yoke in GE and Quasar models also. Therefore, this tip could apply to them as well.

Curtis A. Routley
 Smith TV & Electronics
 Columbus, MS

No HV or picture
Panasonic model CT-26
 (Photofact 1371-1)

When first operated in the shop, there was sound but no picture. The horizontal-sweep tubes were tested and all were normal.

Afterwards, the television operated with a good picture for several minutes before losing the high voltage and picture. Voltage measurements around the 29KQ6 horizontal-output tube revealed excessive voltage at pin 6 and a low voltage at pin 3.

Of course, a jumper wire con-

nected pins 3 and 6. I soldered the jumper carefully at both pins, and the intermittent HV was repaired.

Several other makes and models connect together these same pins,

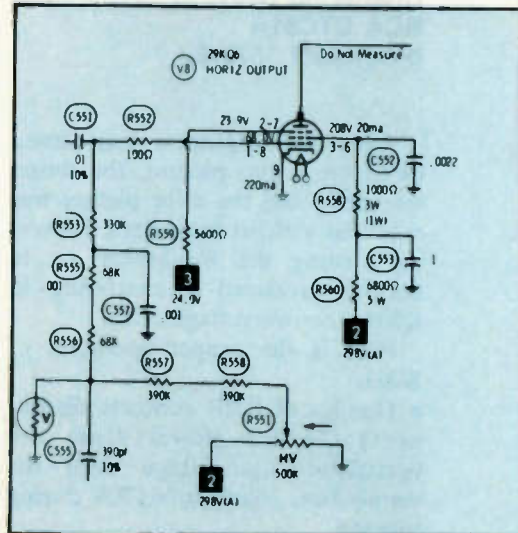

so watch for the same symptoms with them.

Howard W. Phillips
 Phillips TV & Radio Service
 Tulsa, OK

Electronic Servicing
 is Available in
MICROFORM

FOR INFORMATION
 WRITE:

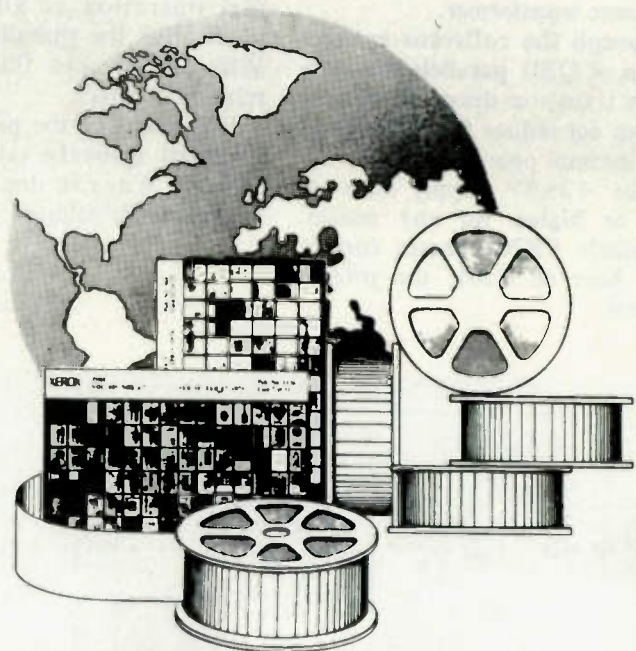

University Microfilms International

300 North Zeeb Road
 Ann Arbor, Mich. 48106
 U.S.A.

18 Bedford Row
 London, WC1R 4EJ
 England

reader's exchange

There is no charge for a listing in *Readers Exchange* for items "Needed," but we reserve the right to select and edit all copy. Due to the limited amount of space for this department, "Needed" listings must contain no more than three items. If you can help with a request write directly

Needed: Instruction manual with schematic for Century capacitor tester model CT-1. Kenneth Miller, 10027 Calvin St., Pittsburgh, PA 15235.

Needed: Dual-trace scope, would trade new Hickok 439-C lab type tube tester. Thomas Burns, 9 Allegheny Terr., Pittsburgh, PA 15207.

Needed: Magnavox T95115AD convergence board and yoke. Edward Galovic, 86 Olde Egbert, Bedford, OH 44146.

Needed: Sencore YF33 yoke and flyback tester, ac line voltage Variac, 0 to 130V range. Philco power transformer no. 32-8929-1 for H-1714 stereo. D. B. Fritz, 3210 St. Lawrence Ave., Reading, PA 19606.

Needed: Schematic, technical information or present address for a Friden electronic calculator model 132. Charles Shimla, 1785 Tull Ave., Courtenay B. C., Canada V9N 6G5.

Needed: Color bar generator Allied KG685, KG688 and KG687. Please state price and condition. S. Uricek, 9674-160 St., Surrey B.C. Canada V3R 4N7.

Needed: B&K-Precision 415 sweep marker/generator or similar equipment with complete leads and manual. J. Irvine, 807 Tyndall, Erie, PA 16511.

to the reader, not to *Electronic Servicing*. "For Sale" listings will be charged for and included in the regular classified section of *Electronic Servicing*. Please consult that section for price and ordering instructions.

Needed: Full schematic for Fujitsu open-reel recorder, TEN, model 701A, prod. no. 6206. Paul Marcum, Rt. 6, Kingsport, TN 37660.

Needed: '01A and/or '00A tubes. Quote price and quantity. Antique Radio, 44409 Leatherwood, Lancaster, CA 93534.

Needed: Supreme Radio diagram manuals for 1955 and 1957. State condition and price. M. H. Vaughan, 2518 Griffith Ave., Louisville, KY 40212.

Needed: Power transformer for Zenith radio A-321552. part no. A-95710N, 117V, 60Hz, 60W. Ora Troyer, RR1, Box 513, Alburtis, PA 18011.

Needed: Riders Radio Manuals. Quote price and condition. Troch's, 290 Main St., Spotswood, NJ 08884.

Needed: On-off/volume control switch for Zenith Royal 275, chassis 7CT40Z2. Part no. 63-4602, sub. 63-3693. Mike Danish, P.O. Box 217, Aberdeen Proving Ground, MD 21005.

Needed: Sams AR-20 (covering Becker Europa MU), also schematic/service data for Dynaco SCA-35 stereo amp. Roger Buford, 544 Magnolia, Oxnard, CA 93030. □

Put your
money where
your Heart
is.



Maxi-Grabber

ITT Pomona Electronics has developed a Maxi-Grabber with banana jack. Model 4724 has a standard 4.22mm (.166") diameter banana jack built into the plunger. It is designed for attaching the grabber directly to the end of a banana plug patch cord. The grabber has a



gold-flashed beryllium copper hook for attachment to the test point. The banana jack is nickel-plated brass with glass-filled nylon insulation that withstands temperatures to +102°C (+216°F).

The Maxi-Grabber 4724 is priced at \$3.95.

Circle (39) on Reply Card

Bypass filter connectors

A line of bypass filter connectors for appliances is now available from the electronic components division of Panasonic. The EMC-P Series

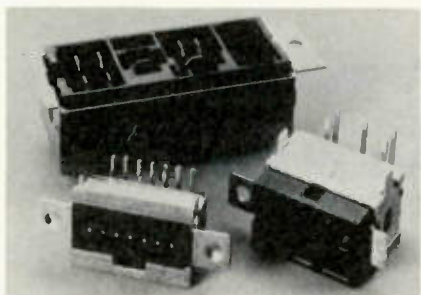

connectors provide noise suppression for appliances by preventing noise from entering an appliance and preventing noise from exiting

from an appliance into the signal lines. Bypass filter connectors are available with up to 36 pins. The prices of the EMC-P series bypass filter connectors (in 1000 lots) range between \$1.45 to \$8.46 each.

Circle (40) on Reply Card

Socket wrap-ID panel

Used to identify pin numbers on wire-wrapping sockets, the Socket Wrap-ID from O.K. Machine and Tool consists of a socket-size plastic panel with numbered holes in each

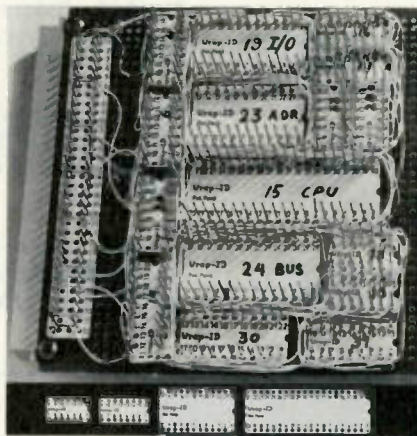

pin location. It is slipped onto the socket before wrapping. Location, IC part number and function can be written on each wrap-ID. The Socket Wrap-ID simplifies initial wire-wrapping and subsequent troubleshooting or repair.

Circle (41) on Reply Card

Electro-mechanical maintenance kit

Jensen Tools has introduced a kit for electro-mechanical maintenance, the JTK-79. The kit contains an



assortment of tools for a variety of tasks in a 6x9x1¼" padded zipper

case for portability and storage. The JTK-79 includes three pair pliers: chain nose, diagonal cutter and miniature diagonal cutter; 3 1/8-inch screwdriver handle with 4-inch extension and 3/16-, 1/4-, and 5/16-inch slotted blades and two Phillips blades; 10 piece hex key set; 10-foot tape measure; wire stripper; penlite, 6-inch adjustable wrench; six piece 1/4" drive socket set with 3/16-, 7/32-, 1/4-, 9/32- and 5/16-inch sockets and a circuit tester for 100-500V ac or dc circuits.

Circle (42) on Reply Card

Ultrasonic delay lines

Wide-bandwidth, low-insertion-loss ultrasonic delay lines are now available from the electronic components division of Panasonic. Their nominal frequencies range between 3.58 to 28.636MHz and offer delays ranging from 63 to 128µs. The delay

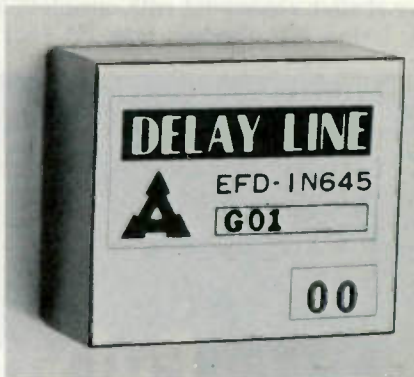

lines are aimed at a variety of applications in video cameras, VTRs, TV receivers, videodiscs and TV cameras. In these applications, they enhance color demodulation, provide vertical aperture correction for video cameras, serve as combing filters, and facilitate noise reduction.

Circle (43) on Reply Card

Digital frequency synthesizers

Jordan Technology has introduced two digital frequency synthesizer/audio function generators that are capable of producing sine wave, square wave, triangular wave, positive slope, negative slope and fre-

quency burst outputs from 0.001Hz to 200KHz. The models DFS-1 and DFS-2 maintain an accuracy of 10PPM from 0°C to 50°C with options that improve the accuracy to 0.5-2.0PPM. Resolution is 1Hz with an option of 0.1Hz to 0.001Hz. LED indicators display operating



function and the nature of the time base internal or external. With an output impedance of 50 OHMS, the unit produces an output level of 15 peak-to-peak open circuited and 7.5V peak-to-peak at full load. Both units are microprocessor compatible.

The model DFS-1 is priced at \$1255 and DFS-2 at \$1775.

Circle (44) on Reply Card

Black box monitor

Cincinnati ElectroSystems has introduced the Buffered LED Black Box, which can monitor six logic outputs simultaneously. The box can



be used to monitor IC and binary counter outputs on printed circuit boards and breadboards, and to monitor connector outputs on back

planes. The unit features triple-prong terminals. The box is TTL, DTL and CMOS compatible, and operates on either 5V or 15V dc power.

Circle (45) on Reply Card

Solder wire

A triple core solder wire has been introduced by Fry Metals. The triple core wire solders feature a constant flux-to-metal ratio to eliminate flux voids. Requiring shorter iron dwell

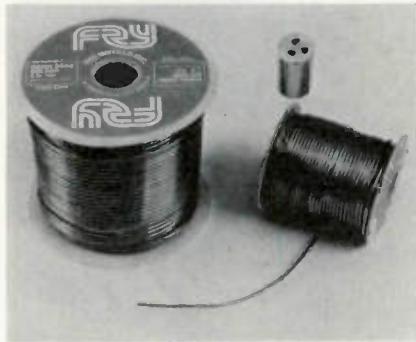

time and lower idling temperatures, a thin solder wall permits faster melting, flux flow and thorough wetting. The solders are available in 1-, 5- and 25-pound spools.

Circle (46) on Reply Card

TV antennas

Zenith has introduced two new lines of indoor and outdoor TV antennas. The seven models in the Chromatenna indoor antenna line provide UHF/VHF/FM stereo reception. Model 973-921 is one model featuring a VHF/UHF selector switch to minimize unwanted signals, a rotator knob for turning the UHF loop, VHF dipole isolators, and five-section VHF elements to reduce snow and color fading.

The 12 models in the Chromatenna II outdoor antenna line feature transmission line termination, aluminum construction, high-impact plastic insulators, FM block, UHF dipole, VHF colinear directions and optional breakaway UHF wing direc-

Circle (47) on Reply Card

NATIONAL ELECTRONICS SERVICE DEALERS

Are you standing idly by while ideas that can be money in your pocket fly away?

Membership in NESDA is one of those ideas.



WHAT DO YOU GET FROM NESDA?

1. Insurance
2. Special Bancard Rates
3. ServiceShop Magazine
4. Electronic Service Industry Yearbook
5. Service Industry Information
6. Legislative Programs with State and National Government
7. Advocate for Better Warranty Practices
8. Business Information



Don't let your bucks get lost in the shuffle.

Send in your check today.

On the bottom line it will mean extra \$\$\$ in your pocket.

JOIN NESDA

And Your State Association
Send for more information:
NESDA, 2708 W. Berry St.
Fort Worth, TX 76109



Circle (10) on Reply Card

Future Shock!

age	65
years worked	40
retirement benefits	0

Many of the 50 million Americans who are covered by private pension plans think they'll automatically qualify for benefits when they reach retirement age.

They're wrong!

Every plan has requirements that must be met under the Employee Retirement Income Security Act. And the time to find out about those requirements is now—even if retirement is 30 years down the road.

There's a lot more to think about too. Does your plan permit early retirement? How much will your plan pay you? Will you receive a monthly payment or a lump sum?

The U.S. Department of Labor has a free booklet that will help you answer these questions and a lot more. Send for it today.

Write: Pensions, Consumer Information Center, Pueblo, Colorado 81009

U.S. Department of Labor



Printed by this publication as a public service.

test equipment report

Universal counter/timer

The **Tektronix TM500 DC503A** universal counter/timer offers high performance in a modular package. The DC503A, which replaces the DC503, features 11 measurement functions. Measurements can be averaged from 1 to 108 times, allowing 10ps resolution in Times A→B and Width modes. Single-shot resolution is 100ns. Two input channels individually provide a full

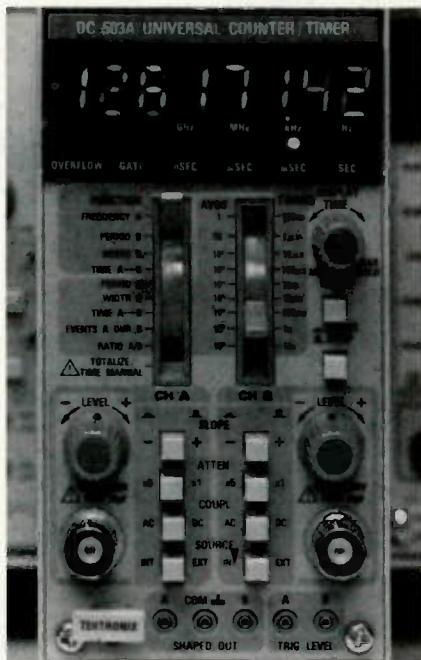

0 to 125MHz frequency range and 20mV rms sensitivity. Trigger levels and the outputs of the signal shaping circuits can be monitored via front panel jacks. The DC503A can be equipped with an optional high-stability (± 0.2 PPM), oven-controlled, 10MHz crystal oscillator time base.

The DC 503A is priced at \$900. The high-stability time base option is \$275.

Circle (48) on Reply Card

Hand-held DMM

B&K-Precision has announced the introduction of a microcomputer-controlled, hand-held, autoranging 3½-digit DMM, model 2845. Basic dc accuracy is 0.1%, with values displayed on a ½-inch LCD. The

2845 measures dc and ac volts; dc and ac current; and resistance. The unit features a built-in audible tone generator that eliminates the need to look at the meter. Other features include a range lock control, comprehensive protection against acci-



idental overloads, auto-zeroing and auto-polarity. Test leads, built-in tilt stand, operating manual and a spare fuse are included. Optional accessories include probes, carrying case and an ac adapter for bench use.

The 2845 is priced at \$175.

Circle (49) on Reply Card

3½-digit bench multimeter

The model 4000 3½-digit multimeter from **Triplet** offers a wide angle LED digital display, single range selector switch, two input jacks, auto-zero and auto-polarity. Thirty-one ranges are available. The LEDs are 0.43-inch high and provide polarity and over-range indication. Pushbutton switches are used to select functions, and a single rotary switch provides simple range selection. Multiple fusing to 1000V on all ranges is provided. Insulated safety test leads with screw-on insulated alligator clips, combination carrying handle/bench stand and a 3-wire detachable long line cord are also included. Optional

accessories include miniature clip leads for high density circuits and a

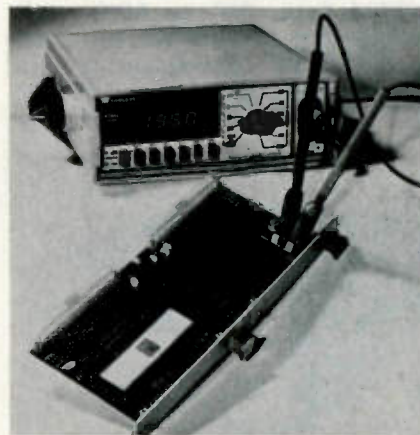

30A dc current shunt.

The model 4000 is priced at \$235.

Circle (50) on Reply Card

30MHz scope

Leader's LBO-515 scope has been upgraded in bandwidth from 25 to 30MHz, and a calibrated delay time function control has been added. The LBO-515B offers 5mV sensitivity in both sweep and X-Y display modes. Dual channel displays can be either chopped or alternated and the sum or differences of the two

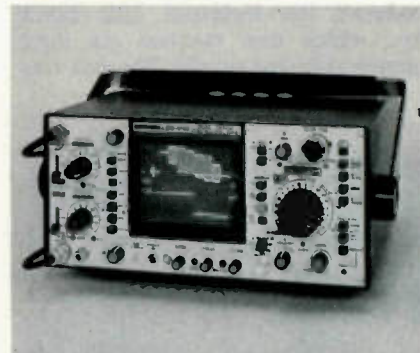

channels can also be displayed.

Trigger controls include selection of CH-1, CH-2 or external sources, AC or DC coupling, video frame or line sync filters, and + or - slope selection, and trigger hold-off control. Available accessories include a protective front cover, top-mounted probe pouch and special purpose probes.

The user price of the LBO-515B is \$1530.

Circle (51) on Reply Card

Multi-tester VOM

A. W. Sperry announces the introduction of its SP-250 multi-tester with temperature ranges. It incorporates full capability over 24 ranges in five functions. Safety features include fused ohm range, diode protected meter, full seating test lead plugs, heavy insulated test leads, and heavy walled plastic housings. Electrical features include double jeweled meter, printed circuit board, latest components, hefty switch construction, and push-button temperature calibration. The unit is powered by one penlight battery and one 15V transistor battery (included).

Circle (52) on Reply Card

DMM series

Hickok has introduced the MX Series of DMMS. The MX 331 and MX 333, both provide 0.1% basic accuracy, 10M Ω input impedance, and overload protection. The MX 333, features Vari-Pitch, a built-in audible signal that changes frequency proportionate to digital readings, and Logi-Trak, a self-contained logic testing capability that combines the features of a high performance logic probe and voltmeter in one convenient function.

The MX 331 is priced at \$179, and the MX333 is \$235.

Circle (53) on Reply Card

Ohms probe

The model 30 clamp-on ac voltmeter/ammeter from Triplet now has extended versatility with the model 32 ohms probe accessory. The plug-in probe permits fast in-the-field or lab continuity checks, resistance checks and checking open and shorted junctions of many semiconductor devices. The model 30 probe features thumbwheel zeroing and measures from 0-1000 Ω with 10 Ω center. It is overload protected up to 600V with a



$\frac{1}{4}$ A/600V fuse. The price of the probe is \$14, the model 30 is \$65.

Circle (54) on Reply Card

Temperature tester

The MTR4-A solid-state four-station temperature tester from Universal can receive inputs from four temperature sensors simultaneously. A slide switch is used to select the

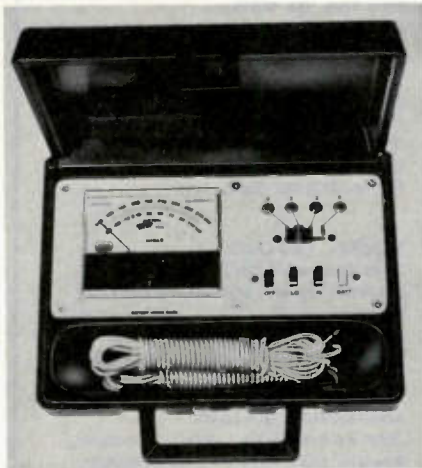

input from one sensor for display. The MTR4-A has dual temperature ranges of -50° to $+120^{\circ}$, $+120^{\circ}$, $+110^{\circ}$ to $+280^{\circ}$ F with 2° F scale increments. Accuracy of the MTR4-A is $\pm 2^{\circ}$ F.

Circle (55) on Reply Card

NATESA
5908 S.
Troy
Chicago
IL 60629



ARE YOU A PRO?

...the not for profit association championing independents' right to compete, and delivering valuable benefits continuously since 1950.

- LEADING SPOKESMAN
- TRADE INFORMATION DISPENSER
- WATCHDOG
- LOBBYIST
- YARDSTICK OF STANDARDS
- CONSUMER RELATIONS
- COUNSELOR
- PROBLEM SOLVER

We are not freeloaders. So our check for \$60.00 dues is attached. As our special premium, please ship the indicated \$15.00 Manual.

- Practical Business Manual
- OR -
 Service Contract Manual

Circle (11) on Reply Card

IT'S NO PUZZLE

TO ORDER

OELRICH SERVICE FORMS

FOR TV, RADIO & 2 WAY RADIO SERVICE LEGAL FORMS FOR CALIF., FLA., UTAH NOW AT YOUR PARTS JOBBER OR WRITE FOR CATALOG B64
OELRICH PUBLICATIONS
4040 N. NASHVILLE AVE. CHICAGO, ILLINOIS 60634

Circle (12) on Reply Card

To get more information...

on items advertised or described in this publication, use the Reader Service Card.

As a free service for our readers, we forward your inquiry to the product's manufacturer. Reader Service Card is pre-addressed.

themarketplace

Advertising rates in the Classified Section are 35 cents per word, each insertion, and must be accompanied by cash to insure publication.

Each initial or abbreviation counts a full word.

Minimum classified charge \$3.00.

For ads on which replies are sent to us for forwarding (blind ads), there is an additional charge of \$3.00 per insertion to cover department number, processing of replies, and mailing costs.

Classified columns are not open to advertising of any products regularly produced by manufacturers unless used and no longer owned by the manufacturer or distributor.

For Sale

AUTOMOBILE RADIO and tape replacement parts: Delco, Chrysler, Philco-Ford, Motorola, Panasonic and many others. Large inventory. Laran Electronics, Inc., 3768 Boston Road, Bronx, NY 10469, (212) 881-9600, out of New York State, (800) 223-8314. 5-79-tf

TV & RADIO TUBES, 36 cents EA! Free color catalog. Cornell, 4221 University, San Diego, California 92104. 8-78-tf

ELECTRONIC SURPLUS: CLOSEOUTS, LIQUIDATIONS! Parts, equipment stereo, industrial, educational. Amazing values! Fascinating items unavailable in stores or catalogs anywhere. Unusual FREE catalog. ETCO-011, Box 762, Plattsburgh, N.Y. 12901. 6-78-tf

TV RENTAL SYSTEMS! Complete & guaranteed. Manual or computerized. Send \$2.00 for complete details. Perry's rental systems, 133 Brenda Street, Milton, Florida 32570. 2-80-tfn

PRINTED CIRCUIT boards from your sketch or artwork. Affordable prices. Also fun kit projects. Free details DANOCINTHS INC. Dept. ES, Box 261, Westland, MI 48185. 5-80-8t

PICTURE TUBE REBUILDING EQUIPMENT capable of producing four high quality tubes per day (WILL TRAIN TO OPERATE) \$3600. Call or write Atoll Television, 6425 Irving Park, Chicago, Illinois 60634, ph. 312-545-6667. 8-80-3t

HEATHKIT SINE-SQUARE, Audio Generator, like new, model SG-5218-\$100.00. W. Olekas, 33650 Baldwin Rd., Solon, Ohio 44139 8-80-1t

ZENITH COLOR PATTERN generator, 852-130, \$65 (used 5X) Heathkit CRT testor IT-5230 \$80 (new case); Heathkit VTVM IM-11 \$25; Heathkit Condenser Testor C3 (no manual) \$15; Call 207-487-3058 8-80-1t

***SCRAMBLED TELEVISION**, encoding/decoding. New book, theory/circuits, \$9.95 plus \$1 shipping, Workshop, Box 393ES, Dept. B, Bethpage, N.Y. 11714* 7-80-tf

FOR SALE SENCORE CB49 analyzer never used complete with manual \$500.00 Lazaro Hoffman Flushing, New York 11365 8-80-1t

STROBE WARNING LIGHTS—PARTS, REPAIRS: R. Cecil, 805 South Penn, Roswell, New Mexico 88201. 8-80-2t

TELEPHONE CALLS recorded automatically, unattended, build yourself for less than \$10.00. Detailed plan \$2.50. Garrett Electronic, 6451-A Imperial Ave., San Diego, California 92114 8-80-6t

HELP WANTED

TELEVISION TECHNICIANS—Experience necessary, top pay, medical benefits, paid vacations. Enjoy a new "Life Style" in a beautiful, friendly, smog free, full service desert community. Send your resume to 225 E. Ridgecrest Blvd., Ridgecrest, California 93555. Telephone 714-375-1361 ask for Service Manager. 3-80-tfn

Business Opportunity

TV SALES AND SERVICE in sunny Florida. Same location over 20 years. \$20,000 firm. Interested apply only. Send letter to shop owner, 1516 South Jefferson Avenue., Clearwater, Fla. 33516 3-80-5t

TV TUNER REBUILDING COMPANY—Excellent business established 20 years same location, help run, can expand, other interests, sell for value of stock, fixtures and equipment, Miles, 4611 W. Jefferson Bl., Los Angeles, Calif. 90016 8-80-1t

TELEVISION SALES AND SERVICE business for sale, country setting in Massachusetts. Services four surrounding towns, includes inventory and equipment, annual gross \$45,000. For sale \$15,000. Electronic Servicing, P.O. Box 12901, Dept. 523, Overland Park, KS 66212. 8-80-1t

SAVE HUNDREDS: American Made quality Head-Ends, V/V, U/V Converters, Camera Modulators, Amplifiers for small CATV systems. Mid-band available. Factory prices. Send \$5.00 (or letterhead). Box 809, Boynton Beach, Fla. 33435. 8-80-tfn

Electronic Servicing

Advertising Sales Offices

NATIONAL SALES MANAGER
Greg Garrison, P.O. Box 12901,
Overland Park, KS 66212;
Phone: (913) 888-4864

NEW YORK, NEW YORK
Joe Concert, 4 West 58th St.,
New York, NY 10019;
Phone: (212) 888-1977

LOS ANGELES, CALIFORNIA
Herbert A. Schill
3055 Wilshire Blvd., Suite 350
Los Angeles, CA 90010
Phone (213) 387-0639

LONDON, ENGLAND
John Ashcraft & Co., 12 Bear St.,
Leicester Square, London, WC2H 7AS;
England;
Phone: 930-0525
Telex: 895-2387

AMSTERDAM, HOLLAND
John Ashcraft & Co., John J. Lucassen,
Akerdijk 150A, 1171 PV-Badhoevedorp
Holland;
Phone: 2968-6226

TOKYO, JAPAN
International Media Representatives, Ltd.,
2-29, Toranomon 1-chome, Minato-ku,
Tokyo 105, Japan;
Phone: 502-0656

advertisers' index

Creative Electronics	15
Enterprise Development Corp.	23
Gamit Enterprises, Inc.	23
General Electric Co.	IFC
Lakeside Industries	15
Lindgren RF Enclosures	7
NATESA	43
NESDA	41
Oelrich Publications	43
Ora Electronics	IBC
RCA Distributor & Special Products	13
Howard W. Sams & Co., Inc.	3
Thordarson Meissner, Inc.	1
Zenith Radio Corp.	BC

This year,
heart disease
and stroke
will kill another
200,000
Americans
before age 65.

Put your
money where
your Heart is.



American
Heart
Association

WE'RE FIGHTING FOR YOUR LIFE



ELECTRONICS

A DIVISION
OF ALLIANCE
RESEARCH CORPORATION

7241 CANBY AVE. • RESEDA, CALIFORNIA 91335

The Professional's Choice

Test equipment, prime grade original replacements, chemicals, tape heads . . . and MORE!

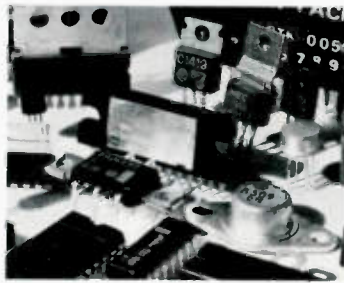

We feature only quality test equipment: Leader Instruments, Hitachi, Beckman, Hickok, and others.



Leader LB0515B



Hitachi V-302



Beckman 330



Hickok LX 304

SPECIAL OFFER

A top quality 30 Mhz, dual trace, triggered oscilloscope with 1 mV sensitivity and delay line.
FOR UNDER \$800.00! (including 2 probes)

Limited to professional technicians, engineers, and members of the trade. Call in for details and complete specifications.

SHIPPED THE SAME DAY • SHIPPED THE SAME DAY

SENDUST ALLOY HEADS

Metal tape compatible!

Standard configuration stereo:

\$13.50

Longer life.

Best frequency response.



AS-2



AS-3

SENDUST ALLOY
AUTO REVERSE
HEADS
\$20.00 ea.

TAPE HEADS

PERMALLOY HEADS
Cassette stereo
\$4.50



PERMALLOY
AUTO REVERSE
HEADS
\$7.00

HIGH QUALITY TEST CASSETTES



- PTC 1 Level Test (-10 dB)
- PTC 2 S/N Ratio (0 dB)
- PTC 3 Speed Test (3000 Hz)
- PTC 4 Head Alignment
- PTC 5 Frequency Response
- CT 120 Torque Meter

AIR CORE INDUCTOR

(for crossover network)

20 AWG Wire!

28 mH	1.60
5 mH	1.86
1.0 mH	2.75
1.8 mH	3.36
2.5 mH	4.35

CRYSTALS

1-11 **\$3.50 ea.**
12-up **\$3.00 ea.**
20 pF Load Impedance!

7.0025 MHz	11.3258 MHz
7.7975 MHz	11.2850 MHz
10.240 MHz	11.2842 MHz
10.695 MHz	11.240 MHz
11.1125 MHz	11.730 MHz
11.2858 MHz	36.570 MHz

ORIGINAL JAPANESE REPLACEMENT PARTS IN STOCK!

I.C.s — Prime Grade

These prices are for 1-11 qty!
Call for better price quotes.

AN 306	VCR Chroma	12.00
AN 318	VCR Servo	9.00
AN 7130	Power Amp.	3.00
AN 7150	Power Amp.	3.25
AN 7156N	BTL Amp	4.00
BA 1310	PLL Demod.	3.50
BA 1320	PLL MPX Demod.	3.50
DA 101	Deico DM98	7.00
HA1366W	Power Amp	2.80
HA1368	Power Amp	2.80
HA1377A	20 Watts Amp	4.90
HA1457	L.N. Preamp	1.80
LA1368	Chroma Processor	3.50
LA1460	Deflection CKT	4.50
LA3155	Equalizer	1.80
LA3160	Preamp	1.60
LA3201	Mini Preamp	1.50
LA4032P	3W Amp	2.25
LA4051P	2.5W Amp	2.50
LA4420	5.5W Amp	2.50
LA4430	4.5W Amp	2.85
LA5110	Regulator	2.00
LB1331	VIR Sig. Processor	6.50
MS3273	VCO for CB	1.00
MB3705	4.5W Amp	3.00
MB3712	5.0W Amp	3.85
MB3756	SIL Regulator	3.50
MB8719	Programmable PLL	7.50
S-40W	40W Amp	13.90
S-60W	60W Amp	17.90
S-100WA	100W Amp	27.90
S-200W	200W Amp	45.25
SM5104	PLL Circuit	9.00
STK0029	Darlington I-YB	6.00
STK0039	Darlington I-YB	7.10
STK0050	Darlington I-YB	8.90
STK011	Hybrid 6.5W Amp	4.50
STK013	Hybrid 15W Amp	13.50

I.C.s — Prime Grade

Continued

STK040	Dual 10W Amp	12.00
STK415	2 Ch Hybrid Amp	9.00
TA7109AP	Amplifier	5.00
TA7205AP	BTL Amp	2.50
TA7217AP	5.8W 4 ohms amp	4.25
TA7222P	5.8W Amp	3.80
TA7227P	BTL Amp	7.00
TA7312P	L.N. Preamp	2.00
TC9106P	C.B. PLL	7.00
UPC671C	Amp	5.00
UPC1181H	BTL Amp	3.50
UPD857C	Ham PLL	7.80
UPD858C	C.B. PLL	6.50
UPD2815	Freq. Synth.	12.50
UPD2816	Freq. Synth.	12.50

TRANSISTORS — Prime Grade

These prices are for 1-11 qty!

2SA509	.50
2SA606	1.45
2SA684	.60
2SA699A	.80
2SA912	.80
2SA912	.80
2SA917	1.80
2SA981	8.00
2SB471	2.00
2SB507	1.50
2SB555	4.60
2SB618	3.00
2SB681	5.75
2SB688	3.30
2SB700	4.00
2SB754	3.75
2SC281	.60
2SC937	8.50
2SC1111	5.20
2SC1209	1.50
2SC1964	3.00
2SC1942	4.50
2SC2001	.50
2SC2086	.60
2SC2101A	11.95
2SC2103A	15.00
2SC2166	2.00
2SD91	1.90
2SD425	3.50
2SD588	3.00
2SD712	1.20
2SD725	6.50
2SD870	7.50
2SD870	7.50
2SD903	6.50
MRF454	22.00
MRF455	15.95
MRF901	3.20

Plus more I.C.s at same low price. Ask for our quantity discount!

"Our Service Makes The Difference"

Free Catalog to the Trade. All Others \$1.00 ea.

PLUS MANY MORE!

Build your own speaker system!

CROSS OVER NETWORKS



4 ohms or 8 ohms — Made with AIR CORE COILS or FERRITE CORE. Many to choose from. Example: NT406H crossover network: 100 watts Input! 3 way, all air core construction for lowest distortion.

ONLY **\$9.00 ea.**

NON POLARIZED ELECTROLYTIC CAPACITORS

For crossover use (axial lead)



uF/V	1-11	uF/V	1-11
1/100	.50	14/100	.60
2.2/100	.50	16/100	.60
3.3/100	.55	22/100	.75
4.7/100	.55	33/100	.95
6.8/100	.55	47/100	1.20
8.0/100	.60	100/100	.65
10/100	.60	150/100	2.55
12/100	.60	200/100	3.00

We sell exclusively to professionals and members of the trade. Minimum order \$25.00. We pay shipping and insurance on pre-paid orders in the continental U.S.A. C.O.D. orders, VISA/MasterCard welcome!

TO ORDER, CALL TOLL-FREE:
(800) 423-5336 • In Calif. (800) 382-3663
Local (213) 705-0022 • Telex 181011

MORE IN IT FOR YOU THAN EVER BEFORE!



ZENITH

TRANSISTORS INTEGRATED CIRCUITS TRIPLERS RECTIFIERS

Zenith Universal Semiconductors

A unique,
one numbering system
of exact and selected
semiconductor
replacements.

ZENER
OP AMPS
DTL

TTL

HIGH POWER

SIGNAL

DARLINGTON

July 1980-81

**MORE CROSS-
REFERENCES!**

**MORE LINE
ITEMS!**

**MORE SUPPORT
DATA!**

More reasons than ever before for you to switch now to the biggest, broadest-ever line of Zenith Universal Semiconductors covering Zenith exact replacements...plus the most popular types in the industry! More triplers, more linear ICs, more digital ICs... more of everything than ever before, including profits. See for yourself!

Call your Zenith distributor now for your copy of Zenith's latest, greatest Universal Semiconductor cross-reference guide... and for info on his exciting promotions and pricing!



ZENITH

The quality goes in before the name goes on®

Zenith Radio Corporation / Service, Parts & Accessories Division / 11000 Seymour Avenue / Franklin Park, Illinois 60131

Circle (2) on Reply Card