

Electronic Servicing

***Protecting equipment
from transients***

Locating ac leakage

Horizontal sweep servicing



DE E6119772PE01A1 E7E3C3E2
EMIL J DE NAGEL
03 2376
BBOX 92A
IKON RIVER
MI 54847

ITEM NO.
WK-7

CMOS SAFE

IC INSERTION/EXTRACTION KIT

KIT INCLUDES

- MOS-1416 14-16 CMOS SAFE INSERTER
- MOS-2428 24-28 CMOS SAFE INSERTER
- MOS-40 36-40 CMOS SAFE INSERTER
- EX-1 14-16 EXTRACTOR
- EX-2 24-40 CMOS SAFE EXTRACTOR



OK MACHINE & TOOL CORPORATION
3455 CONNER ST., BRONX, N.Y. 10475 U.S.A.
PHONE (212) 994-6600 TELEX NO 125091



PRINTED IN U.S.A.

PATENT PENDING

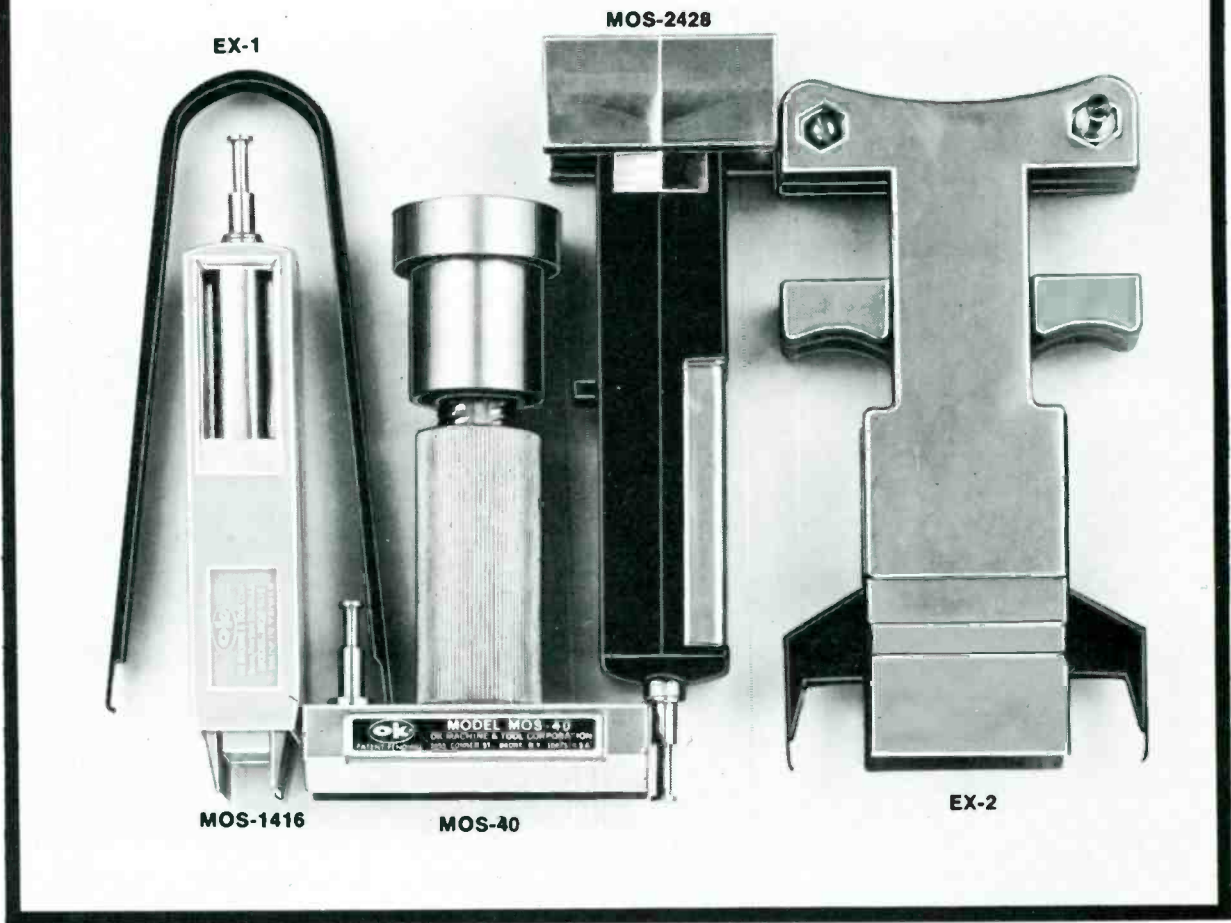

WK-7	COMPLETE IC INSERTER/EXTRACTOR KIT	\$29.95
------	------------------------------------	---------

INDIVIDUAL COMPONENTS

MOS-1416	14-16 PIN MOS CMOS SAFE INSERTER	\$ 7.95
MOS-2428	24-28 PIN MOS CMOS SAFE INSERTER	\$ 7.95
MOS-40	36-40 PIN MOS CMOS SAFE INSERTER	\$ 7.95
EX-1	14-16 PIN EXTRACTOR TOOL	\$ 1.49
EX-2	24-40 PIN CMOS SAFE EXTRACTOR TOOL	\$ 7.95

MINIMUM BILLING \$25.00. ADD SHIPPING CHARGE \$2.00. NEW YORK RESIDENTS ADD APPLICABLE TAX.

OK MACHINE & TOOL CORPORATION 3455 CONNER ST., BRONX, N.Y. 10475 (212) 994-6600/TELEX 125091

Circle (1) on Reply Card

Electronic Servicing

Editorial, advertising and circulation correspondence should be addressed to P.O. Box 12901, Overland Park, KS 66212 (a suburb of Kansas City, MO); (913) 888-4664.

EDITORIAL

Bill Rhodes, *Editorial Director*
Carl Babcoke, *Editor*
Mary Thornbrugh, *Associate Editor*

ART

Dudley Rose, *Art Director*
Linda S. Franzblau, *Graphic Designer*

CIRCULATION

John C. Arnst, *Director*
Evelyn Rogers, *Manager*

ADMINISTRATION

George H. Seferovich, *President*
George Laughead, *Publisher*

ADVERTISING

Greg Garrison, *National Sales Manager*
Pam Morris, *Production*

Regional advertising sales offices listed near Advertiser's Index.



Member,
American Business Press



Member,
Audit Bureau
of Circulation

ELECTRONIC SERVICING (USPS 462-050) (with which is combined PF Reporter) is published monthly by Intertec Publishing Corp., 9221 Quivira Road, Overland Park, KS 66212. Controlled Circulation Postage paid at Shawnee Mission, KS 66201. Send Form 3579 to P.O. Box 12901, Overland Park, KS 66212.

ELECTRONIC SERVICING is edited for technicians who repair home-entertainment electronic equipment (such as TV, radio, tape, stereo and record players) and for industrial technicians who repair defective production-line merchandise, test equipment, or industrial controls in factories.

Subscription prices to qualified subscribers: 1 year—\$12, 2 years—\$19, 3 years—\$24, in the USA and its possessions. All other foreign countries: 1 year—\$15, 2 years—\$25. Subscription prices to all others: 1 year—\$25, 2 years—\$50, in the USA and its possessions. All other foreign countries: 1 year—\$34, 2 years—\$68. Single copy price \$2.25; back copies \$3.00. Adjustment necessitated by subscription termination to single copy rate. Allow 6 to 8 weeks delivery for change of address. Allow 6 to 8 weeks for new subscriptions.



INTERTEC PUBLISHING CORP.

Sams has VCR's covered

New Photofact® Specialized Series brings you complete Service Data for . . . Videocassette Recorders. Service just like famous Photofact coverage of . . . TV, Home Radio, Auto Radio, and CB.



SERVING DATA FOR

SONY SL-7200.A

Everything you have come to expect from Photofact® is now yours for videocassette recorders. Helpful, reliable Photofact information. Full photo coverage for easy I.D. of all components and wiring. CurcuitTrace® testpoints and junctions. Standard notation schematics. Parts lists showing exact replacements. All mechanical and electrical adjustments. And more. Time saving information for servicing VCR's — today's growth product in electronics.

VCR-1 covers Sony videocassette recorders SL-7200 & SL-7200A. This 128 page volume is the first in the Photofact VCR Specialized Series. RCA, Zenith, JVC, Magnavox, Panasonic, and others will follow.

Videocassette recorders are moving. Your customers have them. And Photofact has them covered. Sign up with your Sams Photofact distributor for your VCR series today!



Howard W. Sams & Co., Inc.

a subsidiary of ITT

4300 West 62nd Street/Indianapolis, Indiana 46206

Coming in March

Electronic Servicing.

Multimeter roundup, featuring new multimeter models; and methods for troubleshooting CTC99 regulator and horizontal sweep circuits.

Maintenance

- 7 Preventing damage from transients**
By Carl Babcoke, CET
One method of protecting solid-state components against damage from line-voltage transients is to use metal-oxide varistors. The characteristics and field test methods of varistors are described.
- 15 Locating ac leakage in industrial plants**
By Christian H. Acard
A specialized clamp-type ac meter can measure line-current unbalance caused by leakage resistances. These potential shorts should be repaired before a major breakdown stops factory production.
- 20 A close look at digital signals, part 2**
By Forest Belt, CET
After digital signals are described fully, a method is given for scoping any digital signal.

Servicing

- 27 Understanding CTC99 horizontal sweep**
By Gill Grieshaber, CET
Circuit actions of horizontal-output, pincushion correction and overvoltage shutdown sections are clarified with schematics and many waveforms.
- 38 More Zenith TV repairs**
By Robert L. Goodman, CET
Additional typical failures in older solid-state Zenith color sets are described.

Departments

- | | |
|-------------------------|--------------------------|
| 3 Electronic Scanner | 41 Catalogs & Literature |
| 4 Letters to the Editor | 42 Product Report |
| 6 Symcure | 43 Test Equipment |
| 40 Troubleshooting Tips | |

About the cover

Photograph of lightning storm by Tom Small of the *Kankakee (IL) Daily Journal*. Transient protector photograph courtesy of General Electric. Graphic design by Linda Franzblau.

Attendance at the 1980 Winter Consumer Electronics Show set a new record of 58,626 people. The show was held January 5-8 in Las Vegas. Merchandise of about 750 exhibitors was featured, including many new-technology products for home entertainment. An image-enhancing film called *The Link Between Us...Electronics* was introduced. This EIA film is being distributed now to schools, industry, TV stations and movie theaters.

Almost 100 Kansas and Nebraska technicians attended an Electronic Technicians Association International (ETA-I) seminar recently at Central Technical Community College in Hastings, NE. ETA-I officials and other out-of-state observers participated. Subjects ranged from computer familiarization to certification exams. ETA-I address is 7046 Doris Drive, Indianapolis, IN 46224; phone (317) 241-7783.

Management seminars by National Electronic Service Dealers Association (NESDA) now are available throughout the United States. The first seminars will be held April 13 and April 18-20 in Nashville, TN. C. J. Rucker will lead these meetings. Associations wishing to schedule similar seminars should contact NESDA, 2708 Berry Street, Fort Worth, TX 76109; phone (817) 921-9061.

Employers can receive a substantial tax credit for hiring the handicapped, Vietnam veterans, disadvantaged and ex-offenders. The *Targeted Jobs Tax Credit* program allows each employer a reduction of tax liability. Write to the US Department of Labor for details.

Sales of monochrome TVs to dealers during 1979 were 3.1% higher than for 1978. However, comparable sales of color TVs were down by 3.8%, according to the EIA. All classes of radio sales declined, also. Home VCR tape unit sales increased by 18.3%, far less than earlier predictions. During 1979, sales of 9,846,487 color receivers were the second highest in history.

RCA recently manufactured its 100 millionth television picture tube, the first company in the world to do so. This record number includes all monochrome and color tubes RCA has produced since 1946. Another branch of RCA has made a firm (and costly) start toward mass production of SelectaVision video-disc players. Present specifications call for 12-inch discs that play one hour per side. The discs are stored inside plastic covers which prevent contamination. They are not touched by hands during insertion into the player, and are removed inside the cover after use. Pulse-code-modulation (PCM) video and sound signals are recorded as varying indentations on the record's surface. The capacitive sensor that reads these dents or pits is on the trailing side of the diamond-tipped stylus that rides in a continuous groove. No signals are handled by the groove, which is there only to move the sensor, keeping it centered over the indentations. The groove is metalized for durability. Both players and discs are promised by next December. RCA has licensed CBS to manufacture discs for the SelectaVision system. Of course, RCA's record division also will produce discs.

Sales of color TVs with remote controls were 20% of the 1979 sales, compared to 15% for 1978. A popular combination was remote control of a digitally produced electronic tuning system.

Lou E. Gatlin, Jr. of Ace Appliance, Memphis, TN, was elected president of NARDA at a recent convention. The address of the National Association of Retail Dealers of America is 2 North Riverside Plaza, Chicago, IL 60606; phone (312) 454-0944.

Digital multimeters and other types of test equipment soon may feature readouts in spoken language. The technique is now used in talking calculators and toys. Of course, spoken readouts will increase the cost of this equipment, but it will be valuable for visually handicapped technicians, or uses where visual readouts are not practical.

letters to the editor

To the Editor:

In my position as industrial engineer, I am aware of both electronics and technical writing. (Also, I have a first-class FCC license and repair TVs in my spare time.)

Without a doubt, the articles by Gill Grieshaber contain some of the best writing I have ever encountered. Keep up the good work.

Paul Philipps
Omaha, NE

To the Editor:

I was sorry to read in the December issue that Sam Wilson's Technical Notebook will no longer appear. Sam's feature was the perfect blend of business with pleasure. He has that rare technique of teaching you something you need to know without your realizing it.

I will miss Sam's Technical Notebook, and I am sure I speak for many of your readers.

Mike Badt, CET
Applications Engineer
Bell Laboratories
Whippany, NJ

Mr. Badt:

Sam Wilson stopped writing due to a lack of time. Perhaps your letter and others will induce him to write again. Thank you for your interest.

To the Editor:

Just a line to say that I enjoy **Electronic Servicing** very much, and I think it's the best trade magazine yet.

I especially enjoy articles on IF alignment, SYMCURE, and Troubleshooting Tips. I haven't noticed any Troubleshooting Tips since the July issue. Could we have some more of them? Thanks a million.

Hale's TV Repair
Modesto, CA

Hale's TV Repair:

Thank you for your suggestion. Troubleshooting Tips appears again in this issue, and will be in most of this year's issues.

To the Editor:

I read your publisher's note and endorsement of the Liason seminar held in November and was very interested. However, I was not able to attend.

May I suggest that videotapes (both VHS and Beta) be made available of the four-day sessions, along with manuals. Although I know that face-to-face teaching is best, those of us who cannot attend could gain something from this type of electronic seminar. I am most pleased with your magazine for it keeps me up to date with the new technology.

James Titsworth, Jr.
McLean, VA

Mr. Titsworth:

Although **Electronic Servicing** endorsed the Liason seminars as being beneficial to the industry, the company is independent. Your idea has merit, and it will be passed along to Liason.

To the Editor:

I liked the articles on waveforms in the July issue and found the information to be very useful in TV servicing.

The information given was of practical use in TV troubleshooting. Perhaps future articles could extend to waveforms in transistor horizontal output circuits.

In answer to Mr. Grieshaber's question on the differentiating circuit, there is a voltage gain. Other passive circuits such as voltage doublers and triplers also have voltage gain, but if he means, "Can an RC circuit amplify?" the answer is no. This always requires a source of external power.

Monty Huckle, CET
Tahoe City TV Service
Tahoe City, CA

To the Editor:

I have never taken the time to write to an editor before, but I must let you know how much I have enjoyed Gill Grieshaber's technical articles over the last several years.

The article, *A Second Look at Waveforms, Part 2*, in the July issue of **ES** was exceptionally well done.

Mr. Grieshaber's approach to circuit analysis through the understanding of voltage and current waveforms is extremely effective, giving the technician a grasp of circuit operation which is difficult to come by.

Harvey Weinstein
Great Northern Video
Concord, NH

To the Editor:

I just finished reading October's **ES**. The article on repairing old TVs was fantastic. Gill Grieshaber is right about older TVs having multiple defects. His article is really going to help me. I was wondering if I could have his address.

Miles Smorowski
Toledo, OH

Mr. Smorowski:

Gill will receive your letter, but does not want his address made public. His articles draw more letters than any other features in **ES**. I hope he will be able to help you.

To the Editor:

Presently, I am trying to repair an RCA CTC59 chassis that has no raster. One of your articles mentioned four back issues that explained the SCR-sweep system in depth. Can you send me those issues along with the bill?

I am very impressed with the fine quality of your articles.

William O'Neil
Bay City, MI

Mr. O'Neil:

Those articles were part of the CTC58 coverage and are found in the January, February, March and April, 1976 issues of **Electronic Servicing**. Those issues are available through University Microfilms International, 300 North Zebb Road, Ann Arbor, MI 48106.

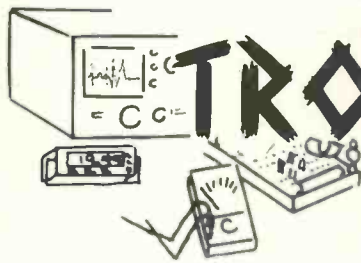

UNLOCK TROUBLESHOOTING SECRETS



Through this Treasure of servicing Know-How!

Chart your path with this introductory collection of REPRINTS from among the best servicing articles ever published.

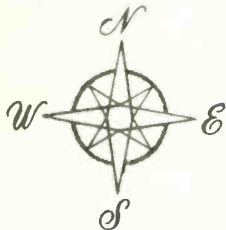

Employ today's TOP Authors as your Guides:

FOREST BELT, JACK DARR, WAYNE LEMONS,* CARL BABCOKE

...and other popular writers.



Valuable bargains in specific, timely, easy-to-remember, profitable training ...at less than \$2 a page.



Service Training REPRINTS

Each \$ 5.50 postpaid
15 - 24 5.25 each
25 or more 5.00 each
(Add 20% outside U.S.)

- | | |
|--|---|
| <input type="checkbox"/> AD-0001 Digital Principles for Communications - 1 | <input type="checkbox"/> AC-0001 Understand CB Transmitters the Easi-Way |
| <input type="checkbox"/> AD-0002 " " " " - 2 | <input type="checkbox"/> AC-0002 Understand CB Circuits the Easi-Way |
| <input type="checkbox"/> AD-0003 " " " " - 3 | <input type="checkbox"/> AC-0003 Understand Oscillators the Easi-Way |
| <input type="checkbox"/> AD-0004 " " " " - 4 | <input type="checkbox"/> AC-0004 Troubleshoot Citizens Band Receivers |
| <input type="checkbox"/> AD-0005 Digital Electronics in Video Cassette Recorders | <input type="checkbox"/> AC-0005 Modulation Limiting in CB |
| <input type="checkbox"/> AD-0006 Replacement Transistors—Do They Work? | <input type="checkbox"/> AC-0006 Mobile Installations in Custom Vans |
| <input type="checkbox"/> AV-0001 Troubleshoot Video IFs with Sweep - 1 | <input type="checkbox"/> AC-0007 How To Fix Small Transceivers - 1 |
| <input type="checkbox"/> AV-0002 " " " " " - 2 | <input type="checkbox"/> AC-0008 " " " " " - 2 |
| <input type="checkbox"/> AV-0003 Find Chroma Troubles with Sweep Generator | <input type="checkbox"/> AC-0009 " " " " " - 3 |
| <input type="checkbox"/> AV-0004 Really Understand Television Alignment | <input type="checkbox"/> AC-0010 Switching From CB to FM Two-Way |
| <input type="checkbox"/> AV-0005 Television Alignment Techniques - 1 | <input type="checkbox"/> AO-0001 Hints for Better Troubleshooting |
| <input type="checkbox"/> AV-0006 " " " " - 2 | <input type="checkbox"/> AO-0002 Installing Security Systems |
| <input type="checkbox"/> AV-0007 Television Chroma Alignment | <input type="checkbox"/> AO-0003 Testing Transistor Automobile Ignition |
| <input type="checkbox"/> AV-0008 Servicing Pulse-Derived B-Plus Supplies | <input type="checkbox"/> AO-0004 Creative Electronic Servicing |
| <input type="checkbox"/> AA-0001 Troubleshoot Direct-Coupled Audio Stages | <input type="checkbox"/> AT-0001 Which Scope—Recurrent or Triggered? |
| <input type="checkbox"/> AA-0002 Cassette Recorder Workshop - 1 | <input type="checkbox"/> AT-0002 Triggered Scopes Simplified |
| <input type="checkbox"/> AA-0003 " " " " - 2 | <input type="checkbox"/> AT-0003 Triggered Oscilloscopes for Color |
| <input type="checkbox"/> AA-0004 " " " " - 3 | <input type="checkbox"/> AT-0004 How To Use Triggered Scopes (programmed) |
| <input type="checkbox"/> AA-0005 " " " " - 4 | <input type="checkbox"/> AT-0005 Why Vectorscopes are Popular |
| <input type="checkbox"/> AA-0006 How Eight-Track Car Stereos Work | <input type="checkbox"/> AT-0006 Introduction to Vectorscopes - 1 and 2 |



HERE!

I have selected _____ Service Training REPRINTS, for which I enclose \$ _____ check or money order.

E5

Name _____ Age _____
Address _____ Phone _____
City _____ State _____ Zip Code _____

FREE...
Binder and Index Guides
with order of
\$200 or more

MAIL TO: Service Training GROUP, Post Office Box 47, West Newton, IN 46183

Chassis—Sylvania E20
PHOTOFACT—1595-1

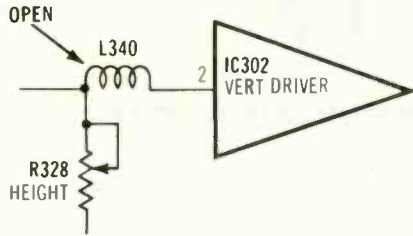

Symptom—No height
Cure—Check inductance L340, and replace it if open

Chassis—Sylvania E21
PHOTOFACT—1587-1

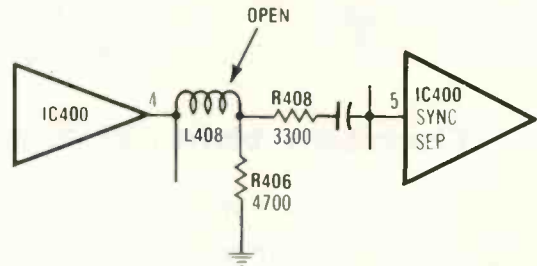

Symptom—No vertical or horizontal locking
Cure—Check coil L408, and replace it if open

Chassis—Sylvania E21
PHOTOFACT—1587-1

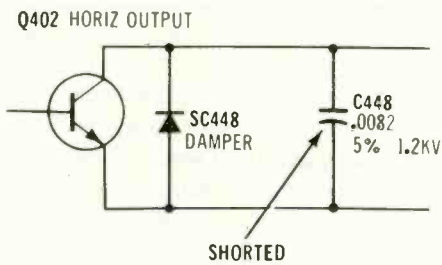

Symptom—Circuit breaker trips instantly, but output transistor, tripler and damper diode are good
Cure—Check critical capacitor C448, and replace it if shorted

Chassis—Sylvania E21
PHOTOFACT—1587-1

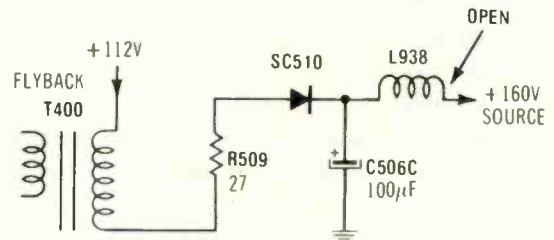

Symptom—Excessive brightness with blooming
Cure—Check coil L938, and replace it if open

Chassis—Sylvania E21
PHOTOFACT—1587-1

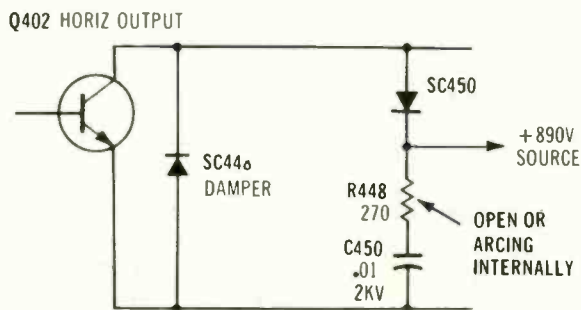

Symptom—Dim picture and color smearing
Cure—Check R448, and replace it if increased or open

Chassis—Sylvania D16
PHOTOFACT—1178-3

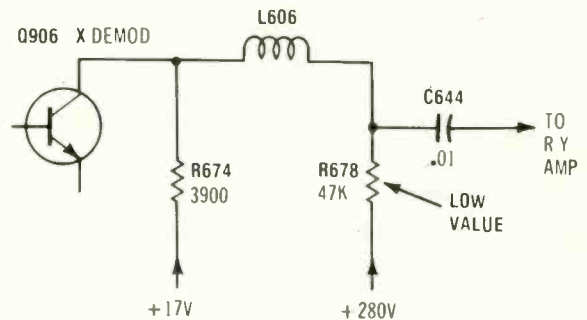

Symptom—Beat pattern in color, and interference is radiated to nearby TVs
Cure—Check demodulator resistor R678, and replace it if reduced value

Preventing damage from transients

Solid-state devices can be ruined easily by any large voltage transients that reach them. Inexpensive thyrectors are included in many late-model machines to hold the amplitude of line-voltage transients within the safety range. Several thyrectors are described, but most of the explanation is about metal-oxide varistors and how to test them.

By Carl Babcoke, CET

Short-duration voltage transients ranging from 100V to 2000V often ride on the 120Vac line-voltage power that operates TV sets, radios, computers and many other machines. These transients are directly responsible for many unexpected failures in all kinds of electric and electronic products.

There is no single typical transient voltage or waveform. Nearby

lightning strikes can produce pulses having thousands of volts across the ac wiring in homes. Other noise sources (such as a food mixer with a brush-type motor) might apply only a few volts of spikes that ride on the larger 60Hz sine waves. Transients can have almost any form or amplitude.

In general, lower-voltage transients occur more often, and higher-voltage ones happen less frequently. But a typical building might have

thousands of over-400V transients per year. A transient monitor in farm home recorded about 300 pulses of 300V, one 20kV pulse, and hundreds of pulses between those extremes. Probably the 20kV transient was caused by lightning striking near the overhead power lines.

A chart showing transient voltages and frequency of occurrences averaged 2kV at 10 pulses per year, while the US composite curve had about 2000 400V transients at the low end and one 5kV pulse at the high-voltage end per year.

Transient voltages of these magnitudes certainly could be responsible for the many failures of solid-state components (especially diodes, transistors, SCRs and triacs) *where no other defects or overloads can be found.*

Because of these facts, plus the practical repair experiences of the industry, it is recommended that all electronic equipment should be protected against line transients up to 2kV. Protection to higher voltages (say to 5kV) probably is not justified because the extra expense of protection would be higher than the cost of the few failures prevented.

Designers of industrial electronic equipment often specify diodes of twice the usual peak reverse-voltage ratings. This is one step in their efforts to stop repair expenses and production losses that occur because of damage from transient voltages on the ac lines.

Diode failures

When a high reverse-bias voltage is applied to a PN junction (in

Origins of transients

Many line-voltage transients are generated by these sources: switching on or off of large inductive loads; commutating pulses in power-conversion units; voltage arcs; lightning strikes; and many other sources not under control of the equipment user.

In addition to transient pulses that arrive on the power lines, other destructive spikes can be produced by normal operation of electronic circuits, or by circuit defects. For example, if a power-supply transformer is switched on at the tip of a positive peak, a pulse and damped oscillation (of double the line voltage) can be generated at the transformer's secondary.

Pulses of higher amplitudes are possible when the same transformer is switched off at a peak of magnetizing current. Amplitudes of 10 times the

normal steady-state voltage have been measured.

A surge from the blowing of an overloaded B+ fuse can apply a huge pulse and ringing to all diode rectifiers in the same circuit. Probably the voltage pulse damages more diodes than the current overload does.

Repetitive arcs and transients from switch-contact bounce can add together, increasing the heat rise of components and multiplying the failures.

Many technicians have noticed diodes that are reverse-voltage connected from B+ to ground. Perhaps some are zeners that regulate the voltage. But many others are installed to clip any negative-going transients (such as negative spikes or the negative peaks of ringing).

Transients that affect the life span of relays and solenoids will be discussed later in other articles.

Transients

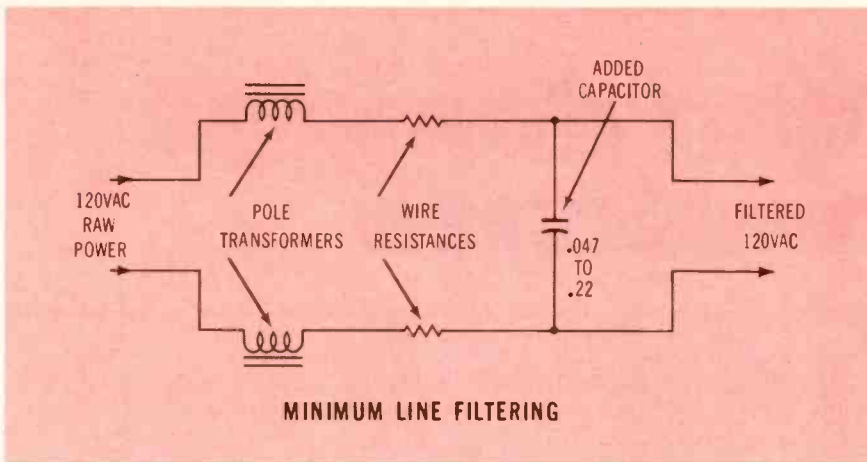

Figure 1 Adding a capacitor across the ac line minimizes some minor transients by forming an RCL-type of low-pass filter that integrates the pulses. The resistance and inductance sections of the filter are in the power wiring.

either a diode or transistor), an avalanche can take place at just one small point in the junction (because of field non-uniformity). And the resulting extreme heat ruins the junction, causing a short.

Because excessive internal heat is responsible for junction failures, the possibility of diode or transistor failure depends on these transient characteristics: *total amplitude of the pulse; whether positive or negative polarity; steepness of wave-shape; duration; and the time between individual transients.*

A pulse of long duration heats a transistor junction to a higher temperature than does another having the same amplitude but of shorter duration. One strong transient can destroy the operation of a transistor in just a few microseconds.

Transient voltages that rise or fall very rapidly can produce a kind of piling-up of voltage in sections of motor or power-transformer windings or other inductances. Turns of wire nearest the transient can arc or be overloaded while other turns farther away are not in danger. Many line transients are narrow pulses with steep sides.

Because line-voltage transients come in many unpredictable amplitudes, repetition rates and wave-shapes, it is difficult to find a single protection method that is effective against all transients. For example, a simple L/C filter that minimizes one type of transient might act as a

tuned circuit to multiply the amplitude of another kind.

Blocking filters

Many low-amplitude transient pulses can be reduced below the danger point by routing the ac power through low-pass R/C or L/C filters. The most simple filter is a capacitor connected in parallel with the line-voltage wires where they enter the chassis. Resistance of the power wires plus the inductances of pole transformers furnish the top leg of the filter (Figure 1), while the added capacitor completes the filter.

Cascaded sections of L/C filters reduce transient amplitudes even more, but they must be damped highly to prevent ringing.

Clamping the amplitude

Another method of minimizing harmful transients is to short-out (or partially short-out) any portion of the waveform which exceeds a certain amplitude.

Crowbar: A crowbar protective device senses harmful overvoltage or overcurrent and places a dead short across both signal and transient. This resulting massive short trips the circuit breaker or blows the protective fuse. Of course, the circuitry cannot operate until the overload is corrected and the protective device is reset. It is a drastic remedy, but one that is justified with computers or digital equip-

ment where a temporary cessation of operation is preferable to the wholesale destruction of ICs.

Clamping: Reduction of the higher amplitude portion of transients (by a resistance change that varies with the voltage) is called *clamping*. At the desired voltage, the clamping device draws little current (high resistance). A transient of about 120% or more of the steady-state voltage forces the clamp to draw a heavier current (low resistance) that reduces the transient by increased loading.

A spark gap is a simple type of shunt or clamp. Excessive voltage causes an arc across the gap, and the arc ionizes the air so considerable current can flow, thus reducing the voltage until the arc is extinguished. However, several microseconds must elapse before the current flow can become maximum, and the delay might allow the transient to reach a dangerous level before ionization occurs. Some follow-through current flows in the ionized path, often reducing the desired voltage or signal level.

Also, it is difficult to manufacture spark gaps having consistent breakover voltages, especially at lower voltages.

Neon bulbs are a specialized kind of spark gap, where neon (with its lower ionization point) replaces air. Limitations are the small current flow before bulb damage occurs, and the lower quenching voltage compared to the ionization voltage.

An old-fashioned antenna lightning arrester is an example of a spark gap. Many digital meters and picture-tube sockets have internal spark gaps to restrict maximum transient voltages.

One of the earliest true clamping products was made using reversed-bias selenium rectifiers. These are constructed similarly to selenium rectifiers, with the element deposited on large metal plates for better heat dissipation. Selenium transient suppressors did not clamp sharply, and had aging problems.

Zener diodes connected back-to-back (opposite polarities) clamp very well, having negligible leakage at the desired steady-state voltage, but changing to strong loading (low

resistance) for pulses of higher amplitudes. Zeners would be the best clamping device, except for thin junctions that place a low limit on the maximum current possible without excessive internal heating and damage.

Varistors: The term varistor comes from the two words *variable* resis-

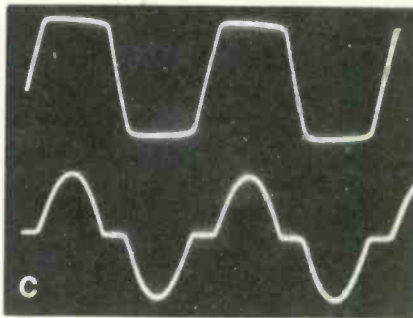
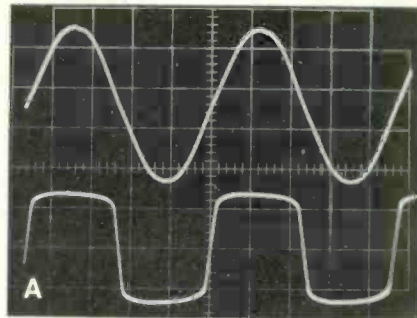
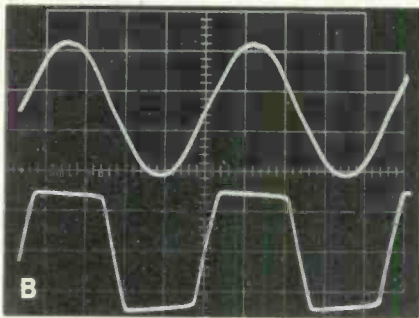

TESTING PROTECTIVE VARISTORS

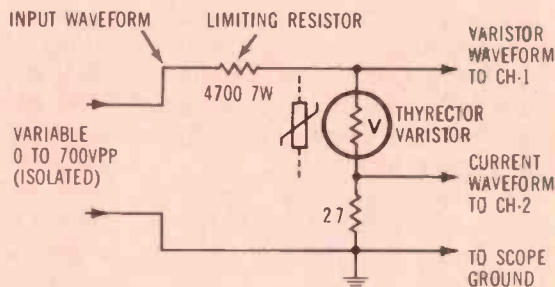
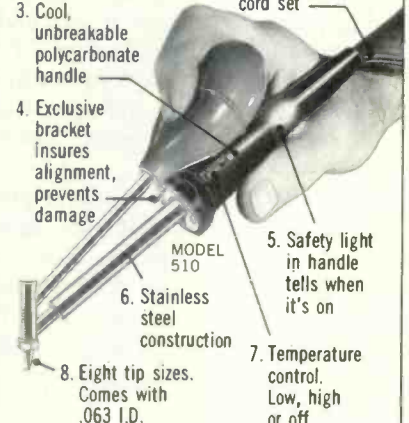

Figure 2 These waveforms show the voltage-clamping operation of metal-oxide varistors. (A) Top trace shows the 400VPP sine waves at the input of a 3300 Ω limiting resistor that was connected to a V33MA1B varistor. Across the varistor were 80VPP rounded square waves (lower trace). This includes both peaks, so transient clipping should begin at about 40V peak. About 200M Ω of varistor leakage was measured by a VTVM, while a digital capacitance meter read 229pF. (B) The same measurements were made for a V130LA20A varistor. Sharper corners were noticed on the 430VPP varistor waveform (this limiting resistor was 18K Ω). Leakage resistance was 90M Ω , and the capacitance tested 3,080pF (.0031 μ F). Notice the absence of any follow-through after current. The end-of-conduction voltage is only slightly lower than the voltage that started the conduction. (C) Top trace is the varistor voltage, and bottom trace shows the current waveform. Notice that current flows only at the sine wave tips. (D) Most transient-type varistors can be tested for clamping voltage level and current waveform by connecting scope and varistor as shown. Input voltage should be about two to three times the clamping voltage. An alternate industrial symbol is shown for the varistor. Notice that most newer scopes are grounded through their power cable, so be certain the test voltage is isolated from raw 120V. A good source is a variable-voltage transformer (Varlac or equivalent) feeding the primary of a tube-type power transformer, with the test voltage taken from the isolated step-up secondary of the power transformer.

9 reasons why the real pros prefer Endeco desoldering irons



1. Operates at 120v, 40w. Idles at 20w for longer tip life
2. Flexible, burn resistant Neoprene cord set
3. Cool, unbreakable polycarbonate handle
4. Exclusive bracket insures alignment, prevents damage
5. Safety light in handle tells when it's on
6. Stainless steel construction
7. Temperature control. Low, high or off.
8. Eight tip sizes. Comes with .063 I.D.
9. Converts to soldering iron with $\frac{1}{4}$ " shank type tip



See your distributor or write . . .

Enterprise Development Corp.

5127 E. 65th St. • Indianapolis IN 46220
PHONE (317) 251-1231

Circle (3) on Reply Card

NATESA
5908 S.
Troy
Chicago
IL 60629

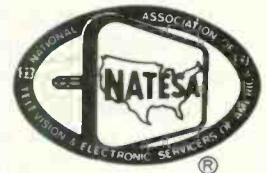

ARE YOU A PRO?

...the not for profit association championing independents' right to compete, and delivering valuable benefits continuously since 1950.

- LEADING SPOKESMAN
- TRADE INFORMATION DISPENSER
- WATCHDOG
- LOBBYIST
- YARDSTICK OF STANDARDS
- CONSUMER RELATIONS
- COUNSELOR
- PROBLEM SOLVER

We are not freeloaders. So our check for \$60.00 dues is attached. As our special premium, please ship the indicated \$15.00 Manual.

- Practical Business Manual
- OR -
 Service Contract Manual

Transients

tors. Until recently, the best varistor material for clamps was silicon carbide. The only limitation is the rounded knee of the curve (between conduction and non-conduction). If a silicon carbide varistor is designed for negligible leakage current at the desired working voltage, the resulting clamping voltage is too high to provide effective protection. If it is designed to give good protection by clamping transient voltages strongly, then it draws excessive power at the rated voltage.

A new family of transient-protection varistors is made of sintered metal oxides (usually zinc oxide with additives), and they provide a large change of resistance from nominal voltage changes (sharp knee on the conduction-versus-voltage curve).

These *metal-oxide varistors* can be manufactured in many different voltages and power ratings. The voltage rating is established by the varistor body thickness. The energy rating is determined by the total volume of material.

Current flows evenly through all areas of these varistors. There are no thin junctions or hot spots. This allows small varistors to have large dissipation ratings. Although similar in appearance to some ceramic capacitors, they are totally different inside. Instead of plates and dielectric elements, varistors have only one homogenous material in the body plus one connecting lead wire soldered to each flat side.

These varistors have capacitance which varies directly according to the area, and inversely with the thickness. Although the capacitance is usually no problem during the protection of power circuits, it is too high for some other circuits including RF stages.

Testing varistors

General Electric furnished three types of MOV-II varistors for examination in the **Electronic Servicing Test Lab**. During the testing procedures, several methods of determining the clamping voltage were developed.

If a metal-oxide varistor is checked for resistance with an ohmmeter, the reading of a normal component is in the high megohms,

and *there is no relationship between exact resistance and the clamping voltage* or other characteristics.

Varistors have no polarity, so the ohmmeter readings are the same regardless how they are connected to a meter. They also work equally well on positive peaks of ac (or positive dc voltages) as on negative ac peaks (or negative dc voltages). These facts must be kept in mind during all tests.

Of course, a shorted varistor is proof of a defect. When overloaded greatly, varistors sometimes explode. One operation at maximum rating sometimes ruins such a varistor, or many lesser conduction can cause failure after long periods of time.

Therefore, if transient protection is vital, the varistors should be tested about once each year for clamping at the rated voltage. Fortunately, a test for the approximate rating can be made easily.

Testing with ac and scope

Figure 2 shows how to connect a variable-voltage ac source and a scope to measure the approximate clamping voltage (the voltage where slight voltage increases produce huge current increases).

The clamping voltage for dc is slightly different than it is for ac voltages; however, this is not impor-

tant. A guard band between the working peak voltage and the clamping voltage always is provided, and a line-voltage increase of 10% does not increase the varistor current appreciably.

Measure in peak volts: Remember that *all line voltages and clamping voltages must be expressed in peak voltages*, which are identical to actual dc voltages and the dc-coupled scope calibrations.

In other words, assuming a sine waveform for the line voltage, the RMS value of each positive and negative peak must be multiplied by 1.414 to give the peak value. For 120V RMS, each peak measures 169.68V peak. Each peak is measured or calculated independently, because these varistors respond to each peak separately.

Figure 2B shows a peak-to-peak voltage of 430V for the clamped (clipped) lower trace. (Both peaks are shown, so peak-to-peak is the correct term.) However, this actually is the clamping of *each* peak at 215V peak. The guard band then is 215V minus 169V wide. No appreciable clamping occurs until the waveforms or transient spikes extend 46V or higher above the normal line voltage sine waves. One single-peak voltage at 135V RMS is

Varistor dc voltage and current

Voltage	Current	Resistance	Wattage
160V	.013Ma	12,300,000	.002W
169V	.017Ma	9,940,000	.0029W
180V	.041Ma	4,440,000	.0074W
190V	.25Ma	760,000	.047W
200V	2.5Ma	80,000	.5W
205V	15.8Ma	12,975	3.24W
206V	19.0Ma	10,842	3.9W
207V	24.0Ma	8,625	4.97W
208V	38.0Ma	5,475	7.9W

Table 1 Dc voltage was increased in steps through a 3300 Ω limiting resistor and a V130LA20A varistor, while the varistor voltage-drops and currents were measured with digital meters. As expected, the current increased rapidly when the varistor voltage approached the clamping level. The varistor became smoking hot at 208V, and the test was ended. (This varistor is rated at 50 joules for *one* large conduction, and is not intended for constant power dissipation.) Varistor resistances and wattages were calculated from voltages and currents.

190.9V peak. Therefore, line voltages up to 135V RMS can be accommodated before the peak voltages come uncomfortably near the 215V limit.

Similar calculations are required for other steady-state voltages. Of course, the manufacturers always list the recommended RMS sine-wave voltage in the varistor specifications.

DC clipping

One of the GE number V130LA20A MOV-II varistors was tested with manually varied dc voltages, and the results are listed in Table 1. The measurements were stopped at 208V dc because the steady-state wattage became excessive there. In fact, the varistor smoked and the coating became soft from the 8W of continuous power. These varistors are rated for transient operation, not steady-state conditions, so the scope method is recommended for practical tests in

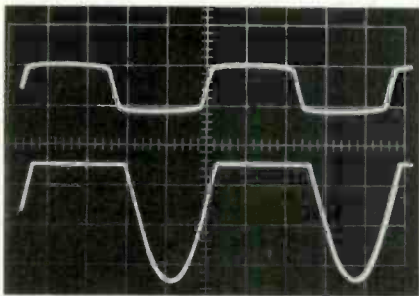

Figure 3 These waveforms illustrate two differences between varistors (top trace) and diodes (bottom trace). Varistor conduction is more gradual. Notice the rounded corners and slightly bulging peaks in the upper trace, compared to the sharp corners and flat clipping of the diode (lower trace). Secondly, a diode clips (conducts) at zero volts (actually, 0.7V on either side), so it removes one entire peak without changing the other (lower trace). By comparison, a varistor clips at a certain substantial voltage on both positive and negative sides of zero voltage. For example, one varistor type clips at +215V on the positive peak and at -215V on the negative peak (parts of both peaks are removed by clipping, as shown by the upper trace). *Diodes have polarity; varistors do not have polarity.*

the field. The table does illustrate the rapid change of current for small changes of voltage at the rated clamping point.

Zener versus varistor clamping

A comparison between diode and varistor clipping is shown in the Figure 3 waveforms. Previous tests have shown diode and zener clipping to be similar, except for the voltage differential. Therefore, the waveform clipping should be typical of zeners also. Tops and bottoms of the varistor waveform are not flat with sharp corners as are those with a zener. Therefore, the varistors have a broader knee in the curve, but one that is satisfactory for the application.

Capacitance effects

Figure 4 illustrates an extreme case of phase shift and amplitude reduction from the large internal capacitance of a varistor. Phase of the 60Hz signal was delayed about 1/8 cycle. A V130LA20A GE varistor was supplied with 60Hz voltage through a 1M resistor. With about 440V input to the resistor, the varistor voltage was about 210V. Part of the drop was from the varistor resistance (about 1.2M at that low voltage), while more loss came from the varistor's 0.003 μ F capacitance. The same capacitance was responsible for the lagging phase.

Smaller varistors have lower ca-

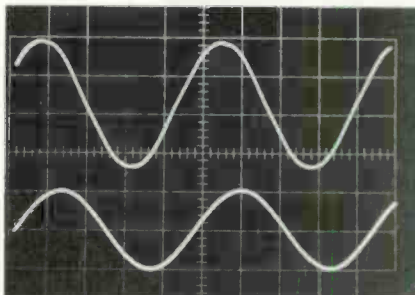

Figure 4 The large .0031 μ F capacitance of the 130V varistor gave a substantial phase delay when connected in series with a 1M resistor. Top trace shows the input waveform of 440VPP, and the 210VPP delayed voltage across the varistor is shown by the lower trace. This is a dual-trace simultaneous picture, so the phase is correct.

pacitance, but all have much more than normal resistors. Although the capacitance prevents these varistors from being used at RF, for example, it usually is an advantage when used in transient-clamping operation.

Operation with test transients

To verify the clipping of tran-

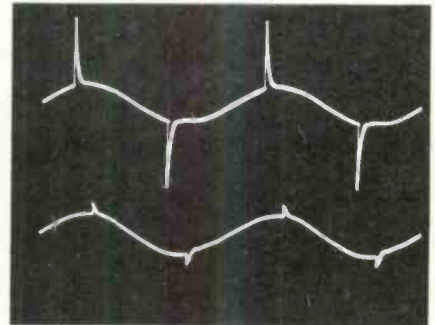

Figure 5 Clamping ability of the 130V RMS varistor was tested by adding large pulses to the line voltage. Top trace shows the 330VPP sine waves with a 680VPP positive pulse on each positive peak and a 680VPP negative pulse on each negative peak. After the varistor was connected, the pulses were clipped very well (lower trace).

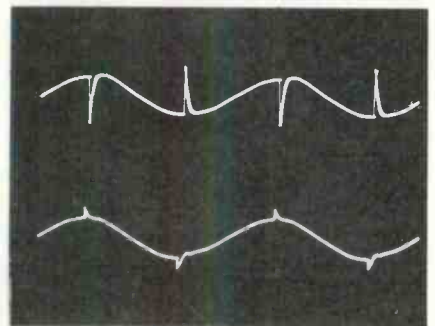

Figure 6 Pulses were not clipped unless they extended far enough beyond the sine wave. Top trace shows varistor clamping of sine waves having out-of-phase pulses. Although the pulse tips above the clamping level were removed, the total pulse amplitude was not reduced very much. When the same pulses were changed to in-phase (positive pulses to positive peaks and negative pulses to negative peaks), more of the amplitude was eliminated, as shown by the lower trace. There is a possibility that such incompletely clipped out-of-phase pulses might damage semiconductors. Perhaps filtering is needed in addition to clamping.

Transients

sients by metal-oxide varistors, a source of high-amplitude 60Hz pulses was connected to an isolated sample of 60Hz line voltage. Then waveforms were made both with and without the varistor, as shown in Figure 5. The individual positive and negative pulses of 680V peak were clipped just above the 330VPP sine wave, proving effective clamping at the correct voltage.

However, the question arose about clipping pulses that were *not extending beyond the peaks*. Figure 6 shows positive pulses on the negative peaks and negative pulses on the positive peaks.

As expected, the out-of-phase

pulses were not clipped unless the total pulse-plus-sine amplitude exceeded the clamping point. This might compromise the protection if these pulses then travel in the equipment beyond the point where the 60Hz waveform is removed.

Power transformers do not necessarily pass pulses according to the turns ratio. It is possible for the secondary to have equal or greater pulse amplitude than is present at the primary.

For these reasons, the use of both varistor and capacitance transient removal is recommended.

Capacitance filtering

In these simulated tests, both the varistor and the $0.47\mu\text{F}$ capacitor (Figure 7) reduced the pulse amplitude about the same. However, with real power systems having much lower impedances, the capacitor would reduce only the narrow high-repetition spikes. And a capacitor has very limited storage power. In actual practice, a varistor no doubt gives better protection than a capacitor alone does. But remember that many new TV receivers have both a transient-protection varistor and a bypass capacitor.

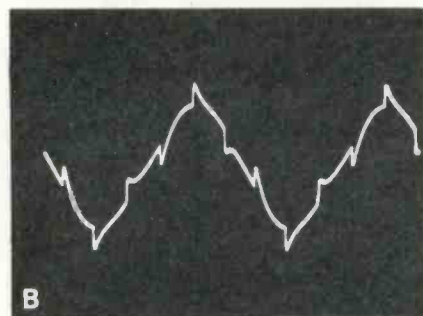
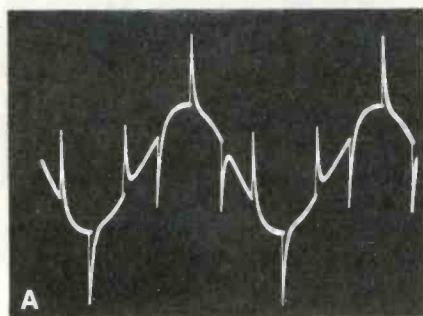

Figure 7 Third-harmonic pulses of 180Hz repetition rate were added to 60Hz sine waves to permit testing the effectiveness of removing the pulses by capacitive filtering. (A) This is the pulse/sine waveform without the added capacitor. (B) Connecting the $0.047\mu\text{F}$ capacitor across the line reduced the pulse heights very well. Notice that the pulses along the sine wave's slopes were reduced as much as those at the tips. Also, the pulses were widened (longer duration) as the filtering reduced the amplitude. This is the way pulse and spike integration operates. Total power of the pulses is the same before integration as after integration. Pulses are *not* "absorbed" as is stated sometimes.



Figure 8 This picture shows the type of metal-oxide varistor used most often for 120V operation in TV sets and industrial controls. When tested for resistance by VOMs and most digital multimeters, a good varistor should read above the highest range. However, a VTVM will show a capacitive kick and perhaps a $100\text{M}\Omega$ reading. But the *best* test is to measure the clamping voltage using ac voltage and a scope, as described before. Remember that a varistor minimizes transients by operating as an open circuit to amplitudes below the clamping voltage, or as a very low resistance to amplitudes above the clamping voltage.

Waveforms with the capacitor and without it are shown in Figure 7.

Summary

Any component resembling the one in Figure 8 that is in the power wiring, without any obvious function, probably is a transient-clamping varistor.

These varistors seldom fail in normal operation, except in localities where frequent strong transients are found. One or more huge transients or many smaller ones can ruin a varistor.

Therefore, all varistors should be tested periodically. The first and easiest test is to measure the resistance (while the varistor is disconnected from the circuit), preferably with a VTVM or FET analog meter having a high range with 10M in the center and a maximum of about 1000M . A shorted varistor obviously is defective. If the meter pointer gives a charging swing (as though testing a $0.01\mu\text{F}$ capacitor) and then slowly rises to above 100M , the varistor probably is normal.

A lead wire could come loose, or be burned loose by a huge transient. This type of open circuit should be found during the resistance tests. A varistor that has absorbed a large number of transients might become only partially effective, or might clamp at an excessive voltage which would not protect completely.

Protective varistors should not change in capacitance very much unless they become defective. Therefore, the capacitance should be tested when a varistor is installed. Capacitance tests made later then serve as an indication of detrimental changes. At the factory, new varistors are capacitance tested by an ac bridge having a 1MHz frequency. When tested by a digital-readout meter (such as the B&K-Precision used during these tests), the reading probably will be higher.

The most accurate field test for proper clamping is to apply sufficient 60Hz voltage through a limiting resistor to the varistor and measure the peak voltage between the clipped tops and bottoms, as shown in Figure 2. □

Locating ac leakage in industrial plants

Finding and repairing the source of minor current leakage can prevent more serious trouble later.

By Christian H. Acard, AEMC Corporation president

Insulation failure in electrical systems and equipment can lead to a number of unfortunate consequences. At the least, an undetected insulation failure that leads to gradually increasing ground fault current can result in an over-current situation that trips a circuit breaker, causing loss of production time and untimely maintenance procedures. At worst, such a condition may result in electrocution or fire.

Timely detection of leakage currents can isolate faulty equipment and allow maintenance to be performed before a breakdown occurs.

Detecting leakage currents

A clip-on current leakage detector provides a relatively simple and convenient method of detecting leakage currents by measuring the leakage current—that shunted to ground—caused by an insulation fault (Figure 1). It enables the operator to locate failures quickly, when or even before they occur without shutting down equipment or spending hours troubleshooting.

The unit is a clamp-on current transformer that is sensitive to ac currents passing through it. One

such device features two ranges: 300 mA and 3 A, full scale.

When a generator supplies an ac load through a pair of wires in an insulated cable, the current going out on one wire is equal to the current coming back on its return. Their sum equals zero. A ground fault changes this equality, and the leakage current detector picks it up, measures it, and indicates the severity of the fault causing the unbalance. But it can only give a reading other than zero if it does not enclose the ground conductor, as shown in Figure 1. It



Clamp-on probe encloses all current-bearing wires except a static ground, and the reading is obtained from the meter unit that's strapped to a wrist.

makes no difference whether the circuit is single- or 3-phase; 3 or 4-wire; balanced or unbalanced. The detector *sees* the leakage current to ground.

How to interpret measurement

A single-phase installation with a ground is shown schematically in Figure 2. The numbers indicate the amplitudes of the currents in the different conductors. Since this installation has no faults a detector clamped around the cables at points A, B, C, or D will read zero.

A fault in a motor, as shown in

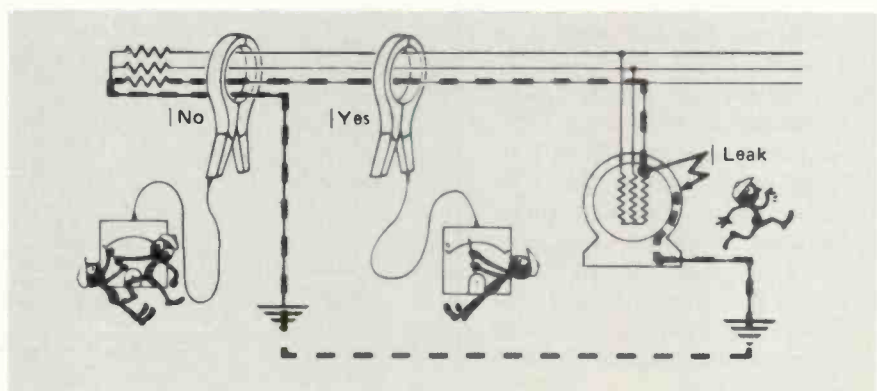

Figure 1 Clip-on ac current leakage detector measures leakage current caused by insulation fault.

Leakage

Importance of eliminating leakage currents

A severe short seldom occurs between power wiring and earth ground without the preliminary warning of a small leakage current that increases gradually over a period of time. If this warning is ignored, the leakage becomes worse and finally might injure or electrocute an employee, start a fire, or halt production while major repairs are made. By contrast, repairs to the wiring made during the stage when the leakage current is too small to trip an overload breaker usually are easy and inexpensive.

Formerly, the problem was to find these shorts before they became serious. The standard measurement in the industry is to employ a current meter which clamps around the insulation of a single wire and reads the current in amperes, sometimes hundreds of amperes.

However, a clamp meter usually can't measure small leakage currents. When placed around the hot wire that carries power to the load (and the wire with leakage to ground), the reading might be 900 milliamperes (0.9A) higher than when the clamp meter is measuring the return wire current. Unfortunately, a difference of less than 1A out of 239A is too small to be read with any accuracy.

Perhaps the best answer is a specialized clamp-on ac current-leakage detector, such as model 126.100 from AEMC Corporation. It has a 0.3A full-scale range and a 3A full-scale range. The low range permits leakage readings down to 0.030A. In most cases, it is not necessary to make any changes in plant wiring during these leakage measurements.

Figure 3, will cause a reading of 1 A at point A (the difference between 16 and 15 A), indicating that there is a fault downstream.

At point C, the detector reads zero. Therefore, the fault is not in the oven. At points B and D, it reads 1 A, showing that the fault is in the motor. If it gets worse, the leakage current will increase and the circuit breaker will trip. This motor must be disconnected immediately and repaired.

In a 3-phase installation (Figure 4A and 4B) the principle is the same. But here it is necessary to pass all active conductors through the detector, including the neutral if one is used. If this is done properly, the detector will read zero if there is no current leaking to ground. If it reads something other than zero, there is a ground fault that should be repaired.

troubleshooting at the incoming low-voltage distribution header, successively checking each feeder. If there is a ground fault, follow the feeder downstream, branch by branch, to the machine with the problem, as shown in Figure 5.

For preventive maintenance it is useful to take measurements to create a history of the quality of the insulation. If you detect a fault current that is very low initially but increases from day to day, this means that electrical failure is imminent and should be taken care of during the next planned maintenance shutdown.

For best results, center the conductors in the detector's clamp. Also, check that the edges of the jaws are perfectly clean and that they close tightly. Try to avoid placing the conductors near the gaps, and group them as much as possible.

Carelessness can affect the magnitude of the reading, depending on

Operating method

To locate a fault quickly, begin

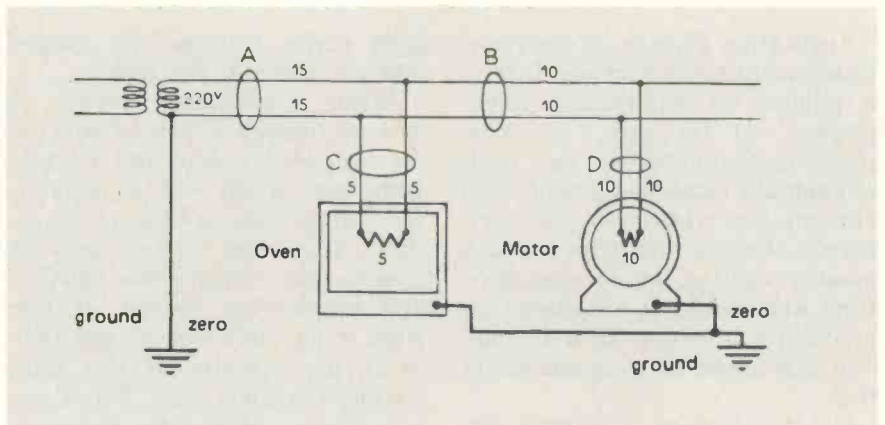

Figure 2 Zero reading of leakage detector indicates that there are no faults in this circuit.

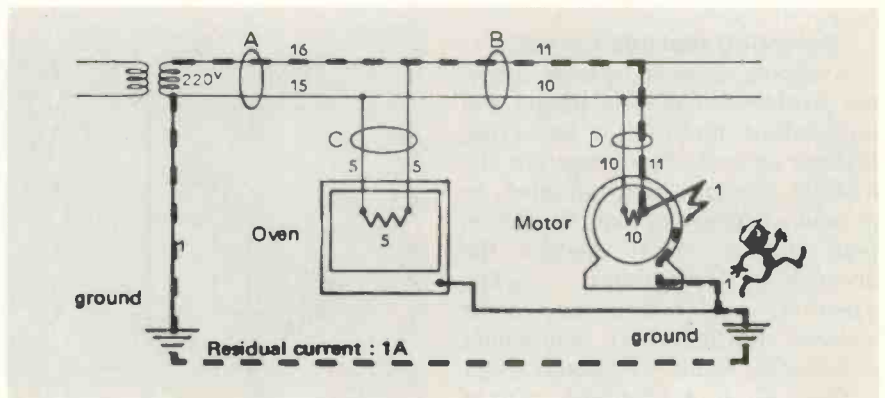
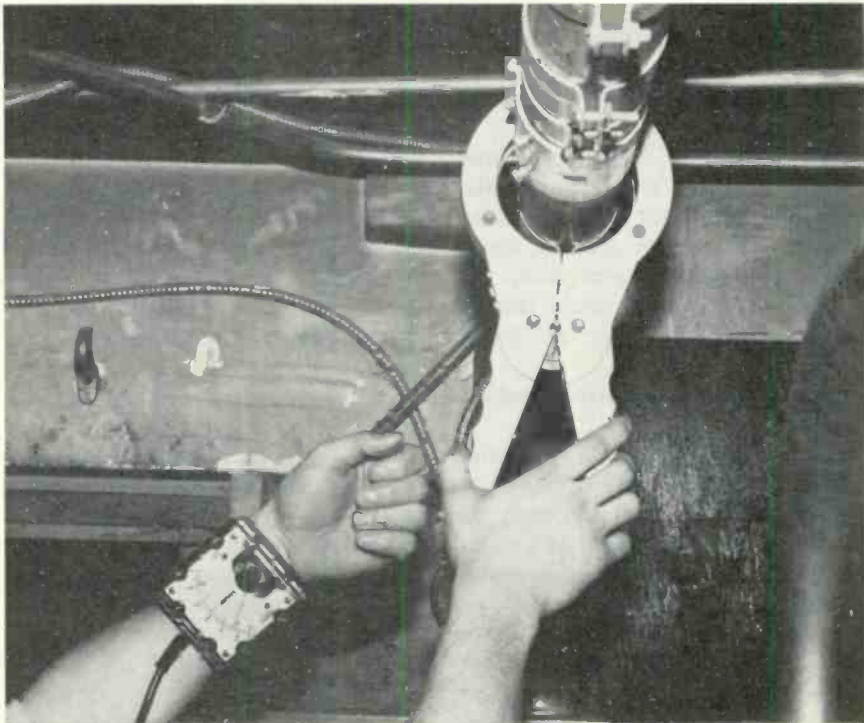

Figure 3 Readings of leakage detector at points A, B, C and D isolates fault to motor.



Current-leakage detector can measure fault currents even when the conductors are in conduit.

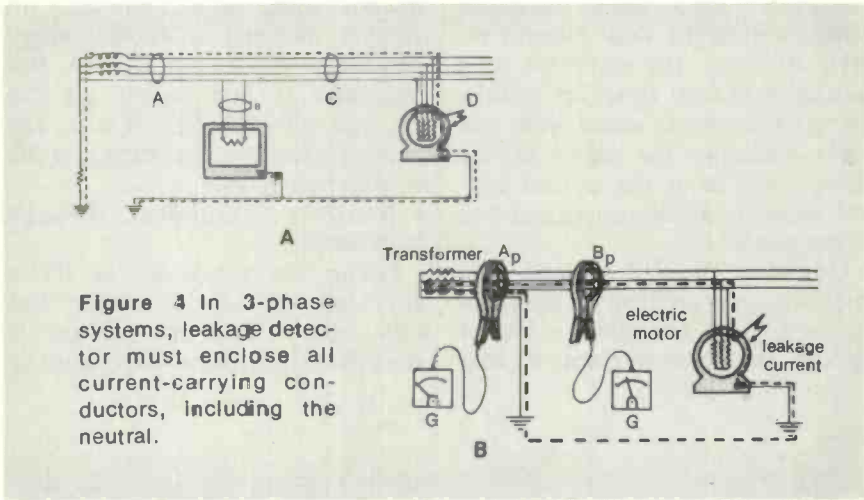

Figure 4 In 3-phase systems, leakage detector must enclose all current-carrying conductors, including the neutral.

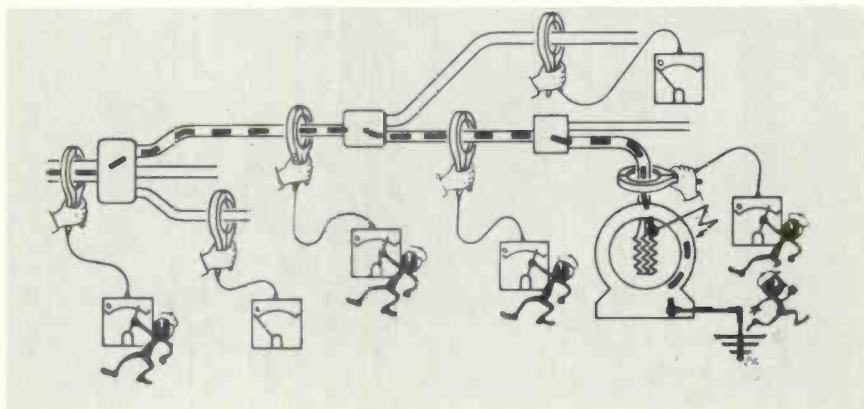

Figure 5 Fault location is isolated by following feeder branch-by-branch downstream.

APPLIANCE REPAIR BOOKS



Thirteen Handbooks written in easy-to-understand language by experts in the service field with illustrations and diagrams! Acclaimed by instructors and professionals alike! How to diagnose and repair air conditioners, refrigerators, washers, dryers, ranges, microwave ovens, dishwashers, vacuum cleaners, electrostatic air cleaners, RV gas appliances, hair dryers, motors, water heaters, coffeemakers, can openers, floor polishers, steam irons, food mixers, lawn care appliances, electric knives, electric and digital clocks and many others. Also fundamentals of solid state, setting up a shop, using test instruments and more Only \$2.65 to \$4.90 ea.

SEND FOR FREE PRICE LIST

Gamit, Dept. ES

110 W. St. Charles Road,
Lombard, Illinois 60148

Circle (4) on Reply Card

NATIONAL ELECTRONICS SERVICE DEALERS

Are you standing idly by while ideas that can be money in your pocket fly away? Membership in NESDA is one of those ideas.



WHAT DO YOU GET FROM NESDA?

1. Insurance
2. Special Bancard Rates
3. ServiceShop Magazine
4. Electronic Service Industry Yearbook
5. Service Industry Information
6. Legislative Programs with State and National Government
7. Advocate for Better Warranty Practices
8. Business Information



Don't let your bucks get lost in the shuffle.

Send in your check today.

On the bottom line it will mean extra \$\$\$ in your pocket.

JOIN NESDA

And Your State Association
Send for more information:
NESDA, 2708 W. Berry St.
Fort Worth, TX 76109



Leakage

the current carried in the conductors. In certain cases, this change requires an interpretation. It is important to remember that the absolute value of ground current is not important. All you need to know is whether or not the reading is zero.

Checking out various cables

Older installations have a wide variety of electrical distribution systems. Cables are clamped to walls and pass through metal conduits, and there are many cases where shielded cable is installed during revamping of an area or an addition to the building.

For cables clamped to walls, first detach the cable and pull it away from the surface at several points, so the clamp can surround the con-

ductors. Those locations become the test points where you will take periodic measurements.

• Cables enclosed in metal conduits not grounded

Cables enclosed in metal conduits not grounded are no problem—just apply the clamp around the conduit. It takes more than a metal tube to block the measurement.

Cable with a metal shield can be handled the same way as metal conduit.

• Cable enclosed in metal conduits grounded

Whether the shield or the conduit are grounded may or may not present a problem. It depends on the terminal connections, as well as the number and type of ground connections along the cable.

In Figure 6, the detector senses the fault because the shield is not connected to the motor frame and the leakage current cannot flow back through the detector.

In Figure 7, however, the instrument cannot see the fault because the shield is connected to the motor frame, letting the fault current return through the detector and causing it to read zero. Try to take the measurement where the shield is not enclosed by the clamp, such as at the nearest control panel or inside connecting box of the motor.

One way to get around this shielded cable problem is shown in Figure 8. Here, the shield is looped through the detector twice, so that

the reading will be that of the fault current.

Type of network

• Inspecting grounded neutral installations

It is easy to take measurements on this type of network, where major faults trip the circuit breaker. Here, the detector can sense minor faults, so repairs can be made before the problem gets worse.

The inspection method is the same for a single-phase. Just remember that on a 3-phase, the currents add accordingly to the vector sum law.

The detector measures the vector sum of the enclosed currents. If you have, for example, a 400 mA fault and a 250 mA fault on the same phase, you will read 650 mA. But if the two faults are on different phases, they add vectorially and may even sum to zero.

Suppose you have two faults, as in Figure 9: 400 mA on a machine in one shop and 250 mA on another machine in another shop. The vector sum is not 650 mA, but 350 mA. If you switch off the machine with the 250 mA fault, the reading increases, indicating faults on different phases.

• Neutrals grounded through impedance

Follow the procedure as for a grounded neutral installation but with care. When the neutral is grounded through an impedance, a

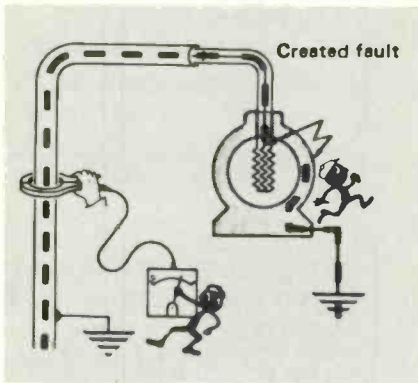

Figure 6 Where shield is not connected to motor frame, fault current can be detected by clamping instrument around shielded conductors.

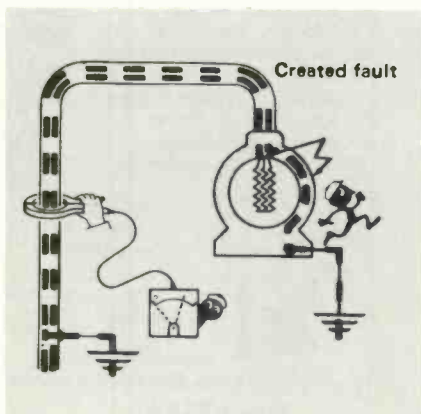

Figure 7 If shield is connected to motor frame, reading should be taken at a point where shield is not enclosed by instrument clamp.

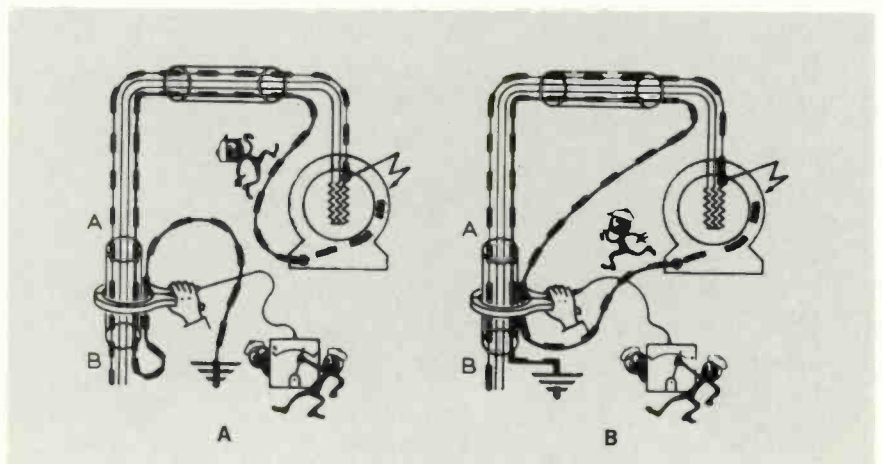

Figure 8 Another way to use the detector on shielded cable is to loop the shield twice through the detector's clamp.

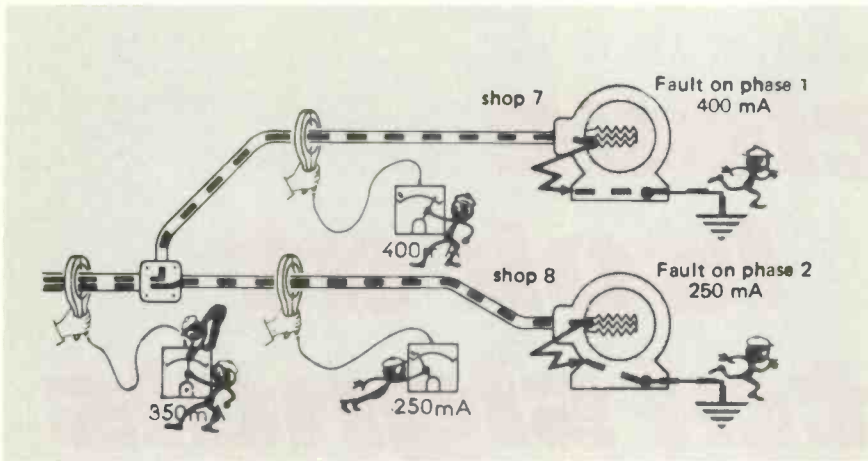

Figure 9 On 3-phase systems faults add vectorially, reading may be misleading.

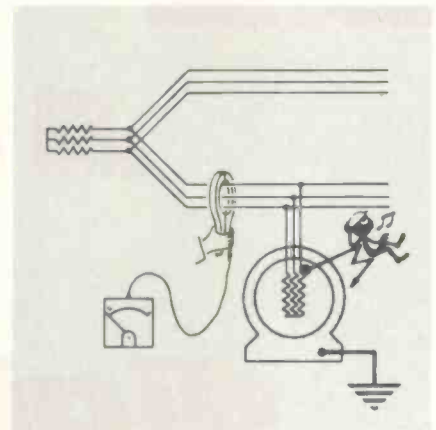

Figure 10 On insulated-neutral systems use of leakage detector may require special techniques.

fault—even a serious one—may not trip the circuit breaker, and thus allow the shop to keep operating.

• **Insulated neutral installations**

The instrument does not work (see Figure 10) but the *trick* is to

treat the insulated-neutral installation as an *impedance* neutral during troubleshooting. A temporary artificial neutral can be made with three equal impedances and ground it.

Certain precautions must be

taken to avoid accidents. Be sure to select impedance high enough so that the first true fault does not produce an excessively high leakage current which could raise the ground potentials to a dangerous level. □

Electronic Servicing is Available in MICROFORM

FOR INFORMATION
WRITE:

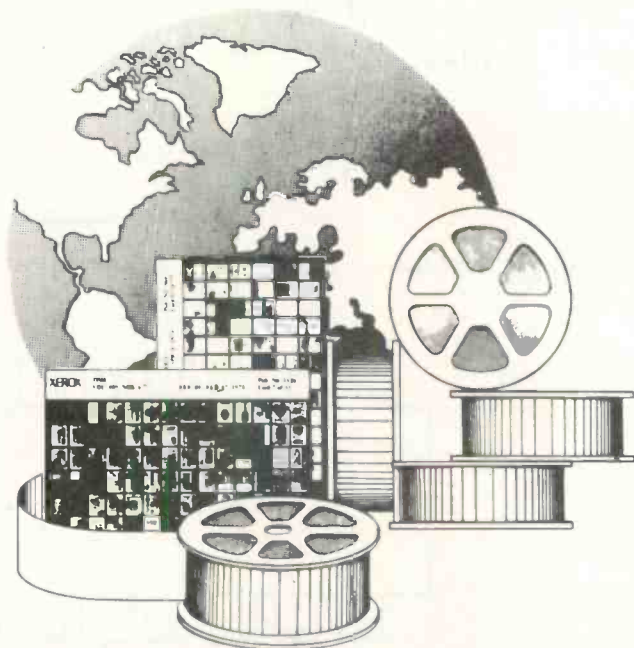

University Microfilms International

300 North Zeeb Road
Ann Arbor, Mich. 48106
U.S.A.

18 Bedford Row
London, WC1R 4EJ
England

A close look at digital signals

By Forest Belt

Scope time-base requirements, the makeup of pulses, a method of measuring repetition rate, and 10 basic steps for scoping any digital signal are subjects covered in this continuation.

The first article of this digital signals series covered the fundamentals of viewing digital signals with a triggered scope. This groundwork included a detailed description of digital signals, both steady-state, and those with fast sequences of logic-high and logic-low signals. The difference in logic levels for TTL and CMOS devices, and the meaning of positive logic were explained. The concept of timing as it applies to digital signals was also explained.

The vital importance of using a scope's dc input mode should now be clear. (Remember, with dc coupling, zero volts always remain at the same position regardless of duty cycle. If ac is used, the waveforms move up and down, which ruins the measurements.)

Question answered

Last month, the question was asked: What time base setting should be used while measuring dc voltages?

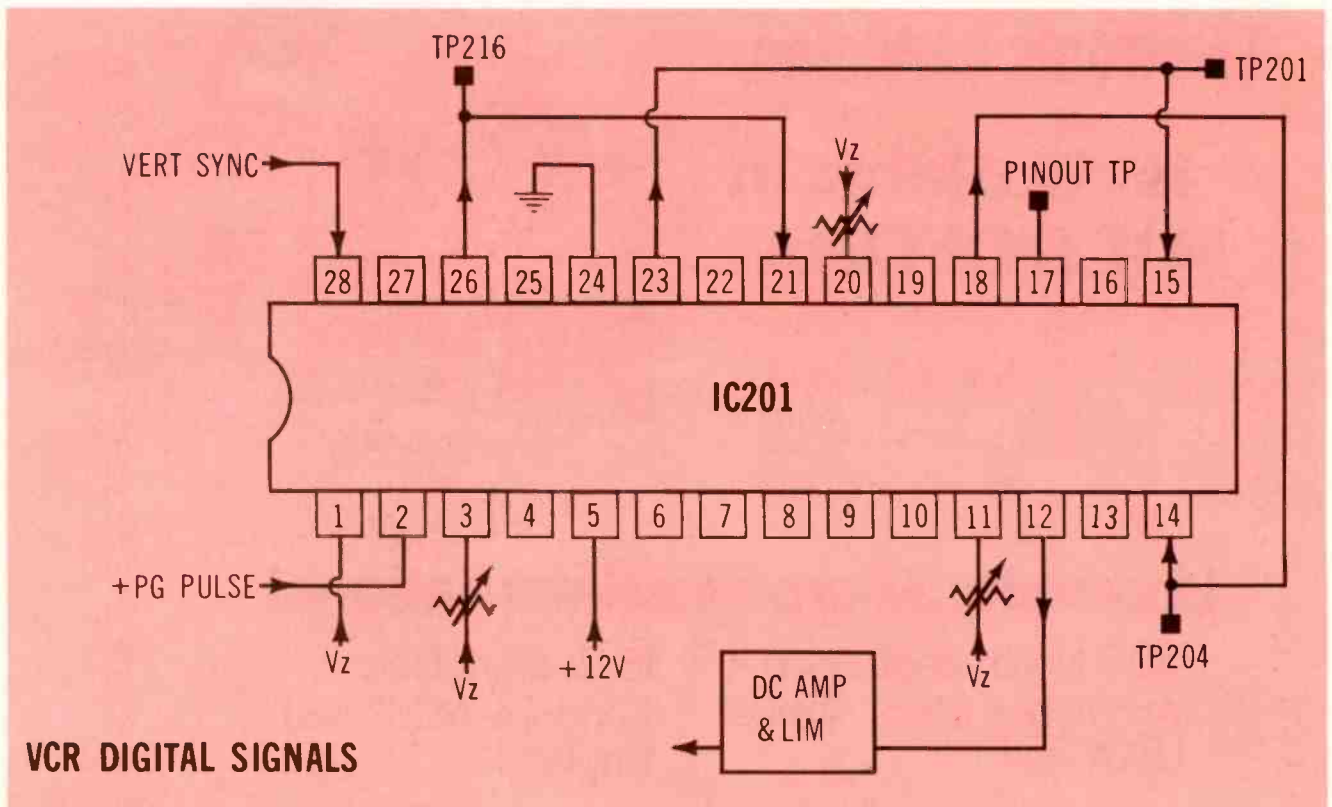

Figure 1 This section of a videocassette tape recorder circuit is used as a source of dc digital signals.

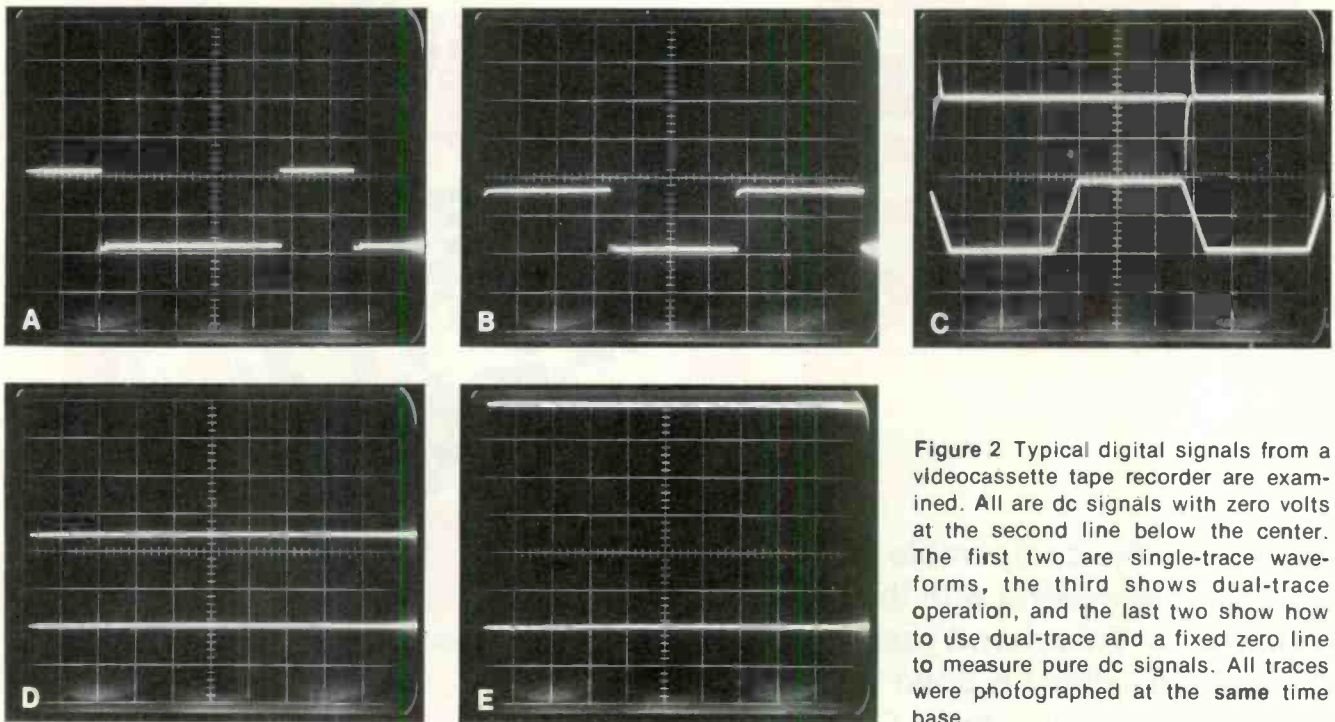

Figure 2 Typical digital signals from a videocassette tape recorder are examined. All are dc signals with zero volts at the second line below the center. The first two are single-trace waveforms, the third shows dual-trace operation, and the last two show how to use dual-trace and a fixed zero line to measure pure dc signals. All traces were photographed at the same time base.

A common answer to the question might be that it doesn't matter about the time base, because the scope is operating on automatic triggering. Although that answer is correct for some conditions, it is not complete.

First, it must be understood that the time base does not affect the dc readings. Any time base fast enough to produce a non-flickering trace will be fine. Slower sweep speeds (longer time bases) also work, but trace flicker can confuse any interpretation. Generally, a time base of 1mS/div or shorter is satisfactory.

However, there is a practical reason for being more specific about the particular time base that is chosen. The reason is to save time. How? Keep the time/div switch set to whatever time base is used for the digital signals to be examined.

Time base and triggering

Assume that digital operation in certain control circuits of a videocassette recorder (VCR) is being tested. A simplified portion of the circuit is shown in Figure 1. Several key waveforms, shown in Figure 2, have been photographed from this circuit.

The significance of the waveforms in Figure 2A, Figure 2B and Figure

2C is that all were photographed while the scope's time base remained at one setting—5mS/div. Some have pulse widths around 16mS, and others nearly 35mS. For this discussion, their exact timing is not important. But it's vital to understand that all signals in this entire section of digital circuitry can be scoped *without one change* of the time/div switch.

Notice also that the zero-voltage base line stays at the same position for all these waveforms, regardless of their amplitude or time duration. That's because *the scope is operated in its dc input mode*. Incorrect dc levels of the signals can be spotted easily. Also, the scope is ready to check pure dc-voltage signals when needed.

Pins 1, 3, 12 and 20 of IC201 have meaningful dc voltages, while the Vcc voltage enters at pin 5. During troubleshooting, touch the scope probe to all these key points in sequence.

Figure 2D illustrates how the dc voltage at pin 12 should be measured. This voltage happens to be the control signal (a dc signal) that determines the frequency of a monostable multivibrator inside IC202. A vertical sensitivity of 2V/div was selected to provide a reasonable deflection of the trace.

Another shortcut for dc voltages (without waveforms) is shown in Figure 2D. Dc coupling is chosen for both channels along with chopped dual-trace mode. With channel B's probe grounded, its trace is positioned to mark the zero-voltage reference line (lower line), while dc measurements are made with the channel A trace. Both zero and dc-voltage traces appear simultaneously, allowing easier reading of the graticule markings. (Preset the two traces by grounding each probe and adjusting both vertical positioning knobs so both traces are covering the same graticule line chosen for zero volts. Then connect the channel A probe to the unknown dc voltage and read the voltage by the number of divisions between the two lines.)

There is no need to change the time base setting for this measurement. So the scope's time base was left at 5mS/div, where it was during viewing of the digital signals. This technique is effective with almost any digital system. *For dc tests, leave the time base wherever it is most convenient for other signals.*

IC201 pin 5 brings Vcc into the IC (Figure 2E waveform). Dual-trace scope mode shows the zero base line and the voltage trace itself. Because the input attenuator

RCA's 1980 SK Guide puts Sylvania ECG* in its place.

You'll find the comparable ECG number right along with the SK number for the second year in a row in RCA's new SK Solid State Replacement Guide.



This is it...

Digital signals

still is at 2V/div, the six divisions between traces indicate +12V at the Vcc pin.

All voltages and waveforms are referenced to chassis ground, where the scope ground lead is attached. IC201 pin 24 is shown as grounded. When the scope probe is touched there, the reading should stay at zero.

Experienced professional technicians use these handy techniques regularly. They are great time-savers.

Another frequently asked question is: If the scope is on automatic triggering for dc measurements (to show traces), don't you change to normal triggering for other signals that are not steady-state? Usually, this is not necessary. When input waveforms are strong enough, they override the automatic triggering. Perhaps the trigger level will require resetting, but that's true even with normal triggering. Of course, some scopes are different. Check the scope's operating manual for details.

Many scopes give better stability when showing pulses of short duty cycle if the normal-triggering mode is selected. Merely pushing one button (or moving one control) changes back to automatic; you do not have to alter the time base.

Troubleshooting can be done in less time when unnecessary steps are skipped, such as reconnection of test leads or extra switch adjustments.

For most digital troubleshooting, set triggering to begin on the upgoing slope of the waveforms. In other words, use positive (+) trigger polarity or slope. That way, *the waveform starts with a logic high*. This is true also with emitter-coupled logic (ECL) devices that have the low condition at -1.65V and the high state at -0.81V. Even there, the high is in the positive direction.

Pulse timing and repetition

A digital pulse is said to recur or repeat each time its voltage or condition goes high. The excursion

from zero or logic-low to logic-high marks the beginning of any pulse. This is the *rising edge* or *leading edge* of a pulse.

A pulse ends when the voltage forming it drops from logic-high to logic-low. On the scope display, this ending of a pulse is the *falling edge*. Since it comes later in time than the leading edge, the plunge from high to low often goes by the name *trailing edge*.

Both edges are vital to pulse timing. Duration of a pulse, generally called *pulse width*, refers to the time the digital signal remains high. Timing of pulse width begins with the leading edge and end at the trailing edge. Measure it along the X-axis of the oscilloscope graticule.

Figure 3A shows one example. It looks like a square wave, but it is not. It is a digital signal with 50% duty cycle (high the same amount of time as it is low).

Signals like these can be duplicated by using a variable-pulse generator. A VIZ model WR-549A

one SK book - all you need to fill your solid state replacement needs.

- DUAL NUMBERING SYSTEM
e.g. SK3444/123A
- EVERYTHING UNDER ONE COVER
- PUBLISHED EARLIER THAN EVER
- 1,080 SK AND KH TYPES REPLACE
MORE THAN 161,000 DOMESTIC
AND FOREIGN TYPES
- MAKE MRO REPLACEMENTS RIGHT
FROM YOUR SHELF

RCA SK's are all manufactured by RCA's Solid State Division or by reputable original solid state device manufacturers. This means built-in quality and fewer costly call-backs for you. Your profit picture gets brighter and brighter with RCA SK's . . . transistors, rectifiers, thyristors, integrated circuits and high-voltage triplers.

See your RCA SK distributor for a copy of the 1980 RCA SK Replacement Guide, SPG 202Y or send your request with check or money order for \$1.50 to RCA Distributor and Special Products, P.O. Box 597, Woodbury, N.J. 08096.

RCA SK Replacement
Solid State

*ECG is a trademark of GTE Sylvania

was used in the preparation of this article. Its specifications and how to use it were detailed on page 11 and 12 in the January, 1980 **Electronic Servicing**.

For Figure 3A, the time base has been set at $20\mu\text{S}/\text{div}$. Positive triggering starts the display on the upslope or leading edge of one pulse, and horizontal positioning places the start of the trace at the left side of the graticule. Vertical positioning has situated the zero-voltage reference two lines below the Y-axis center.

One pulse, from leading edge to trailing edge, occupies three graticule divisions along the X-axis. At $20\mu\text{S}/\text{div}$, width or duration of this pulse measures $60\mu\text{S}$. Logic-low time is the same—three X-axis divisions—measuring another $60\mu\text{S}$.

One complete cycle, from leading edge of one pulse to leading edge of the next, amounts to $120\mu\text{S}$. That's the duration of one cycle in this digital pulse sequence. This is sometimes called one *period* in a pulse series.

Technicians more often use the term *repetition time* to describe the duration of one high plus one low in a pulse train. Origin of the term is that a new pulse *repeats* or recurs every $120\mu\text{S}$ in this instance.

Figure 3B illustrates a different pulse width. The logic-high condition now lasts only $20\mu\text{S}$ —one graticule division with the scope's time base at $20\mu\text{S}/\text{div}$. Interestingly, *repetition time* has not changed at all. Pulse width or time has been shortened, but duration of the logic-low condition has been lengthened. The signal stays logic-high for $20\mu\text{S}$, and then logic-low for $100\mu\text{S}$ (five divisions). The first leading edge lines up with the left edge of the graticule; the next leading edge occurs six divisions, or $120\mu\text{S}$, later. Repetition time, therefore, continues to be $120\mu\text{S}$, despite the change in pulse width.

Figure 3C shows how the pulse train would look if logic-high time had been reduced from $60\mu\text{S}$ to $20\mu\text{S}$ and the logic-low time left at $60\mu\text{S}$. Notice the change in repeti-

tion time. The leading edges (the starts of the pulses) occur four divisions apart in Figure 3C. Hence, $80\mu\text{S}$ is repetition time for this particular digital-pulse signal.

Repetition rate versus time

It is necessary to be familiar with three essential factors of digital-signal timing. They are: (1) *pulse width*, the duration of a logic-high condition; (2) *pulse separation*, the time duration of the logic-low condition; and (3) *repetition time*, which is the time between recurrence of leading edges in a repetitive series of like pulses.

In describing a repetitive pulse signal in terms of how many pulses occur during a given period, usually, the length of time chosen is one second, the basis used for other types of signals. The unit of measurement is *pulses-per-second* or *PPS*; and the characteristic being defined is *repetition rate*.

A few technicians cling to CPS (cycles-per-second) or Hertz as the unit of rep-rate measurement, and



Super Guide for Semiconductors

Nearly 180,000 listings! 1,120 pages! Coverage includes bipolar transistors, field effect transistors, diodes, rectifiers, and integrated circuits.

Use whatever information is available to select the replacement you need. U.S., European, and Far Eastern type numbers and manufacturers part numbers—any number you find stamped on the part or listed in a parts list—all are included. Cross reference is made to General Electric, Maltory, Motorola, Raytheon, RCA, Sprague, Sylvania, Thordarson, Workman, and Zenith replacement parts.

Save time and trouble. Get accurate information. Order your copy of Sams Semiconductor General-Purpose Replacement Guide today!



Howard W. Sams & Co., Inc.

4300 West 62nd Street
Indianapolis, IN 46268
(317) 298-5564

Clip Out-Mail Today

YES—Please send me Sams Semiconductor General-Purpose Replacement Guide. If I'm not completely satisfied, I may return it within 15 days of receipt for full credit or refund. Add sales tax where applicable.



Sams Semiconductor General-Purpose Replacement Guide. No. 21576
Price: \$14.95

Name _____

Address _____

City _____

State _____ Zip _____ Total \$ _____

Check Money Order Master Charge

Visa/BankAmericard

Exp. Date _____

Account No. _____

Interbank No. _____ (Master Charge Only)

Mail to:

Howard W. Sams & Co., Inc.

4300 West 62nd Street
Indianapolis, IN 46268

TC53C

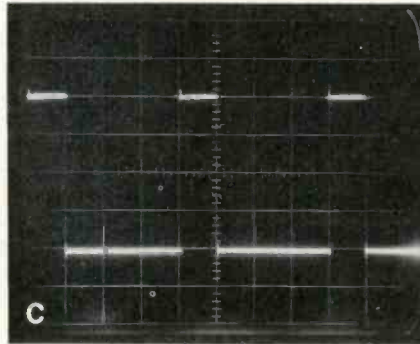
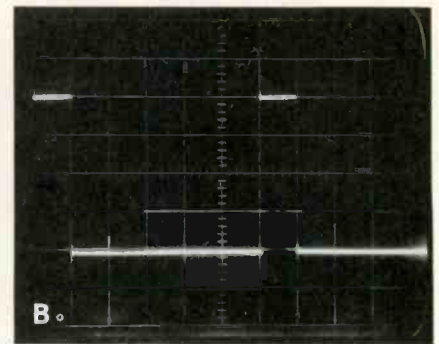
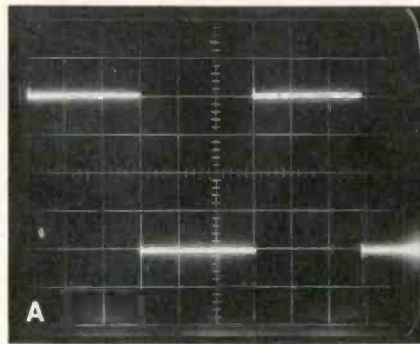

Figure 3 (A) Six divisions for one complete waveform at a time base of $20\mu\text{S}/\text{div}$ proves each cycle occupies $120\mu\text{S}$. (B) Although each pulse has a duration of $20\mu\text{S}$, the logic low is increased to $100\mu\text{S}$, thus giving the same period as in photo A. Both A and B have the same repetition rate. (C) However, if the logic-high time is changed to $20\mu\text{S}$ while the logic-low time remains at $60\mu\text{S}$, the repetition time is $80\mu\text{S}$, thus the repetition rate is faster.

thus call it frequency. Experienced technicians find that neither Hertz nor frequency really fit digital signals (except those few with 50% duty cycles which resemble square waves).

Just as frequency is the reciprocal of cycle duration, so is *repetition rate* the inverse of *repetition time*. To find how many times a digital pulse occurs in one second, divide one second by the repetition time (stated in seconds) of the pulses.

Inexpensive scientific calculators make this arithmetic quick and simple. Enter the repetition time, being sure to enter it as seconds, and then press the invert (1/x) key.

Take the digital pulse signal in Figure 3A as an example. Its repetition time is $120\mu\text{s}$. So, punch 120 on the calculator keyboard. But that's microseconds, the entry needs to be in seconds.

Use scientific notation. $120\mu\text{s}$ is the same as 120×10^{-6} seconds. So, press the EE or EXP key on the calculator, which takes care of the $\times 10$ expression, and sets up the register for an exponent. Then enter 6 as the exponent, being sure to change its sign to minus (use the -/+ key). That enters $120\mu\text{s}$, using proper scientific notation for seconds. Finally, invert with the 1/x key.

An answer of 8333.33 should be

shown. That's *pulses-per-second* or *PPS*. It says that when one pulse occurs every $120\mu\text{s}$, 8333.33 of them fill each second.

Does pulse width have any bearing on repetition rate? Actually, no. To prove this, calculate the rep rate of the digital signal pictured in Figure 3B. Pulse width is only $20\mu\text{s}$; but, with logic-low time at $100\mu\text{s}$, total repetition time is $120\mu\text{s}$. The repetition rate for a digital signal with repetition time of $120\mu\text{s}$ is 8333.33 PPS. Repetition rate therefore is independent of pulse width. *Rep rate depends only on rep time.*

Calculating rep rate for the signal in Figure 3C should clinch this realization. Pulse width is $20\mu\text{s}$, just as in Figure 3B. But logic-low is shorter than in Figure 3B, so repetition time is less. In Figure 3C, repetition time is only $80\mu\text{s}$.

Feed that through a calculator. Enter 80. Press EE or EXP, enter 6 and make it minus with the sign-change (-/+ key). Then press 1/x. A rep rate is shown for Figure 3C of 12,500 PPS. Obviously, the shorter repetition time allows more pulses to occur within each second.

Finding a proper time base

In the exercises outlined so far, the signals have been set up deliberately to illustrate certain points about analyzing digital sig-

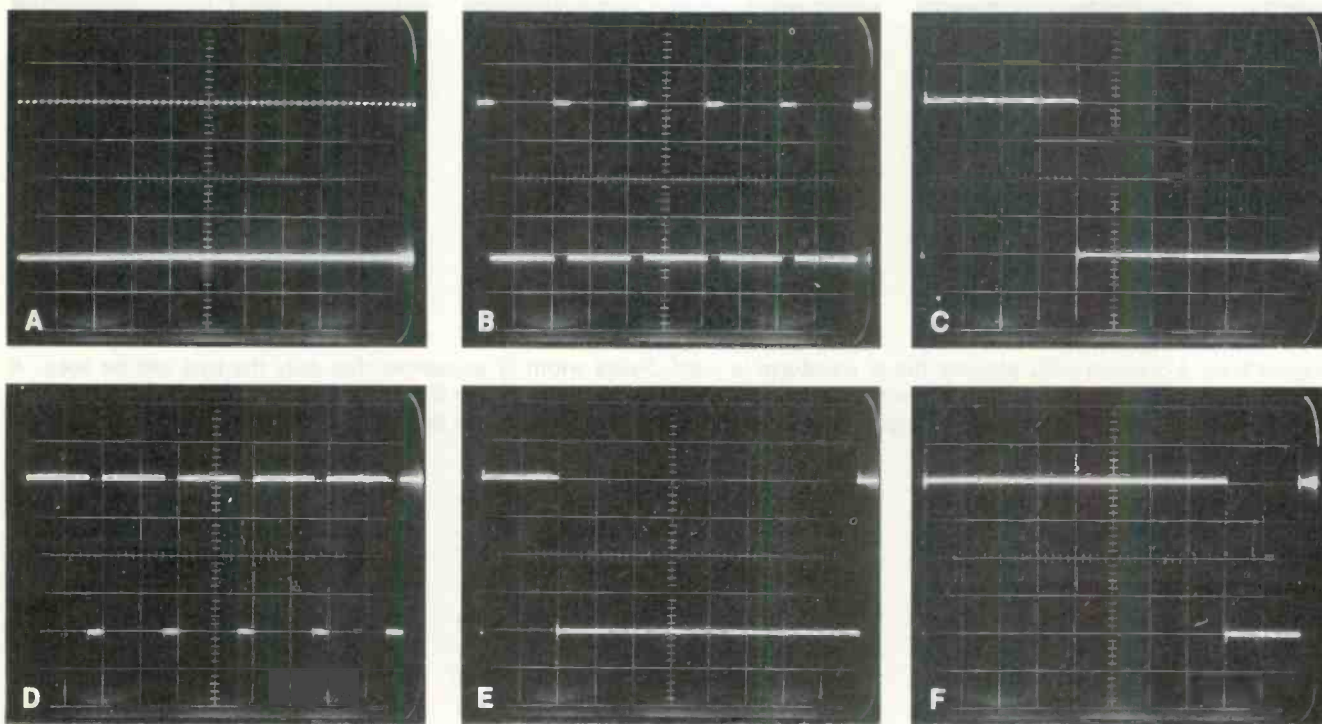

Figure 4 These waveforms illustrate the 10 steps for scoping digital signals. (A) Many dots above and rough line below prove the scope time base is too long (slow). (B) The trace might look like this after the time base is speeded up when the highs are shorter than the lows. (C) This is the same as B trace, except the digital highs have longer duration than the lows. (D) A time-base setting of $5\mu\text{S}$ expanded the positive pulse to fill four divisions so the width could be measured accurately. (E) Repetition time is measured from leading edge to the next leading edge. Ten divisions at $10\mu\text{S}/\text{div}$ produces a repetition time of $100\mu\text{S}$. (F) The Figure 4C waveform is expanded to show the same repetition time as in E ($100\mu\text{S}$).

nals. When troubleshooting a digital control system of whatever kind, that convenience might not be available.

That being the case, a standard procedure is needed that helps to determine quickly the basic timing characteristics of any digital signal. First observe, without fumbling around, the nature and appearance of the signal—most readily gauged by noting its duty cycle. Then measure, accurately and promptly, the pulse widths and repetition times.

All of these are possible with a relatively simple sequence of scope manipulations. Here they are, in step-by-step form; the results are shown in the photographs of Figure 4.

(NOTE: To duplicate these steps as a practice exercise, comparing efforts with the Figure 4 photos, a pulse generator is needed. When using the VIZ model WR-549A or an equivalent, start with T1 at $20\mu\text{s}$, and T2 at $80\mu\text{s}$. Set digital-signal amplitude at 4V.)

These are the steps:

1. Set the zero-voltage base along the second or third line below center of the graticule. Switch the scope's vertical amplifier to dc input coupling.

2. Set the scope's time base at $5\text{mS}/\text{div}$, to start.

3. Feed in the signal, and adjust the input attenuator for on-screen deflection without vertical (Y-axis) overscan. At the start, with digital signals, the waveform has the appearance of two traces sweeping simultaneously from left to right. Actually these are the tops and bottoms, the highs and lows, of digital signal pulses. (This step is not pictured in Figure 4.)

4. Set the scope for normal triggering, positive slope, and adjust trigger level for a steady display. This is done best by rotating the level knob away from center in the + direction; turn it far enough to lose triggering, then back down far enough to establish solid triggering.

5. Begin switching the time base shorter and shorter, watching the scope display at each step of the time/div switch. At some setting,

either the top line of the trace or the bottom one will begin to take on a dashed appearance as in Figure 4A. (NOTE: For the input set up earlier, this should occur at about $0.5\text{mS}/\text{div}$.)

6. Continue shortening the time base until it can be detected which is shorter in time, the pulse highs or the lows in between pulses. Figure 4 shows that the pulses (highs) are shorter. (NOTE: This occurs on a scope at $50\text{mS}/\text{div}$.) Figure 4 would be the appearance if the pulses were longer and the lows short. The object at this step in the procedure is merely to identify the general look of the signal.

7. Now, once triggering is established solidly at the leading or upgoing edge of the first pulse, measure *pulse width*. For greatest accuracy, reduce the time base until only that first logic-high pulse occupies the graticule. In Figure 4D, the displayed pulse has been expanded to occupy four X-axis divisions. It took a time-base setting

Digital signals

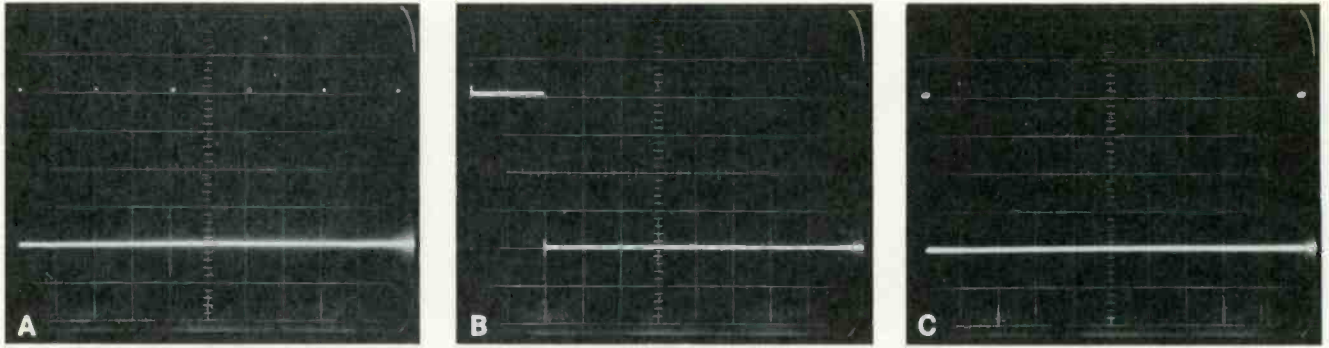

Figure 5 As a practice drill, assume the A waveform is seen. Pulse width is so narrow that only the tips can be seen. A shorter time base must be selected to spread them. (B) A $5\mu\text{S}$ sweep time shows the pulse width is $10\mu\text{S}$. (C) To measure the repetition time of one cycle, a longer time base of $0.1\text{mS}/\text{div}$ allows one period to occupy all 10 divisions, thus proving a rep time of 1mS or 1000PPS .

of $5\mu\text{S}/\text{div}$ to spread the pulse this much. Pulse width thus measures $20\mu\text{S}$. A setting of $2\mu\text{S}/\text{div}$ would spread the pulse to cover the entire 10 graticule divisions; and measurement of pulse width or duration would be even more accurate.

8. Next, measure *repetition time*. Start by lengthening the time base just enough to see one complete pulse, plus one complete off time. In other words, the leading edge of the second pulse must be on-screen.

This has been done in Figure 4, with a time-base setting of $10\mu\text{S}/\text{div}$. The pulse occupies two divisions on the X-axis, and so is $20\mu\text{S}$ in width. Zero-voltage (logic-low) timing occupies eight divisions, making off time $80\mu\text{S}$ long.

Repetition time extends from the leading edge of one pulse to the leading edge of the next. In Figure 4E, the second pulse begins 10 divisions after the start of the first pulse. Repetition time, therefore, covers 10 X-axis divisions. With time base at $10\mu\text{S}/\text{div}$, this indicates a rep time of $100\mu\text{S}$.

(NOTE: Figure 4F shows detail of the signal from Figure 4C. Logic-high is $80\mu\text{S}$; logic low is $20\mu\text{S}$; rep time is still $100\mu\text{S}$.)

9. From the two measurements, rep time and pulse width, the *duty cycle* can easily be calculated. This quantity proves important in many control systems, particularly in feedback and servomechanism loops. *Duty cycle comes from pulse width divided by repetition time*.

Hence, in the examples of Figures 4D and 4E, the digital signal has a duty cycle of 20 divided by 100, which equals a 0.2 or 20% duty cycle. The digital circuit is at

logic-high 20% of the time, and at logic-low the remaining 80%. (NOTE: Duty cycle in Figures 4C and 4F is 80%.)

10. The *repetition rate* is also easy to calculate. Simply invert the repetition time *in seconds*. This gives the rep rate in PPS. In all Figure 4 signals, rep time is $100\mu\text{S}$. Punch up 100, press EE or EXP, enter -06 for the exponent, and invert (1/x). Rep rate in Figure 4 is 10,000 PPS; (or 10kHz).

This 10-step procedure allows measurement of any digital signal, whatever its origin, timing, duty cycle or rep rate. One final exercise will review this technique.

Imagine that, following steps 1 through 6 of the procedure just described, the result is the display in Figure 5A. A series of short pulses, so short they hardly show up on the scope display, can be seen. Their existence is recognized only by the pips that represent their logic-high tops. Reasoning says that the duty cycle of this pulse train must be extremely short. However, proceed with measurements, as directed in steps 7 through 10.

Figure 5B is the display derived by step seven, which measures pulse width. The scope's time base has been turned all the way to $5\mu\text{S}/\text{div}$. This reveals a pulse width of $10\mu\text{S}$ (two X-axis divisions). In the process, scope intensity had to be increased, because such fast sweep-speeds dim trace brightness.

Step 8, measuring repetition time, goes as described in the procedure. In this exercise, the display appears as in Figure 5C. Distance from the leading edge of one pulse to leading edge of the next is 10

graticule divisions, with scope time base set for $0.1\text{mS}/\text{div}$. That means repetition time is 0.1mS multiplied by 10, or 1mS .

Step 9 gives the duty cycle. Inspection of Figure 5A has shown that duty cycle is extremely short. Calculate it accurately by dividing rep time into pulse width. So, $10\mu\text{S}$ divided by 1mS ($1000\mu\text{S}$) equals 0.01 or 1%. This digital signal stays logic-high only 1% of its total time. That is a very short duty cycle.

Step 10 calculates rep rate. It's the reciprocal or inverse of rep time. With a rep time of 1mS , the rep rate is 1000PPS or 1kHz . In other words, a $10\mu\text{S}$ pulse occurs 1000 times per second, or once per millisecond. Pulses of this nature are not uncommon in digital equipment.

Perfection takes practice

Every technician should have the goal to become comfortable and competent with the operation of a triggered scope. A modern triggered scope is the ultimate in versatility. It is the indispensable instrument for present-day complex solid-state circuits. □

A free wall chart for scoping digital signals

In a large envelope, include a 9"x12" manila envelope with 28 cents in stamps affixed, write your name and address with zip code in the center, and write on a separate sheet of paper this information: name, address, company affiliation, job description, and a list of test equipment you use regularly. In return you will receive at no charge a wall chart showing the 10 steps for scoping, measuring, and analyzing digital waveforms.

Address the first envelope (containing the stamped self-addressed return envelope and data sheet) to: Service Training GROUP
P.O. Box 47
West Newton, IN 46183

Understanding CTC99 horizontal sweep

Conventional principles are used in some horizontal-sweep and high-voltage circuits of the RCA CTC99. However, the pincushion and overvoltage-protection circuits are new. Technicians need to know these details before attempting any repairs.

By Gill Grieshaber, CET

Circuits for horizontal sweep, high voltage, pincushion correction and overvoltage safety shut-down functions are all located near the corner of the CTC99 RCA chassis shown in Figure 1.

Last month's article described the horizontal phase detector, master oscillator and divider which together provide a properly-locked near-square waveform at the pin 10 output of the U400 integrated circuit. This circuit analysis begins at that point, continuing with the same series of waveform numbers as those of last month. So, the first horizontal sweep waveform in Figure 2 is the same W8 at the input of R464.

Horizontal buffer stage

The assembly that includes resistors and controls for the variable focus and screen voltages almost hid Q406, the horizontal-buffer transistor. Therefore, the assembly was moved up out of the way for the Figure 3 picture which shows locations of several horizontal parts.

Q406 operates as a simple direct-coupled amplifier. In the W9 base waveform, zero voltage is at the bottom of each negative peak. In other words, there is no fixed bias; instead the base either has positive voltage or zero voltage. Of course, amplification can occur only during each positive excursion of the input waveform.

Amplitude of the base signal (pulses of positive dc voltage) would be excessive except for the signal degeneration produced by emitter resistor R460. (Emitter waveform amplitude is subtracted from the

base waveform amplitude to form the true B/E input amplitude.)

Output at the collector of Q406 is made up of positive dc pulses, with the bottom lines at about +1V. Waveforms in Figure 4 show the correct dc levels of these important signals.

Horizontal driver stage

Although the base signal for driver power-transistor Q407 comes from the Q406 collector, the waveshape is changed by C440 and R463, which are between those points. R463 attenuates both ac and dc components of the signal alike, while C440 passes more high frequencies than low, thus tilting the waveform. This analysis is ac-

ording to frequency response.

A more important viewpoint involves the changing of dc levels and the location of zero voltage on the waveform. Resistor R463 without the paralleling capacitor would feed the digital-type dc pulses to the base, and zero voltage would remain at the *bottom* of the waveform. Capacitor C440 without the paralleling resistor would pass the waveform, but it would place zero voltage at the *average* point of the waveshape. Both capacitor and resistor in parallel provide operation that is between these extremes, as shown in the Figure 4C waveform. Only the design engineer knows for certain why this condition is needed, but probably it

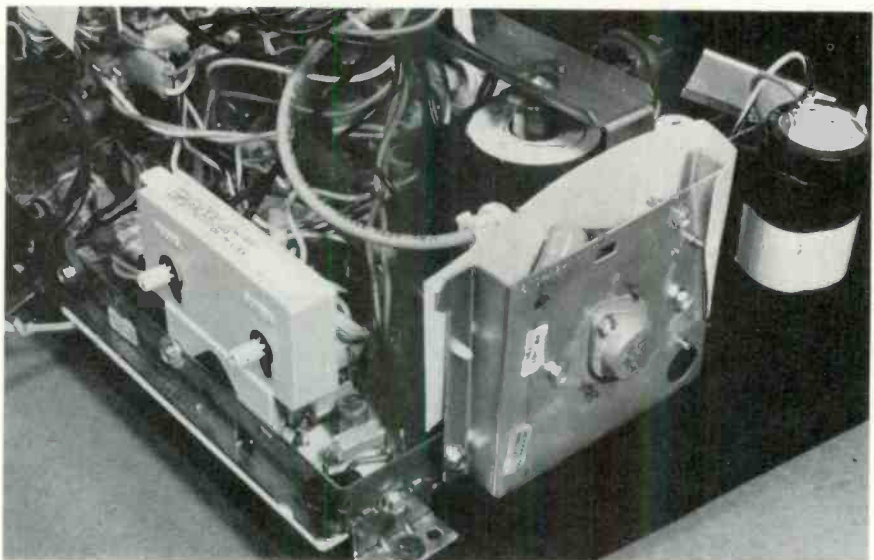

Figure 1 Most horizontal-sweep and high-voltage components are located in this corner of the RCA CTC99 chassis. If tests are needed at the horizontal-driver transistor, removal of one screw permits the focus/screen assembly (box with two shafts at left) to be lifted up. The output-transistor subchassis (at right) also can be unfastened from the chassis rail and laid flat, exposing socket and wiring.

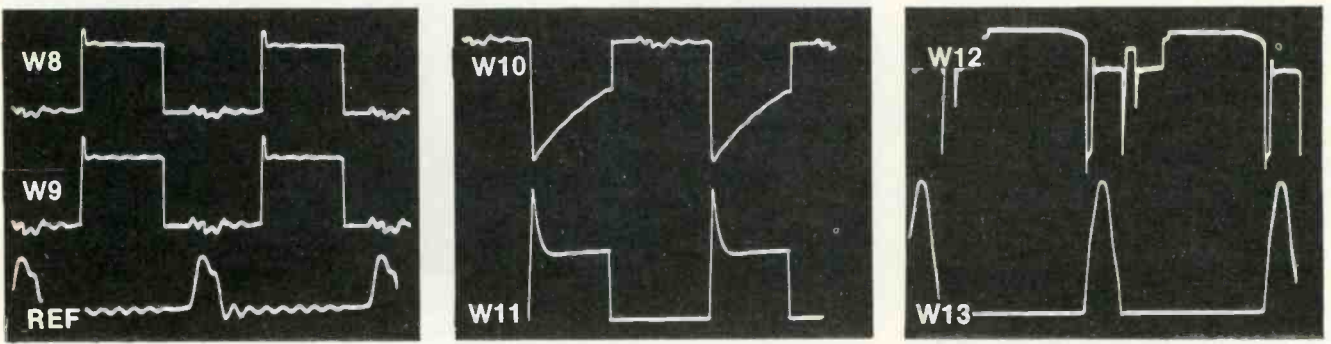
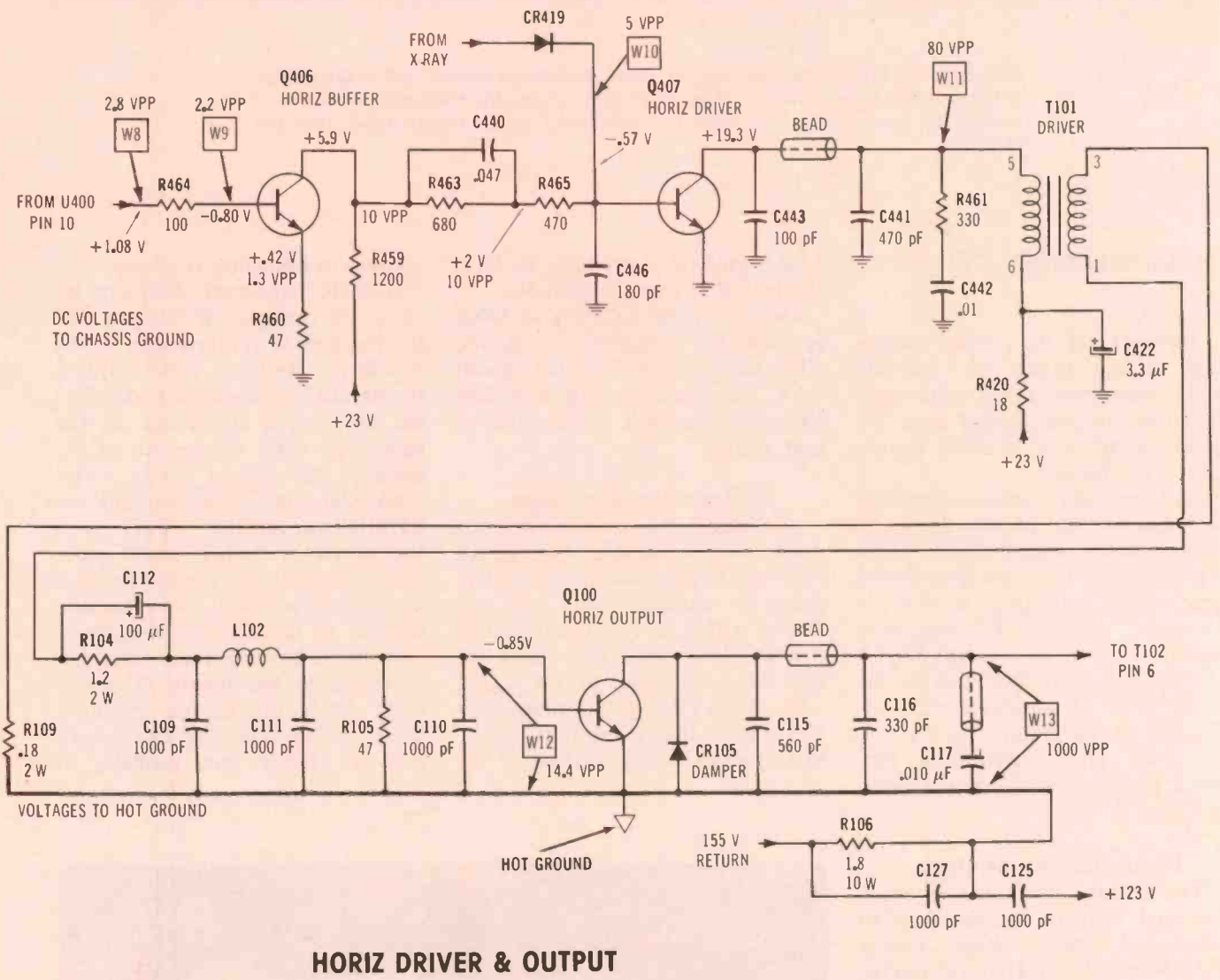

Figure 2 Dc voltages and waveforms are shown for this schematic of the buffer, horizontal-driver and horizontal-output stages. Vertical lines of the waveforms have been touched up to make them more visible. All waveforms have the same relative phase, and HV pulses are shown below W9 trace to show the phase between driver waveforms and the retrace time.

allows more stable operation during amplitude variations of the Q406 output signal.

Driver operation is not affected by diode CR419. If excessive fly-back pulses trigger the overvoltage-protection circuit (X-ray), the diode passes a positive dc voltage to the driver base, thus killing the Q407 gain long enough to activate a shut-down condition where none of the B+ supplies have dc voltage, except for the +155V line-rectified supply. Protection-circuit action is described later.

A casual glance at the base and collector waveforms of Q407 (W10 and W11 in Figure 2) probably would give most techs the idea that the transistor merely is amplifying and inverting the input signal in conventional class-A fashion. Although the waveforms are superficially similar (except for the inversion), the transistor is not amplifying *linearly*. Instead the function is on-and-off switching.

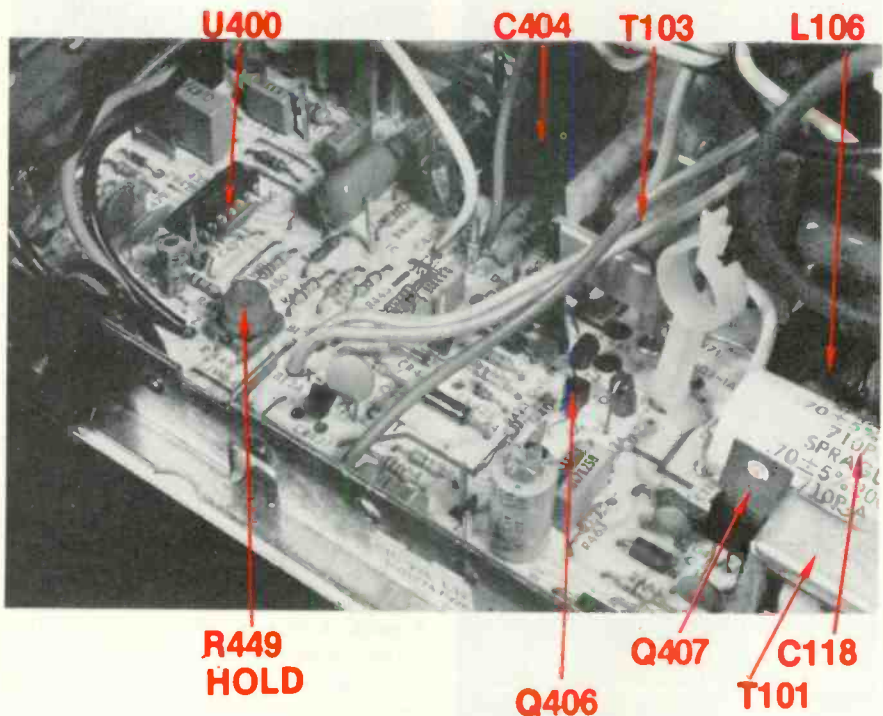
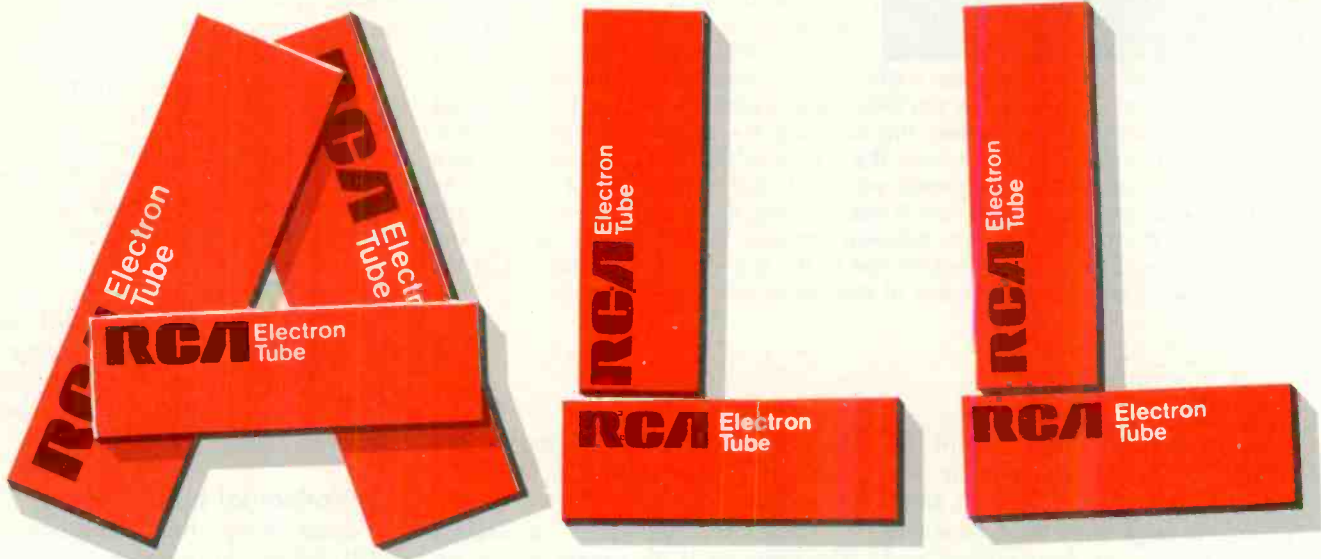

Figure 3 Arrows point out the locations of several horizontal oscillator and driver components.



the Receiving Tubes you'll ever need for most replacements.

With RCA you get the exact replacement tubes you need along with quality you can depend on. Whatever receiving tube you need, you'll find it at your RCA Distributor. Miniatures, Novars, Compactrons, Nuvisitors, Glass Tubes, Metal Tubes . . . over 1,000 types, produced to RCA's exacting standards.

Plus many RCA service aids and business aids to add to your efficiency and promote your business . . . tube cad-dies, service tools, technical literature and a wide assortment of in-store signs and displays.

See your RCA Distributor for all your tube needs.

RCA Distributor and Special Products Division, Deptford, N.J. 08096.

RCA Receiving Tubes



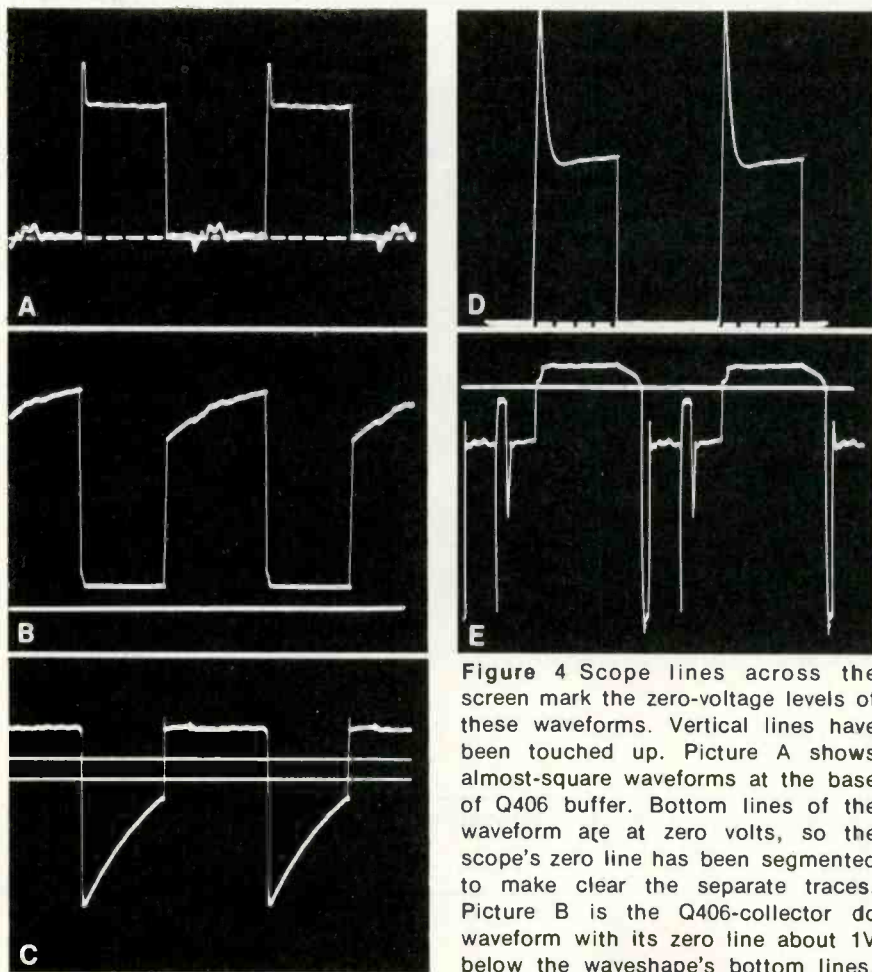

Figure 4 Scope lines across the screen mark the zero-voltage levels of these waveforms. Vertical lines have been touched up. Picture A shows almost-square waveforms at the base of Q406 buffer. Bottom lines of the waveform are at zero volts, so the scope's zero line has been segmented to make clear the separate traces. Picture B is the Q406-collector dc waveform with its zero line about 1V below the waveshape's bottom lines. Picture C is the Q407-base waveform (W10 in Figure 2) that shows both the zero line (nearer the top) and the average-voltage line (near center). The transistor forward bias is the +0.8V of signal that is above the zero line. This transistor should operate saturated (full conduction or none). The Q407 collector waveform in picture D has the zero line along the bottom of the waveform. Picture E is the base-to-emitter waveform of Q100, the horizontal-output transistor. The zero line at the top allows measurement of the +1.1V forward bias. The remainder of this waveform is reverse bias.

The 10VPP level compared to the +23V supply indicates the transistor never is cut off completely. Picture C is the Q407-base waveform (W10 in Figure 2) that shows both the zero line (nearer the top) and the average-voltage line (near center). The transistor forward bias is the +0.8V of signal that is above the zero line. This transistor should operate saturated (full conduction or none). The Q407 collector waveform in picture D has the zero line along the bottom of the waveform. Picture E is the base-to-emitter waveform of Q100, the horizontal-output transistor. The zero line at the top allows measurement of the +1.1V forward bias. The remainder of this waveform is reverse bias.

Positive peaks of the Figure 4C waveform apply instantaneous forward bias of +0.8V to Q407's base. This is a large bias that produces full C/E current (saturation) and maintains the collector voltage at zero during that time (see Figure 4D which is the same as W11 in Figure 2 with the added zero-voltage line).

Negative peak of the base waveform (Figure 4C) varies between -4V and -1V. Of course, these bias voltages drive the transistor far beyond cutoff, so Q407 draws a constant zero collector current for the duration of the entire negative

peak. (All negative voltages are extreme reverse bias for the NPN transistor.)

Therefore, the effect is exactly the same as if dc square waves (of the proper duty cycle) are applied to the base. Either full collector current flows or there is none. According to current flow, the collector waveform *should* show square-tipped dc pulses (almost square-wave duty cycle) of amplitude from zero volts to the +23V supply voltage. The *actual* waveform extends from zero volts to a 80VPP positive spike followed by an almost flat line of 42VPP. These

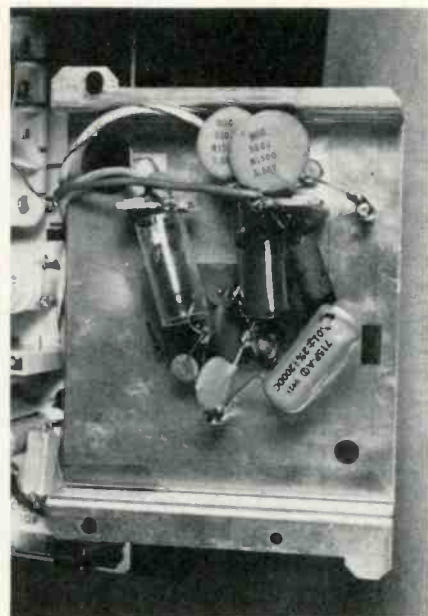

Removal of two screws allows the horizontal-output transistor chassis to be turned over, thus exposing the socket and B/E parts. Contrary to early RCA service data, this metal chassis is **not** floating, but is connected to the hot ground.

results seem to violate the rule that dc pulses cannot exceed the supply voltage.

However, exceptions to that rule include amplitude increase and ringing produced by tuned circuits or other resonant effects. A parallel-tuned circuit is created by capacitors C443, C441 and C442 which are connected across the primary winding of driver transformer T101. Damping is supplied by R461 and the secondary loads. So, ringing is changed to a single positive-going spike, while the resonance increases the overall amplitude.

Horizontal output stage

Signal from the secondary of T101 drives the base of horizontal output transistor Q100 through a network of capacitors and resistors (Figure 2). Figure 4E shows the zero-voltage line and the +1.1Vdc positive peak of the base waveform that controls Q100 conduction.

One continuing mystery is the weird waveform at the base of Q100 (and most other horizontal-output transistors regardless of TV brand). The section above the zero line in Figure 4E causes Q100 conduction,

and it is there by design. Other lines appear to be caused by damper diode conduction and the beginning and ending of HV pulses.

When the output transistor is removed from other models, the base waveform smooths to a square wave or a square wave plus a sawtooth. This cannot be checked on the CTC99 and CTC100 models because the oscillator and driver do not operate unless the output transistor is working correctly. So, the typical waveform shown here must be taken on faith.

The various waveforms in Figure 5 clarify the waveform situation somewhat. One pair of waveforms shows the signal at the output of driver transformer T101, while the other shows the altered waveform after it reaches Q100 base. Apparently, these power transistors turn on slowly and attempt to continue C/E conduction after the base forward bias is gone.

Collector of Q100 drives the flyback (HV) transformer and the

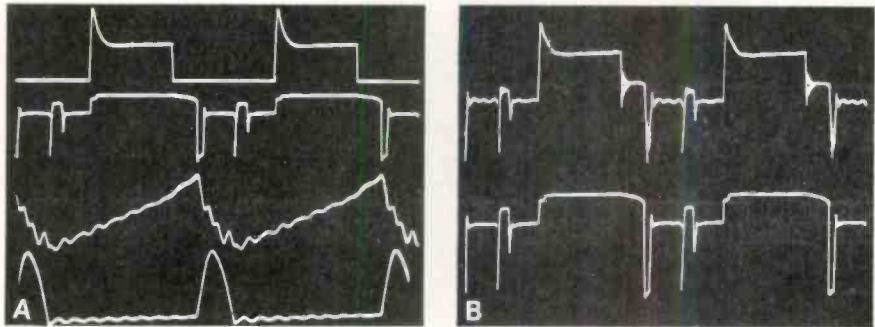

Figure 5 (A) All four traces have the same phase. Top trace is the Q407 collector signal (same as W11 in Figure 2). Second trace shows the Q100 B/E waveform. Its rising edge occurs simultaneously with that in the driver waveform. However, the falling edge lingers longer than the driver edge that produced it. This is W12 in Figure 2. Trace 3 is the Q100 collector current, and Trace 4 shows the HV pulses from the flyback. (B) These waveforms contrast the T101 secondary waveform (top trace) with the Q100 B/E waveform (bottom trace). The T101 secondary waveform shows the primary waveshape with parts of the Q100 base waveform added.

deflection yoke. Yoke wiring is shown with the pincushion circuit schematic.

Side pincushion correction

Top and bottom pincushioning is

eliminated by the design of the deflection yoke, but side pincushioning must be corrected by dynamic variation of the horizontal-yoke current. Only one adjustment control is necessary, and it is used

James L. King, President, King Instrument Corporation, Westboro, Mass. (40 Employees)

One reason Jim King sells 75% of his cassette tape loaders overseas is because it's profitable.

Another is because we showed him how.

Can we do the same for you?

Write:
Secretary of Commerce
U.S. Department of Commerce
Industry and Trade Administration, BED-18
Washington, D.C. 20230



A Public Service of
This Magazine &
The Advertising Council

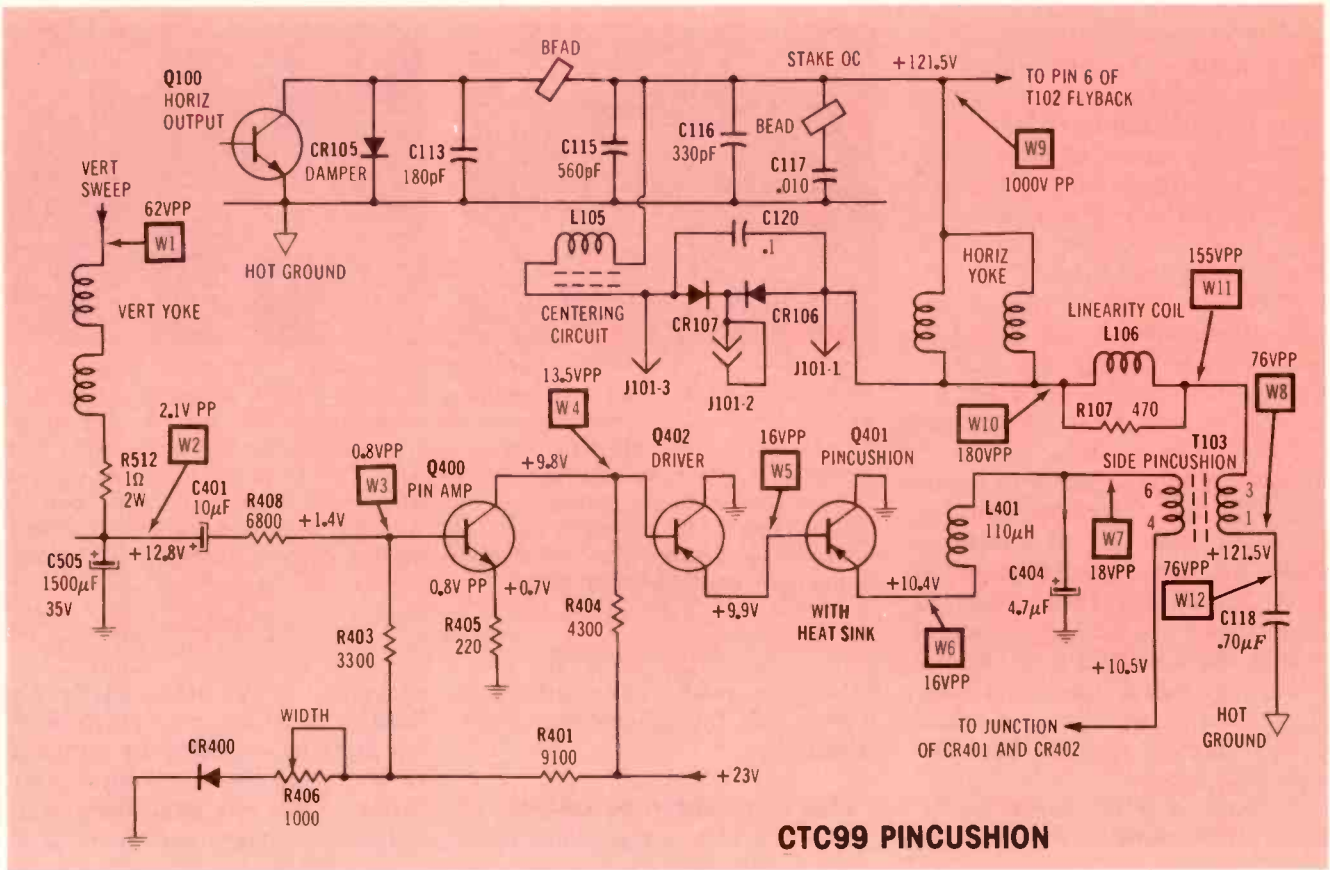

CTC99 PINCUSHION

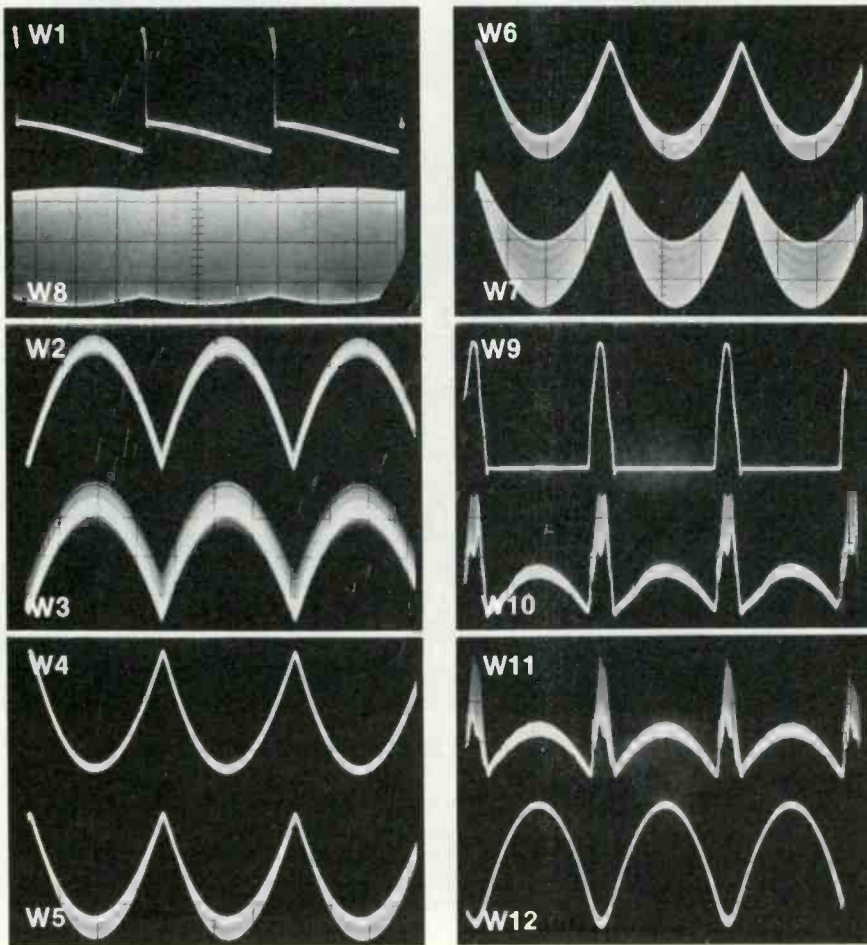

Figure 6 Essentially, the horizontal yoke coils are connected between collector and emitter of Q100 (with C118 in series). Other components are for horizontal centering, fixed linearity correction and side-pincushion correction. Waveforms were recorded from the sample CTC99 chassis.

primarily to set the desired width. Figure 6 shows the schematic and waveforms of the Q100 collector wiring, yoke wiring, horizontal centering, and the pincushion-correction active circuit.

A simplified horizontal-yoke circuit *could* consist only of a series connection of the two yoke coils (in parallel) and the $0.70\mu\text{F}$ blocking capacitor between Q100 collector and emitter (hot ground).

To this basic circuit has been added a non-adjustable linearity coil (L106 and R107), a variable-inductance pincushion transformer (T103) and a centering circuit. (When L106 was shorted for a test, the sweep linearity expanded at the raster's left edge.)

Operation of the centering circuit

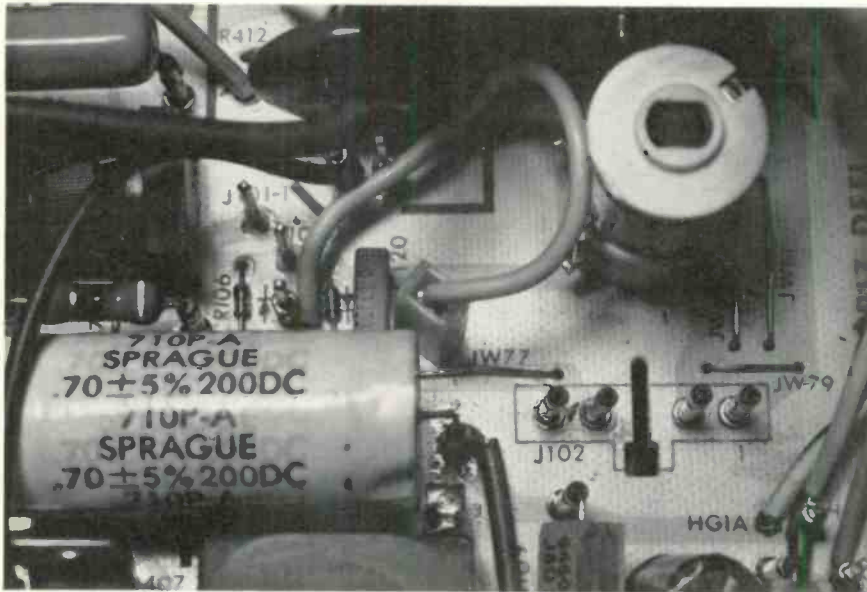

Figure 7 L105 centering coil is at the upper right. Below it are the four pins of the horizontal-yoke socket; to the left is C118, the series yoke capacitor; above C118's right end are the three pins and a lead wire that adjust picture centering; and above the left end of C118 is L106, the horizontal-linearity non-adjustable coil.

is very simple. L105 isolates the centering diodes, thus preventing excessive loading across the yoke coils. Three metal posts on the chassis (Figure 7) and a wire serve as manual switching to move the picture to the left, give no correction, or move the picture to the right. The jumper wire is attached to the central post and has a matching insulated socket.

If diode CR107 is shorted out by the jumper, CR106 applies a negative voltage to the linearity-coil end of the yoke. If CR106 is shorted, a positive voltage from CR107 is applied to the yoke. When neither is shorted, the two diodes are opposed in polarity so no rectification occurs.

Vertical parabola

Proper correction of side pincushioning requires narrower width in a parabolic shape near top and bottom of the raster. A parabola at the vertical-sweep rate is needed for the correction.

A sawtooth waveshape of vertical yoke current flowing through C505 produces a parabolic waveshape (W2 in Figure 6) across it (sawteeth integrate into parabolas). The waveform is coupled through blocking capacitor C401 and resistor R408 to

Q400 base. Width control R406 adjusts the dc bias voltage at the base of Q400, varying the gain and the dc level that are passed through the two downstream direct-coupled transistors to determine the picture width. The amount of pincushion correction is changed somewhat too, but width is more important.

After inversion and amplification in Q400, the parabolic waveform passes through a Q402 emitter follower (that matches impedances) and a Q401 power transistor whose emitter current controls the inductance of pincushion transformer T103. The secondary of T103 is in series with C118 and the cold end of the yoke; therefore, increases in the T103 inductance reduce the yoke current.

While passing through the T103 secondary winding, the yoke current produces pulses across the winding, and also induces a similar waveshape of signal in the primary winding (terminals 4 and 6). The signal is rectified by CR402 (as explained previously) in a circuit that arranges the components in a different way. For example, C404 is the filter capacitor for the +10.5V that supplies Q401.

In other words, T103 supplies a signal that is rectified to power the

What the 1980 Census can do for your business

Help you increase profits.

"The Census is an essential tool in modern marketing research." That's what Arthur C. Nielsen, Jr., Chairman of the Board of one of the country's largest marketing research firms, said about data gathered by the Census, which is available for your business use.

How you can use the Census

- Forecast sales trends, market potential, population growth
- Study buying habits and changes in purchasing power
- Select new areas for testing
- Determine best locations for new stores, plants, shopping centers, warehouses
- Allocate salesmen, advertising and outlets
- Determine sales forces, routing schedules, territories and quotas

We're counting on you.
Answer the Census.

CENSUS '80 **Ad Council**
A Public Service of The Magazine & The Advertising Council

RCA CTC99

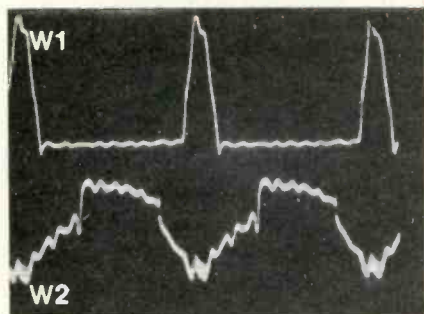
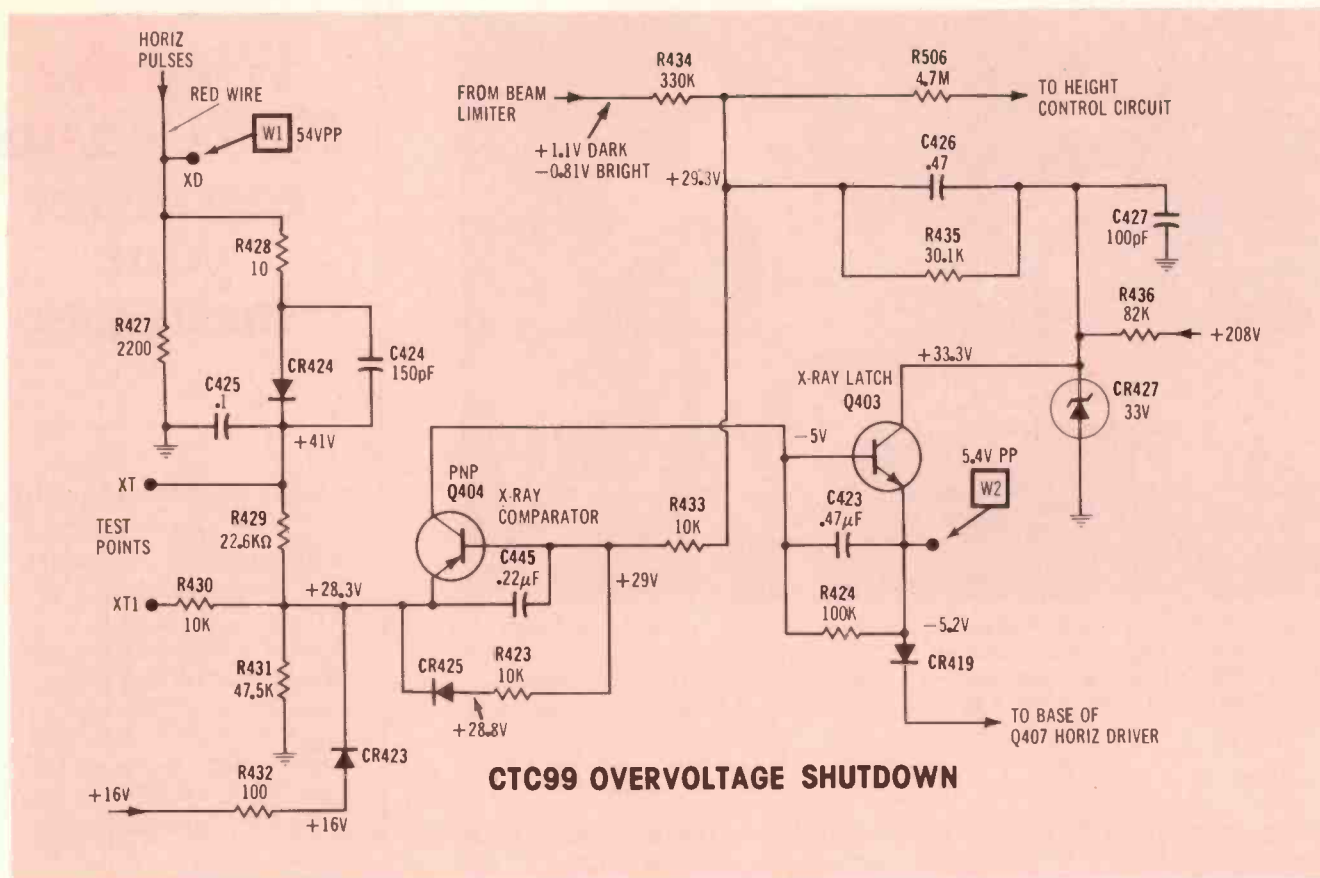

Figure 8 Waveforms and dc voltages are given for this X-ray circuit that kills all functions except the +155V supply if the HV pulses ever rise excessively. In normal operation, Q403 is cut off. Its emitter measures negative because CR419 rectifies the signal at Q407's base. Following shutdown, all waveforms and dc voltages are missing except for a dc volt or so coming from circuit leakage.

transistor which in turn conducts more or less to vary the inductance of T103. Then the changing inductance of T103 varies the yoke current to correct the pincushion distortion.

L401 appears to be included as protection of Q401 by removing

most of the pulse amplitude at the emitter.

The C118 waveshape is shown (at the horizontal rate) by W12. It is a parabolic waveshape formed from the sawtooth yoke current by the capacitor's integrating action. Again, the C118 waveshape is shown in W8, but at the vertical rate, where the reduction of horizontal yoke current (representing raster width) can be seen as less waveform height near the vertical-sweep pulses in the W1 waveform above it.

Overvoltage protection

Protection against excessive high voltage that might produce picture-tube X-rays was included with the SCR regulator circuit in previous RCA designs. This overvoltage protection is accomplished with a separate two-transistor circuit in the CTC99 and CTC100 models.

The complete schematic with typical normal dc voltages and two waveforms is in Figure 8.

If the monitored voltage rises too high, the overvoltage circuit forces the receiver into a shutdown condi-

tion without sound, picture or raster.

Positive-going horizontal pulses from the flyback red wire are rectified by CR424 to produce a dc voltage at testpoint XT of about +41 volts in normal operation at a line voltage of 120V. This dc voltage rises and falls according to amplitude of the flyback pulses. Since the HV is formed by rectification of similar flyback pulses, it is assumed that this supply tracks the high voltage.

Part of the +41V is fed through R429 to the Q404 emitter, while the Q404 base voltage is clamped to a higher fixed voltage provided by zener CR427. (Other circuits are tied in here and there, but they have no major effect on the basic operation. Therefore, they are ignored at this point.) Normally, PNP Q404 is reverse biased.

If the +41V supply rises excessively (for any reason), the Q404 emitter voltage rises above the base voltage, thus forward biasing Q404 and producing a positive voltage at the Q404 collector.

Previously, Q403 had zero bias.

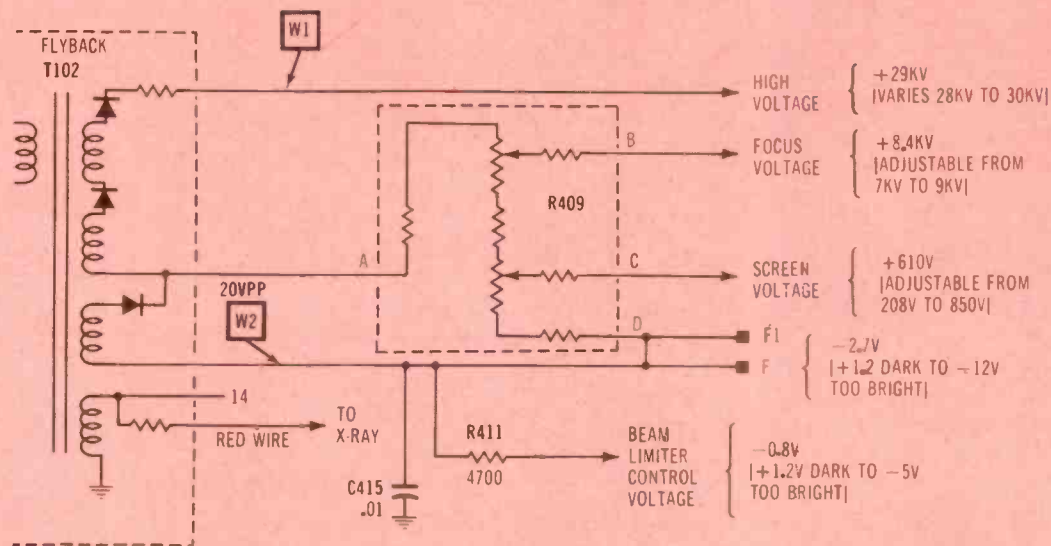

FOCUS AND SCREEN CIRCUITS

(Both emitter and base measured negative because CR419 rectified the Q407 driver's base signal.) The Q404 collector is connected to the Q403 base, so a positive voltage at Q404's collector is forward bias for NPN Q403. Therefore, Q403 conducts some of the stable +33V at its collector to the emitter, where it goes through CR419 to the base of horizontal-driver Q407. The positive voltage is sufficient to overbias the Q407 base and reduce the gain to almost zero. Without drive to Q100 horizontal-output transistor, no pulses are formed by the flyback, and all supplies that are powered by flyback signals go dead. Without dc power, all functions of the receiver cease.

During shutdown, no dc voltage is found in the entire receiver, except for the +155V supply (which now measures about +166V) and a few very low voltages from leakage resistances. Operation of the TV receiver might be restored by turning off the power, waiting a few seconds and switching it back on. If the +41V remain too high, the receiver will begin to operate but instantly shut down again. If the abnormally high voltage was temporary and now is normal, the TV should operate correctly.

Operation of the shutdown circuit can be tested by shorting to-

gether terminals XT and XT1. The Q404 emitter voltage is raised, and shutdown should occur. If not, the protective shutdown circuit is defective and should be repaired.

Methods of defeating the shutdown circuit for troubleshooting purposes will be discussed in the servicing analysis next month.

HV, focus and screen voltages

Diodes for high-voltage rectification are hidden inside flyback T102 (see schematic of Figure 9). Therefore, they are not available for test or replacement. If they become defective, the flyback assembly must be replaced.

Both the adjustable focus voltage and the variable screen voltage for the picture tube come from one assembly. Also, the low end of the high-voltage winding returns to the beam-limiter circuit which prevents excessive picture-tube current.

Flyback terminal F is connected to the anode ends of the HV rectifiers. Therefore, a negative voltage is produced there when HV current is drawn. At zero HV current, the terminal F voltage measured +1.2V. This positive voltage came from the beam-limiter circuit. When the brightness is increased, negative voltage is produced so a normal picture might cause about

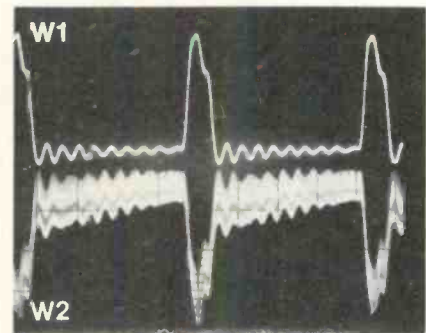

Figure 9 This schematic of the HV, focus, screen and beam-limiter circuits includes two waveforms and the variations and limits of several dc voltages. The amplitude of W2 waveform varies constantly during typical TV scenes, as also does the dc voltages at the beam-limiter components.

-3V. R411 connects the negative voltages to the beam-limiter circuitry in the video amplifiers. The readings shown in Figure 9 at R411 and terminal F vary constantly during typical operation. Therefore, no precise voltages can be given.

Next month

Troubleshooting methods next month will cover these circuits and functions: line-rectified isolated dc supply; start-up operation; SCR regulator; horizontal sweep; and high voltage. □

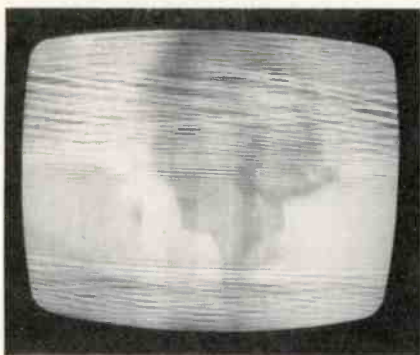

Figure 1 Scanning line disturbances at the top and bottom of the picture often indicate a defect in the pincushion-elimination circuit.

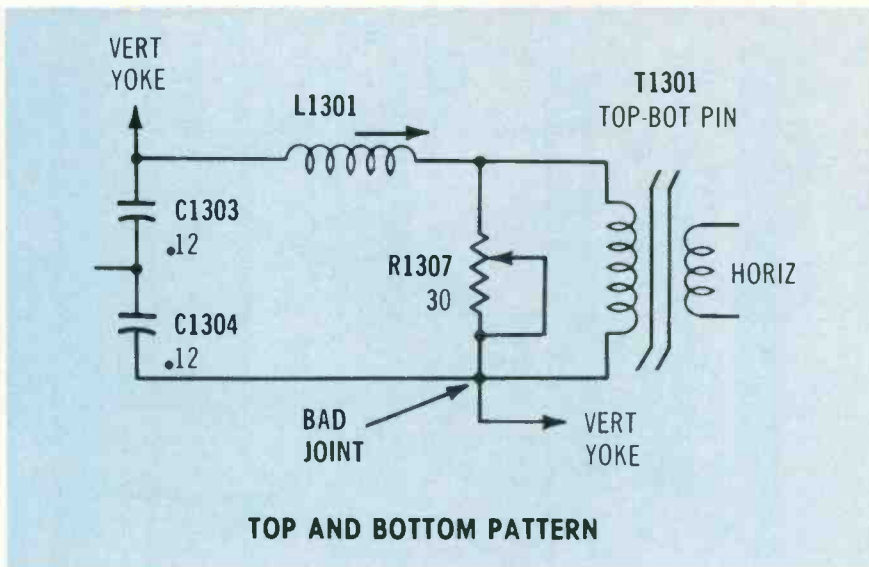

Figure 2 A bad soldering joint in this 25EC58 Zenith pincushioning circuit produced the peculiar pattern shown in Figure 1.

More Zenith TV repairs

By Robert L. Goodman, CET

In specific color TV models, some components develop a higher-than-average rate of failure. These are called *recurrent problems*. They occur in all brands, but older Zenith TVs are the subjects of these case histories.

Unstable pattern

At the raster top and bottom, the pattern shown in Figure 1 resembled woven threads or cloth. Although this TV was an E-chassis Zenith, the same defect sometimes occurs in the F chassis.

After a quick look at the screen, a technician might have suspected that some kind of RF interference was responsible. A more careful examination would have noticed the curved scanning lines. It was *not* a moire pattern from interference in the picture.

Location of the disturbance at the top and bottom of the raster gave the best clue. The pincushion-elimination circuit is the only one that operates exclusively in those areas.

This particular defect was caused by a cracked soldering joint in the top/bottom pincushion circuit (see Figure 2 schematic) located on a circuit board that was mounted on top of the deflection yoke. The bad joint is pictured in Figure 3.

The deflection yoke must be removed from its plastic housing before the circuit board is accessible.

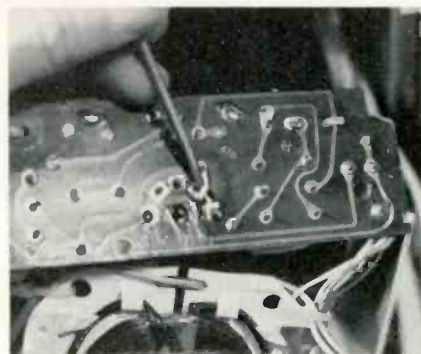

Figure 3 Location of the bad joint at T1301 is pointed out by the screwdriver blade.

Intermittent connections in other components (for example, R1307) also can account for similar deflection patterns.

If T1302 has an open winding, a vertical band 1 or 2 inches wide might be seen on the screen. A cracked circuit board can produce the same symptom.

Loss of vertical deflection (one line across the screen) could be the result of broken connections at the L1301 terminals or an open winding. The problem sometimes is intermittent.

Tripping circuit breaker

No sound and no raster were the major symptoms of a 25EC58 Zenith. Also, the breaker was open from a previous tripping. When the breaker was reset, a loud hum was heard for about five seconds until

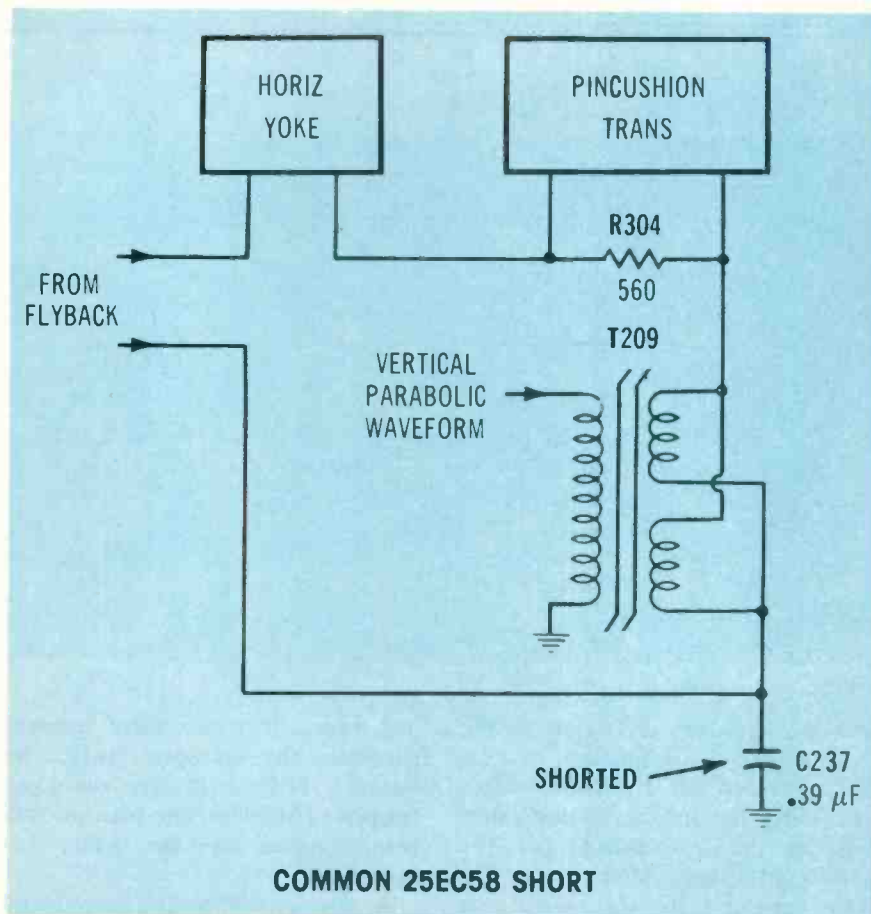

Figure 4 A shorted C237 yoke-coupling capacitor sometimes overloads the 130V supply.

the breaker tripped again and the TV went silent.

One likely source of these symptoms is a short in C237, a $0.39\mu\text{F}$ coupling capacitor that bypasses the cold end of the horizontal yoke winding to ground (through the side pincushion transformer, as shown in Figure 4). (This same $0.39\mu\text{F}$ capacitor in E, F and G chassis is listed as C242, and it is located near the yoke plug.)

Other overloads

Other overloads that trip the breaker include these:

- one or more shorted B+ rectifiers;
- a shorted $3.5\mu\text{F}$ oil-filled regulator capacitor;
- shorted turns in the flyback;
- shorted turns in the yoke windings;
- a shorted 4-wire capacitor;
- a shorted damper diode;
- a shorted feedthrough capacitor in horizontal output stage;
- a defective horizontal-output

transistor; or

- leakage or shorts in the HV tripler assembly.

If the +130V line has a short to ground, test first by removing the yoke plug from its socket. If the short remains, then it is not in the horizontal-sweep system. This test is possible because a jumper between yoke pins 12 and 15 disconnects the horizontal sweep when the plug is removed, thus allowing checks for shorts without the horizontal circuit.

In E, F, G and H chassis that had sound but no raster or HV, one common fault has been an open in the 10-ohm 10-watt resistor that supplies +130V to the flyback transformer. This removed all B+ from the horizontal-output transistor. In 19FC45 chassis, the resistor is identified as R229.

A defective 24V-regulator transistor is the suspect in sets that have no sound, picture, raster or HV, when the +24V supply is near zero.

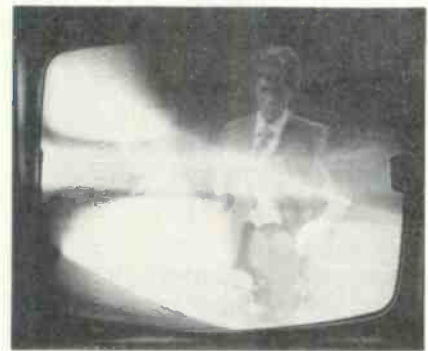

Figure 5 An open CX214C 24V-supply filter capacitor was the source of the single hum bar with picture pulling.

Rolling bar

A horizontal bar with horizontal pulling (Figure 5) that moved slowly up through the picture of F or G chassis TVs was found to be generated by an open filter capacitor at the +24V terminal of the 9-103 audio module. This filter is identified as CX214C in some schematics, and it is the $500\mu\text{F}$ section of a multiple-capacitor can.

No color

Loss of color in H, J or K chassis can be caused by the 9-88-03 or 9-88-06 video module. Also, a loss of video can occur on a faulty 9-86-02 chroma module. This should be kept in mind when troubleshooting these modular receivers.

Delay line problems

One 25EC58 Zenith had symptoms of no video and no control over excessive brightness. The trail of ruined components began with a bad Q203 second-video transistor. This shorted the CR221 boost diode, burned R355 ($150\ \Omega$, 2W) resistor and caused excessive current in the R/G/B color-output transistors. All damage was produced by a delay line that shorted to ground.

Delay lines in similar models have developed loose joints where the terminals are soldered to the circuit board, resulting in intermittent losses of video and brightness.

Other delay lines suffered open grounds, which caused effects similar to antenna ghosts. □

Tripped circuit breaker Quasar LC19TS-929 (Photofact 1476-1)

Each time he turned on the TV power, the customer reported, there was no picture. But after he reset the circuit breaker, the TV operated normally until turned off.

When tested on the service bench, the TV started operation as it should. I connected the set to a variable line transformer and increased the line voltage by about 10%. Afterwards, I noticed that the breaker sometimes would trip about two or three seconds after the power was turned off. Also, the damper plate would glow red after the switch was turned off and until the breaker tripped.

Dc voltage tests proved that the B+ was applied to the damper plate at all times! Although this seemed impossible, a study of the schematic revealed a multi-section on/off switch. One section was shorted, thus applying damper and horizontal-output plate voltage con-

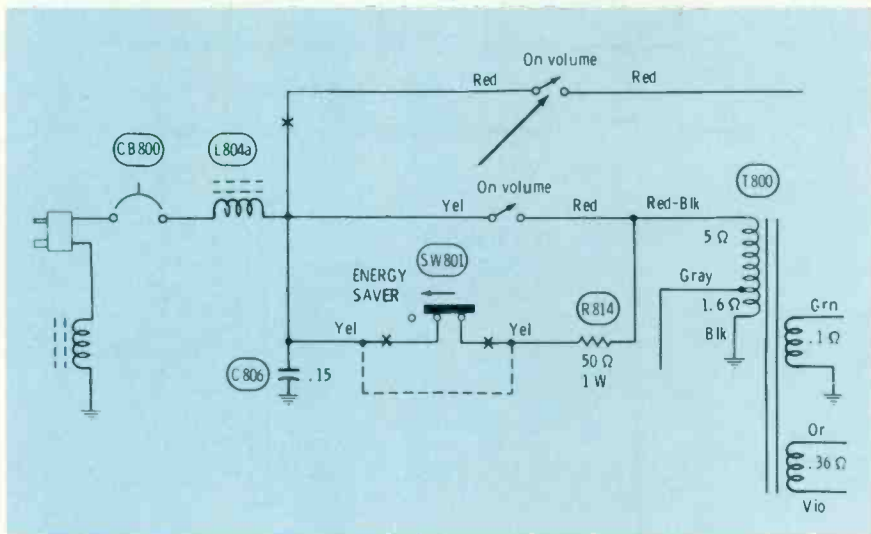

stantly. The non-defective switch section turned off the low voltages that powered all transistor stages (including the horizontal oscillator) and the heater voltage for the horizontal tubes. After the switch was turned off, the oscillator stopped immediately, but for several seconds the horizontal heaters remained hot. The horizontal out-

put tube drew excessive current through the damper until the heaters cooled or the breaker tripped. Therefore, the breaker was being tripped *after* the switch was turned off.

A new on/off switch cured the breaker problem.

Bob Williams
Plano, TX

No raster or sound RCA CTC72B (Photofact 1439-2)

When power was applied to the TV receiver, there was no sound, no raster and no high voltage. Examination of the power-supply section of the schematic showed only one voltage source (+142V) coming from rectification and filtering of line voltage. All other B+ supplies were obtained from rectified horizontal-sweep power. Therefore, any loss of horizontal sweep would stop all functions.

A higher-than-normal B+ voltage appeared at the output of filter choke L103. All other voltage sources measured zero.

While looking for the three points fed from the +142V supply, I noticed that the picture tube heater was not glowing. The schematic shows T402 as the source of

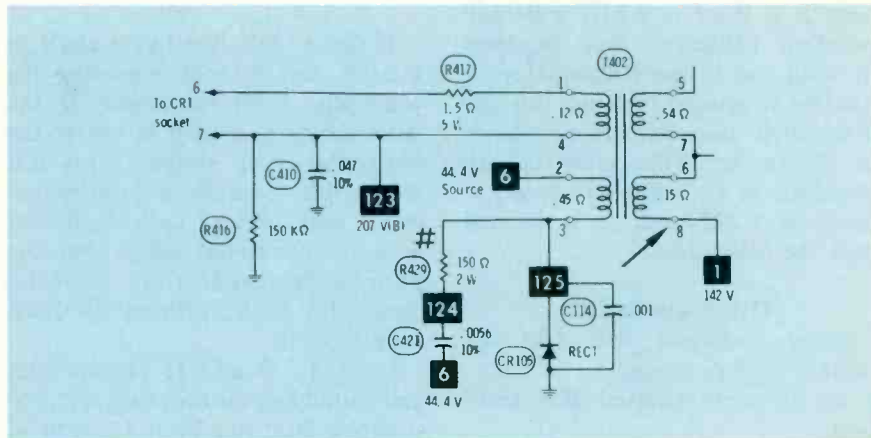

horizontal power that lights the CRT heaters. Significantly, the primary of T402 receives power from the +142V supply. A test at T402 pin 8 found no dc voltage.

After I removed the chassis and examined the underside of PW400 circuit board, I noticed a bad solder joint at terminal 8. A

thorough job of soldering brought the TV back to full operation. The open joint had removed the power from the retrace section, and this eliminated all dc power except the +142V supply.

Frank Sachs
Balto, MD

catalogs literature

The 1980 **Contact East** catalog includes more than 10,000 items for use in the assembling and servicing of electronic equipment. The 144-page catalog features photos, diagrams and descriptions of hand tools, soldering supplies and hard-to-find assembly and test devices. The catalog is free upon request.

Circle (10) on Reply Card

A supplement to the 1979 *Sylvania ECG Semiconductor Master Replacement Guide* has been issued by GTE. The ECG212J-1, a 12-page publication, supplements information in the *ECG Semiconductor Master Guide* published early in 1979. It also contains data on 30 new ECG devices and lists approximately 3200 additional industry part numbers in the cross-reference directory.

Circle (11) on Reply Card

The **Tel Labs Catalog of Fixed Wire Wound Resistors** provides specifications on the Q81 temperature-sensing resistor, epoxy-encapsulated SA series, ceramic core resistor CR/CA/CL series, silicone-coated EL series, and Type EH chassis mounts. The illustrated 16-page catalog includes graphic and tabular data on values, tolerances, temperature coefficients and dimensional characteristics for each resistor. Commercial and MIL-SPEC grades are available.

Circle (12) on Reply Card

The **Standard Handling Devices** winter 1980 catalog features equipment for transporting, conveying and storing. Listed products include ladders, conveyors, waste receptacles and cabinets. Complete prices and specifications are included.

Circle (13) on Reply Card

Correction

An incorrect line appeared in the Figure 2 schematic on page 26 in *Electronic Servicing* for January, 1980. Please delete the line marked in this partial schematic.

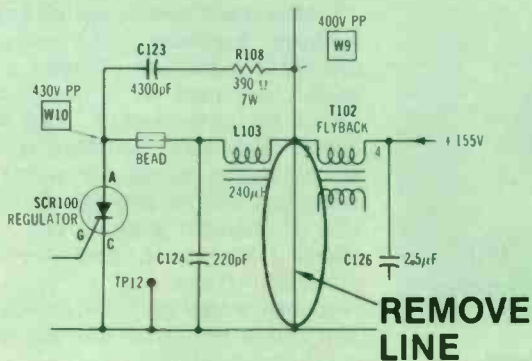

Job-matched pliers for small wire, hard wire, nickel ribbon wire... Klein job-matched pliers for professional electronics workers. They feel right. They work right. At authorized Klein distributors in your area.



KLEIN
Hand me the Kleins
... since 1857.



Send
for
Catalog



Klein Tools, Inc. 7200 McCormick, Chicago, Ill. 60645

Circle (5) on Reply Card



Thordarson replacement flybacks & yokes fit exactly

Thordarson flybacks and yokes are exact replacements... from mounting holes to wiring color code. Engineered and built better than the original you replace. Satisfy more customers with superior Thordarson performance. Buy from your Thordarson distributor.

THORDARSON

Thordarson Melssner, Inc.
Electronic Center
Mt. Carmel, Illinois 62863

Circle (6) on Reply Card

Replacement flyback package

Thordarson Meissner has designed an exact replacement flyback package that is said to help eliminate call backs and improve servicing. A selection of packages is offered. Each box contains: one exact replacement flyback, one each of a Tech-Mate damper diode and horizontal output transistor, and installation instructions.

Circle (14) on Reply Card

Video recorder

A 7-day programmable color video recorder has been added to the 1980 **Philco** entertainment product line. The Philco V1500 features an electronic 7-day programmer and memory circuits that permit pre-set



recording of four different programs on four different channels. The VHS (Video Home Service) format unit has a 6-hour recording capability. It also has built-in UHF/VHF tuners with touch-tuning channel selector.

Circle (15) on Reply Card

Engineering manual

The **Allied Electronics'** 1980 *Engineering Manual and Purchasing Guide* features a selection of industrial electronic parts, components, supplies and equipment. The 260-page, 9"x11" format, book contains illustrations, dimensions, technical data and specifications, and price listings.

The price for the manual and price guide is \$1.

Circle (16) on Reply Card

Mixer pre-amplifier

The **Grommes-Precision G-222** mixer pre-amplifier features six

microphone channels with balanced transformer input, IC circuitry, speech filters and 0-10dB attenuation switches for each channel. Other features include a bridge in or out jack, accessory out-in jacks for equalizer or limiter, and $\pm 18V$ power socket for accessory equipment.

Circle (17) on Reply Card

Capacitance substitution unit

The model 237 hand-held capacitance substitution unit has been designed by **Phipps and Bird**. The 1-pound unit offers a 5-decade

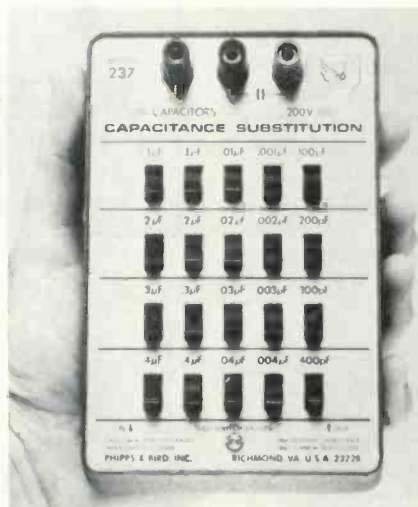

range of capacitance, and includes a discharge feature that allows safe substitution in sensitive circuits. The unit has non-polarized 5% capacitors and features 5-way binding posts.

The unit is available for \$95.

Circle (18) on Reply Card



Electronic megaphone

Holmin has developed the model A-12 Voice Gun, a power mega-

phone with a noise-cancelling, dynamic moving coil microphone, and a re-entrant horn loudspeaker system. Eight watts of battery power provide a ¼-mile range. The molded Cyclac horn is fitted with a ½-inch nylon web carrying strap with adjustable clasp. Total weight (with batteries) is 3¼-pounds.

Circle (19) on Reply Card

Home safety device

General Electric has introduced a GTR ground fault circuit interrupter receptacle kit. The kit (TGTR 115 FCP) is designed to replace a standard 15 amp, 125V duplex receptacle, and protects against electrical leaks to ground. When a



fault occurs, the GFCI cuts the current flow to a point as low as 5mA. The kit contains a GFCI receptacle, spacer, wall plate, wire connectors, mounting screws, ground clip and installation instructions.

Circle (20) on Reply Card

Miniature instrument pickup

Shure Brothers has announced the SM17 miniature dynamic microphone, designed to be mounted on acoustic instruments. The SM17 comes with two mounting options: an expansion mount for string hole mounting, and a clip for the sound hole of acoustic guitars. The microphone features an omnidirectional pickup pattern and a frequency response suited for instrument use. The unit is wired for low-impedance microphone inputs.

User price for the SM17 is \$76.80.

Circle (21) on Reply Card

test equipment report

Digital multimeter

The model 936 hand-held digital multimeter from **Data Precision** emits a beep when measuring low resistance and an audible alarm for overvoltage. The unit also features a 3½-digit LCD display with 0.1% accuracy, and offers 29 ranges of dc or ac voltage and current resistance measurements.

The list price is \$159, including tests leads, battery and instruction manual.

Circle (22) on Reply Card

Industrial temperature probe

The HP model 10023A temperature probe from **Hewlett-Packard** reads surface temperatures directly in degrees Celsius in any general purpose DMM with an input of 10 megohms. High thermal isolation

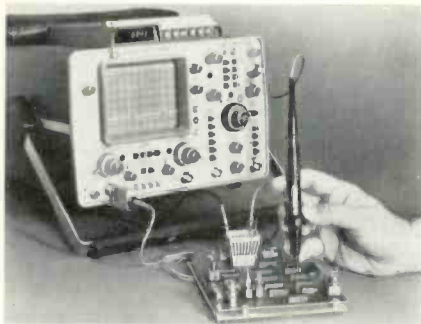

reduces the tendency for the probe tip to act as a heat sink and change the measured surface temperature of electronic components. An electrically isolated probe tip to 600V allows measurements of non-grounded components. The entire assembly, including the battery, is packaged in the probe body.

The price of the 10023A is \$500.

Circle (23) on Reply Card



Dual-channel scope

Kikusui now offers a 15MHz dual-channel portable scope, model 5512A. The unit features a vertical

bandwidth of dc to 15MHz with sensitivity of 5MV/div to 10M/div in 11 steps, four operational modes and three trigger modes. Sweep time is 0.5µsec/div to 0.5 sec/div in 19 steps.

The base price for the 5512A is \$795.

Circle (24) on Reply Card

Hand-held DVOM

The LX 304 hand-held DVOM from **Hickok** features a ½-inch high, 3½-digit LCD display, automatic polarity, zero and overrange indication, automatic decimal point, built-in low battery indicator, diode and

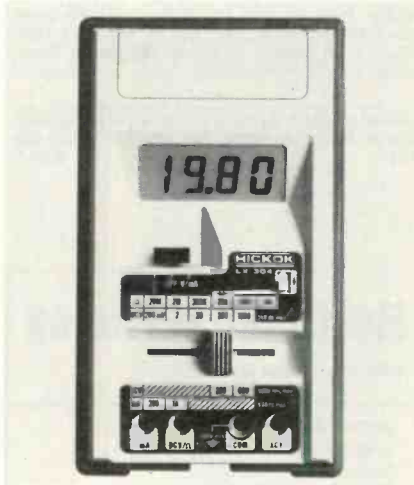

transistor testing capability and 0.5% accuracy on DCV ranges. The LX series multimeters are self-contained, with test leads that store in the removable, protective thermoplastic cover.

Suggested retail price for the LX 304 is \$89.95.

Circle (25) on Reply Card

Frequency counter

Leader has designed the LDC-824S 520MHz digital frequency counter. The unit is equipped with a metal case for shielding, and provides 20mV sensitivity with pushbutton attenuators for triggering. The LDC-824S has a temperature stability of 1ppm. The counter features an 8-digit display, selectable gate time and frequency/period modes and nominal impedance. An ovenized time base providing 0.03ppm stability is optional.

The LDC-824S is priced at \$550, and carries a 2-year warranty.

Circle (26) on Reply Card

"I USE THE AIR PUMP TO SAVE AT THE GAS PUMP."



"I found out that keeping my tires inflated to the highest level recommended by the manufacturer makes a big difference in my gas mileage. Checking the tire pressure takes just a couple of minutes — and it should save me about 40 gallons of gas this year!"

More stops at the air pump will save you stops at the gas pump. For a free booklet with more energy-saving tips, write "Energy," Box 62, Oak Ridge, TN 37830.

ENERGY.
We can't afford to waste it.

U.S. Department of Energy

IT'S NO PUZZLE 
TO ORDER
OELRICH SERVICE FORMS
 FOR TV-RADIO & 2 WAY RADIO SERVICE LEGAL FORMS FOR CALIF. FLA. UTAH NOW AT YOUR PARTS JOBBER OR WRITE FOR CATALOG B64
OELRICH PUBLICATIONS
 4040 N. NASHVILLE AVE. CHICAGO, ILLINOIS 60634

Circle (7) on Reply Card

themarketplace

Advertising rates in the Classified Section are 35 cents per word, each insertion, and must be accompanied by cash to insure publication.

Each initial or abbreviation counts a full word.

Minimum classified charge \$3.00.

For ads on which replies are sent to us for forwarding (blind ads), there is an additional charge of \$3.00 per insertion to cover department number, processing of replies, and mailing costs.

Classified columns are not open to advertising of any products regularly produced by manufacturers unless used and no longer owned by the manufacturer or a distributor.

Business Opportunity

MEN/WOMEN FOR FUN! Shaklee Independent Wholesale Distributors earn \$200-\$5,000 monthly. Bonus, New Car, Etc. Details, Golden, RT2, Box 392ES, Fair Grove, MO 65648 Phone (1-417) 759-2738. 3-79-12t

ESTABLISHED TV SALES & SERVICE business. Lease location back or purchase land, 2 bldgs. & business. Write or call Adams-Dycus Realty, 1016 Hartford Hwy., Dothan, Alabama, 36301. (205) 793-2200. 2-80-1t

For Sale

REPLACEMENT COLOR YOKES—DEALER ONLY. Zenith 95-2501-2532-2638-2667-S-89633 etc. \$19.94, Magnavox 361380-1 \$21.95, Sylvania, GE etc. \$17.95 to \$22.95. Request for price list on your letterhead. David Sims Enterprises, Inc., 665 Jericho Turnpike, Huntington Station, N.Y. 11746, (516) 549-3925. 5-79-1f

AUTOMOBILE RADIO and tape replacement parts: Delco, Chrysler, Philco-Ford, Motorola, Panasonic and many others. Large inventory. Laran Electronics, Inc., 3768 Boston Road, Bronx, NY 10469, (212) 881-9600, out of New York State, (800) 223-8314. 5-79-1f

TV & RADIO TUBES, 36 cents EA!! Free color catalog. Cornell, 4221 University, San Diego, California 92104. 8-76-1f

WHO'S FIRST? Make tests, contests, quiz bowls sparkle. Tell who pushes button first...any number buttons. Ingenious, low-cost, two-wire circuit. No relays, ICs, PCs or special parts. Build public relations loan rental, sales, to teachers, ministers, coaches, club leaders, party givers, sales motivators, etc. Illustrated plans \$5.00 postpaid. Wayne Lemons, Electronics Building R2, Buffalo, MO 65622. 1-80-3t

ELECTRONIC SURPLUS: CLOSEOUTS, LIQUIDATIONS! Parts, equipment stereo, industrial, educational. Amazing values! Fascinating items unavailable in stores or catalogs anywhere. Unusual FREE catalog. ETICO-011, Box 762, Plattsburgh, N.Y. 12901. 6-78-1f

SAVE HUNDREDS: AMERICAN MADE quality Head-Ends, V/V, U/V Converters, Camera Modulators. Mid-band available. Factory Prices. Also small CATV System amplifiers. Send \$5.00 (or letterhead). Box 809, Boynton Beach, Fla. 33435. 2-80-EOM

TV RENTAL SYSTEMS! Complete & guaranteed. Manual or computerized. Send \$2.00 for complete details. Perry's rental systems, 133 Brenda Street, Milton, Florida 32570. 2-80-tfn

PICTURE TUBE REBUILDING equipment capable of producing four high quality tubes per day. Will train to operate—\$3400. Call or write Atoll Television, 6425 Irving Park, Chicago, Illinois 60634. Ph: 312-545-6667. 2-80-3t

BUY FACTORY DIRECT: TV parts, semiconductors, antennas, chemicals. Prices below wholesale. Write: Midwest Semiconductor, 4411 W. North Ave., Milwaukee, WI 53208. 2-80-4t

UNIQUE 1" DIGITAL ALARM CLOCK, in your favorite 12 oz. beer or beverage can. Send \$5.00 for plans. R. Sanderford, 6400 Andy Drive, Raleigh, N.C. 27610. 2-80-1t

SENCORE VA-48 ANALYSER, 6 mos. old only used twice. New price \$1,095 - will sell for \$750. Bill Spiegel, 1639 Nash Ave., Pgh. Pa. 15235. (412) 795-3094 after 8 P.M. 2-80-1t

HELP WANTED

T.V. TECHNICIAN. Sharp, ability to manage. Relocate to suburb of San Francisco in sunny California. Excellent opportunity for ambitious, self-confident person. Send resume to: American T.V., 3309 Vincent Dr., Pleasant Hill, Ca. 94523. 2-80-1t

WHY NOT spend this winter in the warm California Desert? Attractive full service community...ideal working conditions...Health benefits...Paid vacations...Top pay for the right technician. Send resume to 225 E. Ridgecrest Blvd., Ridgecrest, California 93555. 2-80-tfn

EXPERIENCED TUNER TECHNICIAN needed. Start at \$4.00 per tuner, call toll free 1-800-433-7124. 2-80-1t

Electronic Servicing

Advertising Sales Offices

NATIONAL SALES MANAGER

Greg Garrison, P.O. Box 12901, Overland Park, KS 66212; Phone: (913) 888-4664

NEW YORK, NEW YORK

Joe Concert, 4 West 58th St., New York, NY 10019; Phone: (212) 888-1977

KANSAS CITY, MISSOURI

Helen Hull, P.O. Box 12901, Overland Park, KS 66212; Phone: (913) 888-4664

LOS ANGELES, CALIFORNIA

Herb Schlff, 3055 Wilshire Blvd., Los Angeles, CA 90010 Phone: (213) 387-0639

LONDON, ENGLAND

John Ashcraft & Co., 12 Bear St., Leicester Square, London, WC2H 7AS, England; Phone: 930-0525 Telex: 895-2387

AMSTERDAM, HOLLAND

John Ashcraft & Co., John J. Lucassen, Akerdijk 150A, 1171 PV-Badhoevedorp Holland; Phone: 2968-6226

TOKYO, JAPAN

International Media Representatives, Ltd., 2-29, Toranomon 1-chome, Minato-ku, Tokyo 105, Japan; Phone: 502-0656

advertisers' index

Enterprise Development Corp.	11
Gamit Enterprises	17
Klein Tools, Inc.	41
Liasion	IBC
NATESA	11
NESDA	17
Oelrich Publications	44
OK Machine & Tool Corp.	IFC
RCA Distributor & Special Products ...	22, 23, 29
Service Training	5
Thordarson Meissner Inc.	41
Zenith Radio Corp.	BC

GRAB THIS OPPORTUNITY

Attend

Key Electronics Upgrading Seminars

DAY 1 - TRIGGERED SCOPES Hands-On Workshop

Learn to manipulate modern scopes wisely and knowledgeably. Speed up troubleshooting of even the most complex equipment. This familiarization program explains controls for CRT, vertical input, time base, and triggering... plus advanced scope techniques. Scope displays become easy to analyze after this day-long session, with Forest Belt instructing.

DAY 2 - SOLID-STATE UPGRADING and Updating

Gain unexpected insight into new and established solid-state devices and technology. Practical, entertaining tips on solid-state circuitry teach you how to troubleshoot quickly. Industrial maintenance session covers higher-power solid-state devices and applications. Wayne Lemons instructs.

DAY 3 - DIGITAL ELECTRONICS for Home or Industry

Clear up mysteries of digital electronics: gates, flip-flops, R-S stages, truth tables, and more. Practical help in troubleshooting digital circuits. Instruments that make servicing clear and direct. An information-packed day that puts you on top of digital technology, whether for consumer or industrial electronics. James R. Manery and Forest Belt instruct.

LEARN FROM EXPERTS WHO SPEAK
YOUR LANGUAGE

★ Forest Belt

TRIGGERED SCOPES
Hands-On Workshop

VTR Servomechanisms - OPTIONAL

★ Wayne Lemons

SOLID-STATE UPGRADING
and Updating

★ Bob Manery

DIGITAL ELECTRONICS
for Home or Industry

Consumer or industrial electronics upgrading made easy.
Unique, concise tell-and-show methods, plus hands-on experience,
place new electronics technology at your fingertips.

BE THE BEST SERVICE TECH IN TOWN

Two Locations For Upgrading
Quickly and Effectively

Pittsburgh

March 12-14

VTR SERVOMECHANISMS

March 15

Pgh. Enrollment Deadline February 8

Los Angeles

April 13-15

VTR SERVOMECHANISMS

April 16

L.A. Enrollment Deadline March 7

Package Fees Include:

- Timely training
- Best teachers
- Carry-home manual
- Hands-on experience
- Certificate of training
- All workshop materials and functions
- Hotel room (double-occupancy)
- Meals

Seminar-Only Fees Include:

- Timely training
- Best teachers
- Carry-home manual
- Hands-on experience
- Certificate of training

**BE THERE,
ENROLL NOW!**

Pittsburgh

Los Angeles

Put me on LIAISON'S
mailing list.

FEES: 3-day Package \$950 4-day Package \$1100 3-day Seminar Only \$735 VTR Workshop Only \$200

Total Enclosed \$ _____ Check # _____ MO \$200 Deposit, Balance Due Feb. 20, 1980

Charge my Master Charge # _____ Expires _____ Signature _____

NAME _____ AGE _____ PHONE () _____

ADDRESS _____ COMPANY _____ TITLE _____

CITY _____ STATE _____ ZIP _____

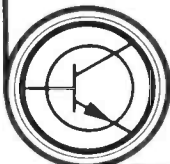

Liaison Electronics Seminars

(317) 253-7774

P. O. Box 40821

Indianapolis IN 46240

150,000 REASONS WHY YOU SHOULD SWITCH NOW TO THE BIGGEST, BROADEST-EVER LINE OF ZENITH UNIVERSAL SEMICONDUCTORS covering Zenith exact replacements plus the most popular types in the industry—all in a new catalog!

SYLVANIA TO ZENITH CROSS REFERENCE

DEVICE	CRSP
ECG109	103-Z9001
ECG123A	121-Z9000-A
ECG125	903-334
ECG154	121-777-01
ECG156	212-Z9000
ECG159	121-Z9003
ECG196	121-987-03
ECG506	103-287
ECG712	221-48
ECG5081	103-Z9000

RCA TO ZENITH CROSS REFERENCE

GE TO ZENITH CROSS REFERENCE

SK	
DEVICE	CRSP
SK3004/102	121-Z9004
SK3051/156	212-Z9000
SK3066/118	212-85
SK3083/197	121-988-03
SK3100/519	103-131
SK3115/165	121-1029
SK3119/113	103-101
SK3313/116	212-76-02
SK3444/123A	121-Z9000-A
SK3452/108	121-522

GE	
DEVICE	CRSP
GE-20	121-Z9000.A
GE-53	121-Z9007
GE-86	121-925
GE-217	121-Z9036
GE-504A	212-76-02
GE-512	212-Z9000
GE-514	103-131
GEIC-1	212-85
GEIC-13	221-45
GEIC-33	221-69



It's all under one numbering system that saves you time and adds value to any Zenith semiconductor you may already have in stock!

Switch now to Zenith Universal Semiconductor replacements and see how well your shop shapes up... your bottom line, too.

Shown here are just a few of the more than 150,000 cross-references in the July, 1979 edition of the Zenith Universal Semiconductor cross-reference guide.

Check with your Zenith distributor for your copy of Zenith's Universal Semiconductor cross-reference guide... and ask how you can enjoy the convenience of our special Tube Caddy/Benchtop Organizer.



The quality goes in before the name goes on®

Zenith Radio Corporation / Service, Parts & Accessories Division / 11000 Seymour Avenue / Franklin Park, Illinois 60131

Circle (2) on Reply Card