

Electronic Servicing



A HOWARD W. SAMS PUBLICATION

Curing Horizontal Oscillator Drift



*Sylvania Chroma
Digital Toggles
Betamax Chroma
Pricing Philosophy*

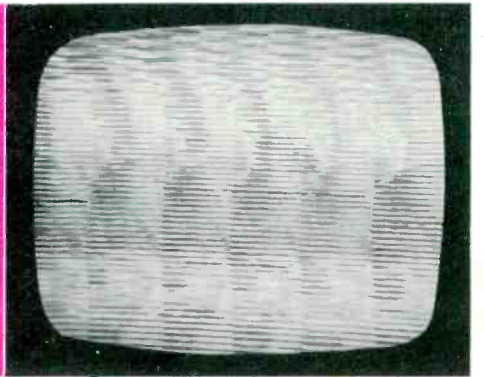
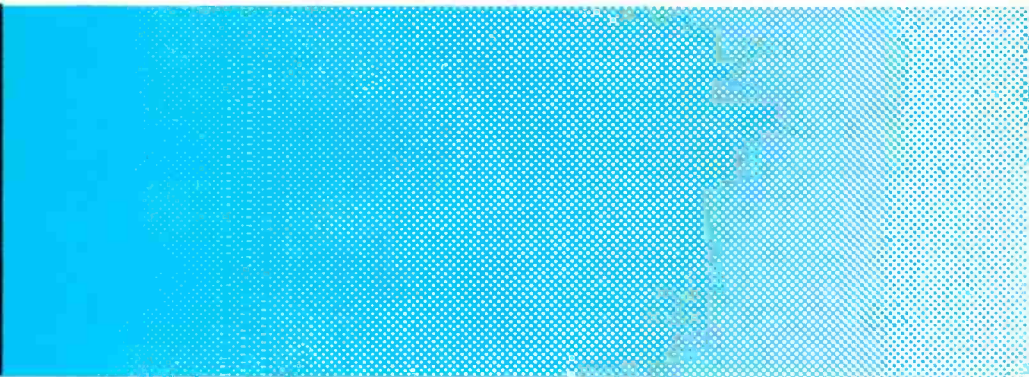
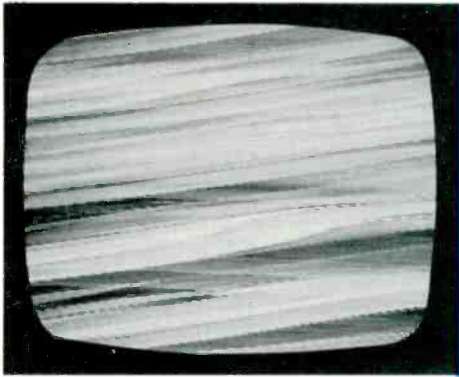

Tibor Komoroczy,
Service Manager
Howard Roach TV & Appliance
300 East Valley Blvd.
San Gabriel, CA 91776

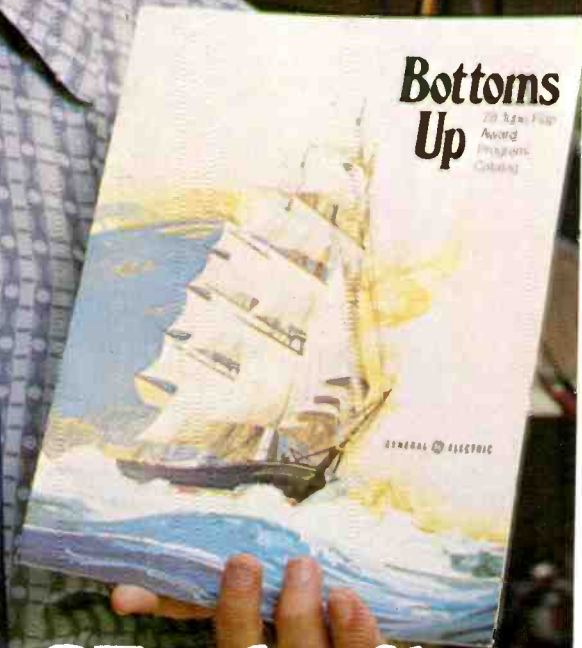

**“Don't throw away that GE tube flap
and lose award points. Get your
Bottoms Up Catalog and win!”**

Your reputation is our reputation

Tube Products Department · Owensboro, Kentucky 42301

GENERAL  ELECTRIC

Electronic Servicing®

Contents

14 Curing Horizontal Oscillator Drift, Part 1—Tips for locating defective parts and making stabilizing adjustments for the cathode-coupled multivibrator oscillator are discussed. Other types will be covered next month—*Wayne Lemons.*



page 14

20 The Basics Of Industrial Electronics, Part 13—The versatile 555 timer IC is described as a clock oscillator. Also, one way to toggle J-K flip flops is illustrated—*J.A. "Sam" Wilson.*

26 Service Management Seminar, Part 7—If you are reluctant to begin the higher rates you know you should charge, then you need all of the facts plus a "philosophy of pricing."—*Dick Glass.*

30 Servicing Sylvania Color TV, Part 6—Chroma functions of the E44 chassis are explained in detail, including identification of the IC pins according to those functions—*Gill Grieshaber.*

38 Sam Wilson's Technical Notebook—A pulse of signal leaves the material with some magnetism, which can be "read" as a logic 1, by proper methods. Also discussed are facts about diode recovery time, and the protection of series diodes—*J.A. "Sam" Wilson.*

45 Servicing Betamax Videotape Recorders, Part 3—Both the typical methods and the specific Betamax circuits for recording chroma are presented—*Harry Kybett.*

About the Cover—These pictures illustrate some visual symptoms of wrong horizontal-oscillator frequency or phase. Photography by Carl Babcoke, with the graphic design by Mary Christoph.

DEPARTMENTS	
4 Electronic Scanner	49 Antenna Systems
6 Symcure	50 Audio Systems
7 Troubleshooting Tips	51 Test Equipment
8 Service Associations	52 The Marketplace
11 Reader's Exchange	52 Advertisers' Index
48 Product Report	

Second class postage paid at Shawnee Mission, Kansas and additional mailing offices. Published monthly at 9221 Quivira Road, Overland Park, Kansas 66212 by Intertec Publishing Corp., 9221 Quivira Road, Overland Park, Kansas 66212. Send Form 3579 to 9221 Quivira Road, P.O. Box 12901, Overland Park, Kansas 66212.

©Copyright, 1978, Howard W. Sams & Co., inc. All rights reserved. Material may not be reproduced or photocopied in any form without written permission of publisher.

Urgent.

Other phone answering machines only take calls. Ours calls you.

Dictaphone announces a system that not only records messages, but calls you and delivers them.

It's our new Ansafone 696 telephone answering system.

After it records a message, it will ring any number you tell it to — including a beeper service, if you have one.

Ansafone 696 means you never need to miss an urgent call — no matter where you are.

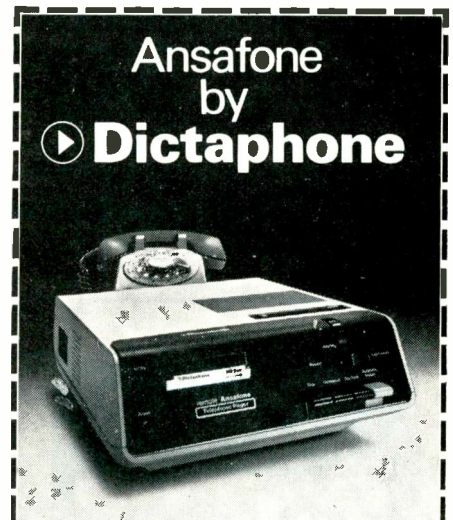

Ansafone
by
▶ Dictaphone

For more information on Ansafone 696, fill in the coupon or call toll-free:

800-431-1710

(In New York call 914-967-3810)

Name _____

Title _____

Phone _____

Company _____

Address _____

City _____ State _____ Zip _____

**Mail to: Dictaphone Corporation
105 Oak Street
Norwood, New Jersey 07648**

Dictaphone and Ansafone are trademarks of Dictaphone Corporation, Rye, N.Y. IES-078

Circle (2) on Reply Card

You can be sure

more times in more circuits in more places
than with any other multimeters on the market today

Each Sencore DVM is backed with 15 Megohm input impedance for one third less circuit loading on every measurement. That means 50% higher accuracy than other DVMs.

DVM38 \$395

3½ DIGIT .1% DCV ACCURACY AUTO-RANGING DVM

A "prime" standard at your fingertips for measurements you can trust. Auto-ranging for extended low-level range and ease of operation. 15 Megohm input impedance assures .1% reading accuracy is maintained in solid state circuits. Highly sensitive, yet fully protected to 2000 VDC overloads. Hi-Lo Power Ohms circuit simplifies in-circuit resistance measurements.

DVM37 ^{New} \$268

3½ DIGIT .1% DCV ACCURACY PORTABLE DVM

Prime standard .1% accuracy on the bench or in the field for less than \$250. The DVM37 is the most accurate portable DVM you can buy, with 15 Megohm input impedance for 50% more accuracy. Includes automatic features—Auto Zero, Polarity, Decimal, Overrange. Fully protected inside to over 2000V on all functions, including Ohms, and protected outside with super-rugged case. Full ranges for every test. Fingertip "Push-On" switch in probe saves batteries as power is applied only when needed.



New DVM37

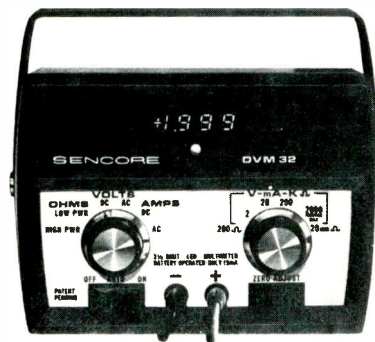

DVM32

DVM32 \$225

3½ DIGIT .5% DCV ACCURACY PORTABLE DIGITAL MULTIMETER

Bench and field master for digital accuracy measurements anywhere. 0.5% DCV accuracy, backed with 15 Megohm input impedance. Exclusive battery-saving Auto-Display turns the display on automatically when you make a measurement. 2000V input protection on all functions and ranges—including Ohms.

DVM36 \$158

3½ DIGIT .5% DCV ACCURACY POCKET PORTABLE DVM

Pocket portable lab accurate performance that fits every budget with highest performance-to-price benefits of any meter. .5% DCV accuracy, backed with 15 Megohm input impedance for lowest circuit loading. Full protection to 1000 V on all functions and ranges—including ohms. Drop-proof case. Battery-saving "Push On" button in probe.

DVM35 \$134

3 DIGIT 1% DCV ACCURACY POCKET PORTABLE DVM

Fast, direct reading digital accuracy for the man on the go. Same features as DVM36, except 3-digit, 1% DCV accuracy, backed by 15 Megohm input impedance that is ten times more accurate than analog meters.



DVM38



DVM36

SENCORE
DIGITAL MULTIMETER SPECIALISTS
3200 Sencore Dr., Sioux Falls, SD 57107 (605) 339-0100

In stock at your favorite local
Sencore Full Line Distributor.

Circle (3) on Reply Card

Electronic Servicing

Editorial, advertising and circulation correspondence should be addressed to: 9221 Quivira Road, P.O. Box 12901, Overland Park, Kansas 66212 (a suburb of Kansas City, Missouri). (913) 888-4664.

EDITORIAL

CARL H. BABCOKE, Editor
MICHAEL SCHEIBACH, Managing Editor
DUDLEY ROSE, Art Director
HILLARY MANES, Editorial Assistant
MARY CHRISTOPH, Graphic Designer

EDITORIAL ADVISORY BOARD

LES NELSON, Chairman
Howard W. Sams & Co., Indianapolis
JOE A. GROVES, Technical Consultant
Howard W. Sams & Co., Indianapolis

CIRCULATION

JOHN C. ARNST, Director
EVELYN ROGERS, Manager



Member, American Business Press
Member, Audit Bureau of Circulations

ADMINISTRATION

GEORGE H. SEFEROVICH, President
GEORGE LAUGHEAD, Publisher

ADVERTISING SALES

Overland Park, Kansas 66212
(a suburb of Kansas City, Missouri)
Phone: (913) 888-4664

MARILYN CARROLL, Production
Regional and Advertising Sales Offices
with Advertising Index

ELECTRONIC SERVICING (with which is combined PF Reporter) is published monthly by Intertec Publishing Corp., 9221 Quivira Road, Overland Park, KS 66212.

ELECTRONIC SERVICING is edited for technicians who repair home-entertainment electronic equipment (such as TV, radio, tape, stereo, and record player) and for industrial technicians who repair defective production-line merchandise, test equipment, or industrial controls in factories.

Subscription prices to qualified subscribers: 1 year—\$8.00, 2 years—\$13.00, in the USA and its possessions. All other foreign countries: 1 year—\$11.00, 2 years—\$19.00. Subscription prices to all others: 1 year—\$25.00, 2 years—\$50.00, in the USA and its possessions. All other foreign countries: 1 year—\$34.00, 2 years—\$68.00. Single copy price \$2.25; back copies \$3.00. Adjustment necessitated by subscription termination to single copy rate. Allow 6-8 weeks delivery for change of address. Allow 6-8 weeks for new subscriptions.



INTERTEC PUBLISHING CORP.
Subsidiary of HOWARD W. SAMS & CO., INC.

ELECTRONIC SERVICING

AVAILABLE NOW!

ONLY \$ 5.90

Add \$1.00 postage and handling
JAPANESE TRANSISTOR SUBSTITUTION MANUAL

JULY SPECIAL

DON'T MISS OUT THIS TIME!

ORDER NOW!

LIMITED Q'TY



An invaluable Japanese to Japanese substitution guide for approximately 3000 transistors.

* Covers the 2SA, 2SB, 2SC, and 2SD series.

* Introduction includes a guide to understanding Japanese transistors.

* A 90 page, 8 1/2" by 11", soft cover book.

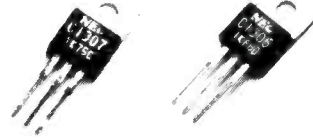

2SC 1306 **\$1.90** REG **\$2.90**
2SC 1307 **\$2.90** REG **\$3.90**

NO FURTHER DISCOUNT
ON SPECIAL OFFER

Seeking Original Japanese Replacement Parts for CB, TV and Stereo Repair Use?

2SA		2SA 744 4.90	2SB 537 1.60	2SC 696 1.95	2SC 1115 4.40	2SC 1675 .59	2SD 313 1.10	HA 1156 3.00	TA 78012M 6.60
2SA 49 .59	2SA 745R 4.90	2SB 539 4.90	2SC 708 1.90	2SC 1116 4.90	2SC 1678 2.25	2SD 314 1.20	HA 1158 5.30	TA 78012P 5.80	
2SA 52 .59	2SA 747 5.80	2SB 541 4.40	2SC 710 4.45	2SC 1116A 6.60	2SC 1679 4.25	2SD 315 1.20	HA 1159 5.80	TA 78015M 6.50	
2SA 53 .59	2SA 748 1.00	2SB 554 10.00	2SC 711 .45	2SC 1124 1.30	2SC 1681 .70	2SD 325 1.10	HA 1196 4.90	TA 78015P 5.80	
2SA 70 1.10	2SA 750 .59	2SB 556 4.90	2SC 712 .59	2SC 1127 1.40	2SC 1682 .45	2SD 330 1.00	HA 1197 3.90	TBA 810 SH 3.70	
2SA 101 .45	2SA 755 1.60	2SB 557 3.40	2SC 717 .59	2SC 1161 1.90	2SC 1684 .59	2SD 341 5.60	HA 1201 1.50	TC 5080P 5.80	
2SA 102 .59	2SA 756 3.70	2SB 561B 7.00	2SC 727 1.90	2SC 1162 1.00	2SC 1687 .70	2SD 350 5.90	HA 1202 2.25	TC 5081P 3.40	
2SA 234 .59	2SA 758 5.80	2SB 564 7.00	2SC 730 4.40	2SC 1166 .59	2SC 1688 .70	2SD 352 .90	HA 1211 1.50	TC 5082 3.90	
2SA 235 1.00	2SA 764 4.40	2SB 595 1.90	2SC 731 5.80	2SC 1167 6.60	2SC 1708 .59	2SD 356D 1.10	HA 1306W 3.70	TD 3505AP 8.50	
2SA 240 .90	2SA 765 4.90	2SB 596 1.60	2SC 732 .59	2SC 1170B 6.60	2SC 1728 1.90	2SD 357D 1.00	HA 1322 4.40	UHC 002 5.80	
2SA 329 .70	2SA 774 .59	2SB 600 7.00	2SC 733 .59	2SC 1172B 8.50	2SC 1730 .59	2SD 358 1.30	HA 1339 4.40		
2SA 342 .90	2SA 777 1.00		2SC 734 .59	2SC 1173 .90	2SC 1756 1.40	2SD 359 1.00	HA 1339A 4.40	UHC 004 5.80	
2SA 353 .70	2SA 794A 1.00	2SC		2SC 1175 .90	2SC 1760 1.90	2SD 360 1.20	HA 1342A 4.40	UHC 005 5.80	
2SA 377 2.00	2SA 798 .70	2SC 183 .59	2SC 735 .59	2SC 1177 14.00	2SC 1765 8.80	2SD 361 1.00	LA 1111P 2.50	UPC 20C 4.40	
2SA 436 2.50	2SA 814 1.90	2SC 184 .59	2SC 738 .59	2SC 1189 1.20	2SC 1775 .45	2SD 370 3.00	LA 1201 2.50	UPC 41C 3.70	
2SA 440 .90	2SA 815 1.00	2SC 185 .59	2SC 756A 3.00	2SC 1209 .70	2SC 1816 3.90	2SD 371S 2.80	LA 1364 4.40	UPC 554C 2.80	
2SA 473 .70	2SA 816 .70	2SC 281 .59	2SC 763 .59	2SC 1211D .50	2SC 1846 .70	2SD 380 7.60	LA 3300 3.00	UPC 555H 2.25	
2SA 483 3.00	2SA 818 1.30	2SC 283 .59	2SC 772 .45	2SC 1212A 1.40	2SC 1885 .70	2SD 381 1.40	LA 3301 3.00	UPC 563 3.70	
2SA 484 2.50	2SA 837 2.80	2SC 284 1.20	2SC 773 .70	2SC 1213 .70	2SC 1908 .59	2SD 382 1.40	LA 4030P 3.40	UPC 566H 1.60	
2SA 485 2.00	2SA 839 2.15	2SC 317 1.20	2SC 774 2.00	2SC 1215 .70	2SC 1909 3.90	2SD 388 3.40	LA 4031P 3.00	UPC 576 3.70	
2SA 489 1.60	2SA 841 .59	2SC 352A 2.50	2SC 775 1.95	2SC 1222 .45	2SC 1913 1.20	2SD 388A 4.40	LA 4032P 3.40	UPC 577H 2.25	
2SA 490 .90	2SA 847 .59	2SC 353A 2.50	2SC 776 2.65	2SC 1226A .90	2SC 1945 5.60	2SD 389 .90	LA 4051P 3.70	UPC 592HZ 1.60	
2SA 493 .59	2SA 850 .59	2SC 367 .90	2SC 777 3.50	2SC 1237 2.25	2SC 1951 1.10	2SD 390 1.00	LA 4400 3.70	UPC 1001H 4.90	
2SA 495 .45	2SA 872A .59	2SC 369 .59	2SC 778 3.60	2SC 1239 3.90	2SC 1957 1.20	2SD 421 8.50	LD 3120 2.50	UPC 1008C 7.00	
2SA 496 1.10	2SA 885 .70	2SC 371 .59	2SC 781 2.65	2SC 1279 7.00	2SC 1969 4.90	2SD 424 8.50	M51513L 4.90	UPC 1016C 3.00	
2SA 497 1.60	2SA 908 11.00	2SC 372 .45	2SC 783R 3.60	2SC 1306 2.90	2SC 1973 1.10	2SD 425 6.50	M5152L 2.50	UPC 1020H 3.70	
2SA 505 1.20	2SA 913 1.20	2SC 373 .45	2SC 784 .59	2SC 1307 3.90	2SC 1974 1.90	2SD 426 4.60	M51841P 2.80	UPC 1025 3.40	
2SA 509 .70		2SC 374 .59	2SC 785 .59	2SC 1310 .59	2SC 1975 4.40	2SD 427 3.00	M5320P 2.25	UPC 1026C 3.70	
2SA 525 .70	2SB		2SC 789 1.00	2SC 1312 .59	2SC 2028 .90	2SD 525 1.60	M53273P 2.80	UPC 1032 2.25	
2SA 530 1.30	2SB 22 .59	2SC 380 .59	2SC 790 1.40	2SC 1313G .59	2SC 2029 3.90	2SD 526 1.10	M53274P 2.50	UPC 1152H 3.40	
2SA 537A 2.25	2SB 54 .59	2SC 381 .59	2SC 793 2.80	2SC 1316 8.50	2SC 2074 1.90	2SD 555A 6.60	M53393 7.60	UPC 1156 3.00	
2SA 539 .59	2SB 55 .59	2SC 382 .59	2SC 799 3.60	2SC 1317 .45	2SC 2076 .59	2SD 610 1.90	M54370 P 8.80		
2SA 545 .59	2SB 75 .45	2SC 383 .90	2SC 802 3.60	2SC 1318 .45	2SC 2091 2.80		MP5 U31 1.90	UPD 858C 9.50	
2SA 561 .59	2SB 77 .45	2SC 387A .59	2SC 815 .59	2SC 1325A 7.60	2SC 2092 3.90	SG 613(tv) 5.95	STK 011 7.60	PLL 01A 8.80	
2SA 562 .59	2SB 88 .45	2SC 388A 1.00	2SC 828 .45	2SC 1327 .59	2SC 2098 4.90		STK 014 9.50	PLL 02A 8.80	
2SA 564A .59	2SB 173 .45	2SC 394 .59	2SC 829 .45	2SC 1330 .70			STK 015 6.60	SN 7400 .19	
2SA 565 1.10	2SB 175 .45	2SC 403 .59	2SC 830H 5.90	2SC 1335 .70			STK 016 8.50	SN 7490 .60	
2SA 566 3.40	2SB 176 .45	2SC 430 .90	2SC 838 .59	2SC 1342 .59			STK 022 11.00		
2SA 606 1.60	2SB 178 .70	2SC 454 .59	2SC 839 .59	2SC 1344 .59	2SD 16 5.90	2SK 198L .90	STK 032 14.00	DIODES	
2SA 607 1.60	2SB 186 .45	2SC 458 .59	2SC 853 .90	2SC 1345D .59	2SD 28 2.50	2SK 23 1.10	STK 032 14.00	78L05 1.10	
2SA 624 1.10	2SB 187 .45	2SC 460 .59	2SC 867 4.25	2SC 1346 .70	2SD 72 1.10	2SK 30 .70	STK 435 8.50	IS 84 .60	
2SA 627 3.60	2SB 202 1.60	2SC 461 .59	2SC 870 .59	2SC 1347 .70	2SD 75 .90	2SK 33 1.10	STK 439 11.00	IS 188 .25	
2SA 628 .59	2SB 220 .70	2SC 478 1.10	2SC 871 .59	2SC 1348 .59	2SD 77 .59	2SK 34 1.10	STK 502 8.80	IS 332 .45	
2SA 634 .70	2SB 303 .59	2SC 481 1.60	2SC 895 4.90	2SC 1359 .59	2SD 81 3.00	2SK 41 1.10	STK 503 9.60	IS 953 .25	
2SA 640 .59	2SB 324 .70	2SC 482 1.50	2SC 897 3.40	2SC 1360 1.00	2SD 90 1.60	2SK 49 1.30	TA 7045M 3.00	IS 1007 .45	
2SA 642 .70	2SB 337 1.60	2SC 484 1.60	2SC 898 4.40	2SC 1362 .59	2SD 91 1.60	2SK 55 1.30	TA 7054P 2.50	IS 1209 .45	
2SA 643 .70	2SB 346 .70	2SC 485 1.60	2SC 900 .45	2SC 1364 .70	2SD 92 1.90	2SK 61 1.40	TA 7055P 3.00	IS 1211 .45	
2SA 653 2.80	2SB 367 1.50	2SC 486 1.60	2SC 923 .45	2SC 1377 4.90	2SD 93 2.80	2SK 68 1.30	TA 7060P 1.60	IS 1555 .25	
2SA 659 .59	2SB 368B 2.15	2SC 493 3.90	2SC 929 .45	2SC 1383 .59	2SD 118 4.40	2SK 22Y 2.50	TA 7061AP 1.90	IS 1588 .25	
2SA 661 .70	2SB 379 1.10	2SC 495 .90	2SC 930 .45	2SC 1384 .59	2SD 130 1.20	2SK 35 2.25	TA 7062P 1.90	IS 1885 .25	
2SA 663 4.90	2SB 381 .59	2SC 496 .90	2SC 941 .59	2SC 1396 7.00	2SD 141 1.40	2SK 37 3.00	TA 7063P 1.60	IS 2076 .25	
2SA 666 .70	2SB 400 .59	2SC 497 1.60	2SC 943 .70	2SC 1398 1.10	2SD 142 2.80	2SK 39 2.25	TA 7064P 1.90	IS 2093 .45	
2SA 671 1.40	2SB 405 .59	2SC 509 .70	2SC 945 .45	2SC 1400 .59	2SD 143 2.80	2SK 40 2.25	TA 7066P 2.00	IS 2473 .25	
2SA 672 .70	2SB 407 1.40	2SC 515A 1.40	2SC 959 1.50	2SC 1402 4.90	2SD 178 1.10	2SK 41 2.50	TA 7074P 4.90	IN 34 .25	
2SA 673 .70	2SB 415 .59	2SC 517 3.95	2SC 971 1.00	2SC 1403 4.90	2SD 180 2.50	2SK 45 2.50	TA 7075P 4.90	IN 60 .25	
2SA 678 .70	2SB 434 1.20	2SC 535 .59	2SC 982 .90	2SC 1407 .90	2SD 187 .59	2SK 48 5.90	TA 7076P 3.00	1001 .60	
2SA 679 4.90	2SB 435 1.40	2SC 536 .59	2SC 983 1.00	2SC 1419 1.10	2SD 188 3.00	2SK 49 2.50	TA 7079P 4.90	10010 .40	
2SA 680 4.90	2SB 440 .59	2SC 537 .59	2SC 984 .90	2SC 1444 2.80	2SD 201 3.40	2SK 49 2.50	TA 7080P 4.90	VD 6B .40	
2SA 682 1.50	2SB 449 1.60	2SC 538A .70	2SC 994 3.90	2SC 1445 3.00	2SD 202 3.90	MK 10 2.00	TA 7106P 4.90	VD 6C .40	
2SA 683 .70	2SB 461 1.20	2SC 562 .70	2SC 996 3.40	2SC 1447 1.60	2SD 204 1.40		TA 7108P 3.40		
2SA 684 .70	2SB 463 1.20	2SC 563 1.10	2SC 1000BL .59	2SC 1448 1.60	2SD 205 1.40		TA 7109P 3.40		
2SA 695 .70	2SB 471 1.60	2SC 605 .70	2SC 1012 1.50	2SC 1449 1.00	2SD 213 5.90		TA 7120P 1.90	ZENER DIODES	
2SA 697 .70	2SB 473 1.20	2SC 619 .59	2SC 1013 1.10	2SC 1451 2.25	2SD 217 4.40	AN 203 2.50	TA 7122AP 1.90	WZ 050 .45	
2SA 699A .90	2SB 474 1.00	2SC 620 .59	2SC 1014 1.10	2SC 1454 5.60	2SD 218 4.40	AN 214Q 3.00	TA 7124P 1.60	WZ 052 .45	
2SA 705 .70	2SB 481 1.20	2SC 627 2.25	2SC 1017 1.40	2SC 1475 1.40	2SD 220 2.50	AN 217 1.90	TA 7129P 1.90	WZ 061 .45	
2SA 706 1.60	2SB 492 1.00	2SC 631 .90	2SC 1018 1.20	2SC 1478S 7.00	2SD 223 1.90	AN 239 7.00	TA 7130P 2.80	WZ 071 .45	
2SA 715 1.40	2SB 507 1.60	2SC 632A .45	2SC 1030C 2.80	2SC 1509 1.10	2SD 224 1.90	AN 247 4.40	TA 7136P 4.20	WZ 075 .45	
2SA 719 .59	2SB 509 1.60	2SC 634A .59	2SC 1047 .70	2SC 1567 1.10	2SD 226A 1.60	AN 274 3.40	TA 7146P 4.40	WZ 081 .45	
2SA 720 .59	2SB 511 1.10	2SC 642A 5.90	2SC 1051 4.40	2SC 1567A 1.10	2SD 227 .45	AN 277B 2.40	TA 7150P 4.40	WZ 192 .45	
2SA 721 .59	2SB 514 1.90	2SC 644 .45	2SC 1060 1.40	2SC 1584 8.50	2SD 234 1.00	AN 315 3.00	TA 7159P 2.50	WZ 260 .45	
2SA 725 .59	2SB 523 1.00	2SC 645 .70	2SC 1061 1.40	2SC 1586 7.60	2SD 235 1.00	AN 328 3.90	TA 7200P 4.60	WZ 280 .45	
2SA 726 .59	2SB 525 1.30	2SC 650 1.30	2SC 1069 39.00	2SC 1624 1.30	2SD 236 1.60	AN 362 3.00	TA 7201P 4.60		
2SA 733 .59	2SB 527 1.60	2SC 665H 8.50	2SC 1079 5.90	2SC 1626 1.10	2SD 255 1.60	BA 511 2.90	TA 7203P 3.70		
2SA 738 .70	2SB 528D 1.60	2SC 668 .45	2SC 1080 4.40	2SC 1628 1.30	2SD 261 .60	BA 521 2.90	TA 7204P 3.40		
2SA 740 2.65	2SB 529 .90	2SC 680 2.80	2SC 1096 1.00	2SC 1647 1.00	2SD 287 3.70	HA 1137 4.90	TA 7205P 2.90		
2SA 743A 1.60	2SB 530 4.40	2SC 681A 5.80	2SC 1098 1.10	2SC 1667 3.40	2SD 288 1.40	HA 1138 4.40	TA 7310P 3.95		
	2SB 531 3.4								

electronicscanner

news of the industry

Introduced by Abbott Laboratories is a microprocessor-controlled analyzer that detects serum hepatitis in blood intended for transfusions. As reported in *Electronics*, the analysis detects the color changes of blood samples when they are mixed with enzymes of certain kinds. A photometer which is sensitive to two light colors measures the light coming through the liquids in a test tube, and the microprocessor changes the signal to absorbance units, prints out the test results, and marks those containing the hepatitis antigen. Used with the microprocessor are a voltage-to-frequency converter, and a counter-timer.

Analog primary field telephones soon will be replaced by digital phones in the U.S. Air Force. Tests of the 25 samples show several advantages, such as: the ability to handle conference calls; four levels of priority, including an override for urgent messages; and no degradation of voice quality over long distances. According to an article in *Electronics*, the Tri-Tac phone system uses Continuously-Variable-Slope Delta Modulation (CVSD) that is non-synchronous. To prevent phase inversions, a diphasic type of modulation is used during transmission; then for reception, the modulation is stripped away. The ICs have a combination of PL and CMOS logic for low power drain.

Ford Motors has an automated optical-inspection unit on the production line. Optical sensors connected to a microcomputer automatically measure the axle gear ratio of 21,000 axles per day. *Electronics* described the unit, and commented that this is a trivial job for a sophisticated microcomputer, but additional automation is planned. Eventually, the system will determine the model of car for each axle, fill axles with the proper level of grease, and measure the dimensions of brake drums. A laser engraver makes metal tags that will be placed on axles listing the model number, axle ratio, the manufacturing date, and the shift.

RCA ColorTrak TVs for 1979 have ChannelLock, a frequency-synthesis tuning system with crystal control that eliminates any need for fine tuning on AFT. The tuning system is said to be available in 27 models.

The "System 3" color-TV line from Zenith has six major and three minor modules that contain most of the circuitry. Even the high-voltage components are on a module; only the large power-supply parts are located on the chassis. The Zenith service department states that no soldering is required to replace any module or other large component, including the power transformer. This design should minimize any need for bench repairs.

Sony offers a subscription microfiche service for all Sony parts. A package of 18 4" x 6" microfiche cards replaces 3,726 pages of printed material. The cards contain the part number, description, available substitutions, price to the servicer, and retail list price. A new packet of 18 cards will be mailed each month to maintain a continuous update, and the price to Sony dealers and authorized service agencies is \$4 per month.

Total United States market sales of color television receivers to dealers increased by 21.0% in April, 1978 compared with the same month last year and monochrome sales increased 7.8% according to the EIA.

Anyone can be replaced.

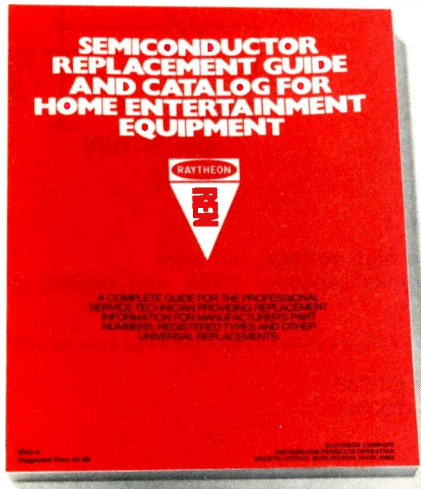

Raytheon did it.

We just made it easier for you to replace more than 100,000 semiconductors. We did it by replacing the old RE number system with easier-to-use, universal REN numbers.

Now all 362 different types (including 67 new types) of our semiconductors for home entertainment service are at your fingertips faster. Without the fuss and bother of cross-referencing numbers. Our new numbering

system exactly corresponds to the one most often used by the service industry. Best of all for you, our streamlined product line meets 95% of your service needs.

But that's all we changed. Using this new red book still opens the way to all of Raytheon's famous advantages. Highest quality. Highest availability. Immediate delivery.

Our new replacement guide and a new inventory starter kit, REN-K2494, are immediately available at your Raytheon distributor. Get this coupon to your distributor, or directly to us. Raytheon Company, Distributor Products Division, Fourth Avenue, Burlington, MA 01803. 617/272-6400.

Rush me a copy of your new Raytheon semiconductor replacement guide.

- I presently use Raytheon semis.
- I am not presently using Raytheon semis.
- I want more info on the REN-K2494 Starter Kit.



The name of my semiconductor distributor is _____

My name _____

Address _____

City _____ State _____ Zip _____

Circle (5) on Reply Card

Chassis—Admiral 9M50
PHOTOFACT—1694-1

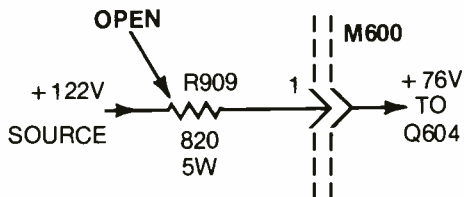

Symptom—No high voltage
Cure—Check R909, and replace if open. Also check T600 and Q604 for damage

Chassis—RCA CTC40
PHOTOFACT—111-3

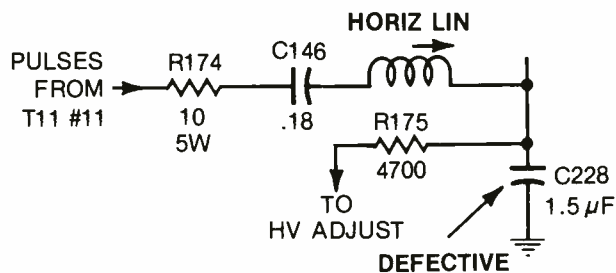

Symptom—No high voltage, hot odor
Cure—Check yoke capacitor C228, and replace it if defective

Chassis—General Electric 19JA
PHOTOFACT—1328-2

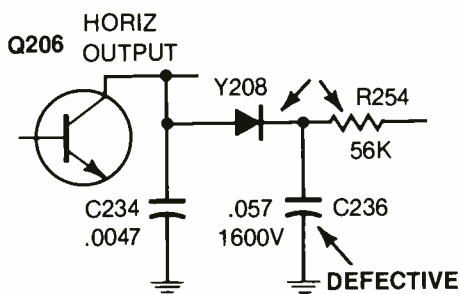

Symptom—Dark picture, screen controls don't work
Cure—Check the components marked by arrows, and replace if bad

Chassis—RCA CTC38
PHOTOFACT—1000-3

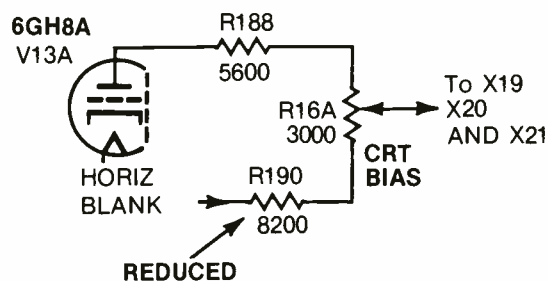

Symptom—Picture is too bright
Cure—Check resistor R190, and replace it if reduced in value

Chassis—Magnavox T952
PHOTOFACT—1293-1

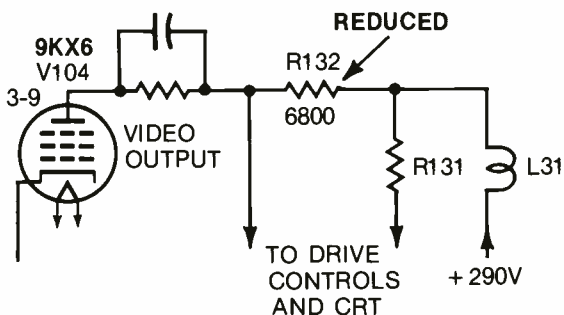

Symptom—Dark picture, screen controls operate okay
Cure—Check resistor R132, and replace if reduced in value

Chassis—Zenith 14DC15
PHOTOFACT—1363-2

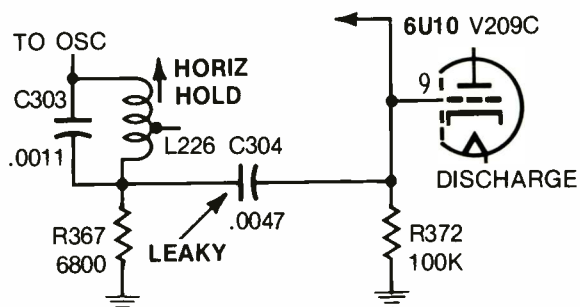

Symptom—Narrow picture, too bright, no horiz. locking
Cure—Check C304, and replace it if leaking

troubleshootingtips

No top convergence Zenith 14Z8C50

(Photofact 1106-3)

During a preliminary diagnosis in the customer's home, the color-TV performance seemed to be normal, except for the bad picture tube. After the picture tube was replaced in the shop, all of the purity and convergence adjustments were proceeding as usual, until I reached the vertical "top" adjustments. None of these three controls had any effect.

From past troubleshooting experiences, I knew which convergence components can cause such a problem. Unfortunately, none of them were bad. Next, I reasoned that if the convergence components were okay, then the defect must be in the AC signal voltages. In this case, all three controls are supposed to obtain a signal from the cathode circuit of the 6HE5 vertical-output tube.

DC voltages of the 6HE5 were about right, so I dragged out the scope to check the waveforms.

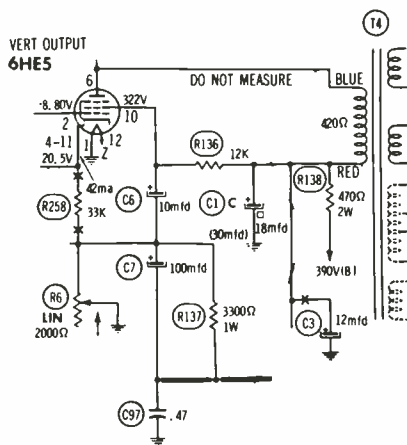

(Waveform analysis is not often helpful with convergence problems, except as here where the driving signal might be bad or missing.)

When C7 was disconnected, the pulses at the cathode changed to sawteeth, but the convergence didn't return. Disconnecting C97 made no change.

After working for too long without any success, I finally remembered that these Zenith terminal strips give more trouble than the

actual components do. I disconnected all of the wires and components from the terminal strip that's common to C96, C7, and R137. I connected them together at the next point of the circuit, and the convergence operated normally. Returning to the empty lug of the terminal strip, I measured a 1,000-ohm short to ground.

Defects are where you find them, and some occur in the wiring and electrical connections. This terminal strip is not shown on the schematic.

Phillip M. Jones, CET
Martinsville, Virginia

Lightning damage General Electric 19QB

(Photofact 1471-1)

According to the customer, he was watching the TV when lightning struck nearby, and at that instant the TV lost both sound and picture. This *seemed* to be a routine repair to replace the components usually zapped by lightning transients.

First, I checked F401 and Y400 power-supply diode, finding (as expected) that the fuse was open and the diode was shorted. However, the TV refused to operate after these parts were replaced.

The power supply voltages tested okay until I reached the 22.3-volt supply (and the others obtained from it). This supply originates as B+ from rectified horizontal sweep, followed by a transistor regulator. These facts and symptoms pointed toward a loss of horizontal sweep.

No pulses were found at the anode of Y402, the 29.8-volt scan

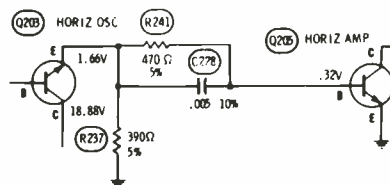

rectifier. Tracing back from the horizontal output, I could find no horizontal signals anywhere, even at

continued on page 8

GTS-10

our new model of
General Television Servicer

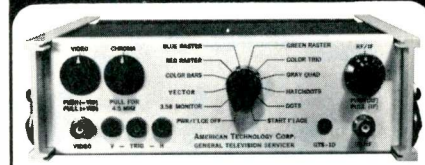

The original General Television Servicer, model ATC-10, set new standards of performance and versatility that far surpassed ordinary color bar pattern generators.

Our new model, the GTS-10, now introduces still more time and money saving features like 4.5 MHz Sound Carrier . . . Blue Raster . . . Green Raster . . . Color Trio. The model GTS-10, with in-home portability, replaces an ordinary color bar pattern generator and includes most of the capabilities of a substitute tuner and an analyst. It also provides capabilities that none of these other instruments can match.

Advanced yet sensibly priced at \$349.00 the GTS-10 is the ultimate instrument on the TV service equipment market.

Write for comprehensive 6 page full color brochure that describes these and many more features.

Telephone orders on VISA and MASTER CHARGE accepted for same day shipment.

2 year factory warranty against all failures in normal use.

30 day money back guarantee.



AMERICAN
TECHNOLOGY
CORPORATION

255 Main Street, Dept. 11, Canon City, CO 81212
Phone (303) 275-8991

ES07

Circle (6) on Reply Card



WE'RE GROWING!

to better represent

YOU

the successful service
business operator.

*Over 2500 firms belong

*39 State Affiliates

*167 Local Associations

YOU CAN JOIN!

and learn how to make
money and work less hours.

Write today for a
membership application
and more information.

1715 Expo Lane
Indianapolis, Indiana 46224
Phone (317) 241-8172

APPLIANCE REPAIR BOOKS



Thirteen Handbooks written in easy-to-understand language by experts in the service field with illustrations and diagrams! Acclaimed by instructors and professionals alike! How to diagnose and repair air conditioners, refrigerators, washers, dryers, ranges, microwave ovens, dishwashers, vacuum cleaners, electrostatic air cleaners, RV gas appliances, hair dryers, motors, water heaters, coffeemakers, can openers, floor polishers, steam irons, food mixers, lawn care appliances, electric knives, electric and digital clocks and many others. Also fundamentals of solid state, setting up a shop, using test instruments and more. Only \$2.65 to \$4.90 ea.

SEND FOR FREE PRICE LIST

Gamit, Dept. ES

5841 W. Montrose Avenue
Chicago, Illinois 60634

Circle (7) on Reply Card

**SERIOUS ABOUT
YOUR FUTURE IN HOME
ELECTRONIC SERVICE?**



The Sign of
Professional
Service

...a not for profit association championing independents' right to compete, and delivering valuable benefits continuously since 1950.

NATESA offers low cost group insurance, discounts on everything from eyeglasses to motor vehicles, individual consultation on particular problems, representation to government and industry at all levels and a place to unite to protect each individual member with the strength of all.

Send this ad with your card or letterhead to:

NATESA, Dept. ES
5908 S. Troy St.
Chicago, Il. 60629

- Membership. \$60.00 enclosed. As our member premium, please send free . . .
- Practical Business Manual - OR -
- Service Contract Manual

troubleshootingtips

continued from page 7

the Q203 horizontal oscillator. Q203 had proper collector voltage, and a quick in-circuit check proved the transistor was not open or shorted. L202 and the emitter components also measured okay.

Finally, I replaced Q203, just because there was little else to do. You guessed it; with the new transistor, the horizontal remained dead.

This called for a serious study of

the circuit, and I noticed that the Q203 emitter drove the base of Q205. When I checked Q205, I found the base/emitter junction to be open, and a new transistor brought back normal operation.

How about one open B/E junction killing the entire TV? Evidently, the lightning spike had blown Q205 also.

Carroll L. Hudson
Dozier, Alabama

serviceassociations

NATESA Convention

August 24 through 27 are the days selected for the 1978 National Association of Television & Electronic Servicers of America (NATESA) convention, to be held at the Great Chateau Louise Resort, Dundee, Illinois (near Chicago's O'Hare Airport).

Sessions for association business will form the center of the convention, but other activities won't be neglected. One panel will discuss industry problems and solutions; another panel is scheduled to consider the problems brought by new technologies. Seminars and the NATESA Certification Test will be offered to technicians. Other knowledge can be gained from fellow servicers and industry leaders, who will be present. Also scheduled are events for relaxation and entertainment. These include a golf tourney, a banquet with floor show, a sing-along, and an encore appearance by Art Holst (a dynamic humorist), who will appear August 26 by courtesy of RCA.

For more details, contact: NATESA, 5908 South Troy Street, Chicago, Illinois 60629.

NESDA/ISCET Conventions

The "City of Roses" (Portland, Oregon) is host to the 1978 conventions of the National Electronic Service Dealers Association (NESDA) and the International Society of Certified Electronic Technicians (ISCET). Participating also in the August 7 through 13 conventions are the Washington State Electronics Council (WSEC) and the Oregon Pro-

fessional Electronics Association (OPEA).

Preliminary plans call for a golf tourney, a Forest Belt scope workshop, and a NESDA executive council meeting on August 8. Wednesday activities include a Business-Management School, technical seminars, and an ISCET Serviceability Inspection. Thursday, August 10, has schedules for a NESDA nominations meeting, the large trade show, CET and CSM tests, and the ISCET annual meeting. Convention events for Friday include the National Service Conference, the NESDA annual meeting and election of officers, and the Zenith annual dance. Saturday is to bring another NESDA meeting, all-day ISCET technical seminars, The Electronics Hall of Fame banquet, and the installation of NESDA officers. Sunday events (August 13) include the annual ISCET breakfast and installation of officers, and the NESDA executive council meeting.

During the August 9 dinner, RCA will present Art Holst, who was the hit of the San Antonio conventions.

Candidates for NESDA officers include Robert "Bob" Villont for president and Warren Baker for vice president. Announced ISCET candidates are: for chairman, Larry Steckler, and Jesse B. Leach, Jr.; for vice-chairman, Forest H. Belt, and Walter R. Cooke.

For more convention information contact: NESDA, 1715 Expo Lane, Indianapolis, Indiana 46224, or: ISCET, 310½ Main, Ames, Iowa 50010.

reader's exchange

There is no charge for listing in *Reader's Exchange*, but we reserve the right to edit all copy. If you can help with a request, write direct to the reader, not to *Electronic Servicing*.

For Sale: New B&K-Precision 1977B TV Analyst (used only once), complete with manual, cables, slides, and extra set of tubes. Cost \$493, will sell for \$325, or make offer. Gerald L. McKouen, 534 Pacific, Lansing, Michigan 48910.

For Sale: Obsolete tubes. Send a list of your needs. Also B&K-Precision tube tester model 707 for \$50. Needs some work. Elmwood TV, 136 Market Square, Newington, Connecticut 06111.

For Sale: Sencore DVM-32, \$100; B&K-Precision 1076 Analyst, \$165; Heathkit post/market sweep generator, factory wired, in mint condition, \$125. John R. Zanath, 1809 Grant, Aliquippa, Pennsylvania 15001.

For Sale or Trade: Superior Instrument TW11 portable tube checker with wood core and roll chart, \$35; Precision tube checker counter model 911 meter with roll chart, series 915, \$45; RCA color-bar generator WR64B, like new, \$75; and Cornell Dubilier BF90 capacitor checker, \$35. Need Rider's Radio Manuals, or what have you. Troch's Television-radio-appliances, 290 Main, Spotswood, New Jersey 08884.

For Sale: 1 RCA WR-52A stereo-FM simulator; 1 RCA WR-69A TV/FM sweep generator; 1 RCA WV-76A high sensitivity AC VTVM; 1 RCA WV-98C VTVM; 1 B&K-Precision model 282 digital multimeter. Best offers. Debra Garcia, Spinks TV Sales & Service, 823 Madeline Court, Baton Rouge, Louisiana 70815.

Needed: A schematic and service manual for a Phase Corporation Medford audio-sweep generator, model ASG-200, and a packard Bell Telecaster, model 900. Will buy, or copy and return. Martin Winkler, 6618 St. Clair, North Hollywood, California 91606.

Needed: A CRT for Tektronix 531A scope (part number 154-0757-00). Send condition of CRT and price. Mike Murphy, 40512 Regency Drive, Sterling Heights, Michigan 48078.

For Sale: A CK3000 Sylvania test jig with manuals and 57 adapters; Sencore YF33 Ringer; Heath IT5230 CRT Tester; IG57A sweep/marker generator, IG28 dot/color generator; Polaris HV probe; EMC model 213 tube tester; one tube caddy with 132 most-used tubes; also, many other audio instruments and meters. Mike Murphy, 40512 Regency Drive, Sterling Heights, Michigan 48078.

For Sale: Duplicate material from my library of early radio and TV service literature. Factory material, data, Rider's manuals, etc. Lawrence Beitman, Box 46, Highland Park, Illinois 60035.

For Sale: B&K-Precision 1077B TV Analyst, \$250; and Heathkit post-marker/sweep-generator, \$100. Allen Rose, 650 Daphne, Broomfield, Colorado 80020.

For Sale: B&K-Precision dual-trace 10-MHz model 1470 triggered scope, with one PR 20 10:1/direct probe and one PR 152 demodulator probe, \$300. Also, B&K-Precision 520B transistor tester with FP-5 Dyna-Flex probe, \$95. Both like new, used only a few hours. Richard Lopez, 9916 Franklin, Glenn Dale, Maryland 20769.

For Sale: Heath CO-1015 ignition analyzer (5-inch CRT), with 12 VDC power inverter, \$95; and Jud Williams curve tracer, \$55 (new in box.) Richard A. Miller, 3909 Marion Drive, Enon, Ohio 45323.

For Sale: Rider's Troubleshooter's Manual, volumes 1 through 19, with index; also, Rider's manual for recorder changers and recorders. Arthur F. Wilhelm, Art's Radio & TV, Rural Route #1, Box 15, Mascoutah, Illinois 62258.

For Sale: Precision scope model ES 500, and sweep generator model E 400, all leads and manuals, in perfect condition, both for \$125. Also, remote control unit model 9K-1 for Fisher 400c Master Audio Control, and BB54-A storage battery. Al Crispo, 159-30-90 Street, Howard Beach, New York 11414.

Needed: University 312 tweeter speaker HF 206 and rear housing. H. D. Stevens, 31 Second Street, No. Arlington, New Jersey 07032.

Needed: Low-cost B&K-Precision model 11075 Analyst. Need not be working. Lowell L. Vonada, Vonada Radio & TV, Park & Fifth, Lincoln, Kansas 67455.

For Sale: EICO 369 sweep and marker generator, with cables and manual, \$85; measurements model 80 standard signal generator, with manual, \$300; both in perfect condition. W. J. Budzyna, 49 Gill Court, Whitinsville, Massachusetts 01588.

Needed: Roll chart for Hickok tube tester, model 534. (For old 4-prong tubes). Need an adapter #C40 for B&K-Precision CRT tester 440, adapter to test 12CWP4, if available. Elmer L. Mosley, 720 Poplar, Kenova, West Virginia 25530.

Needed: RCA Service Notes 1923-1928, 1929-1930, and 1931-1932. Manual/Schematic for Tektronix 511AD scope. J. A. Call, 1876 East 2990 South, Salt Lake City, Utah 84106.

For Sale: Radiola III manual, 26 pages from 5 sources, \$5; Rider's Radio Master Index for volumes 1 to 15, \$12.50 or volumes 1 to 23, \$15; early Riders volume 1, 1919 to 1927, 200 pages, \$17.50; Riders Radio volumes 9, 10, 12, 15, 16, 17 and 19, \$10 each; also, send for a list of other Riders books. Antique Radio Shop, 3403 Broadway, Long Beach, California 90803.

continued on page 12

reader's exchange

continued from page 11

For Sale: Heathkit scope model IO-4540, completely assembled, used only a few hours, \$145. P.T. Hauser, 190 Alexander Avenue, Upper Montclair, New Jersey 07043.

For Sale: Bell & Howell (Heathkit) digital multimeter, like new, \$25 plus postage. Robert M. Dorman, 1917 Ridge Lake Drive, Chesterfield, Missouri 63017.

For Sale: Southwest Technical Products prescaler for any frequency counter, 500 millivolts maximum input level, divides by 10 up to 175 MHz, perfect condition, \$30. John Augustine, 530 North 9th, Reading, Pennsylvania 19604.

Needed: Service information for United Scientific Labs, Contact 23, CB radio. Will pay for copying and mailing. Don Gross, Vision Enterprises, Cameron Mills, New York 14820.

For Sale: B&K-Precision sweep/marker generator model 415, with leads, never used—in carton, \$350 plus shipping. Channel Electronics, Route 206, Andover, New Jersey 07812.

WINEGARD WORKS...

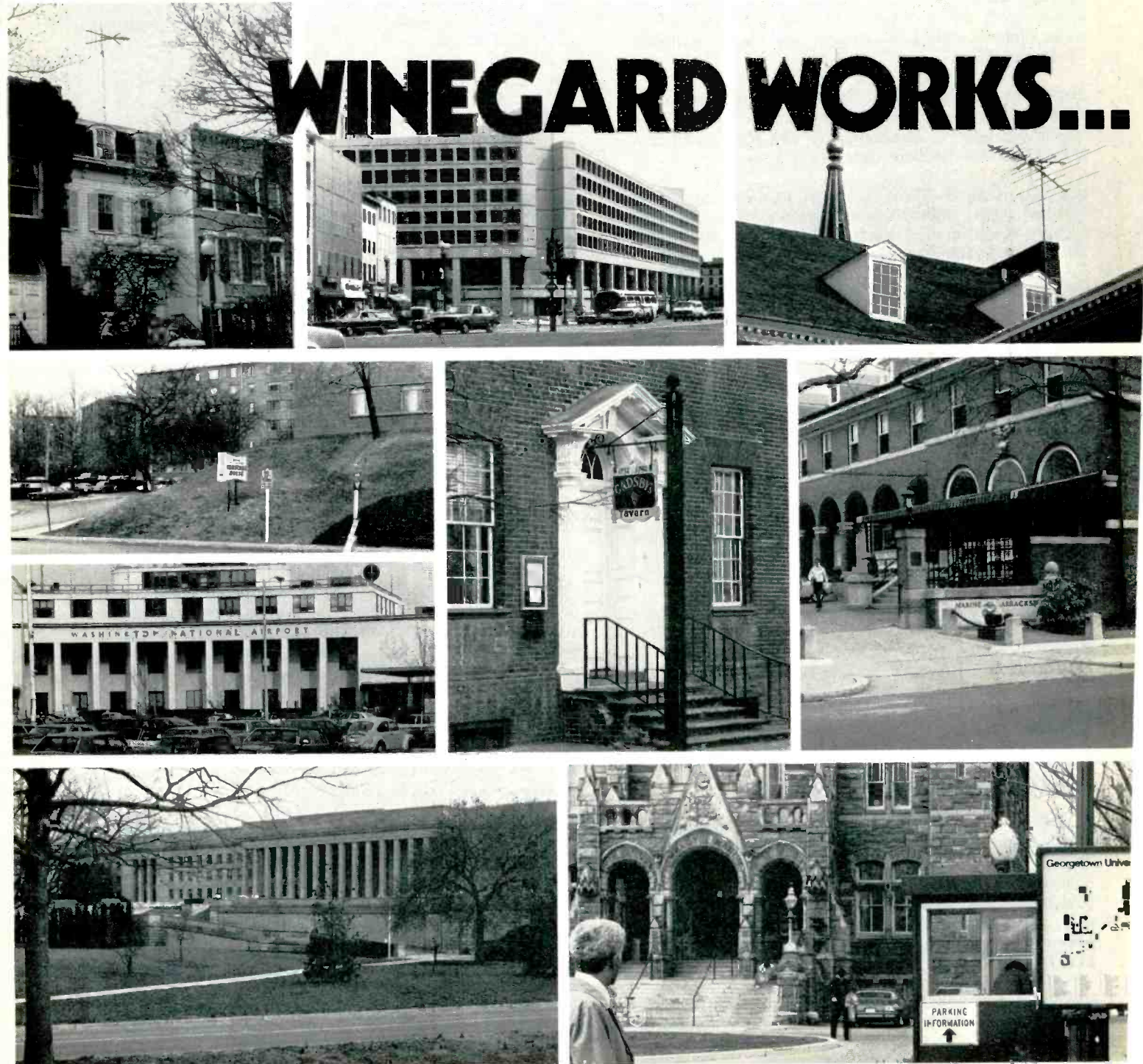

For Sale: Sencore PS148 oscilloscope/vectorscope, excellent condition, \$150. Johnnie L. Jones, RR 2, Box 140, Shelbyville, Missouri 63469.

Needed: Schematic and parts list for Herbrand tach-and-dwell meter (manufactured by Utica-Herbrand division of Kelsay Hayes), model HT-864. Xerox copy is okay. Send price COD. Otis M. Cowart, P.O. Box 987, Vero Beach, Florida 32960.

For Sale: Nine years of **Electronic Servicing**; CIE electronic course leading to FCC license; Knight RF and sweep generators, 5-inch scope, RC boxes, signal tracer. Make offer. Epperson, Star Route B, Satsuma, Florida 32089.

Needed: Schematic for Penncrest model 8400 guitar amplifier. Will buy, pay for copy, or copy and return. Steven C. Martin, Route 2, Box 85C, Rutherglen, Virginia 22546.

Needed: Schematic and instruction book for a Unimatics model XL-1 automatic TV camera. Will buy, or copy and return. Victor Scheideler, 2381 Hamms Road, Burlington, Wisconsin 53105.

Needed: Schematic and service manual (especially for alignment) for an Arlington radio series A2-MB and chassis number 42 400401. Will pay, or copy and return. Oris Hippe, 12109 West Washington, West Allis, Wisconsin 53214. □

in the Nation's Capital.

The greater Washington area gets Capital gains, with Winegard.

From Georgetown to Alexandria, from Chevy Chase to Falls Church



and throughout the District of Columbia, you'll find Winegard products hard at work bringing viewers good TV reception. In fact, there is Winegard equipment in 200-year-old townhouses, in some of the newest federal buildings, on college campuses, in high rise apartments, in embassies, servicemens' barracks, police headquarters, fire stations and residential homes.

The Washington area is pretty hilly, and like other parts of the nation, TV "ghosts" present a problem. That's one reason installers rely on medium or larger Winegard outdoor

antennas. Not because of weak signals, but to cut down or eliminate "ghosting"... a benefit of Winegard's attention to high front-to-back ratio and sharp directivity in its antenna engineering.

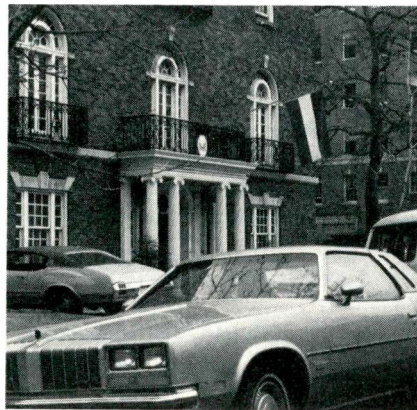

On the other hand, many people in the area want to pull in the weaker Baltimore stations, some 60 and more miles away. They use Winegard high gain antennas and preamps to give good, clear, long distance reception and a bigger selection of programs.

Retail TV set stores need top-notch pictures on their showroom receivers,

too, and many of the leaders rely on Winegard TV systems to do the job. In turn, they recommend Winegard TV reception products to their set customers.

This most important city in the world, Washington, is also one more city in the U.S. where Winegard is at work providing the finest TV reception in a variety of situations.



In the greater Washington area, Winegard products are distributed by Certified Electronics of Alexandria. Certified has been a Winegard customer for fifteen years.

WINEGARD WORKS... Everywhere!

WINEGARD
The Winegard Company • 3000 Kirkwood Street • Burlington, Iowa 52601

Para más datos marque (8) en la tarjeta.

Curing Horizontal Oscillator Drift,

Part 1



Most cases of intermittent locking or drifting horizontal frequency originate in TV receivers that have tubes. Therefore, this article is directed principally to tube circuits. However, after a few logical modifications, the methods apply to solid-state equipment as well.

By Wayne Lemons, CET

Control Or Oscillator?

A customer complains that the TV requires perhaps a dozen adjustments of the horizontal hold during each evening. However, when you examine the TV and try the horizontal-hold control, the locking is normally tight. *Which stage has the problem?*

Another TV receiver is reported to jump out of horizontal lock every time the program changes from network to local, or from local to network. *Where is the defect?*

These two common symptoms illustrate the dilemma of every TV technician. Of course, it's likely the problem is in the sync, power supply, or horizontal-oscillator circuits. But, the analysis of horizontal locking is complicated by the two functions of the oscillator. The oscillator circuit itself can cause a wrong frequency. In addition, each oscillator has a control circuit that varies the oscillator frequency so the sweep is in step with the picture from the station. This control circuit often is called the Automatic Phase Control (APC) or the Automatic Frequency and Phase Control (AFPC). I favor the AFPC acronym, because it makes clear that both the frequency and phase of the

oscillator signal are controlled. (At this time, the sync signal is grouped with the AFPC operation, because the quality or amplitude of the sync signal can't affect the frequency very much.)

Either or both of these basic circuits can cause wrong horizontal-oscillator frequency, loss of locking, or intermittent locking. The question is this: **WHICH of these two circuits has the defect?**

Divide And Conquer

Briefly stated, the method that locates these trouble spots more

rapidly than others is to **disconnect all possible components** (or whole circuits) **while maintaining enough oscillator operation to keep a picture showing on the screen.** We'll supply specific details as we proceed. But, for starters, you should disable any components that are included *only* for stability or noise immunity. Also, disconnect the entire AFPC circuit as a check of the free-running oscillator frequency.

Of course, you must know which components *can* be disconnected or disabled. That is why we will

The combination of slanting bars and one upright bar indicates an unstable oscillator frequency that's varying between about 120 Hz too low, and correct frequency of the wrong phase.



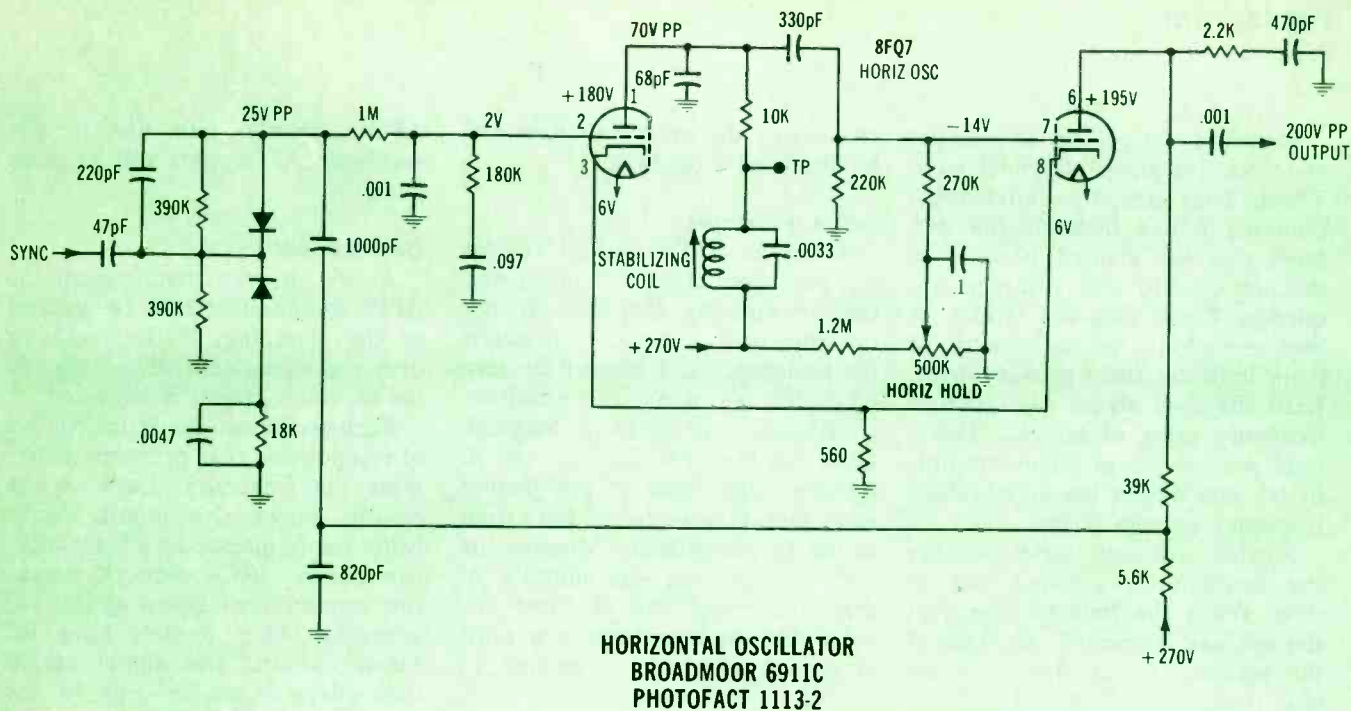

Figure 1

describe the operation and testing of several types of horizontal circuits.

Multivibrator With Ringing Coil

One circuit that was very popular with many B&W TVs (and a few color sets) is the cathode-coupled multivibrator oscillator, with a ringing coil for better noise immunity and stability (see Figure 1).

This type of circuit is one of the easiest to adjust and troubleshoot. One reason for the uncomplicated servicing is that the AFPC voltage

typically measures around zero. Thus, it can be grounded to eliminate any possibility that a defect in the AFPC circuit might force the oscillator frequency out of tolerance. **After the AFPC is disabled by the ground, the oscillator alone can be tested for frequency or for drift.**

Ground The Grid

Most oscillator circuits that resemble the one in Figure 1 can have the AFPC operation disabled by a ground attached to the multivibrator grid at pin 2. The following

instructions allow the method to be used with even more TV models.

If the horizontal can be made to lock at all, measure the range of DC voltages at pin 2 of the 8FQ7 oscillator tube as you vary the hold control as much as possible without losing the locking. (Typically, these circuits show one or two volts of variation before locking is lost.) Adjust the hold control at the center of the locking range, and measure the DC voltage at the grid. If the voltage is between +1 and +2 volts, then connect a 1½-volt flashlight battery with the positive toward the grid and the other terminal grounded.

However, if the grid voltage measures less than +1 volts at the center of the locking range, **merely ground the grid.** In either case, **the oscillator should continue to operate** (later, we'll discuss the steps to take if it quits), and the frequency that results determines our next step.

Examine the picture. An upright picture that drifts slowly to either side indicates a *correct* horizontal frequency, but one that's not locked. Sometimes, this is called "zero beat," and it's the ideal condition. However, such perfect frequency without locking is very rare.

continued on page 16

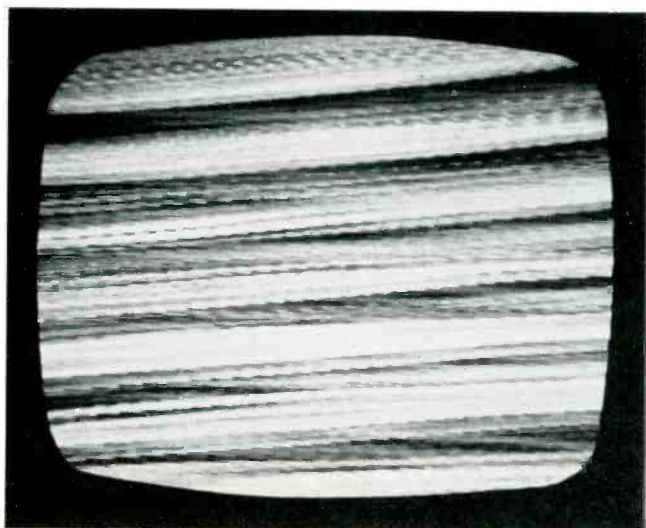

Upward slant of bars on the TV screen prove the oscillator is running too slow, and the 7 bars show the error is about 420 Hz.

Horizontal

continued from page 15

Probably, the picture will consist of several (or many) diagonal bars. These bars are the horizontal blanking pulses between the pictures that are slanted because of the non-synchronized scanning frequency. These diagonal stripes or bars *are* useful, for the number of them indicates the frequency error. **Each diagonal stripe represents a frequency error of 60 Hz.** Therefore, you can count them, multiply by 60, and obtain the approximate frequency error in Hertz.

Further, you can know whether the oscillator is running fast or slow. **When the bars are lower at the left and higher at the right of the picture, the frequency is too low.** (Imagine that scanning beam going up hill, and being slowed by the pull.) **Bars that are higher at the left and lower at the right show a frequency that's too fast.** (The beam is coasting faster downhill.)

Analyze The Drift

After the AFPC control voltage has been clamped or grounded, usually one of two conditions will be seen: either the frequency will be nearly correct (zero beat, or two to three bars), or it will change drastically (a parasitic double-triggering, or many stripes). Tests of the almost-correct frequency are

given next; the radical changes will be discussed a bit later.

Just a few stripes

After the AFPC control voltage has been grounded or clamped and the free-running frequency is not far from being correct, then adjust the horizontal-hold control for zero beat (or as near as possible, considering the lack of locking). Operate the TV for 15 to 30 minutes, and look at the picture every minute or so to see the extent of the frequency drift. Monitor the drift by counting the number of diagonal stripes. **All of these circuits drift in frequency;** you must determine whether the amount of drift is normal or not.

Normal drift perhaps is two or three stripes. But after you have done this series of tests several times, you'll know how many to expect. Of course, you want the least variation of the number of stripes, since that indicates less drift.

Assuming that the symptom (*before* the ground eliminated the AFPC voltage) was excessive drift which caused frequent loss of horizontal hold, but that the frequency drift was normally small *after* the AFPC voltage was removed, **then the defect is in the**

AFPC circuit, and not in the oscillator. AFPC tests will be given later.

Oscillator drift

At the other extreme, when the AFPC was eliminated by the ground or the clamping, if the oscillator drift was excessive, then a defect in the oscillator circuit is indicated.

Each oscillator circuit has one set of components that primarily determine the frequency. Each of the circuits shown this month establishes the frequency by a resistance/capacitance (RC) network versus the amplitude of signal at the RC network. Other models have LC tuned circuits, and signal amplitude plays a smaller role in the frequency. This is a good reason why we are giving specific tips for each model.

No Picture

In cases where grounding or clamping the AFPC DC voltage results in a loss of high voltage and picture, there are two general possibilities.

- Perhaps an oscillator defect is changing the frequency enough to eliminate the high voltage. However, before the AFPC action was defeated, *misadjustments* of the hold control and ringing coil might

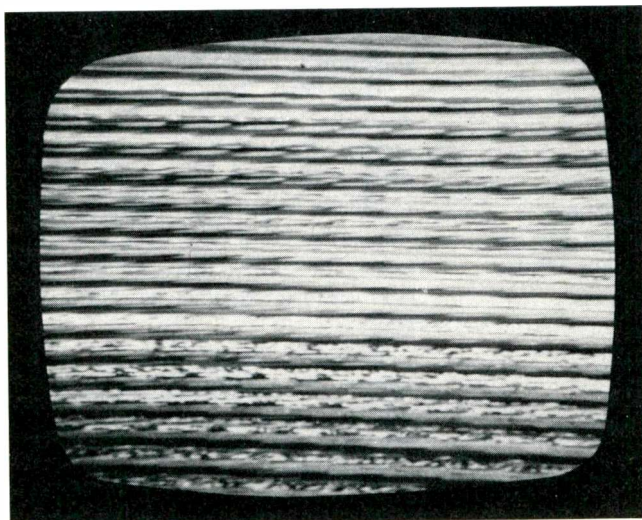

Downward slant of the bars indicates a too-fast frequency, and the many bars show a frequency error of about 1140 Hz.

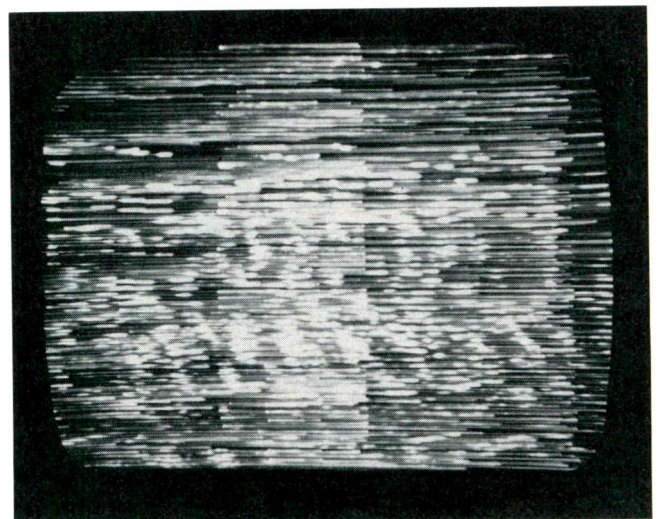

This highly unstable oscillator condition is called "double-triggering," "parasitic-oscillation," or "Christmas-Tree" operation.

warp the frequency enough to permit *some* imperfect operation.

- Perhaps this particular circuit can't be operated with the output DC voltage of the AFPC shorted out. Solid-state circuits, and a few tube circuits, often bring a fixed amount of DC voltage in *through* the AFPC. Probably the extra DC voltage is used for bias; and if so, the oscillator can't function without it. Check your schematic carefully.

Eliminate The Sync

Another method of disabling the AFPC during tests or adjustments is to ground the grid or base of the sync separator. However, the AFPC components remain in the circuit, so the technique has more possibility of mistakes when we are trying to determine where the defect is located.

Ringling Coil

In Figure 1, the component labelled "stabilizing coil" plays an important, but secondary role in the oscillator frequency. The variable inductance of the coil along with the capacitance of the .0033 paralleling capacitor form a tuned circuit that resonates near the horizontal frequency. It improves the noise immunity of the horizontal oscillator. Also, it helps minimize drift of the oscillator frequency. If the coil is misadjusted, both of these advantages are reduced.

However, the importance of these ringing components to our methods of troubleshooting can be condensed as follows:

- Adjustments of the coil affect the oscillator frequency (a few poorly-designed models used the core of the ringing coil as the hold control!); and
- When the ringing coil and capacitor are resonant at the proper frequency, the coil can be shorted out without any change of oscillator frequency.

The first item warns us that a misadjusted ringing coil can cause a wrong horizontal frequency. (Also, it can be misadjusted to produce the correct frequency from an off-frequency oscillator. In other words, two wrongs can make the

frequency right—but, with the problems of drift and susceptibility to noise remaining unsolved.)

The second item reveals a convenient method of adjusting the ringing coil correctly, without instruments.

Adjusting the ringing coil

Here are the steps for fast and accurate adjustment of both the horizontal hold and the ringing coil:

- Defeat the AFPC by grounding the grid of the sync separator tube (this makes any slight change of frequency very noticeable, since there is no automatic correction);
- Disable the ringing coil (by connecting a short jumper wire across the terminals, or by bypassing the test-point end with an electrolytic capacitor);
- Adjust the horizontal-hold control for zero beat (or, as near as possible);

- Remove the jumper or capacitor from the ringing coil;
- *Without changing the horizontal-hold adjustment*, adjust the ringing coil for the same degree of zero beat as obtained before; and
- Remove the short from the sync-separator grid.

The horizontal locking should be very accurate, and not require any hold-control adjustments for some time. Of course, *this is assuming that there are no defective parts in the circuit.*

In many cases, **the correct adjustment of the ringing coil** as part of the sequence **can eliminate minor problems of oscillator frequency drift.**

Double Triggering

When the ringing coil is disabled, some oscillator circuits will become unstable, usually with a pattern variously called parasitic oscillation,

continued on page 18



**PTS 8001
Component Analyzer**

Solid state component tester works in or out of circuit. Simple hook-up to any standard oscilloscope. High, medium and low range switch for matching the impedance to the component being tested. Dealer Net \$54.95

See the Yellow Pages for the PTS Servicenter Nearest You or Contact:



PTS ELECTRONICS, INC.
P.O. Box 272 Bloomington, IN 47401 812-824-9331

Circle (14) on Reply Card

Horizontal

continued from page 17

double triggering, or "Christmas Treeing." Generally, the problem can be traced to open filter capacitors, or to an unusually low plate resistor in the first half of the multivibrator. In Figure 1, this is the 10K plate resistor that supplies pin 1. If the original design specified a low value (such as 3.9K or 4.7K), a larger value can be substituted long enough to set the ringing coil. The temporarily-wrong size produces only a small error of the frequency.

Critical Components

In Figure 1, the two components that are most critical for the oscillator frequency are the 330 pF coupling capacitor between pins 1 and 7, and the 220K grid return resistor for pin 7. The 170K, the 1.2M, and the horizontal-hold control resistances must NOT have any appreciable drift from heat or time. Other components that have some effect on the frequency include: the 2.2K resistor and 470 pF wave-shaping network at pin 6; the 39L and 5.6K plate resistors for pin 6; and the 560-ohm common-cathode resistor.

Of course, no leakage can be

tolerated in the 330-pF coupling capacitor. Equally important is the temperature coefficient. Don't use a garden variety ceramic. Check the parts list, and obtain the *same* type for replacements. In extreme cases, it might be necessary to use a negative-temperature coefficient or a mica type.

Selected Values

The capacitor and resistor at the second grid (pin 7 in Figure 1) MUST have the proper RC time constant so the frequency will be almost perfect when the sync and ringing coil both are defeated. We might call this the "natural" frequency.

A few models have no horizontal-hold control in that grid circuit, and the ringing coil is used as a poor substitute. For such situations, the circuit of Figure 2 is used as a temporary replacement for the non-adjustable grid resistor.

As shown, both the AFPC control and the ringing coil are disabled. Then, the 500K test control is adjusted for zero beat. Afterwards, the 47K and 500K resistors are removed (with care to prevent any change of value) and the total

resistance of both is measured. Finally, select a fixed resistor of the same value, and install it permanently to replace the original grid resistor.

A Brief Look At AFPC

Two specific input signals are required for proper operation of the duo-diode AFPC circuit in Figure 1 (as well as most other similar ones). A sawtooth waveform from either the oscillator or the flyback is the reference signal. Negative-going pulses (of lower amplitude than the sawteeth) from the sync separator are the standard signal.

During correct frequency-and-phase operation of the oscillator, the rectification of those two signals by the diodes results in a near zero DC voltage, which is filtered and fed to the pin 2 grid for control of the oscillator frequency.

When the oscillator changes to a wrong frequency, the diode rectification of the two signals produces a small negative or positive DC voltage, which restores the frequency to the original value.

Most similar circuits have the same DC output to the oscillator when the locking is perfect, as they do if either of the two input signals is missing. Therefore, a total loss of horizontal sync, for example, will not change the oscillator frequency very much.

The two diodes (sometimes packaged together) are the components that are most likely to fail in the AFPC circuit. A scope is your best bet for the waveforms, and a VTVM or digital meter should be used to measure the DC voltages.

Leakage in either the .001 or the .047 capacitors located near the grid of pin 2 can cause the loose locking, and yet all other parts and waveforms will be perfect. Keep this in mind, for it is often overlooked.

Next Month

The critical components and adjustments in other basic types of horizontal oscillators are included, along with more troubleshooting tips. □

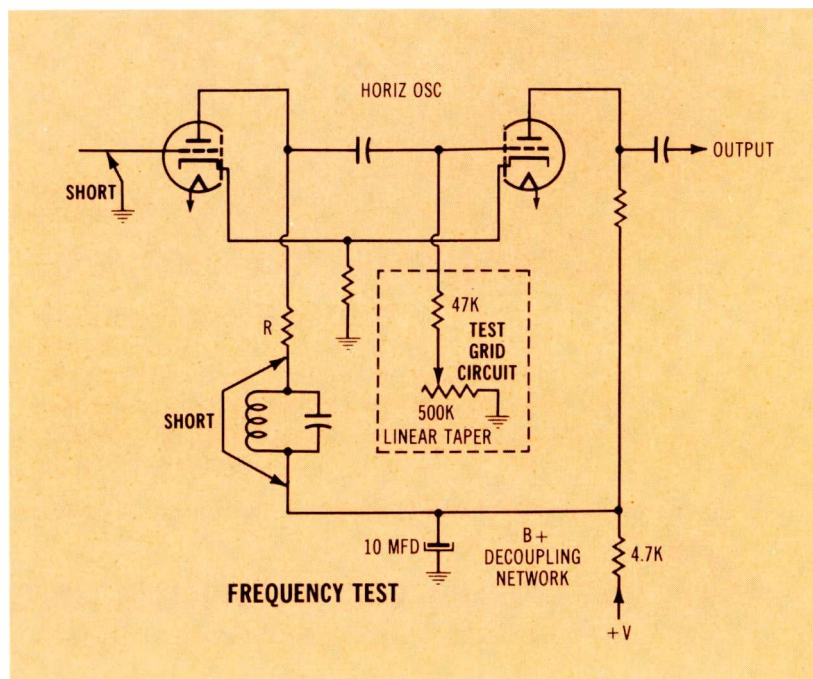
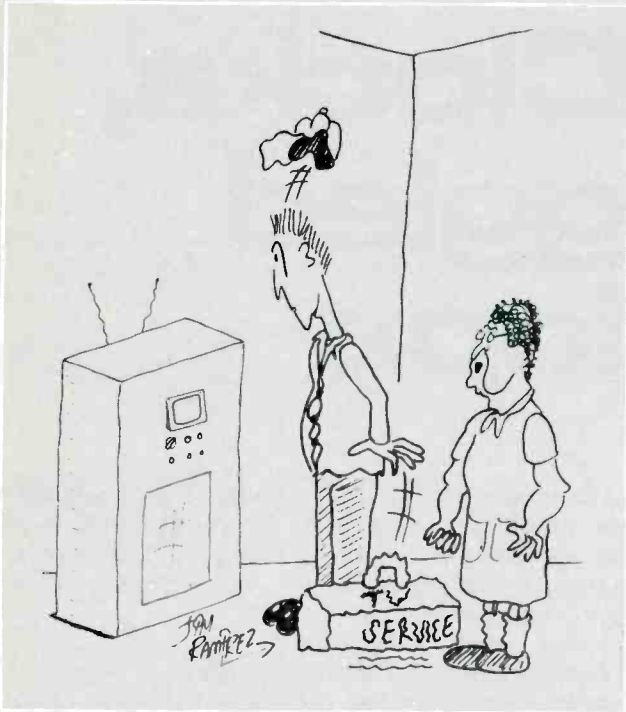

Figure 2

CARTOON CORNER



"And you know sonny, they say it's one of the first TVs made."



"Oh yes ma'am! We have some of the best technicians in town!"



"I'm not telling him it suddenly started working when I plugged it in!"

The Basics of Industrial Electronics, Part 13

Timers, Clocks, and Toggled Flip Flops

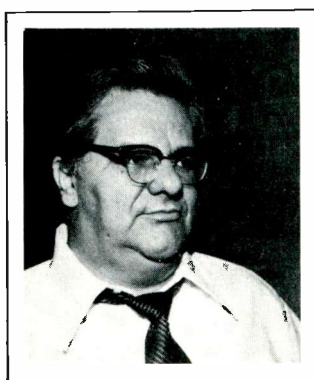

By J. A. "Sam" Wilson, CET

Most versatile of all flip flops is the J-K type, which was introduced last month in this series. One important application for J-K flip flops is in **electronic counters**. But, before electronic counters, we must consider electronic **timers**.

Electronic Timers

Usually, we think of timers as mechanical or electronic devices (such as a clock radio) that are used to start or stop an operation of some kind. And, these devices are used extensively in industrial electronics. The electronic or mechanical timer of a spot welder, for example, controls the length of time that the current flows, to insure proper bonding of the metals.

Many home appliances have timers. Each automatic washer has an electro/mechanical timer that

controls the minutes of each cycle.

Where only a single on/off or off/on cycle (or a continuous series of identical cycles) is needed, an electronic timer can do a better job by allowing shorter or longer timed periods and accurate repeatability. For photographic purposes, some electronic photo timers offer a selection of times from 0.1 second to several minutes.

However, in digital circuits, a timer usually is a "clock," which is a square-wave or pulse generator.

The 555 IC is very popular for various kinds of electronic timers. It can produce a single on/off cycle of any time up to several hours, or continuous square waves with rise times of 100 nanoseconds. This rapid rise and decay time makes the 555 able to function efficiently as a generator of clock signals for counting and display circuits.

The 555 Timer

A square-wave generator is our first application for the 555 timer IC. Other IC timing devices and an in-depth study of the 555 can be found in the *IC Timer Cookbook*, by Walter G. Jung (Howard Sams book number 21416).

An astable multivibrator circuit using a 555 IC is shown in Figure 1. The word "astable" indicates the circuit has no stable state. In other words, it is a free-running multivibrator oscillator. Many tube oscil-

lators of similar basic principle were used in the vertical and horizontal sweep circuits several years ago.

Inside the 555

The dotted lines of Figure 1 enclose the internal circuitry of the 555 IC, while the external components allow the timer to operate as an astable multivibrator oscillator. (However, if pin 2 is disconnected from pin 6, the circuit can't oscillate continuously. Instead, the pin 3 output state will reverse *each* time a negative-going pulse is applied to pin 2. This is called "monostable" operation.)

The values of the R1/R2/C2 time constant determines the free-running frequency of the oscillator. Capacitor C1 is not essential for many applications, although it does minimize the possibility of noise triggering the multivibrator.

Two voltage comparators are in the IC. The output state of a voltage comparator changes according to which input has the highest voltage. Some comparators are merely operational amplifiers (op amps) that don't have any feedback to reduce the gain. In fact, the op amp + and - input identifications sometimes are used also for voltage comparators, as shown in Figure 1. Where used, the - indicates the inverting input, and the + is for

continued on page 22

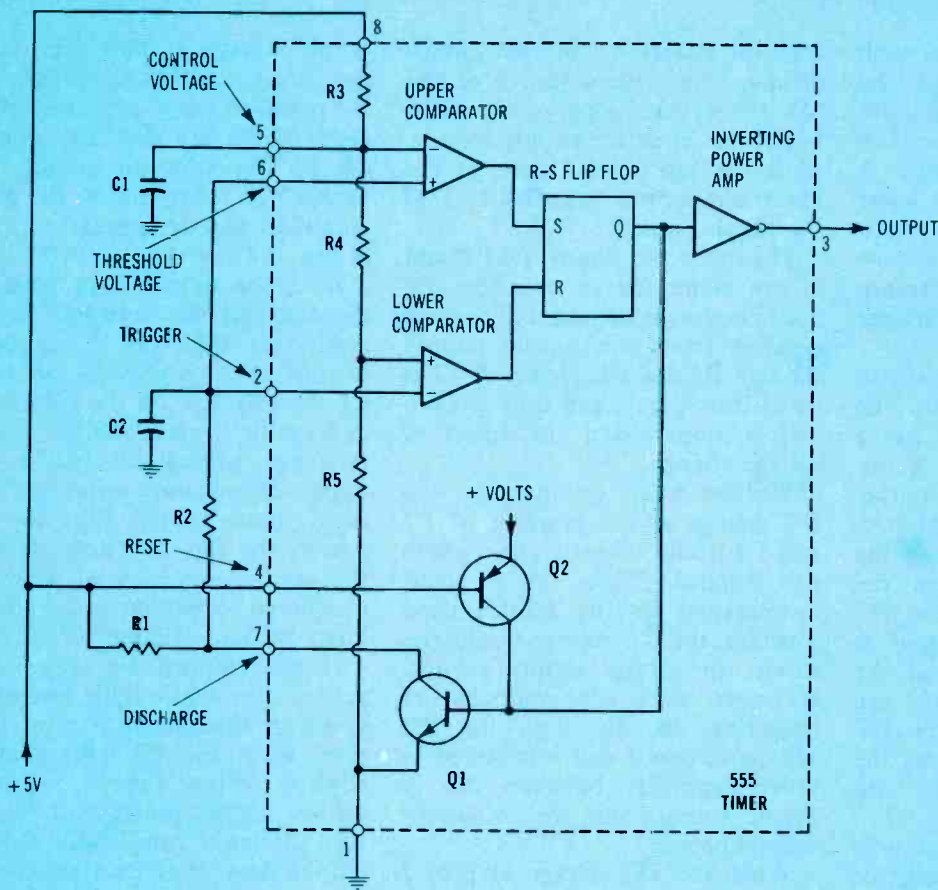
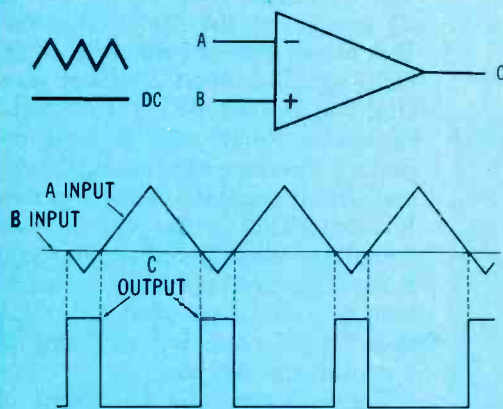

Figure 1 The 555 timer IC is versatile. When wired this way, it becomes a multi-vibrator (time-constant) oscillator, with an output that's compatible with TTL circuits.

A STABLE MULTIVIBRATOR



VOLTAGE COMPARATOR

Figure 2 Op-amp symbols are used also for voltage comparators. When voltage at the "A" input is **more positive** than the voltage at "B", the output goes low. Conversely, when the "A" voltage is **less positive** than the voltage at "B", the output goes high. This is illustrated by the waveforms, which are shown with the correct phase between input and output.

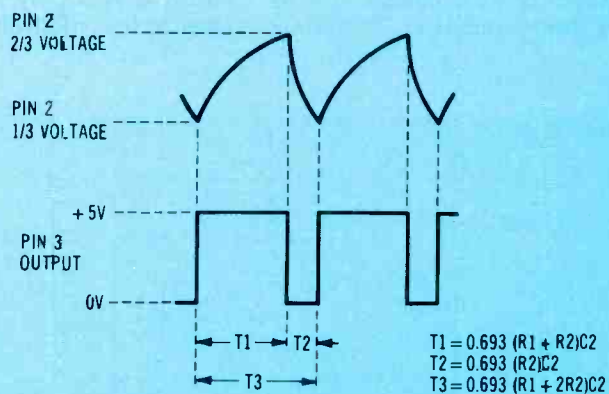

WAVEFORMS OF 555

Figure 3 The sawteeth are shaped by C2, and they are connected to pins 2 and 6. The square-tipped pulses are the waveform at pin 3, the IC output. Remember, the flip flop output state and the IC output state are opposite. T1 begins when the lower comparator drives the flip flop output **low**. During T1, the flip flop output remains **low**. At the end of T1, the upper comparator triggers the flip flop to a **high** output. This starts T2. During T2, the flip flop output remains **high**. At the end of T2, the output of the flip flop is driven **low** again. This is the end of one cycle of operation, and also the beginning of a new T1.

Industrial

continued from page 20

the non-inverting input. In such cases, the output state of the comparator is low when the input has a higher positive voltage than the + input has. Also, the output is high when the - input has a lower positive than the + input has. Because of the very high gain, only a few millivolts of voltage difference between the two inputs can trigger an output change of state.

Figure 2 shows one way to operate a voltage comparator. The B (or + non-inverting) input has a fixed DC voltage, and the A (inverting) input has a triangular waveform. When the triangle voltage rises above the DC voltage, the output goes low. And when the triangle waveform is below the DC comparison voltage, the output is high. These relationships and the corresponding output states are shown by the drawing. If the DC voltage had been centered on the triangles, the output would have been square waves.

Notice that the output has only the usual two digital states: high or low. Reversing the signals at the inputs also reverses the state of the output pulses or square waves.

The 555 as an oscillator

Returning to the circuit of Figure 1, one input of each comparator receives a fixed amount of DC voltage

from the R3/R4/R5 internal voltage divider. The - input (pin 5 of the 555 IC) of the upper comparator has about $\frac{2}{3}$ of the supply voltage, while the top (or +) input of the lower comparator has about $\frac{1}{3}$ of the supply voltage.

The other two inputs (pins 2 and 6) are connected in parallel, and both receive a varying DC voltage coming from the power supply through R1 and R2. However, C2 is wired from pins 2 and 6 to ground, and it slows down the speed of voltage change.

Without either comparator, the DC voltage at the junction of R2 and C2 would be zero when power was applied. Then, at a speed determined by the R2/C2 time constant, the DC voltage would rise slowly up to the supply voltage. However, with the comparators triggering the flip flop, the DC voltage at pins 2 and 6 is forced to move regularly between the $\frac{1}{3}$ supply voltage and the $\frac{2}{3}$ supply voltage points.

When the DC voltage at pins 2 and 6 is between the $\frac{1}{3}$ and $\frac{2}{3}$ supply voltage limits, both comparators have identical outputs (necessary to keep the flip flop in a stable low state). Let's start analyzing the cycle with the C2 voltage rising at $\frac{1}{2}$ supply voltage. When it rises a few millivolts above the $\frac{2}{3}$

supply voltage at the other input, the upper comparator switches to the opposite state, triggering the S input of the flip flop, and causing the flip flop output to go high. Part of this high is inverted by the power amplifier, and it appears as a low at pin 3 of the IC.

Also, the output high from the flip flop supplies forward bias for transistor Q1, and it conducts heavily as it begins to discharge C2 through R2. As the C2 voltage decreases slightly below the $\frac{2}{3}$ reference voltage at pin 5, the upper comparator reverses the S input state of the flip flop. Of course, the flip flop does nothing; this step is necessary to prevent a disallowed condition when the R input is changed later.

If not stopped by some other action, the C2 voltage eventually would be discharged to zero. However, when the C2 voltage drops slightly below the $\frac{1}{3}$ reference voltage (at the junction of R4 and R5), the lower comparator changes output state, thus resetting the flip flop to a low output state. In turn, the inverting power amplifier supplies a high to the IC output at pin 3.

Also, the low output of the flip flop at Q removes the Q1 forward bias, and stops the bleeding of the C2 charge by the Q1 conduction. This allows the C2 voltage to begin rising again. As the C2 voltage rises slightly above the $\frac{1}{3}$ reference voltage at R4/R5, the lower comparator reverses the output state, and with it the state of the flip flop R input. This is the end of one operating cycle. Of course, the cycle is repeated over and over again, as long as power is supplied to the IC, thus the 555 timer is functioning as a continuous oscillator.

Figure 3 gives the waveforms of the 555 multivibrator, along with the formula for the C2 charge and discharge times. Notice that the ramp portion of the sawtooth requires more time than the retrace portion, because the charging of C2 is done through *both* R1 and R2, while C2 is discharged through R2 only.

However, the flip flop and the power amplifier can have nothing but high and low states. The output at pin three consists of square-

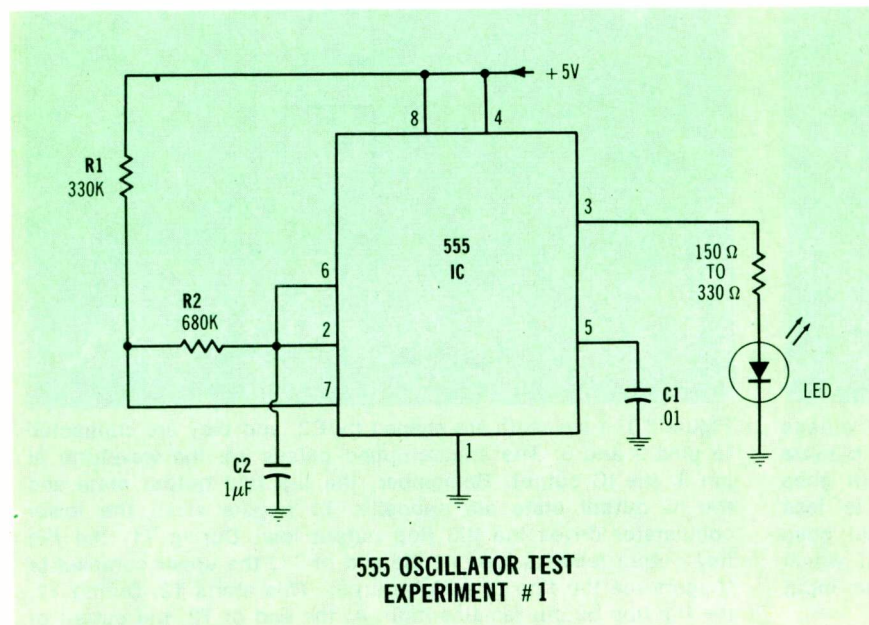

Figure 4 To make a digital clock for the experiment, wire the 555 IC with these values.

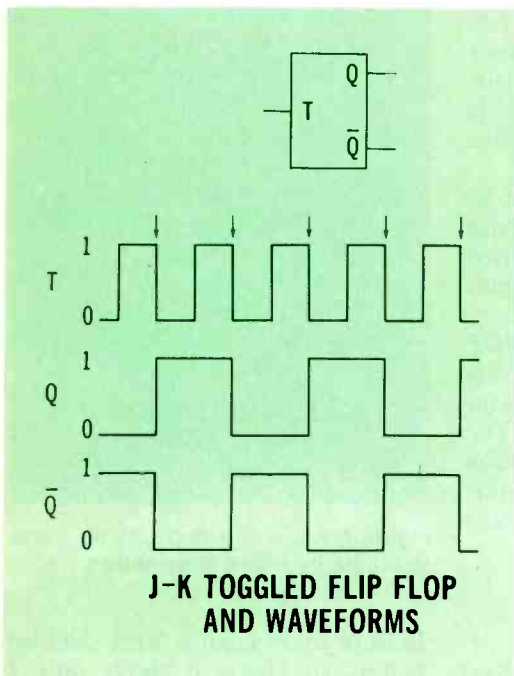

Figure 5 These waveforms of a J-K toggled flip flop prove that the toggle is triggered by the falling side of the input (notice arrows), and that the toggling acts as a divide-by-two.

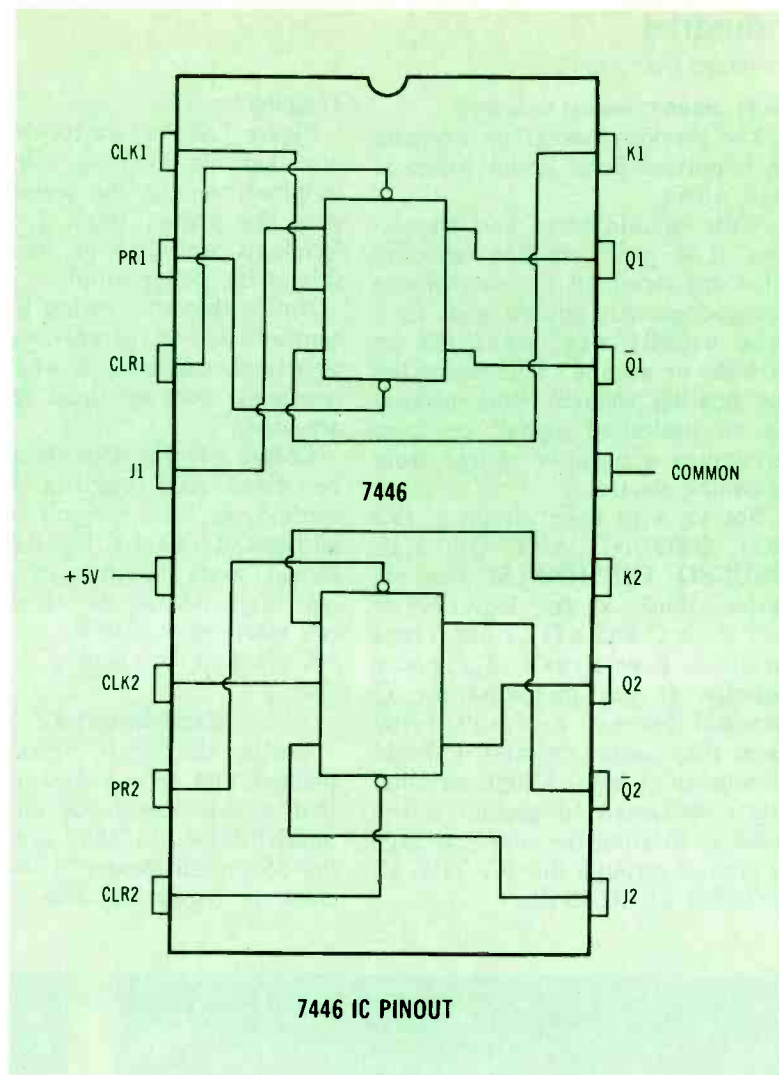

Figure 6 (at right) This is the pinout diagram of the 7446 IC, which has two separate J-K flip flops.

tipped pulses (because the charge and discharge times are not equal), which are satisfactory for TTL operation.

Don't be misled by the output "power amplifier." It is not a high-output amplifier, since the entire 555 IC only draws about 200 milliamperes at 5 volts. However, the output is sufficient to operate LEDs.

In practical circuits, C2 can be an electrolytic type, when a low repetition rate is wanted. The resistors should be rated at 1/4 watt, or larger.

Experiment #1

Construct the astable multivibrator of Figure 4, using these values: 680K for R1, 330K for R2, 1 microfarad for C2, and .01 for C1.

Calculate the values of time 1, time 2, and time 3. Write the figures at the edge of Figure 4. You should obtain about 0.7 seconds for time 1, about .23 seconds for time 2, and

about .93 seconds for time 3. Measure the time of one complete cycle (time 3) by watching the LED in the circuit you have constructed.

Toggled Flip Flops

J-K flip flops are valuable because they can be toggled, as shown in Figure 5. The symbol is that of a toggled flip flop. However, it might be a J-K flip flop which has been wired in a specific way. Either square waves or square-topped pulses should be applied to the toggle terminal (T).

As stated before, TTL flip flops trigger at the trailing edge. In Figure 5, the trailing edges have been marked with arrows. Each time a trailing edge appears at the toggle terminal, the output changes state. However, notice that the Q output at the first arrow changes from 0 to 1, while the change is from 1 to 0 at the next arrow.

The output repetition rate at the Q output is exactly half of that at

the toggle terminal. That's why this operation is sometimes called a divide-by-two.

A popular IC is the 7446, which has two separate J-K flip flops in a 16-pin DIP package. The pinout is given in Figure 6.

When used as a normal J-K flip flop, each section of the 7446 can be triggered to a *high* condition by a low at the *preset* terminal. And, a low at the *clear* terminal drives the flip flop to a *low* condition. Obviously, the preset and clear never should be allowed to have lows at the same time. These terminals are the equivalent of the set and reset in a R-S flip flop.

The Figure 6 pinout shows a common B+ and a common ground for the two flip flops. Otherwise, the two flip flops can be operated independently. In other words, you can wire and operate one flip flop, but connect nothing to the other terminals.

continued on page 24

Industrial

continued from page 23

Don't ground unused terminals

The previous paragraph suggests an important point about practical logic wiring.

With vacuum tubes and transistors, it is good practice never to allow any terminals to float without connections. An unused grid in a tube usually was connected to cathode or ground. This prevented the floating element from picking up an undesired signal, or from developing a negative charge from swarming electrons.

Not so, with logic circuitry. DO NOT GROUND ANY OF THE UNUSED TERMINALS. For example, think of any logic device that has a Q and a \bar{Q} output. These terminals have signals of opposite polarity. If you grounded the \bar{Q} terminal because it wasn't being used, then sooner or later it would attempt to go high. A high terminal that's connected to ground is the same as shorting the supply voltage to ground through the IC. THE IC WOULD BE RUINED.

Toggleing the J-K

Figure 7 shows how to wire a J-K flip flop for toggling. The clock terminal becomes the toggle input; then the preset, clear, J, and K terminals are wired to the positive side of the power supply.

Notice that this wiring is not in contradiction to the previous advice about not connecting to any unused terminals, because these terminals are used.

CMOS J-K flip flops should NOT be wired for toggling by this method. In fact, it won't work for all types of TTL J-K flip flops. You should check the pinouts of each type, and observe the manufacturer's recommendation for wiring any J-K flip flop for toggling.

Experiment #2

Earlier, the 555 IC timer was explained, and an experiment verified that it can operate as an astable multivibrator. In this experiment, the 555 multivibrator is used as a clock to toggle the J-K flip flop.

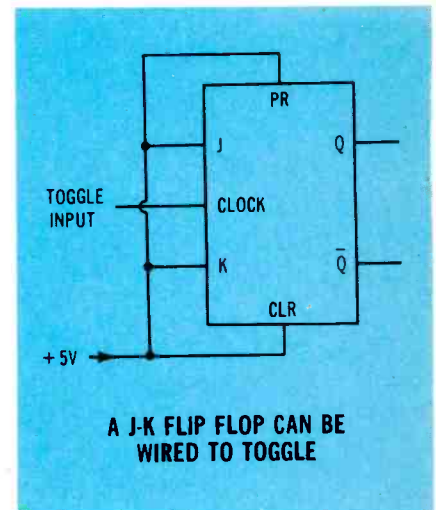

Figure 7 A J-K flip flop can be made to toggle by wiring it as shown.

Both of these circuits were detailed before, so Figure 8 shows only a block diagram of the interconnections and the logic probes.

If you have wired everything properly, the second LED at the

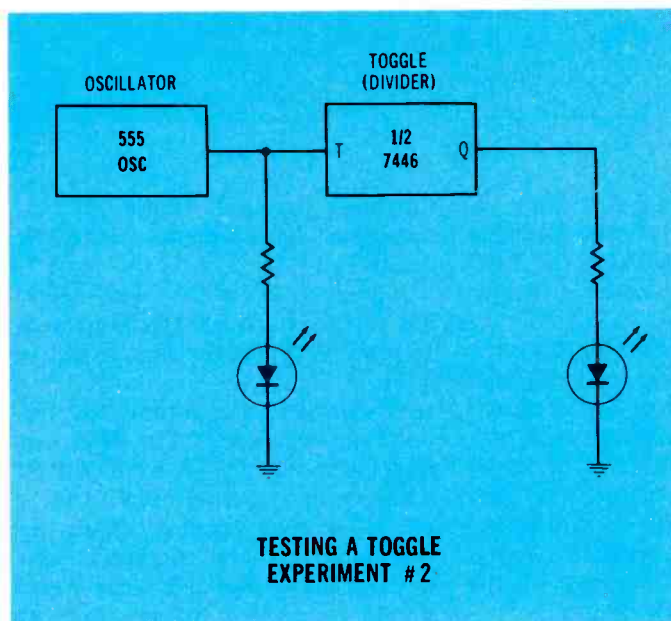

Figure 8 Combine the 555 multivibrator oscillator and one of the 7446 J-K flip flops (which is wired to toggle) as an experiment to prove that a J-K can be made to toggle.

TABLE 1
The Decimal Versus Binary Systems

Decimal Number		Binary Number			
tens	units	2 ³	2 ²	2 ¹	2 ⁰
0	0	0	0	0	0
0	1	0	0	0	1
0	2	0	1	0	0
0	3	0	1	1	1
0	4	0	1	0	0
0	5	0	1	0	1
0	6	0	1	1	0
0	7	1	0	1	0
0	8	1	0	0	0
0	9	1	0	0	1
1	0	1	0	1	0
1	1	1	0	1	1
1	2	1	1	0	0
1	3	1	1	0	1
1	4	1	1	1	0
1	5	1	1	1	1

output of the toggle will flash at exactly half the rate of the first one. If the first LED flashes too fast for good observation, parallel another capacitor or two across C2 until the flashes slow down.

Binary Numbering System

Until now, we have ignored the binary numbering system because it did not help explain the digital circuitry. Now, however, we must pause and learn the basics of binary counting. The next subject is about counters and display systems, which are designed to operate in the binary system.

People count by tens because the norm is ten fingers. But, there are other systems of counting. For example, many electronic devices have just two states of operation, such as on/off, saturated/not-saturated, glowing/not-glowing, energized/not-energized, and many more. So, a system of counting by tens (binary) can be very useful.

Table 1 shows the decimal count

from 0 to 15. The decimal system has ten individual symbols—one for each number 0 through 9. Then, when you reach the count of 9, all of the symbols are used up, and it's necessary to start a new column at the left. The new column uses the same ten symbols over again. To count up to decimal 15, then, two columns are required.

The binary system has only two symbols: 0 and 1. The first four columns are numbered 2^0 , 2^1 , 2^2 , and 2^3 , which correspond with the decimal numbers 1, 2, 4, and 8. Later, you'll discover an important reason for identifying the columns in this way.

Patterns of the counts

In the binary columns, the first number corresponding to decimal 0 also is 0 in binary (or 0000, for all four columns). The next number is 0001 for decimal 1. This has used up both symbols in the 2^0 column, so a new column must be started at the left, making 0010 for 2. Adding

a 1 to the last column changes it to 0011 for 3. Next, a 1 is added to the 2^2 column, for a 0100 (or 4). It's followed by 0101 for decimal 5, and 0110 for 6, and finally filling the three columns, 0111 for decimal 7. And so on, until the binary number is 1111 for decimal 15.

Did you notice the progressive pattern? In binary work, you will find it very helpful to identify this pattern.

The ones in these columns have decimal values, but at the beginning I suggest that you learn the *pattern* for counting. In a pinch, you can start with a number you know and write down the numbers in sequence until you reach the one you want.

Next Month

More information about binary counting and how to use toggled flip flops as frequency counters will be presented next month. If possible, keep the circuit of Figure 8 set up for the next experiment. □

MASTER heat gun

Wherever fast,
portable heat
is the need.

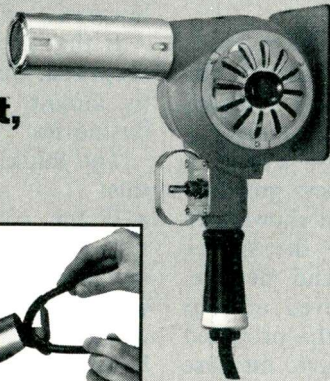
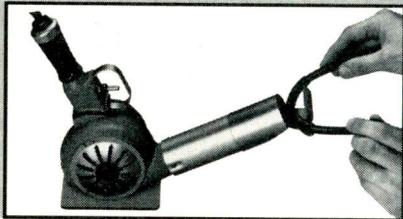

Heating shrink tubing is just one of many jobs the Master Flameless Heat Gun performs in electronic assembly. It's the perfect source of fast, portable heat for drying components, heat-checking circuitry, softening plastics and adhesives, melting solder, etc. Industrial quality for production line duty. Eight models: 200°F to 1000°F, 120V or 230V. UL listed — CSA certified. Base plate rotates 90° for convenient benchtop use. Special application attachments available.

For FREE product bulletin from the originators of heavy duty heat guns, contact your distributor, or call or write:

In Canada, contact Martin Industrial Sales, Ltd. 4445 Harvester Road Burlington, Ontario L7L 2X1

MASTER
appliance corporation
2420 - 18th Street
RACINE, WI 53403 U.S.A.
Tel. (414) 633-7791
Telex 269-505

TUNERS • MODULES

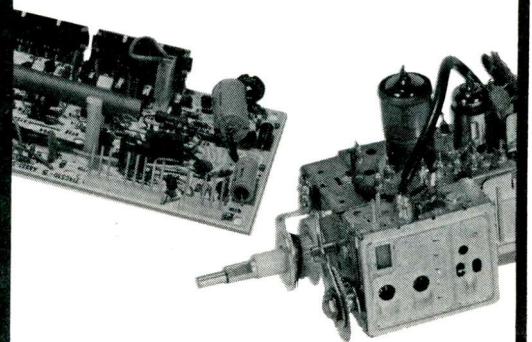

The next time you need
a tuner repaired or module rebuilt:

Remember
FAST SERVICE
Remember
PROFESSIONAL QUALITY
Remember
ONE-YEAR LIMITED WARRANTY
Remember
PTS ELECTRONICS

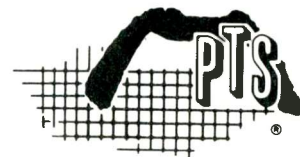

PTS ELECTRONICS, INC.

SEE THE YELLOW PAGES FOR THE
PTS SERVICENTER LOCATION NEAREST YOU

Circle (9) on Reply Card

Circle (10) on Reply Card

The Philosophy of Pricing

By Dick Glass, CET

After you have calculated how much you SHOULD charge, the next step is deciding what rates you WILL charge.

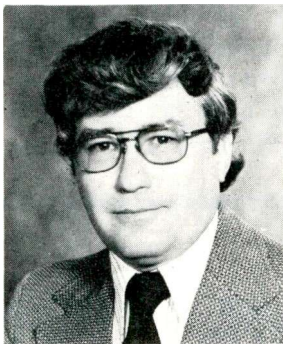

Decision Time

During the past few months, you have been making decisions about many things. However, most of these were minor, and not really the kind to raise your blood pressure from worry.

No doubt, you have done most of these beneficial things:

- set new financial goals for yourself and your business;
- learned how to read P&L statements and balance sheets, thus identifying and *correcting* any weak areas of expenses or income; and
- calculated your productivity, comparing it to the industry average.

These actions should have increased income and efficiency, while reducing expenses and waste as much as possible.

Probably you now have a good, tight operation. But there's one more item you lack: an *increased* income from profits and return-on-investment which also allows a reserve for future business growth.

Previous articles have shown two methods of calculating the service rates that you need and deserve. Probably you have arrived at your own figure by now. If the proposed service rates show a drastic increase over your present ones, it's likely

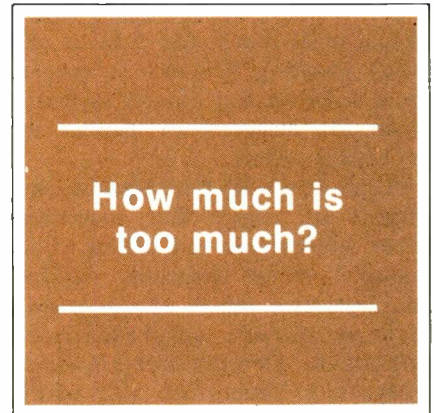

you are *afraid* to adopt them! **YOU'RE CERTAIN NONE OF YOUR CUSTOMERS WILL PAY THE NEW RATES**, and you will lose all of your present volume of business.

If that is your reaction, don't be surprised. Such a dilemma is faced by almost all managers of small businesses.

The thinking goes something like this:

- If the competitor's prices were not so low, I *might* be able to increase my rates slightly.
- If the products I service cost the customers more, the owners *might* be more willing to pay higher repair prices.

Table 1
Figures for 100% Price Increase

Call Rate	Total Jobs	Total Income
\$20	100	\$2,000
\$40	80	\$3,200

Table 2
100% Price Increase
And 40% Job Loss

Call Rate	Total Jobs	Total Income
\$20	100	\$2,000
\$40	60	\$2,400

- If I could refuse all of those unprofitable repairs, *perhaps* the present rates would be satisfactory.
- If I could sell more parts and accessories, those profits *might* compensate for insufficient income from labor.

These four kinds of wishful thinking were thrashed out before. In this painful decision, none of them are relevant. And, decision time is NOW.

If you can't succeed in receiving adequate compensation for your efficient operation, then your business is bound to fail, either quickly or slowly as you dissipate your investment.

The Answer

At this point, the only answer you need (to the question of raising your rates) is what effect the proposed increase will have on your business volume. Nothing else is important.

The experience of others who have faced the same problem shows that the fear of failure from higher rates is about 10% real and 90% imaginary.

You can solve the dilemma by a "Philosophy of Pricing" that's based on these four factors:

- COURAGE,
- COMPETENCE,
- CREDIBILITY, and
- CURRENCY.

Courage

Great courage is needed to charge realistic prices, especially if you have a hungry close competitor who's still charging 1970 prices.

Competence

Of course, you must have sufficient technical ability, parts stock, test equipment, shop facilities, and a good public image to justify the proposed rates. This does not require perfection, which is impossible to achieve. But, your ability to perform must not be less than your customers expect.

Credibility

Credibility goes beyond mere honesty (which is expected), for it must convince the customers that your prices are fair. Customers need proof of the value you have charged for. A TV shows no outward sign of the dozen hours of painful labor needed to solve a "dog" problem. You must tell them. If you used \$1,200 worth of test equipment to locate the defect, it adds credibility to mention the fact. Sometimes solving a minor extra problem (curing a noisy volume control with tuner cleaner, for example) will convince a customer that you give added value.

Customers are just as likely to complain about a low, below-cost repair as a profitable one. However, they all want value, and *you must give evidence of value received.*

Currency

Currency, the money you need to operate, will come as the result of the other three "Cs"—Courage,

Competence, and Credibility. These are far more effective than your self-righteous indignation toward any customer with arrogance enough to question your rates.

A Good Reason To Charge More

One fellow CET formerly was a shop owner, and now is an investigator for a state licensing board.

Will my customers go elsewhere?

Recently, I asked him about the main cause of customer complaints against servicers. He answered quickly, "The servicers who get into trouble most often don't charge enough for their work." This is the reverse of our usual beliefs.

Problems of low prices

Many problems for both you and your customers occur because you don't charge enough. For example, you try to crowd in extra repairs to make a small profit despite below-cost rates. The pressure causes you to make mistakes, requiring numerous recalls. These recalls are done grudgingly because of the lack of time and not having any profit to pay for the extra repair. In turn, your sour face, and his suspicion about why a second repair was necessary, detracts from your credibility.

Other problems arise because you
continued on page 28

Are my rates fair?

Table 3
Price Increase, Job Loss, Parts Income

Call Rate	Total Jobs	Parts Sales	Total Income
\$20	100	\$1,000	\$3,000
\$40	60	\$ 600	\$3,000
CALCULATION:			
	Labor income increase		\$400
	Decrease of parts profit (50%)		-\$200
	Subtotal		\$200
	Decreased overhead		\$100
	Decreased labor costs		+\$300
	Subtotal		\$400
			\$200
			+\$400
	TOTAL GAIN		\$600

can't afford enough employees, adequate test equipment, and a competent office staff.

Even worse, your desperate desire to break even might tempt you to charge for work not done or parts not installed. The justification is that the customer is paying no more than if you charged proper labor without the false items.

Your family is cheated by the long hours of overtime you work just to make a bare living. Even your neighborhood is penalized because your run-down shop eventually becomes an eyesore.

Advantages of higher prices

After you increase your labor rates, your competitors invariably raise theirs. So, your "higher" prices rapidly become "average." Also, those higher rates tend to convince the set owners that your service is better than the low-priced shops. Fewer old sets with difficult multiple troubles will be brought to you, thus eliminating most of the junk sets, which often require extensive and unprofitable repairs.

The higher income will allow you to hire more-experienced technicians, and purchase needed test equipment and supplies. The temptation to charge for parts or labor that are not delivered will be lessened.

Probably you know of two shops in your area. One charges twice the per-hour rate of the other. Yet the higher-priced servicer usually has most of the business. This usually is the case.

Still not convinced? Then read about what is likely to happen when you increase your rates.

After The Price Increase?

Let's imagine that your previous service call price was \$20, and you increase it 25% (up to \$25). Further, we'll assume a 10% loss of calls because of resistance to the price increase.

Previously, your income for 100 calls totalled \$2,000. With the new rate, the remaining 90 calls will bring in \$2,250, which is an increase of \$250 for doing 10% fewer calls.

Of course, the \$250 is not pure profit, for you have eliminated the parts profit from those calls not made. If you average \$10 per call of profit from parts, the \$250 is reduced to only \$150. On the other hand, you have saved truck and overhead expenses, thus bringing the total up to perhaps \$200. This represents a 10% increase of income with a 10% reduction of time and work.

Calls Remain The Same

Actually, those previous figures are too pessimistic, because there are no known cases of such a moderate price increase reducing the business volume.

Experiences around the entire country show that only *extreme* price increases produce *any* loss of business.

Double Rate?

For example, let's assume the service-call rate of \$20 is increased to \$40 (that's double—or a 100% increase). I estimate that the shop might lose no more than 20% of the service volume. And this includes any long-term reduction caused by the competition keeping the old rates.

If you disagree with this 20% estimate, use the form of Table 1, and calculate by your own figures.

If overhead costs and wages remain the same before and after the raise, **the Table 1 \$1,200 increase of income is largely pure profit.**

Worst Case

We'll assume you have properly calculated your costs and found that \$40 per call is absolutely necessary to provide a modest

Will my shop
get a "high price"
reputation?

Regardless of rationalization, it's still petty thievery.

Forcing your customers to settle for someone of less competence is one possible indirect disadvantage to the community, when your below-cost prices drive you out of business. Your distributors suffer when you can't afford to buy proper test equipment and supplies, and the government loses the taxes you would pay if you made a profit.

profit. By disregarding the truth, you expect a 40% loss of repair jobs because of the higher rates. Now, what financial change will be brought by a 40% loss of customers and a 100% price increase? Table 2 tells the glad story. Without including any other factors, the income is \$400 (20%) higher!

Next, we'll calculate the complete gains and losses (see Table 3). The final gain of income is \$600, which is higher than the bare estimate.

Calculate The Effects Of Pricing Change

The purpose of this article is NOT to convince you to RAISE your labor rates, but to give you a method of forecasting the effects of any price change you might make. Many service-shop owners already know they need a certain price adjustment. But, they delay because of fears that the customers will complain loudly, and probably take their business elsewhere.

After you make any change of rates, I recommend you MEASURE any effects of the price change. Disregarding any unusual financial factors (extreme weather, a costly strike in the area, etc.), check your daily, weekly, and monthly volume against the same time period last year during the old rate.

Also, urge your employees to write down every case where a customer complains about the price. Chances are, you will find very few legitimate price complaints. Probably, no more than you received at the old rates.

If you still worry about the backlash from rate changes, make gradual price adjustments and monitor the results each time.

I can't survive much longer on my current rates

Comments

Comparison shopping is a permanent part of our modern life. Price comparisons between identical products in different stores can be done easily with high accuracy. All Buicks (or Plymouths or Pacers) come from the same factory; the prices vary only at the whim of the dealer.

Other comparisons are more difficult and less valid. In my area, all barbers charge the same for a haircut (how has the FTC overlooked that kind of price fixing?), so we choose a barber for his skill or personality. On the other hand, when a broken pipe begins to flood your home with water, do you call a dozen plumbing shops and choose the one with the lowest price? I am the patient of a certain doctor, for he is the only one who was able to help me. His office calls have increased 50% in the last two years, but I will not go to another.

My point is that some price comparisons are valid and helpful, while others are an exercise in futility. Very few electronic-repair prices can be compared directly. Most shops have some kind of a flat-rate price for service calls, and these prices allow some degree of comparison. Even with calls, there are no standards about the specific services which are done within the basic flat-rate price versus others that require an extra charge. Beyond service calls, the price comparisons become even less accurate. One reason is that, before a technician examines the machine, the customer doesn't know what parts and services are needed.

A few customers might call several shops to compare their prices before selecting one. However, most set owners are aware that such a "bargain" often becomes a disappointment. Consequently, the choice of a service shop usually is done according to the various reputations for honesty and competency. **Credibility is more important than price.**

An old saying states, "Quality will be remembered long after the price has been forgotten." That principle certainly applies to the pricing of electronic repairs. □

New Slim-Body scope probes from B&K-PRECISION ...cost effective and really rugged!

B&K-PRECISION's new line of 10:1 direct scope probes is designed to be compatible with most scopes available, up to 50MHz. All are rated at 500Vp-p. B&K-PRECISION slim-body probes range in price from \$25-\$35.



Model	Connector	Bandw.	Matches
PR30	UHF	10MHz	15-120pF
PR31	BNC	10MHz	15-120pF
PR34	UHF	15MHz	10-35pF
PR35	BNC	15MHz	10-35pF
PR36	BNC	50MHz	10-35pF

Available for immediate delivery at your local distributor. Write for a free copy of the latest B&K-PRECISION catalog.

BK PRECISION
DYNASCAN CORPORATION

6460 West Cortland Avenue
Chicago, Illinois 60635 • 312/889-9087
In Canada: Atlas Electronics, Ontario

Circle (11) on Reply Card



Servicing Sylvania Color TV, Part 6

By Gill Grieshaber, CET

Tuning of the take-off and bandpass stages is not adjustable in the chroma circuit of the Sylvania E44 chassis. ICs are used for most functions. A chroma setup switch and several testpoints simplify the troubleshooting. Following the circuit explanations, several suggestions are given for troubleshooting the video and chroma stages.

Chroma Features

Most of the Sylvania E44 video and chroma circuits are located on the chroma module (Figure 1). The video signal is amplitude adjusted by three drive controls and then applied separately to the *emitters* of the three power transistors that drive the three picture-tube cathodes. The three -Y demodulated chroma signals drive the proper *bases* of those same color transistors (pre-CRT matrixing). These plastic-type, medium-power, color-output transistors and their associated components are mounted on a circuit board which is attached to the picture-tube socket.

All color receivers **MUST** have certain basic functions, such as:

- peaking and bandpass tuned circuits;
- chroma IF amplification, de-

modulation, and -Y amplification; • adjustments for tint, color killer, color locking, and color saturation.

Of course, the chroma circuit of the E44 chassis has all of those functions, using one transistor plus two-and-a-fraction ICs. However, the three tuned circuits and several phase-shifting filters are not adjustable. Such functions as color saturation, color tint, color killer, color locking (APC), automatic chroma-level control (ACC), and color threshold are controlled by varying DC voltages (from potentiometers) that are applied to pins of the ICs. Look for these features, as the circuit operation is explained.

Because ICs are "black boxes" whose internal circuits are not shown, the functions of many components connected to the ICs are difficult to understand. There-

Figure 1 Components of both the video and chroma circuits are located on the chroma module (near the center of the chassis), and on a circuit board attached to the picture-tube socket.

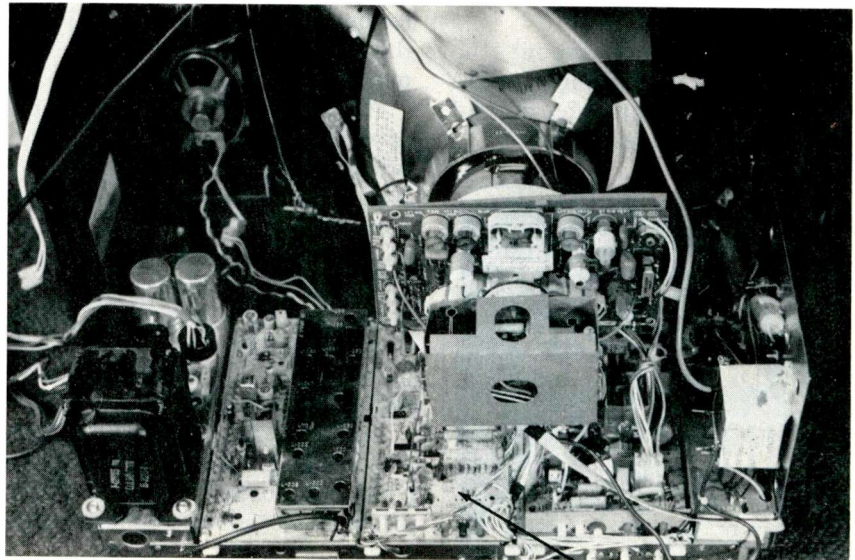

fore, most components will be designated according to circuit or function.

Waveforms are of highest importance in video and chroma circuits, so all those needed for servicing will be shown. In this chroma system, many of the DC voltages change according to the chroma level and the adjustment of the various controls, as well as being different for monochrome signals. Typical DC voltages for various conditions are listed.

Locations of the major chroma components are pointed out by arrows in Figure 2, while the schematic is in Figure 3.

The TC or TD numbers shown on the schematic refer to the module pins, which are plainly marked on the module surface.

First Chroma Amplifier

Negative-going video enters the chroma circuit at module pin TC43. R670, C666, C664, R668, and L670 together form a low-Q resonant circuit that tunes to about 4 MHz. (C664 and L670 are the principal tuned components.)

Notice that only 3.58-MHz chroma and burst remain after the input video color-bar signal (W1 in Figure 4) reaches IC602 pin 2 (W2), after passing through the takeoff filter and coupling capacitor C660. (A color-bar generator with the chroma on black pedestals was the source of the signal at the TV antenna terminals.)

Inside IC602, the chroma IF signal is amplified slightly, and it comes out at pin 3. Incidentally, IC602 is shown in three sections, to

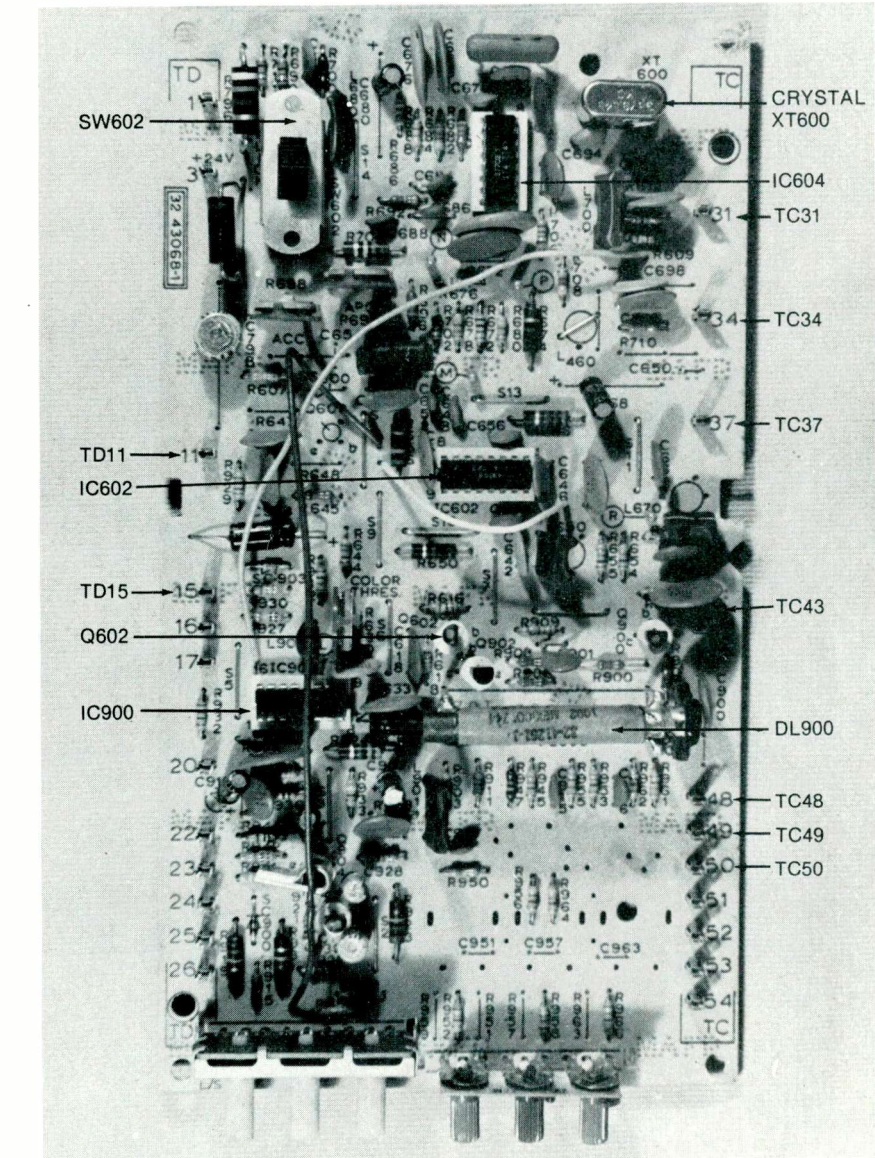

Figure 2 Arrows point out the locations of important chroma ICs, test points, and one transistor.

make the signal-flow paths easier to follow.

One reason for the moderate voltage gain (about 2½) is the Automatic Chroma-gain Control (ACC) DC voltages that are applied to IC602 pins 1 and 16. Variations of the DC voltage BETWEEN these pins control the gain of the first

chroma amplifier. These DC voltages vary *slightly* below and above +8 volts, with the pin 1 voltage *decreasing* with a stronger chroma signal, and pin 16 voltage *increasing* with stronger input chroma level. This action is detailed in Table 1.

continued on page 32

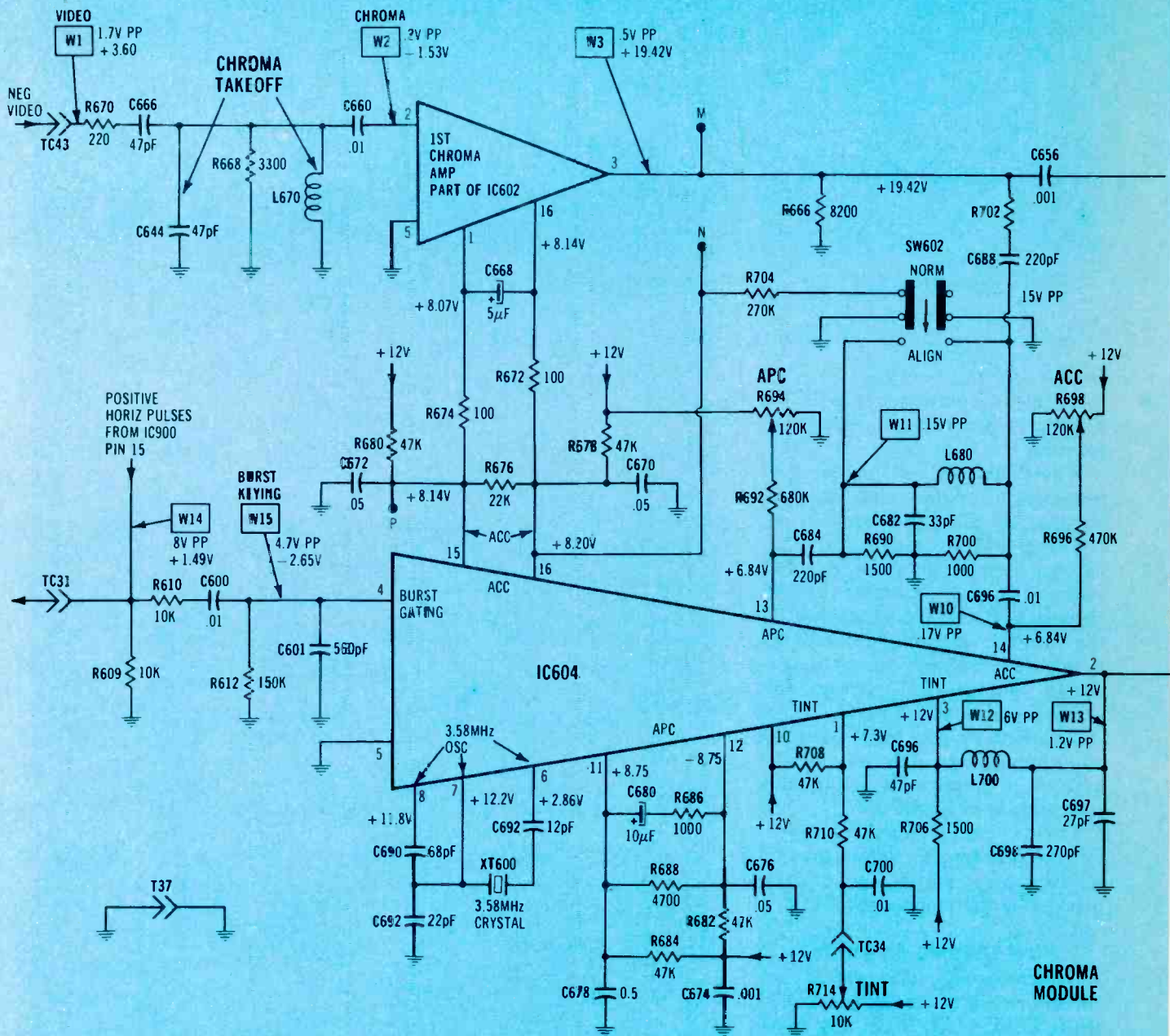

Sylvania

continued from page 31

The ACC DC voltage is supplied by IC604 pins 15 and 16, and the chroma level is sensed by the Waveform 10 signal at pin 14. In addition, the adjustable DC voltage at pin 14 is used during the chroma setup alignment. These three pins (14, 15 and 16) of IC604 are used for ACC. Testpoints "P" and "M"

are connected to the ACC voltages at pins 15 and 16.

Chroma-Bandpass Amplifier

From IC602 pin 3, the chroma-IF signal goes through coupling capacitor C656 to pin 4, where the signal is amplified slightly, coming out at pin 14.

L650 and C642 tune to about 3.58 MHz, and R655 flattens the response, as required for a band-pass stage. This bandpass circuit and the takeoff tuned circuit at pin 2 are the only two resonant circuits in the chroma IF. Neither is adjustable. The signal from pin 14 is ready for the demodulators.

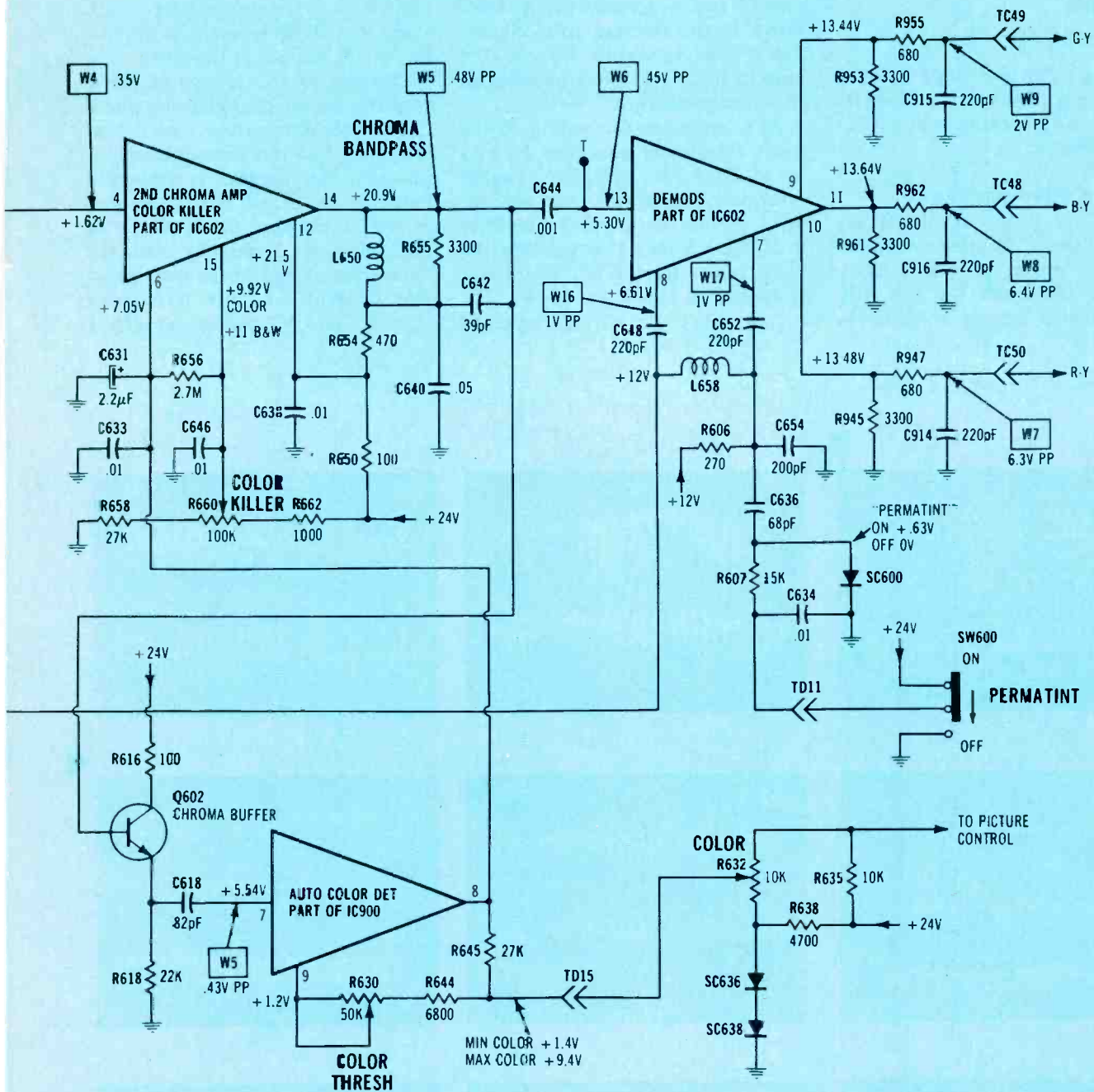

Figure 3 This is the chroma schematic, except for the matrixing color amplifiers. The DC and peak-to-peak voltages shown here were measured during color-bar operation, and the waveforms are in Figure 4.

The pin 14 signal has another job. It's buffered by emitter-follower Q602 transistor, and is applied to IC900 pin 7 (the video IC). The DC voltage output from IC900 pin 8 is filtered and applied to pin 6 of IC602. This DC voltage controls the gain of the second chroma amplifier according to the *average chroma*

level. The ACC, to be described later, controls the gain of the first chroma amplifier according to the *burst* level, which is independent of the chroma amplitude. Both circuits together provide steady, consistent color saturation.

Another function—the color killer—operates in the same part of

IC602, although most of the components are hidden inside the IC. The DC voltage at pin 15 (from the killer control) determines the exact minimum chroma level where the killer eliminates the gain of the second chroma stage.

Before analyzing the demodula-
continued on page 34

Sylvania

continued from page 33

tors—which also are inside IC602—we will describe the 3.58-MHz oscillator, color locking (APC), ACC, and tint circuits.

IC604 Functions

Pins 7, 8, and 6 of IC604 are used for the 3.58-MHz oscillator. Horizontal pulses at pin 4 allow gating of the burst for the APC color-oscillator locking. In addition,

pins 11 and 12 connect external RC filters to the internal APC circuit. These pins (and pin 13) are the ones to test, if a defect happens in the color oscillator.

ACC operation (according to the burst amplitude) uses pins 15 and 16 to filter the ACC DC voltages (previously described) that are applied to the first-chroma amplifier in IC602. Chroma that contains the burst comes from IC602 pin 3 and is applied to IC604 pin 14.

A sample of the chroma signal at

pin 14 is phase-delayed by L680, C682, and R690 before it is applied to pin 13, for use in the APC.

Changes of DC voltage at pin 1 vary the tint by changing the phase of the 3.58-MHz carrier that is sent from pin 2 to the demodulators. A phase shifting network is connected between pins 2 and 3, and the level at pin 3 changes drastically with tint variations, especially near the "green faces" end of the front-panel tint control. In this particular chassis, the DC voltage at pin 1

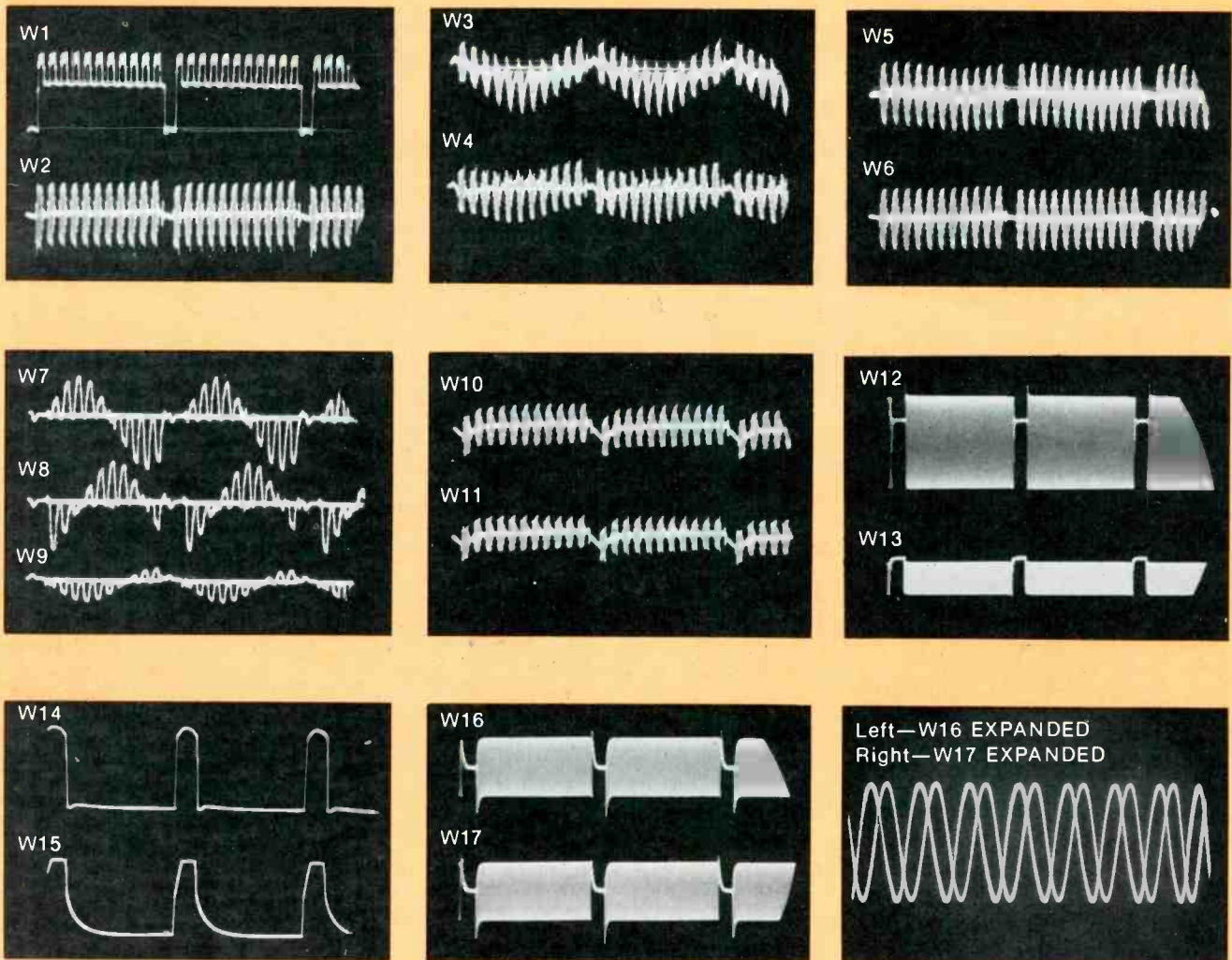

Figure 4 These waveforms are for the Figure 3 circuit. The color bars have black bars between them; so W1 might be different when you use your color/bar generator. Waveforms W2 through W6, and W10 through W11, are chroma-IF signals. Notice the first bar (burst) is not blanked out of any waveforms. Waveforms W7 through W9 are the demodulator outputs. W12 and W13 are 3.58-MHz

CW signals of the tint circuit, shown at the horizontal rate; notice the horiz blanking. W12 varies in amplitude with the tint adjustment. W16 and W17 are the 3.58-MHz CW signals for the demodulators. Scoped at horiz rate, they are identical. When expanded by the triggered scope, the phase difference is shown.

varied between +7.21 for green faces to +7.55 for purple faces.

Test probe warning

Several pins of IC604 are sensitive to the extra capacitance of an X1 scope probe, or a digital meter without an isolation resistor in the probe. When such a high-capacitance probe is connected to pins 6, 7, or 8, the 3.58-MHz oscillator stops, thus eliminating all color.

In the same way, excessive capacitance at pins 1, 2, and 3 of the tint circuit shifts the tint by various amounts.

Demodulators

The chroma signal from the pin 14 output of the second-chroma amplifier goes through C644 to pin 13 and the three demodulators of IC602. A direct 3.58-MHz carrier (without phase shift) from pin 2 of IC604 is brought to pin 8 of IC602, through C648. Part of this signal is phase shifted (delayed) by L658, C654, and R606, before it is sent through C652 to pin 7. The phase difference between pins 8 and 7 is about 90 degrees.

This 90-degree phase difference can be increased by the "Permatint" switch and circuit. When switch SW600 is slid to the on position, +24 volts is applied to R607. The voltage at the other end of R607 biases diode SC600 into conduction, thus grounding the cold end of C636. C636, therefore, is connected in parallel with C654, and the phase of the carrier at pin 7 is delayed even more than the original 90 degrees.

After demodulation between the chroma-IF signal and the various 3.58-MHz CW signals, the unfiltered R-Y, B-Y, and G-Y waveforms emerge at pins 10, 11, and 9 respectively. Ripple in these signals causes the waveforms to appear fuzzy. Therefore, we usually examine them following the RC filters (R947/C914, R962/C916, and R955/C915), as shown by W7, W8, and W9.

These three -Y signals are sent to the bases of the three color amplifiers (Q912, Q916, and Q914). The monochroma video is applied to all emitters of the same color amplifiers, to complete the matrixing.

Signal	=	none	weak	medium	strong
Pin 1		+ 8.23	+ 8.21	+ 8.09	+ 8.06
Pin 16		+ 7.97	+ 8.05	+ 8.16	+ 8.15
Difference		-0.26	-0.16	+ 0.07	+ 0.09
(Both were + 8.75V in the ALIGN position)					

Table 1 These DC ACC voltages were measured at IC602 for various signal strengths.

Matrixing And Color Amplification

Video (which has vertical and horizontal blanking) leaves the chroma module at terminal TD22, goes through S900 service/normal switch, and returns through a coil to terminal TC54 of the same chroma module. That's because the video drive controls are on the chroma board.

When S900 is in the service position, the video is disconnected (which also eliminates any brightness adjustments) and positive-going horizontal pulses of 0.7 VPP are added to the drive controls (and eventually, the emitters of the color-output transistors). These pulses cause positive pulses of about 20 VPP at all cathodes of the picture tube for retrace blanking.

Figure 5 shows the wiring of the drive controls (on the chroma module) and the green, blue, and red output transistors, which are mounted on a module that's fastened to the picture-tube socket.

Color outputs

One power transistor is provided for each of the three colors. The video is applied to each emitter, and a G-Y, B-Y, or R-Y demodulated-chroma signal is brought to each base. The base/emitter conduction plus the unbypassed emitter resistors (that bring in the video) produces some unexpected waveforms. For example, chroma and some video is found at the bases; also video and some chroma is found at the emitters. Blanking pulses of some amplitude can be seen at base, emitter, and collector.

Therefore, you should study the waveforms of Figure 6.

Matrixing of the chroma -Y signal and the video signal is done inside each color output transistor.

Since both signals are applied to each picture-tube cathode, the picture-tube grids have no AC signals. Instead, they have a fixed bias of about +30 volts applied to all three in parallel. Of course, remember that the grid voltage does *affect* the overall brightness.

Troubleshooting

For troubleshooting video circuits such as the ones in the Sylvania E44, the recommended test instruments are a good scope (preferably of triggered-sweep and dual-trace type) and a digital multimeter.

With the scope, begin with the video input at terminal TC43 of the chroma module, and then trace each stage in consecutive order until you locate the one where the video problem first can be seen.

After the approximate location of the defect has been pinpointed, DC-voltage tests and transistor checks should be made. The transistor sockets are a welcome help when transistor testing is required.

Usually, ICs can't be tested adequately. So, just check for the correct incoming waveforms and all outgoing waveforms. Next, measure all IC DC voltages. If the input signals are there, and the DC voltages are okay, but there is no output signal, then it's a good bet the IC is bad.

Probably the most difficult thing about video testing is the several

continued on page 36

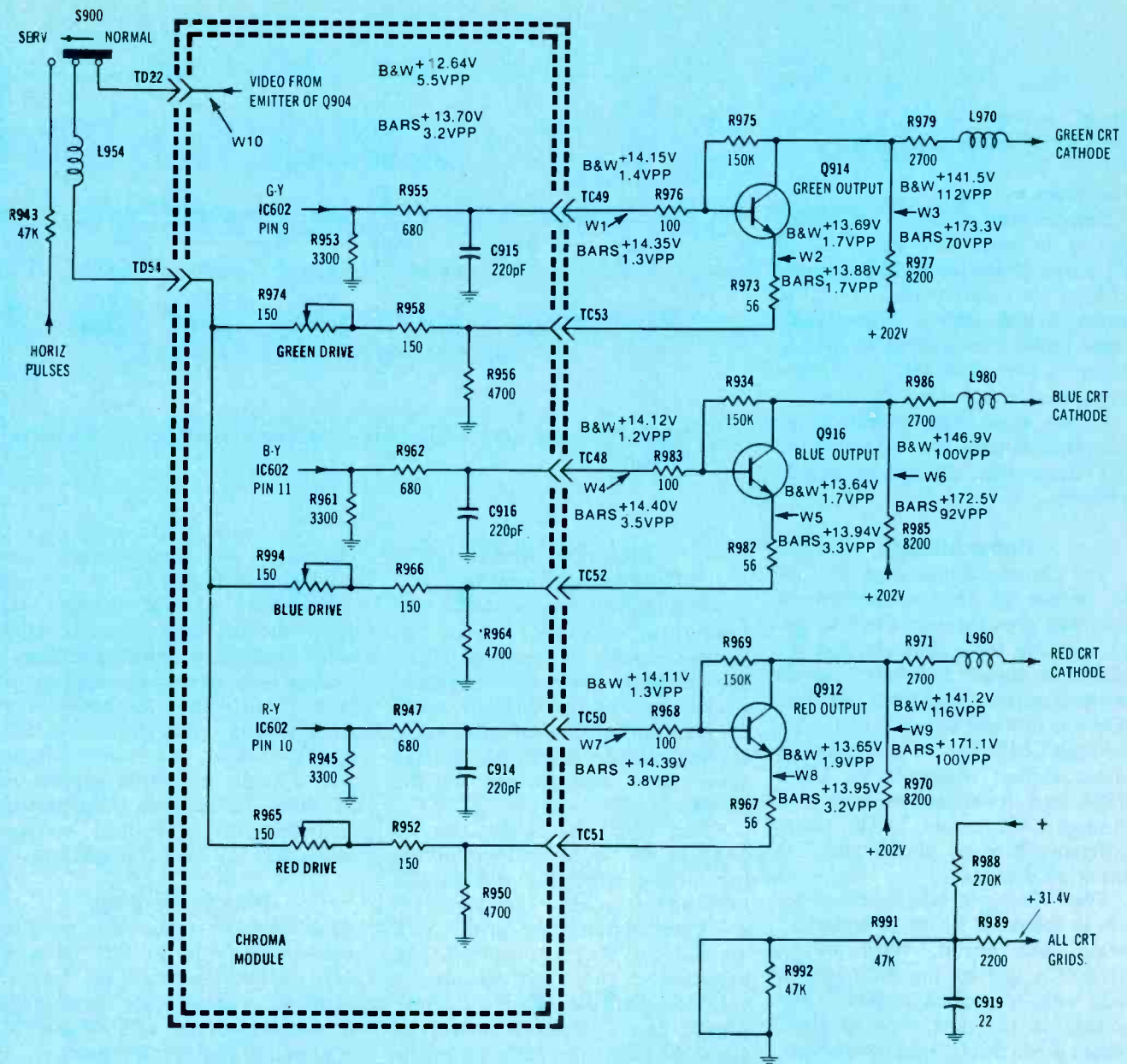

Figure 5 Matrixing is done by applying a -Y signal to the base, and the monochrome video signal to the emitter, of each color power-transistor. Each of the three transistors has a drive control that's adjusted during the gray-scale tracking for B&W pictures. Two sets of DC and PP voltages are listed, because the color-bar readings were drastically

different from the B&W measurements. Also, these voltages do not precisely agree with Figure 3 (several controls were readjusted between the two tests). The color bars and the 4-step-gray-scale video pattern came from an American Technology ATC-10 generator.

Sylvania

continued from page 35

stages that are direct coupled. Of course, there are no real closed loops, so usually the DC voltages will be out of tolerance only following the defective stage. We'll try to expound about servicing direct coupled stages in a later article.

Chroma troubleshooting is simi-

lar, and a good scope and accurate DC meter are the best test instruments. Before the video and chroma matrixing, there are few direct-coupled stages in the chroma. This simplifies most servicing.

Except for the APC control, which adjusts the color-oscillator frequency for proper locking, and the color-killer control there should be no adjustments needed in the chroma channel. The align position

of switch SW602 removes all color locking and the ACC operation. Then, it is necessary only to adjust the APC control so the colors drift sideways slowly and uprightly. Afterward, the switch is slid to the normal position. That's all.

Next Month

Details of the sound IF and audio circuits will be discussed next month in Part 7. □

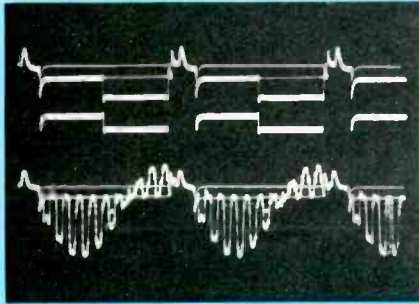

W1 GREEN
Q914 BASE

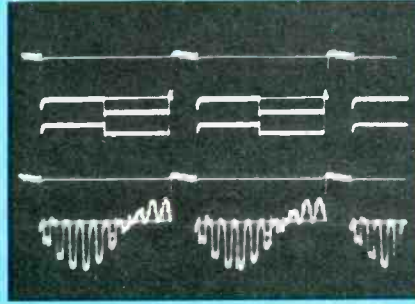

W2 GREEN
Q914 EMITTER

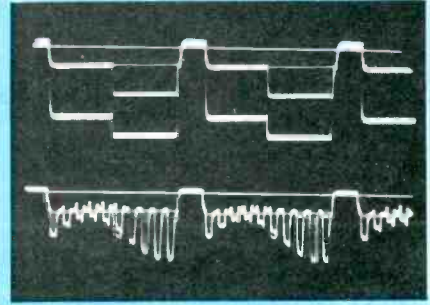

W3 GREEN
Q914 COLLECTOR

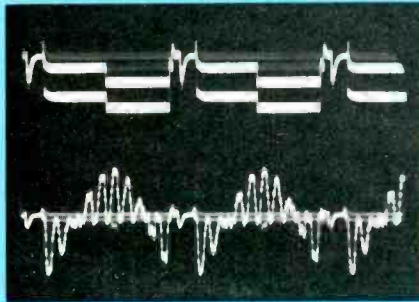

W4 BLUE
Q916 BASE

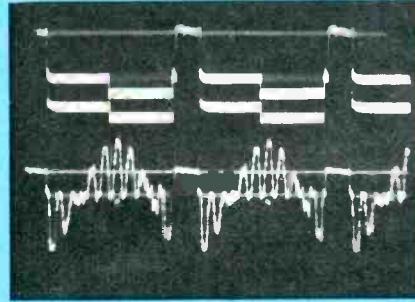

W5 BLUE
Q916 EMITTER

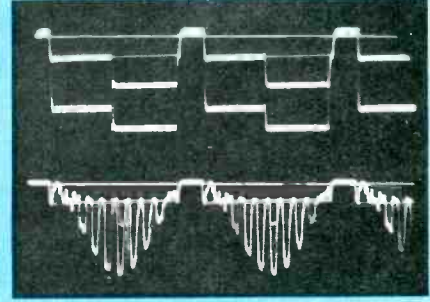

W6 BLUE
Q916 COLLECTOR

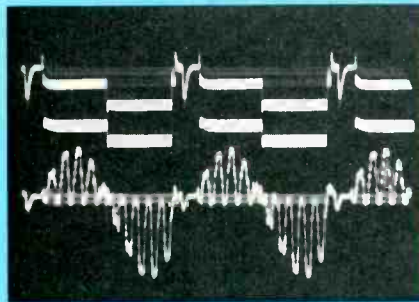

W7 RED
Q912 BASE

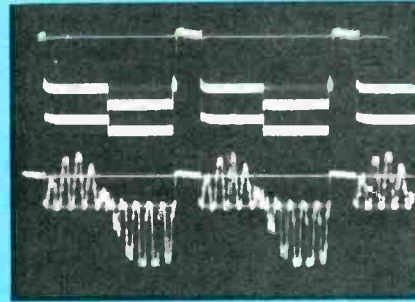

W8 RED
Q912 EMITTER

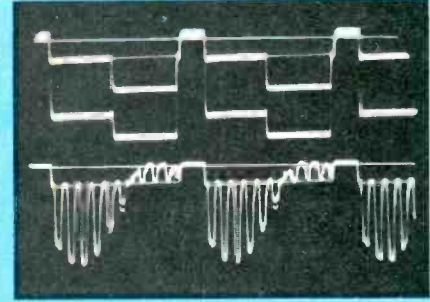

W9 RED
Q912 COLLECTOR

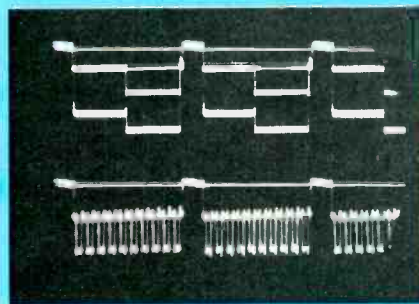

W10
TC22

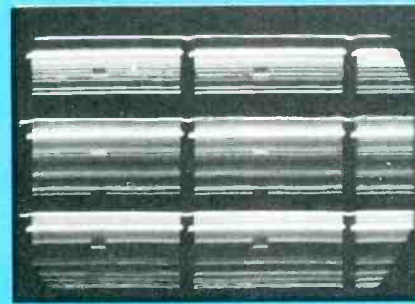

W11
GREEN, BLUE, AND RED
COLLECTORS

Figure 6 These are the waveforms of Figure 5. W1 shows the video waveform (top) and the color-bar waveform (bottom) for the base of Q914. W2 shows the same sequence of emitter waveforms, and W3 displays the same for the collector of Q914. W4 through W9 have corresponding waveforms for the other two transistors. W10 displays the B&W and color waveforms at module TC22 (also TC54), and W11 shows the three collector signals at the vertical rate.



Sam Wilson's Technical Notebook

Magnetic Memories and Diode Protection

By J. A. "Sam" Wilson, CET

Your comments or questions are welcome. Please give us permission to quote from your letters. Write to Sam at:

J. A. "Sam" Wilson
c/o Electronic Servicing
P.O. Box 12901
Overland Park, Kansas 66212

A Simple Magnetic Memory

The reviews of basic magnetism in this column are intended to prepare you for some actual magnetic devices. A simple type of digital magnetic memory will be discussed at the end of this section.

Summary of magnetics

Magnetic circuits and electric circuits do have some similarities that, unfortunately, are used too often in teaching magnetics. However, they are widely different in many important respects, so a direct analogy can lead to serious confusion.

It is common practice to equate magnetomotive force with voltage, flux with current, and reluctance

with resistance. This results in a neat—but misleading—formula called "Ohm's Law For Magnetic Circuits." It states: Flux equals magnetomotive force divided by reluctance. Or, in symbols:

$$\phi = \frac{\text{MMF}}{R}$$

The formula would be useful and totally true, except for one fatal flaw: **MAGNETIC CIRCUITS ALMOST NEVER ARE LINEAR.**

For an example, let's think about some of the exceptions in electric circuits where the DC Ohm's Law is not accurate, either. In the circuit of Figure 1, only one of the
continued on page 40

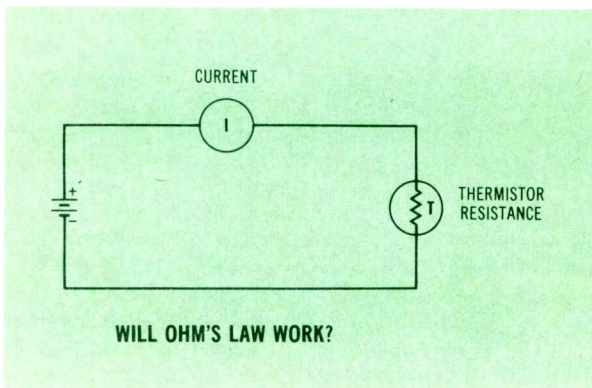

Figure 1 Of the three basic Ohm's Law formulas, only $R = E / I$ is accurate with non-linear resistances. Magnetic circuits also are non-linear, so an Ohm's Law for magnetics is impractical.

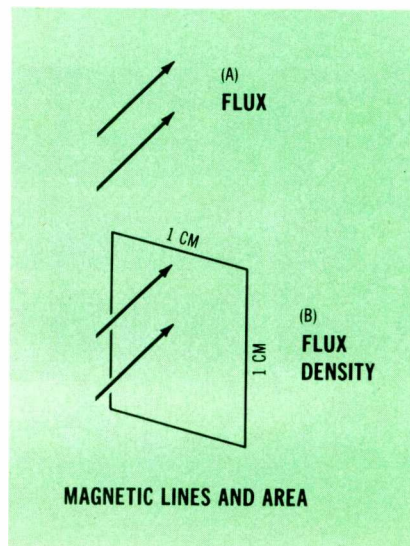
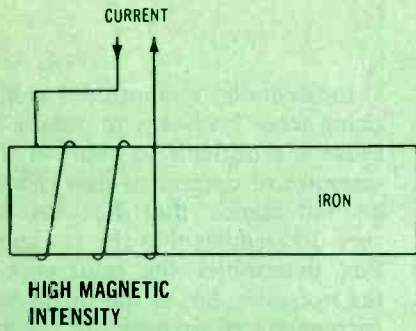
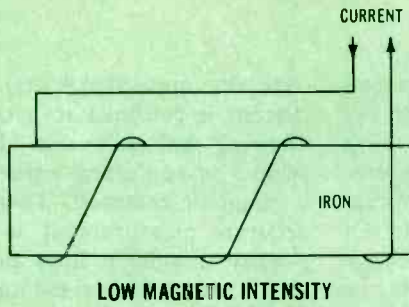

Figure 2 Because magnetic flux can extend beyond the magnetic material, a reading of total flux is of little value, in most cases. The preferred reading lists the number of magnetic lines per square inch (or magnetic density).



(A)



(B)

Figure 3 Magnetic intensity varies according to the concentration.

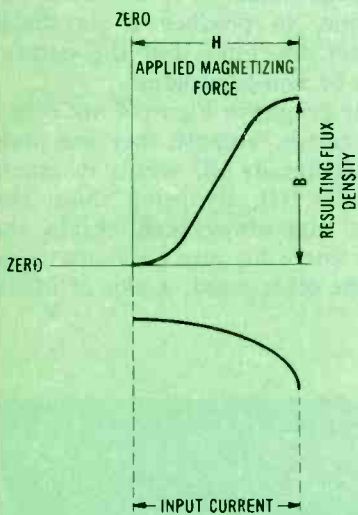

(A) VIRGIN B-H MAGNETIZING CURVE

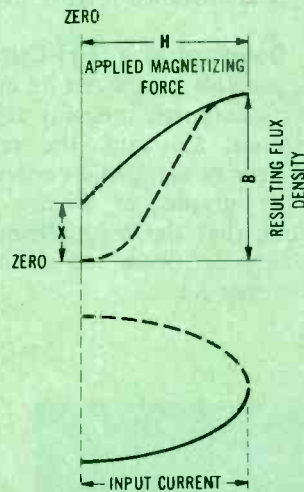

(B) SOME RESIDUAL MAGNETISM (X) REMAINS AFTER FORCE IS ZERO

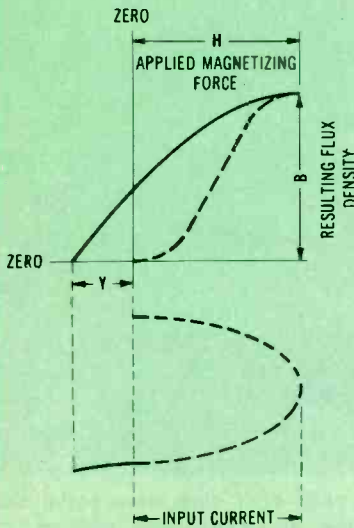

(C) REVERSED FORCE (Y) IS REQUIRED TO REMOVE THE RESIDUAL MAGNETISM

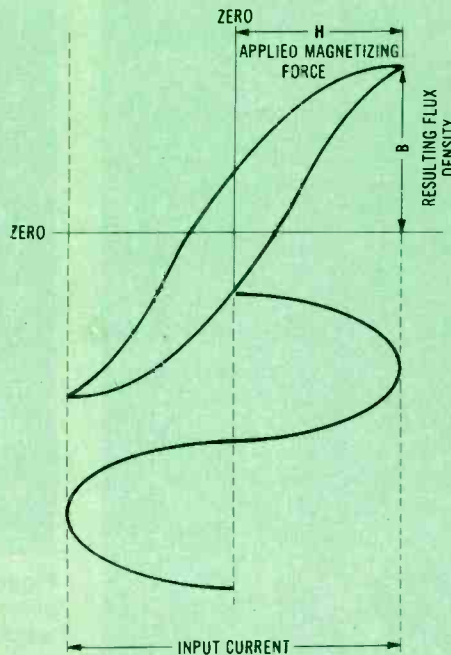

(D) A COMPLETE B-H CURVE

DEVELOPING A B-H CURVE

Figure 4 These are four steps of developing a B-H magnetic curve from a sinewave of current. The B-H curve is shown above the input current waveform. (A) the initial magnetization follows a different curve than the subsequent ones do (see the same part of D). (B) When the current returns to zero, the flux density does NOT return to zero. (C) Negative current is required to reduce the flux density to zero. (D) This is the complete B-H curve (excluding the virgin curve).

three variations of Ohm's Law can be used. The current varies with the resistance, but the resistance of a thermistor depends on the temperature, and the thermistor temperature changes with the current. (Of course, you *can* measure the voltage and current, and then calculate the resistance. But the other two formulas have serious errors.) Similar problems of non-linearity occur with thermistors and diodes.

Magnetic circuits have non-linearity problems comparable to the one with thermistors. Flux in a magnetic circuit depends on the magnetomotive force versus the reluctance of the material. However, the reluctance varies with the amount of flux. And, as the flux increases, so does the reluctance. Such a condition can't be analyzed correctly with a simple equation.

Also, two more problems compli-

cate the measurements. Electric current is confined to a conductor, allowing an easy test. But, flux seldom is contained entirely within a magnetic material. Therefore, an accurate measurement is the *flux density* (magnetic lines per square inch), rather than the total amount of the flux (see Figure 2).

Another problem affecting magnetic intensity is whether the magnetizing force is spread over a short distance (Figure 3A), or over a greater distance (Figure 3B).

Developing a B-H Curve

A valuable graph can be made by placing magnetic intensity along the horizontal axis and the resulting flux density along the vertical axis. In the graphs of Figure 4, we assume that the magnetizing force is sinusoidal (from the sinewave of AC current).

Incidentally, a sinusoidal magnetizing force isn't easy to obtain, because it's difficult to cause a pure sinewave of current to flow through an inductance that has an iron core. Remember that the amount of flux determines the reluctance of the iron core. So, as the sinewave of current starts to peak, it becomes more difficult to establish flux in the iron. Therefore, the counter voltage varies as the current changes for the minimum value to the peak value. It is difficult, but possible, to produce a sinusoidal magnetizing force, but the current must be non-sinusoidal.

The graphs in Figure 4 are called *B-H curves*, because they are plots of flux density (B) versus magnetic intensity (H). By using these two items, you always can obtain the *same* curve for any given material. On the other hand, a plot of MMF

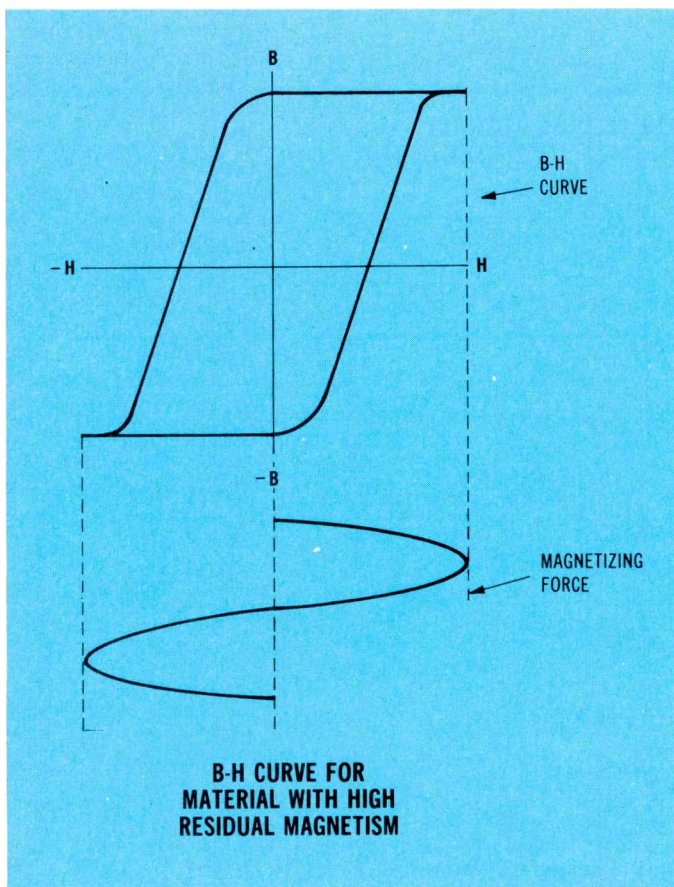

Figure 5 Some magnetic materials have greater hysteresis than the one in Figure 4. More flux density is retained after the force has stopped. These "square loop" materials are better for use in magnetic memories.

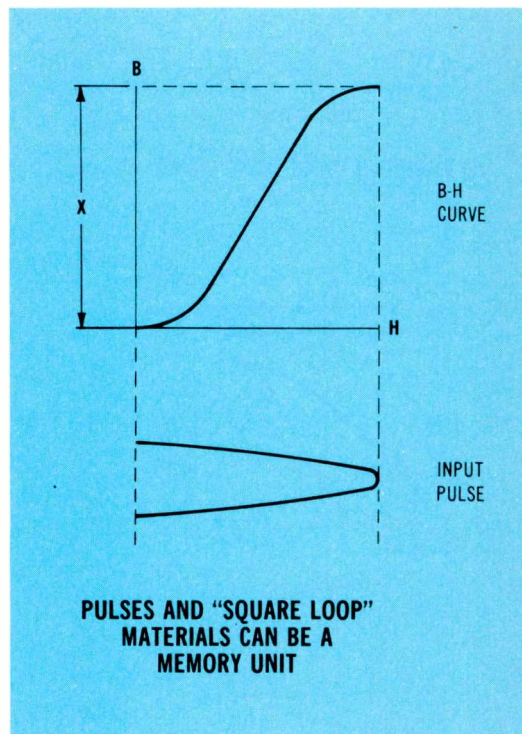

Figure 6 One peak of a sine wave, or a DC pulse, can leave an appreciable amount of residual magnetism after the pulse is over. With some means of detecting the residual magnetism, this can be the basis for a magnetic memory.

versus flux would vary according to the length of the coil or the cross-sectional area of the magnetic material. Clearly, a B-H curve is superior to others.

Magnetic Storage

This information has been giving you the background for a discussion of magnetic materials that can perform as storage devices.

When a magnetic material has a nearly square loop (as shown in Figure 5), it will retain a large amount of residual magnetism after just one-half cycle of magnetizing force (see Figure 6).

In other words, the magnetic material has stored magnetism obtained from an input pulse! Think about the implications for a moment. Digital signals are made up of highs and lows; that is, pulses or no pulses.

Therefore, if there were a way to determine that a certain area of magnetic material retained magnetism, then it would prove that a high pulse *had* been there. A lack of retained magnetism indicates a low was the last signal state.

In other words, **the problem is to move the digital information into or out of storage.** Next month, I'll show you how it's done.

Diode Protection

Rectifier diodes sometimes are connected in series to obtain a

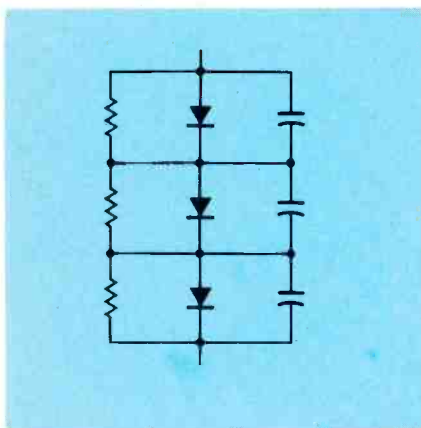

Figure 7 Resistances and capacitances paralleled across each diode of an array help prevent the overload of diodes having different characteristics. Thus, diode failures are minimized.

higher total peak-inverse voltage rating (see Figure 7).

When a high reverse voltage is applied to any diode, a minimum or small amount of current flows. With series diodes, the inverse voltages will be different across each individual diode, because of non-identical reverse leakages. When this unbalanced condition of the voltages is excessive, the PIV

rating of one diode can be exceeded, thus the diode fails by shorting.

In Figure 7, all resistors that are connected in parallel with diodes have the same value, so they equalize the various diode reverse voltages.

Usually, the reason for the paralleling capacitors is stated as an
continued on page 42

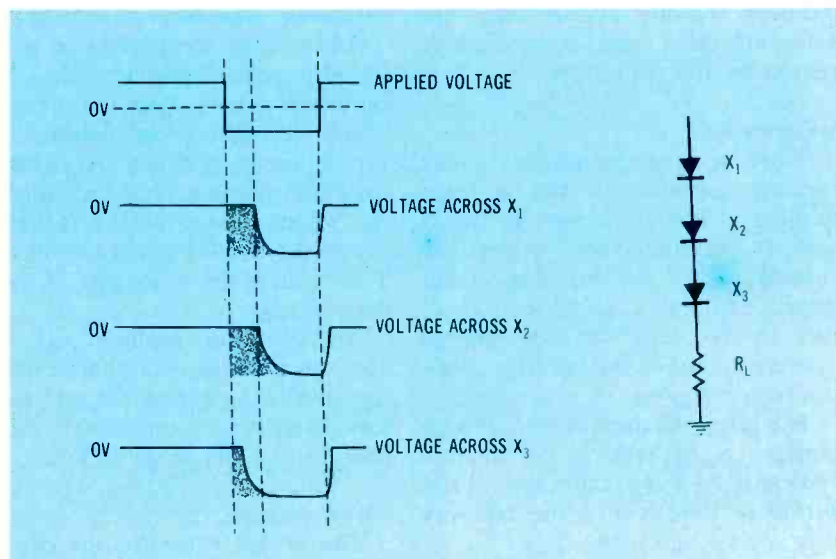

Figure 8 For a brief time following the end of conduction, a diode has zero resistance. This allows part of the reverse peak to appear in the output waveform. This time is called "recovery time," and it is different for individual diodes. The diode having the shortest recovery time has the total reverse voltage across it, during its recovery time.

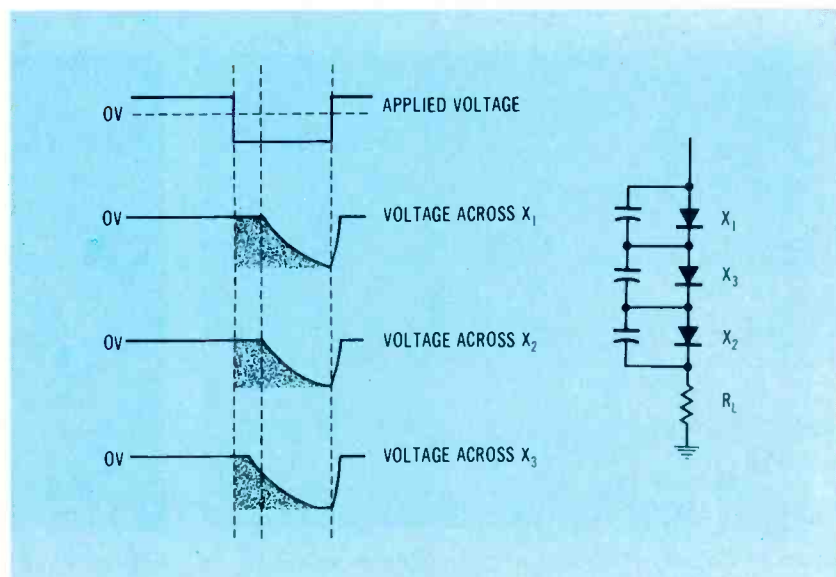

Figure 9 Adding a capacitance across each diode lengthens the recovery time of each one, thus minimizing the *variations* of recovery time, and protecting most diodes from overvoltage shorts.

equalizing of the transient voltages across the diodes. When a diode is non-conducting from a reverse bias, it acts as a capacitor. Therefore, the diode junction having the smallest value of capacitance will have the largest relative voltage across it. Placing a capacitor in parallel with each diode then minimizes any differences of diode junction capacitance.

These reasons undoubtedly are valid, but there seems to be another reason for the capacitors.

Recovery time

When a diode conducts in the forward direction, it has a large number of charge carriers in the N and P regions. Then, when the voltage across the junction is reversed rapidly, a short period of time is required for the charge carriers to move out of the semiconductor regions.

The effect of these stored charge carriers is to reduce the reverse resistance to a low value for a brief period of time (called the recovery time, or storage time).

In Figure 8, the unequal recovery times for three diodes in series are shown by a drawing, with the recovery periods shaded.

When the supply voltage first is reversed from forward bias to

reverse bias, the voltage across each diode remains at approximately zero volts, because the resistance is low while the charge carriers are being swept out. In this case, diode X3 recovers first. So, for a very short period of time, **all of the reverse voltage appears across it!** Such a voltage overload could destroy X3.

Paralleling capacitors

Addition of a capacitor in parallel with each diode lengthens the recovery times (see Figure 9). Thus, the differences between the various recovery times are reduced. Note that diode X3 has only part of the input voltage across it before diodes X1 and X2 begin to conduct. This reduces the possibility of diode destruction.

Anytime you replace just one diode in a series, you should check the paralleling capacitors and resistors. An open component might have caused the diode to fail.

Proper capacity

The proper value for the capacitors of Figure 7 can be calculated by the formula:

$$\text{Shunt Capacitance} = \frac{T_S X_n}{R_T}$$

Where: T_S is the storage time in seconds

n is the number of diodes series

R_T is the internal resistance of the power supply plus the load resistance

Use the test setup of Figure 10 to measure the recovery time. The 10-ohm resistor allows the scope to display the diode *current* waveform. A good triggered-sweep scope with a wide bandwidth is needed to produce a waveform similar to that in Figure 11. By definition, the recovery time is the measured time between maximum negative current and 10% of the negative current. This curve is surprising because it shows that the diode does not remove the negative half cycle *completely*, as is commonly believed. However, the recovery period is short, and some scopes probably can't reveal it.

Proper resistance

The optimum paralleling resistance for each diode of a series is determined by the "rule-of-thumb" that says each resistor should be one-half the minimum value of the diode's reverse resistance. □

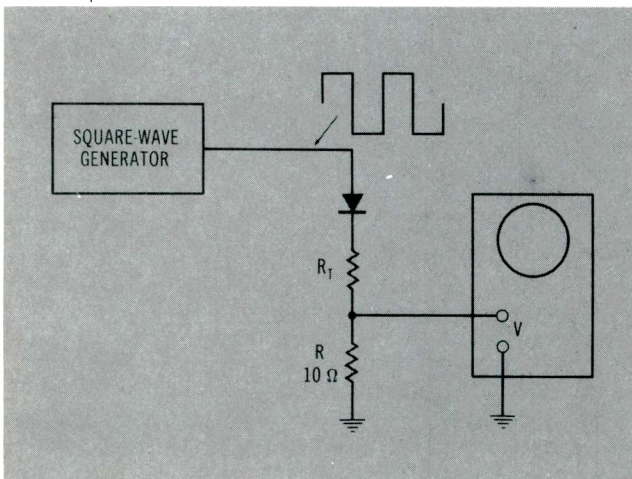

Figure 10 Connect the scope and components as shown, to measure the current caused by the diode recovery time. Spread the waveform by using a triggered scope.

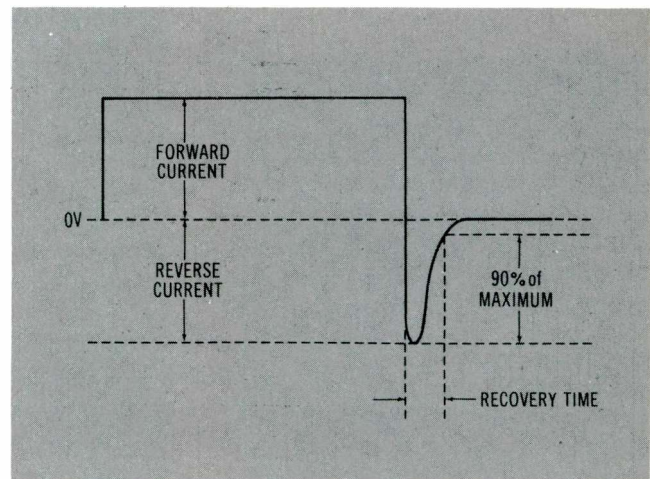

Figure 11 Expect this kind of waveform from the measurement of Figure 10. Repeat the test with power-supply diodes, fast-recovery diodes used in scan rectification, and video-detector diodes. Usually, power-supply diodes show the longest recovery times.

Servicing Betamax Videotape Recorders

Recording and Playing Chroma

PART 3

By Harry Kybett

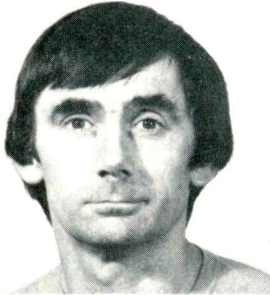

None of the home-type videocassette machines record and play the direct NTSC color signals. Instead, the chroma and luminance components are separated and processed separately. Monochrome recording and playback were described in the past two articles. The general principles of the recording and playback of chroma are given first this month, followed by specific Betamax operations. Troubleshooting tips are supplied at the end.

Broadcast VTRs

Large VTRs used in broadcasting studios have fast writing speeds produced by either four rotating heads or a large-sized helical drum. Therefore, these machines can record and play the NTSC-type of interleaved color-and-luminance video signal without separation of the luminance and chroma portions. Even so, they have some time-base errors that require expensive electronic correction to produce good stable color during playback.

Attempting to record and play the NTSC color/luminance video signal using the low writing speeds of small helical machines would produce unacceptable timing errors for the chroma part of the signal.

Another method must be used.

General Chroma Recording Operations

In small helical tape recorders, the chroma and luminance com-

ponents are separated, the chroma is changed to a low frequency, and both the chroma and the luminance-modulated FM signal are recorded together.

Separate filters (see Figure 1) divide the NTSC input video into two basic components. One filter passes the 3.58-MHz signals, while eliminating the luminance portion. The other passes the luminance, but eliminates the 3.58-MHz chroma. The luminance video is applied to the FM modulator, as explained in previous months.

The chroma signal is processed by an AGC circuit that maintains a constant chroma level, and then it's heterodyned in a balanced modulator against a continuous carrier (usually 4.27 MHz) from a stable crystal oscillator. The original two input frequencies and two sum-and-difference products appear at the output of the balanced modulator, but a low-pass filter eliminates all except the difference frequency of 688 KHz. This new 688-KHz chroma signal has all of the phase and amplitude characteristics of the original 3.58-MHz chroma signal, and it then is recorded by adding it to the luminance FM carrier (the luminance FM signal acts as a record-

ing bias for the chroma signal; this is similar to the bias and signal method of recording audio).

General Chroma Playback Operations

The playback chroma/luminance-FM signal at the output of the pre-amps is split, with one branch going to the luminance-demodulation chain, where the limiters remove the amplitude modulation of the chroma signal. Thus, the chroma signal is removed from the luminance-FM signal.

The other branch (Figure 2) has a low-pass filter which removes the luminance-FM signal, leaving the 688-KHz chroma signal.

Following the AGC correction, 688-KHz chroma is heterodyned against the same 4.27-MHz carrier (that was used during recording), and a bandpass filter extracts the 3.58-MHz difference frequency. The up-converted color now is added to the demodulated luminance signal, forming a NTSC signal at the video output of the machine.

Although, this heterodyne process enables the color to be recorded and adequately played back using a low writing speed and a low FM frequency, it does not avoid the

continued on page 46

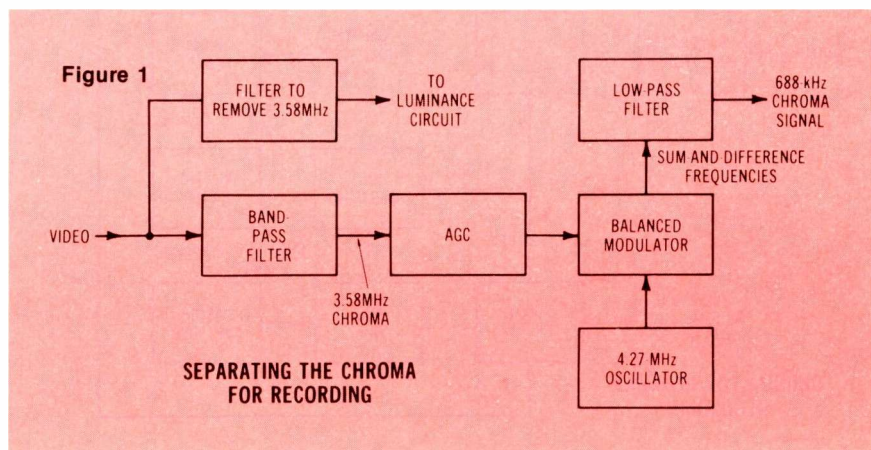

Betamax

continued from page 45

time-base errors. It does, however, allow a method of correcting for the time-base errors in the playback chroma signal, thus providing a color picture with stable tint and color level.

Typical Color Correction

If the same time-base error occurs to both the down-converted chroma playback signal and the 4.27-MHz heterodyning carrier, the two errors cancel, allowing the difference frequency to have the identical 3.58-MHz signal that was present before the recording.

For example, assume that a

certain time-base error increases the frequency of the 688-KHz playback chroma signal by 1 KHz (up to 689 KHz). After up-converting by the 4.27-MHz unchanged carrier, the resulting chroma signal would be 3.581 MHz. This is 1 KHz too high, which would cause wrong colors. (These are the usual round numbers.)

However, if the 688-KHz signal was increased by 1 KHz, and the 4.27-MHz signal also was increased by 1 KHz, the resulting up-converted heterodyned chroma signal would be 3.58 MHz, which would give correct color.

The trick is finding a way to introduce the same frequency errors that the 688-KHz chroma has into

the 4.27-MHz carrier, and to make the correction operate automatically. Fortunately, the method is not very complicated.

In a helical VTR, these timing errors change only a little within each horizontal line. And, the errors between one horizontal line and the next can be identified easily by comparing playback horizontal sync with *stable* horizontal sync, or a stable oscillator of the same frequency.

If a stable oscillator is used to supply one input of a comparator, and playback sync is fed to the other input, then the DC output from the comparator will vary in step with any timing changes of the playback sync.

Variations of the DC comparator output voltage can be used to indicate the severity of the playback sync-timing errors. In addition, the varying DC voltage can be used to control the frequency of the playback 4.27-MHz oscillator, so the frequency variation is identical to that of the 688-KHz chroma during playback. This fulfills the conditions given before for automatic cancellation of the time-base error for playback chroma.

Heterodyne correction of the effects of time-base errors works well, giving a stable picture on most TV receivers. Note that the heterodyning correction applies only to the color. The luminance time-base errors are not corrected; these must

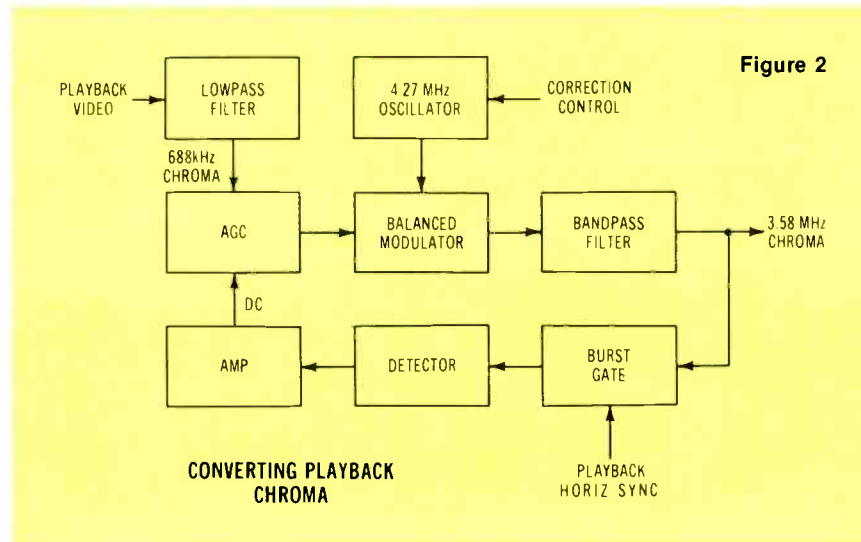

Figure 2

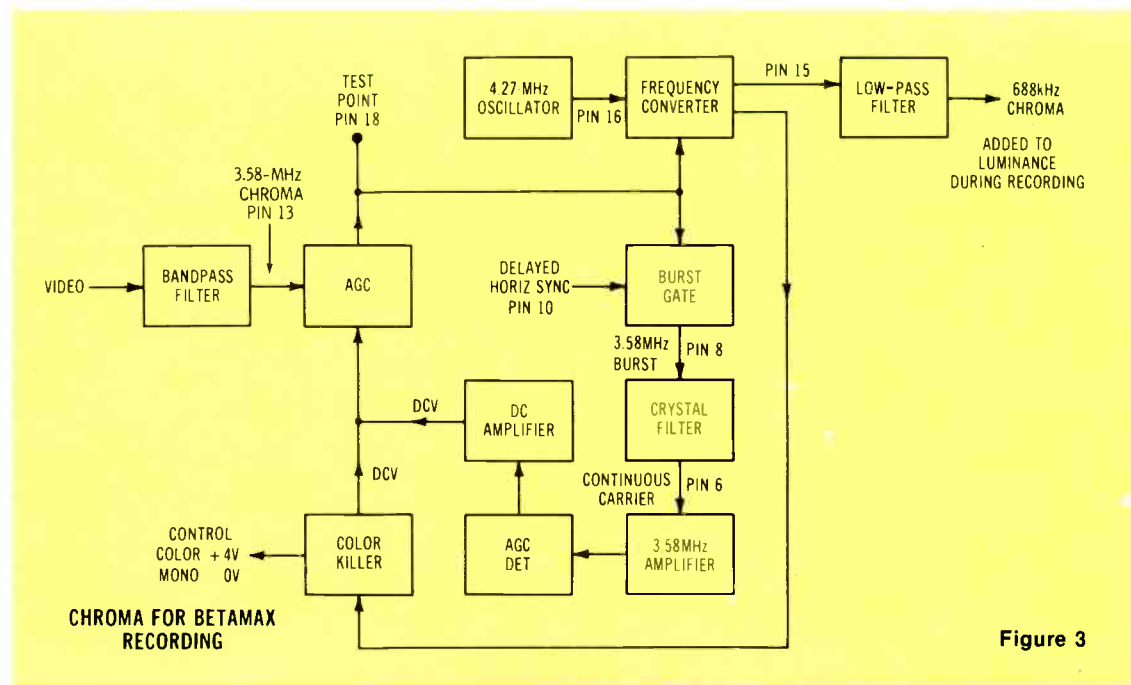

Figure 3

be smoothed out by fast reaction of the horizontal AFC in the receiver.

Disadvantage

The main disadvantage of the heterodyne—or “color under”—process is that the timing relationship between the sync pulses and burst is lost. Such systems sometimes are called “non-phase” color. Note, that this is not true of Betamax.

Betamax Color Recording

Although the Betamax color-recording system is similar to the heterodyne correction just described, it contains two major improvements:

- The 688-KHz chroma signal is phase-locked to the incoming horizontal sync. This makes correction of the color timing errors easier.
- The phase of the 688-KHz chroma signal is reversed during alternate tracks, where the “A” head is recording. The phase reversal tends to cancel the color crosstalk from those adjacent tracks.

A block diagram of the Betamax recording is shown in Figure 3. A bandpass filter rejects the luminance component, accepts the 3.58-MHz chroma frequencies, and sends them to an AGC amplifier. (As described before, the luminance channel has a low-pass filter to remove the chroma signal.)

Output of the AGC amplifier goes to the burst gate and to a heterodyne frequency converter, along with the 4.27-MHz signal from an oscillator. From the frequency converter come four frequencies, and a low-pass filter removes all except the 688-KHz signal, which is added resistively to the FM carrier at the heads, and is recorded on the tape.

Processing the 4.27-MHz carrier

We will concentrate now on how the 4.27-MHz carrier is formed, and why it is controlled differently during recording and playback. This is the area where Betamax is not like the other helical machines.

In general, the phase of the chroma signal is reversed during the recording of alternate tracks across the tape. During playback, the chroma phase again is reversed. So overall, the chroma is correct, but the crosstalk between the tracks is largely cancelled.

Specifically, when the “B” head

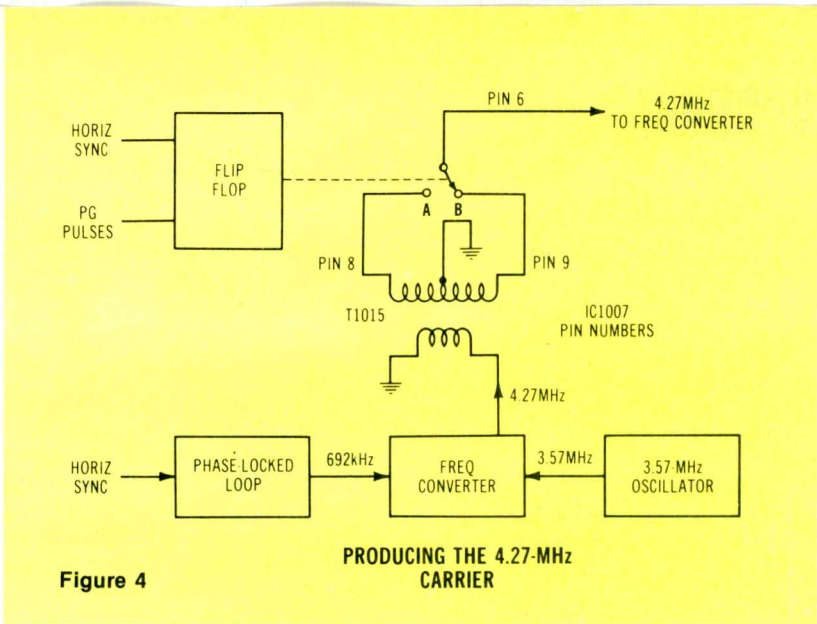

Figure 4

is recording, the 688-MHz chroma has normal NTSC phasing. During times the “A” head is recording, however, the chroma phase is reversed. Notice that the chroma signal *itself* is not inverted, but the phase of the 4.27-MHz heterodyning oscillator is inverted, instead.

Figure 4 shows how the 4.27-MHz carrier is generated, then kept in phase-lock with the horizontal sync, and later the output is switched in phase. Crystal accuracy is needed, which is obtained by mixing together the signal controlled by the horizontal sync pulses (very stable) with a carrier from a crystal-controlled 3.57-MHz oscillator.

Horizontal sync is the frequency standard of a phase-locked loop, which is provided with a continuous-carrier output of about 692 KHz. This carrier and the output of a 3.57-MHz (yes, 3.57—NOT 3.58!) crystal oscillator are inputs to a heterodyne frequency converter. The 4.27-MHz “sum” frequency is applied to tuned transformer T1015. Electronic switching (controlled by a flip fop from the horizontal sync and the pulse-generator signal) alternately selects 180° signals from the transformer secondary (which is centertapped, to provide both phases).

In other words, the “A” position of the electronic switch supplies inverted 4.27-MHz to the frequency converter that changes the chroma to 688 KHz, while the “B” position supplies in-phase 4.27-MHz to the converter.

Therefore, the 688-KHz chroma signal that results from heterodyning this phase-locked 4.27-MHz

carrier with the NTSC 3.58-MHz chroma is phase-locked to the recorded horizontal sync pulses.

Also, reversing the phase of the 4.27-MHz carrier also reverses the phase of the 688-KHz chroma—a characteristic of heterodyning, and the chroma crosstalk (which is not otherwise eliminated by the tilted heads) is largely cancelled by the opposite phases.

The remainder of Figure 3 is more routine. Burst is gated out of the 3.58-MHz chroma by pulses of horizontal sync that have been delayed in phase. (Videotape recorders have no horizontal sweep or high voltage, as color-TV receivers do, and the various gating pulses are produced by delayed sync pulses.) A crystal filter is shock excited by the burst, and it rings until the next sync pulse gates more burst. This produces a continuous carrier at the burst frequency. The carrier amplitude is rectified, the output goes to a DC amplifier, and then to the AGC stage to control the gain. In other words, the burst amplitude determines the chroma level.

Part of the DC voltage from the chroma gain-control circuit triggers the color-killer operation. If no color is present in the video input signal, the color killer shuts down the frequency converter, and switches the other circuits into the monochrome mode.

Next

In the August issue, the coverage begins with Betamax playback operation, followed by chroma troubleshooting. □

Dusting Spray

Chemtronics has introduced Micro-Duster, a new product for cleaning and dusting delicate assemblies with compressed gas. It can be used for dusting modules and circuit boards, electronic chassis, slides, or photographic films.

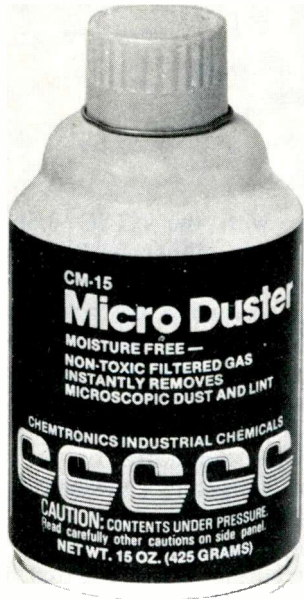

Micro-Duster contains a pure, moisture-free, non-flammable and non-toxic filtered gas in an aerosol can. A single 15-ounce can provides more than 1,800 one-second bursts of gas, or 25 to 30 minutes of continuous dusting. Each can has a 6-inch extension tube for pinpointing the blasts of gas.

Suggested retail price of Micro-Duster is \$2.50

Circle (16) on Reply Card

Semiconductor Handbook

"Archer Semiconductor Reference and Application Handbook" from **Radio Shack** has cross-references of Archer replacements for more than 46,000 transistors, diodes, and other solid-state devices.

In addition to the usual semiconductor data, the handbook has circuit diagrams of most of the ICs listed, schematics for all clock chips and modules, and information about the 8080A computer chip and the Archer line of display and optoelectronic devices.

Other sections have suggestions for the care and handling of transistors, soldering precautions, case styles and dimensions, tips for

testing transistors, and a glossary.

Price of the handbook is \$1.95 at all Radio Shack stores.

Circle (17) on Reply Card

High-Voltage Putty

Premi-Putty from **Oneida** insulates high voltage up to 40 KV, and it can be used for repairing electrical wires, cables, or conduits; and for insulating and sealing against water, oil, fumes, etc. The substance is resistant to the effects of high voltages and ultra-violet light. In addition, it is a sound deadener. It is available packaged in 15-square-inch pieces, or by the spool in larger quantities.

Circle (18) on Reply Card

Replacement Baluns

PTS Electronics is offering a new card of seven replacement baluns in five different types. They are either exact replacements, or will replace almost all baluns used in TV receivers, antennas, MATV, or CATV systems. The card includes one extra of the two most frequently-used baluns, and it sells to dealers for \$9.75 net. These replacement baluns are available from any of the 43 PTS Electronics servicers and stocking electronic parts distributors.

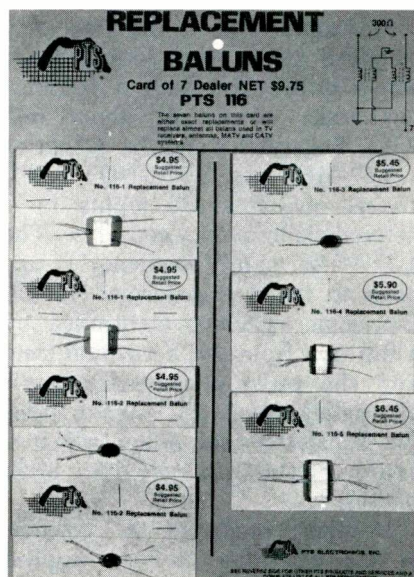

Circle (19) on Reply Card

Mobile Radio

The Fleetcom II 520 UHF low-band two-way mobile radio from the **E. F. Johnson Company** features 55 watts of RF power over the range of

25-50 MHz. This radio provides reliable, long-range communications. All-solid-state circuitry offers low current drain with no warm-up time required. The 520 is said to be a high-performance radio with a sensitive receiver that provides good adjacent channel and intermodulation rejection, for operation in RF-congested areas.

The Fleetcom II 520 has an optional AC power supply so it also can be operated as a base station without modification. Other options and accessories include two channels; "Call Guard" tone squelch; remote-control systems; heavy-duty microphone; and various mounts.

Circle (20) on Reply Card

Transistor Substitution Manual

Fuji-Svea Enterprise has published a 90-page Japanese Transistor Substitution Manual which references 3,000 transistors. The guide crosses Japanese-to-Japanese transistors in the 2SA, 2SB, 2SC, and 2SD series. If a transistor is difficult to obtain or is discontinued, a substitute Japanese transistor is suggested. Most substitution guides cross Japanese numbers to American replacements. This book fills the need for Japanese-to-Japanese sub information which is usually hard to find.

The book is available for \$5.90 plus \$1.00 postage and handling; 85 cents additional for COD.

Circle (21) on Reply Card

CB Tape

The "CB trouble tape" by **GC Electronics** fits all cassette players. It tells CB users how to isolate and eliminate most mobile and base interference. A pamphlet on various types of interferences (and which suppressor to use) is included with each tape.

A countertop merchandising program (17-250) with six trouble tapes (18-250) on a POP easel is available. Suggested retail price of individual tapes is \$4.95.

Circle (22) on Reply Card

Features of these products were supplied by the manufacturers, and are listed at no charge to them. If you want factory bulletins, circle the corresponding number on the Reply Card, affix a stamp, list the required information, and mail the card.

antenna systems report

UHF/VHF Preamp

Blonder-Tongue Lab's new Galaxy series of preamps, which includes the Voyager II 300-ohm mast mounted UHF/VHF preamplifier, has been introduced.



The Voyager II is a solid-state UHF/VHF all-channel preamplifier with an indoor power supply and band separator. Separate UHF and VHF inputs are provided for individual UHF and VHF antennas. The noise figure of the Voyager II is said to be equal to or better than that of solid-state TV sets, and greatly superior to tube-type TV sets. Mast mounting the Voyager II near the antenna, results in a significant reduction of snow on weak TV channels. Four silicon transistors are used in three independent amplifying sections. An accessory band-separator facilitates connections to the TV set input terminals.

Circle (23) on Reply Card

CB Antenna

The "Intenna" by **Microwave Filter**, utilizes a vehicle's metal frame as a slot-fed metal ground-plane antenna to provide high front-to-back ratio CB signal transmission and reception. It mounts inside the vehicle, and is said to have from 3 to 6 dB less noise pickup than outside vehicle antennas.

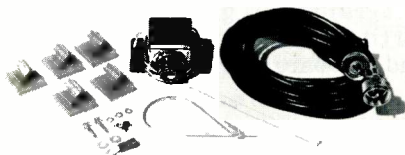

All components, including a tunable matching section and 8 feet of RG-58-U coax cable, are furnished.

Circle (24) on Reply Card

CB Antennas

Channel Master's Mag-Ne-Tenna (model 5029A) and Adjustable Mag-Ne-Tenna (model 5030) CB antennas use an in-line ferrite choke, mounted in the base housing, to stabilize SWR, boost electronic efficiency, and enable the antennas to perform better on vinyl-top cars.

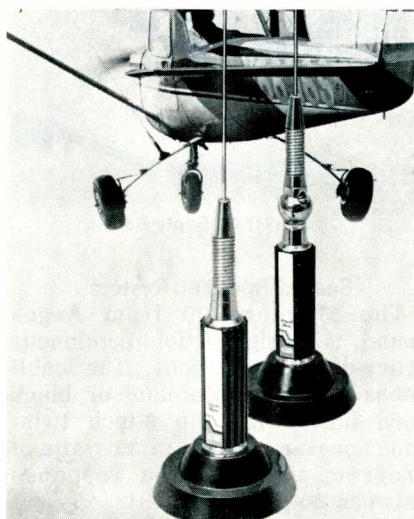

Both antennas have epoxy-dipped, base-loaded coils, 24-feet of coaxial cable, stainless-steel shock spring, and a high-capacitance stainless-steel whip.

The Adjustable Mag-Ne-Tenna comes with a universal balljoint that allows vertical positioning for hatchbacks or cars with sharply-sloped trunks.

Circle (25) on Reply Card

Antenna-Rod Cutter

Larsen Electronics has developed an antenna-rod cutter with 9-inch handles and 18-to-1 compound leverage. The cutter allows cuts spaced 1/8-inch apart. The replaceable blades are made of Swedish tool steel.

Circle (26) on Reply Card

CB Co-Phase Harness

GC Electronics' CB Co-Phase Harness is said to allow the cable to be cut anywhere for two different lengths and still maintain an impedance match. All wire leads are RG-58 and it is possible to transmit and receive if one antenna fails, gets damaged, or is lost.

The co-phase harness is available in three models: Universal Kit 18-392; RV Mirror Mounting Kit 18-391; and Trunk Mounting Kit

18-393. Antenna connectors are supplied with all kits.

Circle (27) on Reply Card

MATV Mixer-Splitter

The model MM-2X2, by **Extronix**, is a 4-port hybrid mixer-splitter that is said to save half of the signal power required for a TV distribution system by replacing two three-port hybrids.

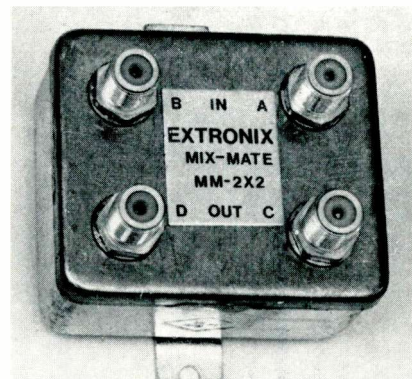

The unit combines signals from two sources and splits them into two mixed outputs, with typical loss of 3.6 dB, isolation of 31 dB and return loss of 23 dB, from 30 to 300 MHz.

Circle (28) on Reply Card

AM/FM/CB Antenna

A manually-retractable AM/FM/CB antenna, the CBA-12, is available from **Mura**. Fully extended, the 40-inch antenna is adjustable for lowest SWR. The unit is center loaded and corrosion resistant.

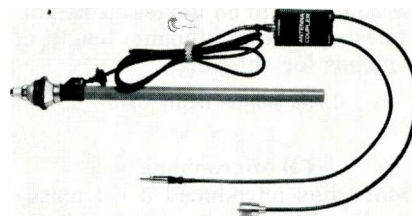

The antenna can be trunk or fender mounted and comes with key, PL-259 connector and instructions. Suggested list price is \$29.95.

Circle (29) on Reply Card

Features of these products were supplied by the manufacturers, and are listed at no charge to them. If you want factory bulletins, circle the corresponding number on the Reply Card, affix a stamp, list the required information, and mail the card.

Microphone Floor Stands

Two new **Atlas Sound** Porta-Series microphone floor stands combine base and tube in a single unit. Both stands have spring-action telescoping legs.

Model PS-C extends from the standard 35-inch height to a maximum of 63 inches, and folds into a 32-inch length for transportation.



Model PS-C3 (especially designed for use by seated performers or for instrument-miking) extends from a low 26 inches to 66 inches in height. It telescopes to a minimum length of 22 inches for shipping.

Circle (30) on Reply Card

CB Microphone

Mura has introduced a CB noise-cancelling power microphone. Model PRX-NC is said to combine 12 dB of noise cancellation, 4 dB of PRM effect, and 16 dB of variable gain for a 15-fold reduction of background noise.

The single-cartridge ported design was developed in conjunction with police-equipment manufacturers interested in eliminating siren and PA background noise.

Maximum sensitivity is -50 dB, maximum gain is 16 dB, and the impedance is 2500 ohms. Wired for

both relay and electronic switching, the mike is equipped with a variable slide-type gain control, a 9-volt battery, one 5-foot coil cord, and a fact sheet.

Suggested list price for the PRX-NC is \$44.95.

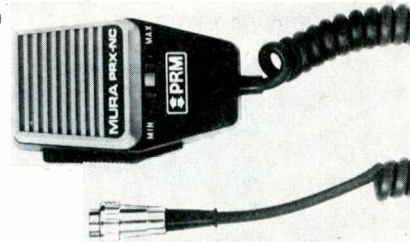

Circle (31) on Reply Card

Sealed Speaker System

The **Magnum-800** from **Argos Sound** is designed for continuous heavy-duty applications. The cabinet is available in walnut or black vinyl finish, and the 8-inch twin-cone speaker is rated at 35 watts of program signal and a response between 60 Hz and 20 KHz.

Circle (32) on Reply Card

Power Booster

A wide-range power amplifier by **Sparkomatic Corporation** converts a car stereo or radio to a high-power system, that uses existing speakers.



The "on" position of model LC-50 boosts power, while the "off" position connects the music source directly to the speakers.

Circle (33) on Reply Card

Equalizer Amplifiers

Jandy International offers two new Car-Fi products. Model 4200 is a stereo 7-band graphic frequency-equalizer/preamp unit. Each equalizer gives up to a 12-dB boost or cut at 60 Hz, 150 Hz, 400 Hz, 1000 Hz, 2500 Hz, 6000 Hz, and 15 KHz. The frequency response is rated at 10 Hz to 35 KHz, and the signal-to-noise-ratio is said to be -85 dB. A balance control, power switch, and several level controls are provided.

The suggested retail price is \$89.95.

Model 310 has five bands of graphic equalization and a stereo amplifier rated at 30 watts-per-channel.

Circle (34) on Reply Card

Folded-Horn Speaker System

Showco Manufacturing is offering **Pyramid 900**, a 3-speaker system with a folded horn for the woofer, and front-mounted mid-range and tweeter speakers. These speakers provide both direct and reflected sound.

The system is said to provide faithful reproduction and high efficiency.

Circle (35) on Reply Card

Cassette Deck

A new stereo cassette tape deck, featuring the exclusive **Akai** head for record/playback and **Dolby Noise Reduction** circuitry, is being introduced by **Akai America**.



The new deck, model GXC-706D, is an amplifier-styled, four-track, two-channel, front-load stereo cassette deck that carries a suggested retail price of \$279.95.

The GXC-706D features large VU meters for easy viewing during recording, a red panel light to indicate recording is in progress, and a three-digit tape counter. Left and right channel mike input jacks and a stereo headphone jack are located on the front panel. The deck also offers a locking pause control for recording convenience.

Powered by electronically-controlled DC motor, the tape deck uses integrated GX glass and crystal ferrite head for record/playback and a separate erase head.

Circle (36) on Reply Card

Features of these products were supplied by the manufacturers, and are listed at no charge to them. If you want factory bulletins, circle the corresponding number on the Reply Card, affix a stamp, list the required information, and mail the card.

test equipment report

Analog Multimeters

Two new battery-operated analog multimeters are offered by **Leader Instruments**.

Model LT-70B features overload protection and polarity reversal, ten DC ranges from .25 to 1,000 volts, three AC ranges from 2.5 to 250 volts, three DC current ranges, and one AC current range from zero to 2.5 amperes. Two AA batteries allow diode testing from 75 microamperes to 75 milliamperes.

Model LT-70B sells for \$42.95,

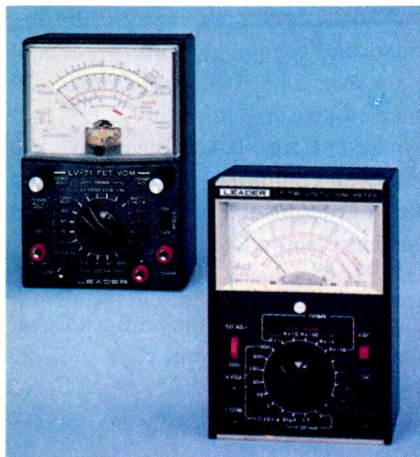

complete with a set of heavy-duty test leads and a set of alligator-clip adapters.

The companion model LV-71 has dual-FET circuitry, a center-zero scale on the 4.5-inch taut-band meter, a polarity-reversal switch, battery-voltage test, and diode-type meter-overload protection. Input impedance is 10 megohms for DC volts and 1 megohm for AC. DC voltage from 0.3 to 1,200 full-scale is covered in 12 ranges, while 5 ranges provide AC readings from 6 to 600 volts. Four current ranges cover from 0.3 milliamperes to 300

milliamperes, while resistances are checked by 4 ranges from RX1 to RX1M. Decibels are measured in two ranges from -20 to +17 dB or +15 to +31 dB.

Priced at \$69.95, model LV-71 is powered by a 9-volt battery, and is supplied with a set of test leads with alligator adapters.

Circle (38) on Reply Card

Oscilloscope Plug-In

The dual-trace SC 504 combines with a selection of pulse generators, counters and other TM 500 instruments to form versatile instrument configurations for measurements on digital equipment. This new oscilloscope plug-in from **Tektronix** further enhances the TM 500 family of modular test and measurement instruments. Featuring 5 mV/div sensitivity at 80 MHz, this multimeter offers a rear panel interface for interconnecting the various instruments.

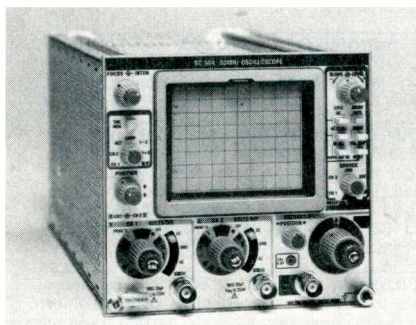

Enhanced auto triggering automatically increases the range of the trigger level control for small signals to make adjustment of the trigger point easy and precise. Trigger view allows display of an external trigger signal and examination of its time relationship to the two input channels without changing any connections. Variable trigger holdoff makes triggering solid and achievable on complex, asymmetric signals such as repetitive serial data words or double-pulse waveforms.

Circle (39) on Reply Card

Wow and Flutter Meter

Fidelipac's wow and flutter meter model 65-390 checks and expedites correction of periodic or cyclical variations in speed at high or low rates in cartridge, reel-to-reel and cassette audiotape recorders; videotape recorders; phonographs and turntables; and in film projectors.



This compact, lightweight, solid-state portable test instrument accurately measures the wow and flutter components in all types of recording and playback devices. Single meter readout indicates the deviation from true speed of a device within a 5% range by the use of a zero-center drift meter. Also featured is an internal 3,150 Hz reference oscillator, self-contained switchable weighting filter and a standard phone output jack for oscilloscope connection. All metal interlocked construction assures immunity to EMI and RFI.

Circle (40) on Reply Card

Multimeter

Model 1350 from **Data Precision** is designed for bench, service shop, or school environments. This line-powered multimeter features a 0.43-inch LED digital display.

Making use of LSI technology, this 3½ digit, full-function multimeter offers 0.1% basic accuracy. The bench-operated unit measures DC volts from ±100 μV to ±1200 volts, AC volts from 100 μV to a full 1000 volts rms. Model 1350 will take ±1200 VDC on any DC voltage range continuously without loss of calibration, or will take a 6000-volt spike on any voltage input for 500ns with no damage.

Model 1350 is housed in a case with built-in carrying case handle and tilt stand, and sold complete with its own set of test leads, spare fuse, a full one-year warranty, operator's and maintenance manual, and a certificate of conformance tracing its accuracy to NBS standards. Recalibration is required at only one-year intervals.

Circle (41) on Reply Card

Features of these products were supplied by the manufacturers, and are listed at no charge to them. If you want factory bulletins, circle the corresponding number on the Reply Card, affix a stamp, list the required information, and mail the card.

IT'S NO PUZZLE

TO ORDER

OELRICH SERVICE FORMS

FOR TV-RADIO & 2 WAY RADIO SERVICE LEGAL FORMS FOR CALIF. FLA. UTAH NOW AT YOUR PARTS JOBBER OR WRITE FOR CATALOG B64

OELRICH PUBLICATIONS

4040 N. NASHVILLE AVE. CHICAGO, ILLINOIS 60634

Circle (12) on Reply Card

NEW TUNERS

NOT universal or customized. NOT seconds, culls, dogs, or oddballs. Only \$24.95 for ANY new tuner. Over 5,000 in stock including Philco TT192.

CALL TOLL FREE 1-800-433-7124

TEXAS TUNER SUPPLY

4210 N.E. 28th St., Ft. Worth, TX 76117

Circle (13) on Reply Card

Advertising rates in the Classified Section are 35 cents per word, each insertion, and must be accompanied by cash to insure publication.

Each initial or abbreviation counts a full word.

Minimum classified charge \$3.00.

For ads on which replies are sent to us for forwarding (blind ads), there is an additional charge of \$3.00 per insertion to cover department number, processing of replies, and mailing costs.

Classified columns are not open to advertising of any products regularly produced by manufacturers unless used and no longer owned by the manufacturer or a distributor.

For Sale

REPLACEMENT COLOR YOKES-DEALERS ONLY. Zenith 95-2501-2532-2638-2667-S-89633 etc. 16.95, Magnavox 361380-1 18.95, Sylvania, GE etc. 14.95 to 19.95. Request for price list on your letterhead. David Sims Enterprises, Inc., 665 Jericho Turnpike, Huntington Station, N.Y. 11746. 12-76-tf

TV & RADIO TUBES 36c EA!! Free color catalog. Cornell, 4221 University, San Diego, California 92105. 8-76-tf

ELECTRONIC SURPLUS, CLOSEOUTS, LIQUIDATIONS! Parts, equipment stereo, industrial, educational. Amazing values! Fascinating items unavailable in stores or catalogs anywhere. Unusual FREE catalog. ETCO-011, Box 762, Plattsburgh, N.Y. 12901. 6-78-tf

TUBES-RECEIVING, Industrial and Semiconductors Factory Boxed. Free price sheet including TV, Radio and audio parts list. Low, low prices. Transletronic, Inc., 1365 39th St., Brooklyn, New York 11218. Telephone: (212) 633-2800. Toll free: 800-221-5802. 5-78-12t

NORTHERN CALIF. TV SALES & Service business. 12 years, top reputation. No real estate incl. Annual Sales \$40,000. Main lines Zenith, RCA, Pioneer, Hitachi. Price includes lease, van, equip., etc. No other shops within 35 miles. Will consider percentage with option for full time work. No window shoppers, please. Dick Murray, Box 816, Hayfork, CA 96041. 5-78-4t

SEEKING ORIGINAL JAPANESE TRANSISTORS, IC's, FET and diodes for CB, TV and stereo repair? See our full page ad in this issue for listing of parts and prices. Write or call TOLL FREE for our complete list and compare prices. FUJI-SVEA ENTERPRISE, Dept. ES, P.O. Box 30323, Cincinnati, OH 45240. Nationwide: (800) 543-1607. Ohio: (800) 582-1630. 4-78-4t

TUNER SUB, \$19.95, wired, tested, complete with batteries and ready to use on tube or transistor sets. Tunes all VHF channels. This unit is without knobs or cabinet but very compact with no wires or controls dangling. Easy to use, simply connect set's coax to sub and view picture (instructions provided). Only \$19.95 and we pay shipping or will ship C.O.D. (\$1.85 C.O.D. charge). Phone Toll Free 1-800-433-7124. This is not a gimmick. If not completely satisfied, return within 10 days for full refund. TEXAS TUNER SUPPLY, 4210 N.E. 28th Street, Fort Worth, Texas 76117. 6-78-3t

TV BUSINESS 18 yrs. same location. Grossing 90,000 +. Unlimited potential. Don Marble, CET. 305-989-5070. 6-78-2t

COMPLETE COLOR B/W PICTURE TUBE Rebuilding Equipment, never used. Phone (212) 387-2744. 616 Grand St., Brooklyn, N.Y. 11211. 8-78-2t

TV SALES & SERVICE—15-year growing business, GE Dealership with room to expand, \$30,000 1977 gross. Write to: Donald Lewis, Route 1, Central City, Neb. 68826. 7-78-2t

TEST EQUIPMENT and Technical Literature. Write for List: J. Criley, 633 Herman Road, Butler, Pa. 16001. 7-78-1t

For Sale (Cont.)

B&K 415 "NEW" GENERATOR in original carton—complete \$395.00. Wincharger—NEW—heavy duty 12 volt - 200 watt - wind generator with ten foot tower - \$395.00. Hickok 215 pocket semiconductor tester—in carton - \$69.00. L.R.E. HA-260 - 120 watt mobile 2 meter, linear amp. - \$95.00. Precision E200C signal generator, used - \$35.00. FRANCE-RADIO-ELECTRONICS, 14 Broadway, Milford, CT 06460, (203) 878-4333. 7-78-1t

HAVE SAM'S VOLTS. 1-150 and Supreme 1926-1942, also Zenith Service Manual Vo. 1 & 2. Will send copy of schematic you need for \$2. 312-546-2998. P. Casher, 117 E. Park Ave., Round Lake, IL 60073. 7-78-1t

UNIQUE EUROPEAN TYPE Home/Auto Alarm. Build your own. Complete schematic, description and instructions. \$2.00. F. W. Hughes, 6901 S.W. 6th Street, Pembroke Pines, Florida 33023. 7-78-1t

355 TUBES, 195 SAMS, Resistors, capacitors, some instruments and many many more items for radio and TV service or repair. \$500.00 cash, you pay the freight. J. M. Hall, 215 N. Birdneck Rd., Virginia Beach, VA 23451. Phone 804-422-4759. 7-78-1t

Professionals Accredited

PROFESSIONAL BACHELOR DEGREE...earned with 4 or more years of Electronic Business Management, Sales, or Servicing Experience. For FREE information write: EBERT PROFESSIONALS INSTITUTE, Box 1651, Dept. R., Columbia, Missouri 62501. 5-78-6t

Business Opportunity

TV TECHNICIAN! Increase your income up to \$60,000 yearly. Rent-lease-sell TVs new-used, even from comfort of your home. Basic Preliminaries \$4.00. Perry's TV Leasing, Box 1407, Santa Maria, CA 93456. 4-78-6t

SAVE HUNDREDS; dependable, quality Head-Ends, V/V, U/V Converters, Camera Modulators. Factory prices. Send \$5.00 (or business card). Box 809, Boyton Beach, Fla. 33435. 6-78-9t-EOM

GET OUT OF THE TV RUT. Start making money now with Paltronix portable security systems. No technical hassles to keep up with. Full training provided. Good margins to work with. Plus your chance to diversify your services. For full details contact Don Musil, 48 West Golden Lake Rd., Circle Pines, Minn. 55014. (612) 786-4244. 8-78-3t

ESTABLISHED TV SALES & SERVICE Business for sale in growth oriented city. Central Ohio. Business includes: attractive store room, current inventory. Also exclusive TV Rental business. This is a substantial quality operation. Owner may assist in purchase for right party. For more information call or write Mr. Bruce Massa, P.O. Box 121, Reynoldsburg, OH 43068. Phone: (614) 864-4363. 6-78-3t

MECHANICALLY INCLINED INDIVIDUALS—BUILD ELECTRONIC DEVICES IN YOUR HOME. GET STARTED IN YOUR SPARE TIME. \$300 TO \$600/WK POSSIBLE. EXPERIENCE NOT NECESSARY. WRITE FOR FREE LITERATURE. ELECTRONIC DEVELOPMENT LAB., BOX 1535A, PINELLAS PARK, FLA., 33565. 8-78-tf

Education-Instruction

REPAIR TV TUNERS—High Earnings. Complete Course Details, 12 Repair Tricks, Many Plans, Two Lessons, all for \$2. Refundable. Frank Bocek, Box 3236 Enterprise, Redding, Calif. 96001. 8-76-tf

INDUSTRIAL ELECTRONICS INSTRUCTOR—Teach theory and laboratory work. B.S. degree in Electrical Engineering. Master's degree preferable. Current industrial experience required. Teaching experience desirable. Position available September 1978. John C. Vander Molen, Acting Department Head, Ferris State College, Big Rapids, MI 49307. An Equal Opportunity Affirmative Action Employer. 5-78-3t

Wanted

EXPERIENCED TV TECHNICIAN WANTED. Group hospital insurance, paid vacation, top wages. Call 509/586-4176 or send resume to Smitty's TV, 114 W. Kennewick, Kennewick, WA 99336. 7-78-1t

Help Wanted

ELECTRONIC TECHNICIANS—MOTOROLA, leader in two-way radio communication, presently has openings throughout the U.S. for technicians and supervisors experienced in the installation and maintenance of communications systems (two-way, paging, microwave and CCTV). If interested in good salary and excellent fringe benefits send your resume and geographical preference to: BOB CLENDENIN, MOTOROLA COMMUNICATIONS & ELECTRONICS, INC., 1821 N. Office Square, Room 200C, Schaumburg, IL 60196. Equal employment opportunity/affirmative action employer. 7-78-3t

advertisers' index

American Technology Corp.	7
B & K Precision, Dynascan Corp.	29
Dictaphone Corp.	1
Dynascan Corp., B & K Precision.	29
Fuji-Svea Enterprise	3
Gamit Enterprises, Inc.	8
General Electric Co., Tube Div.	Inside Front Cover
Howard W. Sams & Co., Inc.	Inside Back Cover
Master Appliance Corp.	25
NATESA.	8
NESDA.	7
Oelrich Publications	51
PTS Electronics, Inc.	17, 25
Raytheon Co.	5
Sencore, Inc.	2
Texas Tuner Supply.	51
Winegard Co.	12-13
Zenith Radio Corp.	Back Cover

Regional Advertising Sales Offices

INDIANAPOLIS, INDIANA 46280
Roy Henry, 2469 E. 98th St.;
Phone: (317) 846-7026

GREENLAWN, NEW YORK 11740
Chuck Horner, P.O. Box 175;
Phone: (516) 757-7863

MOUNTAIN VIEW, CALIFORNIA 94043
Dennis Triola, 2680 Bayshore
Frontage Road, Room 102;
Phone: (415) 961-0378

LONDON, W.C. 2, ENGLAND
John Ashcraft & Co., 12 Bear Street,
Leicester Square; Phone: 930-0525

**1171 VC-BADHOEVEDORP,
HOLLAND**
John Ashcraft & Co., John J.
Lucassen, Mgr., Slotterweg 303;
Phone: 2968-6226

TOKYO 105, JAPAN
International Media Representatives,
Ltd., 2-29, Toranomon 1-chome,
Minato-ku; Phone: 502-0656

Sams has VCR's covered

New Photofact® Specialized Series brings you complete Service Data for . . . Videocassette Recorders. Service just like famous Photofact coverage of . . . TV, Home Radio, Auto Radio, and CB.

Everything you have come to expect from Photofact® is now yours for videocassette recorders. Helpful, reliable Photofact information. Full photo coverage for easy I.D. of all components and wiring. CurcuiTrace® testpoints and junctions. Standard notation schematics. Parts lists showing exact replacements. All mechanical and electrical adjustments. And more. Time saving information for servicing VCR's — today's growth product in electronics.

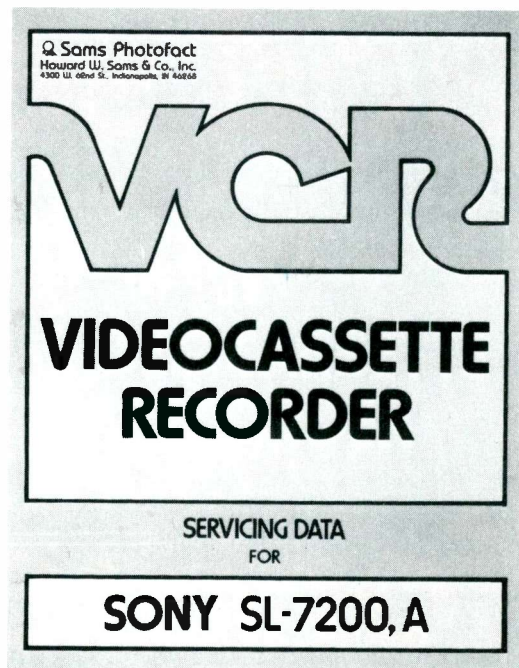

VCR-1 covers Sony videocassette recorders SL-7200 & SL-7200A. This 128 page volume is the first in the Photofact VCR Specialized Series. RCA, Zenith, JVC, Magnavox, Panasonic, and others will follow.

Videocassette recorders are moving. Your customers have them. And Photofact has them covered. Sign up with your Sams Photofact distributor for your VCR series today!



Howard W. Sams & Co., Inc.

a subsidiary of ITT

4300 West 62nd Street/Indianapolis, Indiana 46206

Now from **ZENITH**



212-85

One numbering system of exact and selected semiconductor replacements for the industry

21-888



121-831



121-988

212-76

- It's the closest yet to an all-purpose line of semiconductor replacements with one numbering system.
- Covers not only Zenith exact replacement devices, but also the most popular types in the industry.
- A great money-maker, too!
- Eliminates the need for duplicates. Reduces your inventory. Reduces your total investment. And many of Zenith's high-quality devices are priced lower than those from other sources.

Switch now, if you haven't already, to Zenith Universal Semiconductors and see how well your shop shapes up. Your bottom line, too. Your Zenith distributor is standing by to help you

with the latest Zenith Universal Semiconductor cross-reference guide containing over 130,000 cross-references. Call him now!

For your own reputation and in your customers' best interest, always specify Zenith exact replacement parts and accessories.



The quality goes in before the name goes on.[®]



121-745

121-Z9000-A