

PF Reporter®

PHOTOFACT

the magazine of electronic servicing

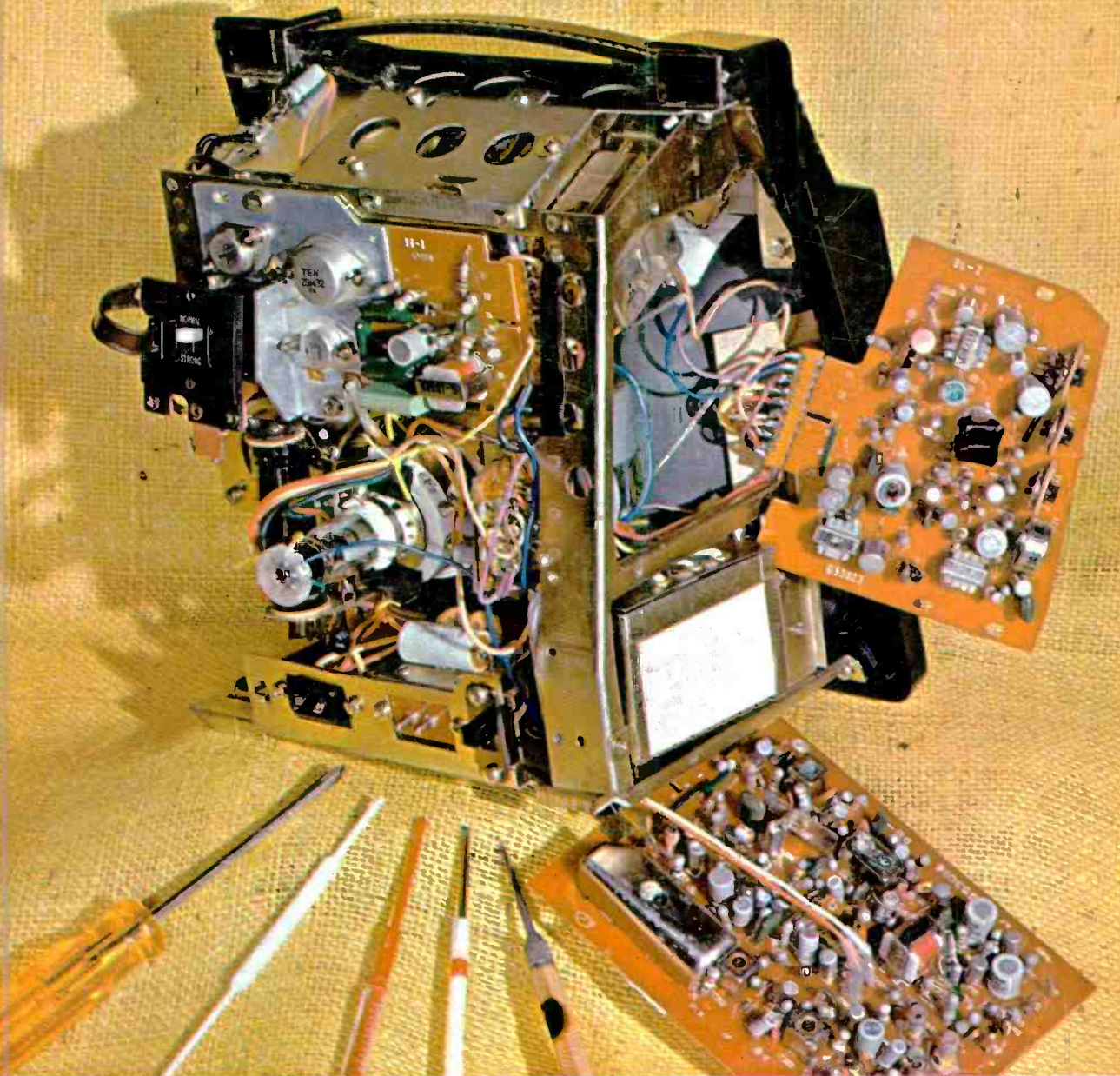

IA OF 4107 1267
 L. W. SEVERSON
 4779 CASANN
 MEMPHIS, TENN. 38128

- TV Alignment
- Scope or Meter—Which?
- Transistor TV Servicing
- Solid-State Stereo Revisited
- Notes on Test Equipment

New Jerrold Colorpeak™ VHF Antenna weathers any reception problem

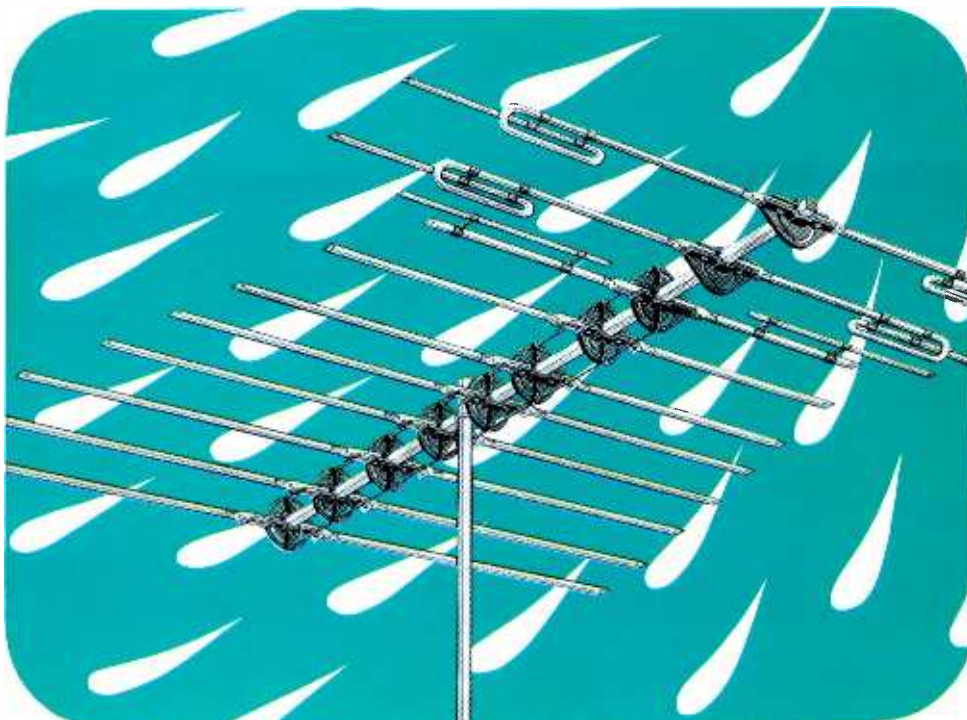

Here's one outdoor antenna that stays put—even in a howling storm. The new Jerrold Colorpeak 300-ohm VHF-FM Antenna.

Colorpeak is a high gain antenna with unusual flatness across the entire VHF-FM band. It picks up strong, clear signals—even in difficult reception areas—because of its excellent front-to-back ratio. And it's built as rugged as a tank.

Vibration-proof point-contact element locks, corrosion-resistant Golden Armor Coating and tough Cyclocac insulators make each insulating mount a strong point. No shorting out because of icing. No wavering image as wind whips through the antenna. No flimsy criss-cross conductors for transfer of the signal. Jerrold Colorpeak quality construction sees to all that.

Jerrold Colorpeak antennas,

like Jerrold VUfinder, Paralog Plus and Pathfinder antennas, assemble faster than any other antenna made today. All parts snap into place—anywhere—on the ground or on the roof. For hook-up ease, Colorpeak lead connections are made close to the mast.

For more details on the Jerrold Colorpeak antenna, see your Jerrold distributor.



Focusing on one thing—
better reception.

Circle 1 on literature card

22 4/ 36241

S W E E P A L I G N M E N T F O R T V

Quicker and more accurate alignment is possible if the step-by-step procedures outlined in service data are supplemented by a thorough understanding of the how's and why's involved in each step.

Material for this article has been adapted from the Howard W. Sams book Radio & TV Alignment Handbook by Warren J. Smith.

Although most service manuals include step-by-step alignment instructions, the average service technician often hits a snag because he does not know how to use alignment equipment properly. Moreover, even though capable of following the manufacturer's instructions to the letter, he does not fully understand the exact purpose behind each step in the alignment procedure. As a result, he usually bogs down at some step along the way—or, more commonly, employs someone else to do the job and thus cuts down on his profits.

Need for Alignment

There are many reasons why a receiver may need realignment. In the past, normal aging of components and mishandling were the most common; but in the present era of "do-it-yourself," it is rather commonplace to encounter receivers in which experimental adjustments have been made by the set owner. This generally makes a complete realignment job necessary, and a strong warning against such further tampering should be given. Finally, in order to achieve optimum receiver performance, it is approved service practice to completely realign a receiver after a component or tube is replaced in a tuned circuit.

Occasionally a receiver may exhibit symptoms which appear as improper alignment but actually are not. Conditions such as poor sensitivity or selectivity, distortion, and oscillation can generally be traced to defective components. On the other hand, effects of misalignment are not always immediately evident, or are confused with poor reception. In a TV receiver, the most obvious result of RF or IF misalignment is poor picture quality. Misalignment will always produce a degraded picture, displaying such defects as limited frequency response, ringing, smear, or overload in one or more amplifiers because of high response peaks in some part of the frequency range. A very common indication of misalignment is multiple images; which at first glance appear as "ghosts" caused by multipath reception, but are actually the result of phase shift in the RF or IF amplifiers. Other less obvious defects which can result from misalignment are unstable sync, improper AGC action, and interference from signals which normally would not affect a properly aligned receiver. To further complicate the situation, any one of the defects mentioned may be due to conditions external to the receiver; multipath reception, for example, can produce many of them.

The resolution of the TV picture often indicates whether a receiver needs alignment, or circuit repairs are in order. As a rule, tuner and video IF alignment should be

checked if any of the following conditions appear.

Tunable ghosts—Varying the fine-tuning control changes the spacing between images and ghosts if the set needs aligning. Ghosts caused by multipath reception maintain a fixed spacing.

Tunable smears—Sharp edges, particularly on the blacks, are blurred. Appears as a white smear trailing off the black edge, and can be varied by adjusting the fine-tuning control.

Weak-signal reception—This condition causes regeneration in the RF or IF amplifiers and appears as horizontal smearing in the wedges of a test pattern.

Poor low-frequency response—Horizontal wedges in test pattern appear gray, in contrast with darker or black vertical wedges. To check video response, roll picture downward out of vertical sync. Adjust brightness and contrast controls until sync pulse appears darker than blanking bar, which should be at least as dark as any gray in the picture. Sync pulse should remain same shade of gray as it moves downward. If conditions other than those described appear, video amplifier is probably defective or the set needs alignment.

Poor resolution—Appears on all received channels as loss of fine detail, or fuzziness, that cannot be corrected with fine-tuning control or focus adjustment. A test pattern provides the most accurate resolution check. Adjust operating controls for

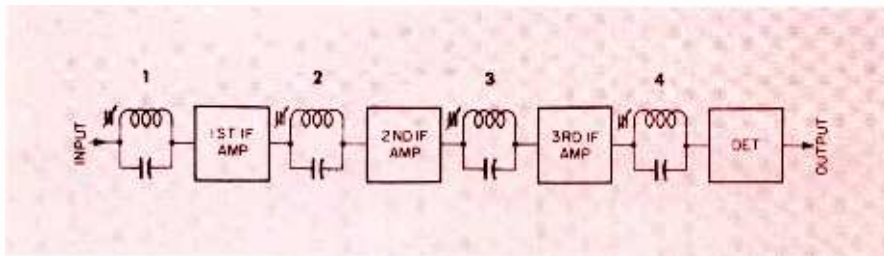

Fig. 1. Typical cascaded IF strip with four tuned circuits.

best possible picture and observe the wedges.

Resolution, or definition as it is sometimes called, is very important to the over-all quality of the picture since it determines the amount of individual detail that can be distinguished by the viewer. When the receiver is not properly responding to all video frequencies, either the vertical or the horizontal wedges of the test pattern appear gray while the others remain a normal black. In the case of poor high-frequency response the vertical wedge turns gray, whereas poor low-frequency response results in a gray horizontal wedge. Generally the majority of receivers exhibiting symptoms of limited frequency response are in need of RF and/or IF alignment.

Conditions which may indicate alignment of the sound section is

necessary are as follows:

(a) Distortion which cannot be corrected with the fine-tuning control.

(b) Weak sound.

(c) Noise (ignition or electrical) in the output of split-carrier receivers, which cannot be nulled out with the fine-tuning control.

(d) Buzz. Normally there is a small amount of buzz, due primarily to intermodulation between the video and sound carriers. However, this condition is aggravated when the sound carrier is too high on the response curve. In a correctly aligned receiver this residual buzz can be nulled or minimized with the fine-tuning control. Accurate alignment of the sound IF and detector is important, but buzz can often be eliminated by touching up the sound detector and sound take-

off coils slightly.

A few words of caution are appropriate here. Do not attempt random experimental alignment adjustments. This practice is often resorted to by the more venturesome service technicians of limited experience. Such unorthodox adjustments could be disastrous, to the point where the receiver would have to be completely realigned at considerable cost in lost time.

Meaning of Alignment

Alignment is the process of adjusting the tuned RF and IF circuits of a receiver to: (1) make the response broad enough to accept all necessary sidebands of the signal, and (2) to adjust all tuned circuits to the correct band of frequencies.

A cascaded amplifier circuit consisting of three stages and four tuned circuits is illustrated in Fig. 1. A signal must pass through each stage in turn, so misalignment in any one of the stages could distort the signal appearing at the detector. Fig. 2 illustrates some of the conditions which prevail when the different stages are misaligned. In Fig. 2A all tuned circuits are properly aligned and each stage responds to the same 7.5-kHz band. In Fig. 2B the last two tuned circuits are misaligned—the third is tuned too low and the fourth too high. The shaded portion of the curve shows the range of frequencies cut off. If a sweep generator is connected to the input and an oscilloscope to the detector output, a waveshape similar to the unshaded portion of (B) will be seen. As the fourth tuned circuit is readjusted toward the proper frequency, the right side of the waveform will move to the left. Upon reaching the proper position relative to the rest of the curve, the waveshape on the scope will appear as in Fig. 2C. Adjusting the third tuned circuit in Fig. 2B will move the left side of the waveform to the right and produce the desired over-all response curve. In Fig. 2C only one stage is misaligned, but the result is almost as pronounced as in B since all frequencies above 3,500 Hertz are cut off. By judiciously adjusting the tuned circuit, we can move the response curve up in fre-

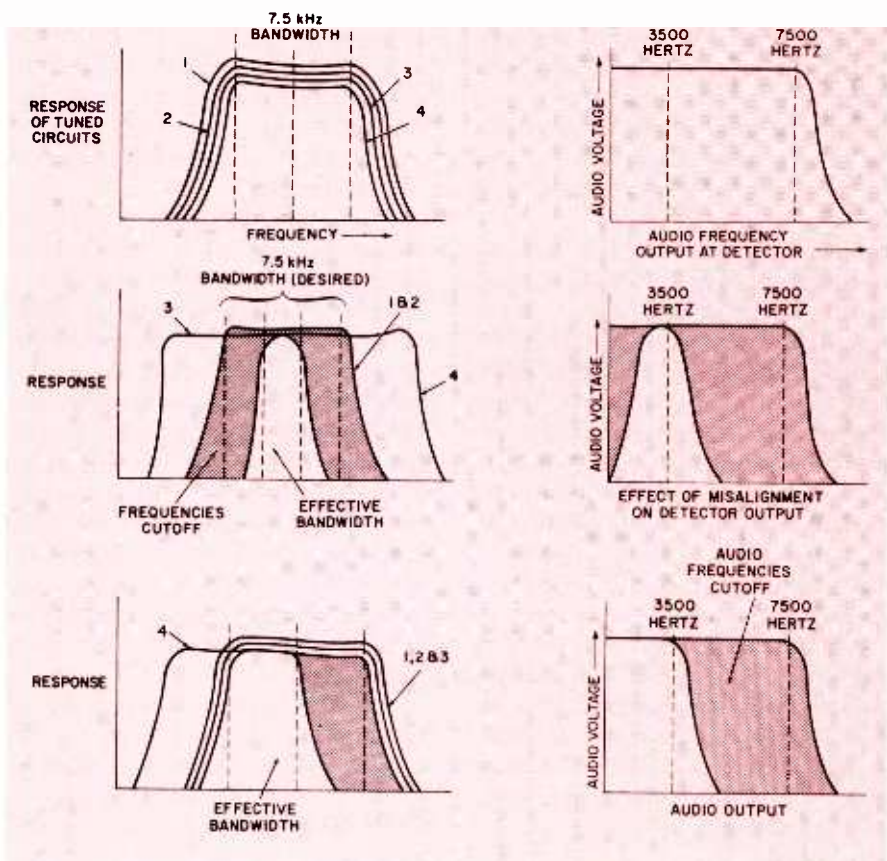

Fig. 3. Effect of misalignment or receiver response.

quency until it coincides with the others as in A.

When readjusting tuned circuits it is very easy to move a curve too far and overshoot the desired position. For this reason it is very important to keep a close check on the frequency of the waveforms (as well as their shape and amplitude). As in the illustrations, the base line on the scope represents frequency. When the frequencies the sweep generator is producing are known, it is possible to estimate the frequency of any point on the base line with acceptable accuracy. With the addition of a marker generator these frequencies can be pinpointed more accurately.

The tuned circuits of a receiver must respond to a certain frequency range which depends on the modulating frequencies of the carrier. All the information transmitted is reproduced only when all these modulating frequencies develop equivalent amplitudes.

Examine the detailed TV transmitter output curve in Fig. 3A. Eliminating one sideband completely would result in detrimental phase distortion, therefore, vestigial-sideband transmission is used. The complete upper sideband and a small portion of the lower sideband are transmitted; the remainder of the lower sideband is suppressed at the transmitter. Since each sideband in an AM signal contains 50 per cent of the modulation energy, the lower video frequencies have 100 per cent modulation; but the higher frequencies have only 50 per cent. Thus the lower frequencies in effect are boosted considerably. In Fig. 3B we have the over-all response curve of a receiver tuned to Channel 2. The tuned circuits are arranged so that the response is nearly linear on the video carrier side of the curve. Therefore, in a properly aligned receiver the video carrier frequency develops only half the signal voltage developed by the higher video frequencies. Because the double sideband, or low frequency, range of the transmitted signal has twice as much modulation energy as the rest of the signal, the attenuation of this range by the receiver corrects for differences in sideband strength introduced at the transmitter. This point is clari-

fied by Fig. 3C. Here we are considering a single video frequency of 500 kHz (0.5 MHz), which lies in the double sideband area of the response curve. Two such side frequencies are transmitted, one 500 kHz above the carrier and the other 500 kHz below. In the receiver, the 500-kHz signal above the carrier develops approximately 75 per cent of the voltage of the signals above 1.25 MHz, and the 500-kHz signal below the carrier develops only 25 per cent. Together, the two side frequencies develop the total voltage of 100 per cent. In other words, the total signal voltage at this frequency is the same as the voltage developed by any video frequency in the single-sideband region.

Fig. 3B illustrates the ideal overall receiver response curve, showing the response from antenna to detector. Its shape compensates for the distortion introduced by vestigial-sideband transmission. The shape of a receiver response curve is determined primarily by the IF

amplifiers. Fig. 4A illustrates the receiver RF response. It obviously is not the same as for the IF systems in B and C; the shape of the IF response curve is the same as the over-all curve of the receiver.

To minimize interference from adjacent television channels, tuned traps are inserted in the IF amplifiers. Being tuned circuits, these traps affect the IF response and thus the over-all IF response curve. The RF response is of course unaffected by traps in the IF's.

Sound signals are handled by the IF amplifiers in intercarrier receivers, and so the shapes of both the RF and the IF response curves differ slightly from those of the split carrier receiver. This can be seen by comparing Figs. 4B and C. In the split carrier receiver curve, there is no response at the sound carrier frequency, whereas in the intercarrier receiver the response extends to approximately 5 per cent above zero.

In Fig. 5A you will note that the RF frequency increases from the

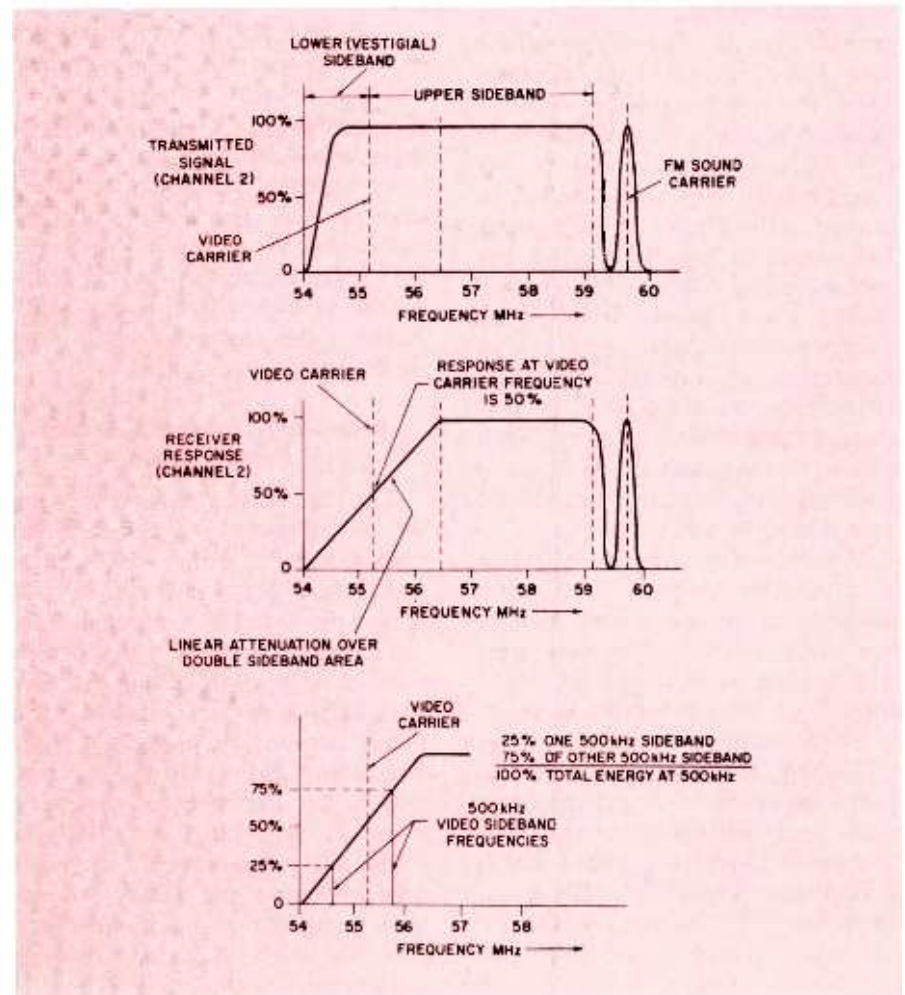

Fig. 3. Method of compensating for vestigial sideband transmission.

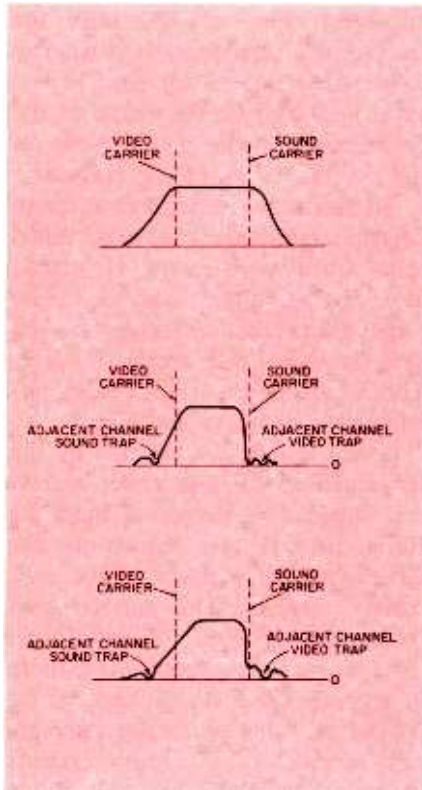

Fig. 4. Typical response curves.

video carrier to the sound carrier, and that the IF frequency increases from the sound carrier to the video carrier. This is always true whenever the local oscillator operates above the frequency of the received signal. Video response is shown in Fig. 5C; zero corresponds to the video carrier. The sound carrier is located in the area of the high video frequencies in the RF and IF response curves. The over-all characteristic curve shown in Fig. 5D always has this shape, regardless of calibration. If calibrated as RF or video frequencies, the frequency increases from video carrier to sound carrier; if calibrated in IF frequencies, the increase is from sound carrier to video carrier.

Certain bandwidths are required in a receiver to pass all the frequencies in the transmitted signals. First, the entire signal must pass unaltered through the RF amplifier; so it must have a bandwidth equal to the transmitted signal, or 6 MHz.

The IF bandwidth required depends on the receiver system being used. In a split carrier arrangement the sound signal may pass through a stage or two of video IF before being taken off. In such a case, the IF's which pass both the video and the sound signals must have a larger bandwidth than IF's which

pass video alone. As a rule a video IF amplifier should have a bandwidth sufficient to cover all frequencies in the video region. In split-carrier receivers this would be 4 MHz.

In intercarrier receivers the entire video plus sound signals pass through all IF stages, and for this reason the IF's must have a larger bandwidth. It is common design practice to make the bandwidth of intercarrier receivers at least equal to the frequency separation between video and sound carriers, or 4.5 MHz.

The total width of the sound signal is only about 50 kHz, so the sound IF bandwidth need not be as great as the video IF's. In split carrier receivers the bandwidth may be comparatively broad, however, to compensate for local oscillator drift, which may cut off or distort the sound signal. The actual bandwidth varies from one receiver to another, but we can safely assume it is in the range of 150 to 250 kHz. Local oscillator drift is of no consequence in intercarrier receivers because the IF is determined by the separation between carriers, and this is held within $\pm .004$ at the transmitter. However, maintaining a broad bandwidth is desirable since it provides a linear operating slope at the detector. As a rule, the sound IF bandwidth is about 200 kHz. Of course the IF bandwidths described are simply optimum—some receivers may use wider or narrower ones.

Alignment Difficulties and Precautions

The individual alignment steps for any receiver are given in the manufacturer's service data. However, these brief instructions presume the service technician has some prior knowledge and experience in alignment techniques. We wish to provide you with the additional information needed to really understand the reason behind each step in the alignment procedure.

In the beginning, it is best to follow the manufacturer's alignment instructions to the letter. As you gain experience and learn the short cuts, the service data then becomes a valuable working guide.

Even after observing all precau-

tions in connecting and adjusting the alignment equipment, you may run into trouble. One problem is that various oscillations and small waveforms sometimes appear on the response curve. One type of spurious response, termed "hash" (Fig. 6), is a very common occurrence. This is simply a poor signal-to-noise ratio in the receiver, caused by using a sweep signal of too low a level. Normally the sweep output signal should be kept low, but if "hash" shows up, try increasing the sweep signal level and reducing the vertical gain of the scope. (Be careful not to increase the signal to the point of overload.)

Another type of curve interference resembling hash is pickup from the vertical or horizontal deflection amplifiers of the receiver itself. The solution is the same as before—or as an alternative, disable the offending oscillator.

In the service shop, oscillation resembling a marker pip sometimes occurs because of stray radiation from the local oscillator of a nearby TV receiver. The obvious solution is to change channels or turn off the offending receiver.

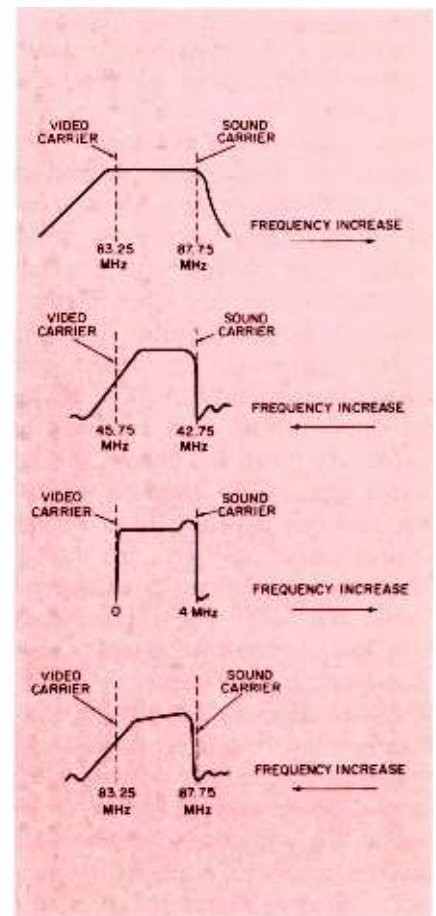

Fig. 5. Frequency increase graphs.

Oscillation in the video IF strip — caused by two stages aligned to the same, or nearly the same, frequency—produces the pattern in Fig. 7. Other possible causes are poor grounding, feedback through a test lead, stray coupling, or an open bypass capacitor.

As in most high-gain circuits, the video-IF amplifiers are highly susceptible to regeneration, a condition of in-phase (positive) feedback from the output to the input circuits. Regeneration greatly increases circuit selectivity and gain, and when it occurs, the normally rectangular IF response curve breaks down into a badly distorted waveform having one or more very high voltage peaks. (A VTVM connected across the video detector load resistor may read as high as 50 volts.) Even slight regeneration will peak the response curve at some frequency.

Because regeneration greatly changes the shape of the IF response, this in turn produces many effects on the screen. Some of these can be very misleading—loss of picture detail, ghosts, weak picture, smearing, negative picture, and herringbone stripes are just a few. The pattern varies with the frequency and amplitude of the regeneration. In many instances you can pinpoint the oscillating stage by bringing your hand close to each circuit and watching for changes in the over-all waveshape.

Since oscillation is most often caused by two IF stages tuned to approximately the same frequency, the first step in correcting the

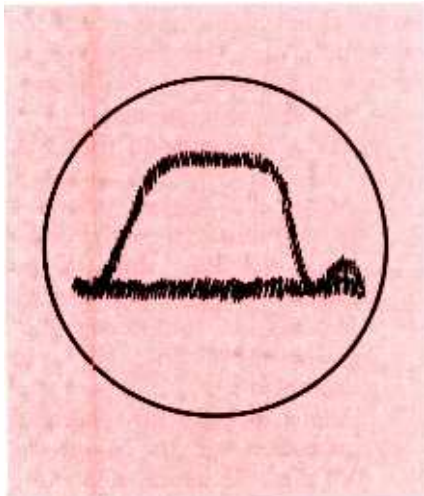

Fig. 6. A spurious response, called "hash," caused by too weak a signal or by pickup from sweep circuits.

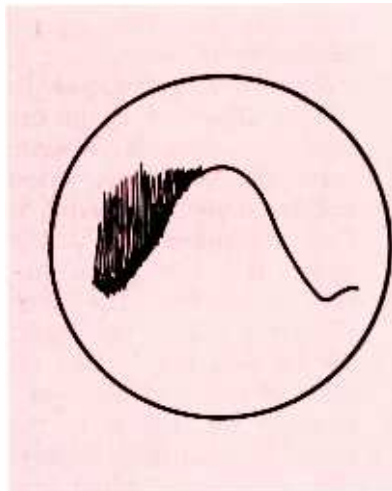

Fig. 7. Pattern produced by oscillation in the video-IF strip.

trouble is to align the entire IF strip. Follow the correct instructions, because there's a good chance someone before you didn't.

The first step is to disable each IF stage, except the last, by temporarily soldering a .005-mfd capacitor between the grids and ground. With the VTVM connected across the video detector load resistor, connect the marker generator to the grid of the last IF stage and peak-align it to the correct frequency. Remove the shunt capacitor from the grid of the next-to-last stage, connect the marker generator in its place, and align to the correct frequency. Repeat this procedure for each IF stage, working back from the video detector to the converter.

Misaligned Traps

Off-frequency traps can distort the response curve badly, as illustrated in Fig. 8. Here, a 41.25-MHz trap is misaligned to a point below the video carrier frequency. If some other factor such as narrow bandwidth were to further distort the response, the curve would probably be totally unrecognizable. If a curve similar to this appears, you can quickly identify the trap points by touching each trap with your finger. The added body capacitance will shift the trap frequency and cause the dip to move. Of course you won't know if the trap is off frequency or not until the marker signal is injected. One effect of an off-frequency trap is illustrated in Fig. 9.

When aligning an IF amplifier using overcoupled transformers, you may notice an unidentifiable

dip, resembling that produced by a trap, on the response curve. This often baffling effect is produced when the sweep generator swamps out the effectiveness of the IF transformer secondary, while the primary (a resonant circuit) acts as an absorption trap. At the resonant frequency of the primary, some of the sweep signal is absorbed. This reduces the signal reaching the detector, and a dip therefore appears in the response curve. The position of the dip depends on the resonant frequency of the primary, and the exact effect on the curves varies. By shunting the primary with a capacitor of 200pf or so, the resonant frequency is lowered sufficiently to remove the trap effect and restore the curve to normal.

Miscellaneous

Regeneration, oscillation, or response-curve instability is sometimes the result of inadequate grounding. The most common of these is due to power line coupling. This is caused by the receiver and alignment equipment being at different ground potentials, so that feedback occurs between the equipment through the power line. Proper grounding is the only remedy.

Before tuner RF alignment is undertaken, two preliminary preparations—usually ignored or overlooked—should be made. First, to prevent curve distortion caused by hum and trap reflections from the IF strip, disable the video IF input stage by pulling the tube or shunting the grid to ground with a .005-mfd capacitor. The second step, though not always necessary, is to load the primary of the first IF transformer by connecting a resistor of approximately 270 ohms across it, to damp out resonance in the converter plate circuit. Always keep

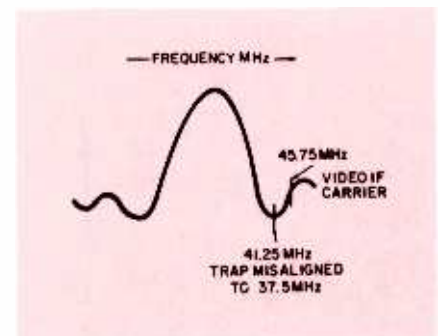

Fig. 8. Effect of a misaligned trap on the response curve.

the oscillator tube in the socket when the RF front end is being aligned. Otherwise, misleading curve distortion occurs if the oscillator bias is removed from the converter.

Practical Alignment Procedure

The following circuits and procedures are intended as a working guide to practical alignment methods, and may be adapted to any TV receiver. Keep in mind that the response curves encountered may differ considerably from the examples presented here, but the basic methods and the results obtained do not.

Checking RF-IF Response

1. Interconnect the alignment equipment as illustrated in Fig. 10, using the proper matching networks and an isolating resistor of approximately 10K in series with the scope's vertical input lead, shunted by a 330-pf capacitor. (The marker is coupled to the circuit by connecting the "hot" generator lead to the insulated body of the grid resistor.)
2. Turn the channel selector to the highest local channel and the fine-tuning control to a midrange setting.
3. Set the sweep generator to the same channel center frequency and the marker to the video IF carrier frequency.
4. Clamp the IF-RF AGC bus

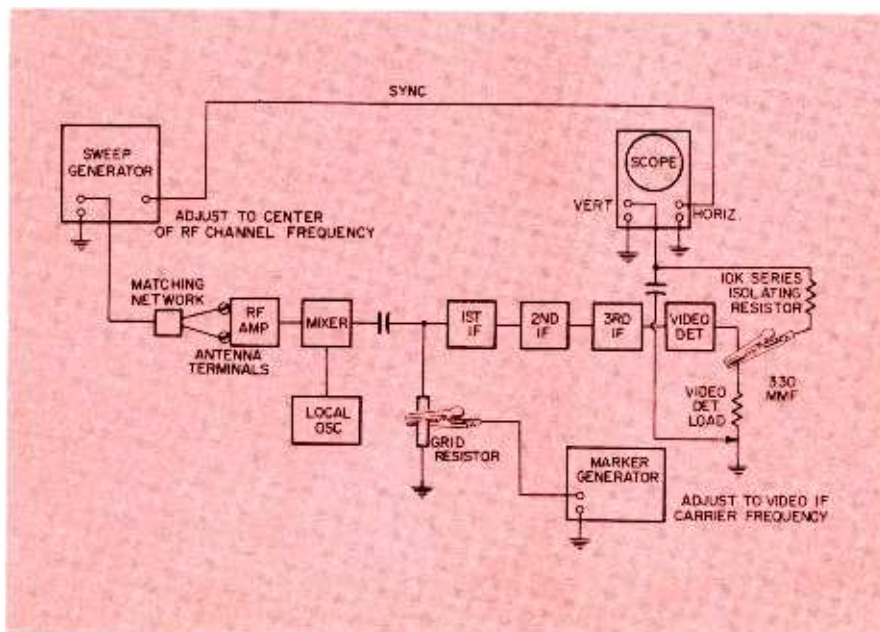

Fig. 10. Method of connecting equipment for checking RF-IF response.

line with the bias voltage recommended.

5. Adjust the operating controls of the alignment equipment until you obtain a response curve of the proper shape and amplitude. Be careful to keep the sweep and marker signals low in order to prevent overloading. The video IF carrier marker pip should fall between the 40 and 60 per cent points on the slope.
6. Readjust the marker to the sound IF carrier frequency. The marker pip should now appear on, or disappear into, the sound trap dip on the curve. After the bandwidth of the first response curve has been checked, the marker can be readjusted to the video IF carrier frequency and left there throughout the remainder of the response check. The width of the other curves on other channels will indicate whether the bandwidth is satisfactory or not.

Check the response on each local channel, changing the sweep generator frequency at each step. Remember that the response will be different on each channel, but must always be within the limits outlined. If the response is not up to par on one particular channel, make a mental note to check its RF response later. If the video carrier marker is outside the specified limits (40 to 60 per cent of the

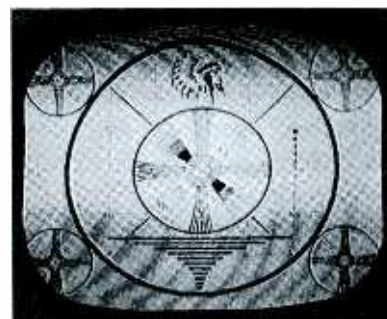

Fig. 9. Effect of an off-frequency trap on picture quality.

slope) on one channel, check the local oscillator by varying the trimmer slug slightly. This will usually bring the marker pip into line.

When the over-all response curve has the general shape of the IF curve on most of the channels checked, you can assume the video IF alignment is satisfactory. If not, check the video IF response by moving the sweep generator lead to the grid of the converter stage and adjusting the generator frequency to sweep the IF bandwidth. This circuit will probably need to be aligned.

Traps

Image and sound interference in the picture is a common problem, because of the position of the carriers in the channels, the circuit design of TV tuners, and the very nature of TV channel allocations themselves. To eliminate these problems, traps coupled to the IF circuits and tuned to the frequencies of the interfering signals are used. The traps absorb these signals from the IF signal before they reach the video detector. The procedure to use in trap adjustment is as follows:

1. Set up the equipment as in video IF alignment. (See Fig. 10.)
2. Adjust the marker generator to the exact frequency indicated for the trap to be aligned (this value usually appears on the circuit diagram, next to the trap symbol).
3. Adjust the trap for minimum indication on the scope or VTVM. If more than one trap is tuned to the same frequency, adjust each one for minimum output.

4. Increase the marker generator output slightly, and retune the trap (or traps) for minimum output.
5. Repeat the process at all trap frequencies, increasing the generator signal level at each until you have obtained the lowest output. Usually there are at least two different trap frequencies; nevertheless, the procedure for each is always the same.

Peak Alignment

If a receiver is too far out of alignment for ordinary sweep alignment touch-up, a procedure known as stage-by-stage sweep, or peak, alignment will be required. The setup for peak-aligning the video IF strip is illustrated in Fig. 11. Either the scope or the VTVM may be used as a peak indicator, or both may be used together. Using both provides a decided advantage; when you are making adjustments for minimum or maximum meter deflection, a look at the scope pattern will indicate the presence of any signal overload. However, the input signal must be modulated to provide the necessary scope deflection. Modulation is not needed when the VTVM is used alone, because it indicates only the DC voltage developed by the video detector.

Sound traps are generally aligned first. An important point to keep in mind, when aligning traps, is to use a reasonably strong signal. Switch the VTVM to the second lowest scale (3 or 5 volts) and adjust the marker generator output for nearly a midscale reading. In our hypothetical receiver of Fig. 11, we would adjust the first sound trap L7 for a minimum indication on the meter, and then adjust the second sound trap, L11. If you have trouble obtaining a definite dip on the meter when adjusting the first trap, detune the second trap until the meter indicates a higher reading, and then adjust the first for a minimum. If difficulty is still experienced, move the marker generator lead to the IF grid just ahead of the second trap and adjust it for a minimum reading. Reconnect the marker lead to the mixer stage, and then adjust the first sound trap. The meter should now indicate a definite

dip in resonance.

Image traps L5 and L9 are adjusted next, using the same procedure. This should be followed by adjustment of adjacent channel video trap L3.

Before making any IF transformer adjustments, set the generator output to minimum and make certain the bias is set at the value recommended.

The service data for any TV receiver will specify that the coils be aligned in a certain order—usually the same as for our typical circuit (L8, L10, L6, and L4). Adjust the marker generator output frequency to that of L8, and increase the signal output until you obtain a legible meter indication. Then adjust L8 for maximum output. Repeat the procedure for remaining coils L10, L6, and L4. This completes the alignment of the traps and stagger-tuned coils.

However, overcoupled mixer-first-IF transformer L1 still remains. The simplest method of aligning L1 is from its response curve, using an RF probe as illustrated in Fig. 12A. The desired response curve is shown in Fig. 12B. Time and trouble can be avoided by using two alignment tools and simultaneously adjusting the overcoupled-transformer pri-

mary and secondary while observing the response curve. With a little patience and practice you will be able to tell if the curve is shaping up properly, and if not, which direction to make each adjustment to obtain the desired response.

A 270-ohm resistor is needed across the RF probe input to swamp out the first video IF plate coil because we do not want to see its response. The probe is connected to this point to isolate it from the first IF grid circuit and prevent loading, which would alter the resonant frequency of the transformer. The transformer response curve can be taken off the video detector without an RF probe, but first it is necessary to disable the other IF stages by shunting all coils with 390-ohm resistors. The traps need not be similarly disabled because their only effect is to add dips in the curve, as shown in Fig. 12C.

The response curve of any IF stage or combination of IF stages can be viewed by disabling the others with shunting resistors. Thus, stagger tuned IF amplifiers can be sweep-aligned if alignment data showing reference curves are available.

Step-Sweep IF Alignment

Step-sweep alignment is a little

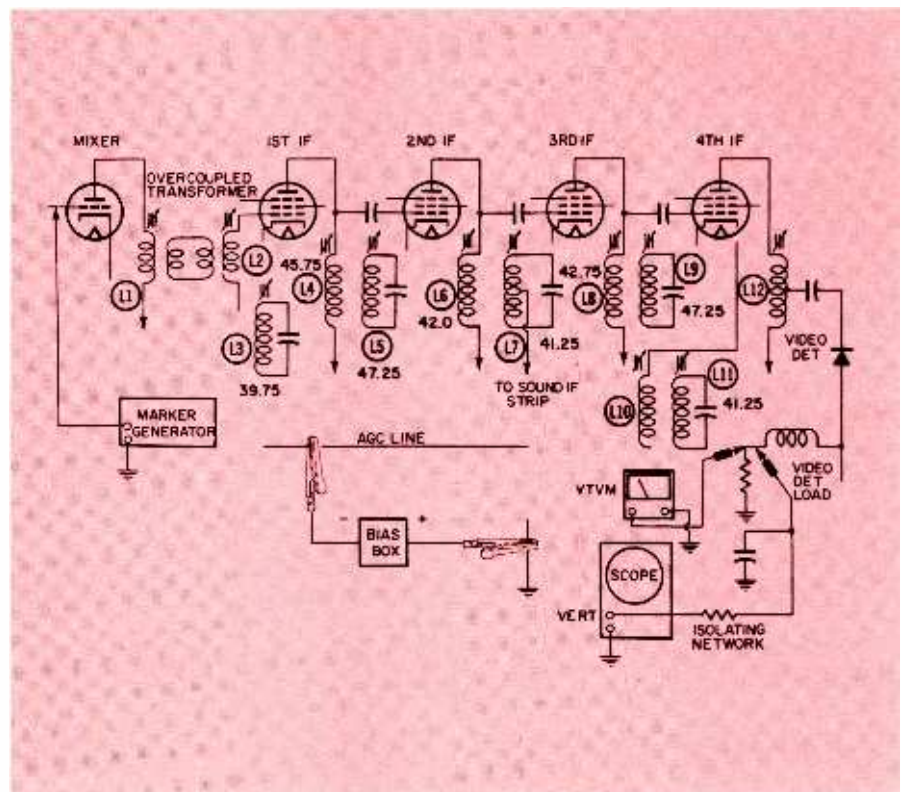

Fig. 11. Test setup for peak alignment of video-IF strip.

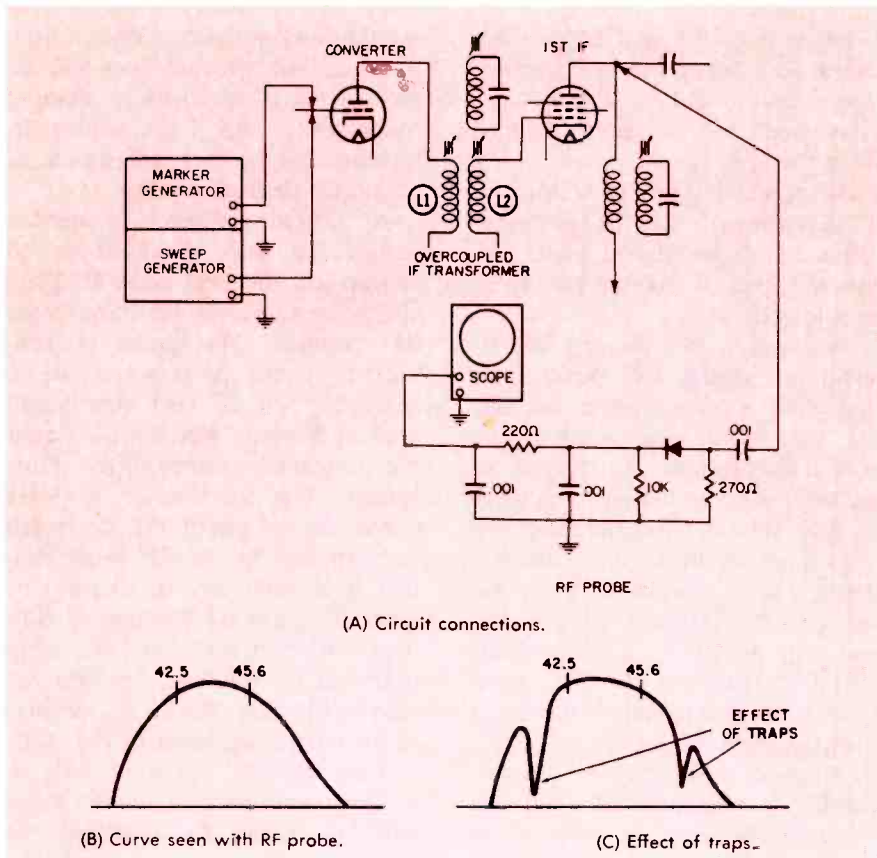

Fig. 12. Using an RF probe to check the response of an overcoupled IF stage.

more complicated than peak alignment, but it is sometimes required in order to obtain the desired result. The equipment is interconnected as illustrated in Fig. 13. The marker signal is injected at the

mixer stage, and the scope is connected across the video detector load resistor. The sweep generator lead, terminated with a series capacitor and shunt resistor, is connected to point A (the grid of the last video

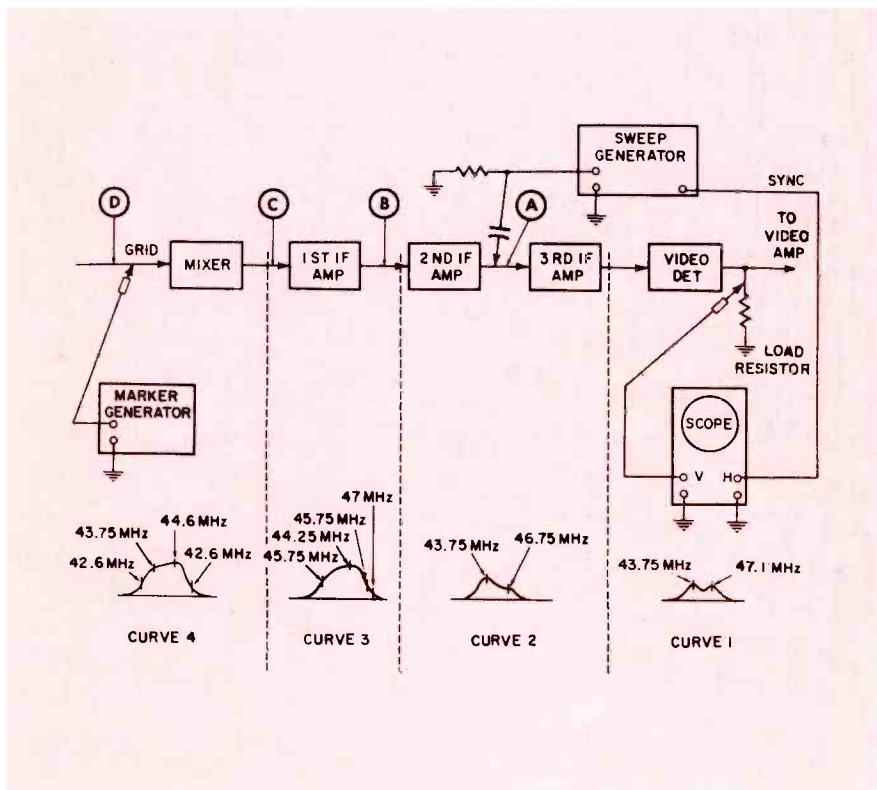

Fig. 13. Method of connecting equipment for step-sweep IF alignment.

IF amplifier). The sweep generator output frequency is adjusted to sweep the entire IF bandwidth, and the marker is adjusted to 47.1 MHz (the first frequency to be checked). The video IF carrier frequency in this example is 46.6 MHz. To obtain the scope response shown by curve 1, adjust the last IF output circuit for a peak at the 47.1 MHz marker frequency. Set the marker output frequency to 43.75 MHz and adjust the transformer between the detector and last IF stage until you obtain a second peak. The curve on the scope should now resemble curve 1.

Readjust the marker generator to the frequency of the trap just ahead of the third video IF stage. Remove the sweep lead and turn on the 400-Hertz internal modulation of the marker generator. Adjust the trap for minimum modulation amplitude on the scope screen.

Reconnect the sweep lead to position B at the grid of the second video IF stage. Turn the sweep generator output attenuator to zero and increase the output until a usable curve is obtained without overloading. Turn the marker modulation off and readjust the output frequency to 43.75 MHz. Adjust the circuits between the second and third IF stages for a response resembling curve 2 but having the main peak at the marker frequency.

Again disconnect the sweep lead, retune the marker frequency to that of the first IF plate trap, turn the internal marker modulation on, and adjust the trap as before.

Most receiver manufacturers recommend aligning the sound IF strip at this time, because of interaction of the sound take-off transformer with the video IF coupling network. After completing the sound IF alignment, connect the sweep lead to point C and align the circuits between the first and second IF stages for a response similar to curve 3. There are no traps to be adjusted, so connect the sweep lead to point D and make final adjustments at the mixer output and at the input of the first IF stage for the over-all response of curve 4. The video carrier marker should fall near the 40 per cent point on the slope of the curve. ▲

Complete TUNER REPAIR for only

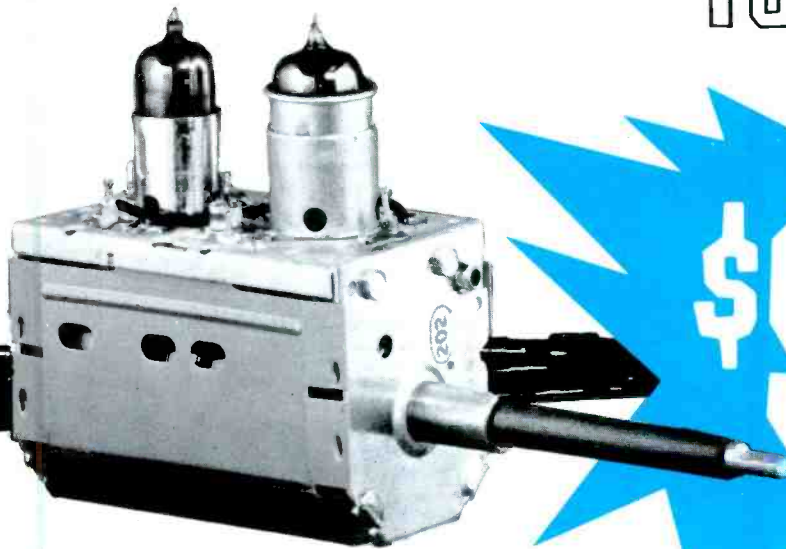

\$9.50

Sarkes Tarzian, Inc., largest manufacturer of TV and FM tuners, offers unexcelled tuner overhaul and factory-supervised repair service. Completely-equipped and conveniently-located Service Centers offer fast, dependable and factory-supervised repair service on all makes and models. Centers are staffed by well-trained technicians, assisted by engineering personnel.

Most Tarzian-made tuners received one day will be repaired and shipped out the next. More time may be required on other makes. Every channel—not just the channels existing in any given area—is checked and re-aligned per orig-

inal specifications. Exclusive cleaning method makes the tuner look—as well as operate—like new.

Cost, including ALL labor and parts (except tubes) is only \$9.50 and \$15 for UV combinations. No additional charge. No hidden costs. Too, you get a full, 12-month warranty against defective workmanship and parts failure due to normal usage.

Always send TV make, chassis and Model number with faulty tuner. Check with your local distributor for Sarkes Tarzian replacement tuners, parts or repair service. Or, use the address nearest you for fast, factory-supervised repair service.



TUNER SERVICE CORPORATION

(Factory-supervised tuner service authorized by Sarkes Tarzian)

MIDWEST — 817 N. Pennsylvania St.
Indianapolis, Ind., Box 1642
Tel: 317-632-3493

EAST — 547-49 Tonnele Ave., Jersey City, N. J.
Tel: 201-792-3730

SOUTH-EAST — 938 Gordon St., S. W.
Atlanta, Georgia
Tel: 404-758-2232

Circle 2 on literature card

WEST—

SARKES TARZIAN, Inc.
Tuner Service Division

10654 Magnolia Blvd.,
N. Hollywood, Calif.
Tel: 213-769-2720



PF Reporter

PHOTOFACT

the magazine of electronic servicing

VOLUME 17, NO. 6

JUNE, 1967

PUBLISHER
HOWARD W. SAMS

GENERAL MANAGER
DONALD W. BRADLEY

EDITOR
WILLIAM E. BURKE

MANAGING EDITOR
JAMES M. MOORE

ASSOCIATE EDITORS CONSULTING EDITORS
Thomas T. Jones Joe A. Groves
J. W. Phipps C. P. Oliphant
Carl F. Moeller George B. Mann

PRODUCTION MANAGER RESEARCH LIBRARIAN
Esther M. Rainey Mrs. Bonny Howland

CIRCULATION MANAGER
Pat Osborne

ART DIRECTORS
Louis J. Bos, Jr. & Robert W. Reed

PHOTOGRAPHY
Paul Cornelius, Jr.

ADVERTISING
SALES MANAGER
HUGH WALLACE

ADVERTISING SALES OFFICES

central and midwestern

ROY HENRY

Howard W. Sams & Co., Inc., 4300 W. 62nd St.
Indianapolis, Ind., 46206 • 317-291-3100

eastern

ALFRED A. MENEGUS

Howard W. Sams & Co., Inc., 3 W. 57th St.
New York, New York, 10019 • 212-688-6350

southwestern

MARTIN TAYLOR

P. O. Box 22025, Houston, Texas 77027
713-621-0000

western/Los Angeles

G. R. (JERRY) HOLTZ

The Maurice A. Kimball Co., Inc.
2008 W. Carson St., Suites 203-204
Torrance, Calif., 90501 • 213-320-2204

western/San Francisco

The Maurice A. Kimball Co., Inc.

580 Market St., Room 400
San Francisco, Calif., 90501 • 415-392-3365

Address all correspondence to PF REPORTER
4300 W. 62nd Street, Indianapolis, Indiana 46206



Copyright © 1967 by Howard W. Sams & Co., Inc. PF REPORTER is a trademark of Howard W. Sams & Co., Inc. No part of PF REPORTER may be reproduced without written permission. No patent liability is assumed with respect to use of information herein. Acceptance of advertising does not in any manner signify the products, policies and services so advertised have been approved, endorsed or recommended by this magazine.

Subscription Prices: 1 year—\$5.00, 2 years—\$8.00, 3 years—\$10.00, in the U. S. A., its possessions and Canada.

All other foreign countries: 1 year—\$6.00, 2 years—\$10.00, 3 years—\$13.00. Single copy 75¢; back copies \$1.

Indexed in Lectrodex. Printed by the Waldemar Press Div. of Howard W. Sams & Co., Inc.

Tube Substitution Supplement 1

Sweep Alignment for TV Warren J. Smith 5
8-page book section describing procedures and test equipment applications for tuning RF and IF circuits.

The Electronic Scanner 21

Letters to the Editor 24

Scope or Meter—Which? Robert G. Middleton 25
An analysis of the relative merits of both test instruments provides the facts on which to base your decision.

Symfact: Color Killer 31
Operation and trouble analysis of this stage will help solve many chroma problems.

Transistor TV Techniques Wayne Lemons 36
Tips on servicing solid-state receivers.

Solid-State Stereo Revisited David Held 40
A review of troubleshooting methods, transistor checking, and case histories will refresh your servicing know-how.

Notes on Test Equipment T. T. Jones 50
Lab report on B & K Model 1242 Color Generator.

Photofact Bulletin 51

Book Review 54

The Troubleshooter 56

Product Report 66

Free Catalog and Literature Service 80

Monthly Index on Free Literature Card

ABOUT THE COVER

Tomorrow is here! Not many years ago, the service industry awoke to the dawn of solid-state rectifiers in TV; something that was considered a part of the future had arrived. And so it is today; yesterday's speculation of the future has suddenly materialized, as though impatient to be a reality. Completely solid-state b-w receivers, such as the portable on this month's cover, are commonplace. The application of integrated circuits in TV is now an accomplished fact. And what of yesterday's future servicing techniques? Many of them can be found in an article beginning on page 36 of this issue.



Photo courtesy of
Howard W. Sams & Co., Inc.



2,365 reasons why Sprague Twist-Lok® Capacitors help you to protect your reputation

When you fool around with makeshift or "fits-all" capacitor replacements by substituting sizes and ratings, you leave yourself wide open for criticism of your work, you risk your reputation, and you stand to lose customers. With so much at stake, it just doesn't pay to use makeshifts when it's so easy to get exact replacement capacitors from your Sprague distributor.

With 2,365 different Sprague Twist-Lok Capacitors as standard catalog items, and more being added regularly, Sprague gives you the world's most complete selection of exact replacements.

We don't have to tell you that it's easier to service with exact replacements. And we don't have to tell you that it's better, too. When sets are designed, specific capacitance values are used for peak operation, so it takes exact replacements to restore original set performance.

And who better than Sprague knows which values and sizes are needed in the replacement market? Sprague, the world's largest component manufacturer, has the most complete specification file on original set requirements. That's why you're always right when you work with Sprague Twist-Lok exact replacements!

GET YOUR COPY of Sprague's comprehensive Electrolytic Capacitor Replacement Manual K-108 from your Sprague Distributor.



HAVE YOU TRIED KWIKETTE* CONNECTORS?

Not just another wire spring connector! Copperweld wire inner core, a layer of flux, and an outer coating of solder... all you supply is heat! They're now being included with all Sprague pre-packaged wire-lead service-type capacitors at no extra cost to you!

*TRADEMARK



WORLD'S LARGEST MANUFACTURER OF CAPACITORS

65-0106R4

Circle 3 on literature card

Sprague Products Co., 105 Marshall St., North Adams, Mass. 01248

June, 1967/PF REPORTER 15

The World's Best Values In Test

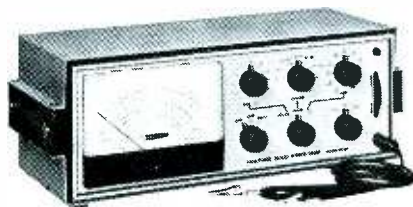

Kit IM-25 Assembled
\$80.00 \$115.00

NEW! Solid-State High Impedance Volt-Ohm-Milliammeter

- Solid-state design for solid-state measurements • All-silicon transistors plus FET's • Full scale ranges down to 150 mv & 15 μ A • AC plus battery power for portability • 6" meter with zero center scale for + & - voltage measurements without switching • Accuracy $\pm 3\%$ full scale on DC volts, $\pm 5\%$ full scale on AC volts • New styling & unitized construction • Separate range switches for each function. 10 lbs.

World's Most Popular VTVM ... Heathkit IM-11

Kit IM-11
\$24.95

Assembled
\$39.95



- 7 AC, 7 DC, & ohms ranges — easy-to-read scales • $4\frac{1}{2}$ " 200 μ A meter • 1% precision resistors for high accuracy • Extended frequency response, ± 1 db 25 Hz to 1 MHz • Measures RMS and Peak-to-Peak • Single test probe for all measurements • Easy-to-build, electronically stable circuit board construction • Costs just 45c more than its predecessor of 16 years ago. 5 lbs.

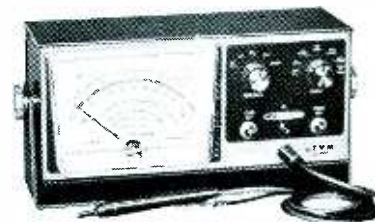

Kit IM-13 Assembled
\$32.95 \$49.95

Service-Bench VTVM ... Ideal For In-Shop Servicing

- Measures AC volts (RMS), DC volts, resistance & db • Separate 1.5 & 5 volt AC scales for high accuracy • Large, easy-to-read 6", 200 μ A meter • Zero center db scale • Single test probe for all measurements • Gimbal bracket for bench, shelf or wall mounting • Smooth vernier controls for zero & ohms adjust • 1% precision resistors. 7 lbs.

Mutual Conductance Tube Tester



Kit TT-1A
\$149.95

- No finer tube tester anywhere • Indicates Gm to 24,000 micromhos • Ultra-sensitive grid current test • Built-in switch-operated calibration circuit for high accuracy • Built-in adaptor for testing Compactron, Nuvistor, Novar & 10-pin miniature tube types • Includes handsome, easy-to-carry cabinet with handle. 33 lbs.

Capacitor Checker ... A Direct Reading Bridge



Kit IT-11
\$29.95

- Tests all capacitor types • Low bridge voltage for safe testing of miniature electrolytics • 16 leakage testing voltages • Direct reading scales — no involved calculations • Measures resistance from 5 ohms to 50 megohms • Measures capacitance from 10 pf to 1000 μ f • Comparator circuit — measures "L", "C", or "R" with external standard • "Eye" tube null & leakage indicator. 7 lbs.



Kit IM-30
\$54.88

Assembled
\$84.95

Lab Transistor Tester Provides Complete DC Analysis

- Ideal for servicing, design work, incoming inspection, production testing, etc. • Provides complete DC analysis of PNP & NPN transistors to 15 amps • DC gain (Beta, Alpha) read direct on calibrated scales • 15 μ A basic range for leakage (Icbo, Iceo) tests • Four lever switches for fast, easy test selection • Internal battery supply, provisions for external power. 10 lbs.



Kit IG-112
Was \$99.00
Now Only \$69.00

NEW LOW PRICE! Now Save \$30 On FM Stereo Generator

- Provides virtually all signals required for trouble-shooting & alignment of multiplex adaptors, FM tuners & receivers • Switch selection of 400 Hz, 1000 Hz, 5000 Hz, 19 kHz, 38 kHz and 65 kHz or 67 kHz SCA signals • Built-in marker oscillator for I.F. and dial tracking checks • 100 MHz sweep signal (adjustable ± 2 MHz) for overall RF & IF alignment on clear area of FM band. 11 lbs.

General Purpose RF Signal Generator

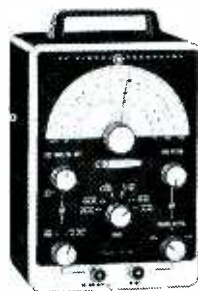

Kit IG-102
\$27.95

Assembled
\$54.95

- Covers 100 kHz to 220 MHz in six bands • Large, accurately calibrated dial scales • Factory wired and aligned coil and band-switch assembly • Modulated or unmodulated RF output up to 100,000 microvolts, controlled by both fixed-step or variable output attenuators • 400 Hz signal modulation and 400 Hz audio output for audio tests • 2% tuning accuracy. 7 lbs.



Kit IG-72
\$41.95

Assembled
\$64.95

Switch-Selected Audio Generator for Near Perfect Sine-Wave Signals

- A near perfect output signal — ideal for servicing or trouble-shooting high fidelity equipment • Switch-selected output frequencies — 10 Hz to 100 kHz • Less than 0.1% distortion — 20 to 20,000 Hz • Panel metered output is calibrated in volts and db • Output level and frequency accurate to within $\pm 5\%$ • 200 μ A meter plus precision resistors for high accuracy. 9 lbs.

Instruments Come From HEATH!



Kit IO-14
Was \$299
Now Only
\$259⁰⁰
Assembled
\$399⁰⁰

NEW LOW KIT PRICE! Now Save \$40 On Professional 5" DC Oscilloscope

- A high stability 5" DC oscilloscope with triggered sweep • DC to 8 MHz bandwidth and 40 nanosecond rise time • Vertical signal delay through high linearity delay lines — capable of faithful reproduction of signal waveforms far beyond the width of the scope • Calibrated vertical attenuation • Calibrated time base • Forced air cooling • Input of Z-axis modulation. 53 lbs.

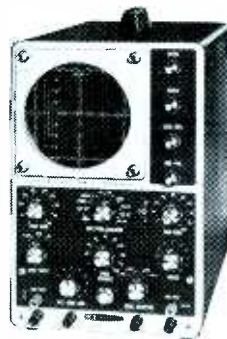

Kit IO-12
\$81⁹⁵
Assembled
\$137⁰⁰

Extra-Duty Wide-Band 5" Oscilloscope

- Ideal for TV trouble-shooting, professional & university labs • 5 MHz bandwidth for TV signal analysis • Heath patented sweep circuit — 10 Hz to 500 kHz • Two extra sweep switch positions which may be adjusted to often used sweep rates • Built-in peak-to-peak calibration reference • Combination of circuit board and wiring harness construction speed assembly time. 24 lbs.



Kit IO-10
\$94⁹⁵

"Space-Saver" 3" DC Oscilloscope

- Identical vertical & horizontal DC or AC coupled amplifiers • DC to 200 kHz bandwidth — less than 5° phase shift • Recurrent sweep generator, 5 Hz to 50 kHz in four ranges • External capacitor binding posts for slower sweep rates • Small, compact, easy to carry from job to job • All critical voltages regulated for high stability • Transformer operated power supply. 16 lbs.



PKW-2
\$12⁰⁰

NEW Low Capacitance Scope Probe

- Completely assembled, ready to use • Essential for high frequency wave-form analysis • Minimizes loss of gain, circuit loading or distortion • Designed for scopes with 1 megohm input, such as Heathkit IO-14 (above) • Switch for X1 direct or X10 attenuated operation • DC response to 25 MHz; max. DC voltage is 600 v. • Sliding, spring-loaded tip is notched for hooking to wires or terminals for hands-free use. 1 lb.



Kit ID-22
\$23⁹⁵

Electronic Switch For Dual-Trace Scope Operation

- Permits display of two separate signals on CRT screen • Displays signal levels as low as 0.1 volt • ± 1 db, 0-100 kHz response • Separate gain controls for each channel • All-electronic switching • Four switching rates — 150, 500, 1500 and 5000 Hz • Sync output to control scope sweep • Simple to use — just connect signal sources to "A" and "B" inputs & output to scope vertical input. 7 lbs.



Kit IO-21
\$58⁹⁵

General Purpose 3" Oscilloscope

- Push-pull vertical and horizontal amplifiers for minimum trace distortion • Wide-range sweep — 20 to 100,000 Hz • Automatic sync • Retrace blanking • Compact, lightweight, versatile • Dependable, well-rated oscilloscope for general purpose requirements • Professional-quality components used throughout • Clean, open circuit layout for easy assembly. 12 lbs.

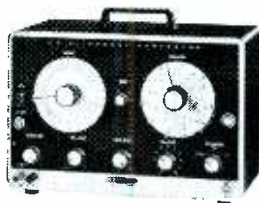

Kit IG-52
\$67⁹⁵

TV Alignment Generator

- FM & TV coverage — Sweep oscillator covers 3.6 MHz to 220 MHz with 0-42 MHz max. sweep width • Stable, all-electronic sweep circuit • Built-in marker oscillators — 4.5 MHz crystal & 19 to 60 MHz variable. 14 lbs.

Color Bar & Dot Generator

- Produces 6 different patterns for picture adjustment • 10 vertical color bars — including special shading bar pattern • Crystal controlled for accuracy & stability • RF & video output. 13 lbs.



Kit IG-62
\$64⁹⁵



FREE!

World's Largest Electronic Kit Catalog!

Describes these and over 250 kits for stereo/hi-fi, color TV, amateur radio, shortwave, test, CB, marine, educational, home and hobby. Save up to 50% by doing the easy assembly yourself. Mail coupon or write Heath Company, Benton Harbor, Michigan 49022

HEATH COMPANY, Dept. 25-6
Benton Harbor, Michigan 49022
In Canada, Daystrom Ltd.

Enclosed is \$ _____, plus shipping.

Please send model (s) _____

Please send FREE Heathkit Catalog.

Name _____

Address _____

City _____

State _____

Zip _____

Prices & specifications subject to change without notice.

TE-162



mystery: where
did all
the color
GO?

here's the missing link in color

Belden's Color Guard Twins deliver full color power all the way to the set. Eliminate many causes of lead-in signal loss. Deliver a ghost-free picture. ■ Belden's COLOR GUARD TWINS are: 8290†† Shielded Permohm with Beldfoil* for congested or high interference areas; and 8285† Unshielded Permohm for rural, low-signal-strength areas. ■ 8290 with patented Beldfoil shielding prevents line pick up of interference signals that produce ghosts and electrical interference. 8285 Permohm's conductors are encapsulated in low-loss cellular polyethylene to maintain a strong signal in all weather conditions, especially in fringe reception areas. ■ 8290 Shielded Permohm is designed so that you can install it without expensive transformers, connectors, and "stand offs." You can even tape it to a mast or run it through a rain gutter. ■ With Permohm lead-ins, the set gets the full color power of the signal (full power for UHF or VHF, too.) Now owners can get the kind of picture they bought a color set for. You get the laurels.

BELDEN MANUFACTURING COMPANY
P. O. Box 5070-A • Chicago, Illinois 60680

reception!

8285[†]

Belden
Unshielded Permohm
for rural areas.

Call your Belden distributor about the
Color Guard Twins—



Belden

8285 PERMOHM

ALL CHANNEL TV

8290^{††}

Belden
Shielded Permohm
with Beldfoil
for congested areas.

*Belden Trademark Reg. U.S. Patent Office †Belden Patent No. 2,782,251 ††Belden Patent No. 2,782,251 and Pat. Pending

Circle 5 on literature card

New low cost.
New ease of operation.
No waiting. No warm-up.
No adjustments.
Brightest patterns in the industry.



The **B&K** 1242 Color Generator is all business\$!

There's nothing else like it. The all-new B&K 1242 represents the highest state of the art today. Go ahead and compare it; it's unique.

Ultrastable solid-state circuits make antiquated heating elements unnecessary. The 1242 works instantly in all service

environments — no waiting, no warm-up, no adjustments. Other units have up to 3 times as many front panel controls. For ease of operation, the 1242 has just two: color level and selector switch. It provides dots, crosshatch, horizontal or vertical lines, and color bars. And these are the sharpest, brightest patterns in the industry.

The 1242 handles easily, too. It's the smallest, lightest-weight color generator! Rugged, too; it's all steel, with storage

space for leads. It's transformer powered and complete with leads. Calls take less time and you make more money, because you can go from a cold or hot truck into a home and get right to work.

On every count, the new B&K 1242 is amazing. In time saved, it will pay for itself in just a few weeks — especially at this low price: \$99.95

B&K Division of Dymascan Corporation
 1801 W. Belle Plaine • Chicago, Illinois 60613



Where Electronic Innovation Is A Way Of Life

Circle 6 on literature card

www.americanradiohistory.com



THE ELECTRONIC SCANNER

news of the servicing industry

Industry Outlook

The annual sales dinner held by **Amperex** preceding the IEEE Show featured a talk by Mr. Frank Randall, President of Amperex. He indicated his displeasure with the pessimistic outlook affecting certain segments of the Electronic Industry.

Mr. Randall stated, "One can only view the present scene with surprise. One cannot expect that the electronic industry will maintain the growth rate it achieved in '66 . . . but to view the immediate future with anything but optimism is ridiculous."

"First," he said, "let's look at the color TV market. Last year the industry sold approximately 4.7 million color TV receivers . . . a mighty jump over the preceding year. But, when we look at the impact of color and its potential, we've only scratched the surface of the market. Sure, some of the early projections of 7 million plus sales in '67 may have been overly optimistic. Maybe the industry will sell only 6 million or even 5.5. What's wrong with that? It's more than last year—and last year was the best we had."

His most challenging remarks were expressed at the conclusion of his talk.

"How," he asked, "can any member of the electronic industry—be he a sales representative or a component manufacturer—view the immediate future with pessimism? There's no part of our daily lives untouched by the dynamic effect of electronic products. Sure, we reach a stage from time to time when one product or another has a slowdown in sales. But, for every one of

Experience for Sale 45¢

Sure seems we started something!

Yes; over ten years ago, when we started overhauling tuners (all makes and models), we set a price of \$9.95 for this service.

Apparently there are those who would like to imitate our achievement—and for 45¢ less.

Maybe the special skills, special equipment and downright old fashioned experience we built up during these past years are worth that little extra.—You be the judge.

Remember; 45¢ buys you more than a quarter of a million man/hours of experience, plus true devotion to our business . . . our only business . . . overhauling your television tuners the best way we know how. And in over ten years we sure know how!

Castle — The Pioneer of TV tuner overhauling
Not the cheapest — just the best.



For complete tuner overhaul we still charge only \$9.95. This includes all labor and parts; except tubes and transistors, which are charged extra at low net prices.

Simply send us the defective tuner complete; include tubes, shield cover and any damaged parts with model number and complaint. Your tuner will be expertly overhauled and returned promptly, performance restored, aligned to original standards and warranted for 90 days.

UV combination tuner must be single chassis type; dismantle tandem UHF and VHF tuners and send in the defective unit only.

Exact Replacements are available for tuners unfit for overhaul. As low as \$12.95 exchange. (Replacements are new or rebuilt.)

CASTLE

TV TUNER SERVICE, INC.

MAIN PLANT: 5701 N. Western Ave., Chicago 45, Illinois

EAST: 41-90 Vernon Blvd., Long Island City 1, N.Y.

CANADA: 136 Main Street, Toronto 13, Ontario

*Major Parts are additional in Canada

Circle 7 on literature card

TRON SUB-MINIATURE PIGTAIL FUSES

BODY SIZE ONLY .145 x .300 INCHES

For use on miniaturized devices, or on gigantic space tight multi-circuit electronic devices.

Glass tube construction permits visual inspection of element.

Smallest fuses available with wide ampere range. Twenty-three ampere sizes from 1/100 thru 15 amps.

Hermetically sealed for potting without danger of sealing material affecting operation. Extremely high resistance to shock or vibration. Operate without exterior venting.

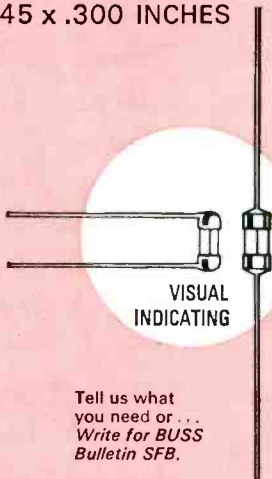

INSIST ON
BUSS QUALITY

BUSSMANN MFG. DIVISION, McGraw Edison Co., St. Louis, Mo. 63107

Cartonologist Award of the year to the **Oaktron** rear deck speaker kit package. Named as a "unique point-of-purchase package," the Oaktron kit won the award in competition with thousands of cartons.

To Open Training Centers

Permanent training centers to help cope with the serious shortage of experienced television technicians are being established by the **RCA Service Company** in six key metropolitan areas, according to president A. L. Conrad.

Mr. Conrad said the project, first of its kind in the television industry, will enable the RCA Service Company to train some 2,500 technicians in the coming year, twice as many as it trained in 1966. He estimated that 25,000 additional color TV service technicians will be required by the industry in each of the next five years because of the tremendous growth of color television.

The training centers are expected to be operating by mid-summer in New York, Philadelphia, Miami, Chicago, Detroit, and Los Angeles. Both present and newly hired employees will take part in the program.

Several different training courses will be conducted at the new centers, including instruction in servicing, color television, basic TV, and commercial products as well as bench service work and overall refresher courses in servicing. It was emphasized that the courses

BUSS: The Complete Line of Fuses and

those, there are two new ones to take its place. My advice is, let us not be concerned about the market. It's there! Let us just be concerned about our share of the market."

New License Law

Indiana has passed a License Law for TV repairmen, to take effect next year. It will require TV repairmen and antenna installers to acquire a license, with the usual testing and "grandfather clauses."

The law has regulatory and penalty clauses designed to protect the consumer from dishonest or incompetent repairmen, and should help "upgrade the image" of Indiana's TV servicemen.

Other states having license or regulatory laws for TV men include California, Connecticut, Louisiana, and Massachusetts. Several cities have similar laws on their books.

Solid-State Color TV?

Rumors are heard from many sources that a completely solid-state color TV receiver will reach the market very soon. We are investigating these stories and will have some solid (state) information in next month's issue.

Receives Award

St. Regis Paper Company recently awarded the

BUSS SUB-MINIATURE FUSEHOLDER COMBINATION

For space-tight applications. Fuse has window for inspection of element. Fuse may be used with or without holder.

Fuse held tight in holder by beryllium copper contacts assuring low resistance.

Holder can be used with or without knob. Knob makes holder water-proof from front of panel.

Military type fuse FM01 meets all requirements of MIL-F-23419. Military type holder FHN42W meets all military requirements of MIL-F-19207B.

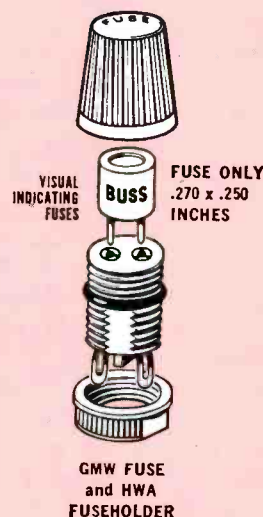

Write for BUSS Bulletin SFB

INSIST ON
BUSS QUALITY

BUSSMANN MFG. DIVISION, McGraw-Edison Co., ST. LOUIS, MO. 63107

Circle 8 on literature card

Get Trouble-Free Fuse Protection
in Wet Locations with a

TRON

IN-THE-LINE
WATERPROOF
Fuseholder

FOR USE ON:

- Electronic Components at Missile Sites
- Marine Equipment
- Mobile Power Supply Units
- Yard Lights
- Military Field Applications
- Communications Equipment
- Any circuit operating in exposed locations.

FOR PROTECTION OF CIRCUITS
OF 600 VOLTS OR LESS

Watertight construction; resistance to damage by weather, water, salt spray or corrosive fumes permit use of TRON fuseholders in exposed locations where safety and long life are of vital importance.

TRON fuseholders are available to take two sizes of fuses, $1\frac{1}{32}$ " x $1\frac{1}{2}$ " and $1\frac{3}{32}$ " x $1\frac{3}{8}$ "; and take many sizes of solid or stranded wire.

Write for BUSS Bulletin SFH-11

INSIST ON

BUSS QUALITY

BUSSMANN MFG. DIVISION, McGraw-Edison Co., ST. LOUIS, MO. 63107

blood—a serious concern in operations near vital organs.

Consolidated net income of **Oak Electro/Netics** increased 81% in 1966 on a sales rise of 23% over the preceding year announced E. A. Carter, president and chairman.

Net income, highest in O/E/N's history, amounted to \$2,694,606 for the year ended Dec. 31, compared with \$1,492,712 in 1965. Consolidated net sales totaled \$67,312,021, also a record, compared with \$5,624,884 in 1965.

Zenith Radio Corporation sales and earnings during the year ended December 31, 1966 were the highest in the Company's history, Joseph S. Wright, President, announced in a preliminary report to stockholders. This marked the sixth consecutive year in which both sales and earnings set new records and the ninth time in ten years that increases were shown over the preceding year.

Consolidated net income was \$43,474,626. This represents a 30% increase over the 1965 record earnings of \$33,553,069. The earnings increase was achieved despite the burden of major preproduction and start-up expenses at the new Melrose Park color picture tube manufacturing facility.

Consolidated net sales for the year rose to an all-time high of \$625,003,460, 33% over the previous record of \$470,503,343 reported for the year earlier. Sales for the fourth quarter were the highest of any quarter in Zenith's history. ▲

.. Fuseholders of Unquestioned High Quality

planned by the RCA Service Company would not be "quickie" courses, but would range up to four weeks in duration.

Light Knife

A new "light knife" has been constructed which allows surgeons to use the focused beam of a laser as easily as they would a scalpel. The device was developed by a group of engineers and scientists at **Bell Telephone Laboratories** to help the medical profession evaluate laser surgery.

The new device guides the beam from the laser source through a hollow, jointed arm to a small probe which is held like a scalpel. The probe is about the size of a fountain pen and can be moved easily in any direction by the surgeon. The probe may also be attached to a surgical microscope for more delicate operations. In this case the beam is transmitted through the microscope, which can be positioned by the surgeon.

Until now, laser devices used in medical experiments did not provide much freedom of movement. Flexibly mounted spherical mirrors or fibre optic systems are used at present to transmit the laser beam to the patient.

One reason laser surgery is of interest is that, according to many medical experts, the light from some lasers, such as the argon ion laser developed by Bell Labs, may cauterize a wound as it cuts, thus stopping the loss of



Write for BUSS
Bulletin SFB.

QUICK-ACTING FUSES

"Quick-Acting" fuses for protection of sensitive instruments or delicate apparatus;—or normal acting fuses for protection where circuit is not subject to current transients or surges.

INSIST ON

BUSS QUALITY

BUSSMANN MFG. DIVISION, McGraw-Edison Co., St. Louis, Mo. 63107

FAST

COMPLETE OVERHAUL ON ALL MAKES OF TV TUNERS

Maximum Time In Shop 24 Hrs.

(WE SHIP C.O.D.)

\$9.50



Black &
White
or Color

VHF or
UHF

UV Combo's \$15.00

Price includes all labor and parts except Tubes, Diodes & Transistors. If combo tuner needs only one unit repaired, disassemble and ship only defective unit. Otherwise there will be a charge for a combo tuner. Ship tuners to us complete with Tubes, Tube Shields, Tuner Cover and all parts (including) any broken parts. State chassis, model number and complaint.

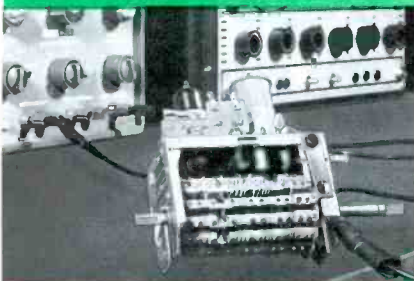

All tuners are serviced by **FACTORY TRAINED TECHNICIANS** with years of experience in this specialized field. All tuners are **ALIGNED TO MANUFACTURERS SPECIFICATION** on crystal controlled equipment and air checked on monitor before shipping to assure that tuner is operating properly.

GEM CITY TUNER REPAIR SERVICE

Box 6 B Dabel Station
2631 Mardon Drive
Dayton, Ohio 45420

Circle 9 on literature card

24 PF REPORTER/June, 1967

LETTERS TO the EDITOR

Dear Editor:

Just received the April issue of PF REPORTER and it is very good. The article on troubleshooting with the scope is very good because it helps a fellow on his troubleshooting when he is not sure about how the waveforms should look.

Your Tube Substitution Supplement is also very good. I have Vol. 10 and immediately put the supplement in it. However, there is one tube I am looking for. This is a 12B-B14 tube used as the horizontal output in Muntz TV. I can't find a replacement for this tube and Muntz has it back-ordered. Can you help me?

F. KLEIN

Pittsburgh, Pa.

The 12B-B14 is a Japanese tube and specifications for Japanese tubes are extremely hard to get. We have written many letters and had answers to only a few. We'll continue trying and hope to include these in our Tube Substitution Supplement.

—Ed.

Concordia, Kansas

Dear Editor:

The method of "tangent convergence" in the December, 1966 PF REPORTER for obtaining the net resistance of resistors in parallel will never fail because it follows the law of adding reciprocals and then finding the reciprocal of the addition, namely:

$$\frac{1}{R1} + \frac{1}{R2} + \frac{1}{R3} = \frac{1}{Rt}$$

Tangents and cotangents are reciprocals, that is $1 \div \cotan = \tan$ and $1 \div \tan = \cotan$.

Obviously, a table of reciprocals would be more usable than a table of tangents and cotangents. However, a Tan-Cotan table may be used in a better way.

Cotan 4.0008 has tan .249946

Cotan 8.0094 has tan .124852

.374798

Tan .374879 has Cotan 2.667522

The above is more direct than "tangent convergence" described in PF REPORTER.

W. MISIEK

compact sets

SPEED DRIVING OF BRISTOL AND ALLEN HEX TYPE SCREWS



No. 99PS-60 Bristol Multiple Spline
Type Screwdriver Set



4 and 6-flute blades
with diameters from
.048" thru .183"



No. 99PS-40 Allen Hex Type
Screwdriver Set



Hex diameters
from .050" thru 3/16"

Compact, interchangeable blade, Xcelite sets permit quick selection of the right tool for the job. With greater reach than conventional keys, these handy blade and handle combinations make it easier to get at deep set or awkwardly placed socket screws, simplify close quarter work.

Each set contains 9 precision formed, alloy steel, 4" blades; 4" extension; shockproof, breakproof, amber plastic (UL) handle with exclusive, positive locking device.

Sturdy, see-thru plastic cases fit pocket, have flat bases for use as bench stands.

WRITE FOR BULLETIN N365

XCELITE

XCELITE, INC., 18 Bank St., Orchard Park, N. Y. 14127

Circle 10 on literature card

Every service technician, at one time or another, has been faced with this decision. To make the most correct choice of test instrument requires an understanding of the advantages and limitations of the many types of test instruments currently available. Because the meter and scope are considered primary test instruments and are used more often than other types of test equipment, this article will discuss the relative merits of each in an attempt to help the technician make a better choice.

Meters

When the radio-servicing profession started in 1921, few meters were available and scopes were a laboratory curiosity. It was chiefly

due to the demands of radio technicians that steady and significant progress was made in meter design. Today, the most sensitive meter movement has a full scale current value of 1 microampere, or a sensitivity of 1,000,000 ohms-per-volt. This DC meter is used only in laboratories. Most service technicians use the VTVM to obtain high input resistance on low-voltage ranges. For example, a 1,000,000 ohms-per-volt VOM has an input resistance of 1,000,000 ohms on its 1-volt range; on the other hand, a service-type VTVM has a typical input resistance of 10,000,000 or 20,000,000 ohms on its 1-volt range.

High input resistance is desirable when making DC voltage measure-

ments in circuits that have high internal (source) resistance. This fact is illustrated in Fig. 1. The internal resistance of a circuit often differs greatly from one test point to another. Moreover, the input resistance of a VOM differs considerably from one range to the next. Hence, circuit loading is often a complex problem in practical service situations. As shown in Fig. 1B, the measurement error at a particular test point in an AGC circuit can vary from 78% to 15%, depending upon the VOM range that is used.

DC voltage measurements in high-resistance circuits are more accurate with a VTVM. With an input resistance of 10 or 20 megohms on all DC voltage ranges, the internal re-

SCOPE or METER which ?

by Robert G. Middleton

A tough decision? If you like lady luck, flip a coin. But, if you want to make your decision a choice instead of a chance, read the facts presented here.

sistance of radio and TV circuits can be disregarded, with a few minor exceptions. One exception in routine service tests occurs when a bias system is defective because of an open circuit. In such a case, the operating bias is due to so-called contact potential. Since a contact-potential bias voltage has an extremely high source resistance, tube operation changes greatly when an attempt is made to measure the bias voltage, even with a VTVM.

On the other hand, if a cathode circuit is open, the source resistance is quite low and the cathode voltage is abnormally high. This is a tricky defect that burns out many VOM's, because the operator attempts to measure the cathode bias voltage on a low range. A meter movement is fragile and cannot withstand sub-

stantial overloads. The moving coil in a 20,000 ohms-per-volt VOM may be wound with 1500 turns of wire that is finer than a human hair. A coil resistance of 2000 ohms is

typical. This coil rotates in an air gap of less than 0.1" with a magnetic field strength of about 2500 gauss. This is 5000 times greater than the strength of the earth's mag-

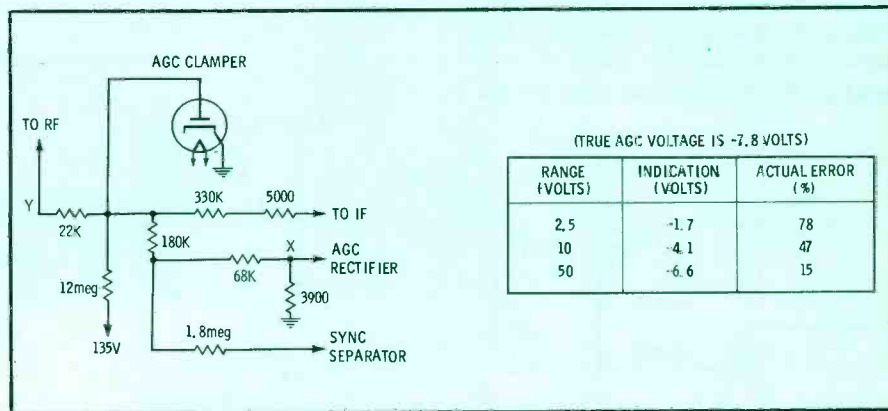

(A) Internal resistance less at X than at Y.

(B) Voltage error using VOM.

Fig. 1. Voltage measurement in an AGC circuit.

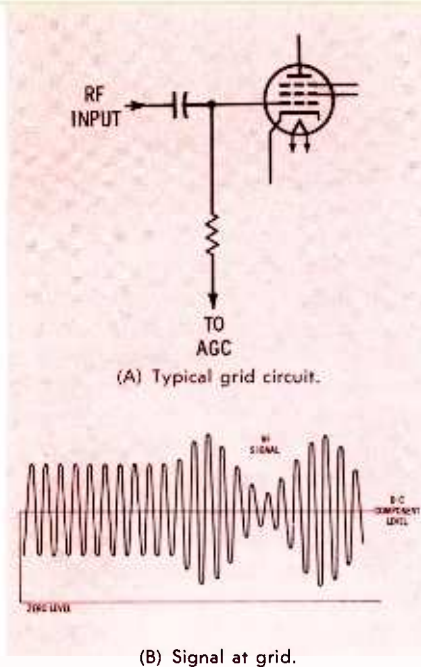

Fig. 2. Measuring voltage at grid with VOM bypasses RF to ground.

netic field that deflects a compass needle.

A VTVM is safer to use in trouble situations than a conventional VOM. Because the tubes in a VTVM operate at comparatively low plate voltage, they will saturate and limit the current flow through the meter movement in case of a substantial overload. However, some VOM's are now available that provide meter protection in the form of silicon-diode shunts. With this protective feature, a VOM is essentially as safe to use in trouble situations as a VTVM. Nevertheless, a VTVM always provides higher input resistance on low-voltage ranges. Conversely, a good VOM provides higher input resistance on high-voltage ranges.

Input Capacitance

Early in the development of VTVM's, it was recognized that input resistance was not the only figure of merit for a DC voltmeter. The reason for this is that most radio circuits operate on the basis of pulsating DC. This means that an AC

component rides on the DC voltage level. For example, Fig. 2 shows a grid circuit and an RF signal riding on the DC bias level. If we shunt appreciable capacitance from grid to ground, the RF signal will be bypassed to ground. In turn, there is little or no signal developed in the plate circuit when the meter is connected to the grid terminal of the tube. Of course, this disturbs circuit action and the AGC voltage falls to a low value. Therefore, a grid-voltage measurement would be in error simply because the input capacitance to the meter "kills" the RF signal that determines the AGC bias voltage.

A VOM has a substantial input capacitance. For example, a 100,000 ohms-per-volt VOM has from 15 to 40 pf of input capacitance, depending on how far its test leads are separated. At 100 MHz (a typical FM radio frequency), 40 pf has a reactance of about 40 ohms. If we connect a 40-ohm resistor from grid to ground in the circuit in Fig. 2A, it is obvious that the circuit will not

operate normally. To prevent such loading, a VTVM commonly employs a 1-megohm probe, as shown in Fig. 3. The purpose of the series resistance is to reduce the input capacitance of the VTVM. This probe has an input capacitance of approximately 2 pf, producing an input impedance of about 750 ohms at 100 MHz.

An input impedance of 750 ohms might seem to be objectionably low; however, circuit capacitance is always greater than 2 pf. Moreover, in RF circuits, the capacitance is resonated by a coil or tuned transformer. Therefore, we are primarily concerned with the **detuning** effect of the DC probe. Since the 2 pf of probe capacitance is only a small fraction of the grid capacitance, its detuning effect is slight. Therefore, we can use a VTVM to measure the grid bias voltage in a 100-MHz stage without appreciably detuning the stage.

Frequency Response

Beginners occasionally encounter

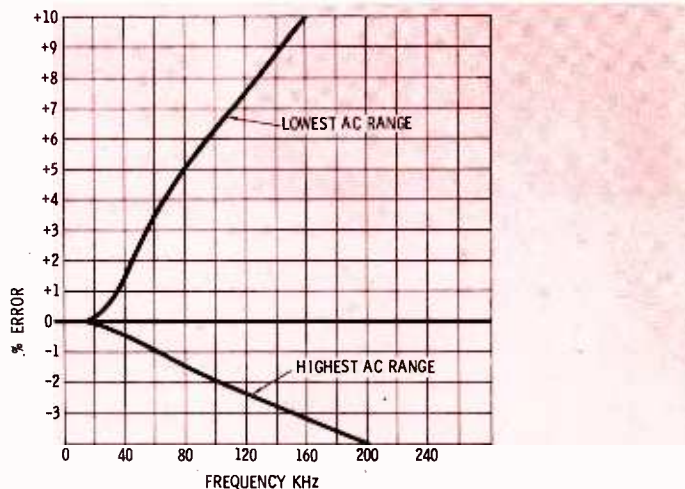

(A) Error vs frequency on AC voltage ranges.

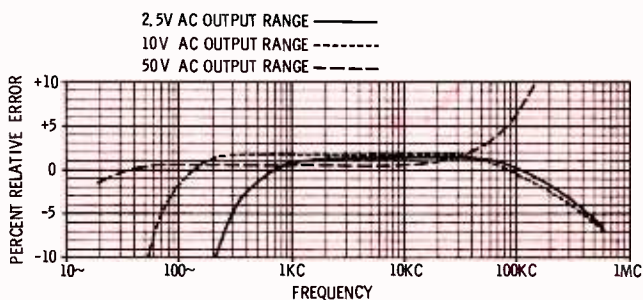

(B) Error vs frequency on output function.

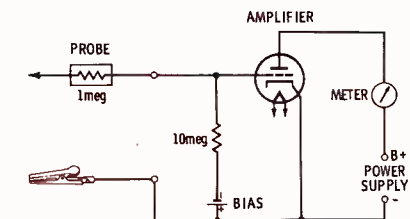

Fig. 3. Input circuit of VTVM using 1-megohm probe.

Fig. 4. Error versus frequency using VOM.





| | METER RESPONSE | SCALE READING |
|---|-------------------|---------------|
|  SQUARE WAVE | PEAK | 0.707P |
| | 1/2 WAVE AVERAGE | 1.11P |
| | FULL-WAVE AVERAGE | 1.11P |
|  SAWTOOTH WAVE | PEAK | 0.707P |
| | 1/2 WAVE AVERAGE | 0.555P |
| | FULL-WAVE AVERAGE | 0.555P |
|  1/2 RECTIFIED SINE WAVE | + PEAK | 0.707P |
| | FULL-WAVE AVERAGE | 0.354P |
|  FULL RECTIFIED SINE WAVE | PEAK | 0.707P |
| | FULL-WAVE AVERAGE | 0.707P |

Fig. 5. Different VOM circuit responses to various waveforms.

difficulty in troubleshooting procedures because they do not recognize the frequency limitations of typical voltmeters. Practically all VOM's measure AC voltages accurately over the audio-frequency range. However, if an attempt is made to measure the output of an audio oscillator or high fidelity amplifier at frequencies above 15 KHz, an appreciable error may occur, as illustrated in Fig. 4A. In this example, a measurement at 160 KHz on the lowest AC range results in a +10% error. On the highest AC range, an error of -3% occurs at 160 KHz. This is a curious type of error, caused by the fact that the moving coil of a meter has both inductance and distributed capacitance, plus the series resistance that is connected to the coil on various

ranges. On the lowest AC range, a resonant rise occurs at frequencies above 15 KHz, causing the scale indication to read high. On the other hand, the Q of the meter system is so low on the highest AC range that the distributed capacitance is dominant and the scale indication reads low above 15 KHz.

When the output function of the VOM is used, additional factors enter into the test situation because a series capacitor is then connected in the VOM circuit. The reactance of the series capacitor attenuates the meter response at 1 KHz, 200 Hertz, and 30 Hertz (Fig. 4B). Resonance effects over the mid-band frequencies produce an error of 1 or 2%. Above 15 KHz, the errors are substantially the same as on the AC voltage function of the VOM. It is

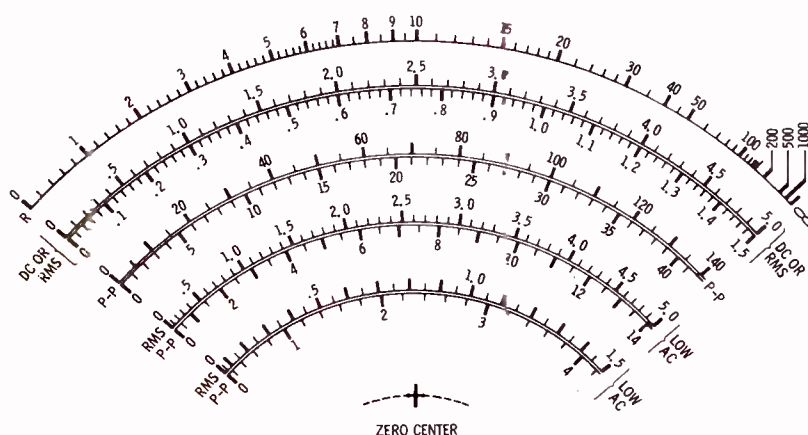

Fig. 6. Typical VTVM scale.

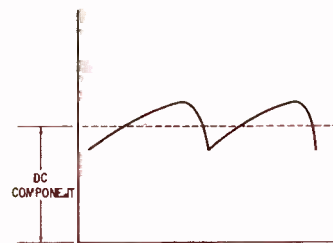

Fig. 7. Ripple is nonsinusoidal.

evident that a VOM cannot be used to measure accurately the AC voltages in a radio transmitter or the output from an RF generator.

The AC and DC voltage functions of a VOM have about the same input capacitance. However, the AC ranges of a VOM have less sensitivity than the DC ranges. Thus, 20,000 ohms-per-volt sensitivity on DC ranges might be accompanied by 1,000 ohms-per-volt sensitivity on AC ranges. There is a trend toward higher sensitivity on AC ranges. Some modern VOM's provide a sensitivity of 5,000 ohms-per-volt on AC ranges. In any case, the AC ranges of a VOM will load a circuit more than its DC ranges. However, a VTVM provides the same basic advantages for AC voltage measurements that it does for DC.

The input resistance and capacitance of a VTVM change from one AC voltage range to another. Note the following input values for a typical VTVM:

- (1) 1.5-, 5-, 50-, and 150-volt

MOVING?

Don't lose touch . . .

RECEIVE PFR AS USUAL

(INCLUDE OLD AND NEW ADDRESS)

**PF REPORTER
CIRCULATION DEPT.**

4300 W. 62nd St.,

Indianapolis, Ind. 46206

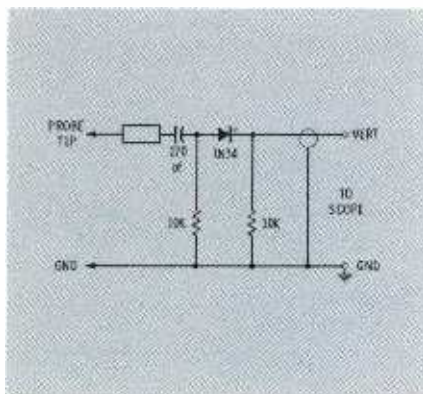

Fig. 8. Typical demodulator probe used with a scope.

ranges: 0.83 meg shunted by 70 pf.

(2) 500-volt range: 1.3 meg shunted by 60 pf.

(3) 1500-volt range: 1.5 meg shunted by 60 pf.

Also, the frequency response of a VTVM is generally much better than that of a VOM. For example, the AC ranges of a typical VTVM have a frequency response from 30 Hertz to 3 MHz. Therefore, we can use a VTVM to measure the output from an audio oscillator over its entire frequency range, or the output from an AM signal generator or RF voltages in many transmitters. Note that any VOM or VTVM can be used with a suitable high-voltage probe to measure DC voltages up to 25,000 volts. Some VTVM manufacturers also provide capacitance-divider probes which permit measurements of high AC voltages.

Waveform Errors

Any VOM will give erroneous AC voltage measurements unless a pure sine wave is applied. In other words, a sawtooth voltage, square-wave voltage, the output voltage from a rectifier, or the ripple voltage from a power supply cannot be measured accurately with a VOM unless a suitable correction factor is used. The correction factor depends not only on the waveform of the AC voltage, but also on the meter circuit. Some VOM's use half-wave rectifiers, while others use full-wave circuits. These factors are summarized in Fig. 5 for some common waveforms encountered in service work.

For practical applications, we need only remember that a VOM will give an erroneous indication if the waveform is not a sine wave. For example, if a defect in an audio amplifier distorts the sine-wave sig-

nal, we cannot rely upon voltage measurements with a VOM. Nevertheless, VOM readings will give us a general idea of the AC voltages at various points in the amplifier circuit. When we are concerned with nonsinusoidal waveforms, it is customary to state the AC voltage values in peak-to-peak volts and to make no attempt to measure RMS voltages. Nearly all modern VTVM's measure p-p AC voltages. Let us consider a practical example.

Fig. 6 shows the p-p and RMS scales for a typical VTVM. The p-p voltage of any waveform can be measured with reference to the p-p scales. The RMS scales indicate correct voltage values only for sine waves. Thus, we can use the RMS scales only in situations where a pure sine-wave voltage is present. For sine waves, the p-p voltage is 2.83 times the RMS voltage. This is the relation between the p-p and the RMS scales of the meter in Fig. 6. If we measure a ripple voltage from a power supply, we must read its p-p voltage because its waveform is nonsinusoidal, as shown in Fig. 7.

The RMS voltage of a sine wave or any nonsinusoidal wave can be measured, if we so desire, with a true RMS voltmeter. Some VOM and VTVM manufacturers offer various types of true RMS meters. The electro-dynamometer type is best suited for service use because it does not burn out as easily as a barretter-type instrument. Also, true RMS voltmeters and ammeters almost always provide a real-power (wattmeter) function. We can use this wattmeter function to make accurate measure-



Fig. 10. Effects of poor horizontal linearity on deflection waveform.

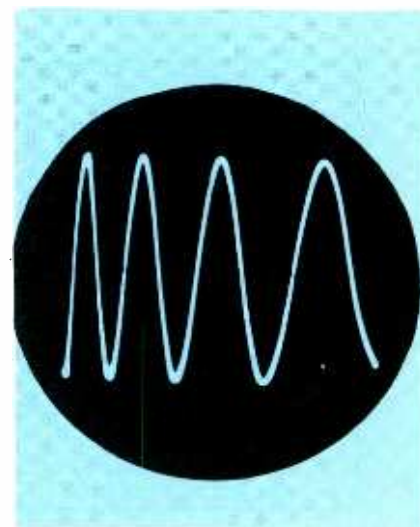

Fig. 9. Poor horizontal linearity cramps sine wave.

ments of power drain and power supply efficiency in any type of electronic equipment. Efficiency is simply the ratio of output power to input power, with both factors expressed in true RMS values.

Advantages and Limitations of the Scope

As with meters, each type of scope has certain advantages and limitations. Some scopes are more sensitive than others. High sensitivity is an advantage when testing in low-level circuits. For example, if we are using a demodulator probe to signal trace an IF amplifier, high vertical amplifier sensitivity is required to obtain a useful amount of deflection from the tuner output and first IF stage. The circuit for a typical scope demodulator probe is in Fig. 8.

Some scopes have greater bandwidth than others. However, all scopes respond over the audio frequency range. Hence, we can use any scope to check audio amplifier waveforms. It is desirable that the scope have good horizontal linearity; otherwise, a sine wave appears cramped at one end, as illustrated in Fig. 9. If we use the same scope to check a peaked sawtooth deflection waveform in a TV receiver, the waveform will appear distorted, as shown in Fig. 10. Obviously, it is difficult to evaluate waveforms properly when a scope has poor horizontal linearity.

Since both p-p voltages and waveforms are a measure of a circuit's condition, we need to measure these voltages on the scope screen. The majority of present-day service

scopes have built-in p-p voltage calibrating facilities. This speeds up voltage measurements considerably. If a scope does not have calibrating facilities, an external calibrator will be required. We will return to this consideration later when the facilities of lab-type scopes are explained.

Greater vertical amplifier bandwidth is required to check the waveforms in a TV receiver than for testing audio amplifiers. If a scope has a flat frequency response out to 1 MHz, waveforms can be checked satisfactorily in b-w receivers. On the other hand, the chroma circuit waveforms in color TV receivers require a flat frequency response out to 4 MHz. It is also desirable to have ample pattern brightness when chroma waveforms are displayed. This is required because the chroma signal moves up and down very rapidly on the screen and a comparatively high brightness level must be used to obtain a clear pattern.

When checking sync and sweep waveforms or the composite video signal in TV receivers, the scope deflection rate is set to either 30 Hertz or 7875 Hertz. It is convenient to have these preset deflection rates provided by the scope controls. Some scopes have "H" and "V" positions provided on the sweep-range control for this purpose. When either of these deflection rates is used, waveforms that have a fundamental frequency of either 60 Hertz or 15,750 Hertz will automatically lock in sync, with two cycles of the waveform displayed on the screen.

For displaying visual alignment curves, it is often helpful to have a 60-Hertz sine-wave deflection voltage with a phasing control provided on the scope. This is because some sweep generators do not have this type of horizontal-deflection voltage built into the instrument. A 60-Hertz sine-wave deflection voltage with a phase control is also very useful in some forms of industrial electronics work. Many industrial processes are accomplished on the basis of sine-wave phase shift. Also, if you are concerned with industrial-electronics servicing, it is very important to use a scope that has a DC response. Ordinary service-type AC scopes cannot display waveforms that have very low frequencies, such as those commonly encountered in industrial control equipment.

The sync facilities provided by a scope are occasionally important. Internal sync is always available, and usually a choice of positive or negative internal sync is provided. Polarity is important whenever we need to display narrow pulses such as the positive ones in Fig. 11. Such waveforms are very difficult to lock-in unless positive sync is used. On the other hand, if the diode in Fig. 11 were reversed, a negative output pulse would be obtained. This negative pulse would be very difficult to lock-in unless negative sync was used. Hence, it is desirable that a scope provide a choice of positive and negative sync.

External sync is less commonly used; however, there are some types of tests that require the use of a scope's external sync function. For example, a delay line cannot be evaluated for a defective section or component unless external sync is used to display the waveforms at progressive points along the delay line. With external sync, we can determine if each test point provides an additional delay, and if the delays are uniform. Also, external sync is very useful for measuring phase shifts in industrial control circuits. If a scope is to be used in industrial electronics servicing, an external sync function is essential.

At this point, let us return to pulse tests. Perhaps the most common service application of pulse testing is in ringing tests of coils and transformers. A typical test setup is shown in Fig. 12. It is convenient to have a pulse output provided by the scope, so that an external pulse generator is not required. We should recognize that a sharp, fast pulse is necessary to obtain a useful test pat-

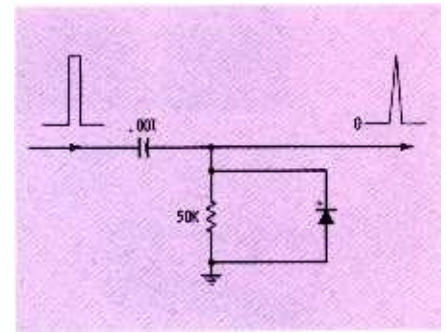

Fig. 11. Positive pulses require positive scope sync for good lock-in.

tern. This becomes increasingly important when the coil or transformer under test has a small inductance. Thus, it is desirable to choose a scope that has a sharp-pulse, test-voltage output; otherwise, an external pulse generator with fast rise time must be employed. One operating advantage of a built-in test pulse is that the scope automatically synchronizes the ringing waveform at any sweep rate, thus speeding up the test.

Some scopes have a terminal board provided at the rear of the case, whereby direct connection can be made to the deflection plates in the CRT. This is a very useful facility, particularly when the vertical amplifier has limited frequency response. A CRT has a frequency response up to several hundred MHz. In turn, we can couple the RF voltage from a radio transmitter to the vertical-deflection plates and measure the percent of modulation.

Horizontal amplifiers in service-type scopes generally have limited frequency response. This is no disadvantage in displaying waveforms using sawtooth deflection, but becomes a difficult problem when vectorgrams are to be displayed

• Please turn to page 59

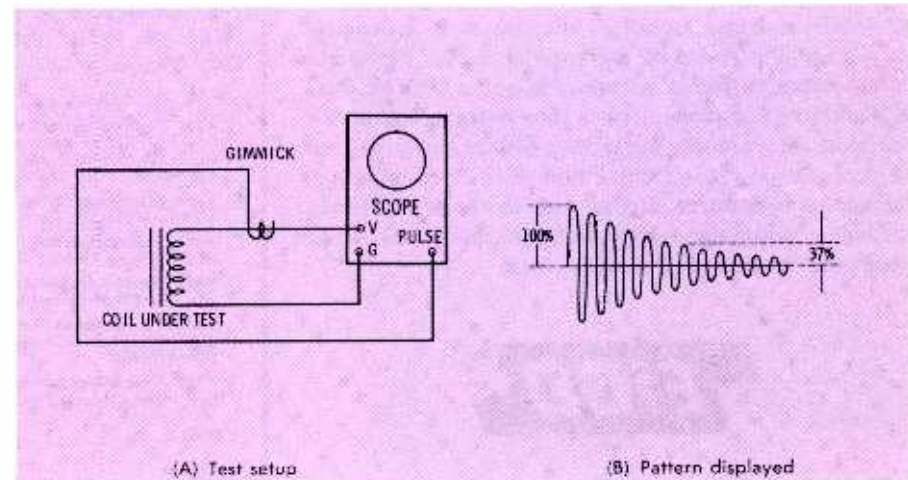

Fig. 12. Ringing test for coils and transformers.



Be choosy.

You can afford to with EICO

The reason EICO's line is the industry's most comprehensive (100 to choose from!) is because each instrument serves a specific group of professional needs. You name the requirement—from a resistance box to a VTVM, from a signal tracer to a scope, from a tube tester to a color TV generator, etc., you can depend on EICO to give you the best professional value. Compare these latest (foreground) professional instruments at your neighborhood electronics distributor. You judge who knows your needs best — and serves your needs with the best values!



21 years of service to the Professional Serviceman.
Laboratory precision at lowest cost.

1967 Guidebook to Professional Test Equipment AVAILABLE FREE TO PROFESSIONAL SERVICE TECHNICIANS

EICO Electronic Instrument Co., Inc. 131-01 39th Avenue, Flushing, N. Y. 11352

Please send further data on New EICO instruments below:

- #235 Professional VTVM. Measures to 0.01V for transistor servicing. Large 6" meter. 8DC ranges 0.5V to 1500V. 7 AC P-P ranges to 4200V. 7 AC RMS ranges to 1500V. 7 ohms ranges to 100M Ω . Response 30Hz to 3MHz \pm 1 db. Kit \$49.95 Wired \$64.95
- #380 Solid-State NTSC Color Generator. The first serviceman-priced. True NTSC Generator. Extremely compact weighs only 4 lbs. \$169.00 Wired Only.
- #1030 Regulated Power Supply. 0-150V @ 2ma. 0-400V up to 150ma, all to 1/2 of 1% Ripple 3mV. 6.3V & 12.6V. @ 3A. Kit \$59.95 Wired \$99.95
- #435 Direct-Coupled DC-4. 5MHz Scope. Outperforms 5" scopes 3 times its size. Kit \$99.95 Wired \$149.95
- #567 Professional V-O-M. Measures to 0.005VDC. 7DC ranges to 5KV (20,000 Ω /V). 5 DC ranges to 10A. 5db ranges. 3R ranges to 20 Meg. Kit \$34.95 Wired \$44.95
- #378 Near-Distortionless Audio Generator. 0.1% 20-20, 000Hz Switch selection of frequencies from 1Hz to 110KHz. Kit \$49.94 Wired \$69.95

NAME _____
 ADDRESS _____
 CITY _____ STATE _____ ZIP _____

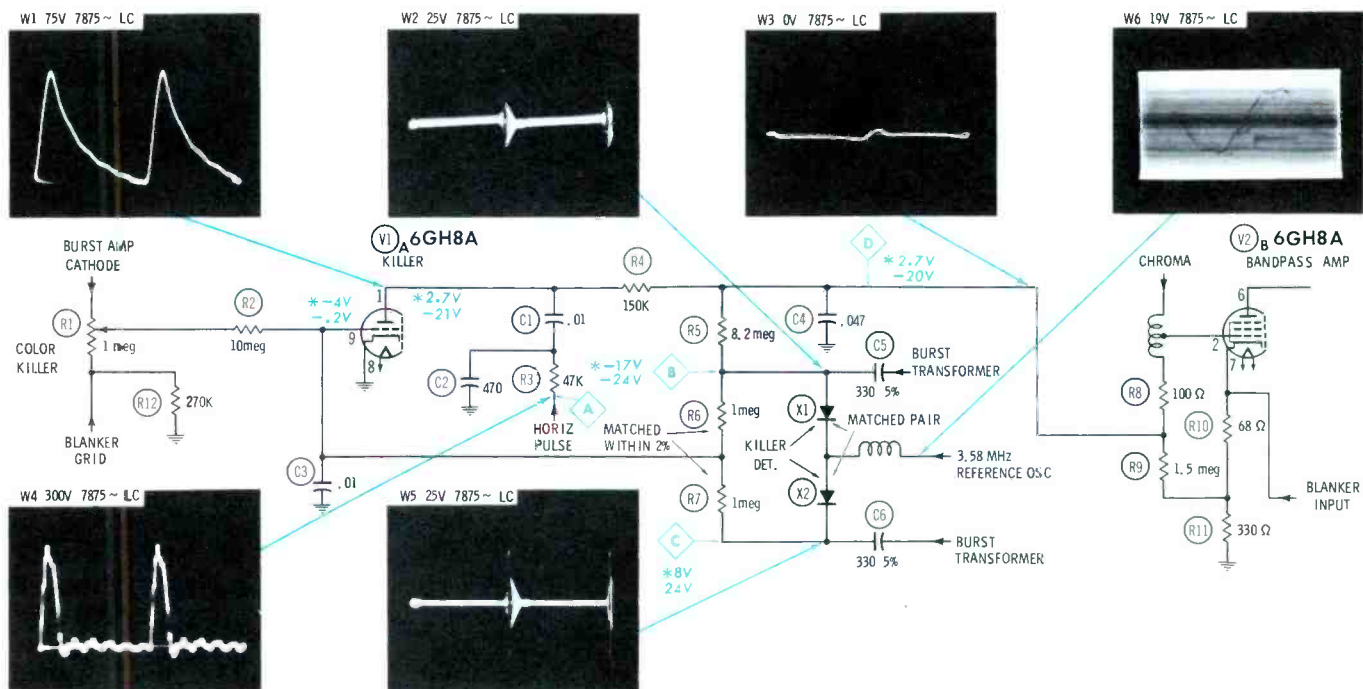

JUNE PFR SYMFACT

WAVEFORMS taken with wideband scope; TV control set to produce normal color. Low-cap (LC) probe used to obtain all waveforms.

DC VOLTAGES taken with VTVM on inactive channel. *Indicates voltage taken with color signal present—see "Operating Variations."

Normal Operation

Color killer stage functions as an automatic switch which turns chroma bandpass amplifier on when a color signal is received, off when signal is monochrome. Blanker stage output to bandpass cathode cuts off tube during horizontal retrace to prevent burst interference on color programs. Killer output to bandpass grid cuts off tube during b-w programs so that only luminance signal reaches CRT. During color reception burst signal is coupled to points B and C with 180° phase difference. Output of chroma reference oscillator connected to junction of killer detector diodes. Phase relationship of burst and reference signal causes both diodes to conduct; however, X1 conducts more heavily and negative voltage develops at detector output (killer grid). With negative potential at grid, killer stage is cutoff and no killer voltage is developed across bandpass amplifier grid bias network R8 and R9—bandpass amplifier free to conduct. Negative voltage at point B varies with burst level (chroma input signal strength) and is coupled to V2 grid through R5 for automatic chroma control (ACC) action. During b-w reception, there is no burst input to killer detectors, conduction is balanced, and no voltage developed at output (V1 grid). Color killer control now establishes conduction point of killer; if set correctly, killer now conducts on horizontal pulses (from flyback) coupled to plate. Tube conduction charges C1. Between pulses, C1 discharges through R4 and maintains a negative charge on C4 of sufficient potential to cut off the chroma bandpass amplifier. Circuit operation is similar when diode vacuum tubes are used as killer detectors instead of solid-state diodes.

Operating Variations

V1, Pin 9

Killer control sets bias when no color received. Adjust control (off channel) for colored snow (killer cut off), then rotate until confetti just disappears (killer conducts). Control varies voltage from -4.4 to +.1 volts—optimum no color reading is near zero. With color signal, grid varies with signal strength—about -3 to -6 volts. About -2.5 volts cuts killer off.

V1, Pin 1

Normal plate voltage reads -21V without color signal,—varies from -18 to -28 volts with killer control setting. With chroma signal, plate voltage same as chroma bandpass grid bias.

B,C

No-color readings vary from 8 to 27 volts (negative at B, positive at C). Voltages must be same, except opposite polarity—zero volts at junction of R6 and R7. With chroma signal, voltages are proportional to burst p-p level and unbalanced—voltage at B varies from -12 volts (weak signal) to -60 (local station). C ranges from 8 to 27 volts.

D

With no color signal, reading similar to V1 plate. With color signal, ACC action regulates bias from about .8 volts on weak signal to near 3 volts on strong.

Waveforms

W1, W3, and W6 constant input signals. W2 and W5 burst signal with 180° phase difference and dependent on chroma signal strength; p-p readings from zero (no color) to about 80 volts (color).

No Color

Killer Control Inoperative

X1, X2 Not Balanced

(Killer Detector Diodes)

Symptom 1

Symptom Analysis

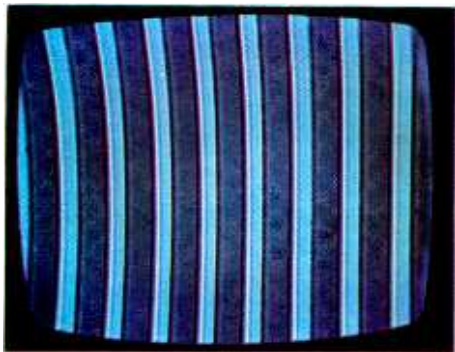

No color on strong or weak station color signal, nor on color generator signal. No colored snow (confetti) off channel at any color killer control setting. Black-and-white picture is normal. Known color programs produce only black-and-white picture.

Waveform Analysis

W1, at 75 volts p-p, only shows pulse is available at V1 plate—tube should conduct if grid bias is correct. Both W2 and W5 show sufficient amplitude—25 and 27 volts p-p—for killer detector operation but content shows excessive 3.58-MHz reference signal. Normally, very little 3.58-MHz signal (about 19 volts p-p) appears in waveforms W2 and W5. Waveform analysis indicates trouble in killer detector circuitry, but does not pinpoint.



Voltage and Component Analysis

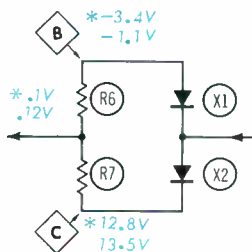

Chroma bandpass grid has cutoff voltage, both with and without color signal. Voltages at V1 grid explain—voltages are similar and allow V1 to conduct all the time. Voltages at points B and C, with and without signal, are key to trouble—B measures -1.1 volts and C measures 13.5 volts. Normally, with color signal, voltages at B and C unbalanced; with symptom here, they are unbalanced, but wrong way—point B should be more negative than C is positive so that killer detector output to killer grid is negative to cut off killer.

Best Bet: VTVM will locate.

Color in B-W Picture

Confetti Off Channel

X2 Leaky

(Killer Detector Diode)

Symptom 2

Symptom Analysis

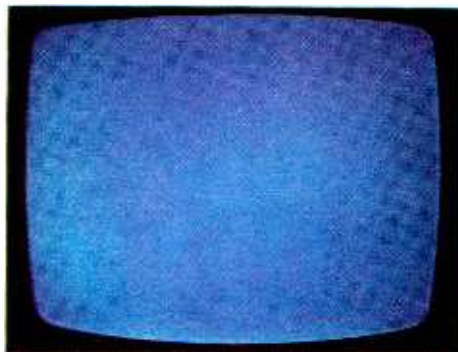

B-w programs have color in them—snow in weak signal picture is colored, as is any random noise. Off channel snow is confetti—impossible to perform correct color killer control adjustment. Color sync may be off, but slight reference oscillator coil adjustment corrects.

Waveform Analysis

W2 and W5 show incorrect content, while amplitude (20 and 22 volts p-p, respectively) is marginal. Burst can be seen in each waveform, but 3.58-MHz reference oscillator output signal is predominant. W6 shows normal 19-volt p-p amplitude. Burst signals at B and C have 180° phase difference. X1 and X2 conduction dependent on phase difference between burst and reference oscillator signals—difference is such that X1 normally conducts more.

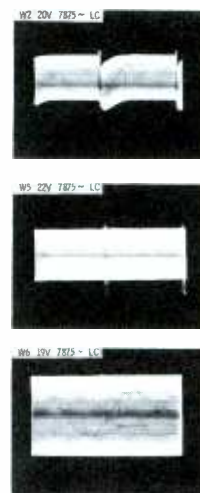

Voltage and Component Analysis

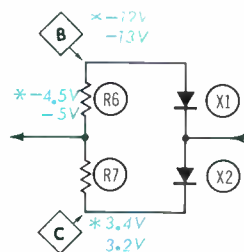

DC voltages at points B and C and resultant voltage at V1 grid are key to locating defective component. Voltages with color signal, while not normal, produce desired results—killer is biased to cutoff and bandpass amplifier is allowed to conduct. Voltage readings with no color signal are similar to “with color” signal measurements—V1 remains cutoff, bandpass amplifier conducts and color circuits are operating on b-w programs. Voltages at point C indicate X2 is not conducting properly. Sync phase may be affected by leaky diode.

Best Bet: Scope helps locate; VTVM isolates.

Colored Snow Off Channel

Color Programs Normal

C1 Open

(Coupling Capacitor—.01 mfd)

Symptom 3

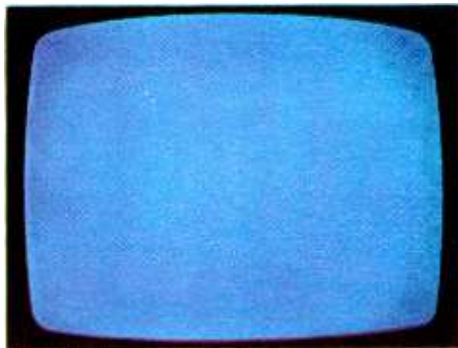
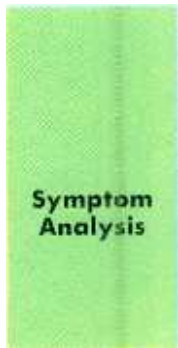

Strong or weak station color programs and color bar pattern from generator are good—color and hue controls operate normally. Off channel snow is colored (confetti) and b-w programs, especially weaker signals or fringe area reception, have random color in them.



Waveform Analysis

Low amplitude of W1 (9 volts p-p and positive portion only about half of that) is good clue—insufficient amplitude of pulse causes conduction even if grid bias is correct. Second waveform, at junction of C2 and R3, shows expected amplitude of 80 volts p-p and shaping action of C2, R3 network. Point A connects directly to horizontal output transformer winding—W4 is horizontal pulse.

Voltage and Component Analysis

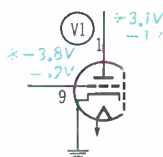

With color signal, voltages at V1 plate and grid are within normal tolerances, as expected since color is normal. On monochrome signal, or off channel, grid bias can be corrected (near zero) by killer control adjustment; but plate, instead of rising to normal cutoff voltage (approximately 20 volts), measures .1 volts—tube not conducting. Normally, V1 conducts on horizontal pulses of 70 volts p-p and charges C1—between pulses, C1 discharges through R4, developing negative voltage at point D to cut off chroma bandpass amplifier.

Best Bet: VTVM; Scope; component substitution.

Weak Color

Color Sync Normal

**C4 Decreased
Toward Open**

(Capacitor—.047 mfd)

Symptom 4

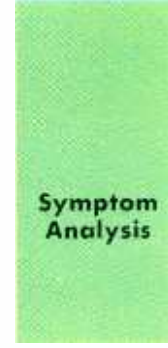
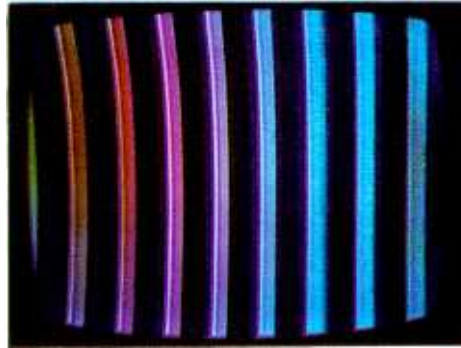

Known color programs may have weak or no color. Color, if received, is in sync. Hue control has no effect on color. With color bar pattern, red is predominant—other colors weak. With receiver off channel, killer control works, but even confetti is weak.

Waveform Analysis

W5 (shown) and W2 (not shown) indicate input signal is sufficient for good color. Keying pulse at killer plate (W1) has proper amplitude for killer action. W3 at point D is obvious clue—horizontal pulse near 20 volts p-p, normally only DC voltage here, with or without color signal input. Although not shown, waveform at bandpass amplifier plate is badly distorted by comparatively large pulse input to grid.

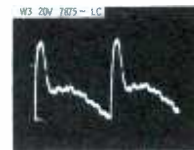
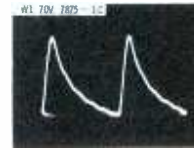
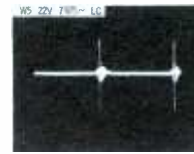

NO VOLTAGE CLUES

Voltage and Component Analysis

All DC voltages are within normal tolerances and offer no clues. C4 has three functions: (1) When V1 conducts, C1 is charged by horizontal pulses. Between pulses, C1 discharges through R4—C4 maintains bandpass cutoff voltage. (2) C4 is RF ground for chroma input signal to bandpass grid. (3) C4 is filter for pulses from killer plate. Decreased capacitance (towards open) of C4 causes partial loss of chroma input signal to bandpass grid, as well as allowing horizontal pulse to distort what signal there is.

Best Bet: Scope after circuit analysis.

Symptom 5

Weak Color Killer Inoperative C4 Leaky (Capacitor—.047 mfd) Symptom Analysis

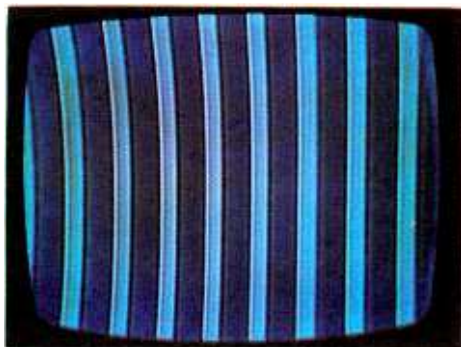
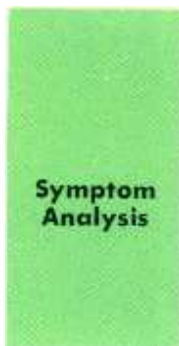

Black-and-white portion (luminance signal) of color program good, but color weak—color control must be at maximum on strong signal—little color on weak signal. Color sync is good. Killer control inoperative—confetti off channel.

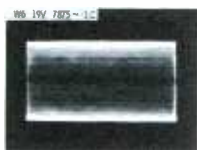
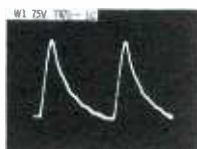
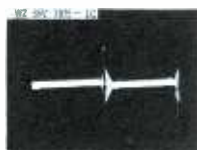

Waveform Analysis

Excellent burst signal, both in amplitude and content, at points B (W2, shown) and C (W5, not shown) indicates good chroma signal is available from video circuits and should be satisfactory signal input to bandpass amplifier. Burst amplifier receives chroma signal before bandpass amplification; therefore, color sync can be normal with weak color picture. Normal waveforms W1 and W6 show circuit has necessary input signals.

Voltage and Component Analysis

*.2V
-2V
D

With no color signal, voltage at killer plate low (about -12 volts) but should be sufficient to cut off bandpass stage. Under same conditions, voltage at D is only about -2 volts—not sufficient to cut off bandpass amplifier. Voltages point to leaky C4 or increased value of R4. Reading of only .2 volts at D with color eliminates R4—normally would mean very strong color signal causing ACC action to decrease bandpass conduction. Leaky C4 defeats killer action during b-w reception and shorts chroma to ground during color.

Best Bet: VTVM for voltage and resistance.

Color Overloaded On Strong Signal Poor On Weak Signal R5 Increased In Value (ACC Resistor—8.2 meg, 5%) Symptom Analysis

Symptom 6



B-w programs normal. Color level control must be adjusted when switching from strong local station color signal to weaker signal. Control must be advanced to get good color. Color overloads when returned to strong signal—control setting must be decreased.

Waveform Analysis

First waveform is W2 at point B with very strong chroma input signal. P-P measurement is 90 volts. Second waveform is also W2, but with weak, barely acceptable, color signal. P-P reading is now only about 20 volts. Third waveform is from point B while b-w signal is being received—contains only low amplitude induced horizontal pulses and noise. Since burst is part of composite color signal, its amplitude varies with color signal strength.

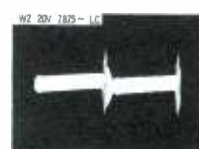
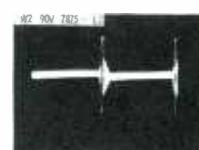

Voltage and Component Analysis

* 3 TO 4V
-20V
D

Best voltage clue is obtained by monitoring D while changing chroma input signal level. With weak signal, reading is about 4 volts—slightly high, but acceptable. Voltage drops to about 3 volts on strong station signal—normally drops below 1 volt. Voltage level at B is set by amplitude of burst—varies with chroma signal strength. R5 couples portion of negative voltage to D. Strong chroma signal means higher negative voltage connected to positive bias—lowers bias and keeps bandpass output stable.

Best Bet: VTVM and circuit analysis.

Customers wear out the Yellow Pages getting to East Orange Radio

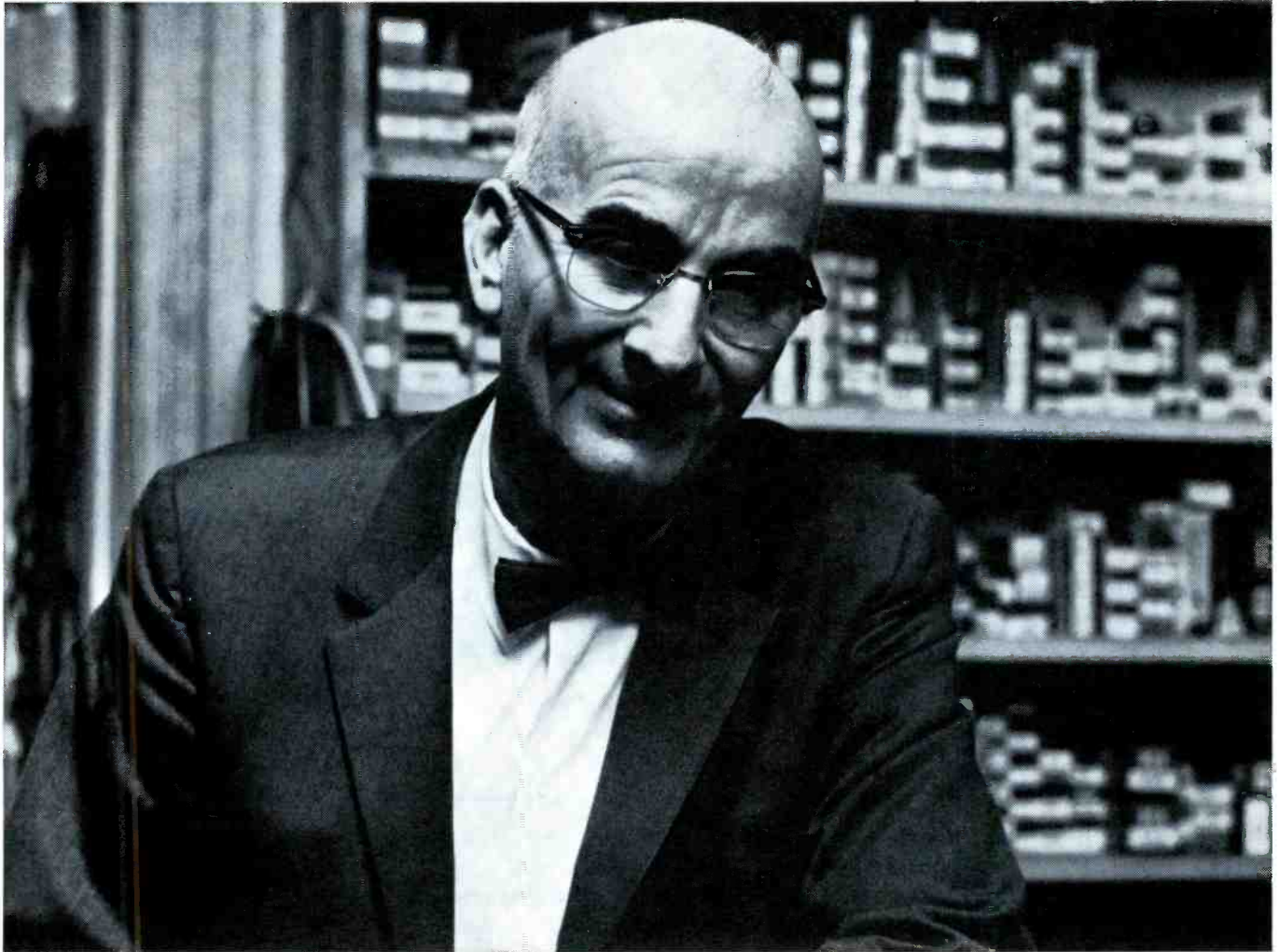

“Half our new business — sales as well as service — comes from the Yellow Pages,” says Romolo Bigonzi, owner, East Orange Radio, East Orange, New Jersey. “We get new calls every day and reference is made as to how these people found us, so obviously we’re sure Yellow Pages works for us. We know that regular customers also turn back to the Yellow Pages to get our number — it’s just human nature to do this. People we reach with our other advertising do the same thing. I think the size of our ad helps get across the idea we’re an established, reliable company. That’s important in attracting institutional business — nightclubs and the like. I’m getting a fair return on my Yellow Pages investment.”

Advertise for action...



**EAST ORANGE
RADIO**
ESTABLISHED 1932

TELEVISION

AUTHORIZED SALES & SERVICE

FEATURING **MAGNAVOX**
THE FISHER

COLOR TV SALES & SERVICE
SERVICE & REPAIRS ON ALL MAKES

OPEN FROM 9 TO 9 MON. WED. - FRI.

VISIT OUR SHOWROOM CONVENIENT TERMS

Dial 673-2288

FOR PROMPT SERVICE

170 N. PARK (corner Dodd St.) EAST ORANGE
FREE PARKING

Customers wear out the Yellow Pages instead of themselves. This ad,* under TELEVISION SERVICE, leads them to East Orange Radio. Call your Yellow Pages man to plan your program. Find him in the Yellow Pages under ADVERTISING — DIRECTORY & GUIDE.
*shown reduced

Transistor TV Techniques

by Wayne Lemons

The trouble symptoms are usually the same as those displayed by tube sets. However, some of the troubleshooting methods are different. The practices and procedures outlined in this article point up these differences.



The first time I heard about transistors, I reacted like the harness maker must have reacted to the automobile. I hoped it was all a bad dream. Gradually, though, my closed mind opened a tiny bit and I began learning my EBC's.

Just about the time I had the emitter-base-collector concept tied down, I found out that transistors had two sexes—NPN's and PNP's—and two nationalities—germanium and silicon. Not only did we have boy and girl transistors that looked at everything in opposite directions, but we had transistors of one kind that required more motivation than another kind.

It all sounded pretty complex, but it turned out better than I had hoped. Transistors, like most everybody else, have some laws they have to follow. All the technician has to do is learn these laws, and suddenly the transistor starts acting like the fellow you thought you'd never like. When you first met, you wished you hadn't, but he turned out to be your best friend when you got to know him.

That's the way with transistor TV service. You shudder the first time

you yank the back off one of those "tubeless wonders" and prepare for the worst. But pretty soon you find the tuner by following the channel selector shaft back from the knob. Then, by looking closely, you find the IF strip snuggled in between the tuner and the video amplifiers. What do you know, it's a lot like a tube set, except a bit of a runt!

So, then what about service? Slowly it dawns on you that the symptoms in a transistor set will have to be pretty much like those in a tube set. If you have sound, a raster, but no picture, you can rightfully suspect the video amplifiers. If the picture won't hold, you can expect sync circuit trouble. If you have no vertical deflection—well—.

The point is this: Finding the **stage** giving trouble should be no more difficult than on a tube set. Finding the trouble **in** the stage is something else again. These are the techniques we want to talk about.

Some Basic Facts

To make sure that we are all in this thing together, let's start with a few basic facts about transistors.

Then we will decide how the troubles in a transistor circuit can be diagnosed. The transistor in its basic form, be it NPN, PNP, germanium, or silicon, acts like a variable resistor whose resistance from emitter to collector changes in proportion to a change in voltage between the base and emitter. (Yes, I said voltage. I know it also uses current, but you can hardly have one without the other, and voltage is the easiest for us technicians to measure.)

This variable resistor has the highest emitter to collector resistance when there is zero voltage between the base and the emitter. It moves toward a lower resistance between emitter and collector as we increase the base-to-emitter voltage.

Let's go over that again. A transistor with no bias has little or no emitter-collector current flow, and so it has a high resistance. A transistor with correct bias voltage and polarity has current flow from emitter to collector (or vice versa) depending on the value of that voltage.

Bias voltage and polarity vary with different transistors. Only .4 volt will probably cause saturation

(almost zero resistance from emitter to collector) in a germanium transistor. It may take around 1 volt to do the same thing in a silicon transistor. Average bias for germanium transistors is about .2 volt, but approximately .6 volt is normal for silicon transistors.

The polarity of the bias is determined by the transistor type—PNP or NPN. I prefer to use the middle letter of this designation as a place to hang my memory hat. An nPn transistor uses a Positive bias voltage (and a positive collector voltage as well). A pNp transistor uses a Negative bias voltage and negative collector voltage. (Polarity is measured with respect to the emitter.)

In-Circuit Testing

Fig. 1 is the circuit of a PNP transistor stage using resistor R3 as a collector load. The transistor is biased from a bleeder across the same battery that supplies the collector voltage.

When the switch is closed, there is zero bias on the transistor. A voltmeter connected from the emitter to the collector would read the supply voltage since there is no current through R3 and consequently no voltage drop. However, with the switch open, the transistor is biased and current flows in the emitter-collector circuit, producing a voltage drop across R3. Therefore, collector voltage drops to a lower value. Normally, the collector voltage in a circuit of this kind is about half the supply voltage. With the switch closed, the collector voltage rises to the supply potential. The precise voltages are not nearly as important

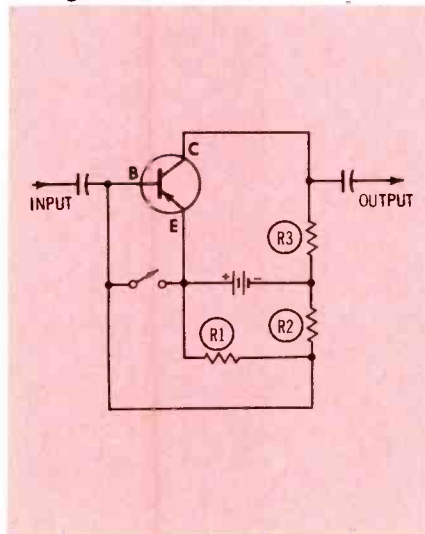

Fig. 1. PNP transistor circuit.

as the fact that the voltage changes. A fairly large change tells the story—the transistor is good.

This suggests a means of “in-circuit” checking of any (well, almost any) transistor. As long as there is a resistor in either the collector or emitter circuit, this check is possible. A jumper connected between the base and emitter should cause a change in either the collector or emitter voltage, whichever can be checked.

Let's carry this thinking into the

typical IF amplifier circuit of Fig. 2. Here we have resistors in both the collector and emitter circuits. The voltage drop across either resistor can be used to determine if the transistor is good.

First measure the voltage from the collector to ground. If it is much below what it should be (roughly —6 volts) there are two likely causes of the trouble: a shorted or leaky transistor, or excessive bias. Both possibilities can be checked by a simple jumper connection between

50,000 USERS CAN'T BE WRONG!



DEPENDABLE!

ACCURATE!

UP-TO-DATE!

NEW
MIGHTY MITE
V

Technicians everywhere believe in the most dependable tube tester of all, the famous Sencore Mighty Mite. For in-home or shop use, 50,000 users rely on its proven accuracy. Here's why.

- **Grid Leakage Test** with ultra-high sensitivity of 100 megohms or ½ microamp.
- **Emission Test** at full rated cathode current spots the borderline types.
- **Shorts Test** picks out interelement shorts of 180K ohms or less. And you'll know the tube type and number you need is listed, as the Mighty Mite truly checks over 3000 tubes, hundreds more than old-fashioned testers, including all the latest domestic and foreign types.

Sencore's new TC142, the Mighty Mite V. Same reliability, same accuracy, with these new features to make the Mighty Mite V the most up-to-date tester of all.

NEW—Magnoval socket so you can check ED500, 6GB5, 6KG6, 19KF6, EL500, 6EC4, and many more.

NEW—Horizontal in-line switch layout saves setup time, makes the Mighty Mite V faster than ever.

NEW—Vinyl-clad steel case is more rugged than any other, stays new-looking longer.

NEW—Brushed chrome panel protected by detachable, hinged cover.

The new Mighty Mite V is truly Sencore's mightiest Mighty Mite and its still only.....

\$74⁵⁰

In stock at your distributor now.



SENCORE

NO. 1 MANUFACTURER OF ELECTRONIC MAINTENANCE EQUIPMENT

426 SOUTH WESTGATE DRIVE, ADDISON, ILLINOIS 60101

Circle 13 on literature card

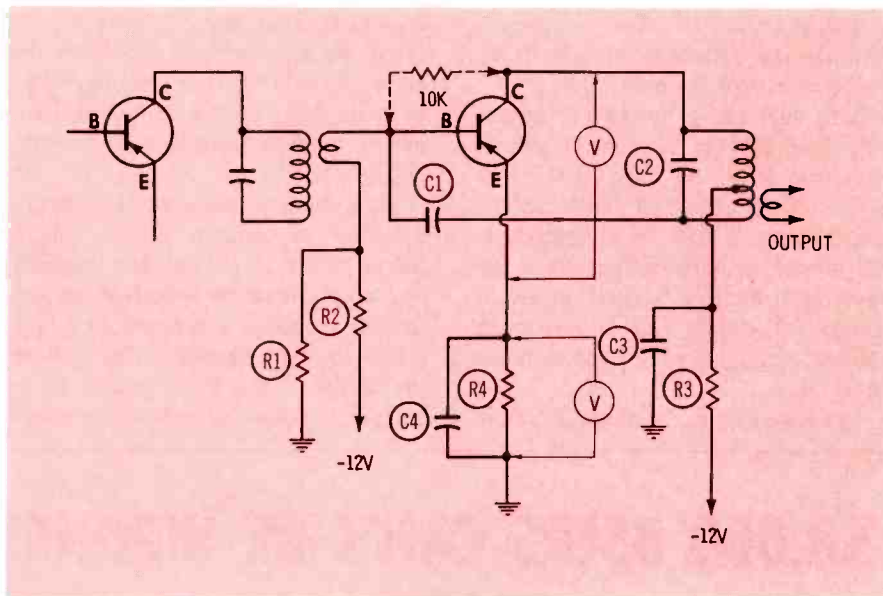

Fig. 2. IF amplifier stage using PNP transistor.

the base and emitter. The jumper will zero-bias the transistor, and if the transistor is good, the collector voltage will rise to the supply voltage. If not, look for trouble in the bias circuit.

If shorting the base to the emitter has no effect on the collector voltage, the transistor is at fault. (Another possibility is leakage through C3.)

But what if the collector voltage is already the same as the supply voltage? Since there is no collector current, the transistor is open or there is no bias voltage. To check this, use a 10K-ohm resistor as a jumper connected between collector and the base. Caution: **Do not short directly between collector and base.**

This resistor, shown in Fig. 2, will bias the transistor toward "turn on" since the base bias is always the same polarity as the collector. If the

collector voltage goes down (or the emitter voltage goes up), you know that the transistor will respond to a bias voltage on the base, and it is not defective.

If the voltage remains unchanged, either the transistor is open or the emitter circuit is open. A simple ohmmeter check will determine if the emitter circuit is defective.

Regardless of whether PNP's or NPN's are used, you may find either the emitter or the collector at ground potential. For this reason, it is usually best to measure voltages from the emitter rather than from the chassis. Bias voltages, which are always small, are easier to measure in this manner than by taking separate base and emitter readings and then subtracting.

Let's go over this again. A good transistor can be turned off by shorting between the base and emitter. It can be turned on if a small voltage of the same polarity as the collector is applied to the base. If the transistor is good, the collector or emitter voltage can be changed by one of these two methods. The transistor can be checked by either increasing or decreasing the bias from base to emitter, and it can be done in-circuit!

No emitter voltage means no emitter current, and that means either an open transistor or no bias. Measure the bias voltage between the base and the emitter. As we mentioned earlier, a germanium transistor should have around .2 volt bias in class-A circuits, while silicon transistors must have around .6 volt bias. If the bias is about right, you should use the "jumper" check to see if the transistor will respond.

Using Ohm's law, you can calculate the current of a transistor by measuring the emitter resistor voltage drop. For each 1000 ohms of resistance, there is 1 volt of drop per milliampere of current. Transistors operating in low level circuits usually operate with .5 to 3 ma of current.

Special Circuits

The circuits we have discussed so far are class-A circuits. That is, they are biased so that the input and output signals have virtually the same waveform. Audio amplifiers, IF amplifiers, video amplifiers, etc.,

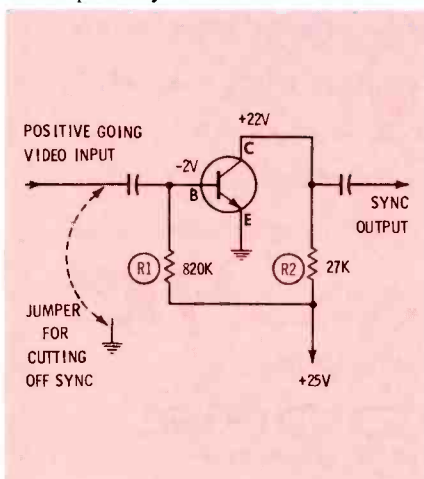

Fig. 3. Sync separator circuit using class-C bias.

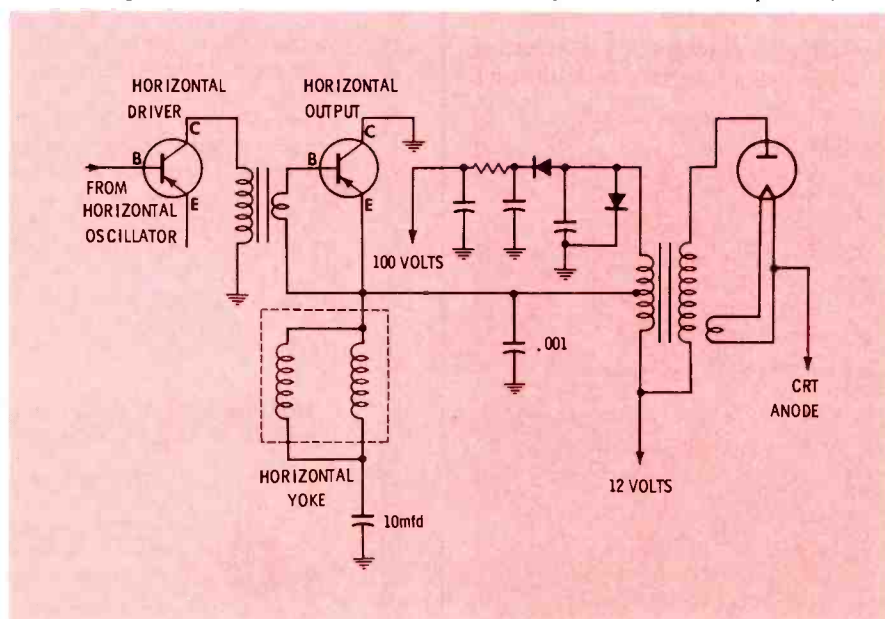

Fig. 4. Transistorized horizontal output is zero-biased.

normally have class-A bias. This means that the collector current is about half-way between cutoff and saturation.

Transistor TV's also use circuits which are biased class-B or class-C. Circuits that depend on a pulse input to the base to turn them on are biased class-C.

Fig. 3 is a typical sync separator circuit that operates with class-C bias. The voltages shown are those measured with a DC voltmeter when a station is being received. Since this is an NPN transistor (emitter arrow pointing away from base), it requires positive bias for "turn on." However the bias here measures -2 volts.

The circuit action is very similar to a sync circuit using a tube. The positive going input signals cause base current to flow through R1 to the emitter. This causes an average negative voltage to develop on the base side of the resistor, so that only the most positive going part of the composite video signal (the sync pulses) will turn on the transistor. Of course, this is what we want—only the sync signals appear in the collector circuit.

Checking this circuit is fairly simple. Shorting the incoming signal with a jumper will remove the bias produced by the signal, and the base will return to approximately .6 volt. Turning the channel selector to an unused channel will cause a somewhat different action.

With the signal input shorted, the collector voltage will drop to approximately 2 volts. Turning the channel selector to an unused channel will not drop the collector voltage to much less than 12 volts because the inherent noise will continue to provide some bias. However, either method works because there will be no change in the collector voltage if the transistor is defective. Of course, we must assume that a scope has been used to make certain that the sync pulses are actually arriving at the base.

If the collector voltage does change, and there is still no sync, the most likely trouble is an open output coupling capacitor or an open circuit in the output of the sync stage.

Horizontal Circuits

It is interesting to note that a

defective horizontal oscillator or driver stage will **not** (in all the circuits we are familiar with) cause any damage at all to the horizontal output transistor. The reason for this is that the horizontal output transistor is zero-biased (no collector current) and conducts only when a horizontal pulse from the oscillator or driver stage is present. When the oscillator is working, the horizontal output transistor is pulse biased so that current flows during trace time and is driven sharply into cutoff

during retrace time.

Fig. 4 is a typical horizontal output stage. Note that the collector is grounded and that there is a low resistance winding between the base and emitter. This transistor is zero-biased. Therefore, our method of using jumpers in diagnosis can't be used too well. A scope is probably the best bet here. Check the incoming waveform. In this circuit, the negative portion of the waveform turns the transistor on during trace

• please turn to page 62

stability!



In one word, STABILITY is why you need a new Sencore CG141 Color King. With its exclusive thermostatically controlled heating element and its patent pending timer circuitry, the Color King maintains absolute stability from 20° below zero to 140° in the shade. Gives you the most reliable and rock solid patterns ever designed into a standard color bar generator.

Now-generates seven patterns in all: Standard RCA color bars, cross-hatch, individual vertical and horizontal lines, adjustable size dots plus two new patterns—single dot and cross that can be moved to any spot on the screen to speed up dynamic convergence. New snap tuning, channel 2 through 6; interlace control to form a perfectly round dot; and increased chroma and sync signals make the color king a complete color analyzer too.

Get yours now — the KING OF VALUE at **\$149⁹⁵**

See America's most complete line of professional test instruments — at your Distributor now.

SENCORE

NO. 1 MANUFACTURER OF ELECTRONIC MAINTENANCE EQUIPMENT

426 SOUTH WESTGATE DRIVE, ADDISON, ILLINOIS 60101

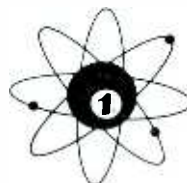

Circle 14 on literature card

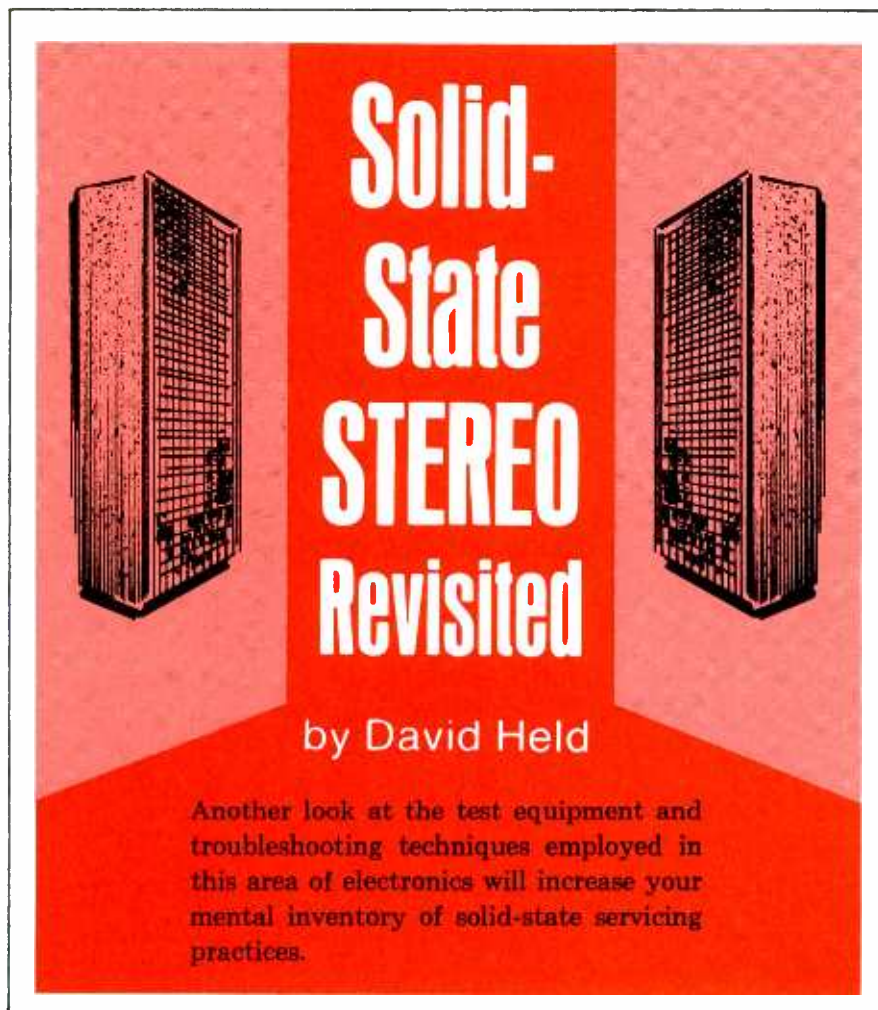

Most prosperous radio and TV businessmen are now getting their share of the AM-FM and stereo phonograph repair business. If you are turning down solid-state repair, take another look at the market. With solid-state TV now firmly entrenched, today is a good time to learn all you can about solid-state repair—tomorrow may be too late.

Methods of Troubleshooting

There are several methods of locating troubles in a solid-state AM-FM receiver. Signal injection has been used for years, in tube equipment, and can be applied equally well to transistor instruments. Signal injection is nothing more than the application of a noise or tone generator to a spot in the circuit which will give a meaningful response.

Noise Generators

A good place to start is at the volume control. With the control wide open, apply the noise generator signal to the center terminal. If the audio stages are working properly you will hear a loud tone in the speaker. Of course the actual volume will depend upon the design of the circuit. When you start at the volume control you are breaking the overall circuit in half and then can work either way to find the trouble.

The noise generator works wonders in the audio sections. In cases of weak or no volume, start at the base of the final output transistor. Apply the noise injector probe to the base of each transistor in turn,

working back to the volume control. At each stage you should have an increase in signal. When the signal becomes weak or is lost entirely, you have located the defective stage.

To narrow down to the actual defective component, use a good VTVM to measure the collector, emitter, and base voltages. Be especially careful not to accidentally short out any transistor terminal to ground or to another transistor terminal. A direct short from base to collector can very easily damage a transistor.

If the audio stages seem to be good, proceed from the volume control back through the detector and IF stages. Inject a signal at the base of each IF, the converter, and the RF stages until the defective stage is located. As before, voltage measurements will then reveal the defective component.

Signal Generators

Many technicians use signal generators rather than noise generators although the method is a little more complicated. The advantage is that it is very easy to check alignment of the chassis while troubleshooting. Most RF generators have an audio output which can be used in the audio stages.

After the audio stages have been checked out, inject a 455-kHz modulated RF signal at the base of the first IF stage. You can use the speaker as a tone indicator while troubleshooting, but clip an output meter across the voice coil of the speaker for alignment. Be sure the volume control is set at maximum position. Reduce the

generator output as needed, to keep the AVC circuit inoperative. If the IF stages are good, go to the base of the converter stage. The RF and oscillator stages can be checked with a loop of several turns of wire laid next to the receiver antenna. Feed the signal generator output directly to the loop. For correct IF, RF, and oscillator alignment, it is best to follow either the manufacturer's alignment procedure or the data found in the appropriate Howard W. Sams PHOTOFACT folder.

Transistor Checking

The transistor tester is a must for anyone attempting to service solid-state equipment. This instrument is just as valuable as a tube tester would be for tube sets. The transistor does cause less trouble than the vacuum tube, but we still have plenty of problems with them.

With most of the older transistor testers it was necessary to unsolder the transistor from the PC board before testing. Today we have in-circuit transistor testers that very quickly check the quality of the transistor right in the circuit. Some service technicians quickly check all of the transistors in the whole receiver, others try to find the defective stage before unleashing their transistor tester. We prefer the latter method.

The transistor in-circuit tester will quickly check the AC beta of a high or low powered transistor right in the circuit. A transistor can also of course be checked for beta and leakage out of the circuit. Diodes and rectifiers can also be checked for opens or shorts in the circuit with an in-circuit transistor tester.

Characteristics

Beta and leakage are two of the most important characteristics of a transistor. Beta is the current amplification factor, similar to Mu in a vacuum tube. DC beta is the ratio of collector current divided by the base current. AC beta is the ratio of the change in collector current divided by the change in base current, while keeping the collector voltage constant. The AC beta measurement is the most revealing because it more closely matches the actual operating conditions of a transistor. However, a DC beta measurement is about as useful as an emission test would be for tubes in a similar circuit.

Leakage current is another important parameter of a transistor. Leakage current can increase as a transistor ages, and it is generally leakage current that causes problems in circuits operating at high and low temperatures. Silicon transistors normally have a very low leakage current, but germanium transistors may have from fairly low to quite high leakage, depending on the application. See chart I.

Typical Germanium Transistor Leakage

Chart I

| Application | Leakage |
|-------------|-----------|
| RF - IF | 0-5 ma |
| Audio | 5-50 ma |
| Power | 50-500 ma |

*the instrument with
endless uses ... the all new
improved completely solid state*

SENCORE FS134 FIELD STRENGTH METER



only
199.50
lowest price going

HERE ARE JUST A FEW OF THE MANY USES ...



INSTALLING AND CHECKING OUT DISTRIBUTION SYSTEMS
Qualify for this multi-million dollar business in hotel, motel, and hospital installations.



COLOR INSURANCE
Be sure the signal is adequate on each channel for proper color TV operation.



CHECK TRANSMISSION LINES
For the first time read actual db loss in either 75 or 300 ohm transmission lines.

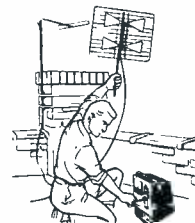

INSTALLING UHF, VHF, AND FM ANTENNAS
Cut down installation time and pay for the FS134 in a short time on critical UHF as well as VHF and FM antennas.

COMPARE ANTENNAS
For actual db gain; see which is best for each location, both VHF and UHF. Also excellent for orienting "dishpans" for translator use at the high end of UHF band.



CHECK ANY GENERATOR OUTPUT
For correct frequency and output all the way up to a tenth of a volt RMS. What a time saver when you want to know if your generator is putting out.

PLUS: LOCALIZE NOISE AND INTERFERENCE
Fine noise source fast; pick quiet locations for antenna installations or orient antenna away from noise when possible.

These are only a few uses of this UHF-FM-VHF accurately microvolt calibrated field strength meter. You can start paying for the FS134 tomorrow in the time saved today—if you see your Sencore distributor now. Why not pick up the phone and ask him to show you the new FS134?

SEE AMERICA'S MOST COMPLETE LINE OF PROFESSIONAL TEST INSTRUMENTS—AT YOUR DISTRIBUTOR'S NOW.



SENCORE

NO. 1 MANUFACTURER OF ELECTRONIC MAINTENANCE EQUIPMENT

426 SOUTH WESTGATE DRIVE, ADDISON, ILLINOIS 60101

Circle 15 on literature card

June, 1967/PF REPORTER 41

Home or commercial? VHF, UHF or 82 channel?

Come up with the big plus in all MATV installations.



New and exclusive with Channel Master

Start with a Channel Master Continuous MATV Color Amp. Add our Color-Duct 82.

When you install new Channel Master continuous MATV color amplifiers and coordinated UHF/VHF components, there's only one piece of equipment you'll ever need to change to convert any MATV installation to 82 channels. That's the antenna.

Why? Because Channel Master color amplifiers—and only Channel Master amplifiers—bring in all 82 channels directly on channel—in a *single broadband electronic circuit*. (Not merely two separate VHF and UHF sections in a little box as it is in all other MATV VHF/UHF amps.) And you get this total bandwidth without sacrifice of power. At tremendous savings.

No matter which channels you have in mind in your MATV setup, a Channel Master color amplifier is automatically ready to receive both VHF and UHF.

Choose from: 30 db Color Tandem Amp (Model 7261), shown above. Combination 75 ohm preamplifier and amplifier. Also available in 300 ohm (Model 7262). 15 db Color Booster, Model 7264. Mast-mounted 75 ohm preamplifier with separate power supply. Also available in 300 ohm (Model 0062). 15 db Color Distribution Amplifier (Model 7263). 75 ohm MATV Distribution Amplifier. Also available in 300 ohm (Model 7260).

Color-Duct 82 is the ultra-low loss UHF/VHF RG-59 type coaxial cable (Model 9537).

It's the first major improvement in 75 ohm coaxial cable since the introduction of braided shielding. And only Channel Master makes it.

It takes the 100% Total Shielding formerly used only on transmission cables in commercial and industrial applications; applies it to MATV-designed 75 ohm coaxial cable; and literally creates a direct line to color. Produces lowest loss in 82-channel coax without losing one iota of the flexibility and handling ease of ordinary coax. (Uses standard F-fittings).

Take the first step now toward installing the most efficient and economical MATV system anywhere. Use a Channel Master color amplifier and a Color-Duct 82 coaxial cable.

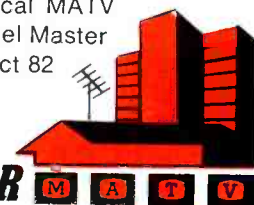

CHANNEL MASTER M A T V

Ellenville, N.Y.

A Few Tips

When troubleshooting, the service technician is interested if the transistor is open or shorted. Any beta indication measured is considered good, but beta normally doesn't change with age. The beta factor is important when replacing a defective transistor. For example, if a given audio transistor is shorted and an exact replacement transistor isn't available, another one with the same beta factor can be substituted.

Open or shorted transistors can be easily located with an in-circuit transistor checker. However, if a diode or another transistor is directly coupled to the suspected transistor, the suspected transistor may have to be removed from the board for a good test. If a transistor checks defective in-circuit, but good out of the circuit, look for defects in other components.

Likewise, if a transistor checks bad in or out of the circuit, the connecting components should be checked to see if they have caused the failure.

When you have a weak output or poor selectivity on the AM or FM bands, check the RF, oscillator, and IF stages. RF and IF alignment should only be made if the need is obvious.

In case of a station fading on any portion of the dial, check the converter transistor by replacement. Noisy reception can be caused by shorted IF transformers, bad capacitors, or noisy transistors. Noisy transistors, however, are generally found in the audio stages.

Weak audio or phono output signal can be checked from the phono stereo cartridge through to the speaker. Many times one side of the phono cartridge will become weak or defective, resulting in low or distorted sound. If you suspect one side of the cartridge to be defective, reverse the cartridge output leads. The symptoms will appear in the other channel if the cartridge is the source of trouble.

Audio distortion is generally found in the last two audio stages. Check suspected transistors with a transistor tester. Before replacing the good transistor be sure the base or emitter resistors are not burned or changed in value. After installing a new transistor, take voltage measurements on all three terminals.

Most power supply troubles are caused by the silicon diodes. In bridge rectifier circuits you'll often find more than one defective diode, so it is best to unsolder one lead of each diode when checking them.

The transistor of course must be removed from the PC board if found defective. To speed up the servicing time, use a small de-soldering iron with a suction bulb. These irons also are less likely to overheat the board, so there's less chance of breaking the

foil. When installing a new transistor, don't cut off the leads until after testing. You may have to try another transistor even if the replacement is good. It helps to match the beta to the counterpart in the opposite channel.

Be sure to place silicon grease on all replacement power transistors, and watch for correct body alignment. It is very easy to short the prongs against the chassis. Most

NO MORE GUESSWORK!

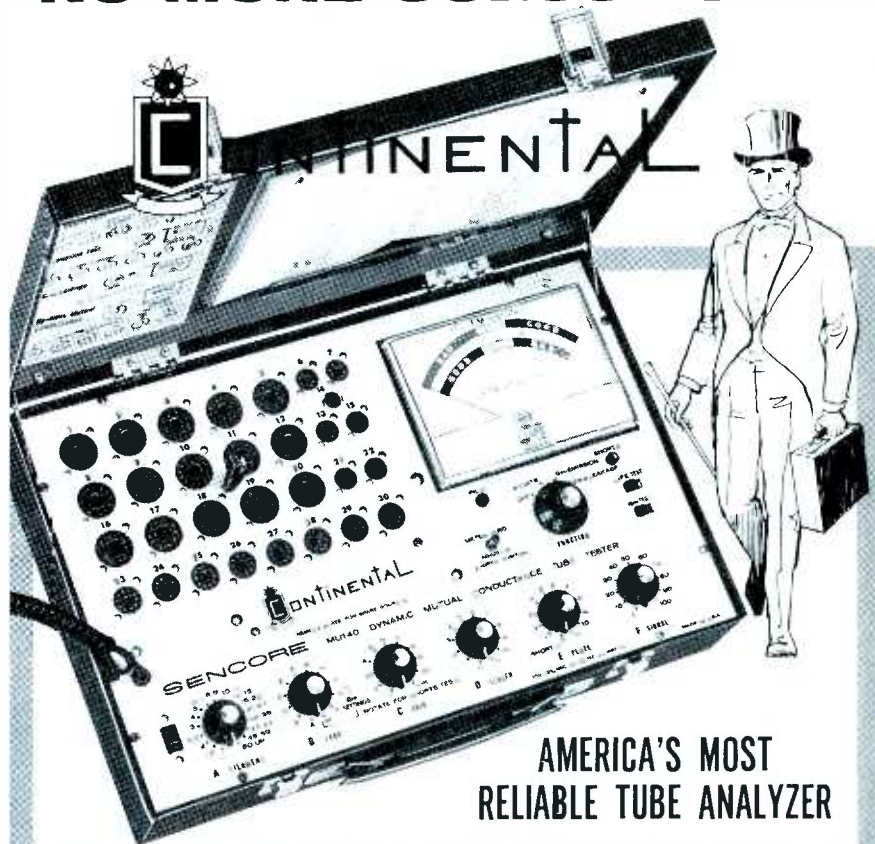

AMERICA'S MOST RELIABLE TUBE ANALYZER

You don't need three guesses to tell if a tube is bad — or why. With the new Sencore MU140 Continental, you **know**. Right now. And you simply can't go wrong. Because it's a complete tube analyzer for 4-way testing — true mutual conductance (using exclusive 5000 hertz square wave), full cathode emission, 100 megohm grid leakage, and internal shorts. Tests all tubes, including foreign — over 3000 in all. Obsolete-proof, too — with "new socket" panel, and controls so standard the switch numbers correspond to the pin numbers in any tube manual.

If it's reliability you want — for years to come — you need the Continental. It's the best way to be sure —

for only
\$179⁵⁰

See America's most complete line of professional test instruments — at your Distributor now.

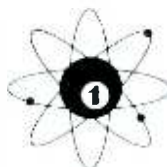

SENCORE

NO. 1 MANUFACTURER OF ELECTRONIC MAINTENANCE EQUIPMENT

426 SOUTH WESTGATE DRIVE, ADDISON, ILLINOIS 60101

Circle 17 on literature card

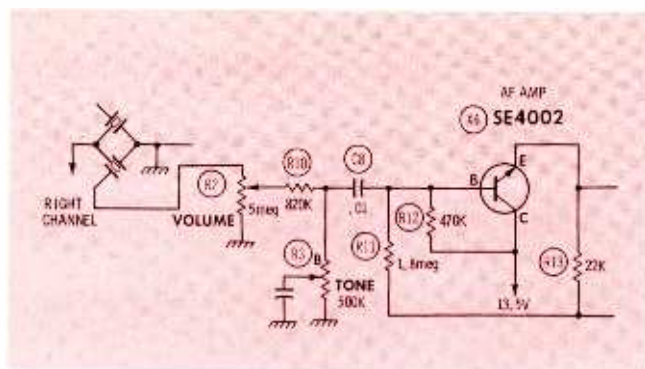

Fig. 1. Leakage in R2 caused low volume.

power output transistors will run warm in actual operation. But if any other type transistors run warm or real hot, there's some trouble indicated.

Case Histories

In a GE AM-FM stereo chassis the left channel was intermittent on both radio and phonograph positions. We knew therefore, that the trouble had to be in the left audio channel of the chassis. With the noise generator we traced the trouble to the first AF and driver stages.

After clipping the dynamic in-circuit transistor checker to the suspected transistor everything worked perfectly. This is like going to the dentist and when you get there, the toothache is gone. So we unsoldered the two transistors from the the PC board for out-of-circuit checks.

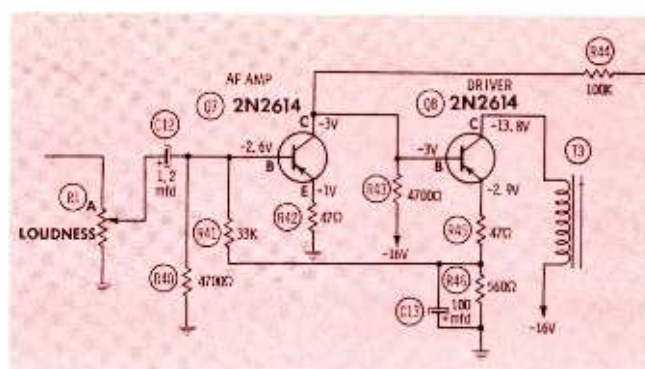

Fig. 2. Defective C13 caused lost signal.

The first AF transistor checked good. But the driver transistor when first hooked up appeared to be open—and then it checked good. By tapping on the transistor, it really acted up. A replacement was installed, and another customer satisfied.

Low Volume

The right channel of an RCA VFP32E stereo phono amplifier had very low volume. At first we suspected a bad cartridge but this time we guessed wrong. The audio stages were checked with an audio signal generator and they tested perfectly from the base of the first AF amplifier to the speaker. But from the phono input to the base terminal there was a big loss of signal.

Checking the circuit, we found an 820-K resistor and an .01-mfd capacitor were in series with the volume control and base terminal. See Fig. 1. The volume was

FREE! *the NEW*
1967
CATALOG
from
EICO®

electronic instruments
(both kit and wired)

Big 36-page catalog features many new models and "best buys." Explore Eico's complete line of 200 electronic kits and factory-assembled instruments for CB, ham, hi-fi, short wave communications, electronics testing and for teaching electronics.

Write today!

Eico Electronic Instrument Co., Inc.
131-01 39th Avenue,
Flushing, New York 11352 PF-6

Send **FREE** 1967 Eico Catalog.

Name _____
Address _____
City _____
State _____ Zip _____

Now an Atlas Sound speaker that can do more than any one speaker could do before...



SERIES AP-30

U.S. Design Patent #205,663
Other Patents Pending.

... and all you need is a screwdriver to mount, connect and adjust it.

New Series AP-30 install easier, faster and better with built-in transformers, screw-to-line terminals and watts/impedance switch. Very high efficiency is thrifty with amplifier power for low level reinforcement. The speakers are 30 watts rugged for penetration over distance and noise.

From solderless installation to quality performance on the job, four weather-sealed AP-30 models cover your requirements for most single and multiple installations.

From \$24.30 net.

For the complete Professional Series AP-30 story, ask for catalog



ATLAS SOUND, Division of
American Trading and Production Corporation
10 Pomeroy Road, Parsippany, N.J. 07054
Canada: Atlas Radio Corporation, Toronto
THIRTY YEARS OF LEADERSHIP IN COMMERCIAL SOUND

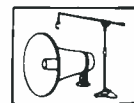

SEE US IN ROOM 513A, CONRAD HILTON HOTEL, 1967 NEW

Circle 18 on literature card

Circle 23 on literature card



COLOR ELECTROLYTICS

CORNELL-DUBILIER ELECTRONICS

COLOR

Here is a book that enables you
to easily replace any electrolytic
in any color TV chassis
tell us where to send your copy!

CDE **CORNELL-
DUBILIER**

50 PARIS STREET
NEWARK, NEW JERSEY 07101

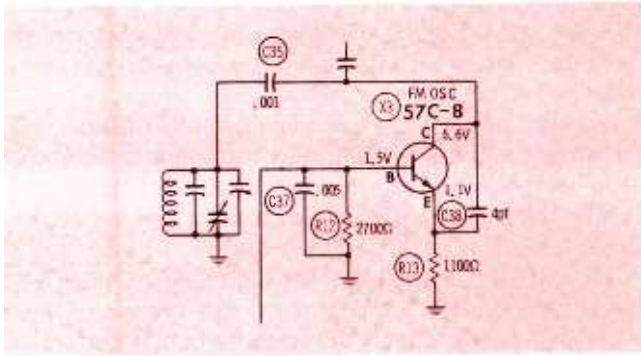

good on both sides of the capacitor, so we suspected the 820-K resistor. Again the ohmmeter proved we were guessing.

But upon checking the resistance from the center lug of R2 to ground, we measured only 400 ohms. No matter to what position the control was turned, we still had only 400 ohms resistance. We removed R2 from the chassis and found a leakage between the control shaft and the center lug. This particular trouble is very rare, but variable resistors can cause plenty of other troubles.

Weak Right Channel

In an RCA model VGP82 (Fig. 2) we had another weak right channel audio problem. Sometimes the volume would rise and then again become very weak. We decided to use the noise generator on this one and started checking at the audio output stage. At the same

time we compared the signal gain with the left channel.

At the base of Q8 we found a very weak signal. Since the first AF transistor was tied directly to the base of Q8, we removed them from the PC board. Both transistors were checked and found perfectly good.

The two transistors were replaced and we resumed signal tracing the circuit. We found that the signal on the emitter of Q7 was just as strong as it was on the base terminal. Things didn't add up. After further testing we found C13, a 100-mfd capacitor, was partly open. Replacing the capacitor brought the volume back to normal.

Motorboating

This RCA AM-FM chassis definitely had a putt-putt sound. The motorboating was pounding the left speaker even with the volume turned way down, so we knew the trouble was after the volume control and only in the left channel.

We quickly checked all of the transistors with an in-circuit tester. The two power output transistors were removed from the PC board for more accurate checks. In one power output transistor we found a 100-micro-amp leakage. After replacing the defective transistor the motorboating sound disappeared.

No Oscillation

The symptom on an Admiral 20C4A chassis was poor FM reception. In fact all we heard was a loud rushing noise in the speakers. We guessed that the oscillator

BUZIT
TRANSISTORIZED
SIGNAL TRACER

FOR ONLY \$9.57 DEALER NET
WITH BATTERIES.



MADE IN U.S.A.

USED FOR TROUBLE SHOOTING

- A.F. CIRCUITS • I.F. CIRCUITS
- R.F. CIRCUITS • CONTINUITY CHECKS • SPEAKERS, ETC.

EXCELLENT FOR TRANSISTOR RADIOS BECAUSE BUZIT USES ONLY A 3 VOLT POWER SUPPLY

ASK YOUR ELECTRONIC PARTS DISTRIBUTOR FOR

MODEL NO. **BZ-1**

MANUFACTURED BY
WORKMAN Electronic PRODUCTS INC.
SARASOTA FLORIDA

Circle 20 on literature card

EVERY 8 MINUTES...

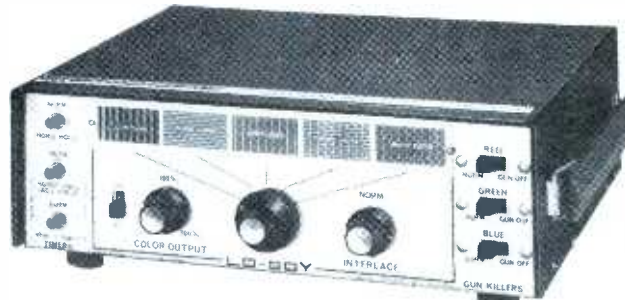

SOMEONE BUYS A NEW SENCORE CG10 LO-BOY STANDARD COLOR BAR GENERATOR

It's time you too switched to Sencore and saved \$100.00 in the bargain. The new compact LO-BOY is a solid Sencore value that outperforms the highest priced generators—and is already selling at the rate of one every 8 minutes.

Compare these features:

- Ten standard RCA licensed color bars plus all patterns found on more expensive generators.
- New patent pending counting circuits using silicon transistors. Crystal controlled timers for the utmost in stability.
- New front mounted timer controls for quick adjustment if they should ever jump. Absolutely eliminates timer instability.
- All solid state. Battery powered by long life "C" cells.
- HI in performance—LO in price. . . . (Less than the cost of a kit.) . . . only \$89.50

SENCORE CG12 LO-BOY—Just like CG10 except AC operated, 4.5 mc crystal controlled signal; recommended for troubleshooting. . . . only \$109.50



SENCORE

NO. 1 MANUFACTURER OF ELECTRONIC MAINTENANCE EQUIPMENT

426 SOUTH WESTGATE DRIVE, ADDISON, ILLINOIS 60101

Circle 19 on literature card



The solid-state technician hard at work.

stage was not functioning.

The FM oscillator transistor (Fig. 3) was checked in the circuit. The first RF and mixer transistors also tested normal. Going back to the oscillator circuit we started to take voltage measurements. On the base terminal we found zero volts. Using the ohmmeter, we found a direct short between base and ground. To make sure the transistor was not causing this low reading, it was removed from the circuit.

Sure enough, C37 had a dead short. Be sure to use an ohmmeter or VTVM with not more than a 3-volt internal battery when checking resistance around transistor circuits, so as not to damage them.

Frigid Baby

We had a Silvertone 528.63430 AM-FM chassis that

would not perform when first turned on. Sometimes a half-hour would go by before music came through the speakers. One cold winter day the receiver took two hours before operating as it should.

A quick check was made on the audio section with a noise generator. The audio was working but there was no RF response. If you quickly rotated the volume control up and down you could hear a rushing in the speaker.

The chassis was pulled from the cabinet and placed on the service bench. Right away the receiver started to play. Of course this always happens (and it performed the rest of the day).

Early the next morning the chassis was dead again and we quickly ran through the transistors with an in-circuit checker. The first and second IF transistors were pulled for a closer check. A beta reading of only twenty was found in the first IF transistor. We suspected this transistor and sprayed some circuit cooler on it.

When clipped back into the beta tester the beta hand would move from open to middle scale and then drop down towards zero. The warmer the transistor became the closer the beta moved toward zero. A new transistor cured the problem.

If coolant spray is not handy, simply run cold water from a faucet over the suspected transistor. (Out-of-circuit of course!) A good transistor, after cooling down, may show a 2% change on the beta scale. But a cold-shouldered transistor, when cooled down, will vary the needle on the beta meter all over the place. ▲

Why not sell the best

**3 ZENITH
WAVEMAGNET®
INDOOR TV ANTENNAS**
built to the quality
standards of Zenith
original parts

Zenith has designed these Wavemagnet antennas for sensitive reception in color or B/W. Fully adjustable telescopic dipoles. Six-position selector switch for top performance on each channel. Handsome molded base of high-impact styrene. Individually packaged for effective sales display. Order now from your Zenith distributor.

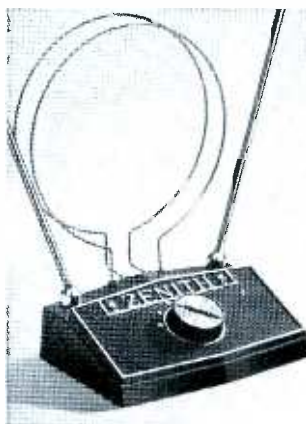

**DELUXE
ALL-CHANNEL**
Part No. 973-56
Two full-size UHF
loops develop high
front-to-back ratios
equal to many
outdoor antennas.



**ECONOMY
ALL-CHANNEL**
Part No. 973-55



VHF ONLY
Part No. 973-58

ZENITH®

The quality goes in before the name goes on

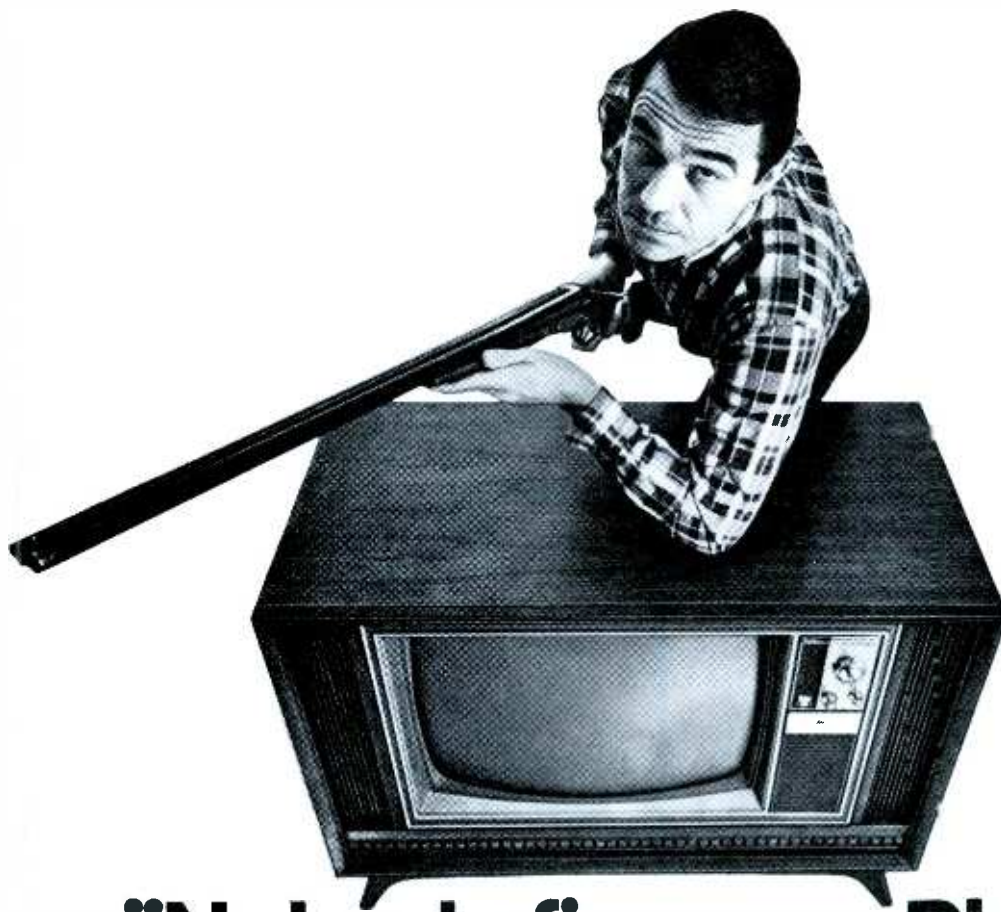

“Nobody fixes my Philco but a Philco technician!”

That color TV cost him \$500 and he wants a real specialist to fix it! Why don't you become the specialist? Give Philco Qualified Service and get the business.



Your service technicians can get all the training they need right there in your area. Local training meetings are held all over the country. Then, after the course, our Tech Data Service keeps them tuned in to what's new. And you get the fastest parts delivery in the industry. Philco Parts Distributors stock almost every part you'll ever need. Any part they don't have will be on its way to you by air within 24 hours through our Lifeline Emergency Service.

Get new customers — more business. Your shop can appear in our Yellow Pages listings, and you become your area headquarters for Philco Service. There's plenty of attractive identification material wherever your firm name is used.

Philco owners are sold on the idea of specialist service. Shouldn't you be? Your local Philco-Ford Distributor will give you all the details. Call him now and ask for the Service Manager.

Philco-Ford Corporation
Philadelphia, Pa. 19134



Circle 22 on literature card

June, 1967 / PF REPORTER 49

NOTES ON TEST EQUIPMENT

*analysis of test instruments
...operation...applications*

by T. T. Jones

Compact Color Generator

B & K's new Model 1242 color generator is by far the smallest we've seen. Completely solid-state, and with but two operating controls, it nevertheless produces a full-sized signal with all patterns. Gun killers are also included.

We weren't expecting the Model 1242 when it was delivered to the lab, so we had no idea what we'd see when we unpacked the box. Of course we were surprised with the unit's small size, so we decided to get right to work and see what it could do.

There's a door at the rear of the 1242, and we figured that's where the leads were stored (they were) and that we could install the batteries back there. That was our second surprise. The Model 1242 isn't a battery instrument; it has a transistor and zener regulated AC supply. The line cord stores in the rear compartment with the other cables. The power transformer projects into the storage compartment and it's as small as the rest of the unit. The transformer measures only $1\frac{1}{4} \times 1\frac{1}{2}$ and more closely resembles an audio interstage transformer

than a power transformer.

We had our third surprise when we hooked the 1242 up to a color set. At a flip of the off-on switch, there was our pattern—rock solid. It's a good pattern too, with narrow lines and small dots.

The color position of the function switch produced a good keyed-rainbow pattern with very well defined edges on the bars. Those of you who may have noticed smear at the trailing edges of the bars on some sets probably realize that it's not really a problem when using a generator—just annoying.

Actually, the smeared trailing edges can be caused by many things. One is rounded keying pulses in the color generator. Another common cause is a mismatched delay line in the set under test, producing a poor color fit. Of course any IF or bandpass deficiencies will also cause smearing. But let's get back to the 1242.

A simplified block diagram of the generator is shown in Fig. 2. Not shown are the power supply, gun killers, or function switch. As shown the generator is in the color mode. Note how few stages are used, as compared to earlier models, such as the 1245. This is possible because the divider stages are unijunction transistors. Due to their inherent stability it is possible to divide by larger sub-harmonics and still maintain an accurate output. The 1242 also uses many RC

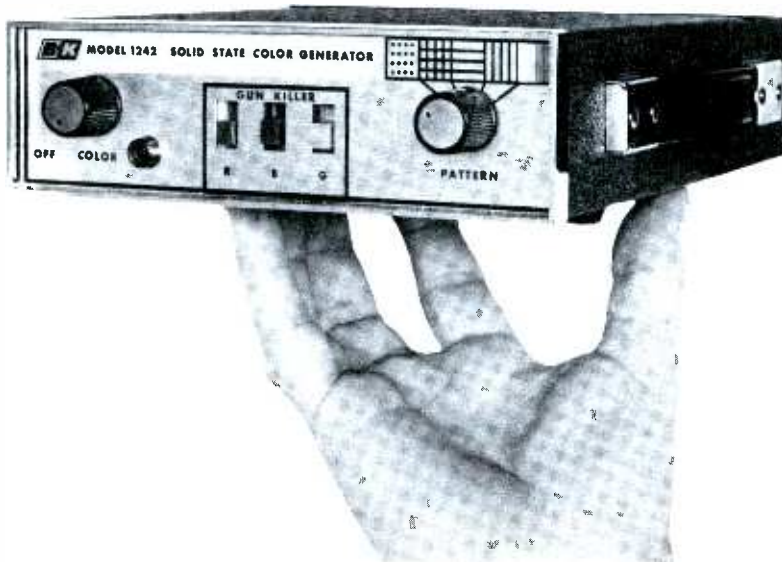

Fig. 1. New pint-sized color generator from B & K.

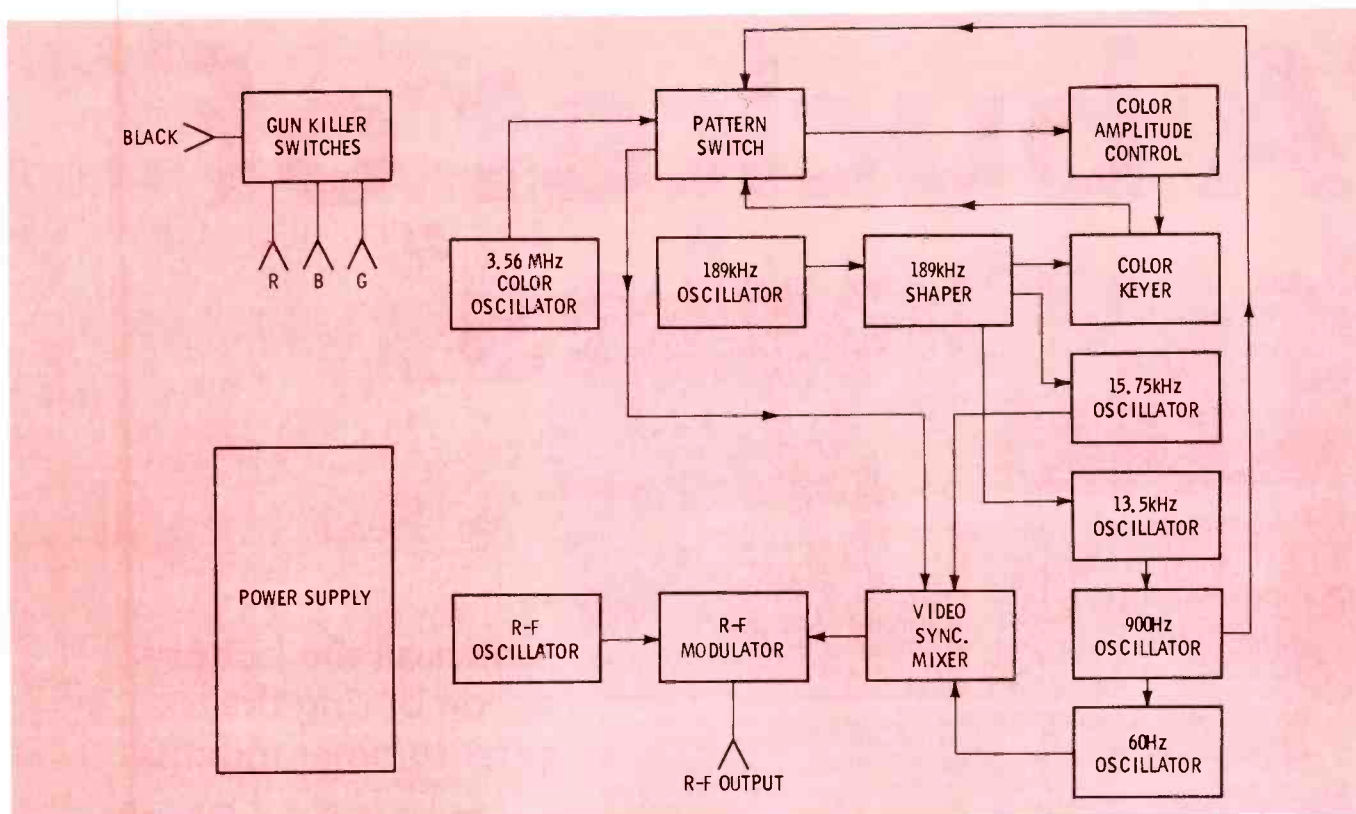

Fig. 2. Partial block diagram of the 1242.

PHOTOFACT™ BULLETIN

PHOTOFACT BULLETIN lists new PHOTOFACT coverage issued during the last month for new TV chassis. This is another way PF REPORTER brings you the very latest facts you need to keep fully informed between regular issues of PHOTOFACT Index Supplements issued in May and September.

| | | |
|-------------------------|--|-------|
| Airline | GEN-8147A, GEN-8157A | 886-1 |
| Ambassador | A-1901 | 882-1 |
| Arvin | 67K48 (Ch. 1.27801) | 884-1 |
| Bradford | BMAT-56614, 60400, 60418 | 883-1 |
| | BWGE-56499A/499B/507A/507B/ 648A, BWGE-60459A/-91660B | 887-1 |
| | WTG-61622, WTG-61630, WTG-61663 | 885-1 |
| Clairtone | Chassis C11 | 883-2 |
| Emerson | 12P51 | 886-2 |
| General Electric | M213CWD (Ch. HC) | 883-3 |
| Magnavox | Chassis T-923-01-AA | 882-2 |
| | Chassis T or U911/919/920 series | 887-2 |

Packard Bell

CSW-502/-602/-606/-702
1-804 (Ch. 98C15)

884-2

Philco

Chassis 17MT80/A/B

885-2

Sony

CVM-2300U

882-3

TV-700U

885-3

Toshiba

711T1 (Ch. TAT-1001)

884-3

Westinghouse

BC12A870 (Ch. V-2490-2)

886-3

Zenith

X1315C/L/P/X,

X-1325W (Ch. 13X18)

887-3

The following TV sets are given schematic coverage in the Extra Contents.

Crosley

JR-21CDBF/CDBU/CDTMF/
CDTMU/CGDBF/CGDBU
(Ch. 474, 475)

886-Cont.

General Electric

M420DEP, PAM424CVY,
PAM451CWD (Ch. DD)

883-10-S

Heathkit

GR-180

882-Cont.

Motorola

XP201CL/CN/CR/CU,
XP-202CE/CH
(Ch. C9TS/9TS-460)

887-9-S

Olympic

9P56, 9P57, 9P58

887-9-S

Order RCA's 9-volt summer special

"A bucket of batteries"

with



TRANSISTOR



catch all the
ACTION
this year!

BATTERIES

9 VOLT VS323



REPLACES 216



Catch all the battery action during the peak summer months

72 of the popular RCA VS323 9-volt transistor batteries are prepacked in this attractive, reusable ice-bucket merchandiser. It's a sure-fire summer seller. Offer the bucket as a gift to the customer who buys the last battery... or use it at home for picnics or parties. All batteries have a plastic terminal protector to prevent shorting.

See your RCA battery distributor and ask about his summer special "Bucket of Batteries" promotion offer!

RCA Electronic Components and Devices, Harrison, N. J.



The Most Trusted Name in Electronics

and diode networks to shape the stage outputs; many other generators use extra transistors for this purpose.

The generator uses 14 diodes, one of which is a zener reference in the power supply, and 10 transistors. Again, one is in the power supply, used as a regulator. The supply will maintain a constant output with line voltage varying from 110 to 150 VAC.

The 1242 exhibits high quality throughout, from the neat layout on the printed circuit board, through the careful assembly, to the eye-catching style. The bezel is a metalized plastic, which is quite attractive. It looks just like chrome, and we'll bet that a few 1242 owners will discover the bezel is plastic only after they lay a hot soldering iron on it.

We loaned the 1242 to a few friends to try out "on the job." The substance of their comments was "It's a good outsider's generator," and "I'll bet B & K sells a lot of these."

B & K Model 1242 Specifications

Outputs:

14 Vertical lines.
10 Horizontal lines.
10 x 14 Crosshatch.
140 Dots.
Keyed Rainbow.

RF Output:

5 mv channel 3 or 4.

Gun Killers:

100 K chms.

Power Requirements:

110-130 VAC 3 watts.

Size (HWD)

2-1/4" x 7" x 9-3/8".

Weight:

3 pounds.

Price:

\$99.95.

For further information circle 56 on literature card

ERRATUM

In the March "Notes on Test Equipment" review of the Mercury Model 1900 color generator, we erroneously reported the price as \$89.50. The actual price of the Model 1900 is \$99.95.

Knuckle-Saver.



Putting a sleeve on a connection can be frustrating. (If your hand slips, it can also be rough on the knuckles.)

Why not use Krylon Crystal Clear Spray Coating instead?

Krylon forms a hard, waterproof coating that stops many of the causes of high-voltage section loss and picture

fading. It doesn't dry out or crack. It prevents rusting.

Try it. All you have to lose are a few skinned knuckles.

Krylon Crystal Clear...standard equipment for all TV/Radio installation and repair work.



Circle 24 on literature card

MOVING?

Don't lose touch . . .
RECEIVE PFR AS USUAL

(INCLUDE OLD AND NEW ADDRESS)

PF REPORTER

CIRCULATION DEPT.

4300 W. 62nd St.,
Indianapolis, Ind. 46206

Winegard introduces
the first

82-CHANNEL (VHF-UHF-FM)
VARIABLE ISOLATION LINE
TAPS DESIGNED FOR
COLOR MATV
SYSTEMS!

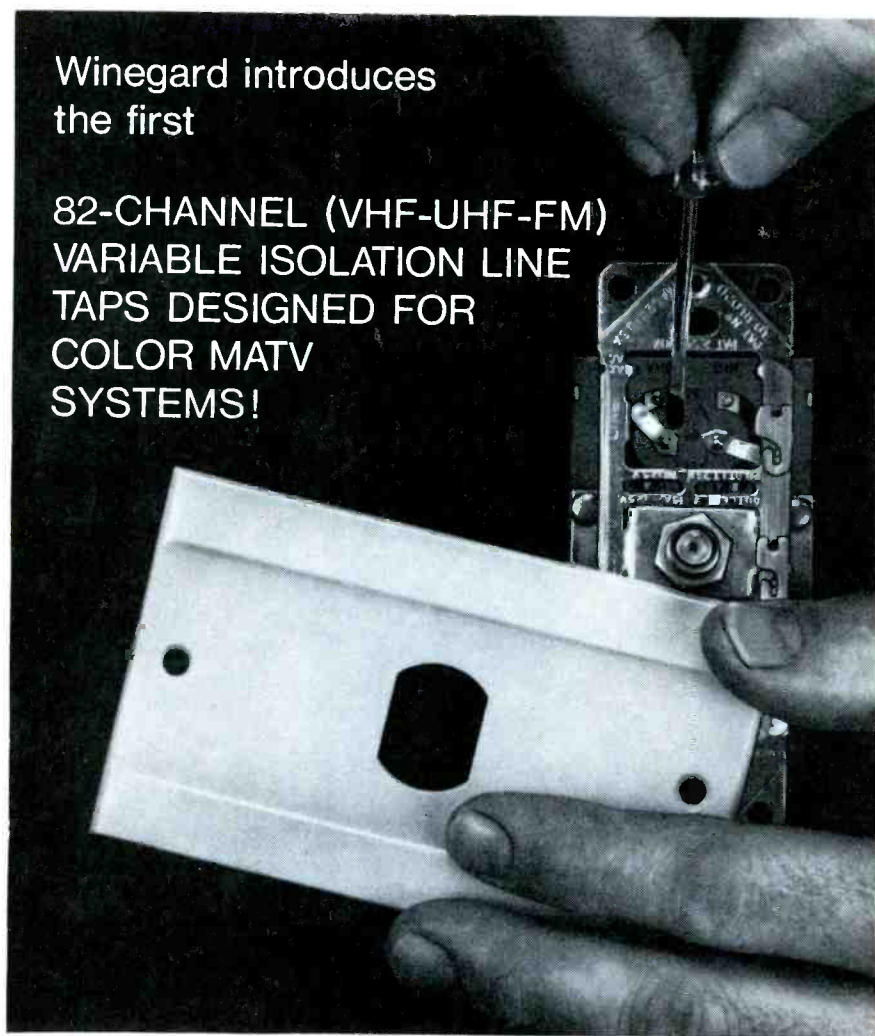

... independently adjust VHF and UHF isolation—in seconds!

... simplifies signal balance between sets!

... available in both 75 and 300 ohm outputs!

Now you can guarantee the best possible color TV reception (for both large and small MATV systems) on *all* channels—and *all* sets!

Because Winegard has now engineered and perfected 75 ohm 82-channel variable isolation taps that do it all.

They simplify installation. They reduce inventory. But, most of all, they give you the first and only foolproof way to guarantee the best color TV reception on all 82-channels and all sets!

First off, Winegard variable isolation line taps are truly easy to install. And once they're installed, you *never* have to remove them to adjust isolation. That's right! Instant up-front adjustment of the exclusive color-tested double wiper arms is all that is required.

Just a flick of the wiper arms lets you vary the VHF and UHF isolation independently from 10 to 25db for the best

reception on all 82-channels, and all sets! And there's no need for meters or mathematical computations, because you can make any adjustment while watching the sets in operation.

Plenty of other features, too, including trouble-free performance; attractive, heavy-duty ivory cover plates (unprinted on the front); and push-on connectors that provide positive connection to the trunk line.

Now that all MATV users (schools, stores, apartment complexes, hotels and motels, hospitals, etc.) are specifying 82-channel color systems, it's time to let Winegard prove how easy it is to be the MATV color expert in your area.

Get the facts about variable isolation line taps, plus 82-channel antennas, amplifiers, splitters, line taps, transformers, equalizers, coax, etc. Call your Winegard distributor or write for Fact-Finder #282.



WINEGARD COMPANY • 3000 KIRKWOOD STREET • BURLINGTON, IOWA 52601

©Copyright 1967, Winegard Company, Burlington, Iowa

Circle 25 on literature card

BOOK REVIEW

Directory of Electronic Circuits:
Matthew Mandl; Prentice-Hall Inc.,
Englewood Cliffs, N.Y., 1966; 226
pages, 6¼" x 9¼", hard cover,
\$10.00.

This book provides a comprehensive, individual analysis of more than 150 circuits commonly employed in television, communications, computers, and industrial control applications. The function, design, and operation of each circuit is discussed, along with component values, applicable equations, and formulas. An illustration of each circuit supplements the text.

The first section of the book is devoted to amplifier circuitry. Types of amplifiers and classes of operation are covered, as well as coupling and decoupling methods. Tone-control circuits, inverse feedback (both current and voltage), and magnetic amplifiers are also included.

Section Two examines a variety of bridge circuits. Demodulation circuitry is the subject of Section Three. AVC, AGC, and de-emphasis circuits are also treated in this section. Filters, attenuators, and pads are discussed in Section Four. Gating and combining circuits are analyzed in Section Five.

Plate modulation, grid modulation, FM, and pre-emphasis circuits are found in Section Six. Section Seven covers oscillators, both sinusoidal and nonsinusoidal. Power supplies and power control circuits are discussed in Section Eight. Voltage regulators, chopper circuits, DC inverters, and thyratrons are also included in Section Eight. Pulse modifiers such as integrating and differentiating circuits, combined ID circuits, clippers, and limiters are the subject of Section Nine. Sections Ten and Eleven cover reactance circuits and servo- and synchro mechanisms. Cathode followers, discharge circuits, dividers, frequency multipliers, flip-flops, frequency comparators, and photocell circuits are grouped with the special circuits analyzed in Section Twelve.

A glossary of electronic terms and an appendix containing units of measure, formulas, color codes, and frequency designations complete the book.

Engineers, technicians, and students alike should find this book informative and easy to understand. ▲

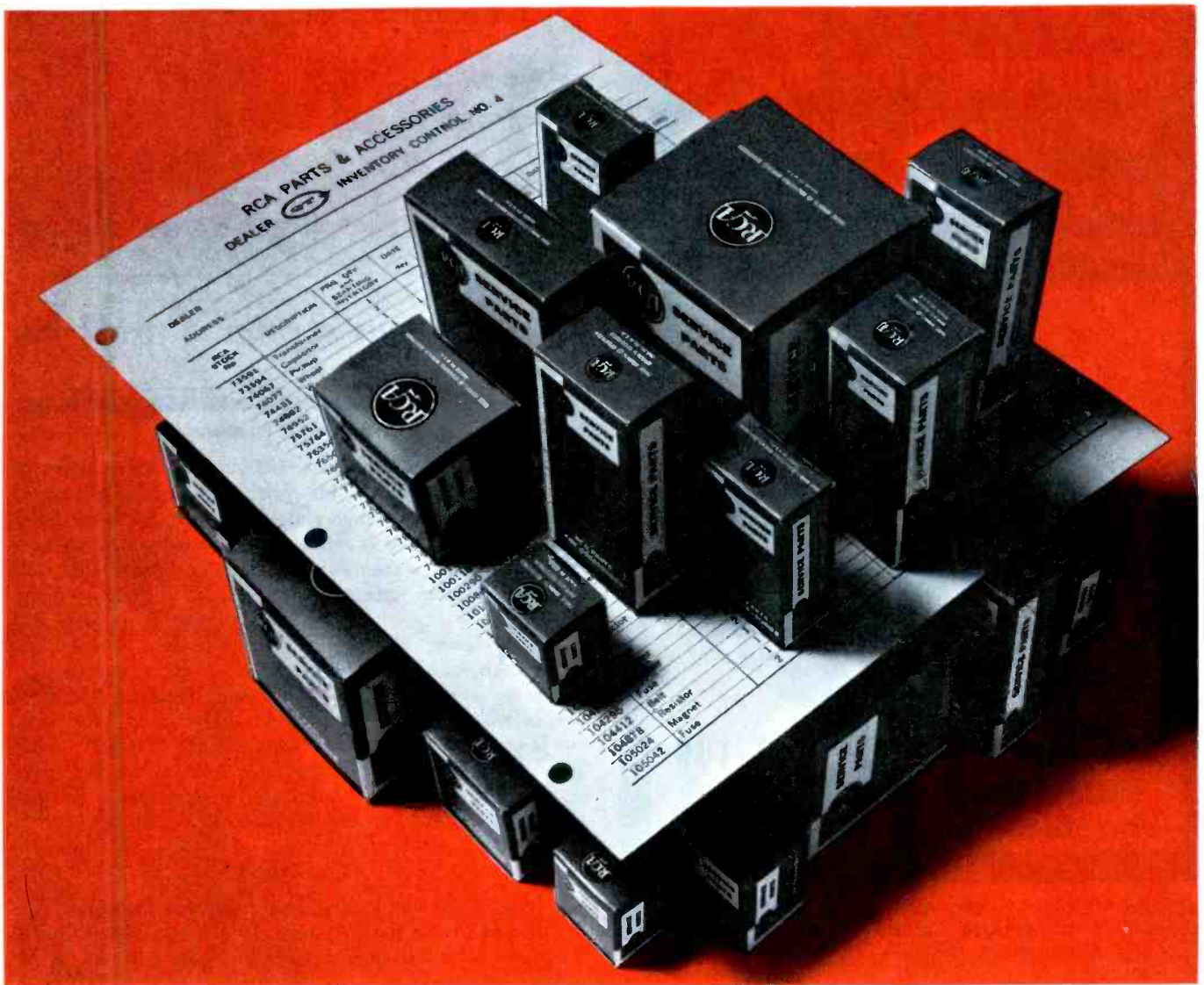

New help from RCA to reduce your loss-time ... increase your profits

An RCA "QT" Inventory takes the guesswork out of stocking replacement parts ... puts the most used RCA home instrument parts at your fingertips.

Your RCA Replacement Parts Distributor has a computer planned inventory program that makes your job easier. It will help you improve efficiency, speed up customer service, reduce inventory liability, and increase profits.

RCA "QT" (Quick Turnover) Inventories are designed to suit various-size service operations, with varying quantities of the most used RCA Home Instruments Replacement Parts.

These inventories are reviewed and updated semi-annually in accordance with the most current usage data, based on an analysis by RCA Electronic Data Processing Equipment of national sales patterns.

Once you get the "QT" habit, you have what's needed to produce better service, satisfied customers and additional business.

There are so many advantages to the RCA "QT" Inventory Program that it will be worth your time to call your RCA Distributor and ask him about them. Call him *today*—and start enjoying the profitable benefits that can be yours.

RCA PARTS AND ACCESSORIES, Deptford, New Jersey



The Most Trusted Name in Electronics

only picture tube analyzer
that tests all color tubes
as they should be tested!

(THE WAY TUBE MANUFACTURERS DO)



**NEW LECTROTECH CRT-100
PICTURE TUBE ANALYZER
FOR COLOR AND BLACK AND WHITE**

Does everything . . . you would need all three units of the leading competitive brands to equal the performance of the Lectrotech CRT-100. No other brand has all the features . . .

- Line voltage adjustment (to insure all tube voltages are correct regardless of line voltage).
- Critical Grid-to-Cathode Leakage is read on sensitive meter for greatest accuracy.
- Leakages in all other elements are indicated on neon lamp.
- Tests all black and white and all color tubes for leakage, shorts and emissions.
- Tests each color gun separately.
- Tests each color gun to a standard set of test conditions. With variable G-2 voltage, each grid is normalized to a reference cut-off voltage. This method is used by tube manufacturers and simulates tube performance in color receiver.
- Rejuvenates and removes shorts on both color and black and white tubes for increased brightness.
- Life expectancy test, predicts remaining useful life of both color and black and white picture tubes.
- Continuously variable G-2 voltage for all tubes, present and future, including new 15 inch color tubes.
- Complete plug-in cables for easy replacement.
- Complete self-contained black and white socket assembly. No adapters to lose or cables to break.
- Including Pilot Light.

Only **89⁵⁰** net

ONE YEAR WARRANTY

See your distributor or write DEPT. PF-6

LECTROTECH, INC.

1221 Devon Ave., Chicago, Illinois 60626

THE TROUBLE-SHOOTER

answers your servicing problems

Inherent Problem

I have a Pontiac Model 983873 auto radio that operates normally on the beach, but when replaced in the car it will not work on the high end of the band. I replaced the DS25 converter and it returned to normal operation (on the bench and in the car) for about a month, then the original symptom returned.

DILLINGER RADIO AND TV

Scranton, Iowa

The symptom you have described is fairly common to transistor auto radios. In many cases involving this particular auto radio, the trouble has been cured by replacing and adjusting trimmer capacitor C16. Other cases required replacing X2, as you have done. Some real stubborn cases have been solved by connecting a resistor (about 22k ohms) between the base of X2 and ground.

TVI Traps

I have a problem setting TVI traps (mostly series) on CB receivers. We have channel 5 TV in this area and it occasionally causes interference on some CB sets. What is the common procedure for setting such traps and what test equipment does it involve?

G. POPDAVID

Canton, Ohio

Setting TVI traps on CB receivers is not complicated. The usual method is to set a TV receiver on the problem channel (in your case Channel 5) and adjust the trap until the interference is negligible. In extreme cases it may be necessary to spread the coil turns slightly and readjust the trap to completely remove all traces of interference.

Hot Transformer

A Zenith Chassis 16E25 (PHOTOFACT Folder 507-2) had intermittent video and sound. After this was corrected, the chassis was cleaned and visually inspected. I noticed that the "tire" on the upper coil of the flyback was lying, in the form of a blob of wax, beneath the transformer.

Two coats of compound were applied to the transformer, and after the compound was dry, the set was turned on. The transformer got very hot after a few minutes of operation.

I changed V9, V10, V11, V12, and V14. Because their plate supply is from the boosted B+, I then changed V4, and V5. Next, I changed C50, C56, C57, C58, C59, C60, C61, C1A, C1D, and C31. R73 was cracked, so I changed it. Then I replaced R80 with a 10-watt resistor, and finally I changed R75 and R8.

The horizontal output transformer was replaced with

Circle 27 on literature card



RCA
Transistors
Rectifiers
Integrated
Circuits

For
EXPERIMENTERS
HOBBYISTS
HAMS
and
TECHNICIANS

LOOK FOR THIS
DISPLAY AT YOUR
RCA DISTRIBUTOR

Here displayed on the RCA Solid-State Center is the RCA SK-Series Transistors, Rectifiers, and Integrated Circuits; the new RCA 3N128 MOS Field-Effect Transistor; RCA's 40214 Silicon Stud Rectifier; and three RCA Experimenter's Kits. This new Solid-State Center, in addition to its host of devices, also includes technical literature to support the devices right on the rack. It's the "one-stop" answer to the solid-state needs of experimenter, hobbyist, ham, or the replacement requirements of the service technician.

All devices and kits are packaged in easily identifiable see-through packs for your convenience. Included with each device is broad performance data or specific ratings and characteristics where applicable.

RCA Solid-State Center Includes:

- RCA Experimenter's Kits. Three kits enable you to build a light dimmer or any one of 14 different circuits for dozens of applications around the house.
- RCA SK-Series "Top-of-the-Line" Devices: 17 Transistors, 2 Rectifiers, and 2 Integrated Circuits, for exper-

imenter or replacement use.

- RCA Technical Manuals. Four manuals include: RCA Experimenter's Manual, RCA Transistor Manual, RCA Linear Integrated Circuits Fundamentals Manual, and RCA Tunnel Diode Manual.
- RCA Solid-State Replacement Guide. Lists all RCA SK-Series "Top-of-the-Line" Transistors, Rectifiers, and Integrated Circuits and the more than 7,300 types which they replace.

Keep RCA Experimenter's Kits and the RCA SK-Series in mind when you're shopping for solid-state devices. Look for the RCA Solid-State Center. Now at your RCA Distributor. Do it today!

RCA Electronic Components and Devices, Harrison, N. J.



The Most Trusted Name in Electronics

Don't let Money-Making Technical Advances Pass You By!

RCA Institutes offers these four comprehensive home study courses especially designed to help build your income immediately:

COLOR TV

Take advantage of the growing profit potential in this area. Add color TV to your skills with this home training course, newly revised to include information on the latest techniques, receiver circuitry and equipment. Train under the direction of RCA Institutes... experts in Color TV home study training.



SOLID STATE ELECTRONICS

You get the necessary background for semiconductor technology including characteristics of tunnel diodes, rectifiers and other solid state devices. Transistor trainer also available.



AUTOMATION & INDUSTRIAL ELECTRONICS

Trains you for the many applications of automation electronics in industry and government including Photo-electronics, Digital Techniques, Synchros and Servomechanisms, Automatic Control Systems, Nuclear Instrumentation and many more!

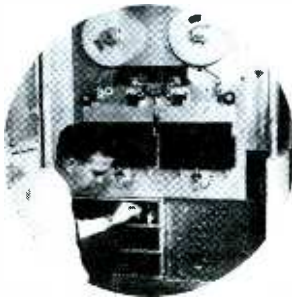

COMMUNICATIONS

Trains you to service and maintain 2-way radio communications on land, sea and air! Gives you the technical foundation for space communications.

You have no long-term obligations with RCA Institutes Liberal Tuition Plan. You only pay for lessons you order. Licensed by New York State Education Department. Approved for veterans.



Send this coupon now for complete free information



RCA INSTITUTES, INC.

Home Study School, Dept. PF-67
350 West Fourth Street, N.Y., N.Y. 10014

Without obligation rush me free information on the following RCA Home Training Course: COLOR TV _____ SOLID STATE _____ COMMUNICATIONS _____ AUTOMATION & INDUSTRIAL ELECTRONICS _____

Name _____

Address _____

City _____ State _____

IN CANADA - The RCA Victor Company, Ltd.

an exact replacement which also got hot. I substituted the yoke with a universal replacement, and then with a yoke from another 16E25 chassis. Incidentally, the horizontal output transformer in this second chassis also runs hot.

Using a VTVM, I measured the tube socket voltages of both chassis. The voltages were nearly the same in both chassis. Most of the voltages were close to those specified; but the horizontal AFC plate voltage measured 125 volts instead of 225; the horizontal oscillator grid voltage was -75 volts while -15 volts is specified; and the horizontal output grid was -42 volts instead of -35. The horizontal output tube cathode is 114 ma, and the screen current is 12 ma. The raster is full size; the video and sound are normal, and the sync is stable.

FRED FINE

Baltimore, Md.

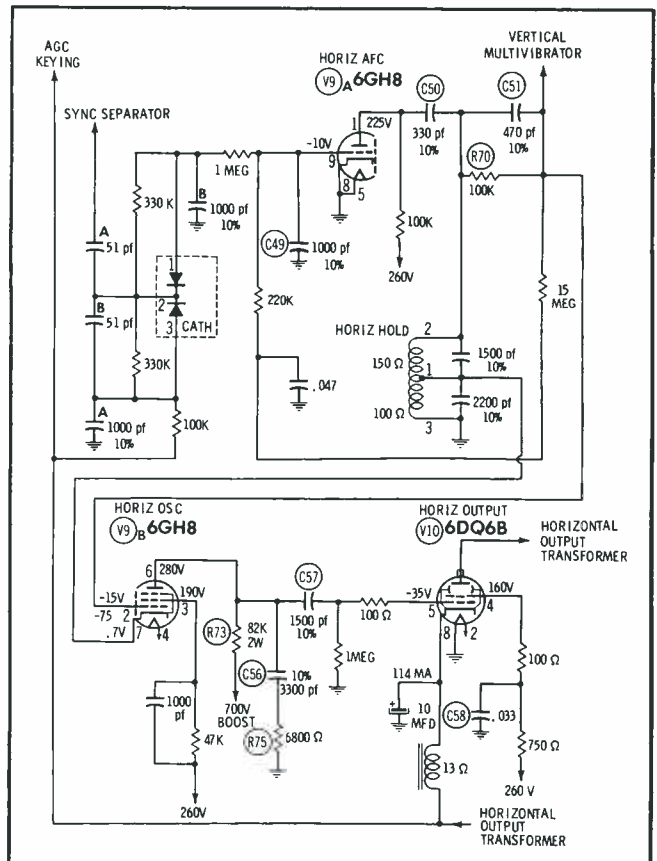

There are so many possible sources of overload in the horizontal sweep system that it is very difficult to pinpoint the exact cause. To simplify troubleshooting, divide the system into three parts such as AFC and oscillator, horizontal output tube and transformer, and the loads on the transformer.

The series of abnormal voltages which you discovered begins in the AFC and oscillator, and so this is the area which should be examined first. Apparently, a large correction signal is being developed by the AFC tube to keep the oscillator in sync. By using your scope, you can verify that the drive pulse at the grid of the horizontal output tube is distorted. This will change the operating conditions of the tube and transformer, and can result in overheating.

This points to trouble somewhere in the frequency-determining circuits. You will probably find that the waveforms in this area are greatly modified from their normal appearance. By further use of your scope, you will be able to locate the component which is at fault. ▲

Scope or Meters

(Continued from page 29)

from the output of a color TV receiver. The basic test setup and resultant pattern is shown in Fig. 13. If the pattern appears distorted (as is usually the case), simply disconnect the leads from the vertical and horizontal input terminals, and couple the test voltages directly to the deflection plates of the CRT.

More sophisticated tests require the use of a lab-type scope. Typical lab-type scopes have considerably greater frequency response than service types. For example, a small lab scope has flat frequency response up to 15 MHz. Other basic features of lab scopes include:

1. An accurately calibrated time base. This permits easy measurement of rise time, as illustrated in Fig. 14. Rise-time measurements are fundamental in square-wave and pulse test work.
2. Stable vertical amplifiers accurately calibrated in terms of p-p voltage. In other words, waveform voltages are read directly from the setting of the vertical attenuator.
3. Better transient response than service-type scopes, as shown in Fig. 15. As a result, better evaluation of the characteristics of wide-band circuits is obtained.
4. Triggered sweep which permits effective expansion of steep leading edges for rise-time measurement. Also, a delay line is included in the vertical-amplifier circuit so that none of the leading edge is lost in the screen display.
5. A wide range of trigger facilities is provided to facilitate expansion of a chosen interval in a waveform. These triggering functions are illustrated in Fig. 16; the trigger controls can be set to start the displayed pattern at any desired point in the waveform. For example, a color burst can be picked out of the composite color signal and expanded, as illustrated in Fig. 17.

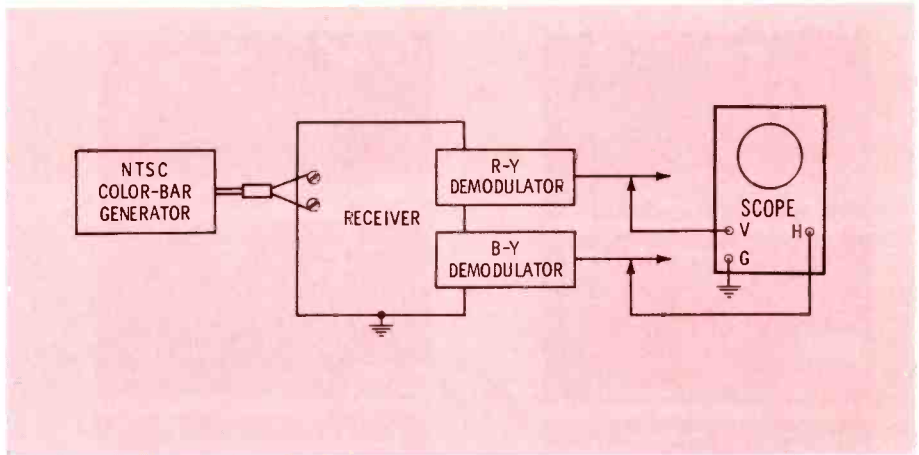

(A) Setup for test.

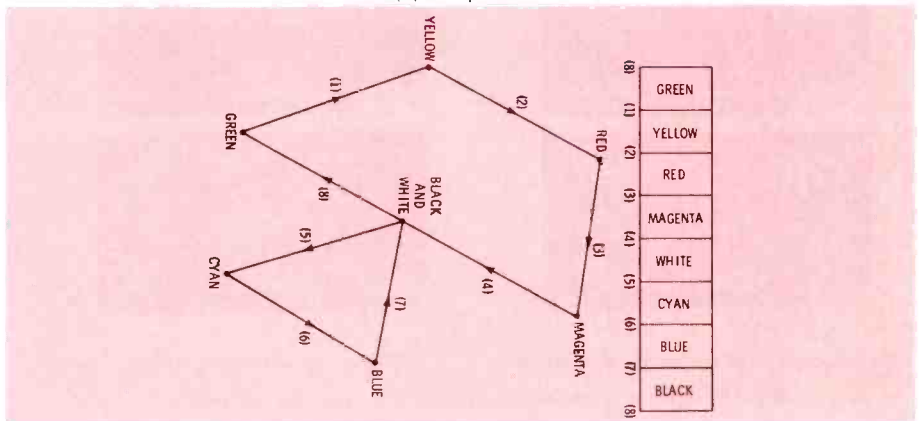

(B) Display for NTSC color-bar signal.

Fig. 13. Vectorgram test of color receiver.

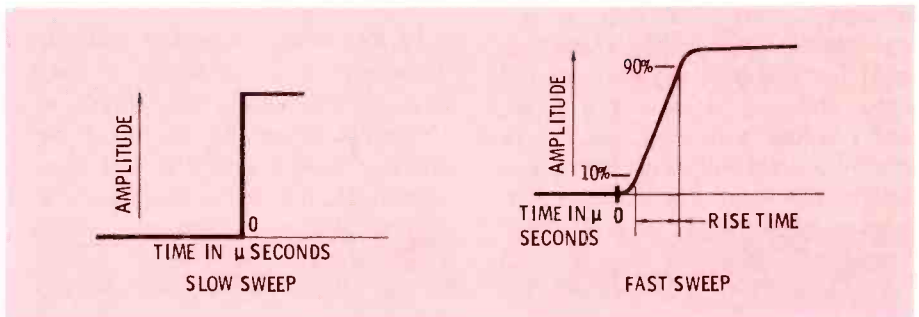
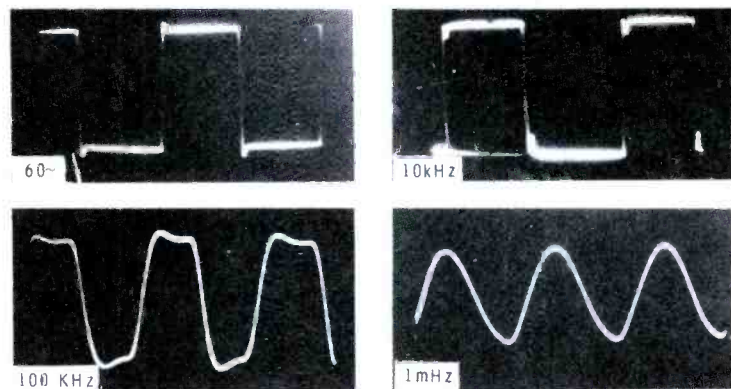
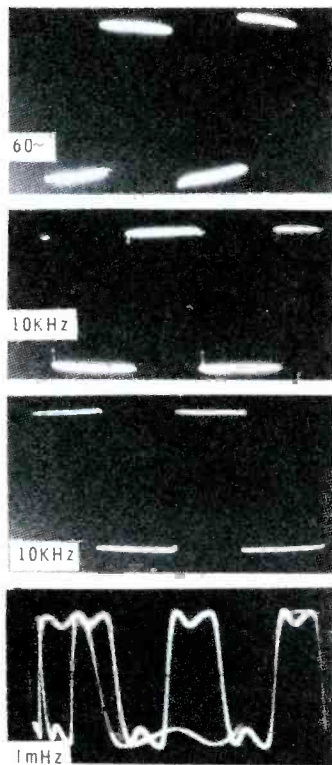

Fig. 14. Measurement of rise time.



(A) Response of service-type, 100-KHz scope.

Fig. 15. Transient responses of lab- and service-type scopes.



(B) Response of service-type, 4-MHz scope.

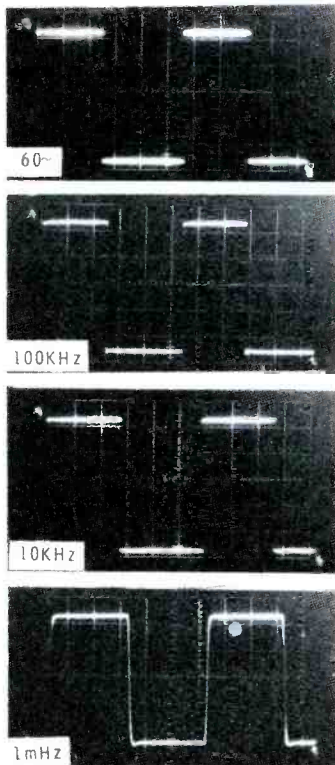

(C) Response of lab-type, 15-MHz scope.

Fig. 15. Transient responses of Lab- and service-type scopes.

Conclusion

We have reviewed the more basic advantages and limitations of various meters and scopes. Although many features have to be considered when choosing a test instrument, cost is often a deciding factor. In general, instruments with fewer limitations are more costly. However,

a very costly scope, for example, might be useless to the beginning technician because he cannot cope with the many unfamiliar controls. Therefore, it is advisable to start one's apprenticeship with simple instruments. After the technician becomes familiar with the operation of controls and the limitations of his

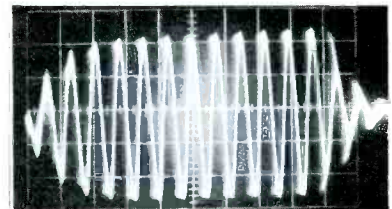
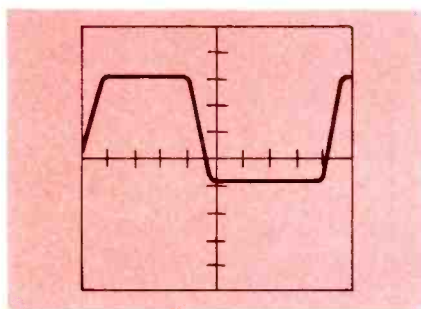

Fig. 17. Expanded color signal.

instruments, he can "graduate" to more elaborate instruments.

The necessity for understanding circuit action is sometimes overlooked. That is, unless we know how circuits work, we cannot evaluate instrument data to troubleshoot the circuits. An understanding of various circuits is gained slowly, both through study and practical experience. An apprentice who has not become familiar with AC circuit action, for example, should limit his activity to VOM and VTVM tests. Then, after he has gained an understanding of AC circuits, he can progress to basic scopes with more confidence and proficiency. After he has become familiar with the advantages and limitations of the basic scope, he will be qualified to tackle a lab-type scope. In any event, understanding circuit action and the operation and limitations of various test instruments go hand-in-hand. ▲



(A) Trigger selector set to +Int.

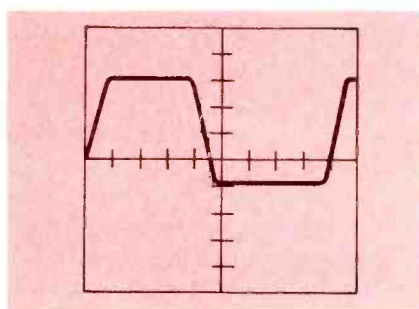

(C) Triggering at low point on leading edge.

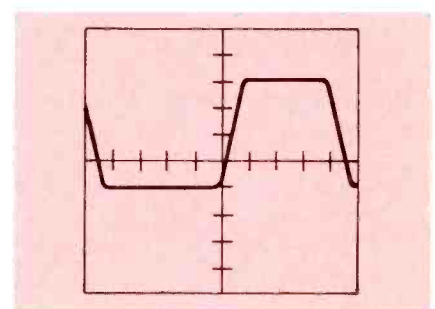

(E) Triggering at low point on trailing edge.

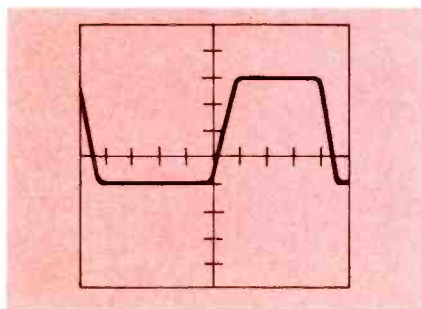

(B) Trigger selector set to -Int.

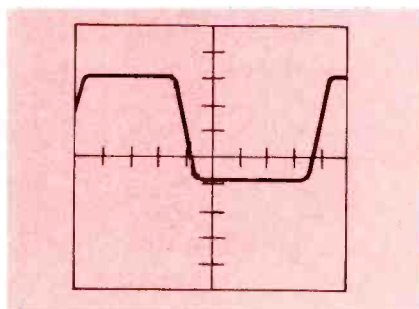

(D) Triggering at high point on leading edge.

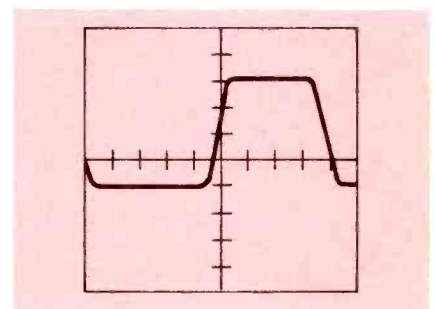

(F) Triggering at high point on trailing edge.

Fig. 16. Trigger controls enable display to start at any point in waveform.

\$100

REWARD

THE EXACT KID



*Be on the lookout for the Wide Ranger. He represents CDE's wide-range electrolytic program in the TV serviceman's never ending fight for easier, faster, more profitable service calls.



There's a \$100 reward for anyone who can challenge the exact ratings of electrolytics and get the Exact Kid! Try your luck and meet CDE's **WIDE RANGER*** at the 1967 NEW Show-Booth 4506-4508. Other prizes, too!

CDE CORNELL-DUBILIER

DELHI

68 FOOT SELF-SUPPORTING TV TOWERS

are only part of our line of precision-built Towers, Masts and Accessories for domestic TV, amateur, CB and lighting installations.

- ★ **DMX Series Towers** — uniformly tapered, self-supporting with concrete bases, have channel legs and riveted "X" braces. Six models from 28 to 68 ft.
- ★ **DMX Series Towers** — but with steel cylinder bases, needs no concrete and can hinge-up. Five models from 20 to 52 ft.
- ★ **DMX Series Heavy Duty Towers** — with concrete bases for supporting amateur arrays. Three models from 32 to 48 ft. plus mast.
- ★ **DME Series Towers** — with parallel channel legs and riveted "X" braces. Six bracketed models from 16 to 52 ft. Guyed to 80 ft.
- ★ **Commercial Guyed Towers** — up to 120 ft.
- ★ **Golden Nugget Tubular Towers** — with rust proof welds, available in 10 foot sections in 18 or 16 gauge.
- ★ **Tripod Roof Mounts** — in 3, 5, 8 and 10 foot models.
- ★ **Pop-up Masts** — from 20 to 50 ft.
- ★ **Welded Galvanized Mastings** — in many lengths, diameters and gauges, swaged or plain.

Ten years of tower building experience plus careful engineering and modern, progressive manufacturing techniques assure your satisfaction.

Visit our Booth No. 4413 at the Electronic Distributors Show, Chicago. Ask about our Show Special — You could save your show expenses.

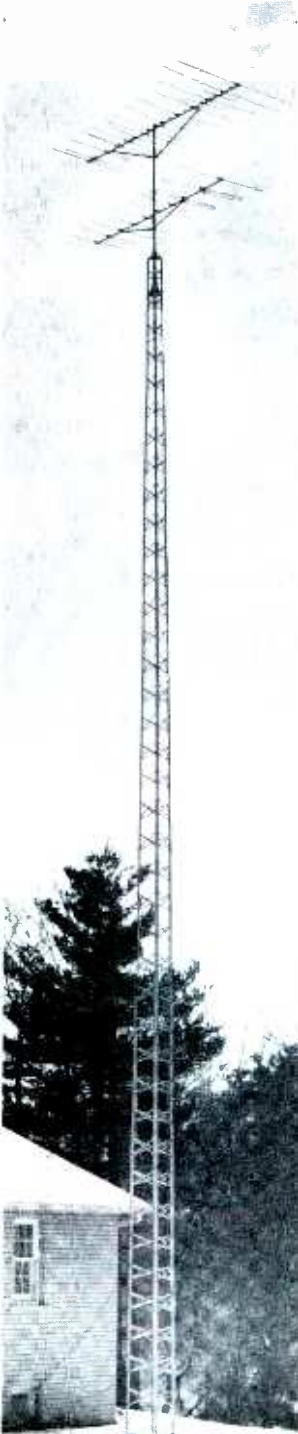

U.S. Patent applied for

DELHI

DELHI METAL PRODUCTS, INC.
SHERIDAN, INDIANA 46069

IN CANADA — DELHI METAL PRODUCTS LIMITED
DELHI, ONTARIO

Circle 31 on literature card

Transistor TV Techniques

(Continued from page 39)

time, and the positive portion of the waveform cuts the transistor off during flyback time.

The damper circuit uses a silicon diode. Another diode is often used to rectify a pulse from the high-voltage transformer to provide approximately 100 volts for the video amplifier. To troubleshoot the damper-circuit, follow standard practices: Check the diodes and capacitors for shorts, and the transformer windings and resistors for opens.

Vertical Circuits

These are essentially transistor counterparts of the tube multivibrators that have been in use for years. A pulse is fed back from the output of the circuit to the input to sustain oscillation. For this reason, a fault in any part of the stage will stop vertical deflection and there will be no waveform available anywhere in the circuit for scope tracing.

A multivibrator is really just an amplifier with a portion of the output fed back to the input. Therefore, a small signal can be introduced into the input circuit (from a signal generator always through a capacitor), and followed using a scope as a signal tracer to find the defective stage.

For problems of insufficient height or poor linearity, be sure to check any electrolytic capacitors in the circuit for us to discuss all of them here. One thing that we do suspected one is the quickest test you can make.

AGC Circuits

There are too many different kinds of AGC circuits AGC polarit in the direction to cut off the transistor, it want to point out is that just about all(if not all) transistor TV circuits use "saturation" AGC.

Saturation AGC means that instead of having the AGC polarity in the direction to cut off the transistor, it is in the opposite direction. Therefore, the transistor is driven toward, or into, saturation. Thus, a PNP IF or RF transistor will have more negative voltage applied to its base when the incoming signal increases, even though a PNP transistor requires a positive bias voltage for cutoff.

The reason for using saturation AGC is demonstrated by the circuit in Fig. 5. As the collector current increases (due to the increased negative AGC bias), the voltage on the collector is reduced because of the increased drop across R3. The decreasing collector voltage quickly

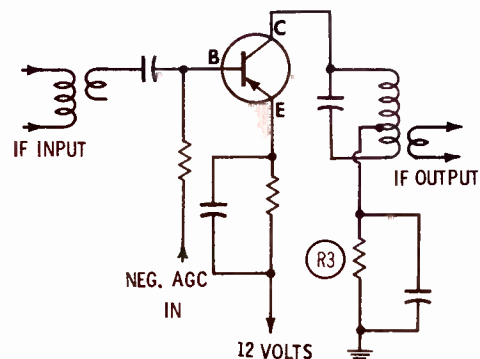

Fig. 5. AGC applied to transistor base saturates transistor.

Will solid state technology stump your TV technicians?

Not if you take advantage of all the training help made possible by Motorola's greatly expanded field-service staff.

Read what it can mean to you.

No question about it. A technological revolution is now underway in the home entertainment business. Radios are solid state. Stereos are solid state, and now TV is rapidly going solid state. And, the trend is bound to continue as customers seek other products with advanced space-age reliability. But, if your men understand tube technology—they can learn transistor technology quickly.

That's why Motorola has introduced the new "Professional Technician Program." Our training staff of technical representatives has been greatly expanded to handle the program. These men will work with Motorola Distributor Service Representatives . . . and in some cases with your own men in your own shop to help them learn the new technology.

With the help of P.T.P., Motorola distributors have strengthened their own service training programs, too. Some have training facilities set up in their own places of business so you can send your technicians in for "refresher courses."

Many hold periodic training meetings for large groups. Motorola Regional Service Managers are often in attendance at these meetings to provide detailed information about design and service features.

Just talk with the service manager from your Motorola Distributor's. He is well prepared to help you with training for solid state circuitry. Motorola is the television industry's largest producer of solid state components and a leader in solid state technology.



Get less for your money!

less crossmodulation,
less harmonic interference,
less windshield wiper effect,
less hash, herringbone, beat

That's why the new Blonder-Tongue Homer gives you more "clean" signal. This one-transistor amplified splitter nearly triples TV or FM signals (9 db) with 2 sets operating from a single antenna; doubles the signal (6 db) with 4 sets. A dramatic new circuit design, called I.C.E.F. (Inductive Coupled Emitter Feedback) is employed for the first time in any RF amplifier. It turns washed-out pictures into clear, life-like ones; fuzzy stereo FM signals, into rich ones.



This new patent-applied-for circuit combines the low distortion and strong signal handling properties of the common base circuit with the low noise, high gain properties of the common emitter circuit.

There's more to recommend the Homer. Its unusually good interset isolation eliminates the problem of interaction between sets. It uses 75 ohm coax cable, the same kind professional installers use in master TV systems. It mounts easily anywhere in the house. Finally, the Model HVB-3P at \$27.50 suggested list (including coax connectors) represents today's best value in a powered splitter. Make an extra profit with it on your next installation or service call.

Blonder-Tongue Laboratories, Inc.,
9 Alling Street, Newark, N. J. 07102.

BLONDER-TONGUE



Circle 33 on literature card

drives the transistor toward saturation, and so a kind of "amplification" of the AGC occurs. Another advantage of this circuit is that the load on the input circuit remains fairly constant. Detuning of the IF stage does not occur, as it might if the transistor were cut off.

Precautions in Transistor TV Service

1. The first precaution is not to be overly cautious about using normal service procedures. Transistors will forgive a lot of mistakes—not all, but a lot.
2. Don't turn up the volume control without a speaker connected to the set. This can damage the audio output transistor.
3. If transistors use sockets, don't pull them from their sockets while the set is turned on. In most circuits it won't hurt a thing, but once in a while, the surge might ruin one.
4. Don't discharge high voltage too close to a transistor. Under some conditions this may damage a transistor—again not too often, but then one time is too many.
5. Diodes are often used in transistor TV circuits and are notorious offenders in some circuits of some sets. Usually, a check with an ohmmeter will find the culprit.
6. Manufacturers like to sell exact replacement transistors, and we recommend their use if it is possible and convenient. However, many circuits will work well with substitute transistors. For example, an auto-converter transistor often makes an ideal video driver. Don't interchange germanium and silicon types. If you are in doubt about which kind is used, check on the schematic for the bias value. If it's about .2 volt, it's germanium; if it's higher than about .5 volt, it's silicon.
7. Re-read precaution 1.
Now would you believe—interesting? ▲

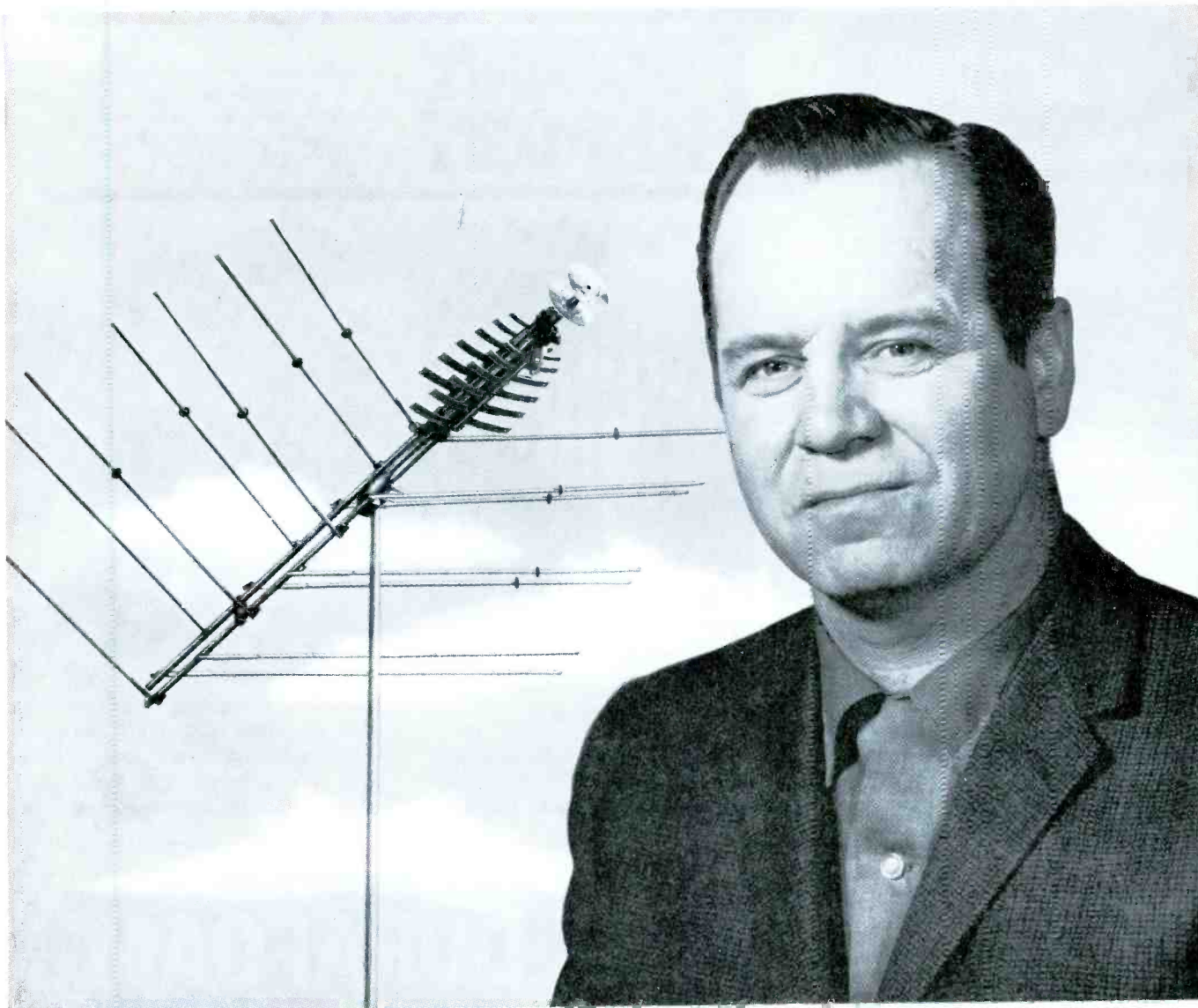

“Out here in the fringes, your reputation depends on the pictures you deliver...”

That's why we stick to JFD Color Laser antennas," affirms HARRY MELANDER, of Melander's Appliance Center, Alta, Iowa.

"The nearest TV stations to us are channels 4 and 9 from Sioux City, over 60 miles away and channel 21 from Fort Dodge, some 70 miles away in the opposite direction. And on their way here the signals have to get through some heavily wooded hills. This makes it real easy for snow and ghosts to creep into the pictures—especially in color.

"We rely on JFD LPV antennas exclusively because they always come through with reception that's ghost-

free and color-true—despite this distance and terrain."

Harry Melander depends on both LPV-TV Log Periodics and Color Lasers—like other professionals—to deliver the performance his customers expect from a professional.

Here's why:

W-I-D-E BAND LPV LOG PERIODIC DESIGN delivers *more gain, higher signal-to-noise ratios, pinpoint directivity* that kills ghosts—VHF and UHF.

SHOWROOM QUALITY COLOR—*flat response across each channel. No "suck-outs" or "roll-off."* *Out-performs any other antenna in color or black/white—keeps customers sold.*

CAPACITOR-COUPLED ELEMENTS work on *both* fundamental and harmonic modes. *Entire antenna* (not just part of it as in other antennas) responds to every channel.

RUGGED NEW "FLIP-LOK" ASSEMBLY snaps out elements—keeps them *tight* and right on target.

Switch to the JFD LPV—the professional's antenna • Your JFD LPV distributor can prove it to you!

JFD®

JFD ELECTRONICS CO.

15 Avenue at 62 Street, Brooklyn, N.Y. 11219

JFD International, 64-14 Woodside Ave., Woodside, N.Y. 11377 JFD Canada, Ltd., Ontario, Canada

JFD de Venezuela, S.A., Avenida Los Haticos 125-97, Maracaibo, Venezuela

LICENSED UNDER ONE OR MORE OF U.S. PATENTS 2,958,081; 2,985,879; 3,011,168; 3,108,280; 3,150,376; 3,210,767; RE. 29,740 AND ADDITIONAL PATENTS PENDING IN U.S. AND CANADA. PRODUCED BY JFD ELECTRONICS CO. UNDER EXCLUSIVE LICENSE FROM THE UNIVERSITY OF ILLINOIS FOUNDATION. LICENSED UNDER ONE OR MORE OF U.S. PATENTS 2,955,287 AND 3,015,821 AND ADDITIONAL PATENTS PENDING.

Circle 34 on literature card

new Sams books

Color TV Servicing Made Easy, Vol. 2



by Wayne Lemons & Carl Babcoke. This second volume brings the technician up to date on new color circuitry and developments introduced since the publication of the best-selling first volume. Initial chapters cover the general theory and circuitry of the newer color TV designs. These are followed by service hints and setup procedures for repairing all brands of color receivers, by actual make and model number. The text is heavily supported by illustrations, including several in full color. 288 pages; 5½ x 8½".

Order 20523, only \$4.50

Transistor Specifications Manual, Revised

The newly revised and expanded edition of this valuable reference provides the electrical and physical parameters for virtually all the transistors now in use. Electrical data includes maximum collector-to-base, emitter-to-base, and collector-to-emitter voltages; maximum collector current; power dissipation; and maximum operating temperature. Also lists frequency gain and leakage parameters. Special section provides physical data, dimensions, and information required to install each unit; another section identifies leads and terminals for each transistor listed. Indispensable to anyone working with semiconductors. 224 pages; 5½ x 8½".

Order 20553, only \$2.95

Synchros and Servos

by Training & Retraining, Inc. This programmed text provides the technician with a clear understanding of synchro and servo motor principles, applications, circuitry, operation, maintenance, and troubleshooting. Also covers the theory and operation of discontinuous, continuous, open-cycle, and closed-cycle control systems, to provide the basic background required to work with the more complex servo mechanisms now in wide use; gives detailed maintenance and troubleshooting methods. Includes questions and answers for helpful study and review. 192 pages; 5½ x 8½".

Order 20533, only \$4.95

North American Radio-TV Station Guide, 4th Ed.

by Vane A. Jones. The latest edition of this widely used guide lists all a-m and f-m radio stations and all television stations in the U.S., Canada, Mexico, and the West Indies. Each station is listed by its geographical location, frequency, call letters, operating power, network affiliation; supplemental information is provided where applicable. 144 pages; 5½ x 8½".

Order 20527, only \$2.50

Projects in Basic Magnetism

by John Potter Shields. The basic principles of magnetism and electromagnetism are demonstrated graphically and interestingly by means of a series of experiments and projects. These include a demonstration induction heater, spot welder, transformer, a-c induction motor, synchronous motor, magnetic amplifier, etc. Over thirty such experiments are covered, and each is coupled with a clear explanation of the basic magnetic principles involved. Each of the projects is easy to perform; only a few low-cost, readily obtainable components are required. 96 pages; 5½ x 8½".

Order 20556, only \$2.25

HOWARD W. SAMS & CO., INC.

Order from your Sams Distributor today, or mail to Howard W. Sams & Co., Inc., Dept. PF-6
4300 W. 62nd Street, Indianapolis, Ind. 46268

Send me the following books:

20523 20533 20556

20553 20527

Send FREE Sams Booklist. \$_____ enclosed

Name _____

Address _____

City _____ State _____ Zip _____

My Distributor is _____

PRODUCT REPORT

for further information on any of the following items, circle the associated number on the Catalog & Literature Card.



CRT Tester (60)

A new CRT Analyzer/Rejuvenator, designated CR-35, has been announced by The Hickok Electrical

Instrument Company. The instrument tests all color and black-and-white television picture tubes for gas, emission, shorts, opens, grid cutoff, and cathode life. It also rejuvenates, re-



DURAFOAM®

Helps Your Customers Enjoy the BEST-LOOKING UHF/VHF & COLOR TV

One of the most critical links in the chain of electronic components between TV broadcast and reception is the antenna lead-in cable. Since it isn't a glamour component, the transmission cable is often overlooked in checking out the customer's set for better reception.

This is a serious matter. Even the finest TV receivers won't give their full potential if they are dependent upon old or inferior transmission cable.

Make sure your customer is getting the full potential of his set by recommending and installing Durafoam cable on every sale. Both you and your customer will be glad you did. Over 18 million feet of Durafoam have already been used to help electronic technicians establish and maintain happier customer relations. Under U.S. patent number 3219752.

Unconditionally warranted for 15 years, Durafoam features two, carefully spaced tubes of yellow foam polyethylene for lowest signal loss of any UHF/VHF channel. The outer protective jacket separating the conductors is specially compounded, with high molecular weight, black, polyethylene insulation.

Impedance of the cable is 290 ohms and nominal capacitance is 4.9. Attenuation per 100 feet is 1.04 DB at 100 MC., 3.5 DB at 500 MC and 4.5 DB at 900 MC. Cable size is .410 wide, .150 over foam polyethylene tubes. Available in 500 and 1,000 ft. spools and 50, 75 and 100 foot coils with terminals at one end. Order from your distributor! Write for complete information today!

Columbia

WIRE PRODUCTS CO.

2850 IRVING PARK RD. CHICAGO, ILLINOIS, 60618

Circle 35 on literature card

timesavers for pros

1. Amphenol CRT Commander tests, rejuvenates both color and black and white tubes. Captivated socket assembly reduces lost sockets. 11 filament steps to 20 v give wide range for future CRT development. Built-in high impedance voltmeter 0 to 1000 v, 0 to 5000 v, 0 to 50 KV.

2. Amphenol Signal Commander is battery operated, easily held in one hand. Plug-in frequency modules—840-13 VHF and FM, 340-83 UHF, to cover entire TV Spectrum. Meter accurately reads direct db or mv.



4. Watch this space for a new timesaver coming soon from Amphenol.

3. Amphenol Color Commander cuts alignment time 40%. Nine test patterns—five are exclusive Amphenol timesavers. Three-color-bar test pattern adjusts demodulators without scope—in the home. Single dot pattern simplifies static convergence—returns to the same dot. Squares for horizontal/vertical linearity.



A new brochure.
"What Watch Watcher Service Means to You"
Details your professional service to your customers. For your free copies see your local Amphenol distributor.



AMPHENOL

Circle 36 on literature card

www.americanradiohistory.com

Join the
P.O.M. Club!
(Photofact-of-the-Month Club)

ONLY \$10 PER MONTH
brings you 20% MORE
PHOTOFACT® coverage!



As a P.O.M. member, you get 6 new PHOTOFACT Sets every month to keep you ahead earning more—and you SAVE OVER \$60 PER YEAR! (Individually purchased Sets now sell for \$2.50 each.) Your 6 Sets come in sturdy file folders sealed in factory carton to insure perfect condition and completeness—easier-than-ever to file and use. To stay ahead, to save money—join the P.O.M. Club today!

SEE YOUR SAMS DISTRIBUTOR
OR SEND ORDER FORM BELOW

HOWARD W. SAMS & CO., INC. Dept. PFF6
4300 W. 62nd St., Indianapolis, Ind. 46268

Enroll me in the Photofact-of-the-Month Club. I agree to pay \$10 per month, and understand I will receive 6 current Photofact sets monthly to be delivered by my Sams Distributor (named below).

Name _____

Shop Name _____

Address _____

City _____ State _____ Zip _____

My Sams Distributor is: _____

Signed: _____

pairs shorts, and determines booster effectiveness. The SCR circuitry employed in this unit provides continuously variable, meter-monitored, test voltages which assure availability of correct heater potentials and provides protection against obsolescence. It is small, lightweight, and mounted in a portable carrying case. Price of the tester is \$99.95.



Circuit Breaker Kit
(61)

An assortment of 12 popular circuit breakers for TV sets is available

in kit form from **Mallory Distributor Products Company**. The circuit breakers are exact replacements packaged in a handy plastic box that fits into most tube caddies. Each breaker is equipped with an "anti-cheat," non-cycling reset action and is tab mounted. The kit, complete with cross-reference, is priced at \$9.95.



Thyristor (SCR) Analyzer
(62)

As silicon controlled rectifiers and other types of thyristors continue to gain popularity as circuit components for industrial equipment and home appliances, technicians have become increasingly aware of the need for a test instrument to check these new components. Recognizing this need, **Seco Electronics** has developed the Model 240 Thyristor Analyzer, a compact, solid-state instrument designed to provide information on gate firing voltage and current and peak forward and peak reverse voltage and current.

The new unit, completely self-contained, is designed for plug-in connection to any 115-volt AC outlet. It provides accurate, simultaneous readout on two separate meters. Gate voltages and currents can be checked for matching and sorting to firing circuit requirements. The unit also provides an accurate check of peak forward voltage and current, as well as peak reverse voltage and current to predetermine the proper SCR to use for various operating conditions. Because the analyzer is fast and relatively easy to operate, it is useful for matching SCR's to specific voltage and current parameters, or for sorting SCR's into matched pairs (or threes)

NEW POWER
FROM

FINCO

Model 65-3 VHF-TV ANTENNA AMPLIFIER

improves reception of WEAK VHF-TV signals in FRINGE AREAS even where strong local TV or FM signals are present. **AMPLIFIES UP TO 7 TIMES** for Better Color and B/W



Model 65-3 VHF-TV ANTENNA AMPLIFIER

A two-transistor-amplifier. Engineered to provide the lowest noise and highest amplification with the most desirable overload characteristics.

Amplifier used in conjunction with dual outlet power supply for one, two, or multiple set installations. 117 V 60 cycle input. AC power up to amplifier: 24 volts-60 cycle.

Let Finco solve your Color and B & W reception problems. Write for complete information, schematics and specifications. Form #20-357.

THE FINNEY COMPANY
34 West Interstate St. • Bedford, Ohio 44014 • Dept.

Circle 38 on literature card

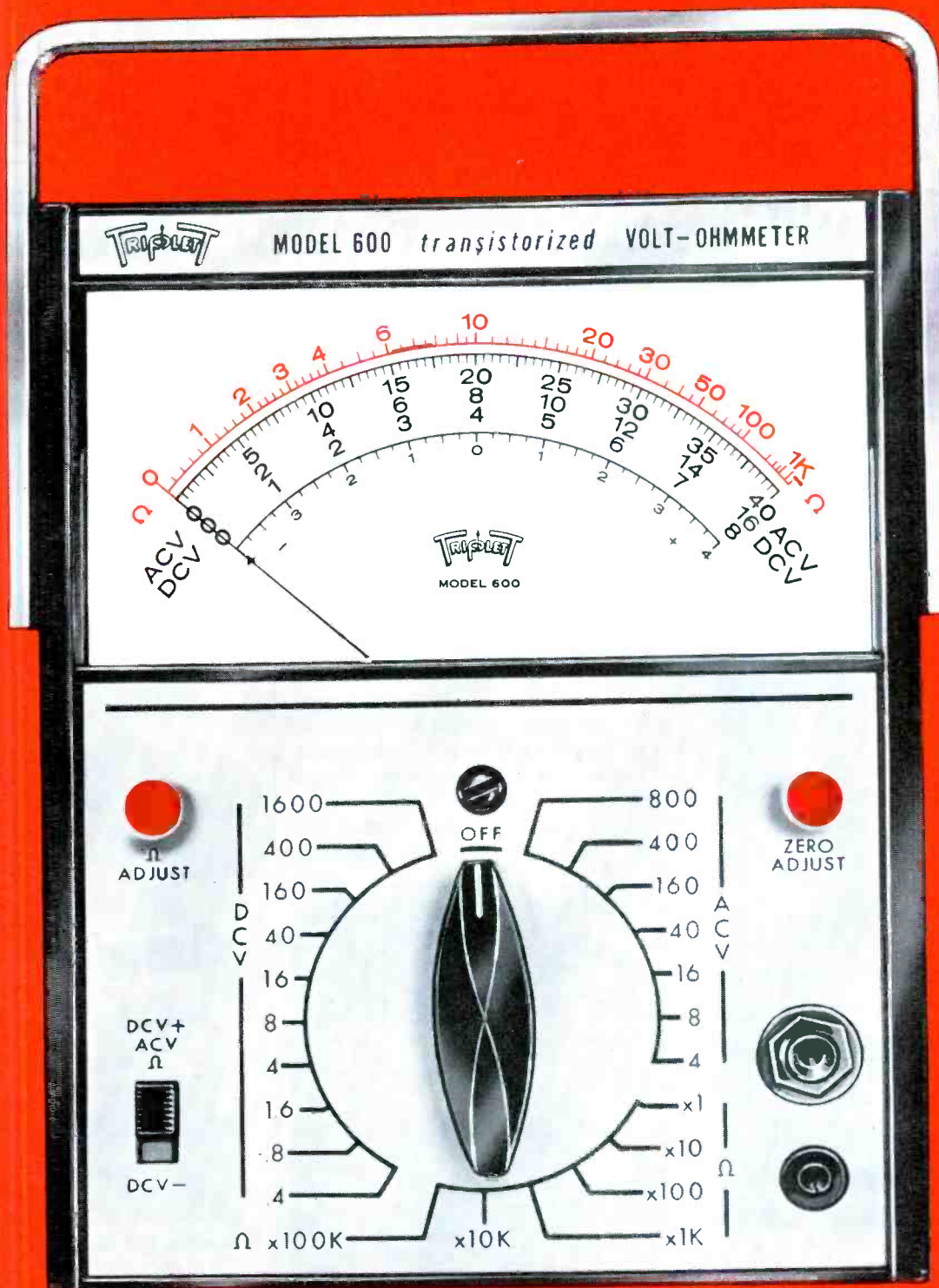

NEW SOLID STATE VOLT-OHMMETER

1. F-E-T Circuitry—Battery Operated with 11 Megohm Input Impedance (Field Effect Transistor).
2. 400 DC MV range at 2.7 Megohm Impedance for Solid State circuit testing.
3. One Selector Switch with 23 ranges plus a Polarity Reversing Switch.



Circle 39 on literature card

Model 600 on stand handle leather case, \$14.00

Model 600 TVO
(Transistorized Volt-Ohmmeter)

\$78

Suggested U.S.A. User Net
Available Now At Your
Local Distributor

www.americanradiohistory.com

TRIPLET

ELECTRICAL INSTRUMENT COMPANY
BLUFFTON, CHIO

ACTUAL SIZE

Eliminate confusion duplication waste

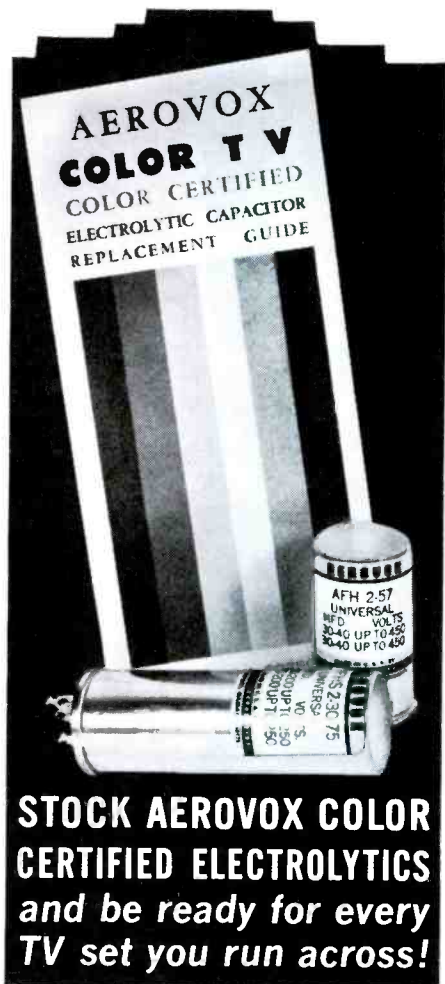

**STOCK AEROVOX COLOR
CERTIFIED ELECTROLYTICS
and be ready for every
TV set you run across!**

Your customers will like the idea of a high quality "COLOR CERTIFIED" Aerovox Electrolytic replacement going into his set... and you will like the ease and convenience afforded by the New Aerovox Color TV Color Certified Electrolytic Capacitor Replacement Guide.

Get one of these guides FREE the next time you visit your Authorized Aerovox Distributor—and while you're at it, put in a supply of Aerovox COLOR CERTIFIED electrolytics to take care of your service needs... you just can't go wrong.



DISTRIBUTOR DIVISION, New Bedford, Mass. 02741

Circle 40 on literature card

70 PF REPORTER/June, 1967

to share work loads evenly in full-wave or three-phase applications.

The Model 240 is mounted in a vinyl-covered carrying case measuring 10½" high by 9" wide by 5" deep. It is equipped with insulated binding posts that accommodate either "tip" or "banana" plugs. A power cord for plug-in connection is also furnished. Price is \$144.50.



Video Tape Recorder (63)

A new, solid-state, industrial video tape recorder, designated NV-204, has been announced by **Matsushita Electric Corp. of America**, which markets its radios, TV receivers, phonographs, and video and audio tape recorders under the Panasonic



ERSIN MULTICORE

NEW EASY
DISPENSER
PAK ONLY 69¢

BUY IT AT RADIO-TV PARTS STORES

Multicore Sales Corp. Westbury, N.Y. 11591

Circle 41 on literature card

NEW! from SECO

"IN-CIRCUIT" CURRENT CHECKER

Eliminates most common cause of "callbacks" (unstable focus, shrinking pictures, etc.)! Should pay for itself on next months' calls alone!

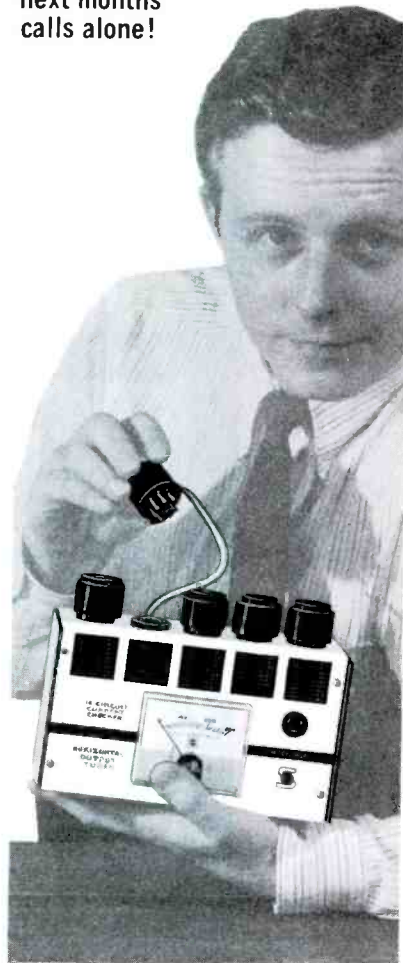

Nothing else like the HC-8 available! Tune horizontal drive and linearity for "dip"—and in seconds—you've got best possible focus, width and stability at minimum cathode current. Makes convergence adjustments faster, easier—longer lasting!

Especially useful on color TV where a slight misadjustment of horizontal linearity or efficiency coils drives cathode currents sky high! 5 pre-wired sockets for all popular horizontal output tubes lets you Model HC-8 plug into circuit fast—no clipping or unsoldering of leads! **\$34.50** Net

ASK YOUR DISTRIBUTOR
or write for full details.



**SECO
ELECTRONICS CORP.**

1001 Second St. So. • Hopkins, Minn. 55343

Circle 42 on literature card

New **B&K** Dynamic Transistor Analyst

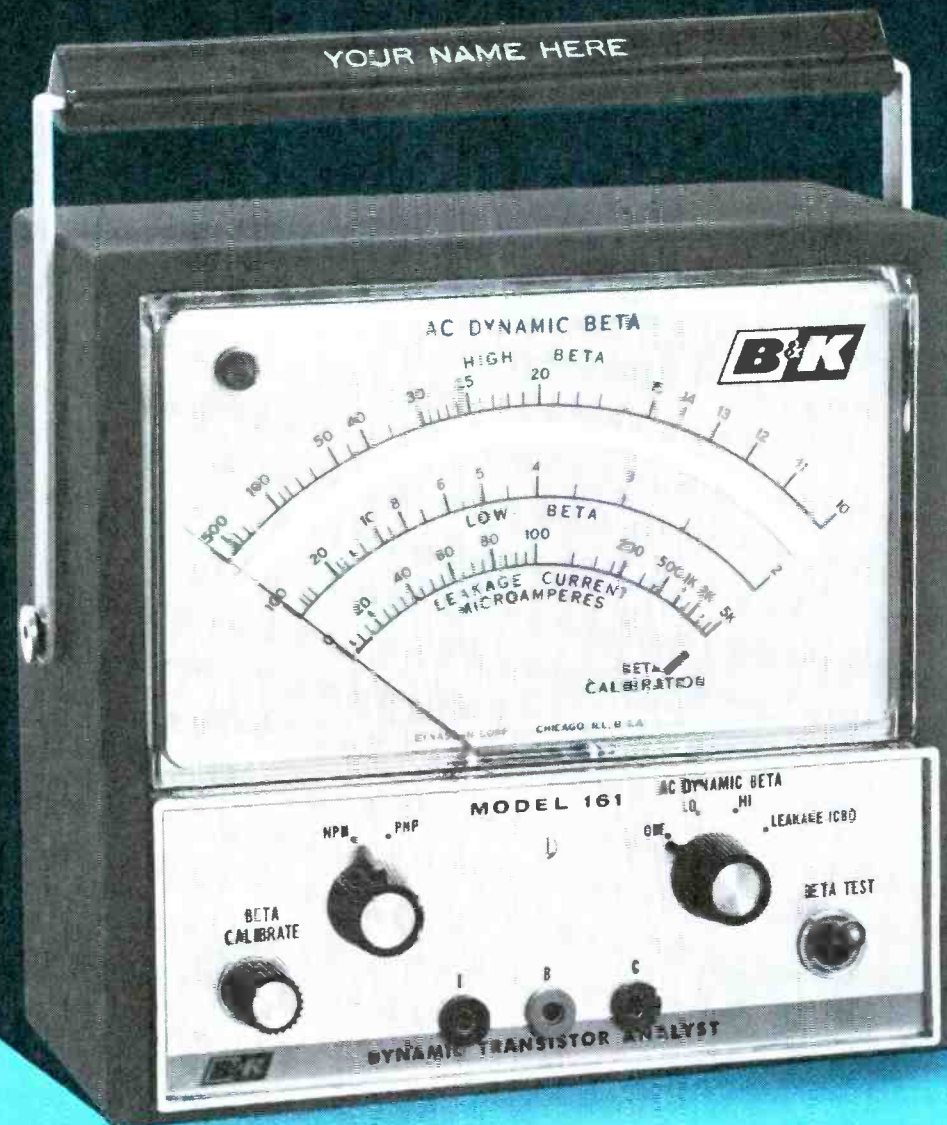

Simple to operate... fast ... safe to use. In-Circuit Transistor Tester. Personalized for professional pride.

B&K ends the mystery, fears and misunderstanding surrounding transistor servicing, application and theory. With every Model 161 Transistor Analyst, you get *two free reference manuals*: the new edition of Howard W. Sams' Transistor Specification Handbook, plus the all-new, years-ahead B&K Basic Course on Transistors—everything you need to know to test and service unfamiliar solid-state sets. You get ahead of your competition and stay ahead of the market.

The new B&K 161 means fast, accurate, *in-circuit* testing of transistors for AC Beta. With the same simple procedures, the 161 makes out-of-circuit tests, too, including I_{cbo} (current leakage) and front-to-back conduction of diodes and rectifiers. There's no chance of damaging transistors or components; special circuitry protects all parts, even if leads are connected incorrectly. The huge 7" mirrored meter insures accurate readings on three separate scales. Two ranges check AC Beta: 2 to 100; 10 to 500. For leakage tests, I_{cbo}

range is 0 to 5000 microamps on an expanded scale for better readability. A flick of the switch checks polarity. It's so simple, you don't need any set-up book.

To stay ahead of the game, get the B&K Model 161 with a scuff-proof case and the two exclusive B&K Transistor reference manuals. A complete transistor service package with all leads included and your personalized name plate—for only \$89.95.

E&K Division of Dynascan Corporation
1801 W. Belle Plaine • Chicago, Illinois 60613



Circle 43 on literature card

Where Electronic Innovation Is A Way Of Life

label in this country. The unit employs five motors, records on a 1" magnetic tape, permits reduction of tape speed to two frames per second, in addition to "stop frame", forward or reverse. A special "pause" lever allows instant "stop action." Other features include a picture resolution of 350 lines, color compatibility, and fast forward or rewind in 2¾ minutes. The recorder can be operated in either vertical or horizontal position. A complete remote control unit and microphone with stand are available

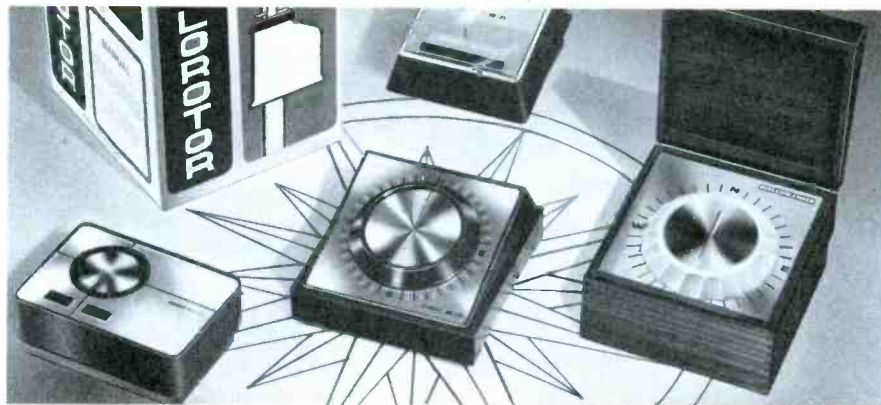

SHARP NEW BRITENER PROMOTION!

Free

SCISSORS

with your next pack of
Vu-Brites or Tu-Brites

This useful premium item is a cut above most "free gifts," just as Perma-Power Vu-Brites and Tu-Brites are a cut above most briteners. These are 6 and 8-inch straight trimming scissors, nickel-plated, with magnetized blade tips . . . and they're included with both of these specially priced Britener Packs . . . available now from your distributor.

SHARP
SERVICEMEN
RELY ON
PERMA-POWER
TO GIVE
EXTRA LIFE
TO FADING
PICTURE
TUBES!

◀ **TU-BRITES**—If the base is right, the boost is right! 4 assorted Tu-Brites—only \$8.95—including the scissors!

VU-BRITES—The world's best-selling Britener! 12 Series or 12 Parallel Vu-Brites—only \$9.95—including the scissors! ▶



PERMA-POWER COMPANY

5740 North Tripp Avenue—Chicago, Illinois 60646
Phone: (312) 539-7171

as optional equipment. Price is under \$4,000.

Antenna Rotators

(64)

A new semi-automatic antenna rotator is included in **Channel Master's** new Colorotor line, which also features a manual rotator and two different console stylings in automatic models. In addition to changes in styling, the drive units for all new models have been designed with increased torque to handle heavy fringe area color antennas and stacked arrays.

The Semi-Automatic Colorotor, designated Model 9513, incorporates a motor in the control console instead of a meter. The motor drives the position indicator dial and is synchronized with the exterior drive unit motor to provide precise aiming and relocation of stations. Installation of the new semi-automatic model is simplified through the use of three-conductor wire.

New control console styling has also been incorporated in manual Model 9503, automatic Model 9512, and deluxe wood cabinet, automatic Model 9516A. All motorized control units utilize quiet-running polyurethane gears and acoustically "re-designed" housings for maximum sound dampening. Prices include \$39.95 for the manual model, \$44.95 for the semi-automatic, \$49.95 for the automatic, and \$59.95 for the automatic model with a wood cabinet control console.

ERRATUM

In the April Product Report we erroneously reported the price of Nortronics' Model WR-30 full-track conversion kit as being \$75.00. The correct price is \$57.00.

Circle 44 on literature card

This **Remington** PREMIER PORTABLE TYPEWRITER

FREE



**WHEN YOU BUY THIS RCA WR-64B
COLOR BAR / DOT / CROSSHATCH
GENERATOR...THE ESSENTIAL
COLOR TV TEST INSTRUMENT**

Here's a deal you can't afford to miss! A FREE Remington portable typewriter—yours when you purchase the most essential color-TV test instrument—the RCA WR-64B!

Just imagine how handy your new typewriter will be—in the shop or at home. You'll use it almost as much as you use the RCA WR-64B—standard of the color TV servicing industry.

Here's how to get your FREE Remington Typewriter. Mail in the warranty card plus the gold label from the shipping carton of your new RCA color bar generator to RCA Test Equipment Headquarters, Bldg. 17-2, Harrison, N.J. We will ship your new Remington portable typewriter to you direct, freight prepaid. But remember—this offer covers only equipment purchased between February 1, 1967 and July 15th, 1967. To allow for postal delay, we will honor cards postmarked up to July 31st.

Plan NOW to take advantage of this BIG offer—a FREE Remington portable typewriter with your purchase of an RCA WR-64B color bar/dot/crosshatch generator.



The standard of the Color-TV Servicing Industry. Generates all necessary test patterns—color bars, crosshatch, dots plus sound-carrier. Only **\$189.50***

*Optional Distributor resale price. All prices subject to change without notice. Price may be slightly higher in Alaska, Hawaii, and the West.

Ask to see it at Your Authorized
RCA Test Equipment Distributor

RCA Electronic Components and Devices, Harrison, N.J.



The Most Trusted Name in Electronics

WHAT'S SO GREAT ABOUT OAKTRON SPEAKERS

?

SUPPLYING ALMOST EVERY MAJOR MANUFACTURER OF RADIOS AND TV, OAKTRON HAS ONE OF THE WIDEST RANGES OF SPEAKERS ON THE MARKET.

THE DISTINCTIVE BLUE SPEAKERS FROM OAKTRON ALL HAVE TRUE ALUMINUM VOICE COILS

ALUMINUM VOICE COILS ELIMINATE WARPAGE FROM HUMIDITY AND OVERLOAD HEAT. YOU GET INCREASED SENSITIVITY AND LONGER LIFE. BETTER QUALITY MEANS BETTER RELIABILITY. BEST OF ALL, THEY COST NO MORE THAN PLAIN SPEAKERS. CHECK YOUR LOCAL DISTRIBUTOR FOR COMPLETE DETAILS OR WRITE

YOUR BLUEPRINT TO BETTER SOUND
OAKTRON
INDUSTRIES, INC.
MONROE, WISCONSIN

Circle 47 on literature card



Sweep Generator (65)

Alignment and peaking of color TV and FM stereo receivers is aided by a new sweep generator and marker adder introduced by **Precision Apparatus**. Designated Model E-410C Sweep Generator and Marker Adder, the new instrument combines a wide-range, frequency-modulated signal source with complete marker adder circuitry specifically designed for the alignment and maintenance of TV, FM, and other high-frequency, wide-band receivers and circuits.

Six-band frequency coverage extends from 3 MHz through 1080 MHz. Features include continuously variable sweep width, marker adder, internal blanking, automatic gain control, and fixed frequency markers. Dimensions of the unit are 13" x 8½" x 7". Price is \$169.95.

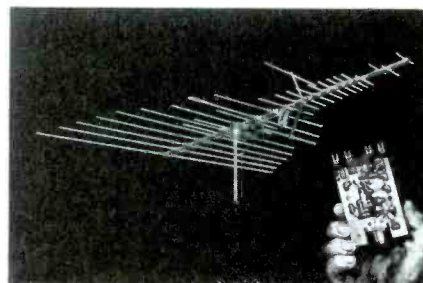

New Antenna Line (66)

New electronic and construction designs are featured in **Winegard's** new Super Colortron antenna line. Among the electronic features are instant-loading, solid-state cartridge pre-amps and terminal cartridges that slip into a totally enclosed, weatherproof cartridge housing at the point of signal interception. Both 300- and 75-ohm VHF, UHF, and 82 channel cartridge preamps are available—six models in all. Three other cartridges are also available. A color spectrum filter cartridge passes only pure TV signals and shuts out all other electromagnetic frequencies. The 300-ohm or 75-ohm

**There's a heckuva lot of VTVM units around.
Only the 177 "Professional"
has battery eliminator, mirrored scale,
half volt scale for transistor circuits
and—your name.**

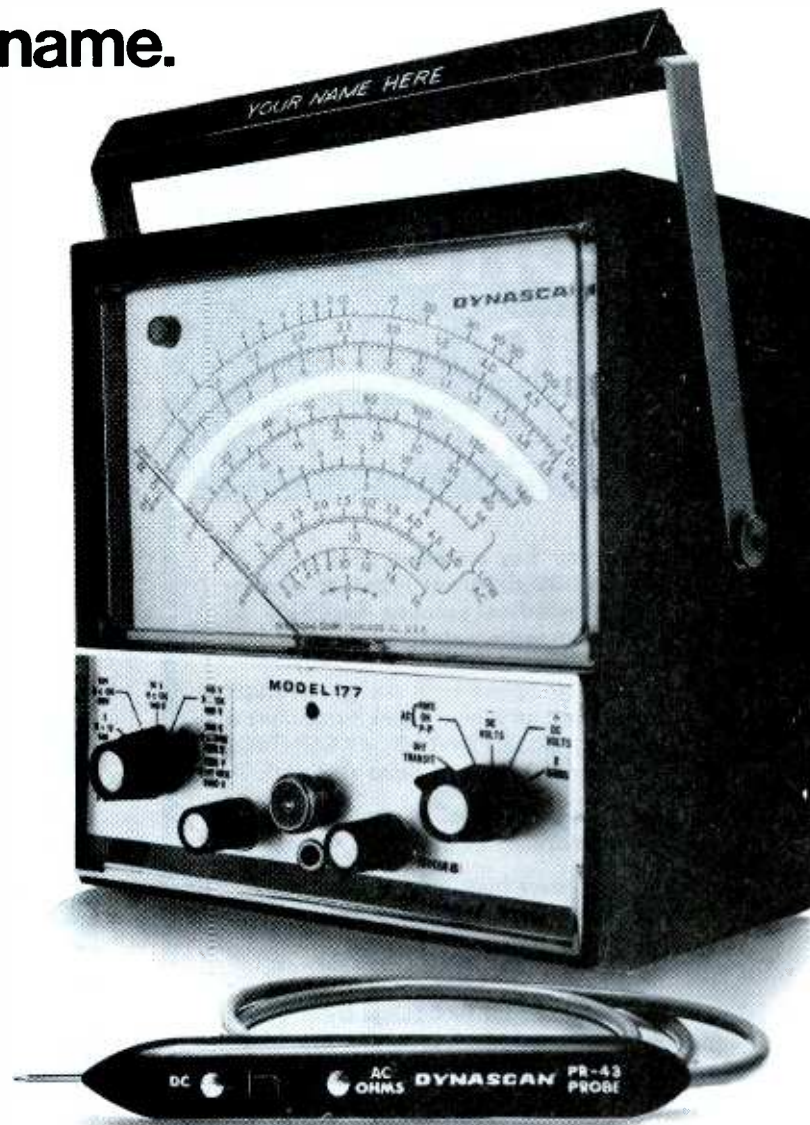

If you're one of the skeptics who think one VTVM is pretty much like another, the B&K 177 "Professional" will change your mind. This one stands out from the crowd.

A gigantic 7" mirrored scale reads faster, more accurately. An extra-sensitive 0.5 VDC range will check transistor circuits.

A zener diode regulated power supply insures reliable ohmmeter performance. No batteries required. A single probe ends cable fumbling. Transit switch position protects the meter on the road. The vinyl covered steel case is good-looking and tough. Its appearance symbolizes your professional status and, above all, it has B&K quality.

Any way you look at it, the 177 "Professional" is really different and it's all yours—the handle is personalized with your name. Cost? Just \$79.95.

B&K Division of Dynascan Corporation
1801 W. Belle Plaine • Chicago, Illinois 60613



Where Electronic Innovation Is A Way Of Life

Circle 48 on literature card

June, 1967/PF REPORTER 75

terminal cartridges give complete weather protection when a pre-amp or color spectrum filter is not used.

Other electronic features include impedance correlators that automatically increase 75-ohm driven elements to 300-ohms, providing 100% signal transfer from antenna to set. Another new electronic feature is the vertical resonant reflectors that provide increased vertical capture area and greater gain on channels 14 through 83. Special UHF control elements provide peaking for channels 52 to 83 in areas where higher gain on these

channels is desirable. The same feature is available on the FM band, permitting attenuation in areas where strong FM signals interfere with TV signals.

In addition to the many electronic features of the new line, construction innovations have also been employed. A built-in weatherproof cartridge housing is an integral part of the antenna and completely eliminates exposed terminals. The blue anodized boom on the Super Colortron is ellipsoidal, specially engineered for antennas to provide greater strength and rigidity. A special aluminum alloy is used for

all antenna elements, making the elements more resistant to bend and wind distortion. New hi-impact Polystyrene wrap-around insulators completely encapsulate and weatherproof elements at the point of electrical contact. They provide perfect alignment of elements by locking the entire circumference.

All antennas in the new line are completely anodized for sunfast, permanent weather protection. There are five 82-channel antennas from \$21.50 to \$69.95, four VHF models from \$24.95 to \$64.95, and three UHF models from \$14.95 to \$32.95. ▲

Duotone[®] MOVES INTO THE COMPUTER AGE!

40 REASONS
Why You
Should Sell
DUOTONE
Phonograph
Needles...

A survey has revealed that only 39 of the 300 different types of phonograph needles account for 91% of current needle sales!

DUOTONE, pioneer in the phonograph needle industry, now offers distributors a COMPUTERIZED INVENTORY CONTROL PROGRAM based on these findings...

- Keeps fresh supplies of popular demand 39 styles always in stock
- Turns over inventory with ease as frequently as 5 times a year
- Avoids costly dead inventory

THE 40th REASON: DUOTONE is the only needle PRE-SOLD by a major record company*. 15 million records tell the DUOTONE story on their jackets. Perpetual point-of-use advertising.

WRITE - PHONE - WIRE! We'll be delighted to tell you how our "40+ PLUS INVENTORY PROGRAM" can be installed in your stockroom without delay. VISIT OUR BOOTH #3216 AT THE CHICAGO ELECTRONIC SHOW

Stephen Nester, President of Duotone stands before IBM Computer.

Duotone[®] COMPANY
6875 SW 81st St.,
So. Miami, Fla. 33143

* Name available on request.



Circle 45 on literature card

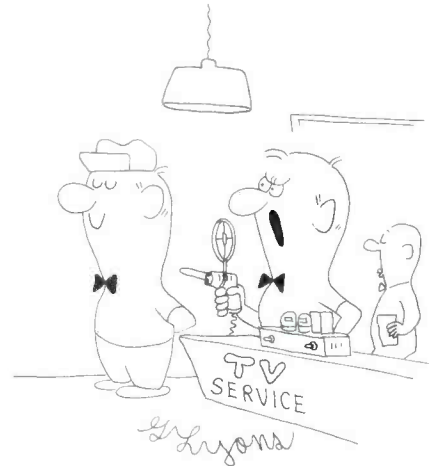

"OKAY, WHO'S THE WISE GUY?"



Now—remove miniature soldered components in seconds—without damage

Hollow tip fits over connection; vacuums all solder for easy removal of component. Leaves terminals and mounting holes clean. Then, with 360° contact, it resolders even faster and better than regular irons. Handles miniature and standard components in printed circuit boards and conventional wiring. Self-cleaning. All parts replaceable. 40 watts, 115-v. 5 tip sizes. Pays for itself in time saved. \$9.95 net East of the Rockies.

Larger model available. See your distributor or write:

ENTERPRISE DEVELOPMENT CORPORATION

5151 E. 65th St. • Indianapolis, Ind. 46220

Circle 49 on literature card



Tips on replacing circuit breakers

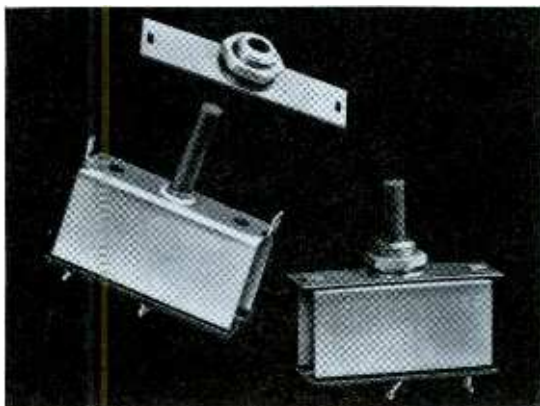
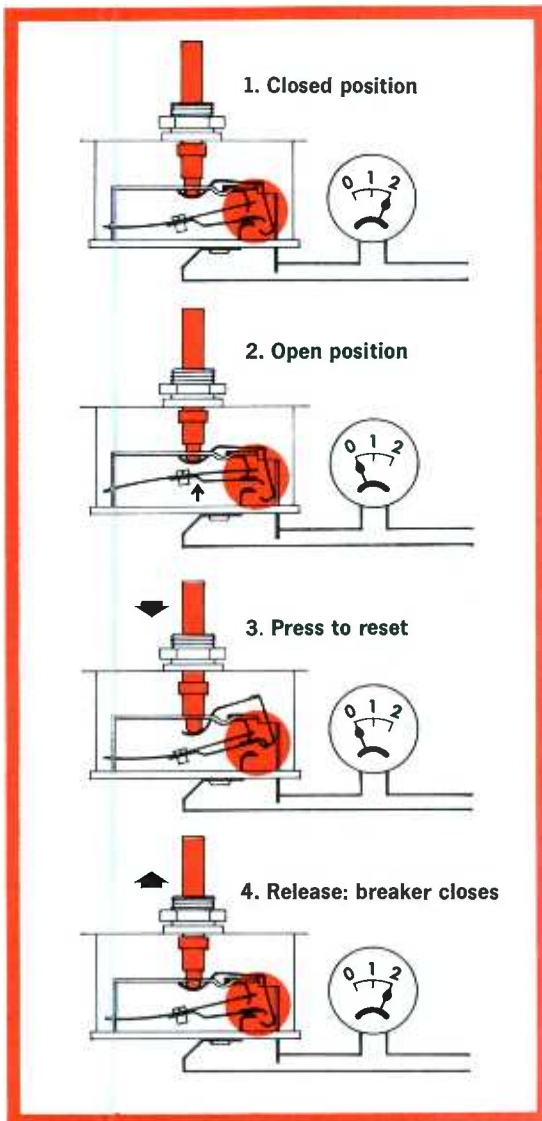

That little red “breaker reset” button that sticks out of the back of nearly every television chassis can be a time-saver or a trouble-maker, depending on what’s wrong inside the set, and who’s pushing the button. As you well know, when a transient fault has popped the breaker, you can get the set back in business just by pressing the reset. But if there has been a short-circuit failure and some uninformed tinkerer presses the button and *keeps* it pressed, there’s a good chance that more power keeps flowing into the fault. Result: a minor trouble becomes a calamity.

This is why Underwriters’ Laboratories require that breakers should be “cheat-proof”—that is, they should not allow current to pass when the reset button is held depressed. Some of the replacement breakers you’ll find on the market *aren’t* cheat-proof. We have one that *is*. It has features that you’ll find valuable any time you need to install a new breaker, or when you’re working on a breadboard circuit that needs over-current protection.

Take a look at how this breaker works, and you’ll see what we mean.

At top (Picture 1) is the way the breaker mechanism looks when it’s in the “on” position.

Along comes an overload (Picture 2). The bi-metal strip heats, snaps into the “break” position, opening the current carrying contacts.

Now you press the button to reset (Picture 3). As long as you hold the button down, the contacts at the right remain open. Release the button and the contacts go back to closed (Picture 4). If the overload is still there, the breaker will open again. You can’t keep it closed on a short circuit!

No wonder this particular breaker is used as original equipment on the majority of all television sets. They’re made for Mallory by Mel-Rain Corp. to the same specifications as for original equipment, and they’re available from a Mallory distributor near you. Off-the-shelf ratings go all the way from 0.5 to 7 amperes break current, and include all the values you’ll need for service replacement or for industrial equipment maintenance. And as an extra convenience, you can get them with either a twist-tab or bushing mount. For your copy of our new 24-page cross-reference guide to circuit breaker replacement in all popular TV sets, see your Mallory distributor, or write to Mallory Distributor Products Company, a division of P. R. Mallory & Co. Inc., P. O. Box 1558, Indianapolis, Indiana 46206.

Circle 50 on literature card

Start here:

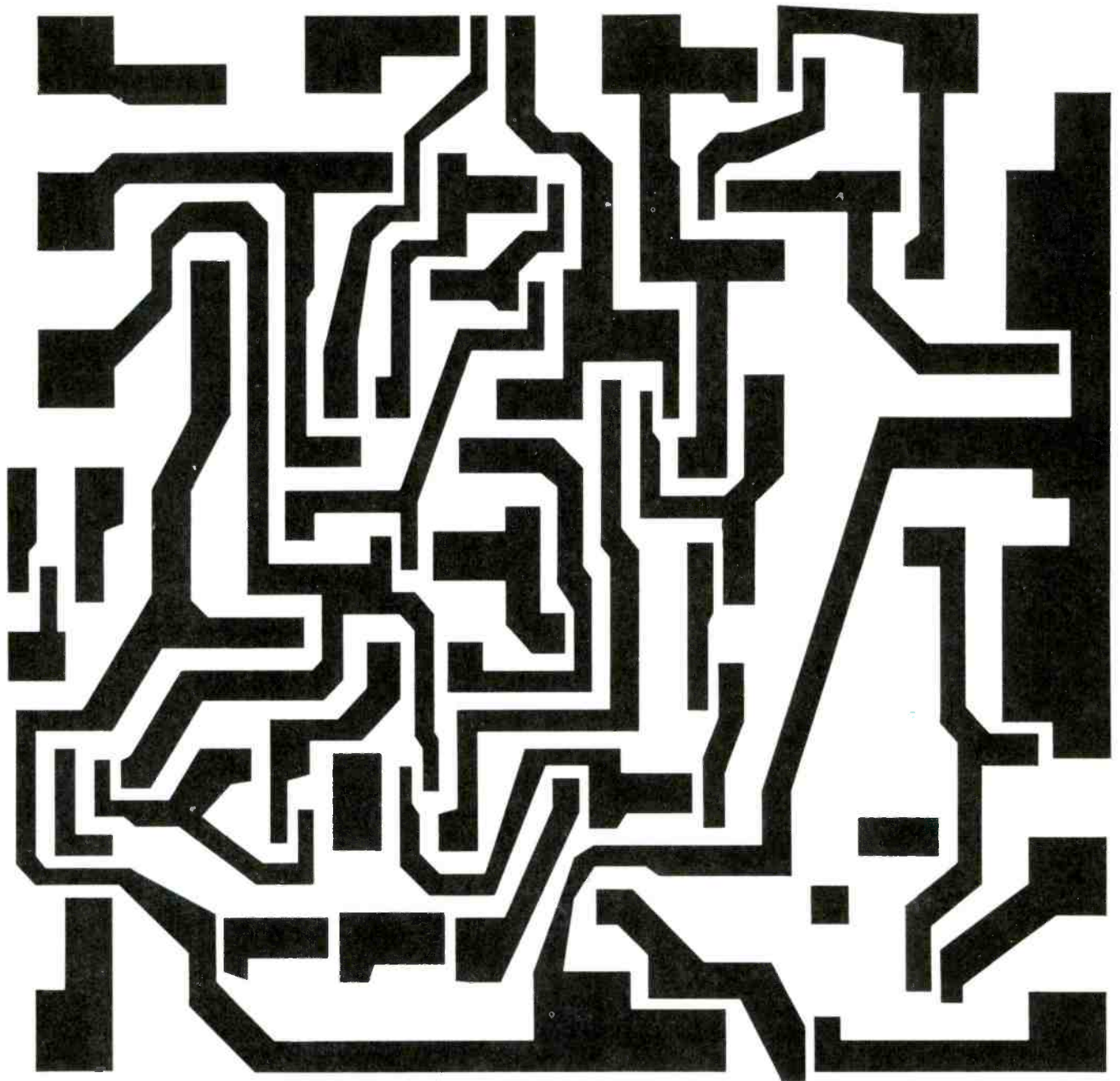

and come out dollars ahead.

(It's an integrated circuit—and RCA Victor uses it now.)

Blown up to several thousand times its actual size, an RCA integrated circuit looks like no more than a maze. In actuality, it's no less than amazing. Just one of these silicon chips may incorporate 40 or 50 electrically interconnected components. Patterns that make up the mosaic are as narrow as two human hairs. Far more amazing than that, though, is their dollar-making potential. Integrated cir-

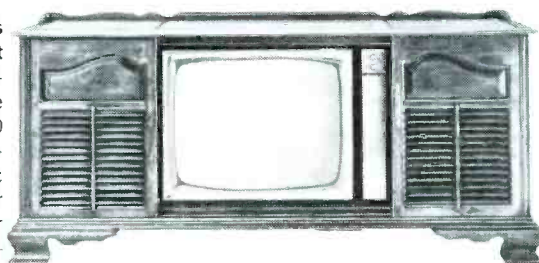

uits are designed to be the most reliable kind of circuitry ever made for a consumer product. Reliability is what prompted RCA Victor to use integrated circuits in the sound system of some of our newest color and black-and-white TV sets. When you start with an integrated circuit, there's just no telling where it can take you.



The Most Trusted Name
in Electronics



NEW



GENERAL PURPOSE
 VINYL PLASTIC
ELECTRICAL TAPE

BUY IT
at your local
GE Electronic
Components
Distributor

Insulating Materials Dept.
GENERAL ELECTRIC
846-03

Circle 53 on literature card

INDEX TO ADVERTISERS

June, 1967

| | |
|--|--------------------|
| Aerovox Corp. | 70 |
| American Telephone and Telegraph | 35 |
| Amphenol Corp. | 67 |
| Atlas Sound | 44 |
| Belden Mfg. Co. | 18, 19 |
| B & K Mfg. Co., Division of Dynascan Corp. | 20, 71, 75 |
| Blonder-Tongue Labs., Inc. | 64 |
| Bussmann Mfg. | 22, 23 |
| Castle TV Tuner Service | 21 |
| Channel Master Corp. | 42 |
| Cleveland Institute of Electronics | 79 |
| Columbia Wire Products | 66 |
| Cornell Dubilier | 45, 46, 61 |
| Delhi Metal Products, Inc. | 62 |
| Duotone Co., Inc. | 74 |
| Eico | 30, 44 |
| Enterprise Development Corp. | 74 |
| The Finney Co. | 68, 79 |
| Gem City Tuner Repair Service | 24 |
| General Electric, Industrial Sales Div. | 79 |
| Heath Co. | 16, 17 |
| Jerrold Electronics Corp. | Cover 2 |
| JFD Electronics Co. | 65 |
| Krylon Div.—The Borden Chemical Co. | 53 |
| Lectrotech, Inc. | 56 |
| Littelfuse, Inc. | Cover 4 |
| Mallory, P. R. and Co., Inc. | 77 |
| Motorola Consumer Products, Inc. | 63 |
| Multicore Sales Corp. | 70 |
| Oaktron Industries, Inc. | 76 |
| Perma-Power Co. | 72 |
| Philco-Ford Co. | 49 |
| RCA Electronic Components and Devices (Battery) | 52 |
| RCA Electronic Components and Devices (Home Study Institute) | 58 |
| RCA Electronic Components and Devices (Parts and Accessories) | 55 |
| RCA Electronic Components and Devices (Picture Tube) | Cover 3 |
| RCA Electronic Components and Devices (Semiconductors) | 57 |
| RCA Electronic Components and Devices (Test Equipment) | 73 |
| RCA Sales Corp. | 78 |
| Sams, Howard W. and Co., Inc. | 66, 68 |
| Sarkes Tarzian, Inc. | 13 |
| Seco Electronics Corp. | 70 |
| SENCORE, Inc. | 37, 39, 41, 43, 47 |
| Sprague Products Co. | 15 |
| Triplett Electrical Instrument Co. | 69 |
| Winegard Co. | 54 |
| Workman Electronic Products, Inc. | 47 |
| Xcelite, Inc. | 24 |
| Zenith Sales Corp.—Parts & Accessories | 48 |

NOW... PERFECT COLOR TV

ELIMINATE FM and OTHER INTERFERENCE

With the Sensational

NEW FINCO FM Trap (Blocks Out FM)



MOUNTS EASILY BEHIND TV SET MODEL 3006

Get pure color signals for perfect color reception. Use a Finco Model 3006 to stop interference and block out unwanted signals from FM, Citizens Band, Amateur transmitters, motors, autos, aircraft, and fluorescent lamps. Size: 4 1/4" x 2" x 1 1/2". Available at your Finco dealer.

Model 3006 Only \$6.25 List

THE FINNEY COMPANY

34 W. Interstate St. Dept. 310
Bedford, Ohio 44014

"FINCO ANTENNAS CAPTURE THE RAINBOW"

Circle 54 on literature card



FREE Electronics Data Guide

Want help in working out those tricky electronics calculations? Send for our FREE Electronics Data Guide. This heavy-duty plastic guide fits right in your shirt pocket—gives you instant reference to over 40 indispensable electronics formulas...plus conversion factors, color codes and decibel table as well. Saves you time and the trouble of memorizing or "looking it up." A "must" for every man interested in electronics—provided as a service by CIE. Why not get your FREE Data Guide today? Just fill in your name and address below, then cut out this ad and mail it to:

Cleveland Institute of Electronics
1776 E. 17th St., Cleveland, Ohio 44114

Name _____
(Please Print)

Address _____

City _____

State _____ Zip _____

Accredited Member National Home Study Council. 902

Circle 52 on literature card



\$ FREES \$

CATALOG AND LITERATURE SERVICES

*CHECK "INDEX TO ADVERTISERS" FOR FURTHER INFORMATION FROM THESE COMPANIES

ANTENNAS

75. **ALLIANCE** — Colorful 4-page brochure describing in detail all the features of Tenna-Rotors.
76. **ANTENNACRAFT** — 12-page catalog listing complete Antennacraft line of UHF, VHF & FM antennas for all types of installations.
77. **BLONDER-TONGUE** — Compact brochure detailing a line of all-channel products expressly designed to improve reception in the home and small MATV systems.*
78. **COLORMAGIC**—Form FR-28-C describes a complete line of antennas and accessories.
79. **CORNELL-DUBILIER** — 16-page booklet illustrates color, black-and-white TV, and FM-stereo reception problems that are eliminated by the installation of a CDE antenna rotor system.*
80. **DELHI**—Twelve-page catalog introducing a complete new line of home TV towers, ham towers, citizen's band towers, masts and telescoping masts.*
81. **FINNEY** — Forms 20-338, 20-356, and 20-357 describing distribution amplifiers and antenna amplifiers for 300-Ohm and 75-Ohm TV and FM systems.*
82. **JERROLD** — New 4-page full-color catalog describes the new Paralog Plus antennas.*
83. **JFD** — Color Laser and LPV antenna brochures. New 1967 dealer catalog covering complete line of log-periodic out-door antennas, rotators, and accessories.*
84. **MOSLEY** — Information on new Mosley MATV system for up to 8 TV/FM sets. Includes TV antenna, distribution system and outlets.
85. **WINEGARD** — 8-page color brochure on new Super-Colortron antennas: 5 VHF-UHF-FM, 4 VHF-FM, 3 UHF. Includes information on 6 new solid-state preamplifiers and 82-channel booster-couplers.*

AUDIO

86. **ATLAS SOUND** — Catalog 556-67 illustrates and describes many new models of public address loudspeakers, microphone stands, and accessories for commercial sound applications.*
87. **DUOTONE** — Catalog of accessory and maintenance items for the audiophile.*
88. **ELECTRO-VOICE** — A comprehensive guide to microphones and microphone accessories is offered in pocket-sized brochure form.
89. **JENSEN**—New electronic musical instrument louspeakers brochure, NY-2, containing newest additions to the line.
90. **KOSS**—Brochure about selected components from the Acoustech line.
91. **NUTONE** — 16-page full color booklet illustrating built-in stereo music, intercom, and radio systems.
92. **OXFORD TRANSDUCER** — Catalog sheets featuring speaker systems for automobiles.
93. **TENATRONICS**—Flyer sheet about a home stereo cartridge player.

COMMUNICATIONS

94. **AMPHENOL** — 2-color spec sheets on new Model 650 CB transceiver and Model C-75 hand-held transceiver.*
95. **COMCO** — Spec sheet on the Model 626 marine radio-telephone.
96. **FANON** — 24-page handbook on intercom systems.
97. **GENERAL RADIOTELEPHONE** — Flyers on the Fieldmaster and MC-9 CB transceivers.

98. **MOTOROLA** — New brochure tells how to reach people on-the-move through use of personal two-way radio.*
99. **PEARCE-SIMPSON** — Brochures and flyers on the complete line of CB transceivers.

COMPONENTS

100. **BUSSMANN** — Bulletin on BUSS Fusat Box Cover Units offers simple, low-cost way to protect work bench tools against damage and burnout. Units fit standard outlet or switch box, have fuse-holder plus a plug-in receptacle, pilot light, switch, etc.
101. **CENTRALAB** — 24-page replacement parts catalog No. 33GL.
102. **COLUMBIA WIRE** — 8-page supplement lists wire, cord, and cable.*
103. **LITTELFUSE** — Pocket-sized TV circuit breaker cross-reference gives the following information at a glance. Manufacturer's part number, corresponding Littelfuse part number, price, color or b/w designation. A second glance gives trip ratings and acquaints you with a line of caddies. Ask for CBCRP.*
104. **MALLORY** — New 1967 full-line catalog.*
105. **QUAM-NICHOLS**—1967 general catalog of speakers.
106. **SONOTONE**—Data reference catalog on a line of nickel-cadmium batteries.
107. **SPRAGUE**—C617, a complete catalog of the Sprague line.*
108. **TRIAD** — 1967-68 replacement catalog. D-816 describes Switchcraft's new "traffic-tailored" audio dealer and distributor accessory merchandiser program.
109. **WORKMAN**—New coil catalog lists general and exact replacements for radio and TV schematic drawings and illustrations of all coils.*

SERVICE AIDS

110. **CASTLE TUNER** — How to get fast overhaul service on all makes and models of television tuners is described in leaflet. Shipping instructions, labels, and tags are also included.*
111. **ELECTRONIC CHEMICAL** — Catalog sheets on aerosol sprays for servicemen.
112. **G.C.** — FR-67G flyer on color harnesses. FR-67A complete Audio-tex catalog.
113. **INJECTORALL** — New 1967 catalog of chemicals and alignment tools.
114. **MIDSTATE TUNER** — 24-hour service on any make tuner is described in a colorful brochure.
115. **PERMA-POWER** — Chart shows correct brightener for every TV set in the field.*
116. **PRECISION TUNER**—Mailing kit and replacement tuner list for same-day service.
117. **QUALITY TUNER SERVICE** — Introductory letter describing costs and service on all makes of TV tuners. Repair tags and shipping labels included.
118. **RAWN**—Bulletins on repair ideas using Plas-T-Pair knob and plastic repair kits. Also, bulletins on tuner cleaners and circuit coolers. Includes price sheets.
119. **SPRAYWAY** — Brochure on C-60 solvent cleaner and degreaser.

SPECIAL EQUIPMENT

120. **VACO** — 28-page, 4-color catalog on solderless terminals.

TECHNICAL PUBLICATIONS

121. **CLEVELAND INSTITUTE OF ELECTRONICS**—Free illustrated brochure describing electronics slide rule and four lesson instruction course and grading service.*
122. **PHILCO**—Information about Tech Data & Business Management service. Also, free parts catalog.*
123. **RCA INSTITUTES** — New 1967 career book describes home study programs and courses in television (monochrome and color), communications, transistors, industrial, and automation electronics.*
124. **RIDER**—Brochures on TV Tech/matics.
125. **SAMS, HOWARD W.**—Literature describing popular and informative publications on radio and TV servicing, communications, audio, hi-fi, and industrial electronics, including special new 1967 catalog of technical books on every phase of electronics.*
126. **SIMPSON**—88-page booklet "1001 uses for the 260 VOM."

TEST EQUIPMENT

127. **B & K**—New 1967 catalog featuring test equipment for color TV, auto radio, and transistor radio servicing, including tube testers designed for testing latest receiving tube types.*
128. **EICO**—New long-form catalog of the complete Eico line.*
129. **HICKOK**—Short form catalog plus specification sheets on the Models GC 660 color generator, CR-35 CRT analyzer/rejuvenator, and 860 Injecto-Tracer.
130. **JACKSON**—New line folder on "Service Engineer," test equipment includes push-button-operated color-dot/bar generator.
131. **LECTROTTECH**—Two-color catalog sheet on new Model V6-B color bar generator, the latest improved model of the V6. Gives all specs and is fully illustrated.*
132. **MERCURY**—All-new-low-price color dot bar generator and Model 2000 conductance tube checker all for under \$100.
133. **PRECISION APPARATUS**—Illustrated catalog describing signal generators, oscilloscopes, and meters.
134. **SECO**—Operating manual for the HC8 in-circuit current checker.*
135. **SEMITRONICS**—Brochure on the new Model 1000 transistor tester.
136. **SENCORE**—8-page full color catalog plus a new 4-page supplement catalog.*
137. **SIMPSON**—New 1967 16-page test equipment brochure featuring a palm-sized VOM, Model 160.
138. **SINGER**—Catalog GD-1 describing frequency meters and standards receivers for the two-way radio communications service.
139. **TRIPLETT**—Literature sheet on the new Model 600 transistorized VOM.*

TOOLS

140. **ARROW**—Catalog sheet showing 3 staple gun tackers designed for fastening wires and cables up to 1/2" diameter.
141. **ENTERPRISE DEVELOPMENT** — Time-saving techniques in brochure from Endeco demonstrate improved desoldering and resoldering methods for speeding and simplifying operations on PC boards.*
142. **XCELITE**—Bulletin N367 on a new 14-piece nut and screwdriver kit.*
143. **GENERAL SEMICONDUCTOR** — 26-page reference list covering 3000 zener and reference diodes.

TUBES AND TRANSISTORS

144. **IR**—Transistor cross reference guide—22 pages of detailed specifications on universal silicon and germanium transistors and a complete listing of more than 5000 devices which they replace.
145. **RADIO CORP. OF AMERICA**—PIX 300, a 12-page product guide on RCA picture tubes covering both color and black-and-white. Includes characteristics chart, terminal diagrams, industry replacement, and interchangeability.*

"DRESS UP WITH QUALITY...!"
FROM RCA

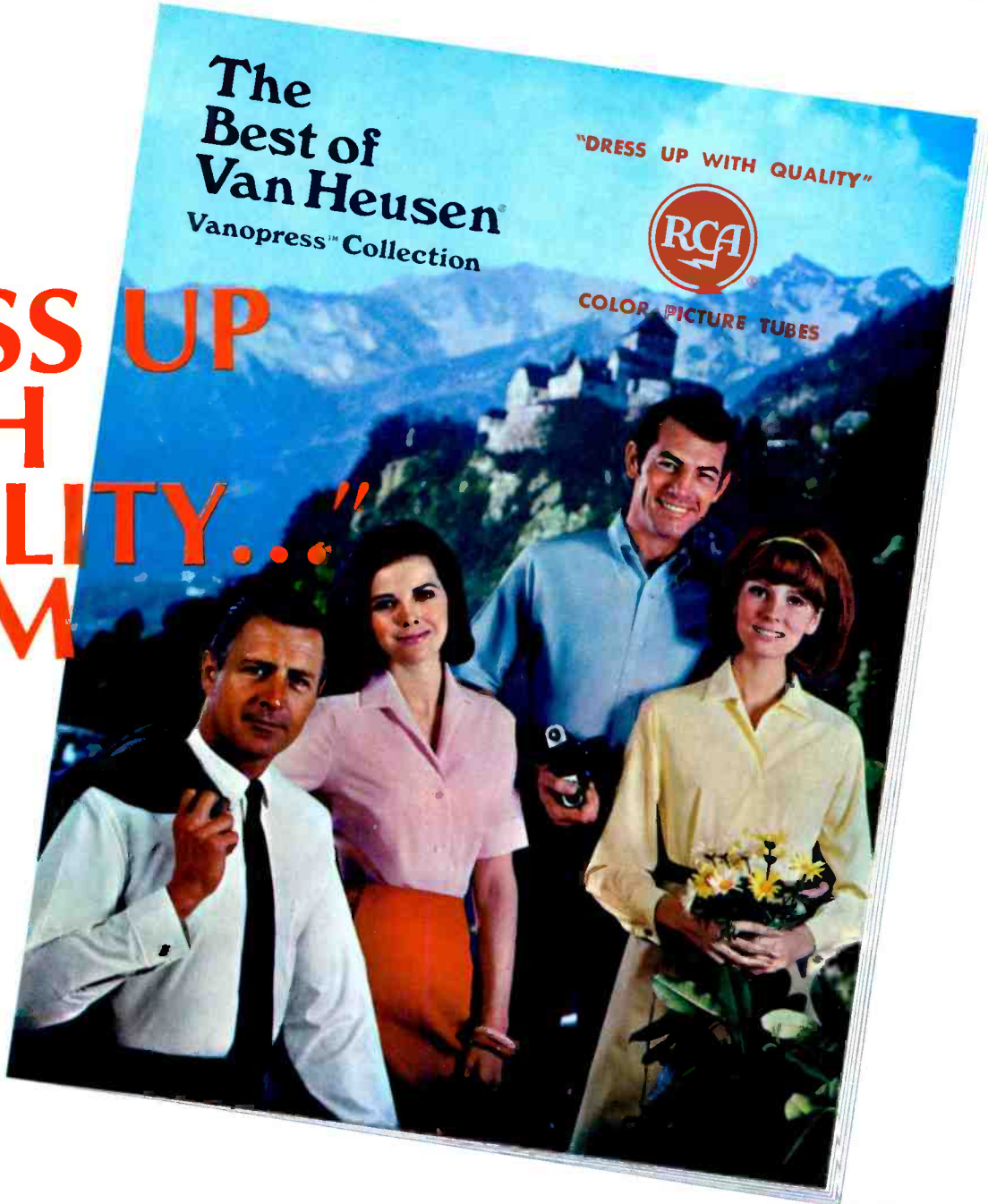

Earn a FREE Van Heusen® Vanopress™ Shirt for each eligible* RCA HI-LITE or Colorama Color TV Picture Tube you purchase between now and July 31, 1967.

Now from RCA, the quality leader in color television, comes the chance for you to "dress up with quality" in Van Heusen shirts, a quality leader in ladies' and men's fashions! And the offer is FREE.

What a selection! You have a 20-page catalog to choose from. *And all are Vanopress... the permanently pressed shirt that never needs ironing!*

You get one shirt FREE through each purchase of any of the four eligible tube types—and there's no limit on quantity.

The details are simple. Complete the Registration Post-card portion of the warranty card, attach it to the Carton Identification Card that comes with each eligible*

tube and mail *both* to RCA, Box 1140, Lancaster, Pa. 17604. They must be postmarked no later than July 31, 1967. Your Van Heusen gift certificate will be sent to you by return mail.

If you have any questions, just call your Authorized RCA Distributor. But don't wait. The more RCA HI-LITE and Colorama tubes you purchase... the more you can dress up with Van Heusen Vanopress shirts. Start now and you can have a whole new wardrobe of shirts by the time this offer ends.

*HI-LITE types H21FJP22A, H21FBP22A

*Colorama types C21FJP22, C21FBP22

RCA Electronic Components and Devices, Harrison, N.J.

The Most Trusted Name in Electronics

Trademark(s) ®Registered

RCA Colorama Picture Tubes contain used materials which prior to reuse are carefully inspected to meet our high quality standards.



Introducing a Complete Line of Littelfuse Quality Circuit Breakers

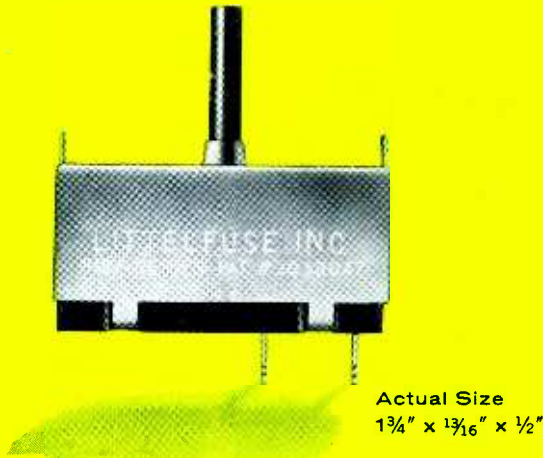

Actual Size
1 $\frac{3}{4}$ " x 1 $\frac{3}{16}$ " x $\frac{1}{2}$ "

Exact replacement from factory to you

Designed for the protection of television receiver circuits, the Littelfuse Manual Reset Circuit Breaker is also ideally suited as a current overload protector for model railroads and power operated toy transformers, hair dryers, small household appliances, home workshop power tools, office machines, small fractional horsepower motors and all types of electronic or electrical control wiring.

LITTELFUSE

DES PLAINES

The Book Garden 801-252-7819 C-14-10
Price \$4.00
PF Reporter, June 1967
Section: Computer Technology
Location: 14m7



93 7853-3-1-15 4 871210-1

Circle 55 on literature card