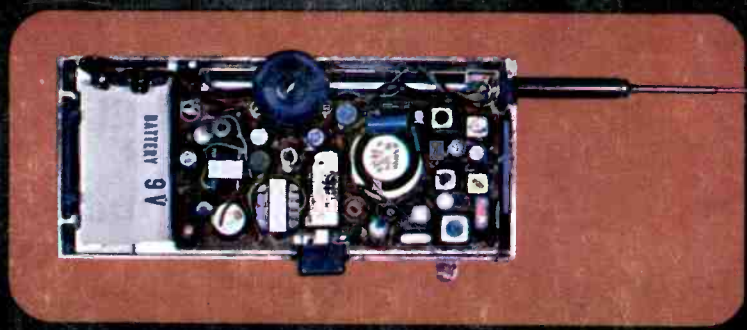


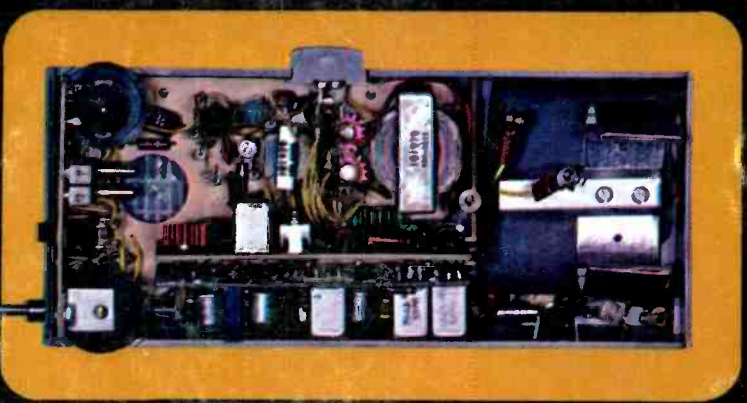
PF Reporter™

PHOTOFACT

the magazine of electronic servicing



LOOKING INTO
**MINIATURE
CB
TRANSCEIVERS**



IA 5L 4279 1268
WM. M. DAVIS
RADIO & TV SERVICE
118 RIVERSIDE AVE.
CANON CITY, COLO.

- Focus and HV Problems in Color Sets
- Square-Wave Tests in Hi-Fi Amplifiers
- Thermistor Circuits in Industry
- Post-Video Twisters
- Investment Tax Credit on Equipment
- Annual TV-Tube Stock Guide

Engineered for Professional Quality and savings up to 50%

Whether you want the creative pleasure and thrift of build-it-yourself, or factory-assembled professional quality equipment ready-to-use—you save up to 50% with EICO

no-compromise engineering. Be super-critical. Compare EICO with anybody else. The more critically you judge, the more you'll see for yourself that your best buy is EICO.

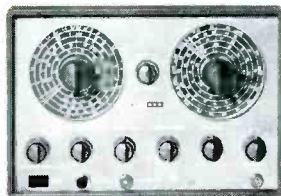
EICO
KITS & WIRED

COLOR TV LAB

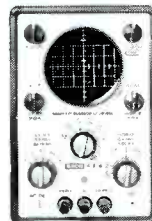
Three compact portable instruments for shop or home Color TV servicing. Add one more and you're set for FM-MPX stereo.



New Model 380 Solid State NTSC Color Generator generates exact NTSC color signals individually and all required dot-bar patterns. Super-compact, 4 pounds light, instant operation. \$159.95 wired only.



Model 369 Sweep/Marker Generator for easiest, fastest visual alignment of color or B&W TV and FM RF and IF circuits. Five sweep ranges from 3-220mc. Four marker ranges from 2-225mc. Crystal marker oscillator. Post injection of markers. \$89.95 kit, \$139.95 wired.



New Model 435 Direct-Coupled Wideband Scope. Top-quality DC-4.5mc scope with 3" flat-face CRT. Zener calibrator. Outperforms 5" scopes three times its size, facilitates on-location color TV and other servicing. \$99.95 kit, \$149.95 wired.



New Model 342 FM Multiplex Signal Generator. Design lab quality. Both composite audio and FM RF outputs. Inputs for stereo audio source for store demonstrations, critical A/B listening tests. \$149.95 wired.



New Model 1030 Regulated Power Supply. Speeds troubleshooting, design work, production line testing, electronics teaching. Variable bias and plate sources regulated to 1/3 of 1%: 0-150V @ 2ma; 0-400V @ up to 150ma. Ripple less than 3mv rms. Unregulated fil. volts of 6.3V & 12.6V, @3A. Switchable, monitoring milliammeter and voltmeter. \$59.95 kit, \$99.95 wired.



New Model 378 Audio Generator. Near-distortionless sine wave generator (<0.1% 20-20,000c) providing fast, convenient switch-selection of frequencies from 1c to 110kc (1c steps 1c-100c, 10c steps 100c-1kc, 100c steps 1kc-10kc, 1kc steps 10kc-110kc). 8-pos. 10db/step output attenuator & fine attenuator. Output meter (4 1/2" 200ua) with 8 voltage ranges & db scale. \$49.95 kit, \$69.95 wired.



New Model 965 FaradOhm Bridge/Analyzer. "Unusually versatile" — Electronics World. 9-range, low-voltage capacitance-resistance bridge safely measures even 1-volt electrolytics. Metered bridge balance, leakage test voltage (6 DC VTVM ranges 1.5-500V), leakage current (11 DC VTAM ranges 0.15ua-15ma). DC VTVM & VTAM externally usable. \$129.95 wired.



Model 460 Wideband Direct-Coupled 5" Oscilloscope. DC-4.5mc for color and B&W TV service and lab use. Push-pull DC vertical amp., bal. or unbal. input. Automatic sync limiter and amp. \$89.95 kit, \$129.50 wired.



Model 232 Peak-to-Peak VTVM. A must for color or B&W TV and industrial use. 7-non-skip ranges on all 4 functions. With Uni-Probe.® \$29.95 kit, \$49.95 wired.



New Model 779 Sentinel 23 CB Transceiver. 23-channel frequency synthesizer provides crystal-controlled transmit and receive on all 23 channels. No additional crystals to buy ever! Features include dual conversion, illuminated S/Rf meter, adjustable squelch and noise limiter, TVI filter, 117VAC and 12VDC transistorized dual power supply. Also serves as 3.5 watt P.A. system. \$169.95 wired.



New Model 3566 All Solid-State Automatic FM MPX Stereo Tuner/Amplifier. "Very satisfactory product, very attractive price"—Audio Magazine. No tubes, not even nuvistors. Delivers 112 watts IHF total to 4 ohms, 75 watts to 8 ohms. Completely pre-wired and pre-aligned RF, IF and MPX circuitry, plus plug-in transistor sockets. \$219.95 kit (optional walnut cabinet \$14.95), \$325.00 wired including walnut cabinet. UL approved.



New Model 753 The one and only SSB/AM/CW Tri-Band Transceiver Kit. "The best ham transceiver buy for 1966"—Radio TV Experimenter Magazine. 200 watts PEP on 80, 40 and 20 meters. Receiver offset tuning, built-in VOX, high level dynamic ALC. Unequaled performance, features and appearance. Sentionally priced at \$179.95 kit, \$299.95 wired.

FREE 1966 CATALOG

EICO Electronic Instrument Co., Inc.
131-01 39th Ave., Flushing, N.Y. 11352 PF-4

Send me FREE catalog describing the full EICO line of 200 best buys, and name of nearest dealer. I'm interested in:

- test equipment ham radio
 stereo/hi-fi Citizens Band radio

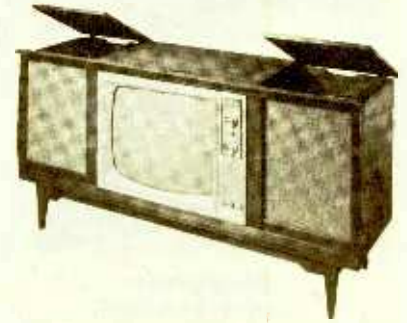
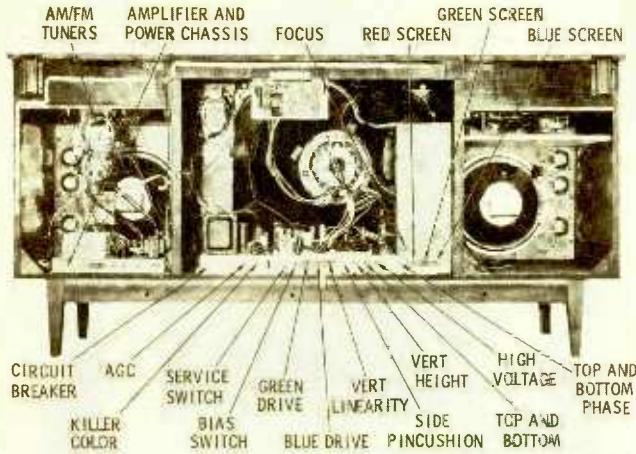
Name _____

Address _____

City _____ State _____

1945-1965: TWENTY YEARS OF LEADERSHIP IN CREATIVE ELECTRONICS

Circle 1 on literature card
www.americanradiohistory.com



**Olympic
Model CK 5367
Chassis CTC-17**

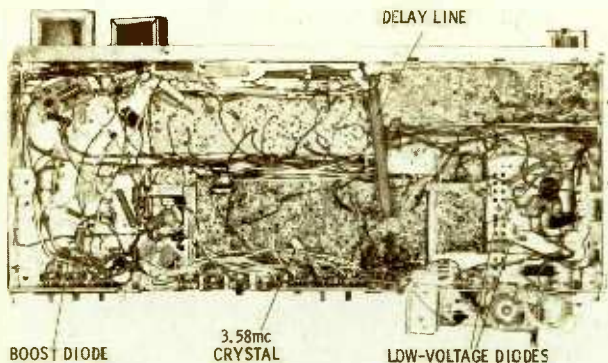
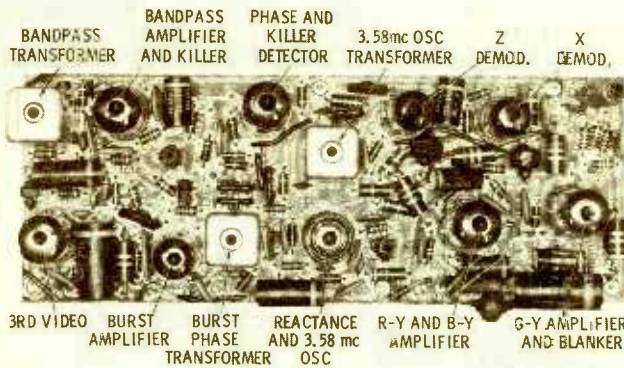
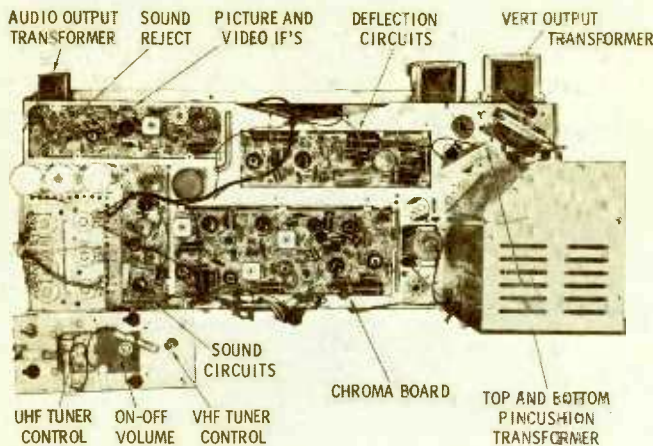
Shown above is Olympic's new 25" color TV with AM/FM-FM-Stereo radio and stereo phonograph combination. The set has not changed drastically from earlier combination models, although there are a few minor physical layout and circuit changes.

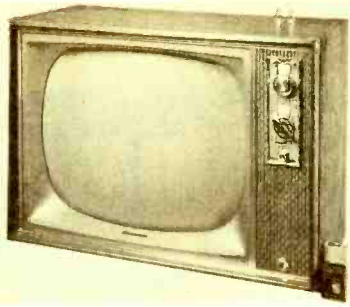
The TV receiver chassis is basically the same as the manufacturer's earlier 21" and 23" color sets, with the only major change being the use of either a 25AP22 or 25BP22 color tube. A continued feature is the automatic degaussing coil which demagnetizes the picture tube when the set is turned on after having been off for at least five minutes. A circuit breaker is provided for overload protection in the low-voltage circuit and a fuse wire protects the parallel filament string.

The VHF tuner tubes have been changed: a 6HA5 triode is now used instead of a 6HQ5 triode in the RF amplifier, and a 6LJ8 triode/tetrode has replaced the 6GX7 triode/pentode as a mixer and oscillator. An NPN transistor oscillator and diode mixer are employed in the UHF tuner.

In the solid state amplifier and power chassis, a full-wave, transformer-powered, rectifier circuit provides the voltage requirements for the audio amplifier circuits. The power circuits also provide filaments and line voltage for the radio chassis and line voltage for the phono motor. A slo-blo 1/2-amp fuse protects the line input circuit from overloads. The amplifier section provides final power amplification for both audio channels and contains six PNP transistors.

Controls for height, vertical, picture, and fidelity adjustments are mounted together behind a pull-down panel on the bottom-front of the receiver. Located immediately above the pull-down panel are the tint, brightness and color controls. The push/pull on-off/volume control is placed between the VHF and UHF tuning controls on the upper right front of the receiver. The TV service controls are mounted on the main chassis rear plate and included are a normal-service switch and CRT bias switch. The radio and phono controls are mounted horizontally in the right hand cabinet compartment.





**Magnavox
Model 1RA362R
Chassis U908-01**

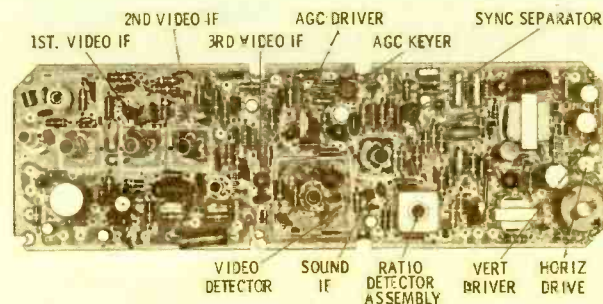
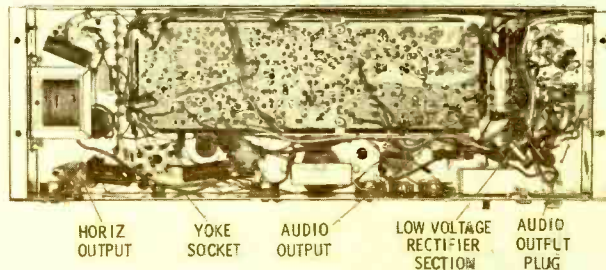
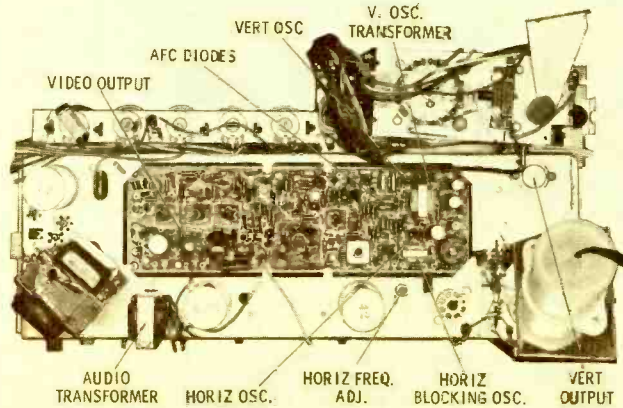
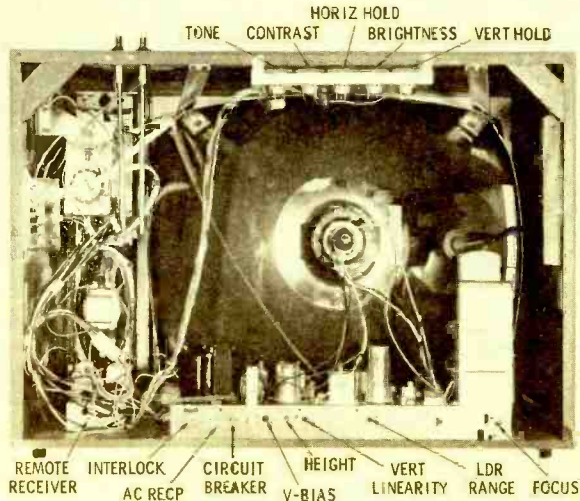
The 19" table model TV shown above features solid-state circuitry with a total of 22 transistors (18 on the main chassis and four in the tuners), plus 22 diodes and one dual-diode used in the horizontal-AFC circuit. The only tube used, with exception of the CRT, is a 1K3 employed in the high voltage rectifier circuit to provide 18KV to the CRT anode. Also featured is the **Mangalux** circuit which varies brightness and contrast as room lighting conditions change. An LDR (light-dependent resistor) changes resistance as the surrounding lighting conditions change, varying the DC voltage on the video amplifier screen and picture tube grid.

The low-voltage power supply uses a power transformer to provide five different positive voltages; 110V, 140V, 14.5V, 68V and a regulated 12V. Also supplied is 6.3 volts AC used for the picture-tube filaments and dial-indicator lamps.

The video-IF circuit employs three transistors, connected as common-emitter circuits with the first two stages AGC controlled. The third IF stage is biased by voltage dividing resistors in the base circuit. The video detector is a conventional diode. This diode and associated components are located inside the third IF transformer shield and are accessible by removing the top of the shield.

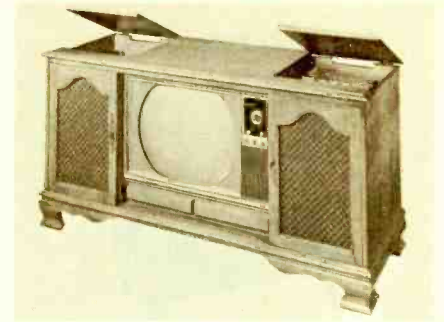
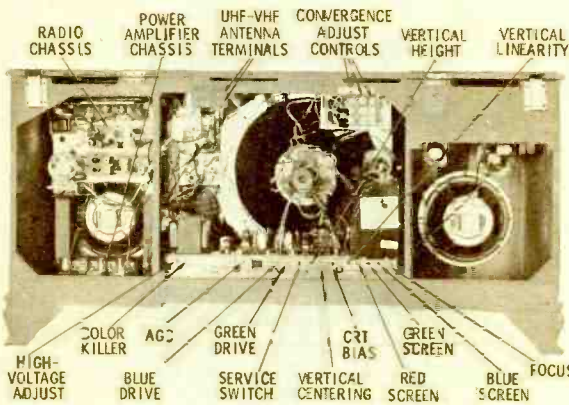
The vertical sweep section consists of a blocking oscillator circuit, a vertical driver, and vertical output stage. The blocking oscillator uses an NPN transistor with common emitter. The vertical driver stage is connected as an emitter follower to match the input impedance of the blocking oscillator. The vertical-output stage uses a power-type transistor; no output transformer is required since the low impedance of the transistor matches the impedance of the yoke. A zener diode is used to couple a pulse to the video circuit to provide vertical retrace blanking.

The sound IF uses a single transistor to amplify the audio coupled from the emitter of the video-driver stage. Audio detection is accomplished by an unbalanced ratio-detector circuit using two germanium diodes. The detector output is coupled through the volume control to an emitter-follower audio-driver stage which provides matched impedance to the audio-output stage. The audio-output transistor is a low-current, high-voltage type.



PREVIEWS of new sets

Sears



**Sears/Silvertone
Model 51991
Chassis 528.662215**

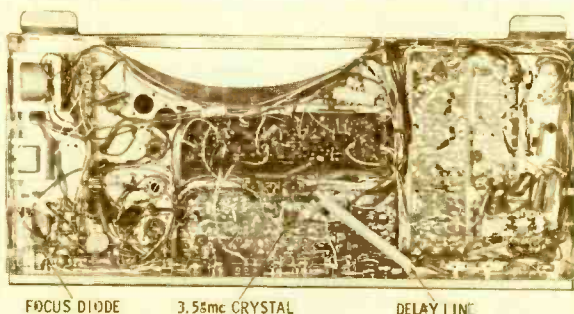
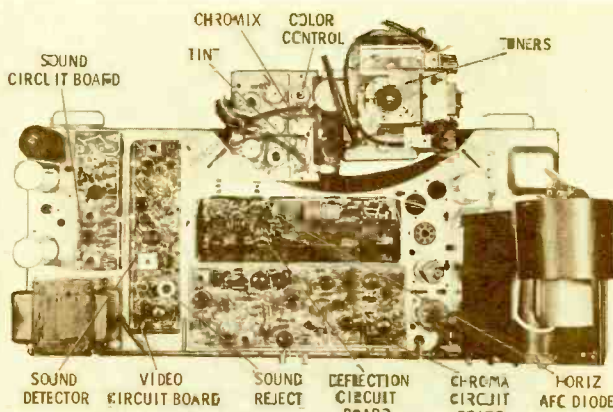
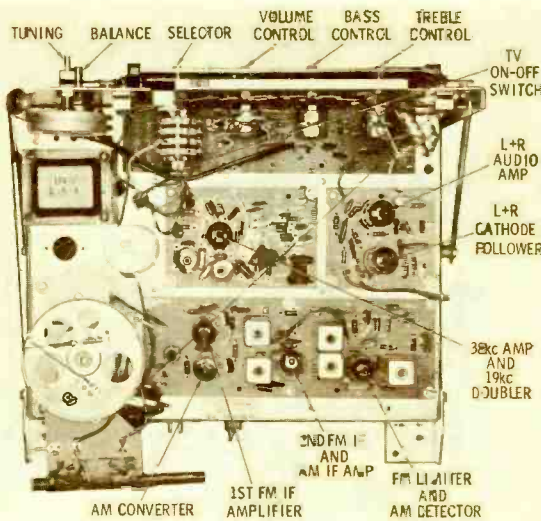
This is Sears' latest 21" color console TV with AM/FM-FM stereo radio/phonograph combination. The model shown has changed little from the manufacturer's earlier color consoles, although there are some minor differences. The transistorized power amplifier has been moved and placed in an upright position on the bottom right of the wood cabinet. A different radio chassis is used with minor tube and circuit changes: 12-volt filament tubes have been replaced by their six-volt counterparts and two 12AU7As have replaced the 12AX7A and 6BQ5 previously used in the audio amplifiers and audio output stages.

Minor changes in the TV receiver chassis include the addition of a Chromix control in the CRT grid circuits. The chroma circuits continue to use a single bandpass stage feeding into the X and Z demodulators. A 21FBP22 or 21FBP22-RE picture tube is used with magnetic convergence and electrostatic focusing. Alternate picture-tube cathode connections have been suggested by the manufacturer for use when adjustment of the video drive controls fails to produce a satisfactory b-w picture; a condition caused by the difference in relative efficiencies of the three phosphors used in the picture tube. Receivers leaving the factory are usually wired to provide the most drive to the red cathode, normally the least efficient of the three phosphors; however, when the CRT temperature adjustment fails to produce a normal b-w picture, the cathode connections can be changed to provide greater drive for either blue or green.

Customer controls located in view on the front of the receiver are the channel selector, a pull-on type on-off/volume control, chromix, color, tint, and fine tuning. Also on the front of the receiver is a pull-down panel containing the horizontal, vertical, contrast, brightness and tone controls.

The service controls pointed out in the rear cabinet picture include a three-position CRT BIAS switch (position 3—minimum brightness) and a normal-service switch.

The convergence-adjust control board (shown in the picture) is designed to permit adjustment from the front of the receiver by loosening the two screws holding the board, sliding the bracket to the left, and removing. Fasten the bracket to the two screws provided on the top rear rail of the cabinet.





**Zenith
Model N2735W6
Chassis 14N22**

Pictured above is Zenith's 23" console model TV using a 23FN4 picture tube. The chassis is physically the same as the one used in previous b-w console models and only minor changes have been made in the circuitry.

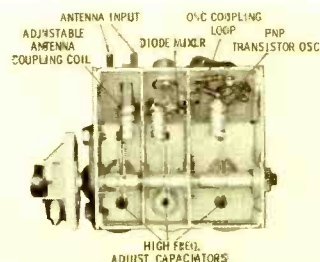
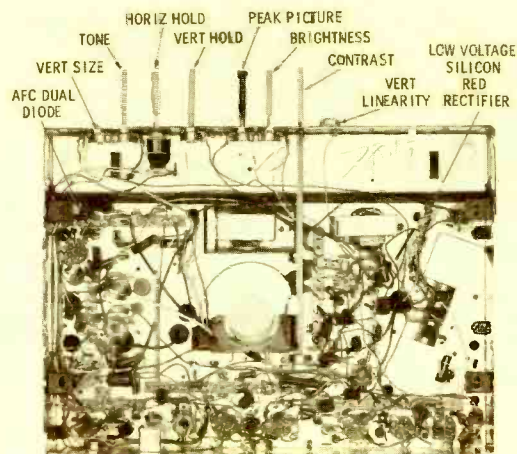
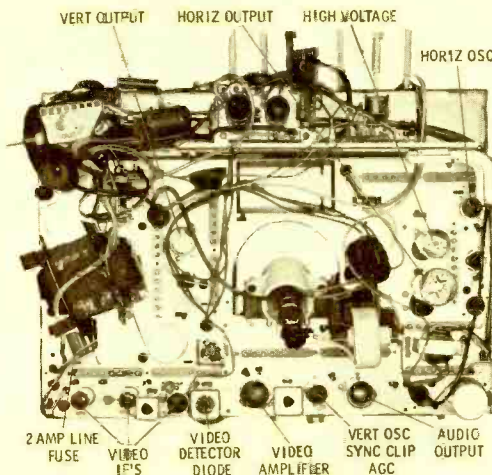
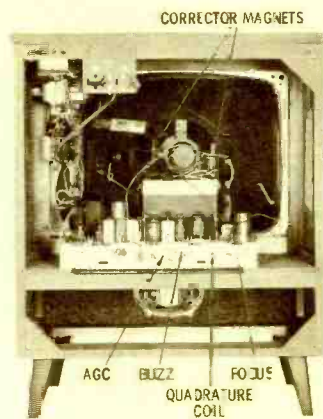
The low-voltage power supply employs a power transformer and two silicon rectifiers in a full-wave voltage-doubler circuit. A two-amp fuse has replaced the circuit breaker that formerly provided line-voltage overload protection. The parallel heater string is protected by a 1½" filament fuse link made of #24 copper wire.

The 1st and 2nd IF amplifier tube types have been changed: 6BZ6 pentodes are now used instead of 6EH7 pentodes. Also, the sound detector and audio output stage now share a 6Z10 dual pentode in place of the 6BN6 and 6BQ5 pentodes previously used.

Two corrector magnets, mounted on the deflection-coil support brackets, (pointed out in one of the photos), prevent pin-cushioning of the sweep lines across the face of the picture tube. Correct adjustment of the magnets is made at the factory and readjustment should not be required unless the brackets have been accidentally bent out of position. If this occurs: reduce the size of the picture by adjusting the height and width controls to that the four corners and sides are visible. Bend the corrector magnet arms until the corners become right angles and the top of the raster is parallel with the bottom and the left side is parallel with the right side. After adjustment of the magnet arms, restore the picture to normal size.

A customer control, labeled **peak pix**, can change the video response from a slight smear at the extreme counter-clockwise position of the control to an exaggerated overshoot at the maximum clockwise position. The control, which is a part of the video-detector load, is adjusted at the factory for best picture detail under normal signal conditions, but can be changed in the field to suit a particular signal or program condition. "Crispness" can be added to an old movie or the texture of snow in a fringe area can be changed.

The customer controls, including **peak pix**, are behind a pull-down panel located on the front of the cabinet beneath the picture screen. ▲



See PHOTOFAC T Set 789, Folder 4

Mfr: Sylvania Chassis No: D01-1, D01-2, D01-5

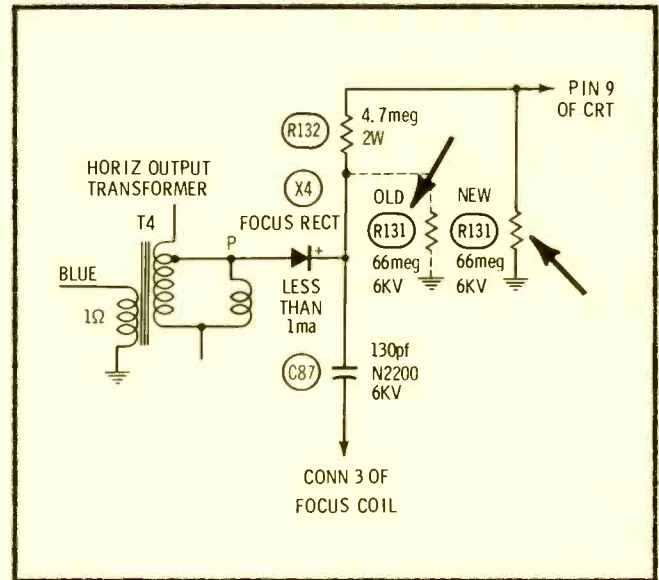
Card No: SYL D01-1

Section Affected: Raster

Symptoms: Unable to reach proper focus at end of control.

Cause or Reason for Change: Focus circuit improvement.

What To Do: Move resistor R131 (66 meg) to side of R132 (4.7 meg) connected to pin 9 (focus grid) of CRT.



Mfr: Sylvania Chassis No: D01-1, D01-2, D01-5

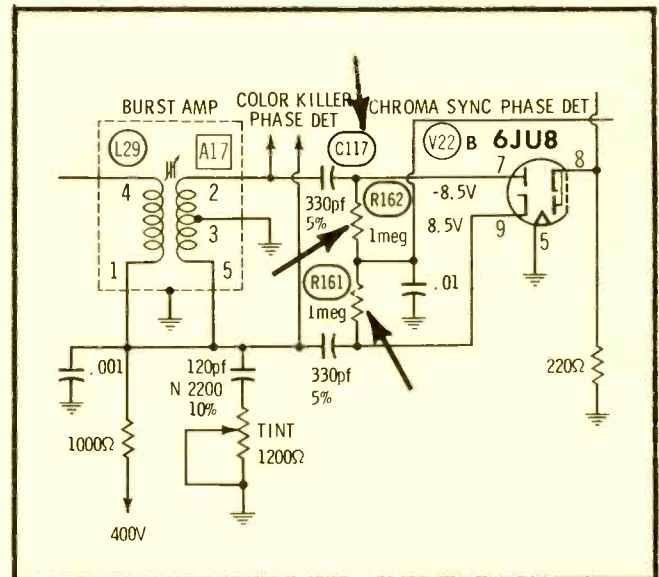
Card No: SYL D01-2

Section Affected: Pix (color).

Symptoms: Poor color sync.

Cause: Sync phase detector resistor(s) change in value.

What To Do: Replace R161 and R162 (both 1 meg). Check C117 (330 pF) for leakage.



Mfr: Sylvania Chassis No: D01-1, D01-2, D01-5

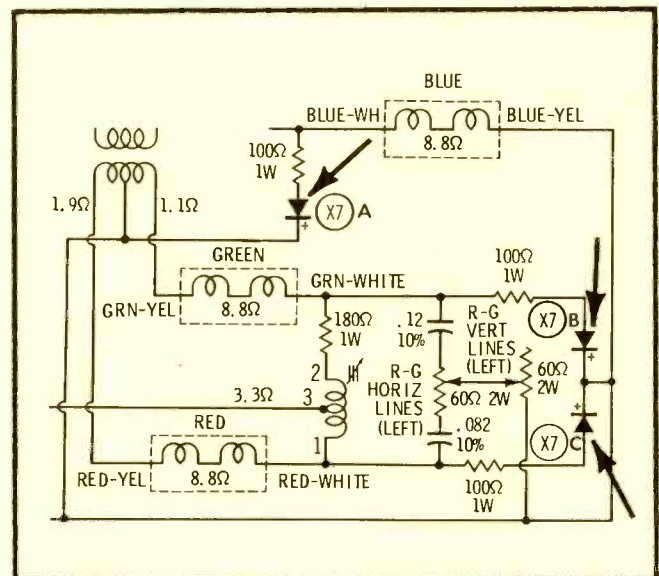
Card No: SYL D01-3

Section Affected: Pix (color and B-W)

Symptoms: Set cannot be converged. Voltages are normal.

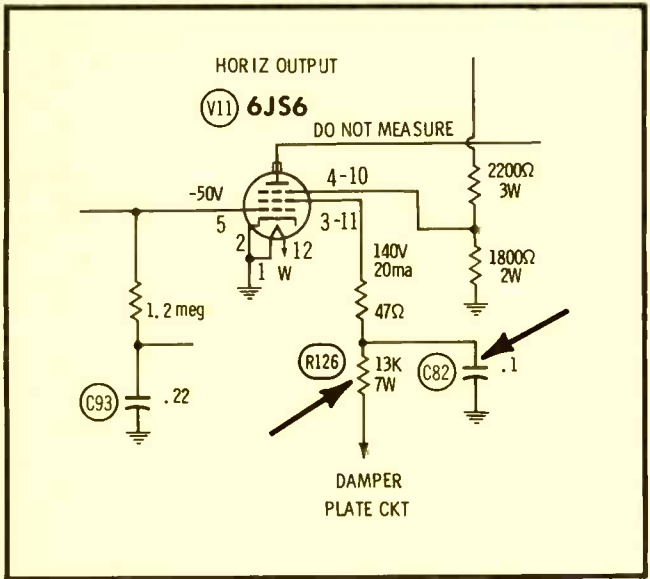
Cause: Defective rectifier section on convergence board.

What To Do: Replace X7 (A, B and C) convergence rectifiers.



See PHOTOFAC T Set 789, Folder 4

See PHOTOFACT Set 789, Folder 4



SEE PHOTOFACT Set 729, Folder 4

Mfr: Sylvania Chassis No: D01-1, D01-2, D01-5

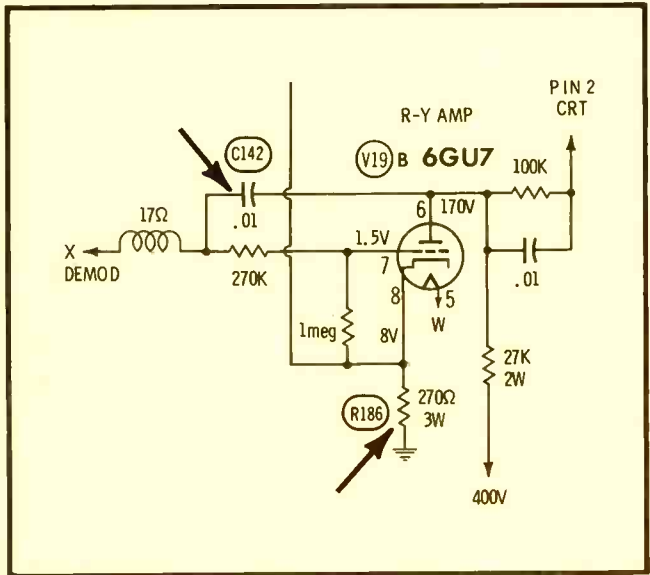
Card No: SYL D01-4

Section Affected: Raster.

Symptoms: Intermittent width. Changing V11, horizontal output tube, has no effect.

Cause: Defective screen-grid series-resistor.

What To Do: Replace R126 (13K ohms, 7W); also C82 (.1 mfd) and V11.



Mfr: Sylvania Chassis No: D01-1, D01-2, D01-5

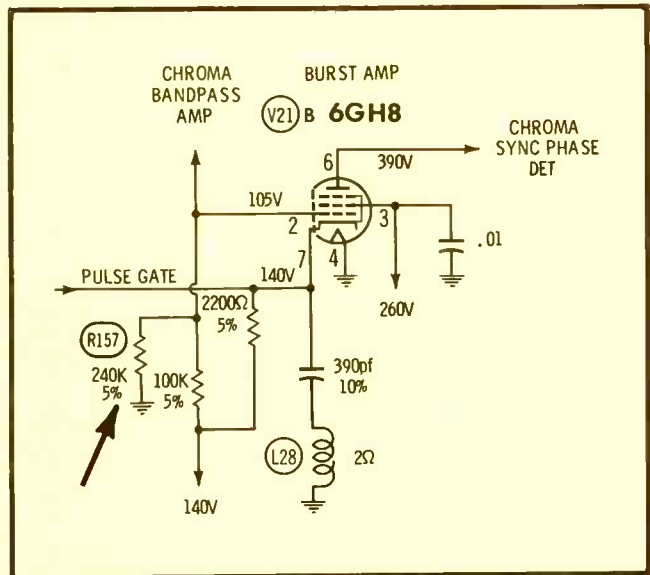
Card No: SYL D01-5

Section Affected: Pix (color).

Symptoms: Dominantly red screen. Slightly high positive voltage on pin 7 of V19B, R-Y amplifier.

Cause: Leaky plate-to-grid capacitor in R-Y amplifier circuit.

What To Do: Replace C142 (.01 mfd). Check cathode resistor R186 (270 ohm-3W) for damage and changed value of resistance.



Mfr: Sylvania Chassis No: D01-1, D01-2, D01-5

Card No: SYL D01-6

Section Affected: Pix (color).

Symptoms: Unstable color sync.

Cause or Reason for Change: Burst amplifier circuit improvement to reduce grid bias on burst amplifier, V21B.

What To Do: Change R157 from 240K ohms to 330K ohms.

See PHOTOFACT set 773, Folder 4

Mfr: Zenith Chassis No: 25MC36

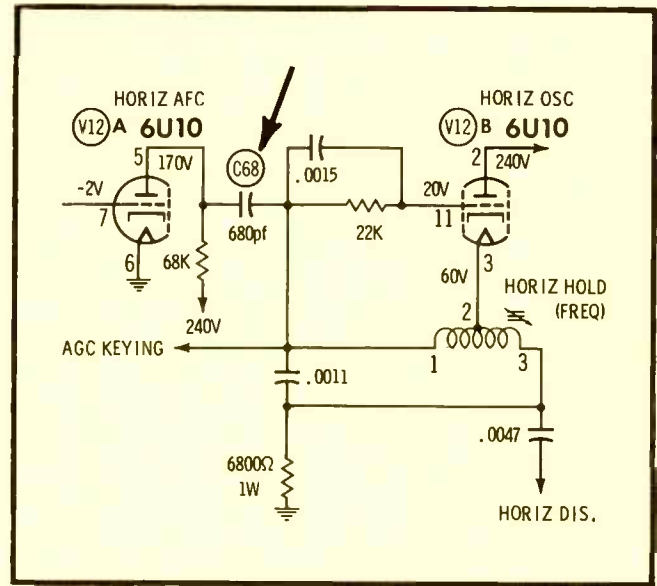
Card No: ZE 25MC36-1

Section Affected: Raster.

Symptoms: No high-voltage on picture tube. Voltage on pin 11, V12B, horizontal oscillator, too high. Plate voltage on pin 5 (plate) of V12A too low.

Cause: Leaky coupling capacitor between horizontal AFC V12A and horizontal oscillator V12B.

What To Do: Replace C68 (680 pf).



Mfr: Zenith Chassis No: 25MC36

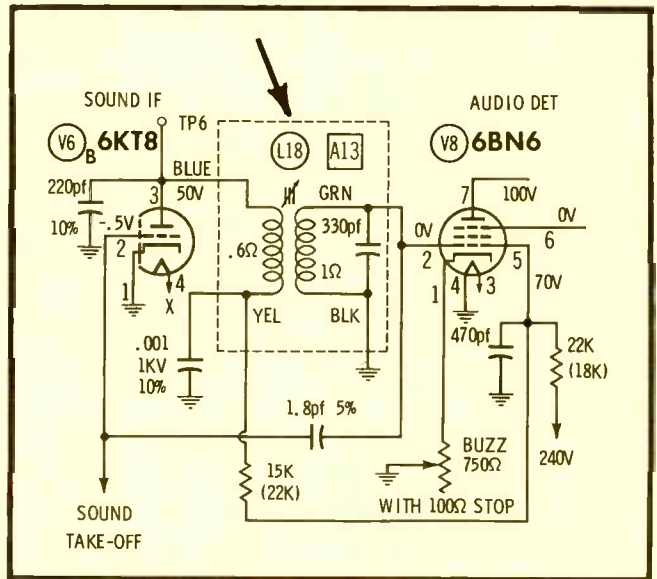
Card No: ZE 25MC36-2

Section Affected: Sound.

Symptoms: Intermittent sound.

Cause: Loose internal connections on sound i-f transformer L18.

What To Do: Resolder internal leads on sound i-f transformer L18.



Mfr: Zenith Chassis No: 25MC36

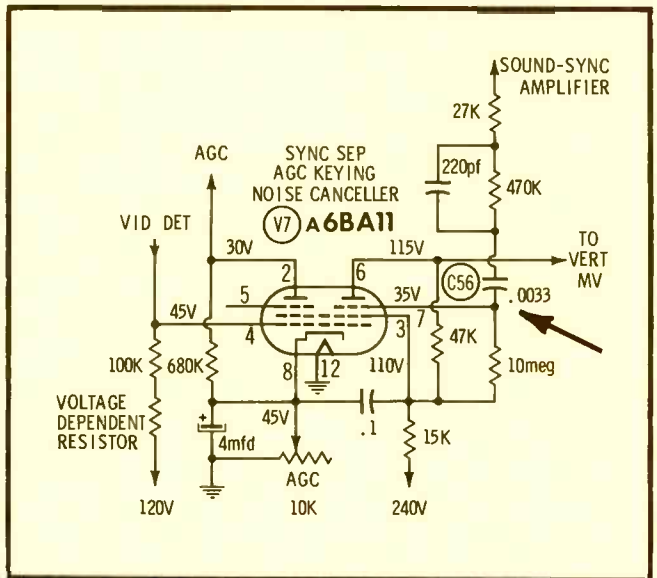
Card No: ZE 25MC36-3

Section Affected: Sync.

Symptoms: No horizontal and vertical sync. Voltages are normal.

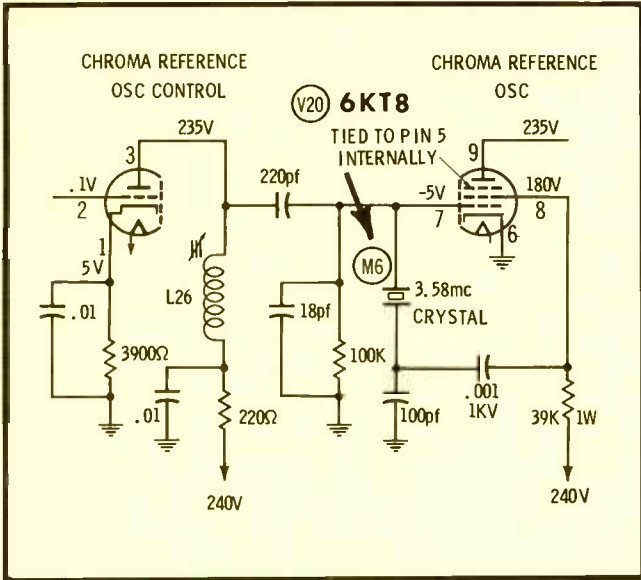
Cause: Leaky coupling capacitor between sound-Sync amplifier and sync separator-noise canceller.

What To Do: Replace C56 (.0033 mfd.).



See PHOTOFACT set 773, Folder 4

See PHOTOFACT set 773, Folder 4



See PHOTOFACT set 773, Folder 4

Mfr: Zenith

Chassis No: 25MC36

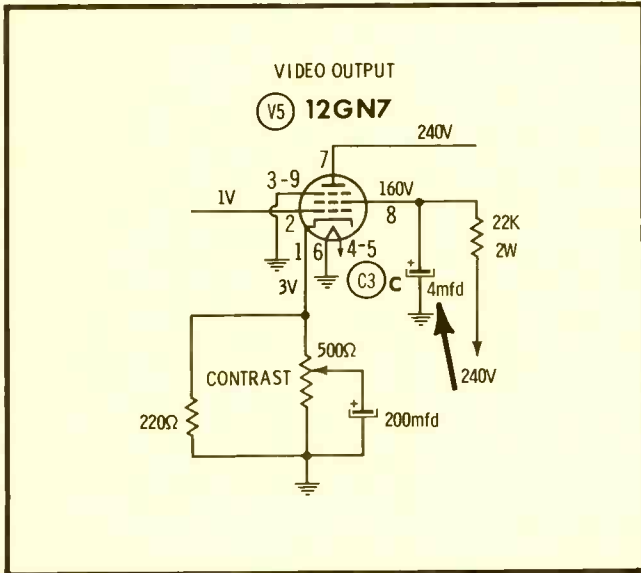
Card No: ZE 25MC36-4

Section Affected: Color sync.

Symptoms: No color sync. Reactance tube voltages normal.

Cause: Defective 3.58 mc crystal.

What To Do: Replace 3.58 mc crystal M6, and realign color sync and demodulator.



Mfr: Zenith

Chassis No: 25MC36

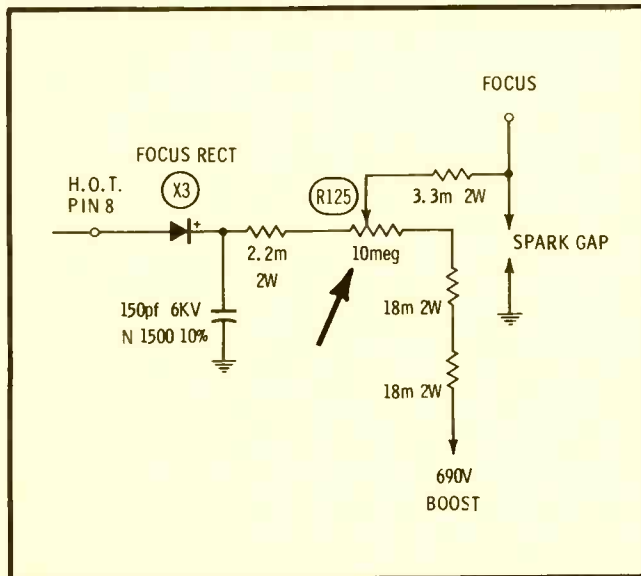
Card No: ZE 25MC36-5

Section Affected: Pix and sync.

Symptoms: Weak video; vertical roll.

Cause: Open filter capacitor in screen grid circuit of video output tube V5.

What To Do: Replace four section filter C3.



Mfr: Zenith

Chassis No: 25MC36

Card No: ZE 25MC36-6

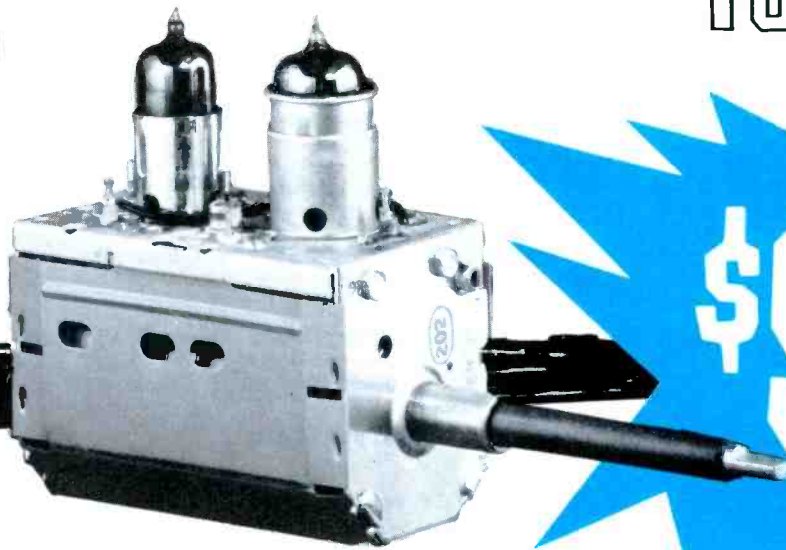
Section Affected: Raster.

Symptoms: No control of focus. Varying control reveals pitted sections.

Cause: Open focus control.

What To Do: Replace focus control R125 (10 meg).

Complete TUNER REPAIR for only



\$9.50

Sarkes Tarzian, Inc., largest manufacturer of TV and FM tuners, offers unexcelled tuner overhaul and factory-supervised repair service. Completely-equipped and conveniently-located Service Centers offer fast, dependable and factory-supervised repair service on all makes and models. Centers are staffed by well-trained technicians, assisted by engineering personnel.

Tarzian-made tuners received one day will be repaired and shipped out the next. More time may be required on other makes. Every channel—not just the channels existing in any given area—is checked and re-aligned per orig-

inal specifications. Exclusive cleaning method makes the tuner look—as well as operate—like new.

Cost, including ALL labor and parts (except tubes) is only \$9.50 and \$15 for UV combinations. No additional charge. No hidden costs. Too, you get a full, 12-month warranty against defective workmanship and parts failure due to normal usage.

Always send TV make, chassis and Model number with faulty tuner. Check with your local distributor for Sarkes Tarzian replacement tuners, parts or repair service. Or, use the address nearest you for fast, factory-supervised repair service.



TUNER SERVICE CORPORATION

(Factory-supervised tuner service authorized by Sarkes Tarzian)

MIDWEST—817 N. Pennsylvania St.,
Indianapolis, Ind. Box 1642
Tel: 317-632-3493

EAST — 547-49 Tonnele Ave., Jersey City, N. J.
Tel: 201-792-3730

WEST—

SARKES TARZIAN, Inc.
Tuner Service Division

10654 Magnolia Blvd.,
N. Hollywood, Calif.
Tel: 213-769-2720



MANUFACTURERS OF TUNERS, SEMICONDUCTORS, AIR TRIMMERS, FM RADIOS, AM-FM RADIOS, AUDIO TAPE and BROADCAST EQUIPMENT

Circle 2 on literature card

April, 1966/PF REPORTER 9



A HOWARD W. SAMS PUBLICATION

PF Reporter™

PHOTOFACT

the magazine of electronic servicing

VOLUME 16, No. 4

APRIL, 1966

publisher
Howard W. Sams

general manager
Donald W. Bradley

editor
William E. Burke

managing editor
James M. Moore

associate editors
Thomas T. Jones
J. Phipps
Ralph M. Scott

consulting editors
Joe A. Groves
C. P. Oliphant

research librarian
Banny Howland

production manager
Esther M. Rainey

circulation manager
Pat Tidd

art directors
Louis J. Bas, Jr. & Robert W. Reed

photography
Paul Cornelius, Jr.

advertising sales offices
Hugh Wallace, advertising sales manager

midwestern
Roy Henry

Howard W. Sams & Co., Inc. 4300 West 62nd St.,
Indianapolis, Ind., 46206
291-3100

central
Paul Houston

Howard W. Sams & Co., Inc. 4300 West 62nd St.,
Indianapolis, Ind., 46206
291-3100

eastern
Gregory C. Masefield

Howard W. Sams & Co., Inc. 3 West 57th St.
New York 19, New York
MU 8-6350

southwestern
C. H. (Jake) Stockwell

C. H. Stockwell Co., 4916 West 64th St.
Mission, Kansas, RA 2-4417

western
Los Angeles Office

G. R. (Jerry) Holtz
The Maurice A. Kimball Co., Inc.
2008 West Carson St., Suites 203-204
Torrance, Calif., 90501
320-2204

San Francisco Office

The Maurice A. Kimball Co., Inc.
580 Market St., Room 400
San Francisco 4, California
EX 2-3365

Address all correspondence to PF REPORTER,
4300 W. 62nd Street, Indianapolis, Indiana 46206



Copyright © 1966 by Howard W. Sams & Co., Inc.
PF REPORTER is a trademark of Howard W. Sams
& Co., Inc. No part of PF REPORTER may be
reproduced without written permission. No patent
liability is assumed with respect to use of
information herein. Acceptance of advertising does
not in any manner signify the products, policies
and services so advertised have been approved,
endorsed or recommended by this magazine.

Subscription Prices: 1 year—\$5.00, 2 years—\$8.00,
3 years—\$10.00, in the U. S. A., its possessions and Canada.
All other foreign countries: 1 year—\$6.00, 2 years—
\$10.00, 3 years—\$13.00. Single copy 50¢; back copies 65¢

Indexed in LECTRODEX.
Printed by the Waldemar Press Div.
of Howard W. Sams & Co., Inc.

CONTENTS

Previews of New Sets	1
Magnavox Model 1RA362R, Chassis U908-01; Olympic Model CK5367, Chassis CTC-17; Sears/Silvertone Model 51991, Chassis 528.662215; Zenith Model N2735W6, Chassis 14N22.	
Video Speed Servicing	5
Service hints on Sylvania Chassis D01-1,2, & 5 and Zenith Chassis 25MC36.	
Letters to the Editor	12
The Electronic Scanner	14
Focus and HV Problems in Color Sets	19
Carl Babcoke Analysis of the circuits, with case histories.	
Square-Wave Tests in Hi-Fi Amplifiers	21
Robert G. Middleton Advanced Service Techniques—New methods of testing and troubleshooting.	
New Tube and Transistor Data	24
Looking into Miniature CB Transceivers	29
Edward M. Noll Scanning the features found in today's walkie-talkies.	
Post Video Twisters	36
Allan F. Kinckiner Shop Talk—Twisters can be found in unlikely places.	
Notes on Test Equipment	46
Arnold E. Cly and T. T. Jones Lab Report on Lectrotech Model U-75 UHF Translator and Hickok Model 662 Color Generator.	
Color Countermeasures	70
Annual TV-Tube Stock Guide	73
The Troubleshooter	78
Product Report	83
Free Catalog and Literature Service	88
Monthly Index on Free Literature Card	

About the Cover

This month's cover highlights the CB walkie-talkie. Service shops across the country have found them adaptable to a variety of applications, including antenna installations. Thousands of sets have been put into service for this purpose. An analysis of the features and circuitry found in today's sets is the subject of the article starting on page 29.





1,863 reasons why Sprague Twist-Lok[®] Capacitors help you to protect your reputation

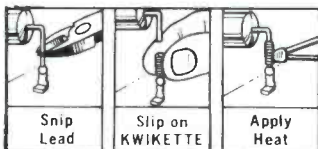
When you fool around with makeshift or "fits-all" capacitor replacements by substituting sizes and ratings, you leave yourself wide open for criticism of your work, you risk your reputation, and you stand to lose customers. With so much at stake, it just doesn't pay to use makeshifts when it's so easy to get exact replacement capacitors from your Sprague distributor.

With 1,863 different Sprague Twist-Lok Capacitors as standard catalog items, and more being added regularly, Sprague gives you the world's most complete selection of exact replacements.

We don't have to tell you that it's easier to service with exact replacements. And we don't have to tell you that it's better, too. When sets are designed, specific capacitance values are used for peak operation, so it takes exact replacements to restore original set performance.

And who better than Sprague knows which values and sizes are needed in the replacement market? Sprague, the world's largest component manufacturer, has the most complete specification file on original set requirements. That's why you're always right when you work with Sprague Twist-Lok exact replacements!

GET YOUR COPY of Sprague's comprehensive Electrolytic Capacitor Replacement Manual K-107 from your Sprague Distributor.



HAVE YOU TRIED KWIKETTE[®] CONNECTORS?

Not just another wire spring connector! Copperweld wire inner core, a layer of flux, and an outer coating of solder . . . all you supply is heat! Now being packed with Sprague Atom[®] Capacitors at no extra cost to you! See your distributor!

*TRADEMARK



WORLD'S LARGEST MANUFACTURER OF CAPACITORS

Circle 3 on literature card

Sprague Products Co., 509 Marshall St., North Adams, Mass. 01248

April, 1966/PF REPORTER 11

NEW

AKTRON
INDUSTRIES, INC.

REAR SEAT SPEAKER KIT

COMPLETE NOTHING ELSE TO BUY
ALUMINUM VOICE COIL SPEAKER
SOLDERLESS HOOK-UP
FADER CONTROL GIVES COMPLETE
SPEAKER BALANCE
MULTI-IMPEDANCE SPEAKER
LOUVERED, CHROME PLATED GRILL
COMPLETE INSTALLATION BROCHURE
EYE CATCHING
PROTECTIVE DISPLAY PACKAGING



STANDS
BY ITSELF



HANGS
FROM PEGBOARD



Circle 60 on literature card



Letters to the Editor

Dear Readers:

We have received several letters stating that roll charts for Precision tube testers were not available from Coletronics Service Inc., as stated in this column (Dec. 1965). A letter of inquiry to Coletronics brought this reply:

Dear Editor:

We wish to advise you that we are developing, printing, and shipping tube data for Precision Tube Testers. Please see the enclosed notice which lists the models we are handling.

I can't understand the complaint you received, since all correspondence and orders receive prompt attention, unless he requested data on the two models (10-40 and 10-60) that we are not servicing.

*Very truly yours,
Coletronics Service, Inc.
H. COLEMAN
Manager*

The enclosed notice lists Precision tube testers 910, 912, 914, 915, 920, 922, 954, 10-12, 10-15, 10-20, 10-22, 10-54, 650, T-62, 612, 614, 620, 654, 640, 660, and T-60. —Ed.

Dear Editor:

I am a subscriber to your magazine, and I must say it is a wonderful publication in all aspects. I have only one small complaint—what happened to the PF REPORTER Puzzler? You had me hung up on them in your November and December issues and now no more Puzzler. They were relaxing and even a challenge to work after reading through the magazine.

Do you plan more to come or were they the last of the Puzzlers?

WILLIAM KEARNEY

Sharpes, Fla.

We do have more puzzles of several types but have hesitated to print them without an indication of their acceptance. Bill's letter is the first comment we've had. If reader opinion favors puzzles, we'll print more.—Ed.

Dear Editor:

Might I make a request? How about more articles like "Repair the TV Portable Quickly" in your February 1966 issue. These should be written by different professional servicemen. I feel that many of us can get a wealth of review, tips, and short cuts in such articles.

Thanks for putting together such an enjoyable magazine as the PF REPORTER.
ADOLF STRIBERNY, JR.

Philadelphia, Pa.

We would be very glad to print more servicing articles by different professional servicemen if only we could obtain more. We have no way of reaching these servicemen; they have to contact us. If any reader is interested in sharing his servicing experiences, drop us a line.—Ed. ▲

MOSLEY Mobile CB Antennas Increase Your Sales and Service Business




Stock . . .

. . . Install . . .

. . . Profitable


Mosley CB antennas with streamline design. Cash in on the revolutionary center-loaded


Mosley DEMON with over-all length of 17


 inches . . . ideal for

roof mounting.

Consider the other outstanding mobile antennas . . . the base loaded DEPUTY with overall length of 43 3/4" (also fine for roof mounting);

the DEVANT '2' an ideal  mobile companion for the Famous

DEVANT '1' base station antenna,  and the SILVER DOLPHIN

Marine Antenna designed to eliminate unwieldy ground and radial systems . . . operates efficiently on all boats  even on wood and fiberglass.

Receive your share of CB profits by stocking the entire Mosley CB line of Top Quality base, mobile, and marine antennas. For complete information write.

Mosley Electronics, Inc.

4610 N. Lindbergh Blvd. Bridgeton Mo. 63044

Circle 4 on literature card

YOU CAN'T SELL IT!

IF YOU DON'T HAVE IT

and CRAFTSMAN has it!

- the **PRODUCT**
- the **QUALITY**
- and the **DEPENDABILITY**

FOR MATV BUILDERS AND DISTRIBUTORS

And You Have The **MARKET!**

You don't have to hunt for it, it's all around you. Your **SCHOOLS, MOTELS, and APARTMENT HOUSES** are all **POTENTIAL CUSTOMERS.**

CRAFTSMAN can help YOU convert these customers to quick **PROFITS.**

Whet your money-making appetite? **GOOD!** We have a honey of a proposition for you. We want to prove to you just how you can cash in on the **CRAFTSMAN LINE.**

WE WANT YOU AS OUR DEALER

DISTRIBUTORS INQUIRY WELCOME

CRAFTSMAN

ELECTRONIC PRODUCTS, INC.

133 WEST SENECA ST. MANLIUS, N.Y. 15104

Area Code 315 Phone Overbrook 2-9105

PARTIAL LINE OF OUR PRODUCTS SHOWN HERE



Model 1592

This two way hybrid splitter provides two highly isolated outputs.



Model 4WDW-F

This four way hybrid splitter provides four highly isolated outputs.



Model DC-20

This directional coupler is perfect for coaxial cable systems... has very low loss, wide bandwidth, high isolation.



Model 6175

This switchmatch with positive termination, has high isolation between the cable and antenna due to Balun transformer built in.



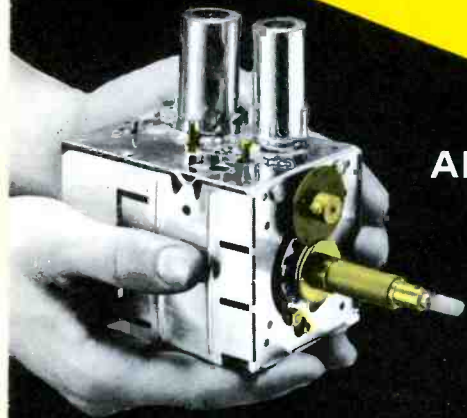
Model T-15

It's a fact! This matching transformer is the only one on the market that's completely potted and epoxy filled for durability! Really strong! Excellent electrical characteristics.

Circle 5 on literature card

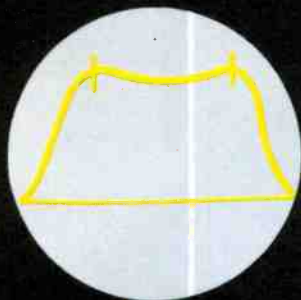
April, 1966/PF REPORTER 13

COMPLETE TUNER OVERHAUL



ALL MAKES —
ONE PRICE

995



3.58

ALL LABOR
AND PARTS
(EXCEPT TUBES
& TRANSISTORS)*

COLOR TUNERS

GUARANTEED COLOR
ALIGNMENT — NO
ADDITIONAL CHARGE



VHF



UHF



COLOR



U-V



TRANSISTOR

Simply send us the defective tuner complete; include tubes, shield cover and any damaged parts with model number and complaint. Your tuner will be expertly overhauled and returned promptly, performance restored, aligned to original standards and warranted for 90 days.

UV combination tuner must be single chassis type; dismantle tandem UHF and VHF tuners and send in the defective unit only.

Exact Replacements are available for tuners unfit for overhaul. As low as \$12.95 exchange. (Replacements are new or rebuilt.)

And remember—for over a decade Castle has been the leader in this specialized field . . . your assurance of the best in TV tuner overhauling.

Pioneers of TV



Tuner Overhauling

CASTLE

TV TUNER SERVICE, INC.

MAIN PLANT: 5701 N. Western Ave., Chicago 45, Illinois

EAST: 41-90 Vernon Blvd., Long Island City 1, N.Y.

CANADA: 136 Main Street, Toronto 13, Ontario

*Major Parts are additional in Canada

Circle 6 on literature card



The Electronic Scanner

news of the servicing industry

Sales and Profits Rise

Record sales, incoming orders, and earnings for any third quarter and nine months were achieved by **Ampex Corporation** in the period ended January 29, 1966. Sales for the first three quarters of fiscal 1966 were \$115,221,000, up 7 percent from \$107,338,000 in like period of 1965.

Consolidated net earnings for Amphenol Corporation and its subsidiaries for 1965 were \$3,749,486, an increase of 41 percent over 1964 earnings of \$2,665,654. Sales hit a new high of \$111,233,322 compared to 1964 sales of \$88,971,454. The 1965 figures include operations of **Cadre Industries Corp.**, merged into Amphenol as of January 1, 1965.

Bell & Howell Company reported record 1965 sales and earnings. Sales of \$185,670,000 were up eight percent to establish an all-time high, as sales of laboratory and industrial instruments continued to increase.

In the first year's operation of **International Electronics Corporation** in its new plant in Melville, Long Island, the company achieved its highest sales volume in history, exceeding \$5,000,000.00. This was over a 25% increase in sales over the prior year, and earnings rose even more sharply. This bright picture is due largely to the increased use of the company's receiving electron tubes and components in the booming color TV market.

For the year ended Jan. 2, 1966, **IRC Inc.** reports that sales were over \$37.6 million, up approximately 25% from the previous year's \$30.4 million. The net income was up \$1.3 million.

Net sales and earnings for 1965 surpassed all previous records for **Littelfuse Inc.** Sales were \$9,823,053, an increase of 32 percent over 1964.

The higher sales and earnings for last year were attributed to new products such as circuit breakers for television and increased demand from the automotive and electronic industries.

It was also announced that with a record backlog of orders at the year's end, **Littelfuse** has started production of some of its circuit protection devices in a new plant located in Centralia, Illinois.

P. R. Mallory & Co. Inc. announced that 1965 sales exceeded \$100 million for the first time and that earnings were at record levels, up 32 percent from the previous year. G. Barron Mallory, president, said sales for the 12 months ended last December 31 totalled \$107,332,432.

Headquartered in Indianapolis, the Mallory company specializes in the manufacture of electronic components, appliance timers, controls, batteries, and special metals and materials for many fields.

Packard Bell Electronics Corporation recently announced net income for the quarter ended December 31, 1965, was \$804,000, compared to a net income of \$359,000, in the same quarter last year. Sales for the current quarter were \$12,172,000, compared to \$10,843,000 last year.

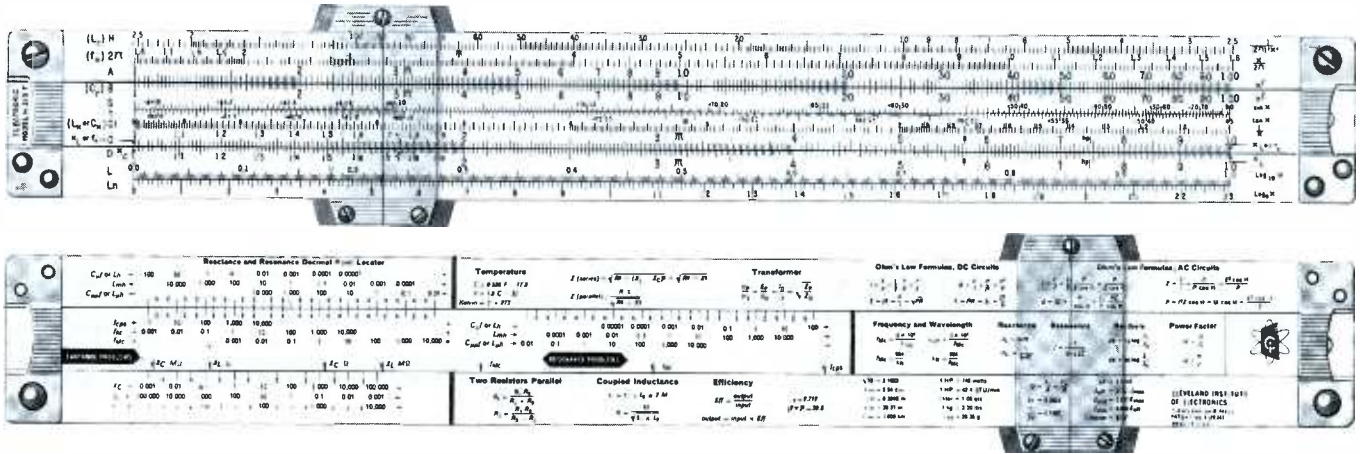
Wendell B. Sell, president, said that increased sales of color television was the principal factor contributing to the larger net income.

Texas Instruments Incorporated reported that on the basis of preliminary data subject to final audit, 1965 net sales billed were \$436,369,000, up 33%. In 1965, TI spent approximately \$42 million for additions to plants and equipment. The facilities expansion continues and capital expenditures in 1966 are expected to approximate \$70 million.

Viking Industries, Inc. announced that 1965 earnings rose from \$272,471 in 1964 to \$602,080 in the fiscal year ended December 31. Sales for 1965 amounted to \$11,684,000, compared with \$8,177,250 in 1964.

LOOK!

A new Electronics Slide Rule with Instruction Course.



This amazing new "computer in a case" will save you time the very first day. CIE's patented, all-metal 10" electronics slide rule was designed *specifically* for electronic engineers, technicians, students, radio-TV servicemen and hobbyists. It features special scales for solving reactance, resonance, inductance and AC-DC circuitry problems . . . an exclusive "fast-finder" decimal point locator . . . widely-used formulas and conversion factors for instant reference. And there's all the standard scales you need to do multiplication, division, square roots, logs, etc.

Best of all, the CIE Slide Rule comes complete with an Instruction Course of four **AUTO-PROGRAMMED** lessons. It includes hundreds of illustrations, diagrams and practice problems. You'll learn ingenious short cuts . . . whip through exacting electronics problems quickly and accurately. This course alone is worth far more than the price of the entire package!

Electronics Slide Rule, Instruction Course, *and* handsome, top-grain leather carrying case . . . a \$50 value for less than \$20. Send coupon for **FREE** illustrated booklet and **FREE** Pocket Electronics Data Guide, without obligation. Cleveland Institute of Electronics, 1776 E. 17th St., Dept. PF-108, Cleveland, Ohio 44114.



*TRADEMARK

GET BOTH FREE!

ELECTRONICS SLIDE RULE

POCKET ELECTRONICS DATA GUIDE

Send coupon today →

Cleveland Institute of Electronics

1776 E. 17th St., Dept. PF-108, Cleveland, Ohio 44114

Please send **FREE** Illustrated Booklet describing your Electronics Slide Rule and Instruction Course.

SPECIAL BONUS! Mail coupon promptly . . . get **FREE** Pocket Electronics Data Guide too!

Name _____ (PLEASE PRINT)

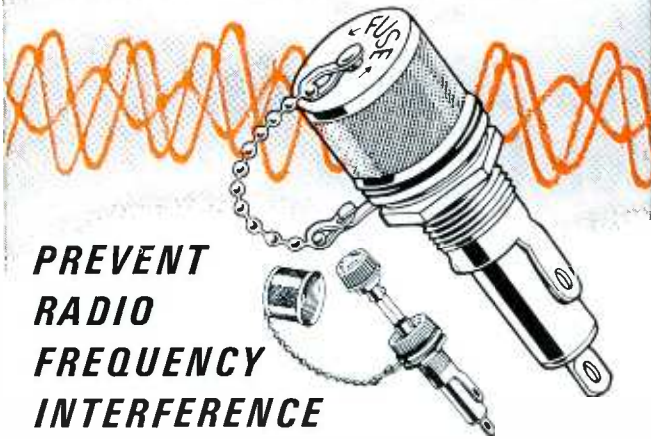
Address _____ County _____

City _____ State _____ Zip _____

A leader in Electronics Training . . . since 1934.

Circle 7 on literature card

BUSS SHIELDED FUSEHOLDERS



**PREVENT
RADIO
FREQUENCY
INTERFERENCE**

For use where fuse and fuseholder could pick up radio frequency radiation which interferes with circuit containing fuseholder—or other nearby circuits.

Fuseholder accomplishes both shielding and grounding.

Available to take two sizes of fuses— $\frac{1}{4} \times 1\frac{1}{4}$ " and $\frac{1}{4} \times 1$ " fuses.

Meet all requirements of both MIL-I-6181D and MIL-F-19207A.

Write for BUSS Bulletin SFH-12

INSIST ON **BUSS**
QUALITY

BUSSMANN MFG. DIVISION, McGraw-Edison Co., ST. LOUIS, MO. 63107

BUSS: The Complete Line of Fuses and

and other electronic components for the community antenna television industry. It also does the engineering and construction of CATV systems.

The **Jerrold Corporation** reported record earnings for its fiscal year. The firm's net from operations for the year ending February 28, 1966, was in excess of \$3.6 million.

The corporation has announced plans for further expansion of its facilities. The Jerrold plant at 15th & Lehigh Avenue, Philadelphia, will now be devoted exclusively to manufacturing. All sales and administrative officers will move to 401 Walnut Street, where seven floors were leased March 1st.

Manufacturing will expand into the vacated office space. The company recently purchased 60,000 square feet of space to add to its TACO manufacturing facility and has instituted other programs at all of its manufacturing plants to increase production.

Acquires Producer of Magnetic Tape

Signing of final papers in the acquisition by **Robins Industries Corp.** of the Magnetic Tape Division of **Ferrodynamics Corp.** has been announced by Herman D. Post, President of Robins, a manufacturer of consumer electronic and data processing products.

Mr. Post said the new product line would raise his company's annual sales to the \$2½ million to \$3 million level by the end of 1966. Sales were \$800,000 in 1964. Genarco, Inc., Jamaica, N. Y., manufacturer of carbon-arc solar radiation simulators was acquired last March.

New Company in Japan

The formation of a joint-venture company with **Mitsubishi Metal Mining Co. Ltd.** to manufacture Mallyory metallurgical products in Japan was announced by **P. R. Mallyory & Co. Inc.**

The joint-venture company, **Mitsubishi-Mallyory Yakin Kogyo K. K.**, will be 60 percent owned by Mitsubishi and 40 percent by Mallyory.

Mitsubishi-Mallyory will manufacture Mallyory metallurgical products for the automotive, aircraft, electrical, and appliance industries. The new operation will utilize Mallyory metallurgical patents and manufacturing techniques.

To Fight Patent Suit

Sylvania Electric Products Inc. stated it will fight a law suit filed against it by **Columbia Broadcasting System Inc.**, alleging infringement of two color television picture tube patents.

Merle W. Kremer, a Senior Vice President of Sylvania in charge of the company's Electronic Components Group, said Sylvania "long has believed that the key patent involved in the complaint (Patent No. 2,690,518, also known as the 'Flyer Patent') is invalid."

Sylvania's reply will be "a complete and general denial" of the allegations, according to the officer.

Mr. Kremer also said that "to the best of my knowledge, no color picture tube currently manufactured infringes the Flyer Patent."

Entertainment Tube Production Curtailed

Tung-Sol Electric Inc., announced that the company will discontinue the manufacture of entertainment receiving tubes and will concentrate on broader development of its power and special purpose tube activities.

Termination of the entertainment receiving tube business was effective February 15, 1966.

Tung-Sol began to phase out the entertainment receiving segment of its tube business two years ago and has been



FUSETRON
dual-element Fuses
slow blowing

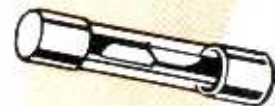
Write for
BUSS
Bulletin SFB

"Slow blowing" fuses prevent needless outages by not opening on harmless overloads—yet provide safe, protection against short-circuits or dangerous overloads.

INSIST ON **BUSS**
QUALITY

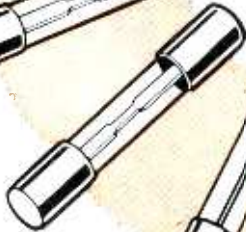
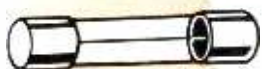
BUSSMANN MFG. DIVISION, McGraw-Edison Co., ST. LOUIS, MO. 63107

Circle 8 on literature card



BUSS

quick-acting FUSES



"Quick-Acting" fuses for protection of sensitive instruments or delicate apparatus;—or normal acting fuses for protection where circuit is not subject to current transients or surges.

Write for
BUSS
Bulletin SFB

INSIST ON **BUSS**
QUALITY

BUSSMANN MFG. DIVISION, McGraw-Edison Co., ST. LOUIS, MO. 63107

systems more profitable for the installer.

Attending the three-day MATV seminar were more than 30 representatives of a dozen companies. Among those present at the training session, a part of the electronics firm's continuing educational program, were distributor-installers, as well as principals and staff members of the Mike Stobin Company, Los Angeles representatives for Blonder-Tongue.

Under the direction of Nick Young, national training manager, the seminar covered a broad range of subjects relating to layout and installation of MATV systems.

New CATV System

Construction begins March 15 on a CATV system at Gettysburg, Pa. An agreement was signed with Ameco, Inc., on Feb. 3 for construction of a solid-state system to serve a potential 1,800 subscribers. Plans call for providing seven television channels and a broad-band FM channel.

Puerto Ricans Get TV Know-How

The National Service Division of Admiral Corporation recently conducted a five-day color television course for Puerto Rican TV technicians.

Participating in the week-long school—designed to help prepare Puerto Rico for the introduction of color TV—were Efran Cansel, Silverio Mojica, Santiago Solero, Victor Roman, and Pedro Tartak, all from Admiral's Puerto Rico distributor, Tartak Distributors. Orlan Nunez, employed at Admiral's new color tube facility in Chicago, acted as interpreter.

The Puerto Rican visitors also had the opportunity to tour Admiral's Harvard, Illinois, electronics center to study the manufacture of color television receivers. ▲

.. Fuseholders of Unquestioned High Quality

expanding production of special purpose and power tubes. These are finding steadily broader use in commercial, industrial and military applications.

Integrated Circuits in Television Set

The Radio Corporation of America announced it is now building tiny integrated circuits—about the size of a match-head—into certain RCA Victor television sets to be marketed this year, opening the way to the most revolutionary advances in TV set making since the introduction of color.

The paper-thin silicon circuits, so small they cannot be manipulated by human fingers yet performing the functions of as many as 26 components, follow in the footsteps of the electron tube and the transistor.

The new microminiaturized circuits are expected ultimately to make possible pocket-size TV sets and thin-screen wall TV sets.

In 1961 RCA designed a prototype pocket-sized color TV set.

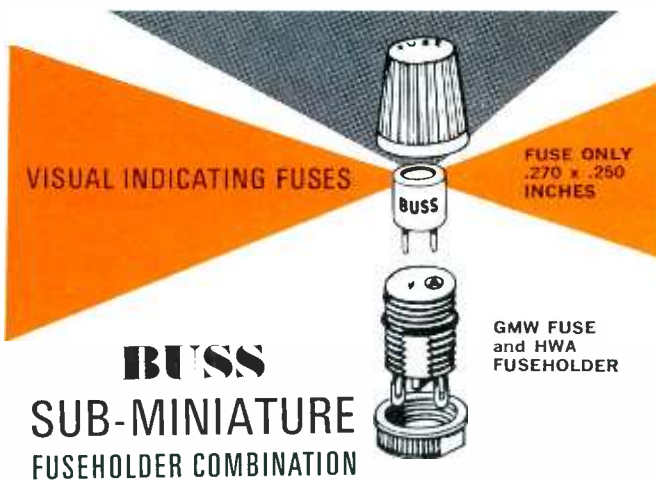
Prefabricated Head Ends

A new concept of factory fabricated head ends designed to increase the sales of master antenna television equipment was announced by Blonder-Tongue Laboratories, Inc.

The new development was unveiled by Walter Ullrich, product manager for the Newark, N. J., electronics firm, at a regional seminar on master antenna television.

Mr. Ullrich said that "the head end is completely fabricated, tested and aligned for the specified channels and is delivered to the distributor ready for installation. No costly labor is necessary for the distributor to assemble all the component parts. He merely hooks up the distribution cables to the output, antenna cables to the input, and the system becomes operative."

Blonder-Tongue describes the new concept as another first in the company's effort to make the sale and installation of



BUSS SUB-MINIATURE FUSEHOLDER COMBINATION

For space-tight applications, Fuse has window for inspection of element. Fuse may be used with or without holder.

Fuse held tight in holder by beryllium copper contacts assuring low resistance.

Holder can be used with or without knob. Knob makes holder water-proof from front of panel.

Military type fuse FM01 meets all requirements of MIL-F-23419. Military type holder FHN42W meets all military requirements of MIL-F-19207A.

Write for BUSS Bulletin SFB

INSIST ON **BUSS**
QUALITY

BUSSMANN MFG. DIVISION, McGraw-Edison Co., ST. LOUIS, MO. 63107

Circle 8 on literature card



The best reason for using Motorola's HEP semiconductors...

is usually put in the bank!



Because HEP, from Motorola, offers you quality solid-state devices at substantial savings.

It's money in the bank when you select Motorola's HEP semiconductor devices to fill your replacement needs. These devices help you in four ways to build your business, to stock fewer parts and lower your costs. (1) Motorola HEP devices cost you less than competitive devices so you can give high quality work and quality devices at lower customer costs. This means more business for you but your profit margin and labor costs remain the same. (2) Motorola HEP's Value Insured Parameters (VIP) assure you of reliability and top performance. Each device is individually tested to printed ratings — that means when the job is sold it stays sold. (3) Motorola HEP's pocket cross-reference covers almost 5,000 JEDEC and manufacturers devices that you use. (You can count 'em.) You stock only a few to cover all of them! (4) Each Motorola HEP device is backed by the leader in the lively art of solid-state electronics —

and bears a name your customers recognize and accept.

See your local HEP distributor today. Reduce your parts investment and lower your costs. You can bank on the fact that you will be first with the latest, best and most dependable semiconductors. Get HEP. Use HEP.



To get your copy of the handy pocket semiconductor cross-reference guide see your HEP distributor or send a card with your name and address to Motorola HEP, Box 955, Phoenix, Arizona 85001.

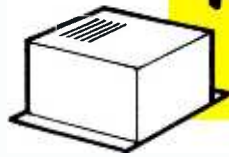


MOTOROLA
Semiconductors

Circle 15 on literature card

Encounters inside the cage

by Carl Babcoke



Focus and HV problems - IN COLOR SETS

This article could be subtitled (in the best tradition of soap operas) "How rocky is the road to electronic truth?" It all started as a minor, simple research project. Being one of the local electronic "experts," I was asked to teach color-TV servicing to an evening class of experienced b-w TV technicians. After 12 years of

focus circuit possible; a voltage divider across the high-voltage supply, with a potentiometer as part of the divider. In Fig. 2 the focus voltage is supplied by a separate rectifier followed by a voltage divider including a potentiometer for adjustment. The circuit in Fig. 3 was used for several years to vary the pulse voltage before it reached the rectifier. The action of Fig. 4 seems complicated until we realize the focus coil and the 300-pf capacitor form a parallel-resonant circuit whose effective impedance varies with the tuning. This variable impedance and the 200-pf capacitor act as a voltage divider across the two flyback taps.

So far, so good. But the first gremlin appeared in the form of the variable focus coil used in some variation by virtually all manufacturers of recent color-TV receivers except Zenith and Motorola. The circuit, as drawn in most of the schematics, is shown in Fig. 5, but this did not help to decipher the puzzle. What are the coupling and phase of the windings, and where does the core move when adjusted? Sleeping on the problem produced only nightmares, no ideas. There seemed to be but one way to find an answer: make some tests on a live chassis.

Thoughtfully choosing a time when the rest of the family would not be watching color programs, I pulled the chassis out of my own receiver (RCA CTC15) and placed it on the home workbench with extension

cables attached so it would operate normally. The VTVM with high-voltage probe verified normal focus operation with a range of adjustment from 4.4 to 5.2 KV. With the set safely turned off, I examined the focus coil with a magnifying glass and even removed the tape from the windings. But the inside ends of the windings were not visible. This was no time for indecision, so I removed two of the windings with a knife and made a diagram of the windings

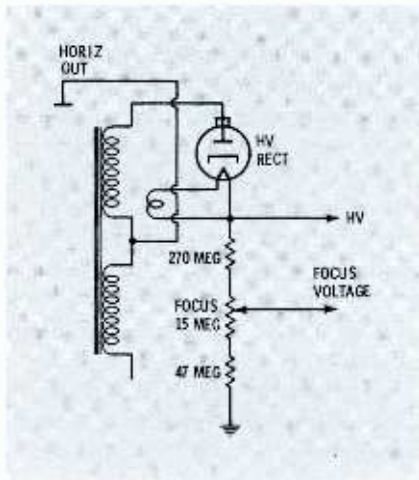


Fig. 1. Circuit in Motorola Ch. TS-912.

servicing color sets, I had few practical problems, but during the course questions arose about a circuit that had seemed too simple to worry about before. And some of these theoretical questions are like the Arizona mountains: the harder you try to approach them, the farther away they seem to move.

Consider the matter of focus circuits. At first the explanations flowed smoothly. Fig. 1 shows the simplest

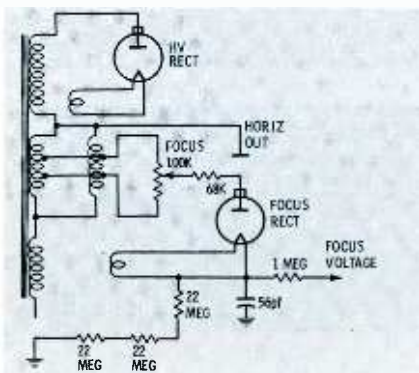


Fig. 2. Circuit in Zenith Ch. 25MC36.

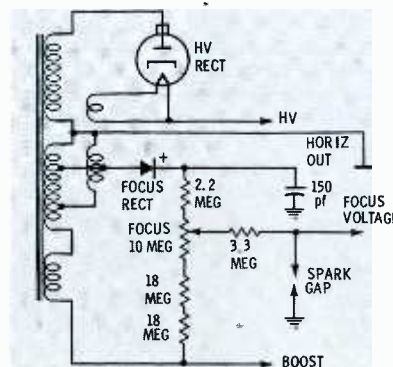


Fig. 3. Circuit in RCA Ch. CTC7.

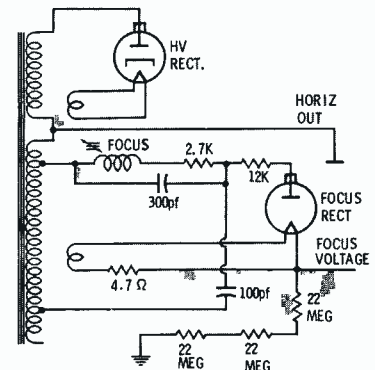


Fig. 4. Circuit in Zenith Ch. 29JC20.

and the numbers of the lugs to which they were attached. The core was removed and found to be long enough to be inside two of the windings at one time. These facts, transferred back to the original diagram, make the circuit in Fig. 6A, and the operation is thus explained: with the core inside windings B and C (the end of the coil nearest the lugs—core screw turned clockwise) they

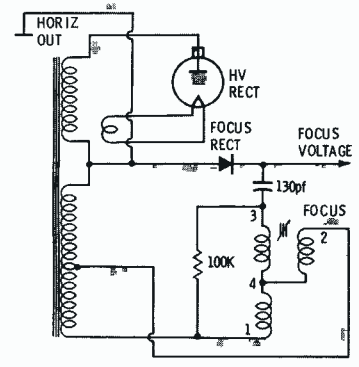
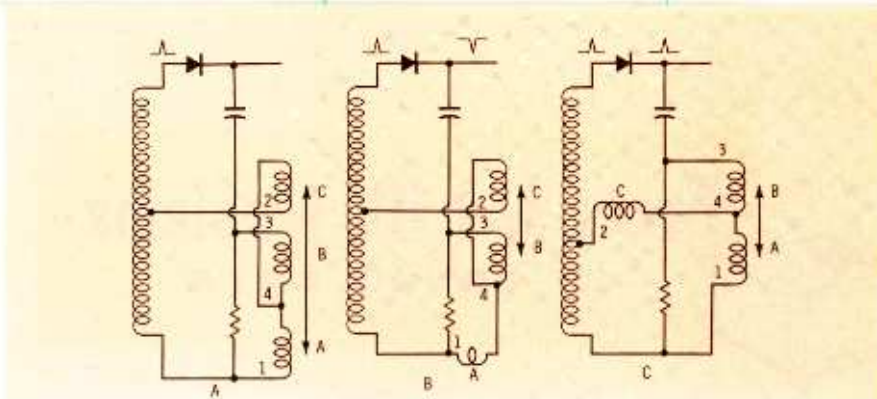


Fig. 5. Circuit in RCA Ch. CTC15.



(A) Normal voltage. (B) Increased voltage. (C) Decreased voltage.

Fig. 6. Effective circuits of Fig. 5.

are coupled together, but winding A will have virtually no inductance or coupling to the other windings. Therefore, the positive-going pulse at terminal 2 will be inverted by the (winding C is nearly out of the circuit since it has no core) to terminal 4. Windings A and B then become an autotransformer and the spike at the output terminal 3 is now positive-going. This *subtracts* from the pulse at the plate and reduces the DC focus voltage. If the core is centered in the form, it will be partially inside windings A and C. These windings are out of phase; hence, their fields cancel and induce no voltage into winding B. Windings A and C act as inductive voltage divid-

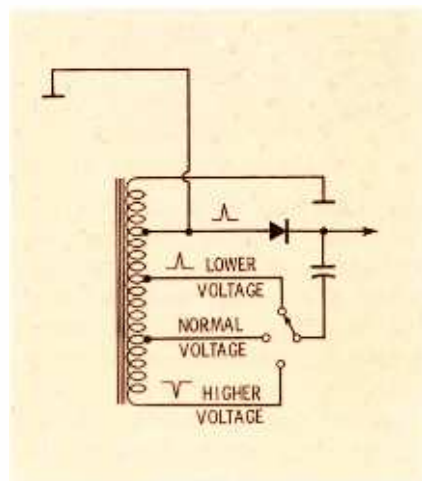


Fig. 7. Equivalent circuit of Fig. 5.

ers to give a pulse midway between the two extreme conditions just given. The circuit action under these three conditions is the same as the simplified circuit in Fig. 7, except the voltage is continuously variable in the actual coil circuit.

This explanation satisfied me, but it didn't replace the windings on the ruined coil, so experiments ended for that night. The new replacement coil was the same as the original coil used on RCA Chassis CTC 16, 16X, 17, 17X, and 19, where winding C is tapped and has more turns of wire to give higher focus voltage. With the new coil wired as shown in Fig. 8, the focus voltage varied between 4.6 and 6KV (this is a better range since optimum focus on this particular tube occurred at about 5KV). To install a new coil, follow the instructions packed with the coil with one addition: the yellow dot on the new coil is between terminal 1 and 5, so hold the coil with the terminal end facing you and count clockwise from the dot as you would the pins of a tube.

Is this circuit action verified in practice? It took only a few minutes to connect the common lead of the scope to B boost and the high side to terminal 3. Figs. 9 A, B, and C show the polarity change with cancellation near the middle of the

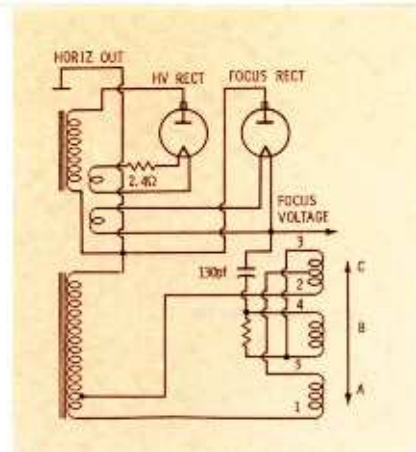
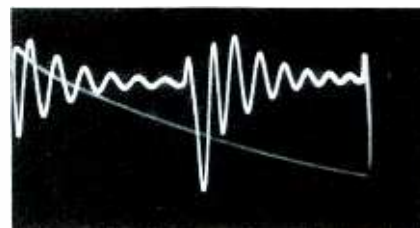


Fig. 8. RCA Ch. CTC16 focus-coil wiring.

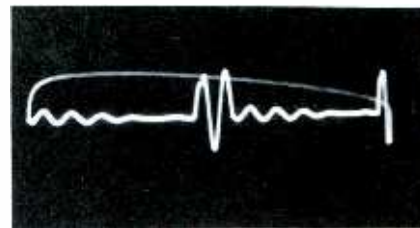
range, although the pulse has become a damped wavetrain because transformer action of windings B and C and the output at terminal 3 will be negative-going. This negative pulse coupled to the cathode of the focus rectifier through the 130-pf capacitor will be *added* to the positive-going pulse at the plate and thus increase the DC focus voltage. Conversely, if the core is moved so that it is inside windings A and B only, the action is reversed. The positive-going spike at terminal 2 goes through winding C with little change of the resonant effect of the coil windings tuned by the focus filter capacitor.

Why does the 100-K damping resistor across the focus coil sometimes burn to a crisp? Shorted recti-

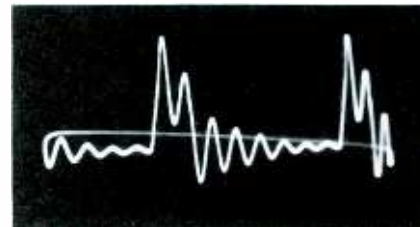
• Please turn to page 52



(A) Higher focus voltage.



(B) Core at middle of range.



(C) Lower focus voltage.

Fig. 9. Waveforms in circuit of Fig. 8.

Table 1.

Effects of line voltage on RCA CTC15.

Line voltage	110VAC	120VAC	125VAC
B plus	350VDC	395VDC	410VDC
B boost	650VDC	730VDC	760VDC
6JE6 screen	138VDC	144VDC	146VDC
6JE6 control grid	-49VDC	-55VDC	-58VDC
Focus	4.4KV	5KV	5.3KV
High voltage	24KV	26KV	27KV
Regulator current	1.1ma	1.3ma	1.4ma



SQUARE-WAVE TESTS



in HI-FI Amplifiers

An extension of modern methods to audio equipment.

by Robert G. Middleton

Preceding articles in our "Advanced Service Techniques" series have introduced you to these basic principles of square-wave testing:

1. A square wave is made up of a fundamental sine wave plus an infinite number of its odd-order harmonics.
2. Square-wave analysis of components and networks will indicate the presence of inductance, capacitance, and resistance.
3. RC, or time constant, of a network can be determined by square-wave tests. If either value, resistance or capacitance, is known, the other can be easily calculated. Since RC measurements can test all components within a network, individual component checks need not be performed.

These basic concepts may seem difficult to learn, but they must be thoroughly understood before more complex techniques are introduced.

A wideband triggered-sweep scope, described in the March 1965 PF REPORTER article "Learning About Triggered-Sweep Scopes," and a fast-rise square-wave generator, described in the April 1965 PF REPORTER article "Advanced Techniques for Future Servicing," were used in obtaining the photos in this article. If you can arrange to use equipment such as this, try to do so. Even if you cannot, at present, make use of one of these scopes, follow with us. Information in this and succeeding articles of this series will be invaluable to you in the future.

—The Editor

High-fidelity amplifiers are designed to reproduce audio frequencies with a high degree of faithfulness to the original source. Unfortunately there is still controversy, not only about response standards for high-fidelity amplifiers, but about methods of measuring their response. Although other means must be used to measure total-harmonic and inter-modulation distortion, square-wave tests can be used to detect ringing, oscillation, phase shift, and poor frequency response; for this reason,

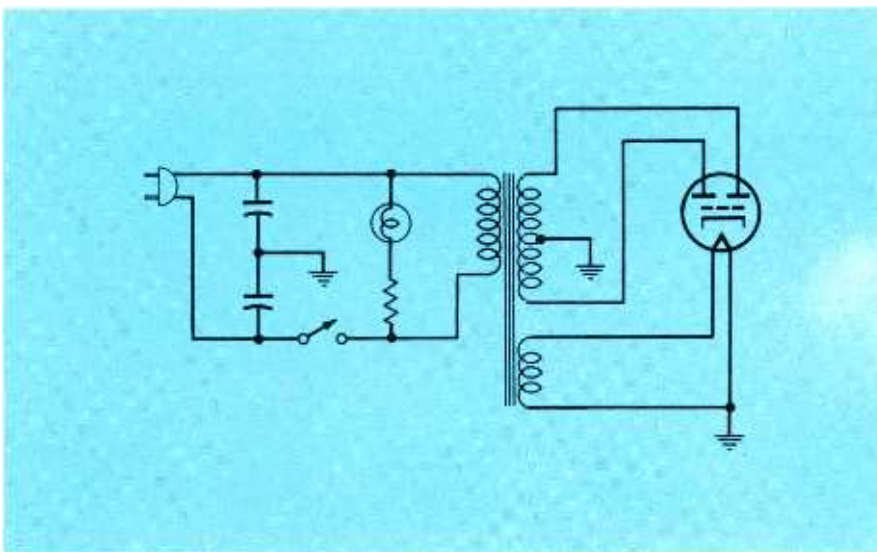
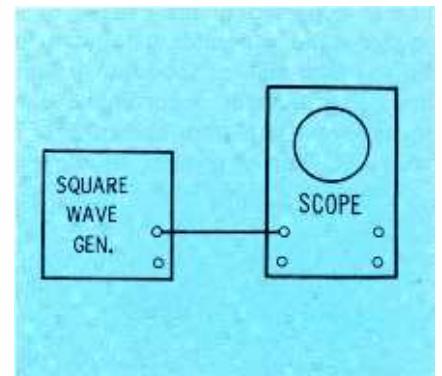


Fig. 1. The AC line is bypassed to the generator chassis.

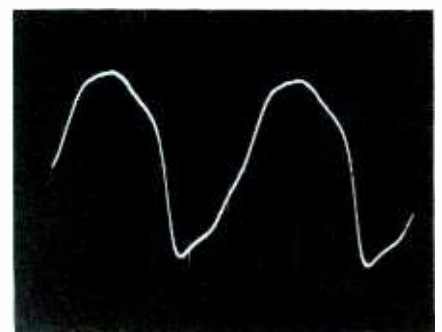


Fig. 2. Demonstration of AC line hum.

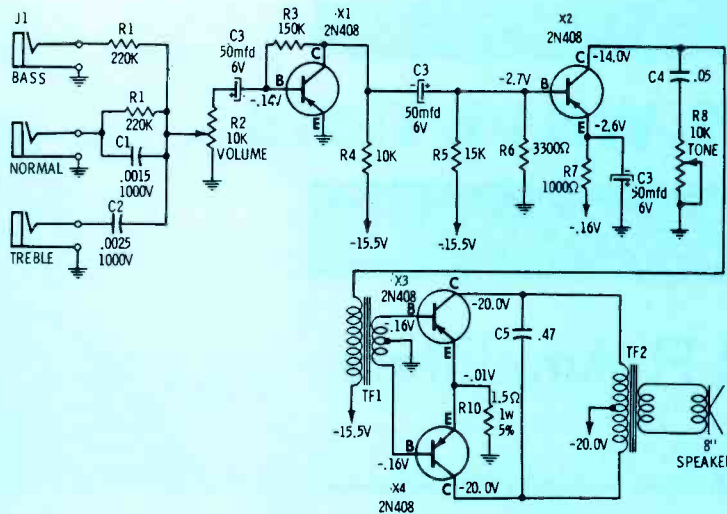


Fig. 3. One side of AC line is coupled to ground through C8.

square-wave tests are an important aspect of audio servicing.

Test Precautions

Some high-fidelity amplifiers employ tubes; others are transistorized. Tube-type amplifiers are much more rugged than transistor types and are not as easily damaged by surges or overloads. You must observe appropriate caution when testing a transistorized amplifier. The first precaution is: Always connect the ground lead of the generator first; disconnect it last. This will avoid possible damage to transistors from power-line coupling. Note that the power line is bypassed to the chassis of a square-wave generator as shown in Fig. 1. One side of the input power line is grounded; accordingly, the square-wave generator chassis is 117 volts AC above ground developed

across either C22 or C21. The output lead from the square-wave generator supplies an appreciable 60-cps voltage as long as the ground system of the test setup is floating. Fig. 2 shows a simple test which demonstrates the presence of high-level hum voltage with a floating-ground system. Next, suppose an amplifier is connected between the generator and scope in Fig. 1. Many transistorized amplifiers have the power line bypassed via a capacitor to the chassis, shown in Fig. 3. If the ground lead is unconnected, the hum level may be twice as great, depending upon the way that the plug is inserted into the outlet. Of course, the scope also has a power supply with one or both sides of the power line bypassed to the scope chassis. With the ground system floating, the resulting high-level hum voltage

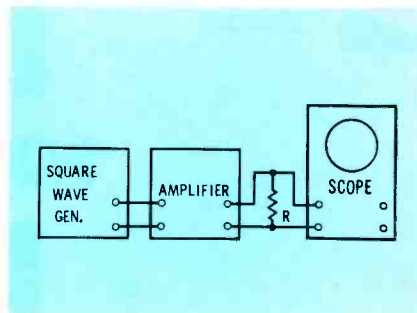


Fig. 5. Square-wave test setup.

would be applied to input X1 in Fig. 3, and transistor damage will be a distinct possibility. On the other hand, if the ground leads are connected first, the generator chassis, amplifier chassis, and scope chassis will be at ground reference (zero volts). After tests are completed, disconnect the ground leads last.

With both tube-type and transistor amplifiers, connect a load resistor across the secondary of the output transformer before applying a square-wave test signal. If the secondary is left unloaded, and the output stage is driven at a fairly high level, the output transformer may burn out.

Test Procedure

Fig. 4 shows the schematic of a simple tube-type hi-fi amplifier. Either an 8 or 16-ohm power resistor may be connected across the corresponding output terminals. It is not advisable to use the speaker as a load, for three reasons: First, the speaker impedance will affect square-wave response; second, the noise from the speaker during a square-wave test is very objectionable in a shop; third, transients induced dur-

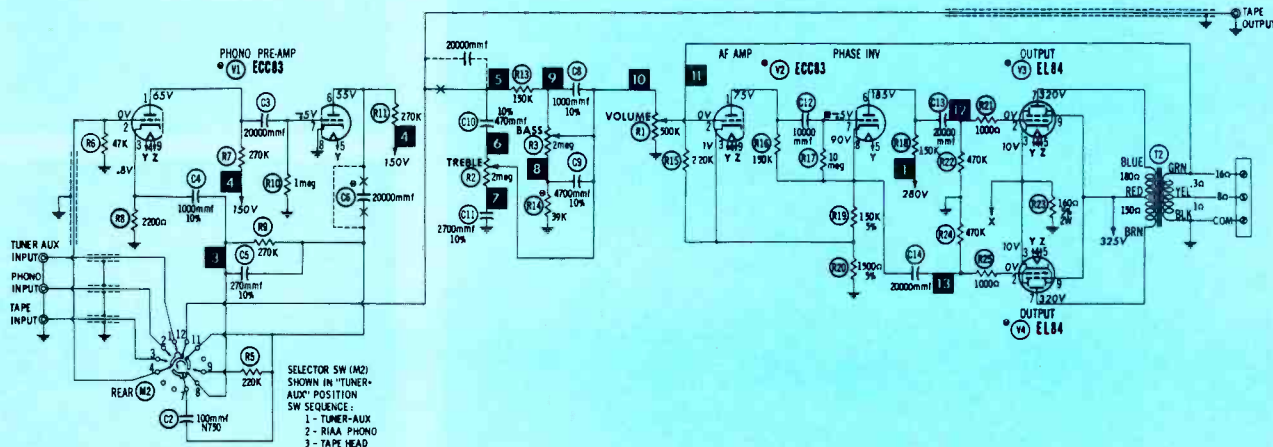


Fig. 4. Schematic of simple hi-fi amplifier.

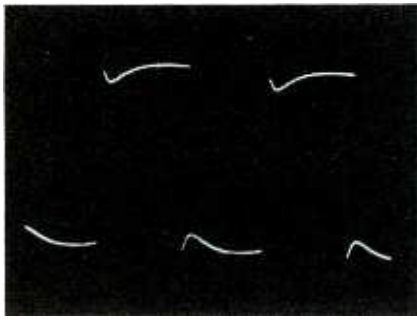


Fig. 6. Sixty-cycle square-wave response.

ing the test can damage the speaker. The test setup is made as shown in the block diagram of Fig. 5.

You will normally find somewhat different square-wave response from the tuner-aux, phono, or tape inputs; each should be checked out. The tuner-aux input provides a basic response test. It is customary to make routine tests at 60 cps and at 2 kc. Fig. 6 shows a normal 60-cps square-wave response, with the bass and treble controls set to midrange. If you set these controls slightly away from their midpoints, you will obtain a flat-topped square-wave which is within the specifications for the amplifier.

If you get this result, fine. On the other hand, suppose that you see a scope pattern as illustrated in Fig. 7, which becomes even more greatly distorted when the bass and treble controls are adjusted. This means that possibly the feedback resistor R15 in Fig. 4 has increased in value, or that the negative-feedback circuit is open. Check the value of R15, and check the ground connection of T2.

Do not set the square-wave generator exactly to 60 cps, but to a frequency such as 58 cps or 62 cps. This will show whether there is a visible hum level. If appreciable hum is present, it will cause a 2-cps beat, and the square-wave pattern will writhe. Hum is usually caused by heater-cathode leakage in a tube. It can also be caused by a defective filter capacitor. However, if

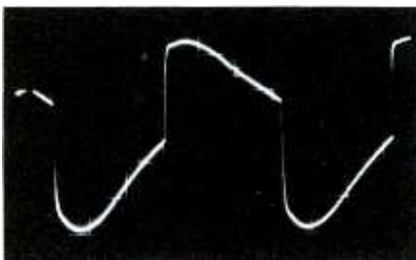


Fig. 7. Feedback resistor increased in value.

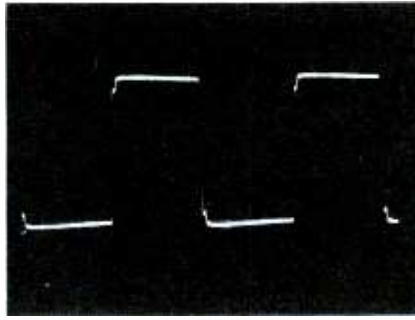


Fig. 8. Response at 2 kc and low level.

these possibilities are cleared, check the setting of the hum-balance control. Adjust the control for minimum writhe in the scope pattern.

Overload Symptom

Note that the waveform in Fig. 6 is symmetrical, but that the waveform in Fig. 7 is not. This indicates amplitude nonlinearity, which can be caused by a weak tube or an off-value cathode-bias resistor. Amplitude nonlinearity is greater if the negative-feedback loop is open or otherwise defective. However, make certain that you are not overdriving the amplifier and exceeding its rated power output. Any amplifier will overload and display amplitude nonlinearity if it is substantially overdriven. The peak-power output of an amplifier is given by the formula $W = E_p^2 R$, where E_p is the peak voltage of the output waveform, R is the value of the load resistance, and W is peak-power watts. Hence, calibrate your scope, measure the peak voltage of the output square wave, and check the peak-power calculation against the manufacturer's rating. Always keep below this maximum rating.

Next, make a 2-kc square-wave test of the amplifier. The normal response is illustrated in Fig. 8. Treble and bass controls are set to midrange. You may observe slight tilt. This tilt can be removed by setting the treble and bass controls slightly off midposition. Corner



Fig. 9. Response at 2 kc and 80% of maximum volume.

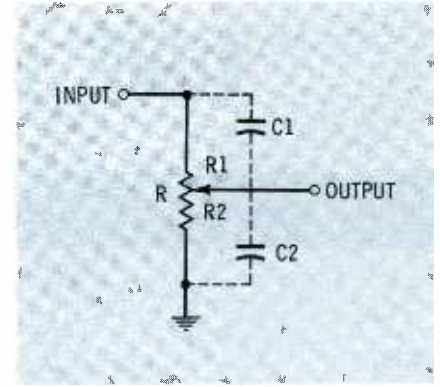


Fig. 10. Potentiometer R is comprised of R1C1 and R2C2.

notching is noticeable, which is not greatly responsive to control variation in the midrange region. In Fig. 7, a low-level square-wave input is used, and the volume control is set to maximum.

Next the volume-control setting is reduced, and output from the square-wave generator is increased. It is perhaps surprising to see a change in square-wave output, as illustrated in Fig. 9. Since this is not an elaborate high-fidelity amplifier, the test result is not an indication of a circuit defect. Fig. 9 indicates that the high-frequency response of the amplifier is poorer than that in Fig. 8. The high-frequency droppoff is due chiefly to stray capacitance in the volume control. Refer to Fig. 10. When the potentiometer is set to less than maximum, the square-wave signal "sees" a series-parallel network, which has two time constants: R1C1, and R2C2. C1 and C2 are made up of stray capacitance. Only when the time constant of R1C1 equals that of R2C2 will the potentiometer have no effect upon square-wave response.

For the amplifier under analysis, the waveform of Fig. 9 is acceptable. However, if you see the waveform illustrated in Fig. 11, serious high-frequency loss is evident. In this ex-

• Please turn to page 56

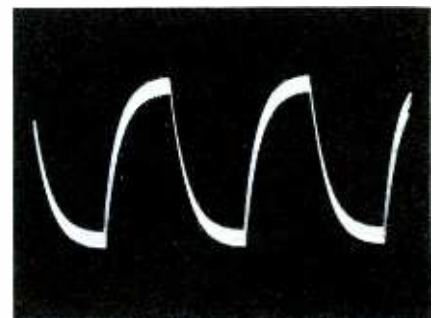


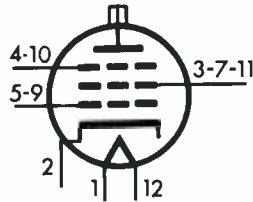
Fig. 11. Response at 2 kc with feedback loop defective.

TUBE and TRANSISTOR DATA

RECEIVING TUBES

6KE6

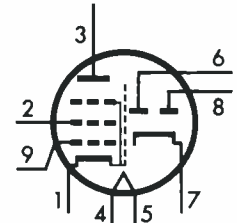
Horizontal Output
Fil.—6.3V @ 1.5A



12GM

6LT8/8LT8

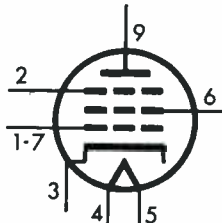
Pentode—Horizontal Oscillator
Dual Diode—Horizontal Phase Defector
Fil.—6.3V @ 0.6A (11sec)
8.1V @ 0.45A (11 sec)



9RL

19KF6

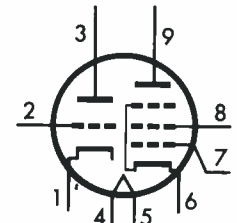
Horizontal Output
Fil.—19.5V @ 0.45A



NOVAR

10LW8

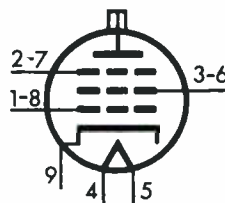
Pentode—Video Amplifier
Triode—General Purpose
Fil.—10.5V @ 0.45A (11 sec)



9DX

6KG6/27KG6/40KG6

Horizontal Output
Fil.—6.3V @ 2.0A/26.7V @ 0.45A
40.0V @ 0.3A

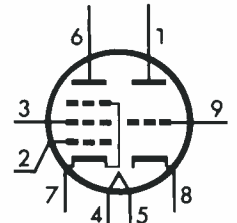


9RJ

NOVAR

6LX8

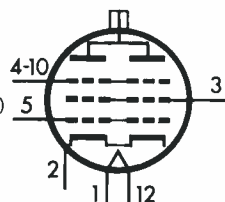
Pentode—Horizontal Oscillator
Triode—General Purpose
Fil.—6.3V @ 0.45A (11 sec)



9DC

6KN6/42KN6

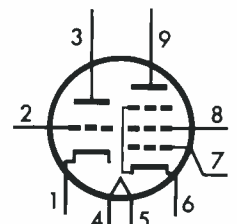
Horizontal Output
Fil.—6.3V @ 3.0A/42.0V @ 0.45A (11 sec)



12GU

6LY8

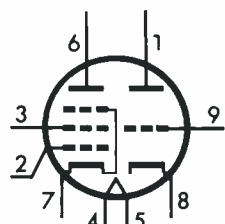
Pentode—Video Amplifier
Triode—General Purpose
Fil.—6.3V @ 0.75A



9DX

6LN8

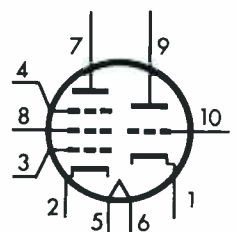
VHF Converter
Fil.—6.3V @ 0.45A (11 sec)
Similar to 6BL8



9DC

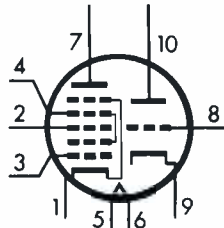
5U9/6U9/8U9

Pentode—Video-IF Amplifier
Triode—Audio or Sync Amplifier
Fil.—5.9V @ 0.45A/6.3V @ 0.41A/8.0V @ 0.3A



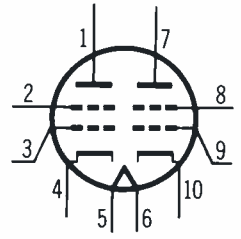
5V9/6V9/9V9

Heptode—Sync Separator
Triode—Sync Amplifier
Fil.—5.0V @ 0.45A/6.3V @
0.435A/9.2V @ 0.3A



15AB9

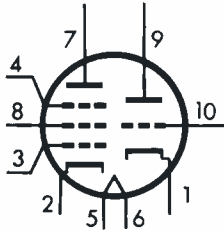
VHF Amplifier
Fil.—15.0V @ 0.15A



10N

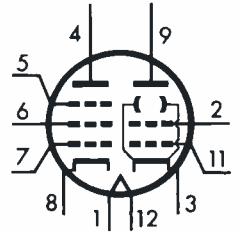
5X9/6X9/8X9

Pentode—TV-IF Amplifier
Triode—General Purpose
Fil.—5.9V @ 0.45A/6.3V @
0.41A/8.0V @ 0.3A



17AB10

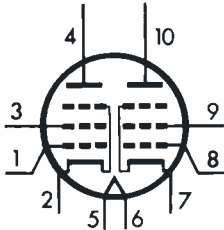
Pentode #1—Audio Detector
Pentode #2—Audio Output
Fil.—16.8V @ 0.45A (11 sec)



12BT

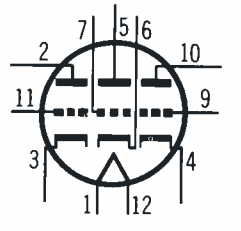
6Y9/11Y9/16Y9

Pentode #1—Video Amplifier
Pentode #2—Audio-IF Amplifier
Fil.—6.3V @ 0.8A/11.0V @
0.45A/16.5V @ 0.3A



6AC10

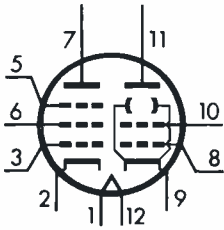
Color-Difference Amplifiers
Fil.—6.3V @ 0.6A (11 sec)



12FE

6Y10

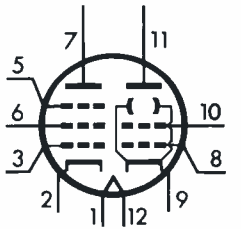
Pentode #1—Audio Output
Pentode #2—Audio Detector
Fil.—6.3V @ 0.83A
Pentode #1 similar to 6GZ5
Pentode #2 similar to 6GX6



12EZ

6AD10

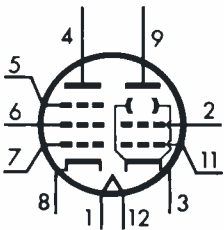
Pentode #1—Audio Output
Pentode #2—Audio Detector
Fil.—6.3V @ 1.05A



12EZ

6Z10/13Z10

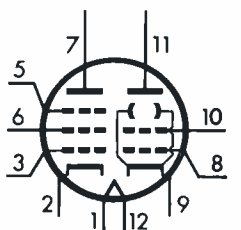
Pentode #1—Audio Detector
Pentode #2—Audio Output
Fil.—6.3V @ 0.95A/13.2V @
0.45A (11 sec)



12BT

12AE10

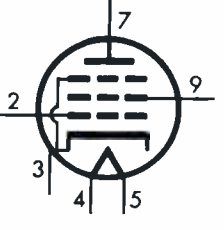
Pentode #1—Audio Output
Pentode #2—Audio Detector
Fil.—12.6V @ 0.45A (11 sec)



12EZ

8327

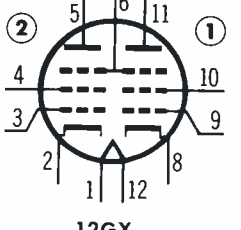
RF Power Amplifier, CB
Fil.—6.3V @ 0.76A



9CV

6AF10

Pentode #1—Audio IF or Burst Amplifier
Pentode #2—Video Amplifier
Fil.—6.3V @ 1.2A

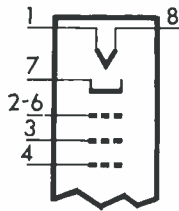


12GX

CATHODE-RAY TUBES

21FVP4

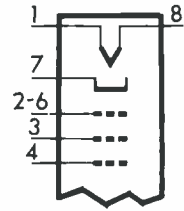
Protection—tension band
 Deflection—114°
 Filament—6.3V @ 0.45A (11 sec)
 Grid 2—400V



8HR

23GVP4

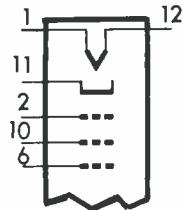
Protection—tension band
 Deflection—114°
 Filament—6.3V @ 0.45A (11 sec)
 Grid 2—45V



8HR

23ECP4

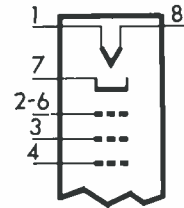
Protection—bonded glass
 Deflection—92°
 Filament—6.3V @ 0.6A (11 sec)
 Grid 2—35V



12L

23GXP4

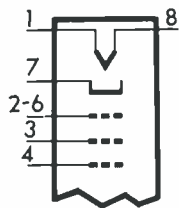
Protection—tension band
 Deflection—110°
 Filament—6.3V @ 0.6A (11 sec)
 Grid 2—300V



8HR

23EZP4

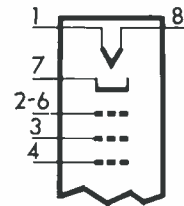
Protection—tension band
 Deflection—94°
 Filament—6.3V @ 0.45A (11 sec)
 Grid 2—50V



8HR

23HFP4/23HFP4A

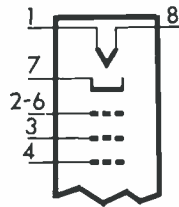
Protection—tension band
 Deflection—110°
 Filament—6.3V @ 0.45A (11 sec)
 Grid 2—400V



8HR

23FAP4

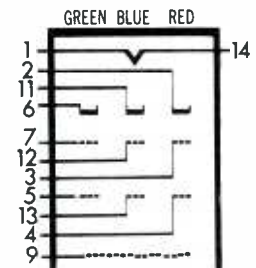
Protection—filled rim
 Deflection—114°
 Filament—6.3 @ 0.6A (11 sec)
 Grid 2—400V



8HR

25AP22/25AP22A

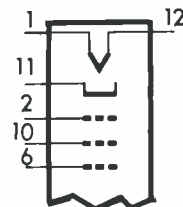
Protection—bonded glass
 Deflection—90°
 Filament—6.3V @ 0.8A
 Grid 2—400V
 25AP22A has rare-earth phosphor



14BE

23FNP4

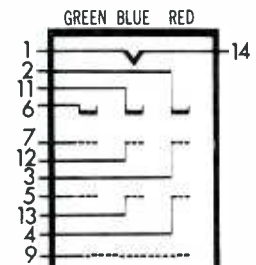
Protection—filled rim
 Deflection—92°
 Filament—6.3V @ 0.45A (11 sec)
 Grid 2—300V



12L

25BP22/22BP22A

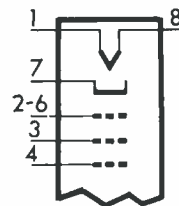
Protection—none
 Deflection—90°
 Filament—6.3V @ 0.8A
 Grid 2—400V
 25BP22A has rare-earth phosphor



14BE

23GDP4

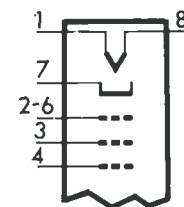
Protection—tension band
 Deflection—114°
 Filament—6.3V @ 0.6A (11 sec)
 Grid 2—400V



8HR

25DP4

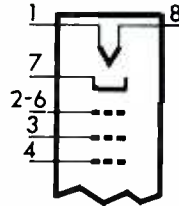
Protection—filled rim
 Deflection—110°
 Filament—6.3V @ 0.3A (14 sec)
 Grid 2—300V



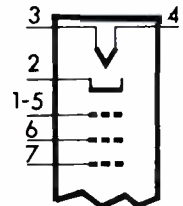
8HR

25LP4

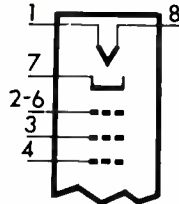
Protection—bonded glass
 Deflection—110°
 Filament—6.3V @ 0.6A
 Grid 2—400V

**8HR****12BMP4**

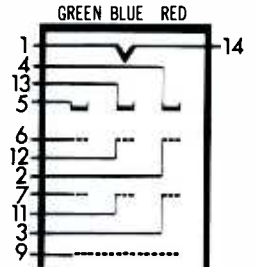
Protection—tension band
 Deflection—104°
 Filament—6.3V @ 0.45A (11 sec)
 Grid 2—140V
 Neck Diam.—0.788"

**7GR****9SP4**

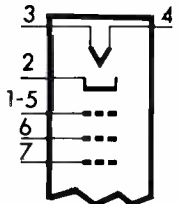
Protection—none
 Deflection—90°
 Filament—6.3V @ 0.6A (11 sec)
 Grid 2—300V

**8HR****17EJP22**

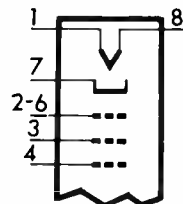
Protection—bonded glass
 Deflection—70°
 Filament—6.3V @ 1.8A (11 sec)
 Grid 2—200V

**14AU****11QP4**

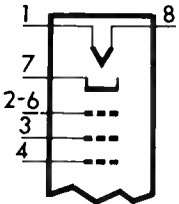
Protection—none
 Deflection 90°
 Filament—12.6V @ 0.075A (11 sec)
 Grid 2—100V
 Neck Diam.—0.787"

**7GR****17ELP4**

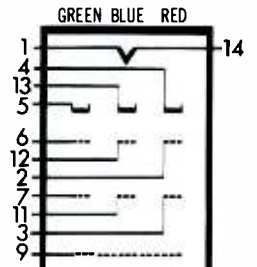
Protection—filled rim
 Deflection—114°
 Filament—6.3V @ 0.45A (11 sec)
 Grid 2—50V

**8HR****12BJP4**

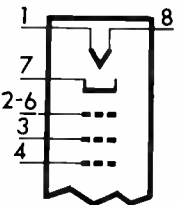
Protection—none
 Deflection—110°
 Filament—4.2V @ 0.45A (11 sec)
 Grid 2—400V

**8HR****17ENP22**

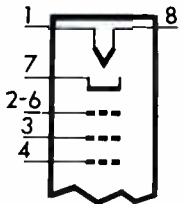
Protection—bonded glass
 Deflection 70°
 Filament—6.3V @ 1.8A (11 sec)
 Grid 2—200V

**14AU****12BKP4**

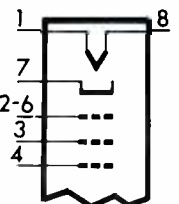
Protection—tension band
 Deflection—110°
 Filament—6.3V @ 0.45A (11 sec)
 Grid 2—50V

**8HR****19CMP4A**

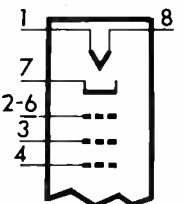
Protection—none
 Deflection 114°
 Filament—6.3V @ 0.45A (11 sec)
 Grid 2—30V

**8HR****12BLP4**

Protection—tension band
 Deflection—110°
 Filament—6.3V @ 0.45A (11 sec)
 Grid 2—30V

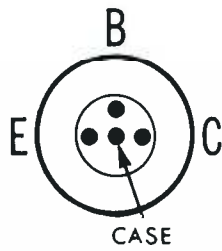
**8HR****19ELP4**

Protection—none
 Deflection—114°
 Filament—6.3V @ 0.6A (11 sec)
 Grid 2—400V

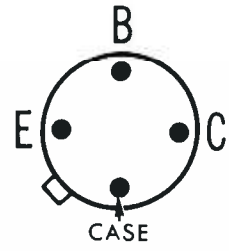
**8HR**

TRANSISTORS

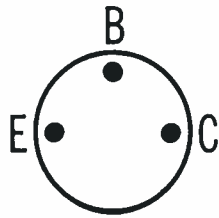
2SA246V
Video-IF Amplifier
PNP—Germanium



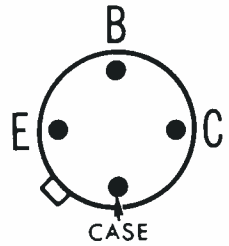
2SA378
VHF Amplifier
PNP—Germanium



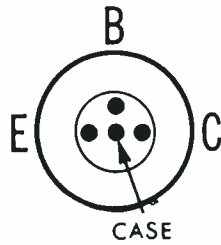
2SA350A
Video Amplifier
PNP—Germanium



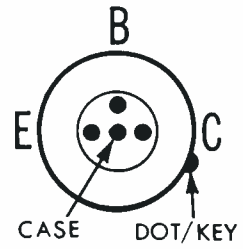
2SA420
Video-IF Amplifier
PNP—Germanium



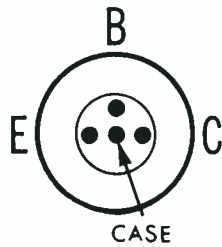
2SA223
Video Amplifier
PNP—Germanium



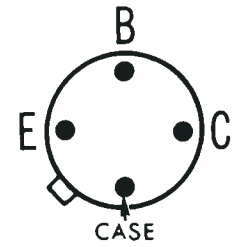
2SA433
Audio Amplifier
PNP—Germanium



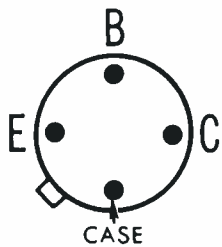
2SA234B
Video-IF Amplifier
PNP—Germanium



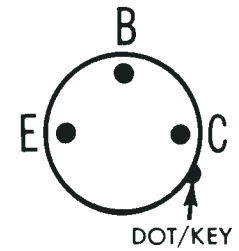
2SA440
VHF Amplifier
PNP—Germanium



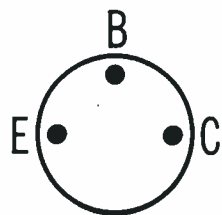
2SA242
VHF Amplifier
PNP—Germanium



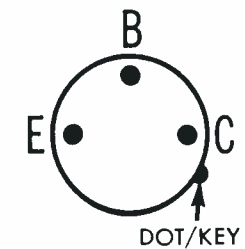
2SB32
Audio Amplifier
PNP—Germanium



2SA321
RF Amplifier
PNP—Germanium



2SB54
Audio Amplifier
PNP—Germanium



Looking into miniature CB TRANSCEIVERS



An analysis of what can be found

by Edward M. Noll

Miniature transceivers provide many convenient and essential voice-communication services. These units operate on the class-D Citizen's Band. Many are licensed in the Citizen's Band service and can be operated on any one of the 23 class-D channels. The same rules and technical performance requirements (FCC, Part 19) apply to these miniature units as to conventional CB base and mobile transceivers.

Unlicensed units (FCC, Part 15) may also be operated in the 26.97-27.27 megacycle spectrum provided they comply with certain FCC requirements: The power input to the final stage (exclusive of filament or heater power) shall not exceed 100 milliwatts, and the antenna shall consist of a single element that does not exceed 5 feet in length. A certificate must be attached to the unit to demonstrate compliance with Part 15 requirements. Unless the units are home constructed, they are usu-

ally certified by the manufacturer or distributor.

Operation of such 100-milliwatt, Part 15 units are subject to the condition that they must cause no harmful interference. Also, they must accept any interference that may be caused by other similar units as well as by any authorized radio service. Class-D licensed CB stations have priority over unlicensed units.

Unlicensed units of the 100-milliwatt type may not be used to communicate with stations licensed in the CB radio service. To communicate with CB stations, such units must themselves be licensed in this radio service and comply with appropriate FCC standards. No radio communications may be established between licensed and unlicensed CB units.

Miniature transceivers can be subdivided into three basic types. First is the very simple 100-milliwatt transceiver which has a variety of

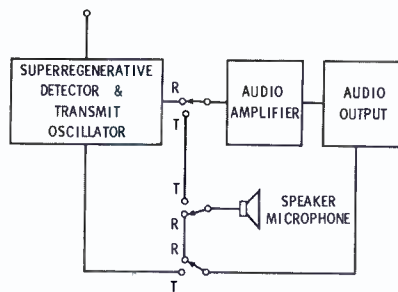
applications from toys to sports use and other limited-range communications. For the most part they are used in the Part 15 unlicensed service.

A second type is the more elaborate and better designed 100-milliwatt units with better stability and a longer useful range. These can be used either in the Part 15 or Part 19 radio services; their technical performance is such that they meet FCC class-D requirements.

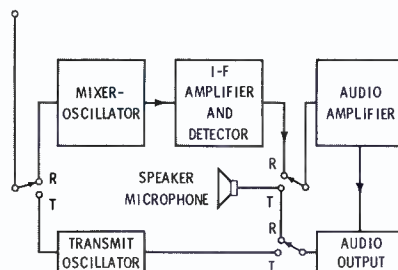
The third type is the higher powered $\frac{3}{4}$ - to 2-watt models. These may be used only in the Part 19 class-D CB service.

Short-Distance 100-Milliwatt Units

The simplest of the 100-milliwatt, Part 15 units contain from three to five transistors. A three-transistor model, Fig. 1, usually consists of one RF transistor stage and two audio stages. The single RF stage oper-



(A) superregenerative.



(B) superheterodyne.

Fig. 1. Functional plan of small units.

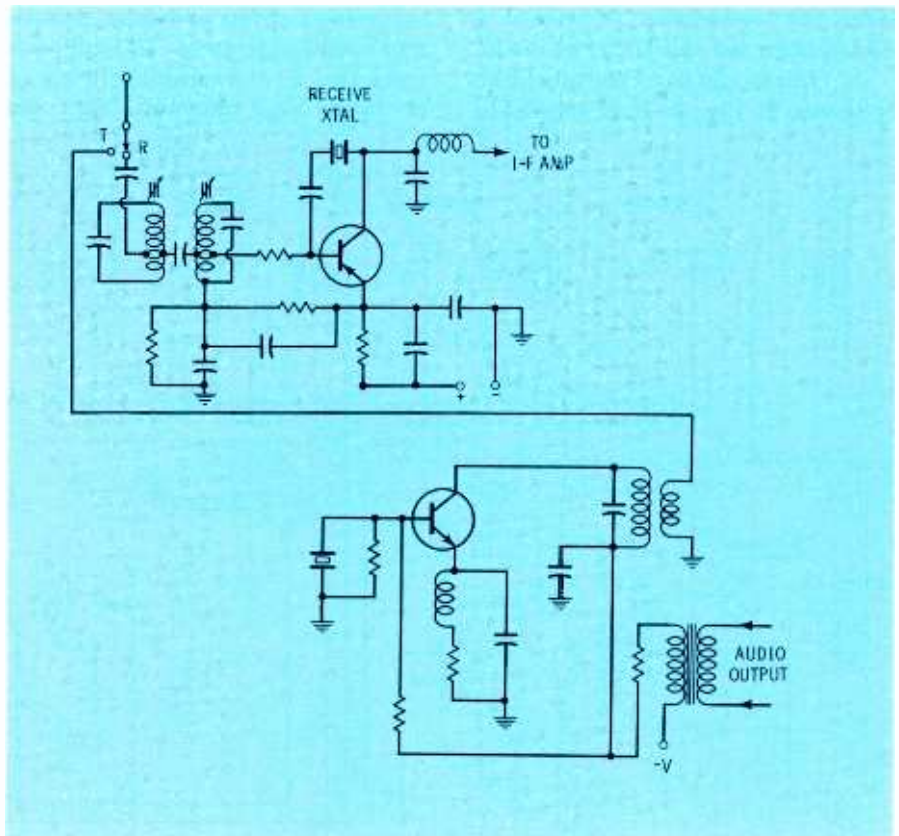


Fig. 2. 100-mw circuit arrangement.

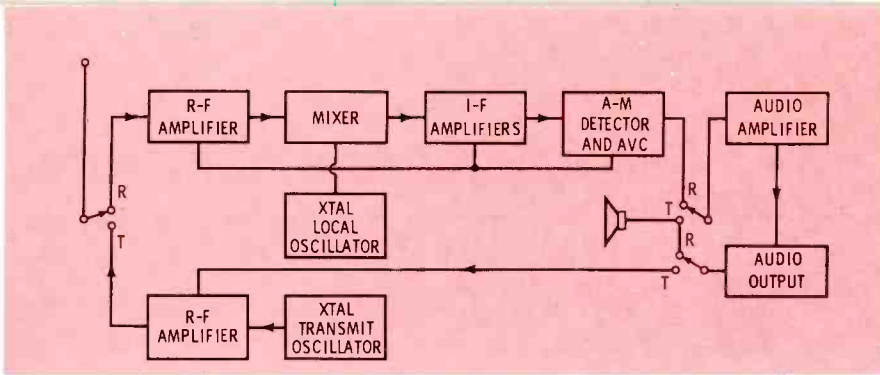


Fig. 3. A 100-mw transceiver with improved performance.

ates as a superregenerative detector on *receive* and a crystal-controlled, AM-modulated oscillator on *transmit*. A five-transistor model is more likely to be a superheterodyne receiver including mixer-oscillator, IF amplifier, and a two-stage audio amplifier. A separate RF transistor is used as a modulated oscillator. Note that the audio amplifier is used jointly in the transmit and receive modes.

The switching process handles three basic operations. The antenna is switched between receiver-mixer input and transmit-oscillator output. A second changeover switches the audio output between the loudspeaker on *receive* and the modulation input circuit of the transmit oscillator on *transmit*. The final switching occurs at the input of the audio amplifier. A changeover of the loudspeaker must be made between the receiver output and the audio input when the loudspeaker is used as a microphone for the transmit mode.

A typical mixer-oscillator circuit is shown in Fig. 2. It is similar to

that employed in other types of transistor radio receivers with the exception that the oscillator is crystal-controlled. The crystal frequency is usually selected to make the receiver sensitive to the transmit channel of the unit.

The transmitter is a single crystal-controlled oscillator, amplitude modulated by the output of the audio amplifier. Note that the collector voltage for the crystal oscillator is supplied through the secondary winding of the audio output transformer. Therefore, the collector supply voltage is itself modulated by any audio voltage variation across the secondary. In this manner the oscillator RF output is amplitude-modulated.

High Performance 100-mw Units

Higher performance 100-milliwatt units are available in miniature units using from seven to twelve transistors. Although only 100-milliwatt units, they have a substantially greater range and reliability than the

simpler models. The increase in range is largely the result of two factors. The receiver is made more sensitive by using one or two RF stages ahead of the mixer. The transmitter consists of a crystal oscillator and a following RF amplifier. The amplifier is modulated, and a higher level of good quality modulation can be obtained.

Fig. 3 is a functional diagram. The receiver usually employs an RF stage and two IF stages followed by a diode AM detector, an audio voltage amplifier, and a push-pull output stage. The transmitter consists of a crystal oscillator followed by one or two stages of RF amplification.

The schematic diagram of a nine-transistor model is shown in Fig. 4. The transceiver is shown connected for receive operation. The input transformer L1 connects the antenna to the low-impedance input of the RF amplifier transistor Q1. The primary of the transformer serves also as a loading coil for the antenna, which is only 39 inches long, a short length in comparison to a quarter wavelength at the class-D frequency range. This loading of the short antenna is particularly important in terms of the transmitter operation, providing an optimum load for the transmitter output transformer L4 which is connected into the circuit in the transmit position of the hand press-to-talk switch S2.

The output of the RF amplifier is

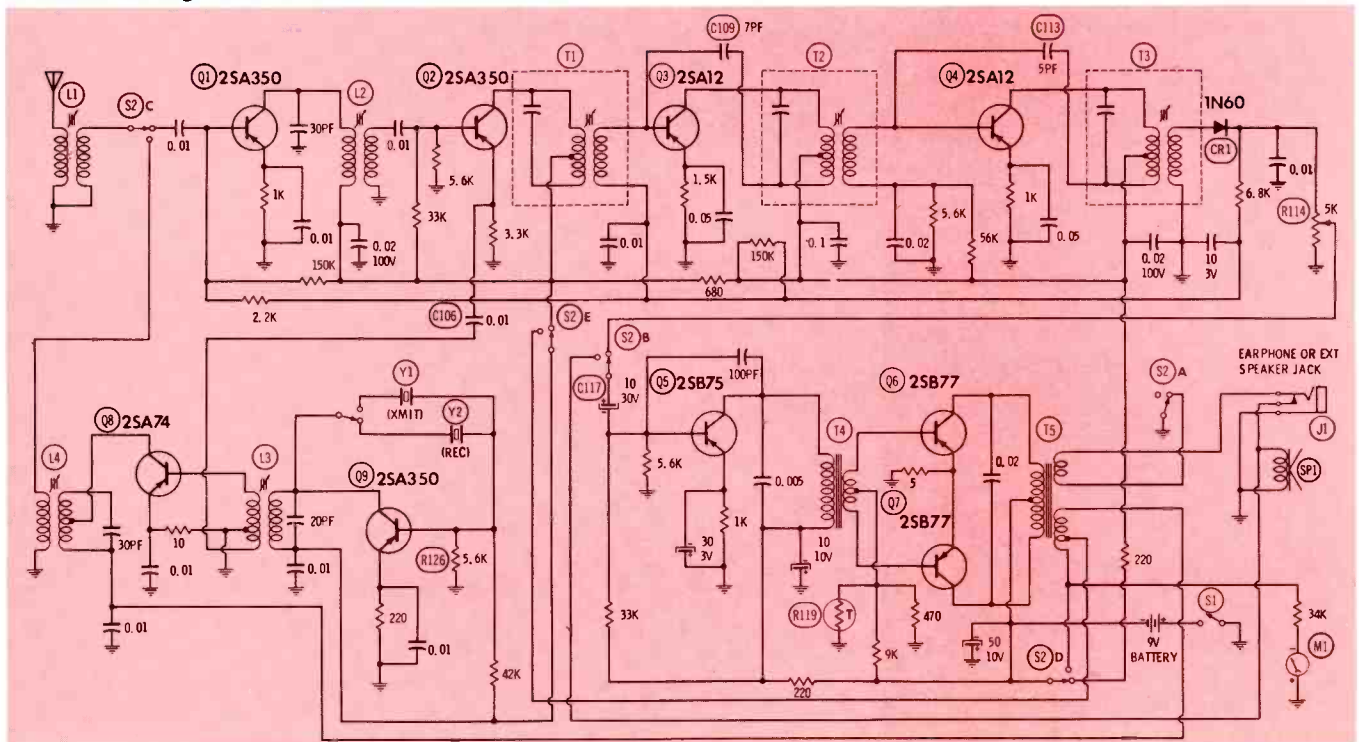
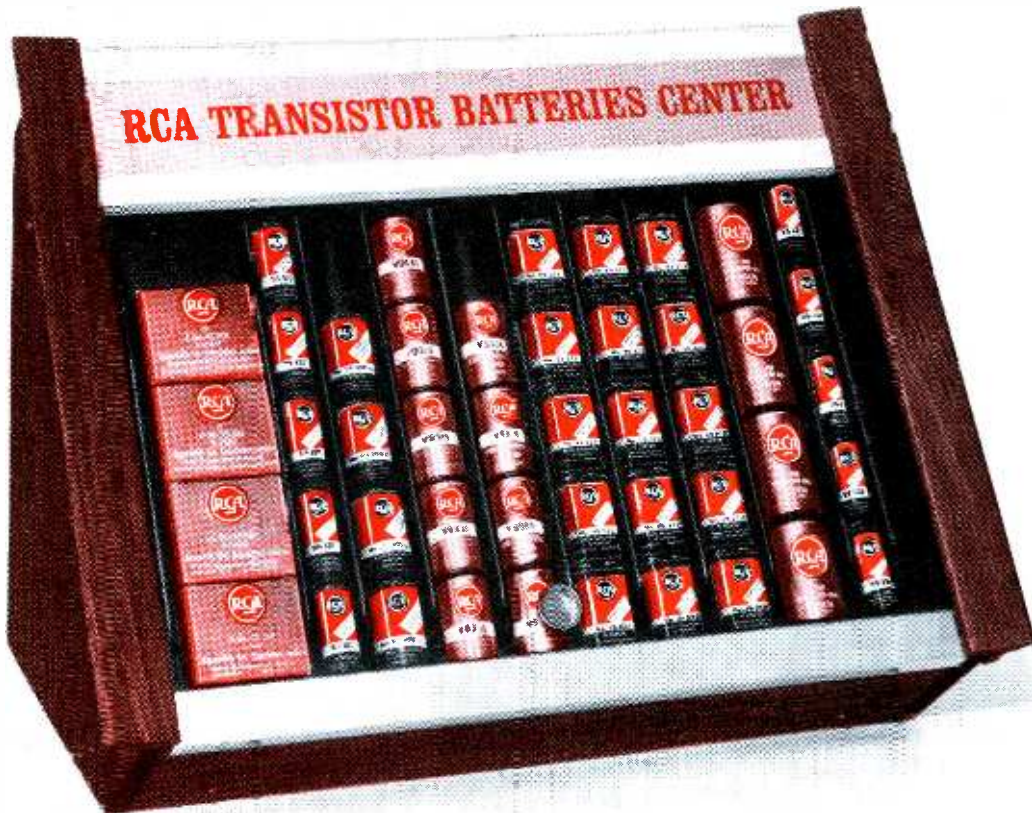
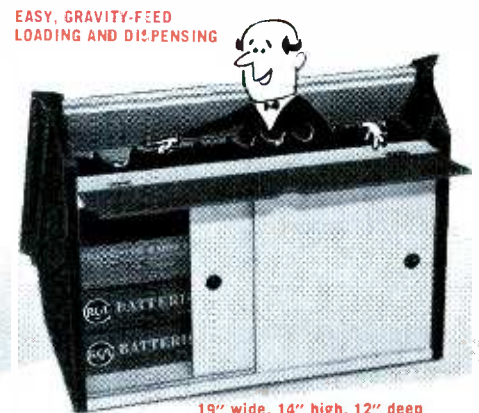
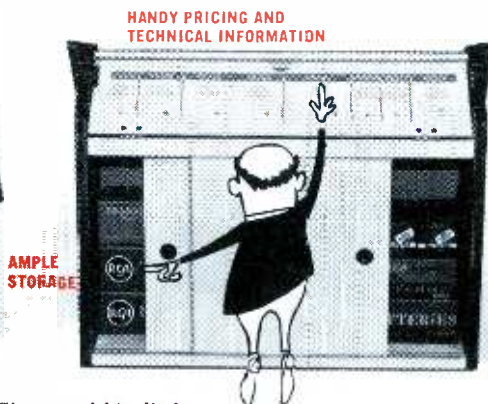
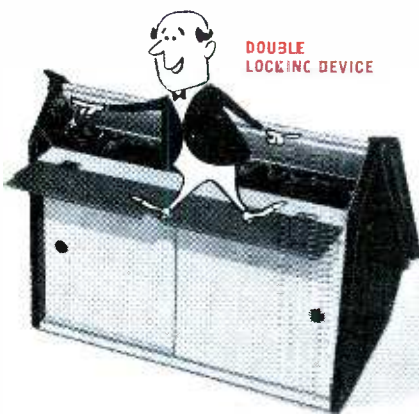


Fig. 4. Schematic of 100-mw transceiver.

Add real selling convenience to your transistor battery business with RCA's NEW "TOP 7" COMPACT SHOWCASE



Quality and convenience...inside and out. Its gold anodized aluminum header and genuine walnut trim reflect the smart styling, top quality, and durable construction of this RCA Battery Showcase. Underneath...there's a real inside story of selling convenience.

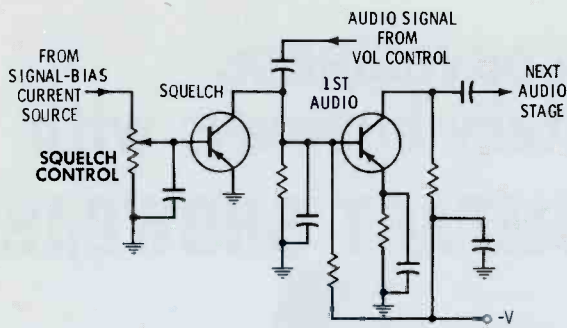


RCA's "Top 7" Showcase (1P1215) can add built-in eye appeal and real convenience features to the established turnover of the seven fastest-moving transistor battery types for which it was designed. It also accommodates the 1P1182A RCA Battery Tester as an optional accessory. Contact your RCA Battery Distributor and learn how you can add this "new look" to your battery business.

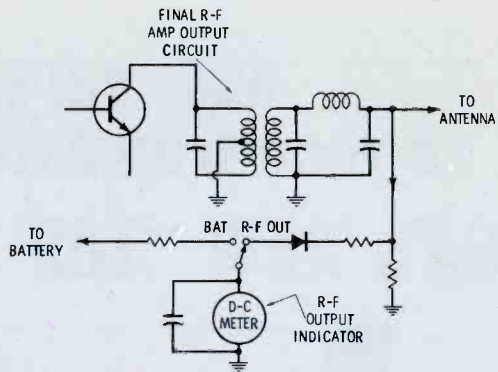
RCA ELECTRONIC COMPONENTS AND DEVICES, HARRISON, N. J.



The Most Trusted Name in Electronics



(A) Squelch



(B) Output indicator

Fig. 5. Typical circuits.

coupled through a similar impedance matching transformer (L2) to the base input of the mixer, transistor Q2. The local-oscillator signal is injected into the emitter circuit by way of capacitor C106; the local-oscillator source is the secondary of transformer L3.

The crystal oscillator Q9 is active in both transmit and receive modes. Only the crystal is switched. In the position shown, the receive crystal is in the circuit. Its frequency is such that a 455-kc intermediate frequency is developed. A two-stage IF amplifier follows. These are high-gain, neutralized amplifiers; neutralizing capacitors are C109 and C113. For good operating point stability, most of the stages operate with a combination of base-divider and emitter-resistor bias.

A crystal-diode detector follows the last IF stage. Some AVC bias is also developed by the same circuit and is applied to the base circuit of the first IF amplifier and the RF amplifier.

Audio signal is supplied from the arm of the volume control R114 through the transmit-receive switching to the input of the audio amplifier. A push-pull audio output stage is used. Bias-point stabilization is

aided with the thermistor R119. This thermistor corrects for the change in input conductance of the power transistors with temperature. The top secondary of the audio output transformer connects to the loudspeaker.

In the transmit mode, the output of the crystal-controlled oscillator is supplied to the base-input circuit of the modulated RF amplifier, transistor Q8. It is operated as a straight-through or fundamental RF amplifier. In transmit, the loudspeaker is used as a microphone; its output is supplied to the input of the audio amplifier by way of switch S2B and capacitor C117. The supply voltage is connected to the RF amplifier through the lower secondary of the audio output transformer. An audio variation developed across this secondary modulates the collector voltage to the RF amplifier. In this manner the output of transistor Q8 is amplitude modulated. Note also that through switch S2, the lower secondary of the audio output transformer is connected to the supply voltage of the crystal oscillator. Therefore there is also some modulation of the crystal oscillator signal that is driving the class-C amplifier. This combined modulation of amplifier and oscil-

lator provides linear and high-level modulation of the transmitter.

Circuit Arrangement and Switching

The unit includes a small meter which provides a continuous check of the battery, indicating whether it is good or should be replaced. Transmit-receive switching is handled by a six-section switch S2, Fig. 4. Switching, according to section, is as follows:

A. On receive it completes the secondary circuit of the audio output transformer to the loudspeaker. This circuit is open on transmit.

B. This section of the switch connects the volume control to the input of the audio amplifier on receive. On transmit, it connects the loudspeaker, to be used as a microphone, to the input of the audio amplifier.

C. This section transfers the antenna and its associated loading coil and transformer between the receiver input and the transmitter output.

D. On receive, this section of the switch connects the supply voltage to the RF and IF transistors of the unit. On transmit position, it

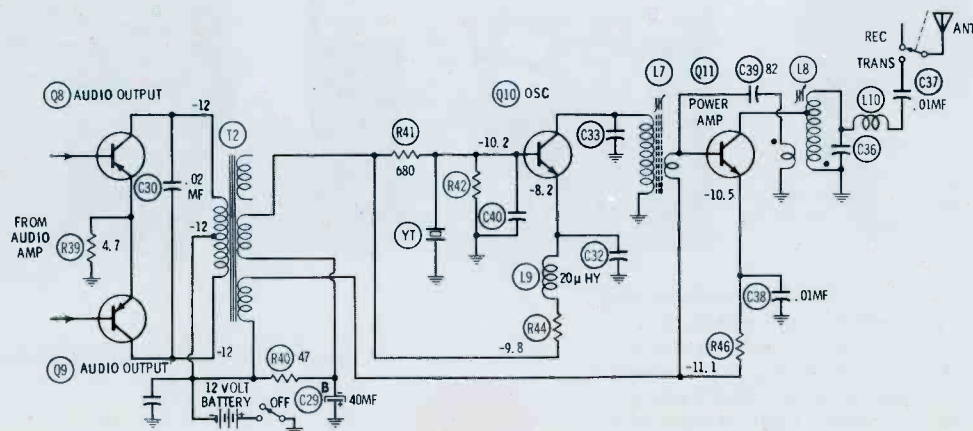


Fig. 6. Modulator and RF section of transmitter.

Brand **NEW** FROM **HICKOK**

MODEL 209C 9-INCH VTVM



HIGHLIGHT FEATURES

- ... Large 9" Display
- ... Ultra Stable Circuitry
- ... High Input Impedance
 - DC—11 megohms
 - AC—10 megohms, 11pf
- ... AC Measurements Up To 200mc
- ... High Accuracy
 - DCV, ACV— $\pm 3\%$ FS
 - Ohms, Capacity— $\pm 3\%$ ARC
- ... Lightweight—15 lbs.
- ... Fully Field Tested
- ... Measurement Ranges
 - DC Voltage—0-1500v
 - DC Current—0-1500ma
 - AC Voltage (RMS)—0-1500v
 - AC Voltage (P-P)—0-1500v
 - Decibels—-10db to +65db
 - Resistance—0.2 ohm to 1000 meg.
 - Capacity—50pf to 2000Mfd
 - Inductance—obtainable mathematically from scale readings

Price \$184.50

THE HICKOK ELECTRICAL INSTRUMENT CO. • 10514 Dupont Avenue • Cleveland, Ohio 44108

Circle 11 on literature card

April, 1966/PF REPORTER 33

Winegard's New CS-283; the only UHF-VHF Signal Splitter with a printed circuit!



How do you improve on a product that out-performs and outsells all competition? It isn't easy. But Winegard has done it with the new CS-283 UHF-VHF Signal Splitter! True, the CS-283 still attaches easily (with only a screwdriver) to the terminals on the back of any TV set or UHF converter. And it still separates the UHF and VHF signals coming from an all-band antenna.

But that's where the resemblance ends. The new CS-283 has a printed circuit—the only one on the market!

The result? The most efficient performance possible with lower VSWR; near perfect 300-ohm impedance match; 15db minimum isolation between UHF and VHF; and the total elimination of capacitance between coils.

That's the new (and better) CS-283 UHF-VHF Signal Splitter. Still only \$3.00 list. And still available free of charge with any Winegard Chroma-Tel antenna.

What do your customers need for the best possible UHF-VHF-FM reception—in color and black & white? Matching Transformers? Splitters? Hi-Lo Couplers? You name it and Winegard makes it. And makes it better. And, chances are, Winegard created and perfected it! Call your Winegard distributor or write for complete information today.

Winegard antenna systems

WINEGARD CO. ■ 3000 KIRKWOOD ■ BURLINGTON, IOWA 52602



Circle 12 on literature card

connects the supply voltage to the transmitter stages through the secondary of the audio output transformer.

E. On receive position, it connects the supply voltage to the crystal oscillator when used as a local oscillator. On the transmit position, it connects modulator supply voltage to the oscillator when used as the transmitter crystal oscillator.

F. This section makes the change-over between the transmit crystal and the receive local-oscillator crystal.

More elaborate 100-milliwatt units may include a noise limiter and/or a receiver squelch circuit. In the simple squelch arrangement of Fig. 5A, the squelch transistor draws a high collector current to bias off the first audio amplifier when there is no receive signal. When there is an incoming signal, the squelch transistor is biased down and its collector current cut off. This permits normal operation of the audio amplifier as it is driven by the audio signal from the AM detector.

Some units also include an RF output meter. This is connected to the output tank circuit of the transmitter as in Fig. 5B. A portion of the RF energy is rectified by the diode and supplied to a sensitive DC meter. The higher the output developed across the tuned circuit, the higher the meter reading. The same meter can also be used to check the condition of the transceiver battery when the switch is set to the BAT side.

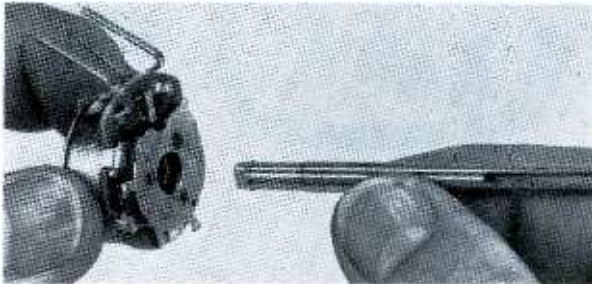
Higher Powered Miniatures

A variety of units are available with transmitter powers that extend between $\frac{3}{4}$ and $2\frac{1}{2}$ watts. The added transmitter power is obtained by using higher-powered RF amplifier transistors and/or an additional RF amplifier stage. Receivers are quite similar to those used in lower-powered models. Sensitivity, response, and improved image-frequency rejection can be obtained with the use of a double-conversion superheterodyne circuit. More elaborate squelch and noise limiting circuits are sometimes included.

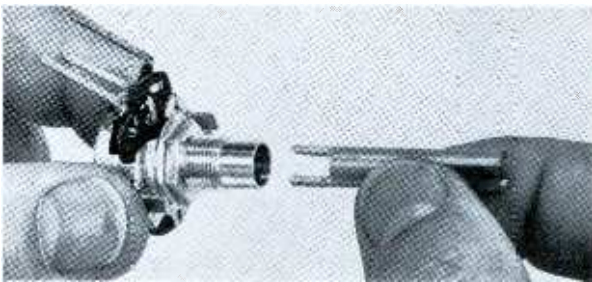
Many of the higher-powered miniature units feature more versatile

• Please turn to page 68

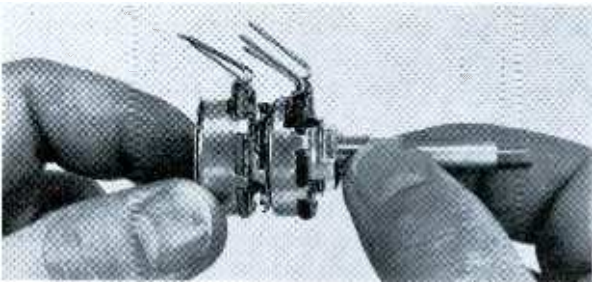
Short-cuts in custom-building controls



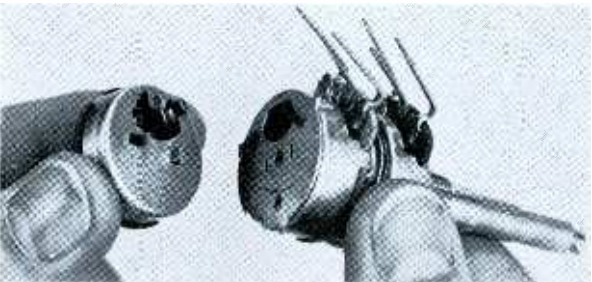
1. Snap shaft into rear section



2. Snap shaft into front section



3. Twist-lock sections together



4. Insert switch



5. Lock switch to rear section

Sometimes it seems as though there's some sort of conspiracy to keep you from getting the exact control you need. For example, some of the new television and auto radio sets have really *wild* combinations of control elements, shafts and switches. And, every once in a while one of these fancy dudes just up and quits.

What do you do now? Hunt all over the town for the exact replacement? Or, maybe you'd like to convince the customer's kids to just stare at that blank tube for a few weeks while you try to order the control from the factory. Well, cheer up. There's a better way!

Just zip down to your Mallory Distributor and explain your problem. He'll turn to his STA-LOC® Control Center and come up with your particular control in three minutes flat. No foolin'! He's got the parts to make any of nearly *FIVE BILLION* different controls. How about *that*, control fans!

But if you think STA-LOC is just for replacement controls, you are wrong. Matter of fact, with just a little imagination, you can dream up a control that would make a graduate engineer turn green with envy. All you do is turn to pages 30, 31 & 32 in the 1966 Mallory General Catalog. You'll find carbon front sections from 100 ohms to 10 megs. You can couple these to all sorts of rear sections. And then add a switch. And then . . . WOW! . . . get a load of all those wild shafts! Maybe you'd like to make a "clutch" control so that both front and rear turn together except for balancing. It's a *snap* with STA-LOC.

STA-LOC controls snap together and *stay* together. Even the shafts just plug in. Everything fits and works smoothly. There's even a special single control series called the "UA" . . . a real timesaver.

If you have really exotic tastes, you can take any rear section and make it into a single control by just snapping on an adapter bushing. Then, you plug in a shaft or, maybe add a switch.

Before you get the idea that STA-LOC is absolutely perfect, we'd like to set the record straight. Every once in a while a set manufacturer comes up with a design problem that can only be solved by an all-in-one-chunk control. Some of these weird designs just *can't* be made up from STA-LOC parts. So, after Mallory has made a few thousand of these "far-out" dudes, we stock some. Then, we can shoot 'em to your Mallory Distributor if and when you ever need one. The whole point of this statement is to let you know that your Mallory Distributor *has*, (or can get), just about any doggone control you'll ever need.

Next time you're talking to your Mallory Distributor, ask him about a STA-LOC Technician Kit. With one of these kits you can make replacements *on the spot*, or experiment to your heart's content. For the name of the distributor nearest *you*, write to Mallory Distributor Products Company, a division of P. R. Mallory & Co. Inc., Box 1558, Indianapolis, Indiana 46206.



POST VIDEO

TWISTERS

Straighten those twisted pictures

by Allan F. Kinckimer

The October 1963 *Shop Talk* Column, discussed a number of twisted picture complaints, their causes, cures, and detection by scope troubleshooting. The examples that were discussed treated twist originating primarily in video signal stages prior to the video output. It was shown the video output signal contained distortions correlating to the twist and very neatly dovetailed sync-tip variations of the signal with bends or hooks of vertical lines in the picture. It was noted that these pre-video twisters usually present horizontal shading bands as well as twist. Scoping the video output signal quickly determines whether a defect distorts the signal in prior stages, or eliminates these circuits as trouble sources, directing troubleshooting to the following circuits, sync, AFC, and horizontal. This



Fig. 1. Twist seems more "ante" than "post" video.

number one scope check is 99.44% effective—but . . .

A brightener was installed on a picture tube in a Westinghouse V-2344 about nine months earlier. It was now so dim the customer was willing to have it replaced. It is our practice to bring sets to the shop to install new picture tubes so that all phases of operation can be thoroughly checked. The video, sync, and filter-ripple signals are scoped. The AGC action, pix contrast, resolution etc. are carefully examined in this check. Such procedure produces customer satisfaction and minimizes callbacks.

After installation of a new 21-inch tube in this particular Westinghouse, the picture appeared with the twist shown in Fig. 1. The single "S" characteristic of the twist suggested either heater-to-cathode short in a tube or a defective filter on a B+ line, since B voltage in this model is derived from a half-wave doubler. The magnitude of twist further suggested pre-video trouble; ordinarily post video twist is less severe. It might seem reasonable to have replaced the RF, IF and video tubes; instead, the scope was used to check the signal at the video output plate.

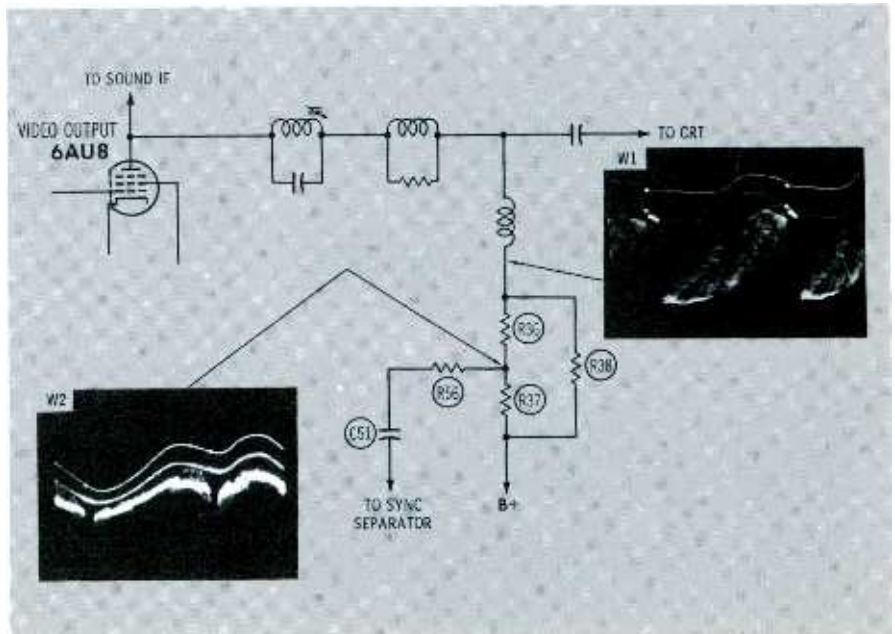
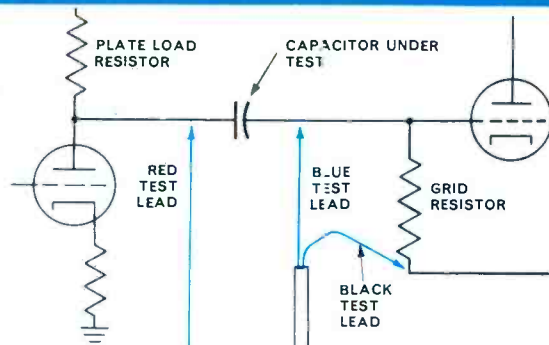


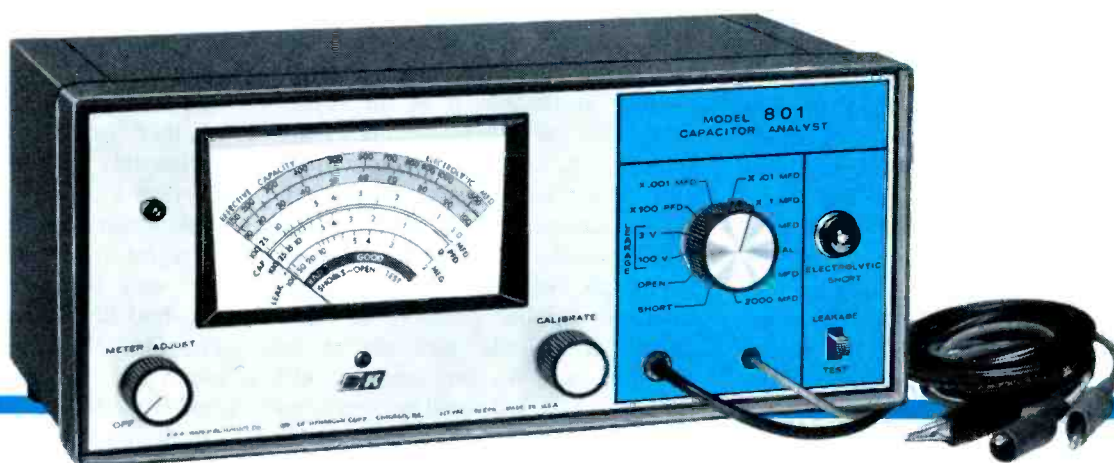
Fig. 2. Video output and waveforms.

locate defective capacitors in-circuit



3-LEAD LEAKAGE TEST: One test lead is connected to the plate side of the capacitor and the ground lead to the grid leak return on the other side of the capacitor, and the meter is zeroed. The third test lead is then connected to the grid side of the capacitor and the meter scale shows the leakage directly in megohms.

The B & K model 801 capacitor analyst really works without unsoldering or altering circuitry



Both in-circuit and out-of-circuit capacitor testing can be done quickly and accurately with the new B & K Model 801 Capacitor Analyst. Foil, mica, general purpose and temperature compensating ceramic, and electrolytic capacitors can be accurately tested for leakage, capacitance, opens, and shorts.

Leakage can be determined in-circuit. The unique B & K 3-lead method permits a degree of accuracy not possible with any 2-lead tester. For normal circuits defective capacitors can be located immediately.

Open capacitors with values as low as 25 pF are easily located with the sensitive high-frequency-signal and resonant- $\frac{1}{4}$ -wave-transmission-line method.

Electrolytic capacitors are tested with a circuit that accurately measures their effective capacitance. Their inherent characteristics of variable equivalent series resistance and internal parallel resistance are automatically accounted for. Only one capacitor lead need be disconnected. The capacitor is charged and then discharged under load. High peak load currents up to 2 amperes ensure testing to in-circuit conditions. Unlike with other testers, capacitor can not be deformed by a reverse polarity voltage. The actual power transferred to a load is measured and the capacitance is read directly from the meter scale for immediate replacement decisions.

All these tests and short tests too are performed with the one set of test leads which is included with the instrument.

Here's the capacitor analyst that really works: B&K Model 801 quickly pays for itself with reduced shop time. Net \$109⁹⁵

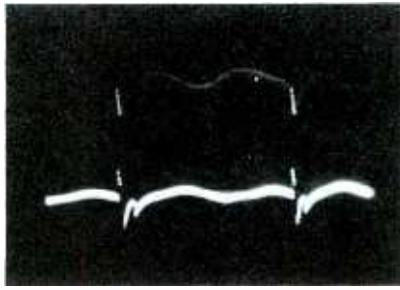
See your B & K distributor or write for catalog AP-22.



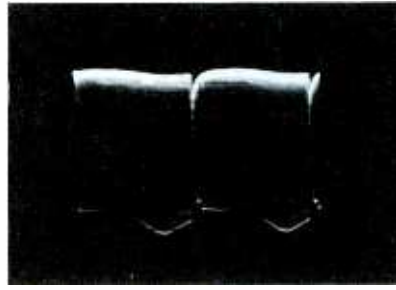
B & K MANUFACTURING CO.
DIVISION OF DYNASCAN CORPORATION
1801 W. BELLE PLAINE AVE. • CHICAGO, ILL. 60613

Export: Empire Exporters, 123 Grand St., New York 13, U.S.A.

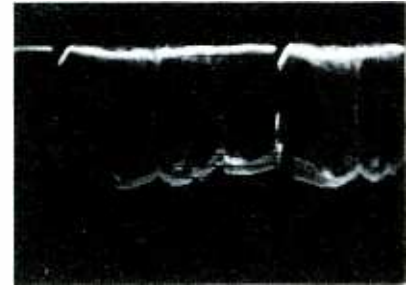
Circle 14 on literature card



(A) With 120-cps ripple.



(B) With 60-cps ripple.



(C) Contaminated sync.

Fig. 3. Sync waveforms.

The video-signal waveform (W1 of Fig. 2) seemed to verify the presence of a bad tube in an early video-signal stage. However, I did not discount the possibility of a bad filter, so the next scope trace W2 was obtained. Working here without a schematic, I erroneously assumed that R36 was the video amplifier plate load resistor; therefore, W2 was assumed, also incorrectly, to be on a B+ line. This led to a quick scoping of all filters, and since none had the W2 signal, I referred to the schematic. The plate load for the video amplifier consists of R36, R37, and R38, with W2 actually at the take-off point for the sync separator. This knowledge led to a comparison and evaluation of the W1 and W2 signals. Because the ripple distortion of W2 was greater, it was fairly obvious that the distortion did not come from a tube in the video signal, RF, IF, etc., stages, but through R56 and C51 feeding the sync separator. On replacing this tube, a 3CS6, both twist and signal distortion cleared up entirely.

If I had jumped to what seemed

reasonable conclusions and replaced the tubes between the RF stages and the video amplifier, I am certain it would have taken longer to complete this job. Moral: It takes less time to pinpoint a source of trouble with the scope.

Sync Circuits and Twist

Twist that causes sync circuit defects rarely distorts the video amplifier signals. Usually the video amplifier and sync input signals are normal, with signal distortion first appearing at the output of the separators. The waveforms in Fig. 3 are typical. Fig. 3A has a 120-cps ripple and 3B a 60-cps ripple at sync amplifier outputs; both were caused by insufficient B+ line filtering. Strangely enough, even though the B+ lines involved supplied some video signal stages, the ripple was absent on video signals. In one early model Admiral, Fig. 3A could be corrected only by adding an additional resistor and capacitor network. In another early Admiral using a 12AU7 as sync separator and amplifier, ripple distortion similar to Fig. 3B was

corrected by replacing the 12AU7 with 6CG7. This substitution involved a minimum of rewiring, and the differences between the tubes (the additional shield in the 6CG7 and its better filament arrangement), plus the high input impedances of the stages, provide ripple-free sync and twist-free pictures.

Whether any of the Fig. 3 signal distortions will produce picture twist depends on the condition of the AFC and horizontal oscillator circuits. These factors also determine whether twist is the only result, or whether twist is accompanied by horizontal instability or tearing. There are no definite criteria applicable; every service man has seen twist, etc., resulting from very minor and very severe Fig. 3 distortions that had little effect on the picture. The Fig. 3C trace, typical of contaminated sync, is commonly associated with twist. It is a by-product of overdriven video amplifiers, resulting from a variety of defects.

Waveform W1 in Fig. 4 is a badly distorted sync separator signal found in a GE Q-2 chassis. It produced the better-than-expected picture in Fig. 5. The fault was an intermittent resistor in the R-C network (K9). Since the negative voltage developed on the grid of the sync separator is used to supplement AGC, the AGC

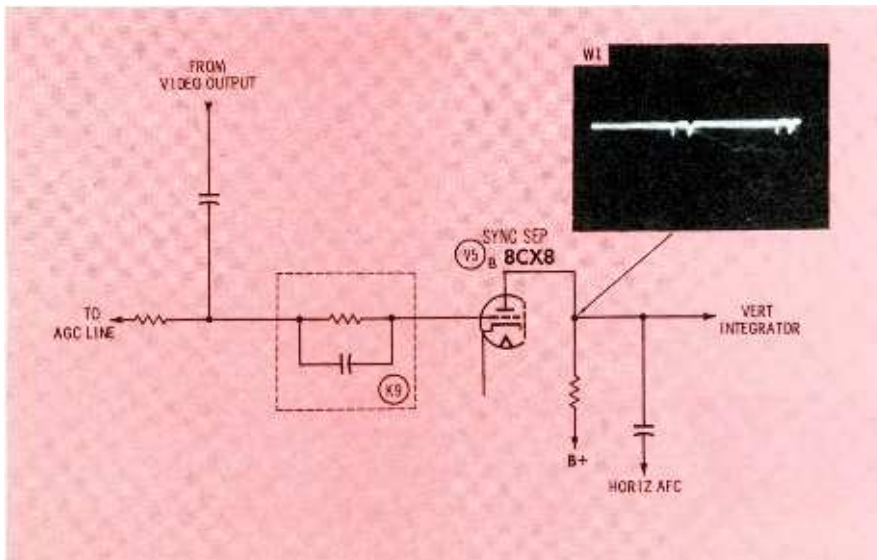


Fig. 4. Distorted sync signal.



Fig. 5. Twist caused by distorted sync.



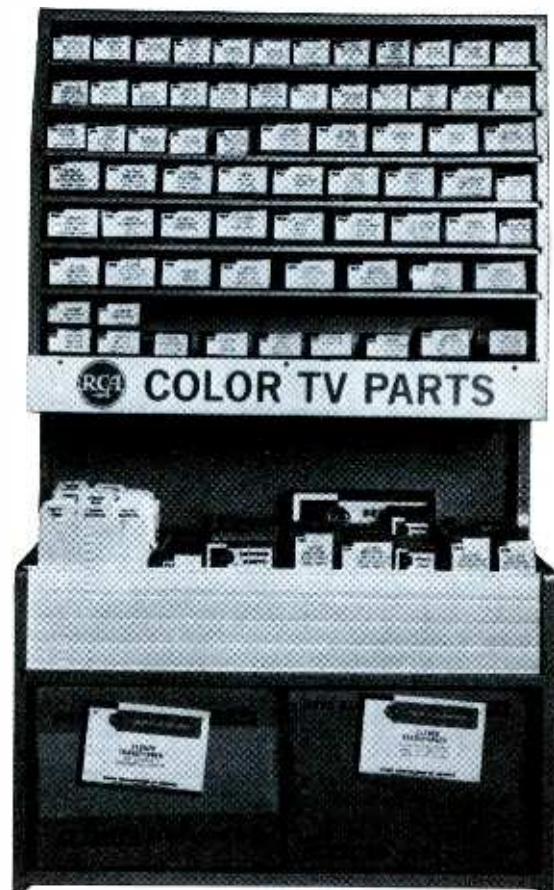
How to increase your **COLOR TV** service volume

RCA helps you do it, without enlarging your shop.

Leave cabinets and picture tubes at the customer's —bring only the chassis to the shop. An RCA color test jig makes it possible. You simply use an RCA type 11A1015A color test jig as your bench-top cabinet. Mount an RCA color picture tube in the test jig. Stock RCA servicing cables, that adapt to every chassis connection required. And you're in business. You "monitor" the customer's chassis on this shop rig. Frees you from any worries about scratching or damaging the customer's cabinet or picture tube. Gives you more usable shop space.

Stock the 120 fastest moving color TV parts—in one rack. Everything but tubes and cabinets—at your fingertips. Order an RCA #11A1014 color profit kit "120" from your RCA Distributor. It meets most color TV set manufacturers' specifications for sockets, switches, lamps, crystals, resistors, transformers, magnets, coils, capacitors, microphones, connectors, clips—and all those other little items that can delay delivery and billing to the customer.

Saves you hundreds of dollars in bench time, otherwise wasted in trips to the Distributor for "nickel and dime" hardware. The parts rack is free. You pay only for the parts—at a low 120-quantity price. Then, just bring your pile of empty parts envelopes to the distributor weekly, for replacement. Handle more color-TV repair jobs. And, at the same time, gain a reputation for faster, better color-TV service. You'll find it easy to do with RCA color-TV service parts. See them at your RCA Distributor today. RCA Parts and Accessories Division, Deptford, New Jersey.



The Most Trusted Name in Electronics



Fig. 6. Twist in Admiral Chassis.

voltage decreased and contrast increased (each time the resistor opened) suggesting AGC trouble. Scope and VTVM readings at the grid of V5B clearly indicated opening of K9. Replacing the network cleared the trouble.

Leaky coupling condensers to sync separators are so common that replacing them is automatic with many service men when confronted with any form of sync trouble. Oddly, in some cases of low-level leakage, replacing the separator tube will produce a cure that is effective for a brief period of time, but the tube

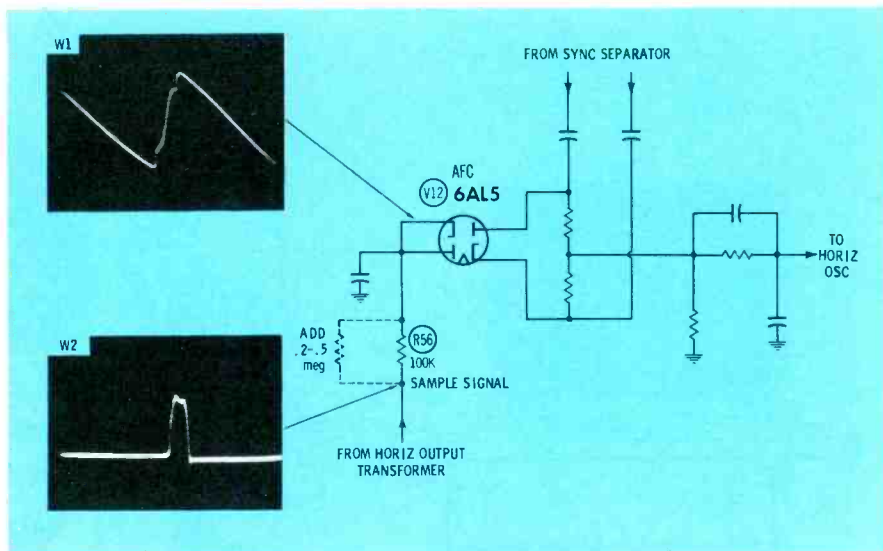


Fig. 7. Horizontal AFC circuit.

will need replacing again. The sync separator in some early Philco sets used a cathode-follower circuit and was subject to this incorrect repair. I have noted that replacing the sync coupling condenser effects a long lasting correction.

AFC Circuits and Twist

Horizontal AFC governs the hori-

zontal oscillator; therefore, any ripple on signals that are combined to generate AFC voltages will likewise result in twist. One unusual case, with picture, signals, etc., was reported in the December 1963 PF REPORTER. An even more unusual case was an Admiral 23E1 chassis, varying amounts, can be seen in the



ARE YOU CASHING-IN ON THE PROFITABLE 2-WAY RADIO SERVICE BUSINESS?

- ★ Motorola will train you for this rewarding, elite profession
- ★ Send for our FREE EVALUATION EXAM. Prove to yourself that you are ready to learn FM 2-way radio servicing.

Opportunities in 2-way radio servicing are virtually unlimited. ■ Just one of the hundreds of successful Motorola Service Stations writes, "we would be pleased to interview any graduate of your school that has received some training in 2-way radio maintenance. We are an established firm, 10 years old, with a promise of expansion governed by our ability to obtain competent technicians." ■ Get all the facts today. There is no obligation and no salesman will call.



MOTOROLA TRAINING INSTITUTE

4545 West Augusta Blvd. • Chicago 51, Illinois • Dept. APX 616

- Send me FREE entrance exam.
- Send full details on Home Study Course on FM 2-way Radio Servicing
- Send me details on how you can help me prepare for an FCC License.

Name _____ Occupation _____

Address _____

City _____ Zone _____ State _____

Circle 16 on literature card

BEST



VACO ALL HOLLOW SHAFT NUT DRIVERS

Best in every test—featuring all hollow shafts for that important extra clearance and extra power on stubborn nuts and bolts. Best—because the precision made shafts are nickel chrome plated and can't rust or corrode. Best because of their extra hard sockets that won't round out. In regular Comfordome handles or in Bull Driver handle. For every repairman, mechanic, service specialist.

Available at better stores everywhere.

The Most Powerful Name in Hand Tools . . . Terminals • Screw Drivers • Nut Drivers • Pliers • Wrenches • Specialty Tools • Solderless Terminals

VACO®

PRODUCTS COMPANY

317 E. Ontario St., Chicago, Ill. 60611

Circle 17 on literature card

*the instrument with
endless uses...the all new
improved completely solid state
SENCORE FS134 FIELD STRENGTH METER*

HERE ARE JUST A FEW OF THE MANY USES...



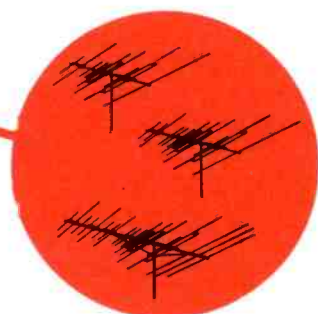
A. Distribution Systems



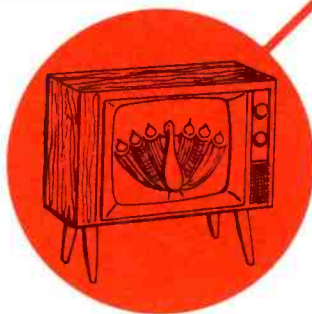
D. Transmission Lines



B. Antenna Installations



E. Antenna Comparisons



C. Color Insurance



only
199.50
lowest price going



F. Checking Generators

A. INSTALLING AND CHECKING OUT DISTRIBUTION SYSTEMS

Qualify for this multimillion dollar business in hotel, motel, and hospital installations.

B. INSTALLING UHF, VHF, AND FM ANTENNAS

Cut down installation time and pay for the FS134 in a short time on critical UHF as well as VHF and FM antennas.

C. COLOR INSURANCE

Be sure the signal is adequate on each channel for proper color TV operation.

D. CHECK TRANSMISSION LINES

For the first time read actual db loss in either 75 or 300 ohm transmission lines.

E. COMPARE ANTENNAS

For actual db gain; see which is best for each location, both VHF and UHF. Also excellent for

orienting "dishpans" for translator use at the high end of UHF band.

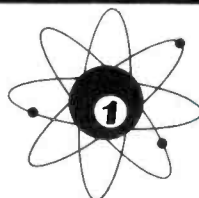
F. CHECK ANY GENERATOR OUTPUT

For correct frequency and output all the way up to a tenth of a volt RMS. What a time saver when you want to know if your generator is putting out.

PLUS: LOCALIZE NOISE AND INTERFERENCE

Find noise source fast; pick quiet locations for antenna installations or orient antenna away from noise when possible.

These are only a few uses of this UHF-FM-VHF accurately microvolt calibrated field strength meter. You can start paying for the FS134 tomorrow in the time saved today — if you see your Sencore distributor now. Why not pick up the phone and ask him to show you the new FS134?



SENCORE

NO. 1 MANUFACTURER OF ELECTRONIC MAINTENANCE EQUIPMENT

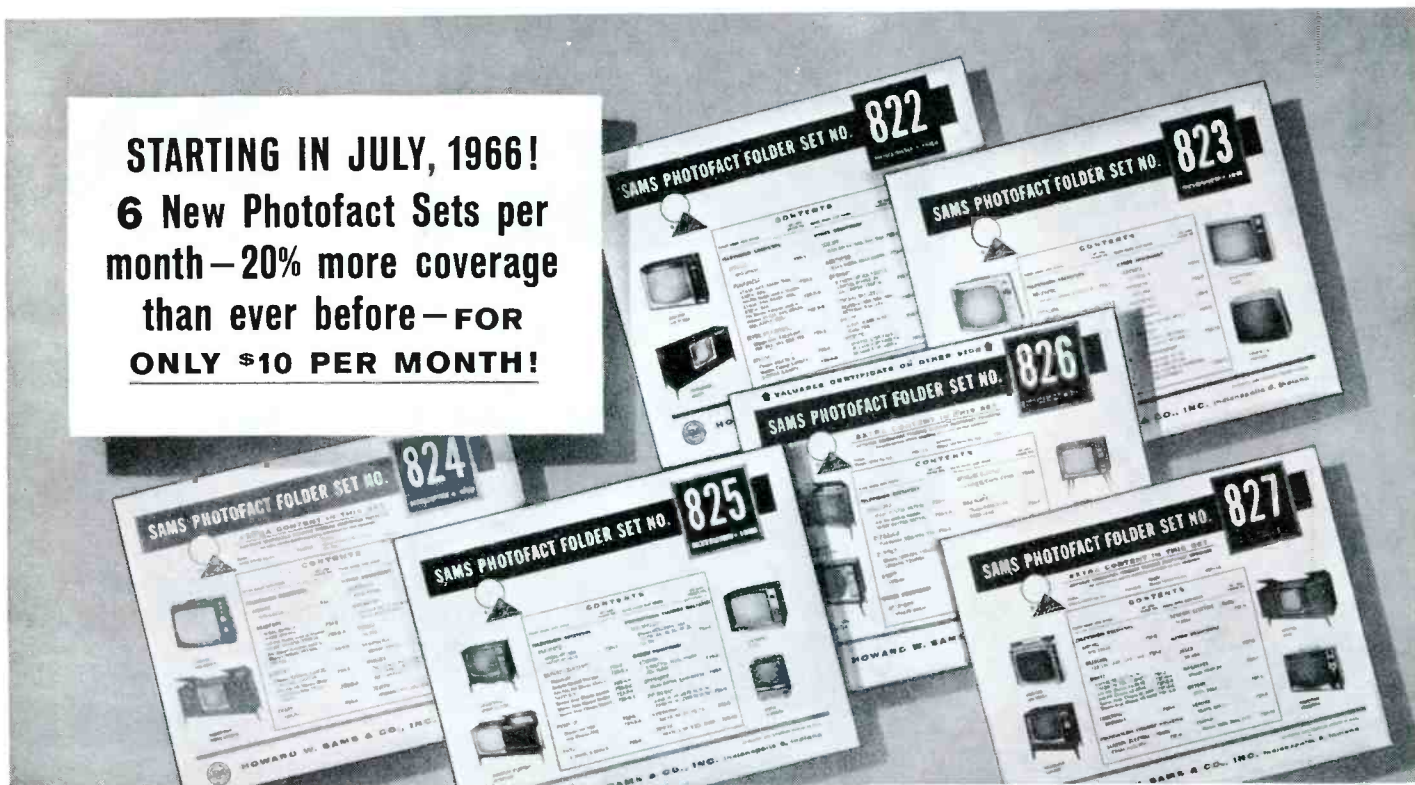
426 SOUTH WESTGATE DRIVE, ADDISON, ILLINOIS 60101

Circle 18 on literature card

NOW! Save up to \$60 per year on the

JOIN THE NEW PHOTOFAC[®]-OF-

STARTING IN JULY, 1966!
6 New Photofact Sets per month—20% more coverage than ever before—FOR ONLY \$10 PER MONTH!



Now! maximum coverage of equipment you service most!

★ **MORE TV COVERAGE**
5 Color TV models per month
More Black & White TV coverage

★ **MORE AC-DC COVERAGE**

★ **MORE AM-FM MODELS**

★ **MORE STEREO HI-FI COMBINATIONS**

★ **MORE RECORD CHANGER COVERAGE**

★ **MORE PHONOGRAPH COVERAGE**

complete service data on at least 50 chassis each and every month to meet all your service needs!

now only \$10 per month

Membership in the new Photofact-of-the-Month Club now brings you 20% more coverage monthly—saves you \$5 per month, up to \$60 per year! You get *more* of the famous PHOTOFAC time-saving, troubleshooting help—*everything* you need to earn more daily. Take the *right* step to faster, more profitable servicing—enroll now with your Sams Distributor as a member of the new Photofact-of-the-Month Club—or send in the membership form today!

ENROLL TODAY IN THE PHOTOFAC-OF-THE-MONTH CLUB

use the
handy coupon

world's finest TV-radio service data!

THE-MONTH CLUB — membership starts in July, 1966

only \$10 per month brings you 20% more monthly current Photofact service data coverage to boost your daily earnings

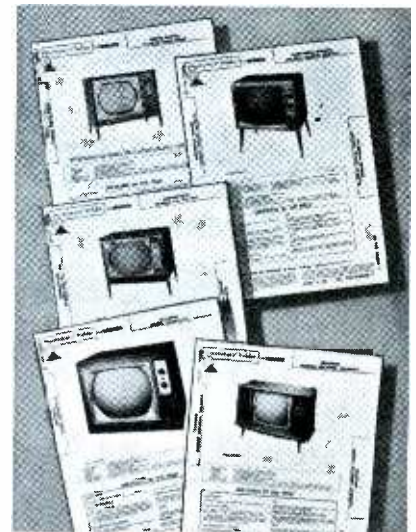
How the Photofact-of-the-Month Club benefits you

more for your service data dollar

Starting in July, 1966, as a member of the P.O.M. Club, you get 6 new Photofact Sets monthly (20% more coverage) for just \$10 per month! You save \$5 per month—\$60 per year (regular price for individually purchased Photofact Sets is \$2.50, effective July 1, 1966). Now you can keep right up with the flood of current equipment output. Now you get the world's finest service data on at least 50 different chassis each month—to help you turn out more repairs daily, with a bigger profit on every job.

how this is possible

We have explained the new Photofact-of-the-Month Club plan to hundreds of electronic technicians. From what they have told us, and from their enthusiastic response, we expect to add substantially to the thousands of present monthly subscribers to Photofact. This means we can effect greater economies through large-volume production, and that's what makes possible not only lower costs to P.O.M. Members, but greater coverage than ever before. It's as simple as that!



IMPORTANT NEWS FOR OUR THOUSANDS OF PRESENT PHOTOFACT SUBSCRIBERS

Your loyalty through the years is deeply appreciated. You will automatically be enrolled as a charter P.O.M. Club member. Starting in July, 1966, you will receive 6 Photofact Sets monthly (20% more coverage), and pay only \$10 per month. Your subscription to Photofact becomes more valuable than ever.

HERE'S ALL YOU DO TO BECOME A MEMBER OF THE NEW

PHOTOFACT OF THE MONTH CLUB

See your Sams Distributor today, or fill out and mail the membership form below. That's all there is to it. Do it today! It's the opportunity you've been looking for—the chance to be a regular Photofact subscriber at the price you can afford. Get started on the road to the kind of profits you've always wanted.

Current COLOR TV coverage

Now—as a P.O.M. Club member, you will get a minimum of 5 Photofact Color TV Folders per month—you keep right up with the biggest growing profit opportunity in the service field.



BONUS File Drawers

As a P.O.M. member, you are also eligible for the Bonus Photofact File Drawer offer.

DO IT TODAY...

Fill Out This Form For Membership In The Photofact-Of-The-Month Club

HOWARD W. SAMS & CO., INC.

4300 West 62nd Street, Indianapolis, Indiana 46206

Dept. PFF-4

Please enroll me as a new member of the Photofact-of-the-Month Club. I agree to pay \$10 per month for my membership, and understand my subscription will begin with the July, 1966

issue, consisting of 6 current Photofact Sets, to be delivered by my Sams Distributor (named below).

Name _____

Business Name _____

Address _____

City _____ State _____ Zip _____

My Sams Distributor is: _____ Sign here: _____

**sign up now
and save!**



Look what's happened to the RCA WR-51A FM Stereo Signal Simulator

...it got to be the WR-52A...

NEW, REDESIGNED AND IMPROVED

Last year we decided to make a few improvements in our WR-51A Stereo FM Signal Simulator...for two years THE established test instrument for multiplex stereo servicing. We intended to call it the WR-51B. But one thing led to another and we made so many extensive improvements that we virtually had a new instrument on our hands. You're looking at it: the NEW RCA WR-52A STEREO FM SIGNAL SIMULATOR. We've added an RF Deviation Meter to measure the modulation level of both stereo and monaural FM signals. The meter is also used to accurately establish the level of the 19 Kc subcarrier.

We've included provisions for modulating left or right stereo signals with an external monaural source.

We've added a switch to disable the 19 Kc oscillator to provide a low-distortion monaural FM output.

We've added a new frequency (72 Kc)...required, along with the 67 Kc frequency, for trap alignment in some sets.

These features, together with numerous internal circuit design changes have resulted in a vastly improved, almost completely new instrument. And, the RCA WR-52A includes all those features that made its predecessor such a valuable servicing tool.

■ COMPOSITE STEREO OUTPUT—for direct connection to multiplex circuit

Choice of left stereo and right stereo signals

■ RF OUTPUT—for connection to receiver antenna terminals

100 Mc carrier, tuneable

Choice of FM signals—left stereo, right stereo, monaural FM, internal test and 60 cycle FM sweep

FM stereo deviation adjustable from 0-100%

100 Mc sweep signal adjustable from 0 to more than 750 Kc at a 60 cps rate

RF output attenuator

■ CRYSTAL-CONTROLLED 19 Kc SUBCARRIER ($\pm 0.1\%$)

■ SINE WAVE FREQUENCIES

Three low-distortion frequencies—400 cps, 1 Kc, 5 Kc

Two crystal-controlled frequencies—19 and 38 Kc

Additional frequencies—67 and 72 Kc for trap alignment

■ READILY PORTABLE—weighs only 12¾ pounds, measures 13½" by 10" by 8"

■ COMPLETE WITH WIRED-IN CONNECTING CABLES

We also raised the price...just 50 cents. The WR-52A is now \$250.00.* Ask to see it at your Authorized RCA Test Equipment Distributor.

*Optional distributor resale price, subject to change without notice. May be slightly higher in Hawaii and the West.

RCA ELECTRONIC COMPONENTS & DEVICES, HARRISON, N.J.



Fig. 8. AFC trouble causing twist.

off-center raster shown in Fig. 6. Usually the twist was more severe than shown, and the number of curvatures changed in step with high level picture signals or black areas.

Grounding the output of the AFC stage or grid of the horizontal multivibrator in Fig. 7 caused the picture to float horizontally, but when the picture was stabilized by careful adjustment of the hold control, the twist was not present. With V12 removed, the sync and sample signals were scoped for hum, and none was apparent. Then with scope sweep set at ½ horizontal frequency, amplitude of these signals was measured; the two opposite polarity sync signals checked normal at twenty volts. The sample signal was slightly low, about nine volts, but its most abnormal feature was the curl on the abrupt slope of waveform W1. This trace indicated trouble in the sample-signal shaping network; however these components were replaced and produced no improvement. Because the two sync signals combine with the center portion of the sample signal's sharp slope to generate AFC control voltage, and because the sample signal was slightly low, a resistor was shunted across R56. When the sample signal increased to about 15-20 volts, it still had curl, but twist disappeared from the picture. The sample signal is obtained from the pulse from the AGC winding on the output transformer. The odd shape of the top of that pulse probably accounts for the curl in the sample signal. I believe the actual top of the AGC pulse changed according to the load placed on it by varying picture content. It is also possible that the cure resulted from

• Please turn to page 62



The Most Trusted Name in Electronics

FINCO[®]-AXIAL COLOR-KIT



FINCO-AXIAL COLOR-KIT, Model 7512 AB

High performance Indoor and Outdoor Matching Transformers convert old-fashioned and inefficient 300 ohm hook-ups to the new Finco-Axial 75 ohm color reception system.

List price for complete kit . . .
7512AB \$8.95

7512-A Mast mounted matching transformer . . . list \$5.40

7512-B TV Set mounted matching transformer . . . list \$4.15

FINCO-AXIAL SHIELDED COLOR CABLE, CX Series

Highest quality, 75 ohm swept coaxial cable (RG 59/U) complete with Type F fittings, weather boot ready for installation.

Available in 25, 50, 75 and 100 foot lengths. List price . . . \$5.55, \$8.65, \$11.50 and \$14.20.

Write for Color Brochure # 20-349



the
complete
color TV
reception
system

For the best color TV picture

*eliminates color-fade, ghosting and smearing!
Improves FM and Stereo, too!*

QUICK, EASY INSTALLATION

ENJOY brilliant "TV-Studio" color reception today by changing over to the new Finco-Axial Color Reception System. NOW, color fade, ghosts and smears are a thing of the past. Finco-Axial shields color sets against signal loss . . . eliminates outside interference and mismatch problems.

THE FINNEY COMPANY 34 WEST INTERSTATE STREET, DEPT. 310 BEDFORD, OHIO

Circle 22 on literature card



Notes on Test Equipment

analysis of test instruments... operation... applications

by Arnold E. Cly
and T. T. Jones

VHF to UHF

A law passed by Congress stipulates that television receivers manufactured after April 30, 1964 must be equipped to receive both VHF and UHF TV channels. You will be servicing these sets, and a determination of whether the UHF tuner can pass a signal will be included in some of your tests. The Model U-75 UHF Translator (Fig. 1), made by Lectrotech, will help you make this check.

The U-75 is simple to use. There are just two setup controls on the front panel, plus the ON-OFF switch. The UHF channel selector has a planetary drive and provides both coarse and fine tuning adjustments with a single knob. On the back of the unit are two terminal boards—one for a VHF input signal, with provision for either 50- and 75-ohm unbalanced or 300-ohm balanced lines; and the other to connect the output of the translator



Fig. 1. Small, but provides UHF signal.

to the UHF terminals of a television.

A local VHF TV station—channel 2 through 6—is the signal source for the U-75. A color-bar or AM signal generator—or any instrument with similar output-signal characteristics—also may be used as a signal source.

A schematic of the UHF translator is shown in Fig. 2. The source of VHF input signal determines which

input terminals to use. The top and bottom terminals are for a 300-ohm impedance, and the two upper terminals match 75-ohm sources.

The input signal is fed from the tap of L1 through the RF choke and L2 to the plate of X1. The transistor oscillator signal is coupled through L2 and also applied to the anode of mixer diode X1. Here the two signals are heterodyned and fed to L3. The resultant UHF signal is applied to the inductance of tuning ring L4B, which is mutually coupled to L4C. This signal is then coupled through L5 to the UHF output terminals.

To use the UHF translator, connect the input signal to its terminal board and the output of the unit to the UHF antenna terminals of a TV set. This latter connection is made with 300-ohm twin-lead. Standing waves on this lead can attenuate the signal and cause distortion of the picture; to minimize this condition, the length of the twin-lead can be varied.

Lectrotech Model U-75 Specifications

VHF:

Accepts channels 2 through 6.

UHF:

Converts to channels 15 through 75.

Power Required:

Self-contained; one 9-volt transistor-radio battery.

Size (HWD):

4" x 6" x 6"

Weight:

3 lb.

Price:

\$39.50 (less battery)

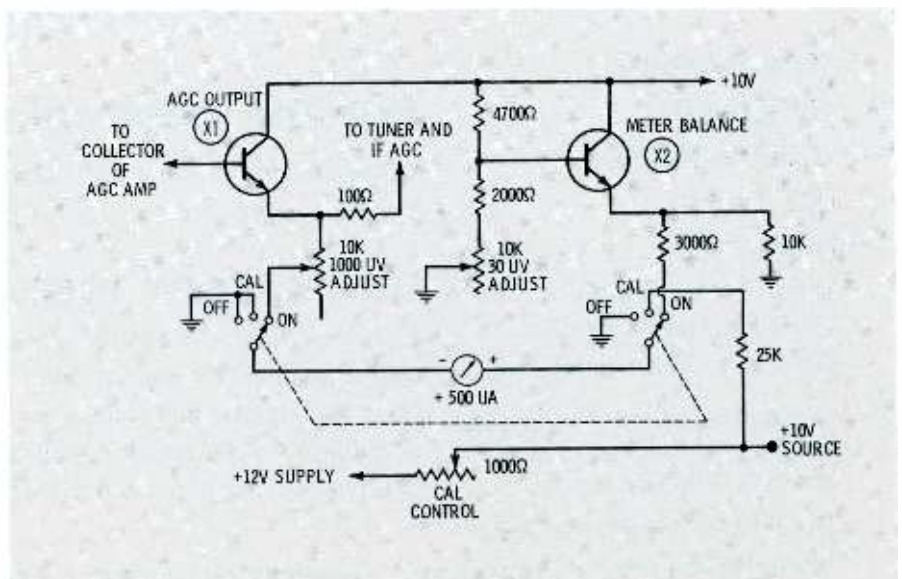


Fig. 2. Complete schematic reveals method used in converting VHF to UHF.

The channel selector of the television receiver is set to the UHF position. Move the VHF channel-selector knob of the U-75 to the same VHF channel that is being fed to its input terminals. Next, set the UHF channel selector of the translator to a desired UHF channel. Tune the UHF selector on the TV receiver to this same channel. It may be necessary to adjust the TV's UHF selector a few channels to either side of that indicated on the U-75, due to tolerances. Readjust the VHF channel selector on the translator until the best possible picture is received on the television receiver.

The instrument we had was field tested using an input signal from one of our local VHF stations. Our location was in a strong-signal area, but the picture on the TV was snowy. The signal receives no amplification as it passes through the U-75, and there is bound to be some attenuation.

The UHF channel selector on the translator was set on channel 65, and the best picture was obtained when the TV was tuned to channel 60. Also, the VHF selector of the U-75 was positioned between channels 4 and 5 to receive the channel 6 input signal; however, this particular setting is insignificant since it is associated with the input VHF tuned circuit and is merely adjusted to pass the maximum signal through its tuned circuit.

In our lab we connected the RF output of a color-bar generator to the input of the unit. The generator was set to produce a dot pattern. After a few simple adjustments of the generator and the U-75, we could see the dot pattern on the TV. The pattern was free of the snow we experienced with a station signal, because the generator output was a stronger signal.

When the U-75 is set up to produce a UHF output signal, the VHF input section can be aligned. We did it, using channel 4—a weak station from our location. Rotate the selector knob until it indicates the VHF channel to be used (in our case channel 4); then couple the station signal on this channel to the input terminals. Alternately adjust trimmer pads A1 and A2 (see Fig. 2) until a maximum signal is visible on the television receiver CRT. The output of a color-bar generator, or a similar instrument, may be used as an input-signal source instead of a VHF station; the generator is simply tuned to the desired channel.

The UHF tuned section of the translator is factory adjusted, and any tampering in this area should be avoided. Should an alignment of this section be necessary, the unit must be returned to the manufacturer.

The translator is a handy instrument to have, especially if you're located in a UHF fringe area. With it, you will always have access to a proper signal when working with the UHF section of a TV receiver.

For further information, circle 69 on literature card

Color-Bar Generator

This past season has seen a great upsurge in color TV sales. Many of you have given your color-bar generator a real workout in the past few months and know by now what features you want most. Hickok anticipated this by designing a generator with the "outside man" in mind.

This instrument, Model 662, was aptly named the "Installer's Color TV Generator." It has rugged simplicity, and is designed for quick setups. The feature we liked best was the little

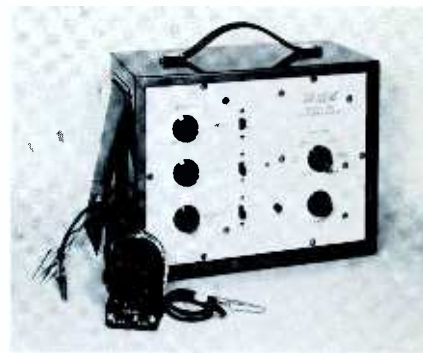


Fig. 3. Outside-man's color-bar.

door on the side. All cables, including power, fit in a compartment behind this door. There is nothing to tangle on the truck.

Hooking the 662 to the set under test is easy as 1-2-3. The gun-killer leads and convergence-pattern outputs are all wired to an adaptor which slips between the CRT base and its socket.

The sync is borrowed from the receiver under test by capacitive coupling to the hot lead of the yoke. The convergence patterns are fed to the CRT, and the color output is at burst frequency. There is no VHF output. By eliminating the sync and RF generator circuits, the designer has added to the reliability of the instrument. The block diagram (Fig. 4) shows how the signals are developed.

The horizontal retrace pulses from the receiver are applied to diode clipper V1A. The clipped pulse goes to sync splitter V1B and is separated into a positive pulse at the cathode and negative pulse at the plate.

The negative pulse from the plate is fed to unijunction transistor X-1.

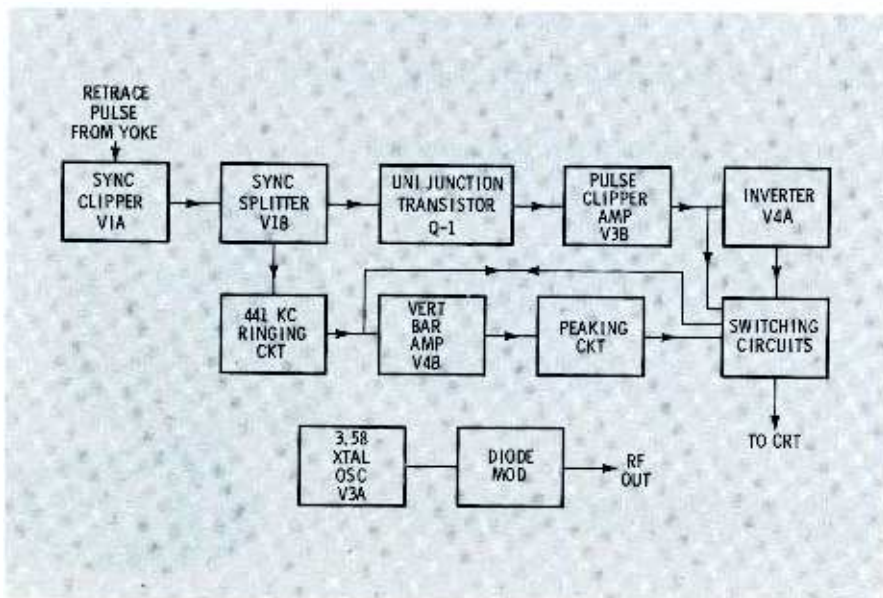


Fig. 4. Simplified block diagram shows many stages but few tubes.

Hickok Model 662 Specifications

Outputs available:

- Color subcarrier (crystal-controlled 3.579545 mc)
- Vertical bars
- Horizontal bars
- Dots
- Crosshatch

Tube complement:

- one 6BM8, two 12AT7

Semiconductor complement:

- one 2N2646 unijunction transistor
- one 1N4005 silicon rectifier
- two 1N31 diodes

Power required:

- 105 to 125 volts, 50 to 60 cps, 25 watts (transformer powered)

Size: (HWD)

- 8½" x 11" x 5"

Weight:

- 6 lbs

Price:

- \$159.95

"I'm British, you know."



New VIDOR batteries are such a spectacular No. 2 line you'll work your tail off to make them your No. 1

Because now you can sell *fine British quality* at discount-outlet...or precedent-shattering profits

Britain...quality. They're the same. Garrard, Rolls-Royce, Wilkinson, to name a few.

Long enough, you've heard the same old song on battery deals and markups. Listen to something new and exciting now.

IRC's VIDOR. With an introductory deal to knock your hat off. And it's just the beginning.

You can sell VIDOR for class, which it is, to the carriage trade. At your usual prices or even more. VIDOR matches or exceeds the quality of any battery you've ever handled. This way, you can make a bloomin' fortune.

Or you can sell VIDOR for mass, discount-priced...and still get a bigger markup than you're getting now! That's a pretty good way to get rich, too.

Either way, you've got to win. VIDOR has the kind of quality-profit story you haven't heard before. And VIDOR is here to stay.

Hop in now, right at the start. The quicker you do, the more money you'll make. Call your IRC representative for all the profitable details today.

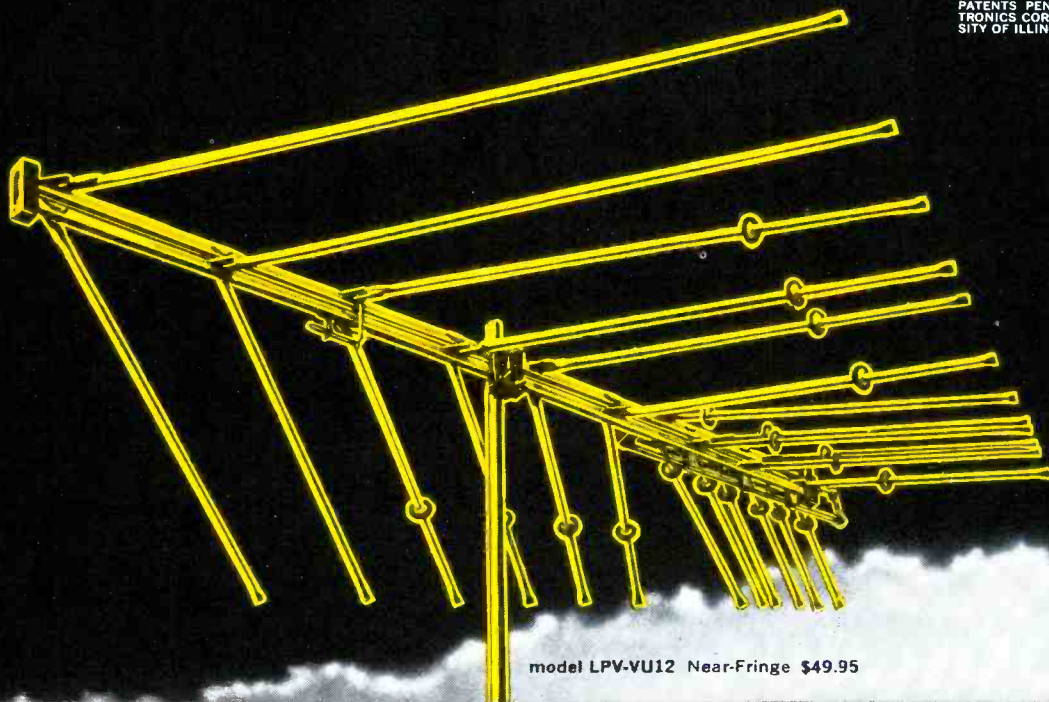
Consumer & Distributor Products Div.,
IRC, Inc., Philadelphia, Pa. 19108.



Circle 9 on literature card

america's no. 1

LICENSED UNDER ONE OR MORE OF U.S. PATENTS 2,958,081; 2,985,873; 3,011,168; 3,108,280; 3,150,376; 3,210,767, RE. 25,740 AND ADDITIONAL PATENTS PENDING IN U.S.A. AND CANADA. PRODUCED BY JFD ELECTRONICS CORPORATION UNDER EXCLUSIVE LICENSE FROM THE UNIVERSITY OF ILLINOIS FOUNDATION.



model LPV-VU12 Near-Fringe \$49.95



VHF / UHF / FM ANTENNA!

Because it delivers best 82-channel TV performance—COLOR or black/white—plus FM/Stereo—using only a single downlead!

No other antenna works like the 82-channel JFD LPV-VU Color Log Periodic...

- Only the JFD LPV-VU is designed according to the patented log periodic design of the University of Illinois Antenna Research Laboratories.

- Only the JFD LPV-VU utilizes capacitor-coupled Cap-Electronic dipoles for higher mode operation that achieves higher gain, narrower beamwidths on VHF channels 7 to 13 and UHF channels 14 to 83. (Our competition's copies of the JFD LPV-VU use only fundamental mode which resonate as simple dipoles with consequently limited gain.

- Only the JFD LPV-VU offers true frequency-independent performance that insures brilliant color on any channel.

JFD®

LPV-VU® Color LOG PERIODIC

You bet you can have everything you want in one antenna—VHF, UHF, FM—with a single down-lead, too! Start teaming up JFD 82-channel LPV-VU Color Log Periodics with all the 82-channel TV sets in your area—see the difference in profits and performance. Call your distributor or write for brochure 806.

32 million readers of LIFE will be seeing spectacular JFD LPV Color Log Periodic advertisements all season long. This unprecedented LIFE campaign will be pre-selling JFD LPV antennas for you!

Full-color television commercials will show millions more why the LPV's patented space-log periodic design works best on any channel—color & black/white.

6 GREAT MODELS TO CHOOSE FROM



JFD ELECTRONICS CORPORATION

15th Avenue at 62nd Street, Brooklyn, N. Y. 11219
JFD Electronics-Southern Inc., Oxford, North Carolina
JFD International, 64-14 Woodside Ave., Woodside 77, N. Y.

Circle 23 on literature card

This stage functions as a relaxation oscillator and produces pulses at 630 cps (1/25 the horizontal frequency). The natural frequency of this oscillator is adjusted close to the receiver sync frequency by the locking control on the front panel. The oscillator then locks to the amplified retrace pulses and is quite stable. The width of the 630-cps pulse is internally adjustable to fill one scanning line on the receiver. This control was found to be factory adjusted "right on the money".

The 630-cps pulse is fed to V3B, an amplifier and clipper, and then to

V4A where it is inverted and further amplified. The output of V4A is a horizontal bar pulse of about 40V amplitude.

The vertical bars are derived from the positive pulse at the cathode of V1B. The sync pulse there is fed to a ringing circuit which produces damped 441-kc oscillations. These are reinforced and amplified by V4B. The output of V4B is fed to a peaking circuit and is then available at the switching network as vertical bars.

Dots are produced the same as vertical bars except that the grid-leak re-

sistor of V4B is lifted from ground by the switch and returned to the grid of the horizontal pulse inverter V4A. The 630-cps pulse is now fed to the grid of the vertical amplifier. The grid and cathode of the inverter act as a clamping diode which keeps the vertical bar amplifier from conducting except during horizontal pulses.

The crosshatch pattern is derived by running the vertical and horizontal bars together. Bright intersections are avoided by tapping off a portion of the negative horizontal pulse and applying it to the grid of the vertical bar amplifier. This cuts off the amplifier during horizontal pulse time.

The color bar is developed by crystal oscillator V3A operating at 3.579545 mc. The output of this stage is fed to the diode modulator, where it is modulated with an unfiltered, half-wave-rectified, 60-cps signal. The modulated 3.579545 mc is then fed to the receiver antenna.

In use, this signal beats with an incoming B/W signal from a station and produces a horizontal bar one-half frame high. Since the color-bar signal is at burst frequency, it produces a chartreuse bar across the black-and-white picture.

To put this bar to use in checking chroma circuits, the blue and green guns are killed; the resulting pattern should be a red picture of uniform intensity if the hue control is properly centered. Running the hue (or tint) control to the extremes of its range should cause the burst-frequency bar to appear lighter or darker than the rest of the picture. Further information on this type of color generator can be found in the March 1966 PF REPORTER article "Understanding Color-Bar Generators."

In testing this generator, it was found that, though the sync was very stable, it took a few minutes to become accustomed to using the locking control. The control has a wide range, and the correct locking spot was missed the first few times. The trick was to operate the control slowly.

The Model 662 comes equipped with an adaptor for 21" round tubes. An accessory adaptor for rectangular tubes is available through distributors. Sufficient room is available in the lead-storage compartment for the extra adaptor.

Who has the largest selection of semiconductor replacements in the world?

Semitronics! Surprised? Did you know that more service technicians, engineers and experimenters buy the Semitron brand than any other in the world for replacement. There are three main reasons. **First, SELECTION.** Semitronics has more types available, off the shelf, than any other source. **Second, QUALITY.** Semitrons always exceed minimum specs for ratings and reliability. **Third, PRICE.** The word is getting around fast. At Semitronics, you always get **more for your money.** Want to prove it? Get the world's most complete Interchangeability Guide (8 Page Booklet or Wall Chart) and price list on semiconductors. Get it **FREE** at your Semitron distributor or send 25¢ directly to Semitronics to cover handling costs. Do it now! You'll be amazed at the savings at Semitronics.

Semitronics
CORPORATION

Dept PF-4

265 CANAL STREET
NEW YORK, N.Y., 10013
PHONE: (212) 226-5401-2

Please send me the Semitron Interchangeability Guide for 25¢ each to cover handling & postage.

- 8 Page Booklet.....8½" x 11"
 Wall Chart22" x 26½"

Name.....

Address

City/State..... Zip
Code.....

For further information circle 70
on literature card

Every time Si Costa replaces a picture tube, he makes a friend.

Si can't afford to have people get sore at him. So when a picture tube goes on the blink, he plays it smart. He recommends and uses Philco Starbright 20/20. Si's found that Philco parts mean no costly callbacks. That's why he sticks with Philco parts almost all the way.

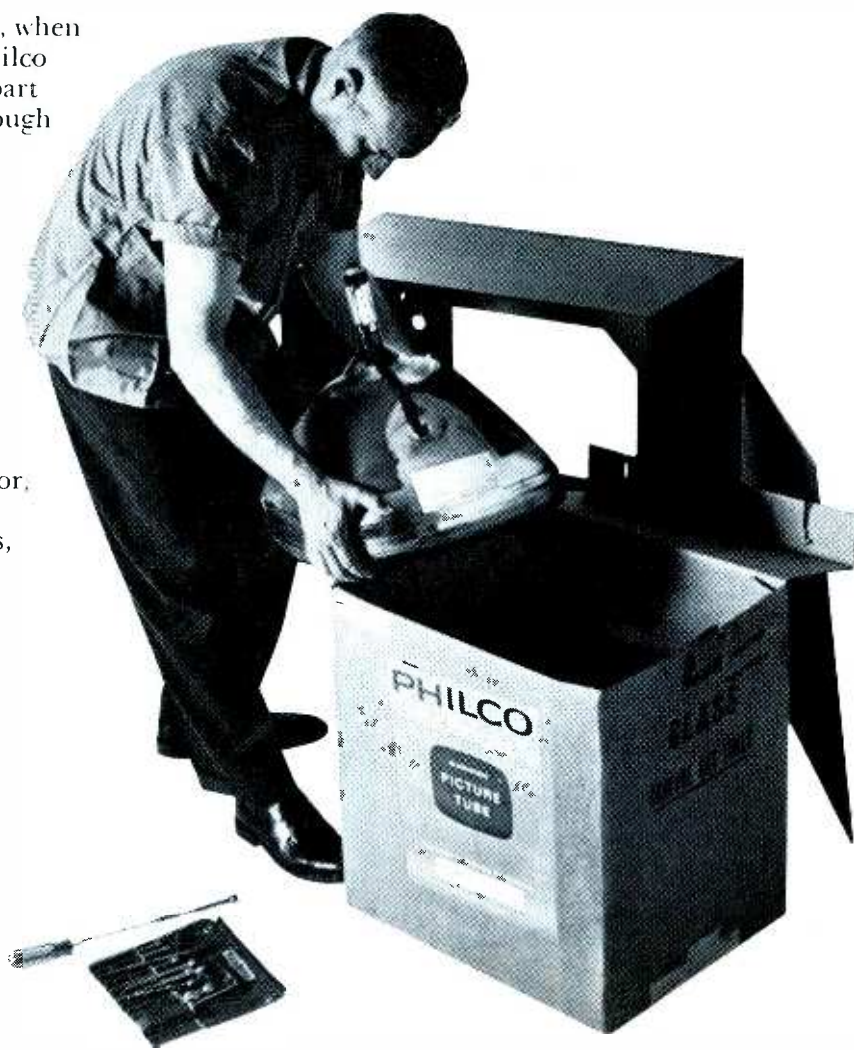
In fact, Si figures that it really doesn't pay to use anything less than Philco quality and dependability. Anything less only means extra trouble for his customer. Which could mean extra trouble for him.

And what's more, 99 times out of 100, when he needs a part, he finds it right at his Philco Distributor's. The hundredth time his part is shipped to him in 24 hours or less through Philco's Emergency Lifeline Service. That's some service.

Philco's Tech Data Service keeps Si up to the second on how to service Philco's new products. And he gets all the facts faster, fuller and at a lower cost than any other service.

Add to this a complete accident insurance plan for his men and himself, and you can see that Si Costa is a mighty happy man. You can be, too. Talk to your Philco Parts Distributor, or contact Parts & Service Department, Philco Corporation, Tioga & "C" Streets, Philadelphia, Pa. 19134

PARTS & SERVICE DEPARTMENT
PHILCO
A SUBSIDIARY OF *Ford Motor Company*



Circle 25 on literature card

compact sets

**SPEED DRIVING OF BRISTOL
AND ALLEN HEX TYPE SCREWS**



No. 99PS-60 Bristol Multiple Spline
Type Screwdriver Set



4 and 6-flute blades
with diameters from
.048" thru .183"



No. 99PS-40 Allen Hex Type
Screwdriver Set



Hex diameters
from .050" thru 3/16"

Compact, interchangeable blade, Xcelite sets permit quick selection of the right tool for the job. With greater reach than conventional keys, these handy blade and handle combinations make it easier to get at deep set or awkwardly placed socket screws, simplify close quarter work.

Each set contains 9 precision formed, alloy steel, 4" blades; 4" extension; shockproof, breakproof, amber plastic (UL) handle with exclusive, positive locking device.

Sturdy, see-thru plastic cases fit pocket, have flat bases for use as bench stands.

WRITE FOR BULLETIN N365

XCELITE

XCELITE, INC., 18 Bank St., Orchard Park, N. Y. 14127

Circle 26 on literature card

52 PF REPORTER/April, 1966

H.V. Problems

(Continued from page 20)

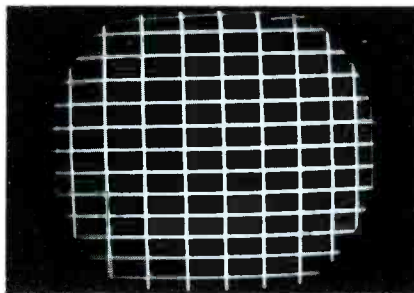


Fig. 10. Compression on right due to leaky capacitor at grid of horizontal output tube.

fier. The short places the full 4.6-KV peak pulse across the coil instead of the normal 350-volt peak. Some of the late model sets have a voltage-sensitive resistor from the focus capacitor to B boost on the flyback to give protection against arcs. When the rectifier is shorted, this resistor gets so hot it will smoke, even

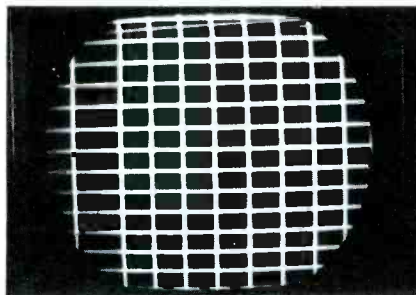


Fig. 12. Expansion on left due to weak damper tube.

though it measures open on an ohmmeter.

One question seems to inspire another: what effect does line voltage have on focus? Or to phrase it practically: will the good sharp focus you adjusted at 117 volts still be acceptable at 105 to 125 volts? To answer this the hard way, a chart was made of the B plus, B boost, horizontal-output grid, horizontal-output screen, focus and HV at 110,



Fig. 14. Noise due to arc inside 3A3 plate cap.

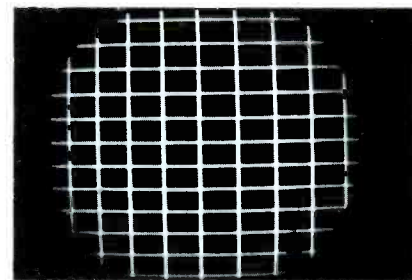


Fig. 11. Compression on left due to excessive regulator current.

120, and 125 volts (see Table 1). All the voltages went in step with the line voltage. Then another chart was made of the optimum focus voltage necessary at various high-voltage readings from 21 to 30 KV (see Table 2). The two charts matched almost perfectly, indicating line voltage would not be a factor in

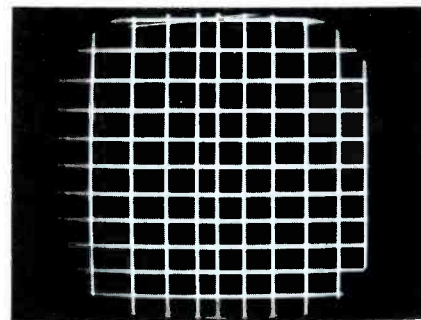


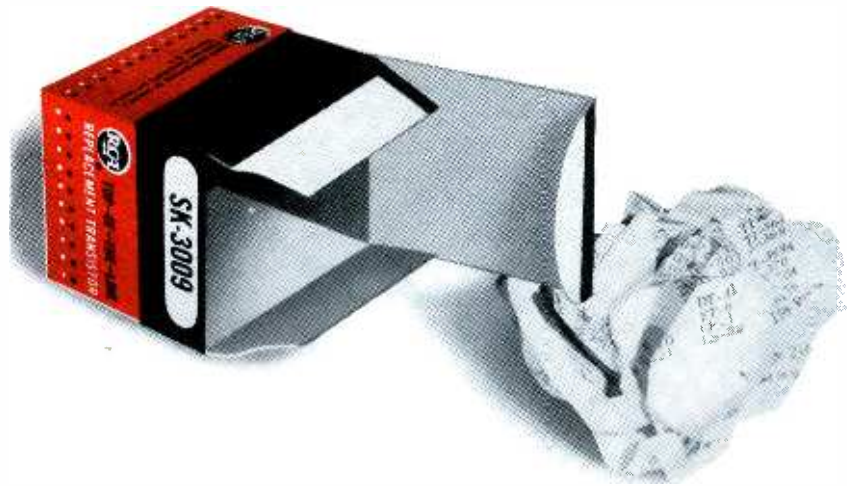
Fig. 13. Distortion due to low horizontal output screen voltage.

good focus. A simple, practical cross-check was to vary the line voltage and check for best focus at each voltage; very little readjusting was required. Whether this happy condition results from good engineering or accident, it is good news to servicemen.

While the receiver was still available for further experimenting, it seemed a good time to perform some tests on high voltage and note the effects of bad tubes and voltages.



Fig. 15. Random noise due to arc inside 6BK4 plate cap.



The SK-3009 transistor that came in this box replaced one transistor in original equipment. But, it could just as easily have replaced almost 600 different transistors. RCA has 16 such replacement transistors plus 2 replacement rectifiers comprising the SK Top-of-the-Line series. If you stock all 18, **you can replace more than 4,000 transistors**, both domestic and foreign types, and **over 1,000 selenium or silicon rectifiers**. Stock the Top-of-the-Line series. The time that you will save in looking for replacements alone is well worth the investment.

RCA's new Top-of-the-Line Replacement Guide SPG-202A is an absolute necessity if you are servicing solid-state entertainment-type equipment. It lists the 18 RCA types and the more than 5,000 types which they replace. Ask your RCA Distributor for your copy or write: Commercial Engineering, Section D 335D, RCA Electronic Components and Devices, Harrison, New Jersey.



The Most Trusted Name in Electronics

Circle 27 on literature card

April, 1966/PF REPORTER 53

5 Transistors No Tubes 30 db Gain*



NEW JERROLD ALL-SOLID-STATE "DE-SNOWER" Model SPC-132 ...the most powerful of all antenna amplifiers

Do you remember the original and famous Jerrold De-Snower? Thousands of De-Snower preamplifiers have served fringe-area antenna systems since 1950, amplifying weak television signals at the antenna before download loss. Now every benefit of the original De-Snower, and more, is offered by the new SPC-132 all-solid-state antenna amplifier.

Jerrold has combined the ultra-sensitive twin-transistor preamp, SPC, with a compact three-transistor postamp, 132, to give you the powerful double-punch performance of this unusual new antenna amplifier—with absolutely no tubes to replace.

**30 db high-band gain* • 26 db low-band gain*
• Lowest input noise figure • Highest output capability
(100,000 microvolts each of 7 channels)**

Use the SPC-132 on your next "tough-dog" antenna system—custom home or multi-set installation. Drive as many as 20 to 30 sets from one antenna system.

Only \$97.95 list. Ask your Jerrold distributor or write Jerrold Electronics, Distributor Sales Division, Philadelphia, Pa. 19132.

*Measured average production unit



The nation's foremost manufacturer and supplier of television antenna systems and equipment

Circle 28 on literature card

The first few tests showing more noticeable change in width and linearity than in high voltage. Therefore the question arose: why not use the crosshatch pattern to analyze sweep problems? After all, each color technician should have a generator with him on all calls; it could save much analysis time. Figs. 10, 11, 12, and 13 show this to be entirely practical.

One phenomenon that seems to puzzle many technicians is an arc that occurs from the aquadag coating to ground or other ground-to-ground contacts. Two basic conditions will cause this: either the high voltage to the picture tube is AC (which will cause no picture) or the high voltage misses part of the time because of opens or arcs. In either case, the visible ground-to-ground arc is a symptom only, not the cause of trouble. It will disappear when the main defect is repaired.

Arcs and coronas never seem to occur when you desire them; therefore, in order to photograph typical arcs I had to simulate them. Some of the results surprised me, for I expected only confirmation of conditions encountered in actual servicing.

The first arc test was a complete failure, for with a piece of solder attached to the plate of the 3A3 to make a large visible corona, no noise could be seen in the picture. The next test to simulate a bad cap on the 3A3 succeeded. A small piece of slide film was wound around the plate and the connector cap replaced over it. Fig. 14 shows the 5 or 6 narrow, vertical noise lines that resulted. Next, film was installed inside the regulator plate cap to give the random noise pattern shown in Fig. 15. But none of these methods gave the broad vertical lines composed of random noise that I have seen many times when the horizontal output or focus rectifier tube is bad. The answer to this puzzle became evident accidentally when two of the temporary extensions got too close together and caused a corona between the 3A3 plate lead and the high-voltage lead to the picture tube. (See Fig. 16). This noise pattern was so intense the white vertical bar was actually a fold-over. It is typical of noise from this source to occur only on the left side of the screen.

In actual servicing it becomes more apparent that high-voltage regulator malfunctions account for a large share of high-voltage troubles, as well as focus and linearity problems. Since high-voltage regulators were discussed thoroughly in the May 1965 PF REPORTER, I will merely add emphasis to one of the recommendations given there. Manufacturers' service-data frequently specifies that the high-voltage be adjusted for a certain value. This would be fine if all the sets were identical and the line voltage always the same, but these conditions seldom occur.

Table 2.

Relationship between HV and best focus.

High Voltage	Focus Voltage
30KV	5.4KV
27KV	5.2KV
25KV	4.9KV
23KV	4.5KV
21KV	4.1KV

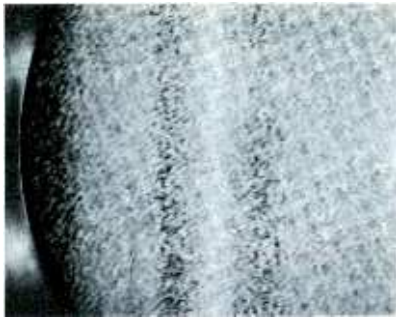


Fig. 16. Noise at left of raster due to corona between HV lead and 3A3 plate lead.

Part of the receiver voltage vs. line voltage chart (Table 1) showed 27KV for 1.4 ma of regulator current at 125 volts AC, 26 KV for 1.3 ma at 120 volts AC, but only 24 KV for 1.1 ma at 110 volts AC. If we had set the regulator for 25 KV at 125 volts AC, the regulator current probably would have been around 1.6 ma; this far exceeds the dissipation rating of the tube. Frequent tube failures result. At 110 volts the current would necessarily have been reduced to about .9 ma to bring the high voltage up to 25 KV.

Thus, the range of correct brightness would have been reduced from 1.3 ma to .9 ma. A good rule of thumb is: if the line voltage is high, set the regulator current .1 to .2 ma low. This will assure relatively good operation if the line voltage returns to normal. By all means, *do* use a high-voltage probe, but use it to verify the voltage *after* the regulator has been set by the regulator-current method.

Almost all present-day color receivers use some variation of the 6BK4 shunt-regulator circuit, but a few models use the variation of horizontal-output tube grid bias to regulate the high voltage (see Fig. 17). Boost voltage varies approximately with the high voltage, because the voltage in the flyback transformer also follows the high voltage. The Motorola flyback supplies about 300 volts pp from the feedback winding, giving about 150 volts negative when rectified. But any correction from this simple voltage would be of no consequence. Therefore, a reverse voltage is fed into the cathode of the rectifier to prevent conduction until the pulse voltage exceeds the DC adjustment. If the potentiometer is

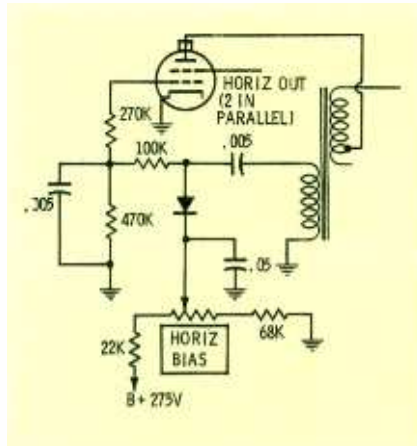


Fig. 17. High-voltage regulation by grid bias.

set on the verge of rectifier conduction, any small increase in pulse voltage will be rectified, and the negative voltage thus produced will be filtered and applied to the tube grid to reduce gain. Thus, a 10-volt increase would supply about 10 VDC for correction purposes. The manufacturer advises to adjust the potentiometer for 26 KV of high voltage with the brightness control turned to "no-raster."



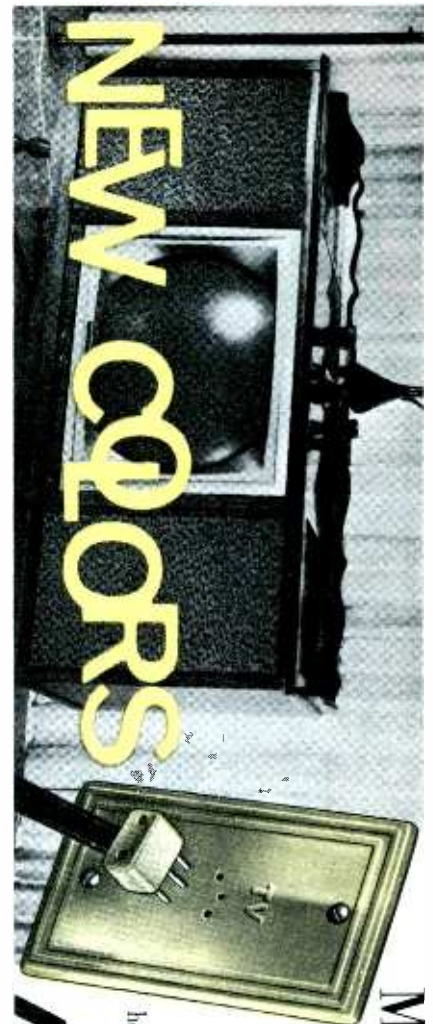
The ENDECO Desoldering Iron Removes Soldered Components in seconds... without damage!

Endeco melts solder, then removes it by vacuum • Leaves terminals and mounting holes clean • Resolders too • One-hand operation • Temperature controlled for continuous use • Ideal for use with shrinkable tubing • 4 tip sizes • Quickly pays for itself in time saved • Only \$18.75 net.

SMALLER SIZE AVAILABLE. SEE YOUR DISTRIBUTOR OR WRITE:

ENTERPRISE DEVELOPMENT CORPORATION
5151 E 65TH • INDIANAPOLIS, IND. 46220

Circle 27 on literature card

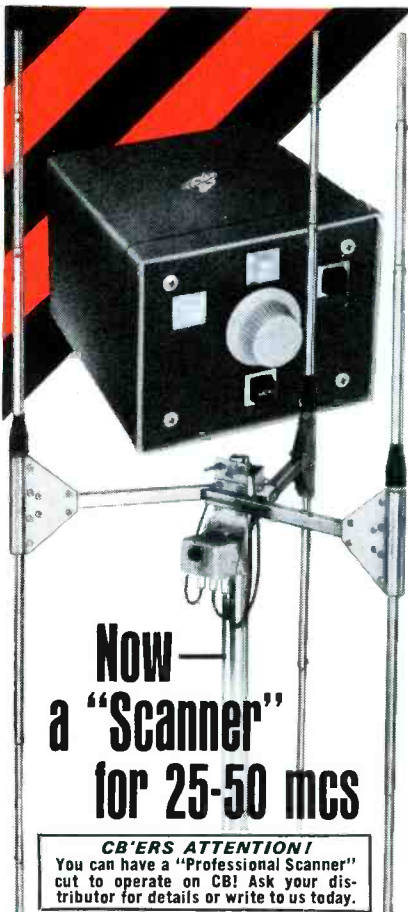


MOSLEY originator of TV/FM accessories, announces a major color breakthrough! Now the entire line of Mosley TV accessories, such as the popular Mosley F1-PK, are NOW available in decor-harmonizing colors... ANTIQUE IVORY, FAWN BEIGE, GREY MIST and Standard Brown and Ivory.

The FR-1PK (shown) connects up to eight TV/FM sets with one antenna; utilizes one lead-in without couplers or boosters. Ideal for homes, motels, hotels. Stock and install the complete line of Color-Oriented Mosley TV accessories today!

Write:
Mosley Electronics Inc. 4610 N. LINDBERGH BLVD., BRIDGETON MO. 63044

Circle 29 on literature card



**Now —
a "Scanner"
for 25-50 mcs**

CB'ERS ATTENTION!
You can have a "Professional Scanner" cut to operate on CB! Ask your distributor for details or write to us today.

- Rotate beam electronically, instantaneously. No mechanical rotor.
- Omni-directional position for monitoring.
- Min. 6 db gain (ref. drooping ground plane), 18 db f-to-b ratio in beam mode.
- Stress-designed for 100 m.p.h. winds.
- Power rating: 500 watts.
- Every unit individually tuned to exact freq. Each receives system checkout.

PROFESSIONAL Scanner

pat. pend.

electronic, sector-phased
omni-beam antennas

the antenna specialists co.

Div. of Anzac Industries, Inc.
12435 Euclid Ave.,
Cleveland, Ohio 44106

Export Div.,
64-14 Woodside Ave.,
Woodside, N.Y. 11377

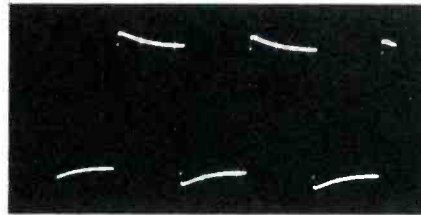


"Stripes of Quality"

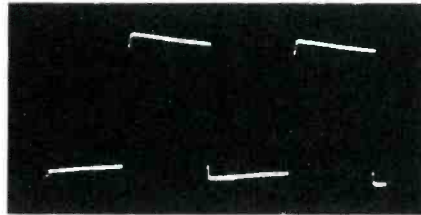
Circle 30 on literature card

Square Waves

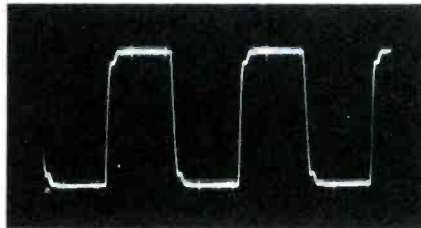
(Continued from page 23)



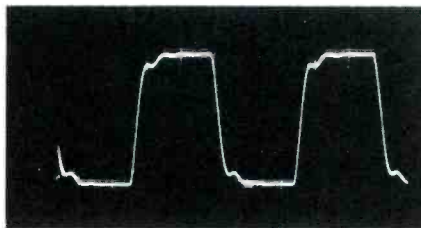
(A) 500 cycles.



(B) 1 kc.



(C) 5 kc.



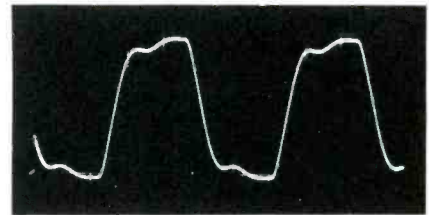
(D) 10 kc.

Fig. 12. Response patterns at different frequencies.

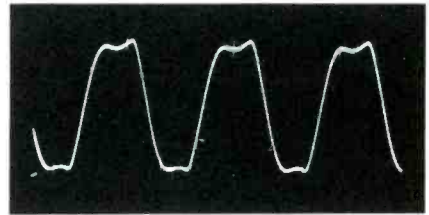
ample, the feedback resistor has greatly increased in value. This defect reduces both the high-frequency and low-frequency response of the amplifier. Note also the thickening of the trace in Fig. 11; this results from an increased hum level. Negative feedback reduces hum making it invisible in Fig. 9. With subnormal negative feedback, the output hum level rises and becomes plainly visible in Fig. 11.

Frequency Response

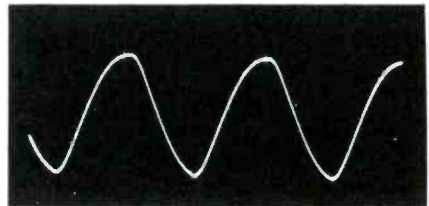
As noted previously, routine square-wave tests are made at 60 cps and at 2 kc. However, it is instructive to consider square-wave response over a wide frequency range. Fig. 12 shows the normal response of the amplifier in steps from 500 cps to 10 kc. Bass and treble controls are set at midposition. The tilt which is noticeable at 500 cps and at 1 kc disappears at 5 kc. This occurs



(A) 20 kc.



(B) 30 kc.



(C) 50 kc.

Fig. 13. Response patterns at high frequencies.

because 5 kc falls on the flat portion of the overall frequency characteristic. At 500 cps, a small indication of corner notching is evident. This waveform detail is greatly expanded in the 10-kc display. The source of corner notching is a combination of ringing and rounding. In other words, the output transformer has leakage reactance which causes ringing, since it is tuned by the distributed capacitance of the transformer. This ringing is not completely suppressed by negative feedback. Corner rounding occurs because the amplifier response falls off at high frequencies. Rounding attenuates the ringing waveform, but leaves its negative excursion present as a notch.

Next, Fig. 13 shows the square-wave response at 20, 30, and 50 kc. At 30 kc, the notch is expanded over the flat top of the reproduced square

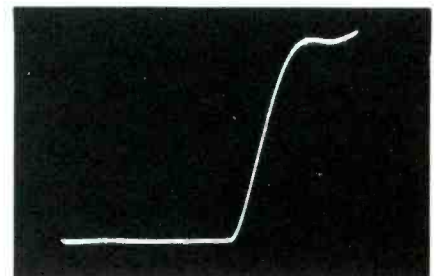


Fig. 14. Leading edge of 30-kc response pattern.

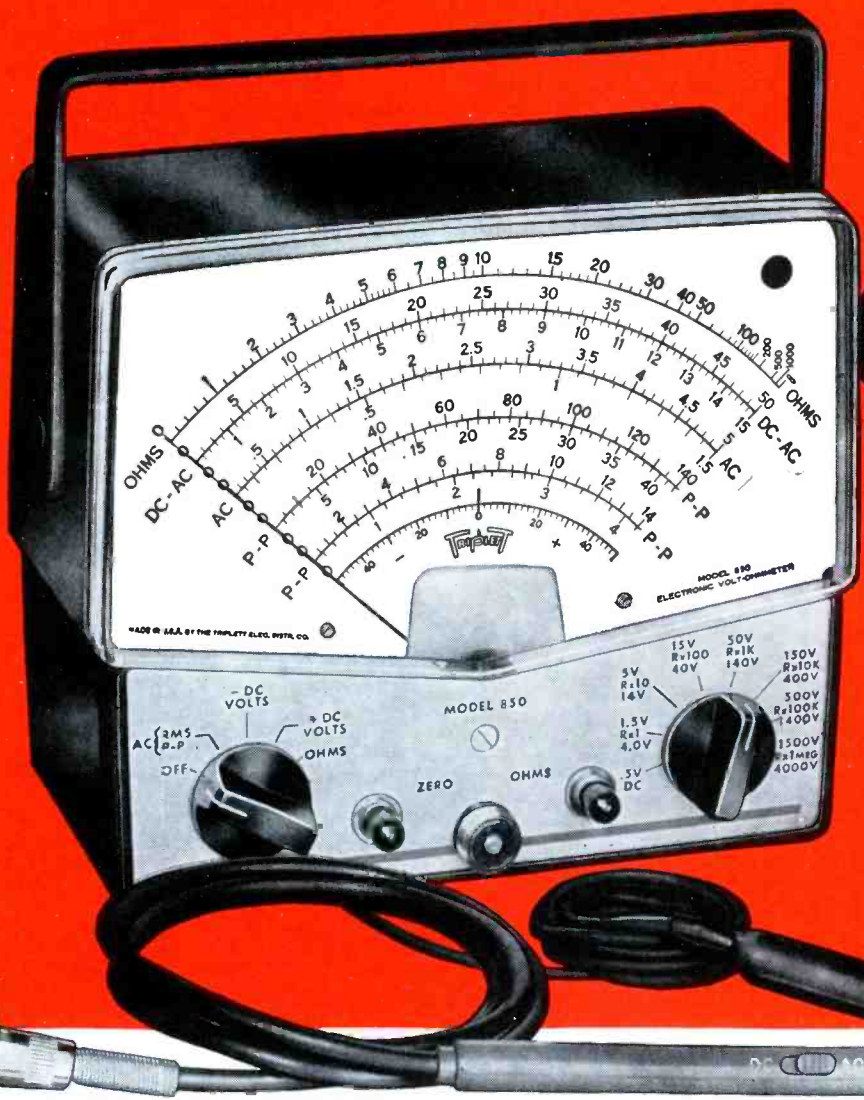
**BEST FOR YOU—
IT'S MOST VERSATILE**



MODEL 850 ELECTRONIC VOLT-OHMMETER

USES UNLIMITED:
Field Engineers • Application Engineers • Electrical,
Radio, TV, and Appliance Servicemen • Electrical
Contractors • Factory Maintenance Men • Industrial
Electronic Maintenance Technicians • Home Owners,
Hobbyists

MODEL 850 \$85.00



FACTS MAKE FEATURES:

- 1** Long 7" easy-to-read scale.
- 2** .5 D.C. volt range for transistor circuits.
- 3** HIGH STABILITY. Meter connected in cathode circuit of 12 AU7.

High Input Impedance (11 MEGOHMS) and wide Frequency Ranges give this extremely versatile Electronic Volt-Ohmmeter considerable advantage in the measurement of DC voltages, AC RMS and Peak-to-Peak voltages. It measures directly the Peak-to-Peak values of high-frequency complex wave forms and RMS values of sine waves on separate scales. Exclusive Triplet BAR-RING instrument is fully self-shielded; high flux magnet and spring-backed jewels for ruggedness. Wired circuit.

ADDED PROTECTION. Meter is shorted out in OFF position for greater damping, meter safety during transit, electrically protected against accidental overload. ZERO CENTER mark for FM discriminator alignment, plus other galvanometer measurements.

New pencil thin test probe used for all functions: DC, AC, and ohms. No need to change cables. Beautifully styled case for professional appearance and functional utility, 7 7/8" x 6 7/16" x 3 3/4".

Carrying handle can be used as a tester stand to place the tester at 25° angle for ease in reading.

Frequencies to 250 MC may be measured with auxiliary Diode. Probe, \$8.00 extra. DC voltages to 50 KV may be measured with auxiliary High Voltage Probe. \$23.00 extra.

TRIPLET ELECTRICAL INSTRUMENT COMPANY, BLUFFTON, OHIO

CARRYING CASE

Case 859—OP—Black leather
Padded Carrying Case. \$21.00 Net



RANGES

8 DC VOLTS RANGES	0-.5-1.5-5-15-50-150-500-1500
7 AC RMS VOLTS RANGES	0-1-5-5-15-50-150-500-1500
7 PEAK-TO-PEAK VOLTS RANGES	0-4-14-40-140-400-1400-4000
7 RESISTANCE RANGES	0-1000-10,000-100,000 OHMS; 1-10-100-1000 MEGOHMS.
FREQUENCY RANGE 15 CPS to 3MC; (Up to 250 MC with accessory diode probe available extra.)	
INPUT IMPEDANCE DC Volts 11 Megohms; AC Volts minimum of .83 Megohms.	



THE WORLD'S MOST COMPLETE LINE OF V-O-M'S. AVAILABLE FROM YOUR TRIPLET DISTRIBUTOR'S STOCK.

Circle 31 on literature card

wave, and at 50 kc, the fall starts at the top of the first ringing peak. The amplifier's response to the high-frequency elements of the square wave is reduced appreciably in Fig. 13C, with the result that the reproduced square wave begins to resemble a sine wave. Only the fundamental is being passed at full amplitude; the harmonics are substantially attenuated.

In Fig. 14, the leading edge of the pattern in Fig. 13B has been expanded to measure the rise time of

the amplifier. The sweep controls of the triggered-sweep scope indicate that the rise time is 5 msec. This marks the upper frequency limit of the amplifier. Recall that the -3 db response at the high-frequency end is equal to $.35/Tr$, where T is the rise time. Frequency is equal to $1/T$, because $T = 1/f_c$. In other words, the rise time is 5 msec. which means that $f_c = .35/5 \times 10^{-6}$. Or, the amplifier is 3 db down at 70 kc. This is a wideband response by ordinary standards.

Faulty, fragile, filament failures.

Phooey.

Yes, phooey to filament failures and costly tube replacements. CB radios should be solid state to take the bumps and knocks of mobile use.

That's why *all* Amphenol Citizens Radios are solid state. We don't believe in thin filaments that heat up and short or snap. Or in fragile glass enclosures. Or in tubes at all, when transistors have

more than ten times the life and warm up instantly. That's why Amphenol has the broadest line of solid state equipment available today.

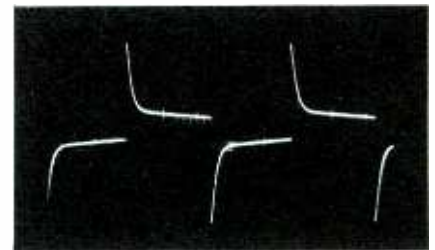
Take the new Spokesman 650 for example. This ten crystal-controlled channel receiver is complete with spot button, S and RF meter, squelch control, 23 channel RF tuner, solid state switching (no relay, making it possible to provide communications even at 25°F below zero), and most important, Amphenol dependability.

Remember, when you want the reliability of solid state circuitry, think of the industry's broadest line, Amphenol. See your local Amphenol distributor for more information on Amphenol solid state, and the Spokesman 650, or write us direct.

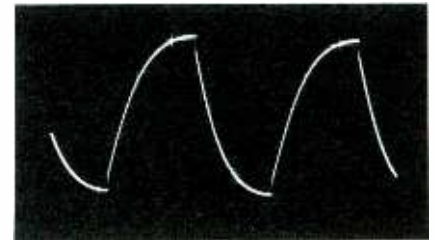


AMPHENOL DISTRIBUTOR DIVISION
AMPHENOL CORPORATION
2875 South 25th Avenue, Broadview, Illinois 60153

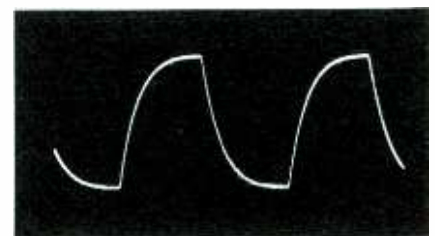
Circle 32 on literature card



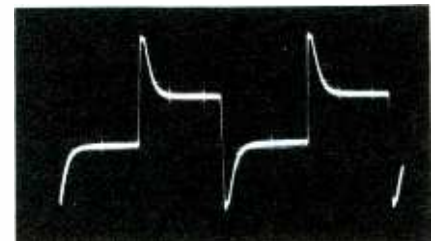
(A) 60 cycles, bass control at full left.



(B) 60 cycles, bass control at full right.



(C) 2 kc, treble control at full left.



(D) 2 kc, treble control at full right.

Fig. 15. Tone controls vary response patterns.

The low-frequency response is found by observing the lowest square-wave frequency at which a flat top is obtained. For example, the amplifier can be driven at 40 cps; and by setting the treble and bass controls slightly off midposition, you can see a fair square wave. However, if the amplifier is driven at 30 cps, substantial curvature appears along the top, and it cannot be flattened out by adjustment of the treble and bass controls. Hence, the low-frequency response checks out at about 40 cps. The bass control has the greatest effect on waveform at low frequencies such as 60 cps. Fig. 15A shows the response with the control at full left, which differentiates the square wave greatly. On the other hand, Fig. 15B shows the response with the control at full right response which greatly integrates the waveform.

The cover gives you the whole story.



The United Delco box tells you for sure you're getting a replacement radio part of the same high quality as the original.

And it tells you who authored it, too. Namely, Delco Radio.

So, if you'd like to hang on to your reputation and customer goodwill, just ask yourself this next time you order transistors:

Do they come individually packed in a distinctive box? (Bushel buying is for potatoes, not transistors.)

Do they carry an easy-to-read, can't-make-a-goof number?

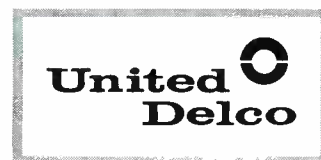
Are the numbers—and the transistors—grouped in such a way that you can service more car radios with fewer parts?

Is there a good chance that the parts are original equipment on nearly half of the car radios on the road?

Delco Radio transistors are all of these, and you can get them from your United Delco supplier. He handles the most widely advertised, merchandised and recognized

name in the parts business—United Delco.

That's how your customers know a good part when they see it.



DELCO RADIO, Div. of General Motors, Kokomo, Ind.

Circle 33 on literature card

A COMPLETE FAMILY OF QUALITY UHF-VHF-FM ANTENNAS

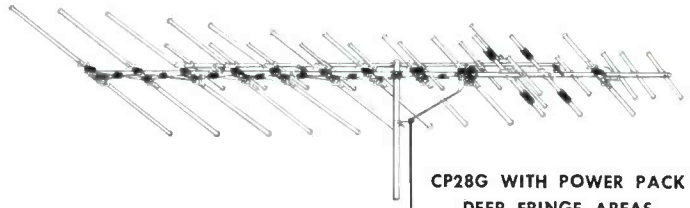
KAY-TOWNES

OVER 900 MODELS FOR EVERY AREA — EVERY PURPOSE

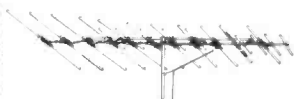
colorphase

WITH PIGGY BACK POWER PACK

Gives the EXTRA PUNCH needed to produce the best in color and improved black and white. High Gain, high front to back ratio. Double U-bolts and double cross-arms for rugged rigidity. 2-piece locking mast clamp. No boom braces needed.



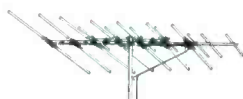
CP28G WITH POWER PACK
DEEP FRINGE AREAS
LIST \$53.75



CP23G WITH POWER PACK
FRINGE AREAS
LIST \$44.80



CP19G WITH POWER PACK
NEAR FRINGE-FRINGE
LIST \$35.05



CP15G WITH POWER PACK
SUBURBAN-NEAR FRINGE
LIST \$26.10



CP11G
SUBURBAN
LIST \$20.19

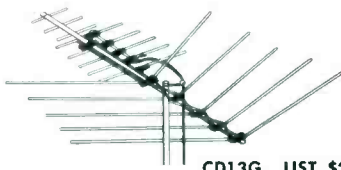


CP7G
CITY AREAS
LIST \$13.02

COLORDYNE

COMBINATION UHF-VHF-FM

An antenna for all channels 2 through 83. Simplicity of design permits high gain reception at low cost.



CD13G LIST \$21.92
SUBURBAN-NEAR FRINGE



SUBURBAN-CITY
CD11G LIST \$17.70

Colorphase Combination

ALL-BAND UHF-VHF-FM
WITH PIGGY BACK POWER PACK

One antenna to cover all channels 2 through 83 with single down lead for all areas including FRINGE AREA.



FRINGE
CPC27G WITH POWER PACK LIST \$40.75



SUBURBAN
NEAR FRINGE
CPC24G WITH POWER PACK LIST \$35.41

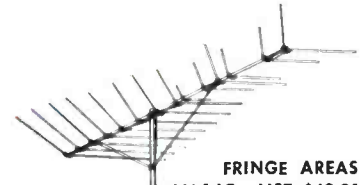


CITY AREAS
CPC12G LIST \$17.42

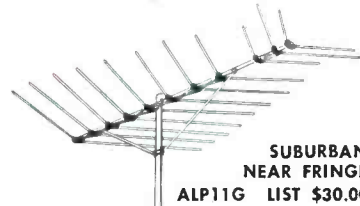
ALP MODELS

VHF-FM

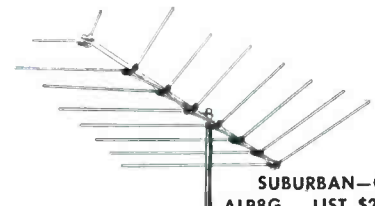
All channels 2 through 13. Simple swept-element permits low cost with high gain and excellent color as well as black and white and FM Stereo.



FRINGE AREAS
ALP14G LIST \$40.31



SUBURBAN
NEAR FRINGE
ALP11G LIST \$30.00



SUBURBAN-CITY
ALP8G LIST \$20.85

COLORVISTA UHF

Converts any existing VHF antenna to 82 channel reception with a single lead. Receives UHF in one direction and VHF in another with no rotor or coupler necessary.



CVU-13G LIST \$14.15



GENUINE
GOLD ANODIZED

Not a Spray to Wash Away!

SEE US AT THE SAN FRANCISCO SHOW — BOOTH 2606

SALES TERRITORIES OPEN IN SOME AREAS

QUALITY • PERFORMANCE • ECONOMY



KAY-TOWNES
antenna company

HEADQUARTERS OFFICE AND PLANT — 1511 DEAN AVE., ROME, GA. 30162

Circle 34 on literature card

The treble control has the major effect on the waveform at higher frequencies. Fig. 15C shows the 2-kc square-wave response with the control at full left, which integrates the waveform substantially. On the other hand, Fig. 15D shows the 2-kc response with the control at full right, which differentiates the waveform substantially. Lack of the variation ranges illustrated in Fig. 15 points to a defect in the tone-control network. Check capacitors for leakage or opens, and check resistors for changes in value. In rare cases, a potentiometer might be defective. Absence of normal range may not be caused by a defect in the tone-control network, but can result from a defect in the negative-feedback loop.

Stereo Amplifiers

A stereo amplifier is actually two amplifiers on one chassis. Hence, you must check each channel individually. First, the left channel is tested by applying the square-wave signal to the left-channel input connector; a load resistor is connected in place of the left-channel speaker. The scope is connected across the load resistor, as in Fig. 5. Square-wave tests are made in the same manner as already described. After the response has been verified, or restored to normal by troubleshooting the left-channel circuitry, the test is repeated for the right channel.

The square-wave signal is applied to the right-channel input connector; a load resistor is connected in place of the right-channel speaker. The scope is connected across this load resistor. Then the response is verified, or restored to normal by troubleshooting the right-channel circuitry. Finally, check for crosstalk between channels. This done by leaving the scope connected across the right-channel output, but transferring the square-wave signal to the left-channel input connector. Remember to load the output of this channel. With the left channel operating at maximum rated power output, little or no output should be observed from the right channel. If you do observe a square-wave output, adjust the balance control for minimum output. ▲

Made for EACH OTHER...

Color Television Production Up 80% in Six-Month Period

June Output Breakthrough
Production of Color Television
Radio Sales Up

Record, Half Year
Sales 1,063,093 Units;
figures Reveal

WASHINGTON, D. C. (AP)—Production of color television sets in the United States in June was up 80% from the same month last year, according to a report by the Electronics Industries Association. The association said that 205,577 units were produced in June, compared with 114,725 units and 36.2 per cent increase from the same month last year.

**THE BEST
TUNER CLEANER
FOR
COLOR SETS**



**THE ONLY
TV TUNER CLEANER
GUARANTEED
NOT TO DETUNE
COLOR SETS**

(Continued on Page 18)

NOW AT ALL
DISTRIBUTORS
\$239
DEALER NET

CHEMTRONICS
1260 RALPH AVENUE
BROOKLYN, NEW YORK 11236

Circle 36 on literature card

**WORLD'S FINEST
5-CORE SOLDER**

**ERSIN
MULTICORE**

**NEW EASY
DISPENSER**

ONLY 69¢

BUY IT AT RADIO-TV PARTS STORES
Multicore Sales Corp. Westbury, N.Y. 11591

Circle 37 on literature card

GET YOUR FIRST CLASS COMMERCIAL F.C.C. LICENSE

or Your Money Back!

The Grantham F. C. C. License Course by correspondence will prepare you to pass the F.C.C. examination for your first class radiotelephone license. We know this, but of course you do not really know if it is true. Therefore, we make this offer: After completing this course if you should fail to pass the F.C.C. exam for this license, Grantham will refund all of your tuition payments!

Read complete details in our new 1966 catalog of courses. For this free catalog, write:

Dept. 69-D
Grantham School of Electronics
1505 N. Western Ave.
Hollywood, Calif. 90027

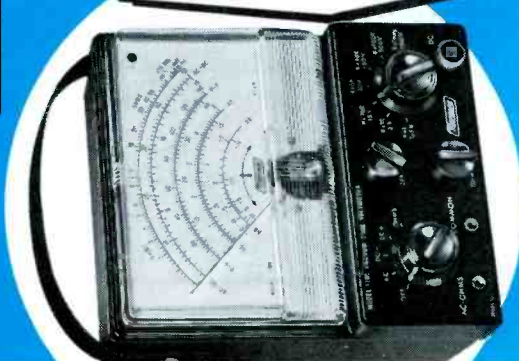
Circle 35 on literature card

Two NEW

Mercury instruments designed to meet today's rigid requirements in troubleshooting

Color TV, B/W TV, Radio, Hi-Fi and Communications equipment

...high input impedance prevents circuit loading



Circle 38 on literature card

Model 1700 VACUUM TUBE VOLTMETER
1.5 volt full scale
 enables you to handle solid state testing easily and accurately
 High impact durable housing... large 6" easy-to-read meters

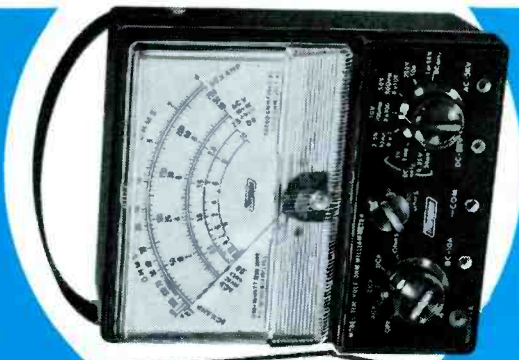
AC RANGES: (7 Ranges) 0 to 1.5, 5, 15, 50, 150, 500, 1500v. Peak to Peak — (7 Ranges) 0.4, 1.4, 4.0, 14.0, 40.0, 140.0, 400.0, 1400.0, 4000v. Output (DBM): (7 Ranges) -20db to 65db. ODB -1 mw across 500Ω. Input Impedance - 1.4 megohms. Frequency Response - 30 ~ to 500kcs within 3%. Accuracy - within 5%.

DC RANGES: (7 Ranges) 0-1.5, 5, 15, 50, 150, 500, 1500v. Input Impedance - 11 megohms. Accuracy - 2%.

RESISTANCE RANGES: (7 Ranges) 0-1k, 10k, 100k, 1 meg, 10 meg, 100 meg, 1000 meg. Accuracy - within 3%.

POWER CONSUMPTION: Less than 10w.

\$3995 Net



Model 1800 VOLT-OHM-MILLIAMMETER
.25 volt full scale
 enables you to handle solid state testing easily and accurately
 High impact durable housing... large 6" easy-to-read meters

AC VOLTS: (6 Ranges) 0-2.5, 10, 50, 250, 1000, 5000v. Input Resistance - 5k Ohms/Volt. Accuracy - Better than 4%.

DC VOLTAGE: (8 Ranges) 0-0.25, 1, 2.5, 10, 50, 250, 1000, 5000v. Input Resistance - 20,000 Ohms/Volt. Accuracy - 2%.

DC CURRENT: (6 Ranges) 0-50ua, 1ma, 10ma, 100ma, 500ma, 10a. Accuracy - 2%.

OUTPUT - Decibels: (4 Ranges) -20 to +10db, -8 to +22db, +6 to +36db, +20 to +50db. ODB -1 mw across 600Ω load.

RESISTANCE: (3 Ranges) 0-2k, 200k, 20 megohms. Accuracy - 2%.

\$3995 Net

See your parts distributor... or write for complete catalog

MERCURY ELECTRONICS CORP., 315 Roslyn Road, Mineola, N.Y. 11501

Export: Morhan Exporting, 458 Broadway, N.Y.C. 10013

Post Video

(Continued from page 44)

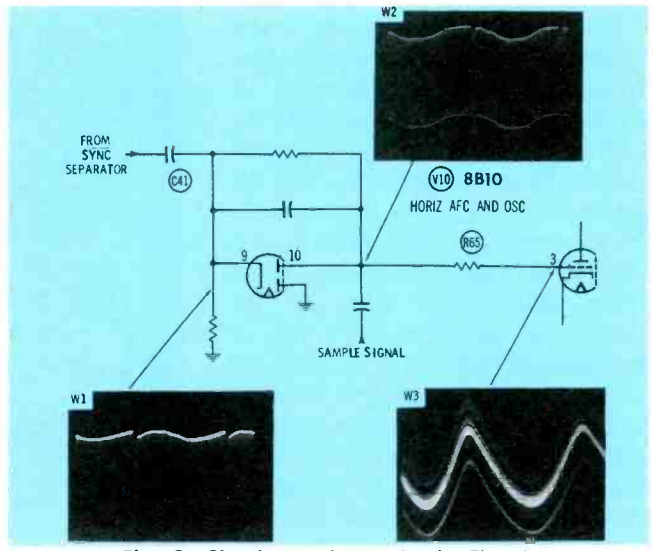


Fig. 9. Circuit causing twist in Fig. 8.

the sync signals combining along a longer straight portion of the curled sharp slope.

Fig. 8 appeared on a GE U3 chassis after about ten minutes of normal operation. It clearly suggested defective AFC diodes. In these receivers, the AFC diodes are contained in a multisection tube, a 6BW8, the other section of which, a pentode, is used as a sound IF. Not having a 6BW8 in stock and not caring to invest in one of these slow sellers merely on suspicion, a common cathode duodiode was inserted in a tube adapter and installed in the 6BW8 socket. Since the picture now had no twist, the tube was purchased and installed.

A similar case of severe twist was found in a GE QX chassis. Here again the AFC diodes were part of a slow moving multipurpose tube, an 6B10 compactron, whose other sections are used as a horizontal multi-vibrator. The symptoms strongly recommended tube replacement. However, a few scope checks and a visual examination indicated the possibility of a defect other than tube failure.

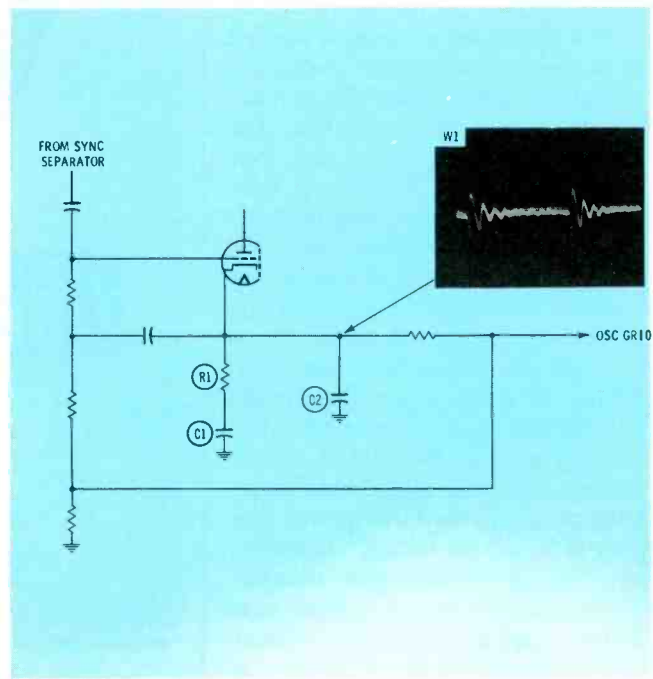
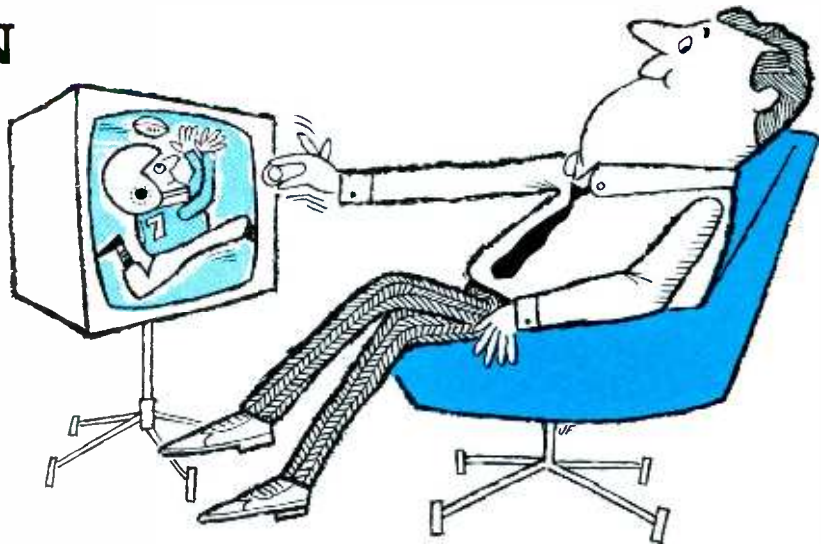


Fig. 10. Synchroguide circuit.

GET SUPERIOR 82-CHANNEL
COLOR TV RECEPTION WITH

NEW BELDEN 8290

SHIELDED PERMOHM*
LEAD-IN



Until the introduction of Belden 8290 Shielded Permohm TV lead-in cable, there were serious limitations in the effectiveness of the various lead-in cables available, whether twin lead or coaxial.

Here Roland Miracle, electronic engineer of the Belden Manufacturing Company, discusses the problems and the reasons why Belden 8290 Shielded Permohm is the all-purpose answer for 82-channel and color TV reception.

Q. What problems have been experienced in using twin lead cables other than 8290?

A. Most installers have found out that using flat ribbon or tubular 300 ohm line for UHF and color installations is unsatisfactory. When these lines encounter dirt, rain, snow, salt, smog, fog, or industrial deposits, the impedance drops abruptly, the attenuation soars and the picture is lost.



To overcome this problem, Belden developed its 8285 Permohm line which encapsulates the flat twin lead in a low loss cellular polyethylene jacket. This keeps all of the surface deposits out of the critical signal areas—regardless of weather conditions.

Although this was a major improvement, there still remained the problem of electrical interference signals from automotive ignition systems, reflected TV signals and extreme electrical radiation which could be picked up by the lead-in to create ghosts and static lines in the picture.

Q. Then, is this why many people recommend coaxial cable as TV lead-in?

A. Yes. Because of the incorporation of a shield, coaxial cable has an advantage over unshielded twin lead.

Q. Then, why isn't coaxial the total answer?

A. Coaxial cable has much higher db losses per hundred feet than twin lead. Although the shield in coaxial cable does reduce lead-in pick-up of interference signals, it is not as effective as a 100% Beldfoil* shield.

Another way to put this is that 8290 delivers approximately 50% of the antenna signal through 100 feet of transmission line at UHF while coaxial cable can deliver only 15% to 20%, frequently not enough for a good picture. Even at VHF, the higher losses of a coaxial cable may be intolerable, depending on the signal strength and the length of the lead-in.

The following chart spells this out conclusively. We have compared RG 59/U Coax to the new Belden 8290 Shielded Permohm. All 300 ohm twin leads, under ideal weather conditions, have db losses similar to 8290.



CHANNEL	MC	db LOSS/100' 8290	db LOSS/100' COAX (RG 59 Type)
2	57	2.1	2.8
6	85	2.6	3.5
7	177	3.7	5.2
13	213	4.1	5.9
14	473	6.1	9.2
47	671	7.3	11.0
83	887	8.3	13.5

Capacitance: 8290—8.3 mmf/ft. between conductors
Coax—21 mmf/ft.
Velocity of Propagation: 8290—71.2%
Coax—65.9%

Q. Won't the use of matching transformers improve the efficiency of a coaxial cable system?

A. No! The efficiency is further reduced. Tests show that a pair of matching transformers typically contribute an additional loss of two db, or 20% over the band of frequency for which they are designed to operate. Incidentally, transformer losses are not considered in the chart.

Q. How does 8290 Shielded Permohm overcome the limitations of other lead-ins?

A. 8290 is a twin lead with impedance, capacitance, velocity of propagation and db losses which closely resemble the encapsulated Permohm twin lead so that a strong signal is delivered to the picture tube. At the same time, 8290 has a 100% Beldfoil shield which prevents line pick-up of spurious interference signals. In short, 8290 combines the better features of twin lead and coaxial cable into one lead-in.



Q. What about cost?

A. In most cases, 8290 is less expensive than coax since matching transformers are not required. The length of the lead-in is also a factor in the price difference. The cost of coaxial cable installations can vary tremendously, depending upon the type and quality of matching transformers used. If UHF reception is desired, very high priced transformers are required.

Q. Is 8290 Shielded Permohm easy to install?

A. Yes! Very! It can be stripped and prepared for termination in a manner similar to 300 ohm line without the use of expensive connectors. It also can be taped to masts, gutters or downspouts, thus reducing the use of standoffs. There is no need to twist 8290 as the shield eliminates interference problems. It is available from your Belden electronic distributor in 50, 75, and 100 foot lengths, already prepared for installation, or 500' spools.

8-11-5

Belden

BELDEN MANUFACTURING COMPANY
P. O. Box 5070-A • Chicago, Ill. 60680
*Belden Trademark Reg. U.S. Pat. Off.

Circle 39 on literature card



Fig. 11. Twist due to Synchroguide defe
 ripple. This ripple was not present at the far side of C41. The second trace (W2) taken at pin 10 of V6 revealed an increased amount of ripple suggesting three possible trouble sources: The AFC section of V6, the sample signal, or through R65 from the oscillator grid.

The next scope trace (W3) was taken at pin 3 of V6B (multivibrator) and revealed an almost pure sine wave, strongly suggesting a defective 8B10. However, during the scoping process on the printed conductor side of the board, it was noted that the soldering process in manufacture had left an excessive

amount of flux and residue around the V6 base. The proximity of pin 3 to pins 1 and 12 (both of which are at a high AC potential) raised the possibility of leakage. A careful cleaning of the area with a toothbrush soaked in alcohol restored the receiver to normal operation.

AFC Filter Circuits and Twist

Horizontal multivibrators using diode-type AFC circuits are more likely to present poor pull-in or locking, rather than twist, when an AFC filter circuit component becomes defective. In horizontal oscillator circuits using a blocking oscillator, particularly the Synchroguide circuit, a faulty component in the AFC filtering network will invariably cause top-of-the-picture twist or hooking. AFC filtering in these designs is obtained by a long-time-constant R-C network and a capacitor which constitutes a short-time-constant filter, R1-C1 and C2 respectively in Fig. 10. This is often referred to as an anti-hunt circuit.

Picture twist accompanying a Syn-



Fig. 12. Twist in Emerson chassis.

chroguide AFC filtering defect appears in Fig. 11. It was found to be caused by an open resistor (R1 in Fig. 10) and was quickly located by the scope trace, W1, taken at the cathode of the AFC stage.

Boost Voltage Filtering and Twist

A twist that varies with picture content and setting of the contrast control is common to some Emerson models. Fig. 12, a typical specimen, was found in a model 120451. The circuit, Fig. 13, is identical to many Emersons using a single selenium rectifier for B+ voltage and a ver-



ASK YOUR WIFE

if she could use some extra Cannon terry cloth printed dish towels. If she says "yes" then

ASK YOUR JOBBER

how you can get them for her FREE with the purchase of certain PLANET condensers.

PLANET SALES CORP.

225 Belleville Ave.
 Bloomfield, New Jersey

Circle 40 on literature card

THE SPRAY WITH THE PAY-OFF

IN BETTER,
 FASTER
 ELECTRICAL WORK

Goes on in seconds—
 dries in minutes!

**KRYLON...
 AMERICA'S NO. 1 SPRAY PAINT**



Circle 41 on literature card



When you use your CRT Commander, everyone wants to watch



Compact and only 7½ lbs, the CRT Commander has a built-in high impedance voltmeter (so you don't have to carry a VTVM). Price: \$89.95.

Sometimes that's the price you pay for using a professional-looking piece of equipment. And there's something about Amphenol's new tester-rejuvenator that attracts attention.

We think the CRT Commander deserves your attention, too. Here are three reasons why:

1. **It tests more tubes than other models.** The CRT Commander has 11 steps of filament voltage plus extra taps for future releases. There's not much chance of its becoming obsolete.
2. **It tests both b/w and color**—and does it the way NCTA recommends. Testing with the CRT Commander is fast and easy. Five permanently-fixed adaptors do the work of seven.
3. **If a tube will rejuvenate,** the CRT Commander will do it—even where others fail. As recommended, it treats each gun separately in color CRT.

Compare Amphenol's CRT Commander to any other tester-rejuvenator on the market. If you want more information, see your Amphenol salesman. Or write to Dan O'Connell, Market Manager for Service Products, 2875 South 25th Avenue, Broadview, Illinois 60153.



AMPHENOL

Circle 42 on literature card

NEW SAMS BOOKS

BRAND-NEW Enlarged 9th Edition
of the famous HOWARD W. SAMS

Tube Substitution Handbook

2-IN-1 PACKAGE!

One copy for your bench...
Compact copy for your caddy



Here's what you get in this great low-priced package: 1. Latest 9th edition handbook (5½ x 8½"), for bench use—lists 11,500 direct substitutions for all types of receiving and picture tubes. 7 sections: 1. Cross-reference of all American receiving types. 2. Picture tube substitutions. 3. Cross-reference of miniature tubes. 4. Industrial substitutes for receiver tubes. 5. Substitutions for communications and special-purpose tubes. 6, 7. Cross-reference of American and foreign tubes.

2. Caddy-size tube substitution guide—now contains all of the above 7 sections, making it an ideal handy reference for outside calls. Each handbook tells you when and how to make proper substitutions. Both handbooks in one vinyl-wrapped package. Order TUB-9P, both for only \$2.75. TUB-9, 5½ x 8½" handbook only \$1.50

ABC's of Antennas

by Allan Lytel. Covers basic theory of radio-wave transmission and reception, and fundamental antenna design principles. Describes basic antenna types, construction, uses, radiation characteristics. Includes antennas for business and amateur communications, microwaves, radio-navigation, etc. Invaluable for students, amateurs, and technicians. 96 pages; 5½ x 8½". Order AAL-1, only \$1.95

First-Class Radiotelephone License Handbook

by Edward M. Noll. Revised 2nd edition, completely updated to cover the latest revision of the FCC Commercial License Examination Element IV. Serves not only as an invaluable preparation for the exam, but is also a thorough textbook for broadcast engineer training. Subjects cover: Frequency assignments; duties and license requirements; broadcast microphones; record and tape machines; studio and control room facilities; remote facilities; a-m transmitters, antennas, lines; f-m transmitters; f-m stereo broadcasting; monitor and test equipment; proof of performance measurements. Invaluable appendices for permanent reference. 384 pages. 5½ x 8½". \$4.95. Order BON-2, only \$4.95

Color TV Trouble Clues, Vol. 2

by the PF Reporter Editorial Staff. Practical procedures for servicing color TV sets; all-new material; emphasis on late models. Describes typical color troubles and shows how experts troubleshoot and repair them. Clearly explains how to tackle each problem. A great aid for seasoned as well as new technicians. 128 pages. 5½ x 8½". \$1.95. Order COL-2, only \$1.95

Electronic Corrosion Control for Boats

by John D. Lenk. Invaluable for boat owners and marine technicians. Describes latest commercial systems designed to reduce and eliminate metal corrosion—a major problem in boat operation. Explains unwarranted causes of corrosion (improper wiring, poor bonding, bad paint, wrong metals), and how to remedy them. Includes data on impressed-current corrosion-control systems. 128 pages; 5½ x 8½". Order CCL-1, only \$1.95

Basic Piezoelectricity

by John Potter Shields. Covers theory and application of unusual metals that produce electricity when subjected to pressure. Describes both natural and synthetic materials and their properties. Discusses phono cartridges, sonar, ultrasonic cleaning, high-voltage power supplies, and ceramic filters. Includes 10 practical experiments. Many photos, schematics and drawings. 128 pages; 5½ x 8½". Order BPS-1, only \$2.50

HOWARD W. SAMS & CO., INC.

Order from your Sams Distributor today, or mail to Howard W. Sams & Co., Inc., Dept. PF-4, 4300 W. 62nd Street, Indianapolis, Ind. 46206

Send me the following books:

- TUB-9P AAL-1 COL-2 BPS-1
 TUB-9 BON-2 CCL-1

Send FREE Sams Booklist. \$ enclosed

Name _____

Address _____

City _____ State _____ Zip _____

My Distributor is _____

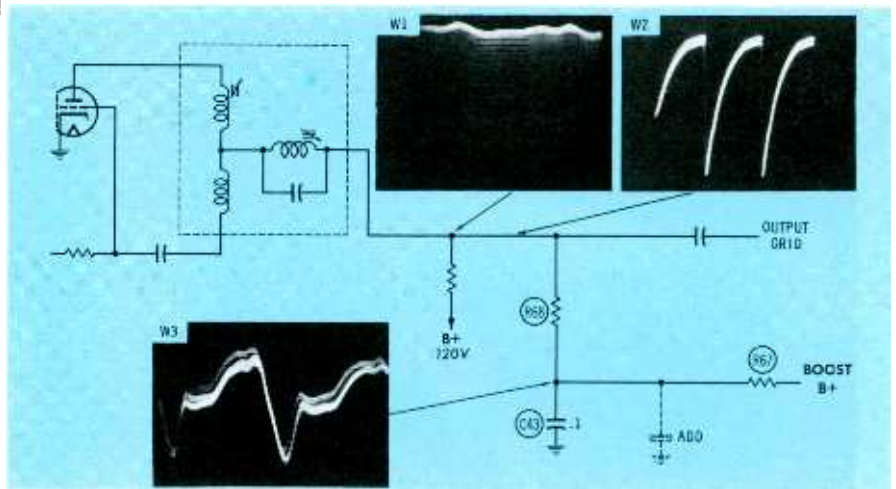


Fig. 13. Circuit of Emerson chassis.

sion of Synchroguide as the horizontal oscillator.

In receivers with this symptom, video and sync signals will be free of any ripple distortion. The ripple will show on the output of the horizontal oscillator if the waveform is scoped at ½ vertical frequency as in W1, of Fig. 13 or at ½ horizontal frequency as in W2. (In many cases of ripple tracing, the horizontal frequency waveform does not show a defect as clearly as W2.) Waveform W1 at the output of the horizontal oscillator indicates three possible trouble sources: The horizontal oscillator tube, the B+ line, or the boost voltage line. A scope trace of the boost voltage line, at the junction of R67, R68 and C43, will show excessive ripple (W3) that can be greatly attenuated by shunting C43 with a 4- or 5-mfd, 450-volt electrolytic. The extra filtering is highly effective in eliminating twist and cleaning up signal distortions.

Anode Voltage Filtering

Twist similar to that of the Emerson, having the same peculiarity of



Fig. 14. Twist due to ungrounded CRT.

being severe only at high contrast levels, will result from insufficient filtering on the high voltage applied to the picture tube anode. Soft focusing usually accompanies this twist, shown in Fig. 14. This is a typical case where the aquadag coating of a picture tube was not grounded.

Conclusion

Because there are many circuits where the trouble can originate, signal examination by scoping is probably the most efficient means of troubleshooting, using a stage-by-stage procedure, as follows:

- Step #1—Scope video output signal.
- Step #2—Scope all B+ lines. #1 and #2 can be reversed.
- Step #3—Scope sync input.
- Step #4—Scope sync output.
- Step #5—Scope sync signals to AFC.
- Step #6—Scope sample signal to AFC.
- Step #7—Scope AFC voltage at source and termination.
- Step #8—Scope horizontal oscillator output signal.
- Step #9—Scope boost line (if it feeds horizontal oscillator).
- Step #10—Check high voltage filtering by shunting or visual examination.

In scoping, use sweep at ½ of vertical frequency and look for ripple on signals, with the number of ripple peaks across entire trace being double the number of twists in the picture. A twist complaint is one of many in which a scope will justify its cost. ▲

Winegard's original BC-208 4-set Booster Coupler is now available in a 75-ohm model; the BC-475.

Producing a 75-ohm, 4-set booster coupler as good as the BC-208 wasn't easy. After all, the BC-208 was the first 300-ohm, 4-set booster coupler made. And it's still the best. It still out-performs and outsells anything like it on the market!

And so will the new BC-475!

Here's why: the new BC-475 is actually two products in one. It's a small system amplifier that will drive 2 to 8 sets for homes, apartments and store displays. And it's an amplified line splitter and extender for adding up to 16 trunk lines in large master antenna systems.

More reasons? The new BC-475 is coax; it provides a 6db gain to each of four

outputs instead of the usual 6db loss (for an overall gain of 12db. per output); it takes up to 400,000 microvolts of signal input (200,000 per band) without cross modulation; and it provides exceptionally high isolation to eliminate interaction between sets.

Sound expensive? How does only \$34.95 list sound for the best 75-ohm 4-set booster coupler made? A booster coupler that drastically reduces snow, picture smear, noise and interaction between TV sets (color and black & white). And does wonders for FM sets, too.

Better call your Winegard distributor or write for Fact Finder WBC-475 today!



Winegard antenna systems

WINEGARD CO. ■ 3000 KIRKWOOD ■ BURLINGTON, IOWA 52602

Circle 44 on literature card

CB Transceivers

(Continued from page 34)

battery arrangements. Facilities for using rechargeable batteries are popular. In one such unit, the base houses the rechargeable battery. This section is removable and has a built-in charger. The simple expedient of plugging it into a 110-volt AC receptacle recharges the battery. Thus it can be recharged overnight or whenever the unit is not in service.

The transmitter RF section of this unit is shown in Fig. 6. The

exciting signal is derived from the low-impedance secondary of the crystal-oscillator output transformer. The "Q" of the output resonant circuit is set reasonably high by providing a low-impedance tap that connects to the collector of the power-amplifier transistor. Inductor L10 serves as the loading coil for the short antenna. For highest possible power gain and maximum stability, the RF amplifier stage is neutralized. The neutralization component is derived from a low-impedance winding

coupled near the output tank circuit and fed back to the base circuit by way of capacitor C39.

Separate windings on the audio-output transformer modulate both the oscillator and the RF power amplifier supply voltages. The modulation is applied between the emitter-base circuit and ground. In effect it is again a form of collector modulation because the collector tank circuit is connected to ground (positive side of battery). The transmitter uses NPN transistors which, of course, must be operated with their collectors positive with respect to the base and emitter. Proper biasing is obtained by applying a negative DC voltage to the base-emitter circuit; thus the resonant tank circuits can be grounded.

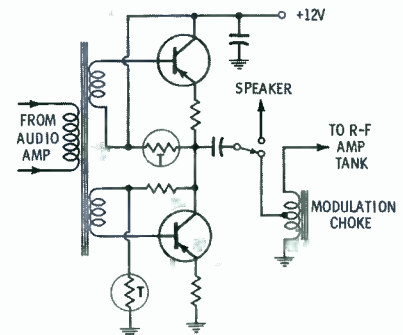


Fig. 7. Output transformerless circuit.

Transmit-receive switching of the audio output is also adaptable to the use of audio-output stages that do not employ an output transformer, Fig. 7. An input transformer provides the necessary push-pull drive for the audio power transistors. This is not the same as a complementary transistor connection because both transistors are PNP types. However, the collector current of one transistor rises as the collector current of the other falls and an additive output is developed between the junction of the two transistors and ground.

The output of the stage is capacitively coupled to the high-impedance loudspeaker on receive mode and to the modulation inductor for the transmit mode. The two transistors must be connected in series across the supply voltage; therefore, each transistor is operated with a collector voltage of 6 volts. Each transistor has an individual biasing divider including a thermistor. ▲



BRITEN UP YOUR DAY (AND HERS) WITH KINGS MEN AFTER SHAVE AND MEN'S COLOGNE

You get them FREE with Perma-Power Britener Packs—Masculine, refreshing, and luxurious Kings Men will brace your skin and your spirits! You'll see it at fine men's toiletry counters; but a generous bottle is Perma-Power's gift to you when you buy a convenient Vu-Brite or Tu-Brite pack. (Who says Christmas comes just once a year?)

VU-BRITES—Brighten TV pictures with the world's best-selling Britener! Your choice of Kings Men Cologne or After-Shave Free with either twelve-pack—series or parallel—at the special \$9.95 price.

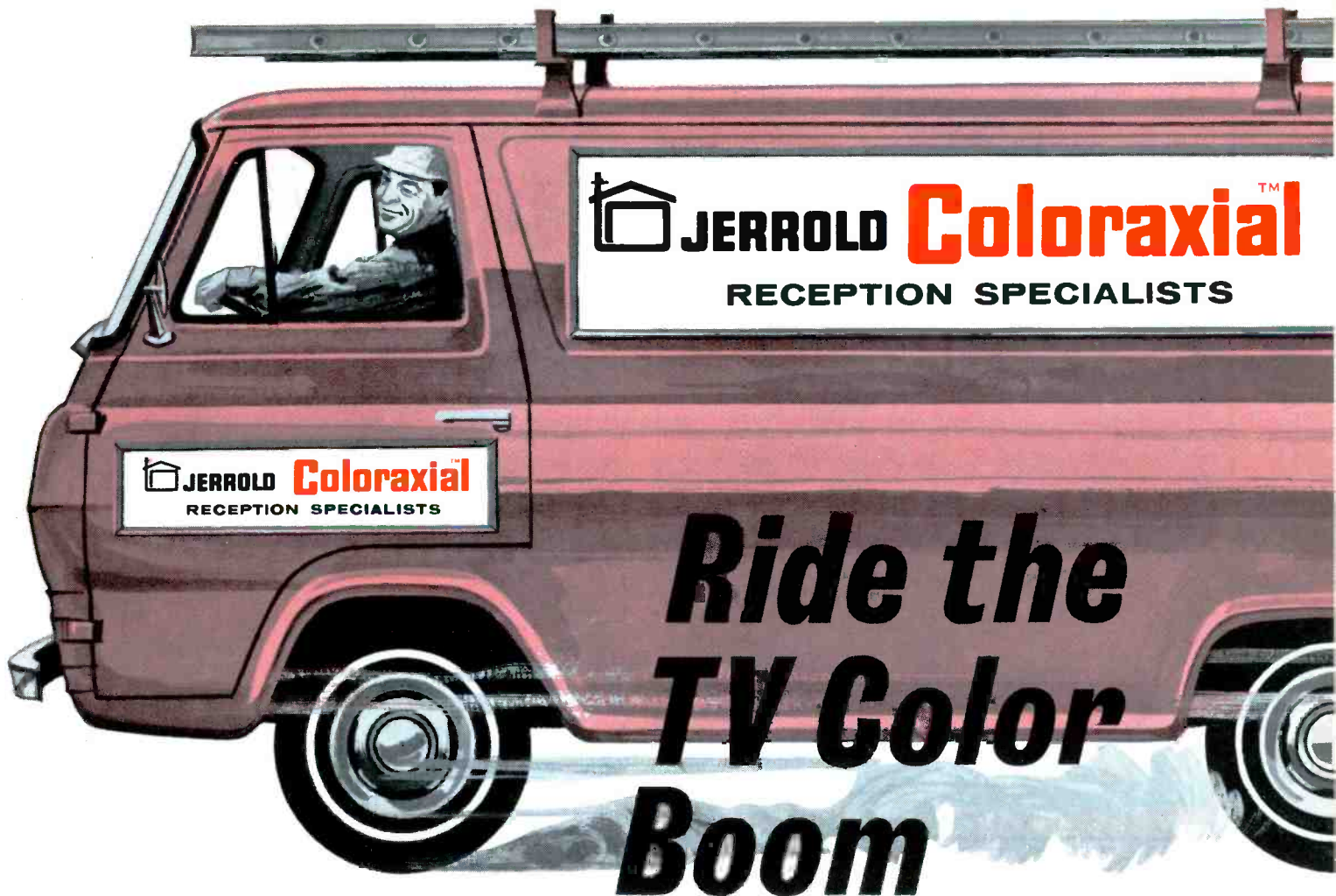
TU-BRITES—If the base is right, the boost is right... and you can be sure the price is right! 4 assorted Tu-Brites (usually \$2.25 each dealer net) for only \$8.95... plus the Kings Men as our gift!

PERMA-POWER COMPANY

5740 North Tripp Avenue • Chicago, Illinois 60646
Phone: (Area 312) 539-7171



Circle 45 on literature card



 **JERROLD Coloraxial™**
RECEPTION SPECIALISTS

 **JERROLD Coloraxial**
RECEPTION SPECIALISTS

*Ride the
TV Color
Boom*

ALL THE WAY TO THE BANK

with Jerrold's New Show 'n Sell Program

'65 was a banner year for antenna sales. In '66 you'll double and triple antenna profits—when you tie in with Jerrold's money-making Show 'n Sell program!

PROMOTION POWER! Jerrold furnishes everything you need to mass merchandise antenna systems. Eye-catching window and floor displays, antenna danglers and mast wrap arounds, knob danglers for TV sets, bulletin board displays, colorful banners, plus hard-selling door hangers to give you leads . . . arm patches and truck signs; window banners to identify you as an "Accredited Reception Specialist"—issued by the American Institute for Better Television Reception.

ADVERTISING! Jerrold's automatic co-op ad program means business. Sales-building ads are easily adapted to give you an individualized ad program that tells everyone to see you for expert antenna services.

HOW TO! Jerrold and your distributor will invite you to dramatic meetings to show you how to take advantage of the booming color TV, second set, UHF and FM stereo antenna markets. You ring up the profits.

SALES! Jerrold packages consumer-accepted antenna systems and reception aids that are right for the specific needs of your area. Consumer acceptance means high sales volume.

PROFITS! You'll profit as never before with Jerrold's Show 'n Sell program. Talk to your Jerrold Distributor fast—he'll show you how to set new profit records this spring.

JERROLD ELECTRONICS CORPORATION
Distributor Sales Division
401 Walnut St., Philadelphia, Pa. 19106

JERROLD

Circle 46 on literature card

April, 1966/PF REPORTER 69

Color Countermeasures

Symptoms and service tips from actual shop experience

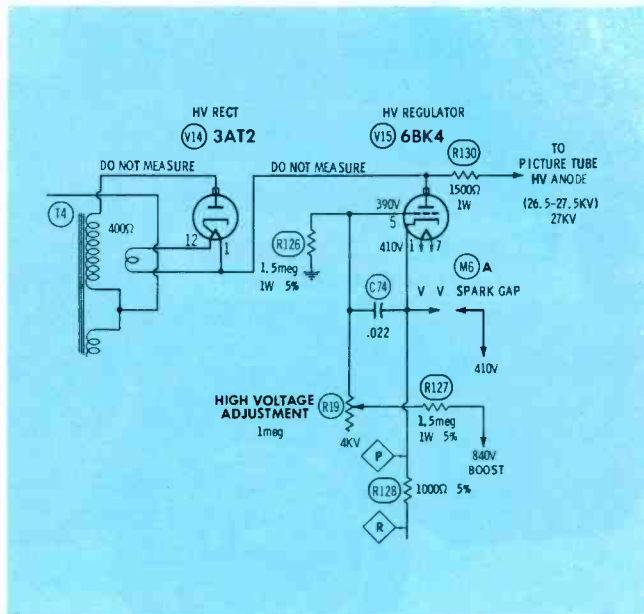
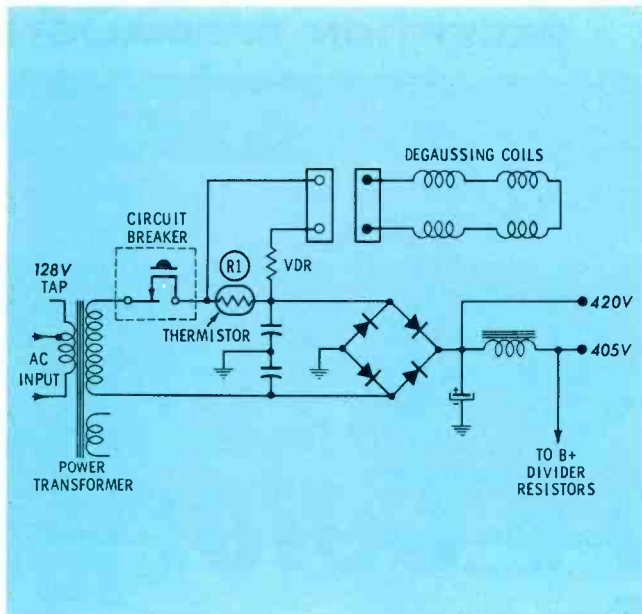
Chassis: Zenith (all chassis)
Symptom: Vertical jitter or loss of sync. Impurity at edges or center of raster. Condition may be intermittent.

Tip: Check automatic degaussing circuit by shorting thermistor. Replace bad thermistor and/or VDR. Complete information on ADG circuits can be found in Sept., 1965 PF REPORTER.

Chassis: Zenith (all chassis)

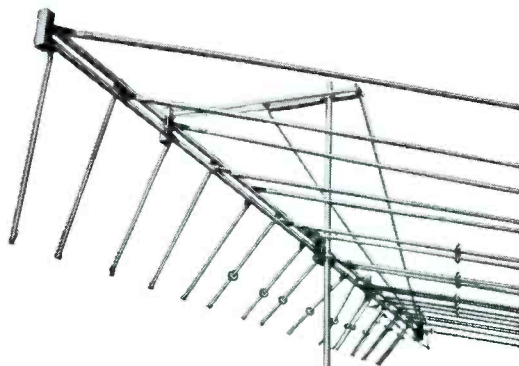
Symptom: Severe Barkhausen oscillations or snivets. Usual checks in horizontal output and damper stages fail to find trouble.

Tip: Check HV rectifier tube by replacement. Check anode resistor under HV rectifier socket for arcing.



ZENITH LOG PERIODIC ANTENNAS

offer high
signal gain and
ghost rejection



All-channel VHF/UHF/FM and FM Stereo

Developed by the University of Illinois antenna research laboratories, each Zenith log periodic antenna works like a powerful multi-element Yagi . . . not on just one or a few channels, but across the entire band it's designed for.

Order Zenith antennas and all genuine Zenith replacement parts and accessories from your Zenith distributor.

BUILT TO THE QUALITY STANDARDS OF ZENITH ORIGINAL PARTS

Also Zenith periodic antennas for

- UHF • VHF
- FM AND FM STEREO
- PLANAR HELICAL UHF

ZENITH

The quality goes in
before the name goes on

Circle 47 on literature card



you get

**full color TV
component
coverage
with Centralab's
quality products**



COLOR TV CONTROLS

Centralab has the exact replacement you need. Single controls, buzz controls, dual concentrics, and twins. With the Fastatch II® system, your Centralab distributors can supply any one of over 9 BILLION different exact replacement control combinations. That's coverage!



COLOR TV CAPACITORS

Centralab has them all: polystyrenes, low-voltage ceramics, trimmer ceramics and the new miniaturized electrolytics. Rely on us for the exact replacement—discs and tubulars, any standard voltage, any standard capacitance. That's coverage!



COLOR TV PACKAGED CIRCUITS

Centralab invented the packaged circuit . . . and has produced over 300,000,000 to date. We've got more exact replacements for color tv, with new ones being added regularly. That's coverage!



FOR COMPLETE COLOR TV COVERAGE . . .
WITH THE FINEST QUALITY REPLACEMENTS . . .
RELY ON YOUR CENTRALAB DISTRIBUTOR

Write for your free catalog to Distributor Products, Centralab, P.O. Box 591, Milwaukee, Wisconsin 53201.



Centralab

DIVISION OF GLOBE-UNION INC.

Join our profit-sharing plan for color TV repair.

Here's how the plan works. First, Sylvania advertises you in TV Guide as the right TV serviceman for color repair—Mister Right. We make you a big name in a booming business.



We have all kinds of tie-in display pieces.

We supply you with our color bright 85™ picture tube and color receiving tubes that you can push or ignore, since you're independent.

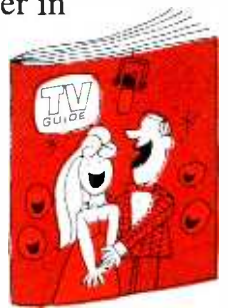
And the payoff: you get the profits from all the new color TV repair business we send you. We get more profit because we make more replacement parts. No one else offers



you a profit-sharing plan like this because no other major tube manufacturer deals exclusively with the

Independent Service Dealer.

In the Mister Right part of the plan, your Independent Sylvania Distributor puts your name, town and phone number in up to four TV Guide ads this year. You're listed right next to our big, full-color ads that talk about you.



He also gives you up to nine Mister Right display pieces. Free banners, displays to spark up your windows, decals and cards. And, an illuminated Color TV Service sign for a slight charge.



So join our profit-sharing plan. There'll be a lot to share. See your Independent Sylvania Distributor.

Sylvania Electronic Tube Division, Electronic Components Group, Seneca Falls, New York 13148.

SYLVANIA
SUBSIDIARY OF
GENERAL TELEPHONE & ELECTRONICS GTE

Circle 5 on literature card

STOCK GUIDE

FOR
TV
TUBES...

This list omits more than 100 of the rarest TV tube types, which many shops find impractical to stock. To simplify the chart as much as possible, common radio and hi-fi tube types used in TV combinations are omitted.

New tube types introduced this year are listed in the separate chart; to help you decide whether to stock these tubes, each listing specifies receivers using that particular type. If you're specializing in one or two brands, you'll pick new tubes listed for those sets and stock your shelves and caddy accordingly.

In the main chart, the figures under "Caddy Stock" suggest a stock of approximately 300 tubes (other than tubes for color sets) which should

account for close to 90% of your replacement needs. As with the rare-tube listings, you may want to carry more of a particular type if it is used in receivers you service often. We've removed some of the older types, such as 6V6, 6W4, and 6BZ7, and replaced them with more current types; also included are some that appeared in last year's new-tube list—if they were used in sets again this year. Most used UHF tubes are also included. Tubes marked with an asterisk (*) are used also in color sets.

The figures under "Shelf Stock" are a suggested backup stock, if you're located near a parts distributor. If you can replenish your tube supply only once a week, you may wish to stock extra of the more common types.

Your volume of business will naturally determine your actual shelf stock, too. Keep in mind three main factors that will influence the demand for various tubes:

1. Relatively high failure rate of power-output and similar tubes.
2. Your specialization in certain makes of sets.
3. Average age of sets containing a particular tube type.

Temporary substitution of available types for rare types, as outlined in the Howard W. Sams book, *Tube Substitution Handbook, Vol. 9*, can also help you reduce stock requirements.

Another way to ease tube-stock headaches is to use only the latest -A or -B versions of various tubes. Types in common use are listed in the chart.

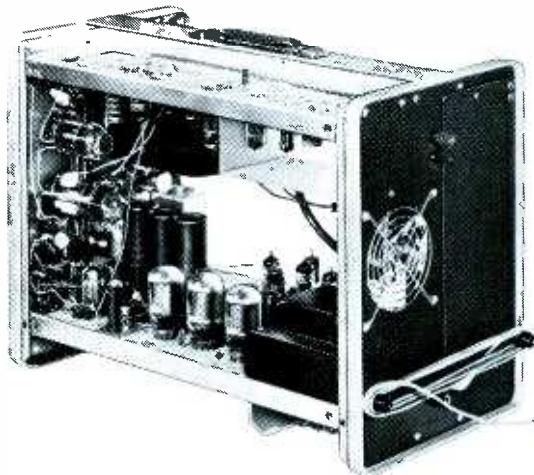
TUBE TYPE	SHELF STOCK	CADDY STOCK	TUBE TYPE	SHELF STOCK	CADDY STOCK	TUBE TYPE	SHELF STOCK	CADDY STOCK
1AD2	1	1	3HM6	1	1	6AF4B*	2	1
1AU2*	1	1	3HT6	1	1	6AF11	1	1
1B3GT	5	2	4AU6	1	1	6AG5	1	1
1G3GT	4	2	4BL8*	1	1	6AG7*	1	1
1J3	2	1	4BQ7	1	1	6AH5	2	1
1K3	4	2	4BU8	1	1	6AH6	1	1
1N2	1	1	4BZ6	4	2	6AK5	1	1
1S2A	1	1	4CB6	1	1	6AL3	1	1
1V2*	2	1	4CS6	1	1	6AL5*	2	1
1X2B*	3	1	4DK6	2	1	6AL11*	1	1
2AF4	1	1	4DT6	2	1	6AM8A	2	1
2AH2	1	1	4EH7	2	1	6AN8*	1	1
2AS2	1	1	4EJ7	2	1	6AQ5A*	4	2
2CW4	1	1	4GK5	1	1	6AR11	1	1
2CY5	1	1	4GM6	1	1	6AS5	1	1
2DS4	1	1	4GZ5	1	1	6AS8	1	1
2DZ4	1	1	4HA5*	1	1	6AU4GTA*	2	1
2FH5	1	1	4HM6	1	1	6AU6A*	4	2
2FS5	1	1	4HS8	1	1	6AU8A*	1	1
2GK5	2	1	4HT6	1	1	6AV6*	2	1
2GU5	1	1	4JC6	1	1	6AW8A*	3	1
2GW5	1	1	4JD6	1	1	6AX3	1	1
3A3*	1	2	4KN8	1	1	6AX4GTB	3	2
3AF4	1	1	5AM8	1	1	6AY3	4	2
3AJ6	1	1	5AQ5	2	1	6AZ8*	1	1
3AL5	1	1	5AT8	1	1	6B10	1	1
3AT2*	2	2	5AU4	1	1	6BA6	3	1
3AU6	2	1	5BC3	1	1	6BA11*	1	1
3AW3	1	1	5BR8	1	1	6BC8*	1	1
3BN6	2	1	5CG8	3	2	6BD11	1	1
3BU8	1	1	5CL8A	1	1	6BE3*	2	2
3CB6	2	1	5DJ4	1	1	6BE6	1	1
3CS6	1	1	5EA8	1	1	6BF11	1	1
3CY5	1	1	5EW6	1	1	6BG6GA	1	1
3DG4*	2	1	5FG7	2	1	6BH8	1	1
3DK6	2	1	5GH8	1	1	6BH11*	1	1
3DT6A*	1	1	5GM6	1	1	6BJ3	2	1
3DZ4	1	1	5HG8	1	1	6BJ8	1	1
3EH7	1	1	5JV8	1	1	6BK4A*	2	2
3EJ7	1	1	5KD8	1	1	6BK7B	1	1
3FS5	1	1	5KE8	1	1	6BL7GT	1	1
3GK5	4	2	5U4GB*	7	3	6BL8*	2	2
3GS8	1	1	5U8	2	1	6BM8A	1	1
3HA5	1	1	5V3	1	1	6BN4	1	1
3HG8	1	1	6AC7	1	1	6BN6*	3	1
			6AF3	1	1			

TUBE TYPE	SHELF STOCK	CADDY STOCK	TUBE TYPE	SHELF STOCK	CADDY STOCK	TUBE TYPE	SHELF STOCK	CADDY STOCK
6BN8*	1	1	6GW8	2	1	10JY8	1	1
6BQ5*	4	2	6GX6*	2	1	10KU8	1	1
6BQ6GTB	5	3	6GY5	1	1	11AR11	1	1
6BQ7A*	2	1	6GY6*	2	1	11JE8	1	1
6BR8A	1	1	6GZ5	1	1	11KV8	1	1
6BU8A	3	2	6HA5*	2	1	12AF3	2	1
6BX7GT	1	1	6HA6	1	1	12AL11	1	1
6BY6*	1	1	6HB5	2	1	12AT7*	1	1
6BY8	1	1	6HB6*	2	1	12AU7	1	1
6BZ6*	10	5	6HD5	1	1	12AV5GA	1	1
6C4*	1	1	6HE5*	3	1	12AX4GTB	2	1
6CB5*	1	1	6HF5*	3	1	12AX7*	2	1
6CB6A*	3	3	6HF8	1	1	12AY3	1	1
6CD6GA	2	2	6HG5	1	1	12AZ7A*	1	1
6CG7*	6	2	6HG8	1	1	12B4A	2	1
6CG8A*	7	3	6HJ8	2	1	12BE3	1	1
6CL6*	1	1	6HK5	1	1	12BH7A*	2	1
6CL8A	1	1	6HL8*	1	1	12BQ6GTB	2	1
6CM7	2	1	6HS8*	3	1	12BY7A*	2	1
6CN7*	1	1	6HZ6*	2	1	12C5/-CU5	2	1
6CQ8*	1	1	6HZ8	1	1	12CA5	2	1
6CS6*	2	1	6J6	1	1	12DB5	1	1
6CU5	2	1	6JB6	2	1	12DQ6B	3	2
6CW4*	1	1	6JC6*	2	1	12DT5	1	1
6CW5*	2	1	6JC8	1	1	12FX5	1	1
6CX8	1	1	6JE6*	4	2	12GC6*	1	1
6CY5	1	1	6JE8	1	1	12GN7A*	1	1
6DA4	1	1	6JH6*	3	1	12GT5	1	1
6DE4	2	1	6JH8*	3	1	12GW6	2	1
6DE6*	2	1	6JN8	1	1	12SN7GTA	1	1
6DE7	2	1	6JT8*	1	1	12W6GT	1	1
6DK6*	2	1	6JU8A*	3	1	13CM5	1	1
6DM4	3	2	6JV8	2	1	13DE7	1	1
6DN7	1	1	6JZ8	1	1	13DR7	1	1
6DQ5*	2	1	6K6GT	1	1	13EM7	2	1
6DQ6B*	5	3	6KA8*	1	1	13FD7	1	1
6DR7	1	1	6KD8	2	1	13GB5	2	1
6DS4*	2	1	6KT8*	1	1	13GF7A	2	1
6DT5	1	1	6KU8	1	1	13J10	1	1
6DT6A*	3	2	6KZ8*	1	1	15BD11	1	1
6DV4*	1	1	6Q11 (6K11)	1	1	15CW5*	2	1
6DW4B*	2	1	6RK19	1	1	15DQ8*	1	1
6DX8*	1	1	6S4A	1	1	15HB6*	2	1
6DZ4	1	1	6SL7GT	1	1	15KY8	2	1
6EA8*	4	2	6SN7GTB*	2	1	15LE8*	1	1
6EB8	2	1	6T8*	1	1	16A8*	1	1
6EH7*	5	3	6U8A*	1	1	16AQ3	1	1
6EH8	3	2	6U10*	1	1	16GK6	1	1
6EJ7*	5	3	6X8A*	2	2	17AX4GT	1	1
6EM5	1	1	7AU7	1	1	17AY3	4	2
6EM7*	2	2	7GU7*	1	1	17BE3	1	1
6ER5	1	1	7GV7	1	1	17BF11	1	1
6ER7	1	1	8AW8A	2	1	17BS3A	2	1
6ES8	1	1	8B8	1	1	17C5	1	1
6EV7*	1	1	8B10	1	1	17DE4	1	1
6EW6*	3	2	8BE8	1	1	17DM4A	1	1
6EW7	2	2	8BQ5	2	1	17DQ6B	2	1
6EZ5*	1	1	8CG7	1	1	17GJ5	2	1
6FD7	1	1	8CW5	1	1	17GV5	1	1
6FG7*	2	1	8CW8	1	1	17JB6A	1	1
6FH5*	1	1	8CX8	1	1	17JZ8	3	2
6FM7*	2	1	8DX8	1	1	19AU4GTA*	1	1
6FQ7*	7	3	8EB8	1	1	21GY5	2	1
6FS5	1	1	8EM5	1	1	21HJ5	1	1
6FV8	1	1	8ET7	1	1	22BH3	2	1
6FY5	1	1	8FQ7	4	3	22DE4	1	1
6FY7	1	1	8GJ7	1	1	22JG6A	2	1
6GB5	1	1	8GN8	1	1	25AX4GT	1	1
6GC5*	1	1	8JV8	2	1	25BQ6GTB	1	1
6GE5	2	1	8JZ8	1	1	25CD6GB	1	1
6GF7*	4	2	8KA8	1	1	33GT7	1	1
6GH8A*	6	3	9A8	1	1	33GY7	2	2
6GJ5	1	1	9AU7	1	1	50C5	2	1
6GJ7*	2	1	9GV8	1	1			
6GK5*	3	1	10AL11	1	1			
6GK6*	1	1	10CW5	1	1			
6GL7*	1	1	10DE7	2	1			
6GM6*	5	2	10DX8	1	1			
6GN8	2	1	10EG7	1	1			
6GT5	1	1	10EM7	1	1			
6GU5	1	1	10EW7	1	1			
6GU7*	4	2	10GK6	1	1			
6GV5	2	1	10HF8	1	1			
6GW6	1	1	10JA8	1	1			

NEW TUBE TYPES INTRODUCED IN '65 TV.

1AY2	Admiral
	Philco
	Sony
5GJ7	Sylvania
5GS7	Delmonico
5JK6	Motorola
6BN11*	Admiral
6BS3A	Coronado
	Truetone

New Professional DC 'Scope Heathkit® IO-14



Kit **\$299**
 Factory Assembled **\$399**



Eighteen Years Ago Heath Broke The Price Barrier On Oscilloscopes With A Low-Cost Scope For Hams, Hobbyists, And Service Technicians. Now Heath Breaks The Price Barrier Again! . . . With A Precision, Fast-Response, Triggered Sweep, Delay Line Oscilloscope For The Serious Experimenter, Industrial Or Academic Laboratory, And Medical Or Physiology Research Laboratory.

- A high stability 5" DC oscilloscope with triggered sweep • DC to 8 mc bandwidth and 40 nanosecond rise time • Vertical signal delay through high linearity delay lines—capable of faithful reproduction of signal waveforms far beyond the bandwidth of the additional circuitry • Calibrated vertical attenuation—from 0.05 v/cm to 600 volts P-P maximum input • Calibrated time base • 5X sweep magnifier • Forced air cooling • Input for Z axis modulation • Input for direct access to vertical deflection plates • Easy circuit-board construction & wiring harness assembly • Components are packaged separately for each phase of construction • Easy to align • Fulfills many production and laboratory requirements at far less cost than comparable equipment—particularly scopes capable of fast-rise waveform analysis • No special order for export version required—wiring options enable 115/230 volt, 50-60 cycle operation

Here Is A Truly Sophisticated Instrument . . . designed with modern circuitry, engineered with high quality, precision-tolerance components, and capable of satisfying the most critical demands for performance. The IO-14 features precision delay-line circuitry to allow the horizontal sweep to trigger "ahead" of the incoming vertical signal. This allows the leading edge of the signal waveform to be accurately displayed after the sweep is initiated.

The IO-14 Provides Features You Expect Only In High Priced Oscilloscopes. For example, switches are quality, ball-detent type; all major control potentiometers are precision, high-quality sealed components; all critical resistors are 1% precision; and circuit boards are low-loss fiber glass laminate. The IO-14's cabinet is heavy gauge aluminum. Its CR tube is shielded against stray magnetic fields, and forced air ventilation allows the IO-14 to be operated under the continuous demands of industrial and laboratory use.

Kit IO-14, 45 lbs. \$299.00
 Assembled IO-14, 45 lbs. \$399.00

IO-14 SPECIFICATIONS—(Vertical) Sensitivity: 0.05 v/cm AC or DC. Frequency response: DC to 5 mc, -1 db or less; DC to 8 mc, -3 db or less. Rise time: 40 nsec (0.04 microseconds) or less. Input impedance: 1 megohm shunted by 15 uuf. Signal delay: 0.25 microsecond. Attenuator: 9-position, compensated, calibrated in 1, 2, 5 sequence from 0.05 v/cm. Accuracy: ±3% on each step with continuously variable control (uncalibrated) between each step. Maximum input voltage: 600 volts peak-to-peak; 120 volts provides full 6 cm pattern in least sensitive position. (Horizontal) Time base: Triggered with 18 calibrated rates in 1, 2, 5 sequence from 0.5 sec/cm to 1 microsecond/cm with ±3% accuracy or continuously variable control position (uncalibrated). Sweep magnifier: X5, so that fastest sweep rate becomes 0.2 microsecond/cm with magnifier on. (Overall time base accuracy ±5% when magnifier is on.) Triggering capability: Internal, external, or line signals may be switch selected. Switch selection of + or - slope. Variable control on slope level. Either AC or DC coupling. "Auto" position. Triggering requirements: Internal; 1/5 cm to 6 cm display. External: 0.5 volts to 120 volts peak-to-peak. Horizontal input: 1.0 v/cm sensitivity (uncalibrated) continuous gain control. Bandwidth: DC to 200 kc ±3 db. General 5ADP31 or 5ADP2 Flat Face C.R.T. interchangeable with any 5AD or 5AB series tube for different phosphor characteristics. 4250 V. accelerating potential. 6 x 10 cm edge lighted graticule with 1 cm major divisions & 2 mm minor divisions. Power supply: All voltages electronically regulated over range of 105-125 VAC or 210-250 VAC 50/60 cycle input. (Z Axis) Input provided. DC coupled CRT unblanking for complete retrace suppression. Power requirements: 285 watts, 115 or 230 VAC 50-60 cps. Cabinet dimensions: 15" H x 10 1/2" W x 22" D includes clearance for handle and knobs. Net weight: 40 lbs.

FREE! 1966 Heathkit Catalog



108 pages . . . many in full color . . . describe over 250 Heathkits for the lab, hobbyist, and industry.

Heath Company, Dept. 25-4
 Benton Harbor, Michigan 49022

Enclosed is \$ _____, plus shipping for model (s) _____
 Please send FREE Heathkit Catalog & full IO-14 specifications.

Name _____

Address _____

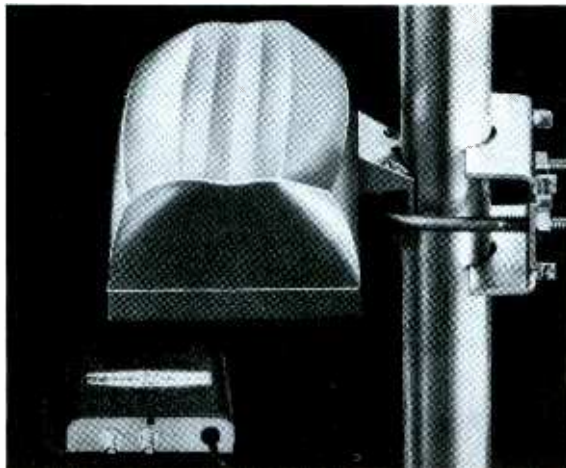
City _____ State _____ Zip _____

Prices & specifications subject to change without notice.

TE-142



“What our business needs is a good UHF VHF amplifier.” “What our business needs is a good UHF-VHF amplifier.” “What our bu..”



“Say no more.”

“You mean there’s an amplifier that covers all TV channels from 2 to 83?”

“You bet. In fact there are two—the outdoor U/Vamp-2 and the indoor V/U-ALL2.”

“Suppose I live in an area where there’s only VHF?”

“Your motto should be ‘Be Prepared’ because there are a lot of new UHF stations soon to come on the air. These all-channel amplifiers are obsolescence-proof.”

“Anything I should know about the U/Vamp-2?”

“Well, the U/Vamp-2 is compact and easy to install on the antenna mast. Has a remote AC power supply.”

“How about performance?”

“Two transistors give you all the power you need for better reception on VHF and UHF. Also protect against overload. Lists for \$49.95.”

“Supposing I don’t want to put an amplifier up on my antenna mast?”

“Then use the V/U-ALL2. Not as effective as the U/Vamp-2, but you don’t have to climb a ladder . . . and it delivers signals to two TV sets. Only \$42.50 list.”

“Guess I’ll rush down and get one of the new Blonder-Tongue UHF/VHF amplifiers.”

(This message was paid for out of the gross profits of
BLONDER-TONGUE, 9 Alling St., Newark 2, N.J.)

Circle 50 on literature card

- | | |
|---------|------------------|
| 6CD3 | Admiral |
| 6GV8 | Setchell Carlson |
| 6GX7 | Coronado |
| | Electrohome |
| | Packard-Bell |
| | Setchell Carlson |
| | Sylvania |
| | Truetone |
| 6J10* | Zenith |
| 6JD6 | Coronado |
| | Truetone |
| 6JG6A | Coronado |
| | Curtis Mathes |
| | Setchell Carlson |
| | Truetone |
| 6JS6* | Sylvania |
| | Zenith |
| 6JT6A* | Packard-Bell |
| 6JW8* | Admiral |
| 6KR9 | Philco |
| 6KV8 | Curtis Mathes |
| 6KY8 | Magnavox |
| 6LE8* | Admiral |
| 6LM8* | Admiral |
| 6LN8 | Delmonico |
| | Dumont |
| | Emerson |
| | Motorola |
| | Zenith |
| 6LV8* | Admiral |
| 6LX8 | Dumont |
| 6R-P22* | Silvertone |
| 6T10 | GE |
| 6X9* | Admiral |
| 6Y9* | Admiral |
| | Clairtone |
| 6Y10* | Admiral |
| 8AV11 | Bradford |
| 8BM11 | Admiral |
| 10EB8 | Airline |
| 10GN8 | Magnavox |
| | Westinghouse |
| | Zenith |
| 10LW8 | Admiral |
| 11LQ8 | RCA |
| 11Y9 | Admiral |
| | Delmonico |
| 12BR3 | Channel Master |
| | Olympic |
| 12HE7 | Muntz |
| 12JT6A | Penncrest |
| | Airline |
| | Silvertone |
| 15EW7 | Silvertone |
| 16GY5 | Emerson |
| 16KA6 | Emerson |
| 17A8 | Arvin |
| | Panasonic |
| | Philco |
| 17BL3 | Firestone |
| 17BR3 | Silvertone |
| 17GT5 | Silvertone |
| 17JN6 | Zenith |
| 17JT6A | Bradford |
| | Truetone |
| 17JV8 | Admiral |
| 17X10 | Zenith |
| 18GB5 | Airline |
| | Magnavox |
| 20AQ3 | Dumont |
| 21KA6 | Dumont |
| 21LR8 | Silvertone |
| 22JF6 | RCA |
| | Silvertone |
| 22JU6 | RCA |
| 34R3 | Arvin |
| | Panasonic |
| | Philco |
| 50JY6 | Arvin |
| | Panasonic |
| | Philco |




Why are RCA
solid copper
circuits
built to take
a beating?



**For fewer service headaches
--Space Age dependability.**

**RCA SOLID
COPPER CIRCUITS**

They won't come loose. Won't short circuit. Won't go haywire. That's why they're the circuits of the Space Age.  The Most Trusted Name in Electronics



add an fm-stereo service center
with this one new
sencore unit!



THE SENCORE MX129 FM STEREO MULTIPLEX GENERATOR & ANALYZER

FM-Stereo growth continues to mount and is fast becoming as big a field as Color TV. This means more FM-Stereo service business for you, now and in the future. Is your shop equipped? It can be — completely and economically — with the MX129, the FM-Stereo "Service Center in a Case." The instantly stable, 19-Transistor, crystal controlled MX129 is the most versatile, most portable (only 7½ pounds), most trouble free and efficient multiplex unit on the market — just like having your own FM-Stereo transmitter on your bench or in your truck. Powered by 115 volts AC, it produces all signals for trouble shooting and aligning the stereo section of the FM receiver . . . can be used to demonstrate stereo FM when no programs are being broadcast. Self-contained meter, calibrated in peak to peak volts and DB, is used to accurately set all MX129 controls and as an external meter to measure channel separator at the FM-Stereo speakers. **NO OTHER EQUIPMENT IS REQUIRED.** only **\$169⁵⁰**

SIGNALS AVAILABLE FOR ALIGNMENT, TROUBLE SHOOTING AND ANALYZING:

- FM-RF carrier with composite multiplex audio signal with 38kc suppressed carrier, 19kc pilot and 67kc SCS signals
- Multiplex signal formed by 60 or 1000 cycle internal tones or any external signal
- Full control over left and right channel amplitude (modulation)
- External 67kc SCA signal available for trap adjustment
- Composite signals available for signal injection FM detector

professional quality — that's the difference!

SENCORE

426 SOUTH WESTGATE DRIVE • ADDISON, ILLINOIS
Circle 53 on literature card



The Troubleshooter

answers your servicing problems

Lost-Sync Pulse

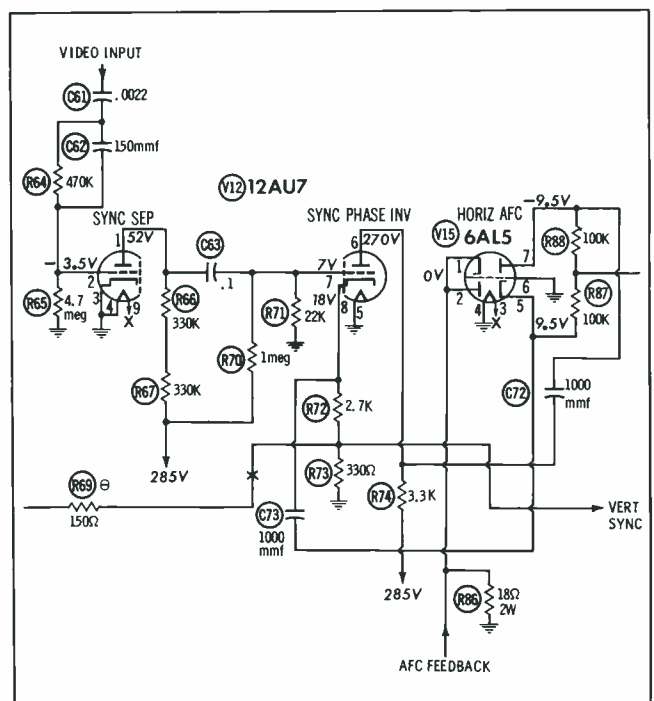
I am having trouble with a Magnavox TV, Chassis CMUS435AA, (covered in PHOTOFACT Folder 278-5). The picture rolls vertically; the set will sync horizontally but has a tendency to pull. I feel sure the trouble is in the sync-separator stage, but I haven't been able to locate the exact component.

I have checked or changed practically all the resistors and capacitors in the sync stages. My scope shows the waveform is present on the grid (pin 2) of the sync separator, but it is missing on the plate of this same tube. There is no signal present on the grid of the phase inverter. The pulse is present on pin 1 of the horizontal-AFC tube. All the DC voltages are normal with the exception of the grid and plate of the sync separator. The plate voltage measures 150 volts (normal is 52) and the grid shows -40 volts (normal is -3.5). Can you tell me what is causing these increased voltages?

RAY CORE

Baton Rouge, La.

The key to your trouble is the negative 40 volts on the grid of the sync-separator tube. The voltages on all PHOTOFACT Folders are taken without signal present; the -3.5 volts shown on the schematic will increase when the re-



Courier gives you the most powerful sales-clincher in the CB business:

a 10 year factory guarantee!

Nothing's more potent in closing a sale than a strong guarantee by the manufacturer. And now Courier gives you the strongest guarantee in the CB world: 10 full years on every solid-state Courier TR-23S! Complete with microphone and a long list of attractive features.

Even without its ten year guarantee, Courier's unprecedented low prices would be enough to ring the


Anvil Chorus on the cash register. But Courier goes even farther—with limited dealerships to protect your mark-up. Courier's CB line is no football.

So if you're interested in a CB line with profit, with a sales-clinching manufacturer's guarantee, quality and features, find out about a Courier CB dealership. Fill in and mail the coupon. It may be the best thing you've ever done with a five-cent stamp.



23 channels
COURIER TR-23S
\$169

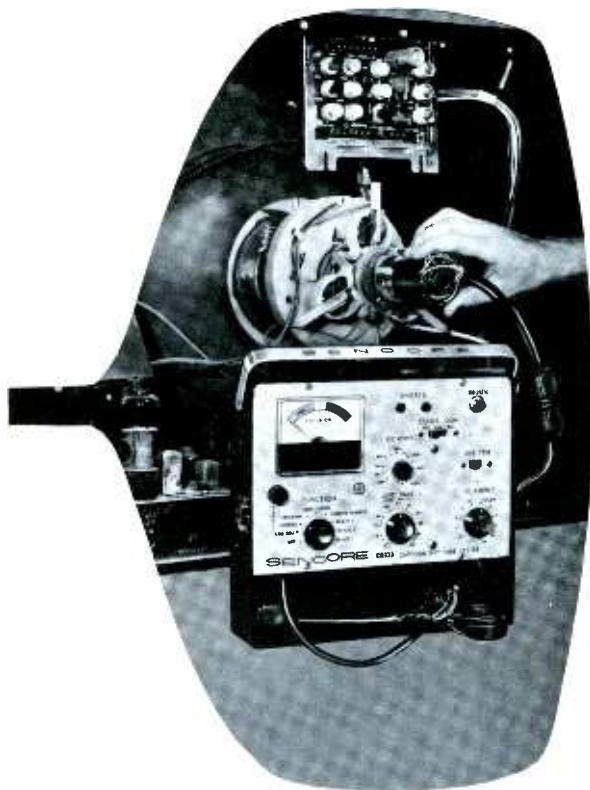
PF-64


E.C.I. electronics communications inc.
56 Hamilton Avenue, White Plains, N.Y.

Yes! I'd like to know more about Courier's transistorized CB line with the 10 year guarantee, and dealership opportunities.

Name _____
Firm _____
Address _____
City _____ County _____ State _____

**top money maker in
the service business**



NEW IMPROVED SENCORE CR133 CRT CHECKER & REJUVENATOR

The new, improved CR133 CRT Checker is designed to test all present picture tubes — and it's ready for future tubes too! Two plug-in replaceable cables contain all sockets required. The compact, 10 lb., CR133 checks CRT emission, inter-element shorts, control grid cut-off capabilities, gas and expected life. Checks all tubes: conventional B&W, new low drive B&W, round color tubes and new rectangular color picture tubes. Exclusive variable G2 Volts from 25 to 325 Volts insures non-obsolescence when testing newly announced "semi-low" G2 CRT tubes. New Line Voltage Adjustment insures the most accurate tests possible. Uses well-filtered DC for all checks to avoid tube damage and reading errors. Color guns are individually tested as recommended by manufacturers. Exclusive automatically controlled rejuvenator applies rejuvenation (ACR) voltage as required by individual tube condition; precisely timed to prevent over-rejuvenation or tube damage. The ACR feature is most useful for color tube current equalization to insure proper tracking. Hand-wired and steel-encased for protection of meter and panel in truck or shop, the new improved CR133 is only . . . **\$89⁹⁵**

The famous CR128 CRT Checker and Rejuvenator is similar to above, but with a three position G2 slide switch and without Line Voltage Adjustment at \$69.95

professional quality — that's the difference!

SENCORE

426 SOUTH WESTGATE DRIVE • ADDISON, ILLINOIS
Circle 55 on literature card

ceiver is tuned to a station. However, the -40 volts is definitely excessive—with signal the normal voltage would be -10 or -15 .

Since there isn't a negative voltage supply in the receiver, the increased negative voltage is probably being caused by oscillation in the video-IF stages. Check the waveform at the input to the video detector; if the IF stages are oscillating, this waveform will be abnormal. This oscillation can also be detected by a greatly increased negative voltage on the AGC line.

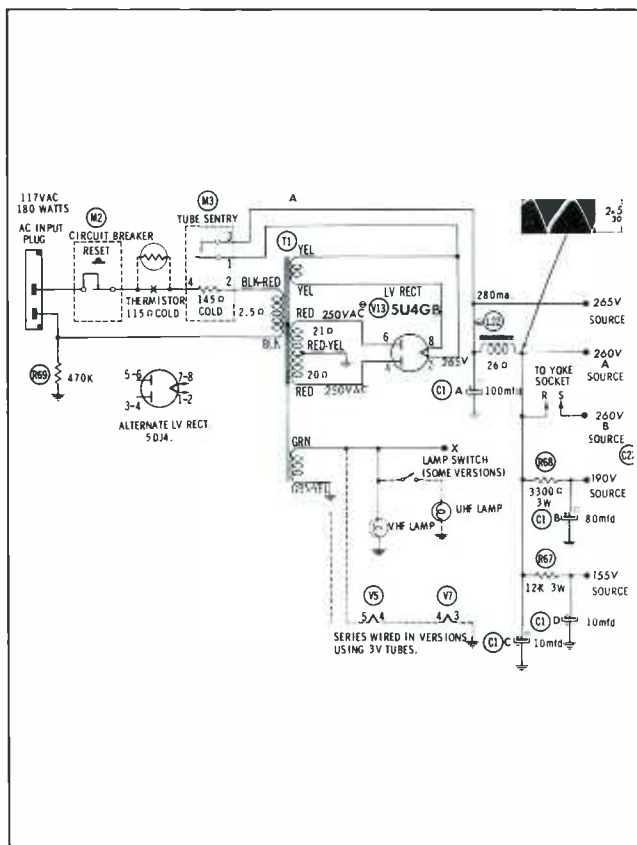
If the trouble isn't in the IF stages, try replacing sync coupling capacitors, C61 and C62.

Low Voltage Overload

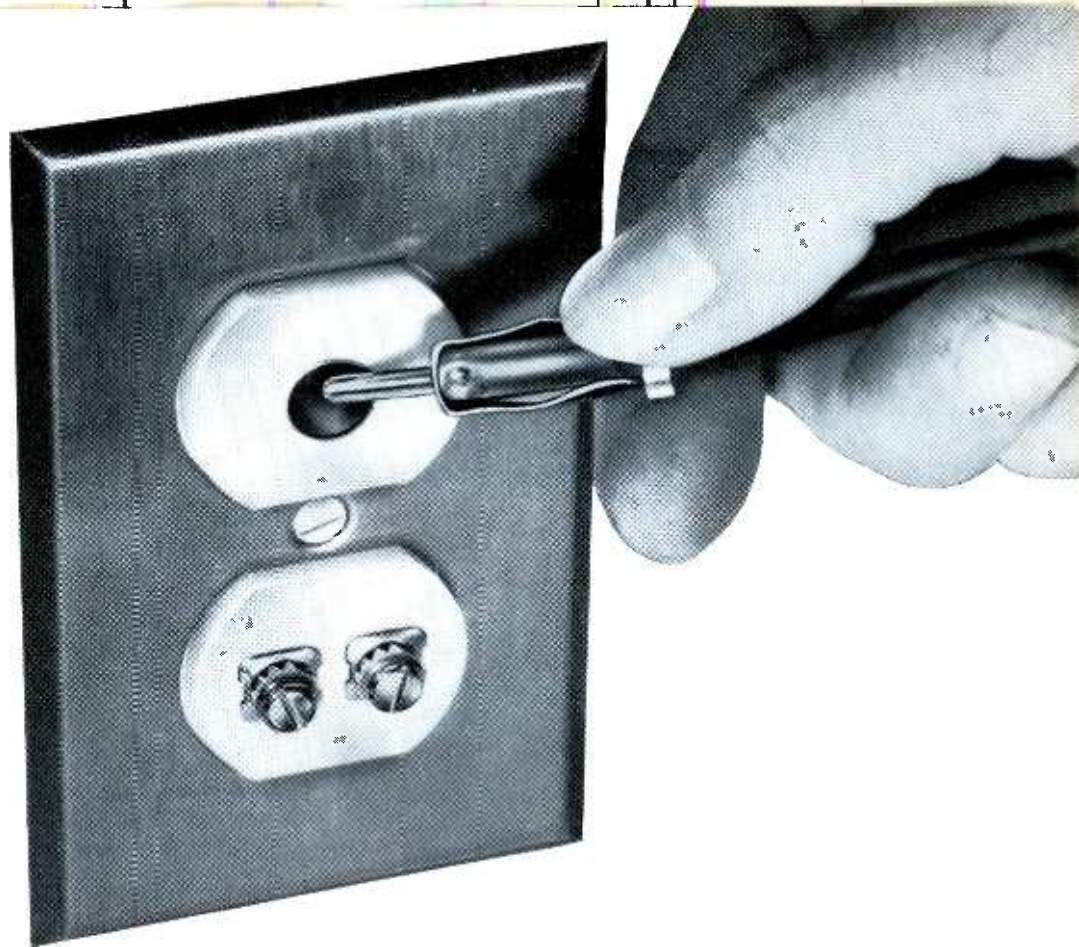
I am having a power supply problem with a Motorola 579 series chassis. Sometimes the circuit breaker opens immediately after the set is turned on and at other times the set will operate for up to an hour before the circuit breaker opens. I have replaced the circuit breaker, power tubes and checked all filter capacitors in the power supply by substitution. I've also checked all of the B+ circuits and associated capacitors for shorts, but found nothing. The B+ voltages are all normal, with the exception of the 155 volt source which measures 125 volts. When the low voltage is disconnected at the filter choke the circuit breaker remains closed; however, as soon as the 260 volt B+ is applied to the set, the circuit breaker opens. When the circuit breaker does remain closed long enough to produce a picture, it is perfect with no distortion of any kind.

JOE MARCINIAK

Minneapolis, Minn.



From all indications, the cause of the trouble is probably in a circuit or stage fed by the 260 volt source. As shown in the schematic, the 260 volt output is divided into two sources, "A" and "B". The "B" source is fed through the yoke socket to the screen of the horizontal output plate of the damper, vertical-output screen and high-voltage circuit.



The most important connection you can make for FULL PROFITS from FULL-HOUSE TV!

The demand for multiple outlet, Master Antenna TV installations has entered a totally new phase ...one which goes far beyond the already big market for commercial applications and reaches to millions of newly created multiple set homes.

Color TV...as well as increasing FM multiplex popularity is the big reason why. Every homeowner who buys a color set instantly becomes a prospect for a residential MATV installation to operate two, three, or more receivers with maximum quality reception from one antenna.

New Channel Master mass production techniques on the same precision-quality, commercial-grade MATV components designed for big building applications have resulted in equipment price reductions that average 25% and more per installation. For MATV installing companies

this means more volume and profit from highly competitive commercial jobs. For radio-TV service dealers it means an opportunity to get started in a totally new, high-income business meeting the booming demand for residential master antenna systems. The market is here now. And, it represents business that only you...a qualified service technician...can get.

NEW . . . for the age of COLOR

Channel Master announces a new 15 db commercial-grade amplifier, Model 7035, with dual 75 or 300 ohm inputs and outputs that make it ideal for private home MATV systems.

Call your distributor or write Channel Master for details.

IMPORTANT . . .Contact your Channel Master distributor now for details on a complete MATV system design and installation course.

CHANNEL MASTER
ELLENVILLE, N.Y.



Circle 56 on literature card

it's here! most advanced
color TV test instrument
ever developed



- OBSOLETE ALL OTHERS
- ELIMINATES ALL GUESSWORK

LECTROTECH V7*

A sensational new color generator with 4 major Lectrotech exclusives . . . plus all of the time-proven standard features . . . in one compact, portable unit. For the first time, you can install and service color TV completely, accurately and faster! Here are the facts:

EXCLUSIVE—COLOR VECTORSCOPE—Until now, available only in \$1500 testers designed for broadcast. Accurately measures color demodulation to check R-Y and B-Y plus all 10 color bars for color phase angles and amplitude. A must for total color and those hard to get skin tones.

EXCLUSIVE—SELF-CALIBRATING — Adjust timing circuit without the use of external test equipment. No need to return unit to a factory for adjustment.

EXCLUSIVE—DIAL-A-LINE — Now, you can adjust horizontal line to any width desired from 1 to 4 lines wide.

EXCLUSIVE—SOLID STATE RELIABILITY — Only two tubes are used in combination with fully transistorized diode-rectifier circuit.

PLUS— the V7 produces all Crosshatch, Dots, Vertical only, Horizontal only and Keyed Rainbow Patterns. RF at channels 3, 4 or 5. Video Output (Pos. and Neg. adjustable) for signal injection trouble-shooting. Red-Blue-Green Gun Killer. All transistor and timer circuits are voltage regulated to operate under wide voltage ranges. Lightweight, compact — only 8¼" x 7½" x 12½". Net. **189.50**

ONE YEAR WARRANTY

For the full story on the V7, write for complete catalog or see your distributor.



V6 Complete color bar generator with all the features of the Lectrotech V7 except the Vectorscope. Only **99.50**

See your distributor or write

LECTROTECH, INC. Dept. PF-4

1221 Devon Ave. • Chicago, Ill. 60626

Circle 57 on literature card

While any tube or circuit fed by the "B" source could provide the trouble, the damper and horizontal-output tubes and associated circuits offer the best bet. If the overload cause is not found in the 260 volt "B" source, try the "A" source and from there start eliminating stages in the receiver by disconnecting the low-voltage from individual stages. If the overload still occurs, the disconnected stage can be eliminated as the source of the overload and the stage re-connected to its voltage source. The 125 volt reading in the 155 volt source could be caused by an open C1, or an increased current drain; check the sound IF and audio detector circuits.

Retrace Lines

I have a Magnavox TV, chassis V18-01CB, with retrace lines on the top half of the raster. This occurs with or without a signal applied to the receiver. When a signal is applied I receive an excellent picture, except for the retrace lines. Reducing the picture down to eight inches with the vertical height control removes the retrace lines. All voltages and components are within tolerance.

STEWART A. BARNUM

APO, New York

A weak video signal or insufficient blanking pulse are two possible causes. Wave form checks of the video stages and blanking pulse will prove helpful in determining the source of the trouble. Refer to Sams PHOTOFACT Set 348, folder 6 for the proper waveforms and their p-p voltage amplitudes. ▲

Look for the MAY issue...

- **Repairing the XYZ Color Circuits**

Typical troubles that can occur in these critical circuits.

- **Keyed AGC**

Find your way through these gain-control circuits.

- **Chasing Troubles in Stereo-On Indicators**

Repairing those troublesome indicators.

- **How to Develop a Good Credit Policy**

Credit sales can make or break a business.

- **plus . . .**

The Troubleshooter

Notes on Test Equipment

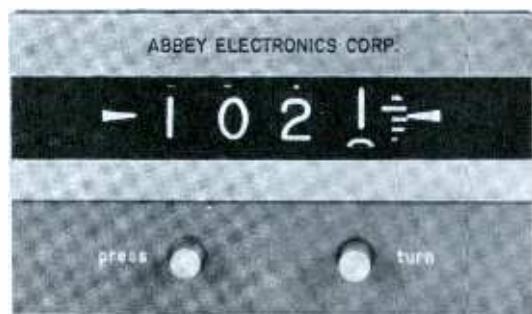
Color Countermeasures

New Tube and Transistor Data



Product Report

For further information on any of the following items, circle the associated number on the Catalog & Literature Card.



Digital Panel Meter
(72)

A new digital panel meter, the Model DM-25, offers a simple, inexpensive means of incorporating digital read-out into any equipment where accuracy and readability are important.

The new device, manufactured by **Abbey Electronics Corp.**, and trademarked **DIGIMETER**® requires less front-panel space than an ordinary 3½" d'Arsonval meter, but it is capable of at least 20 to 30 times better accuracy, linearity, and resolution. One model provides direct-reading digital measurement of AC or DC voltage and current, and of temperature, strain, displacement, pressure or any other parameter for which suitable transducers exist.

The bezel shown in the illustration measures 1⅞" x 3⅛". A push-button switch and a variable control extend through the bezel to permit occasional rezeroing of the meter. Other standard features include a remotely operated hold control for memory function and stand-by operation, while options such as zero-center scales and BCD contact closures are also available.

The standard DM-25 is priced at \$260, with quantity discounts available.



Home Battery Charger
(73)

Dry-cell batteries of the carbon-zinc, alkaline, manganese, mercury, and nickel-cadmium variety may be rejuvenated (depolarized) with this **Dynamic Instrument Corp.** battery charger. It will accommodate the common sizes (penlight, C, and D types) and has a built-in adapter for 9-volt transistor batteries. One to four batteries of different types and sizes may be rejuvenated simultaneously. The Model PNC-12D Plug 'n Charge Deluxe charger is styled in styrene and includes a timer reminder dial.

only picture tube analyzer that tests all color tubes as they should be tested!

(THE WAY TUBE MANUFACTURERS DO)



NEW LECTROTECH CRT-100 PICTURE TUBE ANALYZER

FOR COLOR AND BLACK AND WHITE

Does everything . . . you would need **all three units** of the leading competitive brands to equal the performance of the Lectrotech CRT-100. No other brand has all the features . . .

- Line voltage adjustment (to insure all tube voltages are correct regardless of line voltage).
- Critical Grid-to-Cathode Leakage is read on sensitive meter for greatest accuracy.
- Leakages in all other elements are indicated on neon lamp.
- Tests **all** black and white and **all** color tubes for leakage, shorts and emissions.
- Tests each color gun separately.
- Tests each color gun to a standard set of test conditions. With variable G-2 voltage, each grid is normalized to a reference cut-off voltage. This method is used by tube manufacturers and simulates tube performance in color receiver.
- Rejuvenates and removes shorts on both color and black and white tubes for increased brightness.
- Life expectancy test, predicts remaining useful life of both color and black and white picture tubes.
- Continuously variable G-2 voltage for all tubes, present and future, including new 15 inch color tubes.
- Complete plug-in cables for easy replacement.
- Complete self-contained black and white socket assembly. No adapters to lose or cables to break.
- Including Pilot Light.

Only **89⁵⁰** net

ONE YEAR WARRANTY

See your distributor or write DEPT. PF-4



LECTROTECH, INC.

1221 Devon Ave., Chicago, Illinois 60626

Circle 58 on literature card

April, 1966/PF REPORTER 83

9⁵⁰

ALL PARTS

(except tubes)

Plus Shipping Charge

QUALITY TV TUNER SERVICE

24 hrs. Service

Most Makes

UHF - VHF - COLOR - (COMBOS. - 14.50)

15 YEARS OF TUNER EXPERIENCE

- 1 Year Warranty
- Tuners completely cleaned and checked
- Open Account on approved credit
- Dist. write for price structure



Pack Tuner Carefully
— Insure Package —
Include all parts
(Broken or not)

QUALITY TUNER SERV.
5142 W. 25th St.
CHICAGO, ILL. 60650

Circle 60 on literature card



Appliance Dolly
(74)

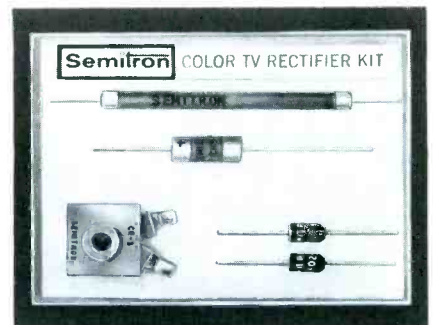
A new two-strap dolly has been introduced by **Yeats Appliance Dolly Sales Company**.

Built on a lightweight aluminum alloy frame, the Model 16 dolly features two ratchet fastened straps. These are adjustable for height of load as well as girth.

Crossmembers on the frame are curved to permit a firm grip on cylindrical appliances. The back of the frame is equipped with rubber belts for traveling on steps.

The front of the frame is completely padded with felt, with plastic padding available at a slightly higher price.

The Model 16 sells for \$89.50.

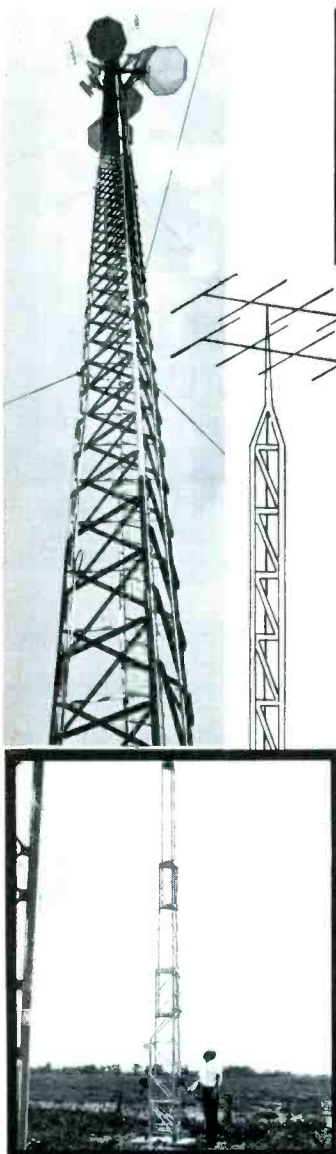


Rectifier Kit
(75)

A new universal color TV rectifier replacement kit has been released by **Semitronics Corp.** The kit contains 1 focus rectifier, 1 boost rectifier, 1 convergence rectifier, and 2 power-supply rectifiers. This kit is suitable for making rectifier replacements in color TV sets manufactured by leading TV suppliers.

Included with the kit is a free copy of the **Semitron Semiconductor Replacement and Interchangeability Guide**, which supplies replacement information for over 5,000 semiconductors.

The **Semitron Universal Color TV Rectifier Replacement Kit** is available in a see-through plastic package for \$5.95.



The most Famous Name in
TOWERS of ALL KINDS!

Here are the advantages you get when you insist on ROHN TOWERS

LARGEST FULL RANGE OF TOWERS—you can get anything from home TV and amateur radio towers to heavy-duty communication and micro-wave towers. Included are 500 foot self-supporting towers, 1,000 foot guyed towers, "fold-over" and crank-up towers. Regardless of your needs, ROHN can supply it.

UNQUESTIONED LEADERSHIP IN DESIGN AND MANUFACTURE—you get the latest in advanced tower engineering. All communication towers are engineered to EIA specifications, and are proved by thousands of installations. No other manufacturer can surpass the quality and fine reputation of ROHN.

QUALITY MATERIALS AND WORKMANSHIP—Only highest quality steel is used which fully meets the specifications for the job. ROHN towers are hot-dipped galvanized **after fabrication**—a feature ROHN pioneered!

SERVICE WHEREVER YOU WANT IT—ROHN representatives are world-wide. Complete erection service for communication systems, broadcasting, micro-wave, and other needs is available; also competent engineering service to help you.

Settle for the BEST in TOWERS—ROHN—today the world's largest, exclusive manufacturer of towers of all kinds!

For your needs, contact your local ROHN salesman, distributor or dealer; or write direct for information.

SEND THE HANDY COUPON INDICATING YOUR NEEDS

ROHN
Manufacturing Co.
BOX 2000
PEORIA, ILLINOIS

ROHN Manufacturing Co.
Box 2000
Peoria, Illinois

Send me complete literature on the following ROHN Products:

- | | |
|---|--|
| <input type="checkbox"/> Home TV Towers | <input type="checkbox"/> Amateur Towers |
| <input type="checkbox"/> Communication Towers | <input type="checkbox"/> AM-FM Broadcasting Towers |
| <input type="checkbox"/> Micro-Wave Towers | <input type="checkbox"/> Government |

Name _____

Firm _____

Address _____

City _____ State _____



Weatherproof Speaker
(76)

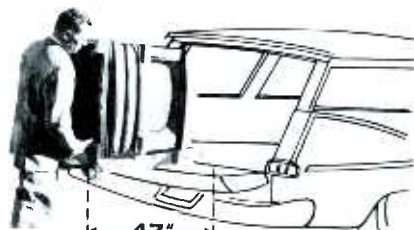
A new weatherproofed speaker for medium-power mobile communications use and mobile public address amplifiers is introduced by **ATLAS SOUND**, Division of America Trading and production Corporation.

The Model MO-2 speaker is designed for limited spaces such as between the automobile grille and radiator, in the engine compartment, or under the dashboard. A reinforced, welded steel bracket is included. All metal parts are Alodine® treated for corrosion resistance and finished with melamine enamel.

Specifications: Power, 25 watts. Impedance, 8 ohms. Frequency response, 300-13,000 cps. Dispersion, 130°. Dimensions, 6-5/8" wide, 8" high, 4-3/16" deep.

List price, \$44.00.

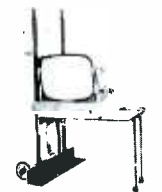
SAVES
your back...
SAVES
your time...



YEATS

SHORTY DOLLY
for
RADIO and TV

just 47 inches high for **STATION WAGONS**
and **PANEL PICK-UPS**



FOLDING PLATFORM
15 1/4" x 24 1/2" top.
Snaps on or off.
(Platform only)
\$11.95

Designed for TV, radio and appliance men who make deliveries by station wagon or panel truck... the short 47 inch length saves detaching the set for loading into the "wagon" or pick up. Tough, yet featherlight aluminum alloy frame has padded felt front, fast (30 second) web strap ratchet fastener and two endless rubber belt step glides. New folding platform attachment, at left, saves your back handling large TV chassis or table models. Call your YEATS dealer or write direct today!



YEATS
Model No. 5
Height 47"
Weight 32 lbs.



FURNITURE PAD

"Everlast" COVER AND PADS

YEATS semi fitted covers are made of tough water repellent fabric with adjustable web straps and soft, scratchless white flannel liners. All shapes and sizes — Write



TV COVER



APPLIANCE DOLLY SALES COMPANY

1307 W. Fond du Lac Ave. • Milwaukee, Wisconsin

Circle 62 on literature card

4 ways to increase your income

RCA Institutes, Inc. offers these four comprehensive home study courses especially designed to help build your income immediately!



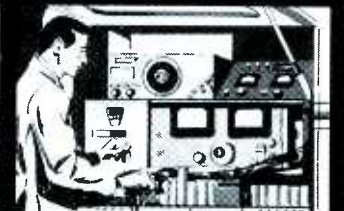
COLOR TV Add Color TV Servicing to your skills with this up-to-the-minute home training course and take advantage of the growing profit potential in this area! Train under the direction of RCA... experts in Color TV.



TRANSISTORS You get the necessary background for semiconductor technology including characteristics of tunnel diodes, rectifiers and other solid state devices. Transistor trainer also available.



AUTOMATION ELECTRONICS
Trains you for the many applications of automation electronics in industry and government including Photoelectronics, Digital Computer Techniques, Synchros and Servomechanisms, Automatic Control Systems, and many more!



MOBILE COMMUNICATIONS
Trains you to service and maintain 2-way radio communications on land, sea, and air! Gives you the technical foundation for space communications!

Take advantage of RCA's Liberal Tuition Plan. You only pay for lessons you order; and have no long-term obligations. Licensed by New York State Education Department. Approved for Veterans.

RCA INSTITUTES, INC.
A Service of Radio Corporation of America
350 West Fourth Street, New York, N. Y. 10014



The Most Trusted Name in Electronics

SEND THIS COUPON NOW FOR COMPLETE FREE INFORMATION

RCA INSTITUTES, INC. Home Study School, Dept. PF-46

350 West Fourth Street, N. Y., N. Y. 10014

Without obligation, rush me free information on the following RCA Home Training Course: **COLOR TV** **TRANSISTORS** **MOBILE COMMUNICATIONS**

AUTOMATION ELECTRONICS

Name _____ Age _____

Address _____

City _____ State _____ Zip _____

CANADIANS—Take advantage of these same RCA courses at no additional cost. No postage. No customs. No delay. Send coupon to: RCA Victor Company, Ltd., 5581

Royalmount Ave., Montreal 9, Quebec.

**If you think
all vidicon
replacement tubes
are alike,
you've got a
surprise coming...**



Amperex Vidicons are pre-tested and pre-selected as direct plug-in replacements for all these popular types:
7735A, 7038, 7697, 7325, 7336, 7291

Manufactured according to traditional Amperex custom quality standards (each tube comes with its own test data; is packed and shipped in an individual, gimbal-stabilized container), these are off-the-shelf replacements at off-the-shelf prices. Yet each tube provides unparalleled sensitivity and resolution, outstanding lag characteristics and amazingly uniform operation throughout its life. All vidicon replacement tubes are not alike; a replacement is an improvement with an Amperex tube.

Three types are available to most economically match the application—the 55850AM for low cost applications; the 8483 for most conventional applications; and the 55850S for the exacting commercial, professional, medical and broadcast applications.

For complete information, write: Amperex Electronic Corporation, Tube Division, Hicksville, Long Island, New York 11802.

Amperex®

Card 69 on literature card



Type Cleaner
(77)

A nonliquid cleaner for teletypewriter keys has been introduced by **Bud Type Cleaner Co.** It employs a wad of pink plastic putty attached to a handle. The putty pulls the dirt out of the type and leaves no residue. The type cleaner can be used repeatedly, and ink will not come off on the hands if used as directed. Price is \$0.50.



**Hip-Pocket Nut and
Screwdriver Set**
(79)

The hip-pocket size 99PS-50 set consists of a 4 1/8" amber plastic handle and 12 interchangeable blades as follows: 7 nutdrivers (3/16" hex thru 3/8" hex), 2 Phillips screwdrivers (#1 and #2), 2 slotted screwdrivers (3/16" and 9/32"), and an extension blade that provides an added 4" reach. Handle and extension feature positive locking device; blades fit snugly, are held firmly for turning, yet are easily removed. **Xcelite's** set is contained in a compact, see-through plastic carrying case.



New Digital Measuring System
(78)

This versatile system consists of a Main Frame display unit capable of accepting any of a number of Plug-in units to measure a variety of electrical parameters.

Depending on the plug-in selected, the instrument can be a Digital DC Volt-

meter, AC Voltmeter, Counter, Frequency Meter, Ohmmeter, Capacity Meter, Current Meter, Multimeter, Ratio Meter, or Event Counter.

Of Modular design, the **Hickok DMS 3200** is solid-state throughout. Highlights of the system are its price, flexibility, and performance specifications. The Main Frame is priced at \$320 and Plug-ins vary from \$175 to \$240.



CB Antenna
(80)

Designed to multiply signal power through full-length capture area and a low angle of radiation, the **Ringo** features power ring tuning for maximum efficiency and full circle gain. The lightweight, low-priced, Citizens-band, 1/2 wavelength, vertical antenna is manufactured by **Cush Craft**.

Construction is all heavy wall aluminum tubing with a phenolic base insulator. The **Ringo** is designed for rapid assembly and installation in any location.

The price is \$16.95. ▲

INDEX TO ADVERTISERS

APRIL, 1966

Amperex Electronic Corp.	86
Amphenol Corp.	58, 65
The Antenna Specialists Co.	56
Belden Mfg.	63
Blonder-Tongue Labs, Inc.	76
B&K Mfg. Co., Div. of Dynascan Corp.	37
Bussman Mfg. Div.	16, 17
Castle TV Tuner Service	14
Centralab, Div. of Glove-Union, Inc.	71
Chemtronics, Inc.	61, 87
Channel Master Corp.	81
Cleveland Institute of Electronics	15
Craftsman Electronic Products, Inc.	13
Delco Radio Div.	59
Electronic Communications Inc.	79
EICO	Cover 2
Enterprise Development Corp.	55
Finney Co.	45
Grantham School of Electronics	61
Heath Co.	75
Hickok Electrical Instrument Co.	33
I. R. C., Inc.	48
Jerrold Electronics	54, 69
JFD Electronics Corp.	49
Kay-towne Antenna Co.	60
Krylon, Inc.	64
Lectrotech, Inc.	82, 83
Littlefuse, Inc.	Cover 4
Mallory, P. R., Co., Inc.	35
Mercury Electronic Corp.	62
Mosley Electronic Inc.	12, 55
Motorola Semicond. Prod.	18
Motorola Training Institute	40
Multicore Sales	61
Oaktron Industries, Inc.	12
Perma-Power Co.	68
Philco Corp.	51
Planet Sales Co.	64
Precision Electronics, Inc.	87
Quality tuner Service	84
RCA Components & Devices	Cover, 3, 31, 39, 44, 53
RCA Institutes	85
RCA Sales Corp.	77
Rohn Mfg. Co.	84
Sarkes Tarzian	9
S and A Electronics	87
Sams, Howard W. & Co.	42, 43, 66
Semitronics Corp.	50
SENOCORE, Inc.	41, 78, 80
Sprague Products Co.	11
Switchcraft, Inc.	87
Sylvania Electronic Product, Inc.	72
Tripplet Electrical Instrument Co.	57
Vaco Products Co.	40
Winegard Co.	34, 67
Xcelite, Inc.	52
Yeats Appliance Dolly Sales, Inc.	85
Zenith Radio Corp.	70



BLACK/WHITE
OR
COLOR

THE ONLY SAFE NON-DRIFT
TV TUNER
CLEANERS
AVAILABLE AT ALL DISTRIBUTORS

CHEMTRONICS

BROOKLYN, N. Y. 11236



Circle 67 on literature card

if

**you want to
take a good look
at what's
really going on
INVESTIGATE
THE S & A LINE**

(—or, buy an S & A Antenna yourself!
There's a pretty bright picture
both profit and pleasure-wise.)



MODEL PW UHF-VHF-FM COLOR ANTENNA

Passive Wave combined with the best features of Log Periodic construction produce this new antenna unequalled in overall operation. See UHF—VHF and Colorcasts as they are transmitted. Enjoy FM listening at its finest.

The wave guide element system in combination with frequency independent drive effects a new breakthrough in a high gain channel 2 thru 83 antenna. The UHF section has a dual function in that it provides director action at the VHF high band frequencies in addition to wave guide control at UHF frequencies.

4 models as low as \$24.95 list.

Write for literature. All inquiries given prompt attention.

S&A Electronics Inc.

Manufacturers of the TARGET ANTENNA

206 West Florence Street • Phone 419-693-0528 • Toledo, Ohio 43605

Circle 65 on literature card

looking for connectors
to fit your
Foreign
tape recorder?



**YOUR NEARBY SWITCHCRAFT
AUDIO DEALER TALKS YOUR LANGUAGE!**

Stop searching. Those hard-to-find miniature, multi-pin connectors for imported tape recorders, dictation machines, audio and P.A. equipment are at your local Switchcraft dealers now! 2 to 7 pin, male, female . . . for Sony, Norelco, Grundig-Majestic, Korting, Uher, Panasonic, Telefunken, etc. Original equipment precision, quality and fit.

Write for complete catalog C-503 and a list of dealers who stock these connectors.

SWITCHCRAFT®
5573 Elston Ave., Chicago, Ill. 60630
Circle 64 on literature card

PRECISION ALL-PURPOSE SIGNAL TRACER



**For fast servicing of AM, FM, TV,
Audio and Electronic Equipment . . .**

Checks all stages from antenna to speaker or picture tube. Tests microphones, appliances, pickups, transformers, speakers, resistors, condensers, etc. Quickly locates intermittents, open circuits, hum, noise, distorted stages. Both visual and aural tracing with super-sensitive indicator eye and built-in 5" speaker. 3 stage preamplifier circuit plus overall feedback. Wide band response, additional voltage gain of 400 for scope or VTVM. 110-120 volts AC at 60 cycles. Wt. 9½ lbs.

Model 202. Signal Tracer with AF Probe. . . . 59.95
Model B Probe. RF Demodulator Amplifier Probe with amplifier-detector tube for high gain and frequency responses to 300 MC. . . . 7.50



See your distributor or write Dept. PE 4
PRECISION ELECTRONICS, INC.
9101 King Street, Franklin Park, Illinois

Circle 66 on literature card



FREE Catalog and Literature Service

*Check "Index to Advertisers" for further information from these companies.

Please allow 60 to 90 days for delivery.

ANTENNAS & ACCESSORIES

90. *ALLIANCE*—Colorful 4-page brochure describing in detail all the features of Tenna-Rotors.
91. *ANTENNACRAFT*—Literature featuring 3 new 75-ohm, all-channel TV antennas available in factory-built or kit form.
92. *FINNEY*—Form 20-349 describes the new Finco-axial color matching transformer kit.
93. *JFD*—New 1966 dealer catalog covering complete line of log-periodic outdoor antennas, indoor antennas, rotators, converters, amplifiers, mastings, splitter-couplers/combiners, matching transformers, lightning arrestors, antenna mounts, and hardware.
94. *MARK PRODUCTS*—New catalog AM-661 describes a complete line of mobile and fixed station amateur band antennas, includes large line of mounts and accessories.
95. *WINEGARD*—12-page brochure "Color Spectacular" featuring antenna products designed for color TV use.
96. *ZENITH*—Information bulletin on antennas, rotors, batteries, tubes, power converters, record changers, picture tubes, wire, and cable.*

AUDIO & HI-FI

97. *ADMIRAL*—Folders describing line of equipment; includes black-and-white TV, color TV, radio, and stereo hi-fi.
98. *ATLAS SOUND*—Catalog No. 565 illustrating public-address loudspeakers, microphone stands, and accessories for commercial sound applications.*
99. *ERCONA*—8-page catalog describes *Fane* line of heavy duty 10-18 inch woofers, also tweeters, crossovers, etc.
100. *HARTLEY*—Brochure of full line of speakers with reprints of reviews on Model 220MS.
101. *JENSEN*—Multicolored 24-page catalog No. 165-L featuring speakers and headphones. Also, 22-page catalog No. 6801 supplying phono-cartridge list and cross-reference.
102. *NUTONE*—Full-color booklet illustrating built-in stereo music systems and intercom-radio systems. Includes specifications, installing ideas, and prices.
103. *OAKTRON*—"The Blueprint to Better Sound," an 8-page catalog of loud speakers and baffles giving detailed specifications and list prices.*
104. *OXFORD TRANSDUCER*—4-page catalog describing three lines of automobile rear-seat speaker kits.
105. *PERMA-POWER*—Catalog B-278 describes Ampli-vox line of sound systems.
106. *QUAM-NICHOLS*—Catalog S-65 listing speakers for PA background music, intercom. Also outdoor speakers and line-matching transformers.
107. *SONNDOLIER*—Short-form catalog of speakers, baffles and transformers packaged ready for installation.
108. *TURNER*—Bulletin 1060 on a new cardioid type microphone with tone switch.

COMMUNICATIONS

109. *AMECO*—Flyer sheet on a new 6 and 2 meter transceiver and VFO.
110. *LAMPKIN*—Technical bulletins describing frequency meter and FM modulation meter. Also a free booklet "How to Make Money in Mobile Radio Maintenance."

111. *MOSLEY ELECTRONICS*—Catalog covering complete 1966 line of Citizens-band equipment.
112. *MOTOROLA*—Details on specialized training in a 2-way FM mobile radio.
113. *PEARCE-SIMPSON*—Specification brochure on 1BC 301 business-band two-way radio, *Companion II*, *Director*, *Escort II*, *Guardian 23*, and *Sentry* Citizens-band transceivers. "The Modern Approach to Business Communications" concerning land mobile radio service for businessmen.
114. *PHILMORE*—Flyer sheet on a new 1-watt walkie-talkie.
115. *POLYTRONICS*—Short forms on Business-band and Citizens-band equipment.

COMPONENTS

116. *BUSSMAN*—New 1966, 16-page car and truck fuse list. Shows proper fuse to use and where it is located. Covers foreign as well as domestic cars and trucks. Buss form AWC.
117. *CLAROSTAT*—Brochure describes *Unitite* line of snap-together TV and radio controls.
118. *CORNELL-DUBILIER*—New 64-page replacement component selector.
119. *GUDEMAN*—New 6-page brochure describes wide range of tubular and bathtub style RFI filters.
120. *OAK*—Catalog and supplement describes Oak line of rotary and lever switches.
121. *SONOTONE*—New cartridge and needle cross-reference guide with over 5,700 entries. Includes replacement data for imported sets.
122. *SPRAGUE*—Handy chart lists most popular sizes of electrolytics for color TV sets, referenced to set manufacturer.*
123. *SWITCHCRAFT*—Bulletin 158 describes new multi-station slide switch. Up to 18 stations of 3PDT. Also, new catalog of miniature audio connectors.
124. *VACO*—New catalog on retaining rings.
125. *WORKMAN*—Form X-47 describes non-inductive ceramic resistors used in color TV sets.

SERVICE AIDS

126. *CASTLE*—How to get fast overhaul service on all makes and models of television tuners is described in leaflet. Shipping instructions, labels, and tags are also included.*
127. *CLEVELAND INSTITUTE OF ELECTRONICS*—New pocket-sized, plastic "Electronics Data Guide" of formulas and tables, including frequency and wavelength, db formulas and table, antenna lengths, and color code.*
128. *ELECTRONIC CHEMICAL*—Brochure of aerosol chemicals for controls, tuners, and tape heads.
129. *G.C.*—New 300-page catalog FR 67 covers *GC*, *Walsco*, *Audiotex*, *Telco*, and *Electrocraft* brands of service aids and components.
130. *3M*—New 8-page brochure describes a variety of tapes and splicing connectors specially designed for the electronics industry.
131. *PRECISION TUNER*—Literature supplying information on complete low-cost repair and alignment service for any TV tuner.*
132. *RAWN*—Bulletins offered on uses of Plast-Pair and tuner cleaner.
133. *YEATS*—The new "back-saving" appliance dolly Model 7 is featured in a four-page booklet describing featherweight aluminum construction.

SPECIAL EQUIPMENT

134. *SETCHELL-CARLSON*—Multicolor sales brochure describing Unitized construction color and B & W TV receivers.
135. *TENATRONICS*—Flyer sheet describing reverberators and FM tuners for mounting under dash of car or truck.

TECHNICAL PUBLICATIONS

136. *CLEVELAND INSTITUTE OF ELECTRONICS*—Free illustrated brochure describing electronics slide rule and four-lesson instruction course and grading service.
137. *HOWARD W. SAMS*—Literature describing popular and informative publications on radio and TV servicing, communications, audio, hi-fi, and industrial electronics, including special new 1966 catalog of technical books on every phase of electronics.*
138. *RCA*—New book titled "Your Career in a World of Electronics." Describes program and courses in television, telecommunications, industrial electronics, drafting, and computer programming.

TEST EQUIPMENT

139. *B&K*—New 1966 catalog featuring test equipment for color TV, auto radio, and transistor radio servicing, including tube testers designed for testing latest receiving tube types.*
140. *EICO*—1966 short-form catalog is 48 pages long. Describes a complete line of test instruments, CB and ham equipment, hi-fi components, and miscellaneous electronic equipment.
141. *HICKOK*—New flyer detailing selected items of service test equipment.
142. *JACKSON*—New catalog of "Service Engineered" test equipment.
143. *MERCURY*—All new test-equipment catalog featuring time saving "Service-Man" equipment.
144. *SECO*—Catalog sheet No. 90065 describing Model 900 color-bar generator and Models 88, 98, and 107B tube testers.*
145. *SENCORE*—Latest 4-color catalog plus other information on new developments in the Econoline series of test equipment.
146. *SIMPSON*—Flyer giving specifications of Model 604 Multicorder for measuring and recording volts, amps, milliamps, and microamps.*
147. *TRIPLETT*—New test-equipment catalog 48-T featuring VOM's, VTVM's, tube testers, transistor analyzers and generators and accessories.

TOOLS

148. *BAY PRODUCTS*—New 40-page catalog on steel shop equipment, featuring the new Converta-bench.
149. *ENTERPRISE DEVELOPMENT*—Time-saving techniques in brochure from Endeco demonstrate improved desoldering and resoldering techniques for speeding and simplifying operations on PC boards.

TUBES

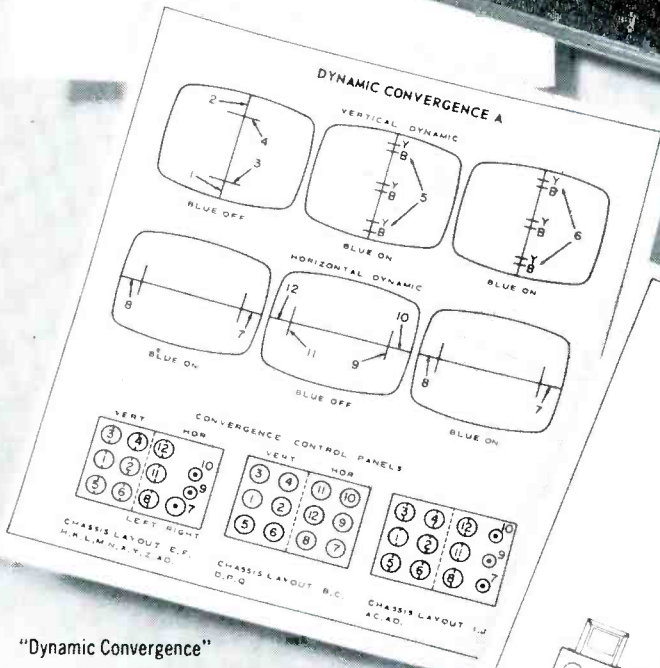
150. *IEC*—New completely revised list of tubes for the service man. Includes over 100 new types.

Now in one handbook...the service information you need for 12 makes of color TV sets

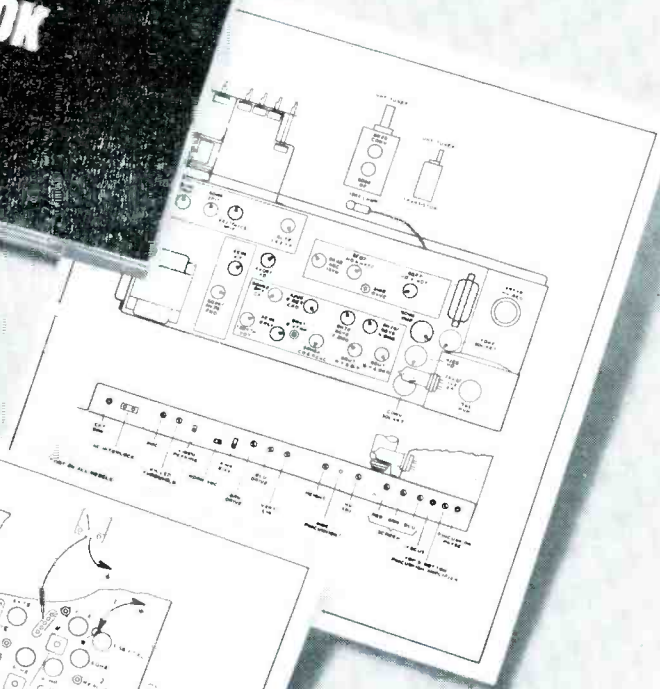


TABLE OF CONTENTS

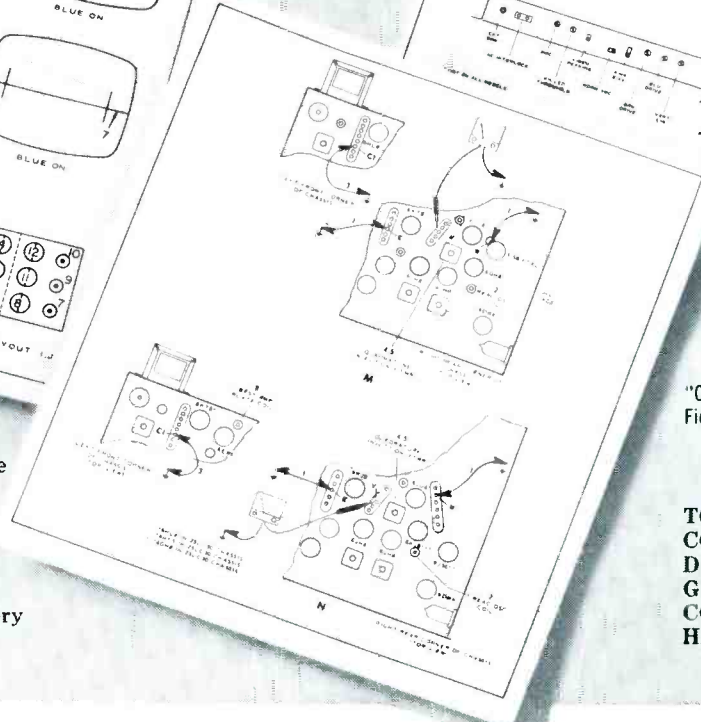
- INTRODUCTION
- HOW TO USE THIS HANDBOOK
- ABBREVIATIONS USED IN THIS HANDBOOK
- Section 1 CHASSIS INDEX
 - CHASSIS LAYOUTS
- Section 2 PURITY ADJUSTMENTS
- Section 3 CONVERGENCE ADJUSTMENTS
 - STATIC CONVERGENCE (general)
 - DYNAMIC CONVERGENCE (specific)
- Section 4 BLACK AND WHITE SETUP ADJUSTMENTS
- Section 5 PHASE AND MATRIX ADJUSTMENTS
- Section 6 COLOR AFPC FIELD ADJUSTMENTS
- Section 7 MISCELLANEOUS ADJUSTMENTS
- Section 8 FUSES AND CIRCUIT BREAKERS
- Section 9 TEST EQUIPMENT FOR COLOR TV SERVICING
- Section 10 RECEIVING TUBES FOR COLOR TV



"Dynamic Convergence"



"Color AFPC Field Adjustments"



"Chassis Layouts"

Just look up the chassis number of the set you are working on in the CHASSIS INDEX and you will be guided to the proper sections of the 140-page RCA Color TV Service Handbook. All the information is based on the manufacturer's own service notes. You'll want to carry a copy in your tube caddy on every color TV service call.

TO KEEP UP WITH COLOR, SEE YOUR RCA DISTRIBUTOR ABOUT GETTING THE RCA COLOR TV SERVICE HANDBOOK (1A1553).

RCA ELECTRONIC COMPONENTS AND DEVICES, HARRISON, N.J.



The Most Trusted Name in Electronics

RCA's personal quality performance program aims for missile-type reliability in commercial receiving tubes. Under this program thousands of RCA people have pledged to strive for error-free performance so that when you replace with RCA receiving tubes you're sure of a satisfied customer.



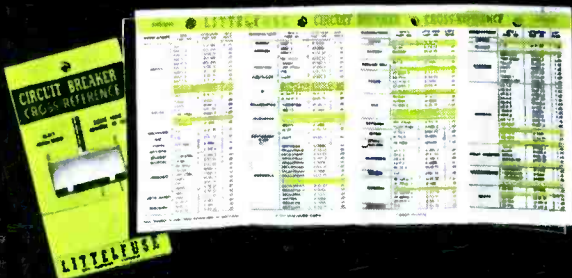
LOOK WHAT'S HATCHING IN **COLOR TV**



Assortment #094074
10 BULK BREAKERS



Assortment #094073
10 CARDED BREAKERS



**A COMPLETE ASSORTMENT
OF CIRCUIT BREAKERS FOR
COLOR TV APPLICATIONS**

Ten-breakers, seven ratings in one handy box for 100% replacement needs. Assortment available consisting of breakers on individual display cards or in bulk.

Included with each assortment: Pocket size cross-reference on color and black/white TV circuit breaker applications. Form No. CBCRP865H.

LITTELFUSE

DÉS PLAINES, ILLINOIS

Circle 68 on literature card