

MAY, 1964 50 CENTS

PHOTOFACT PF REPORTER

Including **Electronic Servicing**

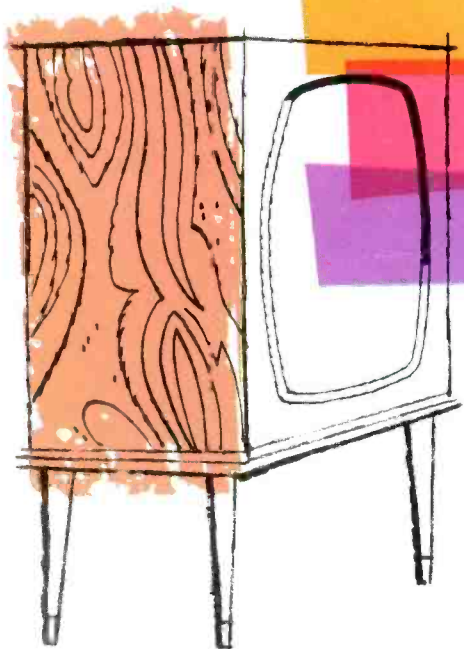

CURES FOR
COLOR HUE
TROUBLES

CARE & CHOOSING
OF TAPE HEADS



FOOLED BY POOR
BOOST ... and
many more 

IA 2L 1104 1266
WM. M. DAVIS
RAD. & TV SERV.
118 RIVERSIDE AVE.
CANNON CITY, COLOR.

WITH JERROLD, YOU DON'T GAMBLE ON SYSTEMS OR PROFITS

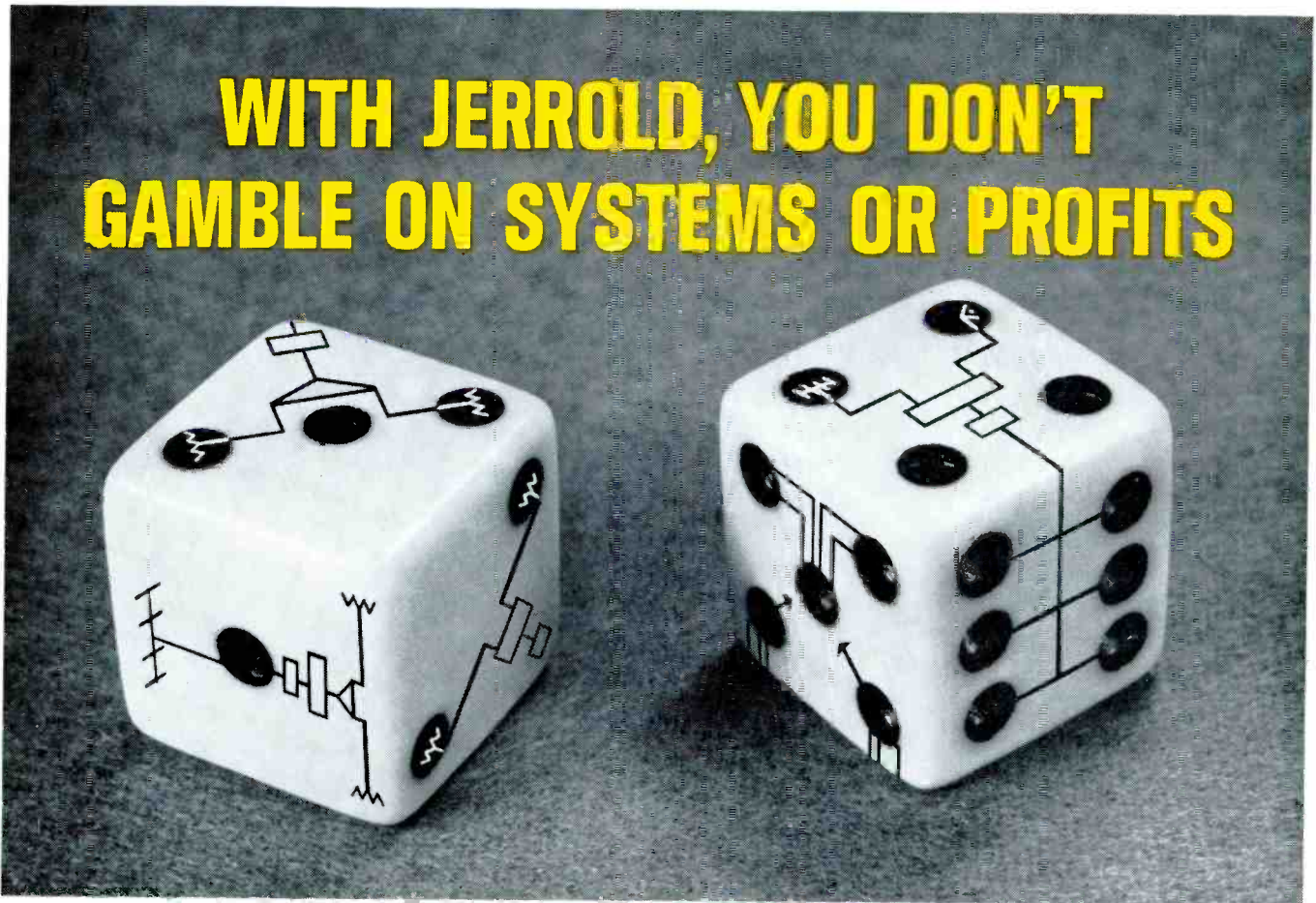

Assure yourself a profitable motel, small-hotel, and apartment-house antenna-system business—rely on Jerrold's 15-year, 50,000-mile cable experience

There are many good reasons why servicemen and architects throughout the nation insist on Jerrold master-antenna systems equipment. One of the most important is *reliability* . . . for Jerrold is the *one* truly reliable name in TV/FM cable systems—proven over fifteen years and in over 50,000 miles of installed systems.

When you go after the growing systems business in motels, small hotels, and small apartment houses, the profits lie in staying with the equipment you don't have to nurse after it's in. That's Jerrold. Everything *works* right off the bat—from the special 75-ohm antenna to the industry's finest room outlet. See your Jerrold distributor today, or write *Distributor Sales Division, Jerrold Electronics, Philadelphia, Pa. 19132.*



THE NATION'S FOREMOST MANUFACTURER AND SUPPLIER OF TELEVISION DISTRIBUTION SYSTEMS

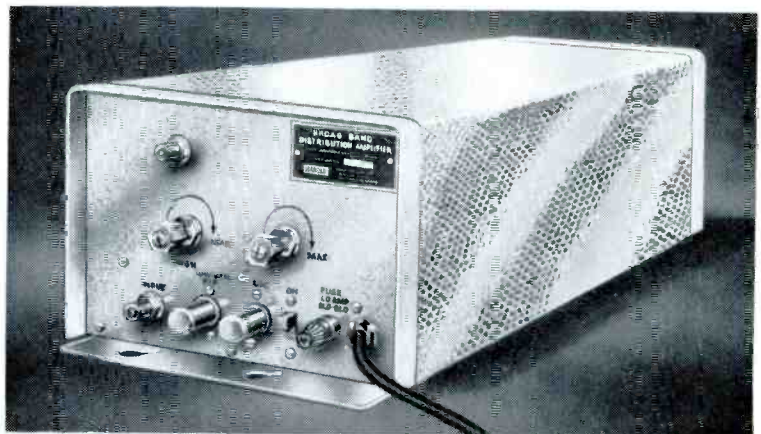

New Model 2300-A, hi-output broadband amplifier—workhorse of the small-systems field. Rugged, heavy-duty construction; excellent overload capability; dual manual gain control (14db range).

New Ultra-Tap—the beautiful universal plug-in wall outlet that accommodates 75- or 300-ohm connectors for TV or FM or both. Flush or surface-mounting, in a wide choice of decorator colors.

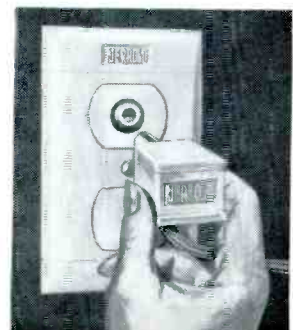

Circle 1 on literature card

AUDIO OUTPUT TRANSFORMER

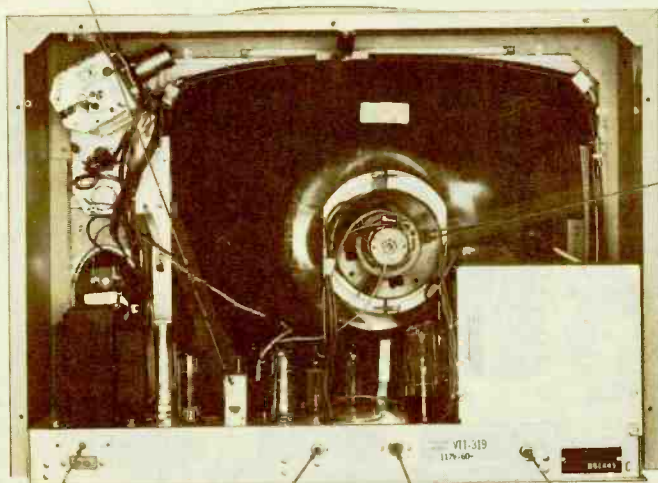

CENTERING

CIRCUIT BREAKER

HORIZ OSC.

HORIZ DRIVE

WIDTH



Andrea
Model VTT319

The above photo is of a 19" portable from Andrea Corp. It shouldn't be necessary to recheck your tube caddy when you're called to service this one, since simplicity and sound design seem to have been the manufacturer's goal, rather than the introduction of new circuits and tubes.

The horizontally mounted chassis is not drastically different in either physical or electrical design from other models of recent years. The chassis is completely hand-wired and is laid out in such a manner that circuit tracing is comparatively easy. The tubes are common types. First and second video-IF amplifiers are 6BZ6's; third video-IF amplifier and video detector are combined in a 6AS8; video output and sync amplifier in a 6CX8; sync separator and AGC keyer in a 6AW8A. Two 6CG7's are used, one as a horizontal multivibrator and the other as a sync phase inverter and vertical multivibrator; the vertical output stage—a 6EM5—serves as the other half of the vertical multivibrator. The sound section has a 6AU6A, 6DT6, and 6BQ5 functioning respectively as sound-IF amplifier, audio detector, and audio output.

The low-voltage power supply uses a power transformer, with two silicon rectifiers connected as a full-wave voltage doubler. Protection for these rectifiers and the entire B+ circuit is provided by a circuit breaker. As additional protection for the horizontal sweep circuit, a .25-amp slow-blow fuse is located under the high voltage cage.

The VHF tuner is a turret type using an extremely high-gain 6DS4 *nuvistor* as the RF amplifier along with a 6CG8A mixer-oscillator. Check points in the tuner are provided either by feed-through bypass capacitors or test terminals protruding through the top of the tuner. This tuner has conventional fine tuning and individual oscillator slugs for each channel; they are accessible by removing the channel-selector and fine-tuning knobs.

Located on the rear of the chassis is the horizontal drive control, width coil, and horizontal stabilizer coil. The vertical linearity and height controls are mounted on top of the chassis and are accessible by removing the rear cover. The volume, contrast, vertical hold, horizontal hold, and brightness may be adjusted from the front.

The horizontal AFC diode is a dual selenium soldered beneath the chassis. For replacement of this component it is necessary to remove the chassis from the cabinet.

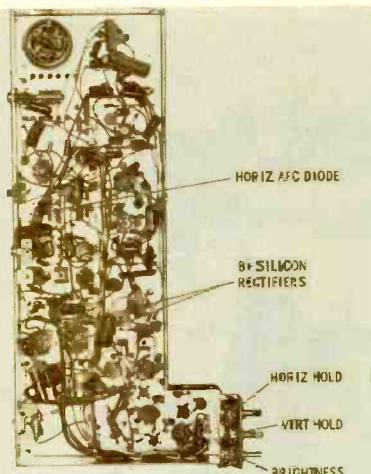

HORIZ AFC DIODE

B+ SILICON RECTIFIERS

HORIZ HOLD

VERT HOLD

BRIGHTNESS

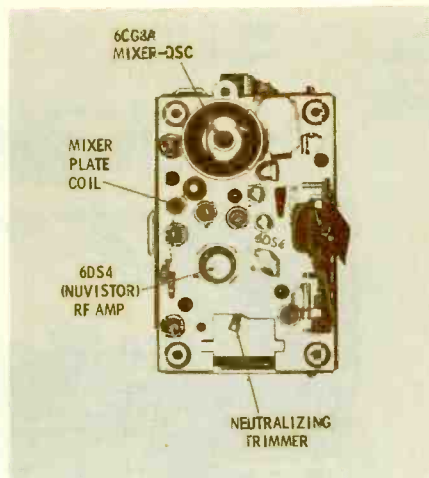

6CG8A
MIXER-OSC

MIXER
PLATE
COIL

6DS4
(NUVISTOR)
RF AMP

NEUTRALIZING
TRIMMER

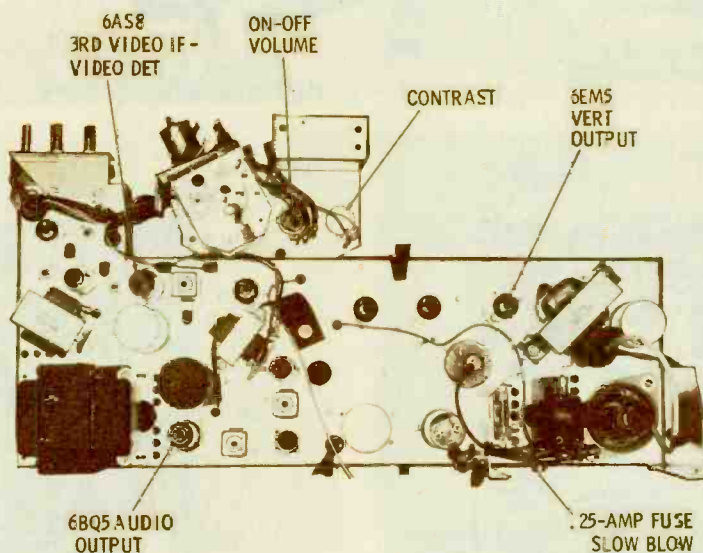

6AS8
3RD VIDEO IF-
VIDEO DET

ON-OFF
VOLUME

CONTRAST

6EM5
VERT
OUTPUT

6BQ5 AUDIO
OUTPUT

.25-AMP FUSE
SLOW BLOW

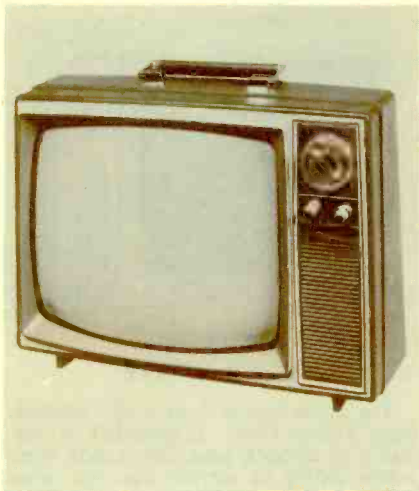

Arvin
Model 63K19

This 16" portable uses a 16AUP4 picture tube, and is equipped with built-in antenna and an earphone jack. This is Arvin's first television receiver for several years and was imported from Japan. The circuitry is very similar to that found in many American-made sets.

The horizontal-sweep section uses a 12BH7A as oscillator and AFC. This tube and its associated components are mounted on the one and only printed-circuit board. The remainder of the circuits are hand-wired and all use Japanese components.

The wrap-around chassis layout is divided into four separate sections. Viewed from the rear, the upper layer contains the horizontal oscillator, with the horizontal sweep section located just to the right. The lower layer holds the sync, vertical sweep, and audio amplifier-output circuits. The left side contains the remainder of the audio stages and the video circuits.

The transformerless power supply uses two silicon rectifiers (1N1764 or equivalent) protected by a 2-amp fuse, to develop the 280 volts B+. The series filament circuit has a 55-ohm, 20-watt dropping resistor.

The horizontal circuit is loaded with adjustable coils—four of them, to be exact. The main horizontal oscillator coil is used for the horizontal hold, but a waveform coil is also available to improve stability. Proper adjustment requires an oscilloscope; set the slugs for equal peaks of the waveform at the center-tap of the oscillator coil. Adjustment of horizontal size and linearity is also accomplished by use of separate coils.

Three crystal diodes are used. A 1N60 follows the three 3BZ6 video-IF amplifiers and serves as the video detector; it is located under a shield covering the final IF transformer. The remaining two diodes are used in the ratio detector.

Mounted on the printed circuit board is a dual- and triple-section control assembly. The dual section contains the brightness and vertical hold; the AGC, vertical size, and vertical linearity are in the triple unit.

This set is without any of the compactrons that are fast becoming popular; all the tubes are common types that have been around for quite some time. The exception is the 8B8 which is used in the audio output stage.

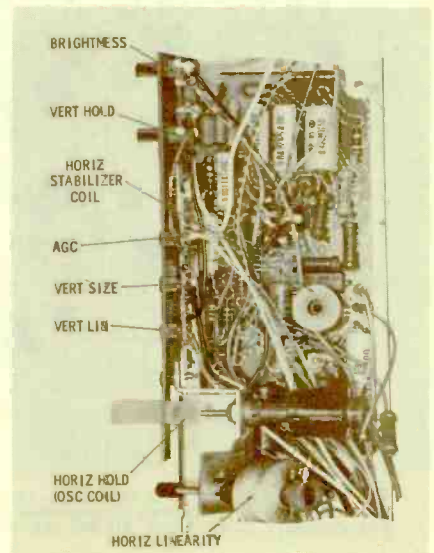
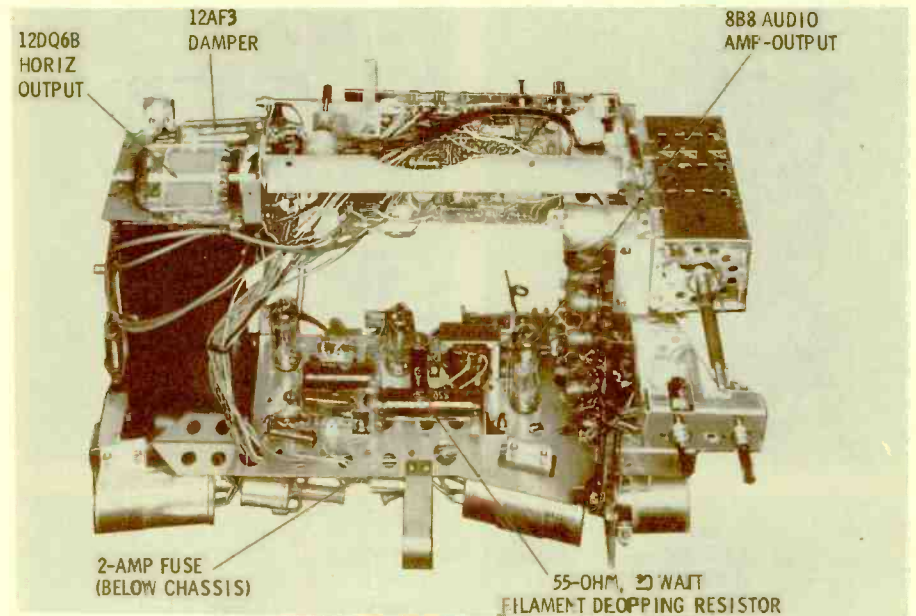
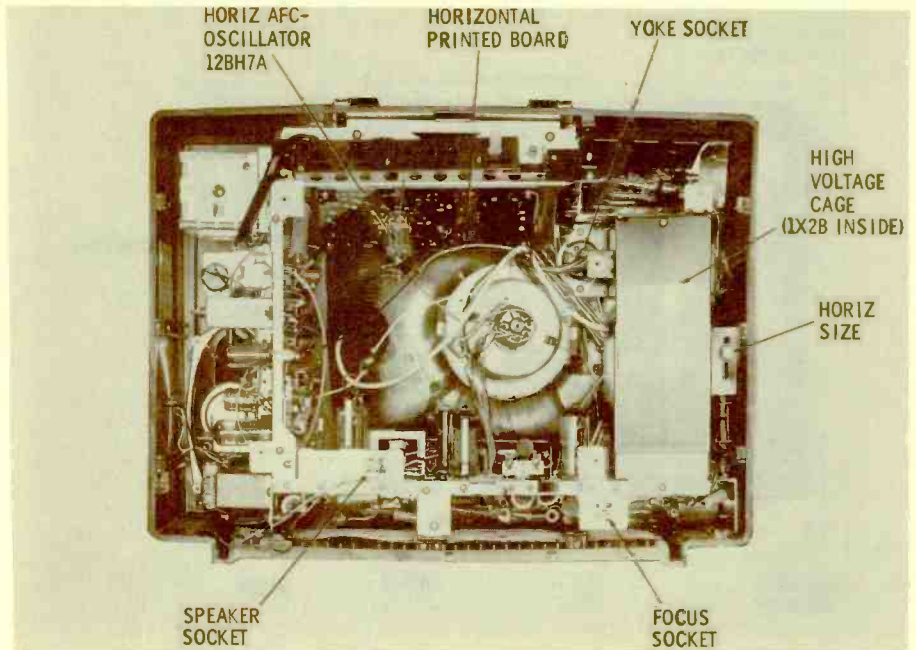

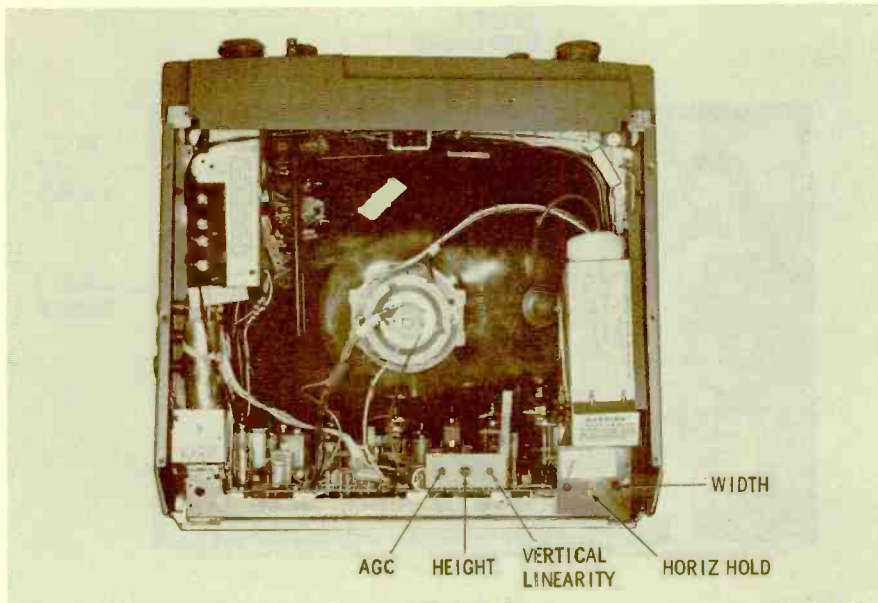

**Sylvania
Model 19P35
Chassis 571 Series**

Quite a change, both physical and electrical, might be a good way to describe this lightweight 19" Sylvania portable. This receiver uses a bonded 114° picture tube, and is equipped with a built-in monopole antenna and earphone jack. This chassis fits snugly inside the cabinet and the minimized depth and width give the cabinet a very "portable" appearance. Only one printed circuit board is used, with practically all the components mounted on it.

Two interconnecting plugs and sockets are used. The socket located directly behind the high voltage cage is for the yoke. The second socket, located on the opposite end of the chassis, is for the cable running to the VHF tuner, on-off switch, and volume control. Both sockets are visible in the photos.

The two-stage video-IF strip consists of frame-grid IF amplifier tubes, a 4EH7 and 4EJ7. A 3GK5 RF amplifier and 5HG8 mixer-oscillator are used in the tuner; these also are frame-grid tubes. The audio section uses the pentode portion of a 5KD8 as a sound IF amplifier and has changed from last year's ratio detector to a 4DT6 quadrature detector. Some unfamiliar tube types are used: 4CS6 sync separator and noise canceller, 13FD7 vertical multivibrator-output, 8FQ7 horizontal multivibrator, 17GJ5 horizontal output, and 17AY3 damper. The last two mentioned are novar types.

The only signal-type diode used is a 1N295 video detector. A 10KU8 (dual-diode pentode) serves as horizontal AFC (no selenium diode for AFC in this set) and video output.

The low-voltage power supply consists of two silicon rectifiers, functioning as a half-wave voltage doubler, furnishing 285 volts B+. Protection for these rectifiers is afforded by a circuit breaker and a 5-ohm, 15-watt surge-limiting resistor. This transformerless chassis has a 450-ma series filament string with a 27-ohm, 10-watt dropping resistor.

The main operating controls are located on the side of the chassis and are mounted on a bracket, which is attached to the tuner. Those controls on the rear of the chassis are vertical linearity, height, AGC (these three all in one compact unit), horizontal hold, and width. Also on the rear of the chassis, located on the high voltage cage, is a tube-placement chart showing tube types and functions along with a diagram showing the filament circuit path.

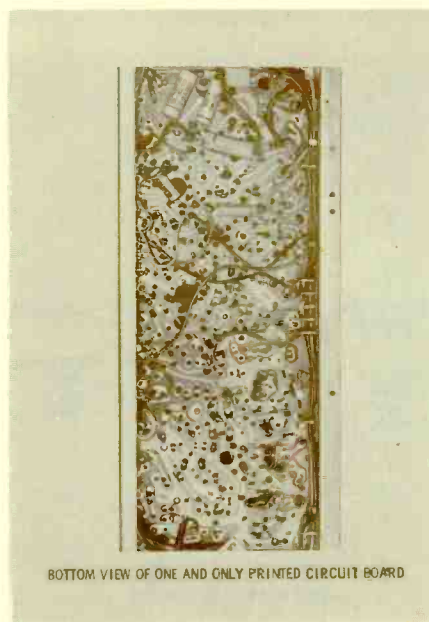
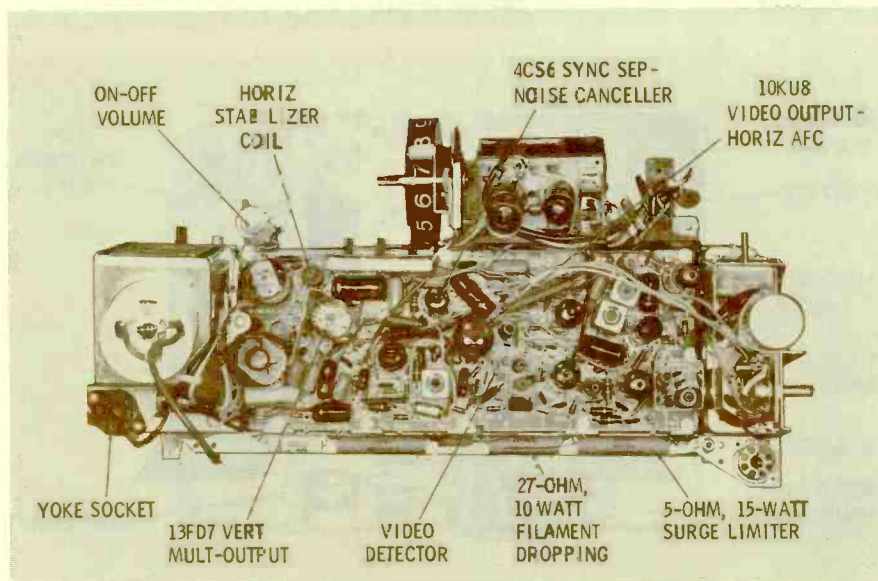

BOTTOM VIEW OF ONE AND ONLY PRINTED CIRCUIT BOARD

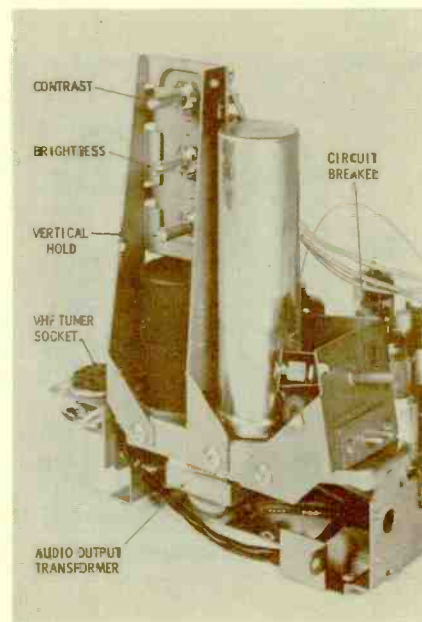

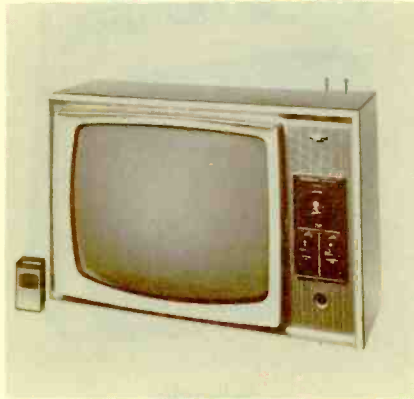

Westinghouse
Model H-P3433
Chassis V-2443-3

Shown here is an *Instant-On* 19" portable by Westinghouse, equipped with a remote-control receiver. This chassis is very similar to last year's comparable model. The chassis is hinged on the bottom corners and will swing down for servicing, giving access to the rear of the printed-circuit board and to components mounted on the rear of the chassis pan. The vertical chassis will swing down into a horizontal position when the four screws—one each in the upper and lower left- and right-hand corners—are removed.

No warmup time is required in this receiver, because a diode in the series filament string keeps the filaments always hot. When the power switch is off, the filaments receive pulsating DC supplied by the diode; when the receiver is turned on, one section of the switch places a jumper across the diode and the filaments operate from normal AC line voltage.

All operating controls, such as contrast, volume, brightness, vertical hold, and horizontal hold are located on the front of the receiver. The vertical linearity and height may also be adjusted from the front simply by removing the knobs from the hold controls and inserting a screwdriver into the hollow shaft.

Trimmers are used again this year for AGC control and horizontal frequency adjustment. The low-B+ tube lineup is exactly the same as that used last year, including the 114° 19CMP4 picture tube.

The input plug is polarized as a safety measure with this "hot" chassis. A single silicon rectifier develops B+ for this receiver and is protected by a 3-ohm, 7-watt surge-limiting resistor and a 1 3/4-amp slow-blow fuse. Other semi-conductors include a 1N295 video detector and a common-cathode dual selenium for horizontal AFC.

The remote receiver is all-transistor, and has its own power supply consisting of a step-down power transformer and a silicon rectifier to supply the negative 13 volts for transistor operation. Four of the six transistors are used as 40-kc amplifiers; the remaining two are relay drivers, one each for volume (which operates at 41 kc) and channel (operating at 39 kc). The remote receiver uses a different B-minus system than the TV chassis and the two chassis should never be connected together.

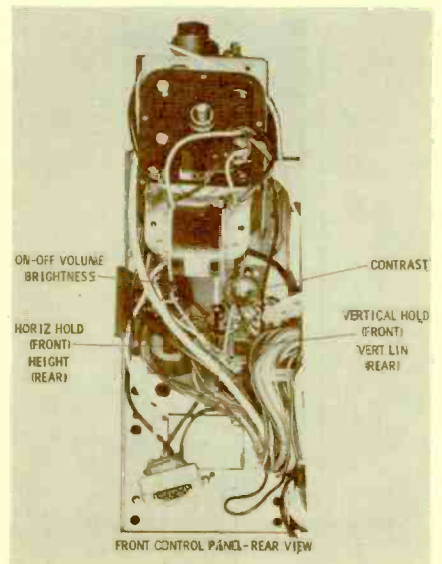
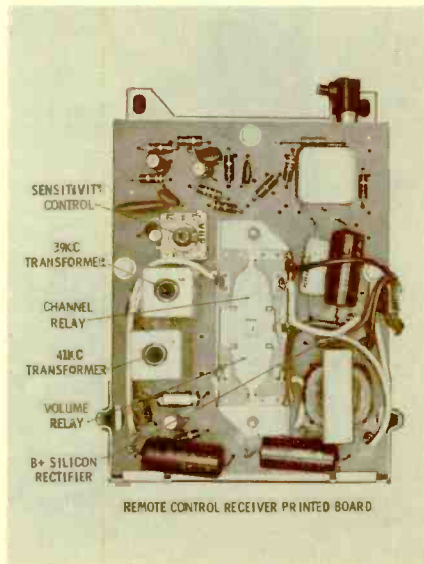
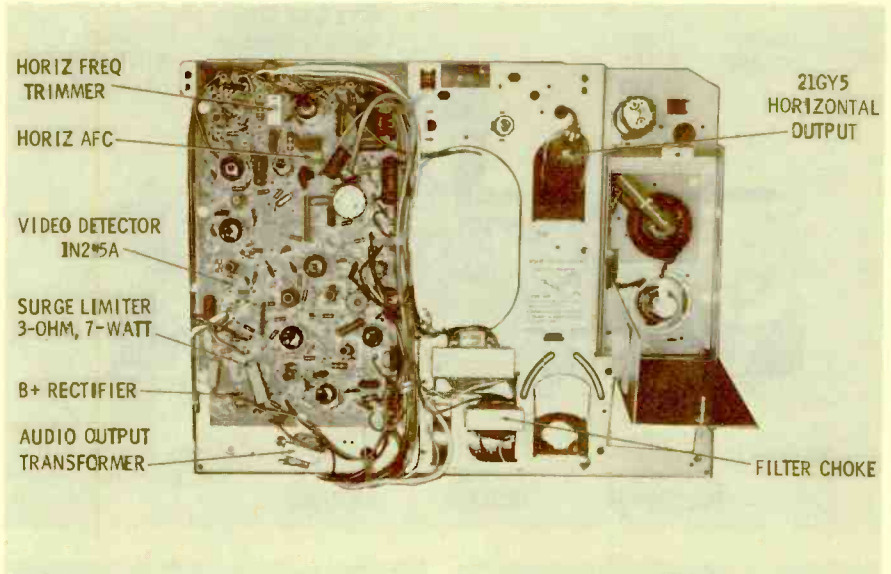
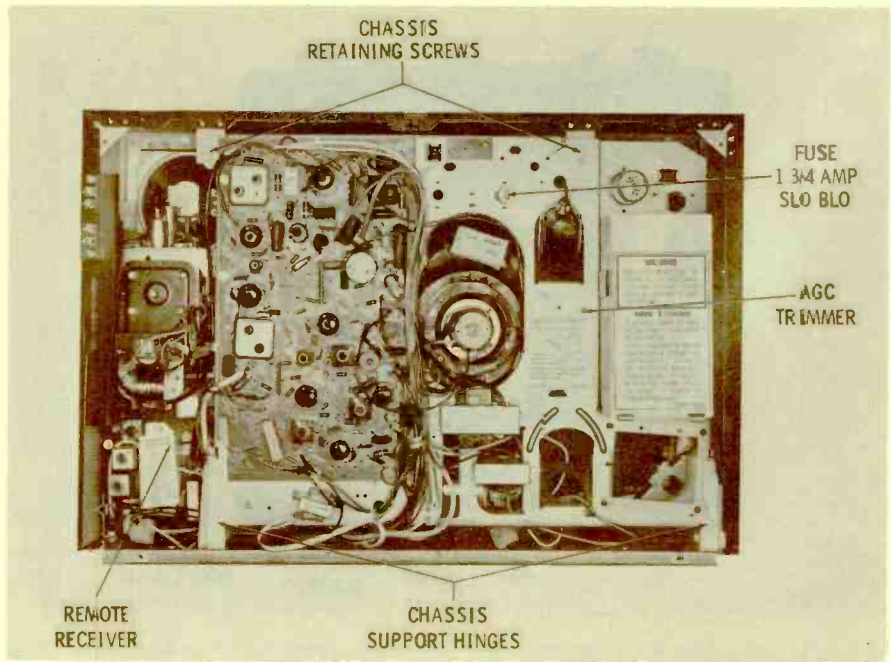

See PHOTOFAC Set 590, Folder 2

Mfr: Philco Chassis No. 12N51

Card No: PH 12N51-19

Section Affected: Pix and sound.

Symptoms: Picture intermittently overloads and pulls; buzz in sound.

Cause: AGC filter C6 in tuner shorting intermittently.

What To Do: Replace C6 (1 mfd).

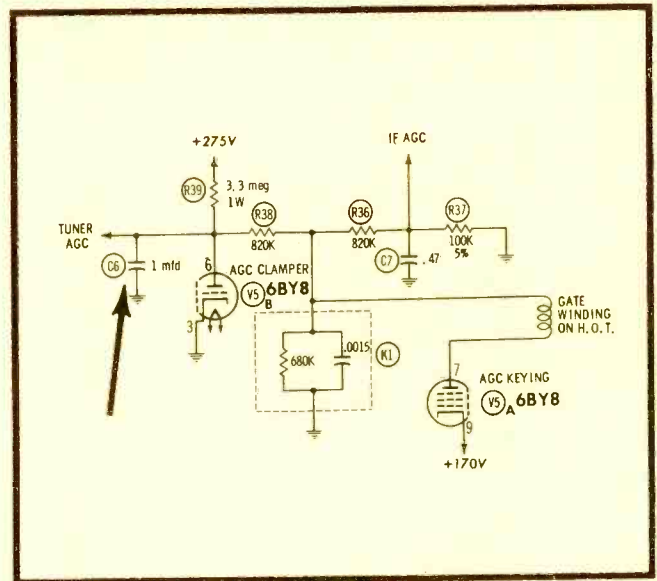

Mfr: Philco Chassis No. 12N51

Card No: PH 12N51-20

Section Affected: Raster.

Symptoms: Brightness level low with set cold; becomes normal as set warms up.

Cause: CRT cathode resistor open; heals when set warms up.

What To Do: Replace R29 (150K).

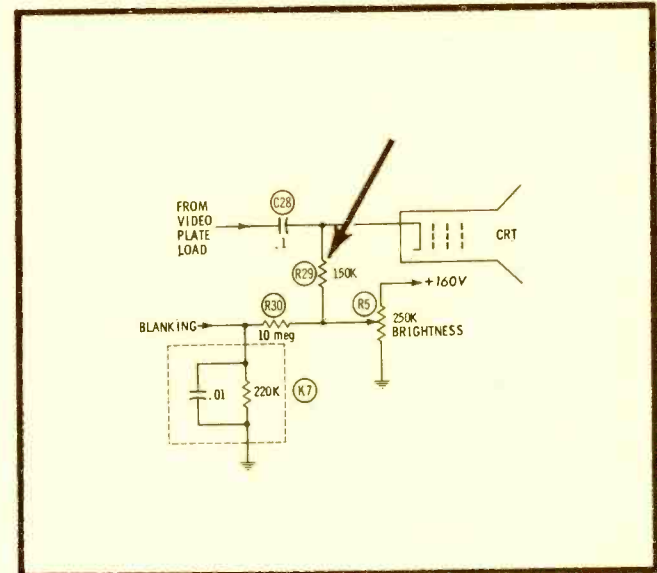

Mfr: Philco Chassis No. 12N51

Card No: PH 12N51-21

Section Affected: Pix and sound.

Symptoms: No pix or sound; raster okay.

Cause: Mixer plate coil open.

What To Do: Repair or replace mixer plate coil (located on tuner); Philco part No. 32-4629-14.

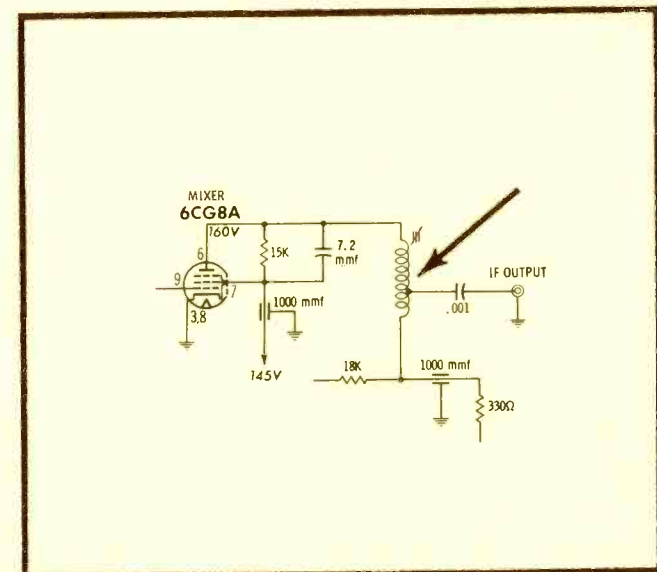

See PHOTOFAC Set 590, Folder 2

See PHOTOFACT Set 590, Folder 2

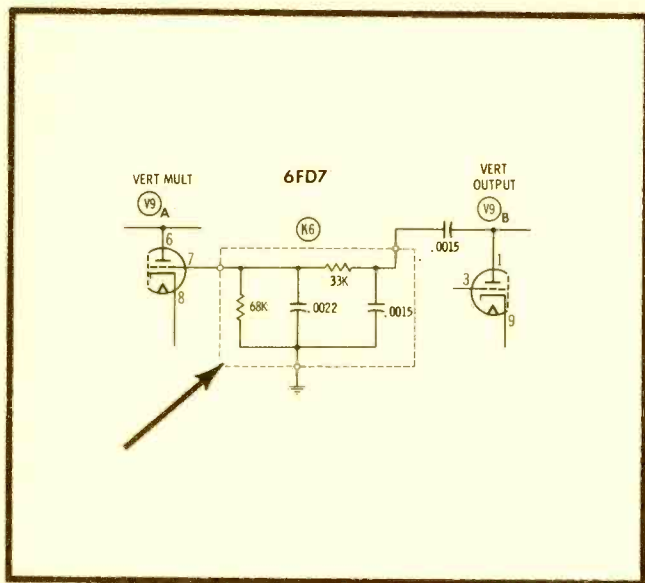

See PHOTOFACT Set 590, Folder 2

Mfr: Philco Chassis No. 12N51

Card No: PH 12N51-22

Section Affected: Raster.

Symptoms: No vertical deflection.

Cause: Capacitor in component pack shorted, shunting feedback signal to ground.

What To Do: Replace entire component pack K6; Philco part No. 30-6539-1.

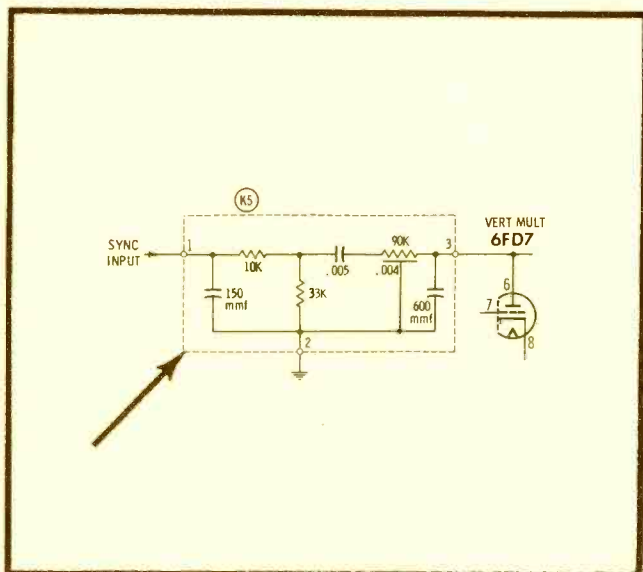

Mfr: Philco Chassis No. 12N51

Card No: PH 12N51-23

Section Affected: Pix.

Symptoms: Vertical sync unstable; horizontal okay.

Cause: Leakage in vertical integrator network K5.

What To Do: Replace entire K5; Philco part No. 30-6030-9.

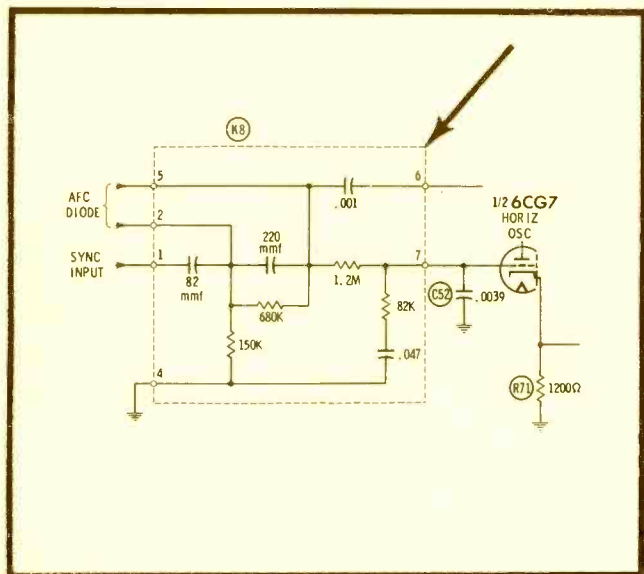

Mfr: Philco Chassis No. 12N51

Card No: PH 12N51-24

Section Affected: Raster.

Symptoms: Raster starts to come on but disappears as set warms up.

Cause: Resistor open in grid circuit of horizontal oscillator.

What To Do: Replace component pack K8.

See PHOTOFACT Set 557, Folder 1

Mfr: TraVler Chassis No. 23K6180F

Card No: TR 23K6180F-1

Section Affected: Pix.

Symptoms: Contrast always maximum; no control.

Cause: Cathode bias resistor overheated and carbonized to very low value.

What To Do: Replace R33 (180 ohms); also V4A (6AW8A).

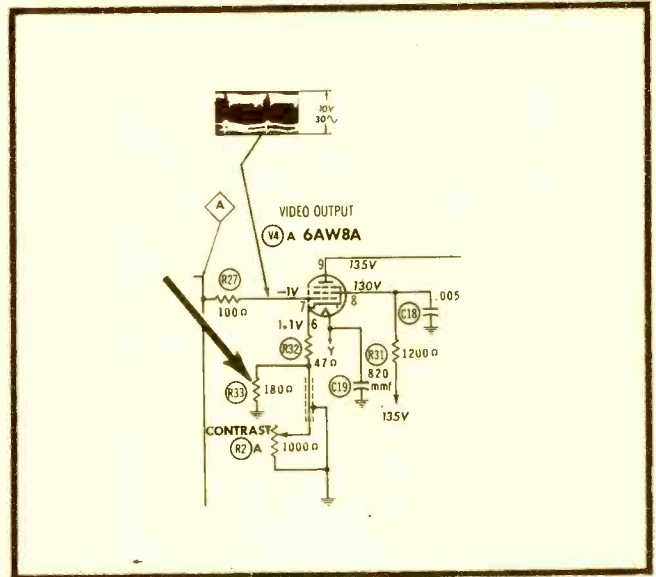

Mfr: TraVler Chassis No. 23K6180F

Card No: TR 23K6180F-2

Section Affected: Raster.

Symptoms: Vertical sweep collapses; streaks and flashes in raster; voltage fluctuates at pin 1 of V9.

Cause: Screen-grid resistor in vertical output circuit overheated.

What To Do: Replace R70 (100 ohms).

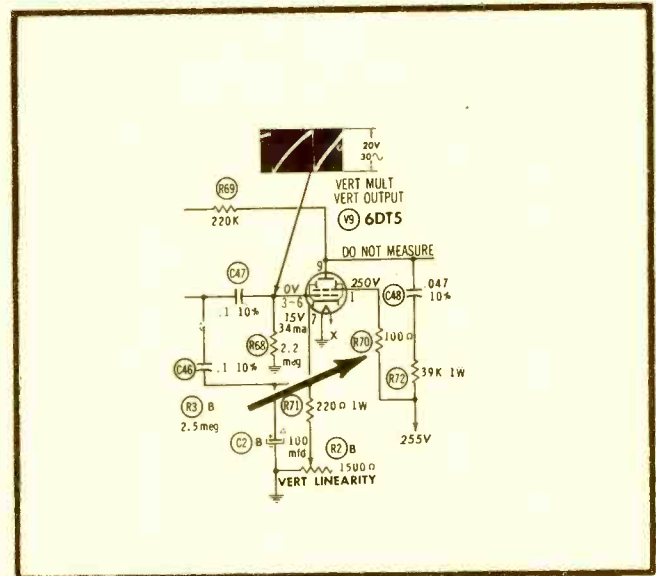

Mfr: TraVler Chassis No. 23K6180F

Card No: TR 23K6180F-3

Section Affected: Raster.

Symptoms: Height insufficient.

Cause: Vertical Multivibrator plate-load resistor increased in value.

What To Do: Replace R66 (820K).

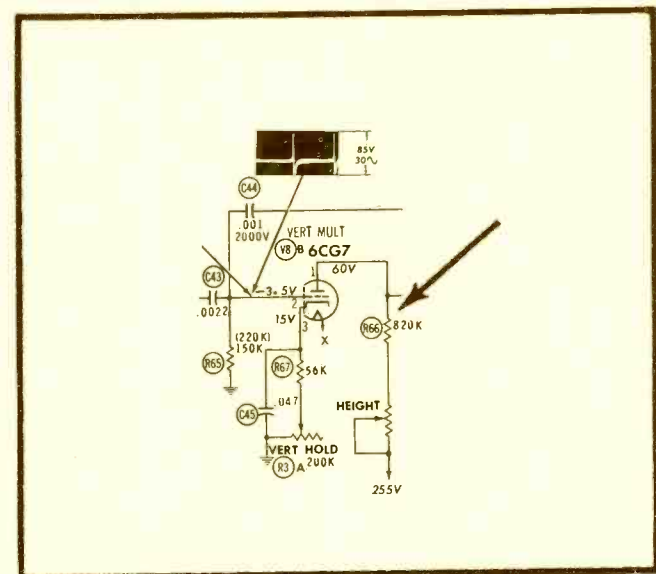

See PHOTOFACT Set 557, Folder 1

See PHOTOFACT Set 557, Folder 1

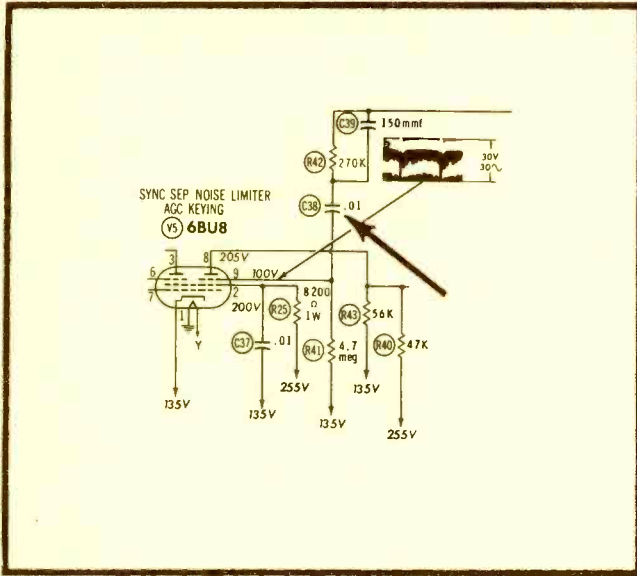

Mfr: Travler Chassis No. 23K6180F

Card No: TR 23K6180F-4

Section Affected: Sync.

Symptoms: Horizontal tearing; vertical rolling; voltage at pin 9 of V5 is too high.

Cause: Leaky coupling capacitor from video output to sync input.

What To Do: Replace C38 (.01 mfd).

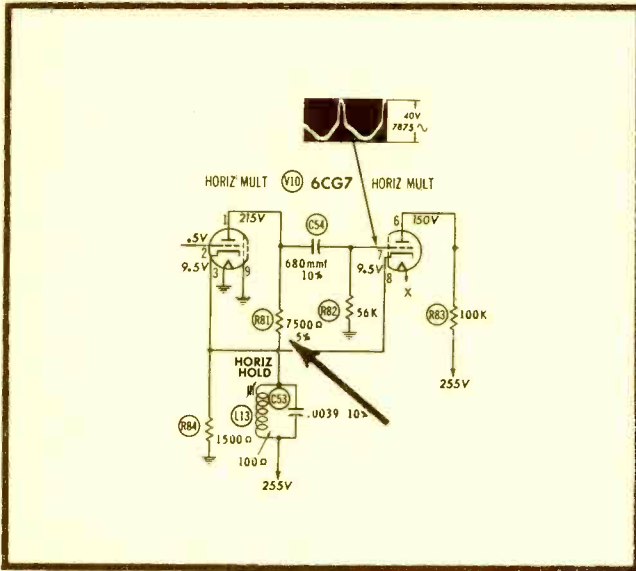

Mfr: Travler Chassis No. 23K6180F

Card No: TR 23K6180F-5

Section Affected: Sync.

Symptoms: Horizontal frequency out of range; possible blooming and squегging.

Cause: Horizontal multivibrator plate resistor changed value.

What To Do: Replace R81 (7500 ohms, 5%).

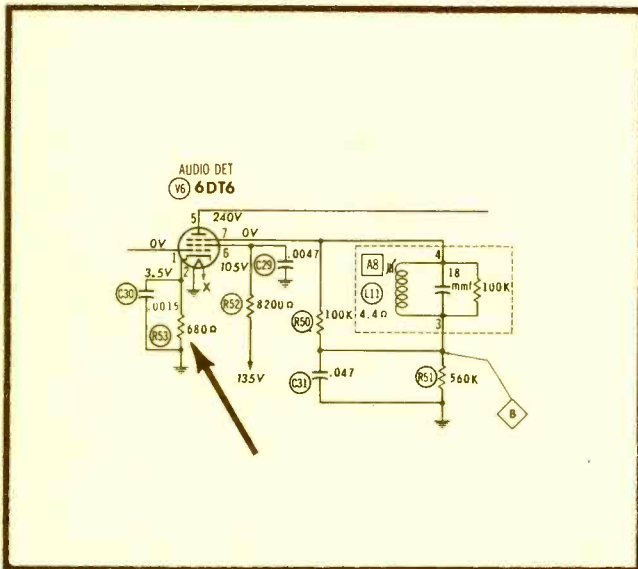

Mfr: Travler Chassis No. 23K6180F

Card No: TR 23K6180F-6

Section Affected: Sound.

Symptoms: Weak sound; then none. Voltage at pin 2 of V6 first too low, then too high.

Cause: Audio detector cathode resistor overheats and increases in value.

What To Do: Replace R53 (680 ohms).

TUNER REPAIRS

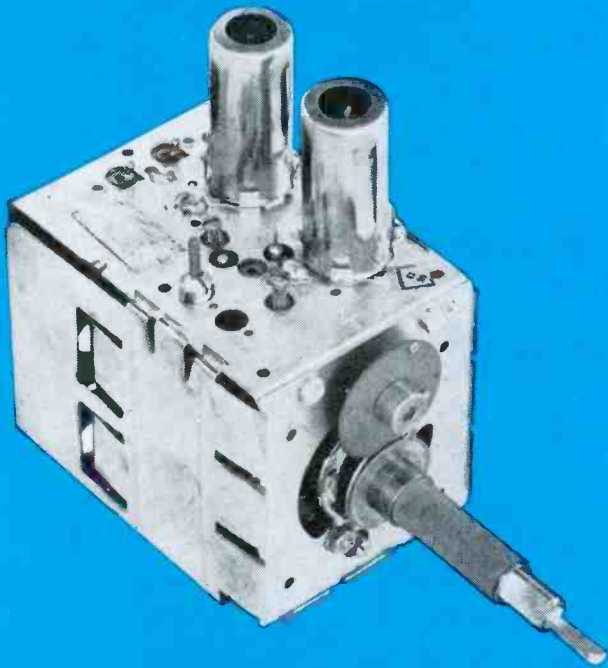

\$9.50

FOR COMPLETE OVERHAUL

**Includes ALL parts (except tubes)
ALL labor on ALL makes**

**24-HOUR SERVICE with
FULL YEAR WARRANTY**

Sarkes Tarzian, Inc., largest manufacturer of TV and FM tuners, maintains two completely-equipped Service Centers to serve YOU. Both centers are staffed by well-trained technicians in this specialized field and are assisted by engineering personnel to assure you of FAST, DEPENDABLE service.

Ⓢ Tarzian-made tuners—identified by this stamping—received one day will be repaired and shipped out the next. A little more time may be required on other makes. Every channel is checked and re-aligned per manufacturer's specifications, not just the channels which might exist in any given area.

You get a 12-month guarantee against defective workmanship and parts failure due to normal usage. Cost to you is only \$9.50 and \$15 for UV combinations, including all labor and parts except tubes. No additional costs. No hidden charges. All tuners repaired on approved, open accounts. You pay shipping. Replacements on tuners beyond practical repair are available at low cost.

When inquiring about service on other than Tarzian-made tuners, always send TV make, chassis and Model number. Check with your local distributor for Sarkes Tarzian replacement tuners, parts, or repair service. Or, use the address nearest you for fast factory repair service.



SARKES TARZIAN, INC.
TUNER SERVICE DIVISION

See your distributor, or use the address nearest you

537 South Walnut St.,
Bloomington, Indiana
Tel: 332-6055

10654 Magnolia Blvd.,
North Hollywood, Calif.
Tel: 769-2720

Manufacturers of Tuners . . . Semiconductors . . . Air Trimmers . . . FM Radios . . . AM-FM Radios . . . Audio Tape . . . Broadcast Equipment

Circle 2 on literature card

May, 1964/PF REPORTER 9

WHY risk your reputation with "just-as-good" capacitors?

When you pay little or no attention to quality in tubular replacement capacitors, you leave yourself wide open for criticism of your work . . . you risk your reputation . . . you stand to lose customers. It just doesn't pay to take a chance on capacitors with unknown or debatable performance records when it's so easy to get guaranteed dependable tubulars from your Sprague distributor!

There's no "maybe" with these 2 great SPRAGUE DIFILM[®] TUBULARS!

The ultimate in tubular capacitor construction. Dual dielectric . . . polyester film and special capacitor tissue . . . combines the best features of both. Impregnated with HCX[®], an exclusive Sprague synthetic hydrocarbon material which fills every void in the paper, every pinhole in the plastic film *before it solidifies*, resulting in a rock-hard capacitor section . . . there's no oil to leak, no wax to drip.



DIFILM[®] BLACK BEAUTY[®]
Molded Tubular Capacitors

The world's most humidity-resistant molded capacitors. Tough, protective outer case of non-flammable molded phenolic . . . cannot be damaged in handling or installation. Designed for 105°C operation with *no voltage derating*. . . will withstand the hottest temperatures to be found in any TV or radio set, even in the most humid climates.



DIFILM[®] ORANGE DROP[®]
Dipped Tubular Capacitors

A "must" for applications where only radial-lead capacitors will fit . . . the perfect replacement for dipped capacitors now used in many leading TV sets. Double-dipped in rugged epoxy resin for positive protection against extreme heat and humidity. No other dipped tubular capacitor can match Sprague Orange Drops!

For complete listings, get your copy of Catalog C-615 from your Sprague distributor, or write to Sprague Products Company, 105 Marshall Street, North Adams, Massachusetts.



WORLD'S LARGEST MANUFACTURER OF CAPACITORS

69-121-63

Circle 3 on literature card

publisher
Howard W. Sams

editor
Forest H. Belt

managing editor
George F. Corne, Jr.

associate editors
Patrick M. Craney
James M. Moore
Stuart N. Soll
Norman D. Tanner

consulting editors
William E. Burke
Joe A. Graves
C. P. Oliphant

production manager
Robert N. Rippy

circulation manager
J. A. Vitt

circulation fulfillment
Pat Tidd, Mgr.
Katherine Krise, Ass't.
Cora La Von Willard, Ass't.

art directors
Gene La Rue
Robert W. Reed

advertising & editorial assistants
Hazel Boyer
Rebecca Clingerman

photography
Paul Cornelius, Jr.

advertising sales offices
Dave Milling, advertising sales manager

midwestern
Hugh Wallace
PF REPORTER
4300 West 62nd Street,
Indianapolis 6, Ind.
AXminster 1-3100

eastern
Gregory C. Masefield
Howard W. Sams & Co., Inc.
3 West 57th Street,
New York, N. Y.
MUrray Hill 8-6350

western
The Maurice A. Kimball Co., Inc.
2550 Beverly Blvd., Los Angeles 57, Calif.
DUnkirk 8-6178; and 580 Market Street,
Room 400, San Francisco 4, Calif. EXbrook 2-3365

Address all correspondence to
PF REPORTER, 4300 W. 62nd Street,
Indianapolis 6, Indiana



Copyright© 1964 by Howard W. Sams & Co., Inc.
PF REPORTER is a trademark of Howard W. Sams
& Co., Inc. No part of PF REPORTER may be
reproduced without written permission. No patent
liability is assumed with respect to use of
information herein. Acceptance of advertising does
not in any manner signify the products, policies
and services so advertised have been approved,
endorsed or recommended by this magazine.

Subscription Prices: 1 year—\$5.00, 2 years—\$8.00,
3 years—\$10.00, in the U.S.A., its possessions and Canada.
All other foreign countries: 1 year—\$6.00, 2 years—
\$10.00, 3 years—\$13.00. Single copy 50¢; back copies 65¢.

Indexed in *Lectrodex*.
Printed by the Waldemar Press Div.
of Howard W. Sams & Co., Inc.



PF REPORTER

including Electronic Servicing

VOLUME 14, No. 5

MAY, 1964

CONTENTS

Previews of New Sets	1
Andrea Model VTT319	
Arvin Model 63K19	
Sylvania Model 19P35 (Chassis 571 Series)	
Westinghouse Model H-P3433 (Chassis V-2443-3)	
Video Speed Servicing	5
Service hints on Philco Chassis 12N51	
and TraVler Chassis 23K6180F	
Letters to the Editor	12
The Electronic Scanner	14
The Troubleshooter	21
Symfact: Reflex Sound IF	25
(Video and Sound in One Tube)	
See what happens to voltages	
and waveforms when troubles occur.	
Tape Heads—Care and Choosing	30
Important facts about magnetic recording equipment.	
Curing Blindness in FM Tuning Eyes	32
An internal look at construction and	
operation of new indicators.	
TV Waveforms Save Analysis Time	34
Become familiar with these key scope traces.	
Foiled By Poor Boost	36
Check these ways to prevent	
second-guessing odd symptoms.	
Improving Retrace Blanking	38
Effective component networks	
and their connections are shown here.	
Cures for Color Hue Troubles	46
Quicker Servicing—Learn techniques for	
troubleshooting the tint circuits.	
Custom Stereo Simplified	56
Tips on all phases of component-type	
entertainment centers.	
Receiver Extraordinary	66
Dollar and Sense Servicing—Watch out	
for this and similar business hazards.	
Notes on Test Equipment	70
Lab Reports on the GC Model 36-540 Tube Tester,	
Heath Model IG-62 Color Bar-Dot Generator,	
and Jackson Model 805 VTVM.	
TV Tubes Stock Guide	78
Product Report	88
Free Catalog & Literature Service	96
Monthly Index	on free literature card

ABOUT THE COVER

From all indications, more color receivers are now in operation than ever before. Naturally, more sets will cause an upswing in your color repair business. These are good reasons why we continue to present meaty color-servicing articles—like the one starting on page 46.

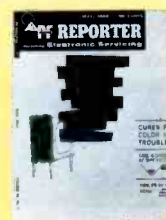

ATR PRODUCTS FOR MODERN LIVING



NOW... THE FABULOUS *G. E. COMBO



PLAYS ANYWHERE ON 110 AC OR 12V DC BATTERY CURRENT

For Auto • Boat • Plane Camps • Picnic • Trailer

ATR MODEL 12T-RME-1 INVERTER .. \$39⁹⁵

*G.E. MODEL M110Y 11" PORTABLE TV \$99⁹⁵

*Available at G.E. TV Dealers

Both Only \$139⁹⁰ Retail
THE ATR MODEL 12T-RME-1 ONLY ONE OF A FAMILY OF FAMOUS DC-AC INVERTERS

Also NOW...

HAND WIRED—NO PRINTED CIRCUITRY

ATR ALL-TRANSISTOR ULTRA COMPACT UNIVERSAL MODEL 707



Karadio
IN DASH... UNDER DASH...

Complete with variable tone control . . . R. F. stage . . . Built-in speaker . . . and External speaker jack.

ATR MODEL 707..... \$29⁹⁵ Retail



ATR ALL-TRANSISTOR ROOF-MOUNT AND IN-DASH MODELS

TRUCK

Karadio

MODEL TR-720

FITS ALL TRUCKS • BOATS • STATION WAGONS INSTANT PLAY... POWERFUL

Complete with patented antenna-yoke assembly. (U.S. Patent No. 3,087,118. Canadian Reg. 575,567)

ATR MODEL TR-720..... \$44⁹⁵ Retail



ATR "A" Battery ELIMINATOR

For Demonstrating and Testing Auto Radios—TRANSISTOR or VIBRATOR OPERATED! Designed for testing D.C. Electrical Apparatus on Regular A.C. Lines.

MAY ALSO BE USED AS A BATTERY CHARGER MODEL 610C-ELIF . . . 6 volts at 10 amps. or 12 volts at 6 amps. Shipping weight 22 lbs.

USER NET PRICE \$55⁰⁰



AUTO RADIO AND COMMUNICATION LONGER-LIFE

VIBRATORS

"The Best by Test!"



SEE YOUR ELECTRONIC PARTS DISTRIBUTOR OR WRITE FACTORY FOR LITERATURE & DEALER PRICES

ATR ELECTRONICS, INC.

Quality Products Since 1931
St. Paul, Minnesota 55101—U.S.A.

Circle 4 on literature card

Letters to the Editor

Dear Editor:

Remember your *Troubleshooter* item "If I Could Erase . . ." on page 62 of the August 1963 issue? Recently I had a somewhat similar problem in a Webcor Model 2207. An inquiry to Webcor brought the information shown in the accompanying schematic. The bulletin was issued because of numerous reports of erase-head failure. Webcor suggests replacing the components indicated whenever trouble is encountered with an erase head. I believe the same information could apply to the unit you discussed in *The Troubleshooter* column.

RONALD HOPLEY

Pittsfield, Mass.

Thanks, Ron. I'm sure our readers will be happy to get this information.

—Ed.

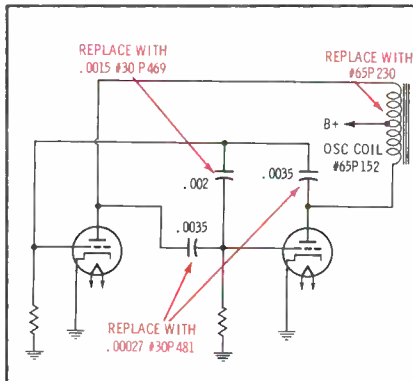

Dear Editor:

Does anyone know a good use for leftover ion traps? I've been saving them since the new straight-gun picture tubes came out. Now I wonder what to do with them.

BILL WHITE

Princeton, Fla.

The small magnet can be removed and used to help attain good purity in color sets when the set's own magnets won't quite do the job. One shop we know of uses them to hold clippings on a metal bulletin board. Any other readers have ideas?—Ed.

Dear Editor:

I couldn't help chuckling over V. W. Hodge's comments on the ten-second scope artist (January *Letters*). Apparently you agreed it was fast, not knowing you have a five-second scope artist on page 48 of the same issue.

TED CIZMAN

East Hartford, Conn.

We knew about it, Ted. And if you ever watched author Lemons work, you'd agree that he is, indeed, a scope artist. He's a perfect example of what self-training and common sense can accomplish in the field of servicing.—Ed. ▲

ALL TAPE HEADS WEAR OUT

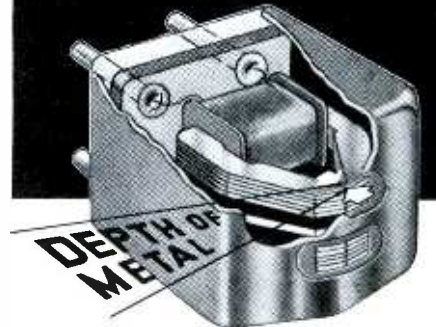

...and that means solid profit for you!

Magnetic tape itself is the real cause of head wear! The abrasive action of tape as it passes over the head face gradually wears away the depth of metal found on a new head (see above). Wear is nearly always uneven, and as the head wears out, it becomes impossible to achieve good contact between the head gap and the signal recorded on the tape. Poor tape-to-gap contact causes severe high frequency losses and erratic outputs — when this occurs, the brilliant realism of tape is lost! Head wear should NOT be permitted to reach this point — much less go beyond it to the limit where the gap actually begins to open up.

REPLACEMENT PROGRAM PUTS YOU INTO THIS PROFITABLE FIELD!

By replacing worn heads with new Nortronics professional type laminated heads, total sound response — particularly in the higher frequencies — is immeasurably improved, and your customers can once again enjoy maximum performance from their tape systems. Laminated heads have the added feature of longer life due to 50% more depth of metal at the gap than the solid-core heads. The Nortronics Tape Head Replacement Program, with "Quik-Kit" accessories, makes it possible for you to offer replacements for more than 500 different recorders . . . opens up new sales and service business! CHECK into the profit-packed Nortronics Tape Head Replacement Program NOW!

Planning to attend the May Parts Show?

Stop at Exhibition Hall Booth 3527 and see the Nortronics Head Replacement Program. We'll be looking for you!

"Music sounds best on Tape—Tape Sounds Best with Nortronics Heads!"



Nortronics

8161 10th Ave. N., Minneapolis 27, Minn.

Circle 5 on literature card

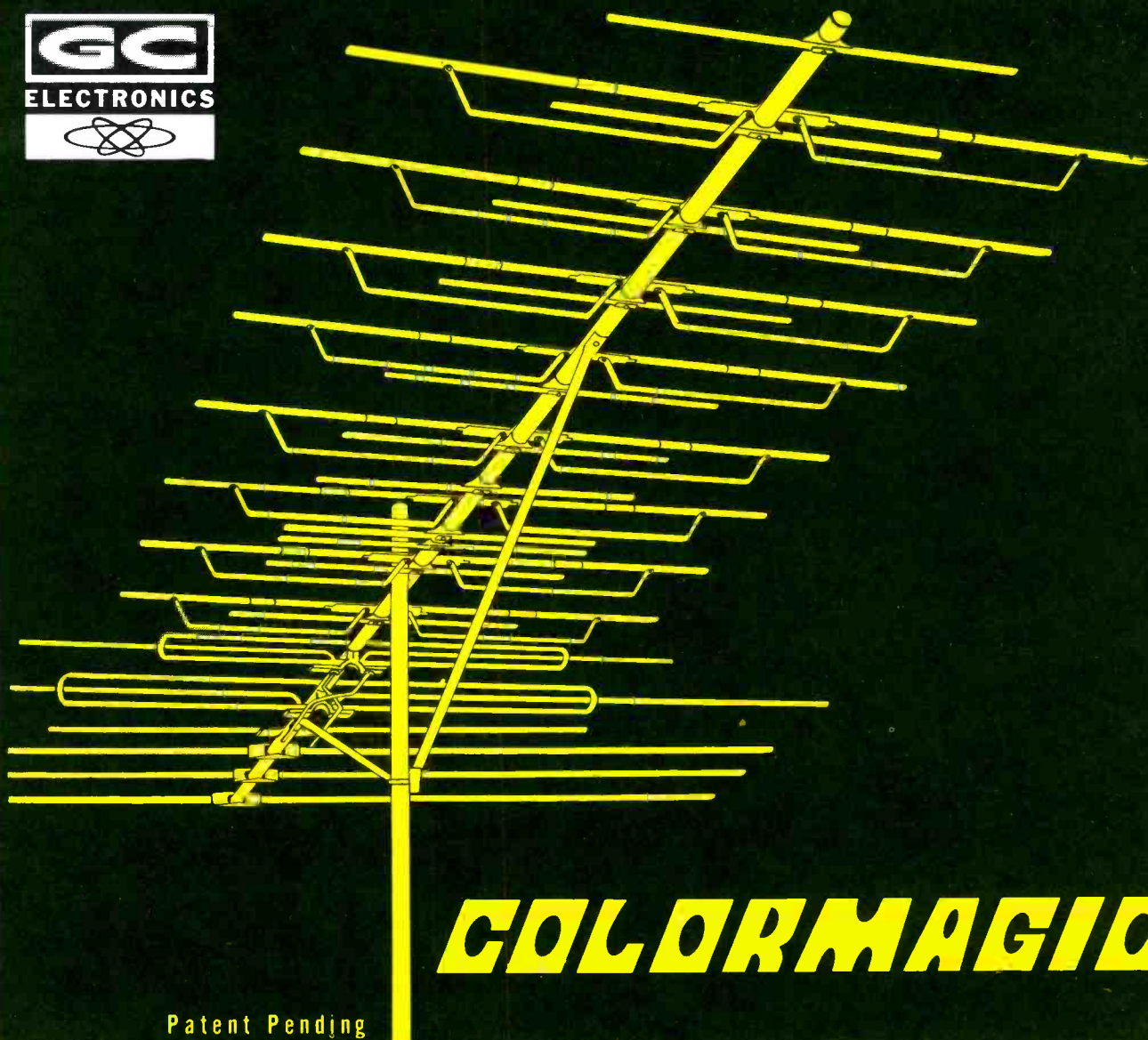

COLORMAGIC

Patent Pending

FHR FUNDAMENTAL HARMONIC RESONANCE...GC'S EXCLUSIVE DESIGN PROCESS! Colormagic elements resonate on the fundamental harmonics within both the high and low bands. Colormagic FHR outperforms the average second harmonic TV element by producing a tight, laser-linked directivity of signal...higher gain! It's in the elements!

GC "GOLD-GUARD" anodizing process guards against pitting, chipping, rust and corrosion...makes the Colormagic series the best protected, all-weather line available!

GC "SOLID-SEMBLED" construction insures quick, easy installation...rigid-lock elements snap securely into place!

Compare! Colormagic Antenna Systems offer pencil-point polar patterns...laser-linked directivity...flat plateau response curve...no traps or peaks...excellent for color or black & white TV reception.

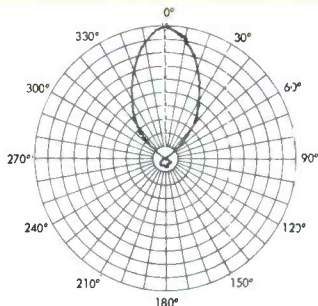

15 All-New Colormagic Combo-Couplers permit cross-direction reception of UHF-VHF-FM antenna combinations...each unit encased in high-impact polystyrene case...supplied with stainless Steel mounting strap. Complete sales program available.



See your GC Distributor! He'll fill you in on this "prestige" package. *CONSIDER THE ELEMENTS INVOLVED!* ...then GO COLORMAGIC! If not stocked locally, write us for name of Distributor nearest you.

GC ELECTRONICS CO.
Division of Textron Electronics, Inc.

Western Plant: 3225 Exposition Place, Los Angeles 18, Calif.
MAIN PLANT: 400 S. Wyman St., Rockford, Ill., U.S.A.

Circle 6 on literature card

GOOD NEWS FOR EASTERN TV SERVICEMEN...

CASTLE TV TUNER-EAST HAS MOVED TO NEW LOCATION WITH IMPROVED FACILITIES

In Long Island City near Postal Concentration Center to provide faster service by mail.

All other U.S. and Canadian Servicemen will get the same fast service from CASTLE-CHICAGO and CASTLE-CANADA.

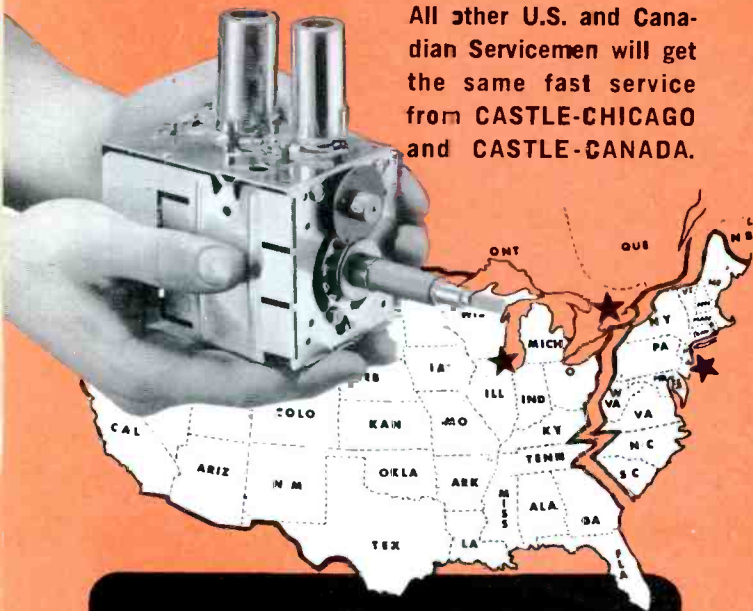

**ALL MAKES
ALL LABOR
AND PARTS
(EXCEPT TUBES) ▶
ONE PRICE**

995

THIS ONE LOW PRICE INCLUDES ALL UHF, VHF AND UV COMBINATION* TUNERS

Simply send us your defective tuner complete; include tubes, shield cover and any damaged parts with model number and complaint. 90 Day Warranty.

Exact Replacements are available for tuners unfit for overhaul. As low as \$12.95 exchange. (Replacements are new or rebuilt.)

*UV combination tuner must be of one piece construction. Separate UHF and VHF tuners must be dismantled and the defective unit only sent in.

Pioneers In TV



Tuner Overhauling

CASTLE

TV TUNER SERVICE, INC.

EAST: 41-90 Vernon Blvd., Long Island City 1, N. Y.

MAIN PLANT: 5701 N. Western Ave., Chicago 45, Illinois

CANADA: 136 Main Street, Toronto 13, Ontario

*Major Parts are additional in Canada

Circle 7 on literature card



The Electronic Scanner

news of the servicing industry

Plant Opening



A new 125,000-square-foot magnetic products plant in Camarillo, Calif. has been placed in operation by the 3M Company. Equipped to produce 3M's entire line of audio, instrumentation, and video tapes, the plant has facilities capable

of increasing the division's total production by nearly 50%. The Camarillo installation will be the largest of the company's three domestic plants and will employ from 200 to 300 persons when production is increased to capacity. It now has a work force of 50.

Company Purchase

Callins Industries, Inc. of Greenfield, Tennessee has been acquired by Whitehall Electronics Corp. The purchase, effective as of November 30, 1963, was disclosed by Fred Callins, president and founder of Callins, and Lee D. Webster, chairman of the board of Whitehall. Callins Industries specializes in the manufacture of miniature and subminiature low-voltage capacitors used in all types of transistorized electronic equipment. Whitehall, a partner company of Electro-Science Investors, is the parent firm of Texas Crystals Co. of Fort Myers, Florida, Aero Corp. of Lake City, Florida, and Master Mobile Mounts of Los Angeles, California.

Moving Day

The entire manufacturing force and equipment of Standard Grigsby, Inc., wholly owned subsidiary of Standard Kollsman Industries, Inc., has been moved to the parent firm's Aurora, Ill. plant. Sales, engineering, purchasing, prototype, short production runs, and all administrative offices and officers will be moved to Standard Kollsman's corporate offices and plant at Melrose Park, Ill. The present plant in Arlington Heights, Ill. will be sold. The move will increase production efficiencies, as over 30,000 square feet of production space and the latest production equipment will be provided.

Managerial Appointment

Lee R. Zemnick has been named manager of the Community Systems Division of Jerrold Electronics Corp., according to Robert H. Beisswenger, Vice President and General Manager. Mr. Zemnick's responsibilities include engineering and selling Jerrold's CATV equipment and systems — particularly the "Turn-Key Systems."

Still Going Strong

The Electronic Marketing Division of Essex Wire Corp. established by Essex late last year, is the exclusive national agent for the long-established catalog lines of "Chicago" and "Stancor" transformers. More than 2,000 types of Chicago-Stancor catalog transformers will be stocked for immediate delivery through authorized Stancor distributors.

Tape Promotion

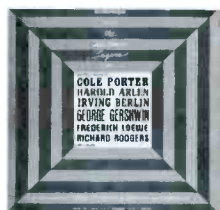

With every 7" reel of Type 2431T Audiotape from the dealers of Audio Devices, Inc., the tape purchaser will receive, for one additional dollar, a 55 minute, four-track stereo recording of the works of such composers as Gershwin, Porter, Arlen, Berlin, Loewe, and Rodgers. The album, "The Melody Lingers On," is attractively packaged in a startling box of orange and magneta.



There's more profit in your hands with ITT tubes

Yes, you can pocket extra profit when you stock ITT receiving tubes . . . with full confidence that you are giving your customers the finest replacement tubes money can buy.

Your customers will appreciate it, too, because they know ITT's international

reputation for quality and leadership in electronics.

ITT can provide this "extra value" of finest quality at higher profit margins because ITT products are available from 154 factories and laboratories in 24 countries. Brands without these world-

wide resources cannot offer you these advantages.

Ask your local distributor about ITT tubes. He'll give you *extra profit* details.

ITT Distributor Products Division, International Telephone and Telegraph Corporation, Box 99, Lodi, New Jersey.

Circle 8 on literature card

ITT

NEW FROM
JFD

The Dramatic Products and You Need for Full Profits in

**Nineteen months ago JFD made history
Now meet the new TV antennas, converters, and**

*MODEL	LIST
LPV17	\$59.95
LPV14	49.95
LPV11	39.95
LPV8	29.95
LPV6	21.95
LPV4	14.95

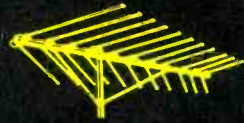

Today begins the JFD 1964-1965 campaign of sales events and product introductions!

Exciting new Log-Periodic antennas from the JFD Antenna Research and Development Laboratories with the engineering advances to help you make the sales others can't in the complex new VHF/UHF/FM age.

**NEW FROM THE NOTED JFD CHAMPAIGN, ILLINOIS LABORATORIES —
NEW LOG-PERIODIC LPV ANTENNAS FOR ANY AND ALL BANDS... EVERY RECEPTION NEED!**

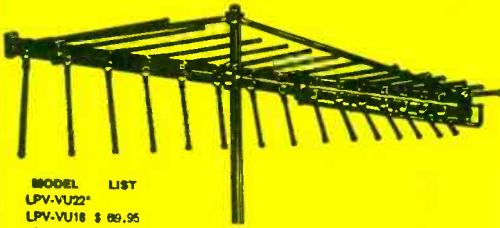

MODEL	LIST
LPV-VU22*	
LPV-VU18	\$ 69.95
LPV-VU15	59.95
LPV-VU12	49.95
LPV-VU9*	

Model LPV-U15 (suburban-fringe) shown

*To be announced

NEW! THE FIRST COMBINATION VHF/UHF/FM ANTENNA —THE LOG-PERIODIC ALL-VU - WITH SINGLE LEAD-IN

Tomorrow's antenna today. The most advanced application of the Log-Periodic formula—receives all FCC authorized television channels (VHF 2 to 13 and UHF 14 to 83) plus all FM/FM Stereo frequencies. This is the first single all-channel antenna using a single down-lead to achieve this performance breakthrough! (So advanced it includes VHF-UHF Splitter to provide separate lead-ins to today's VHF, UHF, and FM stereo set terminals.) Available in five gold alodized aluminum models.

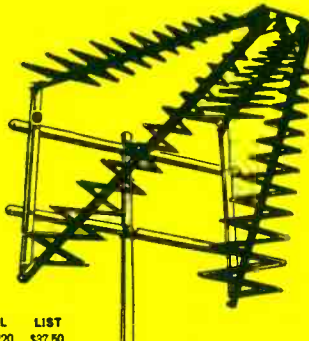

MODEL	LIST
LPV-ZU20	\$37.50
LPV-ZU10	17.95

Model LPV-ZU20 (deep fringe) shown

NEW! LOG-PERIODIC ZIG-A-LOG FOR "PROBLEM" UHF AREAS

This exotic all-new UHF series obsoletes bulky parabolics and wind-prone stacked bowtie-reflectors. Packs more long-distance pick-up sensitivity per element. Another ahead-of-the industry antenna advance that puts you in command of new UHF antenna business in your town. In two gold alodized aluminum models.

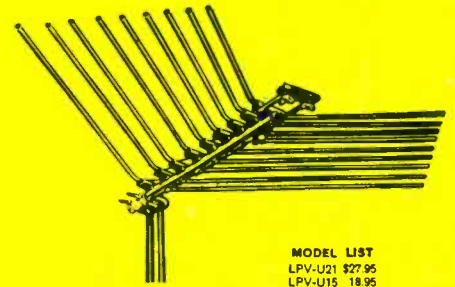

MODEL	LIST
LPV-U21	\$27.95
LPV-U15	18.95
LPV-U9	12.50
LPV-U5	6.95

Model LPV-U9 (local and suburban) shown

NEW! LOG-PERIODIC LPV FOR UHF CHANNELS 14 TO 83 (PLUS VHF 7 TO 13)

Developed by the same team of scientists and engineers that broke tradition with the JFD VHF Log-Periodic LPV. Delivers the high-gain, ghost-free signal needed in complex UHF for best channel 14 to 83 reception—plus channels 7 to 13. Available in four gold alodized solid aluminum rod, models—

BACKED BY EXCLUSIVE EXHIBITION AT THE NEW YORK WORLD'S FAIR HOUSE OF GOOD TASTE!

In 1964 and 1965, JFD puts the prestige and drawing power of the biggest attraction of all time behind every JFD Log-Periodic LPV TV/FM antenna you sell—the New York World's Fair!

This powerful new marketing force will be at work building record Log-Periodic LPV Sales and Profits for you!

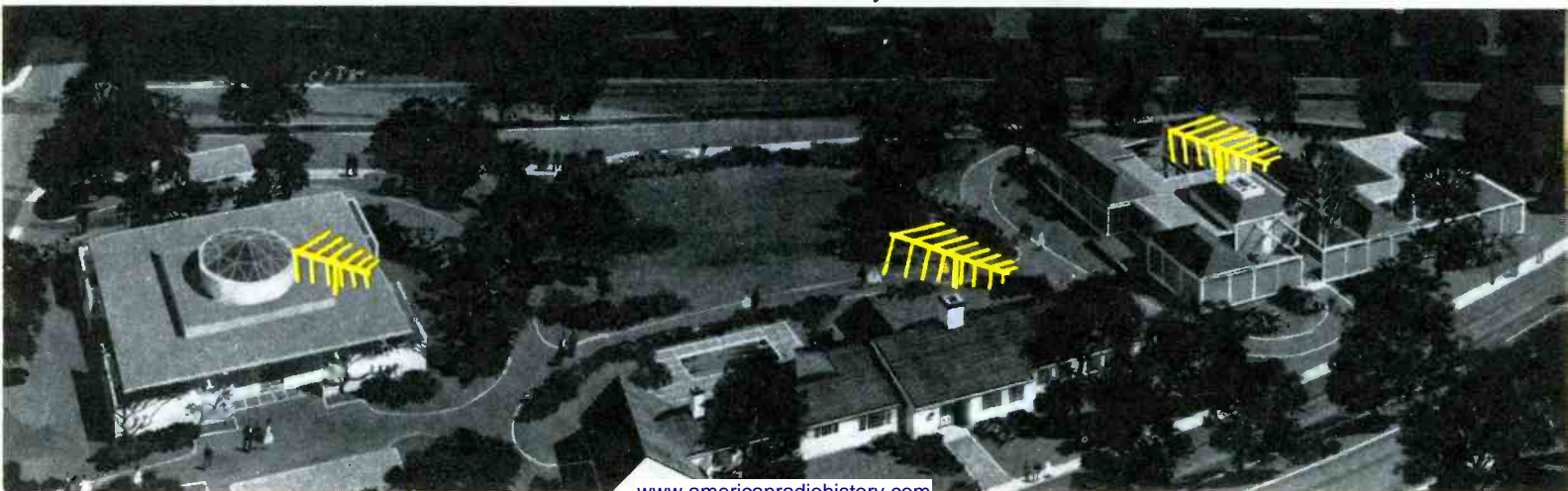

Promotions Today's VHF, UHF, FM Markets!

with the revolutionary Log-Periodic LPV antenna*...
amplifiers that will make new history for JFD dealers and distributors!

All-new precision engineered UHF converters, antennas, TV amplifiers for VHF, UHF and FM that are as powerful as they are saleable.

Backed up by the greatest promotion ever—the JFD World's Fair Festival!

This is the kind of extra-ordinary product and promotion support you can expect as a member of the creative JFD marketing team.



Utahpans Presented by United States Fair
© 1961 New York World's Fair 1964-1965 Corporation

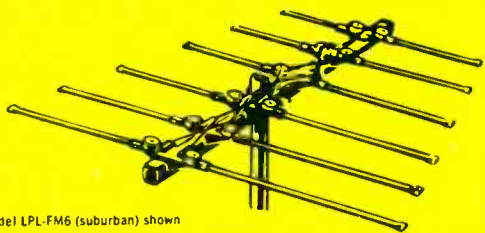

Model LPL-FM6 (suburban) shown

MODEL	LIST
LPL-FM10	\$49.95
LPL-FM8	39.95
LPL-FM6	29.95

NEW! THE FIRST FM/FM STEREO LOG-PERIODIC

Makes even smallest high-fi system pour forth FM sound as it was never heard before. Features unique new Log-Periodic LPL dipole that outperforms FM antennas twice the size. Another new antenna breakthrough through JFD engineering leadership. Available in three area-engineered gold alodized aluminum models. Model LPL-FM8, for 28% more gain, model LPL-FM10 for 52% more gain than the best 10 element yagi.



MODEL	LIST
VF2	\$39.95
VF1	34.95
FM1	34.95
UH1	39.95
NV2	\$39.95



NEW! ANTENNA AMPLIFIERS FOR VHF, UHF AND FM

All-new solid state circuitry for drift-free, distortionless amplification—extra reliability. Mounts on any antenna crossarm for up to 16 db of additional noise-free gain. Uses printed circuitry that is sealed against weather effects. AC power supply, located at set, also serves as multi-set coupler. "OFST" Offset Free-Space Terminals insure maximum signal transfer. Fully warranted. Available in VHF, UHF, and FM/FM stereo models. In both transistor and Nuistor models.

MODEL	LIST
CR2-J	39.95
CR1-J	29.95



Model CR2-J (channels 14 to 83) shown

NEW! UHF CONVERTERS

The first all-transistorized UHF converter. Lower noise, higher reliability, excellent 300 ohm impedance match—outperforms any tube-type converter. Absolutely drift-free because of its heat-less solid state circuitry. Instant start-up. Consumes less power than conventional tube-types. Elegantly styled. Dial light illumination on UHF channel scale for convenient tuning. Only 6" X 7" X 2 1/2". In two models

PLUS!—

Every JFD VHF, UHF or VHF-UHF Log-Periodic LPV you buy between March 1, 1964 and August 31, 1965 earns you valuable JFD Fair Festival Certificates which you can:

1. Trade in for FREE World's Fair Adult Admission Tickets (worth 150 points) or...
2. Trade in for FREE 3-day, 2-night Fair Week-ender holiday (worth 3,000 points) or
3. Redeem for \$1.25 cash for each 150 points, from JFD.

LICENSED UNDER ONE OR MORE OF U. S. PATENTS 2,958,081; 2,985,879; 3,011,168; 3,108,280 AND ADDITIONAL PATENTS PENDING IN U.S.A. AND CANADA. PRODUCED BY JFD ELECTRONICS CORPORATION UNDER EXCLUSIVE LICENSE FROM THE UNIVERSITY OF ILLINOIS FOUNDATION.

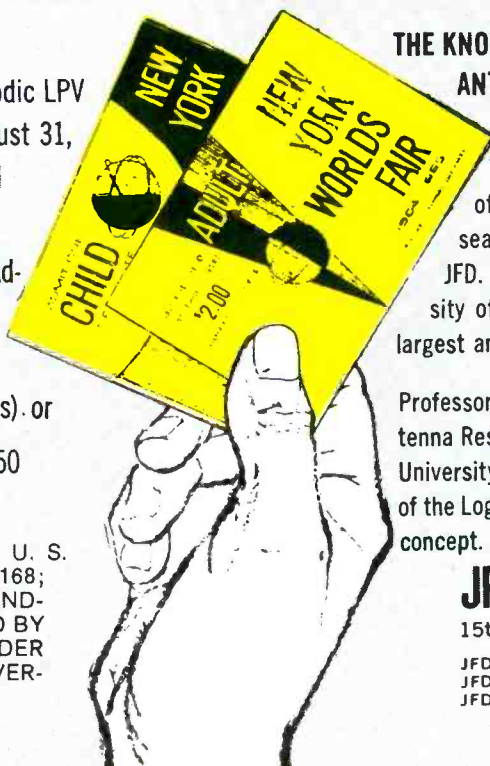

THE KNOW-HOW OF THE WORLD'S NEWEST AND FINEST ANTENNA LABORATORIES IS BUILT INTO EACH JFD LPV ANTENNA YOU SELL!

The Log-Periodic concept is the result of six years of intensive electronic studies at the Antenna Research Laboratories of the University of Illinois and JFD. Located in Champaign, Illinois (home of the University of Illinois), the vast new JFD research center is the largest and most complete of its kind.

Professor Paul Mayes of the Antenna Research Laboratories of the University of Illinois, the originator of the Log-Periodic V-dipole antenna concept.



JFD ELECTRONICS CORPORATION

15th Avenue at 62nd Street, Brooklyn, N. Y. 11219

JFD Electronics-Southern Inc., Oxford, North Carolina
JFD International, 64-14 Woodside Ave., Woodside 77, N. Y.
JFD Canada, Ltd., 51 McCormack Street, Toronto, Ontario, Canada

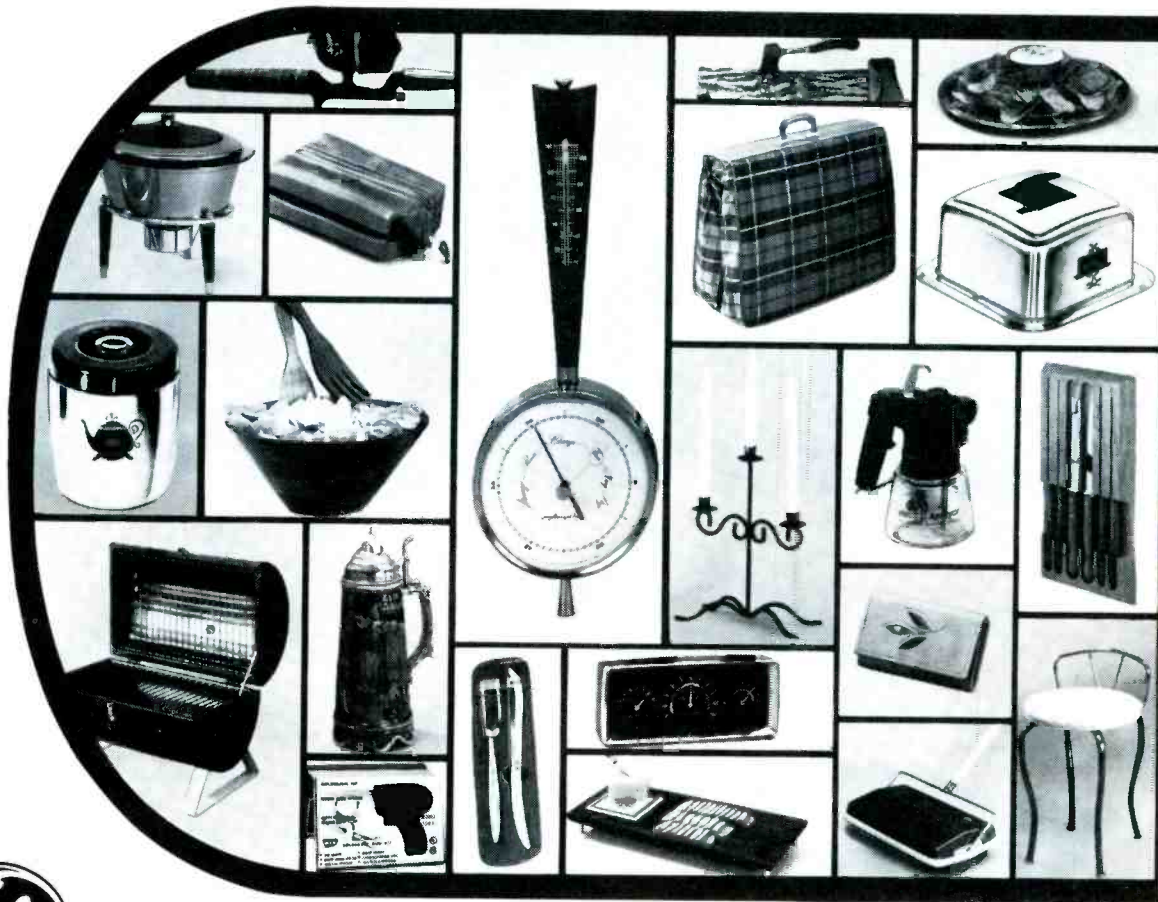

pleasure pak

**DISTRIBUTOR SALES
OWENSBORO, KENTUCKY**

Pleasure-Pak COUPON
EXPIRATION DATE: JULY 15, 1964

This Pleasure-Pak coupon is valid for merchandise from this holder on the schedule outlined below when properly validated by your distributor.

3 Pleasure-Pak Coupons = 1 "B" Award
 2 Pleasure-Pak Coupons & \$3.00 = 1 "B" Award
 1 Pleasure-Pak Coupon & \$6.00 = 1 "B" Award

Keep this coupon and redeem it prior to the expiration date for your choice of Pleasure-Pak Awards.

This offer is valid in any state, county or municipality where use is prohibited, taxed or otherwise restricted. Cash value is one (1) mill per cent.

Pleas
 GENER:
 4200 F.
 OR Local
PLEASE SH
 Date:
 H444 AM
 6271 5214
 the following

 I enclose.....

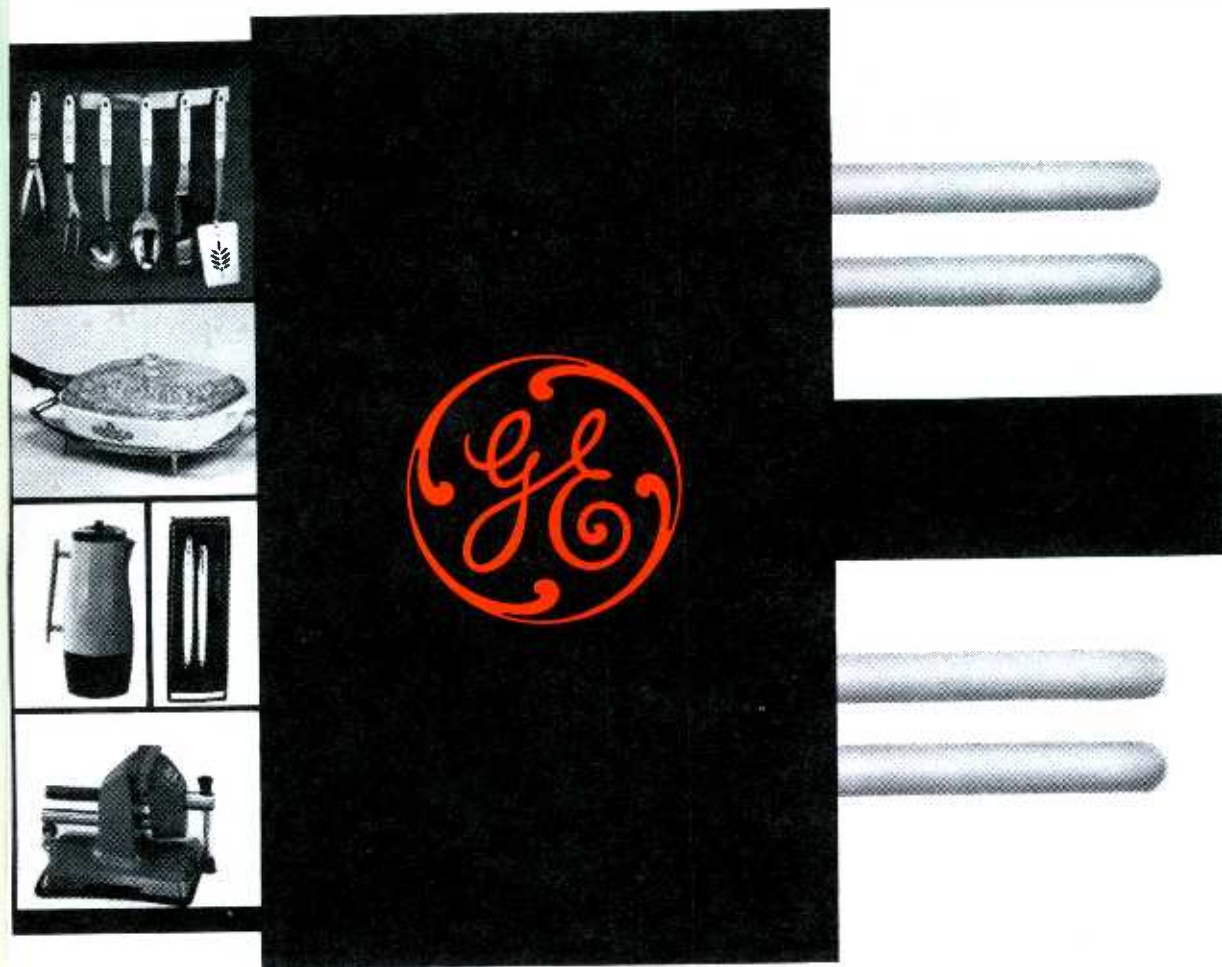

**Get in on General Electric's
Pleasure Pak program**

The purchase of General Electric tubes makes you eligible to receive valuable merchandise during G-E's Pleasure Pak program. Imported musical steins, luggage, barbeque grills, tools, sporting equipment, carving sets and tableware and many other things can be yours at a tremendous discount or *even free*. All of these are well-known brand name products or special items that are not normally for sale.

**Make your own selections
from G-E Pleasure Pak books**

You're not limited to just one or two items. General Electric Pleasure Pak books contain 48 handsome "prizes," accurately illustrated and described. When you buy G-E tubes, you earn one of these books. Then it's *your choice* of the merchandise inside.

**Ask your G-E distributor
how to earn Pleasure Pak books**

Your General Electric receiving tube distributor has a supply of Pleasure Pak books. The back cover of each book is a certificate redeemable for the merchandise shown in the book. Ask your distributor how to get them. The Pleasure Pak program is limited to April and May, 1964. Better stock up on G-E tubes NOW!

Progress Is Our Most Important Product

GENERAL  ELECTRIC

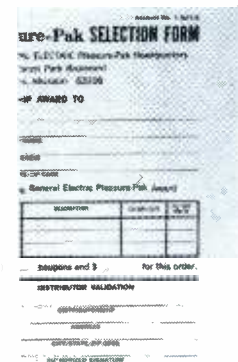

Circle 10 on literature card

New! BUSS SPACE SAVER PANEL MOUNTED FUSEHOLDER

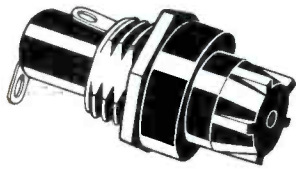

Actual Size
Only 1 5/8 inches long . . .
Extends just 29/32 inch
behind front of panel

- Fuseholder takes 1/4 x 1 1/4 inch fuses. Converts to 9/32 x 1 1/4 inch fuses simply by changing screw type knob. Holder is rated at 30 amperes for any voltage up to 250.
- Also available in military type which meets all requirements of MIL-F-19207A.

BUSS

Write for BUSS
Bulletin SFH-1C

BUSSMANN MFG. DIVISION, McGraw-Edison Co., St. Louis 7, Mo.

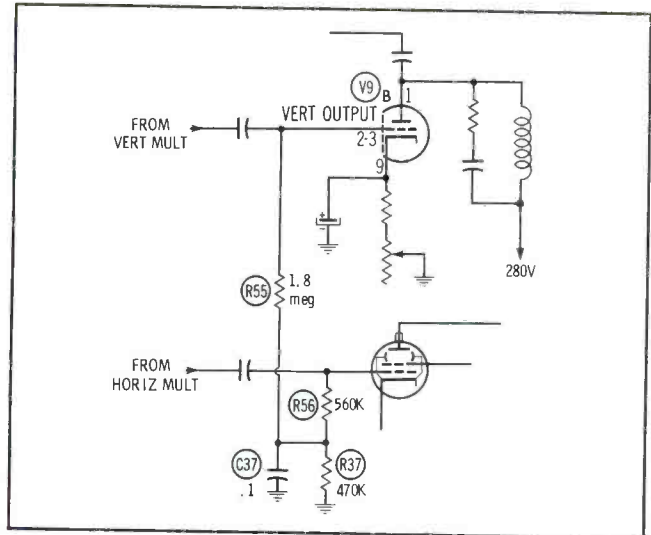

has warmed up—normally 20 to 30 minutes. Then it's fine. I have tried everything I could think of, including Philco change bullets, without success. I have changed tubes and checked waveforms until I'm at the end of my rope.

DUTCH MEYER

Missoula, Montana

This sounds like a thermal problem. Normal troubleshooting procedure for troubles of this type is to hold a soldering iron near various frequency-sensitive components (such as unit K4) while noting the effect on the picture. An alternate method to use after the set has warmed up is to use a freeze spray on suspected components. There is one slightly interrelated factor in this particular circuit. Bias for the vertical output is taken from a voltage divider in the horizontal-output grid circuit. Slow buildup of horizontal drive could be your problem. Elim-

BUSS: 1914-1964, Fifty years of Pioneering....



The Troubleshooter

answers your servicing problems

Rolling Picture

I have an RCA Chassis KCS128 with vertical trouble and I have to call for help. When the receiver is first turned on, I get poor vertical deflection plus rolling at a rapid rate. Deflection is short—about 4" at top and bottom, at first. After a minute or so, the picture stops rolling and expands to normal. In an hour or so, the bottom of the picture begins to creep up. I have used a signal substitutor along the vertical section and have substituted almost every component with no hint as to the trouble.

AUSTIN D. MILLER

Bronx, New York

This chassis is covered in PHOTOFAC Folder 461-1. A look at the schematic leads me to believe the cause of your trouble is the printed control board labeled R6. This is a triple unit containing the AGC, height, and vertical linearity controls. This unit sometimes becomes intermittent after a period of time, with the height being affected first. The replacement units now available from your local parts distributor are an improved version designed to minimize failures of this type.

Hot and Cold

I have a Philco Model G4242M which has been in and out of my shop since the set was purchased. It has had the same trouble every time. The picture rolls vertically until the set

BUSS Sub-Miniature PIGTAIL TRON FUSES

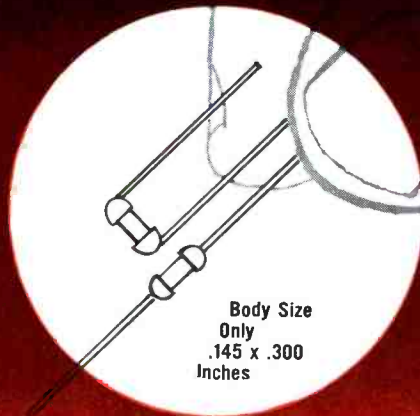

Body Size
Only
.145 x .300
Inches

Tron fuses are so small they can be used as an integral part of circuit—to protect miniaturized devices—or gigantic multi-circuit electronic devices, without sacrifice of space.

They are hermetically sealed for potting without danger of sealing material affecting operation and have high resistance to shock or vibration. Operate without exterior venting. May be teamed with other components in replaceable unit.

BUSS

Write for BUSS
Bulletin SFB.

BUSSMANN MFG. DIVISION, McGraw-Edison Co., St. Louis 7, Mo.

Circle 11 on literature card

Save Assembly Time with Quick-Connect Terminals on BUSS Fuseholders

Eliminates soldering. Permits use of pre-assembled harness. Reduces assembly time.

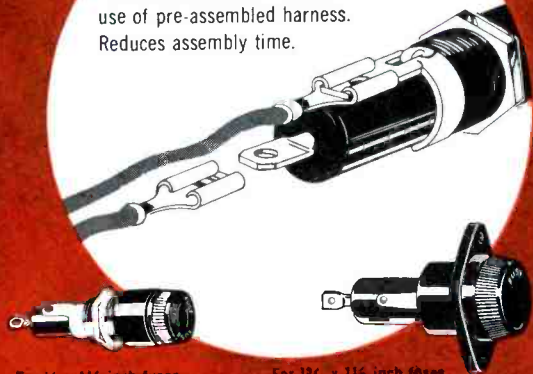

For 1/4 x 1 1/4 inch fuses
Series HJ, HK, and HLD

For 1/2 x 1 1/4 inch fuses
Series HPC

BUSS

Write for BUSS
Bulletin SFB.

BUSSMANN MFG. DIVISION, McGraw-Edison Co., St. Louis 7, Mo.

must fix this set since it belongs to my commanding officer.
SGT. JAMES MANSER

New York, New York

You are probably right in checking for trouble in the 3BU8 circuit. The intermittent 250-volt reading at the plate indicates that the sync section of this tube is being cut off at these times. The reason is probably tied in with the unusually low DC voltage at the screen grid (pin 9). This should go less positive when signal is applied, but not as low as 55 volts. It is unlikely that trouble exists in the line from the video amplifier. Faults here would tend to increase the pin-9 voltage instead of decreasing it. Check for leakage from pin 9 to ground. There is also a possibility of trouble in the noise-limiter circuit at pin 7, since this control grid is common to both stages. Too much bias on this grid will tend to cause erratic conduction. The September and October 1962 Symfact gives a lot of information on this circuit.

Pulley Pulling

Our problem is an RCA record changer Model RP20502 that will not come up to proper speed. We know the idler wheels need to be changed, but how do we get them off without "goofing up the works?" Visual observation fails to show how to remove them. Can you also give replacement part numbers?

ED KARL

Tacoma, Washington

The RCA Model RP 205 02 changer is covered in PHOTOFAC T Folder 358-10. There are three ways idler pulleys can be fastened. They can be mounted on a plate by means of a spindle extending through the plate and held by a spring clip. Another type slides down over a post and is held in place by a spring clip on top. The third type, which I think you'll find in the RCA changer, also slides down over a post but is held in place by an internal snap-ring. A firm upward pull will release this type. Replacement also requires a firm push. Part numbers for the various replacement idler pulleys will be found in the PHOTOFAC T Folder.

...New Developments in Electrical Protection

nate this suspect by disconnecting R55 from the voltage divider and using a bias box as a substitute. For the voltage to use, measure the output of the voltage divider before disconnecting R55 and while the set is operating perfectly.

'BU8 Revisited

I have an Admiral Model PL17F31B in my shop for repair. The trouble is a horizontal tearing which starts at the top and drifts about halfway down the screen. At times, the top of the picture "christmas trees." The horizontal lock control is very critical and the hold control has very little range. Wave-shapes, resistances and voltages are all normal except on the 3BU8 stage. Pin 9 on this tube measures 55 volts, but according to PHOTOFAC T Folder 471-1 it should be 95 volts. Pin 8 sometimes reads 250 volts, but at other times reads normal. I have substituted parts in the sync-separator circuit and can find nothing wrong. The horizontal phase-detector circuit also checks good. I'm lost—any advice would be appreciated. I

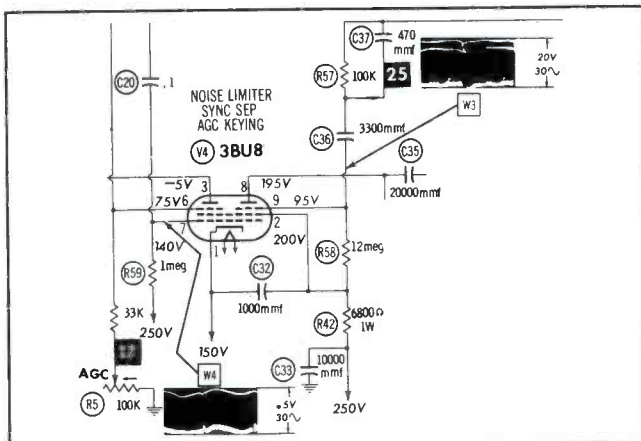

signal or visual indicating fuses

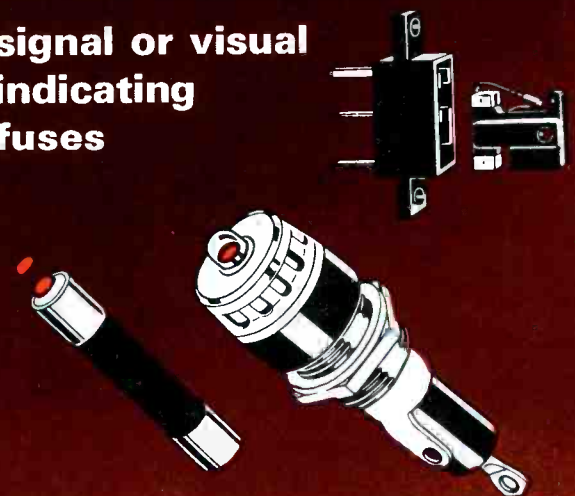

Indicating fuses provide quick, positive identification of a faulted circuit. There are fuses that give a visual signal; fuses that activate an alarm;—and fuses that give a visual signal and activate an alarm.

BUSS

Write for BUSS
Bulletin SFB.

BUSSMANN MFG. DIVISION, McGraw-Edison Co., St. Louis 7, Mo.

Circle 11 on literature card

NEW TV and FM distribution designed specially



MODEL A-430
4-tube, 30 DB GAIN
distribution amplifier
\$84.95 list
Operates 1-50
TV-FM outlets,
100 with preamp.

3 New Winegard
Distribution Amplifiers
to Run 2 Sets, 200 or MORE

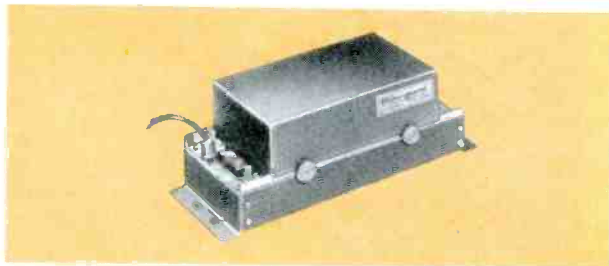

MODEL A-215
2-tube, 15 DB GAIN / general purpose TV-FM Amplifier
\$44.95 list

■ Provides 15 DB gain for home systems, small motels or apartment buildings. Drives up to 20 TV-FM outlets or line tap-offs . . . up to 40 with preamp. 30 volts AC is available by preamp switch at input jack to operate Colortron or Stereotron antenna directly from A-215 without extra power supply.

SPECIFICATIONS—Tubes: two 6HA5. **Gain:** +15db. **Bandpass:** 50-110MC, 170-220MC. **Response:** flat, ±.25db per 6 MC channel. **Noise Figure:** 3.7db lo-band, 5db hi-band. **Max. Signal Input:** 350,000 microvolts. **Max. Signal Output:** 2V. **Input Impedance:** 75 or 300 ohm. **Output Impedance:** 75 or 300 ohm. VSWR input and output better than 1.5 to 1. Two C-59 75 ohm connectors supplied. Blue Baked enamel perforated steel cabinet, 2 1/4 x 9 1/4 x 3 3/8". AC cord. **Switches:** On-Off; power to pre-amplifier. AC fuse. 117V 60 CPS 14 watts.

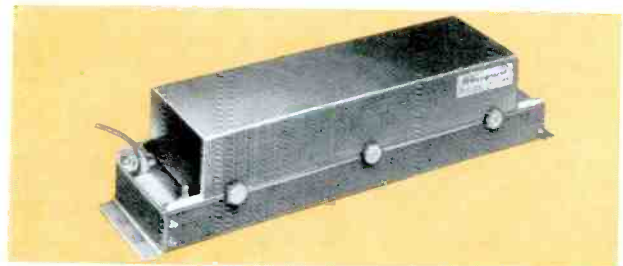

MODEL A-845
8-Tube, 45 DB GAIN / Distribution Amplifier \$159.95 list

■ For large hotels, motels, hospitals, schools and apartments. Operates 1-150 TV outlets, 300 sets with preamp. 30 volts available by switch at input jack for operating Colortron or Stereotron preamplifier directly from A-845 without extra power supply.

SPECIFICATIONS—Tubes: Six 6HA5; two 6DJ8. **Gain:** +45db. **Bandpass:** 50-110MC, 170-220MC. **Response:** flat, ±.25db per 6 MC channel. **Noise Figure:** 3.7db lo-band, 5 db hi-band. **Max. Signal Input:** gain control at max., .008V per band; gain control at min., .025V. per band. **Max. Signal Output:** 3.2V. **Separate Hi and Lo Band Gain Controls:** 0-10db; Separate hi and lo band tilt controls 3-6db. **Input Impedance:** 75 ohm. **Output Impedance:** 75 ohm. VSWR input and output better than 1.5 to 1. Blue baked enamel perforated steel cabinet. 2 1/4 x 14 1/2 x 3 3/8". AC cord. **Off-On switch.** AC fuse. 117V. 60 CPS 48 watts.

ANTENNAS

Colortron All-Channel Antennas
GOLD ANODIZED 4 models
\$24.95 to \$64.95.
Finest TV antennas made.

De Luxe Yagis
GOLD ANODIZED
Broadband and cut-to-channel.
Amplified or non-amplified.
High gain, rugged
construction, channels 2 to 13,
low band and hi band.

Stereotron FM
Antenna
Model SF-8
\$23.65
most powerful
FM antenna,
gold anodized.

A COMPLETE LINE OF WINEGARD MATCHED DISTRIBUTION SYSTEMS . . .

ANTENNA PREAMPLIFIERS

Colortrons—twin nuvistors
300 ohm Model AP-220N,
\$39.95. 75 ohm
Model AP-275, \$44.95
Drive 1-6 sets

Red Head RD-300 transistor
preamplifier Drive
1-6 sets \$29.95

Stereotron Preamplifier for
FM. Twin Nuvistors Model
AP-320, 300 ohm \$39.95
Model AP-375, 75 ohm
\$44.95

system equipment by **WINEGARD** for the TV Service Technician

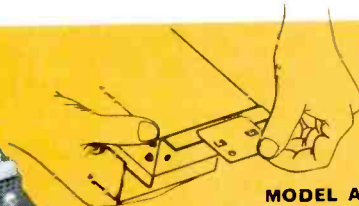
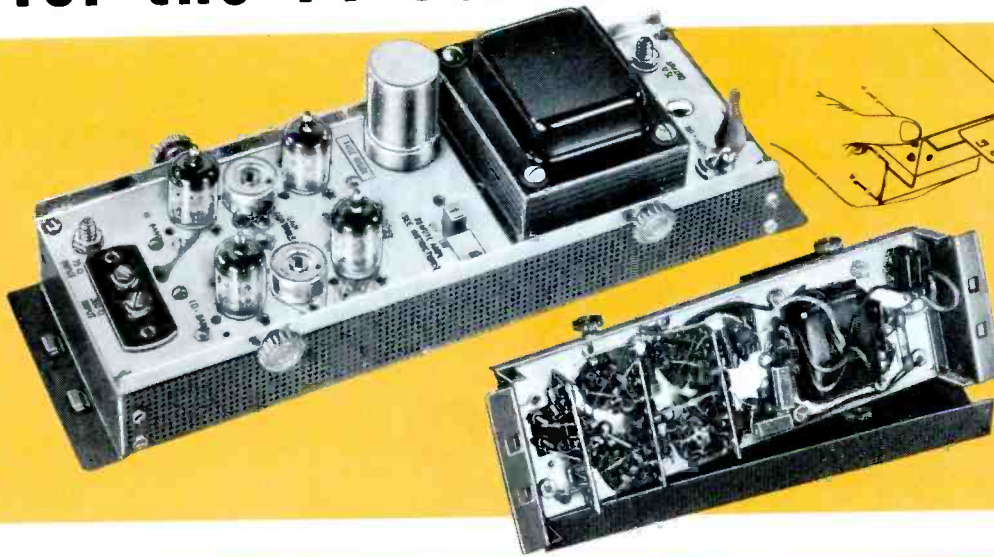

Exc usive wall hanger bracket for instant removal of amplifier.

MODEL A-430
SPECIFICATIONS—Tubes: four 6HA5.
Gain: +30db. **Bandpass:** 50-110MC, 170-220MC. **Response:** ±.25db per 6 MC channel.
Noise Figure: 3.7db lo-band, 5db hi-band.
Max. Signal Input: gain control at max., .02V. per band; gain control at min., .1V per band.
Max. Signal Output: 2V. **Separate Hi and Lo Band Gain Controls:** 0-10db. **Input Impedance:** 75 or 300 ohm. **Output Impedance:** 75 ohm. **VSWR** input and output better than 1.5 to 1. Two C-59 75 ohm connectors supplied. Blue baked enamel fully ventilated perforated steel cabinet, 2 1/4" x 11" x 3 3/4". **AC cord.** **Switches:** OFF-ON; power to preamplifier. **AC fuse.** 117V. 60CPS 25 watts.

BEST DISTRIBUTION AMPLIFIERS MADE—HERE'S WHY

- **DESIGNED FOR COLOR AND FM STEREO**
Flat frequency response, no phase distortion, full gain to top of FM band.
- **LOWEST NOISE** —
Only amplifiers made that use all high transconductance, low noise triodes — no pentodes.
- **EXTENDED BAND PASS** —
Allows cascading without clipping in end channels.
- **EASIEST TO SERVICE** —
All jacks, controls, switches and connections accessible from top of chassis. Knurled thumb nuts for fast removal of dust cover.
- **FULLY VENTILATED TOP AND SIDES.**
Perforated dust cover and chassis cover. Dissipate heat for extra long life.

With Winegard Equipment, any Good TV Technician Can Get Perfect Results with the First Installation

Winegard equipment has been engineered for the busy technician who doesn't have the time to do a lot of pre-planning and experimental work on the job. If you have been installing distribution systems, you will appreciate the way the engineering has been done in the factory to eliminate time on the job. If you haven't installed distribution systems, now you can get into this interesting, exceptionally profitable work in your area.

Every component of a Winegard distribution system is designed to match perfectly, from the antenna to the set... for installations in homes, apartment buildings, schools, hospitals, motels, hotels, trailer courts.

Practically every new public building today has a TV/FM distribution system, and systems are becoming standard equipment in new homes. You should be getting your full share of this profitable, interesting work. Winegard offers you the best equipment and free layout service. If requested, our engineers will be glad to check over your system or lay out a system for you. Same day attention will be given to your problems.

Example Winegard's Simplified System

For instance, an apartment house with 20 outlets, fringe area—stations 50 and 30 miles away—channels 3, 6 and 4 in 3 different directions. Note the Winegard system uses only 4 major components to simplify the installation yet gives better performance as against other systems' use of 7 components.

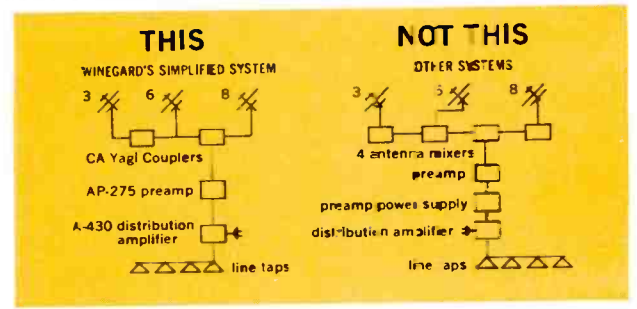

Write today for FREE Winegard layout guide and new book "How to Select and Use Master Antenna System Equipment".

Winegard Co.
ANTENNA SYSTEMS
 3009-E Kirkwood, Burlington, Iowa
 World's most complete line of TV & FM reception equipment.

... ANTENNAS AND ACCESSORIES FOR EVERY INSTALLATION NEED

ANTENNA COUPLERS



EC-230 Amplified 2 set Color Coupler Transistorized amplifies signal, \$17.95, 10 set, 6 set, 4 set and 2 set couplers for 2 to 10 TV or FM sets.



Yagi Couplers— Couple any combination of Winegard cut-to-channel or broadband yagis.



TV-FM Coupler — couples TV and FM antennas, also can be used to split TV-FM signals.

LINE TAP-OFFS, TV/FM OUTLETS, LINE DROP TAPS, SPLITTERS



Flush or surface mount line tap-offs, 75 and 300 ohm models.



TV-FM outlets for both flush and surface mount. Complete with outlet plugs— 10 models.



Line Drop Taps— Drop branch lines from trunk lines. Split line 2 or 4 ways.

- Matching Transformers, . . .
- Pressure Taps,
- Attenuation Pads,
- TV-FM channel Traps.
- A complete line available for all purposes.

Circle 12 on literature card

What's all this talk about "exact replacement" Twist-Prong Electrolytics?

What is an "exact replacement?" To CDE it's the proper capacitor to do the job intended—available when you need it. To others, it means number matching by the service technician—matching the numbers on the old unit with those of the replacement—without regard to availability or cost. CDE's new Twist-Prong line is based on our service-oriented definition.

Matching numbers may be fun, but there comes a time when it's a losing game. In Twist-Prongs the growth in ratings used in original equipment has been phenomenal. Even the loudest advocates of number matching have to hedge. One advertises over 1700 "exact replacements"—catalogs about 1200—and, of that 1200, lists possible alternates for 297 "if the listed capacitor is not available." Then, there's the problem of popular and "less popular items"—or, you're lucky if your distributor has the number you're trying to match in stock.

To Cornell-Dubilier, the availability of a proper replacement to do the job intended is most important. That's why we've designed a complete new Twist-Prong line for the professional electronic service technician. It's a line that recognizes the broad tolerances inherent in electrolytic manufacture and widely recognized throughout the industry—a fact you've used repeatedly in making replacements. It's a line that enables your distributor to have a complete stock so units will be available when you need them. It's an "exact replacement" line in the proper sense of the word.

Only the CDE Twist-Prong line is designed to make your job easier. A new Twist-Prong Replacement Guide and Cross Reference details manufacturers recommended in-stock replacements for every current Twist-Prong rating. The line is listed, too, in the new CDE Replacement Component Selector. Ask your distributor for copies today and end the old fashioned matching numbers game.



CDE **CORNELL-DUBILIER**
INNOVATION WITH RELIABILITY

Circle 13 on literature card

Video and Sound in One Tube

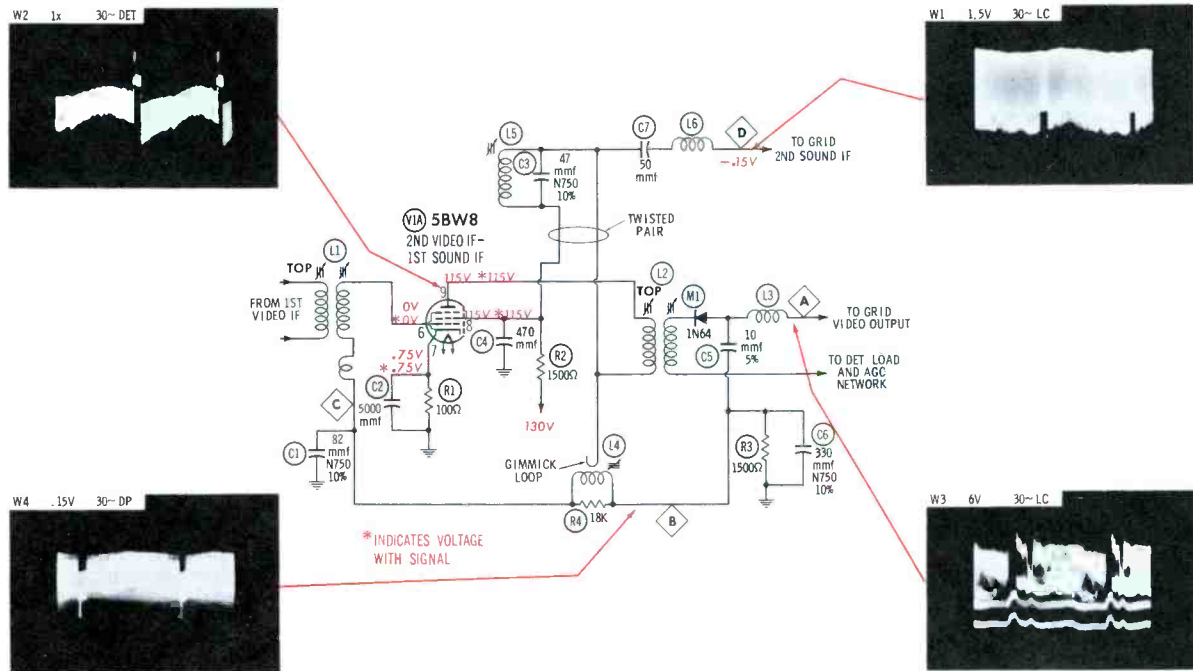

DC VOLTAGES taken with VTVM, on inactive channel; antenna terminals shorted. *Indicates voltages with signal present—see "Operating Variations."

WAVEFORMS taken with wideband scope; TV controls set for normal contrast. DET (detector), LC (low-cap), and DP (direct) probes used where indicated.

Normal Operation

Unusual sound takeoff and amplifying arrangement (from Muntz J-series chassis) is called *reflex* sound-IF system. Intercarrier sound signal is developed by video detector M1 as usual. However, instead of being coupled directly to conventional sound-IF amplifier, 4.5-mc carrier is coupled through C5, tuned circuit L4-C1, and secondary of L1 to grid of V1A, which was video-IF amplifier "first time around." In reflex path, low-value C5 passes only 4.5-mc portion of video-detector output, rejecting lower-frequency video signals; L4 and C1 are series-resonant to 4.5 mc, passing this signal efficiently; secondary of L1 presents low impedance to 4.5-mc signal, being designed to resonate at video IF. V1A then amplifies frequency-modulated sound signal. Tuned circuit L5-C3 is portion of plate load, in series with L2 primary. Winding of L2 offers impedance only to video-IF components, so sound-IF carrier is developed across L5-C3 and coupled to second sound IF by C7. Wire gimmick is connected to same signal takeoff point as C7 and capacitively couples signal to L4 in reflex loop, making circuit regenerative and improving gain for 4.5 mc. Other components serve various functions: C1 helps keep 40-mc video-IF signals out of reflex line as well as resonating with L4; extra (tertiary) winding on L1 controls bandwidth of transformer and minimizes unwanted video-IF regeneration; C6 helps decouple, but also affects level of 4.5-mc signal entering reflex circuit from video detector. B+ is series-fed through R2, L5, and L2.

Operating Variations

PIN 9

Presence or absence of signals have little effect on DC voltages at this pin, or at any other point in this stage. Waveform amplitudes, however, depend considerably on both signal strength and setting of AGC control switch. Demodulator probe must be used to check waveforms at this point; probes will naturally indicate video modulation on IF signal rather than sound signal (which is FM). Designations .1x, 5x, etc., indicate waveform amplitudes as compared with normal 1x amplitude of W2.

B

At this point, video detector has already demodulated video-IF signal, so detector probe isn't needed. Amount of video signal passed by small-value C5 is not great—only .15 volts peak to peak, with direct probe. Low-cap probe would be better, but would attenuate signal so much (10:1) as to render it difficult to see on scope.

D

Waveform here is interesting to compare with others. For example, look first at W4. Signal permitted on reflex line by C5-R3-C6 consists mainly of sound carrier (note RF shading) but video can't be kept out entirely. Further around reflex path, notice W2—plate load is developing mainly video, with sound IF not so noticeable. Look lastly at W1, taken in the plate-load circuit but *below* video-IF tuned circuit: Characteristic appearance of W4 reappears in W1, inverted and minus sync tip; notice also amplitude of W1 is at least 10 times that of W4.

Sound Weak, Garbled

SYMPTOM 1

Contrast Severely Reduced

C3 Open

(4.5-mc Load Capacitor—47 mmf)

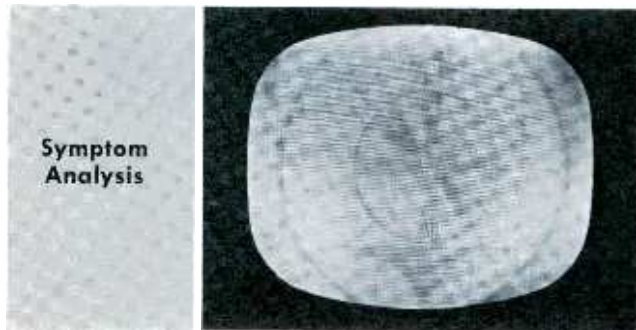

Almost no sound, even a maximum volume. Noise and hum level very high in sound. Fine tuning can be adjusted to improve sound somewhat, but picture is almost lost. Tune for better picture, sound disappears. Ringing ghost can be varied considerably by fine tuning.

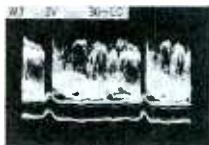

Waveform Analysis

Appearance of W3 is okay, but amplitude is considerably reduced, even with fine tuning set for best possible picture. When fine-tuned for best sound, video reduces to only .1 volt. Sound-IF information is missing from W4; only video shows, at reduced amplitude. W1 so small that direct probe is needed to view; again, strong video indicates poor action of reflex system. Trouble must be in some section affecting 4.5-mc sound signal.

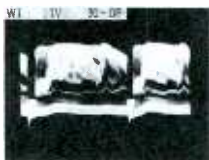

Voltage and Component Analysis

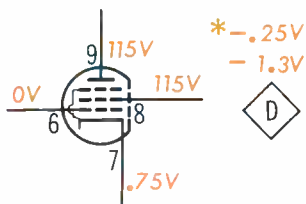

Very few voltage clues available; tube pins show same as during normal operation. DC voltage at point D is higher than normal, but this is not significant clue. L5-C3 normally forms parallel-resonant load for 4.5-mc signal. With C3 open, L5 is no longer proper load and plain video shows up in all waveforms in reflex path, instead of 4.5-mc IF. High hum level is caused by sync pulses making their way around reflex path. Conclusive test is to try aligning L5; naturally, if it won't peak, C3 or L5 is faulty. Replacing C3 furnishes final proof.

Best Bet: Scope will isolate this trouble quickly.

Picture Weak

Audio Affected Somewhat

R2 Increased in Value

(1500-ohm Plate Supply Resistor)

SYMPTOM 2

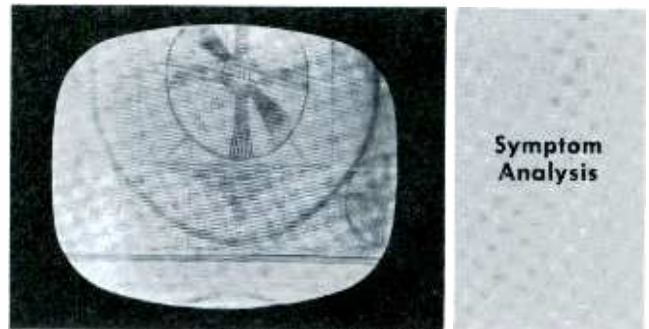

Most noticeable symptom is washed-out video signal. Video almost takes on appearance of AGC trouble—picture seems as if it might turn negative. Sound seems almost normal, except that volume control must be set higher than usual. Buzz is quite noticeable in sound.

Waveform Analysis

W3 is greatly reduced; at some settings of fine tuning, W3 may reverse polarity. W2 is only one-tenth normal amplitude; offers proof trouble is in V1A or prior stage. Some video showing in W1, explaining buzz. W1 is also much lower in amplitude than normal. Considering that all waveforms are reduced in amplitude and 4.5-mc waveform (W1) appears nearly normal in shape, logical conclusion is: Trouble common to both functions.



Voltage and Component Analysis

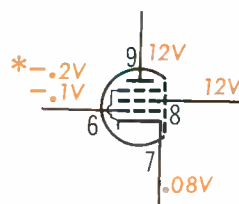

Voltage clues are highly significant in this symptom. Tube will obviously not amplify with plate voltage reduced to 10% of normal. R2 is supply resistor for V1A, and thus is common to both video IF and sound reflex. Video-IF signal can be considered "first through," so is affected more seriously than sound. R2 in this case increased almost to 150K; at 300K, video would be lost completely and very little sound would be audible. Negative-appearing video might lead to suspecting AGC, but clamping has no effect, so that idea is discarded.

Best Bet: VTVM is sufficient, but scope helps.

No Picture, No Sound

SYMPTOM 3

No Snow

C4 Open

(Screen Bypass—470 mmf)

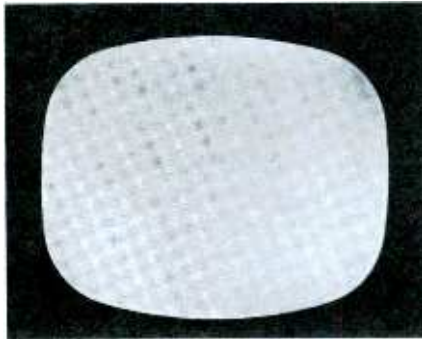

Raster is okay, with normal brightness operation. No video is visible at any setting of contrast control. Shaded bars may appear, caused by stage oscillation. *Note:* Vertical oscillator needs strong sync; therefore vertical sweep may also collapse occasionally.



Waveform Analysis

Complete absence of W3 and W1 indicates V1A isn't passing signal; however, W2 appears normal in shape and amplitude. Confusing clues, but they do pinpoint trouble between V1A and points A or D. More scoping turns up waveform at screen of V1A; C4 should eliminate this signal almost entirely. High amplitude of screen waveform is proof that C4 is totally ineffective. IF waveform can't reach points A or D, nor can video reach M1.

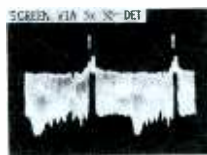
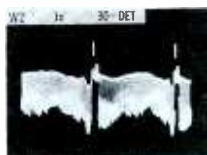

Voltage and Component Analysis

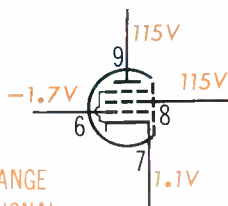

* NO CHANGE WITH SIGNAL

Increased grid and cathode voltages are only clues offered by VTVM. Negative voltage at grid points to open L1 or possible oscillation in tube. Open bypass capacitor fails to keep low end of output load at RF ground. Main result is that tuned circuits (plate load) cannot pass signal on; byproduct could be oscillation. Another way to look at this symptom is to consider that, with bypass open, screen acts same as plate; signals are thus conducted straight to power supply. Neither L2 nor L5 will respond to alignment attempts.

Best Bet: Scope does the full job.

Sound Weak, No Distortion

Picture Okay

C7 Leaky

(Sound-IF Coupling Capacitor—50 mmf)

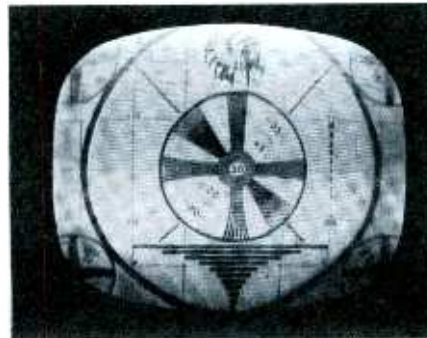

Picture is normal on all channels. Contrast and brightness controls operate normally. Volume is very low, even with control turned wide open, but sound is not distorted. Lack of buzz in sound would indicate trouble is in audio stages, but tests there offer no clues to fault.

Waveform Analysis

W3 is approximately normal, or a little higher in amplitude. Tracing signal around reflex path reveals W4 equally well defined and increased a bit. View of W1 isn't so encouraging, however: Amplitude is reduced to one-third usual value, but most significant clue is total lack of any sync pulses in 4.5-mc signal. Sync pulses aren't important to operation of sound-IF circuits, but fact that they are missing indicates a fault that could block low frequencies.

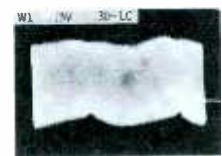

Voltage and Component Analysis

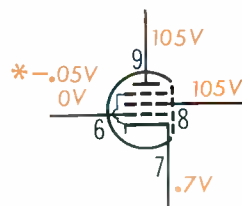

Leaky capacitor accounts for reduced voltages at screen and plate; B+ is dropped slightly by increased current through R2. Indeed, if fault lasts long, or C7 becomes more leaky, smell and sight of smoke will lead to faulty component—R2 will burn, and C7 is most likely cause. One cause for reduction in sound level is positive voltage reaching grid of following tube; upsets limiting action of second sound-IF stage. If L4 or L5 were misaligned, effect on waveform W1 would be similar, but DC voltage would remain about normal.

Best Bet: Scope offers most significant clue.

Picture Washed Out

SYMPTOM 5

Sound Also Reduced

L5 Open

(4.5-mc Load Coil)

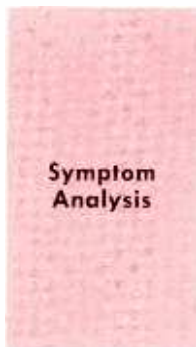

Picture is weak and washed out, even on local channels. Weak stations produce little or no sound or picture. Sound is reduced on all stations and has considerable buzz, indicating IF-circuit trouble. High contrast setting produces near-normal picture, but buzz persists.

Waveform Analysis



W3 appears normal except that amplitude is only 20% of usual. Greatly reduced W2 is indicative of poor amplification in V1A; signal at point B is less than 10% of normal. Checking waveform at grid confirms this indication; amplitude is greater at grid than at plate. Going one step further, test at point D would reveal almost no 4.5-mc signal in W1—mostly video there. Further analysis of waveforms tells nothing; time to switch to VTVM.

Voltage and Component Analysis

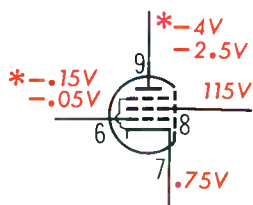

Obvious payoff is voltage check of tube operating potentials. Missing plate voltage is dead giveaway. Since screen voltage is normal, R2 is ruled out as suspect. Trouble could be open L2 or L5; ohmmeter check will verify which. Age, corrosion, poor soldering practice—all could cause this fault. Cause of buzz in sound is explained earlier: Video can get into sound-IF circuit when 4.5-mc tank circuit is no longer tuned; sync pulses cause buzz. Examination of waveform at point D shows video and furnishes conclusive proof of this.

Best Bet: Scope not conclusive; VTVM tells the story.

Contrast Poor, Sound Garbled

SYMPTOM 6

Vertical Hold Critical

R1 Increased in Value

(100-ohm Cathode Resistor)

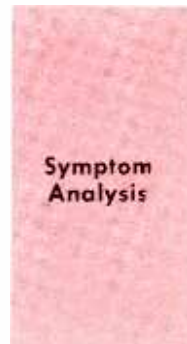
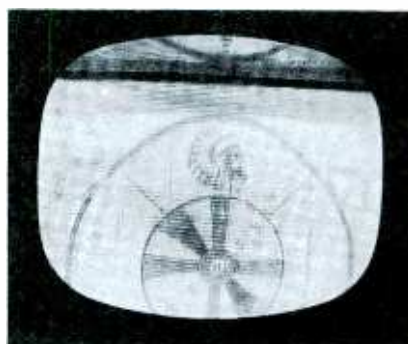

Picture highlights are not at all distinct. Contrast is considerably reduced, and even takes on "negative" appearance of AGC trouble. Clamping AGC has no effect. Vertical sync is poor, and picture rolls intermittently. Sound distortion is severe at all volume settings.

Waveform Analysis



Examination of W3 exposes cause of sloppy sync—compression of pulses is easily visible in this waveform. In addition, amplitude is very low compared with usual 4 to 8 volts p-p. Moving back to plate of V1A, a look at W2 reveals waveshape with very low amplitude, indicating that V1A may not be amplifying. Waveform at grid of V1A verifies that V1A is inoperative; waveform is obviously okay, but is larger at grid than at plate.

Voltage and Component Analysis

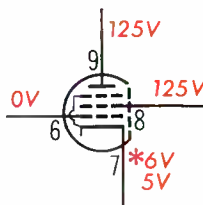

Switching from scope to VTVM, now that trouble is isolated, observe plate voltage of V1A. It is almost at B+ source level; same for screen, and both indicate that tube conduction must be cut off. Check at cathode shows much higher-than-normal voltage there, ordinarily result of increase plate current. Only other explanation is that cathode resistor must be high in value. Test with ohmmeter is conclusive. R1 in this instance had increased to 15K. Could have resulted from temporary overload by faulty tube, or could be result of age.

Best Bet: VTVM for voltage and resistance measurements.

NEW

IMPROVED

MIGHTY MITE!

NEW

Lower voltage checks for Nuvistors and all new frame grid tubes, as demanded by tube manufacturers, but not found on other tube checkers.

NEW

Speedy indexed set-up cards to reduce "look-up" time. No more cumbersome booklets, or incomplete charts.

NEW

Simplified panel layout reduces set-up time — prevents set-up errors.

NEW

Streamline styling with rounded corners and rubber feet, prevents marring Furniture — presents that "Professional look".

fast, accurate, never lets you down . . .

New Burn-out, stick proof meter!



NEW TC 130

only
\$74.50

Checks them all . . .
including Novars, Compactrons,
Nuvistors, 10 pin tubes — plus
Picture Tubes!

Only 7 Lbs. . .
Smaller Than A Portable Typewriter

Here's the famous MIGHTY MITE, America's fastest selling tube checker, with an all-new look and many new exclusive features. MIGHTY MITE III brings you even greater portability, versatility and operating simplicity beyond comparison. Controls are set as fast and simply as A-B-C right from the speedy set-up cards in the cover. The new functional cover can be quickly removed and placed in a spot with more light for faster reading of the set-up data or "cradled" in the specially designed handle as a space saver as shown above. New unique design also prevents cover from shutting on fingers or cutting of line cords as in older models.

In a nut shell . . . the MIGHTY MITE III is so very popular because it checks for control grid contamination and gas just like the earlier "eye tube" gas checkers (100 megohm sensitivity) and then with a flick of a switch, checks the tube for inter-element shorts and cathode emission at full operating levels. Sencore calls this "the stethoscope approach" . . . as each element is checked individually to be sure that the tube is operating like new. User after user has helped coin the phrase "this checker won't lie to me". Most claim that it will outperform large mutual conductance testers costing hundreds of dollars more and is a real winner in finding those "tough dogs" in critical circuits such as color TV and FM stereo.

**See Your Parts Distributor-- And See
The Mighty Mite III For Yourself!**

SENCORE

**426 SOUTH WESTGATE DRIVE
ADDISON, ILLINOIS**

CARE AND CHOOSING

OF TAPE HEADS

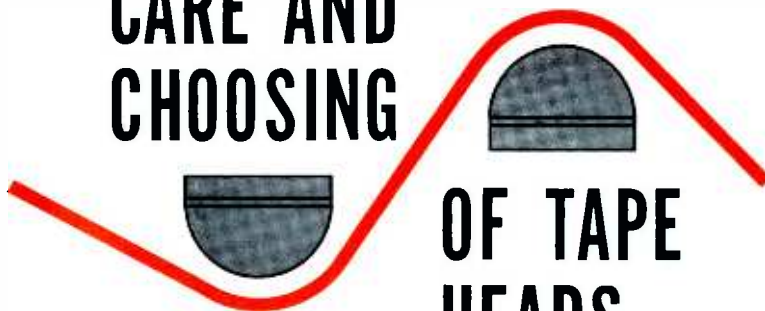

Originally developed for military and commercial applications, modern magnetic tape recording has become one of the most popular media in home entertainment electronics. Tape recorder sales are up and setting new records each season. In many recorder-equipped homes heavy use soon causes parts wear to rear its ugly head as deposits accumulate, and friction takes its toll.

Of all the components in a tape recorder, the heads—record and playback—are victims of the highest rate of wear (with the erase head running third). Only when the heads are clean, properly maintained and adjusted, and exhibit their correct electrical properties, can a well designed machine produce good results.

Basic Theory of Operation

Magnetic tape is made of very fine particles of iron oxide applied in a thin coating to a backing of plastic ribbon. To make a recording, the tape is passed through a magnetic field, the strength of which is varied in accordance with the input signal. The minute particles of the coating are oriented to the instantaneous amplitude and direction of the field.

Recording

To accomplish the above effect on the tape, the head must produce

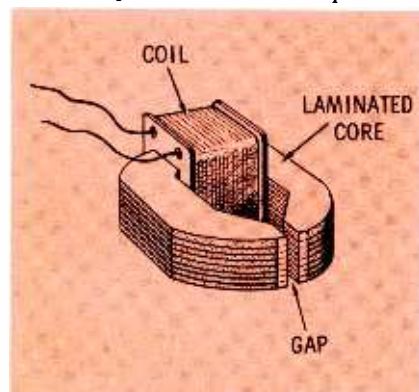

Fig. 1. The internal construction of a typical laminated recording and playback head.

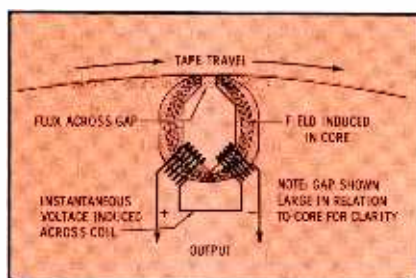

Fig. 2. Action in a typical reproduce head.

and control the magnetic field. The recording head is basically a miniature electromagnet consisting of a core, a separation called the gap, and a coil of wire (Fig. 1). When a segment of tape is opposite the gap, the signal to be recorded and a high-frequency bias signal (used to maintain linearity of the oxide layer) are applied to the tape by the magnetic field. However, it is just as this segment of the tape leaves the gap that the field is effectively removed and the magnetization becomes fixed. The actual sound recording, therefore occurs at the *trailing edge* of the gap. You can see that the gap in the recording head must be wide enough to permit easy application of the bias to the tape as the magnetic field is applied. Gap width in recording heads varies from about 160 mils (.160") to 300 mils.

Playback

Playback is almost the direct opposite of recording. The recorded tape carries within its oxide coating a magnetic pattern directly proportional to the original input signal. When the tape is passed over the gap in the playback head (Fig. 2), a voltage is induced in the coil.

To insure high-frequency response, the gap of the reproduce head is made small—the narrower the gap, the higher the frequency response. There is a point, however, where improvement in response is overshadowed by loss in output—so a compromise is made. Gap

widths of playback heads range from 40 to 250 mils.

In a great many machines, the functions of "record" and "playback" are combined in one head. Compromises are made between frequency response, gap width, and output. One help is the use of laminated cores; the laminations reduce core losses at high frequencies, permitting a larger gap to be used.

Erasure

The head used for erasing the tape is similar to the record/playback head. A main difference is the common use of a double gap, wider than the others, to permit a good transfer of erase flux to the tape for complete saturation; this obliterates any previous recording. Since the frequency of the erase current is four to six times the highest recorded audio frequency it cannot be heard and the tape is essentially quiet. Thus, there is a direct relationship between erase head efficiency and the noise level of the tape—the residual noise must be as low as possible.

Selection of Heads

When choosing a head for either replacement or original installation, there are several factors to consider. These fall into two large categories—electrical and mechanical charac-

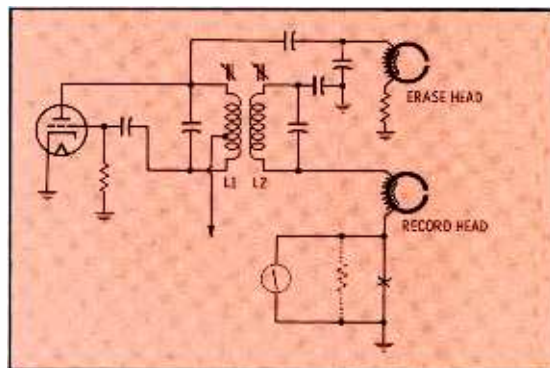

Fig. 3. In this circuit the slugs in coils L1 and L2 are adjusted for proper bias current.

Maintenance and proper selection are important considerations

by Stuart N. Soll

teristics—and include impedance, gap width, track width, and mounting.

Electrical Characteristics

While the basic considerations in choosing record/playback heads and erase heads are the same, there is a difference in relative importance. Impedance of r/p heads may be in some cases noncritical, while a small variation in erase-head impedance may spell the difference between proper operation and incomplete erasure. In both cases the heads must be chosen for proper track arrangement.

The simplest tape recorders employ half-track r/p and erase heads, often mounted together or even in the same housing. More versatile machines offer half-track record/playback and quarter-track playback in stereo. More advanced units have various combinations of stereo record and playback in various track widths. The important point to keep in mind is that *the erase head must match the "record" function* in track arrangement. Thus, a machine with quarter-track recording must have a quarter-track erase head.

Record/Playback Head

When replacing a head it is best to choose one which matches as closely as possible the impedance of the original. This is specially true in machines which have no bias adjustment. Heads are available in three approximate ranges—high impedance (3K and up), medium (1K to 3K), and low (less than 1K). Select a head at least within the same range as the original. After the replacement has been chosen there are two electrical adjustments which should be checked—bias and record current.

Bias—A common result of low bias current in the record head is distortion of the high-amplitude passages of the input signal. On the other

hand, higher-than-normal bias causes a reduction in high-frequency response during recording.

If the head is carefully selected to match the original, or at least approximate its specs, bias should be no great problem. Ideally, proper bias is that which will afford maximum recorded signal at about 500 or 1000 cps. This is checked by measuring the playback level from a tape recorded by the head in question.

Measure the bias by placing a 100-ohm 1-watt resistor in series with the ground return lead of the record head. With a sensitive VOM or VTVM, measure the voltage across the resistor while the machine is in the record function. Now check the specification sheet for the new head. If the bias current measured is within about -10% to +20% of the spec, satisfactory performance will probably result. If the bias is less than 90% of that called for, or if operation is faulty, an adjustment is necessary. This is accomplished quite easily in machines with bias controls—just vary the control while watching the meter. Where there is no bias control, the adjustment involves altering the capacitance (Fig. 3) or coupling (Fig. 4) between the bias oscillator and the record head.

Audio Current—The other electrical adjustment for the record head is audio current. The recording level indicator of the tape machine may require resetting since the optimum audio current for the new head may be different from that of the one replaced. This can be done in two ways. You can approximate maximum level by making a series of recordings with a 1-kc input signal supplied by an audio oscillator. Increase the level on each succeeding

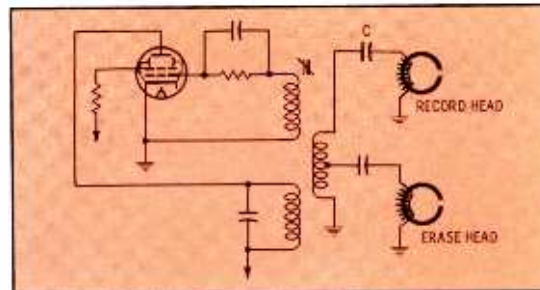

Fig. 4. Here, the value of C may be altered slightly to obtain the correct bias current.

run until distortion is noted on playback. Then reduce the voltage output of the generator by about 80% (-12 db). Leaving the input level control in the same position, adjust the recording-level indicator to 0 vu, 100%, or "Normal."

You can also make the audio current adjustment according to the head specs. Disable the bias collector and insert the 100-ohm 1-watt resistor in series with the head as before. Feed a 1-kc signal into the recorder and set the generator level so the current through the resistor corresponds with that indicated by the manufacturer's spec. Hold the input constant and adjust the indicator to show "normal."

Both methods result in normal recording level occurring about 12 db below maximum tape saturation. Remove the resistor from the circuit and re-energize the oscillator.

Erase Head

In replacing an erase head, try to obtain as closely matched a substitute as possible. This will eliminate the necessity of adjusting erase current, which can be a problem in some recorders. While more erase current than necessary may damage a head through over-heating, too little will cause incomplete erasure of recorded signals.

Determine the oscillator frequency

• Please turn to page 84



Fig. 5. A typical side-mounted head assembly.

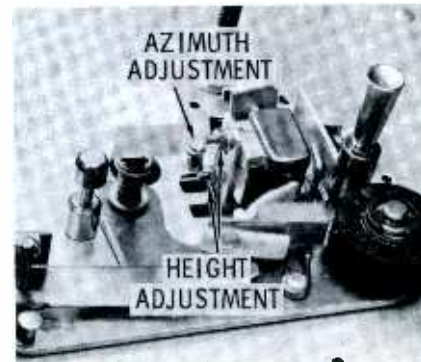

Fig. 6. These heads are mounted together by means of the same machine screws and nuts.

CURING BLINDNESS

in FM Tuning Eyes

A microscopic view of indicators and their operation.

by Patrick M. Craney

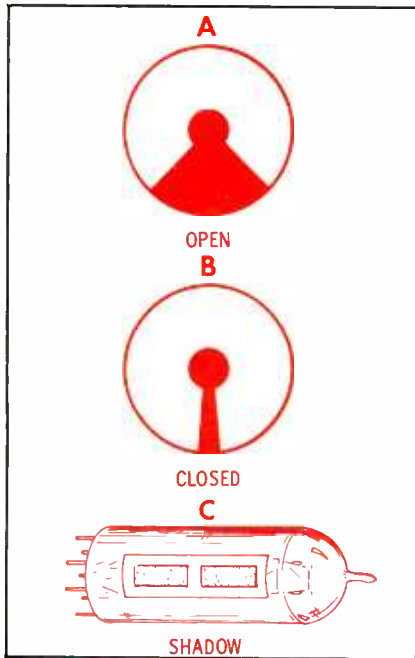

Fig. 1. The patterns of tuning-eye indicators.

Tuning-eye tubes are back, and have they changed! Remember the pre-war 6U5/6G5 (Fig. 1A) with the round green eye that opened and closed as radio stations were tuned? The modern trend in tuning-eye tubes is to have a narrow elongated eye (Fig. 1C), even though there are some of the older types still around.

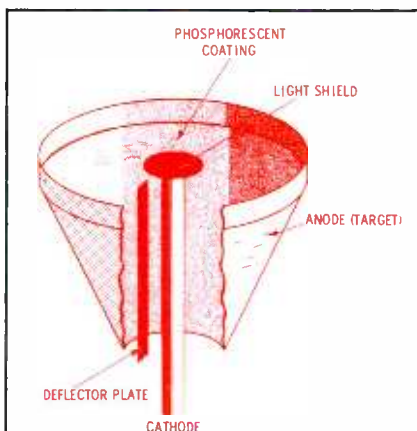

Fig. 2. Construction of 6U5/6G5 indicator tube.

What's the difference between the operation of the two types? First let's look inside the 6U5/6G5 and see how it operates. As shown in Fig. 2, the tube consists essentially of a cathode and an anode (target); there also is a deflection electrode situated so as to prevent electrons from striking a certain portion of the anode. In Fig. 3 the deflector is tied to the plate of the triode section, and AVC voltage is impressed on the triode grid. The more AVC voltage there is present, the less the triode conducts, and the higher the deflector voltage becomes. As the deflector voltage nears that of the target voltage, the repulsion of electrons lessens, and the "eye" begins to close (Fig. 1B).

Fig. 4 illustrates the internal construction of the EM86 tuning indicator; a simplified schematic using it is shown in Fig. 5. The operating principle is similar to that of the 6U5/6G5, even though the electrode arrangement is quite different. In the old tube the anode itself is coated with a chemical that glows when it is bombarded by electrons; in the new tube, however, the chemical is deposited inside the envelope right on the glass.

The exploded view (Fig. 6) of the new type of tuning-eye tube illustrates the action of both the triode and the tuning-eye section. The electron stream leaving the cathode is affected by the surrounding grid.

Circuit action can be followed by referring back to Fig. 3. When no AVC voltage is present on the triode grid, maximum plate current flows in the triode. The IR drop across triode load resistor R5 is maximum, and the voltage on pins 7 and 9 is at its minimum. This low voltage on the deflector makes it more negative than the anode. The anode can

therefore attract the electrons in the beam, pulling them away from center and "opening" the eye.

As signal increases (a station is tuned in), the AVC voltage builds up, and the voltage on the triode grid becomes negative; the triode plate current is reduced, and the deflector voltage rises toward B+.

The electron stream is subjected to a different electrostatic field set up by the deflection electrodes, and is accelerated. The anode can no longer pull the beam outward and the shadow in the center (where no electrons strike the target) becomes narrower. The relationship between anode voltage and deflection-electrode voltage determines the eye opening, and this relationship is determined by the action of the AVC voltage on the triode. Although the grid surrounding the cathode slightly reduces the electron flow toward the target, the phosphor coating is sensitive enough that little difference in illumination is noticed. The major effect is that of beam deflection.

Tuning-Eye Circuits

There are various ways used in FM tuners to actuate a tuning-eye tube. No matter which type of circuit delivers the control voltage to the tube, the voltage must be directly proportional to the signal strength. The weaker the signal, the lower the voltage; the greater the signal strength, the higher the control voltage must go. The only tuner stages

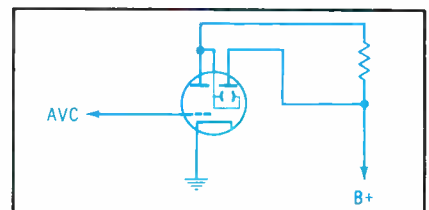

Fig. 3. Control and eye tubes in same envelope.

with this type of DC voltage levels high enough to operate a tuning-eye tube satisfactorily are the limiter and the FM demodulator.

Limiter

Two variations of tuning-eye circuits are shown in Fig. 7. The dotted line shows the eye tube being driven by the limiter input voltage; the dashed line shows it being driven by the discriminator output voltage. In the limiter circuit, when the incoming signal is maximum, the voltage drop across grid resistor R1 is also maximum, and the negative voltage is connected to pin 1 of V3 through isolating resistor R4. This negative voltage drives the control triode nearer cutoff; the rising plate voltage coupled to the control electrodes brings their potential close to that of the anode, thus allowing the eye to close. R4 and C4 form a decoupling network to prevent audio from causing the eye tube to flicker.

Discriminator

If the tuning-eye circuit is actuated by the discriminator, the control-tube grid is connected, as shown by the dashed lines, to the discriminator DC output. When the IF signal across the discriminator transformer makes pin 1 of V2 positive, current flows through the tube, L3, R2, ground, and back to cathode pin 2. A pulsating negative DC voltage thus appears across R2. The opposite-polarity signal excursion flows from cathode pin 3, through the tube, L2, and R3, and back to the cathode; for all practical purposes, this pulsating DC is dissipated in R3. The negative pulses across R2 are filtered by R3-C3 and R4-C4. The AVC voltage thus developed is applied to the grid of the control triode. Thus, when a strong RF signal is received by the tuner, the discriminator output voltage rises in a negative direction and drives the control tube nearer to cutoff.

Ratio Detector

In some FM tuners, the FM de-

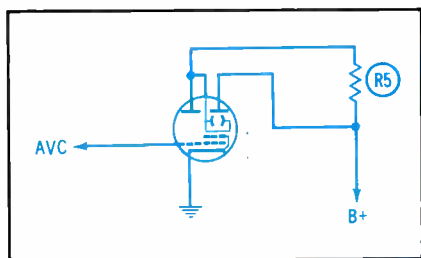

Fig. 5. Schematic of EM86 tuning-eye tube.

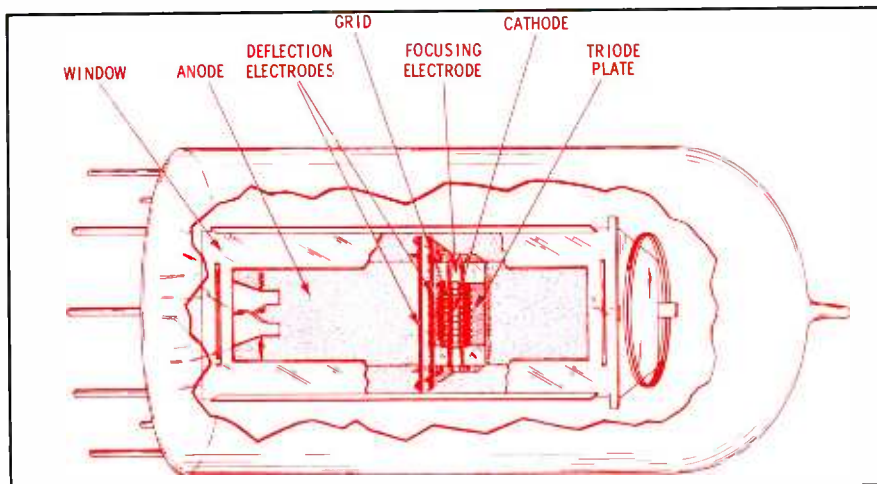

Fig. 4. Cutaway view of the EM86 tuning-eye tube showing respective electrodes in perspective.

modulator is a ratio detector (Fig. 8). The negative DC control voltage for the tuning-eye indicator is developed similarly to that in a discriminator.

When the IF signal is negative on pin 1 of V1, it is positive on pin 2. This causes both halves of the tube to conduct in series with each other through R2, R3, R4, and R5. The negative voltage for AVC develops at the junction of R2-R3 and is applied to V2 through R6. Since V1 acts as a half-wave rectifier, no conduction takes place when the input voltage reverses in polarity. C5 removes the audio that may be developed by ratio-detector action.

Troubleshooting

There is very little that can go wrong with a tuning-eye tube or circuit. It is a rare problem that a tube won't cure.

Of the other troubles that do occur, the most frequent is traced to the triode load resistor. Since control of the eye depends directly on the IR drop across this resistor, the eye will not respond correctly to changes in signal voltage if the resistance changes. If the resistor increases in value, the eye will open too wide and fail to close properly. If the resistor changes to a lower value, the eye will not open nor-

• Please turn to page 80

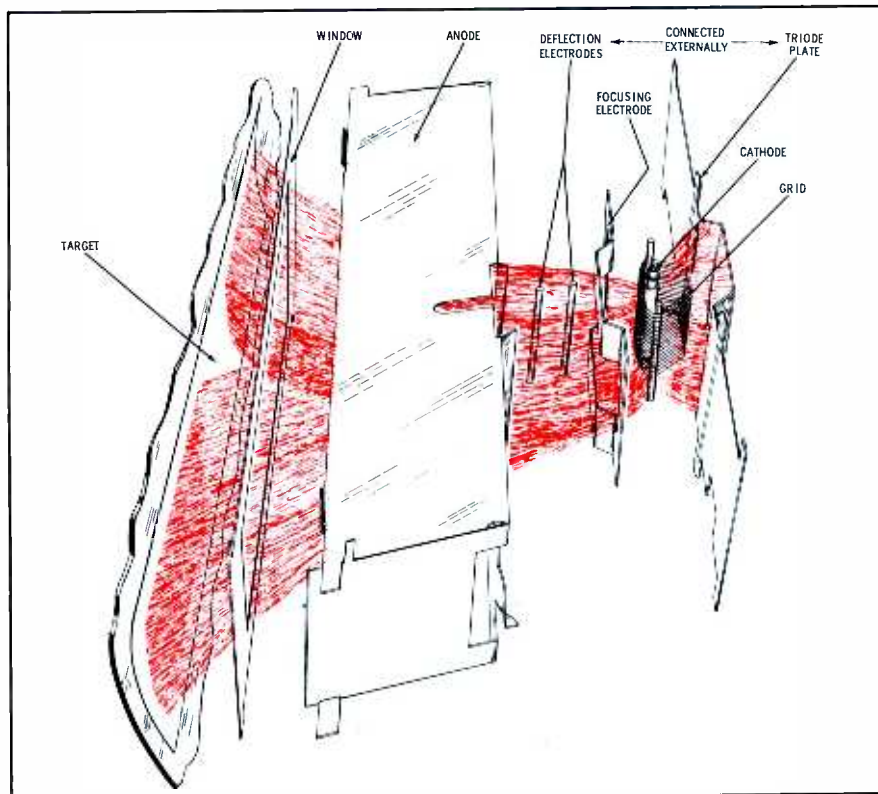
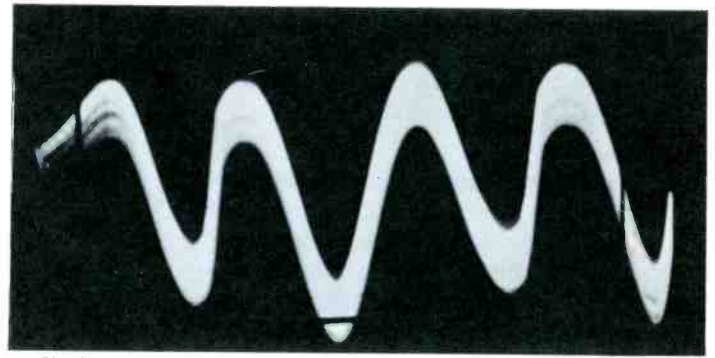
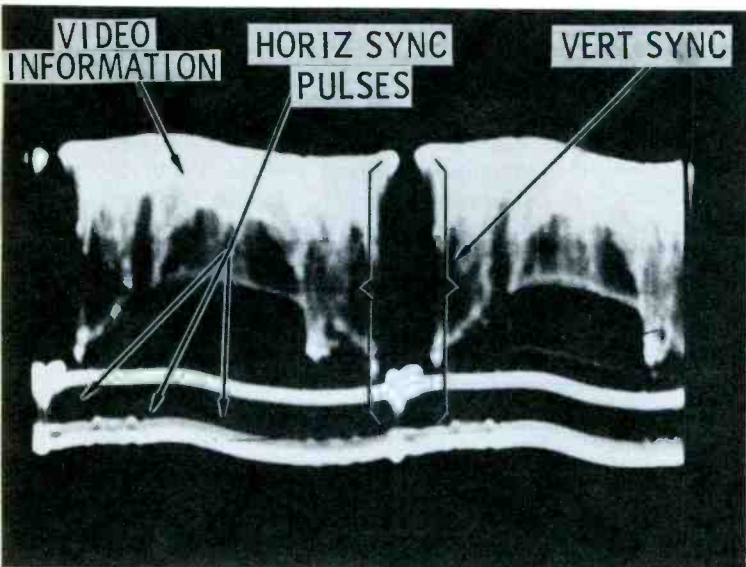

Fig. 6. Exploded view of the EM series of indicator tubes, showing principle of operation.



Ripple content of the filter output will reveal any excessive hum or distortion on B+ which may show up as video or audio troubles.

TV Waveforms save Analysis Time



Grid waveform of the video output tube is an accurate indication of the circuit action in the IF amplifiers and tuner stages.

If sync separator input doesn't closely resemble this waveform, trouble may be indicated in the IF's, video stage, or the AGC line.

... if you don't believe it, try it! Instead of relying solely on your voltmeter, which can tell you only what the DC voltages are and not what the circuit is actually doing, use your scope. Get into the circuit and "see" what is going on. You will be pleasantly surprised at how fast you can spot certain "dog" troubles by noting waveforms. We do not suggest that you scope every stage in the receiver—just a few key check points. By doing so, you can observe the actual shape of video, audio, sweep, and sync signals. You can determine what, if anything, is wrong in each portion of the TV receiver by familiarizing yourself with these key waveforms and learning to identify them on sight.

Spikes and distortion are permissible on AGC keying pulses so long as the fundamental frequency remains stable at 15,750 cps.

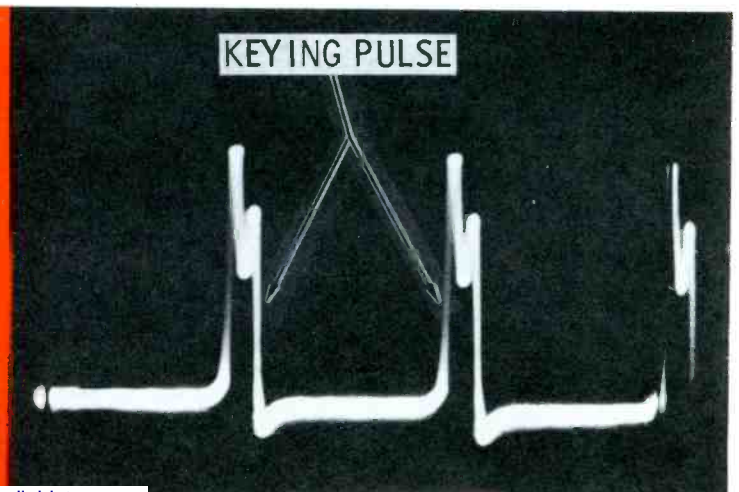
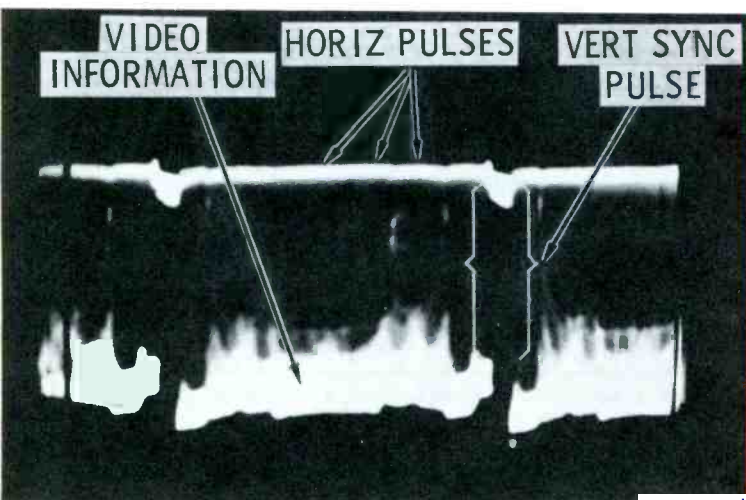

With the oscillator tube pulled,
or the output grid grounded, this
waveform will denote properly
operating sync stages.

Yoke-input signal shows condition
of vertical stages and transformer.
Sweep, retrace, and blanking
should be distinguishable.

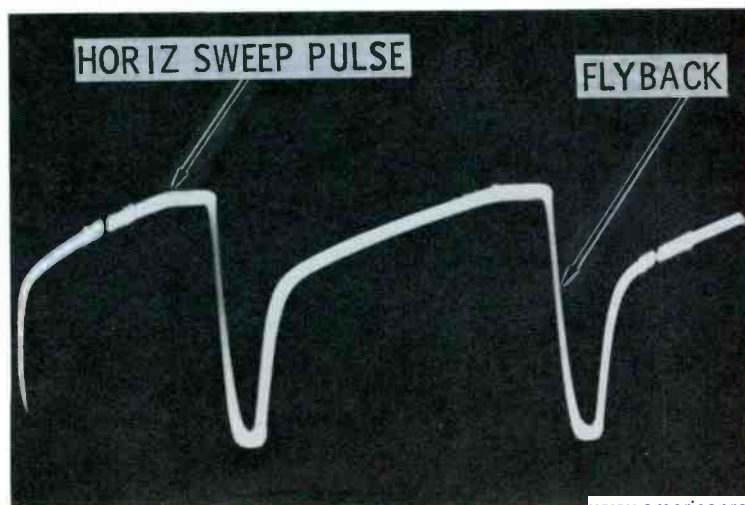
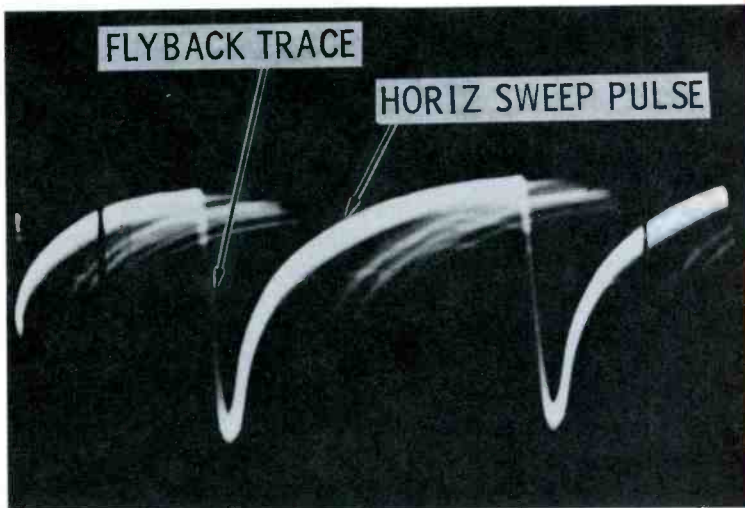
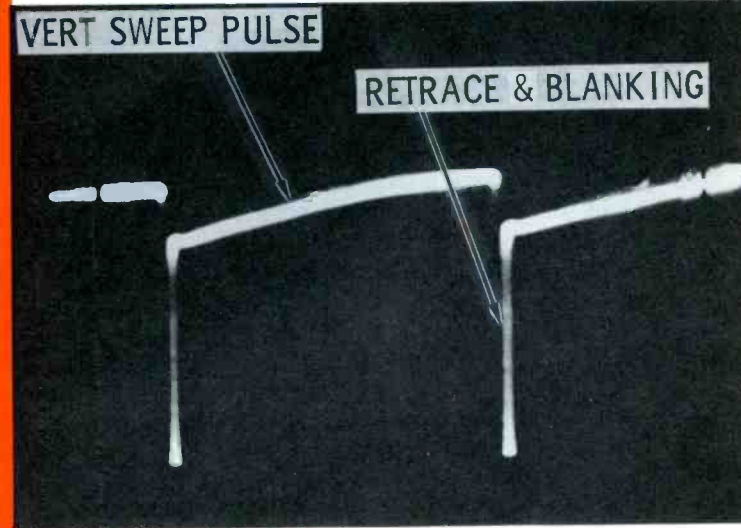
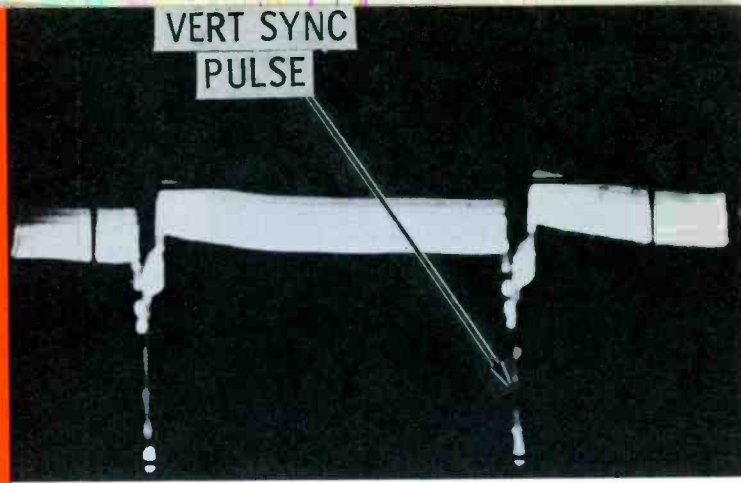

The phase-detector output signal
is a composite of AFC signal fed from
horizontal output, mixed with
station sync signals.

If there is no high voltage, check
the grid drive to the horizontal
output tube. No drive means a
defective multivibrator.

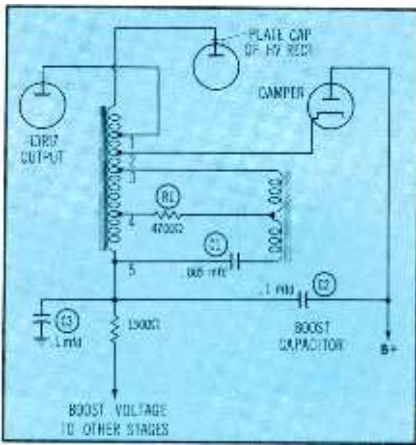

Fig. 1. Schematic shows essential components involved in developing boost from flyback.

There are several key facts that the serviceman must know about a circuit to avoid wasting time making unnecessary tests. He learns to look for these pointers as soon as he unfolds the schematic. The cathode connection of the audio output, for example, tells whether or not the set uses "stacked" B+, and his testing procedure is arranged accordingly. Another essential fact is whether or not there is keyed AGC. Often it is important to know if the CRT is DC-coupled to the video-output stage.

It is just as important to notice which stages are supplied with boost voltage. Failure of the boost voltage can be responsible for symptoms appearing in any of the stages that depend on this voltage for power or for keying pulses. An understanding of how boost voltage is generated is essential to servicing the circuit, so with the aid of Figs. 1 and 2 let's view the operation of the circuit.

Fig. 1 is a popular deflection and boost circuit. Fig. 2 shows only the bottom section of the flyback wind-

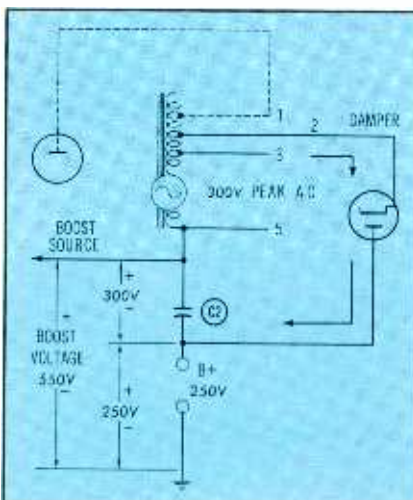

Fig. 2. Equivalent circuit explains boost.

ing, which is the secondary of the autotransformer, redrawn with a generator inserted in series with the winding to represent the voltage induced from the upper section.

During the sweep time, current flows upward through the secondary and through the damper diode. Assume that 300 volts peak AC is induced in the secondary. After a short instant, C2 will become charged to 300 volts, because it is connected essentially across terminals 2 and 5 through the low resistance of the damper diode. With the bottom end of C2 connected to B+, the voltage across the capacitance is in series with 250 volts DC. The voltage from terminal 5 to ground is therefore equal to the sum of the induced 300 volts and the B+—a total of 550 volts DC.

Fig. 3 shows the block diagram of a portion of a newer-model receiver with autotransformers in the vertical and horizontal outputs. In this design even the brightness control uses the boost voltage. In color sets, voltage derived from boost may be used in the burst amplifier, blanking amplifier, color-killer stages, and convergence circuits.

Although very few models use the boost voltage in all circuits possible, you can never be sure where it is being used until you study the schematic. The case histories which follow illustrate how easily you can be fooled.

Vertical Foldover

Fig. 4 shows the symptom which occurred in a receiver using the circuit of Fig. 5. Because of the appearance of the screen, the technician immediately suspected the vertical cathode bypass capacitor. However, substitution of a new capacitor for C18 did not help, and the resistance from cathode to ground with the capacitor disconnected was normal, indicating that the cathode resistors were not defective.

Next, coupling capacitor C12 was replaced with no success. The components in the waveshaping and feedback network (R20, R21, R22, R24, C15, and C19) were all replaced to no avail, and out of desperation C10 and C11 were also substituted. When there was still no change in the raster, the technician, convinced that the trouble

was in the vertical-output stage, changed the output transformer. But when he turned the set on again, the symptom was still there.

All of these tests might have been avoided by a little study of the schematic before jumping to the conclusion that all vertical linearity and foldover problems are caused by failures in the vertical-output circuit. It is very common to find boost voltage fed to the vertical oscillator through the height control. When an autotransformer is used at the output, a jumper within the yoke often connects the vertical winding to the low side of the horizontal winding, thus feeding boost voltage to the vertical output tube.

A good place to begin analysis of any kind of distorted vertical sweep is at the grid of the output tube.



When the linearity is affected, a scope can indicate the shape of the oscillator output signal. When only the vertical size is affected (no change in linearity), a VTVM will indicate the amount of drive voltage present. In the case of the defect illustrated in Fig. 4, both instruments pointed to a defect in the drive signal; this led to DC meas-

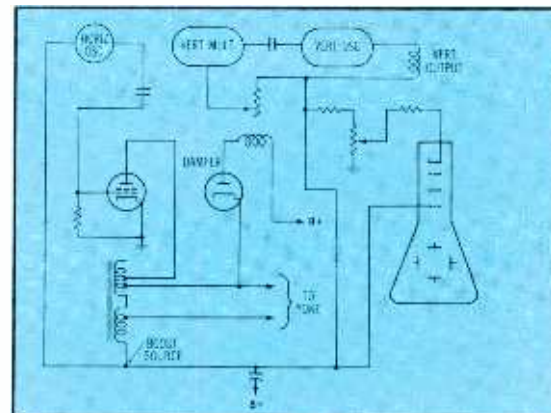

Fig. 3. Many circuits in an ordinary television receiver may depend on boost for power.

urements at the plate of the multi-vibrator (pin 6 in Fig. 5) where the voltage was found to be low. The next step was to check the DC voltage at the junction of R15 and R30, which was also low. The full 480 volts was found at the end of R19 nearest the autotransformer; R19 had increased in value because of leakage through C13.

When you see that the entire vertical section is fed from the boost and that the symptom involves fold-over combined with loss of vertical hold, it is easy to isolate the trouble to those components common to the oscillator and output sections.

Blooming and HV Loss

Fig. 6 shows the circuit which produced the blooming pictured in Fig. 7. After the set had been

A troubleshooting analysis of the extra power supply.

by Edward F. Rice

played for approximately an hour, the brightness began to increase slowly, and the width began to shrink. This process continued until the condition of blooming shown in Fig. 7 was reached; then the raster went out completely, leaving no trace of high voltage at the 1B3 plate cap.

The usual steps to cure blooming were taken—the horizontal-output, oscillator, and damper tubes were changed. Although the 1B3 is the most common cause of blooming, it was not suspected in this case since there was no high-voltage AC

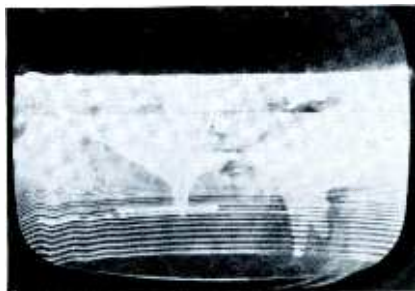

Fig. 4. Unusual symptom was boost problem.

at its plate cap after the raster went out. Next the technician monitored the grid bias on the horizontal output tube as the blooming became worse. The drive voltage remained steady at -25 volts even after the high voltage disappeared. The screen-grid voltage also remained constant.

With this information the technician finally concluded that the defect was in the damper and flyback circuits. Monitoring the boost voltage revealed that it dropped slowly from 560 volts, reaching about 260 volts at the time the high voltage went off. Boost capacitor C1 was replaced, but there was no change in the symptom. The values of the brightness control and series resistor R40 were both checked and found to be normal.

The problem was finally solved by replacing R1, the damping resistor in series with the yoke center tap. Much time could have been saved if the technician had noticed that the boost voltage is applied to the brightness control, causing a positive voltage to reach the cathode of the CRT. Without this current flow through the brightness control, the CRT cathode is practically at ground potential, and brightness reaches maximum. The reduced boost voltage also leads to reduced horizontal output, which in turn causes the high voltage to be reduced. This further contributes to the symptom. Thus the blooming that appeared to be the main symptom was merely a side effect of the gradual decrease of boost.

Unstable Horizontal Sync

The circuit in Fig. 8 developed into a rather confusing set of circumstances and was considered to be quite a "dog" around the shop for a while. The set was brought in with no high voltage. Since the tubes had been checked on the service call, the first test was to measure the drive voltage at the grid of the horizontal-output stage, which turned out to be normal. The screen voltage of the stage appeared to be somewhat low; it measured about 100 volts DC. This suggested that excessive screen current might be reducing the voltage at the screen-grid terminal.

The boost voltage was measured at terminal 2 of the flyback trans-

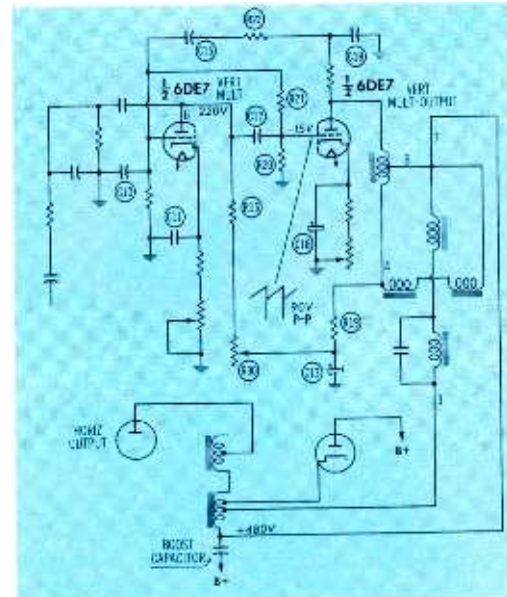

Fig. 5. Circuit that was responsible for the weird display illustrated in photo of Fig. 4.

former and was found to be only a few volts. The ohmmeter indicated that terminal 2 of the flyback transformer was practically grounded, and the repairman was reaching for the flyback catalogue when he spotted C29. When one end of this capacitor was disconnected, the high voltage returned. The capacitor was replaced and the set was turned on.

The raster appeared, but when a station was tuned in there was no horizontal sync. The blanking bar could be made to stand up vertically by carefully adjusting the hold control, but continuous adjustment was required to keep the picture on the screen. The boost voltage was checked again, just to make sure, and it was normal. Until now this

• Please turn to page 82

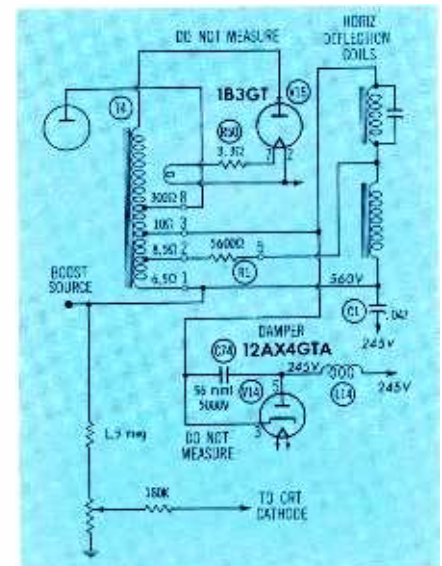

Fig. 6. Circuit in which brightness control and CRT depend on boost action for voltage.



IMPROVING RETRACE BLANKING

Circuits and components to help eliminate those lines.

by Thomas A. Lesh

Vertical retrace lines on a TV screen—the slanting traces seen in Fig. 1—are usually a sign of trouble. However, in some of the oldest receivers still in service, these traces simply indicate the lack of a retrace-blanking circuit. Many early sets rely on only the blanking pulses in the video signal to suppress the retrace lines, and careless adjustment of the brightness and contrast controls could prevent thorough blanking action. Servicemen are still receiving occasional requests to install more efficient blanking networks in these sets; they can do the job easily if they understand a few basic requirements of blanking circuitry.

As a rule, only two to four components need to be added, forming a coupling circuit to feed a sample of the vertical sweep signal to the picture tube. The retrace pulses in this signal ordinarily should have an amplitude ranging from 20 to



Fig. 1. Retrace lines indicate ineffective vertical blanking system in older receiver.

100 volts peak to peak, and the portions of the waveform between pulses should be free from video “hash” to prevent modulation of the CRT beam. The coupling circuit must also eliminate the sawtooth slope from the vertical sweep waveform, so no shading effect will be introduced into the background brightness of the raster. In most cases, these requirements are not at all difficult to achieve.

The blanking waveform is applied

to either the cathode or the grid of the picture tube—whichever does *not* receive the video signal. Since the object of blanking is to cut off the CRT during vertical retrace time, the blanking signal should contain negative pulses if fed to the grid, or positive pulses if fed to the cathode.

Pulse Sources

Usually, the most convenient source for a blanking signal is at one of the secondary terminals of the vertical output transformer. There are cases, however, in which this point is unsuitable, and an alternate connection must be made. When negative pulses are required, an adequate signal can often be obtained from the RC network in the plate circuit of the vertical oscillator or discharge stage; for positive pulses, the plate circuit of the vertical output stage is sometimes a satisfactory source. The design of the blanking network can be modified as necessary for minimum loading at each of these points.

Output Transformer

The isolated-secondary type of vertical output transformer, commonly used in early-model receivers, is relatively easy to work with because pulse waveforms of opposite polarities are usually present at the two secondary terminals. The first step is to scope across both leads to find the pulse polarity. In order to supply the pulse, one winding lead will have to be grounded; the other terminal may then be connected to the CRT through an RC coupling circuit.

In the simplest case—grounded-grid CRT circuitry—the blanking network shown in Fig. 2A may suffice. Again, be sure the correct side of the secondary is returned to ground. C1 merely couples the signal, and the pulse voltage developed across R1 is applied to the grid. If results are not satisfactory, one or more additional components may have to be added. For example, some receivers use extra parts such as R2 and C2 (Fig. 2B) for added isolation and waveshaping.

To avoid exceeding the maximum voltage ratings on the picture tube, it's advisable to apply pulses no stronger than necessary to accomplish blanking. If the available pulse waveform has too much amplitude,

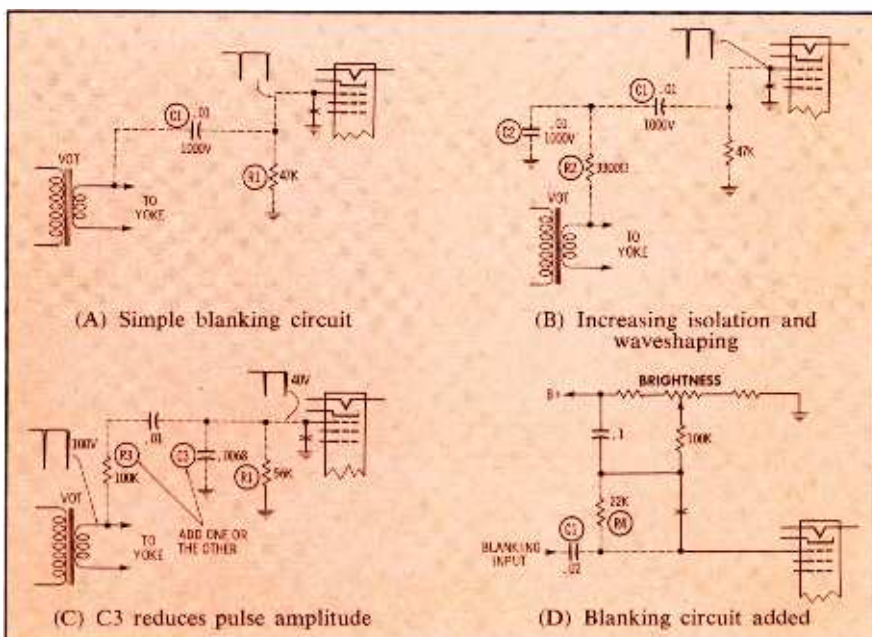
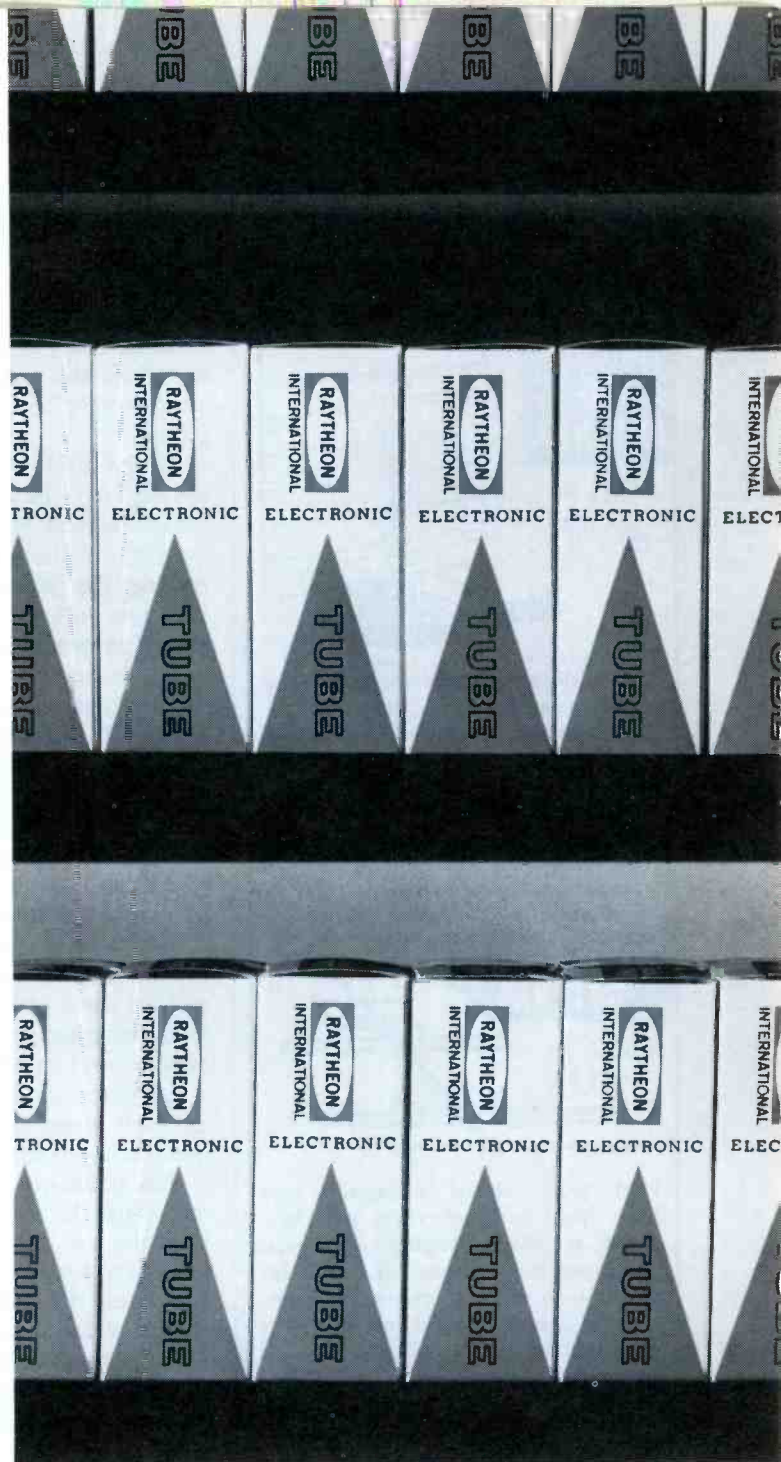
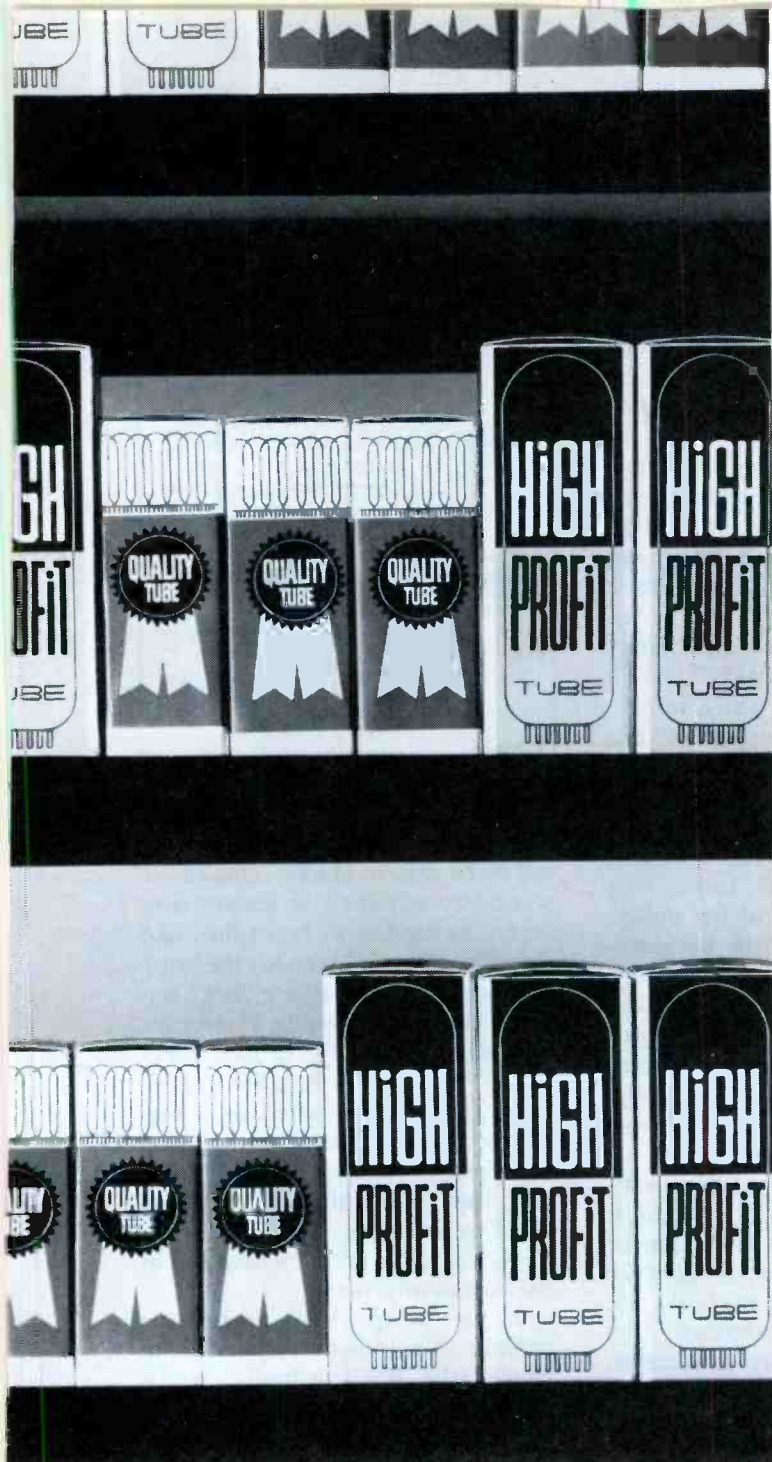

Fig. 2. Blanking pulses can be obtained from secondary of the vertical output transformer.



why stock two? Raytheon gives you both in one carton

Raytheon's International line puts high quality and high profits in one neat package — where they belong! Raytheon International tubes are designed, manufactured and tested by selected foreign producers in accordance with Raytheon specifications and U.S. industry standards. Characteristics are controlled for exact interchangeability and newer types are continually being developed to keep pace with your replacement needs. Right now, for example, 92% of all socket requirements

can be filled immediately by Raytheon International's 284 types.

Raytheon's 40 years of experience plus the Good Housekeeping Seal of Approval provide your customers with the finest warranty in the business. Add a good healthy profit margin for you and you have all the reasons for stocking and selling Raytheon's International line. See your Raytheon Distributor for complete details.

Circle 15 on literature card



See the Complete Line of
Hi-Lo & TRICRAFT
TV ANTENNAS & ACCESSORIES
BOOTH 3115 MAY PARTS SHOW

**INDOOR
UHF
ANTENNA**

MODEL No.
220-UHF



- * New dipole design for maximum gain over the entire UHF Band.
- * Engineered to reject unwanted signals.
- * Gold anodized dipoles.
- * Attractive mahogany color
- * Tip proof base
- * Includes 6 ft. 300 ohm twin lead wire with spade lugs.
- * Individually packed in carton.

**TRICRAFT-OUTDOOR
ANTENNA**

MODEL No.
ACY-9-A

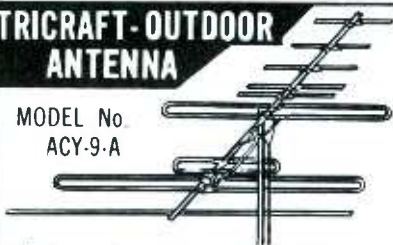

High gain, sharp directivity and high front to back ratio are featured in these quality antennas. Designed for outstanding fringe reception on all VHF channels. Completely pre-assembled, all elements attached to boom utilizing HI-LO's patented "Allsnap" method of assembly.

**TRICRAFT-TV
ACCESSORIES**

MODEL No.
114-088 Two Set
114-090 Four Set



TELE-COUPPLERS—couple two to four sets to a single VHF, UHF or VHF/UHF antenna. Effectively isolates each set from the others—provides sharp picture on all sets. Works equally well for FM.

Hi-Lo MANUFACTURING CORP.
1122-1126 NEWPORT AVENUE • CHICAGO 13
VISIT US AT BOOTH 3115 AT THE 1964
ELECTRONIC PARTS SHOW MAY 18-19-20
CONRAD HILTON HOTEL

Circle 16 on literature card

a capacitor like C3 (Fig. 2C) can be added to reduce it to a safe value. C1 and C3 act as a capacitive voltage divider, and the value of C3 can be "juggled" until exactly the desired proportion of the signal voltage is developed across it. Adding fairly high-value series resistors such as R3 is another way to reduce the pulse amplitude, with considerably less loading of the yoke circuit.

If the grid was originally connected to the brightness-control circuit instead of to ground, blanking can still be added, without disturbing the action of the control. One precaution: If the grid is bypassed to ground or B+ via a large-value capacitor (as in Fig. 2D), it may be necessary to add a resistor such as R4 between the grid and this capacitor, to prevent losing most of the pulse signal. On the other hand, if C1 and the bypass capacitor can be made almost equal in value, the latter will cause only moderate attenuation of the pulses. As we pointed out in the last paragraph, this reduction in amplitude may be desirable, to keep the pulses from being too strong. If the brightness control is *unbypassed*, adding a capacitor similar to that in Fig. 2D will protect the control from possible damage by the pulses.

The technique of feeding a positive pulse to the CRT cathode is basically no different from that of feeding a negative pulse to the grid; the required blanking networks are similar to those just described. Fig. 2D is most generally applicable, since the brightness control is commonly located in the cathode circuit.

Autotransformer

When an autotransformer is used to drive the vertical yoke windings,

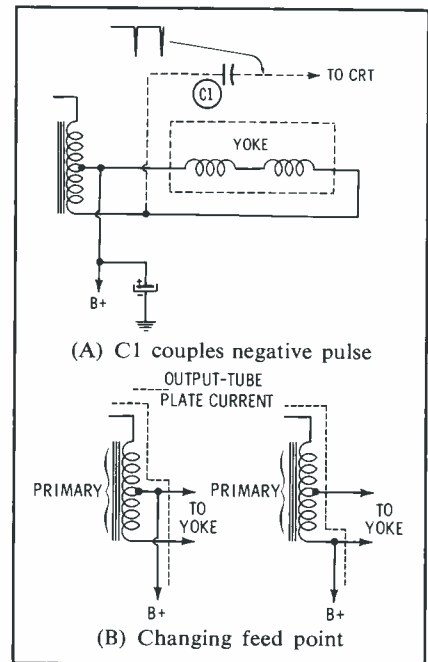

Fig. 3. To obtain negative pulses from autotransformer, make connection at proper lead.

a suitable blanking waveform may not be so easy to obtain. One of the secondary terminals is always connected to the B+ or boost line, and therefore is at AC ground; the pulse polarity at the remaining "hot" terminal may or may not be correct for blanking. Typically, if the center tap is "hot," it has negative pulses. Some receivers are wired as in Fig. 3A to make a negative blanking waveform available for the CRT grid, but sets not equipped with blanking are more likely to have the B+ connection at the bottom tap of the autotransformer.

If the sweep circuit is not too critical, it is sometimes possible to change the B+ feedpoint to the other secondary terminal. This alteration does not reverse the sweep, but it does change the operating conditions of the transformer; only the upper portion, instead of the

TV TUNERS * **REBUILT OR EXCHANGED**
* ALL TYPES

\$9.95 Including all parts and labor (except broken wafers—billed at cost)

- Normally shipped same day received
- 90 day full guarantee
- U/V combinations \$17.95

FREE—If Mailing carton sent to you on request

Phone REpublic 3-9189

L. A. TUNER EXCHANGE
4611 West Jefferson Blvd.
Los Angeles 16, California

Circle 17 on literature card

CHECKS AND REJUVENATES ALL PICTURE TUBES
WITHOUT ADAPTORS OR ACCIDENTAL TUBE DAMAGE

Featuring Automatic
Controlled
Rejuvenation

The All New SENCORE CR125 CATHODE RAY TUBE TESTER

An all new method of testing and rejuvenating picture tubes. Although the method is new, the tests performed are standard, correlating directly with set-up information from the RCA and GE picture tube manuals.

Check these outstanding features and you will see why this money making instrument belongs on top of your purchasing list for both monochrome and color TV testing.

Checks all picture tubes thoroughly and carefully; checks for inter-element shorts, cathode emission, control grid cut-off capabilities, gas, and life test. Checks all picture tubes with well filtered DC just like they are operated in the TV set.

Automatic controlled rejuvenation. A Sencore first, preventing the operator from over-rejuvenating or damaging a tube. An RC timing circuit controls the rejuvenation time thus applying just the right amount of voltage for a regulated interval. With the flick of a switch, the RC timer converts to a capacity type welder for welding open cathodes. New rejuvenation or welding voltage can be re-applied only when the rejuvenate button is released and depressed again.

Uses DC on all tests. Unlike other CRT testers that use straight AC, the CR125 uses well filtered DC on all tests. This enables Sencore to use standard recommended checks and to provide a more accurate check on control grid capabilities. This is very important in color.

No adaptor sockets. One neat test cable with all six



All six sockets, including latest color socket, on one neat cable.



Checks each gun individually in color tubes

sockets for testing any CRT. No messy adaptors, reference charts or up-dating is required. The Sencore CR125 is the only tester with both color sockets. (Some have no color sockets, others have only the older type color socket.)

No draggy leads. A neat, oversized compartment, in the lower portion of the CR125 allows you to neatly "tuck away" the cable and line cord after each check in the home.



MODEL CR128
For the man on the go. Same as above but in all steel carrying case . . . \$69.95

Model CR125 \$69.95

PS127 DELUXE WIDE BAND OSCILLOSCOPE AT A SURPRISINGLY LOW PRICE

This all new 5 inch oscilloscope offers the finest in performance, portability and appearance. Vertical amplifier frequency response, flat within 1 DB from 10 CPS to 4.5 mc and only 3 DB down at 5.2 mc insures true waveform reproduction. Vertical amplifier sensitivity of .017 volts RMS for one inch deflection on wide band (without band switching) is found only on scopes costing hundreds of dollars more. High input impedance of 2.7 megohms shunted by 99 mmfd (or 27 megohms with 9 mmfd with built-in low capacity probe), insures minimum circuit loading. For the first time, waveforms can be viewed in TV horizontal and vertical output circuits with the low capacity probe that will withstand up to 5000 volts peak to peak. To top that, the vertical amplifier attenuator controls are calibrated directly in peak to peak volts for fast direct reading of all peak to peak voltages.

Horizontal amplifier extended sweep range from 5 to 500 kc in five overlapping steps and frequency response from 10 CPS to 1 mc within 3 DB insures linear sweep and positive sync. External inputs for horizontal sweep and sync, intensity modulation, and smart two-toned case and "designer" styled controls brands the PS127 a truly professional oscilloscope.

PS127 \$169.50



Circle 18 on literature card

OXFORD... THE SYMBOL OF BETTER SOUND

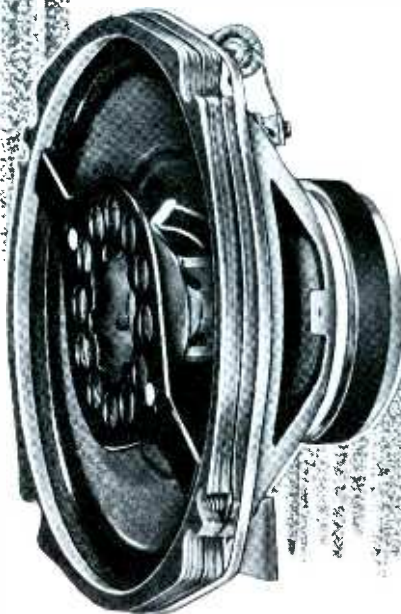

MODEL C8T

INTRODUCES AN ENTIRELY NEW LOUDSPEAKER FOR COMMERCIAL SOUND APPLICATIONS

Here is a full-range speaker that will satisfy the requirements of even the most critical audio engineers.

Designed for varied commercial sound uses, including background music, paging and intercom, the new Oxford C8T features an unusually wide distribution pattern (110°) combined with superb high fidelity sound reproduction. The C8T is a true coaxial type speaker with dual cone and magnet construction and built-in crossover. Frequency response is from 45 to 15,000 CPS and is one of the most

efficient 8-inch speakers available today.

It's priced right, too, providing an edge in today's competitive market. Oxford "know-how" and volume makes it possible to peg the price of the C8T under many single cone 8's in use today.

The C8T is representative of Oxford's advanced commercial sound line, where quality and price are perfectly blended to give you the world's greatest speaker values.

Write today for complete information on the new C8T speaker. Ask for Bulletin No. C-102.



OXFORD TRANSDUCER COMPANY

Division of OXFORD ELECTRIC CORPORATION

2331 North Washtenaw Ave. • Chicago 47, Illinois

Circle 19 on literature card



Fig. 4. Type of pulse that makes spike is most effective for feeding to the CRT for blanking.

whole winding, acts as a primary (see Fig. 3B). Some circuits can be adjusted to compensate for this shift in operation, but others cannot. Therefore, it may be easier to look elsewhere for a blanking pulse.

Vertical Drive Circuit

Although the signal fed to the grid of the vertical output tube is basically a sawtooth, it often contains a sizable negative-pulse component (see Fig. 4). If so, this pulse can usually be routed to the CRT grid in such a manner as to produce effective blanking. The main problem is to tap into the drive-signal forming circuit without changing its RC characteristics enough to distort the vertical sweep. Adding a blanking network may necessitate slight changes in the values of resistors and capacitors in the area between the vertical discharge and output stages.

Some original circuits include one

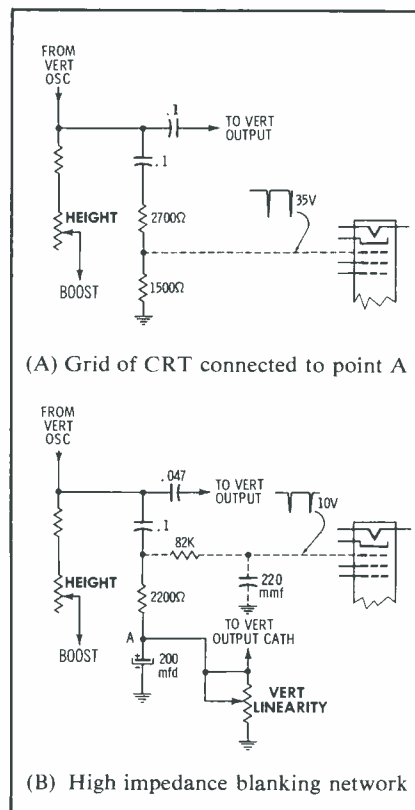

Fig. 5. Blanking pulses can be obtained by tapping into the vertical waveshaping circuit.

QUALIFY NOW FOR



FM STEREO SERVICE

19 TRANSISTORS
ALL CRYSTAL CONTROLLED
TRULY PORTABLE ONLY 7½ LBS.

\$169⁵⁰

SAVE HUNDREDS
OF DOLLARS

... with the ALL NEW **SENCORE** MX129 FM STEREO MULTIPLEX GENERATOR AND ANALYZER

It has been established by all Radio and TV manufacturers that you must have a generator of this type to service FM stereo receivers. Here is a new field just waiting for qualified men, a field that is growing as fast as color TV. Multiplex is simple to service with this generator. If you can service an FM receiver, you can service multiplex once you have the MX129.

Look at the outstanding features of this all transistorized Sencore unit and you will see why it is the most versatile, most portable, most trouble free unit on the market. It is just like having your own FM stereo transmitter on your bench or service truck. All signals are crystal controlled and instantaneous because there are no tubes to warm up. Powered by 115 volts AC to insure top performance at all times.

The MX129 produces all signals required for trouble shooting and aligning the stereo portion of the FM multiplex receiver and can be used as a stereo demonstrator by feeding in left and right audio signals into the jacks marked LEFT and RIGHT EXT. SIG. This unique feature will allow you to demonstrate stereo to the customer even when a stereo program is not being broadcast.

The MX129 becomes a complete trouble shooting analyzer with the addition of a meter calibrated in peak to peak volts and Decibels. No other equipment is required for checking channel separation or alignment. A jack marked EXT. METER is provided for connecting the meter to the stereo speakers or at other points after detection.

Here are the signals available on the MX129 for alignment, trouble shooting and analyzing:

- FM-RF carrier with composite multiplex audio signal just like that transmitted from the FM station: 38kc suppressed carrier, 19kc pilot and 67kc SCA signal. This signal available at RF output cable.
- Multiplex signal is formed by either 60 cycle or 1000 cycle internal tones for greater flexibility in testing.
- Full control over left and right channel amplitude (and therefore modulation). Built-in meter is used to set controls for equal modulation of FM carrier. Channels can be turned completely off when desired.
- 19kc pilot calibrated directly in percentage of modulation; can be generated separately for 19kc amplifier peaking by turning down left and right channels.
- External 67kc SCA (subscription) signal available at jack marked SCA OUT (67KC) for trap adjustment. This signal, not found on some high priced multiplex generators, is very important on new stereo receivers with adjustable 67kc traps.
- Composite signals, same as described above, available on jacks marked COMP. OUT for signal injection beyond the FM detector.

SENCORE

426 SO. WESTGATE • ADDISON, ILL.

Circle 20 on literature card

May, 1964/PF REPORTER 43

ONLY COURSE OF ITS KIND!

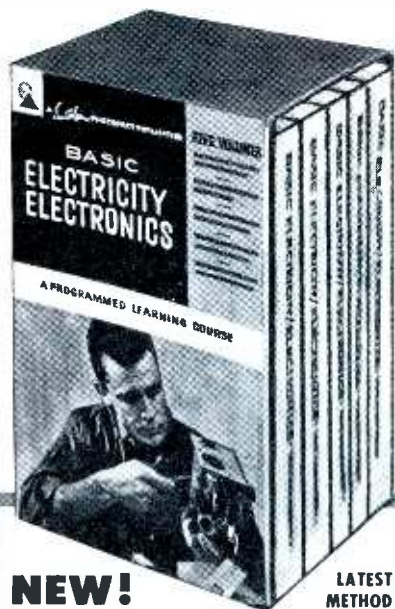

NEW!

LATEST METHOD

5-VOLUME HOWARD W. SAMS

Basic Electricity/Electronics

A PROGRAMMED LEARNING COURSE

now! unique, positive training worth hundreds of dollars...

First completely new Course to be published in the last 10 years...using the latest 5-step Programmed method for quick, effective, positive learning...

This 5-volume series completely replaces any prior publication. Primarily intended for technician-level training; no prior knowledge of electricity or electronics required. Completion of the Course provides all the basic knowledge and preparation for advancing into the study of such specialized areas as Radio Communications, Industrial & Military Electronics, Radio & TV Repair, Electricity & Power, etc. Easy, positive self-instruction is assured by the unique, ultra-modern programmed-learning method used in each volume.

- Vol. 1. Basic Principles & Applications
- Vol. 2. How AC & DC Circuits Work
- Vol. 3. Understanding Tube & Transistor Circuits
- Vol. 4. Understanding & Using Test Instruments
- Vol. 5. Motors & Generators—How They Work

(Complete Set contains over 1300 pages; 1250 illustrations; 51 chapters; in sturdy slip case)

SAVE SPECIAL MONEY-SAVING PRE-PUBLICATION PRICE!

5-Volume Set, ECY-50 (soft-cover in slipcase), Special Prepublication Price, Only \$17.95
(After June 30, 1964, regular price will be \$19.95)

5-Volume Set, ECS-50 (hard-bound in slipcase), Special Prepublication Price, Only \$21.95
(After June 30, 1964, regular price will be \$24.95)

ORDER NOW AND SAVE!

MAIL TODAY!

HOWARD W. SAMS & CO., Dept. PFE-5
4300 W. 62nd St., Indianapolis 6, Ind.

Please send me the following:

- ECY-50. 5-Volume Set (soft-cover) at the Special Prepublication Price of only \$17.95.
- ECS-50. 5-Volume Set (hard-bound) at the Special Prepublication Price of only \$21.95.

Name _____

Address _____

City _____ Zone _____ State _____

My Distributor is: _____

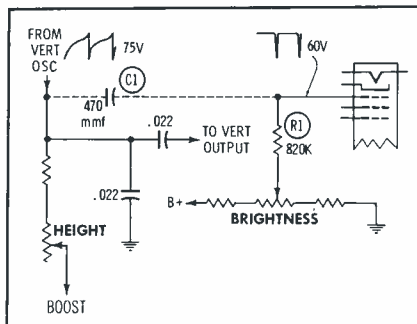

Fig. 6. C1 and R1 filter out the sawtooth.

or more resistors in series with the sawtooth-forming capacitor between the oscillator plate and ground. The purpose of the resistor is to develop the pulse portion of the drive waveform; thus, it is an excellent source of blanking pulses. Since the resistor can also serve as a grid return for the CRT, a simple direct connection can sometimes be made to the grid—as in Fig. 5A. In other cases, an RC coupling circuit similar to C1-R1 in Fig. 2A may be preferable; or, for minimum loading, a higher-impedance blanking network like that in Fig. 5B may fill the bill. Incidentally, as this last figure shows, a low-resistance connection to ground through the cathode circuit of the output stage is a satisfactory ground return for the CRT grid—if special precautions are taken to isolate the grid from the parabola-shaped ripple waveform present at the cathode.

Lacking a convenient resistor as a blanking-pulse source, you can sometimes tap in directly at the plate of the vertical oscillator. However, to avoid picking up the sawtooth component of the drive signal, you may need to use a high value of CRT grid resistance and a rather small retrace-coupling capacitor, as in Fig. 6.

Vertical Output Plate

If you need *positive* blanking pulses (Fig. 7), and can't obtain them easily from the vertical output transformer, you can make use of those at the plate of the output tube (Fig. 8). These extremely strong pulses (500 to 1000 volts) must be divided down to a small fraction of the available amplitude; for this purpose, you can arrange your coupling circuit as a capacitive voltage divider, using values approximately as given in Fig. 6. It's fortunate that the C1-C2 ratio shown in Fig. 8 gives the desired division of the sig-

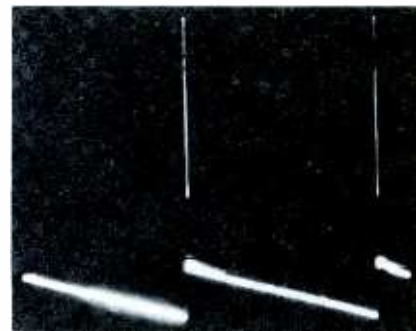

Fig. 7. The sweep pulse at the vertical output tube is a source of positive blanking pulses.

nal, for C1 must be small enough to minimize loading of the vertical circuit, and C2 must be large enough to provide some bypassing of the cathode for video and hum. R1 is mainly an isolating resistor.

In combined vertical multivibrator-output circuits, some point in the feedback network may be usable as a blanking-pulse source. This can be a tricky proposition, though; unless the blanking network is carefully blended into the design of the feedback circuit, it can cause distortion of the multivibrator waveform and lead to vertical instability.

Conclusion

The blanking circuits in this article are intended only as general guidelines to the theory of developing circuits to fit individual circumstances. Experimenting with different component values and circuit hook-ups will pay off in more effective blanking.

Remember that you're dealing with sharp pulses that will place fairly heavy stresses on components in and around the blanking circuit. Therefore, use new parts with generous ratings, and avoid feeding excessively high-amplitude pulses to the CRT. Finally, check to make sure the vertical sweep and the picture quality have not suffered from the addition of blanking. If everything is okay, you can be proud of having made a change that allows the set to operate better than when it was new. ▲

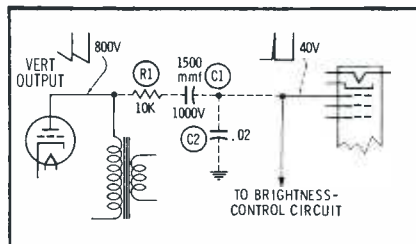

Fig. 8. The pulse in Fig. 7 will be properly shaped by resistor R1 and capacitors C1, C2.

Quality is no gamble!



when you specify **ELMENCO** dipped Mylar* paper

Every time you make a call . . . service a circuit . . . change a component — you bet on the parts used. Make sure the odds are in your favor with miniaturized Elmenco Dipped Mylar-Paper (DP) capacitors. Over 100 million are in use now, because Elmenco DP capacitors give missile quality at commercial cost. Whether for radio-TV repairs, or critical industrial circuitry, reliable, dependable, rugged Elmenco capacitors eliminate profit-killing callbacks and customer complaints. Elmenco DP capacitors operate at 125°C without derating, are completely moisture proof, and are up to 50% smaller than comparable types. You can substitute values in a capacitor, but never virtues. Ask for Elmenco, and be sure you get it. Elmenco DP capacitors are available from stock only at authorized ARCO distributors throughout the U.S.A.

*Reg. Du Pont Trademark



ARCO
electronics inc.

ARCO'S RESERVE WAREHOUSES

You can get your Elmenco (DP) capacitors in any quantity within 24 hours from coast to coast. They're stocked in depth at Arco's reserve warehouses serving authorized Arco distributors throughout the nation. Call your Arco distributor today!

Community Drive, Great Neck, N.Y. □ 516 HU 7-0500
Branches: Dallas 7 □ Los Angeles 35

Circle 21 on literature card



CURES FOR

COLOR HUE TROUBLES

Most TV viewers seem to grow accustomed to the shortcomings of their black-and-white receivers, and such things as ghosts, smear, or dim pictures are eventually taken for granted. They see an acceptable picture as they want to see it, not as it really is. I doubt, however, if these same viewers would ever tolerate a color set that shows a picture in which the skin color of their favorite TV performer is wrong. Of course, the exact color of many objects is unimportant (who cares if a painted wall is light blue or aqua?). But what Western fan would tolerate for long a green-faced Adam Cartwright riding over hills covered with purple trees? Other defects, such as smeared lipstick or pale color would be minor in comparison.

Yet, the difficulty in locating the source of these and similar hue troubles is not nearly so great as their importance might indicate. A few examples from our own experience may help to clarify this point.

For several years, I serviced all the color receivers myself; but color servicing has increased so much that we now route color calls—the same as black-and-white calls—on the basis of location. If the outside

man gets stuck on a set, he merely calls the shop technician for help. This has necessitated a continuing on-the-job training program for our whole force, and we hold a short session in the shop once a week. These short meetings are quite varied in format and range all the way from a short lecture or demonstration about color sets to open sessions where the men tell of recent experiences.

Phase and Saturation

We were talking on demodulators one day recently, and I explained that correct tint depended on proper phase, and that phase was *not* some supercomplicated subject that could be understood only by vector analysis. Vector diagrams offer the engineers a powerful tool, but as practical servicemen we don't consider phase in that way. The sine wave we see on an oscilloscope is one form of vector graph, but it is uncalibrated. A ghost is merely a second signal that has been delayed and so arrives "out of phase" with the main signal. (When the horizontal oscillator locks in with the blanking bar in the middle of the picture, this is a good illustration of correct frequency and wrong phase.)

In color demodulators we are interested only in the instantaneous voltage of each of two separate sine waves; one from the chroma sidebands (color information) and the other from the local 3.58-mc oscillator (demodulator phase information). A change in the *amplitude* of either signal will give a comparable change in the amplitude of the output signal (amount of color or color saturation), while a change in the *phase* of either will produce a different color hue (or tint) on the screen.

Correct Hue

At our next session, I demonstrated how to use a keyed color-bar generator to check the performance of a set, particularly for proper operation of the hue control and correct crossover of the color bars.

When the bar pattern is viewed with only one color gun activated, it is easy to see that the vertical bars of color vary in intensity from bright down to the same intensity as the space between the bars, then with even less brightness until the remaining bars are dark. The crossover point is the particular color bar, out of the ten, that is the same intensity (or brightness) as the space (background) between the bars. It is best located by numbering the bars starting from the left (with all color guns on); when you spot the bar you wish to examine, switch off the other two guns. Red crossover should occur at the sixth bar, green at the seventh bar, and blue at the third and ninth bars. The hue control moves all three colors (the entire spectrum, actually) from side to side as it is turned, but we usually set it so the third bar is maximum red, with the control at midrange. The second bar corresponds closely to skin color, and the hue control should be able to change this bar from cyan to magenta. Some deviation from these perfect conditions must be expected, but they should not exceed one half-bar.

I also demonstrated to the group how to set the 3.58-mc oscillator to its correct frequency. First, ground the reactance-tube control voltage (most color chassis have a special test point for just this purpose) and then adjust the reactance coil for a "zero beat" condition where the bars float slowly across the screen

Can you afford to guess

AT SWEEP, SYNC OR HIGH VOLTAGE TROUBLES?

WHEN IT'S SO EASY TO WALK THE TROUBLE RIGHT OUT OF THESE TIME CONSUMING CIRCUITS STEP BY STEP.....



SYNC. CIR. & H. SYNC. DISCRIM.	VERT. OSC.	VERT. OUTPUT	VERT. OUTPUT XFORMER	VERT. DEFLEC. YOKE
HORIZ. OSC.	HORIZ. OUTPUT	HORIZ. FLYBACK XFORMER	2nd ANODE VOLTAGE CIRCUIT	HORIZ. DEFLEC. YOKE

NEW, IMPROVED SENCORE SWEEP CIRCUIT ANALYZER MODEL SS117

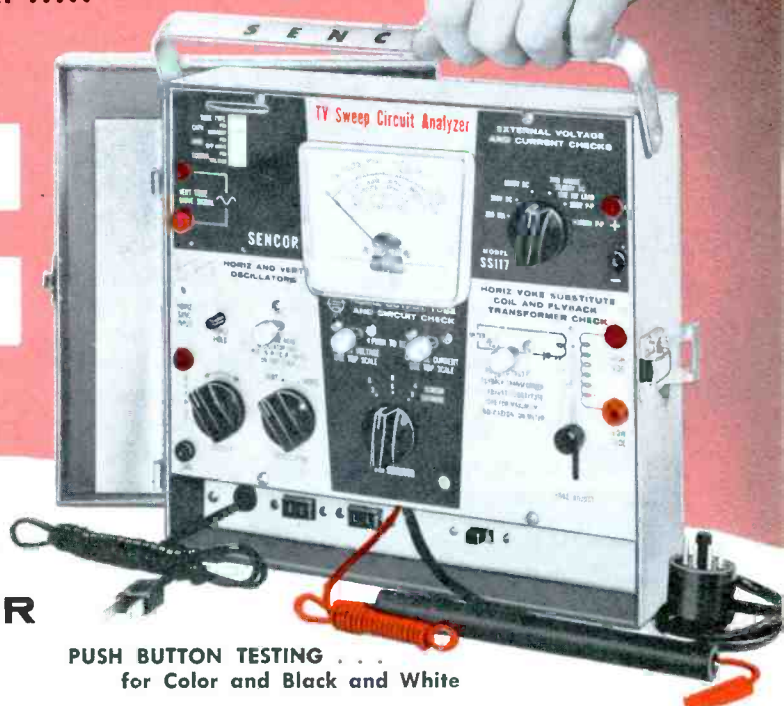

PUSH BUTTON TESTING . . . for Color and Black and White

How many times do you ask, "Why do I take so long finding that sweep trouble?" How often have you wondered whether weak horizontal sync was caused by defective sync circuit, horizontal oscillator, or sync discriminator? Can you quickly isolate inadequate width or low 2nd anode voltage to the oscillator, output, flyback transformer, or yoke? How many times have you changed a good yoke by mistake?

The SS117 will pinpoint troubles like these in minutes with tried and proven signal injection, plus yoke substitution for dynamic in-circuit tests. Error proof push button testing enables you to make all tests from the top of the chassis without removal from cabinet for maximum speed and profit on every job.

Here are the checks the SS117 makes . . .

- Horizontal Oscillator: Checked by substituting 15,750 variable output universal oscillator from SS117. Signal can be injected at any spot from horizontal output grid to horizontal oscillator to determine defective component.
- Horizontal Output Stage: Checked by reliable cathode current and screen voltage checks made with adapter socket and two push buttons,
- Horizontal Output Transformer: Checked for power transfer in circuit and read as good or bad on meter.
- Horizontal Deflection Yoke: Checked by direct substitution with adjustable universal yoke on SS117.

- Vertical Oscillator: Checked by substituting 60 cycle synchronized oscillator.
- Vertical Output Transformer: By simple signal injection for full height on picture tube.
- Vertical Deflection Yoke: By signal substitution for full height on picture tube.
- Sync Stages: Checked by synchronizing triggered horizontal SS117 oscillator from any stage. If oscillator synchronizes, sync is O.K.
- 2nd Anode Voltage: A new dynamic check using simulated picture tube load. C.R.T. does not need to be operating for current tests. No interpretations—read direct from 0 to 30 KV.
- External Circuit Measurements: By applying from 0 to 1000 volts AC or DC to external meter jacks. Meter will read DC or peak-to-peak volts. 0 to 300 milliamp scale also provided for measuring horizontal fuse current.
- New features include: Large 0 to 300 microamp meter for minimum circuit loading; all-steel carrying case with full mirror in adjustable cover; two 115 volt AC outlets in cable compartment.

Size: 10¼" x 9¼" x 3½". Wt. 10 lbs.

Model SS117

Dealer Net **\$89⁵⁰**



Sencore Sam says . . . How can you miss . . .

EACH PACKAGED UNIT CONTAINS:

- An Easy to Follow Instruction Book Especially Prepared and Edited by H. W. Sams.
- A complete 33 RPM, 10 inch Permanent Record on "How to Simplify Sweep Circuit Trouble Shooting."

SEE YOUR AUTHORIZED SENCORE DISTRIBUTOR

Circle 22 on literature card

SENCORE
ADDISON, ILLINOIS

CHEK-IT CIRCUIT TESTER

FOR ONLY **\$1.49** DEALER NET
— LESS BATTERIES

**BATTERY OPERATED
TESTS WITH POWER OFF**



MADE IN
U.S.A.

- CONTINUITY • FUSES • SWITCHES
- CHIMES • APPLIANCES • MOTORS
- BUZZERS • PUSH BUTTONS
- AUTO IGNITION and VOLTAGE REGULATORS, ETC.

ASK YOUR ELECTRONIC
PARTS DISTRIBUTOR FOR

W MODEL NO. BZ5

MANUFACTURED BY
WORKMAN Electronic
SARASOTA, FLORIDA PRODUCTS INC

Circle 23 on literature card

Get Your First Class Commercial F. C. C. LICENSE QUICKLY!

Our business is electronics training. We are now in our fourteenth year of operation, and have trained thousands of electronics technicians for successful careers.

We specialize in preparation for F.C.C. license examinations. Learn how our training can prepare you quickly for your first class commercial F.C.C. license. Write or telephone us at any one of our teaching divisions listed below, and ask for "Catalog #41." It will be mailed to you free of charge.

There is no obligation on your part, and no salesman will call on you. Make your own decision—enroll if and when you wish.

Grantham School of Electronics

1505 N. Western Ave., Los Angeles, Calif. 90027
(Phone: HO 9-7878)

9320 Long Beach Bl., South Gate, Calif. 90280
(Phone: 564-3421)

12732 Garden Grove Bl., Garden Grove, Calif. 92640
(Phone: 530-0795)

408 Marion Street, Seattle, Wash. 98104
(Phone: MA 2-7227)

3123 Gillham Road, Kansas City, Mo. 64109
(Phone: JE 1-6320)

821 19th Street, NW, Washington, D.C. 20006
(Phone: ST 3-3614)

Circle 24 on literature card

upright (rather than in diagonal stripes). The bars should lock in with solid action when the grounding clip is removed. This made a good demonstration and the men left with a little more confidence.

Problems and Cures

The next day Herb called in and said, "This set has the color in stripes. What shall I do?" I reminded him we had just covered the method of setting the 3.58-mc oscillator to eliminate the stripes of color. Herb replied that the color was in sync when a signal from the color-bar generator was used, and that the stripes on the network color show were only a little different in tint than the rest of the picture, especially on anything yellow or orange.

"You had better trust the color-bar generator, Herb, for these particular stripes are caused by a bad head on the video tape recorder at the station." With this assurance and the evidence of the good bar pattern, Herb was able to convince the owner the set wasn't causing the trouble, and thus completed the call. I decided to discuss this and similar transmission troubles with Herb and the other technicians.

A picture is sometimes worth many words, so I dug out a copy of a bulletin which had been issued by the engineers of all three networks and AT&T. I showed our men the pictures of several possible video-tape-recording defects, and how they looked on the screen of a color set. These defects included zig-zag vertical lines, horizontal stripes of different hue or saturation, and many others. A good serviceman should be able to recognize color picture defects that do not originate in the receiver. I suggested they call the shop on suspected transmission problems, to see if the same symptoms were present on our shop color monitor. This would eliminate second-guessing in the customer's home.

All Green

George was the next to encounter a hue problem in his call on a Zenith 29JC20 chassis. The screen showed green faces on colorcasts, regardless of hue control adjustments. Tube replacement in the color circuits did not change the symptoms so George brought the

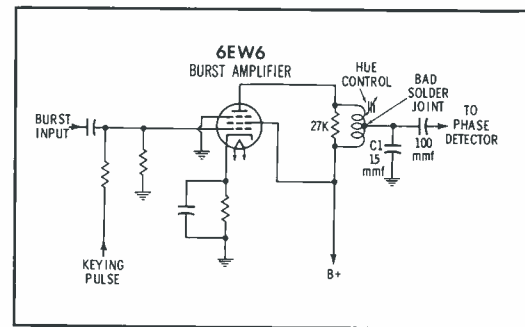

Fig. 1. In Zenith color receivers, hue control is adjustable coil in plate of burst amplifier.

chassis to the shop.

Using a keyed-color-bar generator as the signal source, we scope-traced the chroma signal right up to the grids of the 6JH8 demodulator tubes; the 3.58-mc oscillator signal on the deflector plates also seemed normal. The burst signal was okay at the grid of the 6EW6 burst amplifier, but was weak at the plate; and little or no burst was arriving at the input to the phase and killer detectors. A close visual examination of the 6EW6 plate circuit (Fig. 1) revealed an open solder joint in the center tap of the hue control (a coil in this chassis). This open connection changed the phase of the burst, because C1 no longer tuned the hue coil. A hot iron corrected this problem, and a check with the color generator proved the receiver was now operating normally.

No Blue

A dealer for whom we handle color service called us frantically one morning with the report that both his new color demonstrators had no blue in the color picture, only red and green. He had a potential customer coming in that afternoon to watch a color show, and so he asked us if we could check the sets immediately. This sounded as though some typical trouble might be involved here, since both sets were acting the same way.

My best shop man and I both went to check these sets, hoping for a quick repair. The moment we got the back off the first set and connected a cheater cord, we let out a sigh of relief; the filament in the 6GY6 Z-demodulator tube was not lit. A new tube brought the blue into that set, so we turned our attention to the next.

Thoughts of a similar trouble left us when a new 6GY6 did not help this set at all. We decided we would do some testing with our VTVM

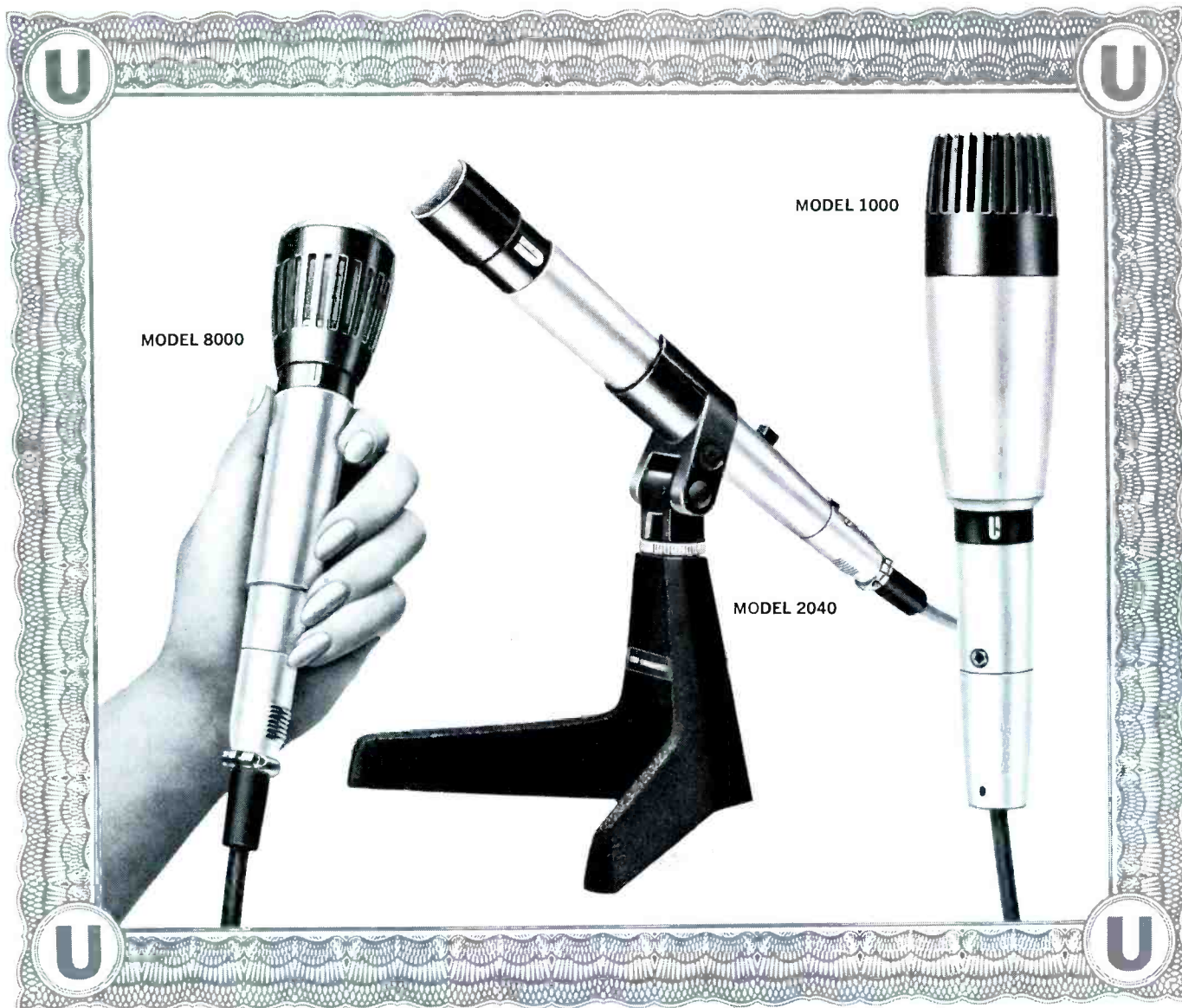

INTRODUCING THE WORLD'S NEWEST MICROPHONES... GUARANTEED FOR FIVE YEARS!

ALL NEW DESIGN...ALL NEW PERFORMANCE—Today... from the laboratories of University... an advanced technology has produced a great new breed of microphones for broadcasting, TV, professional and home recording, P.A., ham and CB applications. Each one represents a clean and dramatic break with tradition...with outmoded notions. Each one is far superior to any other microphone in its class. Let other microphone manufacturers offer the usual two to three-year warranty. Every University microphone—whether designed for the professional studio or the home recordist—is sold with a five-year warranty. For complete specifications, write: Desk PR-5, LTV/University, 9500 West Reno, Oklahoma City, Oklahoma.

EXAMPLES OF THIS GREAT NEW LINE!

MODEL 8000—A high performance dynamic cardioid for only \$29.95 net! Response: 70-13,000 cps. Sensitivity: -156 db (EIA). Output Level: -59 db/1mw/10 dynes/cm². Includes 15 ft. cable with Cannon plug and receptacle, and desk stand adaptor.

MODEL 2040—VOICE REALISM AT ITS BEST! New omnidirectional dynamic microphone that has astounded hams in initial trials! Modulation free of the harshness and muddy effect common to most microphones in this class. Ideal for upgrading P.A. and home tape recording performance as well.

MODEL 1000—CARDIOID DYNAMIC. Unique directional characteristics provide unexcelled discrimination against unwanted sounds—assure superior results even in noisy or reverberant locations. Internally shock-mounted—sensitive elements float, vibration-free, on polystyrene ribs! For any application requiring a truly discrete sound source.

**LTV
UNIVERSITY**

A DIVISION OF LING-TEMCO-VOUGHT, INC.

Circle 25 on literature card

May, 1964/PF REPORTER 49

FREE!

2 EXTRA DE-SOLDERING TIPS WORTH \$1.20...



when
you buy
the *Ungar* #270
De-Soldering Kit

ONLY \$5.83 EACH AT YOUR AUTHORIZED DISTRIBUTOR

Buy this kit, and mail the enclosed bonus coupon to Ungar. We will send you #861 Triangle Tip and #863 Cube Tip... a \$1.20 value - absolutely FREE.

The Ungar #270 Kit meets every requirement for fast, safe, easy component desoldering and removal. Avoids lug breaking, shifting and printed board rupturing.

Ungar's De-Soldering Kit speeds up work and increases efficiency. Here's how: The slotted tip melts solder quickly so that lugs bent close to the

printed board can be lifted, and straightened out in a fraction of the time.

The bar tip makes it easy to de-solder all multiple straight line network components.

A variety of cup tips is a must for de-soldering tube sockets or transformer pins. The Ungar kit includes the 5/8", 3/4", and 1" size - a complete assortment for most jobs.

The two FREE tips are ideal for electrolytic capacitor removal, tube socket pins, and harness leads.

BONUS OFFER

FREE...A DE-SOLDERING BOOKLET

For Just Visiting Your Authorized Ungar Distributor! Get it now!

UNGAR ELECTRIC TOOLS
ELECTRONIC DIVISION OF ELDON INDUSTRIES, INC., Hawthorne, Calif. 90252

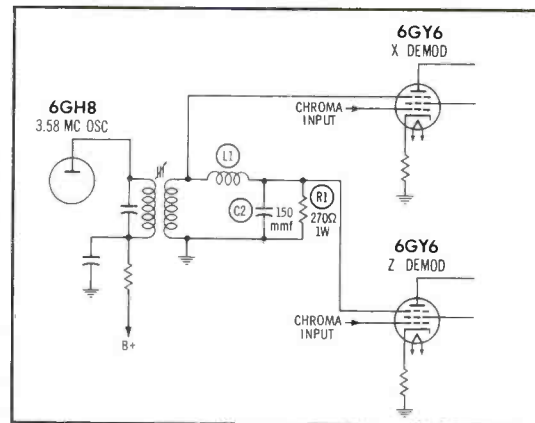

Fig. 2. L1 and resistor-capacitor network R1-C2 shift phase of signal fed to Z demodulator.

before taking the chassis to the shop. The plate, screen, and cathode voltages were okay on both the X and Z demodulators. We had just decided to stop checking further, when John found that the X demodulator had 10 volts of AC on the suppressor grid but the Z demodulator had none. We didn't know whether this was significant or not, since high-capacitance probes sometimes kill the oscillator. To check this reading, we turned the receiver off and set our meter to the ohms scale. At the suppressor of the X demodulator, we checked less than an ohm to ground; at the suppressor of the Z demodulator, the reading was 270 ohms. It was then obvious from the schematic (Fig. 2) that L1 must be open. This choke is one element in the low-pass filter that changes the phase of the oscillator signal applied to the Z demodulator. We verified this diagnosis by hooking a small clip lead across the choke and obtaining the bar pattern shown in Fig. 3. This is typical of the pattern that results from an oscillator signal of the same phase being applied to both demodulators simul-

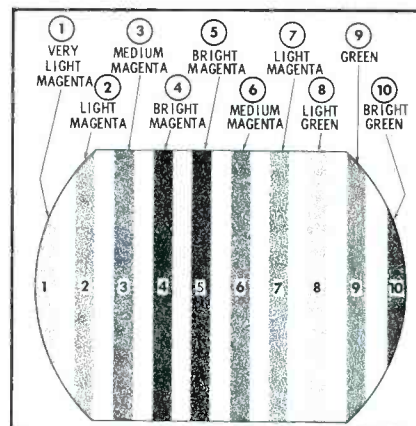

Fig. 3. Color-bar pattern produced when signal of same phase is fed to both demodulators.

SENCORE

SIMPLIFIES COLOR SERVICING

NEW! CA122

COLOR CIRCUIT ANALYZER

A simple approach to a complex problem

Here is an instrument that is designed to eliminate the guesswork in color TV servicing. A complete analyzer that provides all required test patterns and signals for testing from the tuner to the tri-color tube. Additional analyzing signals for injection at each stage including audio, video and sync, brings to life a truly portable and practical TV analyzer for on the spot service; virtually obsoleting other analyzers with the advent of color. Sencore's simplified approach requires no knowledge of I, Q, R-Y, B-Y, G-Y or other hard to remember formulas. The CA122 generates every signal normally received from the TV station plus convergence and color test patterns.

The CA122 offers more for less money:

TEN STANDARD COLOR BARS: The type and phase that is fast becoming the standard of the industry. Crystal controlled keyed bars, (RCA type) as explained in most service literature, offer a complete gamut of colors for every color circuit test.

WHITE DOTS: New stabilized dots, a must for convergence, are created by new Sencore counting circuits.

CROSS HATCH PATTERN: A basic requirement for fast CRT convergence.

VERTICAL AND HORIZONTAL BARS: An added feature to speed up convergence, not found on many other color generators.

SHADING BARS: Determines the ability of the video amplifier to produce shades (Y Signal) and to make color temperature adjustments. An important feature missing on other generators.

COLOR GUN INTERRUPTOR: For fast purity and convergence checks without upsetting color controls. Insures proper operation of tri-color guns, preventing wasted time in trouble shooting circuits when CRT is at fault.



A must for color . . .
a money maker for black and white TV servicing

ANALYZING SIGNALS: RF and IF signals modulated with any of the above patterns for injection into grid circuits from antenna to detector. IF attenuator is pre-set for minimum signal for each IF stage to produce pattern on CRT thus providing a check on individual stage gain. Sync and video, plus or minus from 0 to 30 volts peak to peak, have separate peak to peak calibrated controls for quick checks on all video and sync circuits. Crystal controlled 4.5 mc and 900 cycles audio simplify trouble shooting of audio circuits.

NEW ILLUMINATED PATTERN INDICATOR: A Sencore first, offering a rotating color film that exhibits the actual color patterns as they appear on color TV receivers. Locks in with pattern selector control.

You'll pay more for other color generators only.

Dealer Net 187.50

NEW! PS120 PROFESSIONAL WIDE BAND OSCILLOSCOPE

A portable wide band 3 inch oscilloscope for fast, on-the-spot testing. An all new simplified design brings new meaning to the word portability . . . it's as easy to operate and carry as a VTVM. Though compact in size, the PS120 is powerful in performance: Vertical amplifier frequency response of 4 MC flat, only 3 DB down at 7.5 MC and usable to 12 MC, equips the technician for every color servicing job and the engineer with a scope for field and production line testing. AC coupled, with a low frequency response of 20 cycles insure accurate low frequency measurements without vertical bounce. Sensitive single band vertical amplifier; sensitivity of .035 volts RMS for one inch deflection saves band switching and guessing. Horizontal sweep frequency range of 15 cycles to 150 KC and sync range from 1½ cycles to 8 MC (usable to 12 MC) results in positive "locking" on all signals. New exclusive Sencore features are direct reading peak-to-peak volts —no interpretation; dual controls to simplify tuning; lead compartment to conceal test leads, jacks and seldom used switches. Rear tilt adjustment angles scope "just right" for easy viewing on bench or production line.

Size: 7" w x 9" h x 11¼" d. Weight: 12 lbs.

Dealer Net 124.50
(with low cap. probe)

Kit 74.50



A must for servicing color TV in the home . . . lowest priced broad band scope. All hand wired — all American made

Circle 27 on literature card



Miller Part No.	Use	Manufacturer Part No.
ADMIRAL		
7116-A	Sound I.F.	72-B208-1
7117-A	Quadrature Coil	72B132-37
7501-A	Video I.F.	72-C132-38
7502-A	Video I.F.	72-C132-39
7503-A	Video I.F.	72-C132-31
7504-A	Video I.F.	72-C132-41
7505-A	Video I.F.	72-C132-42
7506-A	Video I.F.	72-C132-43
7507-A	Video I.F.	72-B191-3
BENDIX		
6516	Auto I.F.	2090907-1
6517	Auto I.F.	2090907-7
EMERSON		
7514-E	Video I.F.	720318
7515-E	Video I.F., Trap	720315
7516-E	Video I.F., Trap	720317
OLYMPIC		
7124	Sound I.F.	CL4021
PHILCO		
7113-P	TV Discriminator	32-4631, 31A, 32
7121-P	Quadrature Coil	32-4644-13, 14, 20
7513-P	Video I.F.	32-4686-2, -3, -22
TRAV-LER		
7122	Sound I.F.	L-167
7123	Sound I.F., Trap	L-154
7517	Video I.F.	L-152
WESTINGHOUSE		
6213	Horz. Coil	230V032H01
7118-W	Sound I.F., Trap	230V030H02
7119-W	Quadrature Coil	230V031H01
7120-W	Sound I.F.	235V046H01
7508-W	Video I.F., Trap	230V030H01
7509-W	4th Video I.F.	235V005H01, 02
7510-W	2nd, 3rd Video I.F.	235V020H01, 03
7511-W	1st, 2nd, 3rd Video	235V048H01, 02
7512-W	1st Video I.F.	235V049H01
WELLS GARDNER		
7518	Video I.F.	9A2436
7519	Video I.F.	9A2444
ZENITH		
7114-Z	Sound I.F.	S-41899
7115-Z	Sound I.F., Trap	S-50341
7702-Z	455 kc. 1st I.F.	95-1101
7703-Z	455 kc. 2nd I.F.	95-1102
7704-Z	455 kc. Output	95-1149/95-1350
7851-Z	10.7 Mc. Disc	95-1153
7852-Z	10.7 Mc. 2nd I.F.	95-1150

J. W. MILLER CO

5917 South Main Street
Los Angeles 3, California

Circle 28 on literature card

taneously. A shorted choke would give this same bar pattern, for example.

John drove me back to the shop, and went on to the distributor for a new choke and then back to the dealer's showroom to complete the repair. He pulled the chassis only part-way out and propped one corner on a chair. With the aid of a flashlight resting on the floor, he was able to unsolder the old choke and reinstall a new one without disconnecting all the cables or pulling the tuner.

Color-Bar Hints

The first Tuesday we had a repaired color set in the shop, I showed the men color-bar patterns of simulated defects—such as what happens with a dead 3.58 oscillator, no horizontal blanking, defective X or Z demodulators, etc.

This particular demonstration happened to be on a set with an RCA CTC11 chassis. The bars on the screen were all a weak but uniform magenta (reddish-blue) when the 6GH8 color oscillator tube was removed from its socket. They were surprised at this because they really expected *no color*. However, the chroma signal was detected by demodulator-tube overload and the resulting signal came out as blue and red bars of the same intensity on all parts of the screen. Why no green? Because the green is made by adding the R-Y to a B-Y signal of opposite phase; thus, wherever red and blue bars appeared, the green gun was biased to cutoff.

Some information can be applied to other models, and some cannot; as I soon found out. About a week later, I was checking an RCA CTC12 chassis in a customer's home for a no-color condition. Black-and-white operation was normal. I remembered that the color killer on this model was noise immune and therefore would eliminate the color completely if the color oscillator were out of sync. When I turned the killer control fully counterclockwise, I got a faint hint of color. The color-bar generator supplies more color than does the average color program, so I attached it and was surprised to find *green* bars, exactly like the purple ones on the set I had used in my demonstration. Bars that are all of the same brightness can develop only if the genera-

tor pulses are all the same phase or if the receiver oscillator is dead. But why weren't they purple, like before? The color control worked okay but the tint control had no effect at all. While pondering how this could happen, I plugged in a new 6GH8 oscillator tube and got a normal color pattern just as soon as it warmed up.

After I got back to the shop, I carefully compared the CTC11 and CTC12 circuits and found that the 3.58-mc signal in the CTC11 is fed to the cathodes of the demodulators; in the CTC12 the signal goes to the suppressor grids. Thus the two oscillator signals are opposite in phase, but the chroma signal goes to the grids in both cases. Consequently, we have required our men to memorize this little rule:

CTC7 through CTC11—dead oscillator makes all color bars purple.

CTC12 and CTC15—dead oscillator makes all bars green.

Poor Registration

George brought in an RCA CTC7 chassis because of bad vertical sync, and also remarked that the color was not too good, which might be caused by the set's location. John, our ace bench man, repaired the sync problem and then started to check the color. The fourth bar, which is about 50% red and 50% blue (or magenta) showed a blue border on the left side of the bar and a red border on the right, with the displacement being almost 1/2". The ninth bar (cyan) showed green on the left and blue on the right. John switched to crosshatch and found that misconvergence was not enough to account for this bar displacement. Back on color bars, we noticed the bars were not very sharp and the crossover points were not clear. He tried to adjust the third bar for blue crossover, but the phase adjustment would not move the bar enough without losing most of the blue amplitude.

This called for a conference over coffee cups, and these facts emerged:

1. We didn't know why the bars were displaced or wouldn't cross over.
2. The serviceman who worked on this set previously was noted for his proficiency with a slug-adjusting tool. He

STOP!

LOOK!

SAVE!



A
STANDARD
COLOR BAR
GENERATOR
at **1/2**
THE COST OF
OTHERS

only **\$124⁵⁰**

All crystal controlled

the all new **SENCORE**
CG126 STANDARD COLOR BAR GENERATOR

A standard color bar, white dot, crosshatch generator especially made for field service on color TV . . . and at a great savings to you.

Check these outstanding features and you will see why this generator belongs on the top of your list for color TV servicing.

All patterns crystal controlled offering "rock like" stability. You'll think the patterns are painted on the TV screen.

Simplified operation speeds up every servicing job. Just dial the standard keyed bars, white dots, crosshatch, vertical bars or horizontal bars and watch them "pop" on the screen. That's all there is to it.

Exclusive adjustable dot size. The white dots can be adjusted to the size that satisfies your needs by a screwdriver adjustment on the rear. No need to argue about dot size anymore. Just select the size that you like to work with best.

Pretuned RF output to Channel 4. Other low channels can be selected if Channel 4 is being used in your area by simple slug adjustment. Patterns are injected directly into antenna terminals, simplifying operation and saving servicing time.

Reserved output on color bars for forcing signal through defective color circuits. The color output control is calibrated at 100 percent at the center of rotation, representing normal output. A reserve up to 200 percent is available on the remainder of rotation.

Smaller and more portable. With color receivers weighing much more than black and white TV, portable equipment becomes essential for home servicing. The CG126 weighs less than 10 pounds and measures only 11" x 8" x 6".



Ten standard keyed color bars (RCA type) that automatically provide all colors at specified NTSC phases . . . but without need of interpretation when servicing.

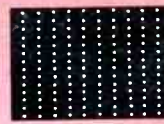

Stable white dots with new exclusive dot size adjustment in rear.

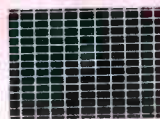

Stabilized crosshatch pattern for simplifying convergence adjustments.



10 thin white vertical lines for horizontal dynamic convergence adjustments . . . often missing on other generators.



14 thin horizontal lines for vertical dynamic convergence. Also missing on many high priced generators.

March into your local parts distributor and demand the CG126 Sencore color generator that sells at 1/2 the price of others. Don't let him switch you.

SENCORE

426 SO. WESTGATE DRIVE • ADDISON, JLL.

Circle 29 on literature card

May, 1964/PF REPORTER 53

MR. ANTENNA INSTALLER

Inside this colorful box is one of 7 TRIO Golden Zephyr VHF Antenna Models. In similar boxes are the new TRIO Color-Brite UHF Antennas and 5 models of popular TRIO Golden FM Antennas. Each is GUARANTEED IN WRITING to offer Better Performance, Better Construction and Better Appearance. This is important to you! Equally important . . . in the envelope on the end of each box, TRIO antenna boxes is a coupon to be redeemed BY YOU for a generous number of \$4 H Green Stamps of TRIO Premium Points. YOU BUILD CUSTOMER GOOD WILL AND YOU EARN VALUABLE PREMIUMS FAST WHEN YOU INSTALL TRIO.

See your TRIO Distributor or write us for details.

TRIO MANUFACTURING COMPANY
GRIGGSVILLE, ILLINOIS



Circle 30 on literature card

would turn anything that was not glued down.

3. The monochrome and color pictures would be displaced from each other almost $\frac{1}{2}$ " if the delay line were not used. This is because the chroma signal is slowed down by going through a comparatively narrow-bandwidth channel.

Could something be changing the chroma bandwidth? If so, would one color be displaced more than another? These questions could only be answered with good test equipment, and luckily we had that.

After seeing the botches that result from random turning of tuning slugs, we make it a strict rule never to turn an IF adjustment unless we are actually doing a complete alignment with full sweep equipment. But it does *no* harm to merely look at a curve; sometimes it will show up troubles other than alignment.

The overall curve from the tuner to video amplifier was good, but from the tuner to the color demodulator it was terrible. There was a peak at 3.6 mc, and nothing above that. Evidently the man had adjusted all the chroma IF's for maximum color.

John was muttering unprintable phrases by the time he brought the chroma circuit into alignment. With crossed fingers, we hooked up the bar generator and saw nice, sharp bars; the compound red-blue and blue-green bars were overlapped perfectly, and the blue bars would adjust easily to correct crossover! Three bad symptoms had been corrected with alignment alone.

Conclusion

As you can see from these examples, some hue problems are easy to remedy and some are quite hard. Learning to recognize and interpret hue troubles on the screen, deciding what circuits might be defective, and picking test instruments to use, are all valuable keys to solving these tint problems.

Plastic Repair

How many times have you wished for a glue that will permanently bond broken radio and TV cabinets, and all types of control knobs? Perhaps cracked cases aren't too hard to mend; but what about those



broken plastic screw mounts? Without them, the mounting screws won't hold the chassis in place.

It's a rare radio or TV man that doesn't swear at one time or another that he'd give his eye teeth for a real good bonding agent to perform just such tasks. One that would harden to such a consistency that it would form a bond stronger than the original material.

Well, the Rawn Co. has introduced just such a bonding agent. Not only can it be molded to any shape, but it will dry, without sticking, around vaseline-coated objects. For example, to reform a mounting hole in a cabinet, the screw is first coated with vaseline; Plas-T-Pair is mixed and shaped about the mounting hole; and the screw is inserted. The vaseline prevents the glue from sticking to the metal, and the screw is simply backed out when the mixture hardens.

Plas-T-Pair comes as a kit consisting of powder, liquid, dispenser, sandpaper, and aluminum foil. The powder and liquid are mixed together according to the manufacturer's instructions, and either poured or pressed into place. The mixture can be poured from any container (such as a paper cup) that will allow a thick liquid to flow. The narrow-mouthed powder dispenser can be used for tight, hard-to-get-at corners; merely spread the powder around the area to be repaired, and add the liquid via the eyedropper included with the kit.

The glue dries clear; it can be sanded, drilled, and painted. It can also be polished to a high gloss with any good plastic polish. ▲

For further information, circle 66 on literature card

you get **PRODUCT PLUS** from your Sylvania Distributor



Sylvania Business Aids Build Prestige & Profits

Your Sylvania Distributor can brighten your display window, add a gleam to your showroom, build your technical library, help your service department. How? He can supply you with tube caddies...showroom displays...display counters...service stickers...illuminated signs...tech manuals...workbenches...pocket guides...banners...clocks...etc., etc. Some items are free; others are offered to you at cost plus handling. All are designed to help you build sales and prestige. You can see the complete selection in the new folder, "Be Money Ahead With Sylvania's Business Aids"—FREE from your Sylvania distributor.

SYLVANIA
SUBSIDIARY OF
GENERAL TELEPHONE & ELECTRONICS GTE

NEW CAPABILITIES IN: ELECTRONIC TUBES • SEMICONDUCTORS • MICROWAVE DEVICES • SPECIAL COMPONENTS • DISPLAY DEVICES

CUSTOM STEREO SIMPLIFIED

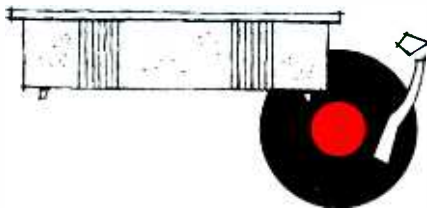

System design
and installations
made easy.

by Art H. Meyerson

Installing a stereo high-fidelity system presents some special problems. For one thing, it is equivalent to working with two separate hi-fi systems. FM multiplex, stereo records and pickups, and dual amplifiers all display characteristics not found in conventional hi-fi systems. Many poor stereo installations result from improper matching of these characteristics.

In many cases the first problem is to reconcile the husband's and wife's viewpoints. Generally these do not coincide, but they can be negotiated; diplomacy usually dictates that you do as much as possible to satisfy the wife's tastes. She is conscious of room decor, so you must make the installation attractive and unobtrusive as well as functional.

Speaker Installation

While the installation of the electronic portion of the equipment is routine, speaker placement is not. There are certain standards that must be observed. Whenever possible, the speakers should face into the longest dimension of the room for best propagation of the low notes. They should be mounted at ear level (when the listener is seated), since treble tones generally follow a straight line. This does not preclude installing the speaker system so it faces into the short room dimension nor does it prevent a deviation in speaker height. However, if the speakers are to be installed at ceiling height or on a high shelf, be sure to get the customer's permission to face them downward at an angle directed toward the listening area.

Should one speaker face a doorway, the results may be disappointing. Normally, this speaker will have to be played at a higher level

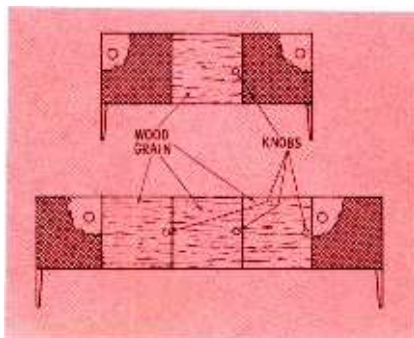

Fig. 1. Placing of tweeters for best results.

to produce an apparent balance. At best, results are usually less than satisfactory with this arrangement.

Balance between speakers is set by playing the system monophonically and adjusting the balance control until the sound seems to come from a point midway between the two speakers.

Physical Separation

The proper distance between the speakers depends on where the listener will sit. It is common to make the distance between speakers two-thirds of the distance from the speakers to the listening area. However, the listening area could be accommodated to fit the distance between the speakers; if the stereo

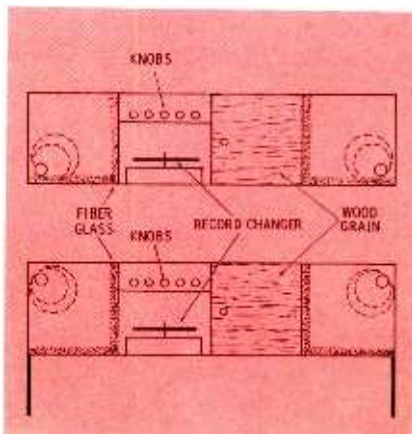

Fig. 2. Speaker location, fiberglass lining.

system is installed in a 6' cabinet, 8' to 10' is a good distance from which to listen. Stereo effect can be enhanced by spreading the speakers up to 8' apart, but care must be taken not to spread them so far apart that the sound seems to split up, leaving a "hole" in the middle. If the speakers are separated by 9' or more, a center speaker is needed. It must operate at a level about 50% below either of the other speakers. This three-point system helps materially when listening to the system from an off-center position. The center speaker need not be capable of reproducing frequencies below about 100 cps. If a summing-type speaker tap is not provided in the amplifier, two small speakers, attached to the left and right channels respectively, may be used.

Mounting

The tweeters are an important factor in producing stereo effect. For this reason, they should be installed at the outer edges of the speaker compartment in smaller cabinets and toward the inner edges in larger cabinets (Fig. 1).

Coaxial or full-frequency speakers may also be installed off-center, depending on the circumstances. Many speaker authorities favor the off-center positioning of speakers to aid cabinet resonance.

Speakers may be installed at either the tops or bottoms of the compartments, depending on the position of the listener. When lining the cabinet with fiberglass or other padding, favor the inside walls and bottom of the speaker section, as shown in Fig. 2.

If the entire system is to be installed in a single cabinet, it is best to use a boxed, or integrated, speaker system. The entire box is then installed in the speaker compartment with foam rubber insulation. This presents a problem in box dimensions, since most speaker-system enclosures are 24" in one dimension. The inside of a speaker compartment is usually 22½" high and 23" wide for a three-section, 6' cabinet. There are two possible solutions:

One is to have a local cabinet-maker build speaker boxes of dimensions to fit inside the cabinet. Install the speakers in these enclosures according to the speaker man-

be a
REAL PRO

the Arnold Palmer way...
 and get set for
EXTRA BUSINESS!



Golf Champ Arnold Palmer is everyone's idea of a Real Pro. In a color TV commercial currently appearing on the Walt Disney "Wonderful World of Color" TV show, this tremendously successful golf pro is telling millions of viewers to "Look for a Real Pro of a TV Serviceman."

Your potential customers are now looking for REAL PRO TV service, at Arnold Palmer's recommendation.

Here's how you can participate:



Your local RCA distributor makes available to you the following Arnold Palmer Real Pro aids:

- COLORFUL WINDOW DISPLAYS IN TWO SIZES
- AD MATS FOR LOCAL NEWSPAPER ADVERTISING
- RADIO SPOT COMMERCIALS (30 and 60 seconds)

All these aids feature Arnold Palmer's Real Pro endorsement of your services, helping to associate you in the mind of your potential customers with the unquestioned professionalism of all time golf pro, Arnold Palmer.

See your local participating RCA distributor for all Arnold Palmer Real Pro aids

Also ask about:



1A1403 — New Compact Flashlight — Remarkably handy, long lasting compact flashlight with 2 RCA alkaline batteries and unbreakable lens.



1A1001A — New RCA SUPERWELD Tube Caddy featuring the amazingly strong new vinyl covering, "Superweld", for extra durability.



1A1414 — New Heavy Duty Multiple Outlet Box — A convenient master control center with 6 sockets for your test equipment and other power requirements.

RCA ELECTRONIC COMPONENTS AND DEVICES, HARRISON, N.J.



The Most Trusted Name
 in Electronics

ufacturer's recommendations. Some speaker systems come already mounted in "black boxes" (so called because they are painted black). They are made from $\frac{3}{4}$ " or $\frac{7}{8}$ " pressed pine board (or other inexpensive material) and usually measure about $21\frac{1}{2}$ " x 16" x 15". When these boxes are used, the back of the speaker compartment may be constructed of $\frac{1}{4}$ " plywood and a framed grille cloth may be used for the front, as shown in Fig. 3.

If a regular shelf-type speaker is to be installed in a large cabinet, one of several methods may be used.

The inside wall of the speaker compartment may be moved over $1\frac{1}{2}$ " to 2" and a false wall installed in the adjoining section. This can be done by a competent carpenter. A good portion of the front may be blocked off without interfering with speaker openings. If the speaker cabinet has grille cloth, this will have to be removed and a framed grille cloth installed on the front of the hi-fi cabinet.

A hole may be cut in the bottom of the hi-fi cabinet and the speaker cabinet hung on foam rubber-covered metal cleats (Fig. 4). A

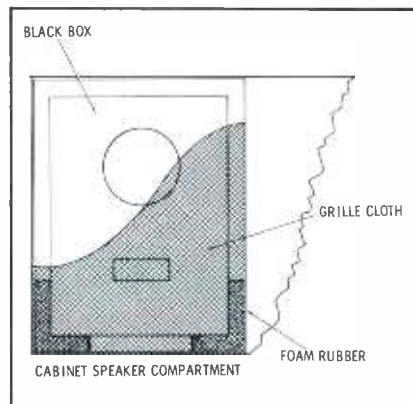

Fig. 3. Construction details of "black box."

A 24" speaker box will protrude about 1" below the cabinet, so make sure the bottom skirt of the cabinet will hide it. Another point: Make the hole at least 1" or 2" larger than the end of the speaker box to allow for maneuvering during installation. Be sure the customer approves what you are going to do.

The purpose of mounting the speaker system on foam rubber is to prevent acoustic feedback. If it is necessary to mount the speakers directly in the cabinet, be sure that $\frac{3}{4}$ " corewood or plywood is used throughout the speaker compartment, including the front and back. It may be necessary to reinforce the sides with a section of 1" x 2" lumber to prevent feedback. (The feedback problem is aggravated in stereo because a portion of the vertical motion of the needle is used.)

Installation Tips

At times, installation is made almost impossible by what the customer wants in the way of equipment, cabinetry, or listening area. Check everything carefully before you commit yourself. A cabinet with loose tambour doors (similar to a roll-top desk) could vibrate and

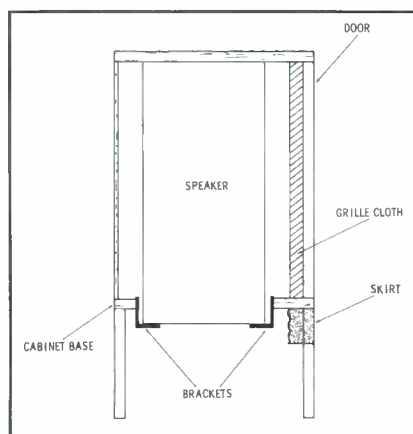

Fig. 4. Hanging black box in hi-fi cabinet.

The difference in screwdrivers is spelled

CHAN N E L LOCK



You'll do the job easier and faster, year after year with CHANNELLOCK drivers. Blades are forged from tough, chrome vanadium steel... won't twist or snap. Tips are ground lengthwise to assure greater "end" strength and snug fit in screw slot. Opaque blue plastic (UL) handles are shockproof, breakproof and locked to the blade. Specify CHANNELLOCK drivers... you'll be glad you did

SHOCKPROOF...
BREAKPROOF

FREE Catalog showing complete line of hand tools yours for the asking.

CHANNELLOCK, INC. Meadville, Pennsylvania
Formerly Champion Instrument Tool Co.

Circle 32 on literature card

**FINEST
MONEY-MAKER
FOR
Professional
Servicemen**

Multiple-Socket Speed with Gm Accuracy

PLUS OBSOLESCENCE PROTECTION

TESTS
All TV and Radio Tubes
—Old and New

TESTS
European Hi-Fi Tubes,
Voltage Regulators, and
Most Industrial Types

TESTS
for True Dynamic
Mutual Conductance (Gm)

TESTS
Nuvisitors and Noyars

TESTS
the New 10-Pin Tubes

TESTS
New 12-Pin
Compactrons



Model 700 DYNA-QUIK DYNAMIC MUTUAL CONDUCTANCE TUBE TESTER

See your B&K Distributor
or Write for Catalog AP21-R

TESTS BOTH OLD AND NEW TUBE TYPES—SELLS MORE TUBES PER CALL

All over the nation, thousands of professional servicemen rely on the "700". Once you use it, you'll be as enthusiastic as they are. *Everyday use has proved its speed . . . its accuracy . . . its efficiency.* This up-to-date, obsolescence-proof tube tester is designed for maximum use *today and tomorrow.* Provides multiple-socket section to quick-check most of the TV and radio tube types the *true dynamic mutual conductance way—plus* simplified switch section to check new tube types in Dyna-Quik emission circuit. Also includes provision for future new sockets.

Makes test under set-operating conditions. Checks each section of multi-section tubes separately. Checks for *all* shorts, grid emission, leakage and gas. Makes quick "life" test. Exclusive *adjustable* grid emission test provides *sensitivity to over 100 megohms.*

Makes complete tube test in seconds. Checks average set in a few minutes. Discovers weak tubes that need replacement. *Satisfies more customers. Sells more tubes. Saves call-backs. Insures your reputation. Pays for itself over and over again.* Net, \$169⁹⁵

Time-Saving, Money-Making Instruments Used by Professional Servicemen Everywhere



Model 960 Transistor
Radio Analyst



Model 360 V O Matic
Automatic VOM



Model 375 Dynamatic
Automatic VTVM

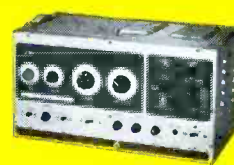

Model 1076
Television Analyst



Model 445 CRT
Rejuvenator Tester

NEW TUBE INFORMATION SERVICE

Available every 3 months, on subscription,
for all B&K Dyna-Quik Tube Testers



B & K MANUFACTURING CO.

Division of DYNASCAN CORPORATION

1801 W. BELLE PLAINE AVE. • CHICAGO 13, ILL.

Canada: Atlas Radio Corp., 50 Wingold, Toronto 19, Ont.

Export: Empire Exporters, 253 Broadway, New York 7, U.S.A.

Circle 33 on literature card

May, 1964/PF REPORTER 59

THE WONDERFUL WIZARD 300*



Another Wizard 300 Master Antenna System — one antenna — twenty outlets — no amplification — done entirely in twinlead. The Castle Shasta Apartments, 11620 Bellflower Road, Downey, California.

WRITE FOR SCHEMATIC DIAGRAM & SPECIFICATIONS
CHARLES ENGINEERING, INC.
 3421 NORTH KNOLL DR., LOS ANGELES, CALIF. 90028
*U. S. LETTERS PATENT NO. 2,913,679

Circle 34 on literature card

ARCHITECTURALLY YOURS



PART NO. 0A56U 8 IN.

OAKTRON'S NEW

DUAL PURPOSE COMMERCIAL SOUND SPEAKER

THE BLUEPRINT TO BETTER SOUND FOR BOTH VOICE AND MUSIC

DESIGNED FOR THE DESIGNER

- PERMITS SIMULTANEOUS PAGING WITH HIGH FIDELITY BACKGROUND MUSIC
- 6 OZ. CERAMIC MAG.
- HEAVY DUTY ALUM. V. C.



SEE COMPLETE LINE RM. 658

Circle 35 on literature card

New BERN'S Perfect Pin Crimper

Picture-Tube Repair Tool

Also for—5U4, 65N7, 6BQ6, etc.

Eliminates that hard soldering job
 only \$1.25 each

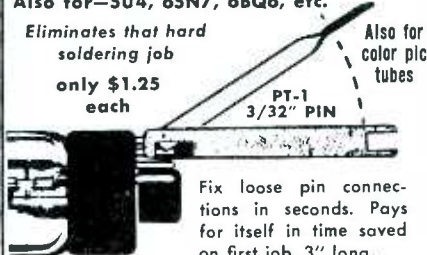

Fix loose pin connections in seconds. Pays for itself in time saved on first job. 3" long.

Patented
 Intermittent operation of picture tubes and other tubes due to defective solder connections easily corrected. Provides solid electrical connections, can also be used as channel-selector wrench and screwdriver. Pin keeps its original form. A 3-in-1 tool.

3 MODELS ELIMINATE SOLDERING

Makes Solid Electrical Connections Phono Pin-Plug Crimper

Slip wire in "pin plug," insert in tool, and squeeze job is done.



C-rings 1c ea.
 Use end of tool to push on C-ring for ground connection.

Model LC-3 for 5/32" pin diameter

At your parts distributor or write us

BERN'S Mfg. Co.
 9853 Chalmers,
 Detroit 13, Mich.

Circle 36 on literature card

prove to be a real annoyance. If the cabinet is to hang on a wall or to be permanently installed against a wall, be sure the equipment can be easily removed for servicing. The speakers will have to be installed from the front and the tuner, pre-amp, or amplifier mounted on L-shaped drawers.

An additional problem under these circumstances is adequate ventilation. Stereo systems radiate almost twice as much heat as their monophonic equivalents. Allow 8" or 9" for equipment height. Insulate the top with cut-up asbestos stove covers, metal side down. Be sure to louver the base on which the amplifier is mounted. It is normally unnecessary to extend the shelf to the rear of the cabinet; leave an inch or two in the rear for ventilation and to ease the problems of interconnection. Louvers may also be cut in the front panel. If the cabinet is wall hung, allow some space in the rear for ventilation, or cut long louvers in the top.

Almost nothing can destroy a cabinet or equipment as fast as heat. If it is necessary to mount an amplifier and a tuner in one compartment, always mount the tuner below the amplifier. Be sure tuners are well ventilated, or the frequency-drift problem may be insurmountable. Instruct the customer to leave the doors slightly ajar when using the equipment, to improve the ventilation.

Be absolutely sure of your dimensions. Nothing can be more embarrassing than to find the changer spindle doesn't clear the top or the changer drawer doesn't clear the door.

The wiring of a stereo system is obviously more elaborate than that of a monophonic system. For this reason it is a must that all wires be identified. For this purpose, adhesive tab markers are excellent.

Speaker Phasing

Speaker phasing is a relatively simple operation. Fig. 5 shows an easy method of checking speaker phase using a DPDT switch with 10' color-coded leads. The switch is mounted on a small panel labeled NORMAL and REVERSE. Use a frequency-test record, and play it in the mono mode. Attach the switch to either speaker, and stand at a point midway between the two



MALLORY

Tips for Technicians

Mallory Distributor Products Company
A division of P. R. Mallory & Co. Inc.
Indianapolis, Indiana 46206

How to select high-reliability capacitors



Computer Grade Capacitor

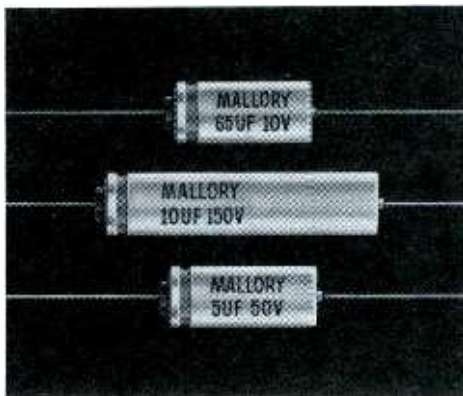

▲ Type TPG Capacitors



Metallized Mylar* Capacitors

Much of today's electronic gear is used in places where a shutdown because of failure can be astronomically expensive—or it could be downright dangerous to life and limb. In these places it is essential that high reliability components be used. But how does one select truly highly reliable components? The surest method is to bank on the reputation of the manufacturer and to have an intimate knowledge of types of products available.

Take the case of tubular electrolytic capacitors. The standard Mallory TC type has been used for years in literally millions of radios and TV sets with unparalleled success. But the new TPG (Tubular Premium Grade) type is engineered and manufactured to vastly more critical standards. These standards apply to the aluminum foil, to the electrolyte, the all-welded construction, safety vent, and to the extra testing required.

Then there are computer grade filter capacitors. Mallory computer grade types have proven their ability to be better than new after twenty years of continuous service. Standard ratings are available "off-the-shelf" up to 115,000 mfd.

When it comes to Mylar* capacitors one may select from dipped, molded, wrapped, and umpteen other styles. There are dual-dielectrics, plain Mylar, Metallized Mylar, etc. Mallory PVC and the all-new GEM series utilize 100% Mylar dielectric, but these are commercial types. For high reliability applications, one needs the new ELECTRON metallized Mylar type available in up to 10 mfd @ 100 WVDC. And in the smallest package by volume available anywhere. ELECTRON capacitors are metallized with *aluminum* . . . not zinc as are virtually all other types. Capacitor cartridges are sealed in pre-molded cases with high-density epoxy and the cases are rectangular to better withstand vibration and occupy minimum space.

Tantalum capacitors to meet the most extreme standards of reliability are stock items with Mallory: solid electrolyte, plain and etched foil, wet slug types and 200°C high capacity types (even radiation resistant types).

Whenever you need a truly high reliability capacitor, call your Mallory Distributor. Just ask him for a copy of the 1964 Mallory General Catalog and you'll be able to make a selection from the hundreds of types listed.

*Registered Trademark E. I. du Pont de Nemours

Circle 37 on literature card

DYMO
IDENTIFICATION SYSTEM

THE ELECTRONICS INDUSTRY IDENTIFIES ITSELF WITH DYMO! DYMO's M-55 TAPEWRITER makes raised-letter labels on-the-spot. Just dial letters, numbers, or symbols—and squeeze the handle. Letters come out crisp white on a colored background of self-sticking vinyl. Complete with round and square corner cutters, accessory wheels for technical symbols and vertical labels. With one tool, a complete system of identification. Always use DYMO tape!

Suggested Price **\$29⁹⁵**

FREE: Tape samples and full details. DYMO INDUSTRIES, INC., P.O. Box 1030, Berkeley, Calif. Dept. PF-5-55.

NAME _____
COMPANY _____
STREET _____
CITY _____ STATE _____

Prices slightly higher in Canada

speakers. Now play a tone below 100 cps, and flip the switch back and forth. The correct position is the one in which the bass note is heard loudest. Normally, speaker phasing is no problem, since most speaker manufacturers code the terminals; but it is necessary to check phasing when servicing someone else's installation or where the customer has tampered with the wiring.

Hum Problems

Installing the record player under the amplifier sometimes leads to hum problems, particularly if the amplifier power transformer is mounted on the side immediately above the tone arm. The proximity of the transformer to the pickup arm may create hum that is more evident when the phono drawer is pushed back into the cabinet. In some cases, the hum may become more evident as the arm approaches the end of the record. This is because the power transformer is mounted on the left side of the amplifier. Some cartridges are shielded against this condition. Many changers short out the cartridge at rest or during the change cycle. In checking for hum, be sure the cartridge circuit is open.

Normally, hum problems are attacked by first turning up the bass and volume controls and switching in the loudness control. Check hum controls in the equipment itself; try reversing AC plugs; make sure phono-plug caps make good contact; ground or unground the motor, turntable, or tone arm; ground the entire system externally (sometimes the AC outlet plate is effective); use shielded braid to interground the entire system.

Determining Left and Right

Many hi-fi manufacturers still use A and B channel designations instead of left and right. Some do not even identify the channels in their instructions. Reading the instructions in front of the customer usually creates doubt in his mind as to your ability. For this reason it is a good idea to learn an old trick in channel identification. The quickest method is to hook up the speakers and then manipulate the balance control on program material. Turning the balance control to the left should increase the volume in the left speaker.

To check proper hookup of the cartridge, use a tone record that

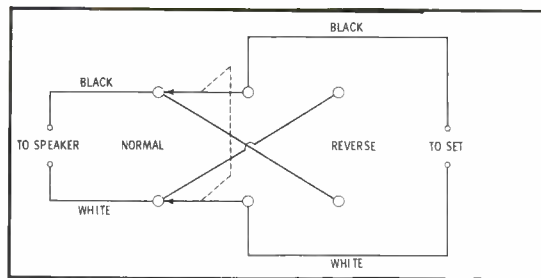

Fig. 5. Hookup for checking speaker phasing.

employs separate bands for the left and right channels. The same record can be used for phasing tests by switching the phono input to monophonic operation.

Changer Problems

Rumble is a greater problem with stereo than with mono. If rumble is objectionable, cut in the rumble filter if the amplifier has one, or instruct the customer in the use of a lower bass-control setting. The better the record changer, the less the rumble that will be produced. When the customer complains of the rumble and feels that reducing the bass will reduce fidelity, be sure to point out to him that better performance will cost more money.

Another problem with changers in stereo installations is needle-skip due to "bouncy" floors. Part of the blame rests with the use of a spring to control needle pressure. On some changers, both spring and a counterweight are used, and this skipping tendency can be minimized by depending on the counterweight adjustment for most of the needle-pressure control. More help will come from leveling the changer for a slight tilt toward the rear of the changer.

Tuner Problems

Where stereo FM tuners are involved, the type of antenna used is very important and depends on the



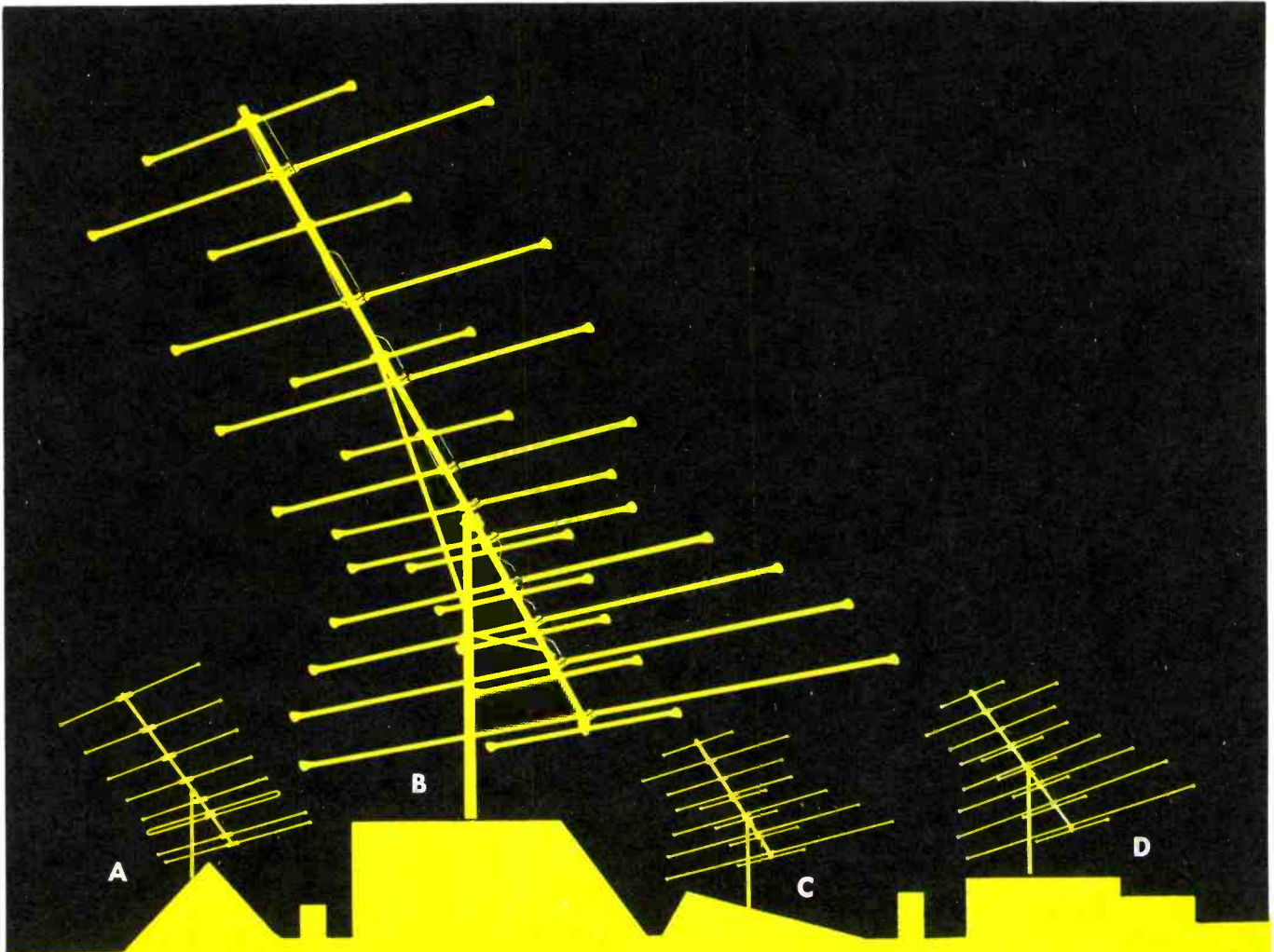

RCA OUTDOOR ANTENNAS

the name... the features... the line that sells

Now you can select the best model for your customer's location from this new RCA outdoor antenna line that combines all-channel yagi and multiple cross-driven types. Satisfy them with the sharpest color and black-and-white pictures.

Explain the RCA *exclusive* feature in customer language. Only RCA antennas feed energy directly into the transmission line from low band driven elements. These are capacitively coupled, positioned directly above high band driven elements. RCA, of course, phases low and high band directors for best high band performance.

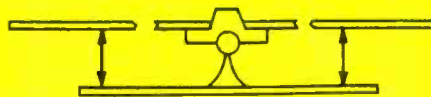

CAPACITIVELY COUPLED

In addition, RCA's electro-lens director system absorbs maximum incoming signal power, gives extremely high gain across the VHF band, offers excellent forward gain on the front end.

More customer interest! A gold anodized finish protects every RCA antenna from weather corrosion. Wrap-around mast clamp aligns antenna on mast, prevents boom crushing.

Just call your RCA Victor distributor. Look at and learn about RCA 200, 300, 400 antennas... from the color TV pioneer! From there on... sell!

A. RCA 500 FM antenna. Eight-element yagi. Acute directivity, 88 to 108 MC. VSWR 1.25:1. Average eight db gain.

B. RCA 400 antenna. 19 elements, for fringe area or distant reception.

C. RCA 200 antenna. 11 elements, for local reception.

D. RCA 300 antenna. 13 elements, for suburban and near fringe area locations.

RCA PARTS AND ACCESSORIES, CAMDEN, N.J.



THE MOST TRUSTED NAME IN ELECTRONICS



**HIDDEN*
QUALITY**

MODEL 630 V-O-M



Standard
Of the
Industry
PRICE†
\$49.50

EXCLUSIVE TRIPLET BAR RING
SHIELDED MOVEMENT

EASY TO CHANGE
STANDARD BATTERIES

FUSED

HIGH-FLUX
MAGNET,
SPRING
BACKED
JEWELS
—FOR
RUGGEDNESS

SIMPLE TO
REPLACE
MULTIPLIERS
OR SHUNTS

HEAVY INSULATED CASE

SPARE FUSE

COMPLETELY WIRED CIRCUIT

FACTS MAKE FEATURES:

- 1** Popular streamlined tester with long meter scales arranged for easy reading. Fuse protected.
- 2** Single control knob selects any of 32 ranges—less chance of incorrect settings and burnouts.
- 3** Four resistance ranges—from .1 ohm reads direct; 4 1/2 ohm center scale; high 100 megohms.

Attention to detail makes the Triplet Model 630 V-O-M a lifetime investment. It has an outstanding ohm scale; four ranges—low readings .1 ohm, high 100 megs. Fuse affords extra protection to the resistors in the ohmmeter circuit, especially the XI setting, should too high a voltage be applied. Accuracy 3% DC to 1200V. Heavy molded case for high impact, fully insulated.

† 630A same as 630 plus 1 1/2% accuracy and mirror scale only \$59.50

TRIPLET ELECTRICAL INSTRUMENT COMPANY, BLUFFTON, OHIO

Circle 38 on literature card

locality. In urban areas, an antenna can be incorporated right in the tuner design, but this may not be sufficient. Sometimes, a 52" folded dipole constructed from 300-ohm line will help. Apartment-house antenna systems, if they do not reject FM frequencies to prevent intermodulation of TV sets, may be used with a two-set coupler. Where outside antennas are not permitted, stretching a so-called "sneak" antenna across a window will sometimes improve reception. Remember that trying all these methods require time, your most saleable commodity, and the cost should be considered when submitting your bill.

Tape Systems

Tape systems are more popular for stereo than for mono. When included in hi-fi installations, they are normally mounted on a flat platform and are generally removable for use at other locations. Input and output leads should be labeled so the customer may detach the unit simply. If wire markers are not available, white adhesive tape can be used, marked appropriately with a ball-point pen.

Matching Equipment

One of the biggest headaches in a hi-fi installation is improperly matched equipment. People will listen to well-meaning friends who consider themselves experts, or they will purchase so-called bargains. Even good name-brand components can give terrible results when improperly matched.

The cartridge should be appropriate for the changer or turntable. Changers, depending on their quality, require from 2 to 6 grams for proper tracking. The cartridge should be operated at its specified needle pressure.

Speakers that have a broad frequency response will accentuate the distortion of an amplifier whose response is not so good. Lower-priced speakers whose response falls off rapidly at low and high frequencies will sound much better with a lower-priced amplifier. This partially explains why some low-priced systems sound better than certain high-priced systems.

A wideband amplifier and speaker system will accentuate rumble produced by a low-priced changer or turntable. And a poor tuner will sound worse when used with a good amplifier and speaker.

Before and After

If the customer supplies the equipment, check it before you commit yourself. Remember that he expects miraculous sound, simply because it is stereo. And no matter how long you estimate the job will take—it'll take longer. Be sure to include in your bill all the time you've spent or expect to spend. Allow at least one hour for checking the system when completed and explaining its operation to the customer.

Bring along some records that show off the stereo effect in dramatic fashion. Recordings featuring trios, quartets, or quintets are usually better for this purpose than recordings of a full symphony orchestra. A flamenco or guitar record, with its high transients, is always a sensation.

Be sure to instruct the customer in the proper operation of the system. The sooner, and the better, he learns how to operate it, the quicker will be his appreciation of how well you have done your job. ▲

Cash in on a natural!

A Hot Item, A Receptive Market, Top Profit



VERBA-MATIX The Prestige Auto-Radio Reverberation System

Exclusive Gyro-Balanced Suspension Eliminates "Bump Boom"

More QUALITY, more FEATURES, more VALUE and more PROFIT FOR YOU

Reverberation Systems are the fastest selling electronic automotive accessories this year. They're even standard option on all cars of the Big 3. Cash in now by selling the one Reverberation Package that offers you and your customer the most!

A handsomely packaged, quality system . . . only VERBA-MATIX has all these features . . .

- 4 Transistors
- Heavy 7 oz. Ceramic-Magnet Speaker
- Complete Control Panel (with Reverb % Control)
- No Drilling, No Screws—Unbelievably Simple Installation
- Fits All Cars, Neg. or Pos. Ground (12 volt) . . . All Speakers, 2 to 40 ohms
- No Noise When Driving Over Bumps.

Here's how it works: VERBA-MATIX electronically delays signal to rear speaker, creating exciting stereo effects never before possible in an automobile. AND—you have complete control over percentage of reverberation at all times!

Complete system includes: Dual-control panel, a 4 transistor amplifier, 6 x 9" rear speaker, deluxe speaker grille, mounting kit and complete instructions.



kinematix, inc.

240 W. WASHINGTON BLVD., CHICAGO, ILLINOIS 60612 • AREA CODE 312 • 666-0066

Distributors: Phone collect when ordering or calling for prices and information

Circle 39 on literature card

Manufacturers of
the amazing IMP II.
World's fastest
selling Wireless
FM Microphone.



My portable radio was *indeed* a most extraordinary receiver. In one month's time it netted me over \$6000 in cold, hard cash, some of which came out of your pocket.

The first time I visited your shop was to have my portable radio repaired. At your suggestion, I left the radio for a few hours till you could get to it.

When I returned later that day to pick it up, I learned that the trouble had been cured by a new tube—which you supplied. However, you supplied me with something more than just a tube: I'd just paid you when a man walked in and asked if you would cash his paycheck. I remember your exact words: "Sorry, sir; I don't know you. I got stuck with a bad check once this year, and I've decided to cash checks for only those people I know." The man thanked you anyway, turned, and walked out. Then and there, I decided *you'd* get to know *me*.

What a lemon that portable radio of mine must have seemed to you. I've forgotten how many times in the next three weeks I returned it to you for some minor repair. Anyway, I was a pretty good cash customer, wasn't I? And you got to know me pretty well, didn't you? Or so you thought. As you yourself once said, our personalities seemed to click right off. We even went fishing and hit a few night spots together in my flashy convertible.

But, during the day when I was supposed to be slaving for the utilities company where I told you I worked, my *receiver extraordinary* was being "serviced" elsewhere. Indeed, many radio repairmen were getting to know me. My personality was clicking in service shops all over town.

Then, one Wednesday evening, as you no doubt loathe to recall, I walked into your place with a quartermoon smile ear-to-ear across my face. When you were through waiting on the other person in the shop, I proudly produced a utilities company envelope, removed a letter from it, and asked you to read it.

The letter read something like this—remember?

*Dear Mr. Bakke:
 Congratulations!*

It is my personal pleasure to inform you that the idea you

RECEIVER EXTRAORDINARY

by 55934



submitted in last month's Employee Idea Contest has been judged best, entitling you to the top monthly award of \$250.

As company president, I . . .

The letter (a product of my own printing press, as were the various identification cards I'd now and then displayed), went on to describe in detail how my winning idea promised to benefit the company.

Remember how happy you were for me? You read every word, then popped for Cokes and we celebrated on the spot.

You didn't know it of course, but that same letter had been read many times that day, and similar celebrations had taken place in several shops like your own. (I had Cokes running out my ears.) Then, as had many of your brothers-in-trade, you asked about the "award" check itself. I explained that I would get it on Friday along with my "regular weekly payroll check." Then I asked if you could go out with me Saturday night to help me celebrate in style. You could and would, you said. So it was all set.

I celebrated Saturday night, all right—with a lush blonde three jet-hours away. Before I left your city, however, I'd cashed 24 of the 30 "idea award" checks I'd printed (\$191.33, after deductions) and 17 of the 30 "regular weekly payroll" checks (some of your brothers-in-trade lacked sufficient cash to handle both checks). I might have cashed the whole lot, except for one hunchy technician across town from you.

On the pretext of going to get more cash, he entered a door

marked "Private" and sneakily telephoned the company in question. When he returned there was a look in his eyes that told me we'd suddenly ceased to be chums. He had my checks in one hand and a .38 Special in the other, and he approached me as a man who meant business.

"I had a hunch something was afool, *friend*," he said coolly. "So I telephoned the utilities company to be sure. And you know what, *pal*? A girl in the payroll department says she never heard of you—*nobody* named Claude Bakke works there." He leveled the gun barrel at my midsection. "So, suppose you just follow me, nice and easy like, step by step, back into my office, where I can make one more phone —"

"Okay. Sure—sure thing," I interrupted, staring at the one-eyed menace in his hand. At that moment I could sympathize with the fly that tried to swallow a frog—the lump in my throat seemed that big. "What I mean is, maybe you'd better take another look at my checks," I managed. Then you'll see that I work for the *County Division*, which not only is a separate unit, but has its own payroll department, supervisory staff, and all."

He didn't seem to know what to make of that. He just stood there sizing me for a long, heart-trembling minute. He didn't know it—not for certain—but he had those rubber checks around my neck tight enough to choke another long prison term out of my life. But then he looked at my checks again, and I began to calm down a bit as he lowered the gun. "Okay," he said at last, but warily, "so it does say County Division."

"Sure it does," I shot at him quickly, "because that's where I work. And here's my County Division employee's pass." I reached for my billfold and pulled the pass from a celluloid insert. "It's got my photo, thumbprint, signature, name and address, and complete physical description." I offered the pass for his inspection, but he refused it. It was just as well though, because the utilities company had no County Division or anything of the kind. I'd printed that on my checks and identification for the express pur-

ANOTHER GREAT ADDITION TO THE
FAMOUS SERIES OF B&K ANALYSTS

SIMPLIFIES AND SPEEDS TV SERVICING

NEW!



Compact Model 1074 TELEVISION ANALYST FOR BLACK & WHITE and COLOR

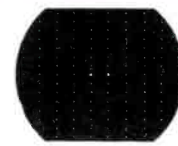

Dot Pattern

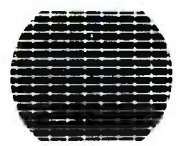

Crosshatch



Vertical Lines



Horizontal Lines



Color Pattern

Here is an exciting new addition to the famous B&K series of Television Analysts—designed to give every service technician a faster, easier way to service more TV sets!

The compact "1074" gives you a complete TV signal generating source of your own. Using the B&K *point-to-point signal injection technique*, you can isolate and pinpoint any performance problem for quick correction.

By injecting your own signals, with a visual check on the TV screen, you can easily signal-trace and troubleshoot any stage throughout the video, audio, r.f., i.f., sync and sweep sections of black & white and color television sets.

It becomes much easier to find and fix "tough dogs," and troublesome intermittents, as well as to solve other general TV set troubles—to the satisfaction of your customer, and to your own profit.

Net, \$24995

Supplies complete r.f. and i.f. signals, with pattern video and tone audio. Video signals are switch selected for fast, visual troubleshooting. Provides FM modulated 4.5 mc sound channel, with built-in 900 cycle tone generator. Provides composite synchronizing signals. Provides separate vertical and horizontal plate and grid driving signals to check complete output circuit and interrelated components. Many other features.

Makes it Easy to Set-up and Service Color TV

Provides dot pattern, crosshatch, vertical lines, horizontal lines, burst signal and individual colors (Green, Blue, B-Y, R-Y, Red, I, and Q) one at a time on the TV set—all crystal controlled for maximum accuracy. Color phase angles are maintained in accordance with NTSC specifications. Thin lines and high stability assure fastest, easiest convergence and linearity adjustments. Color display makes demodulator alignment extremely simple.

Time-Saving, Money-Making Instruments Used and Preferred by Professional Servicemen Everywhere.



Model 375 Dynamatic Automatic VTVM



Model 360 V O Matic Automatic VOM



Model 700 Dyna-Quik Tube Tester



Model 850 Color Generator



Model 445 CRT Tester Rejuvenator

See Your B&K Distributor
or Write for Catalog AP21-R



B&K MANUFACTURING CO.

DIVISION OF DYNASCAN CORPORATION

1801 W. BELLE PLAINE AVE. • CHICAGO 13, ILL.

Canada: Atlas Radio Corp., 50 Wingold, Toronto 19, Ont.

Export: Empire Exporters, 253 Broadway, New York 7, U.S.A.

Circle 40 on literature card



This Sonotone cartridge can replace

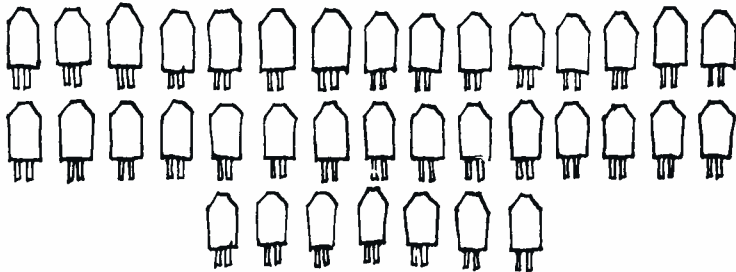

37 Brand A types

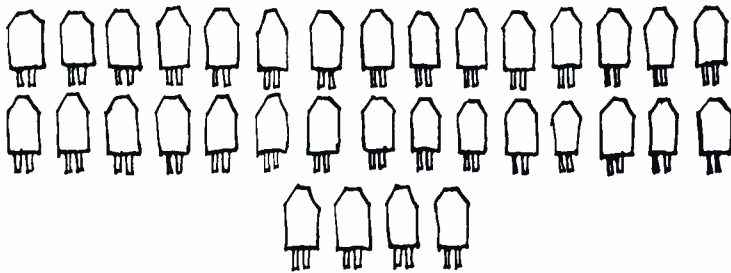

34 Brand B types

and itself!

The 2TA pictured above is just one member of the Sonotone line, the most versatile cartridge line available today.

The Sonotone cartridge line offers the electrical and mechanical flexibility to substitute for dozens of competitive types. Of course, Sonotone cartridges are direct replacements in over 14,000,000 phonographs that use Sonotone cartridges as original equipment, too. Which means: If you stock the compact Sonotone line, you'll have replacement cartridges for just about every phonograph that comes into your shop. You'll also have the famous **Sonoflex**[®], the needle that puts an end to profit-robbing callbacks caused by bent and broken shanks.

The Sonotone Cartridge Replacement Manual tells you what Sonotone cartridge to use. Want an idea of how simple life can be with Sonotone? For a limited time, we'll be glad to send you a **free** copy of the manual—normally, it's 50 cents. Write:

Sonotone

Sonotone Corporation, Electronic Applications Division, Elmsford, New York
Cartridges • Speakers • Microphones • Headphones • Hearing Aids • Batteries

Circle 41 on literature card

pose of getting out of just such situations as this.

"Never mind," he said. "You don't *look* like a crook, Claude. But everything about you—your checks, your letter of congratulations, and your identification—appears just a little too pat. Besides, I've known you less than a month. Furthermore, once or twice I was nudged with the notion that your portable radio was put out of order on purpose. At least, it seemed to be. Anyway, my hunches have saved me money before, so I'm not shelling out that kind of dough until I investigate further and know for sure that you and your checks are okay. In fact—"

"Skip it," I interrupted again. For an instant I had thought everything was going my way again. But now I knew it wasn't—and I certainly couldn't let him get back on that phone to check out my County Division story! "I'll take my checks to the bank Monday," I said, "they know me there." Then I quickly changed the subject. "Anyhow, we've still got some celebrating together scheduled for tonight. Is it still a date, or will you have to investigate further on that, too?"

A mere wink of a grin flashed across his face. "It's still a date," he said, adding a sharp barb, "if you're still around. . . ." He placed the .38 on a counter and returned my checks.

That man *knew* what I was. Yet he allowed me to light a spark of doubt in his mind, and I talked my way out. One near-nab of that kind was enough for me, however. I dumped that convertible in a quick cash deal and headed for the airport, abandoning my "receiver extraordinary" and printing press equipment (new outfits of the same type cost under \$300).

Ultimately, of course, I was caught in a predicament where I failed to talk my way out. As a result, I won't be visiting radio and TV service shops for some time to come (my current sentence expires late in 1970 and two other states have expressed keen interest in my future). But there are many other check cheats who, perhaps at this very minute, are planning ways to get their hands on your money. Will one of them beat you? Don't be too cocky; you swore off once, before I came along. Remember . . . ? ▲

STEREO

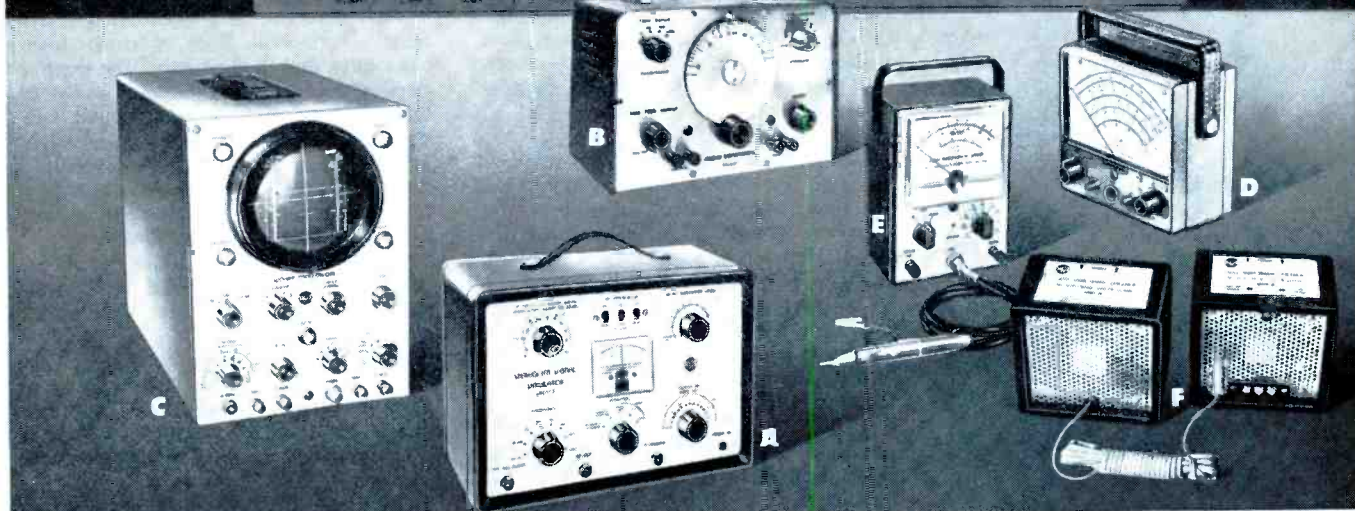

Let **RCA** equip you with **EVERYTHING YOU NEED FOR STEREO SERVICING**

RCA—entertainment leader of the world—now offers you a complete set of test instruments to put you in the stereo servicing business. And now's the time to get in because it's growing bigger and more profitable by the day.

A. NEW! RCA WR-51A FM STEREO SIGNAL SIMULATOR

Generates signals necessary to service and maintain stereo multiplex FM receivers and adaptors. Generates... Choice of 4 FM signals—Left Stereo, Right Stereo, Special Phase Test, Monaural FM • Choice of 8 sine-wave frequencies (400 cps, 1Kc, 5Kc, 19Kc, 28Kc, 38Kc, 48Kc, 67Kc) available separately or for modulating FM signals • 100 Mc carrier tuneable ± 0.8 Mc to permit selection of a quiet point in the FM band • 19 Kc subcarrier, crystal-controlled within ± 2 cps • 100 Mc sweep signal adjustable from 0-750 Kc at 60 cps rate • Choice of 3 composite stereo output signals—Left Stereo, Right Stereo, Special Phase Test • Choice of 3 sine-wave frequencies for composite stereo

signals • Crystal controlled markers for receiver if and rf alignment • Zero-center meter for checking the balance of stereo amplifier output. **\$249.50***

B. RCA WA-44C AUDIO GENERATOR

Generates sine-wave and square-wave signals over range of 20 to 200,000 cps to test audio systems. Can be used to measure intermodulation distortion, frequency response, input and output impedance, speaker resonance, transient response and phase shifts. Less than 0.25% total harmonic distortion over range of 30 to 15,000 cps. **\$98.50***

C. RCA WO-91A 5" OSCILLOSCOPE

A high-performance, wide-band 'scope—serves as a visual VTVM. Choice of wide band (4.5 Mc–0.053-volt rms/inch sensitivity)

or narrow, high-sensitivity band (1.5 Mc–0.018-volt rms/inch sensitivity). New 2-stage sync separator provides solid lock-in on composite TV signals. **\$249.50***

D. RCA WV-98C SENIOR VOLTOHMYST®

For direct reading of peak-to-peak voltages of complex waveforms, rms values of sine-waves, DC voltages, and resistance. Accuracy: 3% full-scale on both AC and DC, with less than 1% tracking error. Color-coded scales differentiate peak-to-peak from rms readings. New 0.5 volt full scale DC range for use with low-voltage transistor circuits. $6\frac{1}{2}$ " meter. **\$79.50***

E. RCA WV-76A AC VTVM

Measures voltages down to 0.001 volt. Decibel scale for measure-

ments from -40 to +40 db. Built-in amplifier which may be used separately as a preamplifier. Typical applications include: frequency response tests of preamplifiers, power amplifiers and tone control circuits, signal tracing; measurements of audio level, power level and gain; amplifier balancing applications and general audio voltage measurements. **\$79.95***

F. RCA WG-360A STEREO PHASE CHECKER

A quick, simple, positive way to check phase alignment of low and mid-range speakers in stereo systems. Completely "sound-powered". Snag-proof recessed grille design. For use with a VOM, VTVM, or oscilloscope. **\$14.95***

See Them all at your Authorized RCA Electronic Instrument Distributor
RCA Electronic Components & Devices, Harrison, N. J.

*User price (optional)



The Most Trusted Name in Electronics

Notes on Test Equipment

analysis of test instruments . . . operation . . . applications

by Stephen Kirk

New Pep for Old CRT's



Fig. 1. General-purpose tube tester and picture tube rejuvenator is also portable unit.

Today's technician, with an already overloaded tube caddy, should welcome a small portable tube tester that is rugged enough to be carried in the service truck and small enough not to get in the way.

The GC 36-540 (shown in Fig. 1) is just such a tester. Its metal case measures only 9 1/4" x 8" x 3 3/4" with the lid closed. The tester will make emission and short checks on more than 1300 tubes, including *nuvistors*, *novars*, compactrons, and foreign and industrial types. Also, picture tubes can be checked and reactivated.

The 36-540 uses a neon short check whose sensitivity can be varied by changing the value of the resistor across the neon bulb. The unit comes from the factory with sensitivity about 1.5 megohms. This sensitivity is ample for all shorts and for leakage of any consequence in radio and TV tubes. The short and leakage test can be made either between the grid and cathode or between the heater and cathode at the flick of a front-panel switch. The neon bulb used for short tests acts as a pilot lamp when the function switch is in the emission position.

Eight tube sockets are mounted on the front panel: octal, *novar*, compactron, *nuvistor*, two 7-pin and two 9-pin types. In addition, there are 7-pin and 9-pin straighteners.

To operate this tester it is necessary only to find the tube type number in the chart booklet furnished with the tester and set up *three* controls—an 11-position SELECTOR switch (that determines correct

wiring connections); a LOAD potentiometer; and a heater VOLTS selector switch. The FUNCTION switch is set for G-K (grid-cathode) and F-K (heater-cathode) short checking and finally moved to the EMISION position for final testing of the tube on the BAD-?-GOOD scale of the 2 1/4" x 3" meter.

This tester will also check or reactivate picture tubes using the standard duodecal socket, with an adapter for other types. Emission of the CRT is measured at the second anode, and because of this a separate lead must be connected to the high-voltage socket of the picture tube.

If the CRT measures low in emission, the FUNCTION switch can be moved to the REACTIVATE position; this applies a high forward bias between the cathode and grid of the CRT to increase the cathode emission. A "magic eye" lamp (GE 1829) indicates when to stop rejuvenation, to prevent damage to the tube.

DC power for tube checks and CRT reactivation is supplied by a silicon voltage-doubler circuit.

We used this compact checker to check many different radio and TV tubes. For general testing—finding out whether or not a tube will work—the emission test has considerable merit.

Although the 36-540 has no gas check, as such, the short check is sensitive enough to show up most tubes that are bothered with grid contamination or gas.

We tried rejuvenation of two different picture tubes whose emission measured low. One of these tubes responded to rejuvenation, but the other was too far gone to be recovered. The rejuvenation circuit of this small tester is essentially the same as for any CRT checker. A positive DC voltage is applied to the grid of the CRT and the heater voltage is increased. This tends to break up contamination or "glazing" that may have developed on the cathode coating. Of course no rejuvenator or reactivator can ever do a 100% job, but reactivation of this kind is the most successful. Quite often a brightener will be useful in keeping the emission of a CRT high after rejuvenation.

For further information, circle 67 on literature card

Low-Cost Color Bars

Numerous tests and color-set alignments have indicated that the Heath Model IG-62 Color-Bar and Dot Generator exceeds its published specifications. The unit is pictured in Fig. 2.



Fig. 2. This color generator produces dots, crosshatch, and vertical and horizontal bars.

The generator produces dots, crosshatch, horizontal lines, vertical lines, color bars, and shading bars. The shading bars provide four different levels of brightness so that the background controls may be adjusted accurately. Highlights and dark areas are displayed in a stationary pattern for easier adjustment than with the constantly changing picture usually transmitted by the station.

Fig. 3 is a block diagram of the IG-62. A crystal-controlled 189-kc oscillator is used as the source of most signals provided by the instrument. 189 kc is a common denominator of both 15,750 cps and 60 cps; since it is twelve times as high in frequency as the 15,750 horizontal scan, it will produce twelve vertical bars (two will be lost in blanking and overscan).

Multivibrator counters are used to step the 189-kc signal down to the other required frequencies. Fig. 4 shows a typical multivibrator as used in the IG-62, this one operates at 31.5 kc, but all are similar except for resistor and capacitor values. A multivibrator is simply a resistance-coupled amplifier with its output fed back to its input. Because of this, it will oscillate at a frequency determined primarily by the values (RC time constant) of the resistors and capacitors used and to some degree the plate voltage applied. The most salient feature for this application is that this type of multivibrator may be "locked in" by a positive signal on the grid higher in frequency than the natural oscillating frequency.

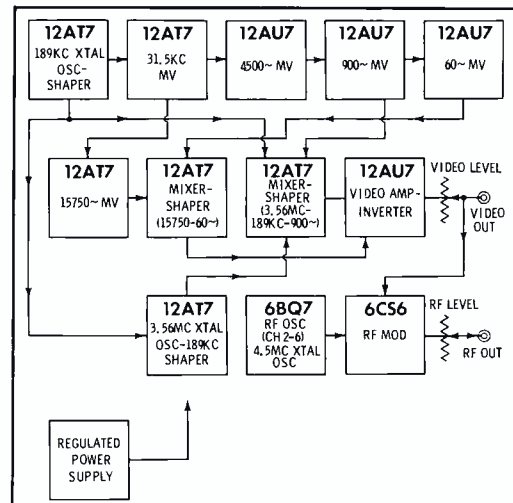
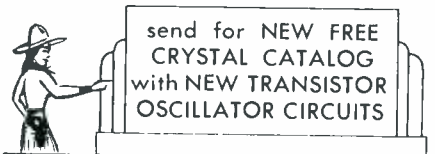

Fig. 3. Three crystal oscillators and regulated power supply for very high stability.

As you read this ad . . .
A Finco Engineer is designing
A "special area" TV Antenna
Finco has produced 3,152 already
Each one is the best in its area
Want proof?
See your Finco distributor
Or write us.



Circle 43 on literature card



**3 PLANTS TO SERVE YOU BETTER
HERMETICALLY SEALED
PRECISION GROUND
CUSTOM-MADE
NON-OVEN CRYSTALS**

Gold or silver plated, spring mounted, vacuum sealed or inert gas, high freq. stability, 10 milliwatt max. current cap. Meet mil. specs.
1000KC to 1600KC (Fund. Freq.)
1601KC to 2000KC (Fund. Freq.) \$5.00 ea.
2001KC to 2500KC (Fund. Freq.) 4.00 ea.
2501KC to 5000KC (Fund. Freq.) 3.50 ea.
5001KC to 7000KC (Fund. Freq.) 3.90 ea.
7001KC to 10,000KC (Fund. Freq.) 3.25 ea.
10,001KC to 15,000KC (Fund. Freq.) 3.75 ea.
15MC to 20MC (Fund. Freq.) 5.00 ea.

OVER-TONE CRYSTALS
15MC to 30MC Third Overtone \$3.85 ea.
30MC to 40MC Third Overtone 4.10 ea.
40MC to 65MC Third or Fifth Overtone 4.50 ea.
65MC to 100MC Fifth Overtone 6.00 ea.
DRAKE 2-B Receiver Crystals \$4.00
(All Channels—Order by Freq.)

OVEN-TYPE CRYSTALS
For Motorola, GE, Gonset, Bendix, etc.
Add \$2.00 per crystal to above prices
SUB-MINIATURE PRICES slightly higher
ORDER FROM CLOSER PLANT

TEXAS CRYSTALS
DEPT. PF
1000 Crystal Drive
FORT MYERS, FLORIDA
Phone 813 WE 6-2109
TWX 813-334-2830
AND
4117 W. Jefferson Blvd.
LOS ANGELES, CALIF.
Phone 213-731-2258
TWX 213-737-1315



Circle 44 on literature card



TYPE CTC . . . cardboard tube electrolytics especially designed for exact placement in television sets . . . one end closed . . . long insulated leads out the other end . . . sealed with high melting point wax . . . guaranteed for one year . . . individually packaged.

PLANET SALES CORP.

225 Belleville Ave.
Bloomfield, New Jersey

Circle 45 on literature card

This means a multivibrator can be used to develop a frequency which is a sub-harmonic of the driving frequency. For example, in the 31.5-kc mode, the multivibrator is adjusted to trigger on every sixth pulse of the 189-kc oscillator.

Looking back at the block diagram of Fig. 3, we see that the first count-down oscillator is the one operating at 31.5 kc. Its output is fed to two other multivibrators: one signal triggers a 15,750-cps counter and the other triggers a 4500-cps counter. The 4500-cps counter in turn triggers a 900-cps and a 60-cps counter.

The 15,750- and 60-cps counters, used for horizontal and vertical sync, are mixed and shaped by a circuit using a 12AT7, and the composite is fed to a video amplifier. Signals from the 900-cps counter (for horizontal bars), from the 3.56-mc color oscillator (see Fig. 3), and from the 189-kc oscillator are all mixed and shaped in another 12AT7 circuit, and this composite is also fed to the video amplifier.

Video, including sync, can be taken off at the VIDEO OUT jack in either positive or negative polarity, for use in signal tracing the video or sync stages—or to make convergence adjustments, if you wish. The sync and video are also fed to an RF modulator that is excited by a variable oscillator which can be tuned to any TV channel from 2 to 6 by a front-panel control. For making convergence and other adjustments, it is necessary only to connect the RF OUT cable to the antenna terminals of the set to be tested.

Color bars are produced by the offset-carrier method; that is, a crystal-controlled oscillator (approximately 3.56 mc) beats against the color set's 3.58-mc oscillator. Since this beat is at 15,750 cps, there is a complete 360° phase shift for each horizontal scanning line, which yields a rainbow of colors. These colors are then "keyed" into color stripes or bars so they can be easily identified; at the same time, the keying process modulates the color signal so it can be traced through the circuit with a scope. These color bars are presented in the order shown in Fig. 5.

It is necessary to set up the multivibrator counters after assembling the IG-62, but this involves simply putting the generator on an operating TV set and adjusting for the correct number of

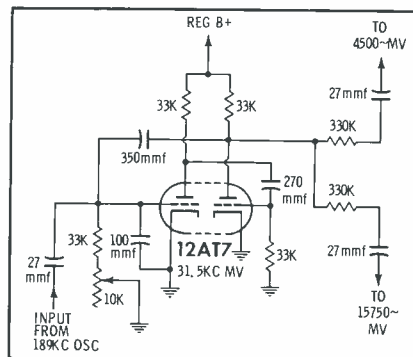

Fig. 4. This multivibrator counter circuit is typical of those in the color generator.

horizontal and vertical bars with no weaving. The adjustment point is so definite that there is no mistaking the correct position.

After setting up the unit we were anxious to try it. The first set was a new Zenith that needed convergence touchup. We set the IG-62 for dots and center-converged with the neck magnets, then switched to crosshatch for the dynamic adjustments. We used the horizontal and vertical lines separately to check convergence; although we had not been in the habit of using anything but crosshatch for making dynamic convergence adjustments, we could see the advantage of having either vertical or horizontal lines both for "roughing in" and "fine" convergence. For example, when you are making an adjustment that has (or should have) primary effect on the horizontal lines only, switching the generator to horizontal lines keeps you from being distracted by movement in the vertical lines.

The next set was an RCA CTC5.

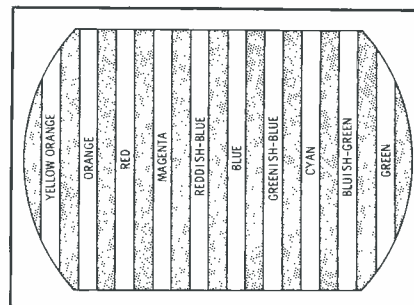

Fig. 5. This is the lineup of bar colors in the easily read bar-generator presentation.

PRECISION TUNER SERVICE

P. O. BOX 272
BLOOMINGTON, IND. 1200 S. WALNUT ST.
EDISON 99653

7.50
V or U

COMBO PLUS
9.95 POSTAGE

6 MONTH WARRANTY



All Types T.V. Tuners Cleaned, Repaired and Aligned to Factory Specifications. Same day in shop service on most Tuners. Price Includes Minor Parts, Major Parts at Cost Price. We use Original Parts if possible. State Make Model and Enclose all Parts and Tubes. Pack Well and Insure.

ALSO HAVE LARGE STOCK OF EXCHANGE TUNERS, WRITE FOR TYPES AND PRICES.

Circle 46 on literature card

BEST PROFESSIONAL VTVM VALUE

EICO 232 peak-to-peak VTVM featuring exclusive Uni-probe® (U.S. Pat.)



Deluxe VTVM for color & B & W

- Calibration without removing from cabinet
- Measure directly p-p voltage of complex & sine waves: 0-4, 14, 42, 140, 420, 1400, 4200
- DC/RMS sine volts; 0-1.5, 5, 15, 50, 150, 500, 1500 (up to 30,000 volts with HVP probe, & 250 mc with PRF probe)
- Resistance ranges: 0.2 ohms to 1000 megs in 7 ranges
- 7 non-skip ranges on every function
- 4 functions: + DC Volts, — DC Volts, AC Volts, Ohms.
- Uniform 3 to 1 scale ratio for extreme wide-range accuracy
- Large 4½" meter in can't-burn-out circuit
- Zero center for TV-FM discriminator alignment
- Smart professional styling—new satin finish etched panel with contrasting knobs and meter and grey wrinkle steel case.

Kit \$29.95; wired \$49.95.

Exclusive UNI-PROBE: (pat. pending) Terrific timesaver, performs all functions: A half turn of probe-tip selects DC or AC-Ohms

EICO KITS FOR 1964

BEST BUY SCOPES



EICO 460 WIDEBAND 5" SCOPE For color & black-and-white TV servicing. Easily reproduces 3.58 mc color TV synchronizing burst. Vert. amp. flat from DC to 4.5 mc, usable to 10 mc; 25 mv rms/inch sensitivity. Horiz. amp. flat from 1 cps to 400 kc; 0.6 v rms/inch sensitivity. Automatic sync. Sweeps from below 10 cps to 100 kc. Kit \$89.95; Wired \$129.50.

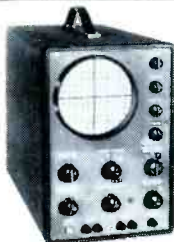

EICO 427 ADVANCED GENERAL PURPOSE 5" SCOPE High sensitivity scope has all the facilities and quality demanded for servicing audio, communications and industrial equipment. Vert. amp. flat from DC to 500 kc, —6 db at 1 mc; 3.5 mv rms/cm sensitivity. Horiz. amp. flat from 2 cps to 450 kc; 0.18 v rms/cm sensitivity. Automatic sync. Sweeps from 10 cps to 100 kc. Kit \$69.95; Wired \$109.95.



EICO 430 PORTABLE GENERAL PURPOSE 3" SCOPE Remarkably fine compact scope. Excellent for servicing audio, communications, and industrial equipment. Ideal as a ham shack monitor. Flat-face 3" CRT with mu metal shield eliminates affects of external fields. Vert. amp. flat from 2 cps to 500 kc, —6 db at 1 mc; 25 mv rms/cm sensitivity. Horiz. amp. flat from 2 cps to 350 kc, 0.25 v rms/cm sensitivity. Sweeps from 10 cps to 100 kc. Kit \$69.95; Wired \$99.95.



EICO 955 IN-CIRCUIT BRIDGE-TYPE CAPACITOR TESTER Unique shunt-resistance balancing* provision, permits in-circuit short checks even in the presence of as little as 1 ohm shunt resistance. Sensitive open check down to 15 μf normally, adjustable to as little as 5 μf. Wien Bridge capacity measurements from 0.1 to 50 μf. Kit \$19.95; wired \$39.95 *Pat. applied for.

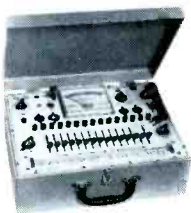

EICO 667 DYNAMIC CONDUCTANCE TUBE & TRANSISTOR TESTER Combines mutual conductance test with a peak emission test—gives a single reading of tube quality. Also spots bad NPN and PNP transistors by gain and leakage tests. New 1964 design has sockets and settings for the latest receiving types, including 5 and 7-pin novistors. Also tests novars, 10-pin miniatures, and compactrons, many low-power transmitting and special-purpose tubes, voltage regulators, electron-ray indicators, etc. Multi-circuit lever switch; 13 tube-element pushbutton switches. 4½" meter; roll-chart in snap-in window. Kit \$79.95; wired \$129.95. **EICO CRU CRT ADAPTER**—Adapts 667 to test all color and B & W CRT's. Wired \$9.95.



EICO 369 TV/FM SWEEP GENERATOR WITH BUILT-IN POST INJECTION MARKER Feeds only the sweep signal to the circuit under test or alignment. A demodulator picks off the response signal and feeds it to a mixer stage where the markers are added before scope display. Thus, troublesome interaction effects are eliminated. Sweep generator has controllable inductor sweep circuit (all electronic) with no mechanical parts to wear and give trouble, and 5 fundamental ranges from 3.5 to 316 mc. Variable frequency marker provides output on 3 fundamental ranges from 2 to 60 mc., and 60 to 225 mc range on harmonics. 4.5 mc crystal supplied for rapid check of marker generator alignment. Kit \$89.95; wired \$139.95.

FOR COLOR AND B & W



TOP-NOTCH TRANSISTOR TESTING TEAM
EICO 1020 POWER & BIAS SUPPLY with 0.005% ripple. Continuously variable metered output voltage, 0-30 VDC at 150 to 300mA. Kit \$23.95; wired \$29.95.



EICO 680 TRANSISTOR & CIRCUIT TESTER Measures basic characteristics of signal and power transistors. Provides DC current, DC voltage (20K ohm/volt), and resistance ranges normally needed for transistor work. Kit \$25.95; wired \$39.95.

EICO Electronic Instrument Co., Inc. PF-5
131-01 39th Avenue, Flushing, N.Y. 11352

Send new 1964 catalog featuring more than 230 EICO Products.

NAME _____
ADDRESS _____
CITY _____ ZONE _____ STATE _____
Add 5% in West

NEW PRICES from QUIETROLE



the oldest, most
widely proved and
sold radio and TV
lubricant

- | | |
|------------------------------------|----------------|
| 2 oz. bottle
with dropper | LIST
\$1.49 |
| 4 oz. bottle | LIST
2.54 |
| 4 oz. bottle
(brush-n-cap) | LIST
2.64 |
| 8 oz. bottle | LIST
5.07 |
| 6 oz. spray can —
with extender | LIST
2.79 |
| 3 oz. spray can
with extender | LIST
1.79 |

Quietrole is your guarantee of the most effective, quick silencer of noisy radio and TV controls — the quality product that is a top value. Get Quietrole at quality jobbers. Some territories available for Experienced Representation.



Circle 61 on literature card

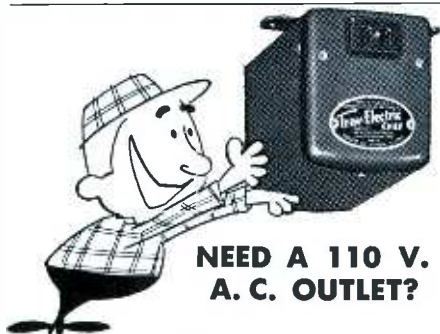

NEED A 110 V.
A. C. OUTLET?

IN CAR, BOAT OR TRUCK,
YOU HAVE IT WITH A

terado POWER INVERTER

Actually gives you 110 volt, 60 cycle A.C. from your 6 to 12 volt D.C. battery! Plug inverter into cigarette lighter, and operate lights, electric shavers, record players, electric tools, portable TV, radios, testing equipment, etc. Frequency stable within one cycle.

See Your Electronics Parts Jobber, or Write:

Models from 15 to 300
watts, priced as low as **\$12.95**
LIST



Circle 62 on literature card

Newer sets are somewhat easier than this one when it comes to setting background or "gray scale" adjustments. Here was our chance to try out the "shading bars" of the IG-62. It is always a problem trying to locate a "highlight" or "low-light" in a constantly moving transmitted picture. But since the shading bars gave us a stationary pattern, it was not difficult to get the correct tracking adjustment and to check the results from low brightness to high.

We checked the video output of the IG-62 on a black-and-white set. We were able to drive a picture tube directly at the cathode and produce a weak video picture. Injecting the signal at the grid of the set's video amplifier produced

For further information, circle 68 literature card

Easily-Read Meter

The new Model 805 VTVM manufactured by Jackson is compact (7" x 6" x 4") and features long, easy-to-read scales in three colors. The OHMS scale is in red, and the function switch selects scales of Rx1, Rx10, Rx100, Rx1K, Rx100K, and Rx1 meg. The DC-RMS-VOLTS scales on the meter are black and marked 0 to 5 and 0 to 10 in increments of .1 to .2 volt. The range switch selects voltage ranges from 1 to 1000 volts. A blue meter scale marked 0 to 14 and 0 to 28 is used to read peak to peak voltages from 0 to 2800 volts in seven ranges. Most of these features can be seen in the photograph—Fig. 6.

The 805 features a relatively new kind of meter movement called a "Taut-Band" mechanism which, as the name implies, uses no pivots or jewels and no movement springs. The meter pointer and moving coil are supported by a tight metal band clamped securely at each end, providing both support and return energy for the pointer.

The test cables for the 805 come out the side of the case; a departure from most VTVM's. This gives an uncluttered front panel, and the right-angle connectors make it easy to store the cable by wrapping it around the case. The "hot" cable is small, highly flexible coax with a plastic covering, terminated in a single probe used for all measurements. This means that no isolating resistor is used for DC measurements to minimize the effects of cable capacitance. For most testing, an isolating resistor is not necessary, but in some instances—such as checking the grid bias of an oscillator tube—some detuning would result from the added load of the instrument. If less loading is required, solder a 1-meg resistor into the circuit temporarily; this will reduce the effects of cable capacitance and have only slight effect on the voltage reading. The big advantage of the switchless probe is its convenience; simply set the switches on the meter panel and measure.

The function switch has OFF-TRANSIT, -DC, +DC, AC, and OHMS positions. Also on the front panel is an electrical ZERO knob, an OHMS ZERO knob, and a mechanical zeroing screw for the meter movement.

overload when the IG-62's video gain control was up full. There are a number of ways that this unit could be used for signal tracing in video or sync stages.

The IG-62 also has a 4.5-mc crystal oscillator that can be turned off and on with the SOUND CARRIER switch; it can be used for checking the color set's 92-kc beat rejection (the beat between the sound carrier and the color carrier).

All in all we were satisfied with the performance of this unit, both for setup and for other service procedures. Its low price may mean that it could be the answer for the shop where only occasional color TV work is done; if carefully built, this unit can hold its own with some factory-assembled equipment.

The circuit is a variation of the familiar 12AU7 dual-triode bridge circuit, used almost exclusively in modern VTVM's because of its excellent stability. A 6AL5 is used as a rectifier for measuring AC volts, with its output applied to a voltage divider at the input of the measuring circuit. This rectifier is used for both peak-to-peak and rms measurements by providing appropriate scales on the meter. One half of another 6AL5 is used as a halfwave rectifier for supplying the necessary operating voltages. The other half is used to balance out the contact potential (Edison effect) developed by the peak-to-peak rectifier. This circuit is shown in Fig. 7.

The basic ohmmeter circuit (shown in Fig. 8) operates much the same as in other VTVM's. A 1.5-volt internal battery is connected through a group of precision resistors (selected by the range switch when the function switch is in OHMS position) to the input of the 12AU7 tube of the DC measuring circuit. Connecting an unknown resistor between the probe and ground establishes a voltage-dividing network and less voltage is applied to the 12AU7 grid. This causes



Fig. 6. Easy-to-read scales in three colors and cable from side: features of new VTVM.



Suggested List 169.50

ACTUAL SIZE!

The sensational new Hallmark 1250

NEW! Small size! **NEW! Rugged modular construction!**
NEW! Full wave Silicon bridge! **NEW! Weatherproof ferrite speaker!**

Hallmark has done it again! Here's the CB transceiver everyone has been waiting for! Hallmark's famous top performance and rugged reliability built into the superlative new Hallmark 1250 in a compact size!

Consider the size: so compact it will fit into the smallest vehicle, yet the 1250 is a complete 12-channel, dual-powered 5 watt unit. Hallmark's creative engineering and production skills have achieved this through rugged modular construction. **Performance?** Unequaled! Hallmark's unique squelch circuit, already the best in the field, has been further improved in the Model 1250. Sensitivity equals or excels any present specifications in the Hallmark line (better than 0.3 μv for 10 db S+N/N ratio). Adjacent channel rejection is in excess of 30 db.

And talk power! The new silicon rectifier full wave bridge easily provides the power for maximum output and modulation. The new ferrite speaker gives an audio output greater than 4 db over conventional speakers!

Plus easy maintenance! For adding crystals, or when occasional servicing is necessary, four sturdy catches provide

immediate access to the crystal sockets and hand-wired modules.

In every way, this smart-looking new 1250 has been designed for action, for top performance and for rugged reliability in any mobile or base application. Once you see it and hear it play, we think you will wholeheartedly agree that the Hallmark 1250 is the finest CB transceiver available today!



Write for complete information

HALLMARK INSTRUMENTS
 6612 Denton Dr. P.O. Box 10941 Dallas, Texas 75207 FL7-0184



Circle 48 on literature card

STATEMENT OF OWNERSHIP, MANAGEMENT AND CIRCULATION (Act of October 23, 1962; Section 4369, Title 39, United States Code).

1. Date of Filing: October 8, 1963.
2. Title of Publication: PF REPORTER.
3. Frequency of Issue: Monthly.
4. Location of Known Office of Publication (Street, city, county, state, zip code): 4300 W. 62nd St., Marion County, Indianapolis, Indiana 46206.
5. Location of the Headquarters or General Business Offices of the Publishers (Not printers): 4300 W. 62nd St., Indianapolis, Indiana 46206.
6. Names and Addresses of Publisher, Editor, and Managing Editor: Publisher (Name and address): Howard W. Sams & Co., Inc., 4300 W. 62nd St., Indianapolis, Ind. 46206; Editor (Name and address) Forest H. Belt, 4300 W. 62nd St., Indianapolis, Ind. 46206; Managing Editor (Name and address) None.

7. Owner (If owned by a corporation, its name and address must be stated and also immediately thereunder the names and addresses of stockholders owning or holding 1 percent or more of total amount of stock. If not owned by a corporation, the names and addresses of the individual owners must be given. If owned by a partnership or other unincorporated firm, its name and address, as well as that of each individual must be given.) See sheet A.

Sheet A: Jean B. Eldred, Redwood Drive, Franklin, Kentucky; Genoy & Co., c/o Morgan Guaranty Trust Co., P. O. Box 491, Church St. Station, New York, New York; David H. Hertel, 30600 Salem Dr., Bay Village, Ohio; Robert E. Hertel, 1014 Wyandotte Street, Kansas City, Missouri; Lehman Brothers, One William St., New York, New York; Loriot & Co., c/o Manufacturers Trust Co., Corporate Trust Dept., 55 Broad St., New York, New York; James A. Milling, 7905 Morningside Dr., Indianapolis, Indiana; Mufun & Co., c/o Bankers Trust Company, P. O. Box 1371, Church St. Station, New York, New York; Reing & Co., Box 491, Church St. Station, New York, New York; Salkeld & Co., c/o Bankers Trust Company, P. O. Box 407, Church St. Station, New York, New York; Howard W. Sams, 414 Kessler Blvd., W. Dr., Indianapolis, Indiana; Sigler & Co., c/o The Hanover Bank, 70 Broadway, New York, New York; C. Rhoads Smalley, Trustee U/I dated 4/19/63, Executed by Frank D. Smalley, 1006 Grand Ave., 1500 Home Savings Bldg., Kansas City, Missouri.

8. Known Bondholders, Mortgagees, and Other Security Holders Owning or Holding 1 Percent or More of Total Amount of Bonds, Mortgagees or Other Securities (If there are none, so state.) See sheet B.

Sheet B: Armer F. Ahlstrand, 335 Wilty Ave., Rockford, Illinois; John D. Baur and Ruth E. Baur, 3239 Sutherland Ave., Indianapolis, Indiana; Mary M. Benham, 215 N. Senate, Indianapolis, Indiana; McFarland Benham, 601 Lemcke Building, Indianapolis, Indiana; Bertha Binninger and Frieda Binninger, 3510 Watson Rd., Indianapolis, Indiana; Lucille Lee Brayton, 3943 N. Illinois St., Indianapolis, Indiana; R. M. Brotherson and Mary H. Brotherson, 560 Princeton Ave., Apt. A3E, Des Plaines, Illinois; Hazel J. Earl, 5890 Compton Dr., Indianapolis, Indiana; Kenneth D. Earl, 5890 Compton Dr., Indianapolis, Indiana; Marguerite M. Edmonson, 19 S. Rebecca Dr., Indianapolis, Indiana; Phyllis T. Hale, Bainbridge, Indiana; Edward D. James, 122 East Michigan, Indianapolis, Indiana; Edward D. James, Architect, Inc., 122 East Michigan Street, Indianapolis, Indiana; Grace Knox, 505 W. Oak St., Zionsville, Indiana; John B. Kolling and Helma G. Kolling,

515 W. South St., Crown Point, Indiana; Florence T. Lewis, 523 E. 51st St., Indianapolis, Indiana; Katherine B. Lewis and Robert J. Lewis, 3640 Watson Road, Indianapolis, Indiana; Melvin R. Moser, 864 McGill Street, Orrville, Ohio; Crawford H. Naugle and Ruth Naugle, 6470 N. Rural St., Indianapolis, Indiana; Frieda Neil and Harold Neil, 5247-32nd Terrace, N., St. Petersburg, Florida; Edward E. Petri, c/o Petri Jewelry Company, Guaranty Bldg., Indianapolis, Indiana; Helen N. Sams, 510 Primrose, Indianapolis, Indiana; Howard W. Sams & Co., Inc., 4300 W. 62nd St., Indianapolis, Indiana; Kenneth Swan, 4243 Broadway, Indianapolis, Indiana; William G. White & Helen A. White, 4520 Marcy Lane, Apt. 23, Indianapolis, Indiana.

9. Paragraphs 7 and 8 include, in cases where the stockholder or security holder appears upon the books of the company as trustee or in any other fiduciary relation, the name of the person or corporation for whom such trustee is acting, also the statements in the two paragraphs show the affiant's full knowledge and belief as to the circumstances and conditions under which stockholders and security holders who do not appear upon the books of the company as trustees, hold stock and securities in a capacity other than that of a bona fide owner. Names and addresses of individuals who are stockholders of a corporation which itself is a stockholder or holder of bonds, mortgages or other securities of the publishing corporation have been included in paragraphs 7 and 8 when the interests of such individuals are equivalent to 1 percent or more of the total amount of the stock or securities of the publishing corporation.

10. This Item Must Be Completed for all Publications Except Those Which Do Not Carry Advertising Other Than the Publishers Own and Which Are Named in Sections 132.231, 132.232, and 132.233, Postal Manual (Sections 4355a, 4355b, and 4356 of Title 39, United States Code).

	Average No. Copies Each Issue During Preceding 12 Months	Single Issue Nearest to Filing Date
A. Total No. Copies Printed (Net Press Run)	90,604	91,719
B. Paid Circulation		
1. To Term Subscribers by Mail, Carrier Delivery or by Other Means	66,567	68,987
2. Sales Through Agents, News Dealers, or Otherwise	17,366	16,287
C. Free Distribution (including samples) By Mail, Carrier Delivery, or by Other Means	4,263	3,673
D. Total No. Copies Distributed. (Sum of lines B1, B2 and C)	88,196	88,947

I certify that the statements made by me above are correct and complete.

(Signature of editor, publisher, business manager, or owner)

(Signed) MAL PARKS, JR., Bus. Mgr.
This is to certify the signature of
Mal Parks, Jr., Business Manager.
County of Marion
State of Indiana

PHYLIS L. SHAFFER
Notary Public

My commission expires November 16, 1965.

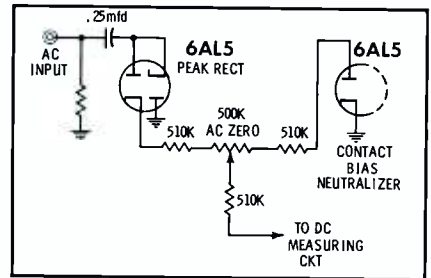

Fig. 7. Circuit for measuring the AC voltage and for neutralizing the contact potential. The meter to read less in inverse proportion to the size of the unknown resistor. Zero ohms is at the left hand side of the meter scale.

For use where necessary, such as for aligning FM detectors, a zero-center position is available in the +DC position of the function switch by simply rotating the electrical ZERO knob until the meter pointer is at center scale. In this mode, a negative voltage applied will cause the meter pointer to swing left and a positive voltage will swing the pointer to the right.

We put the 805 Tele-Volter through its paces in both radio and TV servicing. The meter scales are uncluttered so there is little problem in interpreting what you read. Just two sets of numbers for the DC and AC scales provide a wide selection of ranges—1, 5, 10, 100, 500, and 1000 volts. This array of full-scale ranges is ample for anything from transistor radio servicing to color TV. In addition, an accessory high-voltage probe (Type 85HV) is available for measuring voltages to 30 kv.

The frequency range on AC extends relatively flat from 20 cps to 3 mc at 600 ohms impedance; ample for making exacting tests on audio and most video equipment. We checked the meter for accuracy on both the voltage and ohms scales and found it well within its published ratings of 3% full scale on DC, 5% on AC, and 3% on ohms—more than enough for the most discriminating service work in radio or TV. ▲

For further information, circle 69 on literature card

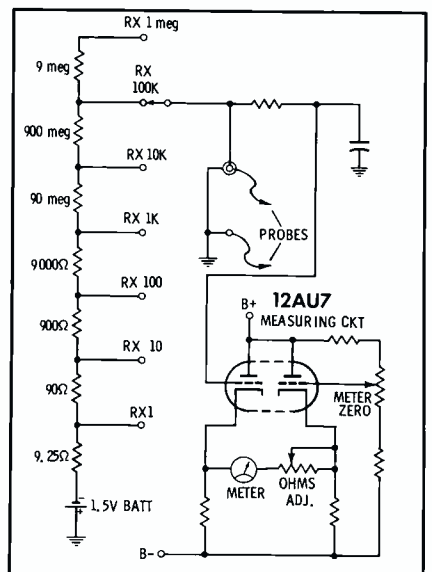

Fig. 8. Basic ohmmeter circuit uses a tapped voltage divider and single internal battery.



How to calculate required resistance in silicon-for-selenium rectifier replacement

■ Will silicon rectifiers used as replacements for selenium rectifiers fail in predominantly capacitive circuits? Not if you pay strict attention to the peak current limits of the replacement units, as specified by the manufacturer.

Why may silicon replacements fail?

Failure is caused by excessive inrush currents during the first few cycles after turn-on. Silicon rectifiers have extremely low impedance in the conduction region at voltages above 1.5 volts. In addition, the capacitor "looks" like a short circuit until it is charged. This combination allows extremely high currents to flow from low impedance sources such as household mains. Being small, the rectifier has so little thermal mass that failure is instantaneous.

Watch your resistance

Sarkes Tarzian F Series rectifiers are widely used in replacement applications. They carry a surge current rating of 30 amperes. With a 120 volt line, the maximum instantaneous voltage that can be impressed is 1.4 times 120, or 168 volts. You should add to the circuit a minimum surge limiting resistance of $\frac{168}{30}$, or 5.6 ohms. This will apply to doubler or half wave circuits.

For practical purposes, we can ignore the impedance of an F unit with 168 volts impressed during the conduction cycle.

Transformer sets require no additional resistance. Enough impedance is inherent in the secondary to provide limiting action. Figures 1, 2, and 3 show typical circuits and recommendations. Our best advice to you: *depend on Tarzian silicon rectifiers for dependable performance.*

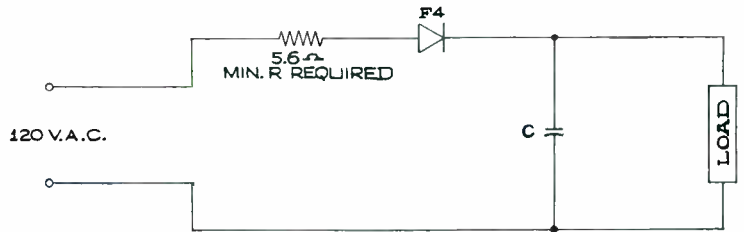

Fig. 1 Rectifier replacement—no transformer

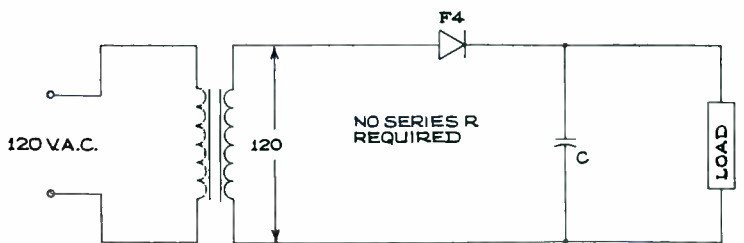

Fig. 2 Rectifier replacement—with transformer

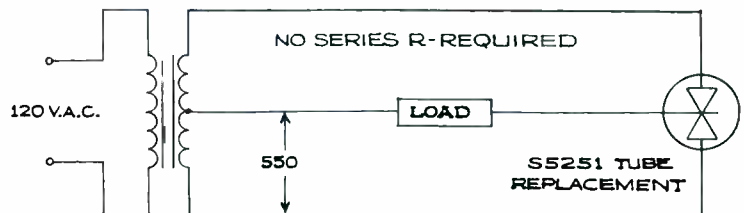

Fig. 3 Tube replacement



The Tarzian Replacement Line includes silicon rectifiers and conversion kits, tube replacement silicon rectifiers, and "condensed stack" selenium rectifiers. Immediately available from distributors throughout the nation, in the quantities and ratings you want most.

FREE... The new 48-page Tarzian Silicon Rectifier Handbook is crammed with interesting technical information and product specifications. For your free copy, ask for Handbook 63-SI-6.



SARKES TARZIAN Inc.

World's Leading Manufacturers of TV and FM Tuners • Closed Circuit TV Systems • Broadcast Equipment • Air Trimmers • FM Radios • Magnetic Recording Tape • Semiconductor Devices
SEMICONDUCTOR DIVISION • BLOOMINGTON, INDIANA
Canadian Licensee: Marsland Engineering Limited • 350 Weber Street North, Waterloo, Ontario

Circle 49 on literature card

STOCK GUIDE

FOR TV TUBES...

This list omits more than 100 of the rarest TV tube types, which many shops find impractical to stock. To simplify the chart as much as possible, common radio and hi-fi tube types used in TV combinations are omitted; so are the majority of tubes used only in color sets. The Color-Caddy Guide, in the November 1963 issue, lists a tube stock especially for color technicians.

New tube types introduced this year are listed in the separate chart; to help you decide whether to stock these tubes, each listing specifies receivers using that particular type. If you're specializing in one or two brands, you'll pick new tubes listed for those sets, and stock your shelves and caddy accordingly.

In the main chart, the figures on white background suggest a caddy stock of ap-

proximately 300 tubes which should account for close to 90% of your replacement needs. As with the rare-tube listings, you may want to carry more of a particular type if it is used in receivers you service often. We've removed some of the older types, such as 6V6, 6W4, and 6BZ7, and replaced them with more current types; also included are some that appeared in last year's *new-tube* list—if they were used in sets again this year. Most-used UHF tubes are also included.

The figures on gray background are a suggested backup (shelf) stock, if you're located near a parts distributor. If you can replenish your tube supply only once a week, you may wish to stock extra of the more common types. Your volume of business will naturally determine your

actual shelf stock, too. Keep in mind three main factors that will influence the demand for various tubes:

1. Relatively high failure rate of power-output and similar tubes.
2. Your specialization in certain makes of sets.
3. Average age of sets containing a particular tube type.

Temporary substitution of available types for rare types, as outlined in the Howard W. Sams book, *Tube Substitution Handbook, Vol. 7*, can also help you reduce stock requirements.

Another way to ease tube-stock headaches is to use only the latest -A or -B versions of various tubes. Types in common use are listed in the chart.

PER CADDY TUBE	TUBE	PER CADDY TUBE	TUBE	PER CADDY TUBE	TUBE	PER CADDY TUBE	TUBE	PER CADDY TUBE	TUBE	PER CADDY TUBE	TUBE						
1000 STOCK	TYPE	1000 STOCK	TYPE	1000 STOCK	TYPE	1000 STOCK	TYPE	1000 STOCK	TYPE	1000 STOCK	TYPE						
8	3	1B3GT	2	2	4BZ6	2	1	6AM8A	5	3	6CG7	1	1	6FV8	1	1	8EB8
2	1	1G3GT	1	1	4CB6	3	3	6AQ5A	5	2	6CG8A	1	1	6FY5	1	1	8EM5
2	1	1J3	1	1	4CS6	1	1	6AR11	1	1	6CL8A	1	1	6FY7	1	1	8ET7
3	1	1K3	1	1	4DT6	1	1	6AS5	2	2	6CM7	2	2	6GE5	2	1	8FQ7
1	1	1S2A	1	1	4EH7	1	1	6AS8	1	1	6CQ8	3	2	6GH8	1	1	8GN8
2	2	1X2B	1	1	4EJ7	2	2	6AU4GTA	2	1	6CS6	3	2	6GK5	1	1	9AU7
1	1	2AF4	1	1	4GK5	3	2	6AU6A	2	1	6CU5	1	1	6GK6	2	1	10DE7
1	1	2AH2	1	1	4GM6	1	1	6AU8A	1	1	6CW4	3	2	6GM6	1	1	10EG7
1	1	2CW4	1	1	4GZ5	2	2	6AV6	2	1	6CW5	2	1	6GN8	1	1	10EM7
1	1	2CY5	1	1	4HM6	3	3	6AW8A	1	1	6CX8	1	1	6GT5	1	1	10HF8
1	1	2DS4	1	1	4HS8	1	1	6AX3	1	1	6CY5	1	1	6GU5	1	1	11JE8
1	1	2DZ4	1	1	4HT6	3	3	6AX4GTB	1	1	6DA4	1	1	6GW6	2	1	12AF3
1	1	2FH5	1	1	5AM8	2	2	6AY3	2	2	6DE4	2	1	6GX6	1	1	12AT7
1	1	2FS5	2	2	5AQ5	1	1	6B10	2	1	6DE6	1	1	6GY6	1	2	12AU7
2	1	2GK5	1	1	5AT8	3	1	6BA6	2	1	6DE7	1	1	6HA5	1	1	12AV5GA
1	1	2GW5	1	1	5AU4	1	1	6BC8	2	2	6DK6	1	1	6HA6	3	2	12AX4GTB
1	1	3A3	1	1	5BR8	2	1	6BE6	1	1	6DN7	1	1	6HF8	2	2	12AX7
1	1	3AF4	3	2	5CG8	1	1	6BG6GA	5	3	6DQ6B	1	1	6HG8	2	1	12B4A
1	1	3AL5	1	1	5CL8A	1	1	6BH8	1	1	6DR7	1	1	6HF8	2	2	12BH7A
2	1	3AU6	1	1	5EA8	1	1	6BJ8	2	2	6DS4	2	1	6HS8	2	1	12BQ6GTB
1	1	3AW3	1	1	5EW6	1	1	6BK7B	2	2	6DT6	2	2	6J6	2	1	12BY7A
2	1	3BN6	2	1	5FG7	2	2	6BL7GT	3	2	6EA8	1	1	6JC8	3	1	12C/-CU5
1	2	3BU8	1	1	5GH8	2	2	6BL8	2	1	6EB8	1	1	6JE8	2	1	12CA5
5	2	3BZ6	1	1	5GM6	1	1	6BN4	3	3	6EH7	1	1	6JT8	1	1	12DB5
2	2	3CB6	8	3	5U4GB	3	2	6BN6	3	2	6EJ7	1	1	6K6GT	3	2	12DQ6B
1	1	3CS6	2	2	5U8	1	1	6BN8	1	1	6EM5	1	1	6KA8	1	1	12DT5
1	1	3CY5	1	1	5V3	3	2	6BQ5	2	2	6EM7	1	1	6KD8	1	1	12SN7GTA
2	1	3DG4	1	1	6AC7	5	3	6BQ6GTB	1	1	6ER5	1	1	6Q11(6K11)	1	1	12W6GT
2	2	3DK6	1	1	6AF3	3	2	6BQ7A	2	1	6ES8	1	1	6S4A	1	1	13DE7
1	2	3DT6	2	1	6AF4B	1	1	6BR8A	1	1	6ET7	1	1	6SL7GT	1	1	13DR7
1	2	3EH7	1	1	6AF11	3	2	6BU8	2	2	6EW6	2	3	6SN7GTB	2	1	13EM7
1	2	3EJ7	1	1	6AG5	1	1	6BX7GT	2	2	6EW7	1	1	6T8	1	1	17AX4GT
1	1	3FS5	1	1	6AG7	1	1	6BY6	1	1	6FD7	1	2	6U8A	1	1	17DE4
2	2	3GK5	1	1	6AH6	1	1	6BY8	2	1	6FG7	2	2	6X8A	2	1	17DQ6B
1	1	4AU6	1	1	6AK5	8	3	6BZ6	1	1	6FH5	1	1	7AU7	1	1	19AU4GTA
1	1	4BL8	1	1	6AL3	1	1	6C4	2	1	6FM7	2	1	8AW8A	1	1	22DE4
1	1	4BQ7A	2	2	6AL5	3	3	6CB6	5	3	6FQ7	2	1	8BQ5	1	1	25AX4GT
1	1	4BU8	1	1	6AL11	1	1	6CD6CA	1	1	6FS5	1	1	8CG7	1	1	25BQ6GTB
												1	1	8CX8	1	1	25CD6GB

NEW TUBE TYPES INTRODUCED IN '64 TV

1AD2	General Electric
1N2	Silvertone
2DZ4	Admiral Motorola
2GU5	Admiral
3AJ8	Clairtone
3GS8	Silvertone
4JC6	RCA
4JD6	RCA
5BC3	Zenith Muntz
5FG7	Admiral
5HG8	Motorola
5KE8	RCA
6BD11	General Electric
6BE3	General Electric
6BF11	General Electric
6BJ3	General Electric
6DM4	Zenith
6DX8	Zenith
6GJ7	Motorola Zenith
6GU5	Admiral
6HA5	Curtis Mathes Zenith
6HB5	General Electric
6HD5	Motorola
6HK5	Admiral
6HZ6	RCA
6HZ8	Philco
6JB6	RCA
6JN8	General Electric
6JZ8	General Electric
6JV8	Admiral
6RK19	Curtis Mathes
8B8	Clairtone
8CW5	Emerson
8DX8	Clairtone
8GJ7	Motorola
8KA8	RCA
9GV8	Admiral
10AL11	Admiral
10DX8	Zenith
10EW7	Silvertone
10JY8	Philco
11KV8	RCA
12AY3	Bradford Truetone
12BE3	Admiral
12GT5	Airline Bradford Truetone
13CM5	Clairtone
13FD7	Philco
13GF7	RCA
13J10	Zenith
16AQ3	Clairtone
16GK6	Motorola
17DM4	Airline
17BE3	Philco
17GV5	Zenith
17JB6	RCA
21HJ5	Truetone

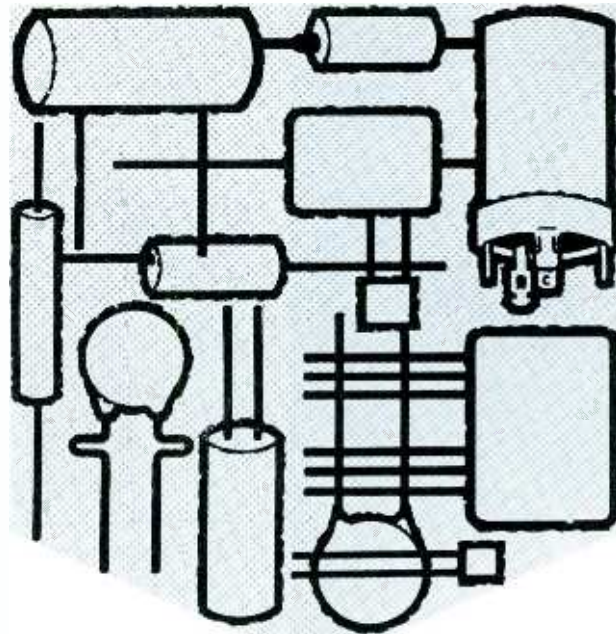

Whatever your replacement need...

CALL FOR
AEROVOX
CAPACITORS

Whatever the requirement, there is an Aerovox capacitor to satisfy it. Your Aerovox distributor can supply your every need with a complete line of in-stock capacitors that are designed and manufactured to meet the highest possible reliability standards.

And when we say "A COMPLETE LINE" we include:

ELECTROLYTIC CAPACITORS

Twist-Prong Cans
Tubular
Miniatures
Wax Filled

BYPASS CAPACITORS

Radial & Axial Leads
Dual Dielectric
Straight Mylar

CERAMIC CAPACITORS

High Voltage
Temperature Compensating
General Purpose Discs
Tubulars

MICA CAPACITORS

Molded
Axial Lead
Dipped Radial Lead

Your local Aerovox distributor offers sure, one-stop service for all capacitor replacement. Buy the best—buy Aerovox.



AEROVOX CORPORATION

DISTRIBUTOR DIVISION

NEW BEDFORD, MASS.

Technical Leadership - Manufacturing Excellence

EXCITING
NEW LINE!
EXCITING
NEW SOUND!



QUAM

FULL FIDELITY HI-FI SPEAKERS

Slim-line styling! Ceramic magnets! Superb reproduction over the full audio spectrum! Complete choice: coaxials, extended range, tweeters, woofers! The new Quam hi-fi line is as modern as tomorrow—and it's designed to offer the *serviceman* a top-quality product at a *list* price that's lower than others' "audiophile net." (Quam never advertises net prices—to protect your mark-up!)

Use Quam Hi-Fi Speakers in new systems, as extension speakers in existing hi-fi systems, and as replacement improvements in stereo consoles. They'll open your way to exciting new sales!

Write for your free copy of the new Quam Hi-Fi Catalog HF-64.

QUAM-NICHOLS COMPANY
234 East Marquette Road • Chicago, Ill. 60637

Circle 50 on literature card

FM Tuning Eyes

(Continued from page 33)

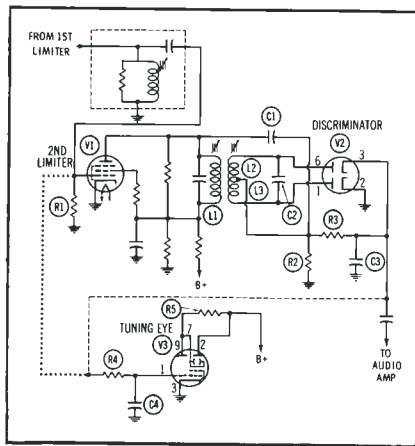

Fig. 7. Two ways of actuating tuning-eye tube.

mally. To determine if a fault is in the eye-tube circuit or in the AVC system, disconnect the control voltage and use a variable bias box connected to the triode grid to ascertain correct eye operation. If changing the control voltage from the bias box doesn't affect operation properly, check the eye tube and its associated components.

Slight audio on the grid of the control tube can cause eye fluctuations. The ratio detector is designed with a large capacitor across its output to prevent audio fluctuations. The discriminator, however, is not equipped with this large capacitance. Therefore it is necessary to decouple the audio voltages before they enter the control tube. These decoupling components are suspects if flickering is a problem.

Tuning Eyes Are Useful

In all types of tuning-eye circuits, you can use the eye in place of a VTVM while performing alignment. As the signal level increases, the eye closes. When the signal decreases, the eye opens. Consequently, not only does a tuning-eye tube aid in accurately tuning in FM stations, but it also provides a built-in signal-strength meter for antenna orientation or alignment. ▲

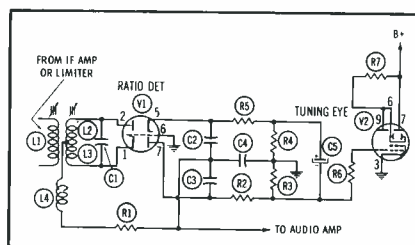

Fig. 8. Eye tube operated from ratio detector.

Winegard
Dealer of the month

No. 17 of a Series

David McKalip says: "We have to be sure we're making top quality antenna installations. With Winegard Colortron and Color-Ceptor antennas, satisfaction is 'assured'".



Winegard congratulates
Rex Service Co., Chicago, Illinois
and their distributor,
Melvin Electronics, Oak Park, Ill.

David McKalip, President of Rex Service Co., founded the firm just 8 years ago, and has built it into one of the most successful TV service outfits on the competitive south side of Chicago.

When asked about Winegard antennas, Mr. McKalip said, "We have installed many Colortrons for fringe area as well as metropolitan reception with excellent results... well over a hundred antennas with never a call back! They've performed even in the most difficult areas with phenomenal results. Ease of assembly, uniformly high performance, impressive appearance and national advertising are some of the features that make them our favorite."

The confidence Mr. McKalip has shown in Winegard comes from installing Winegard antennas and seeing them in action. He's one more important service man who knows Winegard's standards of excellence.

Winegard Co.
ANTENNA SYSTEMS

D3009E Kirkwood • Burlington, Iowa

Circle 51 on literature card

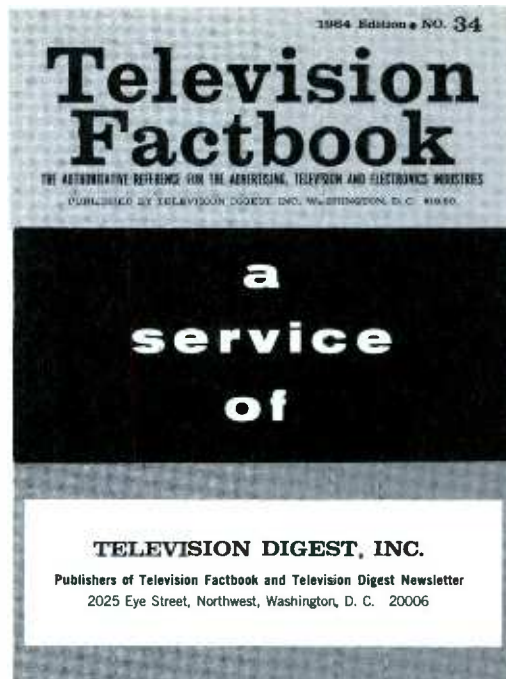

THE BIGGEST... MOST AUTHORITATIVE REFERENCE IN THE TELEVISION AND ELECTRONICS INDUSTRIES

The 1964 edition of TELEVISION FACTBOOK, the basic industry reference since 1945, is now available. Expanded and completely up-dated, its 1220 pages contain even more reference material than ever before. Distributors, dealers and technicians in Television and Electronics equipment, supplies and services find it invaluable as a source of technical, operational and managerial information. Some of TELEVISION FACTBOOK's major features are:

- A full page devoted to each TV Station, complete with coverage map, ARB circulation data, Grade A & B coverage contours, personnel, engineering data and other features.
- Directories of Station Equipment Manufacturers, TV Set Makers, Tube Manufacturers and comprehensive TV-Radio-Phono Production Tables for 1922-1963.
- Complete and up-to-date list of VHF and UHF Transmitters.
- Detailed data on all Community Antenna TV Systems (CATV), including ownership, personnel, number of subscribers, rates, stations, etc.
- Full data on all Educational TV Stations, covering ownership, personnel, technical facilities, legal and engineering representatives, etc.
- Directories of Attorneys, Engineers, Brokers, Consultants, FCC Personnel and Congressional Committees.
- Subscription Television organizations.

With your TELEVISION FACTBOOK you will also receive a 23" x 35" wall map of television stations and network routes covering the United States, its possessions and Canada. This map shows all cities with operating stations, all AT&T and privately owned inter-city network routes, and a complete log of U.S. and Canadian stations. The price is only \$19.50 per copy (\$17.00 if you order five or more), and we pay the postage. Your payment must accompany your order.

A Service of TELEVISION DIGEST, the Weekly Industry Newsletter. Write to:

Television Factbook

SUITE 210-C, 2025 EYE ST. N.W., WASHINGTON, D. C. 20006

Circle 52 on literature card

1



Genuine, fresh Little Devil® resistors (on "Tally Tape" or in Cabinet Assortments)

2

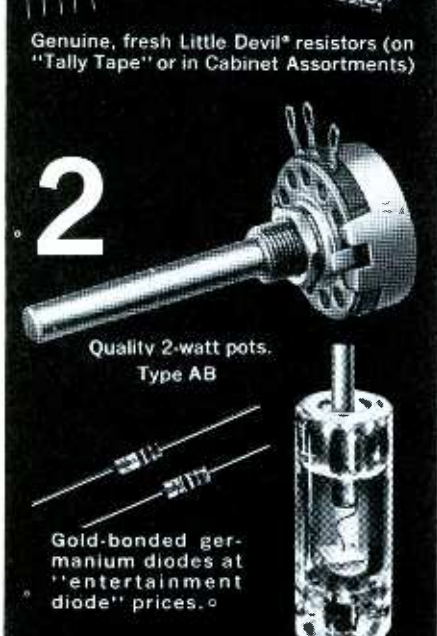

Quality 2-watt pots. Type AB

Gold-bonded germanium diodes at "entertainment diode" prices.

3 WAYS TO MAKE SURE IT STAYS FIXED

You're always safe, always sure with any of these three quality replacements. Why be otherwise? Repair jobs that boomerang cost you hard-earned profit. Little Devil® resistors come in 1/10, 1/4, 1/2, 1, and 2 watts from 2.7 ohms to 22 Megs . . . AB Pots from 50 ohms to 5 Megs in several shaft lengths and styles . . . gold-bonded diodes in ninety 1N types off the shelf.

Call your distributor for the latest Ohmite Stock Catalog 30.

Be right with



Circle 53 on literature card

Poor Boost

(Continued from page 37)

had been a rather routine job.

The technician decided to concentrate on the horizontal AFC section. The first step after replacing the 6AL5 was to connect a zero-center VTVM from ground to the junction of R77 and R78. This junction is the source of the DC control voltage that keeps the horizontal oscillator in sync. When the picture is in sync, this voltage should be nearly zero. It varies 1 or 2 volts on either side of center when the horizontal-hold control is operated. In this case the voltage didn't vary; it remained about -15 volts for any setting of the hold control. It was clear that the AFC wasn't working.

Resistors R77 and R78 were checked and found to have the proper resistance. The same was true of R79. Next the sync input waveforms were checked with the scope at C77 and C78 in the sync phase-inverter stage. These traces were both normal, so the sync stage and the coupling capacitors were eliminated as suspects. This narrowed the search down to the reference line coming into the AFC at pins 1 and 2 of the 6AL5.

When a scope check was made at R79, it revealed that the reference sawtooth was missing. This signal is taken from the width coil through the phase-shifting and waveshaping network composed of C60, R41, and the C29 we'd just replaced. Thinking he had the problem solved, the technician anxiously moved the scope probe to the other terminal of C60, but there was no trace. At the junction of R41 and C29 there was still no sign of the sawtooth. Could C29 be shorted again? The DC voltage at the junction of C29 and R41 was checked; it was zero. Immediately the voltmeter probe was moved to terminal 2 of the flyback transformer, and there was the full

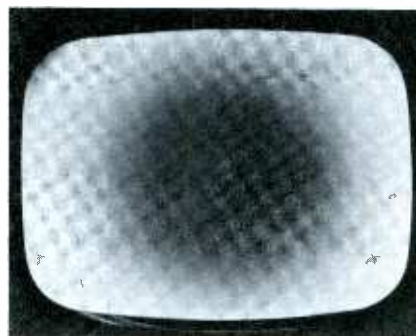

Fig. 7. Severe blooming preceded raster loss.

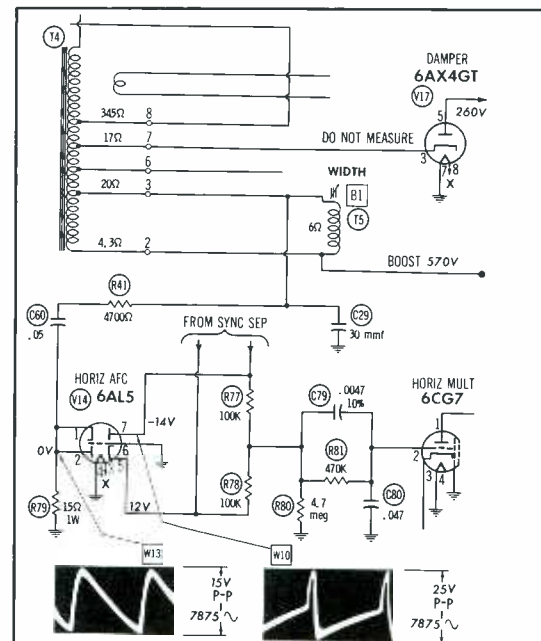

Fig. 8. Replacing component caused new fault.

570 volts. The meter was moved to terminal 3; the boost was there also. Why was the voltage missing at the junction of C29 and R41?

With the width coil connected, the resistance between terminals 2 and 3 was slightly less than 2.5 ohms (about right for the two coils in parallel). Therefore the width coil was not suspected. But after a great amount of time was spent rechecking, the width coil was finally removed for closer inspection. Fig. 9 illustrates what we found. At one end of the coil there are three solder terminals, one of which is a dummy not connected to any part of the winding. This extra terminal served a tie point for mounting C29 and R41, and a jumper was originally soldered between this tie point and one of the true coil terminals. When C29 was replaced, the jumper was inadvertently removed, thus disconnecting the AFC reference line from the coil.

Check the Boost

The three-dimensional effect

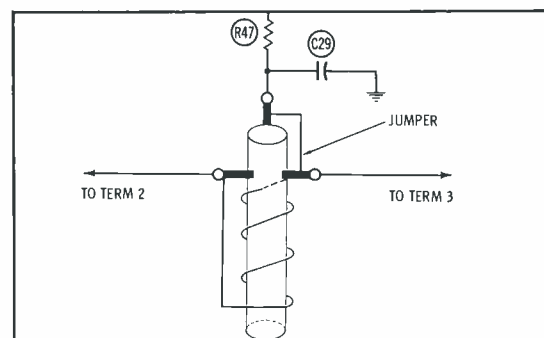

Fig. 9. The jumper was removed inadvertently.

shown in Fig. 10 was the result of a width-coil defect in a circuit in which both the vertical and horizontal oscillators were supplied from boost. The repairman lost a lot of good time and profit checking B+ filters and replacing the yoke. The receiver also used keyed AGC, and the pulses for the plate of the keyer were taken from the flyback. When he found a strange-looking waveform at the plate of the keyer, the technician wasted some more time checking out the entire AGC system.

It was finally discovered that arcing in the width coil was setting the entire flyback system into oscillation; the boost voltage contained a high percentage of this crazy ripple and conducted it to many other circuits. Thus you see that poor boost can be the cause of many symptoms, ranging from AGC and sync trouble to vertical-deflection problems and even blooming and loss of focus. Whenever your study of the schematic reveals the slightest possibility that the boost may be a source of the trouble, this possibility should be followed up. It's easy to make a quick check on the boost in the following manner:

1. Replace the horizontal output and damper tubes.
2. Measure boost voltage on the side of the boost capacitor farthest from B+.
3. If the boost voltage is normal at its source, use a voltmeter to trace the voltage across each of the components between the boost and the circuit which is not functioning properly.
4. If the boost voltage is low, check the resistance of each section of transformer winding and the deflection yoke.
5. If the resistances are normal, the cause of low boost voltage may be any of the capacitors in the system. ▲

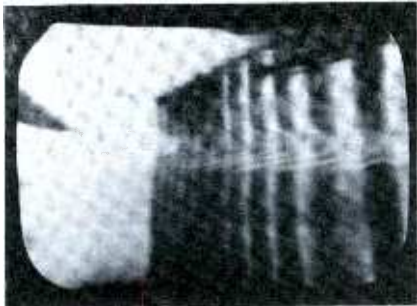
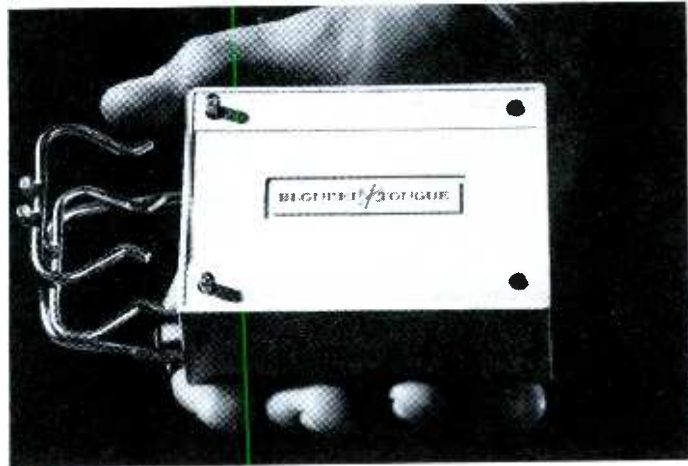

Fig. 10. Three-dimensional effect was caused by faulty width coil that affected boost line.

"Here it is. An all channel UHF amplifier."



"So what?"

"So, Bob, it's the world's first two transistor UHF amplifier."

"Big deal."

"Gives twice the gain of those one transistor jobs."

"Go on, Harry. Go on."

"It's the first to deliver peak performance on all UHF channels."

"So what does it all mean to me?"

"Cleans up fuzzy pictures, brings in distant signals sharp and clear."

"Now you're really talking."

"Remote power supply, Miracle Mount for instant mounting, 300 ohm striplless screws."

"I'm sold. What's it called?"

"The Blonder-Tongue Able - U2. Only \$44.95* at your TV dealer."

"Did you say Blonder-Tongue? Great! I can use it with my Blonder-Tongue Golden Dart UHF antenna."

"Hey, Charlie! Here it is. An all-channel UHF amplifier!"

"So what?"

*list

Blonder-Tongue Laboratories,
9 Alling St., Newark 2, New Jersey



Circle 54 on literature card

SAMS Best Sellers

LATEST EDITIONS OF TWO FAMOUS HOWARD W. SAMS HANDBOOKS!



Tube Substitution Handbook
still the Leading Reference—lists 10,000 Tube Substitutions Absolutely indispensable! 7 Sections cover: Cross-reference of American Receiving Tubes; Cross-reference of Subminiature Tubes; Industrial Substitutes for Receiving Tubes; Communications and Special-Purpose Tubes; Foreign Substitutes for American Types; American Substitutes for Foreign Types; Picture Tube Substitutions. 128 pages; 5 1/2 x 8 1/2". Order TUB-7, still only... \$150



Transistor Substitution Handbook
Computer-Selected Substitutes for Over 5,000 Transistors—Updated! Lists over 40,000 direct substitutions, including all popular types used in transistor radios and similar equipment. Shows basing diagrams, polarity identification and manufacturers for over 5,000 types. Special section lists more than 15,000 American replacements for foreign transistors—plus a semiconductor and diode guide containing 800 substitutions. 128 pages, 5 1/2 x 8 1/2". Order SSH-5, still only \$150

Transistor Ignition Systems Handbook

by Brice Ward. Transistor ignition systems are revolutionizing the auto industry. This new book clearly explains the principles of these highly efficient systems—how they work, how to install them, how to tune them up. Describes typical systems now in use; provides complete data on installation. 128 pages; 5 1/2 x 8 1/2". Order IGS-1, only... \$250

Color TV Servicing Made Easy

by Wayne Lemons. Written in "make easy" style. Takes the mystery out of color TV servicing. Introduces you to color principles and setup adjustments; thoroughly covers color circuitry, adjustments, and servicing of all color TV sets produced to date. This book will help to put you into this fast-growing, profitable service work. 128 pages, 5 1/2 x 8 1/2". Order CSL-1, only... \$295

PHOTOFACT Guide to TV Troubles

by Herrington & Oliphant. Contains over 240 photos of actual TV picture troubles, keyed to defective components in typical circuits. Shows exactly what happens to picture tube display when any component becomes defective. By making the quick checks recommended in special charts, troubleshooting is reduced to minutes. 160 pages, 5 1/2 x 8 1/2". Order PFG-1, only... \$295

Troubleshooting with the Oscilloscope

by Bob Middleton. Explains how you can best use the scope to actually view and analyze electronic circuit actions, and apply what you see to more effective TV and radio troubleshooting. Practical chapters on scope operation, use of probes, signal-tracing, visual alignment, signal testing, circuit analysis, and troubleshooting TV, Radio, and Hi-Fi. 128 pages; 5 1/2 x 8 1/2". Order TOS-1, only \$250

Troubleshooting with the VOM-VTVM

by Bob Middleton. Shows how to use these instruments for troubleshooting TV circuits. Tells how to check and interpret voltages; gives step-by-step procedures for analyzing every type of TV circuit. Also describes measurement and analysis of both AC and DC voltages, resistance, capacitance, and RF signals. 160 pages; 5 1/2 x 8 1/2". Order TWV-1, only... \$250

Phonograph Cartridge & Needle Replacement Guide

by the Howard W. Sams Technical Staff. Most comprehensive guide available to replacement cartridges and needles. Listed by original parts numbers and by equipment manufacturers' model and part numbers. Fully cross-referenced. 96 pages, 5 1/2 x 8 1/2". Order RCN-1, only... \$195

HOWARD W. SAMS & CO., INC.

Order from your Sams Distributor today, or mail to Howard W. Sams & Co., Inc., Dept. PF-5 4300 W. 62nd Street, Indianapolis 6, Ind.

Send me the following books:

- TUB-7 IGS-1 PFG-1 TWV-1
 SSH-5 CSL-1 TOS-1 RCN-1

\$_____ enclosed. Send FREE Booklist

Name _____

Address _____

City _____ Zone _____ State _____

My Distributor is _____

IN CANADA: A. C. Simmonds & Sons, Ltd., Toronto 7

Tape Heads

(Continued from page 31)

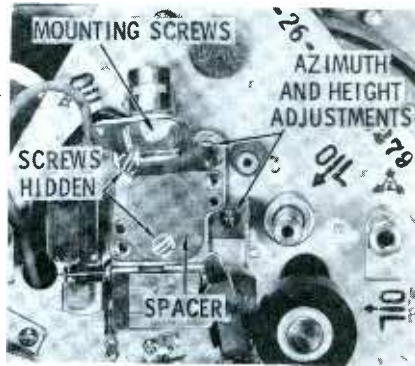

Fig. 7. Two typical bottom-mounted tape heads.

and erase voltage of the recorder. If possible, determine the proper erase current in the head circuit. Select a replacement head that properly matches this frequency and voltage. Connect the head in the circuit and insert the 100-ohm 1-watt resistor in series with the head. Measure the voltage across the resistor and compare the calculated current with that specified by the head manufacturer. In most cases the current will be fairly close; if it isn't, increase or decrease the current slightly by placing a resonating capacitor or dropping resistor in series with the head.

Mounting

As important as impedance matching is the proper mechanical positioning of the heads. Record/playback heads are available in a variety of mounting arrangements to replace most of the heads used in recorders today.

The essential part of the mounting procedure is the assurance that the gap of the head is in proper vertical position to line up with the tape. Before removing the defective head from the assembly study its position, sketch the mounting, and measure the distance from the top



Fig. 8. Example of rear-mounted playback head.

3 WAYS TO BIGGER



NEEDLE



CARTRIDGE PROFITS!

1. More "look-alike" exact replacement models than any other brand. Over 350 needles, 225 cartridges.
2. Easy-to-use reference material. E-V computer-printed catalogs make proper needle/cartridge selection easy, fast and accurate.
3. Highest standards. Rigid quality control and inspection cuts call-backs, gives full value to every customer.

Stock and sell E-V needles and cartridges for more profits, today! Write for FREE replacement guides!

ELECTRO-VOICE, INC.
Dept. 547R, Buchanan, Michigan 49107

Electro-Voice
SETTING NEW STANDARDS IN SOUND

Circle 55 on literature card

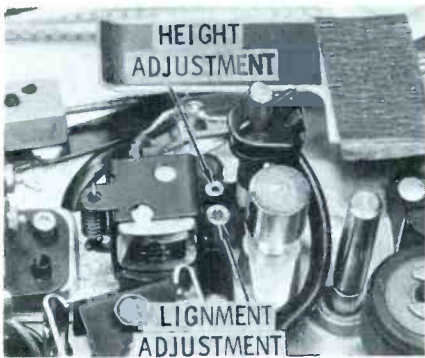
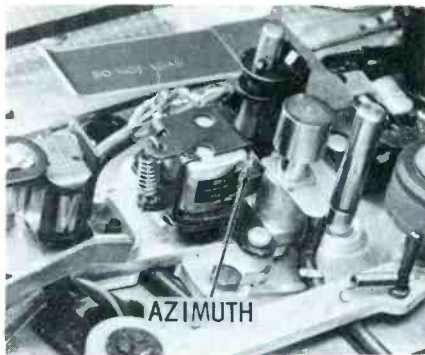

Fig. 9. A "no-mount" R/P head in its bracket.

edge of the gap to the top plate of the recorder. Use this information in mounting the new head.

Side Mount

Many heads found in recorders today are of the side-mount type. Machine screws are inserted horizontally through the heads and fastened to an "L" bracket (Figs. 5 and 6). The vertical, or height, adjustment is accomplished by sliding the head up or down in the slotted screwholes of the bracket. Position the head as well as you can by eye at this point.

Bottom Mount

Heads mounted from the bottom (Fig. 7) by means of screws or a threaded bushing are usually positioned vertically by spacers or shims between the top surface of the deck and the bottom of the head case. Since a replacement head may not be the same size as the original, the removal or addition of shims may be necessary.

Rear Mount

Some heads are mounted from the rear by means of a threaded bushing that is an integral part of the head case (Fig. 8). This bushing can be moved up and down since the hole in the bracket is slotted. In some cases it may be necessary to insert several spacers on the bushing to position the head face closer to the tape.

THIS AD RAN IN APRIL 1961!
MERIT has
always been first
in quality!

Even competition tries to imitate superior MERIT quality.

INSIDE STORY



OF HOW MERIT BUILDS MAXIMUM PERFORMANCE into FLYBACK TRANSFORMERS

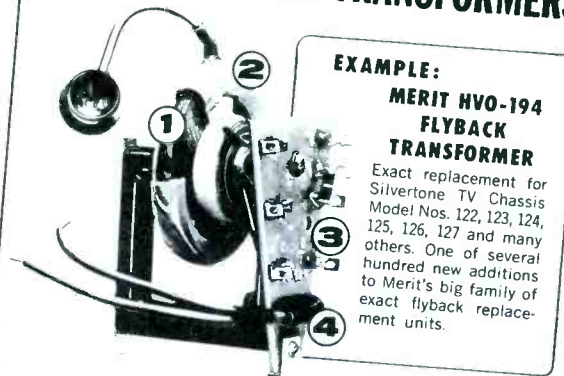

EXAMPLE: MERIT HVO-194 FLYBACK TRANSFORMER

Exact replacement for Silvertone TV Chassis Model Nos. 122, 123, 124, 125, 126, 127 and many others. One of several hundred new additions to Merit's big family of exact flyback replacement units.

EACH Merit Flyback (like all Merit Components) subjected to rigorous tests far beyond ordinary usage. No "spot checking."

EACH Merit Flyback unit designed to fit perfectly and to furnish the same horizontal scanning voltage beam, accelerating anode voltage for the cathode ray tube, and filament voltage for the high voltage rectifier, as original equipment.

PLUS

- 1** Vacuum varnish-impregnated coil.
- 2** Flame-resistant molded anti-corona tire.
- 3** Heavy duty Bakelite terminal board assures mechanical strength and improved electric characteristics.
- 4** Vinyl insulation for high voltage protection.

MERIT QUALITY BUILDS CONFIDENCE



COIL AND TRANSFORMER CORP.
 MERIT PLAZA • HOLLYWOOD, FLORIDA

Friction Mount

Friction mount, or "no-mount," heads do not employ screws directly in the head casing. Rather, they are inserted into a U-shaped bracket and held in place by friction and spring action (Fig. 9). The adjustments are performed on the bracket. In this case if the head fits, you are in great shape; if the head doesn't fit, it's the wrong head.

Adjustment and Maintenance

The two main adjustments for tape heads are vertical alignment and azimuth—the angular position of the gap with respect to the tape. Once the proper head is selected and installed, final positioning adjustments can be made with the use of a standard alignment tape and an audio voltmeter or VTVM.

Alignment

Thread a tape on the machine and check to see that the tape will track in the center of the head face. Adjust the vertical position of the head to the proper height by means of screws or spacers.

Parallel position—Look at the record/playback head from the side and sight along the face to the capstan and the tape. Adjust the head by resetting the mounting screws, varying the adjustment screws, or slightly altering the shape of the mounting bracket. When you are certain the record and play heads are parallel to each other and to the capstan, do the same with the erase head. The heads should now be perpendicular to the top surface of the deck and parallel to each other and the tape.

Azimuth—Thread a standard alignment tape on the

machine. Connect an audio voltmeter or VTVM to the output jack and turn the volume control to maximum. Start the tape in play and adjust the head azimuth (angle between the gap and a line perpendicular to the direction of tape motion) for maximum reading on the meter. You may note several minor peaks on either side of the true peak. When the output is maximum, the head gap will be perpendicular to the direction of the tape motion.

If the machine has separate record and playback heads, you can align the record head by using the output of the already-aligned playback head in the following manner. With a recorder that has separate record and playback *amplifiers* the job is somewhat simplified. Connect your VTVM to the output of the playback amplifier, and place a .01-mfd capacitor across the terminals of the meter to eliminate from the reading whatever bias signal is picked up by the playback head. If the machine uses the same amplifier for both record and playback (as will most often be the case), connect the playback head to an external preamplifier with a low-level, high-gain input; connect the meter to the amplifier output.

Now thread a blank tape on the recorder and connect to the input an audio oscillator set at 10 kc. With the machine in the record function, set the generator for an output of about .1 volt on the VTVM. Adjust the record head azimuth for maximum reading on the output meter. Various azimuth adjustments are shown in Figs. 5 through 9.

Inspection and Cleaning

Indications of head wear and use occur in various

See new line of 18 regulated and semi-regulated power supplies

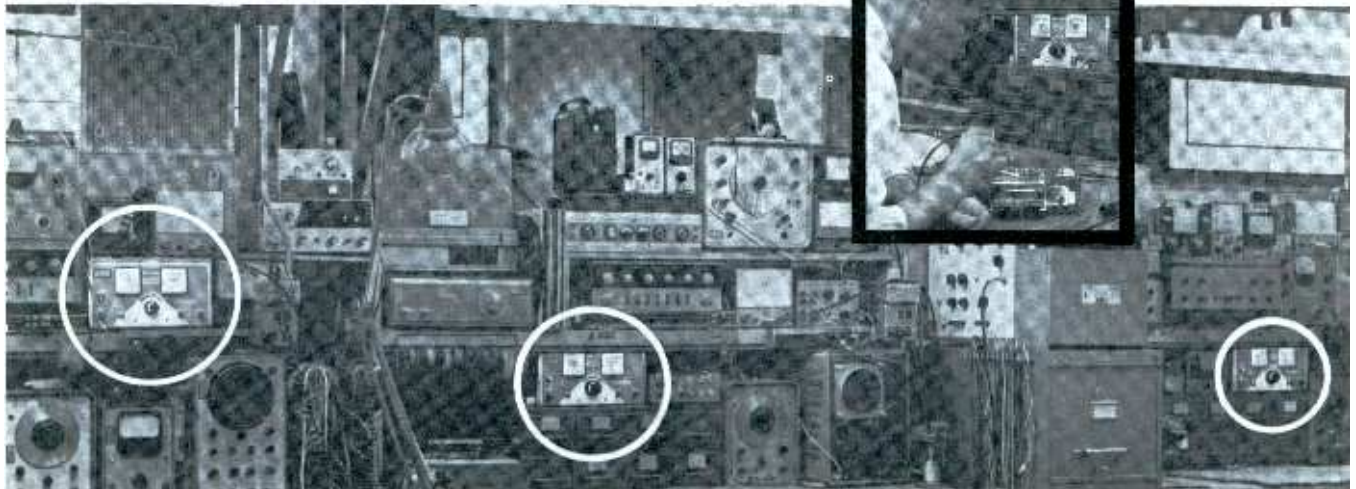

BOOTH 4020
May Parts Show

Electro chosen by Service Dept. of *ALLIED RADIO*

When this nationally known Chicago distributor needed test instruments for their Customer Service Department, they knew, through experience in selling them, which brands could best serve their varied requirements most efficiently.

Electro DC Power Supplies, featured in Allied's catalog, qualified for the job. Three Electro universal D-162T models (circled above) were selected and put to work immediately. Here are some of the reasons:

- D-612T out-did others in operating signal seeking auto-radios • Filtering proved to be superior over 0-8/0-16 continuous voltage output • Ampere rating over 0-12 volt range registered a full 10 amperes • Heavier overloads under continuous service could be handled
- Backed by one year guarantee.



**ELECTRO PRODUCTS
LABORATORIES**

6125-R Howard, Chicago (Niles), Ill. 60648
Phone: 312/775-5220

Canada: Atlas Radio Corp., Toronto

FREE SELECTION GUIDE on complete line . . . write or phone

SOLD THROUGH ALLIED RADIO & OTHER TOP DISTRIBUTORS Since 1936—Pioneers in Low Voltage Power Supplies

Circle 57 on literature card

www.americanradiohistory.com

ways. The most common sign of use is a deposit of oxide and tape lubricant on the face of the head. (Most tape manufacturers apply a lubricant to the tape to help it pass the heads, guides, and capstan.)

Cleaning

The residue can be removed from the heads with a suitable solvent such as those specially available for the purpose. Denatured alcohol can be used on some heads, while a solution of xylene and .1% *Aerosal* is recommended for others. The best rule is to follow the head manufacturer's directions. The cleaner should be applied with a cotton swab—never use any abrasive instrument or material, since the head will become damaged from even slight scratches on the face.

Inspection

When the heads are clean, inspect them for wear. A slight grooving of the face, with a widening of the gap uniformly over its entire length, indicates normal wear and proper head position. If you notice the gap has worn more at the top or bottom of the face, the head may be out of adjustment. It is then necessary to check the parallel position as described earlier. Uneven wearing of the gap can also be caused by pressure pads exerting uneven force on the head face. Check the pressure-pad assembly to be sure the pads are parallel to the face of the head.

There are now on the market heads which are designed with a face contour that follows the curve of an hyperbola. The resulting "sharpening" of the gap area improves tape-to-head contact, making pressure pads unnecessary and increasing head life.

As the head wears, and the gap widens, it becomes increasingly difficult to record high frequencies. On playback, high-frequency response seems to improve slightly at first; then, as the gap widens, the highs are lost. When normal operation cannot be restored by adjustments of the heads or bias, and the heads show definite signs of wear, it is time for replacement.

Demagnetizing

Recording and playback heads gradually build up residual magnetism from constant exposure to magnetic fields during operation. When the heads do become magnetized, you will notice an increase in noise, distortion, and a loss of high frequencies due to partial erasure. It is necessary then to demagnetize the heads; inexpensive devices are available for this purpose. Erase heads do not require this treatment.

To demagnetize the heads, remove the head cover and turn the machine off. If the tips of your demagnetizer are bare, cover them with smooth tape. Turn the demagnetizer on and bring the tips into contact with the record-head face, straddling the gap. Move the tips up and down several times the full length of the face, and then *very slowly* remove the demagnetizer. The slow removal is necessary to correct demagnetization. Now repeat the operation on the playback head.

The heads should now be properly aligned, clean, and in condition to make a good recording in a properly operating machine. While replacement is not under normal circumstances a very frequent necessity, the procedures of cleaning, inspection, adjustment, and demagnetizing should be followed fairly often. Use these hints, and offer this service—and keep your customers' tape rolling! ▲

JOIN THIS MAN!



MAKE MORE MONEY IN ELECTRONICS

SEND COUPON NOW FOR FREE BOOK

Trained men get ahead fast in the exciting field of Electronics. Learn all about Transistors, Communications, Aerospace Electronics, Computers. Cleveland Institute of Electronics can teach you . . . **at home** for a fraction of classroom training cost. Check these CIE advantages:

No Experience Needed: "Check-Point" Home Study Plan presents material in small, easy-to-understand bits . . . reinforced with clear explanations, diagrams, examples.

Nationwide Job Placement: Cleveland Institute students get bi-monthly listings of hundreds of high-paying jobs in electronics . . . the world's fastest growing industry!

A Commercial FCC License . . . or Your Money Back: Should you fail your FCC exam after completing your licensing program, CIE will refund all your tuition!

Cleveland Institute is an accredited member of the National Home Study Council; is also approved for Veteran's training under the Korean GI Bill.

ACT NOW... SEND COUPON FOR FREE BOOK

Cleveland Institute of Electronics

1776 E. 17th St., Dept. PF-12
Cleveland, Ohio 44114

Please send FREE Electronics Career Book without obligation. I'm a high school graduate interested in (check one):



- Electronics Technology
- Broadcast Engineering
- Industrial Electronics
- First Class FCC License
- Electronic Communications
- Advanced Engineering

Your Occupation _____

Name _____ Age _____
(Please Print Clearly)

Address _____

City _____ State _____ Zip Code _____



Product Report

For further information on any of the following items, circle the associated number on the Catalog & Literature Card.

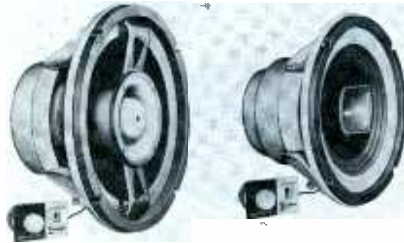

Unitary Speakers (70)

Seven completely new 8" and 12" high-fidelity loudspeakers from **Jensen Mfg. Co.** combine recent advances in acoustic design with added performance and convenience features. Ranging in price from \$16.50 to \$69.50, the new "Sigma" series speakers offer die-cast alloy housings for permanent alignment of all critical parts, high-energy Syntox-6® magnets, carefully formulated cones for excellent coupling to air, Flexair® cloth cone suspensions, low-crossover (2000-cps) tweeters, and remote high-frequency control.



Coaxial-Cable Counter Display (71)

A compact counter display that takes up only 2½ square feet of space and yet provides a complete selection of coaxial

cable especially for communications, is available from **Columbia Wire and Supply Co.** This colorful, attractive display is stocked with 12 rolls each of RG58A/U 50-ohm and RG8/U 52-ohm cable, and 8 rolls of RG59/U 73-ohm cable—in 25', 50', and 75' lengths.

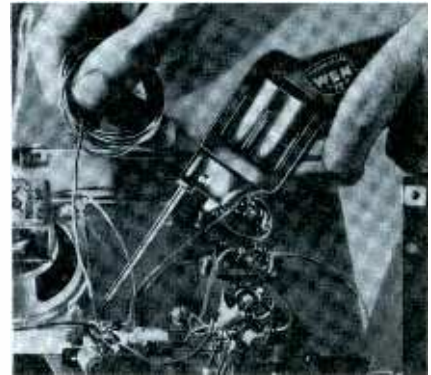

Soldering Pistol (72)

A new tool that provides unusually efficient electrical heat is the **Wen** soldering pistol. It will produce as much effective heat as a 100-watt iron from a normal rating of only 30 watts. All the heat is concentrated at the pistol's tip; no current is wasted, and yet the tip will not overheat. Compact in size and shaped like a pistol, the **Wen Model 75** is 9" long, including the 3" tapered tip, 4½" high, and weighs only 1 lb. Housed in shock-resistant molded red plastic, the pistol is priced at \$4.95.



because:

I'M SAFE FOR ALL PLASTICS

I CLEAN THE BEST

I'm blended from not just 1 but 3 special cleaners.



And I'm the best buy anywhere

8 ozs. just 1.89



No. 1630-85

TRY ME AND SEE

COLMAN Electronic Products

Amarillo, Texas

Circle 59 on literature card

SAVES
your back...

SAVES
your time...



YEATS **SHORTY DOLLY**
for RADIO and TV

just 47 inches high for STATION WAGONS and PANEL PICK-UPS



FOLDING PLATFORM
15¼" x 24½" top.
Snaps on or off.
(Platform only)
\$11.95

Designed for TV, radio and appliance men who make deliveries by station wagon or panel truck... the short 47 inch length saves detaching the set for loading into the "wagon" or pick up. Tough, yet featherlight aluminum alloy frame has padded felt front, fast (30 second) web strap ratchet fastener and two endless rubber belt step glides. New folding platform attachment, at left, saves your back handling large TV chassis or table models. Call your YEATS dealer or write direct today!



YEATS
Model No. 5
Height 47"
Weight 32 lbs.



FURNITURE PAD

"Everlast" COVER AND PADS

YEATS semi fitted covers are made of tough water repellent fabric with adjustable web straps and soft, scratchless white flannel liners. All shapes and sizes — Write



TV COVER

YEATS

APPLIANCE DOLLY SALES COMPANY

1307 W. Fond du Lac Ave. • Milwaukee, Wisconsin
Circle 60 on literature card

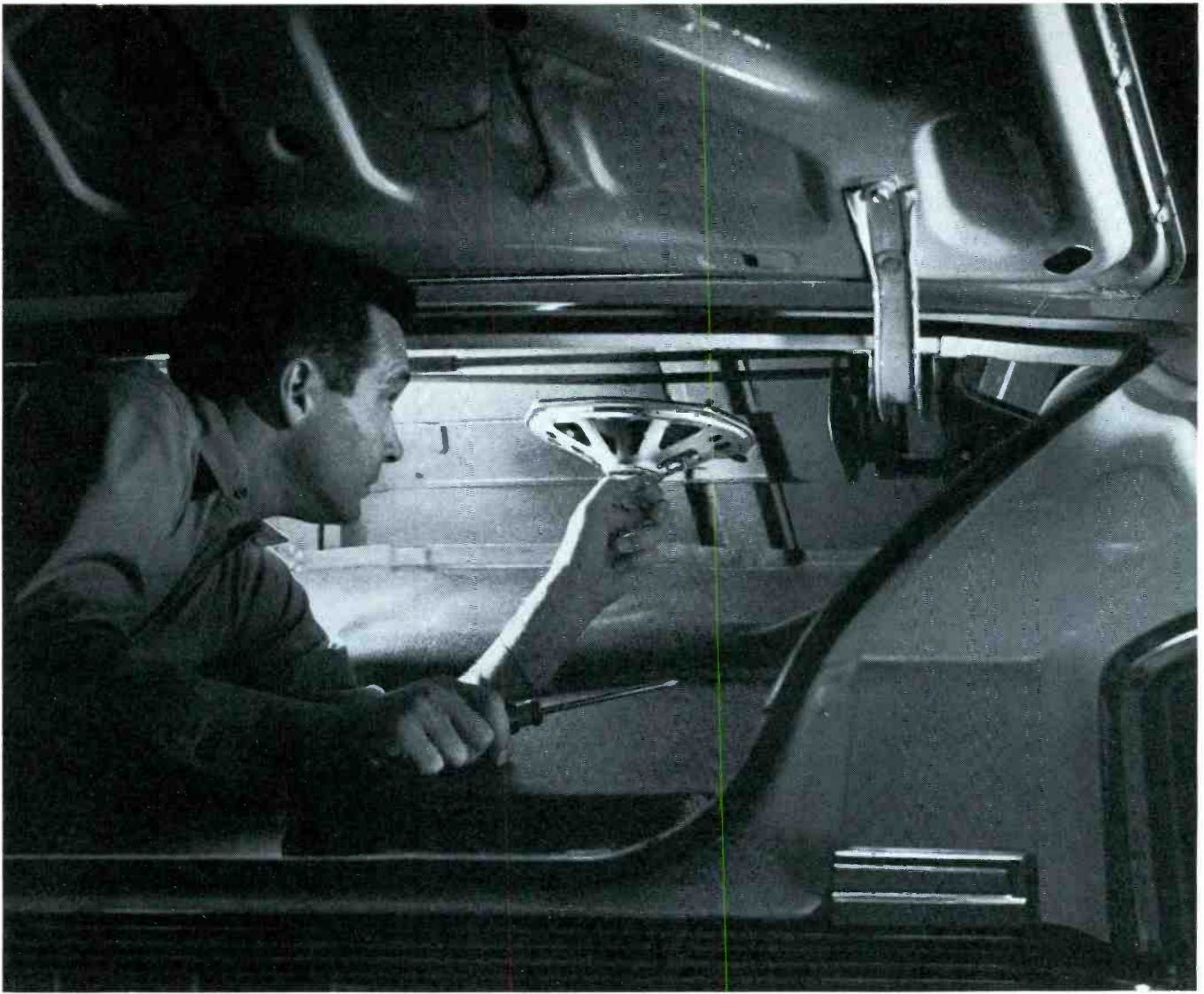

How to make some sound money

Talk up rear-seat speakers! Here's a good profit item you can sell to your car-owning customers. And spring is the time when everyone wants one. If he doesn't have a rear-seat speaker now he's probably already half sold, just waiting for someone to ask him to buy.

The Delco Radio Universal 8-10-OHM 6"x 9" Rear Speaker Package #6122 contains all material necessary for a quick, easy one-man installation. Will take "tip jack", "blade", or

solder connection. And you're sure of selling the "right kind" because these speakers are acoustically designed for use in cars.

This spring make some sound money on rear-seat speakers. For full information on the complete Delco Radio line of speaker packages and accessories, call your United Delco supplier.

DELCO RADIO, Division of General Motors, Kokomo, Indiana

simply say **Delco**

Delco Radio Automotive Radio Service Parts and Electro-Mechanical Devices are distributed nationally through **United Delco**



Circle 58 on literature card

THE GRAND OLD MAN OF ELECTRONICS PREDICTS . . .



by Hal Bergida

Ever make a service call to repair an electronic piano? Or have a customer complain that his laser system needed adjusting because his private communications system wasn't operating, or wasn't bouncing off the moon right?

Calls like these will soon become part of the everyday routine of servicemen — according to Benjamin Franklin Miessner. The winner of the 1963 DeForest Audion award from the Veteran Wireless Operators Association sees many new and amazing things in the future for servicemen.

He predicts that the old-fashioned piano tuner, once a community necessity, will turn over his duties to radio and TV technicians as Miessner's new electronic pianos replace the present instruments.

Laser beams and improved transistor circuitry will make it

possible for almost anyone to own his own private communications system, capable of reaching distant planets.

Servicemen will find their services demanded more and more as laymen acquire new and more complex electronic devices for their daily living — Miessner points out.

Another encouraging point he made, in an interview at his home in Miami Shores, Fla., was that today's servicemen won't have too much trouble with the new devices he sees on the horizon. He says, "TV circuits are about as complicated as I think any of the new devices will be, and today's good technicians will be able to handle them."

Although technically retired, the "grand old man" of electronics works about 12 hours a day at experiments. He is presently trying to improve his electronic piano that is marketed by Wurlitzer Co., who bought the basic patents. He has been selling such patents to manufacturers since his first invention in 1910—the "cat's whisker" detector for early crystal sets. Among his 200-odd patents are those for perfecting superheterodyne radio circuits, a photoelectric exposure meter, the automatic orientation device known as the "Electric Dog," self-aligning telescopes, anti-aircraft searchlights, and many others.

Despite all the past has meant to him, Miessner continues to look ahead in electronics and predicts, "Today's servicemen will soon be handling equipment that they now cannot even dream of." ▲



Two-Way Radio (73)

An industrial radiotelephone which contains many features not usually found in a two-way radio is being marketed by General Radiotelephone Co. The Model VS-2 boasts such innovations as electronic switching to eliminate relay problems, and a transistorized power supply with automatic short-circuit protection. The set will operate from either 115 volts AC or 12 volts DC. Priced at \$139.95, the VS-2 comes with microphone, and is equipped with crystal for one channel.

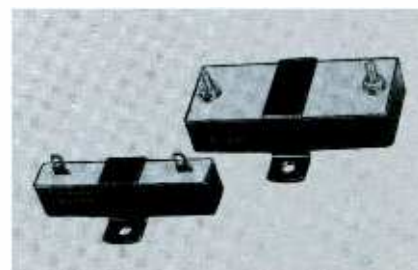

Steel-Cased Resistors (74)

A heavy-duty, heat-sink-type resistor is now available with the resistance winding imbedded in a high-grade potting compound inside a steel casing with "L"-bracket mounting. Originally developed by Milwaukee Resistor Co. as a ballast resistor for transistorized ignition circuits, it can be used in other applications — especially where severe duty is required. Quick-connect terminals, standard tabs, or studs can be furnished. Sizes are 25 watts and up.



Alignment Generator (75)

This miniature battery-operated oscillator, which is factory adjusted to $\pm .002\%$ accuracy and can be used for alignment of communications IF circuits and discriminators, is a product of Texas Crystals. The TC-3 can be used as a secondary frequency standard and as a marker generator, or as a signal source for broadcast- or marine-band alignment. Complete with battery, this 200-kc to 3-mc oscillator includes a choice of three standard-frequency crystals, and is priced at \$29.95.

Now...MORE TV THAN EVER in PHOTOFACT®

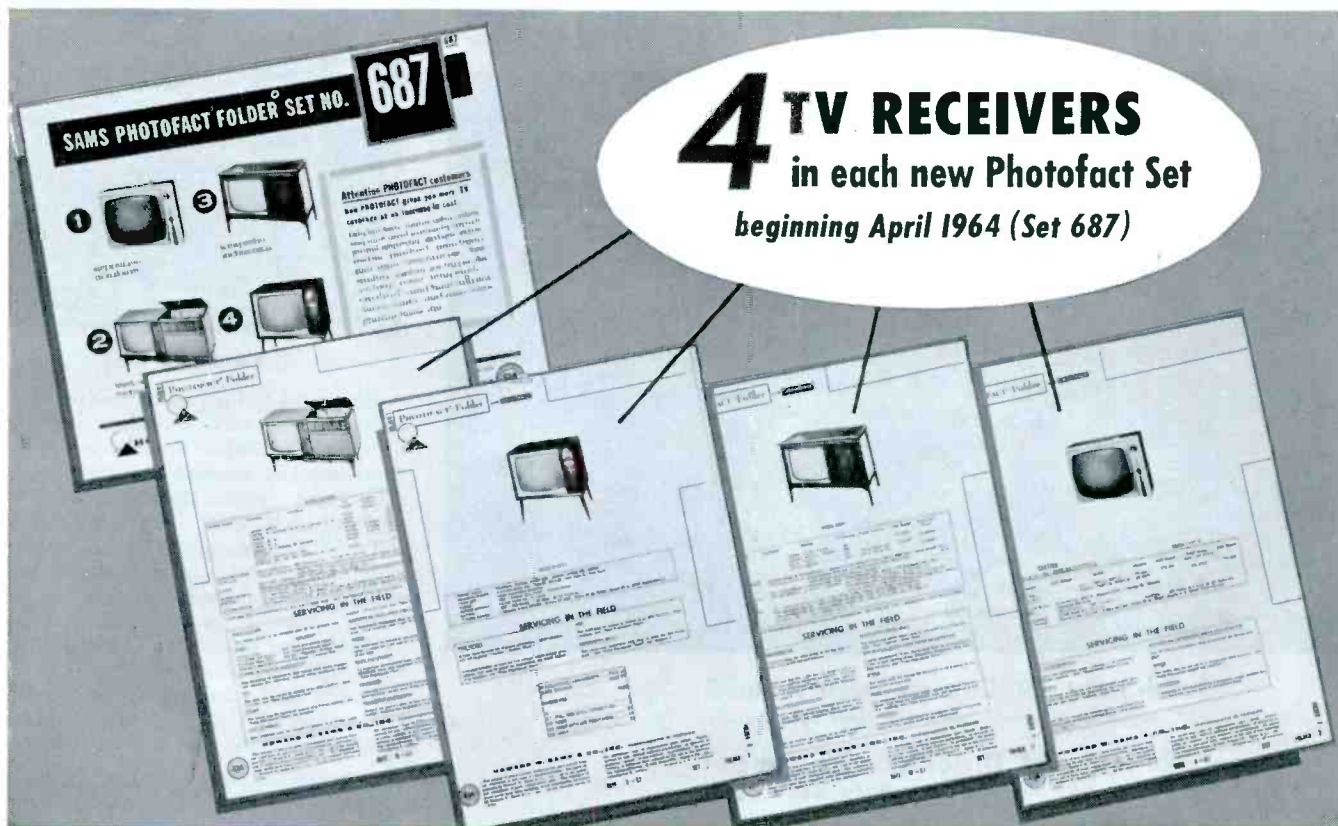

keep up-to-the-minute—at no increase in cost!

Now—PHOTOFACT gives you MORE and quicker-than-ever TV service data coverage (plus coverage of the kind of equipment you most frequently repair—AM, FM, Phono, Hi-Fi and Stereo). It's a bigger value than ever!

You get these famous PHOTOFACT time-saving, troubleshooting aids to help you earn more daily: Exclusive Standard Notation Schematics, packed with the service details you need; full photo coverage

of all chassis views; complete replacement parts lists; tube placement diagrams; actual waveform photos; CircuiTrace® for printed boards; alternate tuner data; disassembly instructions; field servicing tips—dozens of other great time-saving features.

Take the right step to fast, money-making service work—be sure you have PHOTOFACT at your fingertips when you need it. Sign up now for a money-saving Standing Order Subscription!

SEE YOUR SAMS DISTRIBUTOR AND SUBSCRIBE TODAY—OR SEND ORDER FORM BELOW

**LIMITED
INTRODUCTORY OFFER
FOR NEW
SUBSCRIBERS**



HALF-PRICE CABINET OFFER EXPIRES JUNE 30, 1964

Sign up for a PHOTOFACT Subscription for at least six months, and get this all-steel file cabinet valued at \$9.95 for only \$5.00! Remember, too, with a Standing Order Subscription you pay only \$1.95 per Set instead of the regular \$2.25 price. You save 30¢ per Set!

HOWARD W. SAMS & CO., INC.

HOWARD W. SAMS & CO., INC., Dept. PFF-5
4300 W. 62nd St., Indianapolis 6, Indiana

- Enter my subscription to PHOTOFACT effective with Set. No. _____ Month _____
- I enclose \$5 for the single-drawer cabinet at half price. I agree to keep this subscription for at least six months. Place my subscription with my Sams Distributor, who is:

(Distributor must be specified)

Name _____

Address _____

City _____ Zone _____ State _____

Signature _____

Coming in the June SPECIAL TRANSISTOR ISSUE

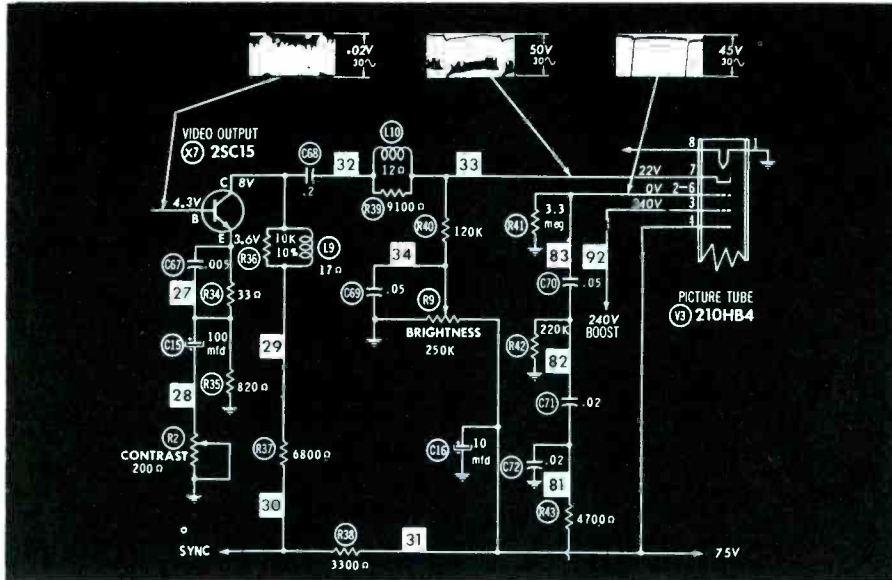

Solid-State TV Circuits from A to Z

... explains modern circuits and their operation.

Techniques of Distortion-Chasing

... gives quick and sure methods for locating defects.

Me? Do Transistor Servicing?

... tips on getting into the business.

Guide to Importers

... a comprehensive and current list of foreign-made transistor radios and tape recorders, including brand names, suppliers, and addresses.

PLUS:

Testing Transistors—The Modern Way

Symfact coverage of transistor AGC circuit

Notes on Test Equipment

... and others

Get Free Premium Books With Subscription

Enter my subscription to PF REPORTER and send me free book(s) checked.

3 Years \$10.00 2 Years \$8.00 1 Year \$5.00

- The Troubleshooter's Handbook No. 2
- Servicing Industrial Electronics
- Servicing TV from Tuner to Picture Tube

Check one for each year you subscribe

Bill Me

Remittance Enclosed

Extend Present Subscription

Take this coupon to your distributor, or mail to:

Howard W. Sams & Co., Inc.

4300 W. 62nd St., Indianapolis, Ind. 46206

Name _____

Firm _____

Address _____

City _____ Zone _____ State _____

Please Check Your Business Classification

- Independent Radio, TV Serviceman
- Retailer with Service Department
- Industrial Electronics Service
- Other (Specify occupation and title)
- Owner, Mgr.
- Service Mgr.
- Employee

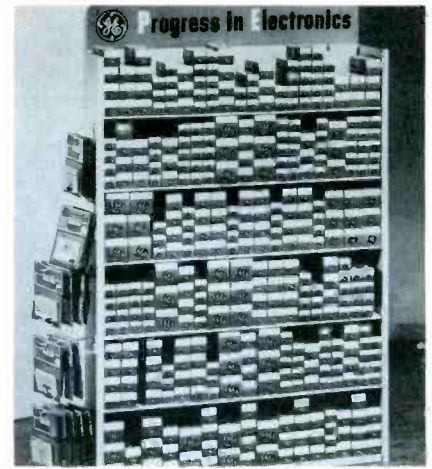

Tube Shelf (76)

A new tube-and-parts cabinet for radio and television service dealers and technicians is available through authorized distributors of General Electric receiving tubes and semiconductors. With six shelves, each 6½" deep, this cabinet (ETR-3803) measures 25" x 40", and can easily be wall-mounted using slotted holes in the back. An extra feature is the peg-board hanger holes on the sides which facilitate merchandising card-packaged semiconductors or other parts. The cabinet will hold more than 650 receiving tubes. Assembly is easy; parts snap into place without the use of nuts and bolts.



All-Cartridge Stereo Head (77)

A quarter-track stereo record/play head that will accept all cartridges now on the market is new from Michigan Magnetics, Inc. The head, which has a rear stud mount, has an impedance rate ranging from a high of 500 mhy to a low of 90 mhy. Available with metal or bakelite face, the O9P17 is offered with or without mounting hardware.



Single-Sideband CB Unit (78)

Two simultaneous conversations on the same channel by two separate stations without mutual interference are possible if both stations are equipped with the

Mark Products SSB-27 "Sidewinder" transceiver. This feat is made possible by utilizing the upper sideband as one channel and the lower sideband as another. In this manner, 46 channels are possible within the present 23 Citizens-band channels. A thermostatically controlled oven maintains constant crystal temperature. A four-section crystal-lattice filter rejects adjacent-channel interference and increases signal-to-noise ratio. The Mark SSB-27 is supplied with one crystal for operation on the upper and lower sidebands of channel 3. It operates on 11-15 volts DC, measures 5 1/4" x 12" x 11", and is priced at \$229.50.

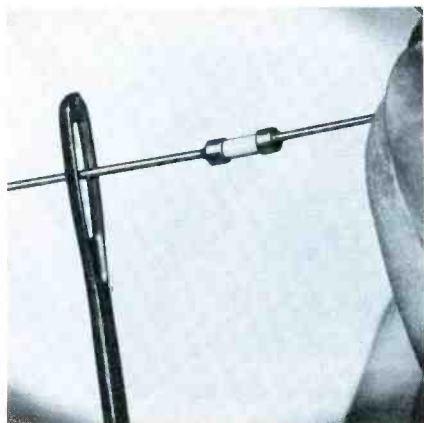

Picofuse (79)

Tiny fuses only .078" in diameter and 7/32" long, and having ratings up to 5 amps with an interrupting capacity of 300 amps at 130 volts DC, are available from **Littelfuse, Inc.** Five of the new cartridge-shaped fuses weigh only one gram. The fuses are available with 2 styles of leads—axial and radial—or they can fit into diode-type mountings.



The Big Sound (80)

An 18" woofer with response down to 16 cps has been developed by **Hartley Products Co.** The 218MS speaker, featuring a mammoth 14 lb. magnet, a cast aluminum frame, and a patented tripolymer plastic cone, utilizes the Hartley magnetic suspension principle. Magnetic restoration employs a positive force for eliminating speaker hangover, resulting in improved transient response and lowered distortion. The speaker sells through hi-fi dealers at \$195.00.

NEW

SECO TUBE TESTER Model 98

GUARANTEED TO GIVE ALL MODERN TV TUBES, RADIO TUBES AND FILAMENT RECTIFIERS A COMPREHENSIVE ANALYSIS . . .

checks heater current on series string tubes



A SECO PLUS! Replaceable socket chassis plugs into metering chassis. Can be economically replaced as it wears out or becomes obsolete. Available with special sockets upon request. Guaranteed up-to-date for all modern receiving tubes including novars, nuvistors, 10-pin types, compactrons and MAGNOVALS.

GRID CIRCUIT TEST detects faults such as grid emission, leakage and shorts—a rapid, reliable multiple-check developed and patented by Seco.

TUBE MERIT TEST indicates functioning ability of a tube by the quality of cathode emission.

HEATER CURRENT TEST reads on meter. Relies on heater resistance to show cold operation or improper voltage distribution in a series string of heaters.

SECO SELECTRO SYSTEM isolates or transposes tube circuits and controls test current—achieves laboratory precision and flexibility with dial-switch ease and speed.

See Model 98 Booth 3112
Exhibition Hall May Parts
Show, Hilton Hotel,
Chicago, May 18-20

NEW SECO MODEL 98

ONLY **\$99.50** NET

This new test instrument is a complete tube tester that locates all tube faults quickly and accurately. It has a two-stage DC amplifier which isolates the rugged 1 ma meter from the tube under test, protecting the meter and permitting a wide range of load currents and test conditions. The new Model 98 tests more than 2500 different tubes. The entire unit is contained in a compact case with removable cover. The cover holds speed-indexed tube data cards, pin straighteners and condensed operating instructions. For complete information see your electronic supply dealer or write to Seco.



SECO ELECTRONICS, INC.

1221 S. Clover Drive, Minneapolis 20, Minn.

A DIVISION OF DI-ACRO CORPORATION
Circle 63 on literature card



Be a wise owl!

How to save time, increase profit with Admiral antennas!



Simplified for easier installation . . . priced for bigger profits! All Admiral antenna kits are designed to help you increase outdoor antenna sales and installations. New "All-Snap" assembly overcomes customer complaints of slow installation and high cost.

Each kit is prepacked in its own carton with all the necessary hardware. There's nothing more to buy! No need to have extra hardware lying around your shop—or in your service vehicle.

You can sell every antenna need with conical, in-line, yagi, uhf, and new parabolic styles. Many are available with gold anodizing for custom installations.

And the remarkable Admiral price gives you bigger profits from the expanding antenna market.

Call your Admiral Distributor today . . . start saving installation time, pocketing new profits tomorrow.

Be wise . . . standardize on

ADMIRAL® "ALL-SNAP" ASSEMBLY ANTENNAS

Always Precision Crafted Quality



Let's Communicate (81)

The "Courier 1M" CB transceiver by **Electronics Communications Inc.** features a triple-conversion receiver with a sensitivity of better than .25 uv and a selectivity of 4000 cps at 6-db points. The receiver has an RF gain control and an AVC circuit which controls both the IF and RF stages. The transmitter, which is limited to a power input of 5 watts, is capable of delivering more than 3 watts output into any 50- or 75-ohm unbalanced load. Using a high-impedance microphone input, the unit features high-level plate modulation and a frequency stability of $\pm .005\%$. A relative-power output meter, an "S" meter, and a frequency-spotter circuit are standard equipment. The unit operates from 110 volts AC or 12 volts DC.



Meter Protection (82)

A novel device called "Metergard," used to prevent meter-movement burnout by overloads of up to 10,000%, is built by **Lectrotech, Inc.** "Metergard" offsets both the high cost of repairing burned-out meter movements and the inconvenience of doing without the meter. The "Metergard" is not a fuse, has no moving parts, and will cause less than 1/4% change in movement accuracy. Installation is extremely simple: merely connect it across the movement terminals.

Combination Microphone-Headset (83)

A dynamic headset-microphone combination featuring a frequency response of 30-20,000 cps is a new product of **Telex, Inc.** This headset, of stainless steel construction, is rust-proof, tamper-proof, and serviceable. Foam rubber or vinyl-polyurethane foam cushions of deep-cavity design provide an acoustic seal, and are removable for washing. The headset can be worn in comfort over glasses without destroying the acoustic seal between ear cup and head. Complete



with cord, the entire unit weighs only 15 oz. and has a yoke which provides 180° cup rotation for perfect fit with single-ear monitoring.



Rotator-Booster (84)

The "Gemini," an antenna rotator mounted with a TV-signal booster, is a new innovation of **Channel Master Corp.** Both units are housed in a corrosion-proof case that mounts on the antenna mast, and are protected against moisture.

ATTENTION COMMUNITY ANTENNA TV TECHNICIANS

Move up in the field of CATV
Technical Management.

Several positions of Chief
Technician now open with
large multiple-systems
owner.

QUALIFICATIONS:

- . . . Experience in CATV maintenance
- . . . Capable of supervising technical staff
- . . . Knowledge of TV and RF circuits essential
- . . . Willing to relocate

Liberal salary plus benefits.
Reply in confidence giving
complete resume, salary re-
quirements to PF Reporter,
Dept. 101.

A built-in coupler in the control unit allows as many as four sets to be played simultaneously.



Work Magnifier (85)

A magnifying glass that produces excellent magnification over 48 square inches, is a new product of **Ednalite Research Corp.** Mounted on rotating pivots for

individual or group viewing, this 6" x 8" glass yields a flat field with enough depth of focus that hands, tools, and chassis are all visible without distortion.



Lightweight Speakers (86)

A new series of speakers using barium ferrite magnets is being introduced by **Utah Electronics**. Altogether, there are nine models with magnet weights ranging from 3 to 10 oz; for the best possible bond, the magnetic assemblies are joined with RF-cured epoxy.

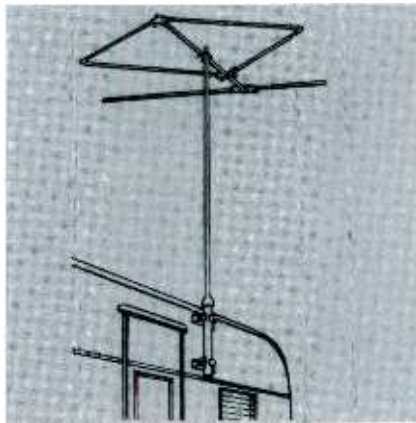

Traveling Antenna (87)

A TV antenna kit designed for quick mounting and dismantling on mobile homes is a new product of **Clear Beam Antenna Corp.** Designated the Model JR150, the antenna supplied with the kit is capable of both UHF and VHF reception. ▲



"You sure this is the right address?"



Be a wise owl!

How to simplify installation, increase profit on all-channel UHF converters!



Model UC100A. Modern, 2-tone design with brushed gold knobs.

Improved for greater reliability . . . priced for greater profits! New Admiral UHF Converters use a 2-speed ball-bearing planetary drive for easy single-knob channel selection. Trouble free 3-gang tuning provides years of dependable service.

The latest nuvistor I.F. amplifier circuits give power to spare. Even fringe area reception can be clearer with added picture power. We've tested all makes—here's the best!

Installation is easy, too. Use just a screwdriver to connect the antenna lead and 300 ohm lead to any TV set.

And the remarkable Admiral price makes your "profit picture" look better than ever before.

Economy model UC100B also available . . . contact your Admiral Distributor now . . . start pocketing bigger profits right away!

Be wise . . . standardize on

ADMIRAL® ALL-CHANNEL UHF CONVERTERS

Always Precision Crafted Quality
Circle 64 on literature card

May, 1964/PF REPORTER 95

INDEX TO ADVERTISERS

ATR Electronics, Inc.	12
Admiral Sales Corp.	94, 95
Aerovox Corp.	79
Arco Electronics, Inc.	45
B & K Mfg. Co.	59, 67
Div. of Dynascan Corp.	
Berns Mfg. Co., Inc., The	60
Blonder-Tongue Labs	83
Bussmann Mfg. Div.	20, 21
Castle TV Tuner Service	14
Channellock, Inc.	58
Charles Engineering, Inc.	60
Cleveland Institute of Electronics	87
Colman Electronic Products	88
Cornell-Dubilier Electric Corp.	24
Delco Radio Div.	89
Dymo Industries, Inc.	62
EICO Electronic Instrument Co., Inc.	73
Electro Products Labs	86
Electro-Voice, Inc.	84
Finney Co.	71
GC Electronics Co.	13
General Electric Co.	18, 19
Grantham Schools, Inc.	48
Hallmark Instruments	75
Hi-Lo Antenna Corp.	40
ITT Distributor Products Div.	15
JFD Electronics Corp.	16, 17
Jerrold Electronics	Cover 2, 94
Kinematix, Inc.	65
L. A. Tuner Exchange	40
Littelfuse, Inc.	Cover 4
Mallory, P. R. & Co., Inc.	61
Merit Coil & Transformer Corp.	85
Miller, J. W. Co.	52
Nortronics Co., Inc., The	12
Oaktron Industries, Inc.	60
Ohmite Mfg. Co.	82
Oxford Transducer Co.	42
Planet Sales Corp.	72
Precision Tuner Service	72
Quam-Nichols Co.	80
Quietrol Co.	74
RCA Electronic Components and Devices	57, 69, Cover 3
RCA Parts and Accessories	63
Raytheon Co.	39
Sams, Howard W. & Co., Inc.	44, 84, 91
Sarkes Tarzian, Inc. Semiconductor Div.	77
Tuner Service	9
Seco Electronics, Inc.	93
SENGORE, Inc.	29, 41, 43, 47, 51, 53
Sonotone Corp.	68
Sprague Electric Co.	10
Sylvania Electric Products, Inc.	55
TV Factbook	81
Terado Corp.	74
Texas Crystals	72
Trio Mfg. Co.	54
Triplet Electrical Instrument Co.	64
Ungar Electric Tools	50
University Loudspeakers, Inc.	49
Winegard Co.	22, 23, 80
Workman Electronic Products, Inc.	48
Yeats Appliance Dolly Sales Co., Inc.	88



FREE Catalog and Literature Service

*Check "Index to Advertisers" for further information from these companies.

Please allow 60 to 90 days for delivery.

ANTENNAS & ACCESSORIES

88. **ALLIANCE**—Brochure describing *Tenna-Rotor* C-225.
89. **ALL CHANNEL PRODUCTS**—New catalog showing complete line of *Rembrandt* indoor antennas for VHF-UHF TV and FM stereo.
90. **ANTENNACRAFT**—Catalog sheet, illustrated in color, with information on connecting a UHF and a VHF antenna together using intercoupler G1483W.
91. **CHANNEL MASTER**—Brochure sheet describing gold medal *FM Rondo* antenna for stereo reception.
92. **CORNELL-DUBILIER**—Copy of informative booklet titled "Improved TV and FM reception." Bulletin describing line of antenna rotor systems.*
93. **FINNEY**—Brochures showing newly introduced line of amateur beam antennas for 1 1/4-, 2-, and 6-meter bands; includes information on combination unit for 2 and 6 meters.*
94. **JFD**—Specifications and operating information on *Transis-tenna* and newly designed, long-range LPV log-periodic TV antennas. Illustrated brochure showing entire line of indoor antennas and accessories for TV and FM. Data sheets on UHF antennas.*
95. **MOSLEY ELECTRONICS**—Illustrated catalog giving specifications and features on large line of antennas for Citizens band, amateur, and TV applications.
96. **STANDARD KOLLSMAN**—Brochure describing new UHF converter kit; built-in type designed to fit most existing VHF-only receivers.
97. **TRIO**—Illustrated sheets showing line of antennas for TV and FM reception; also includes information on *Color-Brite* line of UHF antennas for color reception.*
98. **WINEGARD**—Factfinder sheet No. 220, giving details on two-tube TV-FM booster coupler, Model BC208.*
99. **ZENITH**—Informative bulletin on new line of log-periodic vee-type antennas for FM, and monochrome and color TV.

AUDIO & HI-FI

100. **ATLAS SOUND**—New 1964 catalog No. 564 contains illustrations and specifications on PA speakers, microphone stands for commercial and industrial installations, and other new products.
101. **DUOTONE**—Catalog listing line of phonograph needles.
102. **GIBBS SPECIAL PRODUCTS**—Folders describing principles of sound reverberation and *Stereo-Verb* reverberation units for automobiles.
103. **MILLER**—Product sheet on AM broadcast tuner kit using germanium diodes.*
104. **OXFORD TRANSDUCER**—Product information bulletins describing complete line of loudspeakers for all types of sound applications; including replacements for public address and intercom systems.*
105. **PERMA-POWER**—Catalog sheet on *Diplomat*; a complete sound system in an attache case.
106. **QUAM-NICHOLS**—Brochures listing speakers used in 1955 through 1963 vintage automobiles; both front and rear seat types.
107. **SONOTONE**—4-page brochure describing three new phono cartridges.*
108. **SWITCHCRAFT**—Product bulletin No. 139 on new *Hi-D Jaz* line of phone connectors for uses with all 1/4" plugs.

COMMUNICATIONS

109. **CADRE**—Catalog sheet on complete line of Citizens band radios.
110. **GENERAL RADIOTELEPHONE**—Brochures describing two-way radio systems for all types of applications.

111. **PEARCE-SIMPSON**—Specification brochures on *Companion II* and *Escort* Citizens band transceivers.
112. **COMMUNICATIONS CO.**—Specifications brochure describing *Comco* Model 684 UHF-FM two-way radio.

COMPONENTS

113. **BUSSMANN**—Bulletin SBCU on Buss Fustat Box Cover Units offers simple, low-cost way to protect workbench tools, soldering irons, drills, and the like against damage and burnout. Units fit standard outlet or switch boxes; have fuseholder, plus a plug-in receptacle, switch, and pilot light.*
114. **GC ELECTRONICS**—24-page supplement No. FR-65-S listing newly introduced products.*
115. **RCA BATTERIES**—Brochure No. 1P1162, illustrating various selection of counter merchandiser display racks and promotional items on radio batteries.*
116. **ROBINS INDUSTRIES**—Condensed catalog No. 19C on all types of tape splicers and accessories.
117. **SPRAGUE**—Latest catalog C-615 with complete listings of all stock parts for TV and radio replacement use, as well as *Transfarad* and *Tel-Ohmike* capacitor analyzers.*
118. **STACO**—8-page condensed catalog on line of variable voltage transformers for all types of electronic applications.
119. **TRIAD**—Brochures on newly introduced replacement transformers for hi-fi and stereo amplifiers.
120. **WALDOM**—Wall chart on line of quick-disconnect devices for electronic wiring applications.
121. **WORKMAN**—Cross-reference charts on antenna coils, transistors, and circuit breakers; general replacement catalog No. 102.*

SERVICE AIDS

122. **CASTLE**—How to get fast overhaul service on all makes and models of television tuners is described in leaflet. Shipping instructions, labels, and tags are also included.*
123. **EQUIPTO**—16-page "Idea Book" of steel storage equipment and related items; including shelving, bins, benches, etc.
124. **PRECISION TUNER**—Literature supplying information on complete, low-cost repair and alignment services for any TV tuner.*
125. **RAWN CO.**—Product sheet and instruction bulletin gives description and uses for *Plas-T-Pair* kit; permits quick, sure repair of all types of plastic material—knobs, cabinets, etc.
126. **WILCO**—Brochures describing, and giving uses for hand cleaner, plastic cleaner, and scratch removing compounds.
127. **YEATS**—The new "back-saving" appliance dolly Model 7 is featured in a four-page booklet describing feather-weight aluminum construction.*

SPECIAL EQUIPMENT

128. **AMPROBE**—Brochures describing new series of AC ammeter chart recorders.
129. **ACME ELECTRIC**—Complete specifications and applications for control-type magnetic amplifiers with capacities from 5-1000 watts and voltage ranges from 24-160 volts.
130. **ATR**—Descriptive literature on selling new, all-transistor *Karadio*, Model 707, having retail price of \$29.95. Other literature on complete line of DC-AC inverters for operating 117-volt PA systems and other electronics gear.*

131. **GREYHOUND**—The complete story of the speed, convenience, and special service provided by the Greyhound Package Express method of shipping, with rates and routes.
132. **TENATRONICS**—Product sheet describing Model SM-751 AM-FM auto radio for installation in domestic and foreign cars.
133. **TERADO**—Bulletin on *CinePower* No. 25 portable power pack; designed for field operation of 60-cycle equipment.*
134. **VOLKSWAGEN**—Large, 60-page illustrated booklet "The Owner's Viewpoint" describes how various VW trucks can be used to save time and money in business enterprises; includes complete specifications on line of trucks.

TECHNICAL PUBLICATIONS

135. **CLEVELAND INSTITUTE OF ELECTRONICS**—"Pocket Electronics Data Guides" with handy conversion factors, formulas, tables, and color codes. Additional folder, "Choose Your Career in Electronics," describes home-study electronics training programs, including preparation for FCC-license exam.*
136. **HOWARD W. SAMS**—Literature describing popular and informative publications on radio and TV servicing, communications, audio, hi-fi, and industrial electronics; including special new 1964 catalog of technical books on every phase of electronics.*

TEST EQUIPMENT

137. **B & K**—Catalog AP-21R describing uses for and specifications of new Model 1074 Television Analyst, Model 1076 Television Analyst, Model 850 Color Generator, Model 960 Transistor Radio Analyst, new Model 445 CRT Tester-Rejuvenator, new Model 250 Substitution Master, Model 375 *Dynamatic* VTVM, Model 360 *V-O-Matic VOM*, Models 700 and 600 *Dyna-Quik* Tube Testers, and Model 1070 *Dyna-Sweep* Circuit Analyzer.*
138. **EICO**—New 32-page, 1964 catalog of test instruments, hi-fi components, tape recorders, Citizens band, and amateur radio equipment.*
139. **HICKOK**—Complete descriptive and specification information on newly introduced equipment—Model 662 installer's color generator; Model 580 portable tube tester; Model 727 multiplex generator; Model 235A portable field strength meter.
140. **JACKSON**—Complete catalog describing all types of electronic test equipment for servicing and other applications.
141. **MERCURY**—Description and specification brochures on Model 900 Color TV Analyzer.
142. **SECO**—8-page brochure giving specifications and prices for Models 88, 98, and 107-B tube testers.*
143. **SENCORE**—Question-and-answer bulletin on new Model MX-129 *Multiplex Analyzer*, and Model CR-128 Picture Tube Tester-Rejuvenator.*
144. **SIMPSON**—Latest series of VOM's are described in test-equipment bulletin; also information on line of automotive test equipment.
145. **TRIPLETT**—Brand new test equipment catalog No. 45-T, listing complete line of testers and accessories.*

TOOLS

146. **ACME LITE**—Descriptive bulletin on line of *Magniflex* fluorescent lamps.
147. **ARROW FASTENER**—Leaflets describing Model T-18, T-25, and T-75 tackers for speeding cable and wire installations. Illustrations show methods and models used for various wire thicknesses.
148. **BURNS**—Data on unique 3-in-1 picture-tube repair tools, on *Audio Pin-Plug Crimper* that enables technician to make solderless plug and ground connections, and on new-style *ION* adjustable "beam bender" for CRT's.*
149. **ENTERPRISE DEVELOPMENT**—Time saving techniques in brochure from *Endeco* demonstrate improved desoldering and resoldering techniques for speeding up and simplifying operations on PC boards.
150. **LUXO LAMP**—Catalog on line of "touch-and-stay-put" lamps.

TUBES & SEMICONDUCTORS

151. **SEMITRONICS**—New updated 16" x 20" wall chart CH10 lists replacements and interchangeability for transistors and diodes.



**Keep Inventories Low!
Save Time and Money!
Speed Up Repairs!**

NOW, WITH ONLY 10 RCA "TOP-OF-THE-LINE" TRANSISTORS YOU CAN REPLACE OVER 1900 ENTERTAINMENT TYPES

RCA's ten new "Top-of-the-Line" transistors can solve nearly every transistor replacement problem you will encounter in your servicing of phonographs, tape recorders, battery-operated portable radios, auto radios, and other entertainment-type equipment.

With an inventory of only 10 types, the RCA SK-Series transistors can quickly, easily, and economically provide you with hundreds of replacements—over 1900 in all, including many types of foreign manufacture.

For example, if you are active in the servicing of auto radios, you will find that just three types, the SK-3008, SK-3009 and SK-3012, will speed up repairs by providing you with replacements for virtually every transistor type used in auto radios.

RCA Type

SK-3003
SK-3004
SK-3005
SK-3006
SK-3007
SK-3008
SK-3009
SK-3010
SK-3011
SK-3012

Application

SK-3003 pnp type, AF Driver and Output Stages (9 V Supply)
SK-3004 pnp type, AF Driver and Output Stages (15 V Supply)
SK-3005 pnp type, RF, IF, and Converter Stages of Broadcast Receivers
SK-3006 pnp type, RF, IF, and Converter Stages of FM and AM/FM Receivers
SK-3007 pnp type, RF, IF, and Converter Stages of All-Wave Receivers
SK-3008 pnp types, RF, IF, and Converter Stages of Auto Radios
SK-3009 pnp type, Audio Output Stages of Auto Radios
SK-3010 npn type, AF Driver and Output Stages of Broadcast Receivers
SK-3011 npn type, RF, IF, and Converter Stages of Broadcast Receivers
SK-3012 pnp type, Audio Output Stages of Auto Radios

Ask your RCA Distributor for your copy of the new RCA replacement wall chart. It lists in alphabetical-numerical order the more than 1900 types which the 10 RCA SK-Type Transistors can replace.

RCA Electronic Components and Devices, Harrison, N. J.



The Most Trusted Name in Electronics

WORLD'S smallest FUSE

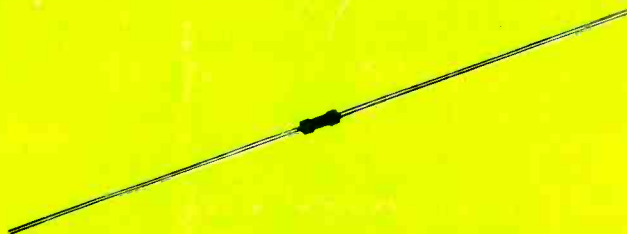

THE picoFUSE

Shown actual size.
1/8, 1/4, 3/8, 1/2, 3/4, 1, 1-1/2, 2, 3, 4,
and 5 amp. @ 125 volts. Interrupting
capacity 300 amps DC at 130 volts.
Color-coded to identify amperage
rating.

Blowing characteristics:

100%—4 hours minimum
200%—5 seconds maximum

LITTELFUSE

DES PLAINES, ILLINOIS

Circle 65 on literature card