

JANUARY, 1962

35 CENTS



PHOTOFACT

# RF REPORTER

including **Electronic Servicing**



Replacement Parts  
for  
Transistor Radios

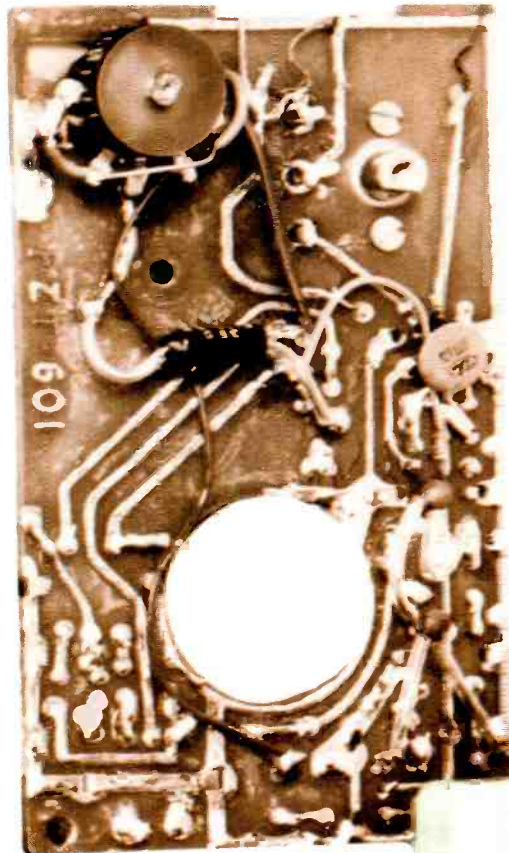
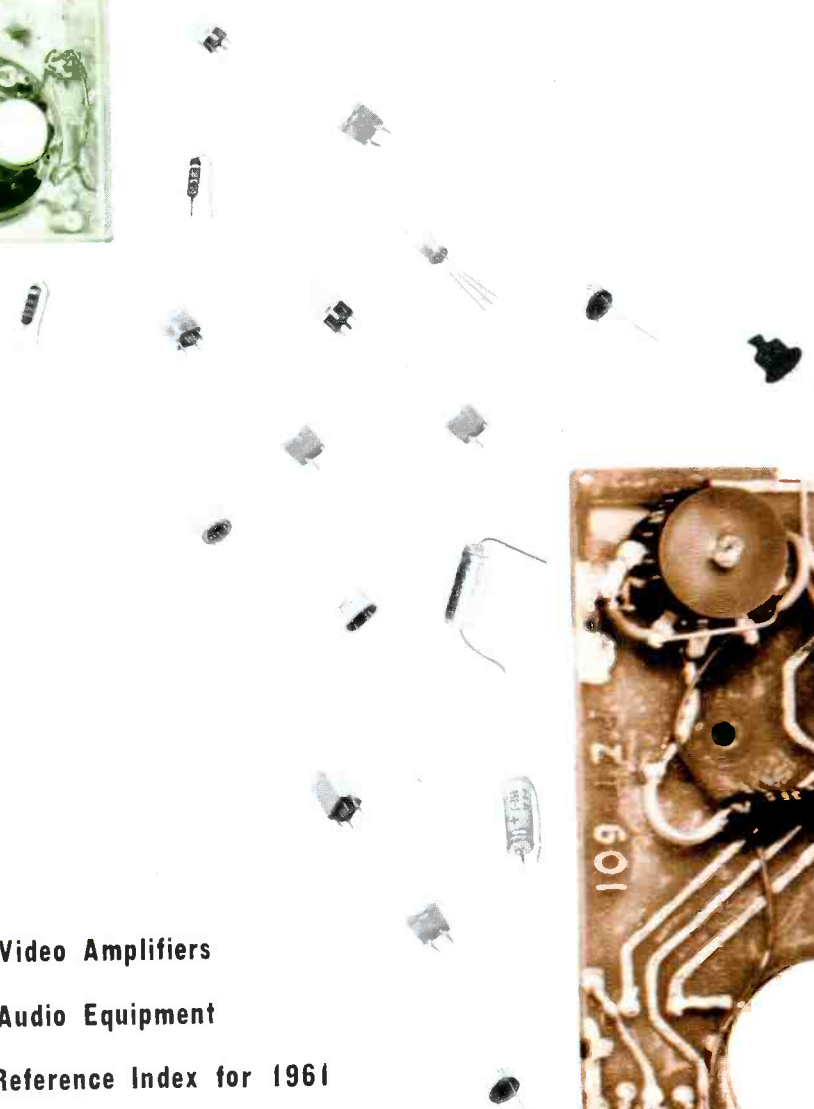

Checking Up on Video Amplifiers  
Hum-Hunting in Audio Equipment  
Annual Subject Reference Index for 1961  
Plus 8 Page Bonus Section . . .  
Vertical Sweep Troubleshooting From A to Z

IA 9K 1923 193  
ROBERT G. WALRAVEN  
803 HEUSS AVE.  
SCHOFIELD, WISC.

**Servicemen everywhere are saying:**

**T-BIRD**

**ELECTRA**

**brings in sharp**

**pictures where other electronic antennas fail**

It stands to reason that TACO would produce, in the T-BIRD ELECTRA, the world's best electronic antenna. Only TACO gives you the combination of the most rugged, highest-performance antennas plus the finest in antenna-mounted transistorized preamplifiers (designed by Jerrold).

So, with the T-BIRD ELECTRA you assure customer satisfaction, even in severest "problem" areas. Rigid chrome-alloy aluminum elements and

contacts eliminate the antenna "friction noise" and "signal flutter" inherent in some so-called "high-gain" antennas. There's a T-BIRD ELECTRA for every TV/FM home need, priced from \$79.75. And it's completely pre-assembled for your convenience.

Only TACO offers custom area-engineering on electronic antennas to help you solve any type of signal problem. For these special services, see your TACO distributor.

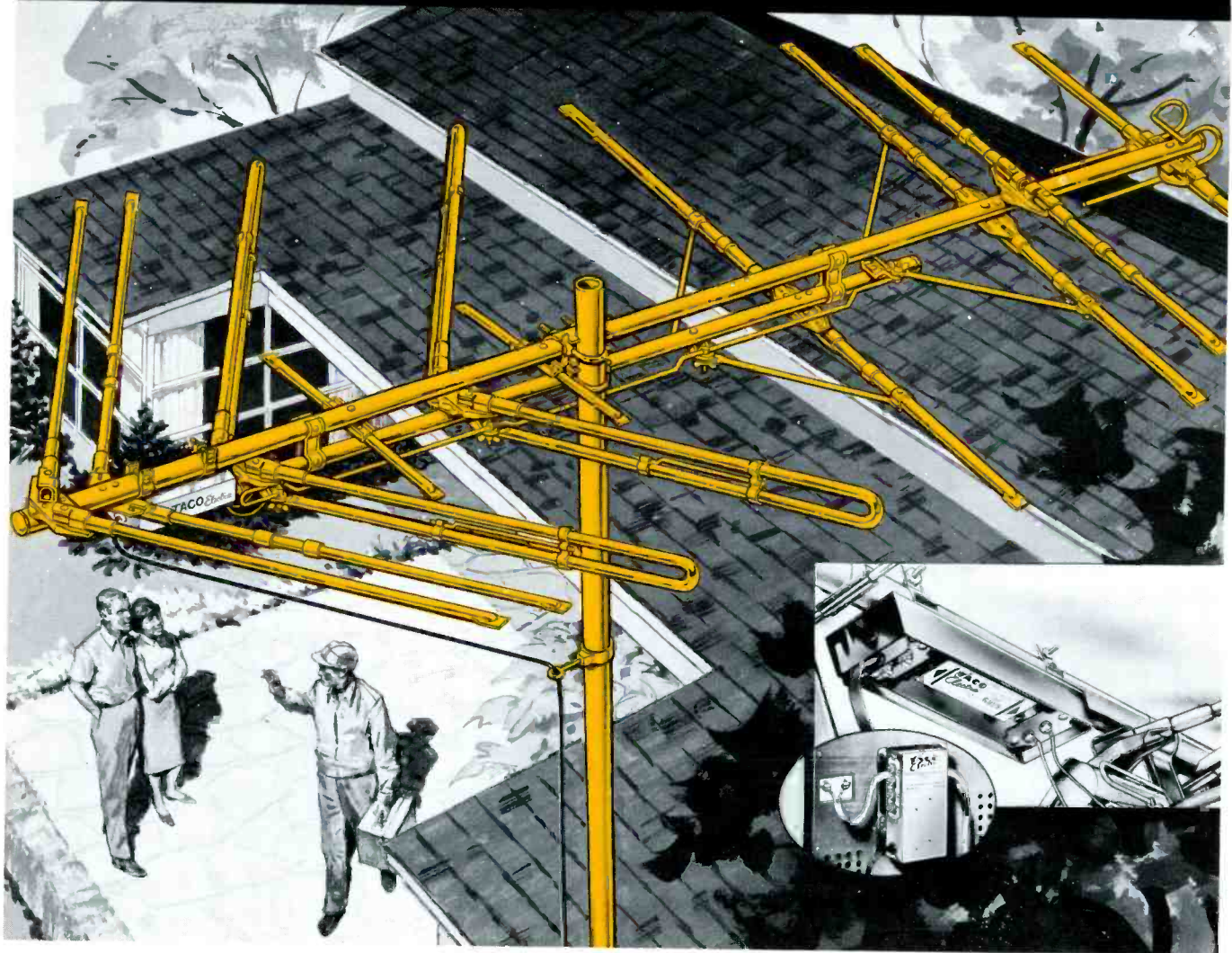

**TACO**

**TECHNICAL APPLIANCE CORPORATION**

Distributor Sales Division • Dept. JTD-14, Sherburne, New York  
A Subsidiary of Jerrold Electronics Corporation

Many troubleshooting problems in vertical sweep circuits are the result of unfamiliarity with circuit operation. Every vertical sweep system must perform the same function; it must sweep the CRT beam from top to bottom of the screen in a specified length of time, snap it back to the top very quickly, and again sweep it to the bottom. This cycle must be repeated continuously and unchangeably all the time the set is in operation. In addition, this sequence must begin at a particular instant, initiated by the television station.

# VERTICAL SWEEP

## Troubleshooting from A to Z

# VERTICAL SWEEP

### Four Circuits, Eight Sections

There are only four basic vertical sweep circuits in use. These are: (1) A multivibrator stage in which half the multivibrator serves also as the vertical output stage, (2) a multivibrator circuit which drives a separate output circuit, (3) a blocking oscillator stage driving an output tube, and (4) a combination circuit which uses one beam-power pentode as both oscillator and output stage. There are several variations on these circuits, but each falls into one of the basic categories. Let's see how these four systems differ from one another, and develop an efficient way to analyze and troubleshoot them.

What makes one vertical sweep system different from another? There are eight sections of the circuit which we can classify and examine. These elements will prove to be the eight keys to troubleshooting vertical sweep problems. You will see presently how every symptom of vertical trouble can be related to some portion of the circuit. Meanwhile, let's enumerate the sections and then discuss their importance in the system. They are:

1. Oscillator circuit
2. Output circuit
3. Height-control circuit
4. Linearity-control circuit
5. Hold-control circuit
6. Sync input point
7. DC supply source
8. Auxiliary circuits (such as retrace blanking)

The oscillator circuit includes the basic oscillator configuration, the feedback network, and the frequency-determining circuit. The vertical output circuit provides amplification for the sweep voltage, usually shapes the waveform, and couples it to the deflection coils. To adjust circuit operation, the vertical height and linearity controls affect the amplitude and shape of the waveform applied to the deflection yoke; but since they differ in their method of control, you should note their location in each circuit.

The hold control is a part of the frequency-determining circuit of every vertical oscillator. It functions in various ways; it may be part of the feedback network, or it may control operating voltages. However, its purpose is always the same.

The sync pulses which are received with the station signal must be applied to the oscillator. Their purpose is to determine the exact instant the beam begins its sweep. The nature of the sync input will often determine your troubleshooting procedure in the vertical system, so note how and where it takes place.

DC operating voltages for the tubes come from either of two sources: the low-voltage power supply, or the boost circuit. It is often necessary, when troubleshooting the vertical sweep system, to consider which supply is used for each section of the circuit.

Most vertical sweep circuits provide some means of eliminating retrace lines from the screen of the CRT. You must not overlook the effect a fault in this circuit might have on the sweep system.

### Circuits Versus Symptoms

We are going to analyze the more common vertical

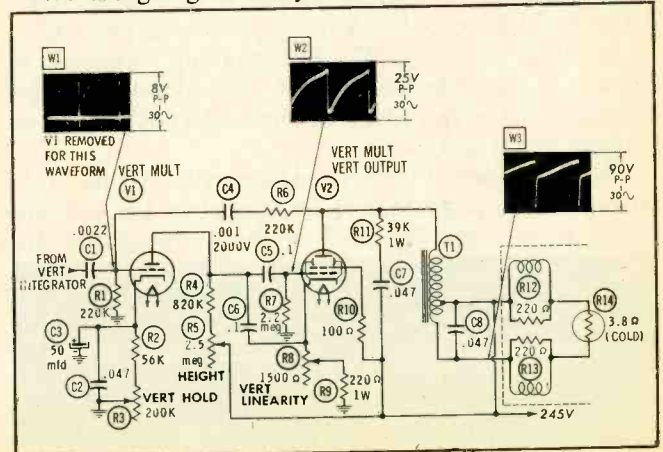

Fig. 1. Portion of multivibrator is output stage.

## SPIKE OVERCOMES INDUCTANCE OF DEFLECTION COILS

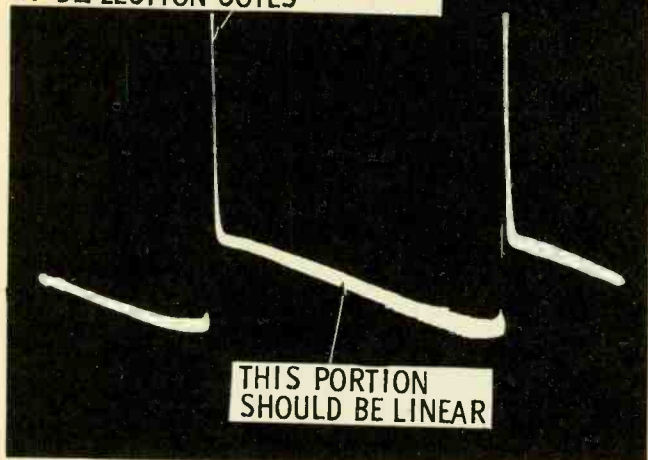

Fig. 2. Trapezoid waveform applied to yoke coils.

sweep circuits. Then you will see how troubleshooting a vertical system can be simplified by a method of relating each trouble symptom to a portion of the circuit.

Fig. 1 shows a typical multivibrator-output circuit; this is probably the most common vertical sweep circuit in use today. It has a number of variations, but each incorporates the basic features of the circuit shown here.

The oscillator consists of V1 and V2, connected as a plate-coupled multivibrator. The variation of plate voltage in V1 is coupled to the grid of V2 by capacitor C5. This signal is amplified by V2, and a portion of the output is fed back to the grid of V1 via capacitor C4. In V1 it is amplified again, and the cycle repeats itself.

The output circuit in Fig. 1 consists of pentode V2, output transformer T1, and the deflection yoke. The beam-power pentode provides power amplification to drive the sweep coils, as well as the voltage to be fed back to the first half of the multivibrator. Any tube capable of furnishing this power can function as an output stage; indeed, some circuits use a dual triode for the entire sweep system. We shall presently examine such a circuit.

The output stage provides the trapezoidal waveform (Fig. 2) needed to drive the deflection yoke. The inductance of the yoke must be overcome rapidly to prevent the sweep from being somewhat sluggish at the start of each cycle; for this purpose, the sawtooth waveform furnished by the multivibrator is modified into the required trapezoidal shape by a network (R11-C7) in the plate circuit of V2. The resulting waveform is coupled to the deflection yoke by transformer T1. The current in the yoke coils then causes the CRT beam to perform its vertical sweep.

The hold-control circuit, which controls the frequency of the multivibrator, is located in the cathode circuit of V1, the first half of the multivibrator. Its

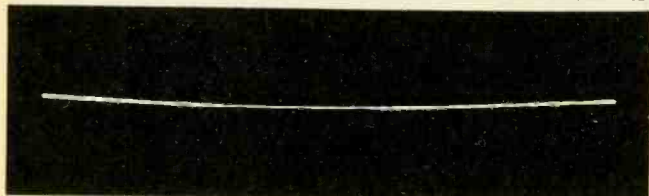

Fig. 3. Thin line denotes lack of vertical sweep.

function is to adjust the bias on tube V1, which sets the exact point at which the tube starts to conduct. If the bias is lessened, the tube can begin conducting sooner, and the multivibrator frequency will increase; on the other hand, an increase in bias will lower the frequency.

The frequency is also controlled by the time constant of the charge-discharge circuits. In Fig. 1, R1, R6, and C4 form the charging network for V1. In the grid circuit of V2, both C5 and R7 affect the rate of the multivibrator.

Vertical height is controlled by adjusting the voltage fed to the plate of V1. Increased plate voltage increases the height, and a decrease has the opposite effect. Linearity is adjusted by varying the bias on the grid of V2; this is done with adjustable cathode resistor R8. R9 prevents complete elimination of the bias, which might damage the tube.

Sync pulses which control the multivibrator in Fig. 1 are fed into the circuit by C1. The multivibrator remains cut off until the positive-going sync pulse reaches the grid of V1; then V1 fires, and one cycle of vertical sweep takes place. This action is repeated for each succeeding cycle, at a rate of 60 times per second.

Plate and screen voltages for V1 and V2 are all furnished by the same source, the 245-volt low-voltage power supply.

Now you understand how the vertical sweep system is divided into sections for analysis. The next step is to relate trouble symptoms to the sections most affected. This is the basis for the troubleshooting procedures we shall discuss.

### Four Trouble Symptoms

Vertical sweep troubles are grouped into four general complaints. The first is no sweep at all, characterized by a thin white line across the face of the screen, or at most, only a strip an inch or two wide. (See Fig. 3.) This indicates there is little or no sweep current flowing in the deflection coils. The cause could be in any of several sections of the circuit, as we shall see presently.

Second on our list of vertical sweep troubles is lack of height, as in Fig. 4. The customer describes this symptom as, "All the people are short and fat!" This complaint signifies that for some reason the deflection coils are not receiving sufficient current to sweep the CRT beam all the way to the top or bottom of the screen.

Sometimes you hear the complaint, "The actors' heads are flat," or "The heads are pointed and the legs are short." This means that the current waveform being fed through the deflection coils is not linear; that is, one portion of the sweep is taking place faster (or slower) than the remainder. The raster lines in that portion are spread apart (or squeezed together) more than the rest, resulting in a picture that looks like Fig. 5A or 5B.

The final vertical sweep symptom is often called "rolling", since it gives an observer the impression that the picture is rolling up or down, or "flipping"—see Fig. 6A. This complaint is the result of an off-frequency oscillator. If the oscillator frequency fails to coincide exactly with the vertical scan rate of a received station, the vertical blanking bar can be seen, along with the picture, moving up or down the screen. If the frequency

should become extremely slow, it would be possible to obtain a "locked-in" multiple picture such as seen in Fig. 6B.

### Troubleshooting Multivibrator Systems

Now that we have classified the common symptoms, we are prepared to relate them to the circuits in Fig. 1, and determine the most likely causes of various defects. This approach will simplify the troubleshooting of any vertical deflection system, as you will see when we consider other circuit configurations.

#### No Vertical Sweep

Suppose you are faced with the symptom of no vertical deflection. The trouble really could be anywhere in the circuit, since anything which prevents sweep current from reaching the deflection coils will create this symptom. Look at Fig. 1, and try to pick the most likely causes. Of course, removal of the 245-volt supply from any portion of the circuit will result in complete failure of the sweep system, so if your practice is to begin troubleshooting with a voltmeter, here is the place to start.

You also may want to unlimber the oscilloscope and quickly take a few waveform measurements, since you'll probably need them anyway. The waveforms you can expect are shown in Fig. 1. A check of waveform W2 at the grid of V2 will offer a quick indication as to whether or not the multivibrator is operating. If not, W3 will also be conspicuous by its absence.

Voltage measurements at the cathode and plate of V1 will show any malfunctions such as might be caused by an open R4, R5, R2, or R3. Trouble in the grid circuit will usually be reflected in the voltages developed in the plate and cathode circuits.

If you suspect trouble in the output section, voltmeter measurements at V2 will help isolate the fault. However, be certain you don't connect the voltmeter to the plate of V2 unless you're sure the multivibrator isn't working, since the high pulse voltages normally developed at this point might possibly damage the meter movement. To check the continuity of transformer T1, remove V2 temporarily from its socket and measure the voltage at the plate of V2. Otherwise, the transformer must be disconnected and measured with an ohmmeter,

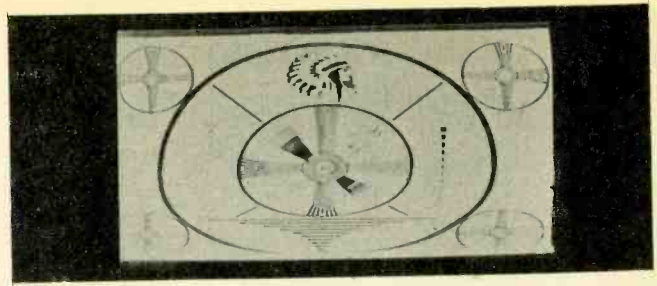

Fig. 4. Shrunken picture from insufficient sweep.

a more time-consuming method.

The deflection coils and thermistor R14 are best checked with your ohmmeter. First disconnect one yoke lead from transformer T1 so as to prevent false readings due to the shunting effect of the transformer winding.

One other possible cause of the "no sweep" symptom is an open feedback network (either C4 or R6 could be open). Slight voltage changes will result from the lack of oscillation, but since cathode bias is used for both tubes, the changes will be quite small. Therefore, if you find nearly normal voltages, but no multivibrator action, try substituting for C4 and R6.

#### Lack of Height

The next symptom, according to our classification, is insufficient vertical sweep. What parts determine the amplitude of the waveform which is fed to the deflection coils? Naturally, the most obvious possibilities are R4 and height control R5. We assume you are, of course, trying to adjust the height control (at the same time resetting the linearity control if necessary) but are unable to obtain enough drive to fill the screen.

In Fig. 1, the height control adjusts the plate voltage of V1, controlling the tube amplification and the amplitude of waveform W2. The amplification of output tube V2 is held constant in spite of the linearity control in the cathode circuit. This stabilization is accomplished by C6, which applies a portion of waveform W2 to the cathode. The degeneration is controlled — along with the bias — by R8. Therefore, R8 has little effect on the height of output waveform W3; its effect is on the linearity.

Since plate voltage is important to the operation of the circuits, be very sure the power supply is furnishing

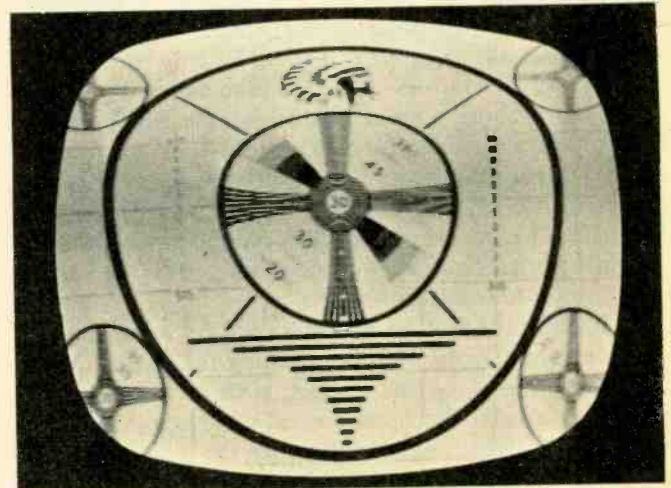
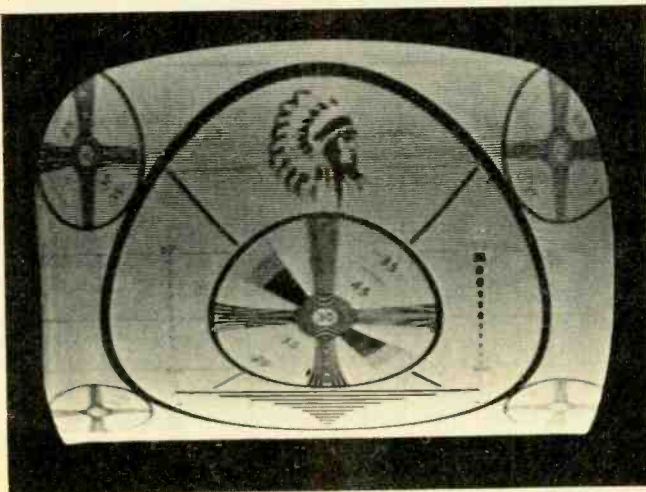
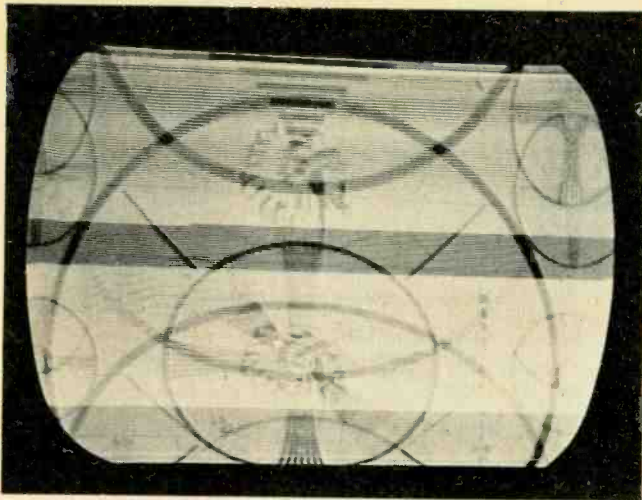
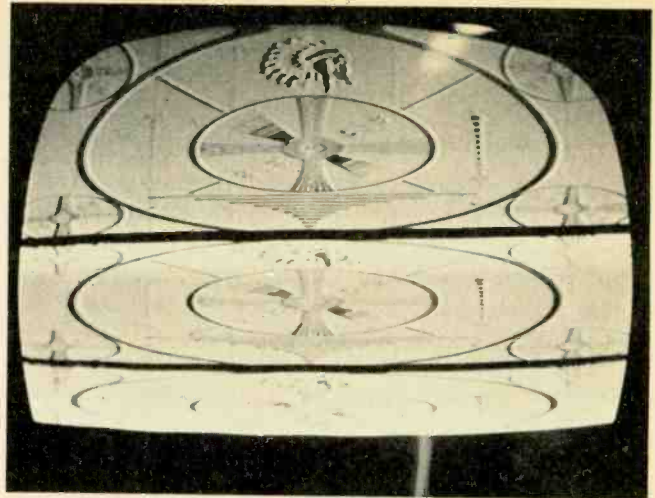

Fig. 5. Linearity can affect either top or bottom.

PF REPORTER for January 1962, Vol. 12 No. 1. PF REPORTER is published monthly by Howard W. Sams & Co., Inc., 2201 E. 46th St., Indianapolis 6, Indiana. Second-class postage paid at Indianapolis, Indiana. 1, 2 & 3 year subscription prices: U.S.A., its possessions, and Canada: \$4.00, \$7.00, \$9.00. All other countries: \$5.00, \$9.00, \$12.00. Current single issues 35c each; back issues 50c each.



(A) "Rolling" due to slight frequency error.



(B) Multiple pictures—far off frequency.

Fig. 6. Two symptoms of off-frequency operation.

the indicated 245 volts. Next, be certain that the necessary voltages are reaching the plate of V1 and the plate and screen of V2. These circuit paths are easily seen, and you will recognize R4 and R5 as the path to V1, while R10 and T1 provide the path to V2.

You should remember that plate and screen supply voltages can be lowered by leaky capacitors as well as open resistors. Therefore, you will want to check the possibility of leakage in capacitors such as C4, C5, and C6.

One possible cause for lack of height is the ability (or lack of it) of each stage to amplify. For instance, an open C3 will cause degeneration in V1 and a lowered amplitude for waveform W2. (The accompanying effect on vertical-multivibrator frequency may have been counteracted merely by readjusting the hold control.) In transformer T1, shorted turns (or a leaky C8 across the winding) can cause a lowered output waveform W3 and insufficient drive to the vertical deflection coils. An off-value C5 could contribute to a lack of height by altering the amount of signal coupled to V2.

#### Poor Linearity

From these analyses of symptoms as related to circuit functions, you can see how a knowledge of circuit action helps you determine which portion of the circuit may be at fault. For instance, a complaint of nonlinear vertical sweep will point to the output stage. This is not because you have learned some lengthy theory concerning transfer curves and load-inductance characteristics, but because a quick analysis of the circuit layout shows you that linearity is controlled in the output stage. Varying the bias of the output stage adjusts the characteristics of V2 for best operation with its particular load. The linearity control is needed because these operating conditions vary from tube to tube and from transformer to transformer.

If linearity cannot be made normal by adjusting the control, some circuit fault is upsetting the output stage. Resistor R9 is a logical suspect, since a change in its value would alter the operation of V2. Here, again, T1 may have a defect which will cause the load to be abnormal, and the tube would become nonlinear in an effort to overcome the effects of the unusual load.

#### Rolling

"Rolling," or off-frequency operation, probably

causes more technicians to tear their hair than any other problem in vertical circuits. However, you can start once again by looking for the most obvious cause — in this case, the hold-control circuit. In Fig. 1, R3 controls the frequency of the multivibrator by varying the cathode bias of V1. This sets the point at which each cycle starts. Any change in value of R3, R2, C3 or C2 will influence the frequency because of their effect on V1.

In addition to the hold control, you will remember there are other components in this multivibrator which affect its operating frequency. Therefore, any consideration of frequency changes must necessarily include these components. Resistors R6, R1, and R7 affect the natural frequency of the multivibrator, as do capacitors C4 and C5, since all are part of charge-discharge networks.

When considering this symptom, you must decide whether the rolling is caused by the vertical oscillator or by the sync circuits. To determine which, you can try either of two approaches: You can disable the oscillator and check the waveform W1 from the vertical integrator, or you can disconnect the sync input at C1 and try to adjust the oscillator to its proper frequency (using hold control R3). Either method will show you which section of the receiver is creating the problem.

#### Variations

As mentioned earlier, there are variations of each basic vertical sweep circuit. Fig. 7 shows one variation of the circuit we have just analyzed. For example, the multifunction output tube is a triode, and is contained in the same envelope with the first half of the multivibrator. The transformer, rather than being a tapped autoformer type, is a simple impedance-matching unit feeding a thermistor-controlled deflection yoke. The hold control is in the grid circuit of V1A, and the vertical-linearity control is common to the grid circuits of both V1A and V1B. Only the height control in Fig. 7 is in the same location as in Fig. 1 — in the plate circuit of V1A. The feedback network is much more elaborate; in this case, it contributes to the final wave-shape. This network consists of C1, R7, C2, R8, C3, and R13.

Another important difference in Fig. 7 concerns the power-supply voltages, which are taken from three

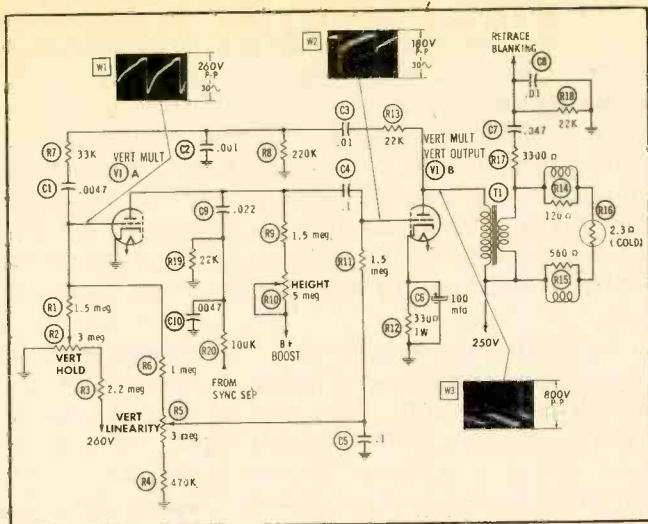

Fig. 7. Multivibrator-output stage uses two tubes.

sources. Bias for the first multivibrator section, and plate voltage for the output section, are obtained from taps on the low-voltage power supply. But plate voltage for V1A is boost voltage from the horizontal sweep circuit. This is important when you are troubleshooting this circuit, as you will see.

Confronted with no sweep from this circuit, you will probably check the supply voltages with your voltmeter. If these are normal, a scope will help you find out if any part of the multivibrator is functioning. After localizing the trouble in this manner, you can check specific points in much the same manner as outlined for the previous circuit.

If the multivibrator is not functioning, measure the plate and grid voltages of V1A. The cathode of V1B is not grounded, and so must be checked for proper voltage. Any discrepancy in these measured voltages must be tracked down to its source.

Tracing trouble in the feedback network presents something of a problem. If a thorough check of the multivibrator circuit leads you to believe that the feedback system is the source of trouble, a simple, quick procedure is to measure each resistance with your ohmmeter, and then try substituting each capacitor. You may feel this to be the easy way out, and you're right! But, after all, your job is to find the trouble in the shortest possible time and repair it. If substituting a suspected part is the simplest test of the part, then by all means do it that way. This has proven to be a practical troubleshooting method for feedback networks, especially a complex RC system such as used in Fig. 7.

If lack of vertical drive (height) is the problem, you can investigate the most likely causes for a lack of amplification — either lowered voltages or degeneration in the circuit. An open C6 or C5 might cause degeneration; lowered plate voltage on either tube will lower amplification. Since height control R10 affects the amplitude of the vertical sweep, the most logical starting point is in the plate circuit which is supplied through R10.

Don't forget, however, that a trouble such as a leaky C4 may cause lack of height. C4 is connected between the plate of V1A and the grid of V1B. Inspection of the circuit shows that R5, the vertical linearity control, is also connected to this grid. So you see, any fault

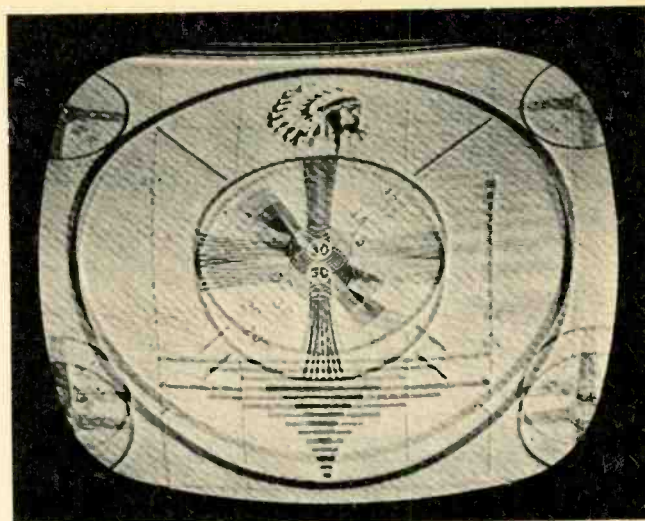

Fig. 8. Combination of symptoms could be misleading.

which causes abnormal bias on V1B — such as a leaky C4 — will affect the linearity. Therefore, at the same time C4 is causing lack of height (by lowering plate voltage on V1A), it is also upsetting linearity in V1B.

This demonstrates two important points: One, you must evaluate the symptoms carefully to be sure you are considering all the pertinent factors, and two, you should analyze the circuit carefully to be sure you are looking in the right place for the fault. These two points can save much valuable troubleshooting time.

Poor linearity of the sweep waveform will, in this configuration, be due to some defect in the grid circuit of V1B. Since this is a triode output tube, the grid has more direct control over linearity of operation than the cathode. (This rule would be reversed for a pentode.) Therefore, the bias is adjusted by voltage-divider network R4, R5, and R6. The minimum bias is determined by cathode resistor R12, and the range of adjustment is kept within certain limits by R4 in the divider network. Changes in value of any of these resistors can cause considerable nonlinearity in the waveform (W3) fed to the deflection coils.

As usual, off-frequency operation is a bit more elusive, but your new system of analysis puts the answer at your fingertips relatively easily. The vertical hold control R2 in Fig. 7 adjusts the frequency by controlling the bias on the grid of V1A. Off-value resistors R1 or R3 can shift the frequency as easily as control R2. If R4, R5, or R6 change value, however, nonlinearity would be noted along with the "rolling," as in Fig. 8. Once again, noting *all* the symptoms helps isolate the defect to only a few possible components.

Portions of the feedback system will affect the multivibrator frequency. R8, C2, C3, and R13 are primarily waveshaping components; but C1 and R7 have a definite effect on frequency of oscillation, since they are closer to the grid of V1A. In the coupling circuit between V1A and V1B, C4 and R11 will affect the rate of the multivibrator.

As with all vertical oscillators, "rolling" cannot be discussed without considering the possibility of vertical sync troubles. Sync pulses are fed into this circuit at the plate of V1A, through capacitor C9. C4 couples them to V1B, which amplifies them and returns them through

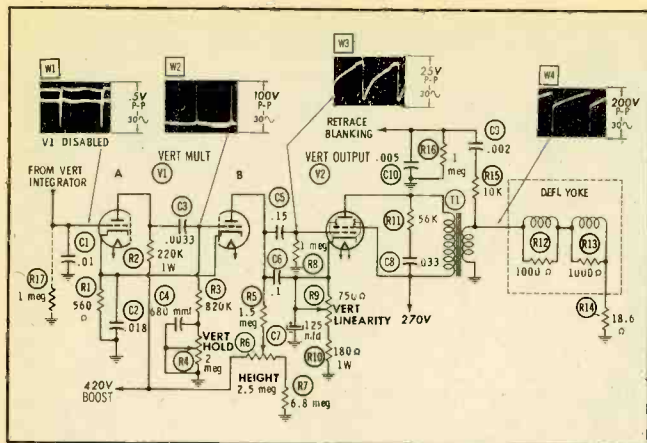

Fig. 9. Separate multivibrator and output stages.

the feedback network to the grid of V1A. Here they override the bias, triggering the multivibrator at the proper time. In this way, the vertical sweep is kept in step with the pulses provided by the station signal. So, before troubleshooting the vertical oscillator for "rolling," be sure the cause is not a sync fault.

Take note of auxiliary circuits which depend on the vertical sweep circuits for their operation — for example, the retrace-blanking network in Fig. 7. Why? Just suppose C7 develops a short. Output waveform W3 will be bypassed to ground through the relatively low impedance of R17, R18, and C8, reducing its amplitude considerably. In addition, the 250-volt source will find a path through the secondary of T1, R17, and R18; the very minimum effect of this will be DC flowing in the transformer and deflection coils, upsetting the circuit waveforms even further. At worst, R17 and R18 might be damaged by overload, and perhaps even cause troubles in other sections of the receiver. So never discount the possibility of faults in circuits which are external to the vertical system.

#### Another Multivibrator

Some vertical sweep systems use the circuit in Fig. 9. Using the analysis method, you can classify this system as a cathode-coupled multivibrator driving a pentode output tube. The deflection-coil coupling is via an impedance-matching transformer.

Now, look at this circuit as it should appear to you for troubleshooting. First examine the possible causes of no sweep. The circuit has two DC voltage sources, the boost B+ from the horizontal circuits and 270 volts from the low-voltage power supply; the boost voltage supplies both plates of multivibrator V1, while the 270-volt supply furnishes plate and screen voltages to the output stage. Failure of either voltage at its source will result in no vertical sweep. Discontinuity in any component feeding these voltages to the plates can also cause failure of the sweep system. An open R2 disables V1A, an open R6 or R5 stops the functioning of V1B, and an open primary winding on T1 proves fatal to the operation of V2.

Feedback to sustain oscillation in the multivibrator is accomplished by a common-cathode connection of the two stages, so there are no complicated networks to troubleshoot. Instead, you must simply be certain that the values of R1 and C2 are correct, and that C1 and C3 are performing their jobs. If any of these components develop serious faults, oscillation in the multi-

vibrator will stop.

Of course, the usual possibilities exist in the output circuit; a defective transformer, open or shorted coils in the deflection yoke, or an open R14 will affect the signal voltages, resulting in a lack of vertical sweep. Besides this, an open coupling capacitor C5 can keep the signal from being fed to the grid of V2. To determine which of these possibilities is the culprit, you can use your scope to advantage, checking the waveforms at various points from the multivibrator to the deflection coils.

To analyze the symptom of "not enough vertical sweep," you can begin by noting the location of the vertical height control. R6 is part of divider network R6-R7 across the 420-volt boost supply. A drop in boost voltage or a change of value in R7, R6, or R5 will affect the plate voltage of V1B, lowering the amplitude of waveform W2. The result will be insufficient sweep voltage applied to the deflection coils.

Vertical linearity, as you remember, is usually regulated in the output stage; the circuit in Fig. 9 is no exception. R9 controls the bias applied to V2, within limits set by R10. A defect in either resistor or in capacitor C7 will almost invariably result in nonlinear operation. Other faults which might affect linearity are defective capacitors C5 or C6, as leakage in either of these will alter the bias on V2.

The vertical hold control is an important part of the frequency-determining network in this circuit. C3, C4, R3, and R4 comprise the grid-discharge or time-constant network for the grid of multivibrator V1B. In addition, feedback network R1-C2 has a pronounced effect on the oscillation rate. This vertical multivibrator is simpler to troubleshoot than those with complicated feedback networks, provided you maintain an analytical approach to each symptom.

The sync input to this circuit is uncomplicated, with pulses being applied to the first multivibrator grid. The DC grid return R17 is, in fact, part of the vertical integrator network, and C1 helps the integrator to shape a uniform control pulse for the oscillator. If it becomes necessary to disable the sync input to this stage, you must go back into the integrator to disconnect the sync, since R17 is necessary to the operation of the vertical multivibrator.

#### Blocking Oscillators

Fig. 10 shows a different form of vertical oscillator. This is a blocking oscillator—perhaps the most simple, straightforward circuit in use. It is still being incorporated in some new sets, since it can be combined with the output stage in one dual-triode. The blocking-oscillator output is easily shaped to the desired waveform for the deflection yoke.

The output stage in Fig. 10 is conventional; but the transformer is slightly different from any we have discussed. It is an autotransformer, with the deflection coils connected across a small portion of the winding to provide the correct impedance match for the output tube. A portion of the winding provides the retrace-blanking pulse for the CRT circuits.

Analysis of symptoms in this circuit is not difficult. Lack of sweep can result from the usual causes: The oscillator might stop; C4 might open and keep the



waveform from being developed in the grid of V2; or the output circuit could develop some defect such as an open R9, an open or shorted T2, or even an open deflection coil.

Inspection shows that the DC source for both stages is the 560-volt boost line, and any defect in the boost circuit will affect the vertical sweep system. Several components form the plate-supply path to V1, and failure in any of these can stop the blocking oscillator. The blocking-oscillator action depends on the feedback pulse which is coupled from plate to grid by transformer T1 so as to sustain oscillation. Any fault which prevents this function, such as a defective T1, shorted C2, open R1, or open R2, will stop the oscillator. Your ohmmeter will help pinpoint the fault in a very short time. Certain defects in T1 may best be determined by substitution, but most of them can be found by ohmmeter measurements.

As evidenced by the location of height control R8, insufficient height will result if waveform W2 applied to the output stage has insufficient amplitude. This circuit differs from the others we've discussed in that the height control is not in the plate circuit of the oscillator. Of course, the reason for a loss of height can sometimes be traced to the oscillator stage. Any fault which lowers the amplitude of waveform W2 may be the culprit — lowered plate voltage on V1, a short in waveshaping network R7-C3, or an open or change of value in capacitor C4.

Linearity troubles will naturally lead you to the output stage in your hunt for a faulty component. Capacitor C5, resistor R9, and linearity control R10 are the most likely suspects. Transformer T2 deserves its share of suspicion, but trouble in T2 will also be accompanied by lack of height — once more a tale of two symptoms.

For "rolling," you must again determine if the sync pulses are changing the frequency of the blocking oscillator. Disabling the sync input at the vertical integrator will let you see if the oscillator will "run free" at a nearly correct rate. If not, you must decide which components determine the oscillator frequency. The location of the vertical hold control furnishes a clue; the frequency is decided in the feedback arrangement of V1. This includes transformer T1 and its associated components R3 and C2, the hold control R2, and sync-input network C1-R1-R13. Of all these components, R13 will have the least effect on vertical frequency. If the transformer is suspected of altering the oscillator rate, substitution is the only sure way of finding out; even slight changes in characteristics are sufficient to cause faulty operation.

#### B-O Variation

Fig. 11 depicts a variation of the blocking-oscillator vertical sweep system. V1 is incorporated in a Hartley-type oscillator circuit feeding a very conventional triode output stage. Feedback takes place within the transformer, which is common to both the grid and cathode circuits. The operating voltages in this circuit cause the operation to be somewhat different from the usual Hartley oscillator; you can consider this to be a pulsed Hartley oscillator. The pulse, of course, is vertical sync from the integrator network. The output waveform of this oscillator stage is more difficult to shape into the desired waveform W2 for amplification in the output

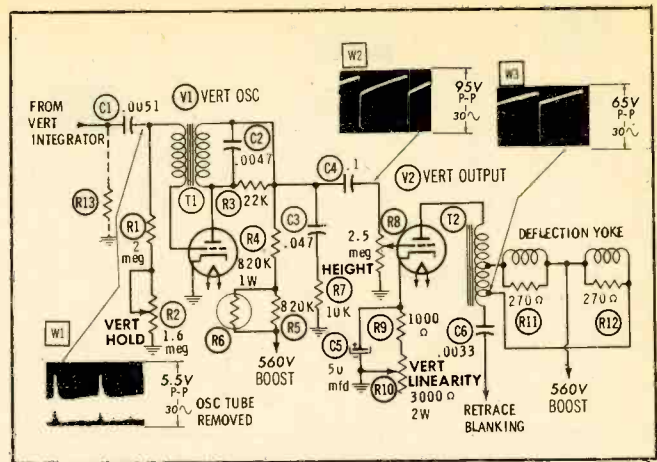

Fig. 10. Blocking oscillator drives output stage.

stage, hence the more complex waveshaping network R6-C4-C5.

This circuit is so similar to Fig. 10 that only the frequency-determining components differ. The remainder of the system is much the same, up to and including the deflection yoke.

Frequency in the vertical oscillator V1 is controlled primarily by the time constant of C1-R1-C2 in conjunction with hold control R2. Measuring R1 and R2 with an ohmmeter, and substituting C1 and C2, is the most rapid method of troubleshooting a frequency problem which might exist in this stage. Of course, there is the possibility that trouble in the sync circuits may cause the "rolling" symptom, but disconnecting the sync input will quickly indicate if this is the case.

#### All-in-One Circuits

The combination circuit in Fig. 12 brings together the functions of oscillator and output circuits in one stage. This is perfectly feasible, provided the oscillator can generate enough output of the proper waveshape to drive the deflection coils. These standards are fulfilled by the circuit shown.

Due to the unusual nature of this circuit, you'll find it helpful to analyze some of its operating characteristics before attempting to troubleshoot any malfunctions. When you start to visualize the trouble symptoms in this circuit, you will then see that the same troubleshooting principles apply as with the other vertical sweep systems we have discussed.

First consider the circuit as an oscillator. Part of the feedback is obtained by feeding a portion of the plate-voltage variation through C5 to R11. This introduces a 90° phase shift, which is then shifted another 90° by C4, R10 and R9. The signal is now in proper phase to add to signal variations at the grid, causing oscillation within the circuit.

Some additional feedback is provided by winding 3-4 on transformer T1, and is applied to the screen grid of V1. This feedback serves another purpose. Since it is applied to the screen, it controls tube conduction and assists in shaping the waveform for application to the deflection coils.

The output circuit also utilizes V1. Additional waveshaping takes place because of R10 in the feedback network. Transformer T1 matches the tube's output impedance to the lower impedance of the deflection-yoke coils.

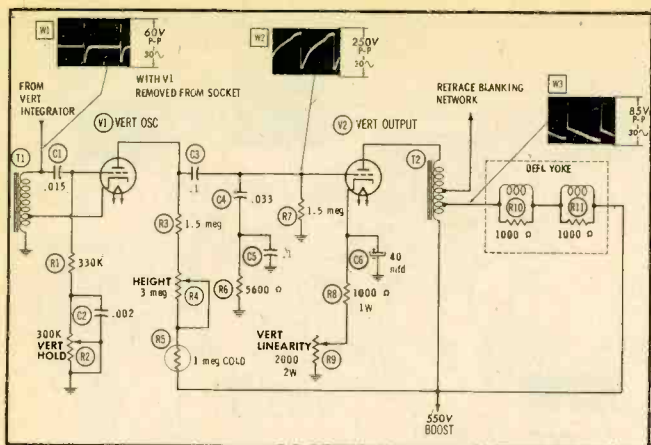

Fig. 11. A different form of blocking oscillator.

Following our analysis as before, next examine the hold circuit. Hold control R6 combines with R8, R7, and R5 to form a voltage divider across the 155-volt power supply. Grid bias is applied to V1 through R9 and R12. You will note that control R6 and resistors R8 and R9 are also a part of the feedback network from the plate of V1. By adjusting both the phase shift of the feedback and the amplification of tube V1, R6 controls the frequency of oscillation.

The height circuit is unusual in some respects. R3 adjusts the amount of 155-volt, B+ which will be applied to the screen of V1 through R4, R2, and winding 3-4 of transformer T1. This adjusts the amplification of V1, and controls the amplitude of waveform W2 which is applied to the deflection coils.

Linearity control R12 is in the grid circuit of V1. By controlling the amount of grid current which will flow, it establishes operating conditions for the tube.

Note that all three controls will interact more than in any other circuit we have discussed. When servicing this vertical sweep system, you will have to use care in the adjustment of these controls. A procedure which will result in the quickest adjustment of the entire stage is as follows: Adjust the hold control for a stable picture. Then adjust the height control, which will have little effect on the vertical hold. Adjusting the linearity will affect the other controls to some extent, so after a slight adjustment of linearity, readjust the hold and height controls in that order. Proceed in this 1-2-3 manner, and you will have very good results in a minimum time.

After this circuit analysis, the symptoms will present

you with few problems. Lack of vertical sweep may be the most difficult symptom to troubleshoot in a circuit like this, so here are a few suggestions. First, with a voltmeter, ascertain that each of the supply voltages is reaching V1. Check the voltage-divider networks to see that they are performing as intended. This will pinpoint any troubles in power-supply paths and locate most resistor troubles. Troubles in capacitors such as C4 or C5 can be most easily isolated by substituting known good components. Troubles (which did not show up in voltage checks) in C6, C2, or C3 will be easily located by bridging each with a part having equivalent ratings. This leaves only the deflection coils and the output-transformer secondary, both of which can be checked with your ohmmeter.

This entire troubleshooting procedure takes only a matter of minutes, proving the value of a systematic approach. You can save even more time in troubleshooting such symptoms as lack of height, poor linearity, or off-frequency operation, if you will use the method of looking first for trouble in circuits which are directly concerned with the specific symptoms.

For example, in Fig. 12 the symptom of "rolling" might be caused by lack of sync pulses. If a scope shows pulses at the input (junction of R1, R2, and C2), they have to be coupled to the screen of the oscillator-amplifier tube by winding 3-4 of T1. If they are not, winding 3-4 may be somehow at fault. And if sync is not the problem, a check of the hold-circuit and frequency-control networks will reveal the cause of the trouble.

In a good troubleshooting procedure, you cannot overlook the possibility of troubles outside the vertical circuit, which may have direct effects on vertical sweep operation. We discussed such things as retrace-blanking networks and the effect of poor sync. But when servicing vertical systems, you must consider other possibilities such as lowered boost-circuit voltages and low B+. System analysis applies as usual; if the section which is affected takes its power from the low-voltage supply, it is obviously incorrect to consider boost troubles.

Certain vertical output systems derive bias for their operation from external sources such as a video- or horizontal-output grid circuit. In cases such as this, be sure you are looking in the right place for trouble. If analysis of symptoms leads you to think grid bias is a factor in the trouble, by all means make sure that the bias from an outside source is correct.

Some television receivers use certain other stages as voltage dividers for the supply voltages. If any of these supply voltages are used in the vertical circuits, a fault in the divider stage can cause trouble in the vertical sweep system. A thorough investigation would be in order.

On the other hand, troubles in outside circuits sometimes result from faults in vertical circuits. For example, in color television receivers, the convergence of the beams depends on proper operation of the vertical sweep circuits. Or a CRT-circuit defect might be traceable to the retrace-blanking circuit of the vertical-sweep system.

If you keep these possibilities in mind, and make a systematic analysis of each symptom as it applies to the circuit, you will have very few tough-dog vertical sweep problems. ▲

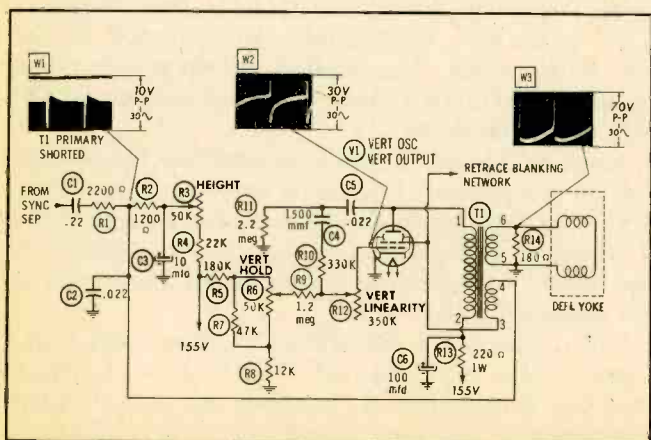
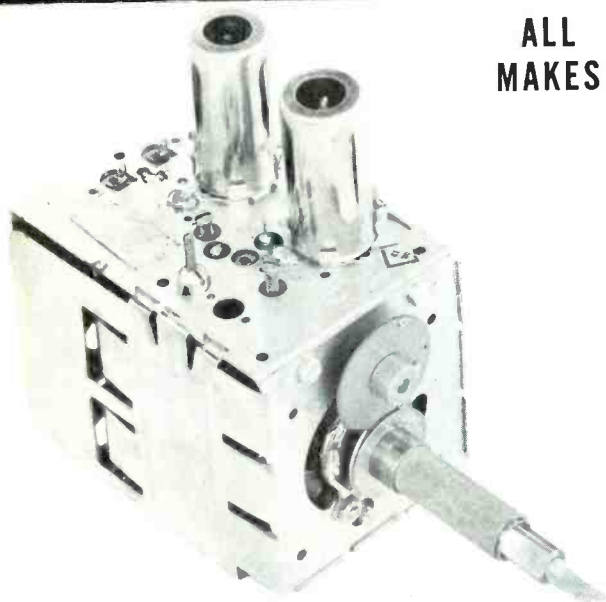

Fig. 12. One tube is both oscillator and output.

Tarzian offers

# FAST, DEPENDABLE TUNER REPAIR SERVICE



ALL  
MAKES

It just makes sense that a manufacturer of tuners should be better-qualified, better-equipped to offer the most dependable tuner repair and overhaul service.

Sarkes Tarzian, Inc., pioneer in the tuner business, maintains a complete, well-equipped Factory Service Dept.—assisted by Engineering personnel—and staffed by specialized technicians who handle **ONLY** tuner repairs . . . on **ALL** makes and models.

Tarzian-made tuners received one day will be fixed and shipped out the next. Cost is only \$8.50 and \$15 for UV combinations. That includes **ALL** parts (except tubes which are furnished at our cost) and labor, and a 6-month guarantee against defective workmanship and parts failure due to normal usage. Replacements available at low cost on tuners beyond practical repair.

Ⓢ Tarzian-made tuners are identified by this stamping. When inquiring about service on other tuners, always give tube complement . . . shaft length . . . filament . . . voltage . . . series or shunt heater . . . IF frequency . . . chassis identification. All tuners repaired on approved, open accounts. Check with your local distributor for Sarkes Tarzian replacement tuners, replacement parts, or repair service.

SERVICE MANAGER • TUNER DIVISION • DEPT. 3A



## SARKES TARZIAN INC

east hillside drive • bloomington, indiana  
edison 2-7251

MANUFACTURERS OF TUNERS . . . SEMICONDUCTORS . . . AIR TRIMMERS . . . FM RADIOS . . . AM-FM RADIOS . . . AUDIO TAPE . . . BROADCAST EQUIPMENT and SHISH-KABOB GRILLES

ONLY

# \$8.50

INCLUDING

## ALL PARTS and LABOR

## 24-HOUR SERVICE 6-MONTH WARRANTY

## Tuners Repaired on Approved, Open Accounts

See your distributor, or  
use this address for fast,  
factory repair service

**WHEREVER COUNTERMEN  
WEAR THIS BUTTON  
YOU'LL FIND 31 WAYS  
TO HELP BUSINESS...**

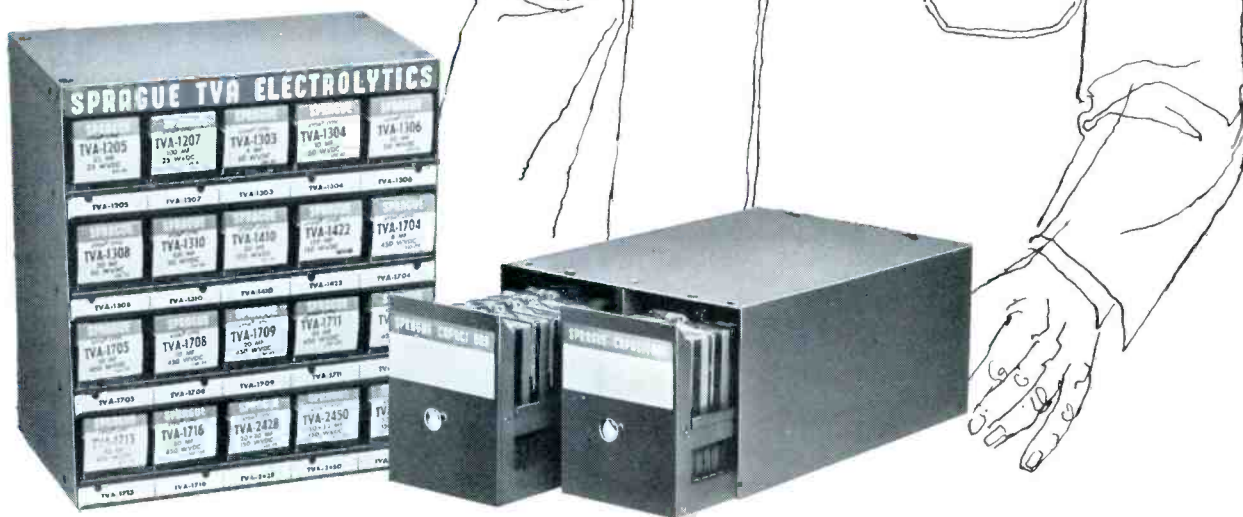

## **31 Sprague Capacitor Assortments in FREE Stock Cabinets and Cases**

Radio and TV Service Technicians swear by Sprague's Capacitor Assortments for **SEVEN** good reasons. Widest line in the industry, Sprague's **31** Assortments in Custom-designed Cabinets and Cases . . .

### **1. Convert wasted time to profits!**

No need to run to your distributor when you need a capacitor. No searching through cluttered parts bins. Sprague Assortments give you more time at the service bench.

### **2. Assure balanced inventories—no dead stock!**

Sprague Assortments include only the most popular, most frequently used ratings. No dogs. No slow movers. Every capacitor rating is one you need and use in your day-to-day service work.

### **3. Simplify inventory-taking!**

You see at a glance what capacitors you have in stock. Clearly identified compartments in custom-designed cabinets and cases let you take inventory without loss of time.

### **4. Speed re-ordering!**

Whether you handle re-orders yourself, or let Distributors' Salesmen do it, Sprague's "see-at-a-glance" Assortments save time all around.

### **5. Put capacitors at finger tips!**

No hunting. No delay. Sprague Assort-

ments give you the types and ratings you need—when you need them. Repair jobs go out on time. Profits increase.

### **6. Make your shop more attractive!**

A planned Capacitor Section saves space, looks business-like, makes a good impression on customers.

### **7. Cost you nothing extra!**

When you buy Sprague Capacitor Assortments, you pay for capacitors only. Sprague Custom-designed Cabinets and Cases are yours FREE!

**Take the first step to faster servicing and greater profit. Visit your Sprague Distributor and ask about Sprague's 31 Assortments. Or, write to Sprague Products Co., North Adams, Mass.**



**WORLD'S LARGEST MANUFACTURER OF CAPACITORS**

**publisher**  
Howard W. Sams

**general manager**  
Mal Parks, Jr.

**editor**  
Verne M. Ray

**associate editors**  
Forest H. Belt  
James F. Galloway  
Thomas A. Lesh

**consulting editors**  
William E. Burke  
Robert B. Dunham  
Joe A. Groves  
George B. Mann  
C. P. Oliphant  
Paul C. Smith

**art director**  
Anthony M. Andreone

**advertising & editorial assistants**  
Georgeanna Caldwell  
Paula Haffner  
Ruth E. Bastin

**production manager**  
Robert N. Rippy

**circulation fulfillment**  
Pat Tidd, Mgr.  
Constance Bland, Ass't.  
Katherine Smith, Ass't.

**photography**  
Robert W. Reed

**advertising sales offices**  
**midwestern**  
John Grace, advertising sales manager  
PF REPORTER  
2201 East 46th Street, Indianapolis 6, Ind.  
Cliffard 3-6441

**eastern**  
Charles Horner  
Howard W. Sams & Co., Inc.  
3 West 57th Street,  
New York, N. Y.  
MUrray Hill 8-6350

**western**  
The Maurice A. Kimball Co., Inc.  
2550 Beverly Blvd., Los Angeles 57, Calif.  
Dunkirk 8-6178; and 681 Market Street,  
San Francisco 5, Calif. Exbrook 2-3365

Address all correspondence to  
PF REPORTER, 2201 East 46th Street,  
Indianapolis 6, Indiana



Copyright © 1962 by Howard W. Sams & Co., Inc. PF REPORTER is a trademark of Howard W. Sams & Co., Inc. No part of PF REPORTER may be reproduced without written permission. No patent liability is assumed with respect to use of information herein. Acceptance of advertising does not in any manner signify the products, policies and services so advertised have been approved, endorsed or recommended by this magazine.

Indexed in *Lectrodex*.  
Printed by the Waldemar Press Div.  
of Howard W. Sams & Co., Inc.



# PF REPORTER

including **Electronic Servicing**

VOLUME 12, No. 1

**CONTENTS**

JANUARY, 1962

<b>Vertical Sweep Troubleshooting From A to Z</b>	1
Eight pages of information to help you master all four types of vertical deflection circuits.	
<b>Letters to the Editor</b>	12
<b>The Electronic Scanner</b>	18
<b>Multiple Troubles Again!</b> Stan Prentiss	20
Across the Bench—Could there be as many defects as there were symptoms?	
<b>Replacement Parts for Transistor Radios</b>	24
Where to find exact replacements or workable substitutes.	
<b>Checking Up on Video Amplifiers</b> Jim Galloway	26
A square-wave generator and scope let you know if frequency response is normal.	
<b>Eliminating TVI</b>	28
Typical RF interference patterns and suggested remedies.	
<b>Getting Rid of the "Christmas Tree"</b>	30
Quicker Servicing—What to do with a horizontal oscillator that won't settle down.	
<b>1961 Annual Subject Reference Index</b>	37
<b>Hum-Hunting in Audio Equipment</b> Norman H. Crowhurst	42
Audio Facts—Causes and cures for different kinds of hum.	
<b>Raise the Efficiency of Your Service Operation</b>	50
Dollar and Sense Servicing—Avoid doing things "the hard way" and gain more time for productive work.	
<b>The Troubleshooter</b>	60
<b>Notes on Test Equipment</b> Forest H. Belt	62
Lab reports on the B & K Model 960 Transistor Radio Analyst and the Triplett Model 800 VOM.	
<b>Service Dealer Advertising Program</b>	67
Here's your last opportunity to obtain these ads specially designed for service shops.	
<b>Product Report</b>	77
<b>Free Catalog and Literature Service</b>	80
<b>Monthly Index</b> on free literature card	

## ABOUT THE COVER

As many readers have vehemently told us, their main problem in servicing transistor radios is not troubleshooting, but obtaining replacement parts. We even had a hard time finding all the components we needed to set the stage for our cover photo. If this is your problem too, don't miss the article beginning on page 24.



# ATR

## PRODUCTS FOR MODERN LIVING



### ATR PLUG-IN TYPE PORTABLE INVERTERS\*

A. C. HOUSEHOLD ELECTRICITY Anywhere  
... in your own car, boat or plane

Operates Standard A.C.

- Record Players
- Dictating Machines
- Small Radios
- Electric Shavers
- Heating Pads, etc.

In your own car or boat!

**MODELS**  
6-RMF (6 volts) 60 to 80 watts. Shipping weight 12 lbs. DEALER NET PRICE **\$33.00**  
12T-RME (12 volts) 90 to 125 watts. Shipping weight 12 lbs. DEALER NET PRICE **\$33.00**  
\*Additional Models Available

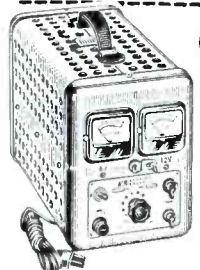

### ATR "A" Battery ELIMINATOR

For Demonstrating and Testing Auto Radios—**TRANSISTOR or VIBRATOR OPERATED!**

Designed for testing D.C. Electrical Apparatus on Regular A.C. Lines—Equipped with Full-Wave Dry Disc-Type Rectifier, assuring noiseless, interference-free operation and extreme long life and reliability.

**MAY ALSO BE USED AS A BATTERY CHARGER**  
MODEL 610C-ELIF... 6 volts at 10 amps. or 12 volts at 6 amps. Shipping weight 22 lbs. DEALER NET PRICE **\$49.95**  
MODEL 620C-ELIT... 6 volts at 20 amps. or 12 volts at 10 amps. Shipping weight 33 lbs. DEALER NET PRICE **\$66.95**

### AUTO-RADIO VIBRATORS



By every test ATR Auto-Radio Vibrators are best! ... and feature Ceramic Stack Spacers, Instant Starting, Large Oversized Tungsten Contacts, Perforated Reed, plus Highest Precision Construction and Workmanship and Quiet Operation!

There is an ATR VIBRATOR for every make of car!  
Ask your distributor for ATR's Low Priced type 1400, 6 volt 4-prong Vibrator; and 1843, 12 volt 3-prong; or 1840, 12 volt 4-prong Vibrator. THE WORLD'S FINEST!

There is a trim plate kit for YOUR CAR!



### ATR CUSTOMIZED KARADIO

Vibrator-Operated with Tone Control ATR KARADIO is ideal for small import cars or compact American cars! Unit

is completely self-contained—extremely compact! Powerful 8-tube performance provides remarkable freedom from engine, static, and road noises. The ATR Customized Karadio comes complete with speaker and ready to install. Can be mounted in-dash or under-dash—wherever space permits! No polarity problem. Neutral Gray-Tan, baked enamel finish. Overall size, 7" deep, 4" high, and 6 1/2" wide. Shipping weight, radio set, 7 lbs. Model K-1279—12 for 12V Dealer Net Price **\$33.57** Model K-1279—6 for 6V Dealer Net Price **\$33.57**

Airplane Style Overhead Mounting under Cab Roof

NO PRINTED CIRCUITRY

### ATR TRUCK KARADIO

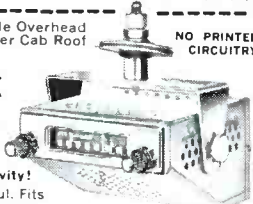

Excellent Tone, Volume, and Sensitivity!

Compact, yet powerful. Fits all trucks, station wagons, most cars and boats. Just drill a 3/8 inch hole in roof and suspend the one-piece unit (aerial, chassis and speaker) in minutes. Watertight mounting assembly holds antenna upright. Yoke-type bracket lets you tilt radio to any angle.

Extra-sensitive radio has 6 tubes (2 double-purpose), over-size Alnico 5 PM speaker for full, rich tone. Big, easy-to-read illuminated dial. Fingertip tuning control. Volume and tone controls. 33-in. stainless steel antenna. Neutral gray-tan enameled metal cabinet, 7 x 6 1/2 x 4 in. high over-all. Shipping weight 10 1/2 lbs. Model TR-1279—12A for 12V Dealer Net Price **\$41.96** Model TR-1279—6A for 6V Dealer Net Price **\$41.96**

See Your Electronic Parts Distributor Write Factory For Free Literature

## ATR ELECTRONICS, INC.

Formerly: American Television & Radio Co.

Quality Products Since 1931

ST. PAUL 1, MINNESOTA—U.S.A.

## LETTERS TO THE EDITOR

Dear Editor:

Mr. Allan Kinckiner deserves to be commended very highly on the article, "Painless TV Alignment," in your October issue. The article is *par excellence*; I can see no single criticism.

This is a type of article that should have been published years ago, and I would like to see Mr. Kinckiner write more on this subject—if he has any more material to draw on.

E. F. SCHWARZ

Petersburg, Va.

Since Mr. Kinckiner is now the regular author of our Shop Talk column, you can count on seeing more articles of this kind in the future.—Ed.

Dear Editor:

I read your magazine with great interest every month, and was especially interested in "Servicing Imported Transistor Portables" in the July, 1961 issue. I enjoy working on transistor radios, but when I am unable to repair a damaged volume control or tuning capacitor, I have to give up. Jobbers tell me they are unable to get these parts. Would you please tell me where I can order parts for transistor portables, especially the Japanese ones which are so common today?

J. RANDELL

Blaine, Wash.

You're sure to find some helpful information in the article, "Replacement Parts for Transistor Radios," beginning on page 24 of this issue.—Ed.

Dear Editor:

The item entitled "Shop Color Tube," on page 42 of your November issue, is not entirely correct. The RCA Color Test Jig (stock no. 11A1015) does not include a tricolor CRT, as you stated in that article.

R. C. BERNHARDY

RCA Parts and Accessories  
Camden, N.J.

Information on this "test jig" reached us some time after the editorial deadline for our all-color November issue. Not wishing to miss the opportunity to mention this unit in the most appropriate place, we rushed the item into print; thus, we were not able to double-check on whether or not the "test jig" contained a CRT.

We'd like to set the record straight—no CRT is included. The "jig" does include deflection yoke, convergence yoke, additional magnets, special lead wires, convergence panel for late-model sets, and CRT mounting hardware. Dealer net price, not available at November issue press time, is \$135.00.—Ed.

Dear Editor:

Will you please give us the correct wording, or fill in the omission, or do whatever is needed to give us the information intended in the next to last paragraph of the center column on page 4 of the November issue? These facts are important for a complete understanding of the subject.

JOHN H. LEACOCK

Lincoln, Nebr.

This paragraph was sabotaged by a stray line of type that usurped the place of the fourth line. Corrected, it should read:

"A subcarrier is a signal which is first amplitude-, frequency-, or phase-modulated by a lower-frequency signal, and is then used to modulate a higher-frequency RF carrier. After being detected and separated from the main carrier, the subcarrier must go through an additional step of demodulation to recover the low-frequency information it conveys."—Ed.

Dear Editor:

I greatly enjoyed reading "Schoolroom TV Takes to the Air" in the October issue. I am sure this well-written article has proved most helpful to the many installers and servicemen who are concerned with the reception of MPATI signals.

One point needs correction, however. Fig 2 and the discussion relating to it put the radio horizon well under 200 miles from Montpelier, the aircraft orbit center. Actually, with the aircraft 23,000' above sea level, which is more than 22,000' above the average terrain in its service area, the radio horizon is about 210 miles from Montpelier.

DEW. SCHATZEL

Coordinator of Technical Affairs  
MPATI  
Purdue University  
Lafayette, Ind.

Our illustration was based on optical line-of-sight distances — the horizon as actually seen from the aircraft. However, since even UHF radio waves bend slightly along the curvature of the earth's surface, the "radio horizon" is somewhat farther away from the transmitter than the true horizon. Because of the great height of the airborne transmitter, effective line-of-sight coverage extends well over 50 miles beyond the point where the aircraft drops out of sight. This explains the phenomenal coverage which has been achieved with the MPATI broadcasts.—Ed.

Dear Editor:

I have been taking PF REPORTER ever since 1955, and like it very much. For the past two years, however, I have not received an annual index like the ones you used to send on request.

R. D. GRAHAM

San Bruno, Calif.

In response to requests from many readers, we have included a 1961 Annual Subject Reference Index in this January issue. It begins on page 37.

No separate annual index was issued for 1960, because all references for that year were incorporated in the cumulative

• Please turn to page 16

# ARE YOU "ON TARGET?"

Test Yourself.....

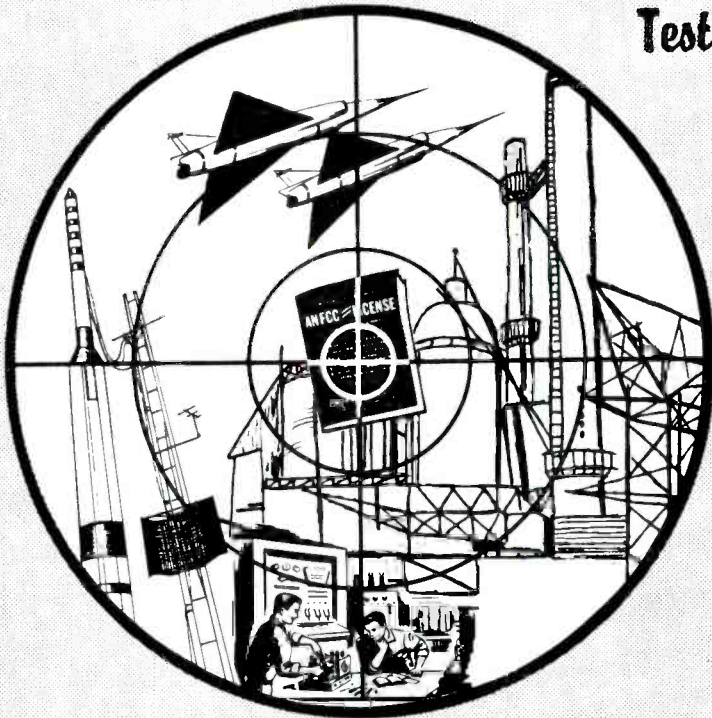

## ANSWER THESE QUESTIONS:

- DO YOU want to get into ELECTRONICS?
- Do you have a SPECIFIC OBJECTIVE in mind ... Are you shooting at a particular target (such as an FCC License)?
- Do you want the kind of training that will take you straight to this objective QUICKLY... without wasting valuable time on non-essentials?

The Grantham Communications Electronics Course prepares you for your first class commercial

## F.C.C. LICENSE QUICKLY!

CORRESPONDENCE OR RESIDENCE CLASSES

## Is Grantham Training for You?

### CHECK THESE FEATURES:

- Grantham teaches the *theory* of electronics. Every basic concept of electronics fundamentals is covered in the Grantham course... whether you take it in resident classes or by home study. Grantham training "*makes electronics yours.*"
- You can get your First Class FCC license IN ONLY 12 WEEKS in Grantham resident classes (or, in a correspondingly short time in the Grantham home-study program). THINK OF IT! A *commercial U. S. Government license*... PROOF OF YOUR qualifications in meeting these U. S. Government requirements as an electronics communications technician... a nationally recognized certificate. By preparing you for this license in only 12 WEEKS, Grantham conserves YOUR TIME!
- Mature men select Grantham Schools for electronics training. (The average age of Grantham Students is 28.8 years.) MATURE MEN want a definite objective (not a pot of gold at the end of the rainbow). Grantham training has this specific objective: To prepare you for your First Class FCC license and greater earning capability. The Grantham Course is for mature men who know what they want.

- Grantham Schools' tuition rates are low, yet the instructional service is not equalled by many of the *most expensive schools!* Grantham can do this because of highly efficient instructional methods and because Grantham has a sincere desire to out-do all others in service rendered per tuition-dollar. Grantham has established *reasonable* tuition rates. And, the percentage of students who successfully complete the Grantham course — and who get their FCC licenses — is one of the highest in the nation.
- YOU GAIN RESPECT by showing your Grantham diploma, once you earn it. YOU GAIN RESPECT by showing and posting your First Class FCC License — a nationally recognized certification of your electronics knowledge. Many companies which employ industrial electronics technicians require them to have this license. YOU CAN GET IT IN ONLY 12 WEEKS. Let Grantham show you how!

**HERE'S PROOF:** Here is a list of a few of our recent graduates, the class of license they got, and how long it took them:

	License	Weeks
James C. Bailey, 217 Behrends Ave., Juneau, Alaska	1st	12
Edward R. Barber, 907 S. Winnifred, Tacoma, Wash.	1st	20
M. A. Dill, Jr., 20 Cherry St., Gardiner, Maine	1st	12
Bernhard G. Fokken, Route 2, Canby, Minn.	1st	12
Kenneth F. Foltz, Broad St., Middletown, Md.	1st	12
James C. Greer, Mound City, Kansas	1st	12

Get your First Class Commercial F.C.C. License Quickly by training at



## GRANTHAM SCHOOL OF ELECTRONICS

Accredited by the National Home Study Council

1505 N. Western Ave. Los Angeles 27, Calif. (Phone: HO 7-7727)    408 Marion Street Seattle 4, Wash. (Phone: MA 2-7227)    3123 Gillham Road Kansas City 9, Mo. (Phone: JE 1-6320)    821-19th Street, N.W. Washington 6, D. C. (Phone: ST 3-3614)

MAIL COUPON NOW — NO SALESMAN WILL CALL →

(Mail in envelope or paste on postal card)

TO: GRANTHAM SCHOOL OF ELECTRONICS

1505 N. Western • 408 Marion • 3123 Gillham Rd. • 821-19th, NW  
Los Angeles • Seattle • Kansas City • Washington

Gentlemen:

Please send me your free booklet telling how I can get my commercial F.C.C. license quickly. I understand there is no obligation and no salesman will call.

Name \_\_\_\_\_ Age \_\_\_\_\_

Address \_\_\_\_\_

City \_\_\_\_\_ State \_\_\_\_\_

Interested in:  Home Study,  Resident Classes

29-A

# ACTUAL PHOTOS OF TV PICTURES RECEIVED UP TO 248 MILES AWAY



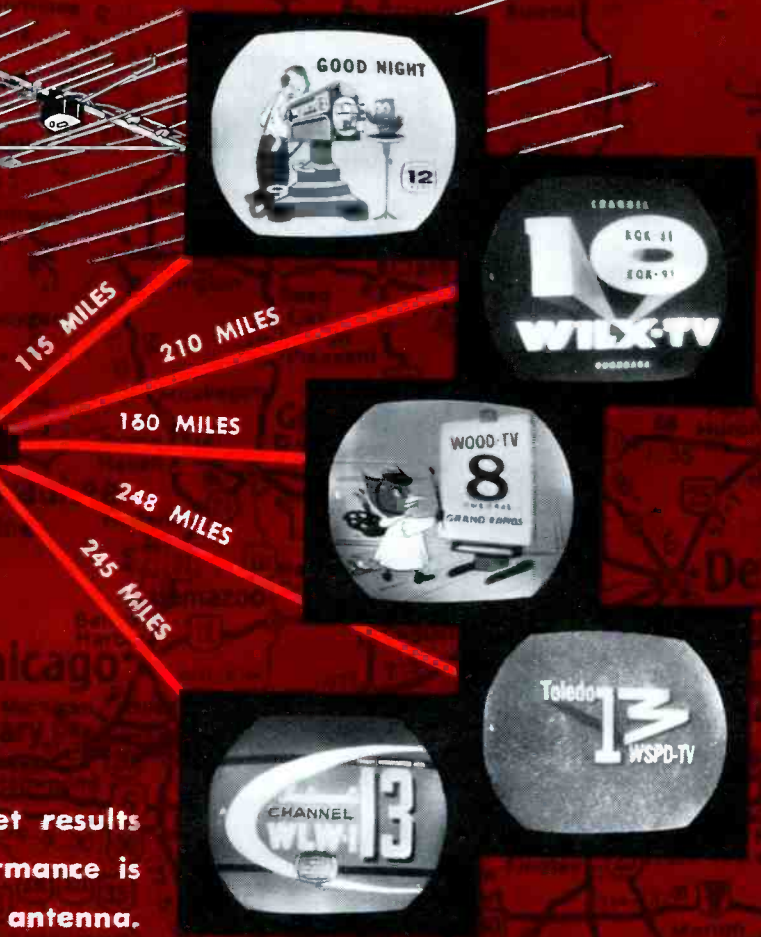

## PULLED IN BY A *Winegard* SUPER POWERTRON TV ANTENNA

We can't guarantee that everyone will get results like this but long distance reception performance is not unusual for the world's most powerful TV antenna.



© 1964 by the Company

### Why the Winegard Super Powertron is the Most Effective Antenna Ever Designed—

-  **IT CAPTURES MORE SIGNAL** than any other all-channel antenna ever made. Patented design, electro-lens director system, dual "TAPERED T" driven elements, 30 precision-tuned elements in all.
-  **IT'S THE ONLY TRUE ELECTRONIC ANTENNA.** Only the Winegard Powertron is built with the amplifier as part of the driven element—not an "add-on" attachment.
-  **IT ELIMINATES ALL SIGNAL LOSS** that normally occurs between the driven element and the amplifier due to transmission and coupling mis-match.
-  **IT BOOSTS WEAK SIGNALS UP OUT OF THE SNOW** far better than any other antenna or antenna-amplifier combination made.



ONLY POWERTRON HAS BOTH 300 OHM TWIN LEAD AND 75 OHM COAX TERMINALS ON BUILT-IN AMPLIFIER.



ONLY POWERTRON GIVES YOU YOUR CHOICE OF TRANSISTORS OR TUBES (TUBE MODELS 300 OHM ONLY).



ONLY POWERTRON HAS RANGE AND POLARITY CONTROL SWITCH TO PREVENT OVER-DRIVING ON STRONG CHANNELS.



ONLY POWERTRON HAS AC PLUG-IN OUTLET FOR TV SET BUILT INTO THE POWER SUPPLY.



**POWERTRON POWER SUPPLY IS ALL AC—SAFE, SHOCKPROOF.**  
 Transistorized Model has rectifier and filter in power supply—not in amplifier, where servicing is difficult. No nuisance batteries. Costs 27c to operate for a full year.



# Read what Charles J. Milton of Moyer TV, Milwaukee, has to say about the Winegard Super Powertron...

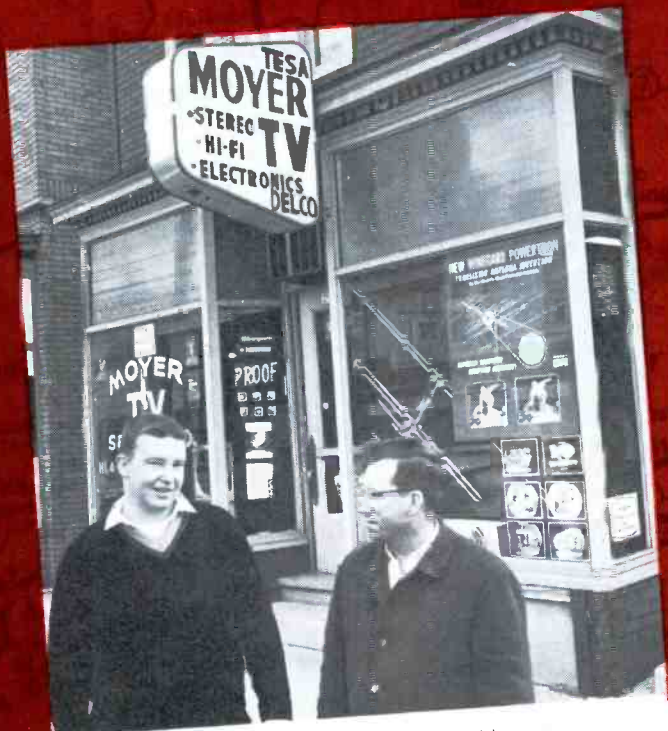

Charles Milton and J. M. Moyer  
in front of Moyer TV

Of course, everyone can't get reception results like Charles Milton has experienced. Each area has its own unique reception characteristics and problems. But one thing we can promise, the Powertron will deliver more clean pictures on your TV screen than any antenna you can own.



TESA-MILW.

## MOYER TV & RADIO SERVICE

3111 W. NORTH AVE.

MILWAUKEE 8, WIS.

2913 W. NORTH AVE.

Hilltop 4-0740

Winegard Company  
3000 Kirkwood  
Burlington, Iowa

Gentlemen:

I would like to thank the Winegard Company for building the Super Powertron SP-44X.

With this antenna, reception at the local station level is perfect in both black and white and color. At medium range, the Powertron outperforms all others. Channel nine from Chicago, about 90 air miles, comes in clear and regularly. This is the Cubs baseball station and the one Milwaukeeans are willing to pay big money to get.

When the "Big Winegard", as it is affectionately called around the shop, is on long range it probes the unknown alone. All other antennas have fallen far behind. I have picked up eleven stations over 100 air miles away. The farthest of these is WWJ, Channel Four, Detroit, an unbelievable 251 miles. I have included a few pictures that I took off the TV with a Rolliflex F 3.5 at one second using Verichrome Pan.

We use the pictures in a window display and I use a set of pictures to explain the advantages of a Winegard to prospective customers. Believe me the pictures work -- and so does the "Big Winegard."

Sincerely,

*Charles J. Milton*

**POWERTRON IS 100%  
CORROSION-PROOFED**

ANTENNA IS GOLD ANODIZED,  
ALL HARDWARE IRRIDIZED,  
AMPLIFIER HOUSING OF HIGH  
IMPACT POLYSTYRENE.

## PHOTOGRAPH YOUR OWN TV STATION PICTURES AND SEND THEM IN!

If you own a Powertron, chances are you too are experiencing unusual results. Why not photograph the stations you receive and send them in to us. We are always interested in hearing from Winegard antenna dealers and owners. We will be glad to enlarge your camera shots so that you can make your own window or store display like Moyer TV has done. The photos make

great sales persuaders to prospects and can be used in many ways to sell more Powertrons.

If you have never tried a Winegard Electronic Powertron, give it a test and be agreeably surprised. Don't take our word for it—let your eyes and ears and field strength meter tell the story. For full details and spec sheets, ask your distributor or write.



**Winegard**  
ANTENNA SYSTEMS

Winegard Co., 3009-1A Kirkwood St., Burlington, Iowa

**Letters**

(Continued from page 12)  
10-year index published in the January, 1961 issue.

A few copies of the separately-printed Annual Subject Reference Index for both 1959 and 1958 are still available on request.

By the way, don't overlook the individual monthly indexes printed on the reverse side of the Free Catalog and Literature card, just inside the back cover of each issue.—Ed.

Dear Editor:

We are experiencing considerable interference to TV reception from Citizens band radios in this locality. I have tried traps in the antenna circuit, but to no avail.

Can you suggest any method of eliminating or greatly reducing this type of interference?

STANLEY W. CALDWELL  
Natural Bridge, N.Y.

This is the first specific case of such interference which has been brought to our attention. Our initial thought is that TV receivers with IF frequencies in the 20-mc range would be more likely to be affected than those with 40-mc IF's. Following the same track, sets of the former type might benefit from a careful check of IF alignment to insure maximum attenuation of frequencies in the 27-mc range. Anybody else have suggestions or solutions to offer?—Ed.

Dear Editor:

Recently I picked up a copy of your January, 1960 issue, and was particularly interested in the article, "Scoping Video and Vertical Troubles." The title mentioned that it was part 3 of a Shop Talk series. This article was so easily understood and interesting that I just had to write to you for the following information:

1. Did the series cover all stages of a TV receiver?
2. In what issue did the series begin?

3. How can I obtain the complete series?

MICHAEL BALOCIK  
North Braddock, Pa.

Yes, the series covered the subject of TV troubleshooting like a fur-lined parka. The specific stages covered, and the issues in which the articles appeared, are as follows:

- Sept. 1959—General discussion of a methodical troubleshooting technique.
- Nov. 1959—B+ and sound circuits.
- Jan. 1960—Video and vertical.
- Mar. 1960—Horizontal output and high voltage.
- May 1960—Horizontal AFC and oscillator.
- July 1960—RF, IF, and AGC.
- Sept. 1960—Sync and sound IF.

You can still obtain all of these issues at the usual back-number price of 50¢ each, although some are in short supply.—Ed.

**NEW TRANSISTOR TV-FM  
WINEGARD  
TENNA-  
BOOST**

**MOUNTS ON ANY ANTENNA**

**NEXT BEST THING TO THE  
WINEGARD ELECTRONIC  
POWERTRON TV ANTENNA**

**MOUNTS ON  
ANTENNA**



ON MAST



ON WALL

Model  
MA-300

**\$34.95**  
only LIST

**INSTALL IT . . . FORGET IT!**

ALL ELECTRIC, ALL-AC POWER SUPPLY costs less than 27¢ a year to operate. Many exclusive features.

No costly, nuisance batteries!



Built-in two set coupler.



Exclusive Gain Control Switch



AC outlet on power supply.

**19 DB GAIN! CUTS SNOW...BOOSTS SIGNAL!**

Now you can make any TV or FM antenna work better by magnifying signals with the new Winegard transistor Tenna-Boost.

Tenna-Boost has up to 19 DB gain, no peaks and valleys. Ultra low noise. Linear frequency response. VSWR input better than 1.5:1 across all frequencies. Output VSWR 1.8:1 or better. This fine frequency response plus the very low VSWR make Tenna-Boost excellent for color.

Winegard's exclusive input band-pass filter eliminates interference from citizen's band, Hams, garage door openers, etc. Only TV and FM signals are amplified.

All metal parts are anodized, irradiated or stainless steel. Completely weather-proof, trouble-free. Install it . . . forget it.

There's a big difference in antenna amplifiers! Ask your distributor or write for technical bulletin.

**FOR THE ULTIMATE IN  
TV RECEPTION**

Winegard Transistorized Electronic  
Powertron TV Antennas. 3 Models  
to Choose From



**Winegard**

**ANTENNA SYSTEMS**  
3009-18 Kirkwood • Burlington, Iowa



# 30-second story on the WISE BUY in picture tubes



**Make \$2<sup>85</sup> to \$16<sup>00</sup> more profit on a 21" Admiral Ensign**

Now Admiral's vast purchasing power and national distribution give you the one picture tube line with everything: Finest quality workmanship and material... famous brand-name acceptance... attractive list prices... plus the biggest profit margin in the industry.

You can actually pocket from \$2.85 to \$16.00 more profit on a 21"

Admiral Ensign than on other brands. (Comparably higher margin on all other tube sizes.) Get the facts! Compare Ensign quality, performance, prices and profits. Discover for yourself why dollar-wise servicemen are switching to the Admiral Ensign. Call your nearby Admiral Distributor today! Start earning more right now!

**NOTICE:** All materials and parts used in the manufacturing of Admiral Ensign tubes are new, except for the envelope, which prior to re-use, was carefully inspected to meet the standards of the original new envelope.



**NEW Admiral Tube Carton**  
Remarkable new package is lighter, stronger... has built-in carrying grips... takes 40% less space! Another Ensign "Extra."

# ADMIRAL<sup>®</sup> ENSIGN Picture Tubes

New transistor  
Home TV and  
FM System!

# Winegard BOOSTER-PACK & 'SIX-SET' COUPLER



**BOTH**  
for the price  
of the amplifier  
**\$34.95\***  
A \$42.90 value



## DRIVE UP TO 6 TV AND FM SETS

Cut snow . . . improve contrast . . . deliver sharper, clearer pictures to each set. New low noise, high gain transistor combined with advanced circuitry gives Winegard AT-6 "Booster-Pack" a flat gain of 16 db on low and FM bands . . . a flat 14 db gain on high band.

Shock-proof, full AC chassis with AC isolation transformer (NOT AC-DC). Draws 1.2 watts. Gain control switch prevents overdriving sets on local stations. No heat. Can be mounted remote from coupler. Also ideal as single set booster.

New, Winegard 300-ohm "Six-Set" coupler has low insertion loss, positive isolation between sets. No need to terminate unused outputs.

You get both AT-6 "Booster-Pack" and LTS-63 "Six-Set" for the price of "Booster-Pack" alone: a \$42.90 value for only \$34.95 list. Ask your distributor.

For real convenience, add Winegard flush or surface mount 300-ohm plug-in outlets. Even folks with only one TV set appreciate being able to move it from room-to-room.  
For finest all-channel reception, use a Winegard "Teleton" antenna with your "Booster-Pack".

\*Limited Time Offer



# Winegard

ANTENNA SYSTEMS

Winegard Co., 3009-1C Kirkwood St., Burlington, Iowa



## The Electronic Scanner



Roland Barnett  
(H. L. Dalis, Inc.)



John Wierma  
(T&W Electronics, Inc.)



George E. Hornstein  
(Electronic's Assoc. #14)

### Color TV Winners

Three distributor salesmen who recently competed in the PHOTOFAC Sales Contest have been announced as winners of color TV sets. The contestants were aided in their sales efforts by the bonus offer of a 16-lesson Color TV Course. Starting this month a 20-lesson 2nd Class FCC License Course will be included as a bonus for regular PHOTOFAC subscribers.

### Pix Tube Replacement Guide

A new edition of the General Electric "Television Picture Tube Replacement Guide" is available from distributors. The guide, in the form of a 24" x 30" wall chart, contains a section on picture tube interchangeability. Essential characteristics are given for 460 types of tubes, ranging in size from 2" to 30" faceplates.

### E-V Expands Cartridge and Needle Line



Planned to aid the distributor and dealer by eliminating the confusion often found in carrying multiple lines, a complete line of replacement phonograph cartridges and needles is being offered by **Electro-Voice**. A program of sales aids, including banners and displays, will be offered with each order.

### Fisher Park Dedication

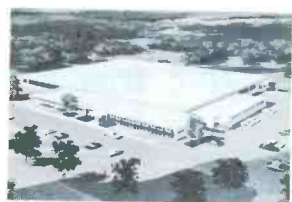

In conjunction with the beginning of **Fisher Radio's** 25th Anniversary Year, the company is opening a new Milroy, Pa. plant for added service to customers, particularly in the Middle and Far West. Speaker manufacturing facilities will remain at the Belleville, N.J. facility.

### "Roadshow" Premium Program Launched

A new distributor program, planned to promote sales of **RCA** receiving and picture tubes, will offer an extensive selection of name-brand tires, auto accessories and gift items as premiums. Distributors ordering specified quantities of tubes receive certificates to be passed on to service-dealers. These certificates are redeemable for premiums from authorized Firestone dealers.

### Raytheon Acquires CBS Semiconductor Facilities

The year-old fully automated **CBS** semiconductor manufacturing facilities were recently acquired by **Raytheon**. This new equipment, when added to **Raytheon's** existing automated equipment in Lewiston, Maine, will provide the manufacturer with one of the most modern semiconductor facilities in the country. Further expansion is planned for the future.

### Comco Completes Expansion Program



Three new buildings at Coral Gables, Fla., provide **Comco** with three times the floor space previously available. The company, which specializes in design and manufacture of two-way VHF/FM communications systems, expects to quadruple its output capacity with the addition of the new facilities.

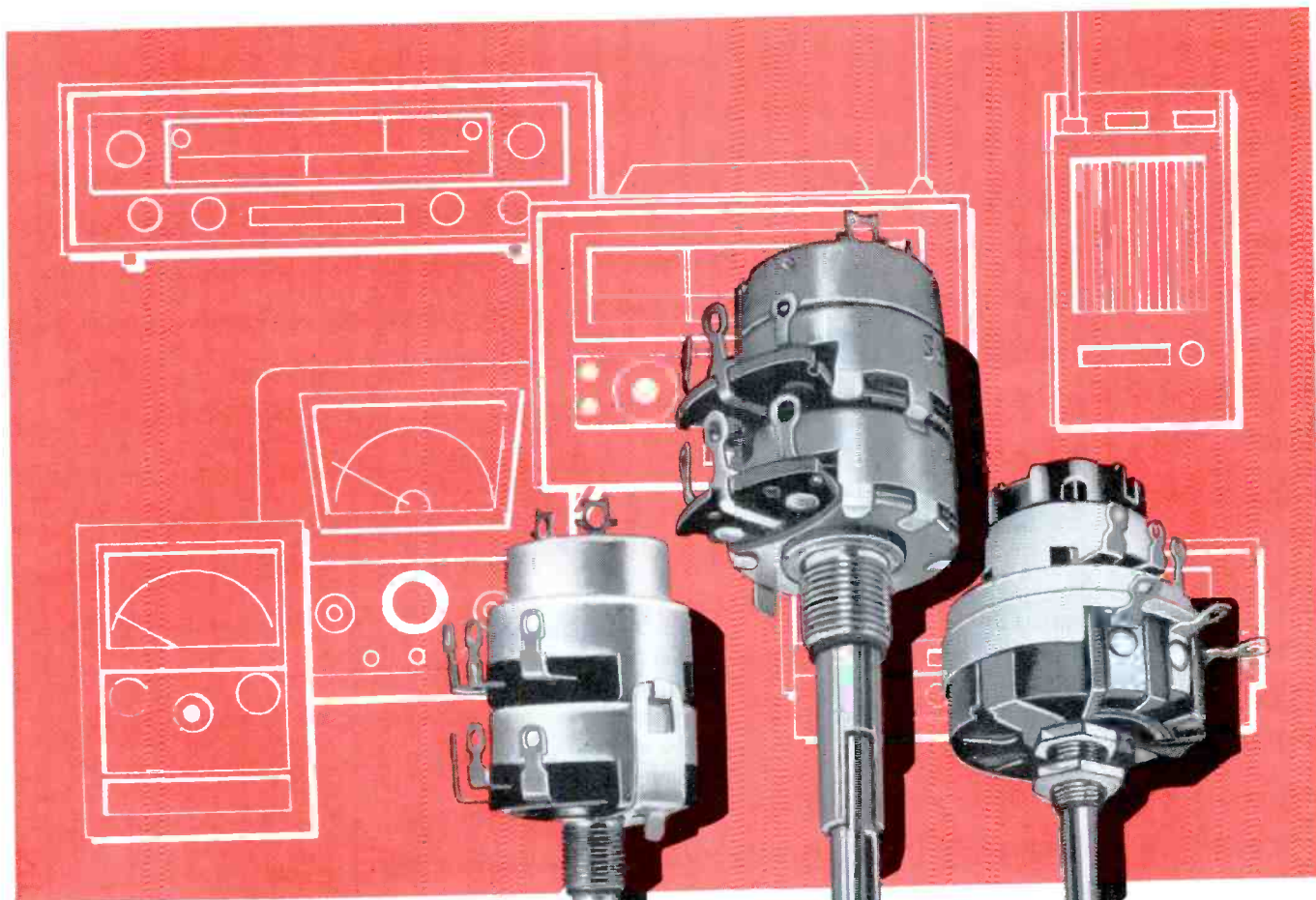

*wherever control is needed . . .*

- ★  
*Dual and single carbon controls*
- ★  
*Dual and single wire-wound controls*
- ★  
*RTV exact-duplicate dual concentrics*
- ★  
*Uni-Tite field-assembled dual concentrics*
- ★  
*Switches*
- ★  
*Sound system controls*

## ...USE **CLAROSTAT** **REPLACEMENTS**

Television, radio, auto radio, citizens' band, amateur equipment, hi-fi, multiplexers, stereo, marine equipment...and just about every place electronic control is required you'll find the right control at your Clarostat distributor.

Clarostat specializes in controls for replacement purposes. These controls are designed to fit right, work right in every single case. They save you time, money and headaches. Always ask for CLAROSTAT controls in the green box and back your skills and knowledge with the very finest performances available.

ASK YOUR DISTRIBUTOR FOR CLAROSTAT CATALOG...

# CLAROSTAT

CLAROSTAT MFG. CO., INC. DOVER, NEW HAMPSHIRE

# MULTIPLE TROUBLES AGAIN

A service call that started off with the complaint, "... a little buzz on warm-up," turned into a many-headed monster. I'm still wondering why the customer was worried about a slight buzz in the sound, considering all the trouble symptoms she had to choose from.

On entering the home, I promptly turned on the receiver (a Magnavox Model 108A) and waited expectantly for the "little buzz" to appear. I mused that perhaps a couple of new tubes and a slight adjustment of the sound detector might be all that was necessary. After what seemed like an interminable wait (actually only 20 seconds), the buzz appeared. There were also several "fringe benefits." Close on the heels of the buzz came a negative picture; shortly afterward, these symptoms vanished, and were replaced by a smeary picture with

multiple sound bars. Fine tuning had no appreciable effect. To top it off, the width of the raster was only three-fourths of normal.

"How long," I asked the customer, "has the set had this trouble?"

She thought for a moment, and then guessed it had been acting this way for some time; "... even before our neighbor, who knows electronics, put in a new piece that goes around the picture tube."

"Why did he do that?" I asked.

"Picture went out," she replied.

My eyes glazed for a moment, and then slowly began to clear as I removed the rear cover of the cabinet. Sure enough, glistening under the neck-support bracket of the picture tube was the shiny plastic casing of a new deflection yoke. I reasoned that if the neighbor knew enough to replace a bad yoke, he'd probably chosen a correct replace-

ment; he just hadn't been able to finish repairing or adjusting the horizontal circuit for normal width. I wasn't inclined to blame him for all the troubles in this receiver; for the moment, at least, I was willing to give him the benefit of the doubt. However, I already knew that I had a great deal more to contend with than I had expected.

Deciding to see what I could accomplish in the home, I substituted new 6SN7 horizontal oscillator, 6BQ6 horizontal output, and 6AX4 damper tubes to see if the raster could be filled out to normal size. I also tried adjusting the width coil. The raster did expand horizontally, but even with the width slug positioned for the least possible reactance, I couldn't obtain full sweep. In addition, all the other symptoms were still present.

Looking at the tube-layout chart inside the cabinet, I saw that the set had a 6AU6 pentode serving as a keyed AGC tube, the IF's were conventional 6CB6's, and the tuner used a 6BZ7 RF amplifier and a 6U8 mixer-oscillator. Replacement of these didn't help. This took me as far as I cared to go in home servicing. The customer was informed that the repair job would probably be a rough one, and a high estimate for shop service was given—with the promise that satisfactory results could be expected after replacement of all defective parts and probable IF alignment. With these assurances, she permitted me to take the set.

## Down to Business

Intrigued by this three-in-one problem, I went right to work as soon as I arrived at the bench. First I checked the part number and circuit connections of the replacement yoke, just to satisfy myself that the customer's neighbor had made a correct substitution (surprisingly, he had). Then I plugged in the set and turned it on. Since I planned to tackle the sweep problem first, I didn't bother to connect an antenna. On warm-up, I noted that the buzz and the negative picture did not develop. Here was proof that these symptoms had been due to overloading of the picture circuits by the strong signal received in the customer's home. I made a mental note to check out the AGC circuit

• Please turn to page 71

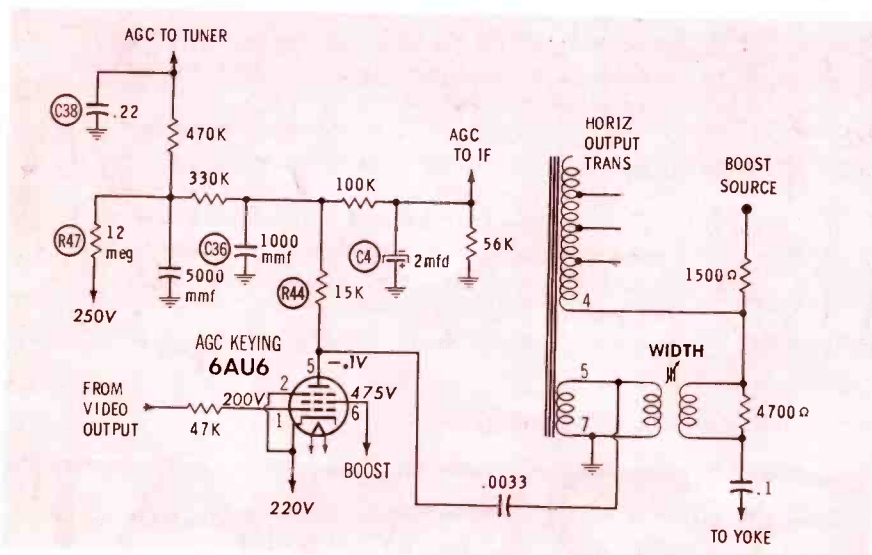

Fig. 1. Sweep trouble affected AGC through keying-pulse connection.

# exclusive in PHOTOFACT the world's finest electronic service data

## famous Howard W. Sams ALIGNMENT SYSTEM and PARTS GUIDE!

speedy shortcuts to simplify servicing...to eliminate guesswork...  
to save you valuable hours each day for greater profits...

### Time-Saving ALIGNMENT SYSTEM

#### OVERALL VIDEO IF RESPONSE CHECK

Connect the negative lead of a 6 volt bias supply to point  $\diamond$ . Post Connect Vert. Amp. of scope thru 47K to point  $\diamond$ . Low side to c

SWEEP GENERATOR FREQUENCY	MARKER GENERATOR FREQUENCY	ADJUST	REMARKS
45.0MC (10MC Swp.)	42.5MC 45.75MC	A5 and Mixer Plate Coil	Adjust for maximum gain and response similar to Fig. 1 w/ shown.
"	42.5MC 45.0MC 45.75MC	A1, A2, A3	Check for response similar to necessary, retouch A1, A2, proper response.

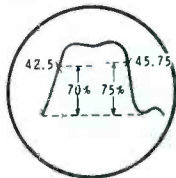

FIG. 1

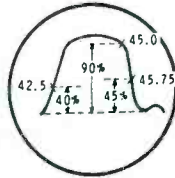
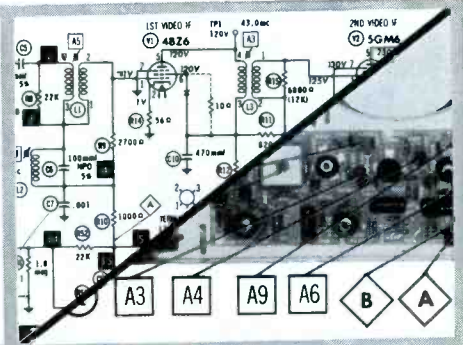

FIG. 2



**1.** Complete ALIGNMENT INSTRUCTIONS are presented in an easy-to-follow, standardized form. All procedures have actually been performed and verified in the PHOTOFACT analysis lab. Tells you what to adjust, how to connect equipment, and how to perform the alignment.

**2.** Detailed response curves show you where alignment markers should appear for proper frequency response. Response curves are developed from actual scope measurements made during lab processing. For convenient use, actual frequencies and markers are shown on response curve.

**3.** Test equipment connections (test-points) and adjustment sequences given in the Alignment Instructions are clearly coded to the famous Sams Standard Notation Schematic and photos for quick, easy identification.

### Tell-All PARTS GUIDE

ITEM No.	USE	REPLACEMENT DATA			
		OLYMPIC PART No.	Merit PART No.	Sencor PART No.	Thor. PAR PART No.
T2	Vert. Output	TR-25781-2	MDF-92 1	DY-18A 1	Y-16
T3	Yoke Horiz. 18.45MH (92) Vert. 40MH Rear Cover and Centering Device Horiz. Output	CL-3800-7			
T4		TR-3599-5	HVO-131 2	HO-315 4	FLY

1 Use original rear cover and centering device, yoke damping network if available. Filament requires two mounting holes.  
 2 Drill new mounting hole(s).

ORIGINAL TERMINAL CONNECTIONS	Merit Replacement Connections	Sencor Replacement Connections	Thor. Par Replacement Connection
9	8	9	4

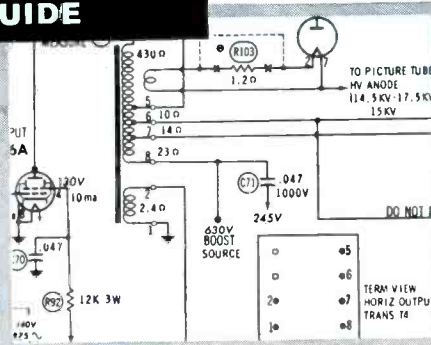

**1.** A complete PARTS GUIDE is available for each model. Parts List item numbers tie in with schematic and photos. Original set manufacturer's part numbers are shown, as well as a choice of replacement part numbers. Parts connection data is given to eliminate guesswork.

**2.** The Standard Notation Schematic identifies components and values, shows terminal numbers and layouts, color codes, and resistance of coil windings—all invaluable helps in localizing trouble quickly.

**3.** All items on Parts List are keyed to and clearly identified on chassis photos and Standard Notation Schematic for easy cross-reference.

The exclusive time-saving Alignment System and tell-all Parts Guide are just two of dozens of great features in PHOTOFACT for fastest, easiest, most profitable servicing. See your Sams Distributor for full details on an Easy Buy Library or Standing Order subscription!

**FREE!**

**BONUS 20-LESSON COURSE**

**Beginning This Month in PHOTOFACT!**

**SECOND-CLASS RADIOTELEPHONE LICENSE COURSE**

Take advantage of this special bonus offer Course! Will help you pass the exam for an FCC License, so you can upgrade your career in electronics and become an expert in communications. Course begins this month (in Photofact Set No. 561) as a bonus to PHOTOFACT subscribers. Be sure your Sams Distributor has your Photofact Standing Order subscription!

**SUBSCRIBE TODAY!**



**HOWARD W. SAMS & CO., INC.**

Howard W. Sams & Co., Inc., Dept. 7-A2  
1720 E. 38th St., Indianapolis 6, Ind.

Please enter my subscription to Photofact.

My Distributor is: \_\_\_\_\_

Send FREE Photofact Cumulative Index

Send Details on:  Easy Buy Plan  "Peet" Program

Shop Name \_\_\_\_\_

Attn.: \_\_\_\_\_

Address \_\_\_\_\_

City \_\_\_\_\_

Zone \_\_\_\_\_ State \_\_\_\_\_

# MALLORY SILICON



For top performance *every time*, use Mallory silicon rectifiers. From 50 to 600 PRV, you'll get all of the rating you pay for. You can stake your reputation on the quality of these rectifiers. They meet the standards required for military types, yet you don't have to pay premium prices. You'll get 750 ma up to +50°C and 500 ma at +85°C. Quality is

so high you won't even need equalizing resistors in most cases.

Available in parallel lead "T" type and axial lead "A" type from your nearest Mallory distributor, five to a pack, in a reuseable jewel box, on a handy file card.



#### ELECTROLYTIC CAPACITORS

Famous FP-WP metal can types, reliable TC tubulars, and tiny TT tubulars.



#### VIBRATORS

Sure-start Gold Label® and every other type for auto or mobile communications.



#### PVC CAPACITORS

Premium quality Mylar\* Capacitors in handy zip-lip package.

\*Reg. Trademark E. I. du Pont de Nemours, Inc.



#### STA-LOC® CONTROLS\*\*

30 second delivery on every imaginable control.

\*\*U.S. Patent 2,958,888



# RECTIFIERS STOP CALL-BACKS

... premium quality *now at new low price*

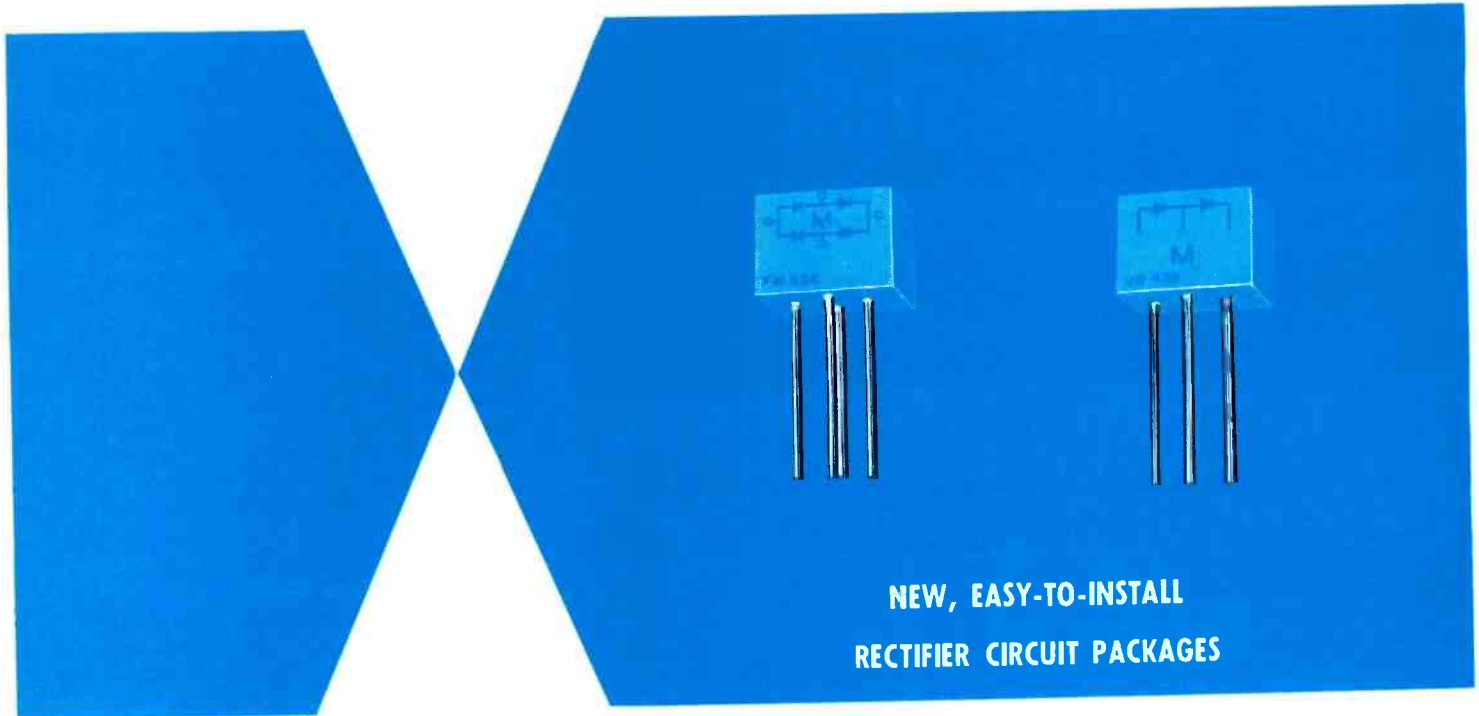

**NEW, EASY-TO-INSTALL  
RECTIFIER CIRCUIT PACKAGES**

These new Mallory silicon rectifier packaged circuits are a cinch to install, ideal replacements for selenium stacks. Two models: Type FW full wave bridge, rated 1.5 amp. at 50° C, 1.0 amp. at 100° C; 50 to 600 volt ratings. Type VB voltage doubler, .75 amp. at 50° C, .5 amp. at 100° C, in ratings from 50 to 600 volts. Cold case design, encapsulated in moistureproof resin. Ask your distributor today!



**DISCAPS®**  
The standard of the ceramic capacitor field.

® Trademark Radio Materials Company, a Mallory Division



**MERCURY BATTERIES**  
Get the details on the New Mallory Battery Program today.

Distributor Division, Indianapolis 6, Indiana



In Canada: A. C. Simmonds & Sons, Ltd., Toronto 7, Ontario

# REPLACEMENT PARTS

## FOR TRANSISTOR

### RADIOS

Most components are available somewhere . . . by Forest H. Belt

One of the most difficult service problems encountered these days is the procurement of replacement parts for transistor radios, especially for the imported variety. There are several reasons for this difficulty. First of all, these radios are usually very small, and the parts must conform to physical dimensions not usually found in any other home-electronics equipment. Secondly, an importer occasionally fails to make replacement parts available for the sets he imports. However, in the majority of cases, someone, somewhere, supplies the needed parts. Thus, the solution is simply a matter of finding these suppliers.

The serviceman who is faced with the problem of finding parts for a transistor portable can usually arrive at a solution in one of two ways. First, he can try substituting a similar part obtained from his local parts jobber or he may have to order a part from the manufacturer of the set, or from a supplier designated by the manufacturer.

As for substitutions with readily available parts, they are really quite practical in transistor radios. A lot of standard-

ization has taken place, both in circuitry and in the physical dimensions of parts—especially in the imported sets. Let's examine the various components, find out which ones are easy to substitute, and learn the precautions that are necessary in making substitutions.

#### Antenna and Oscillator Coils

The loopstick antenna coil is a most difficult part to locate on the market, and is also one of the most often-needed replacements. When a transistor radio is dropped, the component most likely to be damaged is the loopstick antenna. The ferrite core material used in many of these antennas is quite brittle, making it very susceptible to breakage. Mending the break is of little value, since the impact usually destroys the magnetic properties of the material. So the loopstick must be replaced. There are several considerations; the mounting is important, the physical dimensions vary with the size of the radio, and the electrical characteristics are not standardized because of input-circuit differences.

Substitution is one possible approach, either using a universal replacement or a similar antenna (perhaps one made for another model). If the sensitivity of the receiver can then be brought up to normal by alignment, the substitution is satisfactory. In the event it cannot, the customer must wait until a replacement is received from the manufacturer or importer.

Inductances of oscillator coils are much the same for most transistor radios, both domestic and imported; however, two physical sizes are found. In addition, two slightly different circuit configurations are commonly used in converter stages, as in Fig. 1. The basic difference between the two circuits is the method of obtaining feedback; the oscillator coil may be returned to either the base or the emitter of the transistor. The emitter-feedback system is the more widely used of the two, and coils are readily available for this type of circuit. Where mounting is a problem, or the other feedback system is used, you can sometimes cut out a portion of the printed circuit (with a razor blade) and wire the replacement coil into the circuit by means of short lengths of hook-up wire.

#### IF and AF Transformers

Most manufacturers use 455-kc IF transformers in their radios, although a few older sets have other IF frequencies (principally 262 kc). The 455-kc IF transformers fall into three physical categories, as a rule: Large square can, small square can, or round can. Of these, the round can is least used. Besides physical size, the location in the circuit must be taken into account, since there are distinct differences between first, second, and third IF transformers. They are similar, and can be interchanged in emergencies; but since their impedances are different, an improper substitution frequently results in lowered receiver sensitivity or stage oscillation. In a few sets, however, no detrimental effects are noted when IF transformers are interchanged.

At least one type of replacement part is not hard to find—audio driver and output transformers, both so standardized that mounting is practically the only consideration. They are available at most parts distributors, and several transformer manufacturers provide a line of replacements. Of course, the winding impedances must be considered. Service notes usually give the DC resistances of windings, which can be used in determining a suitable replacement. Voice-coil impedances, which you'll learn more about later, are not very critical.

As indicated, mounting is a more important consideration than electrical characteristics; therefore, physical dimensions should be chosen carefully when replacements are purchased. Some service shops keep a stock of one or two very small transformers, since these can normally be substituted for larger types by using the razor-blade technique described for oscillator coils.

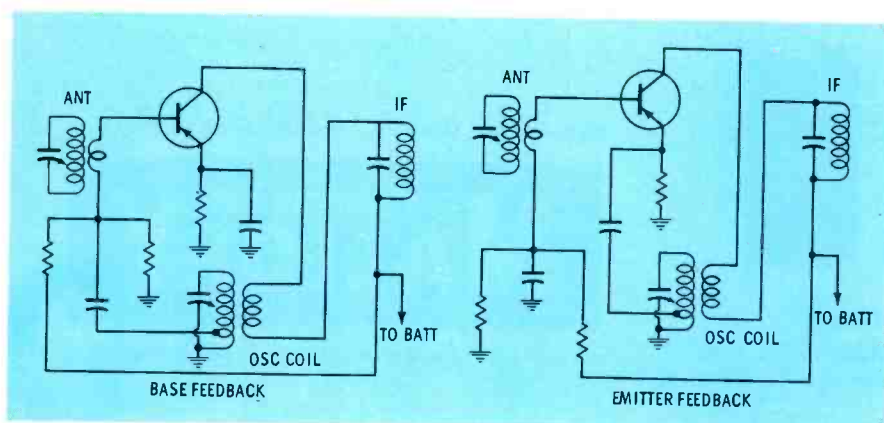

Fig. 1. Simple converter stages used in most transistor portable radios.

## Capacitors

Ceramic capacitors for transistor radios are the same as those used in non-transistorized equipment, except that much lower working voltages can be used, resulting in much smaller sizes. It is much simpler to replace a larger unit with one of smaller dimensions, and so the smaller-sized replacements should be chosen for transistor-radio repairs. For example, a ceramic capacitor with a 200-volt rating would be smaller than an equivalent component with a 600-volt rating. But for use in low-voltage transistor equipment, the 200-volt capacitor is quite satisfactory.

Electrolytic capacitors for transistor radios are easily found at local parts houses, because several parts manufacturers produce a complete line of miniature tantalum types for use in these receivers. The electrical characteristics of the original capacitor are the prime consideration in choosing replacements. In most circuits, a larger value of capacitance or voltage can be used — provided the mounting space is sufficient — but rarely is it advisable to use a smaller value. The wide range of available replacements makes substitutions unnecessary, except in the most extreme cases. Many capacitor manufacturers even furnish replacements in kits containing the most-used types—an easy method of keeping shelf stock.

Tuning capacitors can usually be substituted for one another, especially in the imported sets—provided the mounting problems are not too difficult. Sometimes, as with other components, a replacement can be used interchangeably in several sets by slightly altering the method of mounting. Experienced servicemen have found that almost any tuning capacitor will work satisfactorily if it can be properly mounted, since the same capacitance ranges are used in most receivers. As yet, no parts manufacturer has presented the service trade with a line of tuning capacitors, and replacements must usually be ordered from the distributor who handles parts for the set.

## Resistors and Controls

Resistors used in transistor radio circuits are usually 1/4-watt and 1/8-watt

• Please turn to page 74

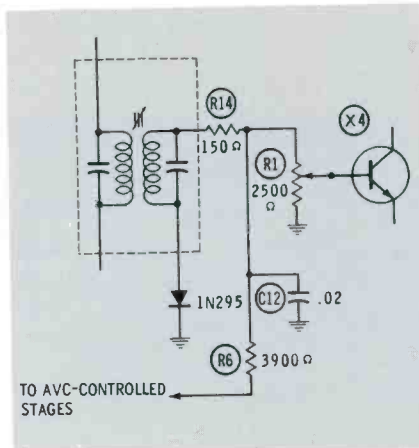

Fig. 2. Audio and AVC circuits could be upset by careless substitutions.

## Table I

### Brand

### Importer or Manufacturer

Aiwa	Aiwa Electric Co., Ltd., 15109 Broadway, Cleveland, Ohio
Arrow	Arrow Trading Corp., 1133 Broadway, New York City
Americana	Interocean Commerce Corp., 170 Broadway, New York City
Ardsley	Trade Distributors, Inc., 461 Fourth Avenue, New York City
Admiral	Admiral Corp., 3800 W. Cortland St., Chicago 47, Illinois
Airline	Montgomery Ward & Co., 619 Chicago Ave., Chicago, Illinois
Arvin	Arvin Industries, Columbus, Indiana
Argonne	see Lafayette
Brother	Brother Int'l. Corp., 36-50 38th St., Long Island City, N.Y.
Brighton	A & A Trading Co., 1140 Broadway, New York City
Benlioda	Marubeni Iida, 39 Broadway, New York City
Bulova	Electronics Guild, Inc., Sunrise Highway, Valley Stream, Long Island, N.Y.
Coronet	see Arrow
Crestline	see Canton-Son
Constant	see Canton-Son
Canton-Son	Canton-Son, Inc., 12 W. 27th St., New York City
Channel Master	Chunnel Master Corp., Ellenville, New York
Commodore	Commodore Import Corp., 74 Throop St., Brooklyn, New York
Continental	Continental Merchandise Co., 236 Fifth Ave., New York City 1
Cosmopolitan	Elize Mercantile of N.Y., 1140 Broadway, New York City
Crown	Shriro, Inc., 276 4th Avenue, New York 10, N.Y.
Candle	Toyama & Co., 855 Sixth Avenue, New York City
Calrad	Burstein-Applebee Co., 1012-14 McGee St., Kansas City 6, Mo.
Columbia	CBS Electronics, 100 Endicott St., Danvers, Mass.
Coronado	Gomble-Skogmo, Inc., 15 N. 3rd St., Minneapolis, Minn.
Delmonico	Delmonico International, 120-20 Roosevelt Ave., Corano, N.Y.
DeWald	DeWald Radio Mfg. Corp., 35-15 37th Ave., Long Island City 1, N.Y.
DuMont	Allen B. DuMont Labs., Inc., 257 16th Ave., Passaic, N.J.
Eterna	see Cosmopolitan
Emerson	Emerson Radio & Phono Corp., 524 W. 23rd St., New York 11, N.Y.
Excel	Excel Corp. of America, 9 Rockefeller Plaza, New York 20, N.Y.
Empire	see Ardsley
Fuji-Denki	Eisenberg & Co., 52 Broadway, New York City
Fujiya	Fujiya Corp., 405 Lexington Ave., New York City
Fleetwood	Panorama Enterprises, Inc., 1289 S. LaBrea, Los Angeles, Calif.
Firestone	Firestone Tire & Rubber Co., 1200 Firestone Pkwy., Akron, Ohio
General Electric	General Electric Co., Product Service, Radio Receiver Dept., 869 Broad St., Utica, New York
General	Trans-America Import & Export Co., 116 S. Michigan Ave., Chicago 3, Ill.
Global	Masuyama International Corp., 214 W. 14th St., New York City
Harpers	Harpers International, Inc., 315 5th Avenue, New York City
Hitachi	Sampson Co., Parts Dept., 2416 W. 23rd St., Chicago 8, Ill.
Holiday	see Americana
Hi-delity	Petely Sales Corp., 300 Park Ave. S., New York City
Hallcrafters	Hallcrafters Co., 4401 West 5th St., Chicago 24, Ill.
Hoffman	Hoffman Radio Corp., 6200 S. Avalon Blvd., Los Angeles 3, Calif.
Invictor	Toyomenka, Inc., 2 Broadway, New York City
Koyo	see Fleetwood
Kawa	Kawa American, Inc., 230 5th Ave., New York City
Lafayette	Lafayette Radio Co., 165-08 Liberty, Jamaica 33, N.Y.
Linmark	see Crown
Longwood	see Kowa
Little Pal	see Mantone
Matsushita	Matsushita Electric Corp., 41 E. 42nd St., New York City
Manhattan	see Mantone
Mantone	Mantone Radio Co., 263 Canal St., New York City
Mitsubishi	Lissner Trading Corp., 1111 N. Cherry St., Chicago 2, Ill.
Maco	Maco Electric Corp., 1776 Broadway, New York 19, N.Y.
Magnavox	The Magnavox Co., 2131 Bueter Rd., Fort Wayne 4, Ind.
Minute-Man	Intercontinental Industries, Inc., 555 W. Adams St., Chicago 6, Ill.
Mitchell	Mitchell Mfg. Co., 2525 Clybourn Ave., Chicago 14, Ill.
Motorola	Motorola, Inc., 4545 W. Augusto Blvd., Chicago 51, Ill.
Nanola (Nanoo)	Leopold Sales Corp., Box 276, Highland Park, Ill.
NEC	Halen Associates, Ltd., 125 Fifth Ave., New York City
Norelco	North American Philips Co., Inc., 230 Duffy Ave., Hicksville, N.Y.
Nipco	Omscolite Corp., Stokley St. and Roberts Ave., Philadelphia, Pa.
Olympic	Olympic Div., Siegler Corp., 34-01 36th Ave., Long Island City 1, N.Y.
Olimpic	Nichimen Co., 39 Broadway, New York City
Onkyo	Sonyo Trading Co., 149 Broadway, New York City
Olson	Olson Radio Corp., 260 S. Forge St., Akron 8, Ohio
Packard-Bell	Packard-Bell Co., Service Div., 11th & Hope Sts., Los Angeles 15, Calif.
Philco	Philco Corp., Tioga & C Sts., Philadelphia, Pa.
Petite	Sterling Hi Fi Co., 50-27 38th St., Long Island City, N.Y.
Realtone	Realtone Electronics, 184 5th Ave., New York 10, N.Y.
Realistic	see Brighton
RCA Victor	RCA Victor Radio Div., Camden 8, N.J.
Raytheon	Raytheon Mfg. Co., TV & Radio Div., 5921 W. Dickens, Chicago 39, Ill.
Regency	Regency Div., I.D.E.A., 7900 Pendleton Pike, Indianapolis 26, Ind.
Rockland	Rockland Precision Mfg. Co., Inc., Orangeburg, N.Y.
Roland	Roland Radio Corp., 716 S. Columbus Ave., Mt. Vernon, N.Y.
Rabin	Capital Appliance Distr. Div., 1201 W. Washington, Indianapolis, Ind.
Sentinel	Sentinel Radio Corp., Fort Wayne 4, Indiana
Sharp	see Invictor
Silvertone	Sears, Roebuck & Co., 925 S. Homan Ave., Chicago, Ill.
Sonic	Sonic Industries, Inc., 19 Wilbur St., Lynbrook, N.Y.
Sonora	Sonora Radio & TV Corp., 325 N. Hayne Ave., Chicago, Ill.
Sony	Sony Corp. of America, 514 Broadway, New York City
Spartan	Spartan Div., 2131 Bueter Rd., Fort Wayne, Ind.
Standard	Polyrad Corp., 521 Broadway, Cincinnati 2, Ohio
Superex	Superex Electronics Corp., 4-6 Radford Place, Yonkers, N.Y.
Sylvania	Sylvania Home Electronics Div., 700 Ellicott St., Batavia, N.Y.
Star-lite	Starlite Merchandise Corp., 37 W. 23rd St., New York City
Spica	see Americana
Toptone	Gosho Trading Co., 50 Broad St., New York City
Toshiba	Transistor World Corp., 52 Broadway, New York City
Ten	see Onkyo
Trancel	see Excel
Trav-Ler	Trav-Ler Radio & TV Corp., 571 W. Jackson Blvd., Chicago, Ill.
True-tone	Western Auto Supply Co., 2107 Grand Ave., Kansas City 8, Mo.
TWI	Transworld Industrial Corp., 5204 Hudson Ave., West New York, N.J.
Universal	see Olimpic
Viscount	Consolidated Sewing Machine Corp., 1115 Broadway, New York City
Watterson	J. W. Davis Co., 9212 Denton Dr., Box 35313, Dallas, Texas
Wilco	see Onkyo
Westinghouse	Westinghouse Electric Corp., Radio-TV Div., Metuchen, N.J.
Yashica	Yashica, Inc., 50-17 Queens Blvd., Woodside 77, N.Y.
Zenith	Zenith Radio Corp., 6001 Dickens Ave., Chicago 39, Ill.
Zepher	Eastern Associates Ltd., 214 Mission St., San Francisco, Calif.

# CHECKING UP ON

There's more to video troubleshooting than

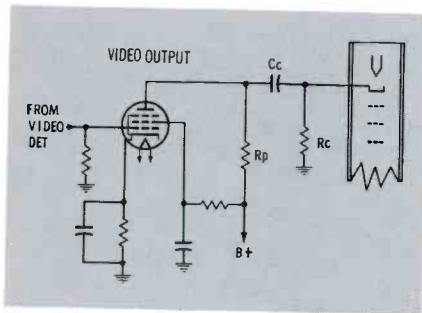

Fig. 1. Low frequencies in video signal are attenuated by reactance of  $C_c$ .

The video amplifier is one of the most neglected circuits in a TV receiver. Since a picture will often be obtained even when the video circuit is not operating properly, many sets with defective video amplifiers never reach the shop unless they are brought in for repair of some other defect. Even then, the video problem is too often ignored by the technician, who is anxious to cure the complaint and return the set to the customer. A little time spent in examining the video quality of all sets can pay off in improved professional standing and greater profits for a service shop. For instance, it would be good for a serviceman's reputation (and thus his pocket-book) if a customer whose set had been brought in for repair of a defective sync circuit could say that his picture was better than before the sync trouble occurred.



Fig. 2. "Trailing reversals" are due to phase distortion at low frequencies.

To do an efficient job of checking and repairing video circuits, it is necessary to be aware of all the things that can go wrong with them. This requires a thorough knowledge of how these circuits normally operate.

The video circuitry of a TV receiver includes all stages and components from the video detector through the input of the picture tube. The composite video signal to be amplified is made up of horizontal and vertical sync and blanking pulses, as well as complex video waveforms. In order to amplify the many frequencies present in this signal, the video amplifier should have a frequency response from 60 cps to approximately 3 or 4 mc. In addition, it must boost the amplitude of the signal from a few volts to 50 or sometimes as much as 200 volts.

Earlier receivers employed two or more stages of amplification in order to obtain the necessary gain and response. Multistage amplifiers were necessary because the compensating methods used then and now sacrifice gain in order to obtain increased response. In the last few years, however, new tubes with very high transconductance have made it possible for receivers to provide more gain with only one stage of video amplification than used to be obtainable with two stages.

Video-frequency amplifiers usually use resistance coupling similar to that used in audio amplifiers. However, the requirements for a video amplifier are much more exacting than those for an audio amplifier, and it is necessary to add circuit elements that improve the bandpass at both low and high frequencies.

## Low-Frequency Compensation

The circuit element which detracts most from the low-frequency

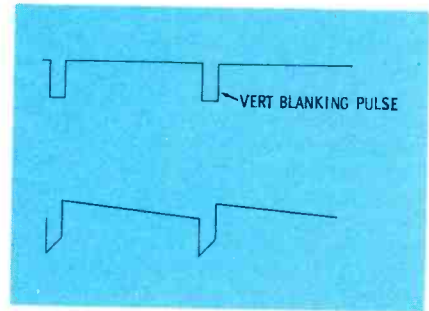

Fig. 3. Low-frequency phase shift can also cause tilt of waveform baseline.

response of an amplifier is the output capacitor ( $C_c$  in Fig. 1). The phase-shifting effect of this capacitor is more serious than the effect on amplification. As the frequency of the signal being amplified decreases, the reactance of the capacitor increases. The voltage drop across the capacitor then increases, with the result that less voltage is developed across the input resistance of the next stage. (In Fig. 1, a smaller voltage appears across  $R_c$ , the cathode-load resistor of the picture tube.) In addition, the increasing reactance of the coupling capacitor causes the phase of the output signal from the stage to lead that of the input. Phase distortion usually can be noticed in the picture as white streaks trailing the black portions of the video, as shown in Fig. 2. It is also possible for tilt to be present on the baseline of the

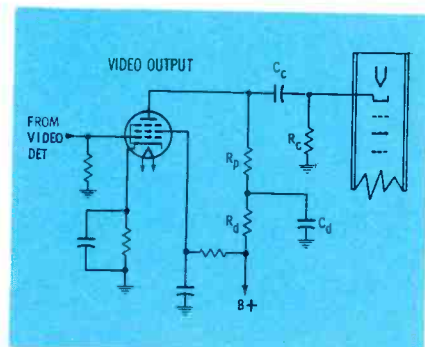

Fig. 4. Decoupling network ( $R_d$  and  $C_d$ ) opposes low-frequency effect of  $C_c$ .

# VIDEO AMPLIFIERS

just restoring a picture . . . by Jim Galloway

composite waveform, as in Fig. 3. Baseline tilt usually causes the picture to be shaded so that the bottom portion appears brighter than the top.

While the phase distortion introduced by the coupling capacitor can be lessened by using a large capacitor and grid resistor, it is usually more practical to introduce elements in the circuit that cause a phase lag between the output and input signals — thereby neutralizing the effect of the coupling capacitor. The amplifier in Fig. 4 contains the required additional elements,  $C_d$  and  $R_d$ , which form a decoupling network in the plate circuit. These two components neutralize the effects of the output coupling capacitor and extend the response of the amplifier down to the required 60 cps.

If there is a bypassed cathode resistor in the circuit, the value of the bypass capacitor must be large; otherwise, it will have a high reactance at low frequencies, and in effect the cathode resistor will not be bypassed at the low end of the band. If this is the case, low-frequency degeneration will occur, and the output of the amplifier will be substantially reduced toward the lower end of the video band.

The screen-bypass capacitor will cause some low-frequency phase

distortion, but this is usually compensated for in the same manner as that of the coupling capacitor.

## High-Frequency Compensation

The high-frequency response of an amplifier is limited primarily by the input capacitance of the picture tube ( $C_i$ ) and by the output capacitance of the video amplifier ( $C_o$ ). These capacitances present a decreasing impedance to the signal as the frequency of operation increases, thereby shunting the plate and grid resistors  $R_p$  and  $R_g$  (see Fig. 5), and decreasing the gain of the stage. The obvious solution would be to make the values of these resistors small, so that a given amount of shunt reactance will produce less change in the total impedance of the plate-load circuit. However, the over-all gain of the amplifier will suffer from the decreased value of these resistors, and therefore their values must be based on a compromise between over-all gain and high-frequency compensation.

Additional compensation is usually obtained by a method referred to as peaking. Two types of peaking, shunt and series, are commonly employed in video amplifiers. Shunt peaking is the result of placing a peaking coil ( $L_p$  in Fig. 6) in series with the plate load of the amplifier.  $L_p$  forms a parallel resonant circuit with output capacitance  $C_o$  at a frequency toward the upper end of the video range, and increases the gain of the stage at this resonant frequency by increasing the plate-load impedance of the tube. The  $Q$  of the coil should not be too high, so that peaking will not be too sharp. In actual TV circuits, peaking coils are usually shunted by resistors to lower the value of  $Q$ .

For series peaking, a coil ( $L_s$  in

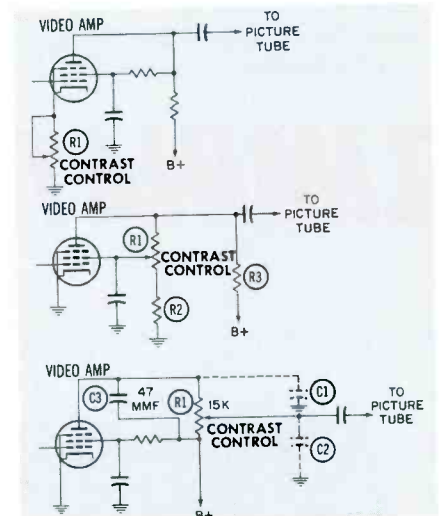

Fig. 7. Three types of contrast-control circuits employed in TV receivers.

Fig. 6) is placed in series with the signal path to form a series resonant circuit at a high video frequency. This resonant circuit presents a low impedance to the higher frequencies and allows a larger value of plate-load resistor to be used. This type of peaking also reduces the shunting effect of  $C_i$  by isolating it from  $C_o$ . Television receivers often use a combination of both types of peaking.

## Contrast Controls

Many viewers fail to recognize the difference in operation between the contrast and brightness controls,

• Please turn to page 68

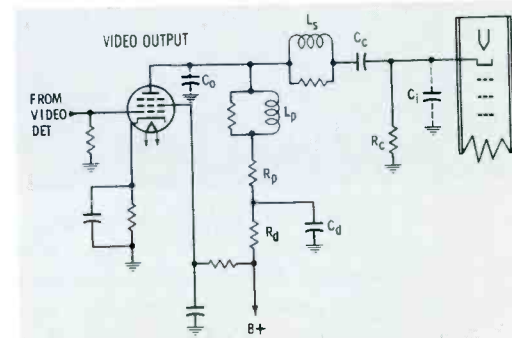
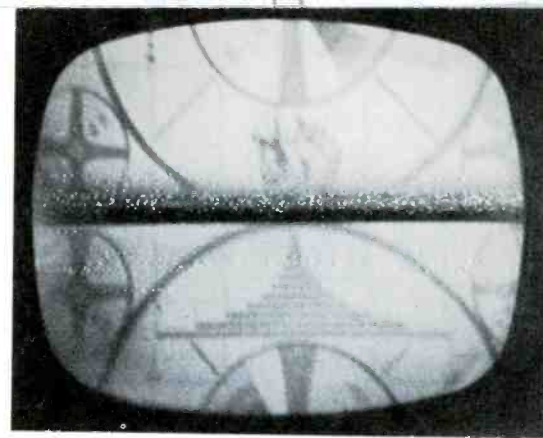
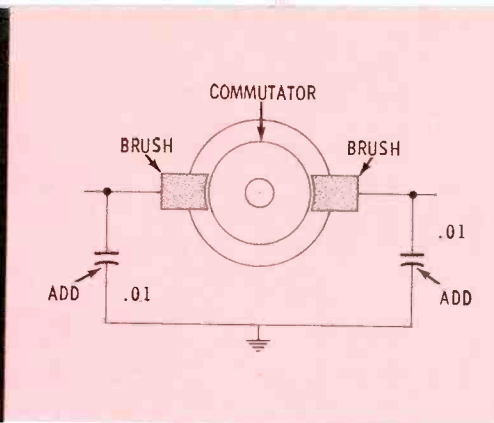
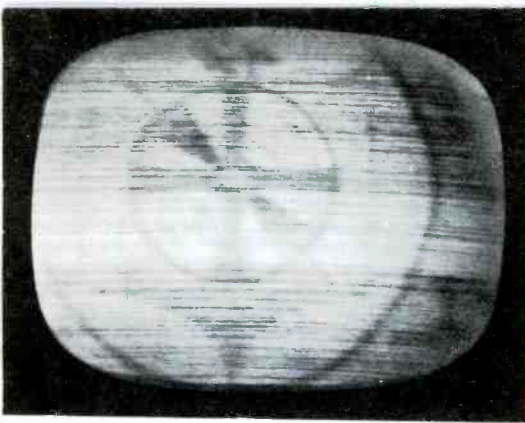

Fig. 6. Series resonant circuit, including  $L_s$ , peaks high video frequencies.



Any small motor of the brush type can cause interference if excessive arcing is present between the brushes and the commutator. Resurfacing or replacing the brushes is the usual cure, but it may also be necessary to install a simple filter like the one shown here. The capacitors are .01-mfd ceramics and should be installed as close as possible to the brushes.

Electric ranges of the old open-wire type often cause this interference pattern. Cleaning the switch contacts will sometimes help, but the only sure cure is to get rid of the range!

# ELIMINATING



RF noise is as old as radio itself. In the frequency range used for television, almost any type of interference can become intolerable. Here are some tips (from actual case histories) that should help in determining the cause of non-atmospheric interference. Included are some helpful cures that have been successfully used in the past.

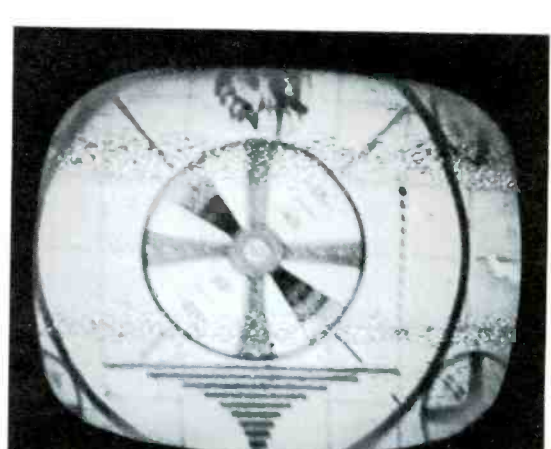
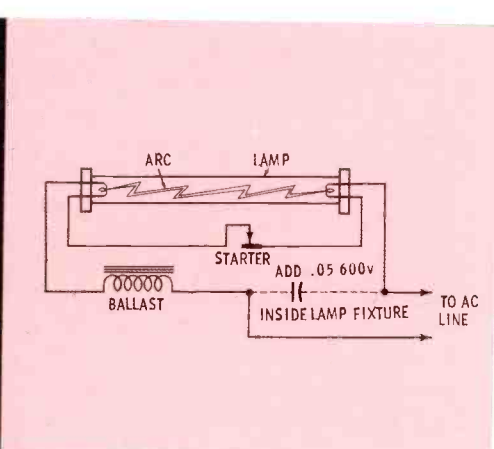
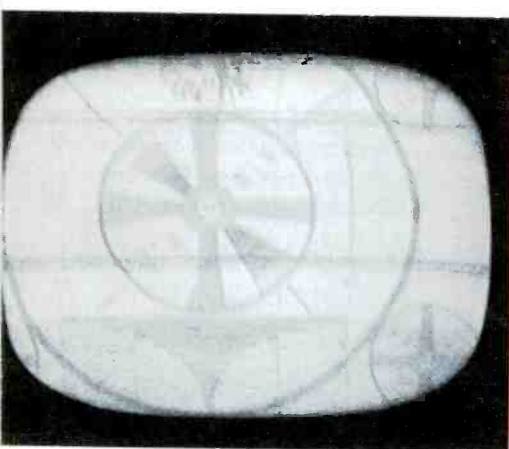

Fluorescent lights may produce the pattern shown in this picture. While fairly elaborate filters may be necessary to remedy this condition, it can often be corrected by wiring a .05-mfd, 600-volt capacitor across the line.

Power-line interference is characterized by two bars, composed of flashing dots, which may creep up or down the screen. One bar may be more prominent than the other, but both are always present.

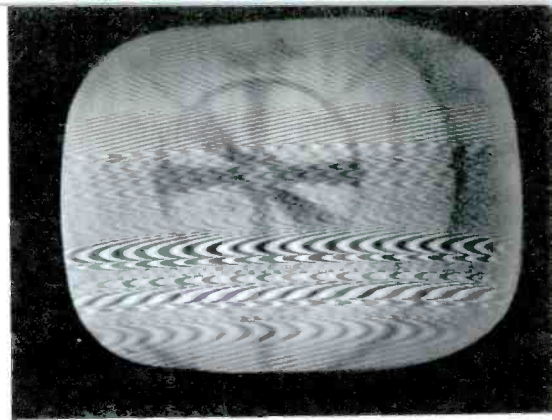
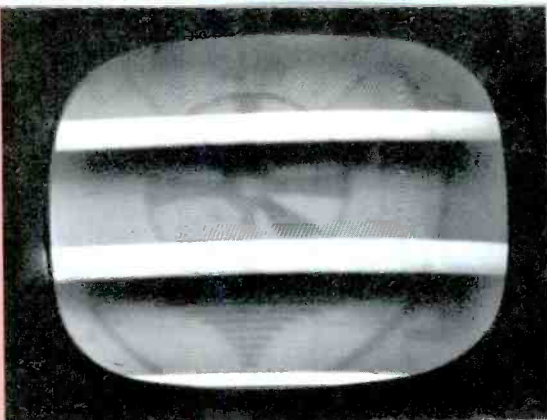
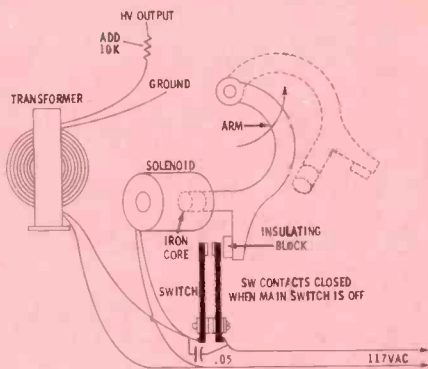

In rural areas, electric fences often make hash of a TV picture. The auxiliary diagram shows the pulsing system used for most fences. The arm closes the switch contacts which energize the HV transformer. In addition, the contacts apply current to the solenoid which repels the arm. The interference problem can be cured by adding a capacitor across the switch contacts and a damping resistor in series with the high-voltage line.

FM-transmitter interference usually shows up as herringbone, wavy lines, and assorted streaks. These patterns are continually in motion, following the modulation of the FM carrier. The interference appears only intermittently—whenever the transmitter is keyed. The operator of the interfering station should be notified that his transmitter may be defective.

Although similar to transmitter interference in appearance, FM-receiver radiation usually differs in that it is present for long periods of time. Use a field-strength meter to locate the defective receiver, and advise the owner that his set needs additional shielding. Usually the local oscillator is the cause of such radiation; however, the mixer is sometimes at fault.

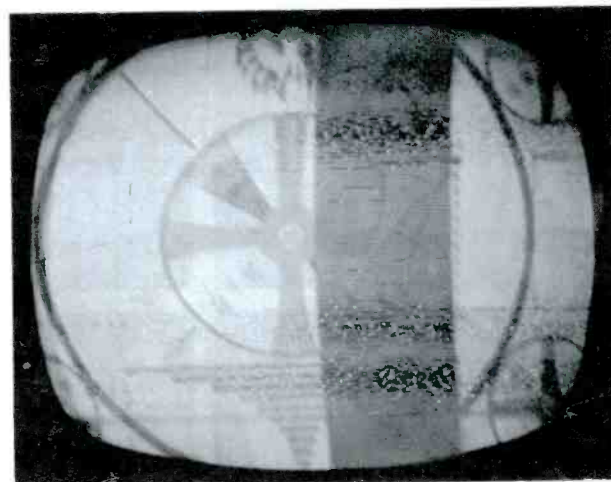
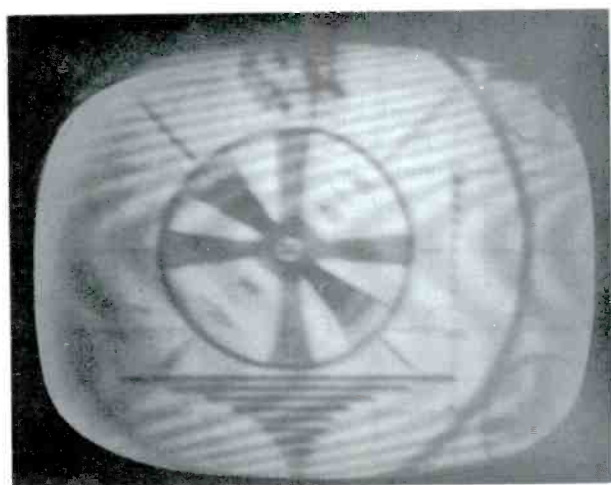
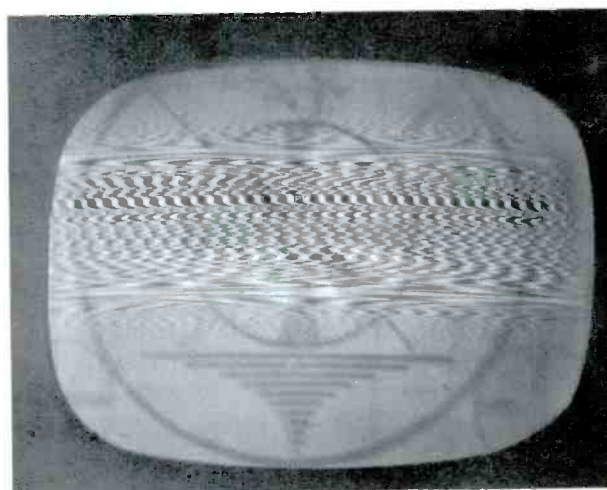

Booster-oscillation interference can easily be recognized by its disappearance when power is removed from the booster. (Incidentally, thermal-type booster switches often become inoperative and fail to turn off the equipment at scheduled times.) If no circuit trouble can be located, additional shielding may help.

Community cable systems sometimes radiate signals to nearby sets not connected to the system. Since these reradiated signals have been delayed by passage through the transmission lines in the system, they produce ghost images on the screen. The company operating the community system should be notified of the problem.



# Getting Rid of the Christmas Tree



Any day now, the average householder will drag the family Christmas tree out into the yard and put a match to it. He may be inclined to give his TV set the same treatment, if it displays the exasperating trouble symptom known to servicemen as "Christmas-tree effect." When a set behaves this way, the owner probably thinks it is ready to burn itself up in \$50-\$100 worth of smoke. However, you can reassure him that this trouble can be corrected for a comparatively small fee. It's not as menacing as it looks, and it isn't hard to pinpoint once you have the set on the bench.

The term, "Christmas-tree effect," as it is generally understood by TV technicians, applies to any of the trouble symptoms shown in Fig. 1. In the words of an excited customer, "It makes streaks and stripes, and goes *Weech! Weech! Weech!*" This

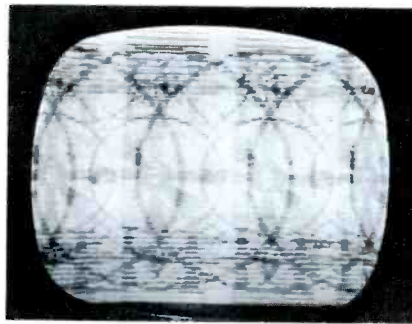

Fig. 2. This symptom—with overlapping images—is not Christmas-tree effect.

is your clue that the horizontal oscillator is being triggered at irregular intervals, or is intermittently dropping in and out of oscillation. In either case, the sawtooth wave fed to the horizontal output tube is erratic in both frequency and amplitude. The squealing noise which results is the outraged flyback, howling at being fed such a sloppy waveform! Because of the wild variations

in the drive signal, the raster breaks up into a random pattern of flashing, jumping lines. These are of unequal length, thus giving the raster a ragged-edged appearance.

Some of the earliest TV sets also had a tendency to produce shorter lines at the top of the raster than at the bottom, probably as a result of interaction between the vertical and horizontal sweep or sync circuits. This gave the faulty raster a somewhat tapered appearance — which, together with the zigzag edges, suggested the outline of a Christmas tree. Therefore, the symptom received the nickname of "Christmas-tree effect." This name still persists, but it has lost much of its descriptiveness because present-day sets generally develop a simple jagged-line pattern with no tapering. If the symptoms in Fig. 1 have never reminded you of shaggy pine branches, don't blame it on your lack of imagination.

Several other terms are also used by servicemen to describe the same type of symptom. Among the most common words are *squegging* and *gunboating*, which both imply intermittent oscillation. Another name, *mode-hopping*, indicates that the oscillator is jumping back and forth from normal to abnormal forms of operation.

Occasionally, one of the symptoms in Fig. 1 is caused by an intermittent breakdown in the flyback or yoke circuit; however, most troubles of this type are due to malfunctions of the horizontal oscillator or AFC stage. Incidentally, it is important to avoid confusing the Christmas-tree effect with another horizontal oscillator - AFC defect that produces the symptom shown in Fig. 2. This trouble also causes a somewhat ragged-looking raster, with loud "singing" from the fly-

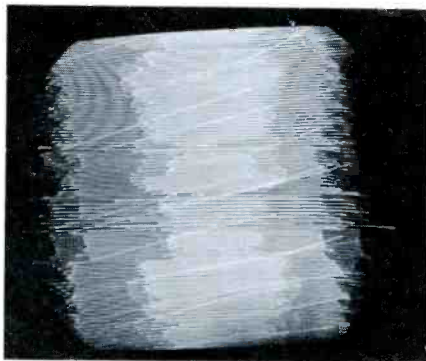
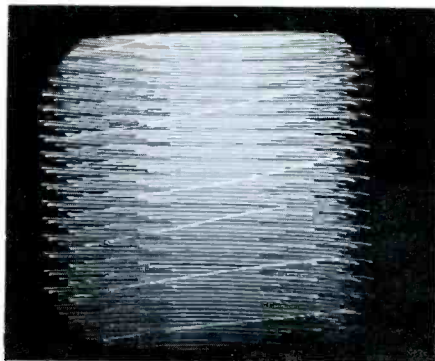

Fig. 1. "Christmas-tree" symptom takes several forms.



back; however, note that overlapping picture segments are clearly visible. Two or more complete pictures would mean the horizontal oscillator is locked into sync at some submultiple of the normal frequency—7875, 5250, or even 3937.5 cps. The causes and test indications for this trouble are considerably different from those for Christmas-tree effect. When the latter symptom is present, the oscillator is attempting to operate near the correct frequency (15,750 cps), but is unstable.

### Stumbling Synchroguide

The popular *Synchroguide* circuit (Fig. 3) is especially prone to break into erratic triggering or squegging as a result of misadjustments or circuit defects. The key to this behavior is the horizontal waveform coil in series with the oscillator plate load. If this coil is correctly tuned, the oscillator frequency is extremely well stabilized; on the other hand, the circuit will operate better with no waveform coil at all than with a misadjusted coil.

The waveforms in Fig. 4 will help to explain this point. These photos were obtained with the aid of a low-capacitance probe, which had some loading effect on the circuit, but which did not disturb it enough to prevent making useful observations.

Fig. 4A is the familiar "hump-spike" waveform observed on the oscillator-plate side of a properly-adjusted waveform coil. A sine wave—developed across the parallel resonant circuit consisting of the coil and C101—is superimposed on the basic sawtooth waveshape of the oscillator-plate signal. Feedback of this signal to the grid of the oscillator (through C100) causes the grid waveform to appear as in Fig. 4B. Note the gradual, fairly linear rise in grid voltage through most of each cycle, and the steeper climb just prior to the triggering time for the next cycle. Since there is a more rapid change in voltage at the most critical time in the sweep cycle, the oscillator is more likely to "fire" at exactly the correct instant. Therefore, oscillator stability is increased.

Now let's see what happens when the waveform coil is misadjusted so that the rounded hump in the plate waveform rises higher than the sharp sawtooth peak (Fig. 4C).

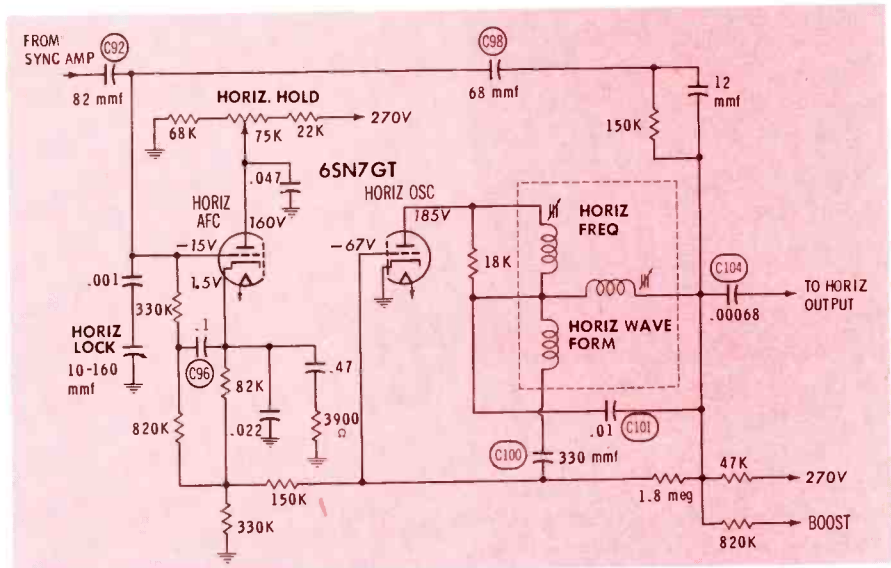

Fig. 3. *Synchroguide* often develops "Christmas-treeing."

This exaggerated sinewave hump, when fed back to the oscillator grid circuit, causes the grid voltage to be higher than normal during the early part of each sweep cycle, as in Fig. 4D. Note that the voltage rises uncomfortably close to the level at which the oscillator tube will be driven into conduction. In fact, only a slight loss of negative bias voltage on the grid will cause the oscillator to "fire" occasionally on sine-wave peaks. Squegging will then begin.

When the waveform coil is incorrectly set, a slight change in the setting of the horizontal hold control may be sufficient to induce squegging. Misadjustment also magnifies the effect of any AFC or oscillator fault which tends to reduce the bias on the oscillator.

Under certain conditions, a trouble which would ordinarily generate squegging or "Christmas-treeing" may cause the raster to lock into the stable pattern shown in Fig. 5. The horizontal-oscillator waveforms observed at this time give further insight into the Christmas-tree symptom.

The oscillator-plate signal (Fig. 6A) has a regularly-recurring waveform which can be synchronized on the scope screen. However, each two cycles of a normal waveform are replaced by three unequal cycles of oscillation. The waveform-coil circuit attempts to maintain a normal sine-wave signal component, and the RC discharge circuit of the oscillator tries to keep up the normal sawtooth-wave pattern; but the relationship between these two por-

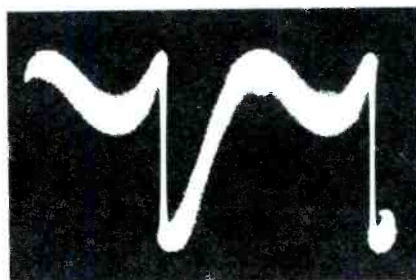

(A) At top of waveform coil—normal.

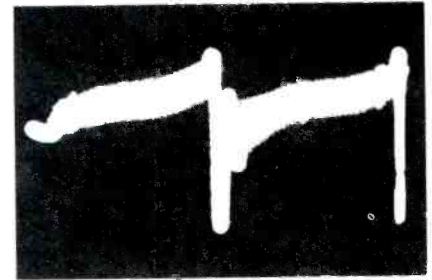

(B) At oscillator grid—normal.

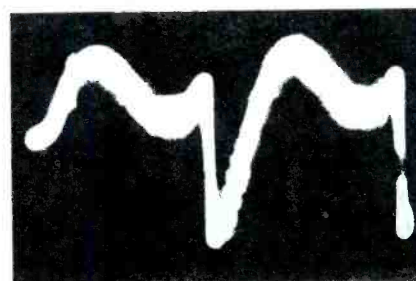

(C) At waveform coil—misadjusted.

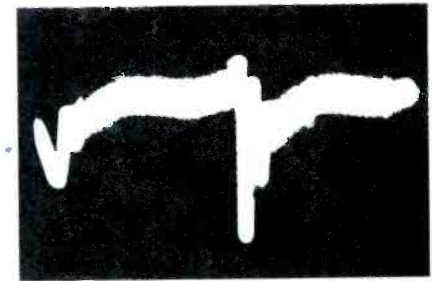

(D) Oscillator grid—misadjusted.

Fig. 4. Waveforms for Fig. 3.

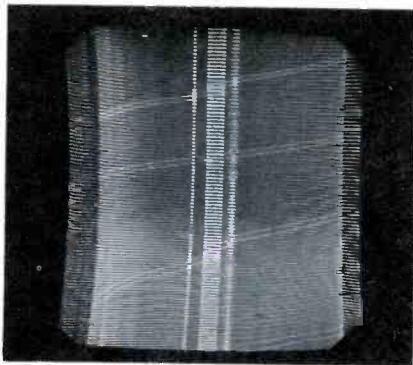

Fig. 5. The cause of this pattern is the same as for Christmas-tree effect.

tions of the plate signal is upset. Periodic triggering of the oscillator by sine-wave peaks causes the relative phase of the sine wave to differ from cycle to cycle; therefore, the discharge of the RC network is speeded up on some cycles, and retarded on other cycles. The surprising thing is that the horizontal sweep follows a consistent pattern!

Figs 6B and 6C show the oscillator-grid and output-tube drive signals (equivalent to four cycles of normal oscillation) when the symptom of Fig. 5 is present. The jagged drive waveform accounts for the "backtracking" of horizontal sweep which is evident in the raster.

#### Causes and Cures

If the waveform coil of a *Synchroguide* circuit is not accurately tuned, anything that decreases the bias on the oscillator tube will tend to induce Christmas-tree effect. Thus, the oscillator may squeg when the horizontal hold control is reset for an increase in operating frequency — even though nothing is really wrong with the circuit.

Even in a properly-adjusted circuit, a slight amount of squegging at one extreme setting of the hold control may be considered normal. However, any more than a bare minimum of squegging — accompanied by a narrow lock-in range — may be a tip-off to circuit trouble. Several capacitors in the circuit of Fig. 3 (particularly C100, C96,

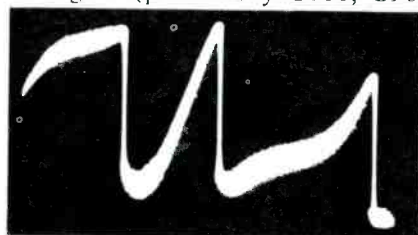

(A) Across horizontal waveform coil.

and C92) can cause Christmas-tree effect if they become even slightly leaky. C98 could possibly produce the same symptom, but it is more apt to cause a drastic change in oscillator frequency (or even kill the oscillator) if it leaks. C101, across the waveform coil, is less sensitive to leakage; however, a change in the value of this capacitor can cause a type of Christmas-tree effect by altering the frequency of the sine-wave portion of the plate signal.

#### Multivibrators

The familiar cathode-coupled horizontal multivibrator (Fig. 7) is less likely than the *Synchroguide* to develop the Christmas-tree symptom. One reason is that the sine-wave stabilizing signal developed across ringing coil L23 is relatively low in amplitude. A misadjustment of this coil can cause instability, but not to such a great extent as in the *Synchroguide* circuit.

In the unlikely event of random-frequency oscillations in a multivibrator, the possibility of ringing-coil trouble can be checked by simply shorting across the coil. Another part of the circuit which should be checked is the AFC filter network. If C68 in Fig. 7 became open, for example, the control voltage fed from the AFC stage to the multivibrator would be incompletely filtered. In this case, there might be enough ripple in the control voltage to cause fluctuations in the frequency of the multivibrator; the results would be somewhat similar to Christmas-tree effect. It's very unlikely that you'll find this trouble in a receiver which has more than one shunt capacitor in the AFC filter, since two or more open capacitors in the same circuit are an uncommon coincidence.

#### Subminiature Signal Source

A compact, but versatile, instrument, the *Metrex "Genie"* is a tran-

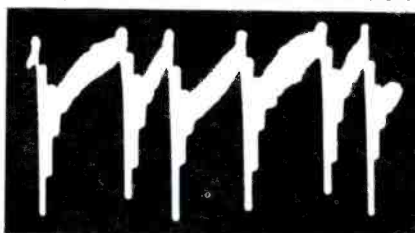

(B) Oscillator grid (at 3937.5 cps).

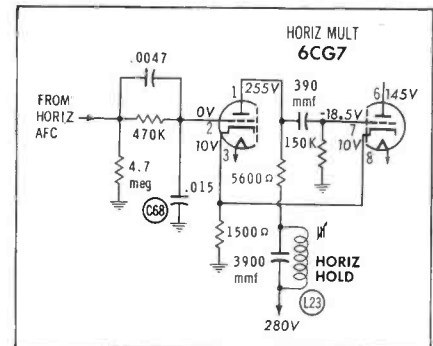

Fig. 7. Cathode-coupled multivibrator is more immune to "Christmas-treering."

sistorized signal generator capable of a number of service functions. Measuring only 3½" x 2¾" x 1½", weighing a total of 12 ounces, this miniature signal source can be readily carried along on any service job. It will even fit into a shirt pocket.

Two transistors are wired as a pulse-switching oscillator, and the output is a series of short-duration pulses ranging in frequency from about 20 cps to over 3 mc. A control in the panel adjusts the amplitude of the output.

The sharp leading edge of each pulse, when applied to a resonant network, will shock-excite the circuit into producing a damped wave. By applying a continuing train of pulses, the "Genie" can maintain this oscillatory action. In this way, energy can be passed on to succeeding stages by normal action of the tuned circuit.

We used the "Genie" to troubleshoot a small transistor radio. In the audio and IF stages, the generator proved its ability as a signal-injection device. When using it for troubleshooting the RF circuits, we couldn't help wishing it were a modulated-RF type generator, but it pushed a signal through as anticipated, establishing that the RF amplifiers were operative. We found it a very convenient instrument, particularly because of its small size, portability, and controllable output.

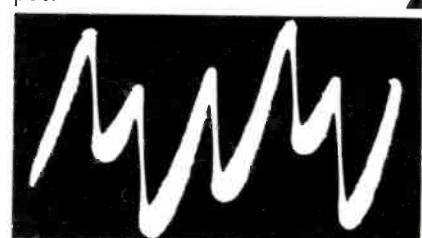

(C) Drive signal (at 3937.5 cps).

Fig. 6. Waveforms related to Fig. 5.

# SENCORE Simplifies SERVICING

with 17 "made for the job" tools that pay for themselves in time saved

## SENCORE Simplifies TUBE TESTING

### SENCORE MIGHTY MITE TUBE CHECKER

A complete tube tester that is smaller than a portable typewriter yet outperforms testers costing hundreds of dollars. A real money maker for the serviceman and a trusty companion for engineers, maintenance men and experimenters. The original Mighty Mite has been acclaimed from coast to coast as the real answer for the man on the go. Even though the Mighty Mite weighs less than 8 pounds, new circuitry by Sencore enables you to use a meter to check grid leakage as high as 100 megohms and gas conditions that cause as little as one half microamp of grid current to flow. Then too, it checks for cathode current at operating levels and shorts or leakage up to 120,000 ohms between all elements. And it does all this by merely setting four controls labeled A, B, C, & D.

Check these plus Sencore features . . . Meter glows in dark for easy reading behind TV set . . . Stainless steel mirror in cover for TV adjustments . . . Rugged, all steel carrying case and easy grip handle. . . Smallest complete tester made, less than one foot square.

And now comes Mighty Mite II as shown here. This improved version will test every radio and TV tube that you encounter, nearly 2000 in all, including foreign, five star, auto radio tubes (without damage) plus the new compactrons, Novar, Nuvistor, and 10 pin tubes. Mighty Mite II also has larger, easy-to-read type in the set-up booklet to insure faster testing. Size: 10 1/4" x 9 1/4" x 3 1/2".

Model TC114

Dealer Net ..... \$67.50

Checks them  
all . . . finds  
them fast.



Fast . . . accurate . . .  
never lets you down

### NEW TM116 TUBE TESTER MODERNIZING PANEL . . .

Now, you can test all of these new tubes in the Sencore Mighty Mite or any other tube tester except the "cardomatic" type. Don't throw away your tube tester just because you can't check the RCA Nuvisitors, the GE compactrons, the Sylvania 10 pin tubes or the all new RCA Novars.

These new tubes which are the industry's answer to the transistor are causing a revolution in electronics today. Thousands are being installed in electronic equipment every day from coast to coast. You will be called on to test them tomorrow. Be prepared with the TM116 tube tester modernizing panel.

Tests are made by plugging the TM116 into an octal socket on your tester and setting controls from the chart provided with the unit. All tests are the same as your tester now makes. Some other adaptor units merely reduce all tests to an emission check. Sencore uses additional internal circuitry to provide complete mutual conductance or high grid leakage checks if your tester now makes them.

You can own the TM116 for less money than it costs to keep substitutes in your shop or lab.

TM116

Dealer Net \$24.95



### FILAMENT CHECKER FC4

The ideal tool for servicing series string filaments. Purposely works off your cheater cord to give you a positive check on line voltage. Only checker that checks all tubes automatically and has no batteries to replace. Cost half that of battery operated testers. Patented.

FC4 Dealer Net ..... \$2.75



### VIBRA-DAPTER VB2

Checks 3 and 4 prong Vibrators Faster and Easier. Plugs into any tube checker; ideal for use with LC3 or the Mighty Mite. To check 6v. vibrators, set for 6AX4 or 6SN7; for 12v. vibrators, set for 12AX4 or 12SN7. Two No. 51 lamps indicate whether vibrator needs replacing. Instructions on front panel.

VB2 Dealer Net ..... \$2.75



# SENCORE Simplifies TRANSISTOR TESTING

## SENCORE TRANSI-MASTER-TR110

A new transistor tester that will analyze the entire transistor circuit in minutes. Transistors can be checked in-circuit or out-of-circuit. Here is how it works:

First, check the batteries or power supply with the 0 to 12 volt voltmeter. Next, check the current drain with the 0 to 50 milliamp meter. A special probe is provided so that you do not need to break the circuit. Intermittents caused by cracked boards can be localized by the current check.

If trouble is not located by now, isolate the trouble to a specific stage by touching the output of the harmonic generator to the base of each transistor and note spot where sound from speaker (or scope where no speaker is used) stops or becomes weak. The generator becomes a sine wave generator for audio stages to help find distortion.

If trouble points to a transistor, check it in a jiffy with the exclusive in-circuit power oscillator check provided by the TR110. A special probe is also provided for this.

If the transistor checks bad in-circuit, remove it and give it an out-of-circuit check with the oscillator check or the more accurate DC check.

The DC check is provided for comparison reasons, experimental or engineering work and to match transistors in audio output stages. Beta (current gain) is read direct or on a good-bad scale for service work.

**Model TR110** Dealer Net ..... **only \$49.50**



*Tests all transistors in-circuit or out-of-circuit*

### Model TR110

**It's a COMPLETE TRANSISTOR TESTER**

- SIGNAL TRACER • VOLTMETER
- BATTERY TESTER • MILLIAMMETER



### TRANSISTOR — DIODE CHECKER TR115

Here is a low cost tester that has become America's favorite. The TR115 provides the same DC out-of-circuit checks as the TR110; leakage and current gain. Current gain (Beta) can also be read direct or as good or bad. Opens or shorts in the transistor are spotted in a minute. The TR115 checks them all from power transistors to the small hearing aid types. Japanese equivalents are listed also. This famous tester is used by such companies as Sears Roebuck, Bell Telephone and Commonwealth Edison. New circuit enables you to make service checks without set-up charts even though charts are provided for critical checks.

Dealer Net ..... **\$19.95**



### BATTERY ELIMINATOR — TROUBLE SHOOTER PS103

Replaces Batteries During Repair. Many servicemen say that they wouldn't service transistor circuits without this power supply. The tried and proven PS103 is a sure fire answer. It can be used to charge the nickel cadmium batteries as well. Dial the desired output from 0 to 24 volts DC and read on meter. Low ripple insures no hum or feedback. Total current drawn can also be read on the PS103 by merely flicking the function switch to milliamps. The PS103 is the only supply that will operate radio with tapped battery supplies such as Philco, Sylvania, and Motorola. No other supply has a third lead.

Dealer Net ..... **\$19.95**



### HARMONIC GENERATOR HG-104

Finds Defective Stage in a Minute... a real time saver. Just touch the output leads of the HG104 to inputs and outputs of transistors and a clear 1000 cycle note from speakers will tell you whether or not the stage is defective. Here is an unexcelled time saver, not a "pencil" gimmick. It actually works every time from speaker to antenna. Two leads and calibrated output (not found on pencils) are a must for speaker connection, grounding to prevent RF spray and front end checks. Also saves time when servicing Hi-Fi, TV and radios. With life-time batteries.

Dealer Net ..... **\$9.95**

# SENCORE Simplifies CIRCUIT TESTING

## SENCORE "SERVICE MASTER" SM112

Sometimes, you want a VTVM where circuit loading is a problem. Other times, you want a VOM because power is not available or you do not wish to wait for a VTVM to warm up and stabilize. The SM112 is your answer. Merely flip the function switch to left and you have a complete Deluxe VTVM; flip it to the right and you have a handy VOM that operates from a standard 1.5 volt flashlight battery. Especially made for the "time saving" man. Automatic scale indication on VTVM; a lighted arrow points to the correct scale to read no matter where you place the switches. Two 115 volt AC outlets to provide power to the unit under test. One permanent test probe to do every job for both VOM and VTVM; even the high voltage probe fits on the end of the permanent probe to save wasted time in connecting and disconnecting leads. And, for the first time, an easy grip handle and all steel case with cover and storage compartment so that you leave the job with no leads or line cord hanging. The removable cover is "loaded" with that hard to remember technical data such as standard transistor testing guide, etc. The SM112 is truly a master of service.

6 AC and DC ranges from 0 to 1000 volts on both VTVM and VOM; 6 resistance ranges from 0 to 1000 megohms on VTVM with 2 ranges on VOM; one easy reading scale and a 2 percent six-inch meter provide laboratory type specifications. Zero center scale and peak to peak voltage measurements on VTVM place the SM112 in the category of the finest on any bench or in any laboratory. Dealer Net ..... **\$69.95**

New Combination VTVM-VOM



Model SM112

# SENCORE Simplifies Parts SUBSTITUTION

## SENCORE "HANDY 36" H-36

Substitute for Capacitors, Resistors . . . provides the 36 most often needed resistors and capacitors for experimenting, substituting or testing. Eliminates searching for replacement components, unnecessary soldering and unsoldering and the mess it creates. Says goodbye to crumpled parts. Flick of a switch instantly selects any of: 24 Resistors from 10 ohms to 5.6 megohms, 10 Capacitors from 100 mmfd to .5 mfd, 2 Electrolytics, 10 mfd and 40 mfd at 450 Volts. All components are standard American brands. Dealer Net ..... **\$12.75**



## SENCORE "BIG 20" PR11

For all resistors up to 20 watts from 2.5 to 15,000 ohms. Covers all power resistors encountered in Radio, Hi-Fi and TV Circuitry. Substitute for all questionable power resistors; determine values of burned out 2 and 4 watt carbon resistors, wire wound potentiometers, fuse resistors and resistor values in a hundred and one places in servicing and engineering. Restores circuit to normal fast so that you find the actual defective component. Each resistor stands up to 20 watts during normal testing time. The Big 20 pays for itself the first month in time saved. Dealer Net ..... **\$12.75**



## SENCORE "FUSE SAFE" CIRCUIT TESTER FS-3

Instantly tells you whether or not it is safe to replace fuse resistors, fuses, or circuit breakers. Separate red and green scale for each commercially available fuse resistor used in radio and TV. Eliminates guesswork, wasted time. Also handy for wattage checks up to 1100 watts at 115v. Dealer Net ..... **\$8.95**



## SENCORE "ELECTRO-SUB" ES102

Complete, safe substitution for Electrolytic Capacitors from the smallest types used in transistor radios to the largest used in Hi-Fi amplifiers. Contains 10 electrolytics from 4 to 350 mfd. Select correct value with the flick of a switch. Features automatic discharge, surge protector circuit. Prevents accidental "healing" of capacitor being bridged. Completely safe — no arc or spark when connecting or disconnecting. Usable from 2 to 450 volts, DC. Dealer Net ..... **\$15.95**



## SENCORE DUAL TV BIAS SUPPLY BE113

A single 0 to 20 volts DC bias supply or two separate 0 to 20 volts DC bias supplies — without interaction. Save time in AGC trouble shooting and when aligning TV sets. This special low impedance bias supply instantly provides all TV biases recommended in photofact schematics and by all TV manufacturers. The BE113 is extremely well filtered providing virtually pure DC with less than one tenth of one percent ripple. Calibration accuracy is better than equivalent battery tolerance. Dealer Net ..... **\$12.75**



## SENCORE RECTIFIER TROUBLE SHOOTER RS106

Locate faulty Rectifiers, Diodes . . . This unique substitution unit simplifies trouble shooting rectifiers and diodes, gives you a positive check every time. Substitute for suspected rectifier or diode, watch picture or listen to sound and you'll know in seconds whether or not the rectifier or diode should be replaced. No guess work, soldering mess or time lost. The RS106 costs less than having loose rectifiers and diodes in the shop for testing and is worth many times more. A must for servicing voltage doubler circuits. Protected by a 1/2 amp. Slow Blow Fuse. Dealer Net ..... **\$12.75**



# SENCORE Simplifies SWEEP CIRCUIT TROUBLE SHOOTING

Now in minutes you can analyze any sweep, sync, or high voltage circuit!

## NEW SS117 SWEEP CIRCUIT ANALYZER



For Black and White and Color TV

CHECKS THEM ALL

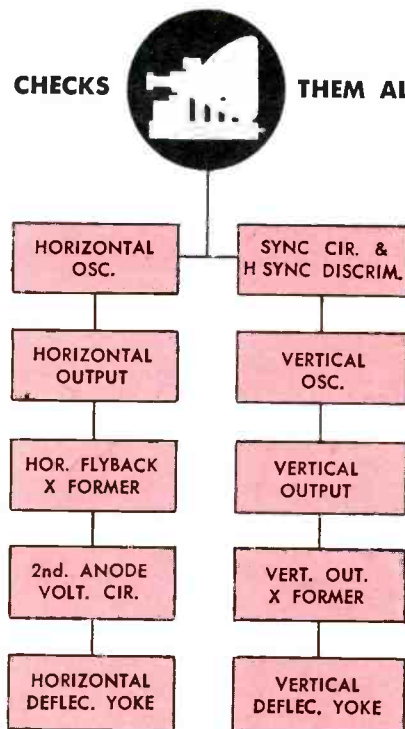

- Make all important checks from the top of the chassis without removing from cabinet.
- Disconnect only one yoke lead for all tests, can be disconnected at yoke to save pulling chassis.
- New "push button" testing greatly simplifies test procedures.



Sencore Sam says . . . How can you miss . . .

EACH PACKAGED UNIT CONTAINS:

- An Easy to Follow Instruction Book Especially Prepared and Edited by H. W. Sams.
- A complete 33 RPM, 10 inch Permanent Record on "How to Simplify Sweep Circuit Trouble Shooting."

**You may ask . . .** why test just the sweep, sync and high voltage circuits? Because, this is over 60 percent of the entire TV set and up to 90 percent of the tough dog troubles; especially in the horizontal sweep section where loss of 2nd anode voltage leaves you working in the dark. Most technicians can easily find tuner, IF, and sound troubles.

**Circuits are tested completely . . .** all checks are made under dynamic conditions with the TV turned on. No need to worry about some make-shift "current off" test that indicates the circuit good but break down occurs after the TV is turned on.

**Roll chart provides all necessary data** for setting controls or interpreting readings. Average peak-to-peak driving voltages, cathode currents and grid and screen pin numbers are listed for each horizontal output tube.

**See how easily you can check:**

**HORIZONTAL OSCILLATOR:** Checked by signal substitution from a known good oscillator in the SS117. Restoration of raster or full width when injecting signal from horizontal output grid to TV oscillator determines exact point of trouble. Just push the button in this section and the meter will indicate the P to P drive from SS117 oscillator.

**HORIZONTAL OUTPUT:** Checked by the reliable Cathode Current Check using an adapter socket. Cathode current or screen voltage automatically read by depressing push button.

**HORIZONTAL DEFLECTION YOKE:** Checked a sure fire way by substituting a universal yoke from the SS117. Restoration of 2nd anode voltage or bright vertical line indicates a bad yoke every time. TV yoke is left on picture tube.

**HORIZONTAL OUTPUT TRANSFORMER:** Checked by depressing flyback transformer button. Meter automatically indicates whether or not the transformer is delivering adequate power to sweep the tube in set being checked.

**SYNC AND DISCRIMINATOR CIRCUITS:** Check by connecting sync input lead to any sync stage and attempting to sync SS117 oscillator with horizontal hold control on front of SS117.

**VERTICAL CIRCUITS:** Checked by injecting universal vertical oscillator at grid or plate of output tube.

**VERTICAL DEFLECTION YOKE:** Checked with special vertical signal to give full height if yoke is good.

**2ND ANODE VOLTAGE:** Checked by connecting picture tube 2nd anode lead into high voltage lead on SS117. Meter reads from 0 to 30,000 volts. Meter provides a load that simulates average picture tube load.

**EXTERNAL CHECKS:** • 0 to 300 and 0 to 1000 volts DC for checking B plus and Boost Volts. • 0 to 300 and 0 to 1000 volts P to P for checking sync and osc. outputs. • 0 to 300 DC milliamp range for checking horizontal output fuse current.

**SPECIAL SERVICING FEATURES:** All steel case. Mirror in detachable cover for setting up TV after repair. Two 115 Volt AC outlets provided in lead storage compartment. Size: 10 $\frac{1}{4}$ " x 9 $\frac{1}{4}$ " x 3 $\frac{1}{2}$ ". Wt. 10 lbs.

**SS117 Dealer Net** ..... **\$89.50**

# PHOTOGRAPH REPORTER

# 1961 ANNUAL SUBJECT REFERENCE INDEX

## ANTENNAS AND ACCESSORIES

Common defects in home installations  
*There's Big Money in Antenna-System Business* ..... 45 Dec

Communications-radio types  
*Two-Way Radio Antennas* 22 Jul

High-gain type with built-in booster, Winegard  
*Powertron*  
*Quicker Servicing* ..... 33 Jun

Installation and replacement  
*There's Big Money in Antenna-System Business* ..... 44 Dec

Installation codes and laws  
*Antenna Installation News* ..... 39 Feb

Jerrold *Magic Carpet*  
*Quicker Servicing* ..... 34 Mar

Lead-in types  
*Antenna Installation News* ..... 40 Feb

Mast-mounted VHF pre-amplifier, Jerrold Model APM-101  
*Quicker Servicing* ..... 46 Sept

Mounting hardware  
*Antenna Installation News* ..... 40 Feb

Polar graphs  
*Antenna Installation News* ..... 38 Feb

Repair-business promotion  
*Service Promotions That Work* ..... 56 Nov

*There's Big Money in Antenna-System Business* ..... 44 Dec

Rotator control box, Channel Master  
*Quicker Servicing* ..... 42 Oct

Strapless chimney mount  
*Quicker Servicing* ..... 38 Aug

UHF installations to receive MPATI airborne TV  
*Schoolroom TV Takes to The Air* ..... 36 Oct

Wall-outlet system kit, Mosley Model BK-1  
*Quicker Servicing* ..... 42 May

**AUDIO**

Audio signal generator  
*Test Equipment for Audio Servicing* ..... 26 Sept

Commercial sound—amplifiers  
*Breaking the Commercial Sound Barrier* ..... 23 Jun

—bass boost for mike-input circuit  
*Troubleshooter* ..... 22 Jun

—intercom-system installation  
*Planning Intercom Installations* ..... 34 Oct

—table of power-output and speaker requirements for various jobs  
*Breaking the Commercial Sound Barrier* ..... 62 Jun

Crystal headphones hooked up to audio output of TV  
*Troubleshooter* ..... 70 Sept

FM stereo circuit features and service hints  
*FM Stereo and the Serviceman* ..... 38 Dec

Harmonic-distortion meter  
*Test Equipment for Audio Servicing* ..... 27 Sept

Hum in phono after 15 minutes  
*Troubleshooter* ..... 76 Jan

Intermodulation-distortion analyzer  
*Test Equipment for Audio Servicing* ..... 76 Sept

Phono-needle selection and installation  
*Phono Cartridge and Needle Replacement Guide* ..... 38 Oct

Power computed from voltage across load (chart)  
*Test Equipment for Audio Servicing* ..... 26 Sept

Radio-signal pickup on speaker wiring  
*Troubleshooter* ..... 56 Mar

Reverberation systems in '61 hi-fi  
*The Latest in Hi-Fi: Reverberation* ..... 38 Jan

Speaker requirements for various applications  
*What You Should Know About Speakers* ..... 27 May

Stylus-inspection device, Robins  
*Syl-a-Scope*  
*Quicker Servicing* ..... 44 May

Tape recorders—electronic troubles  
*Servicing Tape Recorders* 52 Mar

—operating difficulties of owners  
*Servicing Tape Recorders* 46 Mar

—record-level indicator failure  
*Troubleshooter* ..... 70 Sept

—treble response  
*Troubleshooter* ..... 60 May

VTVM for audio work  
*Test Equipment for Audio Servicing* ..... 26 Sept

Wow and flutter checks  
*Test Equipment for Audio Servicing* ..... 77 Sept

Zenith *Extended Stereo* circuit  
*The Latest in Hi-Fi: Reverberation* ..... 96 Jan

**BUSINESS**

Advertising program for shops  
*Service Dealer Advertising Program* ..... 58 Jan

..... 77 Feb

..... 69 Mar

..... 63 Apr

..... 65 May

..... 53 Jun

..... 54 Jul

..... 51 Aug

..... 48 Sept

..... 66 Oct

..... 74 Nov

..... 85 Dec

Antenna repair, promoting  
*Service Promotions That Work!* ..... 56 Nov

*There's Big Money in Antenna-System Business* ..... 44 Dec

Burglary, protecting shop against  
*A Burglar's-Eye View of Service Shops* ..... 62 Dec

Citizens band sales and service opportunities  
*The Service Dealer and the CB Market* ..... 30 May

Color-TV service promotion  
*Service Promotions That Work!* ..... 54 Nov

Diversification of service business  
*A Survey of Upgrading Courses* ..... 54 Feb

Expansion of service business into sales  
*Expanding Into TV Sales* ..... 46 May

Fees charged by typical TV shops  
*TV Service-Charge Survey* ..... 40 Dec

Home-call sales by servicemen  
*Home-Call Sales Techniques* ..... 40 Jul

Inventory-control systems for shop  
*Simplified Inventory-Control Systems That Work* ..... 20 Mar

License, FCC second-class  
*Preparing for the Second-Class 'Phone Exam* ..... 22 Sept

Overhead, list of typical items  
*Putting the Lid on Overhead* ..... 40 Aug

Printed forms for service shops  
*Business Forms Boost Efficiency* ..... 36 Jun

School courses for advanced technical training  
*A Survey of Upgrading Courses* ..... 54 Feb

Service-truck leasing  
*Service Vehicles—Buy or Lease?* ..... 44 Oct

"Setside manner"  
*Developing Your Home-Call Technique* ..... 64 Sept

Sound-system leasing and rental  
*Renting Sound Equipment Leads to Sales* ..... 38 Sept

Tactful handling of customers  
*Let the Customer Have Your Way* ..... 21 Feb

Test equipment—choosing instruments for shop  
*How to Select Test Equipment* ..... 26 Apr

Translator stations, establishing  
*Translators Bring New TV*

*Horizons* ..... 61 Aug

Unclaimed merchandise, disposal by service shops  
*Solving the Unclaimed Merchandise Problem* ..... 56 Dec

Vehicle-rental firms, national  
*Service Vehicles—Buy or Lease?* ..... 48 Oct

**CIRCUIT AND CHASSIS DESCRIPTIONS**

AGC-filter time constants  
*Troubleshooter* ..... 50 Jul

Audio output tube as B+ divider  
*The Secret Source of Low B+* ..... 28 Mar

Automatic brightness and contrast control  
*Highlights of 1962 TV Lines* ..... 1 Oct

B-minus section of power supply in older-model TV  
*Troubleshooter* ..... 84 Dec

Color TV sets, 1962 models  
*What's New in Color TV?* ..... 34 Nov

"Common negative" point in power supply  
*Troubleshooter* ..... 56 Mar

Damper-cathode ground-return path  
*Troubleshooter* ..... 49 Aug

Focus circuits in 1962 color sets  
*What's New in Color TV?* ..... 89 Nov

Horizontal AFC circuits  
*Troubleshooting Diode AFC Systems* ..... 66 Dec

Imported transistor portable radios, typical schematic  
*Servicing Imported Transistor Portables* ..... 24 Jul

Motorola TS-570, horizontal oscillator  
*Highlights of 1962 TV Lines* ..... 4 Oct

Packard-Bell Chassis 98D14, DC restorer circuit  
*Highlights of 1962 TV Lines* ..... 5 Oct

Philco Chassis 12N50 series, automatic width control  
*Highlights of 1962 TV Lines* ..... 5 Oct

Philco RF Chassis 35, production change  
*Recovering From the Bends* ..... 65 Mar

RCA Chassis KCS47, width control  
*Troubleshooter* ..... 77 Jan

RCA Chassis KCS68C, keyed AGC and tuner-input circuits  
*Snowed Under by an RCA KCS68C* ..... 26 Feb

RCA Chassis KCS131, noise inverter

- Noise inverters in  
Action . . . . . 32 May
- RCA Chassis KCS136  
Magic Eye brightness-  
contrast control  
Highlights of 1962 TV  
Lines . . . . . 6 Oct
- RCA Chassis CTC7A color  
TV, chroma sync circuit  
Across the Bench . . . . . 33 Nov
- RCA Chassis CTC11 color  
TV, demodulator  
and matrix  
Fundamentals of the Color  
TV System . . . . . 6 Nov
- Spark gap to protect  
picture tube  
Troubleshooter . . . . . 59 May
- Thumbnail descriptions of  
all 1962 TV chassis  
Highlights of 1962 TV  
Lines . . . . . 1 Oct
- Trav-Ler Chassis 1150-39,  
vertical multivibrator  
Operation Vertical . . . . . 34 Jan
- Vertical multivibrator, esti-  
mating pulse amplitudes  
in feedback circuit  
Troubleshooter . . . . . 48 Aug
- Westinghouse Chassis  
V-2384-15, noise  
inverter  
Noise Inverters in  
Action . . . . . 62 May
- Westinghouse Chassis  
V-2417, width and  
horizontal linearity  
control  
Highlights of 1962 TV  
Lines . . . . . 8 Oct
- Wireless remote controls  
for TV  
Troubleshooting TV  
Wireless Remotes . . . . . 20 Jun
- Zenith Chassis 16H28,  
AC-DC switch and  
G2 control  
Highlights of 1962 TV  
Lines . . . . . 8 Oct
- Zenith Chassis 29JC20  
color TV  
What's New in Color  
TV? . . . . . 34 Nov
- COLOR TV**
- Color-bar generator  
Test Equipment for Color  
TV . . . . . 31 Nov
- Color-difference amplifiers  
Fundamentals of the Color  
TV System . . . . . 6 Nov
- Color-difference signals  
Fundamentals of the Color  
TV System . . . . . 2 Nov
- Complementary colors  
Fundamentals of the Color  
TV System . . . . . 8 Nov
- "Confetti"  
Troubleshooter . . . . . 80 Nov
- Automatic chroma control  
(ACC)  
Chroma Bandpass  
and Demodulator  
Circuits . . . . . 26 Nov
- Bench servicing  
Isolating Color TV  
Troubles by  
Symptoms . . . . . 28 Nov
- Burst amplifier, normal  
waveforms  
Understanding Color  
Sync . . . . . 48 Nov
- Chroma bandpass amplifier  
—operating principles  
Chroma Bandpass  
and Demodulator  
Circuits . . . . . 26 Nov
- single-stage circuit typical  
of 1962 designs  
What's New in Color  
TV? . . . . . 34 Nov
- Chroma demodulator  
—circuits in 1962 color sets  
What's New in Color  
TV? . . . . . 34 Nov
- theory of operation  
Fundamentals of the Color  
TV System . . . . . 6 Nov
- Chroma Bandpass  
and Demodulators  
Circuits . . . . . 84 Nov
- Chroma reference oscillator  
—operating principles  
Understanding Chroma  
Sync . . . . . 48 Nov
- Chroma section  
—signal paths  
Isolating Chroma  
Troubles by  
Symptoms . . . . . 28 Nov
- troubles, step-by-step chart  
for pinpointing  
Isolating Chroma  
Troubles by  
Symptoms . . . . . 29 Nov
- waveforms, normal  
Isolating Chroma  
Troubles by  
Symptoms . . . . . 28 Nov
- Chroma signals  
Fundamentals of the Color  
TV System . . . . . 3 Nov
- Chroma sync  
—adjustments, simplified for  
recent models  
A Bout With a Color  
Set . . . . . 96 Nov
- circuit theory  
Understanding Color  
Sync . . . . . 46 Nov
- loss, analyzing cause  
Isolating Color TV  
Troubles by  
Symptoms . . . . . 28 Nov
- Color Servicing in  
the Home . . . . . 42 Nov
- Convergence  
—adjustment procedure  
How to "Converge" the  
New Color Sets . . . . . 32 Jan
- intermittent  
Case Histories of Color  
TV Troubles . . . . . 79 Nov
- test equipment for  
Test Equipment for  
Color TV . . . . . 68 Nov
- Divided-carrier modulation  
Fundamentals of the Color  
TV System . . . . . 5 Nov
- Dot and crosshatch  
generators, desirable  
characteristics for  
use in convergence  
Test Equipment for Color  
TV . . . . . 68 Nov
- Doubly-balanced modulator  
Fundamentals of the Color  
TV System . . . . . 3 Nov
- Focus  
—circuits in 1962 color sets  
What's New in Color  
TV? . . . . . 89 Nov
- trouble, intermittent  
Troubleshooter . . . . . 80 Nov
- Frequency response,  
bandpass amplifier  
Chroma Bandpass  
and Demodulator  
Circuits . . . . . 82 Nov
- Functions of color-signal  
stages  
Overcoming "Coloritis" . . . . . 22 Mar
- G - Y signal, recovery  
by receiver  
Fundamentals of the Color  
TV System . . . . . 3 Nov
- Home-call servicing  
Color Servicing in the  
Home . . . . . 36 Nov
- Hue, definition  
Fundamentals of the Color  
TV System . . . . . 1 Nov
- Hum bars in color  
Chroma Bandpass  
and Demodulator  
Circuits . . . . . 86 Nov
- I and Q signals, definition  
Fundamentals of the Color  
TV System . . . . . 4 Nov
- Incorrect colors,  
analyzing cause  
Isolating Color TV  
Troubles by  
Symptoms . . . . . 28 Nov
- Color Servicing in  
the Home . . . . . 40 Nov
- Interleaving video,  
chroma signals  
Fundamentals of the Color  
TV System . . . . . 4 Nov
- Isolating chroma trouble  
(chart)  
—in home  
Color Servicing in the  
Home . . . . . 38 Nov
- in shop  
Isolating Color TV  
Troubles by  
Symptoms . . . . . 29 Nov
- Keyed rainbow generator  
—operating principles  
Test Equipment for Color  
TV . . . . . 66 Nov
- use in signal tracing  
A Bout With a Color  
Set . . . . . 33 Nov
- Loss of color  
—case history  
A Bout with a Color  
Set . . . . . 32 Nov
- troubleshooting procedure  
Color Servicing in the  
Home . . . . . 36 Nov
- Luminance signal  
Fundamentals of the Color  
TV System . . . . . 2 Nov
- Matrixing of Y and  
color-difference  
signals in receiver  
Fundamentals of the Color  
TV System . . . . . 7 Nov
- Modulation on color  
subcarrier  
Fundamentals of the Color  
TV System . . . . . 4 Nov
- New features of '62 models  
What's New in Color  
TV? . . . . . 34 Nov
- NTSC color-bar generator  
Test Equipment for  
Color TV . . . . . 66 Nov
- Pattern generators,  
desirable characteristics  
Test Equipment for  
Color TV . . . . . 68 Nov
- Picture tube, 21FBP22  
or 21FJP22, sulfide  
type  
What's New in Color  
TV? . . . . . 90 Nov
- Primary colors  
—chroma phase angles with  
respect to burst  
Fundamentals of the Color  
TV System . . . . . 4 Nov
- RCA Chassis CTC4  
color TV, burst  
keyer and killer  
Troubleshooter . . . . . 80 Nov
- Response of eye to  
light waves of  
different frequencies  
Fundamentals of the Color  
TV System . . . . . 1 Nov
- Saturation, definition  
Fundamentals of the Color  
TV System . . . . . 1 Nov
- Signal formation at  
transmitter  
Fundamentals of the Color  
TV System . . . . . 2 Nov
- Signal paths in chroma  
section  
Isolating Chroma  
Troubles by  
Symptoms . . . . . 28 Nov
- Snow in color  
Troubleshooter . . . . . 80 Nov
- Sync, vertical or horizontal,  
affected by color  
reception  
Troubleshooter . . . . . 81 Nov
- Test equipment  
—accessories and service aids  
Test Equipment for  
Color TV . . . . . 31 Nov
- color test jig for bench,  
RCA no. 11A1015  
Quicker Servicing . . . . . 42 Nov
- instruments available  
(chart)  
Test Equipment for  
Color TV . . . . . 30 Nov
- Transmitted color signal  
Fundamentals of the Color  
TV System . . . . . 1 Nov
- Trouble case histories  
Troubleshooter . . . . . 80 Nov
- brightness control  
ineffective, RCA  
Chassis CTC7A  
An Experience With  
a Color Set . . . . . 55 Jul
- ghosts in color  
Case Histories of Color  
TV Troubles . . . . . 76 Nov
- intermittent convergence  
Case Histories of Color  
TV Troubles . . . . . 79 Nov
- loss of color  
A Bout With a Color  
Set . . . . . 32 Nov
- Tubes commonly used in  
chroma section  
Color Servicing in the  
Home . . . . . 38 Nov
- Troubleshooting chroma  
section  
—at bench  
Isolating Chroma  
Troubles by  
Symptoms . . . . . 28 Nov
- in home  
Color Servicing in the  
Home . . . . . 36 Nov
- Weak or wrong colors,  
causes of  
—Isolating Color TV  
Troubles by  
Symptoms . . . . . 28 Nov
- Color Servicing in the  
Home . . . . . 40 Nov
- X and Z demodulation  
Fundamentals of the Color  
TV System . . . . . 6 Nov
- COMMUNICATIONS RADIO**
- Antennas  
Two-Way Radio  
Antennas . . . . . 22 Jul
- Antenna tester, Seco  
Model 520  
Notes on Test  
Equipment . . . . . 77 Dec
- Bench power hook-ups for  
various two-way radios  
Test Setups for Servicing  
Two-Way . . . . . 92 Dec
- Citizens band  
The Service Dealer and  
the CB Market . . . . . 30 May
- CONELRAD alarm for  
stations  
Troubleshooter . . . . . 58 May
- FCC field-office directory  
Preparing for the Second-  
Class Phone Exam . . . . . 22 Sept
- Field-strength meter



in test set	Photoelectric relays	(Chassis WTS-436B) . . . . .	3 Dec	AC-DC set	
Test Setups for Servicing	Photoelectric Control	Olympic Model 17TU95	(Chassis KU) . . . . .	Troubleshooter . . . . .	54 Jun
Two-Way . . . . .	Circuits . . . . .	Packard-Bell Model 23DD3	(Chassis 98D10) . . . . .	Repeated burnout of 1R5	
89 Dec	Photoelectric switches	for illumination control	Philco Model J-3210PL	tube, General Electric	
License, second-class,	Electronic Control of	Lighting . . . . .	(Chassis 11J27) . . . . .	Model 670	
studying for	Synchros and Servo	Systems . . . . .	Philco Model J-4818	Troubleshooter . . . . .	72 Sept
Preparing for the Second-	Synchros	—electrical troubles	(Chassis 11N53) . . . . .	Servicing small AC/DC	
Class 'Phone Exam . . . . .	—mechanical-trouble chart	Troubleshooting Synchro	RCA Model 192-A-079RS	types	
22 Sept	Troubleshooting Synchro	Systems . . . . .	(Chassis KCS137P) . . . . .	You Can Fix Small	
Signal generator	Systems . . . . .	—motor and generator	RCA Model 211CB412	Radios . . . . .	18 Feb
applications in testing	—twinkle-light display for	operation	(Chassis CTC11) . . . . .	Silver-migration leakage in	
Using Communications	Christmas decoration	Synchros and Servo	RCA Model 211CDR936U	IF transformers	
Test Equipment . . . . .	Letters to the	Systems . . . . .	(Chassis CTC10) . . . . .	Handling IF-Transformer	
31 Apr	Editor . . . . .	Vibration test equipment	RCA Model 232B152MV	Troubles . . . . .	26 Dec
Test-equipment items needed	Industrial Electronic	Test Equipment . . . . .	(Chassis KCS136A) . . . . .	Transistor portables	
Using Communications	Test Equipment . . . . .	Voltmeter requirements for	Setchell-Carlson Model	—imported types, finding	
Test Equipment . . . . .	MISCELLANEOUS EQUIPMENT	industrial servicing	19C61	parts and service	
30 Apr	Air conditioners,	Industrial Electronic	(Chassis 361) . . . . .	information	
Test set for metering and	troubleshooting chart	Test Equipment . . . . .	Setchell-Carlson Model	Servicing Imported	
operating two-way	Air-Conditioning Repairs	52 Apr	601C	Transistor Portables . . . . .	24 Jul
radios (a unit the	Made Easy . . . . .	Electronic depth finders,	(Chassis X159) . . . . .	Troubleshooter . . . . .	50 Jul
technician can build	24 Jun	operation and	Silvertone Model 1134	Transistor-Tailored	
for himself)	Electronic depth finders,	troubleshooting	(Chassis 528.50356) . . . . .	Techniques . . . . .	24 Mar
Test Setups for Servicing	Finders . . . . .	Electronic organ,	Silvertone Model 21061	<b>TELEVISION SERVICING</b>	
Two-Way . . . . .	Electronic organ,	oscillator bias	(Chassis 528.52422) . . . . .	AGC keying tube fails	
42 Dec	Troubleshooter . . . . .	Photoflash, electronic	Sylvania Model 19P11	repeatedly, RCA	
<b>COMPONENTS AND PRODUCTS</b>	69 Feb	Servicing Electronic	(Chassis 546-1) . . . . .	Chassis KCS104	
Capacitor test methods	Photoflash Equipment 44 Feb	Photoflash Equipment 44 Feb	Sylvania Model 23L48F	Troubleshooter . . . . .	74 Oct
and replacement	Repairing Small	Small electrical appliances	(Chassis 555-01) . . . . .	Alignment	
Practical Capacitor Testing	Appliances . . . . .	operation and	(Chassis V-2411-6) . . . . .	Painless TV Alignment . . . . .	32 Oct
and Replacement . . . . .	30 Aug	troubleshooting	Westinghouse Model H-K4150	Bench-construction ideas	
28 Aug	TV translator stations	Electronic depth	(Chassis V-2411-6) . . . . .	Service Bench Designs—	
Feed-through capacitors	Translators Bring New	Finders . . . . .	Westinghouse Model	Build 'Em or Buy	
Troubleshooter . . . . .	TV Horizons . . . . .	26 Jun	H-P3150U	Em . . . . .	28 Sept
50 Aug	27 Aug	Electronic organ,	(Chassis V-2384-15) . . . . .	Bend in top of raster,	
Furniture polish for	<b>PREVIEWS OF NEW SETS</b>	oscillator bias	Zenith Model F3344E	Philco sweep chassis F2	
cabinets, aerosol	Admiral Model ST19J169	Troubleshooter . . . . .	(Chassis 16E24Q) . . . . .	Recovering From the	
foam type	(Chassis 15H1) . . . . .	69 Feb	Zenith Model F3368M	Bends . . . . .	18 Mar
Quicker Servicing . . . . .	1 May	Photoflash, electronic	(Chassis 16F28Q) . . . . .	B-minus supplies	
83 Dec	Admiral Model STF-24M169	Servicing Electronic	Zenith Model F3388W	Troubleshooter . . . . .	84 Dec
Germanium crystal diodes	(Chassis 20C7) . . . . .	Photoflash Equipment 44 Feb	(Chassis 16F23Q) . . . . .	—voltage measurements	
Solid-State Diodes in	1 Jan	Photoflash Equipment 44 Feb	Zenith Model G3360W	Troubleshooter . . . . .	56 Mar
TV . . . . .	1 Sept	Small electrical appliances	(Chassis 17G28Q) . . . . .	Boost-voltage measurement	
26 Jan	Airline Model WG-6030A	Repairing Small	<b>RADIO</b>	Pinpointing Yoke and	
Diode and Rectifier	2 Jan	Appliances . . . . .	Auto radio	Flyback Troubles . . . . .	40 May
Replacement Guide . . . . .	Andrea Model WFCO-VS	30 Aug	—battery-polarity change on	Where'd the Boost Go? . . . . .	32 Aug
26 Jul	323-5	TV translator stations	12-volt vibrator type	Buzz in sound	
High-voltage insulating	(Chassis VS 323-5) . . . . .	Translators Bring New	Troubleshooter . . . . .	—service hints	
chemical	1 Aug	TV Horizons . . . . .	74 Oct	—recognizing intercarrier	
Quicker Servicing . . . . .	DuMont Model RA-700A-B50	27 Aug	—driver-stage trouble in	and vertical-sweep types	
38 Jul	(Chassis 120602A) . . . . .	<b>PREVIEWS OF NEW SETS</b>	hybrid type	Eliminating TV Buzz . . . . .	30 Jun
IF transformers in	1 Jul	Admiral Model ST19J169	Troubleshooter . . . . .	—scope check of sound-IF	
radios, repairing when	Emerson Model 1534	(Chassis 15H1) . . . . .	84 Dec	signal for pulse	
unreplaceable	(Chassis 120541C) . . . . .	Admiral Model STF-24M169	—fader-control circuits for	modulation	
Handling IF Transformer	1 Mar	(Chassis 20C7) . . . . .	dual speakers	Getting the Most From	
Troubles . . . . .	Emerson Model 1542	1 Jan	Output-Transistor	Your Scope . . . . .	1 Apr
26 Dec	(Chassis 120564C) . . . . .	Admiral Model STG24K131	Failures in Auto	Color TV troubles	
Picture tubes	2 Aug	(Chassis 20L7) . . . . .	Radios . . . . .	see Color TV	
—substitution chart	Fleetwood Chassis 1010	1 Sept	44 Jun	Contrast poor because of	
Selecting a CRT	1 Feb	Airline Model WG-6030A	—hum elimination during	defect in audio output	
Replacement . . . . .	General Electric Model	2 Jan	bench servicing	circuit	
68 May	M204WVY	Andrea Model WFCO-VS	Troubleshooter . . . . .	Final Scope Checks	
Selenium AFC diodes	(Chassis LW) . . . . .	323-5	37 Dec	Reduce TV Callbacks . . . . .	18 Jun
Solid-State Diodes in TV	2 Sept	(Chassis VS 323-5) . . . . .	—interference to FM types	Cracked horizontal output	
87 Jan	General Electric Model	1 Aug	installed in Fords	and damper tubes	
—replacements	M204WVY	DuMont Model RA-700A-B50	Troubleshooter . . . . .	Troubleshooter . . . . .	51 Jul
Diode and Rectifier	(Chassis LW) . . . . .	(Chassis 120602A) . . . . .	55 Jun	Current-drain checks of TV	
Replacement Guide . . . . .	2 Sept	(Chassis 120541C) . . . . .	—output-transistor failures	What? A Wattmeter for	
27 Jul	General Electric Model	1 Mar	Output-Transistor	TV Servicing? . . . . .	44 Apr
Silicon power rectifiers	R870VWD	Emerson Model 1534	Failures in Auto	Damper	
Solid-State Diodes in TV	(Chassis U5) . . . . .	(Chassis 120541C) . . . . .	Radios . . . . .	—circuit testing	
89 Jan	2 Mar	Emerson Model 1542	40 Jun	Where'd the Boost Go? . . . . .	32 Aug
—replacements	Hoffman Model B3823	(Chassis 120564C) . . . . .	Capacitors inside IF cans,	—filament troubles	
Diode and Rectifier	(Chassis 356) . . . . .	Fleetwood Chassis 1010	replacements for	in RCA Chassis KCS81F	
Replacement Guide . . . . .	3 Mar	1 Feb	Handling IF-Transformer	Troubleshooter . . . . .	60 May
27 Jul	Magnavox Model 1U401M	Andrea Model WFCO-VS	Troubles . . . . .	Excessive B+ to IF strip	
Speakers for various	(Chassis 35-02-00) . . . . .	323-5	87 Dec	Troubleshooter . . . . .	76 Jan
applications	2 Jul	(Chassis VS 323-5) . . . . .	CONELRAD alarm built	Feed-through capacitors in	
What You Should Know	Motorola Model 23K40CW	DuMont Model RA-700A-B50	from radio	tuners, replacing	
About Speakers . . . . .	(Chassis VTS-569) . . . . .	(Chassis 120602A) . . . . .	Troubleshooter . . . . .	Troubleshooter . . . . .	50 Aug
27 May	3 Aug	Emerson Model 1534	58 May	Final check of bench-	
Tubes	Motorola Model A19T2-3	(Chassis 120541C) . . . . .	FM tuning-eye installation	repaired set using scope	
—newly-introduced types	(Chassis WTS-435) . . . . .	DuMont Model RA-700A-B50	FM Stereo and the	Final Scope Checks	
New Ideas in Tube Design	2 May	(Chassis 120602A) . . . . .	Serviceman . . . . .	Reduce TV Callbacks . . . . .	18 Jun
84 Sept	Motorola Model A19T8CHA	Emerson Model 1542	38 Dec	Flyback and yoke	
—stock guide . . . . .	3 Aug	(Chassis 120564C) . . . . .	IF transformers, repairing	troubleshooting	
34 May	Hoffman Model B3823	Fleetwood Chassis 1010	Handling IF-Transformer	Pinpointing Yoke and	
28 Oct	(Chassis 356) . . . . .	1 Feb	Troubles . . . . .	Flyback Troubles . . . . .	39 May
<b>INDUSTRIAL ELECTRONICS</b>	2 Jul	Andrea Model WFCO-VS	26 Dec	Focus-magnet replacement	
Control transformers	Motorola Model 23K40CW	323-5	Loop antennas for		
Synchros and Servo	(Chassis VTS-569) . . . . .	(Chassis VS 323-5) . . . . .	bench testing		
Systems . . . . .	3 Aug	DuMont Model RA-700A-B50	Troubleshooter . . . . .		
82 Jan	Motorola Model A19T2-3	(Chassis 120602A) . . . . .	50 Aug		
Frequency meters	(Chassis WTS-435) . . . . .	Emerson Model 1534	74 Oct		
Industrial Electronic	2 May	(Chassis 120541C) . . . . .	Pilot-lamp failure in		
Test Equipment . . . . .	2 Apr	DuMont Model RA-700A-B50			
54 Apr	Hoffman Model B3823	(Chassis 120602A) . . . . .			
Gas amplification in	(Chassis 356) . . . . .	Emerson Model 1542			
phototube	2 Jul	(Chassis 120564C) . . . . .			
Photoelectric Control	Motorola Model 23K40CW	Fleetwood Chassis 1010			
Circuits . . . . .	(Chassis VTS-569) . . . . .	1 Feb			
28 Jul	3 Aug	Andrea Model WFCO-VS			
Light-dimming control using	Motorola Model A19T2-3	323-5			
saturable reactor	(Chassis WTS-435) . . . . .	(Chassis VS 323-5) . . . . .			
Electronic Control of	2 May	DuMont Model RA-700A-B50			
Lighting . . . . .	2 Apr	(Chassis 120602A) . . . . .			
52 Oct	Hoffman Model B3823	Emerson Model 1534			
Oscilloscope accessories	(Chassis 356) . . . . .	(Chassis 120541C) . . . . .			
Industrial Electronic	2 Jul	DuMont Model RA-700A-B50			
Test Equipment . . . . .	Motorola Model 23K40CW	(Chassis 120602A) . . . . .			
52 Apr	(Chassis VTS-569) . . . . .	Emerson Model 1542			

- Foreign TV sets, conversion to U.S. standards  
*Troubleshooter* ..... 57 Mar
- Glich  
*Track Down That Visible Hum* ..... 44 Sept
- High-voltage rectifier (type 5642), purple glow  
*Troubleshooter* ..... 74 Oct
- Horizontal AFC, diode type  
*Troubleshooting Diode AFC Systems* ..... 66 Dec
- Horizontal linearity and width adjustments, RCA Chassis KCS47  
*Yoke Trouble Plus* ..... 81 Sept
- Horizontal oscillator, Zenith Chassis 16E20  
*Circuit Voltages Tell the Story* ..... 80 Dec
- Horizontal sweep  
—collapsed; high voltage OK  
*Yoke Trouble Plus* ..... 30 Sept
- intermittent loss, RCA Chassis KCS126  
*Troubleshooter* ..... 68 Feb
- Horizontal sync  
—“piecrust” effect  
*Smoothing Out the “Piecrust”* ..... 40 Oct
- tearing, intermittent, involving pulse-width  
AFC  
*Final Scope Checks Reduce TV Callbacks* ..... 68 Jun
- “Hot” transformer-powered chassis  
*Troubleshooter* ..... 72 Sept
- Hum  
—bars or wiggles in raster  
*Track Down That Visible Hum* ..... 40 Sept
- in video signal  
*Final Scope Checks Reduce TV Callbacks* ..... 67 Jun
- Interference  
—from DC electric fan motor  
*Troubleshooter* ..... 37 Dec
- ignition  
*Troubleshooter* ..... 71 Sept
- Intermittent troubles  
—general information  
*Blast Those TV Intermittents!* ..... 26 Oct
- loss of sound  
*Troubleshooter* ..... 37 Dec
- smear in picture, Emerson Chassis 12507A  
*Circuit Voltages Tell the Story* ..... 82 Dec
- thermal  
*Solving Slow Warm-Up Problems* ..... 56 Aug
- Keyed AGC  
*Excessive AGC Leads to Wild Goose Chase* ..... 28 Jan
- with noise inversion, RCA Chassis KCS131  
*Noise Inverters in Action* ..... 32 May
- Negative picture, weak  
*Troubleshooter* ..... 70 Feb
- Noise inverters and limiters  
*Noise Inverters in Action* ..... 32 May
- No picture; blank or snowy raster  
*Have Easter—No Pix* ..... 62 Jan
- Picture and sound both missing, Motorola all-transistor 19P1  
*Troubleshooter* ..... 56 Jun
- Picture troubles caused by defect in audio output stage  
*The Secret Source of Low B+* ..... 28 Mar
- RF-IF circuits, signal-injection testing  
*Special Analyzers for TV Troubleshooting* ..... 22 Apr
- RF potential on chassis due to improper grounding  
*Troubleshooter* ..... 60 May
- School installations to receive MPATI airborne UHF programs  
*Schoolroom TV Takes to the Air* ..... 36 Oct
- Shading from left to right in raster  
*Shadowing a Shadow* ..... 34 Jul
- Slow warm-up of TV set  
*Solving Slow Warm-Up Problems* ..... 22 Aug
- Snowy picture  
—after half hour of operation  
*Troubleshooter* ..... 37 Dec
- RCA Chassis KCS68C  
*Snowed under by an RCA Chassis KCS68C* ..... 28 Feb
- Sound detector, 'DT6  
*Eliminating TV Buzz* ..... 34 Jun
- Speakers, multiple, temporarily replaced with shop speaker  
*Troubleshooter* ..... 50 Jul
- Sweep-circuit testing with specialized instruments  
*Special Analyzers for TV Troubleshooting* ..... 77 Apr
- Sync section, pinpointing trouble  
*Wanted: Pix—Must Be Steady* ..... 32 Feb
- Tuners  
—directory of repair services  
*TV Tuners—Repair or Replace?* ..... 80 Sept
- universal-replacement types  
*TV Tuners—Repair or Replace?* ..... 33 Sept
- Tuning wands  
*Painless TV Alignment* ..... 86 Oct
- UHF picture and sound cannot be tuned in together  
*Troubleshooter* ..... 37 Dec
- Vertical bar in raster  
*Shadowing a Shadow* ..... 34 Jul
- Vertical multivibrator  
—feedback-pulse amplitudes  
*Troubleshooter* ..... 48 Aug
- general troubleshooting hints  
*Operation Vertical* ..... 34 Jan
- Vertical shrinkage on channel 5  
*Troubleshooter* ..... 72 Oct
- Vertical sync  
—drift during warm-up  
*Troubleshooter* ..... 72 Oct
- instability  
*Circuit Voltages Tell the Story* ..... 32 Dec
- Wireless remote controls, general service procedures  
*Troubleshooting TV Wireless Remotes* ..... 20 Jun
- Yoke arcing internally  
*Troubleshooter* ..... 60 May
- TEST EQUIPMENT**  
AC power supply, EICO 1037  
*Notes* ..... 44 Aug
- AC volt-wattmeter, EICO 260  
*Notes* ..... 60 Oct
- Audio generator  
—Jackson Model 605, -6  
*Notes* ..... 38 Mar
- RCA Model WA-44C  
*Notes on Test Equipment* ..... 63 Feb
- Availability from various manufacturers  
*How to Select Test Equipment* ..... 27 Apr
- Bench test jig for color  
*Quicker Servicing* ..... 42 Nov
- Capacitor tester  
—general information  
*Practical Capacitor Testing and Replacement* ..... 64 Aug
- Sprague Model TCA-1  
*Notes* ..... 48 Jun
- Color bar-dot-crosshatch generator, RCA Model WR-64A  
*Notes* ..... 60 Sept
- Color-bar and rainbow generators  
*Test Equipment for Color TV* ..... 31 Nov
- Component substitution unit  
—Mercury Model 500  
*Notes* ..... 52 May
- CRT tester-reactivator  
Mercury Model 800  
*Notes* ..... 46 Aug
- DC bias source, Sencore  
*Align-O-Pak* ..... 58 Nov
- DC power supply  
—EICO Model 1064  
*Notes* ..... 74 Dec
- Electro Products PS-3  
*Notes* ..... 38 Mar
- Jackson Model 607  
*Notes* ..... 48 Jun
- Paco Model B12  
*Notes* ..... 58 Oct
- Hi-fi test equipment  
*Test Equipment for Audio Servicing* ..... 26 Sept
- Kit building, fine points  
*The Professional Touch in Kit Building* ..... 28 Apr
- Oscilloscope  
—input attenuators  
*Getting the Most From Your Scope* ..... 5 Apr
- Jackson Model 600  
*Notes* ..... 56 Sept
- maintenance checks  
*Getting the Most From Your Scope* ..... 1 Apr
- Precision Apparatus ES-525  
*Notes on Test Equipment* ..... 70 Jan
- requirements for color service  
*Test Equipment for Color TV* ..... 70 Nov
- ringing test for transformers  
*Troubleshooter* ..... 71 Sept
- Waterman miniature  
*Primer-Scope* ..... 58 Nov
- Pattern generators  
*Test Equipment for Color TV* ..... 68 Nov
- Power-resistor substitution unit, Sencore Big 20  
*Quicker Servicing* ..... 42 Oct
- Signal injector, Eby Signal-Jet  
*Quicker Servicing* ..... 34 Feb
- Signal-substitution tester  
*Special Analyzers for TV Troubleshooting* ..... 22 Apr
- B & K Model 1076 Analyst  
*Notes* ..... 44 Jul
- Specifications, interpreting  
*How to Select Test Equipment* ..... 26 Apr
- Sweep and marker generators, requirements for color alignment  
*Test Equipment for*
- Color TV* ..... 72 Nov
- Transistor-radio tester, Superior Model 88  
*Notes* ..... 65 Feb
- Transistor tester  
—beta-measuring circuits  
*Understanding Transistor Testers* ..... 24 Jan
- breadboard-type measurements  
*Understanding Transistor Testers* ..... 92 Jan
- cross-reference feature chart  
*Understanding Transistor Testers* ..... 24 Jan
- Hickok Model 890 (in-circuit)  
*Notes* ..... 47 Jul
- in-circuit tests  
*Understanding Transistor Testers* ..... 94 Jan
- Sencore TransiMaster  
*Notes* ..... 50 May
- Win-Tronix Model 620  
*Notes* ..... 72 Jan
- Tube-element tester, Seco Model GCT-9W  
*Notes* ..... 42 Mar
- Tube tester  
—basic types and applications  
*Using a Tube Tester to Advantage* ..... 50 Sept
- Jackson socket-modification kit  
*Notes* ..... 62 Nov
- making own new-tube setup data  
*Troubleshooter* ..... 62 Apr
- Superior Model 85  
*Notes* ..... 54 May
- Voltmeter  
—error due to shunt effect  
*Pitfalls of Meter Readings* ..... 48 Apr
- VOM-VTVM combination, Sencore Service-Master  
*Notes* ..... 56 Sept
- VOM-Capacity Tester, Mercury Model 400  
*Notes* ..... 60 Feb
- VOM, miniature, Audiotex  
*Quicker Servicing* ..... 46 Sept
- VTVM  
—kit, RCA WV-98-B (K)  
*Notes* ..... 74 Dec
- maintenance and repair  
*Getting the Most from Your VTVM* ..... 32 Apr
- Triplett Model 850  
*Notes* ..... 62 Oct
- Wattmeter, troubleshooting with  
*What? A Wattmeter for TV Servicing?* ..... 44 Apr
- VIDEO SPEED SERVICING**  
Admiral Chassis 20H6 ..... 5 Jun
- Airline Model WG-5081A ..... 5 Jul
- Airline Model WG-5200A ..... 7 Dec
- Andrea Chassis VS-323-1 ..... 5 May
- DuMont Chassis 120600A ..... 7 May
- Emerson Chassis 120517E ..... 5 Jan
- Magnavox 32 Series ..... 5 Aug
- Motorola Chassis  
RTS-433Y ..... 7 Jul
- Motorola Chassis  
TS-567Y ..... 5 Sept
- Olympic Chassis JB ..... 7 Jun
- Olympic Chassis JE ..... 7 Jan
- Packard-Bell  
Chassis 98D8 ..... 5 Feb
- Philco Chassis 11H25 ..... 7 Sept
- RCA Chassis KCS127AE ..... 5 Mar
- Sylvania Chassis 547-1 ..... 7 Aug
- Westinghouse  
Chassis V-2378 ..... 7 Feb
- Westinghouse  
Chassis V-2412-1 ..... 9 Dec
- Zenith Chassis 16Z27 ..... 7 Mar

**STOP TRAFFIC . . .  
START SALES . . .  
PROMOTE PROFITS**



# JFD EXACT REPLACEMENT TV ANTENNA SALES-MAKERS

**FREE self-merchandise displays pack maximum selling power in minimum space!**

Take your choice of the self-merchandise display that suits your store best. Each one is styled to *show...tell...and sell* traffic on your expert portable TV antenna service. Hang one on your wall, place it on your counter or in your window, then watch your sales grow.

Using minimum space, JFD Exact Replacement displays build turn-over, offer self-service convenience—for maximum profits. And you pay only for the antennas—the display is *free*.

Gleaming, self-selling skin-packaging—protects and identifies each antenna on sight. Pre-priced in code for full profit mark-up. PLUS these JFD Sales Aids: Reference charts, listings in Howard W. Sams Photofact Index, selling guides, streamers, newspaper mats and mailers to keep your sales booming.

PLUS the option of replacing any numbers with faster-selling models.

\$3,500,000 dollars worth of portable TV antennas will be replaced in the next 12 months. See *your* JFD distributor for your exact replacement antenna salesmakers and put yourself in business.

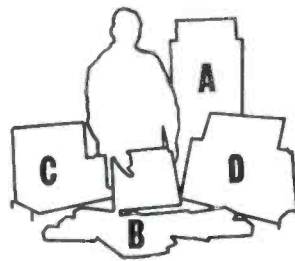

- A—Traffic Display Kit No. PA530, 2 Each of 15 Antennas (Total: 30)
- B—Starter Display Kit No. PA500, 1 Each of 5 Antennas (Total: 5)
- C—Display Kit No. PA515, 1 Each of 13 Antennas (Total: 13)
- D—Franchised Dealer Display Kit No. 505, Available for RCA, Philco, GE, Admiral, Motorola, Sylvania and Westinghouse portable TV dealers. Each kit contains 5 best-selling antenna numbers.

**THE BRAND THAT PUTS YOU IN COMMAND OF THE MARKET**

**JFD ELECTRONICS CORPORATION**

6101 16th Avenue, Brooklyn, New York

JFD Electronics-Southern, Inc., Oxford, North Carolina

JFD Canada, Ltd., 51 McCormack Street, Toronto, Ontario, Canada

JFD International, 15 Moore Street, New York, N. Y.

## HUM HUNTING

in

## AUDIO EQUIPMENT

When you've already tried everything you can think of to cure hum in an audio system, it can be very exasperating to find that the hum's still there. But you have to cure it, and you obviously haven't tried the right thing yet. What else can there be? Well, what have you tried?

The quick test most technicians try is reversing the power plug. If this doesn't make a difference, forget about which way you have line cords plugged in. But if there is any difference at all — even if reversal makes the hum worse — this may be a clue to your trouble. You may find a solution in better grounding of the equipment, or in the elimination of ground loops. If several pieces of equipment have separate line cords, try reversing each of them to find the offending unit.

Even if careful attention to line-plug polarity seems to chase your problem away, the chances are it will come back — perhaps when somebody flips a light switch, or when a refrigerator or other appliance starts up on a circuit that seems to have no connection with yours. To avoid callbacks, it's best to track down your trouble more diligently and make sure, when you're through, that reversing any number of plugs won't bring back the hum.

If possible, it may be useful to learn the history of a hum. Has it always been there? Did it appear suddenly, or did it gradually develop over a period of time? If it happened suddenly, look for frayed leads and broken shield connections. If it came on gradually, it is most likely due to one of two things (barring tube troubles)—a deteriorated electrolytic filter capacitor, or a defective power transformer. Remem-

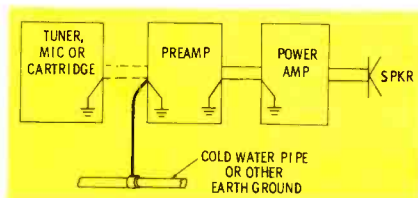

Fig. 1. Connecting an audio system to earth ground at times minimizes hum.

ber that a leaky capacitor is less likely to cause hum than a filter or decoupling capacitor which has dried out and dropped in value. A faulty transformer may give much worse hum when the line plug to it is reversed, or changing the plug may make very little difference—it depends on the kind of trouble. If you're not sure about a particular power transformer, check it by interposing a line-isolating transformer between the AC outlet and the suspected component. If this makes no difference, look elsewhere.

When it turns out that the hum has always been present in the equipment, your problem may be more elusive. It can stem from several causes, as outlined below:

#### Poor Ground

In a well-designed system, the presence or absence of an earth-ground connection should normally make little difference as far as hum suppression is concerned. However, some systems develop hum if they

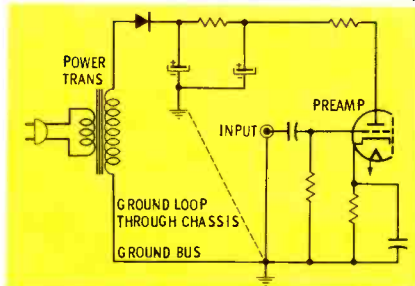

Fig. 2. Hum may be induced in ground loop within single piece of equipment.

are left "floating"; their common ground connection thus needs to be anchored to a true ground return such as a cold-water pipe (Fig. 1). This must be a *good* connection; if it has a resistance of several ohms, you need a better connection.

#### Ground Loops

Use of two ground connections, where one will do, creates a ground loop. This effect may be produced within a single chassis, as in Fig. 2. On the other hand, it may be caused by making more than one ground connection between components, as in a stereo system (Fig. 3). If individual components are free from improper internal ground connections, ground loops in the connecting cables between chassis may cause no trouble whatever. But a poor internal ground arrangement, even if it causes no trouble in a component operating by itself, can cause complications when multiple ground connections are made to other components in the system.

If an external ground loop is causing trouble, the best and easiest thing is to eliminate the loop by whatever method is most convenient. For example, when the common ground connection of a three-terminal stereo cartridge presents a hum problem, as in Fig. 3, the loop through the dual cartridge leads can be broken by severing one shield connection at one end.

Ground loops within components of a system are difficult to detect. These are usually caused by connecting some part such as an electrolytic bypass capacitor to a ground point which happens to be convenient, but which is unsuitable for avoiding hum. A scope comes in handy for spotting the offending

# DOUBLES YOUR EFFECTIVE MANPOWER



Fix "Tough Dogs" Fast!

Save Half Your Time!

Step Up Your Profit!

**B&K** NEW  
MODEL 1076

## TELEVISION ANALYST

for Black & White and Color



Check all circuits—Pinpoint any TV trouble...in minutes

**By Easy Point-to-Point Signal Injection,  
You See the Trouble on the TV Screen and  
Correct it—Twice as Fast and Easy!**

There's no longer any need to "lose your shirt" (and customers)—and worry about the lost hours you never recover—on "tough dogs" or even intermittents. The remarkable B&K Analyst enables you to inject your own TV signal at any point and watch the resulting test pattern on the picture tube itself. Makes it quick and easy to isolate, pinpoint, and correct TV trouble in any stage throughout the video, audio, r.f., i.f., sync, and sweep sections of black & white and color television sets—including intermittents. Makes external scope or wave-form interpretation unnecessary. Most useful instrument in TV servicing! Its basic technique has been proved by thousands of successful servicemen the world over.

The Analyst enables any serviceman to cut servicing time in half, service more TV sets in less time, really satisfy more customers, and make more money.

Model 1076. Net, \$299.95

Available on Budget Terms. As low as \$30.00 down.

Combines all the features of both  
the Model 1075 and Model A107

- |  |   |
|--|---|
| COMPLETE R.F. and I.F.                       | HI-VOLT INDICATOR                                 |
| VIDEO TEST PATTERN                           | YOKE and HI-VOLTAGE <sup>2</sup> TRANSFORMER TEST |
| COMPOSITE SYNC                               | <b>Also Now Provides:</b>                         |
| FM MODULATED AUDIO                           | SWITCH-TYPE TUNER                                 |
| COLOR PATTERNS                               | NEGATIVE BIAS SUPPLY                              |
| HORIZONTAL and VERTICAL PLATE and GRID DRIVE | AGC KEYING PULSE                                  |
| B+ BOOST INDICATOR                           | PICTURE TUBE MODULATION                           |



**B & K MANUFACTURING CO.**  
1801 W. BELLE PLAINE AVE • CHICAGO 13, ILL.  
Canada: Atlas Radio Corp., 50 Wingold, Toronto 19, Ont.  
Export: Empire Exporters, 277 Broadway, New York 7, U.S.A.

See Your B&K Distributor or Write for Bulletin AP18-R

# MUSIC BIG AS LIFE

## Utah's High-Fidelity CONTINENTAL SPEAKERS

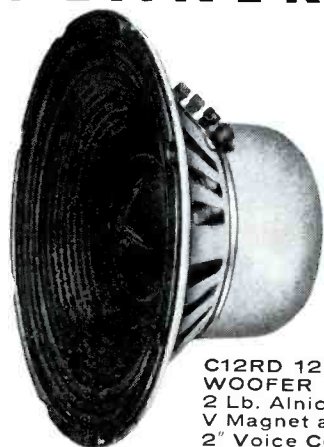

C12RD 12"  
WOOFER  
2 Lb. Alnico  
V Magnet and  
2" Voice Coil

**YOU GET LIFE-SIZE SOUND** in every range, from 20 to 20,000 CPS, with Utah's precision-engineered stereo/high-fidelity speakers. Tweeters and mid-range speakers feature a specially engineered horn formula to enhance "presence". Each speaker has color-coded 4-way terminals.



1124 Franklin St.  
Huntington  
Indiana

Please mail me prices, specifications and performance details of your Continental speaker line.

NAME \_\_\_\_\_

ADDRESS \_\_\_\_\_

CITY \_\_\_\_\_ STATE \_\_\_\_\_

connections by showing the points of maximum hum signal on the ground bus or chassis. You usually can't locate a better ground point by temporarily trying various connections with a clip lead, because the lead picks up hum. Only very thorough changing of connections, with careful attention to lead dress in each stage, can produce a solution.

### Shielding

Low-level circuits and components, such as pickups, microphones, and input transformers, all need proper shielding to avoid hum. The kind of shielding needed, and its relative effectiveness, depend on two factors — the kind of radiated field that induces the hum, and the kind to which the circuit or component is susceptible.

### Electrostatic

Electrostatic fields radiate from circuits where high AC voltages are present — for example, the wiring from the power-transformer secondary to the rectifiers, or connections from the AC line to transformers, motors, and other units. High-impedance circuits are especially susceptible to hum due to capacitive pickup of this type of radiation. For this reason, some critical high-impedance circuits are totally enclosed in a grounded shield made of aluminum or other highly conductive material. In addition, shielded cable is generally used for interconnecting high-impedance stages.

Reducing the impedance of a circuit, without changing the signal-voltage level, reduces capacitive hum pickup without any shielding at all. The desire to avoid the use of shielded connecting leads, with their extra cost and high-frequency attenuation, explains the common

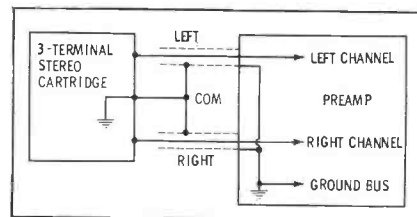

Fig. 3. Dual cable connections between components often set up ground loops.

practice of using a cathode follower to reduce the output impedance of audio components.

### Electromagnetic

Magnetic fields radiate from power transformers, AC motors, filter chokes, and other large inductive components, as well as from wires that carry considerable alternating current. Any part with a core of magnetic material—for example, an input transformer, a magnetic phono pickup, a tape head, etc.—is susceptible to pickup of this radiation. Also, low-impedance circuits can develop hum from this source by electromagnetic induction.

Components in the magnetic-core category often come equipped with a magnetic shield—a seamless enclosure made of a material having high permeability and low hysteresis. One such material is *Mumetal*. Its desirable magnetic properties are obtained by hydrogen-annealing the shield after fabrication. Dents, bends, or sharp blows can destroy the effectiveness of the shielding; therefore, a damaged magnetic shield should be replaced rather than repaired.

The aluminum shields used on tubes and IF transformers are generally effective in screening out electromagnetic radiation. Since they are grounded, they also double as electrostatic shields. If not connected to ground, they would still

## TV TUNERS \* REBUILT OR EXCHANGED

• ALL TYPES

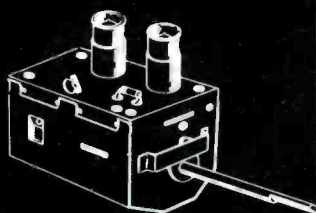

**\$9.95** Including all parts and labor  
(except broken wafers—billed at cost)

- Normally shipped same day received
- 90 day full guarantee
- U/V combinations \$17.95

FREE—If Mailing carton sent to you on request

Phone Republic 3-9189

**L. A. TUNER EXCHANGE**

4611 West Jefferson Blvd.  
Los Angeles 16, California

# new

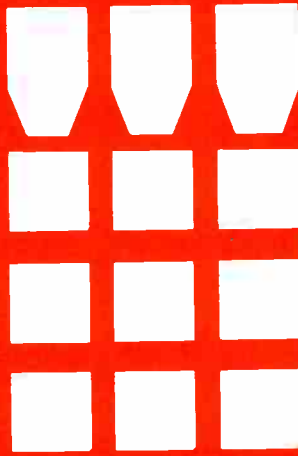

## RCA COLOR TEST JIG

#11A1015

A **must** for any serviceman now servicing or planning to service Color TV receivers ■ Make a one man service call out of a costly two man cabinet pulling job ■ Eliminate possibility of damage to the customer's set when transporting to and from his home ■ Eliminate the need to reconverge the customer's set when the chassis is returned ■ Professional Appearance—Finish matches that of RCA Test Equipment ■ Partial Assembly—Safety glass and kine mask assembled at factory ■ Components Kit furnished with Test Jig includes all necessary components, hardware and Instructions for installation of an RCA Tri-Color Kinescope ■ Convergence control panel supplied provides dynamic as well as static convergence for the CTC-10 and CTC-11 chassis ■ Instructions included with test jig provides data for utilization with CTC-4, 5, 7 and 9 chassis and lists extension cables required ■



## act now for the color season

### see your RCA distributor for details

*RCA parts & accessories/camden, n. j.*



**RCA The Most Trusted Name in Color Television**  
**RADIO CORPORATION OF AMERICA**

# JUST RIGHT

for Profit-Minded Service Technicians



\$335.00

# JACKSON 600

for wide band or high sensitivity operation

Your profit potential goes up when you're equipped with a new Jackson 600 Oscilloscope. You can do all these jobs:

- Peak to peak voltage measurements
- Square Wave Testing from 10 cycles to 200 KC
- Modulation Checks
- Transformer Ringing
- Low Frequency Measurements
- Checking Audio and Video Distortion low frequency and high frequency response... phase shift.

This is a fine quality instrument "service-engineered" by Jackson to best suit the needs of the really active radio and TV Service Technician.

## SPECIFICATIONS:

**Linear Sweep:**  
10 cycles to 100 KC

**Sensitivity:**  
20 mv/inch

**Wide Band**  
Vertical Amplifier:  
Flat within 1 db from  
less than 10 cycles  
to 4.9 MC.

Ask your electronic distributor to demonstrate a Jackson 600 or write for Bulletin 106.



**ELECTRICAL INSTRUMENT COMPANY**

124 McDonough St., Dayton, Ohio

In Canada: The Canadian Marconi Co.

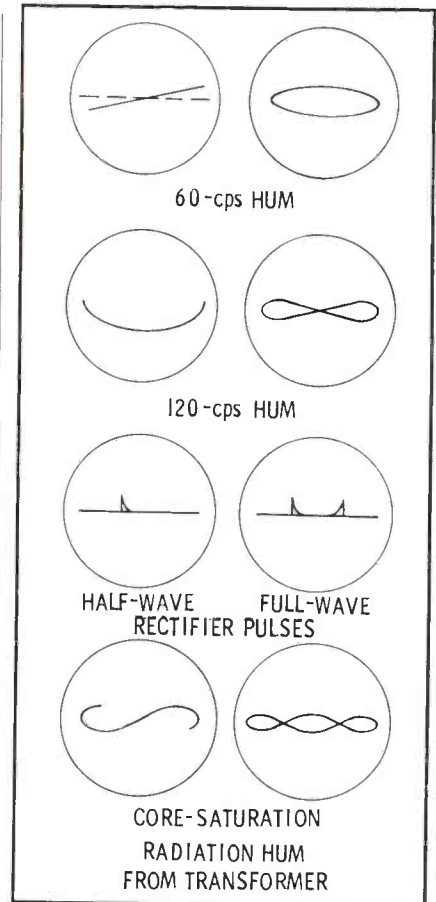

Fig. 4. Hum displayed on scope using a 60-cps sinusoidal horizontal sweep.

give protection against hum caused by electromagnetic radiation, but they would be subject to capacitive pickup from electrostatic fields.

Transformer shields are not always as effective as they are supposed to be. This may not be because they are defective, but because the magnetic field to which they are subjected is different from that for which they were designed. High-efficiency shields, advertised as giving 60 to 90 db hum reduction, are designed for linear hum fields of low intensity. Within a short distance of a power transformer or electric motor, however, the field is neither low-intensity nor linear, and the effectiveness of the shield may almost vanish. Sometimes a much less elaborate shield will actually do a better job under these circumstances.

Just as reducing the impedance of a circuit reduces hum pickup from electrostatic sources, so raising the impedance reduces the pickup of electromagnetic hum. Therefore, the choice of "line impedance" for interconnecting units in professional audio systems requires a compromise. Typically, the line impedance



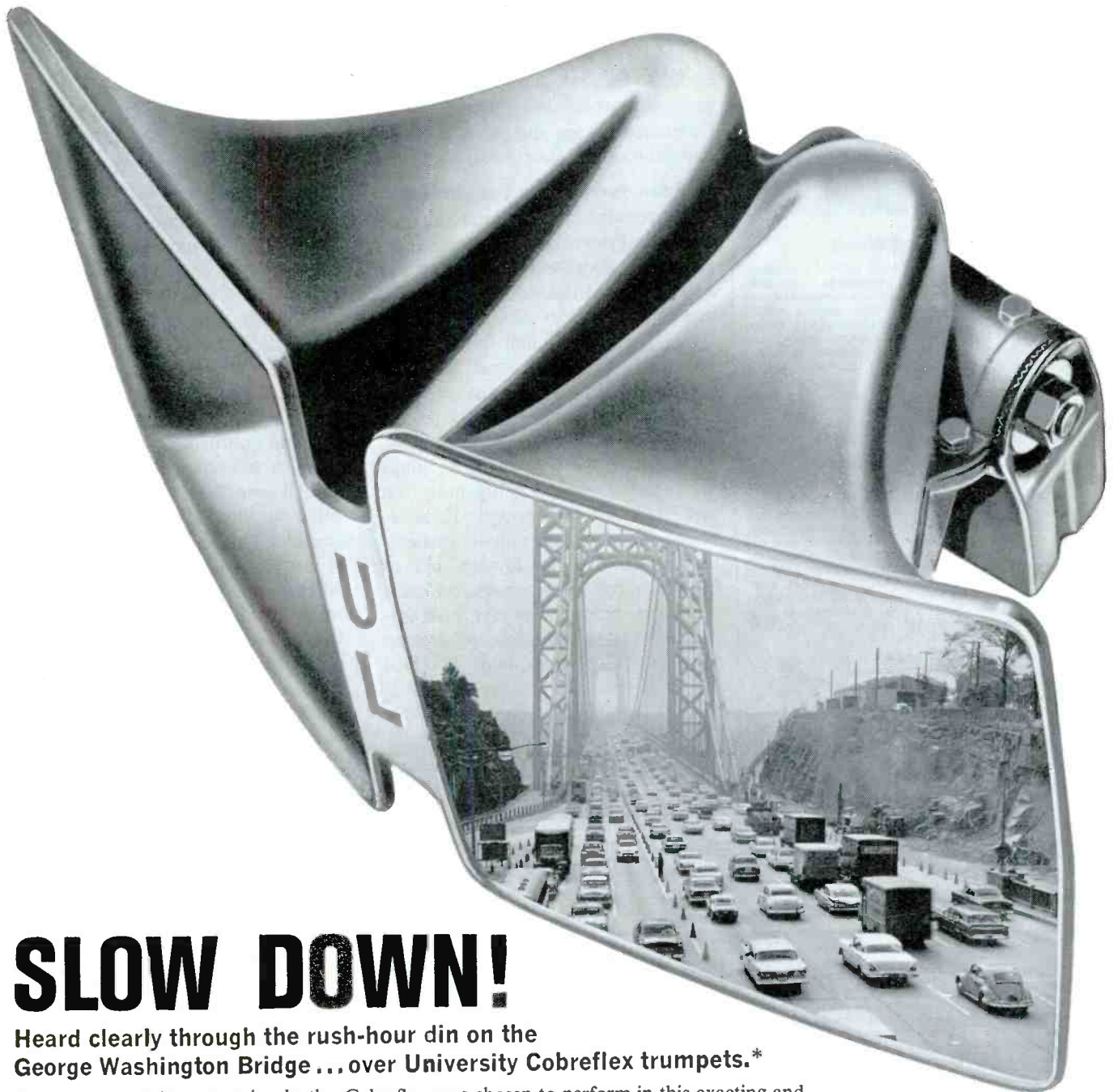

# SLOW DOWN!

Heard clearly through the rush-hour din on the George Washington Bridge ... over University Cobreflex trumpets.\*

But what's most important is *why* the Cobreflex was chosen to perform in this exacting and difficult location. One of the main reasons is that every Cobreflex embodies the unique combination of *battleship* construction and *Swiss watch* precision! This unexcelled ruggedness of construction paired with its exceptionally high articulation of speech makes the Cobreflex ideal for the most grueling applications. Its wide angle projection over 120° is but another good reason why it is sought after in situations that call for ultra-wide projection. And this extremely smooth, wide radiation pattern over the full frequency range is the result of University having incorporated a pair of folded exponential horns having twin air columns onto a *single* assembly. These two identical one-piece heavy aluminum die-castings with integral tone arm and reflectors ensure there are no separate parts to loosen or vibrate. Resonant vibration is non-existent! Reasons enough?

And for installations requiring full-range wide angle coverage, there's the CLH, a rectangular reflex trumpet loaded with significant engineering refinements. A conoidal reflector at the critical final bend improves high frequency response, and a rugged, *ribbed and braced* fiberglass bell subdues resonances, providing more extended, natural response for the reproduction of music as well as speech. The wide horizontal coverage helps you get sound into dead spots that would not be reached by ordinary trumpets, while narrower vertical directionality lets you practically 'tune' the speaker during installation for minimum reverberation and feedback.

But for the complete story of University Public Address Speakers, Write Desk C-11, University Loudspeakers, Inc., White Plains, N.Y.

*NOTE: All University P.A. Loudspeakers are F.C.D.A. approved.*

\*Engineered with HIGH 'A'—HIGH AUDIBILITY—exclusive with University!



*A Division of Ling-Temco-Vought, Inc.*

January, 1962/PF REPORTER 47

# NEW SAMS BOOKS

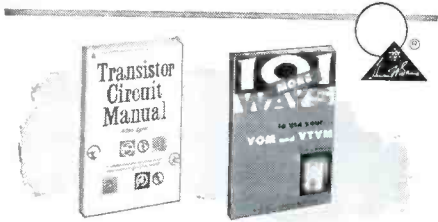

## Transistor Circuit Manual

Allan Lytel presents hundreds of typical transistor circuits, illustrating virtually every type of application. Of great value to technicians, engineers and experimenters—makes design and operation understandable. Schematics and parts values are shown for each circuit; accompanying text describes function and characteristics. Applications include: Switching Circuits; Counters; Flip-Flops; Power Control; Tuners; Indicators; Photoelectrics; Controls; Converters & Inverters; Audio Amplifiers; RF & IF Circuits; Oscillators; Power Supplies & Regulators; Radio & TV Circuits; FM and Special Circuits. 224 pages; 5½ x 8½". Only... \$4.95

## 101 More Ways to Use Your VOM—VTVM

Sequel to Bob Middleton's earlier volume—shows all-new uses for VOM and VTVM units. Includes schematics and equipment hookup for checking and troubleshooting door openers, all types of appliances, fluorescent lamps, time controls, electric motors, audio and hi-fi circuits, power supplies, transmitters, tuned circuits, crystal circuits, transistor and photo-tube circuits, delta transformers, fuel gauges, burglar alarms, etc. Tells how to use units as S-meter, cavity-wave meter, tachometer, field-strength meter. 128 pages; 5½ x 8½". Only... \$2.50

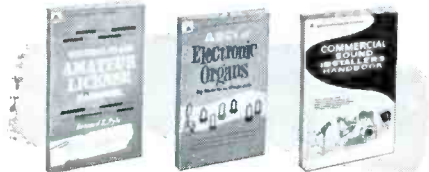

## General Class Amateur License Handbook

Howard Pyle, W70E, provides a complete new guide, including typical questions and answers, to prepare the novice or aspirant for the Technician, Conditional, or General class amateur radio exam. Covers license requirements; learning the code; the written exam; transmitter circuits; basic electronics theory; FCC regs.; general operating practices. 128 pages; 5½ x 8½". Only... \$2.50

## ABC's of Electronic Organs

Explains theory, development, features and operation of electronic organs, electronic circuitry used, how to select an organ, maintenance and troubleshooting. Most informative for owners and potential owners of organs, as well as for technicians and students. 96 pages; 5½ x 8½". Only... \$1.95

## Commercial Sound Installer's Handbook

Leo G. Sands describes the installation, operation, and maintenance of the various types of sound and intercom equipment used in factories, schools, stadiums, vehicles and other commercial fields. Fully describes and illustrates amplifiers, input devices, speakers, distribution, control circuits, portable and mobile equipment, installation and maintenance. A valuable book for technicians and sound specialists. 288 pages; 5½ x 8½". Only... \$4.95

## HOWARD W. SAMS & CO., INC.

Order from your Sams Distributor today, or mail to Howard W. Sams & Co., Inc., Dept. A-32  
1720 E. 38th St., Indianapolis 6, Ind.

Send me the following books:

- Transistor Circuit Manual (TCM-1)
- 101 More Ways to Use Your VOM-VTVM (TEM-8)
- General Class Amateur License Hand. (ALP-1)
- ABC's of Electronic Organs (ECO-1)
- Commercial Sound Install. Hand. (ISS-2)

\$..... enclosed.  Send Free Book List

Name \_\_\_\_\_

Address \_\_\_\_\_

City \_\_\_\_\_ Zone \_\_\_\_\_ State \_\_\_\_\_

IN CANADA: A. C. Simmonds & Sons, Ltd., Toronto 7  
(outside U.S.A. priced slightly higher)

is between 125 and 600 ohms. Values in this range are high enough to avoid difficulty with electromagnetically-induced hum, and yet low enough to avoid difficulty with high-frequency losses due to the shunt capacitance of electrostatic shields.

## Transformerless Equipment

Interconnection between units of transformerless design introduces problems, because each chassis has a separate connection between the power line and its ground bus, and there are also signal connections between chassis. Ground loops of the worst kind seem almost unavoidable—to say nothing of the shock hazard.

Attention to the way line plugs are inserted can be a big help, but this may not be enough. If interconnection between units is made at line impedance (or lower), use of line-isolating transformers on each unit can help; however, high-impedance interconnections present an almost impossible problem. The best policy is to avoid getting into it!

## Hum on the Chassis

A word of warning to anyone planning to construct audio components "from scratch": Steel chassis transmit electromagnetic hum fields far from the transformer or motor that radiates them. Where low-level circuits are used, trying to eliminate electromagnetic hum from equipment built on steel chassis can be a nightmare. It is much simpler to use an aluminum chassis.

## Scope Analysis

So far, we've discussed only the basic varieties of hum. Unfortunately, hum often doesn't present itself as neatly as this. Instead of having one source of hum that fits con-

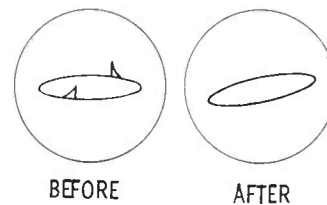

Fig. 5. After circuit changes, pulses were gone; 60-cps hum shifted phase.

veniently into some standard classification, you may have a combination of two or more kinds of hum at the same time. Curing one form may make another form worse, or "unmask" it so that it becomes noticeable for the first time. Working in this kind of situation (which is quite a common occurrence) can become confusing.

With experience, you may learn to tell one kind of hum from another by the way the different kinds sound. This can be helpful; but it may not be altogether reliable, since a more audible form of hum may cover up a less audible form. For more accurate diagnosis, an oscilloscope is an invaluable help. Fig. 4 shows some of the traces produced by various basic types of hum when the horizontal amplifier of the scope is driven by a 60-cps sine wave and the hum signal is applied to the vertical amplifier. Besides enabling you to recognize where the hum is coming from, the patterns show you how much you are accomplishing in your efforts to reduce the intensity of the hum. When more than one type is present, you can see the combined effect in the trace (as illustrated in Fig. 5), and proceed accordingly.

Like so many other chores encountered by the technician, "hum-hunting" is really a matter of knowing what you're doing and then doing it systematically.

## MERCURY TV TUNER SERVICE

890-1 River Ave., Bronx 51, N.Y.

"Largest in the East"

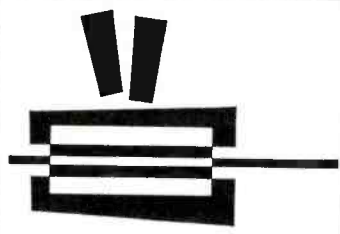

## VHF-UHF TUNERS

7 Months Warranty

Price Includes Labor & Minor Parts

TUBES & MAJOR PARTS  
AT NET PRICES

When Shipping Tuner: Include Tubes,  
Shields and Damaged Parts.

Give Model Number and State Complaint

PACK WELL AND INSURE  
24 HOURS ON POPULAR TYPES

ALL MAKES  
ONE PRICE!

**\$9.50**

**BUY  
"ET"**



**THE TRANSISTOR LINE THAT TUNG-SOL TAILORED TO YOUR NEEDS**

- LOW INVENTORY ■ HIGH TURNOVER
- RELIABILITY ■ PROFIT
- CUSTOMER SATISFACTION

"ET" is your guide to the compact transistor line engineered and packaged specifically for entertainment replacement. You can make just about every radio and TV replacement from only a handful-size inventory. Eleven PNP and NPN types replace hundreds of older numbers.

Each package is plainly marked with the type of service as well as the part number to save you time in selecting the units you need. Every Tung-Sol

transistor is fully warranted. Tung-Sol takes *your* responsibility seriously and spares no effort to provide the very highest in transistor performance. So make your transistor purchases with an eye to convenience, profit and customer satisfaction. Tell your supplier you'd rather have Tung-Sol "ET" transistors. Write for the Tung-Sol Transistor Interchangeability Guide. Tung-Sol Electric Inc., Newark 4, New Jersey

 **TUNG-SOL®**

**A TYPE FOR EVERY JOB**

**PNP TYPES**

**Low power**

- ET1 Mixer/oscillator/converter
- ET2 IF amplifier
- ET3 AF amplifier 6v.
- ET4 AF amplifier 12v.
- ET5 AF amplifier 9v.

**Medium power**

- ET6 AF power amplifier

**High power**

- ET7 AF high power amplifier

**NPN TYPES**

**Low power**

- ET8 Mixer/oscillator/converter
- ET9 IF amplifier
- ET10 AF amplifier 9v.
- ET11 AF amplifier 12v.



by Forest H. Belt

**CLEANS & RESTORES  
 CONTROLS & CONTACTS**  
 WITH MIRACLE  
 ACTIVATED CLEANER VC-5



**NEW 8 OZ.  
 ECONOMY SIZE... \$1.98**

includes FREE "SPRAY-AID"  
 AND PREMIUM

**SPECIAL 3 OZ.  
 "CADDY SIZE"..... 98¢**



**CHEMTRONICS inc.**

870 East 52nd Street, Brooklyn 3, New York

# Raise the Efficiency of Your Service Operation

The service technician has one commodity to sell — time! The amount of his income is directly connected with the quantity of time he can sell, and the price he can charge for it. To raise his total income, he can increase either the time he devotes to productive work or the amount of work he produces in a given time. The latter will enable him to receive a better return for time spent.

In a service business, a continual battle against time must be fought on several different fronts. For instance, home service calls often take longer than necessary. Also, in the shop itself, more time (and money) can be lost by poor procedure and inefficient use of space. Careless arrangement of test equipment and tools at the service bench can cost the technician still more wasted effort. Improvement in any, or all, of these areas will help create a more

efficient operation and a correspondingly better profit picture. Let's consider how to utilize our time most profitably.

## Service Calls

Much time and money can be lost through careless handling of home service calls. Often the service-shop operator sets his charge for this service at a fixed amount; therefore, the logical way for him to make more money is to complete more calls within a day's time.

Carefully-planned routing is one answer to making more calls in a day, but this is seldom a simple task. Some customers are home only during certain parts of the day, and calls must be scheduled at their convenience. Other service calls come in from widely-scattered parts of town; some may even be outside of town. Sometimes the problem can be minimized if the serviceman will

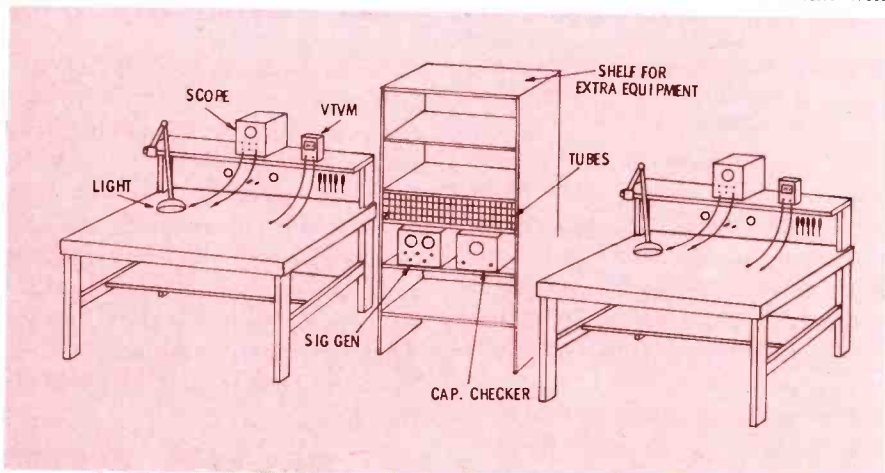

Fig. 1. Each technician has his own bench; extra shelves hold test equipment.



## BIG REASONS

why

## SYLVANIA 6AW8A

is preferred for

## VIDEO AMPLIFIER SERVICE

1. Automount construction provides uniform and tight mount structure featuring low noise and microphonics.
2. Insulator coating on heaters is electronically controlled to maintain exacting tolerances, provide improved heater warm-up time.
3. Embossed cathodes provide extra-firm positioning of cathode in the mica.
4. Automated grid manufacture eliminates handling and contamination, provides uniformity. Result: improved cutoff characteristics, reduced noise, more stable characteristics.
5. Exclusive hook-design heater connectors enable reliable heater welds, longer life through reduced open welds.
6. Special radiators on screen grid dissipate heat rapidly, virtually eliminate secondary emission, reduce interelement shorts, maintain cutoff characteristics; longer tube life is realized.
7. Tubes are set-tested for microphonism; assures against "picture tearing and jittering."
8. Special plate material provides stable plate characteristics during life, enhances stability of contrast and brightness.

There's another big reason why SYLVANIA is preferred—it offers the complete line of popular TV types. For example, this group of video amplifier tubes: 6AU8, 8AU8, 8AW8A, 6GN8, 8GN8, 6BA8A, 8BA8A, 6ET7, 8ET7, 12BY7A, 6CL6, 6BH8, 8BH8, 6CX8, 8CX8, 6EB8, 8EB8. Always specify SYLVANIA TUBES—"quality" is the big, BIG REASON. Electronic Tubes Division, Sylvania Electric Products Inc., 1740 Broadway, New York 19, N. Y.



# SYLVANIA

SUBSIDIARY OF

## GENERAL TELEPHONE & ELECTRONICS





# WHAT EVERY NEEDLE DEALER SHOULD HAVE...

## DUOTONE'S NEW DIAMOND NEEDLE DISPENSER!



Because...your needle sales will skyrocket. This attractive display contains the most wanted stereo and monaural diamond needles. The dispenser, by being constantly in front of your customers, will stimulate point-of-purchase needle sales...and it will save you Inventory Time. The dispenser is FREE! You just pay for the 32 Duotone Diamond needles it contains. They're newly and handsomely packaged for customer eye appeal.

SEE YOUR DUOTONE DISTRIBUTOR TODAY!  
**DUOTONE**  
COMPANY, INC.  
KEYPORT, N. J.

make some arrangement with each customer at the time of the original phone call. Often, several calls in a row can be made in one part of town, or a distant call can be temporarily postponed to coincide with another in the same locality. Customers will usually cooperate in this respect; they needn't know the precise reason for the delay, but they should be informed about any alteration of the time schedule agreed upon.

Servicemen who do both bench work and outside calls are often plagued with the interruption of their bench work by customers who want them to drop everything and "run right out" to replace "just a tube." These technicians can work out a compromise by doing bench work in the morning, without interruption, and scheduling their service calls for the afternoon. There are two advantages to this procedure. First, the more complex job of performing bench repairs is accomplished while the technician is still fresh. Second, the outside serviceman will find more of his customers at home in the afternoon and early evening. In addition, many women customers prefer to have service calls made later in the day, "when the house is straighter."

### In the Home

Once in the home, the serviceman is faced with an important decision: "Do I fix it here or take it to the shop?" His efficiency as a service-call technician rests squarely on his ability to make this decision promptly. The temptation is always strong to "try just one more thing" when faced with a tough service problem. The successful technician

must guard against this temptation, and learn to reach a decision promptly and be on his way without appearing to hurry.

Some very successful technicians use a methodical approach which quickly furnishes them with the information they need to make the decision. The complaint is first confirmed by turning the set on and observing its symptoms. While this is taking place, the customer is quizzed to determine how and when the set started showing the symptoms, and any signs of trouble which may have been noticed prior to the existing failure. This procedure will often provide clues to the cause of failure, and occasionally offer means of locating future faults before they become serious.

If tube substitution fails to cure the trouble symptoms, the usual procedure is to remove the set to the shop for more complete servicing. At this point, another problem sometimes presents itself in the form of customer objections: "What will the children do tonight?" "My husband said it was only a tube." The best way to handle such comments is to listen patiently, while carefully explaining to the customer that the average TV set contains some 300 to 400 parts, any one of which can become defective at any particular time. An explanation that a more complete job can be done in the service shop with adequate instruments (and at less cost than carrying the instruments to the set) will usually quell all but the most unreasonable complaints.

Even when a trouble is obvious—burnt resistors or the like—the set is usually taken to the shop. As most technicians know, the failure of some other part is often the cause

## PRECISION TUNER SERVICE

P. O. BOX 272

BLOOMINGTON, IND.

1200 S. WALNUT ST.

EDISON 99653

**7.50**  
V or U

COMBO PLUS  
9.95 POSTAGE

6 MONTH WARRANTY



All Types T.V. Tuners Cleaned, Repaired and Aligned to Factory Specifications. Same day in shop service on most Tuners. Price Includes Minor Parts, Major Parts at Cost Price. We use Original Parts if possible. State Make Model and Enclose all Parts and Tubes. Pack Well and Insure.

ALSO HAVE LARGE STOCK OF EXCHANGE TUNERS, WRITE FOR TYPES AND PRICES.

# NEW 7-INCH VOMs AT \$49<sup>95</sup>

By *Simpson*

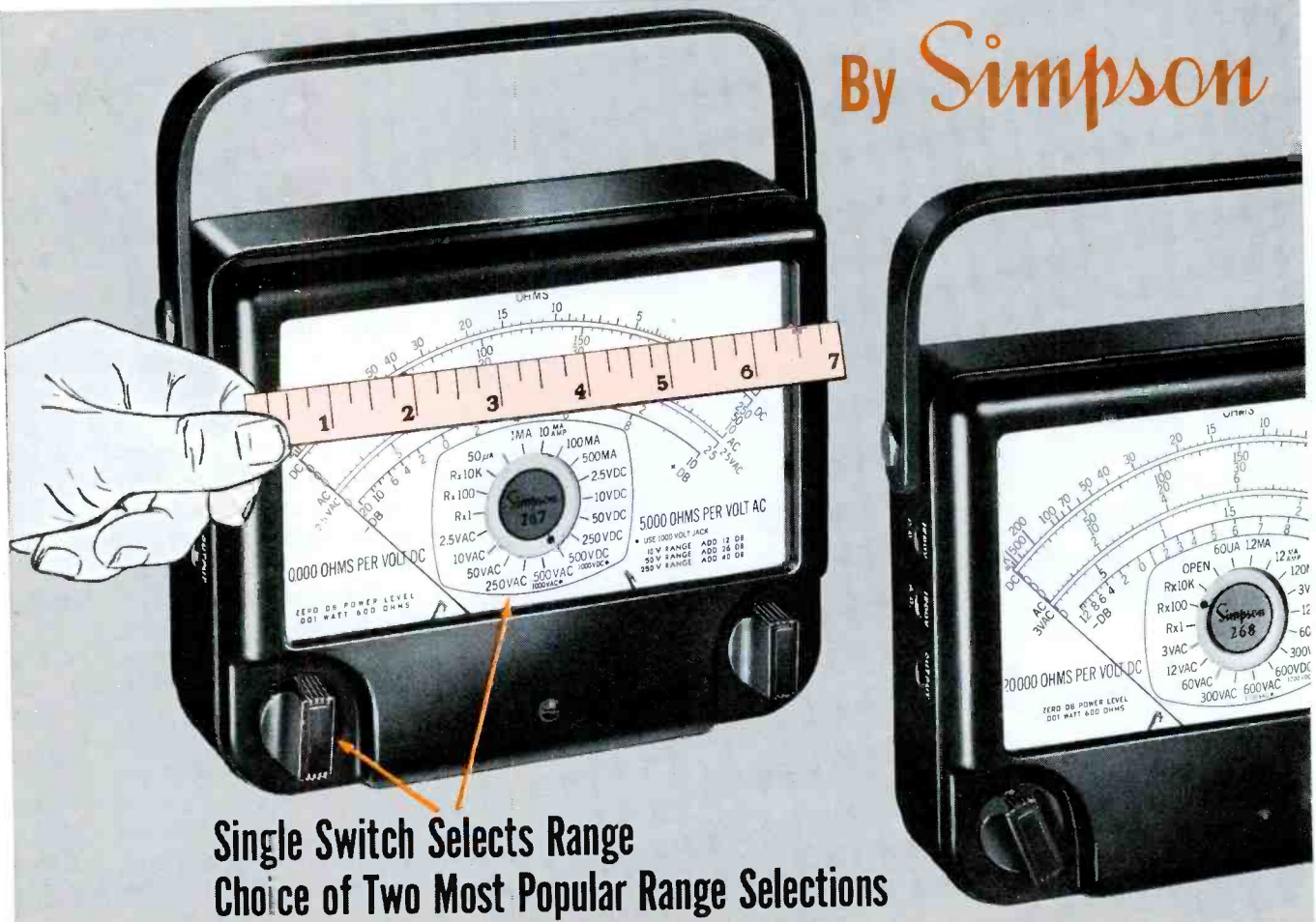

**Single Switch Selects Range  
Choice of Two Most Popular Range Selections**

From whom but Simpson (makers of the world famous 260 Volt-Ohm-Milliammeter) could you expect testers like Models 267 and 268?

Although their price tags fall in the same area as other makes with small 4½" meters, Models 267 and 268 give you big, easy-to-read 7" meters plus quality features such as: *self-shielding*, core-type movements with spring loaded jewels . . . single-switch range selection . . . black and red scales that are spread out for close repetitive reading . . . Adjust-A-Vue handles . . . plus all the rugged, stay-put accuracy that you *expect and get from Simpson*.

Vital statistics for Models 267 and 268 are: DC sensitivity, 20,000 ohms per volt; AC, 5000 ohms per volt. Accuracy: DC volts, ±3% of full scale; AC volts, ±5% of full scale.

*Have your distributor bring one out for trial.*

## Choice of 250 or 300 Volts

	Model 267	Model 268
DC VOLTS	0-.25/2.5/10/50/250/500/1000	0-3/12/60/300/600/1200
AC VOLTS	0-2.5/10/50/250/500/1000	0-3/12/60/300/600/1200
DC MICROAMPERES	0-50	0-60
DC MILLIAMPERES	0-1/10/100/500	0-1.2/12/120
DC AMPERES	0-10	0-12
DB SCALE	-20 to +10 DB 1 MW in 600 ohms	-12 to +11 DB 1 MW in 600 ohms
OUTPUT RANGES	AC Volt ranges to 250 V with .1 mfd condenser in series	AC Volt ranges to 300 V with .1 mfd condenser in series
OHMS		
Ranges	RX1	RX100
Ctr. Scale Value	12	1200
		RX10K
		120,000

Also Available: carrying cases, high-voltage multipliers, and special types of test leads.

Model 267 or 268  
complete with test leads  
and operator manual . . . . .

**\$49<sup>95</sup>**

See Your Distributor Also  
For Simpson's Famous 260.  
Outsells All Other VOMs Combined.  
Still Only \$43.95



Famous around the world...260® VOM

# Simpson

**SIMPSON ELECTRIC COMPANY**

5209 W. Kinzie St., Chicago 44, Illinois

Phone: ESTEbrook 9-1121 (Area Code 312)

In Canada: Bach-Simpson Ltd., London, Ontario

# Easy Adjustment of Hidden Controls

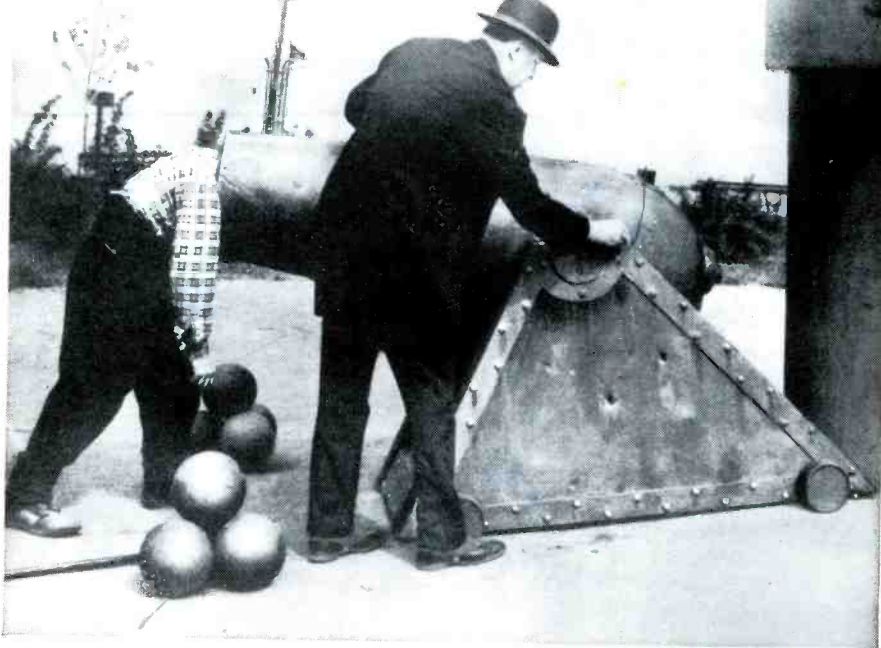

## With Centralab Twist-Tab Radiohms



You'll get a big bang out of CENTRALAB tab-mounted Radiohm Controls—because they're easy to install and easy to adjust. These Twist-Tabs are tailored to the *minimum* shaft length needed for TV hidden controls. When a *longer* shaft is needed, it's simple to use the 2" polyethylene extension packed with each unit. Nothing to saw—a snip of the scissors gives the needed length, and the adjustment slot is still there, and still easy to get at.

CENTRALAB Twist-Tabs are available in 25 values from 200 ohms to 7.5 megohms... rated at  $\frac{1}{2}$  watt,  $\frac{15}{16}$ " diameter,  $\frac{7}{16}$ " deep. Shoot over to your CENTRALAB distributor for full details.

**Centralab**

THE ELECTRONICS DIVISION OF GLOBE-UNION INC.  
942A EAST KEEFE AVENUE • MILWAUKEE 1, WISCONSIN  
CENTRALAB CANADA LIMITED—AJAX, ONTARIO

B-6115 S

ELECTRONIC SWITCHES • VARIABLE RESISTORS • CERAMIC CAPACITORS  
PACKAGED ELECTRONIC CIRCUITS • ENGINEERED CERAMICS

54 PF REPORTER/January, 1962

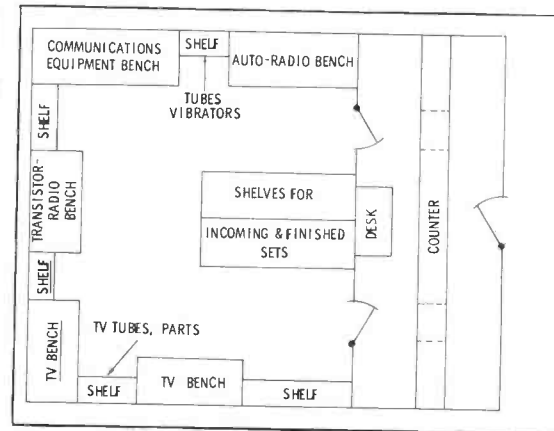

Fig. 2. Different arrangement has separate benches for various types of jobs.

of a burnt resistor, blown fuse, or similar obvious fault. Sets with intermittent troubles are, of course, almost invariably taken to the shop, since much time can be lost in the home while the serviceman is involved in guesswork. Inevitably, he can do a more complete service job in the shop, resulting in fewer call-backs.

If the set requires shop repairs, the technician should pull the chassis out of the cabinet and take it along. This saves manpower, requires less space in the truck and in the shop, and presents less danger of cabinet damage. For chassis which do not have the CRT mounted on them, the shop should have small test CRT's on hand so the technician need bring only the chassis and yoke to the shop—eliminating the need for an assistant to help pick up and deliver the set.

### Shop Efficiency

Inside the shop, some attention to details such as wasted steps and lost motion will usually turn up interesting areas for improvement. Efficient shop layout, convenient arrangement of shop and office furniture, and adequate lighting where needed are all ways and means of decreasing lost time.

Many ideas have been advanced concerning the most effective arrangement of benches, parts shelves, and set-storage shelves. A number of such ideas were pictured and described in the September, 1961 issue. Arrangements should be adapted to the needs of the individual shop, keeping in mind the need for saving time.

One arrangement (see Fig. 1)



# WEAK SIGNAL?

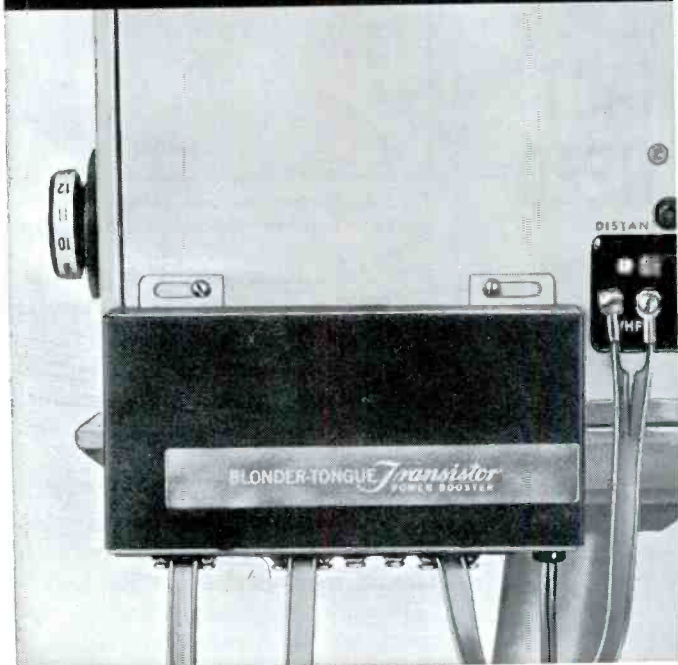

# READY FOR UHF?

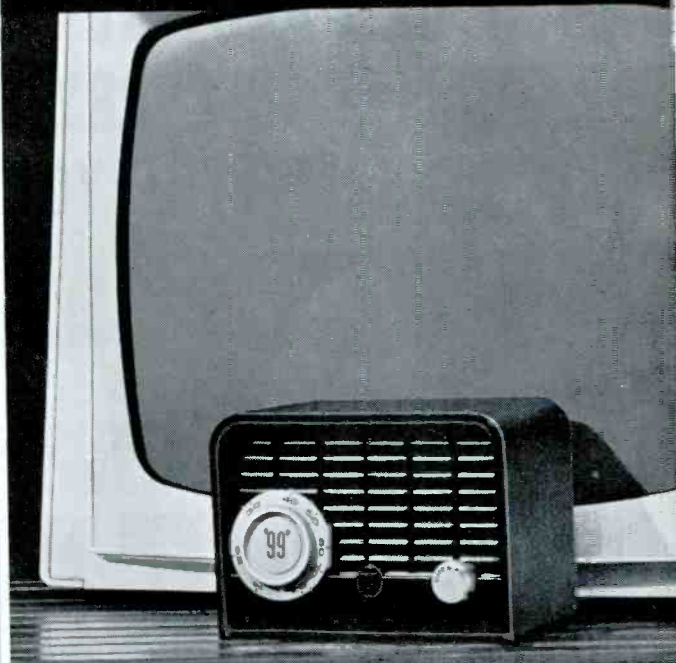

## TV & FM AMPLIFIERS

MODEL	DESCRIPTION	GAIN AVERAGE	AMPLIFIER	MOUNTING	LIST PRICE
BTA	Home VHF/FM booster for single set.	8 db	Tube	Indoor	15.70
B-24c	Home VHF/FM booster for up to 4 sets.	9 db	Tube	Indoor	24.95
IT-3	Home VHF/FM booster for up to 4 sets.	12 db	Transistor	Indoor	33.00
AB-4	Home VHF/FM booster, battery powered. For up to 4 sets.	12 db	Transistor	Indoor or Mast Mounted	29.95
AB-2	Home VHF mast mounted booster. Remote power supply.	10 db	Tube	Mast Mounted	53.95
UB (70-83)	UHF booster (ch 70 thru 83).	15 db	2 Tubes	Mast Mounted	84.50
UB (72-76)	UHF booster (ch 72 thru 76).	21 db	2 Tubes	Mast Mounted	103.75

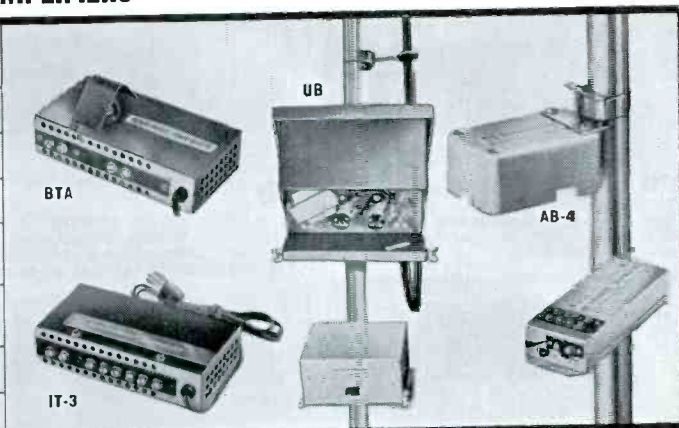

## UHF CONVERTERS

MODEL	IMPEDANCE	INPUT CHANNELS	OUTPUT CHANNELS	GAIN	LIST PRICE
BTC-99R	300 Ohm	14 thru 83	5 or 6	—	23.95
BTU-2S	300 Ohm	14 thru 83	5 or 6	5 to 8 db	39.95
BT-70	300 Ohm	70 thru 83	5 or 6	5 to 8 db	41.50

Where all other methods fail to bring in UHF channels, use the model UB-UHF amplifier with the BTC-99R, the BTU-2S converter, or any all channel (VHF and UHF) receiver.



BTC-99R

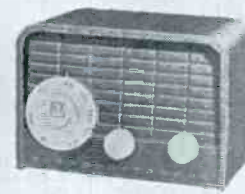

BTU-2S

## SELECT THE BLONDER-TONGUE TV PRODUCT TO DO THE JOB BEST

From the world's only matched, and integrated line for CATV, CCTV, ETV, MATV and home TV. Available through parts distributors. Write for 28-page planning and installation manual.

engineered and manufactured by

**BLONDER-TONGUE**



9 Alling St., Newark, N. J.

Canadian Div.: Benco Television Assoc., Tor., Ont. Export: Rocke Int'l Corp., N. Y. 16, N. Y.-CABLES:ARLAB  
home TV accessories • UHF converters • master TV systems • closed circuit TV systems

# AEROVOX ELECTROLYTIC CAPACITORS PROVIDE TOP QUALITY IN EVERY EXACT REPLACEMENT TYPE YOU NEED



Continuous research and product development by Aerovox engineers, coupled with advanced manufacturing techniques, has produced the most dependable and complete line of 'lytics in the electronics industry. Some of the most widely used types are featured here.



**AFH** twist-prong 'lytics feature 85°C operation, improved sealing, high-purity aluminum foil construction throughout, ruggedized prongs and mounting terminals. Tops for filter audio bypass in TV radio and amplifiers.



**PR** wax-filled tubulars manufactured to same high standards as more expensive metal-cased units. Made for exact replacements in TV receivers and antenna rotating devices. Available in singles, duals, triples, quads, and quints for 0-65°C operation.

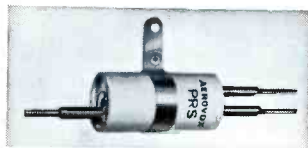

**PRS** compact "Dandee" units for trouble-free repair of series-string TV and AC-DC table radios. Aluminum cans with cardboard insulating sleeves. Made in singles, duals, and triples, as well as AC rated and non-polarized units.



**SRE**... "Bantam" metal tubular 'lytics hermetically-sealed in aluminum cans with cardboard insulating sleeves. Smaller than the PRS but capable of handling full size loads to 85°C.

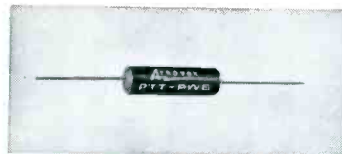

**PTT-PWE** miniaturized tubular 'lytics for repair of personal transistor radios, portable TV sets, and all space-tight requirements. Feature "Polycap"® plastic cases with exceptional humidity resistance.



**BCD** upright mounting 'lytics for replacement in printed circuits, transistorized and auto radios. "Polycap" case and epoxy seal offer excellent moisture barrier to protect against drying out or leakage.



**HCB**... high-capacity-low voltage 'lytics designed especially for applications such as motion picture sound equipment, electric fence controls and other low voltage applications. Feature bakelite case which eliminates need for cardboard outer insulating tubes.

Ask your local Aerovox Distributor for a free copy of the TV Electrolytic Capacitor Replacement Guide AFG-370 and AFH Twist-Prong 'Lytic Booklet AFH-461.

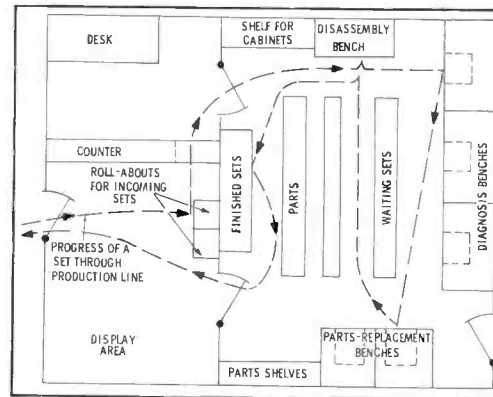

Fig. 3. Production-line setup can improve efficiency of large service shop.

provides a separate service position, with basic test instruments close at hand, for each technician. In this case, a roll-around rack is utilized to keep the lesser-used generators and special test equipment conveniently nearby.

Fig. 2 depicts another layout which is sometimes used. This plan provides a service bench for each type of equipment to be serviced—auto radios, communications equipment, television receivers, transistor radios, and any other types of equipment handled by the servicer. Each bench is equipped with the special test instruments for the job.

A large service operation could use a production-line system (see Fig. 3). Sets are disassembled at one position, moved (on a roll-about cart) to a service location for diagnosis, and then sent to a third bench for parts replacement. Final assembly and checkout often take place at the disassembly position. This method of handling service jobs permits the efficiency of specialization at each service position.

Parts shelves should be convenient, but out of the way. The tube stock is usually located in a central area, along with special parts—yokes, transformers, and such items. A few of the most-often-used tubes and small parts are placed at each service location. In specialized shops, such as in Fig. 2, only those parts and tubes peculiar to certain equipment need be stocked at each bench.

## On the Bench

Test equipment and tools are significant items in any bench repair job. If these are placed inconveniently, and are either hard to reach or see, they lose their effect-



Remember—it pays to use Aerovox!

**AEROVOX CORPORATION**  
DISTRIBUTOR DIVISION NEW BEDFORD, MASS.

Technical Leadership — Manufacturing Excellence



flightiness is for the birds

(smart technicians stay with one major supplier!)

CDE distributors are men you can be loyal to. They've earned the Cornell-Dubilier product line because they have demonstrated integrity, sound business judgment, professional knowledge and long-term financial stability. But, most important, they have demonstrated a sincere "urge to serve" you. Their principal concern is to have available for you what you want, when you want it. Toward that goal they carry ample and well-diversified lines of top-brand components and devices.

Maintaining such a program of service for you is an undertaking of no small proportion. It requires skill, time and lots of money. In return they ask only that you recognize them as an important factor in your business success by making them your steady source of supply for the products you use in your daily work.

Because Cornell-Dubilier products have been first choice for over a half century, CDE distributors stock

CDE products in depth—in hundreds of product categories. Now, with the brand-new 40-page CDE Service Selector, you and your CDE distributor can conduct business more quickly and efficiently—more profitably!—than ever before, over the phone or over the counter. If you have not yet received your copy of the CDE

Service Selector, your CDE Distributor will be glad to supply you. In fact, whatever your supply problem may be, he'll never leave you "up in the air." For he's that all-too-rare bird—the kind of man who reciprocates loyalty with service.

CORNELL-DUBILIER ELECTRONICS, DIV. OF FEDERAL PACIFIC ELECTRIC COMPANY, 50 PARIS STREET, NEWARK 1, NEW JERSEY



# MAKING ROOM AT THE TOP



## AC VTVM & AMPLIFIER #250

**NEW** EICO ENGINEERING ACHIEVEMENT Kit \$49.95 Wired \$79.95

Phenomenally good AC VTVM, bound to make room for itself at the top of the professional market. 12 ranges from 1 mv to 300 V full-scale, 10c-600kc  $\pm 0$  db response, 10 megohms input impedance,  $\pm 3\%$  of full scale accuracy. At the flick of a switch, the internal wide-band amplifier is available for external use. Provides 8c-800kc  $\pm 0$  db response, 5 VRMS output, 5 kilohm output impedance, gain control, noise  $-40$  db. Regulated power supply, frame grid tubes.

**AC VTVM #255** Kit \$44.95 Wired \$72.95

All the precision VTVM facilities of the #250, less the external use of the wide-band amplifier.

## ARMED TO THE TEST LEADS FOR THE TRANSISTOR GAME

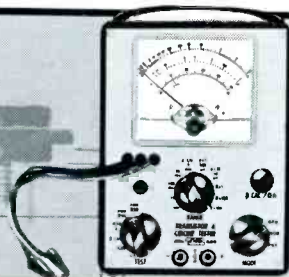

## TRANSISTOR AND CIRCUIT TESTER #680

Kit \$25.95 Wired \$39.95

Measure ICEO, ICBO & dc $\beta$  directly, ac $\beta$  indirectly, without charts or special settings—plus all dc volts, currents, and resistances needed to service transistor equipment. 50  $\mu$ A, 3 1/2" face meter movement provides sensitivity and scale length necessary for accurate measurements. Built-in 20,000 ohms/volt VOM facilities let you work on transistor equipment with minimum equipment tie-up.

## SITTING DUCKS FOR THIS SNOOPER



## IN-CIRCUIT CAPACITOR TESTER #955

Kit \$19.95 Wired \$39.95

- Leave those capacitors where they are! Without unsoldering:
  - check for shorts (even in the presence of as little as 1 ohm shunt resistance)
  - check for opens (determine the presence of as little as 5mmf in the circuit), and to confirm open indication . . .
  - measure capacitance with  $\pm 10\%$  accuracy between 0.1 mf and 50 mf
  - measure RC product, convertible into dissipation or power factor.

### Also New From EICO:



**Battery Eliminator and Charger #1064**  
Kit \$43.95  
Wired \$52.95



**AC Bench Supplies:**  
Model 1073—  
Kit \$35.95  
Wired \$47.95  
Model 1078—  
Kit \$42.95  
Wired \$54.95



**AC Volt-Watt Meter #260**  
Kit \$49.95  
Wired \$79.95



For complete catalog of over 80 EICO kits and wired units—hi-fi, test equipment, citizens radio, ham gear—plus name of nearest distributor, write to dept. PF-1

**ELECTRONIC INSTRUMENT CO., INC., 3300 N. BLVD., L. I. C. 1, N. Y.**

Add 5% in the West

Export Dept: Roburn Agencies, Inc. 431 Greenwich St., N. Y. 13, N. Y.

iveness as troubleshooting aids; thus, care should be exercised in their placement. The most-used test instruments, such as VTVM's and oscilloscopes, can be mounted in a backdrop or placed on a shelf at eye level, or they can be propped on the bench top. If they are on the surface of the bench, it is helpful to tip them back slightly so as to eliminate strain on the technician who is trying to observe their indications. However, care should be taken to avoid reflection of light from the scope screen, which makes it very difficult to see the trace.

Many hours are lost, and vast efforts wasted, in service shops where technicians fail to use proper test equipment for the job to be done. True, hundreds of sets are fixed by "brute-force" methods, but the really efficient service technician learns to use the correct instrument for the job. In many instances, a certain repair will entail the use of several different test instruments; each one makes its own contribution to the complete repair. Failure to utilize the proper instruments merely lengthens the time required to locate and eliminate a fault.

The time-conscious technician takes advantage of special circuit-testing instruments, in addition to the old standbys. Instruments for analyzing audio circuits, color-TV circuits, and sweep circuits all play their part in the really efficient service operation. Equipment is available to simulate almost every type of signal with which the average service technician must cope. Special scopes, easy-reading VTVM's, quick-change test probes, special adjustment tools, and even tube testers for quick-testing most tubes, are built for the efficiency-minded technician.

Efficiency does not just happen; it can be attained only through conscious effort. Each phase of the service operation must reflect this effort. Efficiency is a state of mind; it is a way of approaching each service problem with the feeling that this particular job can be dispatched in a minimum time while adhering to a standard of thoroughness. In most service businesses, a long look at operating methods will reveal many possibilities for improvement. ▲

**NEW**

# .....VALUE ENGINEERED

## FOR LOWEST INSTALLED COST

### 8" SPEAKERS FOR DISTRIBUTED SOUND

This new line of Jensen 8-inch Professional Series loudspeakers is specially designed to meet the exacting rigorous demands for commercial sound installations. The 8-inch size is ideal for the majority of all distributed sound systems giving more than adequate low frequency range without enclosure and mounting complications.

A wide selection of models to meet every need—from the lowest cost highly competitive application to the most sophisticated highest quality system.

This entire line is *value engineered* for lowest installed cost of the entire system. Convenient 10-pack with or without preattached 70.7 or 25-volt transformers are options available. Handy KWIKON\* instant connectors for input and power tap adjustment.

For full details write for individual data/specifications available on each speaker.

#### 1. AVAILABLE IN HANDY 10-PACK

Added savings and convenience in bulk-packed carton of ten speakers, with or without preattached transformers.

#### 2. PREATTACHED TRANSFORMERS

CHOICE OF 70 AND 25-VOLT LINE TYPES

Especially designed for use with the popular "constant voltage" distribution systems. Center-tapped primary windings for balanced-line or special circuit needs. Tapped secondary for adjustment of power to 8-ohm speaker in 3 db steps from 1/8 watt to 4 watts. Core size 3/8" x 5/8". Two 3/16" dia. mounting holes on 2 5/8" centers. Prices below are for transformers only.

**70CV4.** For 70-volt distribution systems.

**25CV4.** For 25-volt distribution systems.

List Price ..... \$4.75

#### 3. KWIKON\* INSTANT CONNECTORS

Simply twist bare ends of two 12" input leads supplied for each speaker to incoming signal cable leads, insulate with wire-nut or tape. Slide sleeve clips onto input terminal lugs of speaker or preattached transformer as speaker assembly is raised into place. KWIKON\* instant connectors also provide simple fast power tap adjustment on transformer.

\*T.M.



C-855

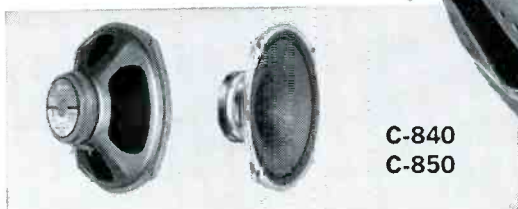

C-840  
C-850



P-830



P-810



Model	Power Rating Watts	Magnet Weight Ounces	Loudness Level <sup>(3)</sup>	Overall Depth	Net Weight Pounds	List Price
C-855	12	10.0 <sup>(1)</sup>	85.0	3 1/16"	2 1/2	\$13.50
C-850	12	10.0 <sup>(1)</sup>	85.5	3"	2 3/8	12.95
C-840	11	6.0 <sup>(1)</sup>	84.5	2 15/16"	2	10.95
P-830	10	2.5 <sup>(2)</sup>	84.0	3 1/4"	1 1/4	7.25
P-810	9	1.47 <sup>(2)</sup>	82.0	3 3/16"	7/8	5.80

(1)—SYNTOX-6® Ceramic. (2)—DP-Alnico-5.  
 (3)—db above 2x10<sup>-4</sup> dynes/cm.<sup>2</sup> @ 10 Ft. for input power of 1.0 watt standard 800-1250 cps warble signal.  
 Speakers conform to applicable EIA Standards. Max. O.D. 8 3/4" width and height 7 1/4". Recommended baffle cutout 6 3/4" dia. Nom. voice coil impedance 8 ohms. Facilities for standard 2-hole mounting transformers up to 3/4 x 3/4 nominal core size.

**Jensen** MANUFACTURING COMPANY  
 Division of THE MUTER COMPANY  
 630 S. Laramie Avenue, Chicago 38, Illinois  
 In Mexico: Universal De Mexico, S.A., Mexico, D.F.

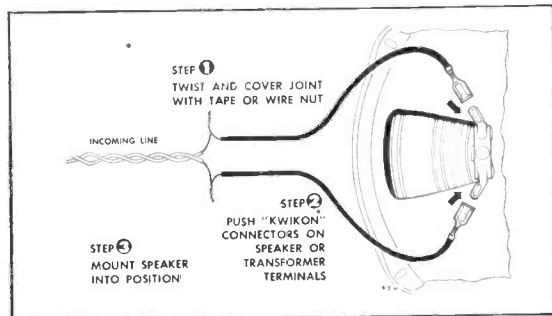

**FINE ENOUGH**

to cut a human hair

**STURDY ENOUGH**

to cut 12-gauge copper wire



**Specially Designed**  
**CHANNELLOCK**<sup>®</sup>

No. 748 Long-reach  
**End Cutter**

Here's the answer to your hard-to-get, at wire cutting jobs . . . the CHANNELLOCK Long-Reach End Cutter. Gets into tight places you can't reach with any other cutter. Especially handy for electrical, radio, TV, Hi-Fi and electronics work. Precision-honed, specially hardened cutting edges. Long, blue-plastic coated handles. Top quality polished forged steel. Ask your tool supplier for a CHANNELLOCK No. 748 End Cutter. If he doesn't have one, ask him to order it for you.



Write for Catalog of  
Complete Line of Pliers



#718 LONG-REACH FLAT-NOSE PLIER



#728 LONG-REACH DIAGONAL CUTTER



#738 LONG-REACH ROUND-NOSE PLIER

Channellock Pliers are made only by

**CHAMPION DEPARTMENT TOOL COMPANY**  
Meadville, Pennsylvania

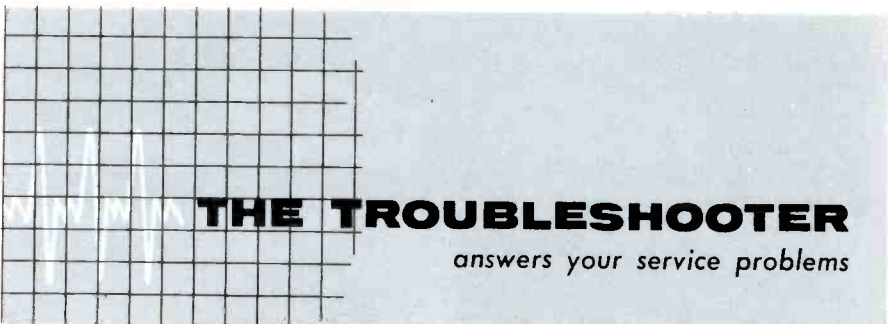

**THE TROUBLESHOOTER**

answers your service problems

**Oscillator Off the Track**

If you have an answer to this, several engineers will take off their hats to you. A Pilot T601 FM tuner could not receive a station at 107 mc, but was okay on 94.5 mc and 92 mc.

A check at the oscillator grid proved the oscillator was not stopping, so we used a frequency meter to discover that the oscillator tracked normally to 100 mc, then suddenly shifted to about 310 mc. Further rotation of the tuning dial increased this frequency to nearly 340 mc; the oscillator trimmer would vary it about 10 mc.

We tried the following series of operations: Checked wiper contacts, grounds, and tuning-gang connections; changed all oscillator-circuit resistors and capacitors; tied grounds to a common bus; changed the RF and IF bypass capacitors; shifted

lead dress; in fact, everything we could think of, sometimes just grasping at straws. Alignment was impossible at the high end. We found there was interaction between the adjustments of A9 and A10, but removing RF amplifier V1 only resulted in the frequency going even higher, to above 500 mc. Removing IF amplifier V3 had no effect on the oscillator.

We know what's happening, but can't come up with a cure. Incidentally, this is the first service the tuner has ever had, other than tube replacement.

PAUL G. SMITH

New York Mills, N.Y.

*I'll be glad to give it a try! Your statement that removing the RF amplifier caused the frequency to shift even further suggests a relationship between this stage and the oscillator. A similar case in a Pilot tuner was traced to stray coupling caused by the oscillator injection capacitor,*

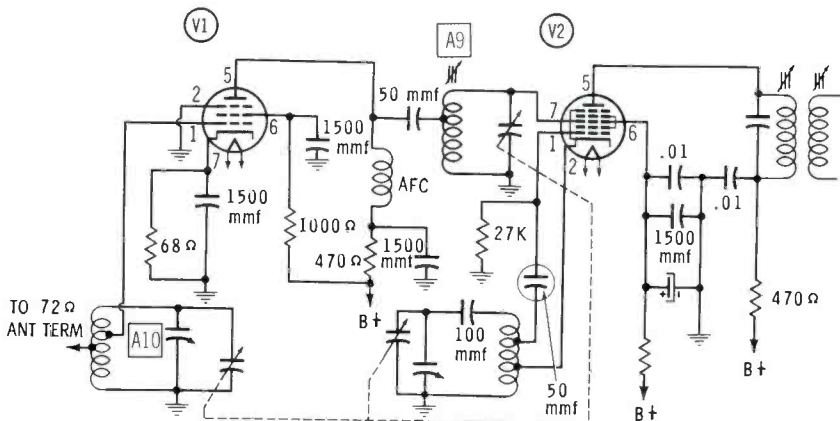

**QUICK and LASTING**

When You Use  
**HUSH**<sup>®</sup>

Chemically-Electronically, engineered for Tuners  
and Switching Mechanisms.

When New HUSH is applied it will wash-away that dirt, leaving clean and positive contacts protected by a lasting lubricant. New HUSH is made from the finest solvents and it contains Electro-Silicone oils.

6 oz. Spray can. Also available 2 oz., 8 oz., 32 oz. containers

**FREE 6" Plastic Extender With Every Can**

**EVER-QUIET**<sup>®</sup>

Since 1949

VOLUME CONTROL AND CONTACT RESTORER

EVER-QUIET is a free-flowing liquid that leaves no powder residue. Scientifically designed to seep around the shaft and penetrate the control or potentiometer, cleaning the contacts and leaving a safe protecting film. Harmless to metals, wire or carbon.

2 oz. Bottle & dispenser. Also available—6 oz. Spray can



**CHEMICAL ELECTRONIC ENGINEERING, INC., Matawan, New Jersey**

which was slightly out of position in the chassis. The location and orientation of this capacitor is very critical, and a picture of the chassis in PHOTOFACT Folder 28-26 was a great help in finding this trouble.

Of course, it is possible that stray capacitance between the rotor sections of the tuning gang is coupling energy into the wrong circuit, but this is unlikely if the unit has ever operated normally.

Double-check all three bypass capacitors in the screen circuit of V2, and the bypass capacitors at the plate and screen of V1. Also, recheck for improper lead dress (using the PHOTOFACT photo if needed), since this might be the cause of signal feedback into the tuned circuit of the oscillator.

### My Hero!

I have in my possession an Emerson Model 611-B, given me by a friend. My plan was to repair it and give it to my little girl for her room. But I don't know.

The problem is critical vertical sync. The hold control must be constantly adjusted to keep the picture locked. I replaced the integrator network and all coupling capacitors back to the sync amplifier, to no avail. I also noticed that the vertical hold becomes even more touchy when brightness or contrast is reduced slightly.

I know I should toss this "oldie" out, but my kid likes it because it's a 10" table model and will fit her room nicely. Can you help save face and make me a hero in her eyes?

IRWIN KAMNER

Philadelphia, Pa.

*I'll try, Irwin, I'll try. You may be troubled with compression of the vertical sync pulse somewhere in the RF, IF or video stages. Use your scope to check the video-amplifier output waveform supplied to the sync separator. Waveform analysis with a scope will help you locate the point of attenuation.*

*On the other hand, your remark about the settings of the brightness and contrast controls leads me to think that filter capacitor C6A may be opening, permitting unwanted signals to enter the vertical oscillator circuit. This capacitor is a common bypass for the video and brightness-control circuits. C4B is a possible offender in this respect, too.*

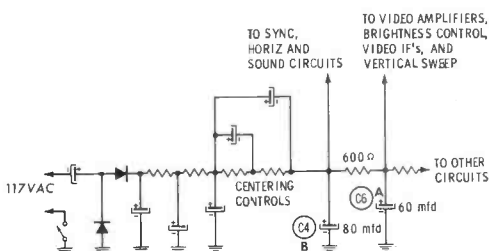

# Arcolytic<sup>®</sup>

Available from all authorized ARCO distributors



## 1401 Values...The largest selection of exact replacement twist-mount & tubular electrolytics

- 99.99% high purity aluminum foil electrolytics at no extra cost!
- Choose from stock any single, dual, triple or quadruple capacitance-voltage combination for replacement in television, radio, and other electronic equipment
- Made to withstand high ripple and high surge voltages
- Designed for 85°C high temperature operation
- Greater shelf and operating life because only premium grade ingredients are used
- Built and tested to meet EIA Specification RS-154
- Individually packaged with mounting plates for your convenience
- Unconditionally Guaranteed.

Manufactured by

# ARCO electronics inc.

ELECTROLYTIC DIVISION

Community Drive, Great Neck, New York • HUinter 7-0500

Branches:  
Dallas 7  
Los Angeles 35

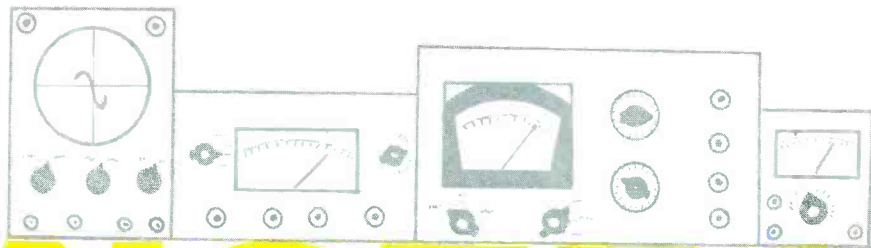

# NOTES ON TEST EQUIPMENT

by Forest H. Belt

## Transistor Specialist

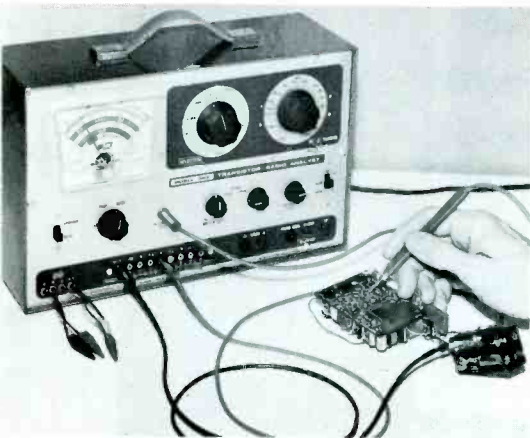

Fig. 1. Complete servicing instrument for testing transistor receivers.

For the busy technician who is interested in convenience and servicing speed, the Model 960 Transistor Radio Analyst (shown in Fig. 1) facilitates the analysis and troubleshooting of transistor portable radios. This instrument is manufactured by B & K Manufacturing Co. of Chicago. On the service bench, it provides in one compact case the signal-generating and measurement devices

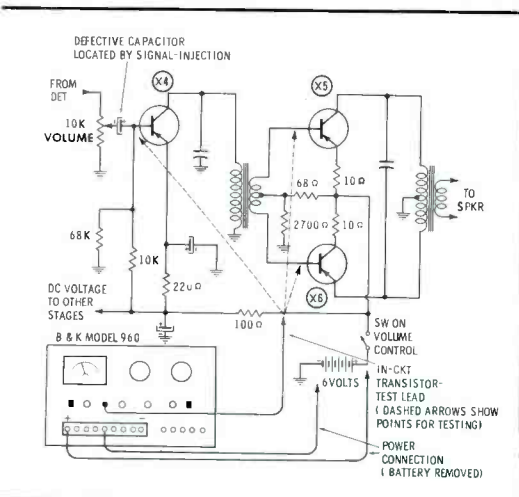

Fig. 2. Power hookup and test points for in-circuit transistor testing.

needed to diagnose and isolate troubles in a transistor radio.

Specifications are:

1. *Power Requirements*—117 volts, 50-60 cps AC; power consumption about 10 watts; power switch incorporated in function switch.
2. *RF Output*—250 kc through 2.2 mc; either unmodulated or 30% modulated by internal 2000-cps tone generator.
3. *Audio Output*—2000-cps tone available separately; special low-impedance output for directly testing voice coils.
4. *VTVM Ranges*—two ranges measure DC voltage, from 0 to 1.5 volts and from 0 to 15 volts; one range measures ohms, from 0 to 1 megohm, with a center-scale reading of 1000 ohms.
5. *DC Power Supply*—furnishes low-impedance source of DC; isolated from power line and chassis; voltages from 0 to 12 volts (in 1½-volt steps) available at pin jacks on front panel; tapped-voltage arrangement simulates tapped batteries; ripple content 1.2% at voltages up to 9 volts, 3.1% at 10½ and 12 volts; power-supply current metered in two ranges—0 to 15 ma and 0 to 150 ma.
6. *In-Circuit Transistor Test*—tests NPN or PNP transistors; "Dynatrace" method, exclusive with B & K, uses one lead from jack on front panel.
7. *Out-of-Circuit Transistor Test*—tests NPN or PNP transistors; reads leakage on GOOD-BAD scale; reads beta on 0 to 150 scale or GOOD-BAD scale; tests both triode and tetrode transistors; special test indicates shorted or open power transistors.
8. *Meter*—3½" panel meter, 1-ma movement; ohms scale reads 0 to infinity; two numbered scales, 0 to 1.5 and 0 to 150, used for DC volts, milliamps, and beta measurements; one leakage GOOD-BAD scale and one beta GOOD-BAD scale for out-of-circuit transistor tests; SET marking for in-circuit transistor-test calibration.
9. *Size, Weight, and Price*—7½" x 12½" x 5", 7½ lbs., \$99.95.

The signal-generator section covers a

frequency range of 250 kc through 2.2 mc in two bands, using a Hartley oscillator circuit. The lower-frequency "A" band covers the popular IF frequencies and lower broadcast band, while band "B" covers the remaining broadcast frequencies. The RF output can be used without modulation, or modulated by the internal 2000-cps blocking-type audio oscillator. For troubleshooting audio stages, the 2000-cps tone is available separately.

The VTVM section provides a DC voltmeter having two ranges which permit measuring the voltages encountered in many transistor portables. The ohmmeter section contains only one range, but is sufficient for measurements in the low-impedance circuits of transistor radios. For checking leakage of miniature electrolytics, this ohmmeter has the advantage of placing only 1.5 volts across the ohmmeter leads, eliminating the danger of damaging the capacitors during testing.

The milliammeter can be used only in conjunction with the power supply of the *Analyst*, since no provision is made for monitoring current drain from the radio's own battery. To check the current drain of a radio, the power supply of the instrument must be utilized.

The 12-volt power supply—sufficient for most transistor receivers—is tapped at 1.5-volt intervals, and each tap is accessible on the panel of the instrument through pin jacks. Therefore, the *Analyst* can substitute for the tapped-battery type of power supplies found in some transistor radios. Power-supply leads are inserted into the correct jacks and connected to the appropriate points on the radio power plug.

The out-of-circuit transistor tester will test most low-power NPN and PNP types. In addition, provision is made for testing four-element (tetrode) transistors. The test used with high-power transistors consists of reversing the NPN-PNP test switch while performing the usual test procedures. This test is dependable, only if the power transistor is open or shorted—a fact pointed out in the instruction manual furnished with the instrument.

In-circuit testing of transistors is accomplished by applying a forward bias to the base of the transistor under test, while a sensitive metering circuit measures the resulting increase in current drain of the radio (Fig. 2). Due to this method of indicating test results, it is necessary to keep the volume control at minimum, and to disable the antenna coil with a shorted turn of wire. Otherwise, current fluctuations at the input would render the test meaningless, and perhaps damage the metering circuit. In applying this test, care must be taken not to short the collector lead of the transistor to another lead, as this could result in transistor damage.

The instruction manual which accompanies the *Analyst* takes up in detail the subject of transistor-radio servicing. In explaining the operation and use of the *Analyst*, it discusses troubleshooting meth-





### GMW TRON FUSE

Diameter: .270 inch  
Length of Body: 1/4 inch



### HWA FUSEHOLDER

Diameter: .500 inch  
Length with Knob and Terminals: 15/16 inch

ACTUAL SIZES SHOWN

## Another BUSS sub-miniature fuse and holder combination

#### EXTREME RELIABILITY UNDER HIGH SHOCK AND SEVERE ENVIRONMENTAL CONDITIONS.

Rigid construction of fuse and holder assures extraordinary reliability under high shock and vibration conditions. Fully insulated ceramic body isolates fusible element from effect of dust, corrosion, moisture and vapors.

#### DESIGNED FOR SPACE-TIGHT APPLICATIONS

*Panel Mounted.* Holder can be mounted on panel by hand. No special tool required to run down holding nut.

Prong type contacts on fuse make it easy to install or replace.

A knob for the holder may be used to make holder water proof from front of panel.

#### HOLDER CAN BE MOUNTED IN PRINTED CIRCUITS

Terminals of holder can be inserted into holes and soldered on printed circuit board without additional forming.

If desired, GMW fuse may be used without holder and mounted directly into printed circuit boards.

#### AVAILABLE RATINGS FOR GMW FUSES.

Fuses are made in sizes from 1/10 to 5 amperes for use on circuits of 125 volts or less where fault current does not exceed 50 amperes.

Transparent window in end of fuse body permits visual inspection of fusible element.

Before crystallizing your design using sub-miniature fuses be sure to get full data on the Buss GMW fuse and HWA holder combination.

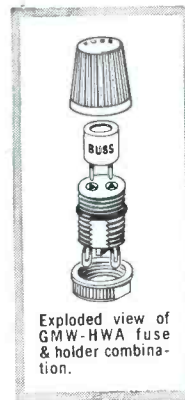

**IN THE BUSS LINE**, you'll find the type and size fuse to fit your every need... plus a companion line of clips, blocks and holders.



**BUSSMANN MFG. DIVISION, McGraw-Edison Co., UNIVERSITY AT JEFFERSON, ST. LOUIS 7, MO.**



**DON'T REPLACE CRYSTALLIZED RUBBER  
PHONOGRAPH DRIVE WHEELS UNNECESSARILY**



**brush on NEW FONO-MAGIC  
eliminate slipping...dragging**

**EASY... SAVES EXCESSIVE DRIVE  
WHEEL INVENTORY COSTS TOO!**

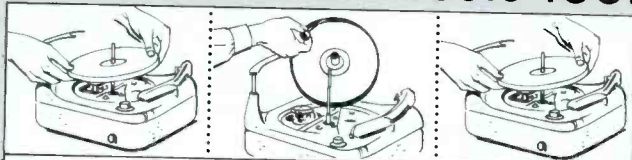

simple as...

- 1** Remove slipping, dragging phonograph turntable.
- 2** Brush FONO-MAGIC on metal friction drive surfaces. (FONO-MAGIC dries in 2 minutes.)
- 3** Replace turntable, stilling changer will immediately cycle properly.



\*FONO-MAGIC is a NEW compound of special rubber and carbide particles. When FONO-MAGIC is brushed on metal drive surfaces, it forms a coat of live, pliable non-slipping rubber .00065 inches thick. Carbide particles imbedded in the rubber coating will scratch slipping rubber idler wheels, exposing live rubber and prolonging the life of the idler wheel. Just one bottle of FONO-MAGIC is equivalent to the replacement of 100 drive wheels. Trade Mark

**only  
\$1.95**  
DEALERS NET.

manufactured by COLUMBIA PRODUCTS CO., INC. Highland Park, Illinois

**NOW! Profits for you bringing better TV to problem areas.**



Distributors, Servicemen... investigate the profits in selling, installing, servicing, the EMCEE VHF Translator in areas that lack good direct TV reception.

You also profit from increased TV set sales, service customers and sales of replacement parts.

- **CONVERSION FLEXIBILITY**... any Input channel to any non-adjacent output channel.
  - **FREEDOM FROM INTERFERENCE**... no Internal signals which coincide with input to any other translators.
  - **EASY OPERATION UNDER FCC RULES**... simple control and identification unit minimizes maintenance and reduces cost... no operator required.
  - **EASY-INSTALLATION**... available for cabinet/rack mounting or in weatherproof housing.
- TRANSLATORS MAY BE RUN IN TANDEM TOO!



ELECTRONICS, MISSILES & COMMUNICATIONS, INC.  
264 E. Third Street • Mt. Vernon, New York  
Gentlemen:

— Please rush free planning package including data sheet, complete installation check list, coverage calculation form.

— Please send free reprint of FCC rules covering translators. P.J

NAME \_\_\_\_\_  
ADDRESS \_\_\_\_\_  
CITY \_\_\_\_\_ STATE \_\_\_\_\_

ELECTRONICS, MISSILES AND COMMUNICATIONS, INC.  
264 E. Third Street • Mount Vernon, New York

ods and procedures which aid the service technician in putting the instrument to use. Examples of common service problems are illustrated, with remedies involving the use of the *Analyst*.

When the *Analyst* is used as a signal-injection instrument, possible transistor damage is prevented by the isolating capacitors in series with the output test jacks. If this protection were not included, a collector-base or collector-emitter short might be completed through the instrument. With the capacitor in the test circuit, it is safe to inject the signal at the base, emitter, or collector without regard for the internal resistance of the instrument.

The *Transistor Radio Analyst* was used quite successfully for troubleshooting transistor radios in our lab. For example, it helped us service a two-band, six-transistor portable receiver which was motor-boating and would receive no stations.

With the *Analyst* providing power, the amount of input current to the radio failed to indicate any abnormality such as a shorted transistor or capacitor, so we tried a signal-injection procedure. In tracing back from the speaker, the audio sections were found to be normal. At the base of the first audio transistor, adequate signal was still reaching the speaker, but when the test signal was applied to the volume-control arm (see Fig. 2), the speaker output was greatly attenuated. A loose axial lead in the audio coupling capacitor proved to be the offender, so the capacitor was replaced. A complete alignment of both bands, using the signal generator in the *Analyst*, resulted in a great improvement in sensitivity and a complete repair job.

We concluded that the *Analyst* was indeed a specialist for transistor-radio repairs. Although many of its functions can be duplicated by equipment which the usual service shop has on hand anyway, there is an unmistakable advantage in having all these functions in one instrument, without the necessity for numerous interconnecting cables.

## Mirrored Meter

One of the most-used items in any service shop is the volt-ohm-milliammeter. Many servicemen prefer it above the VTVM for servicing countless different types of equipment. A new, easily-read version of this old standby is shown in Fig. 3—the Model 800, introduced by the Triplett Electrical Instrument Co. of Bluffton, Ohio.

Specifications are:

1. **DC Voltmeter**—eight ranges of from 0 to .24, .6, 3, 12, 60, 300, 1200, and 6000 volts at a sensitivity of 10,000 ohms per volt (except .24-volt scale); eight ranges of from 0 to .12, .3, 1.5, 6, 30, 150, 600, and 3000 volts at a sensitivity of 20,000 ohms per volt (except .12-volt scale); polarity reversal by use of function switch; accuracy  $\pm 1\frac{1}{2}\%$  of full scale, except  $\pm 3\%$  of full scale on ranges 0-3000 and 0-6000 volts.

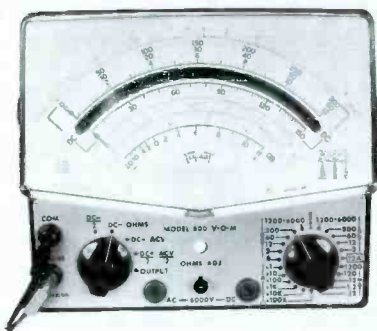

Fig. 3. Sensitive VOM has many ranges.

2. AC Voltmeter — six rms ranges of from 0 to 3, 12, 60, 300, 1200, and 6000 volts, at a sensitivity of 5000 ohms per volt; six rms ranges of from 0 to 1.5, 6, 30, 150, 600, and 3000 volts at a sensitivity of 10,000 ohms per volt; accuracy  $\pm 3\%$  of full scale, except  $\pm 4\%$  of full scale on ranges 0-3000 and 0-6000 volts; frequency response on ranges to 300 volts compensated from 35 cps to 20 kc.
3. Output Meter—twelve ranges extending from  $-20$  to  $+77$  decibels; 0-db reference at 1 milliwatt on 600-ohm line; not frequency-compensated.
4. Ohmmeter—six ranges of from 0 to Rx1, 10, 100, 1000, 10K, and 100K; center-scale value 44; ohms-adjust control on front panel; accuracy  $\pm 1\frac{1}{2}\%$  of DC scale with fresh battery; circuit fused for overload protection; spare fuse inside case.
5. DC Microammeter—two ranges of from 0 to 60 and 600 ua, at 120 mv; one range of from 0 to 120 ua, at 240 mv; accuracy  $\pm 1\frac{1}{2}\%$  of full scale.
6. DC Milliammeter—three ranges of from 0 to 6, 60, and 600 ma at 120 mv; four ranges of from 0 to 1.2, 12, 120, and 1200 ma at 240 mv; accuracy  $\pm 1\frac{1}{2}\%$  of full scale.
7. DC Ammeter—one range of from 0 to 6 amperes at 120 mv; one range of from 0 to 12 amperes at 240 mv; accuracy  $\pm 1\frac{1}{2}\%$  of full scale.
8. Meter—7" face; 40-ua, 3000-ohm movement, accuracy  $\pm 1\frac{1}{2}\%$ ; AC voltage, DC voltage and current readings on same numbered scale, except 1.5 and 3 volts AC; ohmmeter scale

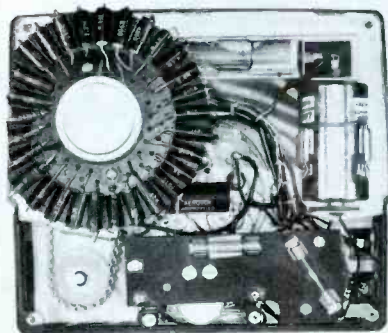

Fig. 4. Batteries for the ohmmeter are accessible by removing rear cover.

# HERE IT IS!



..... the best

## RESOLUTION

you can make for 1962!

'I hereby resolve to use Genuine  
MERIT REPLACEMENT PARTS  
and reduce 'call-backs' to a minimum.'

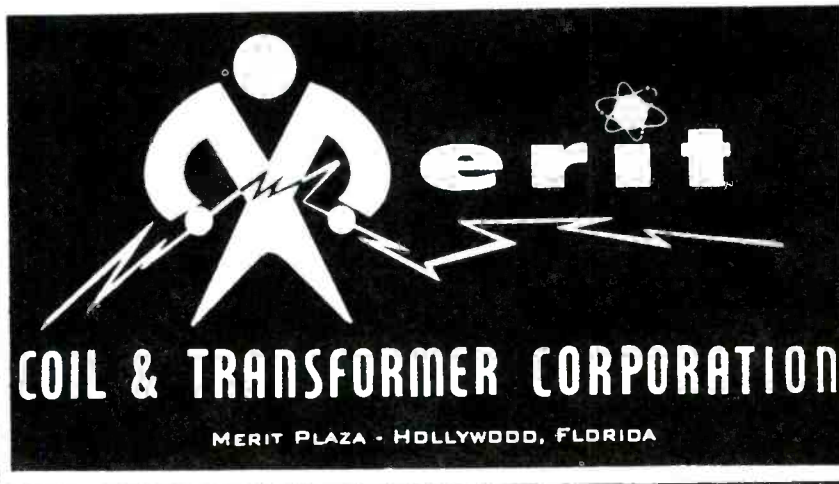

with right-side zero; decibel scale -20 to +11, with conversion data for higher ranges printed on scale card; germanium-diode overload protection; temperature-compensated; mirror strip to eliminate parallax.

9. Size, Weight, and Price—3 5/8" x 7 5/8" x 6 1/2"; approximately 4 1/4 lbs; \$89.50.
10. Power Requirements—one 1 1/2-volt, size D flashlight battery and one 30-volt battery (NEDA No. 210) for ohmmeter operation.

The Model 800 features more sensitive voltage ranges than the usual VOM. This makes it useful for measurements in transistorized equipment, where voltages are very low and slight differences are important. The loading effect of the

VOM still must be considered, but not so much as with less sensitive instruments.

An AC voltmeter is useful in audio-circuit measurements only when the frequencies are within the response range of the instrument. Most VOM's are calibrated for greatest accuracy at approximately 60 cps; the Model 800 includes components which provide a flat response over an extended range of frequencies. In fact, lab tests showed the Model 800 to have a response within  $\pm 1$  db from 20 cps to 50 kc. (It is well to remember, however, that the compensation used is effective only on voltage ranges of 300 or lower.)

The decibel-meter function is most often used in audio circuits, especially

where DC is present. As is usual for this type of instrument, the low-frequency response on the db range drops off rather rapidly below 400 cps; however, the high-frequency response extends to 85 kc. The low-frequency deficiency is the result of the blocking capacitor, which is always used in series with the output meter.

The ohmmeter circuit is protected with a 1-amp fuse (visible in Fig. 4), which prevents meter damage when external voltage is applied to the ohmmeter. Most VOM's include some sort of meter protection for this reason, but often an overload causes damage to the resistors associated with the ohmmeter circuit—resulting in inaccurate readings or none at all. In the Model 800, the circuit itself is protected to eliminate this common cause of inaccuracies.

The meter in the 800 is protected by specially-designed germanium diodes which bypass any overload currents around the meter movement. Included in the meter case is a temperature-compensating thermistor network, which maintains the accuracy of meter readings regardless of air temperatures surrounding the VOM.

In the lab, a few other features and idiosyncrasies were noted. For instance, the range switch is not directly connected to its knob; a sprocket-and-chain arrangement drives this switch when the knob is turned (See Fig. 5). The tension adjustment can be seen near the tip of the screwdriver in this illustration.

We noted a wide variation in the ohmmeter-zero position from range to range. New batteries were some help, but it was still necessary to reset the zero-adjustment knob on the front panel each time a different range was chosen. The ohmmeter circuit operated satisfactorily, however, even with batteries delivering as low as 70% of rated voltage; below this point, the zero potentiometer failed to bring the ohmmeter pointer to zero on some ranges. We also noted that the positive voltage in the ohmmeter is brought out to the common or black lead. This is a good point to remember when you are checking diodes or electrolytic capacitors with the Model 800.

After trying the Model 800 in the lab, we felt it was an excellent VOM, and a useful addition to any service shop.

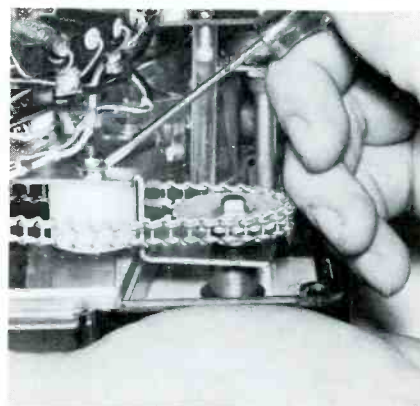
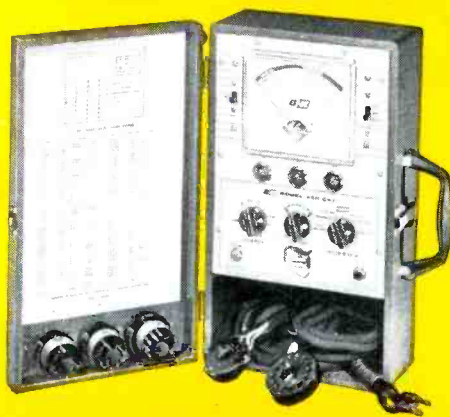

Fig. 5. Screwdriver shows where to adjust chain-drive tension for switch.

**SAVE  
CUSTOMERS  
MAKE  
MONEY**

**THE INDUSTRY'S STANDARD**  
*Most Widely Used Today  
by Professional Servicemen*



**FAMOUS  
DELUXE**



**CRT 440**



**For Black & White and Color**

*"Most valuable and useful" . . . "Wouldn't be without it" . . . "Pays for itself over and over again" . . . servicemen say. Quickly checks and corrects television picture tube troubles in a few minutes right in the home without removing tube from set. Gives new life to weak or inoperative tubes. Checks for leakage, shorts, open circuits and emission. Removes inter-element shorts and leakage. Repairs open circuits and low emission. Restores emission and brightness. Life Test checks gas content and predicts remaining useful life of picture tube. Makes new tube sales easier. Completely self-contained. Rich leatherette-covered carry-case. Net, \$74.95*

**TESTS AND REJUVENATES**

all picture tubes at correct filament voltage from 1 to 12 volts

**TESTS AND REJUVENATES**

110° tubes and the new 19" and 23" tubes

**TESTS AND REJUVENATES**

color picture tubes. Checks each gun of color tube separately

**UP-DATE YOUR B&K CRT WITH THESE ACCESSORIES**

Subscribe to New Picture Tube Information Service

**Model C40 Adapter.** For use with previous Models 400 and 350 CRT's—to test and rejuvenate TV color picture tubes and 6.3 volt 110° picture tubes. Net, \$9.95

**Model CR48 Adapter.** For use with previous Models 400 and 350 CRT's—to test and rejuvenate 110° picture tubes with 2.34, 2.68, and 8.4 volt filaments. Net, \$4.95

See Your B&K Distributor, or Write for Catalog AP18-R

**B&K MANUFACTURING CO.**  
1801 W. BELLE PLAINE AVE • CHICAGO 13, ILL.  
Canada: Atlas Radio Corp., 50 Wingold, Toronto 19, Ont.  
Export: Empire Exporters, 277 Broadway, New York 7, U.S.A.



# SERVICE DEALER ADVERTISING PROGRAM

If you haven't already taken advantage of the PF REPORTER Service Advertising Program, here's your last chance to climb on the bandwagon.

Advertising is a mainstay of a healthy business. It provides an effective way to tell people what services you offer and where you are. Keeping this information in the public eye is essential just to make up for normal shrinkage in your customer list as people move away, die, or drift over to your competitors. With good advertising, your business won't just hold its own; it'll grow.

You can get results from the professionally-designed ads described on this page. The complete set of 60 ads will be supplied at cost (\$25), including both ad mats and reproduction proofs for use with any method of printing. Twelve different sets of five ads each are also available, as described below. (These are the same groups originally offered in different months of 1961.) Price per group is \$1.75 for ad mats or \$1 for reproduction proofs. If you don't already have a complete set, this is your final opportunity to obtain the full series. Just fill in the handy coupon.



... with two other "plugs" for TV service, one ad for use by hi-fi specialists, and an offer of \$1 credit toward TV service charges.



... also two ads that promise satisfaction with your service, one on a "Have Tubes - Will Travel" theme, and one to stimulate hi-fi business.



... plus a "jittery TV" cartoon, another with a Western theme, an offer of free tube testing, and an ad stressing color-TV service.



... and a kangaroo advertising repair of "pocket" radios, two ads emphasizing fast service, and a TV check-up offer.



... in addition, cartoons based on four themes: Ghosts, "bugs" in equipment, wrestling with TV sets, and an "eye" for clear viewing.



... also a "TV squint" cartoon, a 10% discount offer, a TV tune-up promotion, and a pitch for a radio service.



... with a special discount offer for new customers, "TV Tiff" and "Mirror-Sharp TV" ads, and a stark selling radio batteries.



... plus a border for your own special offer, and three ads pointing out how much better a set will perform after you service it.



... also four ads to combat customers' fears of slow service, careless handling, unnecessary shop work, and inadequate test equipment.



... plus a cartoon aimed at second-set sales, a "tired woofers" ad for hi-fi service, and two whimsical drawings to attract TV owners.



... with another TV Neurosis (perturbed), Christmas and New Year's greetings, and a get-acquainted offer of free toys.



... in addition to three other cartoons on TV service (stressing dissatisfaction with present performance) and an ad for tape-recorder specialists.

NEW 1962 EDITION!

# RIDER TUBE CADDY - TUBE SUBSTITUTION GUIDEBOOK

by H. A. Middleton

(Direct Receiving Tube Substitutions Only... plus added new feature - 1300 direct CRT substitutions).



**NOW  
AVAILABLE  
AND EVEN MORE  
VALUABLE**

The 1960-61 edition of Rider's Tube Caddy-Tube Substitution Guidebook, has become just as much a part of the service technician's standard equipment on every call as his tube caddy. The 1962 edition of this remarkable service "tool" is now available, and it is even more valuable than the first. The number of direct replacements for receiving tubes has been greatly increased by listing many new tubes that replace certain older tubes, and in turn can be replaced by older tubes. Further, a complete 16-page section of direct CRT substitutions has been added. These CRT substitutions are direct except in a few cases where some minor external modifications are required i.e. (tying together CRT basing pins, removal or insertion of an ion trap magnet). Where such minor external modifications are required, they are so indicated and described.

This direct substitution guide, designed to be carried in the tube caddy, contains only direct receiving tube substitutions which can be made without modification of the wiring. All substitutions will yield good or excellent results as indicated in the guidebook.

This guidebook will—

- save you time
- eliminate carrying needless tube types
- enable you to select the best substitution
- minimize sales losses because you don't have the right tube

It will pay for itself on the first service call!

It contains substitutions for: ● Receiving tubes ● Ruggedized tubes ● European-to-American tubes ● American-to-European tubes ● Cathode-Ray Picture tubes  
Cat. #299... still only 90c

Order this indispensable service 'tool' today at your electronic distributors

**JOHN F. RIDER, PUBLISHER, INC.**  
116 West 14th Street, New York 11, N. Y.  
a division of Hayden Publishing Company, Inc.  
Canada: Chas. W. Pointon, Ltd.  
66 Racine Road, Rexdale, Ont.

PF REPORTER, 2201 E. 46th St., Indianapolis 6, Ind.

ad mats @ \$1.75     glossy prints @ \$1.00     both for \$2.50

Please send me group(s) \_\_\_\_\_ post paid.

Enclosed is \$ \_\_\_\_\_ to cover cost.

Please send entire program including glossy proof forms @ \$25.00.

Name \_\_\_\_\_

Address \_\_\_\_\_

City \_\_\_\_\_  
162

Zone \_\_\_\_\_ State \_\_\_\_\_

## Video Amplifiers

(Continued from page 27)

since both have some effect on the shades of gray in the TV picture. While the brightness control varies the bias on the picture tube, and therefore determines the average level of beam current, the contrast control varies the peak-to-peak amplitude of the video signal superimposed on this bias. The greater the signal amplitude, the greater the difference in beam current between "black" and "white" portions of the signal, and the stronger the contrast.

In various types of receivers presently in use, contrast controls are found in three different parts of the video-amplifier circuit. As shown in Fig. 7A, one type of contrast control is found in the cathode circuit of the video amplifier and varies the bias of the stage. A second type of control (Fig. 7B) is in the plate circuit of the video amplifier and acts as a voltage divider; the amount of video applied to the picture tube is determined by the setting of the wiper arm in the potentiometer. The final type of contrast control, more

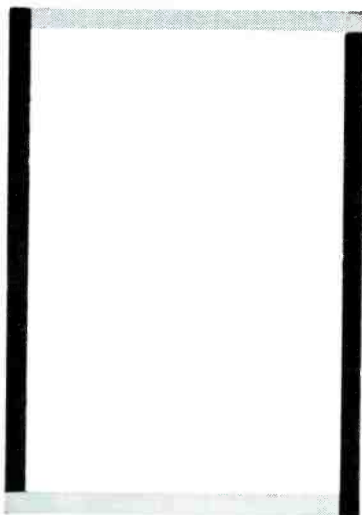

◀ *this*

is a picture of the technician who had a call-back on a Quam Speaker installation.

(You'll notice the space is blank. Servicemen who install Quam speakers can "sell 'em and forget 'em." You just don't get called back.)

*this* ▶

is a picture of a Quam speaker which was defective when received from the factory.

(This space is blank, too. Every Quam speaker is individually checked and tested before it leaves the factory.)

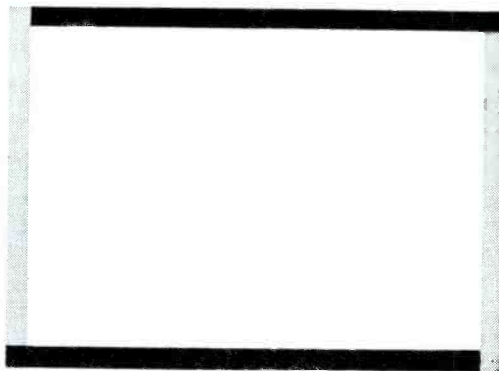

◀ *this*

is a picture of your bank book.

You'll notice how your deposits grow when you rely on Quam Adjust-a-Cone Speakers for every installation.



**QUAM-NICHOLS COMPANY**

234 E. MARQUETTE ROAD • CHICAGO 37, ILLINOIS

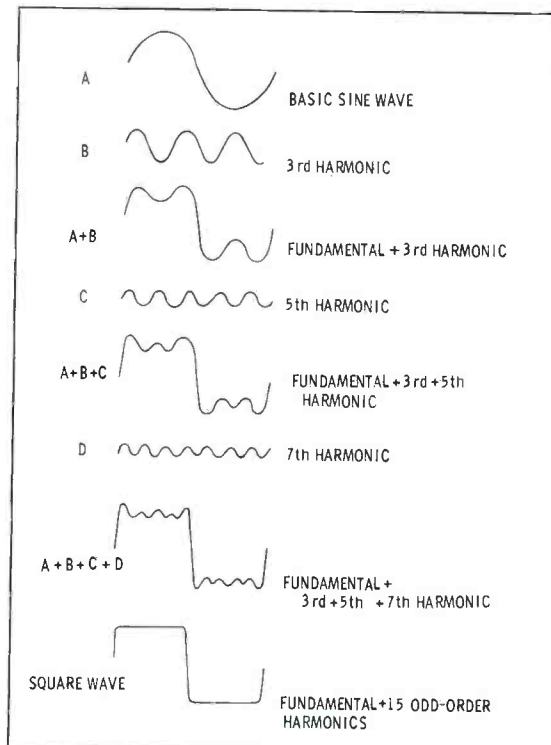

Fig. 8. Adding multiple harmonics to a sine wave produces a square wave.

rarely seen than the other two, varies the screen voltage of the amplifier in order to vary the gain (see Fig. 7C).

### Checking Frequency Response

If, in troubleshooting a video amplifier, the trouble cannot be located by ordinary visual and voltage-resistance checks, it is often advisable to check the frequency response of the circuit. Although the effects of poor response can usually be seen in the picture, a more exact indication is necessary for pinpointing the location of the faulty component. The best method of checking response would require using a sweep generator with a sweep frequency from 0-4 mc. However, this particular piece of test equipment is not often found in the average shop. An alternative method which gives excellent results is to use a square-wave generator and a wide-band (0-3.5 mc) oscilloscope.

A square wave is composed of a fundamental sine wave and its odd harmonics (see Fig. 8). In a particular test setup, the method used to generate the square wave and the bandpass of the amplifier stages following the generator are the main factors in determining the number of usable harmonics that will be present in the output wave. A good generator will produce odd har-

monics as high as the 15th at a fundamental frequency of 250 kc; therefore, its output is usable for checking a high-frequency response extending to 250 kc x 15, or 3.75 mc.

Observe the shape of the square wave by feeding it directly into the vertical amplifier of the scope. If the response characteristics of the scope and generator are adequate, the wave will appear very nearly square. If the wave has rounded corners, indicating a lack of high frequencies, study the shape of the wave; then, in the following checks, try to obtain this same waveshape instead of a perfect square wave.

Next, inject the square wave into the output of the detector (Fig. 9) in order to check the high-frequency response of the entire video system of the receiver. Attach a low-capacitance probe to the scope and disconnect the picture-tube socket from the tube to eliminate the effect of CRT input capacitance. (The probe replaces this input capacitance.) Place the probe on the side of the output coupling capacitor away from the video amplifier, and adjust the generator output so that the video amplifier is putting out about 50 volts of square wave. Observe the waveform on the scope and see if it is being reproduced properly. Compare this waveshape with those in Fig. 10A and B. Change the frequency of the square wave to 60 cps, and compare the output waveform with those in Fig. 10C, D, and E. If either low- or high-frequency response should appear to be poor, the fault can be isolated by injecting

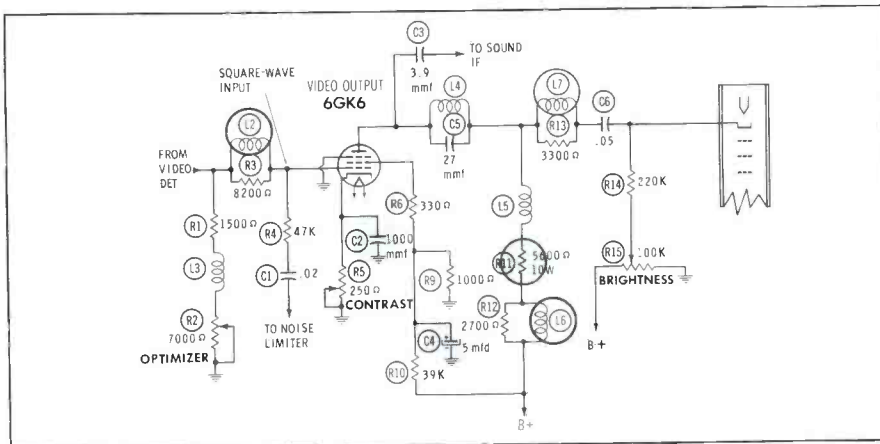
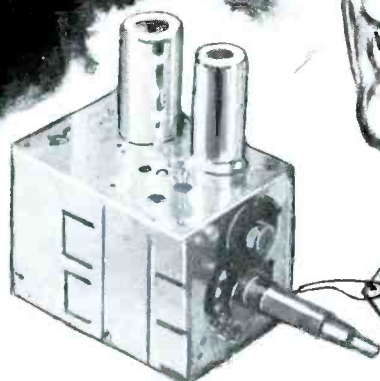

Fig. 9. Faults in circled components can cause low- or high-frequency loss.



*a simple solution*



OVERHAULED BY  
**CASTLE**  
TV TUNER SERVICE, INC.  
Pioneers in TV Tuner Overhaul

**THAT SOLVES ALL YOUR TV TUNER PROBLEMS**

*Ask yourself*

- ... do you have the time to fool around drilling, sawing, filing ... trying to make a "Universal" replacement tuner fit in place of the original?
- ... do you have all the expensive instruments and equipment to complete the alignment so essential after each tuner repair or replacement?
- ... can you spare the time repairing and adjusting your own TV tuners and can you charge enough to justify the time spent?

**A Castle Overhaul eliminates every one of these problems.**

Castle replaces all defective parts, (tubes and major parts are extra at net prices) and then aligns your tuner to the exact, original specifications.

Simply send us your defective tuner complete; include tubes, shield cover and any damaged parts with model number and complaint.

Send for **FREE** Mailing Kit and complete details.

**ONE PRICE**

**9<sup>95</sup>**

**ALL MAKES**

**VHF TUNERS  
UHF TUNERS  
UV COMBINATIONS\***

\*UV combination tuner must be of one piece construction. Separate UHF and VHF tuners with cord or gear drives must be dismantled and the defective unit sent in.

90 Day Warranty

**CASTLE**  
TV TUNER SERVICE, INC.



5710 N. Western Ave., Chicago 45, Illinois • 653 Palisade Ave., Cliffside Park, New Jersey  
In Canada: 136 Main St., Toronto 13, Ontario

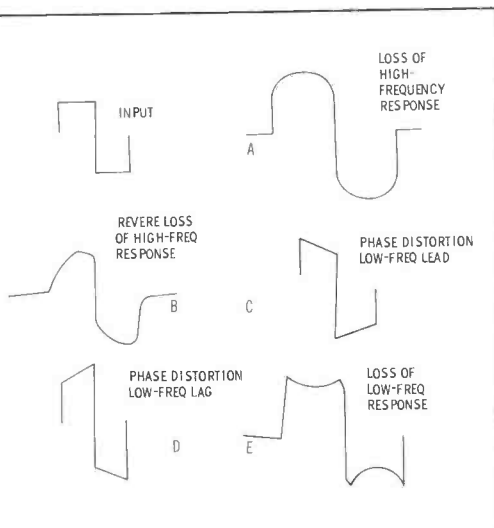

Fig. 10. Typical square-wave distortion patterns and their respective causes.

the square wave at different points in the video circuit and watching for disappearance of the distortion.

If a good square-wave generator is not available, the response of the video circuit can be checked with an RF sine-wave signal generator. First, check the amplitude of the generator output (with a scope) while tuning it from the lowest available frequency to 3.5 mc, and look for points at which the output drops. The signal should remain fairly constant until the bandpass of the scope begins to limit its amplitude. Next, connect the generator

and scope into the TV video circuit in the same manner that was described for the square-wave generator, and again tune the generator from zero to 3.5 mc. The scope signal should not vary greatly in amplitude from low to high frequency. This method does not check phase distortion, but is a good test of frequency response.

#### Examples of Poor Response

If the picture contains evidence of low-frequency phase distortion, as in Fig. 2, the trouble is likely to be found in one of the components

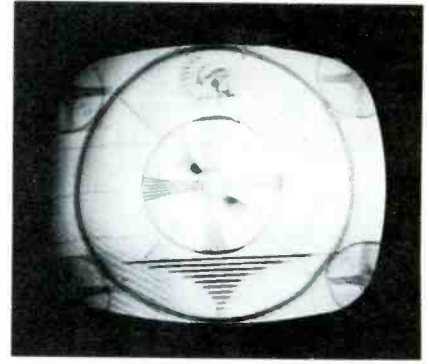

Fig. 11. This type of smearing is due to a loss of high-frequency response.

corresponding to those in the grey spots in Fig. 9. On the other hand, troubles due to a loss of high-frequency response (such as the smearing which is apparent in Fig. 11) are often caused by components such as those circled in black in Fig. 9.

Fig. 12 depicts ringing in the video circuit. The lines produced by ringing are similar in appearance to multiple ghosts; however, ringing will appear the same on all channels, while ghosts will usually vary in appearance from channel to channel. Excessive high-frequency response is the usual cause of ringing. The same components that might be to blame for loss of high frequencies would also be suspect when ringing is present.

Most response troubles are variations of those listed above. Sometimes, pictures that appear to be slightly unfocused are instead afflicted with loss of high frequencies. Any doubt on this score can be removed by checking the lines in the raster. If the individual lines are focused, start checking the video amplifier.

Remember, troubleshooting video circuits does not take a lot of test equipment. A square-wave generator and a scope are the major items required for a thorough check. ▲

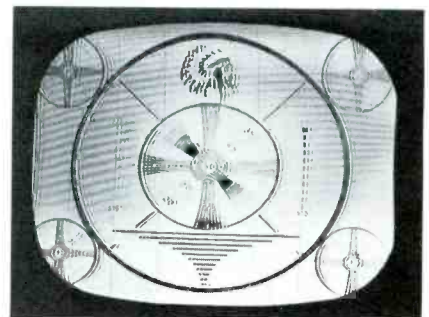

Fig. 12. Excessive gain at high frequencies is the usual cause of ringing.

# NEW

## a true DYNAMIC MUTUAL CONDUCTANCE TUBE TESTER



for \$79<sup>95</sup>

Net

Model 1000  
MUTUAL CONDUCTANCE TUBE TESTER

Tests all present tube types... and all new tube types including the

- NEW NUVISTORS
- NEW 12-PIN COMPACTRONS
- NEW 10-PIN TUBES
- NEW NOVARS

✓ Tests for true dynamic mutual conductance (GM)

✓ Tests for shorts and leakage between any tube elements

✓ Tests for gas and grid emission... sensitivity over 100 megohms

✓ Tests picture tubes

The Model 1000 is one of the most up-to-date mutual conductance tube testers available today. It is extremely quick to set-up, enabling you to make a complete and accurate test in just seconds of any tube you may possibly come across—present types or new types—under actual dynamic operating conditions.

JUST CHECK THESE ADDITIONAL FEATURES

- Also tests foreign and hi-fi tubes, voltage regulators, battery type tubes, auto radio hybrid tubes, thyratrons and most industrial tube types
- 13 lever switches provide complete versatility in accommodating all tube types and basing arrangements
- Two point test principle overcomes obsolescence caused by new base pin arrangements or new internal jumpers in tubes
- Automatic line voltage regulation
- Built-in 7-pin and 9-pin straighteners on panel
- Long lasting phosphor bronze tube sockets
- Handsome two-tone etched aluminum panel
- The most complete tube chart conveniently located in cover
- New tube listings subscription service available
- Housed in handsome gray leatherette case with convenient compartment for cables
- Small compact size: 14" x 9 1/2" x 4 3/4".

\* Slightly higher in the West



ELECTRONICS CORPORATION

manufacturers of quality electronic products

111 Roosevelt Avenue, Mineola, New York

West coast branch: 4306 W. Victory Blvd., Burbank, Calif.



## Multiple Troubles

(Continued from page 20)

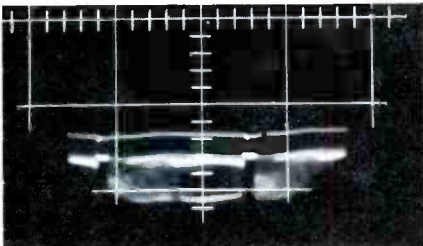

Fig. 2. Detector-output check showed high DC voltage and inverted signal.

after I had taken care of the horizontal-sweep problem.

This triggered a new train of thought: Since the plate of the keyed AGC stage receives pulses from the horizontal flyback circuit (see Fig. 1), might there be some connection between the horizontal trouble and the overloading symptom? I might even solve the sweep problem by attacking it via the AGC circuit! Then, as an afterthought, it occurred to me that the overloading could be due to a video-amplifier trouble not even connected with AGC.

To settle this last question, I pulled the line plug, hooked up an antenna, and let the receiver cool off. Then I placed the low-capacitance probe of my DC scope on the output side of the video detector, and applied power to the TV set. As the expected negative picture hove into view, I saw an inverted waveform (Fig. 2) with the positive peaks riding at -13 volts DC. No question about it—I was confronted with IF overloading, which could very easily be due to a loss of AGC voltage.

I unplugged the set once more, and prepared for a tricky bit of "double-header" troubleshooting. On the next try, I would not only find out if the AGC bias voltage was missing, but would also see if the loss of AGC was due to insufficient keying-pulse amplitude. After clipping the scope probe to the plate of

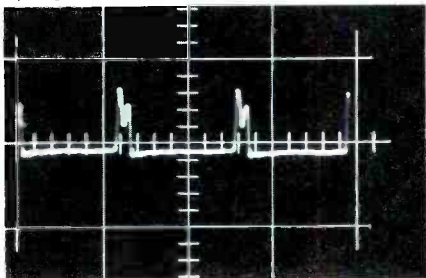

Fig. 3. AGC keying pulses were normal after completion of warm-up period.

the keying tube. I attached the DC probe of my VTVM to the "main stem" of the AGC line (junction of C36 and R44—Fig. 1). Then I zeroed the meter pointer at center scale, and fired up the TV set.

The meter needle hung for awhile at -15 volts — small wonder the IF's were overloaded! In addition, the plate pulses were low in amplitude at the beginning, but rose to the normal amplitude of 700 volts (Fig. 3) when the buzz and negative picture cleared up.

### Heart of the Matter

Pleased that my educated guess

was on the right track, I moved on to the horizontal output circuit. Once again, I decided to "double up" on my tests, in order to minimize the cooling-off periods between observations. I connected the scope to the grid of the horizontal output tube for monitoring the drive waveform (Fig. 4), and made preparations to check the DC screen voltage with the VTVM. Soon after power was applied to the set, a well-shaped drive signal with a 100-volt amplitude was fed to the grid. On the other hand, the screen voltage rose to only 90 volts. Now I was

**Model 1100 TUBE TESTER**

New... TESTS THEM ALL!

Tests all present and all new tube types including:

- NEW NUVISTORS
- NEW 12-PIN COMPACTRONS
- NEW 10-PIN TUBES
- NEW NOVARS

... and is priced amazingly low ... only **\$39<sup>50</sup>** Net

- ✔ Tests for dynamic cathode emission
- ✔ Tests for shorts and leakage
- ✔ Tests for grid leakage
- ✔ Tests for gas content

See your local electronics parts distributor

Here is the answer to aggressive-minded technicians who seek a dependable, professional performing tube tester at a minimum cost. Hard-to-find tube defects are a snap for the Model 1100! It will test all the present tube types and all the new tube types... in fact any type you may possibly come across. It is so compact and versatile, the serviceman will want it at his side wherever he goes.

**JUST CHECK THESE ADDITIONAL FEATURES**

- Also tests battery type tubes, auto radio hybrid tubes, voltage regulators, foreign and hi-fi tubes, thyratrons and most industrial tube types
- Exclusive meter bridge circuit provides accuracy found only in the more expensive tube testers
- Will detect any short in a tube, even where internal pins are tied or heater is tapped
- Checks each section of multi-section tubes separately
- Long lasting phosphor bronze tube sockets
- Handsome two-tone etched aluminum panel
- Built-in 7-pin and 9-pin straighteners on panel
- The most complete tube chart conveniently located in cover
- New tube listings subscription service available
- Housed in handsome black leatherette case with a special lead compartment
- Small compact size: only 10 3/4" x 8 1/4" x 3 1/4".

\* Slightly higher in the West

ELECTRONICS CORPORATION

manufacturers of quality electronic products

111 Roosevelt Avenue, Mineola, New York  
West coast branch: 4306 W. Victory Blvd., Burbank, Calif.

# Coming in February PF REPORTER

## Restoring Horizontal Sweep

We'll have a new slant on a "hardy perennial" problem that causes TV servicers more grief than any other type of trouble.

## Antenna Installation Techniques

Find out how to make safer, neater-appearing antenna mounts and lead runs that will give good service for years.

## Getting Into the Background Music Business

You're in a good position to set up and service music systems for stores and offices. In this article, you'll learn how to plan these systems and utilize the complete "packages" (including records or tapes) available to you on a franchise basis.

## What's Different About FM Radio Servicing?

Many of the conventional troubleshooting techniques applied to ordinary table radios can also be adapted for use in servicing the low-cost FM radios now on the market. This article tells how, and also points out some special tests and procedures called for in FM servicing.

## How to Save \$ on Your Federal Income Tax

Rule one: Start thinking about it as early as possible! We'll have some ideas that will help to start the wheels turning.

**YOU CAN STILL OBTAIN YOUR CHOICE OF FREE PREMIUM BOOKS WITH YOUR NEW OR RENEWAL SUBSCRIPTION**

Enter my subscription to PF REPORTER and send me free book(s) checked.

- 3 Years \$9.00    2 Years \$7.00    1 Year \$4.00  
 The Troubleshooter's Handbook  
 Servicing Industrial Electronics  
 Servicing TV from Tuner to Picture Tube  
 Check one of above for each year you subscribe  
 Bill Me    Remittance Enclosed  
 Extend Present Subscription

Please Check Your Business Classification

- Owner, Mgr.    Employee    Service Mgr.  
 Independent Radio, TV Serviceman    Retailer with Service Department  
 Industrial Electronics Service    Other (Specify occupation and title)

Name \_\_\_\_\_  
 Firm \_\_\_\_\_  
 Address \_\_\_\_\_  
 City \_\_\_\_\_ Zone \_\_\_\_\_ State \_\_\_\_\_

Take this coupon to your distributor, or mail to:  
 Howard W. Sams & Co., Inc., 2201 E. 46th Street,  
 Indianapolis, Indiana

162

getting warmer! Three possibilities were evident — low B+, a leaky C70, or a rise in the value of screen-dropping resistors R94 and R95. A quick measurement with an ohmmeter condemned the resistors.

With the new parts installed in place of R94 and R95, the picture and sound were much improved. The raster also looked better, but it wasn't entirely normal even after readjustment of the width and linearity controls. Flyback transformer T2 had seen a lot of service, and I wondered if it had deteriorated over the years. Since I had an exact replacement in stock, I thought it would be worthwhile to make a ringing test of the old and new units (for particulars, see "Across the Bench" and "The Troubleshooter" in the September, 1961 issue), and compare the results. As it turned out, there were no shorted turns in the old flyback, but the amplitude of the oscillations produced by the old unit weren't equal to those of the new one. Therefore, I went ahead and installed the replacement transformer. The raster could now be restored to normal size and linearity, and my only remaining problems were the hum bars and the rather fuzzy reproduction of the picture.

As I always do in older receivers, I went back and checked the AGC filter capacitors (C4 and C38 in Fig. 1) with a capacitor tester, noting value, power factor, and presence or absence of leakage. In this case, both units were somewhat leaky, so I replaced them. I also checked R47 in the RF-AGC delay circuit (a frequent offender), but it was okay.

Although the new AGC filter capacitors were good callback insurance, they made little difference in the already-existing symptoms. Since I had already tried all new tubes in the tuner, IF, and video stages, I knew the receiver required more work on the picture section — probably including alignment. So, in case I might need my sweep and marker generators, I turned them on and let them warm up while I checked the IF stages.

To catch any troubles which might be causing mistuned IF's, I checked all voltages throughout the IF strip. Everything seemed normal; even so, I made a second check with a scope and detector probe to be

every standard electronic part you'll ever need is pictured and described in the  
**1962 RADIO ELECTRONIC MASTER**

**JUST OUT!**  
**'62 EDITION**



**1600 PAGES**  
 world's largest electronic catalog

It's new! Covers all the latest parts and equipment necessary to repair and maintain radio-TV-audio electronic equipment.

It's the world's biggest electronics purchasing guide! 1600 pages, more than 175,000 items — with descriptions, specs, illustrations and prices.

It's easy to use! organized in 32 product sections for rapid references; fully indexed to save you time. At parts distributors, \$3.95 (\$4.95 in Canada).

**THE RADIO-ELECTRONIC MASTER**  
 60 Madison Ave., Hempstead, N.Y.

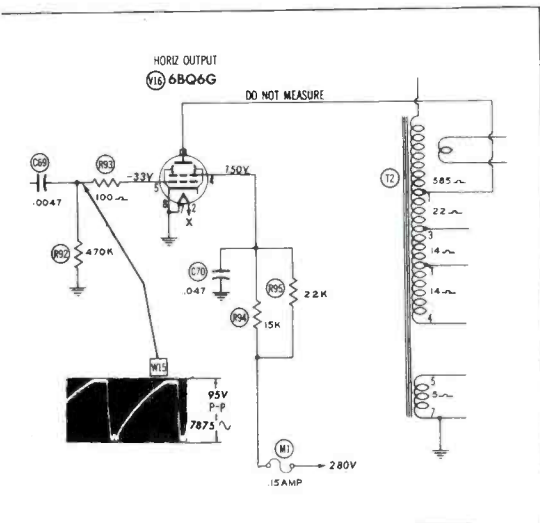

Fig. 4. One defect in horizontal output stage was cause of several symptoms.

sure all bypass and decoupling capacitors were doing their jobs. They apparently were. About the only thing left to do was to check the alignment.

#### IF-Response Check

I set the sweep generator for a center frequency of 44 mc. The marker generator supplied a crystal-calibrated output at 42.75 mc, plus additional markers at 2-mc intervals (produced by a crystal-controlled heterodyne circuit). Both sweep and marker outputs were fed into a separate marker-adder unit instead of being applied directly to the TV set. I like to use this extra piece of equipment because it provides clearer marker pips, and also minimizes distortion of the sweep curve.

The over-all response of the circuitry between the mixer and the video detector appeared as in Fig. 5. The middle of the curve was too sharply peaked. Furthermore, the 42.75-mc marker was at the 80% level on the left side of the curve, instead of occupying its proper position below the 60% level. Even the 40.75-mc marker was slightly above the base line, and the 41.25-mc

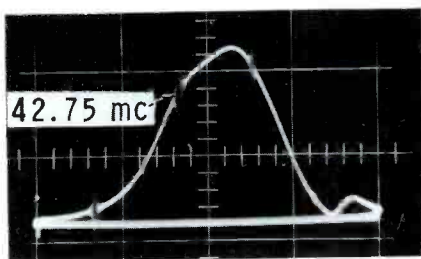

Fig. 5. IF response curve indicated too much gain on sound-carrier side.

sound-carrier frequency appeared to be well above the 5%-10% level that is normal for intercarrier receivers. Therefore, the sound signal was obviously receiving enough gain in the IF strip to create a problem with sound bars in the picture.

I followed the recommended procedure for touch-up alignment, paying special attention to the single-tuned transformer between the first and second IF stages. (This adjustment has the greatest effect on frequencies near 42.75 mc.) Without too much trouble, I succeeded in obtaining a nearly ideal curve; 42.75

and 45.75 mc were slightly above the halfway mark on opposite sides, the top was nearly flat between 43.5 and 45.0 mc, and the 41.25-mc region was pushed down almost to the base line.

Disconnecting the equipment and tuning in the picture, I noted clean reproduction of both large and small areas. Gray-scale linearity was also pretty good, and there were absolutely no sound bars when the fine-tuning control was correctly adjusted. When I delivered the set to the customer, she paid her bill without a murmur. ▲

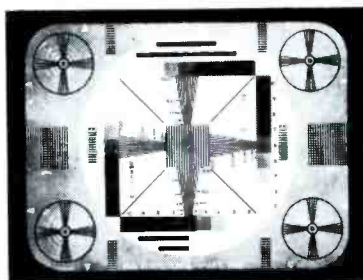

## TV TIPS FROM TRIAD

NO. 15 IN A SERIES

A Professional Television Man we know had a nasty problem. One of his customers owned a 21" metal tube receiver — which shall be nameless — that was a service repeater. When it worked, it worked very well indeed, but when it was bad it was awful. Which was often. Every three or four months a new 6CD6 was needed, and every couple of 6CD6's, a new flyback was called for.

This PTM was typically conscientious. He installed highest quality tubes — and got failure. He tried "exact" replacement flyback. Again, failure. He tried "original" replacement flyback. Still the wax heated up and oozed all over. Results: one very peeved customer, one very perplexed PTM.

About the time it dawned that the original set circuit was something less than perfect, a parts salesman handed him the brochure "Taking the Heat off Flybacks."

"Heat comes from high B plus, defective linearity coils, bad screen resistors — and as many as twelve other causes," he read first off. Immediately our PTM, who reads too fast, said he'd take a B plus dropping resistor, screen resistor, new flyback and linearity coil.

The parts man interrupted — which was just as well. "If this is for that direct drive receiver with the 21" metal kine, we have a complete kit of all these parts. The Triad people call it their D-153. When you install, which is almost as easily done as said, good things happen. Your plate current drops from 150 to about 100 milliamps, and you can expect normal life from tubes and flybacks."

When our PTM installed the parts according to instructions, he had a cool running job with good high voltage and width, and a happy customer.

"Why," he said, "I could have spent \$100 worth of time just working this circuitry out myself." That night he told his wife, and the next day she spent most of the \$100 on new clothes.

**MORAL:** Never tell women anything. Also, just installing an "exact" or "original" flyback in this set is not enough. You need engineered parts and tested instructions to rewire and solve the problem permanently. Ask your distributor for Triad kit D-153. Like other products designed to make life happier, it is made by the **Triad Transformer Corporation**, a division of Litton Industries. Triad also publishes a series of service aids for Professional Television Men. These make fascinating reading. Are you on the mailing list? Our address is 4055 Redwood Avenue, Venice, California.

# For your custom stereo installations



**THE FISHER 800-B**

## Three of the world's finest components on one chassis

- 1 AM-FM-Stereo Multiplex Tuner:** separate tuning indicators for FM and AM; exclusive Fisher STEREO BEAM automatically shows whether an FM station is broadcasting in stereo.
- 2 High-Power Stereo Amplifier:** 65 watts music power; special center-channel output connection for third speaker.
- 3 Master Audio Control-Preamplifier:** complete, easy-to-use control system assures total flexibility; provisions for every type of input. **Price \$429.50\***

\*Walnut or Mahogany cabinet \$24.95; prices slightly higher in the Far West

### USE THIS COUPON FOR DETAILED INFORMATION

**Fisher Radio Corporation**  
21-54 44th Drive, Long Island City 1, N. Y. PF-101

Please rush the following FREE literature:

Complete specifications on the Fisher 800-B Receiver.

The 1962 Fisher Handbook, a 40-page illustrated reference guide and component catalogue for custom stereo installations.

Name \_\_\_\_\_

Address \_\_\_\_\_

City \_\_\_\_\_ Zone \_\_\_\_\_ State \_\_\_\_\_

**NEED AN  
A.C. OUTLET?  
IN CAR,  
BOAT OR TRUCK,  
YOU HAVE IT WITH A**

**terado POWER  
CONVERTER**

Actually gives you 110 volt, 60 cycle A.C. from your 6 or 12 volt D.C. battery! Plug converter into cigarette lighter, and operate lights, electric shavers, record players, electric tools, portable TV, radios, testing equipment, etc.

Models from 15 to 300 watts, priced as low as **\$12.95** LIST

See Your Electronic Parts Dealer or Jobber, or Write:

**terado COMPANY**  
1073 RAYMOND AVE.  
ST. PAUL 8, MINN.

In Canada, ATLAS RADIO CORP. LTD. — Toronto, Ont.

## POWER TRANSISTORS

FOR GENERAL REPLACEMENT PURPOSES IN AUTO RADIOS, POWER AMPLIFIERS, FARM RADIOS, MARINE RADIOS, ETC.

Individually packaged in a plastic see-thru box with instructions and cross-reference information.



**4 TYPES OF POWER TRANSISTORS THAT WILL REPLACE A LARGE MAJORITY OF TRANSISTORS IN USE TODAY**



V176 LOW WATTAGE TYPE  
V155 MEDIUM WATTAGE  
V40 HIGH WATTAGE TYPE  
V50 *Gold Bond*  
HIGH WATTAGE—HIGH GAIN  
(Finished in gold)

## SILICON RECTIFIERS

FOR GENERAL REPLACEMENT PURPOSES

For use in radios, television sets, amplifiers or any electronic equipment presently using a tube, selenium or silicon rectifier.

INDIVIDUALLY PACKAGED IN A PLASTIC SEE-THRU BOX

750 MA. 400 P.I.V.  
PART No. SR-74

For use in all TV sets and electronic equipment where an RMS voltage of 280 volts or less is applied.

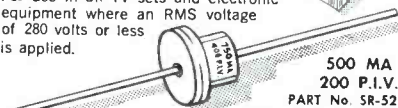
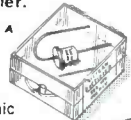

500 MA  
200 P.I.V.  
PART No. SR-52

For use in all radios, phono amplifiers and electronic equipment where an RMS voltage of 140 volts or less is applied.

**Vidair ELECTRONICS MFG. CORP.**  
365 BABYLON TPKE. — ROOSEVELT, N. Y.

## Transistor Radios

(Continued from page 25)

types. Replacement by 1/2-watt types is satisfactory if mounting space is sufficient, but the service shop handling a lot of transistor-radio repairs would do well to accumulate a stock of the smaller 1/4-watt and 1/8-watt sizes.

Some receivers use a thermistor (a temperature-sensitive resistor) in the base-bias circuit of the push-pull output stage. This component should be ordered from the manufacturer as a rule, to insure that it will have the desired characteristics. In an emergency, however, operation of the set can be restored by substituting a standard resistor of a value which will keep the class-B bias at the proper point. The exact value can be determined by measuring the voltage between the base and emitter, and choosing a substitute which will set the base-emitter voltage at approximately that called for in the service notes.

The volume control used in a transistor receiver is typically a 5- or 10K-ohm potentiometer, combined with a single-pole, single-throw on-off switch. A few models use control values of from 2 to 3K, but these are in the minority. Imported sets commonly use 5000-ohm controls which are physically very much alike in most models. In a number of circuits, the exact value of the control is not too important; thus, it can be substituted without undue fear of upsetting circuit operation.

For circuits in which the volume control is part of a voltage-divider network, care must be taken that substitution of a different value does not affect important voltages in the circuit. Changing an associated resistor sometimes enables the servicer to use a substitute control. For example, in Fig. 2, if the 2500-ohm control were changed to the more common 5000-ohm control, the bias on transistor X4 would be altered, and the AVC voltages would be upset. But if R14 were changed to 300 ohms at the same time, proper balance would be restored in the voltage-dividing network.

## Diodes and Transistors

Replacement diodes for transistor radios are very easy to find. Almost any germanium diode will do a satisfactory job; the most common replacements are 1N60, 1N64, and 1N295, all of which are interchangeable. Some sets do not use a diode for the detector; instead, they use a transistor, often as a combination detector-AVC stage. Even in these circuits, the transistor is not critical, except that it should be of the same polarity as the original—NPN or PNP.

A number of manufacturers have introduced so-called "universal" replacement transistors. These can be used satisfactorily in most applications, but occasionally one will oscillate in a circuit where oscillation is not intended. In these cases, the only remedy is to try another transistor.

Transistors can be interchanged, within limits, in quite a number of different cir-

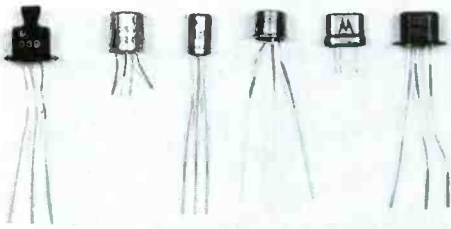

Fig. 3. Replacement transistors come in many different sizes and shapes.

cuits. For example, converter transistors can be used in IF stages, as RF amplifiers, and even as audio drivers. It is seldom necessary to alter the bias arrangement when transistors are substituted, since this has little effect on the gain of the stage (provided limitations of the transistor are observed). Care should be taken that gain and sensitivity are not sacrificed.

Some universal-type transistors, especially the less-expensive ones, are rather low in gain; if so, it is better to use a higher-gain transistor rather than leave the set in an abnormally weak condition. Occasionally, a high-gain transistor will cause oscillation when placed in a circuit; but before condemning the transistor, be sure the stage decoupling and bypass capacitors are in good condition.

In class-B push-pull audio output circuits, it is usually unnecessary to match the transistors, but the replacement should be either a unit with the same type number, or an accepted substitute. When in doubt about transistor substitutions, consult a substitution guide such as the Howard W. Sams publication *Transistor Substitution Handbook*.

Mounting problems sometimes occur with transistors — especially the “universal” types, which tend to be larger than their counterparts. For example an oblong type (see Fig. 3) might have a round type as a suitable substitute. If the location in the chassis happened to be between two closely-spaced IF transformers, it might be difficult to squeeze the larger unit into such a space. Then, too, the base of a transistor (which cannot be permitted to touch the IF shield can) may be connected to the transistor case. In such a predicament, the only solution is to find a different replacement transistor.

### Speakers

Mounting replacement speakers in transistor portables is frequently a difficult problem. For imported receivers, a few general types will fill most replacement needs. For replacement purposes, the most critical dimension of the speaker is the depth. The mounting is usually done with clips, and presents little problem if the cone size is correct. But it is advisable to carefully note the depth—the distance from the front of the cone to the rear of the magnet—before proceeding to mount the speaker, only to find that the cabinet cover will not go into place.

PLANET  
CAPACITORS  
CAPACITORS  
"Engineered for Quality"

SIZE:  
1/4" x 7/8"

## TRANSISTOR LYTICAPS

### TYPE "TL"

TYPE "TL" . . . Sub-miniature aluminum foil capacitors . . . hermetically sealed in aluminum tubes . . . clear plastic outer insulating sleeves . . . all mechanical internal connections . . . no "cold weld" nor "pressure" connections . . . engineered for quality for replacement in all transistorized circuits.

Write today for complete information.

## PLANET SALES CORPORATION

225 Belleville Avenue      Bloomfield, New Jersey

## the business-like approach

to SERVICE CHARGES and RECORD KEEPING

For customer's prices on every replacement part, plus flat rate and hourly service charge data, regional and national. Dave Rice's OFFICIAL PRICING DIGEST, listing over 63,000 items. \$2.50.

▲ AVAILABLE FROM YOUR DISTRIBUTOR ▼

If you want to operate on a professional level, Dave Rice's OFFICIAL ORDER BOOKS give you triplicate forms for order, invoice, and office records . . . spaces for tubes, parts, serial numbers, labor and tax charges, signatures, etc. 75c per book, \$6.50 for dust-proof box of 10. *Dave Rice's*

**ELECTRONIC PUBLISHING COMPANY, INC.**  
133 N. JEFFERSON ST. • CHICAGO 6, ILL.

TV-RADIO SERVICE

DAVE RICE'S OFFICIAL ORDER BOOK

### New BERNS Perfect Pin Crimper

#### Picture-Tube Repair Tool

Also for—SU4, 6SN7, 6BQ6, etc.

Eliminates that hard soldering job

only \$1.25 each

PT-1  
3/32" PIN

Fix loose pin connections in seconds. Pays for itself in time saved on first job. 3" long.

Patented

Intermittent operation of picture tubes due to defective solder connections easily corrected. Provides solid electrical connections, can also be used as channel-selector wrench and screwdriver. Pin keeps its original form. A 3-in-1 tool.

#### 3 MODELS ELIMINATE SOLDERING

#### Makes Solid Electrical Connections Phono Pin-Plug Crimper

Slip wire in "pin plug," insert in tool, and squeeze . . . job is done.

AU-2  
1/8" PIN

C-rings 1c ea.

Use end of tool to push on C-ring for ground connection.

Ant. plugs, hi-fi, multiple plugs, public address, radio and TV tubes, radar, speakers, and loop connections. Many, many more uses.

**Model LC-3 for 5/32" pin diameter**

At your parts distributor or write us

**BERNS** Mfg. Co.  
9853 Chalmers,  
Detroit 13, Mich.

## NEW! TWO MAJOR SAMS PUBLICATIONS



**TIMELY  
AUTHORITATIVE  
COMPLETE**

# COMPUTER BASICS

**THEORY • DESIGN • OPERATION  
TESTING • MAINTENANCE**

The definitive 5-volume study of electronic computers—past, present and future...

The most comprehensive work ever published on computers. Developed for use by the U. S. Navy at a cost of over \$250,000, this 5-volume study, based on the work of a team of qualified experts in the field of computers has been prepared by the well-known scientific writing organization, Technical Education And Management, Inc. Invaluable to anyone engaged in the manufacture, use, repair or study of computers.

- Vol. 1. Introduction to Analog Computers
- Vol. 2. Analog Computers—Mathematics & Circuitry
- Vol. 3. Digital Computers—Mathematics & Circuitry
- Vol. 4. Digital Computers—Storage & Logic Circuitry
- Vol. 5. Computer Organization, Programming & Maintenance

Over 1200 pages; 955 illust.; handsome slip case  
Prepublication Price (until Jan. 31, 1962) . . \$19.95  
(Regular price thereafter, \$22.50)

## HOWARD W. SAMS MODERN DICTIONARY OF ELECTRONICS

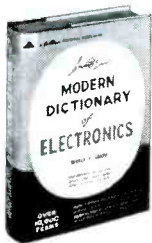

This authoritative reference volume, compiled by Rudolf Graf, is the most comprehensive dictionary now available on electronics. Defines over 10,000 words and terms; includes more than 350 illustrations. Over 350 pages; 6 x 9" hardbound.

Prepublication Price (until Feb. 15, 1962) \$5.95  
(Regular price thereafter, \$6.95)

**SPECIAL  
PREPUB  
SAVING**

Order from your Sams Distributor  
or send coupon below

**HOWARD W. SAMS & CO., Dept. A-132  
1720 E. 38th St., Indianapolis 6, Ind.**

Please send me:

- 5 Vol. Computer Basics (CSS) Prepub Price \$19.95
- Modern Dictionary of Electronics (DIC-1) Prepub Price \$5.95
- Check enclosed (postage paid)

Name \_\_\_\_\_

Address \_\_\_\_\_

City \_\_\_\_\_ Zone \_\_\_\_\_ State \_\_\_\_\_

Electrical characteristics are somewhat standard, with a 3- to 4-ohm speaker being the rule. Some imported sets, and a few of those built by domestic manufacturers, use higher-impedance speakers; but for practical purposes, a standard-impedance replacement will usually perform satisfactorily. In a few domestic receivers, tapped voice coils are used; a duplicate replacement for these sets must be ordered from the manufacturer or his distributor.

### Parts—Where?

The service shop interested in servicing transistor receivers should keep a stock of the more common parts. The substitution suggestions in the foregoing text will enable the serviceman to keep his shelf stock at a minimum. Resistors, ceramic capacitors, electrolytic capacitors, audio transformers, and IF and oscillator coils can be used in various sets, and should be kept available at all times. A list of successful substitutions (as they are made) will prove valuable for future reference and further aid in keeping inventory to a minimum.

Many special parts are stocked by local distributors, and more are likely to be when service shops indicate their desire to buy them. Therefore, the quickest and most convenient source for transistor-radio replacement parts is, as always, your local parts supply house.

But certain parts can be obtained only from the supplier of the set. Some of the special-type parts mentioned earlier, plus certain cabinet parts and knobs, can come only from the set manufacturer. Sometimes these parts must be ordered directly; other manufacturers arrange for certain large parts distributors to handle their replacements.

Table I lists the more popular makes of portable transistor radios, and gives the name of the importer, distributor, or manufacturer of both foreign-made and domestic receivers. Non-standard replacement parts can be obtained for most of the sets listed.

Occasionally, the serviceman will encounter a set which is not listed in this chart, and for which he can find no service information. However, it will ordinarily resemble some other set for which information (and parts) can be found. Help with this problem of chassis identification is offered in an article "Servicing Imported Transistor Portables" which appeared in the July, 1961 issue.

The customer who brings his transistor portable radio (probably a gift from someone near and dear) into a service shop for repairs is usually willing to stand a bit of inconvenience — such as waiting for parts — if he is assured that the serviceman will make the effort to locate the needed parts. And he is happy to pay for these extra services in most cases. Some shops have made a specialty of repairing only transistor radios, and find their customers more cooperative than most. Since finding and obtaining parts is not so difficult after all, more service shops will be getting into this profitable activity. Will you? ▲

**Magnavox**

## STEREO-MONOPHONIC TEST RECORD



## FOR FAST PHONO SERVICING USE A Magnavox STEREO-MONOPHONIC TEST RECORD

Now service all phonographs in the shortest possible time. Here is a proven way of making your present service staff more productive... a must for all shop and outside men. Here are the features found on no other records:

- 5 minute test tone bands of 400 cycles, 1,000 cycles and 3,000 cycles
- gliding frequency band from 15,000 to 40 cycles
- stereo balance test
- channel identification
- complete instructions on record jacket.

**only \$249 (2 for \$349)**

Order today from the MAGNAVOX jobber nearest you—he has a complete line of genuine Magnavox replacement parts.

**B & D Electronic Distributors, 12433  
Ventura Blvd., North Hollywood, California,  
serving the 11 Western states.**

**Certified Electronic Distributors, 5044  
Fullerton Ave., Chicago 39, Illinois, serving  
11 Mid-Western states.**

**Associated Electronic Distributors, 2912  
Euclid Ave., Cleveland, Ohio, serving the  
North Central states.**

**Greenville Service Company, 370 North  
Street, Teterboro, New Jersey, serving the  
New England states.**

**Greenville Service Company, P.O. Box 499,  
Greenville, Tennessee, serving the South.**

**THE MAGNAVOX COMPANY  
Fort Wayne, Indiana**

# PRODUCT REPORT

For further information on any of the following items, circle the associated number on the Catalog & Literature Card.

## CB Transceiver (42J)

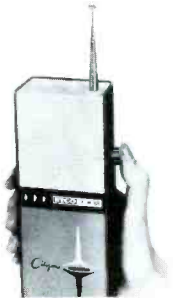

Supplied complete with a nickel-cadmium rechargeable battery and charger, the **EICO** Model 740 Citizens band transceiver is capable of 100 milliwatts output with 100% modulation. The transistorized unit incorporates a 41" telescoping antenna and a 2 1/4" PM speaker as well as an earphone jack. Sensitivity of the receiver is 1-2 microvolts for 10 db signal-to-noise ratio. Price is \$54.95 in kit form or \$79.95 wired.

## Composition Resistors (43J)

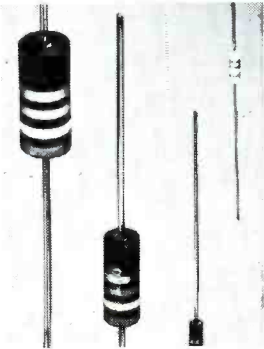

New resistance values as low as 2.7 ohms in the 1/4, 1/2, and 1-watt sizes are now available from **Ohmite** in their "Little Devil" series. The 1/4-watt unit as well as the smaller 1/10-watt size are subminiature types finding application in transistorized and miniaturized equipment. Rated at 70° ambient temperature, these resistors have molded insulation except for the 1/10-watt size which is coated with insulating material. "Little Devils" are sold only through **Ohmite** distributors.

## Ceramic Stereo Cartridge (44J)



The Model 108, a miniaturized stereo cartridge with two needle tips, is now in production by **Electro-Voice**. Featuring low tracking force, the cartridge produces a relatively high output so that it can be used with low-gain amplifiers. Available with either .7-mil and 3-mil sapphires (Model 108) or a .7-mil diamond and a 3-mil sapphire (Model 108DS), the unit offers good bass response and high compliance.

## Glass and Plastic Cleaner (45J)



Technicians who have been looking for a good way to clean up TV sets and radios will be interested in an antistatic solution developed for use on glass tube faces, safety glass, plastic masks, cabinets, etc. "Mask-N-Glass" Cleaner by **Chemtronics** is non-staining and non-abrasive. Especially useful on late-model plastic cabinets. "Mask-N-Glass" is available in a 6 oz. aerosol can, and nets at \$1.79. A large lint-free cloth is given with each can.

## Replacement Flybacks (46J)

Two new exact-replacement flybacks have been added to the **Stancor** line, and are now being stocked by distributors. Flyback HO-325 replaces Trav-Ler part no. TR-28, and HO-330 replaces Sparton part no. PC-70036. Both units can be used in a wide range of models with circuit or chassis alteration.

# NEW! SARGENT. ELECTRONIC CHEMICALS and FINISHES

Specially Formulated for Today's Service Needs

## SARGENT RED INSULATOR

Stops corona discharge and arcing. Waterproofs exposed wires and circuits. Impervious to moisture and temperature variations. Dielectric strength exceeds 20,000 volts. Excellent for use in printed circuit repairs. Laboratory tested and approved.

Giant 16.4 Oz. Can \$1.29 Dealer Net

## OTHER PRODUCTS IN THE SARGENT ELECTRONICS LINE

Tuner Cleaner, Gear and Parts Cleaner, Degreaser, Clear Acrylic Plastic, Penetrating Oil, Squeak Stopper, Enamels, Lacquers, Metallics, Engine Enamels, Stop Rust, and other Specialties.

For Free Literature and Prices, Check Your Electronics Parts Distributor, or write . . .

ELECTRONICS DIVISION

## THE Sargent-Gerke Co. ©

Producer of Paints and Chemicals for Over 60 Years  
P. O. Box 729 • INDIANAPOLIS 6, INDIANA



**SAVES**  
your back . . .

**SAVES**  
your time . . .

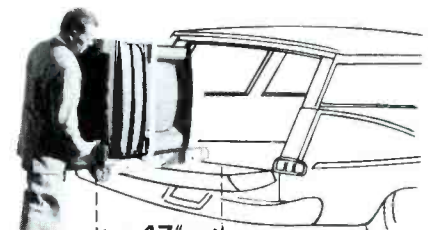

# YEATS SHORTY DOLLY

for RADIO and TV

just 47 inches high for STATION WAGONS and PANEL PICK-UPS



FOLDING PLATFORM  
15 1/4" x 24 1/2" top.  
Snaps on or off.  
(Platform only)  
\$11.95

Designed for TV, radio and appliance men who make deliveries by station wagon or panel truck . . . the short 47 inch length saves detaching the set for loading into the "wagon" or pick up. Tough, yet featherlight aluminum alloy frame has padded felt front, fast (30 second) web strap ratchet fastener and two endless rubber belt step glides. New folding platform attachment, at left, saves your back handling large TV chassis or table models. Call your YEATS dealer or write direct today!



YEATS  
Model No. 5  
Height 47"  
Weight 32 lbs.



FURNITURE PAD

## "Everlast" COVER AND PADS

YEATS semi fitted covers are made of tough water repellent fabric with adjustable web straps and soft, scratchless white flannel liners. All shapes and sizes — Write



TV COVER

# YEATS

APPLIANCE DOLLY SALES COMPANY

2103 N. 12th STREET MILWAUKEE, WISCONSIN

**CORRECT  
OVER VOLTAGE**

**CORRECT  
LOW VOLTAGE**

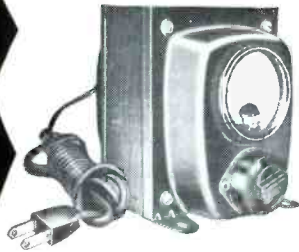

and get  
**BETTER PERFORMANCE**  
with this  
**ACME ELECTRIC VOLTAGE ADJUSTOR**

TV sets, hi-fi's and other electronic equipment operate best when voltage holds closely to the normal 115-117 volts for which they were designed. Over-voltage and/or under-voltage affects the performance of the tubes and the life expectancy of all other components. Why fight an off-standard voltage condition? Correct it with an Acme Electric T-8394M Voltage Adjustor.

Corrects voltage over a range from 95 to 125 volts to normal 115/117 volts, simply by turning a regulating switch. Includes voltmeter which indicates output voltage; cord and plug and built-in, plug-in receptacle. Tell your supply dealer who you want the Acme Electric T-8394M Voltage Adjustor. No other so compact, complete, practical, inexpensive.

SA 3402-1849

**ACME ELECTRIC CORPORATION**

941 WATER STREET

CUBA, N.Y.



**QUALITY PRODUCTS! . . . for High-Profit  
Sales and Year-Round Business!**

**2 NEW PRODUCTS FOR  
TAPE RECORDER  
MAINTENANCE**

**"SPOT" LUBRICATING OIL**  
For pin-point oiling of bearings, shafts and oil holes. "SPOT" is a high grade lubricant that reaches hard-to-get-at bearings with a concentrated spray.

**TAPE RECORDER CLEANER**  
An approved chemical spray that washes accumulated iron oxide from tape recorder heads. The combination of the spray and pin-point applicator results in fast and efficient cleaning of tape recorder heads.

**INJECTORALL** **INJECTORALL COMPANY**  
2081 Shore Parkway  
Brooklyn 14, New York

**FM Antenna (47J)**

Signal at the terminals of the "S" configuration AFM450 FM antenna by JFD shows no frequency discrimination regardless of the transmitter direction. Also available as a complete kit (Model AFM475) including the antenna and necessary installation hardware, the anodized dipole is omnidirectional and is designed to operate in the 88-108 mc range.

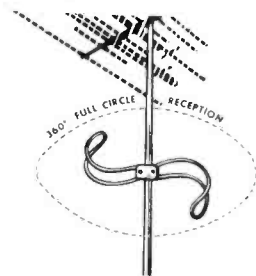

**FM Stereo Adapter (48J)**

A self-powered, transistorized stereo multiplex adapter has been announced by ABC Electronics. Providing 20 db of channel separation, the unit features a front-panel stereo balance control, and is capable of 30-15,000 cps response on both channels. Designed to convert any conventional FM tuner or receiver to stereo operation, the Model 611 measures 3" wide x 4" high x 5" deep and has a retail price under \$40.



**Capacitor Kit (49J)**

Fourteen types of tubular electrolytics are found in a kit (K-100) supplied by General Electric. Designed to serve as replacements for more than 50 original types, the 19 capacitors in the kit are packed in a 10-drawer plastic parts cabinet. Capacities range from 2 to 500 mfd in working voltages from 50-475 volts. Net price of the complete kit, including cabinet, is \$17.95.



**Speaker Selector Switch (50J)**

A completely shielded housing is a major feature of the Model 671 monophonic speaker-selector switch by Switchcraft. The unit permits connecting any one of five speakers to a monophonic amplifier by means of a five-position tap switch. Furnished with instruction sheet and hardware, the Model 671 can be either wall- or cabinet-mounted.

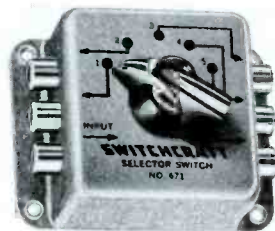

**Tube Tester (51J)**

Facilities for testing new 10- and 12-pin tubes are contained in the Seco Model 88 tube tester. Providing 10 different sockets, the Model 88 uses a grid-circuit as well as a cathode-emission test. Employing a two-stage DC amplifier circuit, the unit contains one meter which shows results of all tests. In addition, it also checks filament continuity and provides an open-element test. Net price is \$69.50.

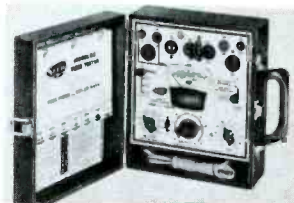

**Audio Distribution (52J)**

The Jerrold Model AT modulator provides a method of reproducing AM or FM radio, background music, or public announcements through unused channels of standard TV receivers. Hotels, motels, or industrial establishments having a TV distribution system can provide as many as five separate channels of audio to any room containing a TV receiver. The "Audio-Trol" lists for \$325.00.





### Communications Transistors (53J)

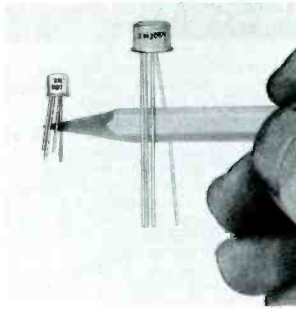

Two new PADT germanium alloy-mesa transistors have been made available by **AmpereX**. The 2N987 (TO-18 case) and the 2N2084 (TO-33 case) are designed for use as RF and IF amplifiers in mobile and airborne communications equipment operating in the HF and VHF bands. Having a typical beta of 140 and a breakdown voltage of 40V, these transistors provide a typical power gain of 14 db at 100 mc.

### Gm Tube Tester (54J)

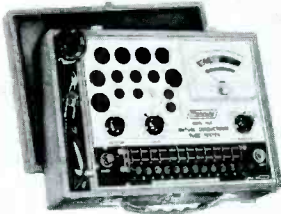

The **Mercury Model 1000** tests tubes for dynamic mutual conductance, shorts, leakage, gas, and grid emission. Pin connections are individually set up by lever switches. The 15 panel sockets accommodate "nutvisor," "Compactron," 10-pin, "novar," and all conventional tubes. A CRT test socket is also supplied. The tester is 14" x 9 1/2" x 4 3/4" in size; net price is \$79.95.

### Sound Columns (55J)

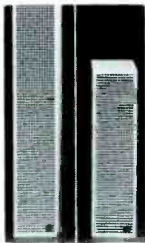

Dual-element speakers, similar to those used in high-fidelity sound reproduction, allow the **University UCS-6** and **CS-4** sound columns to handle large amounts of power. Wide horizontal dispersion (120°), and vertical dispersion which is constant throughout the frequency range of the column, assure uniform sound coverage.

### Public-Address Amplifiers (56J)

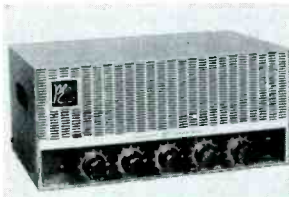

A completely redesigned line of **Precision Electronics** PA amplifiers has "squared" styling, and power ratings 25% higher than in comparable models previously available. In all units, the on-off switch is separate from the volume control. The new series includes AC-powered models 10PA, 20PA, 30PA, and 60PA, plus two mobile types — a 25-watt transistorized unit, and a 30-watt amplifier with a combination 6/12V DC and 117V AC power supply.

### Non-Slip Compound (57J)



Effective when used on automatic record changers which tend to stall during the change cycle, "Fono-Magic" by **R-Columbia** is a liquid compound of rubber and carbide particles. Applied by brush to the metal drive surfaces of phonograph mechanisms, it leaves the metal surfaces coated with a non-slipping .00065" film of pliable rubber when dry. Net price is \$1.95 per can.

### Receiving Tubes (58J)

Four new tubes have been added to **Raytheon's** replacement line. A 9-pin miniature triode-pentode, the 5FG7, is intended for use in oscillator and mixer circuits. The 6DR4, a 7-pin miniature triode, is designed for phase-inverter and voltage amplifier circuits where high voltage gain is desired. An octal-based beam-power pentode, the 6FW5, is used as a horizontal deflection amplifier. Used in both monochrome and color receivers, the 6HF8 is a 9-pin miniature triode-pentode.

actual size

# New Stethotracer

## \$29.95

DEALERS' NET

The instrument for every electronic signal tracing need in your vest pocket. Locates defective circuit fast!

The pen-size, transistorized **STETHOTRACER** locates hum, oscillations, ground loop, breaks in printed circuit boards and other common trouble shooting ailments in seconds! This dependable, top quality instrument detects and demodulates any low level microwatt audio or modulated radio frequency signal...the signal is then amplified 1,000 times into a high quality earphone, or observed on a scope, using a plug-in scope adaptor (available optionally).

Ideal for test and trouble shooting all types of radio, amplifiers, phonographs, magnetic tape recorders, dictating machines, hearing aids, and phono pickup cartridges, or used as a preamplifier.

Complete with earphone, cord, 4 interchangeable attenuator probes and R. F. detector-demodulator crystal diode probe, ground clip lead and battery.

Accessory probes (available optionally) include Vibration Pickup Probe, Miniature Microphone Probe, Magnetic Tape Head Probe, Microwave Demodulator Probe and Telephone Pickup Induction Probe.

Ask also about the famous **MOSQUITO**, the new vest pocket size signal injector—a signal source for every application! \$9.95 dealers' net.



See your local distributor or write for details to:

**Don Bosco**  
ELECTRONICS INC.  
Littell Road • Hanover, N. J. • TUCKER 7-5575  
A Subsidiary of Howell Electric Motors Company



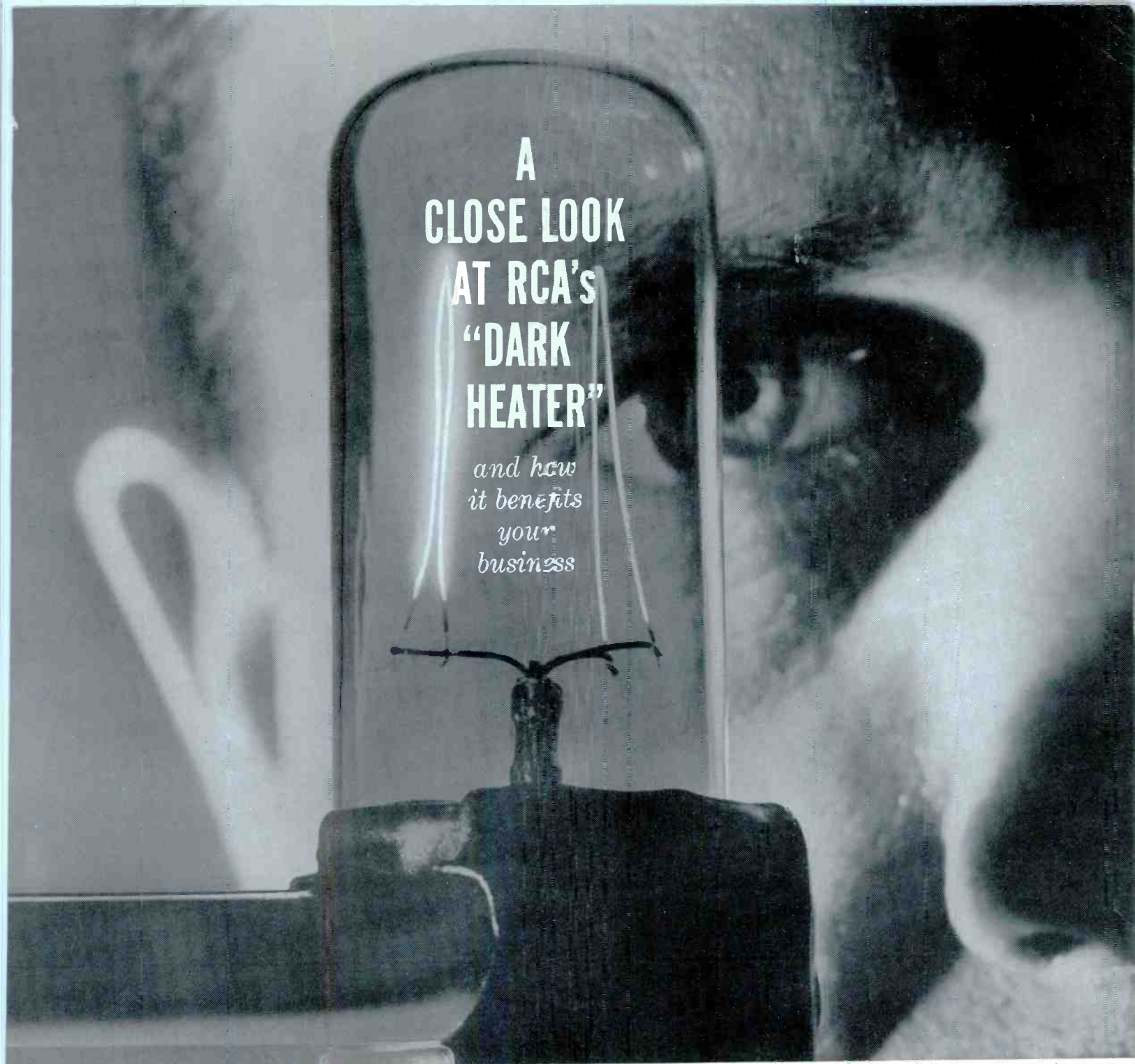

A  
CLOSE LOOK  
AT RCA'S  
"DARK  
HEATER"

and how  
it benefits  
your  
business

You are looking at a dramatic example of RCA leadership in tube technology.

The wire at the right in the demonstration envelope is the new RCA "Dark Heater"—an exclusive RCA development. Operating at about 350°K below the temperature of a conventional heater (left), the remarkable "Dark Heater" reduces chance of heater failure, increases heater-current stability during the life of the tube, eliminates "spike" or pulse-leakage current, cuts AC heater-cathode leakage and hum, and provides greatly improved overall mechanical stability.

RCA Electron Tube Division, Harrison, N. J.

NET RESULT TO YOU: *even greater assurance* of customer satisfaction with your work—*even greater freedom* from callbacks, and in-warranty failures.

Now available in an increasing number of RCA receiving-type tubes, the RCA "Dark Heater" will be incorporated in those receiving-type tubes where potential benefits of increased life and reliability can be realized. This new RCA development is further assurance that you are working with the best and latest receiving tubes when you specify and install RCA.



The Most Trusted Name in Electronics

# WHAT'S IN A FUSE?

Only a fuse element, glass & caps?

No! Every fuse carries  
with it the skill and quality of its manufacturer.

You can't reach out and touch or taste this  
you can't even be sure it will do  
its job when needed except  
by purchasing from a company  
that has the know how of 30 years  
of manufacturing fine fuses.

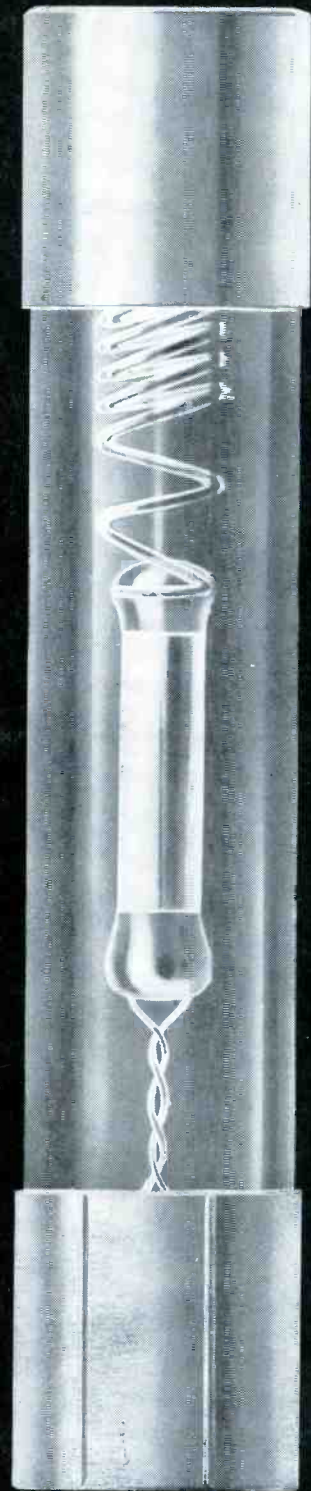
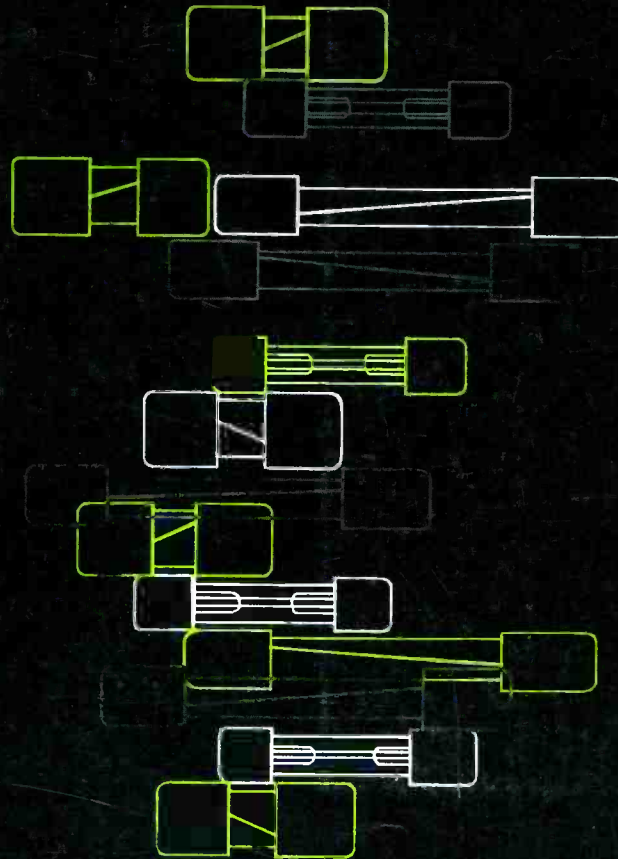

BURTON BROWNE ADVERTISING

## LITTELFUSE

1865 Miner Street · Des Plaines, Illinois