

JUNE, 1960

35 CENTS



PHOTOFACT

RF REPORTER

including **Electronic Servicing**



This Month's Highlights

PA Speaker
Installation Tips

•
A Key to Keyed AGC

•
Understanding
Antenna Rotators

WA 442 1262
WA. M. DAVIS
RADIO & TV. SVC.
118 RIVERSIDE AVE
CANNON CITY, COLORADO

7 NEW CATALOGS Write For Yours Today

240 PAGES—COUNT 'EM—240



NOT JUST ONE, but 7 new product catalogs for you . . . packed with the latest time-and-money-saving ideas in service aids. You merely clip and mail ONE COUPON to bring you FREE the new catalogs from GC, WALSCO, AUDIOTEX, AMERICAN MICROPHONE and special Citizens Band and Electrocraft editions.



THOUSANDS & THOUSANDS OF PRODUCTS!



SEND POSTCARD OR CLIP AND MAIL COUPON TODAY



GC ELECTRONICS CO.

Division of Textron Electronics, Inc.
West Plant: Los Angeles 18, California
Main Plant: Rockford, Illinois, U. S. A.

GC ELECTRONICS CO., Division of Textron Electronics, Inc.
Los Angeles 18, California OR Rockford, Illinois (send to address nearest you)

Please send me FREE:

- GC Electronics Resistor and Knob Catalog No. FR-61-D
- Walsco Catalog No. FR-61-W-1
- GC Electronics Chemical, Tool and Hardware Catalog No. FR-61-G
- Audiotech Catalog No. AD-60
- Electrocraft Catalog No. FR-61-E
- Citizens Band Catalog No. AN-61
- American Microphone Catalog No. FR-61-P

NAME _____
FIRM _____
ADDRESS _____
CITY _____ ZONE _____ STATE _____

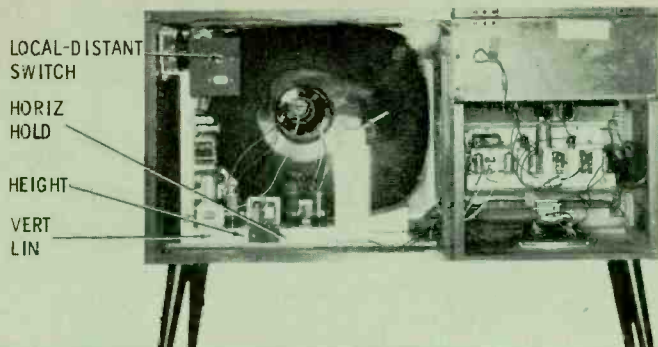

**Muntz Model 21CP-3M
Chassis T3707**

This 21", 110° lowboy combination has AM-FM radio, phono, and TV. Variations of this model include TV only, TV with 4-tube AM radio, TV and 7-tube AM radio, and TV with stereo amplifier. The safety glass can be removed for cleaning by removing the six Phillips-head screws holding the decorative trim strip across the lower edge of the cabinet. For identification purposes, use the model number stamped on the rear cover.

The 13-tube "hot" chassis is "L" shaped — the power and deflection circuits forming the base, and all other circuits mounted on the vertical section. Conventional wiring is used throughout. Several rather rare tubes are used, including a 5BW8, 12AV5, 19AU4, and 25DN6. Only two stages of video IF amplification are used, and the second stage (a reflex amplifier) also serves as the first of two sound IF stages. A *Fireball* tuner is used, and since the adjustments for the VHF oscillator are accessible through the right side of its shield, the chassis must be removed before touch-up adjustments can be made.

All operational controls are mounted inside the massive channel selector knob on the right side of the cabinet. The brilliance control operates like any standard brightness control, in that it serves to vary the bias on the picture tube. To remove the chassis, the knob escutcheon must be taken off first, requiring removal of four Phillips-head screws. The knobs and two additional Phillips-head screws can then be removed to free the vertical part of the chassis. A 3/8" hex nut holds the picture tube to the front of the cabinet, and four 5/16" bolts secure the bottom part of the chassis. Removal of these and the speaker leads allows the entire assembly to be slid out of the cabinet.

We removed the horizontal output tube to show you the single silicon rectifier. It's interesting to note that an autotransformer is used to step up the voltage applied to the rectifier circuit, which provides a B+ supply of 165 volts. A 5-ohm fusible resistor, protecting the B+ supply, is the only device used for safeguarding the TV chassis. A 3-amp line fuse protects the radio power supply—which, incidentally, incorporates an EC81/6CA4 rectifier.

The 11-tube AM-FM radio requires a long-handled nut driver for the four 1/4" mounting bolts. Slipping the chassis to the back allows the mounting bolts to clear the elongated slots, and the chassis to be lifted out. Notice the unusual placement of the speaker in the last photo. The wire mesh guarding the cone vibrated on bass notes until we secured it with a few staples.

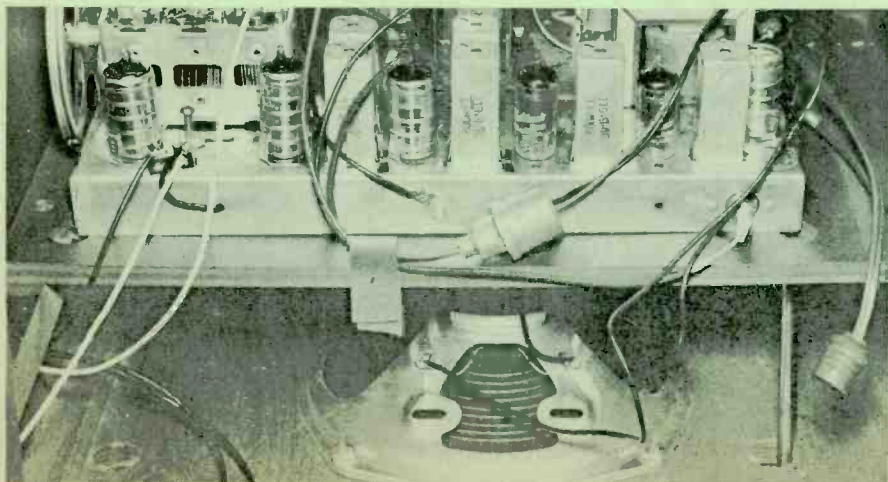
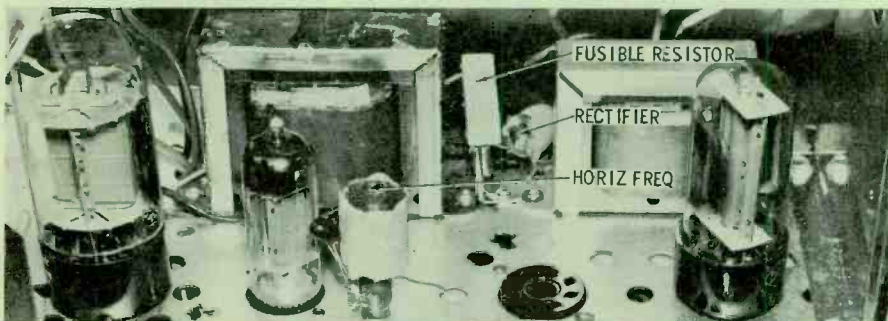
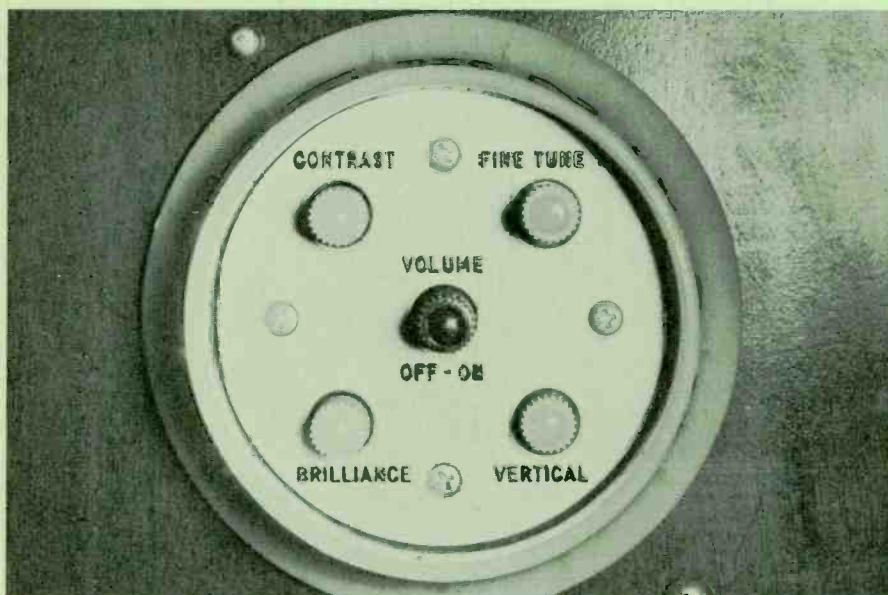

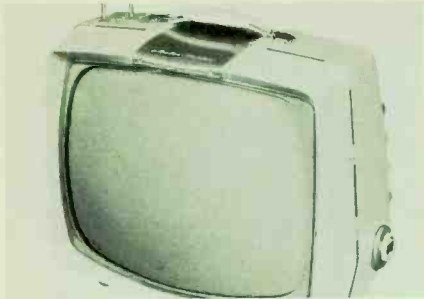

**Silvertone Model 106DS
Chassis 528.51660**

This 17", 110° portable from the Medalist series is housed in a plastic cabinet. Removing the metal trim at the top permits the plastic shield protecting the picture tube to be removed for cleaning. Caution: Use only a soft cloth dampened with a mild detergent.

The "hot" chassis is protected by a circuit breaker and contains 16 tubes in a 450-ma series string. The rarest tube types are the 3CY5, 4AU6, 8BA8A, and 13DE7. To explain the chassis number (stamped in a metal plate near the yoke plug), the first three digits will be either 456, or 528, indicating at which plant it was manufactured. (This also applies to the model number.) The next three digits specify the general classification, while the last two define specific run and chassis. Chassis numbers ending with 0, 2, 4, etc., signify use of a VHF tuner, while odd numbers indicate that a UHF-VHF tuner is used. For example, the UHF-VHF version of this basic chassis is 528.51661. Each change made in production introduces a new chassis number. For the first change, the chassis number would become 528.51662 or 528.51663, depending on tuner design; the second change would cause the numbers to end in 64 and 65 respectively.

Height and vertical linearity adjustments are accessible through the hollow shafts of the brightness and vertical hold controls. However, the control panel must be removed before the thumbwheel knobs will come off. Circuits for the video IF, video, sync, and sound stages are contained on the left printed board. No stampings or circuit details of any kind are provided on the boards to aid in servicing.

In the upper right-hand corner of the chassis, we find the keyed AGC circuit, which is part of the conventionally-wired section. The board contains the entire vertical circuit as well as the horizontal AFC and oscillator stages. Wire-wrap terminals provide various voltage sources for the focus anode of the picture tube.

The horizontal drive control in this chassis is somewhat unusual. It is located in the cathode circuit of the output tube, and regulates the amount of fixed bias for the stage. The fish paper covering the sockets of the horizontal output and damper tubes has been removed to show that measurements can be made without removing the chassis. However, servicing is complicated by the placement of these tubes. The horizontal output tube must be removed in order to get at the damper. The silicon rectifiers are located on the bottom side of the chassis, making chassis removal mandatory when servicing the power supply.

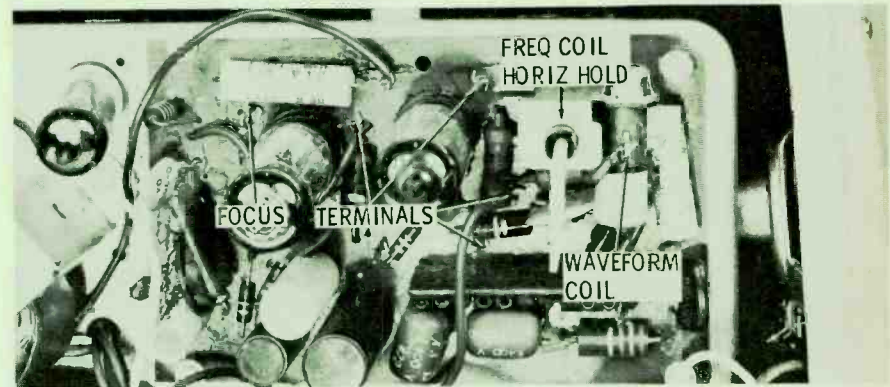
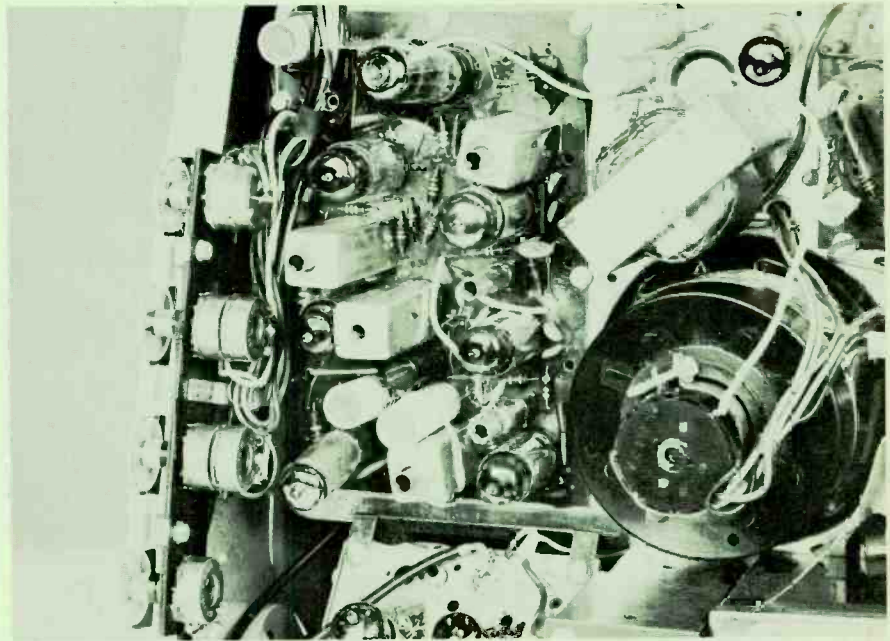
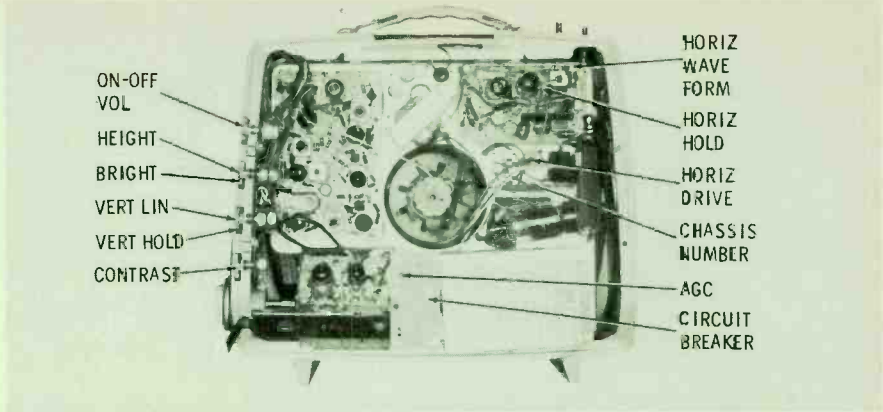



**Westinghouse
Model H-P3300U
Chassis V-2384-2**

Attache is the name of this set, as you'll see when you raise the lid to uncover the speaker and get at the built-in "rabbit-ear" antenna. The set shown is a 16-tube, UHF-VHF version, but it also comes equipped for VHF only. For a 17", 110° unit, it is just about as compact as they come. The chassis must be removed to clean the plastic safety glass, on which only a mild soap or detergent should be used. The height and vertical linearity controls are located behind the channel selector knob so they can be adjusted while viewing the picture on the screen.

You may have noticed, prior to removing the rear cover, that the AC interlock plug is polarized. If not, you'll find out when you try to use a conventional "cheater cord." One of the prongs is of a larger diameter, and won't fit a standard receptacle. Nevertheless, this polarization technique provides excellent protection against shock hazards from the "hot" chassis. The wall plug itself is polarized, too, so that the "hot" side of the line cannot become accidentally connected to the chassis. (In today's standard AC receptacles, the slot for the grounded side of the line is longer than the other slot, thereby permitting a polarized plug to be used when necessary.)

The conventionally-wired part of the chassis is on the right, and consists of the horizontal-deflection and power-supply circuits. The latter uses two silicon rectifiers in a voltage-doubler configuration, and is protected by a circuit breaker in series with the line. A 3/4-amp, slow-blow, pigtail fuse is used for horizontal circuit protection. You'll find it directly below the rectifiers, covered by a piece of fish paper.

The rest of the circuits are on one large printed board mounted at an angle on the left side. Although the bottom of the board is equipped with *See-Matic* coding, easy accessibility of most parts will make topside servicing preferable in most cases. Wire-wrap terminals and easy-to-get-at component leads also make in-cabinet servicing easier.

The only complication to chassis removal is in the speaker mounting. Because of the compact design, prior removal of the handle and speaker baffle makes it a lot easier to get the chassis out.

The compactness and rigidity of the chassis are more obvious in the last photo. The three-section B+ filter is difficult to get to: it's located between the CRT and printed board. The combination knob and shaft of the *Memory Tuning* is an integral part of the fine tuning mechanism, and adjusts the cams for each individual channel.

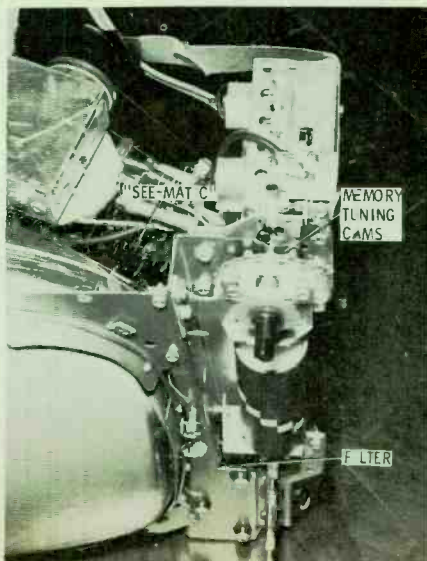
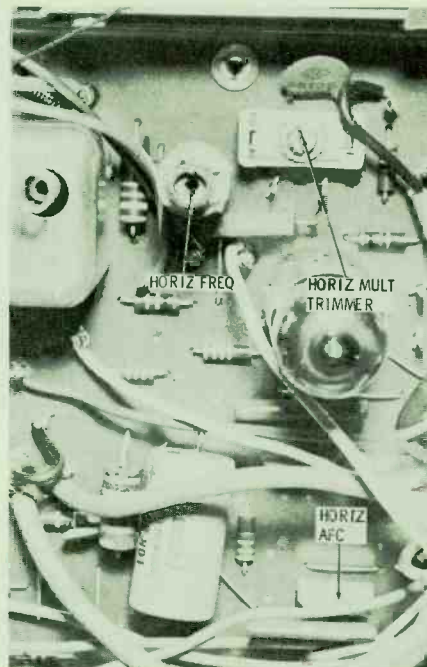
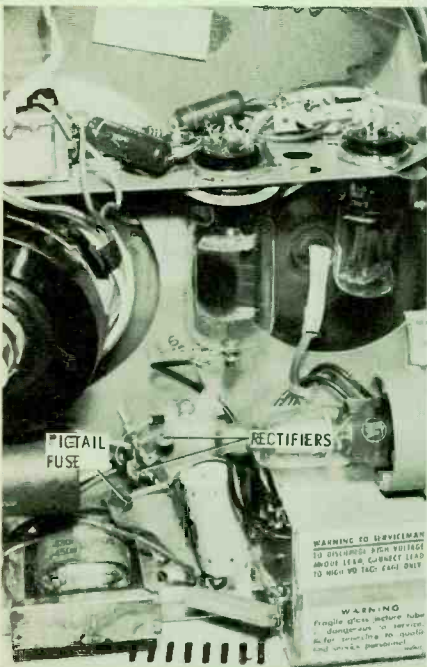
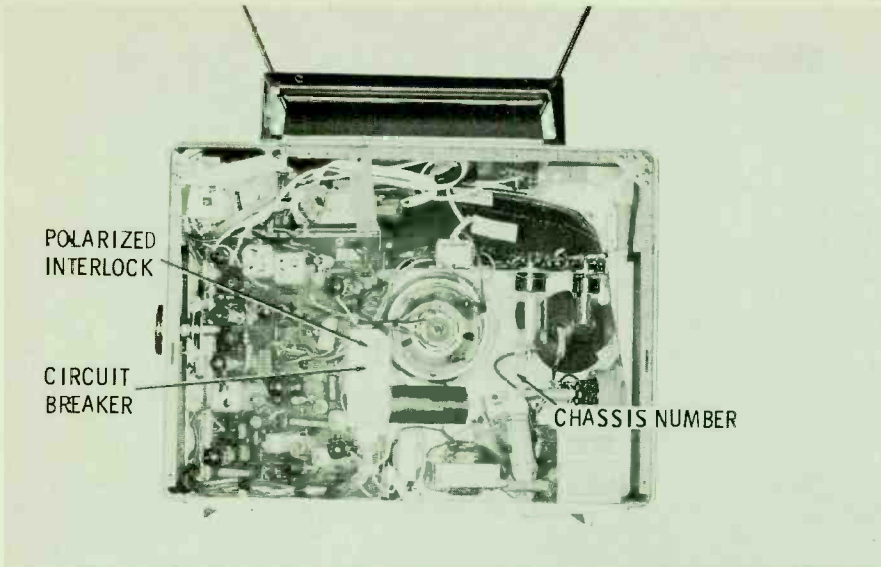

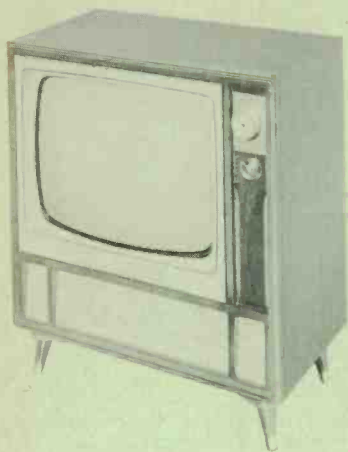

**Zenith Model E2755W
Chassis 18E20**

This 23" set represents fifteen models using one of the four largest chassis in Zenith's 1960 line. The CRT has a bonded safety glass, eliminating the tube-cleaning problem. All of the 18E-series chassis are the same, although there are minor variations in the tuner and some are equipped for remote tuning. All operational controls are up front, most of them hidden by the control-panel door below the picture tube. Setup adjustments for height, vertical linearity, and focus are also behind the door. All controls are labeled for easy identification.

The 18-tube, transformer-powered, hand-wired chassis has dip-soldered terminal connections. The picture tube mounts on the chassis, but is offset—flush with the side of the chassis containing the power transformer — to make the chassis stable when turned on its side for service. Both width and linearity coils are used, the width adjustment protruding through the right side of the cage, and the linearity coil housed inside the cage. While you're looking at the same photo, notice that the quadrature coil adjustment is located on the rear apron. The power supply uses both a 5U4 and a 5Y3, and is protected by a 7/10-amp, slow-blow, N-type fuse mounted near the transformer. The AC line is protected by a 5-amp pigtail fuse located beneath the transformer on the bottom side of the chassis. Incidentally, the rather rare 6EZ5 vertical output and 6GH8 horizontal AFC-oscillator tubes are used in these chassis.

Cage construction is a little unusual. The parts inside are mounted at an angle, providing easy access to the tubes; tube location along the back of the chassis (permissible because of cage design) also aids in accessibility.

The right side of the chassis contains the entire horizontal circuit plus the audio output stage. The horizontal AFC circuit incorporates a solder-in dual crystal diode, which is located on the bottom side of the chassis. The width-control circuit is unusual; the primary winding is connected in series with the yoke-return lead, and the secondary is connected between the AGC winding of the flyback and the cathode of the horizontal output tube.

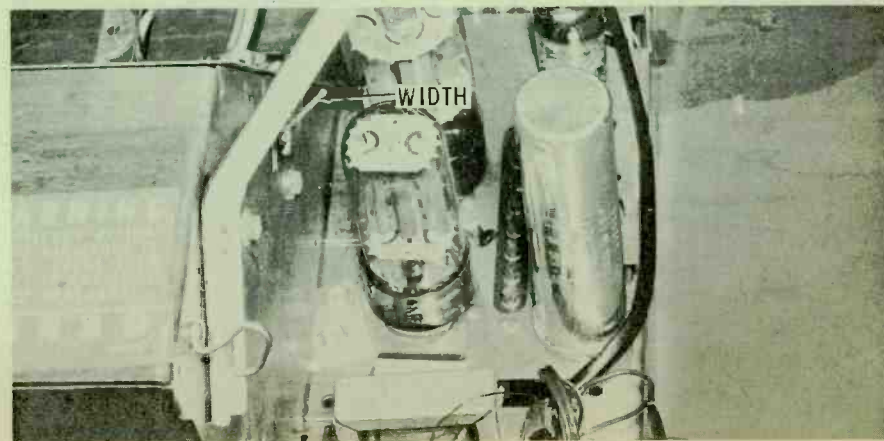
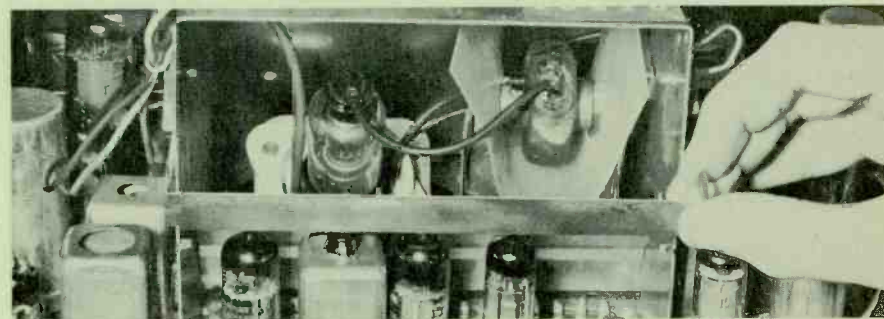
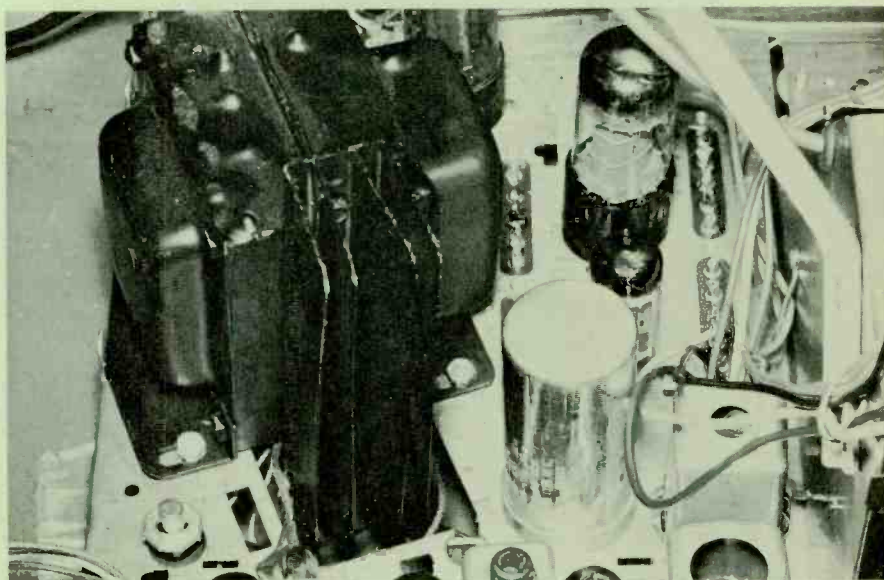
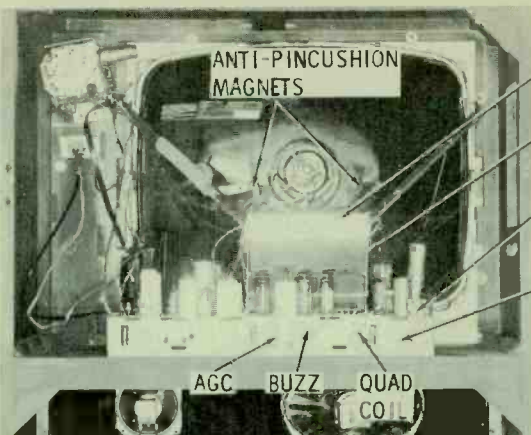

See PHOTOFACT Set 420, Folder 1; PCB 460-3

Mfr: Airline Chassis No. GTM-4213A

Card No: AI-GTM4213A-1

Section Affected: Raster.

Symptoms: Collapsed vertical sweep.

Cause: Shorted feedback capacitor in vertical multivibrator.

What To Do: Replace C37 (.1 mfd—600V).

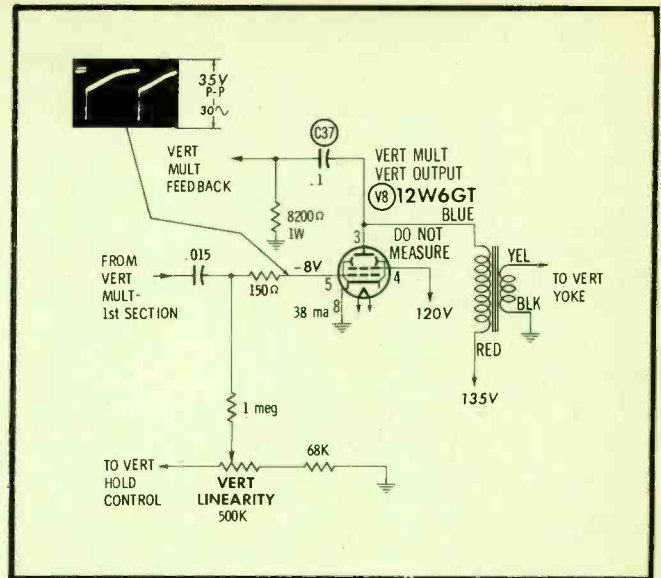

Mfr: Airline Chassis No. GTM-4213A

Card No: AI-GTM4213A-2

Section Affected: Pix.

Symptoms: Picture flashes off and on.

Cause: Open cathode resistor in video output circuit.

What To Do: Replace R24 (100 ohms—1/2 W) and check V3 (6BH8).

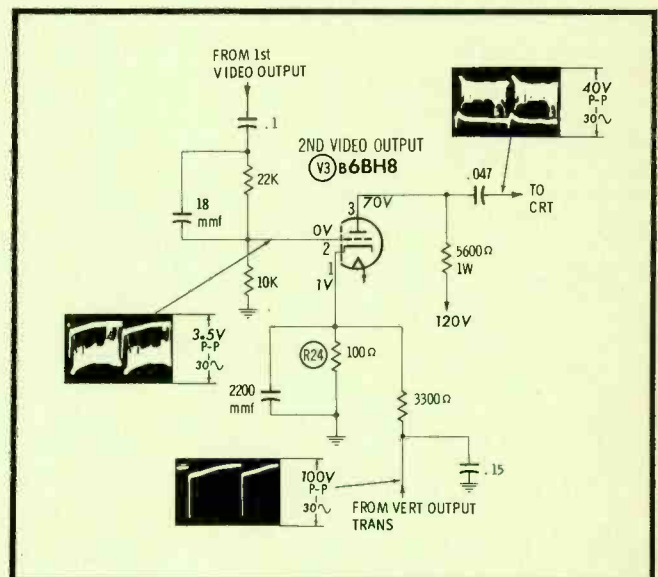

Mfr: Airline Chassis No. GTM-4213A

Card No: AI-GTM4213A-3

Section Affected: Sync.

Symptoms: Poor horizontal and vertical hold.

Cause: Open screen resistor in sync separator circuit.

What To Do: Replace R37 (15K—2W).

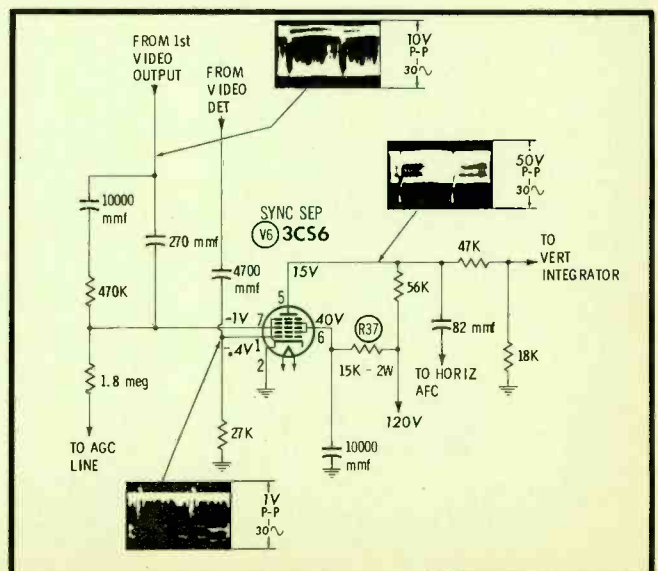

See PHOTOFACT Set 468, Folder 2

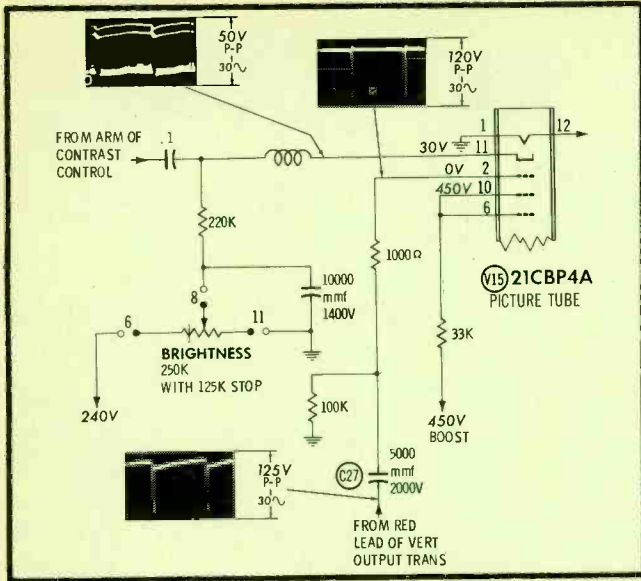

See PHOTOFACT Set 468, Folder 2

Mfr: Motorola Chassis No. TS-561

Card No: MO 561-4

Section Affected: Pix.

Symptoms: Brightness always at maximum; brightness control has no effect.

Cause: Leaky coupling capacitor in vertical retrace-blanking circuit.

What To Do: Replace C27 (5000 mmf—2000V).

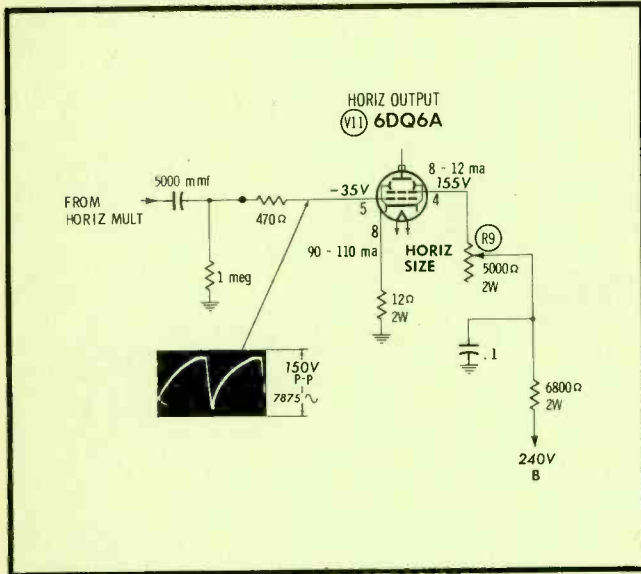

Mfr: Motorola Chassis No. TS-561

Card No: MO 561-5

Section Affected: Raster.

Symptoms: Fluctuations in raster width, accompanied by flashes on screen.

Cause: Defective horizontal size control.

What To Do: Replace R9 (5000 ohms—2W).

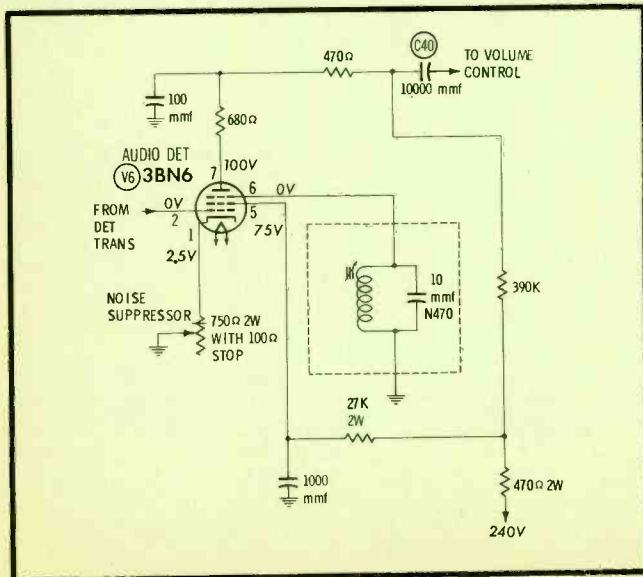

Mfr: Motorola Chassis No. TS-561

Card No: MO 561-6

Section Affected: Sound.

Symptoms: Intermittent sound.

Cause: Intermittently open coupling capacitor between audio detector and volume control.

What To Do: Replace C40 (10000 mmf).

Remember us? We're still cutting call-backs...



... because I've got new coil heaters. You can wave goodbye to your front-end troubles.

Your CBS 6BQ7A



... because my new plates behave like plates ... not filaments. You can forget your low-voltage rectifier problems.

Your CBS 5U4GB

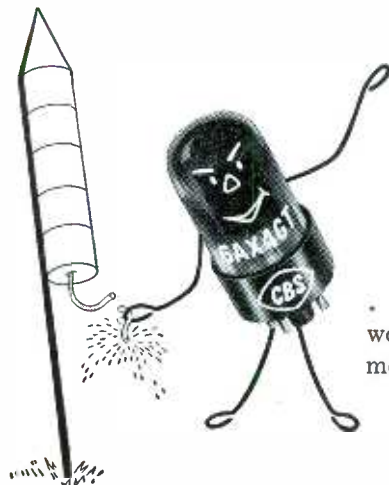

... because you get no fireworks with me. That means no more damper arcing for you.

Your CBS 6AX4GT

... because I like high voltage. So stop worrying about arcs and burnouts.

Your CBS 1B3GT

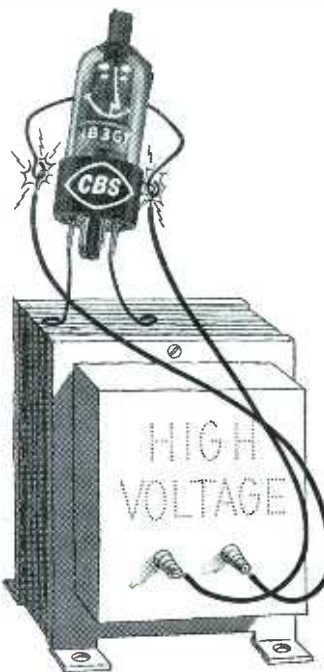

... because I'm loaded with performance, man. You buy no sync problems with me.

Your CBS 6CG7

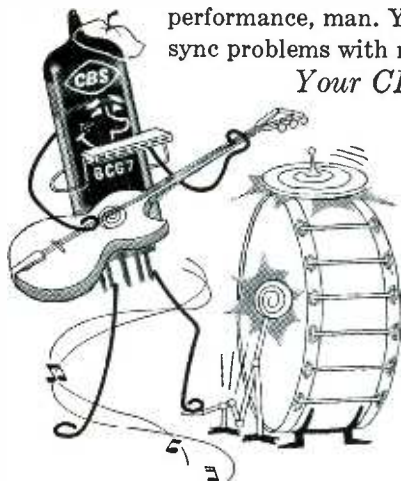

TOTAL RELIABILITY ... proved in performance

Yes, we are typical CBS receiving tubes especially designed to cut your call-backs. We offer you *total reliability* ... proved in performance by leading TV set manufacturers — and service technicians too. You can profit more from the *total reliability* of CBS tubes. Just make it a habit always to replace with us ... and with other dependable CBS tubes.



COLUMBIA NEEDLES NOW AT YOUR ELECTRONIC PARTS DISTRIBUTOR

The Columbia phonograph needle line is now available from your local distributor of CBS Electronics products. You'll find it a complete line ... a quality line ... with a famous name, a proud name known and respected by your customers. Ask *your* distributor for dependable Columbia needles.



CBS ELECTRONICS, Danvers, Mass.
A Division of Columbia Broadcasting System, Inc.

Receiving, industrial and picture tubes • transistors and diodes • audio components • and phonographs

2 great **SPRAGUE DIFILM**® tubulars

are tops in their field . . . take your choice!

For maximum reliability
and performance
under toughest conditions

SPRAGUE DIFILM® **BLACK BEAUTY**®



For extremely small
size and exact
original replacement

SPRAGUE DIFILM® **ORANGE DROP**®

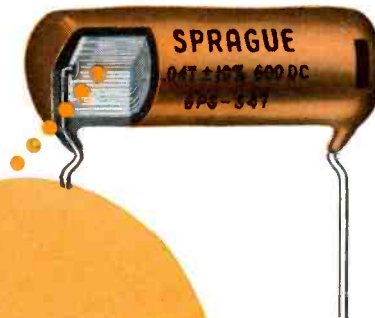

Sprague Black Beauty tubulars are missile-type capacitors. Actually, they are low cost versions of the famous Sprague capacitors now being used in every modern military missile. Where positive reliability is important, make no mistake, use Black Beauty Difilm Molded Capacitors! You get the most for the least with Black Beauties!

Difilm Black Beauties are engineered to withstand the hottest temperatures to be found in TV or auto radio sets—in the most humid climates. Further, unlike straight polyester film tubulars, these capacitors operate in a 105°C environment—without derating!

Black Beauty tubulars are tough units, too—no fragile shell to break—you can't damage them in soldering. For your convenience, every capacitor is marked twice . . . no need to twist capacitor around to read rating.

The heart of these Sprague Difilm Capacitors can't be beat! It's a dual dielectric combination of Mylar® polyester film and special capacitor tissue—resulting in capacitors which are superior to all other comparable tubulars. Sprague's rock-hard solid HCX® impregnant fills voids and pin holes in the film. Difilm capacitors have high insulation resistance, low power factor, and excellent capacitance stability and retrace under temperature cycling!

Sprague Difilm "Orange Drops" are a "must" for your service kit where only an exact replacement will fit. They are the perfect replacement for dipped capacitors now used by leading manufacturers in many popular television receivers. And when a dipped tubular is called for, you'll find that Orange Drops outperform all others, safeguarding your work and reputation for quality service.

Orange Drops are specially designed for easiest possible installation. Radial leads are crimped to assure neat mounting parallel to printed wiring boards . . . extremely small size makes them fit handily in tight spots. They'll beat heat and humidity because the solid, rock-hard capacitor section, double-dipped in bright orange epoxy resin, is well protected against moisture. A perfect team-mate for Black Beauty.

±10% CAPACITANCE TOLERANCE IS STANDARD AT NO EXTRA COST

Difilm Black Beauty and Difilm Orange Drops are packaged in sturdy, reusable rigid plastic Kleer-Pak® boxes. Your distributor is stocked in all the popular ratings. Order some today. You can count on Difilm.

SPRAGUE®
THE MARK OF RELIABILITY

publisher
Howard W. Sams

general manager
Mal Parks, Jr.

editor
Verne M. Ray

associate editors
Leslie D. Deane
Thomas A. Lesh
Joe A. Groves

consulting editors
William E. Burke
Robert B. Dunham
George B. Mann
C. P. Oliphant
Paul C. Smith

art director
Don W. Bradley

advertising & editorial assistants
Georgeanna Caldwell
Marjorie Spiegel
Jean Sekulski

production manager
Robert N. Rippy

circulation fulfillment
Pat Tidd, Mgr.
Constance McCawley, Ass't.

photography
Robert W. Reed

advertising sales offices
midwestern

John Groce, PF REPORTER
2201 East 46th Street, Indianapolis 6, Ind.
Clifford 3-6441

eastern

Howard W. Sams & Co., Inc.
Corning Glass Building,
717 Fifth Ave., New York 22, N. Y.
MUrray Hill 8-6350

western

The Maurice A. Kimball Co., Inc.
2550 Beverly Blvd., Los Angeles 57, Calif.
Dunkirk 8-6178; and 681 Market Street,
San Francisco 5, Calif. Exbrook 2-3365

Address all correspondence to
PF REPORTER, 2201 East 46th Street,
Indianapolis 6, Indiana



Copyright © 1960 by Howard W. Sams & Co., Inc. PF REPORTER is a trademark of Howard W. Sams & Co., Inc. No part of PF REPORTER may be reproduced without written permission. No patent liability is assumed with respect to use of information herein. Acceptance of advertising does not in any manner signify the products, policies and services so advertised have been approved, endorsed or recommended by this magazine.

Indexed in Electronic Guide and Lectrodex.

Printed by the Waldemar Press Div.
of Howard W. Sams & Co., Inc.



PF REPORTER

including Electronic Servicing

VOLUME 10, No. 6

JUNE, 1960

Previews of New Sets	1
Muntz Model 21CP-3M, Silvertone Model 106DS, Westinghouse Model H-P3300U, Zenith Model E2755W.	
Video Speed Servicing	5
Service hints on the Airline Model GTM-4213A and Motorola Chassis TS-561.	
Letters to the Editor	14
The Electronic Scanner	18
Know the Law Fred Howard	20
Hold your temper all day; keep the lawyers away.	
A Key to Keyed AGC Joe A. Groves	24
Even the most complicated BU8 circuits respond to a logical troubleshooting approach.	
Understanding Antenna Rotators	26
Here are some pointers to help you circuit-trace a rotator system and check for correct mechanical operation.	
PA Speaker Installation Tips Jack Darr	28
Audio Facts—Overcome those acoustic nightmares by careful choice of speaker type and location.	
Dollar and Sense Servicing	30
Notes on Test Equipment Les Deane	32
Lab reports on the EICO Model 710 grid-dip meter, and Precision Electronics Model 202 signal tracer.	
Tuner Trouble? Maybe It's Mechanical Calvin C. Young, Jr.	42
Quicker Servicing—A close visual inspection is often all you need to uncover the source of an odd tuner defect.	
All We Want Are the Facts H. M. Layden	50
Theory is indispensable, if taken with a pinch of common sense.	
The Troubleshooter	56
Tips for Techs	58
Rebuilding a "Burned-Up" Circuit Stan Prentiss	60
Across the Bench—Cleaning up after an underchassis fire took awhile—then an old-style cascade tuner posed another problem.	
Product Report	74
Free Catalog & Literature Service	76

ABOUT THE COVER

Enough sound to fill the mammoth Indianapolis Coliseum pours forth from this cluster of horns. Our lucky serviceman has this job literally "on ice," thanks to pulleys and a long supporting cable; if it weren't for these, he'd be clinging to the rafters. For some right-to-the-point reading about more modest-sized PA installations, turn to page 28.

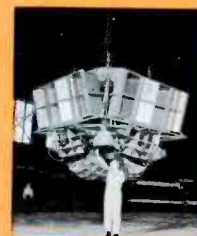

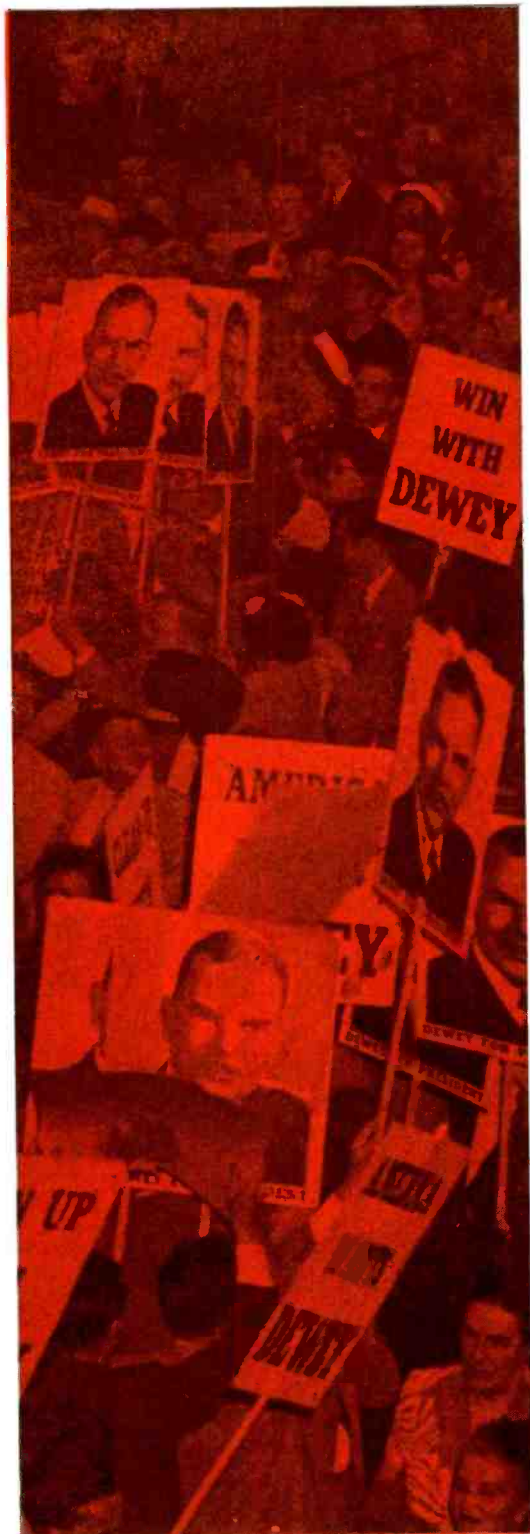

EVERY DAY



**DURING BOTH
POLITICAL
CONVENTIONS**



**BETTY
FURNESS**



**WILL
SELL**

FOR YOU!

Now "Miss Westinghouse" is going on the air with the biggest, most powerful Westinghouse TV and Radio Tube promotion ever for Service Dealers! Daily during both political conventions—beginning July 9 (Democrat) and July 24 (Republican)—she'll blanket the country over a 204-sta-

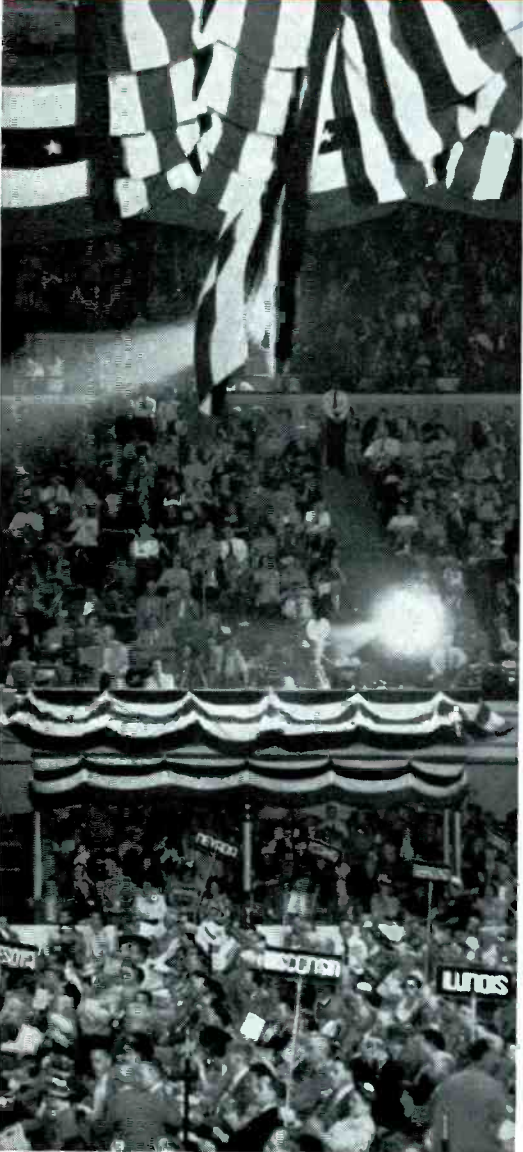

tion CBS-Radio network reaching more than 11 million listeners per broadcast. The result will be a tremendous parade of customers looking for their local Service Dealer who sells Westinghouse TV and Radio Tubes. Get ready to cash in on this profit opportunity. Put up the special Westinghouse Tube displays. Tie in with your own advertising. **BUT FIRST**—call your Westinghouse Distributor and place your tube order right away! You're going to need a lot!

YOU CAN BE SURE...IF IT'S Westinghouse

Westinghouse Electric Corp., Electronic Tube Division, Elmira, New York
Tune in Westinghouse-CBS TV-Radio Coverage, Presidential Conventions, July 10-29.

by
every
test



ATR AUTO RADIO VIBRATORS

Have Ceramic Stack Spacers

A COMPLETE LINE OF VIBRATORS

Designed for Use in Standard Vibrator-Operated Auto Radio Receivers. Built with Precision Construction, featuring Ceramic Stack Spacers for longer lasting life. Backed by more than 28 years of experience in Vibrator Design, Development, and Manufacturing.

Free



"A" Battery Eliminators, DC-AC Inverters, Auto Radio Vibrators



NEW MODELS NEW DESIGNS NEW LITERATURE

See your jobber or write factory

AMERICAN TELEVISION & RADIO CO.
Quality Products Since 1931
SAINT PAUL 1, MINNESOTA—U. S. A.

Letters to the
EDITOR

Dear Editor:

I would like to get some information concerning the repair and servicing of small appliances and model trains.

According to the information I have been able to get from appliance and department stores, there is no one within a 200-mile radius who does this type of servicing. It seems that anyone needing repairs, or small parts such as wheels and couplers, must wait two or three weeks while the dealer sends away for service.

Could you please advise me whether or not this could be a profitable business? If so, could you tell me where to get service information and parts catalogs for the various types of appliances and model trains on the market?

THOMAS NEELY

Morgantown, W. Va.

There are many things to be considered in starting such a business. First of all, in order to obtain the necessary replacement parts, etc., for model trains, you must make direct application to the manufacturers and obtain their authorization to establish a service station under their auspices. They, in turn, usually send someone out to investigate your facilities, capabilities, etc., and if no one else in the area already operates such a station, may then establish you as an authorized service outlet. A. C. Gilbert and Lionel are the two major model train manufacturers you would want to contact.

A good measuring stick to use in deciding whether or not a specific business will be successful is the actual need for such service. I rather doubt that many people could make a living by just repairing model train equipment unless business could be obtained from a tremendously large area. However, if it were tied in with a small-appliance service (lamps, toasters, electric skillets and ovens, coffee makers, waffle irons, electric shavers, electric blankets, etc.), I'm sure an enterprising serviceman could do very well. Again, however, a lot depends on the ingenuity of the serviceman and his ability to get replacement parts and service information.—Ed.

Dear Editor:

In my opinion, your magazine is tops in the electronics field; my only complaint has to do with your method of presenting *Previews of New Sets*. Since two completely different makes of receivers are described on opposite sides of each page, I haven't been able to figure out a filing system that will allow me to file the material alphabetically or with the proper PHOTOFACT Folders. Surely I'm not the only one who makes it a practice to cut out these items and

VALUABLE **SAMS**
REFERENCE BOOKS
available from your local
SAMS DISTRIBUTOR



Howard W. Sams Handbook of Electronic Tables and Formulas. A time-saving one-source reference for all those valuable charts, tables, formulas and laws indispensable to the service technician. This is the reference book you'll refer to again and again. Five comprehensive sections contain most-used and most-needed information on: Formulas and Laws; Constants, Standards, Symbols, and Codes; Service and Installation Data; Mathematical Tables and Formulas; Miscellaneous Data. Full-color six page fold-out shows latest frequency spectrum chart. 5½" x 8½", hard-bound. No. HTF-1. **\$2.95 Only.**

Radio & Electronics Handbook. All the basic knowledge of radio and electronics digested in 18 sections. Extremely helpful in the solution of everyday problems in fundamentals, vacuum tubes, basic circuits, receivers, transmitters, sound systems, power supplies, antennas, testing and aligning, etc. Dozens of tables, charts, graphs, etc. Over 1200 illustrations. 890 pages. No. BB-1. **\$4.95 Only.**

Video Handbook. Valuable instruction on the entire subject of Television; gives expert data on methods of design, construction, production, installation, operation and servicing. Profusely illustrated and clearly written. 892 pages. 5" x 7". No. BB-2. **\$5.95 Only.**

The Audio Cyclopedia. The authoritative reference work by Howard M. Tremaine. Comprehensive coverage on every phase of Audio! Over 8 years in production, it is easily the most complete reference work on audio ever published. Gives you accurate explanations of all subjects in the field: basic sound principles, acoustics, recording, reproduction, audio equipment, optical film recording, audio test equipment and measurements, installation techniques and latest stereo information. Unique reference system quickly locates any of the 3400 topics covered. 1280 pages, cloth-bound. No. ACT-1. **\$19.95 Only.**

Handbook of Electronic Circuits. A practical reference book on important circuits, including: 4 power supply circuits; 14 circuits used in radio stages; 8 circuits used in transmitter stages; 32 circuits used in TV receiver stages; 7 additional circuits having special application. An analysis of the operation of each circuit is given; a schematic for each is included; a component failure analysis describes troubles which could occur if particular components should fail. No. HEC-1. **\$1.00 Only.**

Electronics Reference Data. Vol. 1. A compilation of many valuable articles covering the design, application, and theory of operation of several TV circuits; various oscillator circuits; wave-forms and wave shaping; meters and measurements; and the specialized applications and development of such equipment as Geiger counters, photoelectric cells, printed circuits, citizens radio service. No. ERA-1. **\$2.00 Only.**

Vol. 2. Important compilation includes sections on: Antennas and transmission lines; UHF television; circuit design (magnetic, dielectric and tubeless amplifiers); audio measurements; radar; meters and measurements; specialized application and development (microwave tubes, RF transistors, traveling wave amplifier, etc.) 8½" x 11". No. ERA-2. **\$2.50 Only.**

FREE SAMS BOOKLIST AVAILABLE—ask your Distributor or write us direct

Available from your Sams Distributor
HOWARD W. SAMS & CO., INC.
1720 E. 38th St., Indianapolis 6, Ind.

Look for the label that looks out for you

Golden Symbol of Service...

GENUINE
MOTOROLA
Golden **AA**
PREMIUM RATED
PICTURE TUBES
RECEIVING TUBES

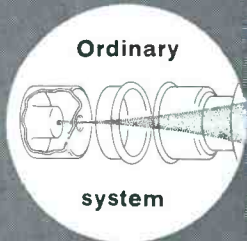
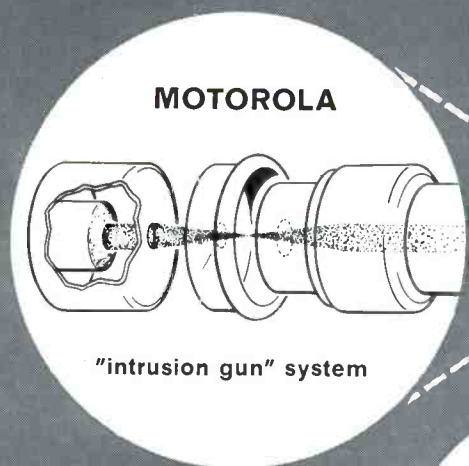

New Golden "M" Tubes up to 10 times more reliable

than picture tubes without the "intrusion gun" system

New Tube-Saver Electron Gun ends main cause of tube failure! The intrusion gun system provides electrons from a 10 times greater effective area on the cathode . . . greatly reducing cathode omission area as compared to tubes without "intrusion gun" system.

Result? The most reliable tube ever! Next time you need tubes, buy Golden "M"® Picture Tubes. They're premium rated, yet cost no more.

SPECIAL OFFER for a limited time only
PORCH 'N' PATIO ENSEMBLE

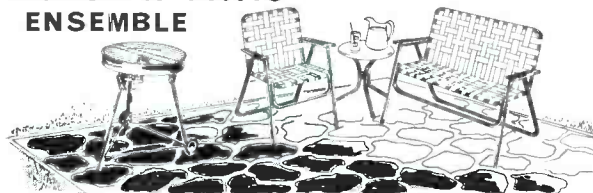

Now you can obtain any one or all of these deluxe units simply by ordering a supply of Golden "M" Picture/Receiving Tubes. Contact your Motorola Distributor today for details.



MOTOROLA



PARTS AND ACCESSORIES, FRANKLIN PARK, ILLINOIS

The World's
FINEST TUNERS
 For the World's
FINEST SETS

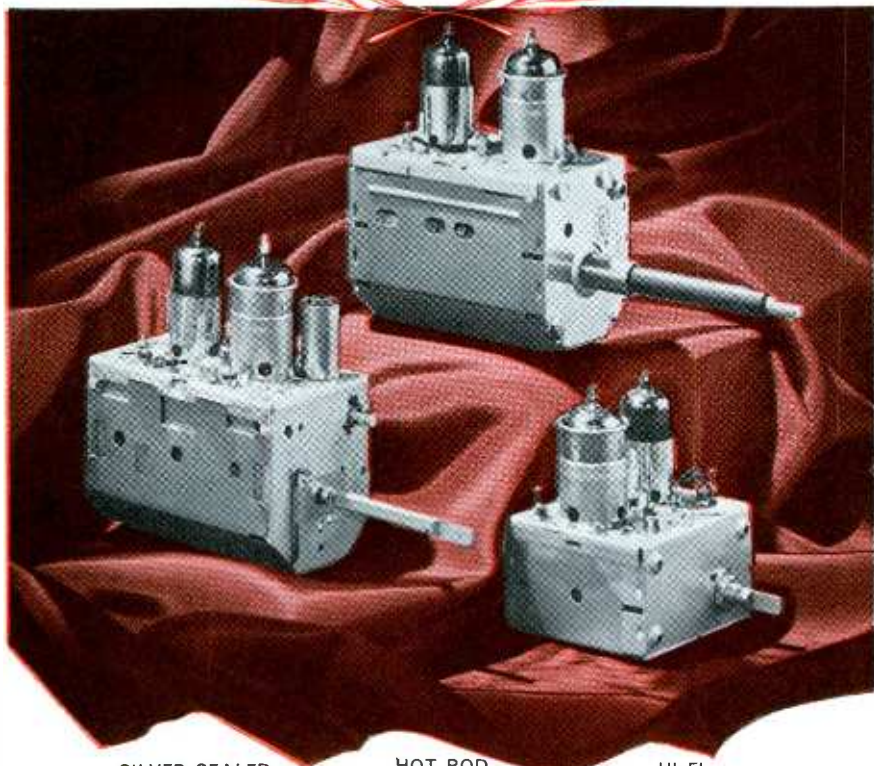

SILVER SEALED
 (switch-type)

HOT ROD
 (turret-type)

HI FI
 (FM) Tuner

For more than 15 years, manufacturers of the world's finest receivers have been specifying TARZIAN TUNERS . . . over 15,000,000 all told!

Sarkes Tarzian, Inc., the pioneer in the industry, is recognized as the world's largest commercial tuner manufacturer with licenses in North and South America, Europe and Australia.

Today, only Tarzian offers manufacturers both the HOT ROD (turret-type) and SILVER SEALED (switch-type) . . . as well as the newer Hi Fi FM Tuner. All with built-in HIGH-QUALITY . . . DEPENDABILITY . . . UNEXCELLED PERFORMANCE . . . at low cost!

For more information, write to: Sales Department
 Tuner Division



SARKES TARZIAN INC

east hillside drive • bloomington, indiana

Manufacturers of Semiconductors, Air Trimmers and Broadcast Equipment

to match the pins with the socket—! Even when you finally pull the chassis out of the cabinet for a more direct view of the socket, it's still a case of twisting and fumbling to align the pins.

Let's put up a howl for tubes like the ECC40! It guides itself into place easier than the octal and loctal types; yet, it is a miniature-base, all-glass tube with evenly-spaced pins all around.

ERNEST LUKIS

Tyler Electronics Co.
 Bronx, N.Y.

You should have howled years ago! This European "Rimlock" design now appears to be on its way out—not in. Like the loctal tube, it seems to be dropping by the wayside because of a worldwide trend toward standardizing tube-base designs. Examine recent models of foreign radio and hi-fi equipment, and you'll find the familiar octal or 7- and 9-pin miniature sockets almost everywhere.

Therefore, it looks as if we'll have to keep on handling miniature tubes. But at least we won't have any new sockets to add to our tube testers!—Ed.

Dear Editor:

I wish you would run an article on servicing a negative picture.

FRED P. KETCHAM
 Chattanooga, Tenn.

No sooner said than done! We'll have it for you by fall.—Ed.

Dear Editor:

I have a collector's item—a copy of each and every issue of PF REPORTER—and I use them quite a lot for reference. Please keep up the good work; you have a wonderful publication.

R. C. TIDWELL
 Santa Barbara, Calif.

Your vote makes it unanimous.—Ed.

Dear Editor:

I get a lot of help from PF REPORTER, but I have just one complaint to make. Would it be asking too much of you to insert the staples from the back of the magazine instead of from the front? If you would make this simple change in binding, we could neatly remove the *Previews of New Sets* and *Video Speed Servicing* pages for filing, and still not tear the rest of the magazine to pieces. If the above pages are left in the separate issues, they are hard to find when needed.

If the staples cannot be changed, could the green pages be put in the back of the magazine to permit easier removal?

OSLER SCHULER
 Dumont, Iowa

Yes, it would—our binding machinery is set up to insert the staples from front to back. This shouldn't be as much of a problem as it seems, however, for with a little care and a straight edge, the green pages can be easily torn out without affecting the rest of the issue.—Ed.

...and here's a New
Amperex®



AMPLIFRAME*

for improved TV tuner performance... **Triode Type 6FY5**

You'll Find Amperex Ampliframe Tubes in the Best TV Sets You Handle

ONE YEAR AGO, Amperex made the AMPLIFRAME type 6ES8 available to the TV industry for their highest quality cascode tuners. By virtue of its high transconductance, low noise and exceptional reliability, the type 6ES8 is now accepted as the standard of the industry. NOW, to establish another new industry standard —

in this case for less expensive tuners—Amperex presents the AMPLIFRAME triode Type 6FY5, an improved version of the now famous AMPLIFRAME type 6ER5, offering 1 db lower noise and 2 db higher gain. The extraordinary uniformity of this tube is the result of the special Amperex techniques utilized in its mass production.

Here are some of the outstanding features of the new type 6FY5:

- extreme tube-to-tube uniformity almost invariably eliminates necessity for re-alignment when changing tubes.
- extremely high transconductance and input impedance provide very high gain-bandwidth factor.
- internal screening-shields reduce plate-to-grid capacitance.
- newly designed tongue-mica clamp on cathode eliminates microphonics.
- remote characteristics insure low intermodulation distortion.
- operational at lower supply voltage for greater design flexibility.

*AMPLIFRAME



a new concept in electron tubes, designed and mass produced exclusively by Amperex, incorporates the unique FRAME GRID... the closest approach to the ideal "Physicists' grid"—electrical characteristics but no physical dimensions. The FRAME GRID results in: • higher transconductance per milliamperere • tighter Gm and plate current tolerance • low transit time • low capacitance • lower microphonics • rugged construction

AMPLIFRAME TYPE 6FY5	
remote cut-off triode for TV tuners	
transconductance	13,000 micromhos at 11 mA
amplification factor	70
capacitances: input	4.75 μf
output	3.3 μf
plate-to-grid	0.50 μf
plate voltage	typical 135V
heater current & heater voltage	200 mA, 6.3V
AMPLIFRAME TYPE 2FY5	
controlled heater warm-up version	
heater current & heater voltage	600 mA, 2.4V
AMPLIFRAME TYPE 3FY5	
controlled heater warm-up version	
heater current & heater voltage	450 mA, 3.1V



ask Amperex

about Ampliframe tubes for
 TV and other entertainment applications

Amperex Electronic Corporation, 230 Duffy Ave., Hicksville, L. I., N. Y.

This new
BOGEN
GUIDE-BOOK
 tells you
 how to cash
 in on the
 profitable
 commercial
 sound market in
 PA and INTERCOM

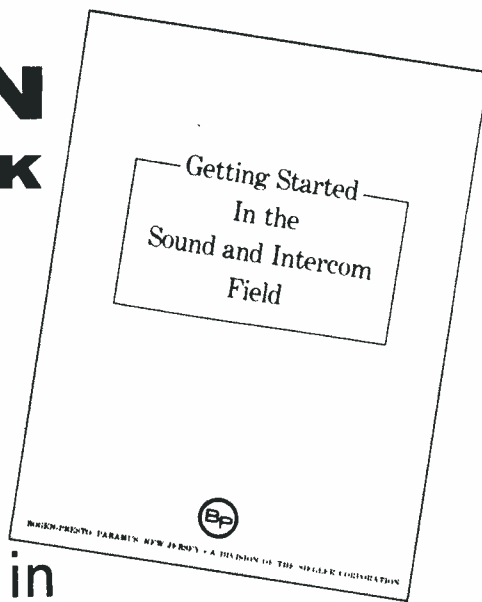

“GETTING STARTED IN SOUND”

16 pages, packed with valuable information, advice, answers to all your questions—discusses qualifications required—how much capital it takes—costs of operation—and, most important, how to get started on a modest investment. This guide book also tells you how to obtain...

VALUABLE FREE SALES KIT TO HELP PUT YOU IN THE FAST-GROWING SOUND BUSINESS

FREE sound sales kit contains sales literature — sample solicitation letters — job quotation forms—technical and installation data — product specification sheets — merchandising ideas.

You will also receive additional free material from time to time. And if you are not already dealing with a Bogen Sound Distributor we will also put you in touch with one to serve as your local supply source. This valuable sales kit will be furnished to you when you send in the special card included in each copy of “Getting Started in Sound”.



THIS MAY BE the very opportunity you have been waiting for. Don't miss it! Visit your local Bogen Sound Distributor for your copy of “Getting Started in Sound”. It will be the best 25c investment you ever made. If your distributor has not yet received his supply or is sold out, use this convenient coupon. Enclose 25c in coin, and a copy will be mailed to you directly.

**BOGEN-PRESTO,
 BOX 500, PARAMUS, NEW JERSEY**

Dept. PF-6

Yes, I am interested in earning more money in sound systems, so please send me “Getting Started In Sound” by return mail. I enclose 25c in coin.

NAME _____

ADDRESS _____

CITY _____ ZONE _____ STATE _____

Look to Bogen-Presto for the big profit opportunities in sound.



BOGEN-PRESTO PARAMUS, NEW JERSEY A Division of the Siegler Corporation



Self-Service Pays Off

The Ray-O-Vac folks have just come out with a tester that encourages your customers to check their old batteries and replace them with new ones when necessary. Included is a built-in voltage tester, a plastic cover to discourage pilfering and protect the batteries against dust, plus an assortment of 13 fast-selling battery types covering 95% of the replacement market. A printed tray gives the suggested inventory and stock number at a glance.



A Look-See at CRT's

Those grinning servicemen above recently toured the Rauland Corp. Chicago plant to see first-hand how picture tubes are made. Flown in from Elizabeth, N. J., the visitors enjoyed a “night on the town” at a local country club, unexpectedly overstayed their trip when trapped for two days by the season's worst snow storm.

Need a Needle?

Astatic's got 'em—a complete line of needles (even exotic types). A new venture for Astatic Corp. of Conneaut, Ohio, the new line contains over 450 needles designed to fit every cartridge and record groove marketed or in use today. Boxed in individual plastic packages, each needle is accompanied by an index tab containing data on the unit.

Now They're Putting “Pancakes” in Sets

A new “Pancake” transistor, one-tenth the size and weight of conventional units, has been announced by Sylvania. Designed for the latest micro-sized circuitry, the “Pancake” (only 1/20th of an inch high and 1/4 inch in diameter) makes possible even smaller and lighter electronic equipment, including airborne communications and computer systems.

Here's a Free Tip for You!

That's right! Owners of ESICO Luger soldering guns can obtain a specially-shaped tip for their guns by simply sending in a sketch and describing its use. To acquaint servicemen with the versatility of their unit, ESICO will supply the tip at no charge.



Vertical Non-Linearity



Horizontal Non-Linearity



Smeared Picture



Loss of Vertical Sync



Heater-Cathode Leakage

PINPOINT TV TROUBLES



Video I.F. Overload



60-Cycle Hum in Picture



Loss of Horizontal Sync



Loss of Vertical Sweep

IN 1/2 THE TIME



TELEVISION ANALYST

**By Easy Point-to-Point Signal Injection,
You See the Trouble on the TV Screen and
Correct it—Faster and More Profitably!**

Most useful instrument in TV servicing today! Enables you to inject your own TV signal at any point and watch the resulting test pattern on the picture tube itself. Makes it quick and easy to isolate, pinpoint, and correct TV trouble in any stage throughout the video, audio, r.f., i.f., sync, and sweep sections of black & white and color television sets—including intermittents. Makes external scope or wave-form interpretation unnecessary. Enables any serviceman to cut servicing time in half, service more TV sets in less time, really satisfy more customers, and make more money. Color generator provides both rainbow pattern and color bars. Net \$279⁹⁵



Solve Rough Sweep Output Problems with **DYNA-SWEEP CIRCUIT ANALYZER**

Saves many hours of service work. Provides vertical and horizontal sync and driving pulses that enable you more easily and quickly to check out every stage in the sync and sweep sections of a television receiver. Tracks down troubles in the horizontal and vertical output circuit including defective output transformer and yoke; checks for shorted turns, leakage, opens, short circuits, and continuity. Includes unique high-voltage indication. Eliminates trial and error replacements.

Model A107 Dyna-Sweep. Companion unit for use only with B&K Model 1075 Television Analyst for driving source. Net, \$54.95

Model 1070 Dyna-Sweep. Same as Model A107 but has its own horizontal and vertical driving pulse, and is used independently of the Model 1075 Television Analyst, for separate testing. Net, \$74.95

MODEL 1075 TELEVISION ANALYST
Makes Money for Thousands of Service Technicians



See Your B&K Distributor
or Write for Bulletin ST25-R

B & K MANUFACTURING CO.
1801 W. BELLE PLAINE AVE • CHICAGO 13, ILL.

Canada: Atlas Radio Corp., 50 Wingold, Toronto 10, Ont.
Export: Empire Exporters, 277 Broadway, New York 7, U.S.A.

Know The LAW

If your state is typical, you'll do well to settle your claims out of court — and protect yourself at all times!

You've probably heard the old saying, "When you act as your own lawyer you have a darn fool for a client." While this certainly has its points, there are many things we can do to minimize the need for a lawyer. Laws vary from one state to another, but the law of common sense is just about the same in every state as far as the judge and jury are concerned. The following story will show you what we mean.

Joe has just finished repairing Mr. Doe's set and is delivering it to him. Before Joe began work on this set, he told Mr. Doe it would cost \$36.60. Mr. Doe thought this was reasonable and told Joe to go ahead. He would pay when the job was done. Joe brought the set back, connected the antenna, plugged it in, and turned it on. Mrs. Doe, after seeing how it worked, was well pleased. Noting this, Joe thought it a good time to present the bill. She said her husband would not be home until late, but he would be over in the morning to give Joe a check. Joe had her sign his copy of the transaction and left.

One week went by, and Joe was still minus his \$36.60 — so he stopped by Mr. Doe's house. Mr. Doe said he couldn't pay right now because his wife needed money for the dentist, but assured Joe he would pay him in a couple of days.

Well, Joe waited four days—still no pay. By this time, Joe was getting a little hot under the collar, so he made another call on Mr. Doe. This time Mr. Doe had had his car worked on, and was still unable to pay.

Joe blew his top. "Of all the dirty excuses," he said. "You'll either pay me now or I'll take the set back!"

"Don't you dare touch that set," bellowed Mr. Doe.

Joe said, "OK, if you want to be smart, I'll just take my parts out—

most of them were tubes anyway—and we'll forget the service charge."

By this time, both sides were hot, and Mr. Doe ordered Joe out of the house. Joe thought about inquiring at the neighbors' to find out just what kind of joker he was dealing with. Backing out of the driveway, he was even tempted to back over a rose bush. "Darn driveway is only half big enough, anyway," he thought. When Joe got back to the shop, his first thought was to dun Mr. Doe by postcard. Maybe this would bring him around.

Knowing this much of the story, what would you do now? Don't jump to conclusions too quickly! First, let's go back and review the legal aspects of the case. When Mrs. Doe signed Joe's copy of the bill, it didn't mean a thing. Legally, all Mr. Doe *has* to pay for is Mrs. Doe's necessities (food, clothing, etc.). Fact is, the whole household could sign it, including Mr. Doe—but unless he signed a bona fide contract, it still wouldn't mean a thing. Oh sure, it proves you delivered the set, but this could be proved anyway. Signing a completion certificate simply means the set was working properly upon delivery.

Well, then, could Joe legally collect his money? He sure could. He could take it to common pleas court and would probably win hands down, but this would cost Joe many times the \$36.60 in lost time, bad publicity, etc.

Why didn't Joe take possession of the set, or at least his parts? Had he taken the set, it would have been classed as illegal possession; the same goes for the parts. According to the law, a man's home is his castle. Nothing can be removed without his permission, unless a court order is issued. Had Joe removed anything other than his own person, Mr. Doe could have sued him. As for Joe raising his voice, he

could have been arrested for disturbing the peace, or possibly even sued for slander. As for Joe taking his troubles to Mr. Doe's neighbors, running over the rose bush, or dunning him with a postcard, don't ever try it. It can lead to serious trouble. In the first place, the court would frown on Joe for his attitude in collecting the bill—especially when all this happened in less than one month.

Mr. Doe finally gave Joe a check for \$36.60. Joe was happy—until it bounced for insufficient funds! He called Mr. Doe about the check. Mr. Doe came right over and told Joe he was sorry. He offered Joe \$7.50 but wanted his check back, saying he would pay the rest in two payments—one in two weeks, the other in four.

Joe said, "Oh no! I'm taking this check to court." He did, and lost all the way around. The court reasoned Mr. Doe had tried to pay, but Joe wouldn't accept.

Rather than waste all this energy in trying to recover a bad debt, it's better to put in a little extra effort *before* delivery of the set in an attempt to obtain prompt payment. Sometimes all it takes is a phone call to tell the customer, "Your set is ready; the bill is \$..... Should we have our man collect on delivery?"

If you do get stuck with a bill like the one Joe had, here are three things you can do to collect: Try to bluff, but be diplomatic about it; be kindhearted and wait it out; give the bill to a collection agency, but be sure they accept full responsibility.

One last warning—never attempt to "unfix" a set or disturb anything while you are on the customer's property. Not only can the customer sue you and win, he's also liable to punch you in the nose—and the courts will back up his right to do so! ▲

make your first move to **ROHN**



You Have the Greatest Sales Potential by Far With America's MOST COMPLETE LINE OF

TOWERS—MASTS ROOF TOWERS Installation Accessories

ROHN TV TOWERS

ROHN makes the finest towers available for television reception! Illustrated is the No. 25 with amazing "zig-zag" cross bracing design. The entire tower is rated 33% stronger than other similar sized towers. Yes, sell and install the No. 25 up to 50 feet self-supporting or, properly guyed, up to 360 feet!

Or if you prefer, sell the popular ROHN No. 6 tower with the famous "Magic Triangle" cross-bracing. Both are fully HOT DIPPED GALVANIZED AFTER FABRICATION! Sections in easy-to-handle 10 ft. lengths.

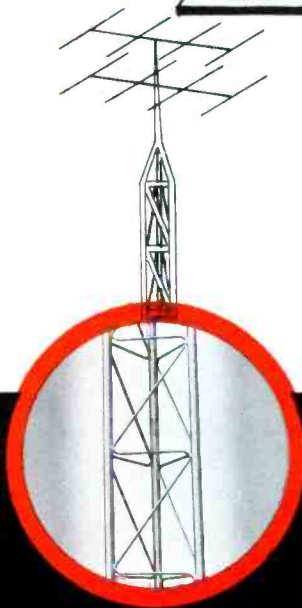

From every standpoint, ROHN Towers offer you MORE... more quality, more variety, more advanced design, more sales features, more service, more total sales and more PROFITS! Move forward with these ROHN items!

ROHN COMMUNICATION TOWERS

Here you have FIVE complete lines of heavy-duty, FULLY ENGINEERED communication towers to fulfill any communications requirement. Shown is the ROHN "SS" tower which is self-supporting up to 130 feet. Other models — (30-40-50-60) are available in heights up to 630 feet when guyed! Handle these towers for the demand in your area. There's a complete NEW catalog on this line. Get a copy so you'll have it on hand.

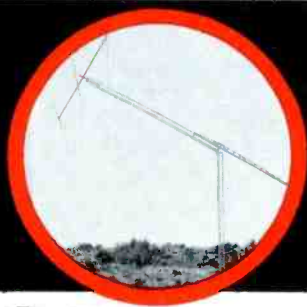

AMATEUR "FOLD-OVER" TOWERS

Specially designed "fold-over" towers are the best ever designed for amateur radio and experimentation. They are the most desired because they "fold-over" completely so you work on the ground for ease and safety. Three sizes, including heavy-duty type to handle any needs. All hot dipped galvanized.

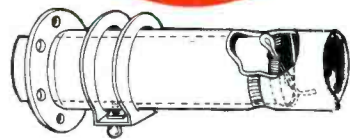
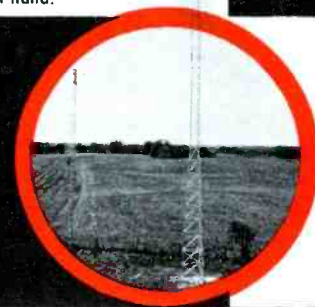

TELESCOPING MASTS

Unexcelled in design, structural strength, and sales appeal. All popular sizes, heights, and weights available. Also, mast tubing in exact specifications that's demanded today.



ROOF TOWERS . . .

in 10, 5, 3, and 2½ feet heights — very popular — easily shipped — ideal in use — the best ever designed — in hot-dipped galvanized finish — truly a big profit item for you!

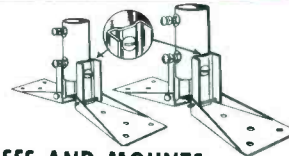

BASES AND MOUNTS

Wide variety of bases and mounts. Special features include "locking" device — also cast aluminum roof mounts — and a host of other installation items . . . get full details.



TV SERVICE TABLE

For holding TV sets while servicing, or storing, or for mobile use of set in such places as markets, hospitals, etc. Ideal for dozens of uses — thousands sold. Large casters—a real work-saver.

ROHN

Manufacturing
Company

116 Limestone, Bellevue
Peoria, Illinois

Get complete catalog from your ROHN representative or jobber or MAIL THIS COUPON!

Gentlemen: Please send me literature on ROHN Towers and Accessories.

Firm _____

Name _____ Title _____

Address _____

City _____ State _____

**WIN A DREAM VACATION
FOR TWO IN**

Jamaica

MALLORY
Cool Deal
CONTEST

.....
1st PRIZE—BIG 5-DAY TRIP TO
JAMAICA FOR TWO

2nd PRIZE—\$150 IN COOL CASH

3rd PRIZE—\$50 IN COOL CASH

WITH THE

MALLORY Cool Deal



Mallory has done it again . . . with the coolest deal this side of the moon . . . a real bargain in parts, a free cooler, and a chance to win a fistful of cash or a 5-day trip to a tropical wonderland!

MALLORY COOL DEAL is out of this world! For only \$24.88, a smart serviceman can latch on to more than \$48 (list) worth of parts . . . snag a beautiful "Voodoo Cooler" for free . . . and line up a big fat chance to win himself some loot or a huge 5-day ball under Jamaica skies. (Bring your own bongos!) What a deal.



a \$48.82 value **\$24.88**

LOOK WHAT'S IN THE VOODOO COOLER: "Gem" Packs, FP Electrolytics, TC Tubular Electrolytics, Gold Label® Vibrators, Mercury Batteries, RMC Discaps,® Vitreous Resistors; and Carbon Controls and switches . . . \$48 worth of parts for less than \$25!

PICNICKERS TAKE NOTE: the free "Voodoo Cooler" is made of sturdy, insulated, waterproof plastic . . . keeps things hot or cold . . . would even make a good tube caddy (if the little woman doesn't see it first!).

PLAY IT COOL . . .

SEE YOUR DISTRIBUTOR TODAY . . .

**CASH IN NOW ON THE
MALLORY COOL DEAL**

Distributor Division
Indianapolis 6, Indiana

P. R. MALLORY & CO. Inc
MALLORY

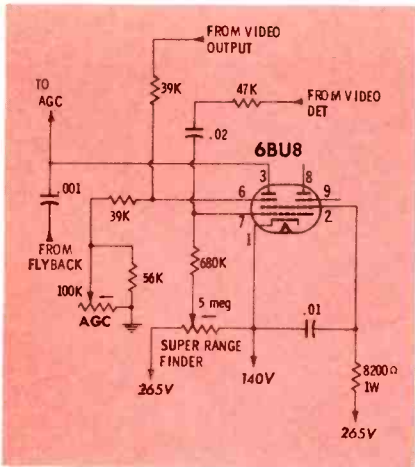

Fig. 1. AGC section of Admiral 'BU8 circuit has controls at both grids.

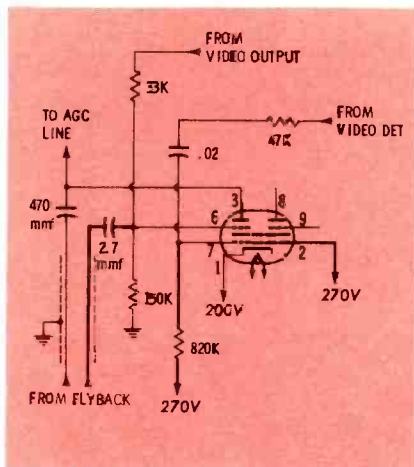

Fig. 2. Grids are operated at fixed potentials in Motorola AGC circuit.

In the March installment of "Tough-Dog Sync Troubles," we carefully examined the sync-separator section of a 'BU8 tube, including the built-in noise-immunity circuit. Now let's give the same treatment to the *other* section of the 'BU8, which operates as a keyed AGC amplifier.

The 'BU8 circuit has become the most widely-used keyed AGC system in recent TV production. It started about four years ago as a special non-keyed circuit, but since then it has taken on the characteristics of a keyed system. Once this happened, it was only natural for

Complete details of an effective troubleshooting procedure for the latest-type 'BU8 circuits — Joe A. Groves

A KEY

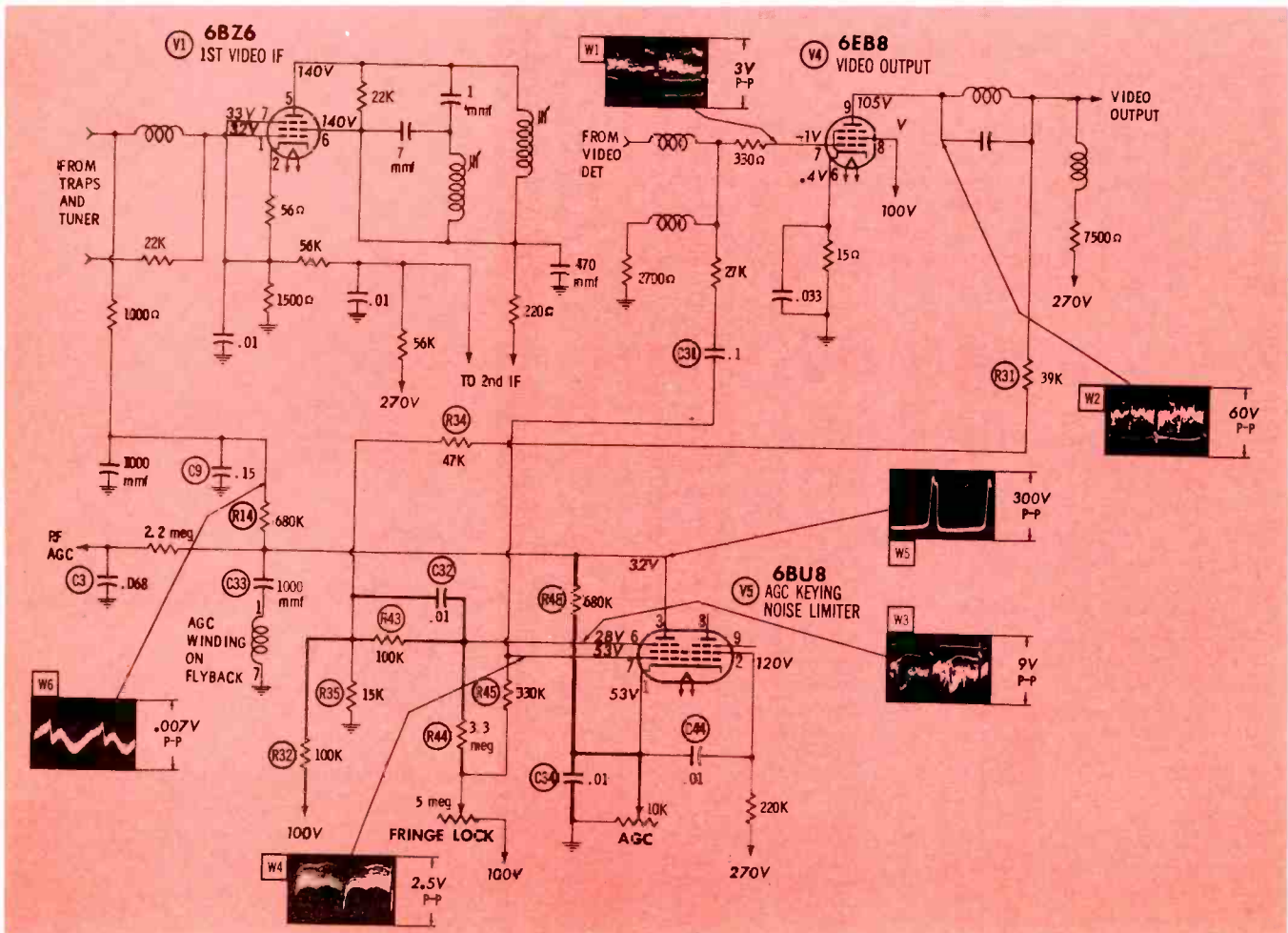

Fig. 3. Present version of Zenith's AGC system is a fairly conventional keyed circuit except for DC voltages.

it to gain favor over triodes and ordinary pentodes in this application. But what about servicing? What equipment is required? How, when, and where should you use each piece of test equipment in order to get to the root of a circuit defect with the least amount of effort, and in the shortest possible time? You can save countless man-hours of struggling by determining in advance how to go about solving the problems that are sure to come.

Presuming you already know the basic theory of AGC, and understand how a keyed system develops a control voltage, you'll have very

is used to regulate the amplitude of the signal presented to the grid.

Motorola's System

In Fig. 2, heavy lines are used to show how this circuit differs from the one in Fig. 1. The noise-limiter grid (pin 7) is operated at a fixed potential, whereas the corresponding part of the Admiral circuit includes a SUPER RANGE FINDER adjustment. The screen grid (pin 2) is returned directly to B+, and the control grid (pin 6) has no AGC control. Note the 2.7-mmf capacitor connected between pin 6 and the flyback; this component couples a

If you can master this complex circuit, you can easily figure out any other keyed AGC system! For this reason, we have chosen the circuit of Fig. 3 as the basis for this month's presentation. The tube-pin voltages in the positive 30- to 50-volt range under "no-signal" conditions may seem unnatural at first, but don't let these bother you; we'll explain them as we go along. Meanwhile, remember that circuit analysis, possible troubles, and servicing procedures are basically the same for all other keyed 'BU8 circuits.

One thing in particular must be

TO KEYED AGC

little trouble adding the following 'BU8 servicing information to your store of knowledge. The circuitry used with the 'BU8 tube varies somewhat from chassis to chassis, so let's explore these differences before trying to develop a general troubleshooting method.

Admiral's System

A study of Fig. 1 will disclose that this system is very similar to keyed AGC circuitry employing a pentode, except for the added noise-immunity feature provided by the first control grid (pin 7). The plate (pin 3) receives a keying pulse from the flyback, and the second control grid (pin 6) gets its input signal from the video amplifier. As in many other keyed systems, a control

low-amplitude negative pulse signal to the 'BU8 to cancel an undesirable positive pulse which is coupled back from plate to grid through the internal capacitance of the tube.

Zenith's System

In Fig. 3 we see the most radical departure from conventional AGC circuitry in the field today; however, this circuit isn't as complicated as it looks. We have again used heavy lines to show the differences when compared to Fig. 1. The Zenith circuit is set apart from others by its highly unusual DC voltage distribution. (By the way, this is an updated version of the same circuit described in detail in "AGC Circuits for '58," April, 1958 PF REPORTER.

borne in mind: Even though the grid voltage of the AGC-controlled first IF amplifier in Fig. 3 is positive with respect to ground, it is a few volts *negative* with respect to the cathode of that stage. Therefore, the *grid-cathode bias* is controlled by AGC in exactly the same way as in a more conventional IF-circuit layout.

AGC Symptoms

Visually, AGC troubles may appear in any of several ways—as an overloaded picture (Fig. 4A), a case of bends (Fig. 4B), a snowy picture, or a completely white raster with no sign of snow (Fig. 4C). Unfortunately, AGC troubles aren't

• Please turn to page 66

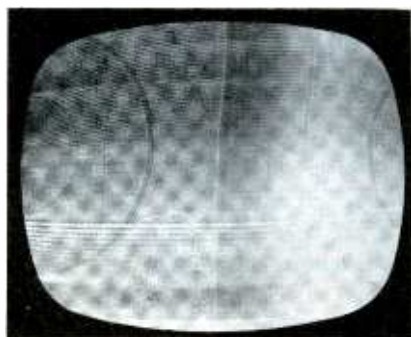

(A) Overloading.



(B) Bends due to AC hum.

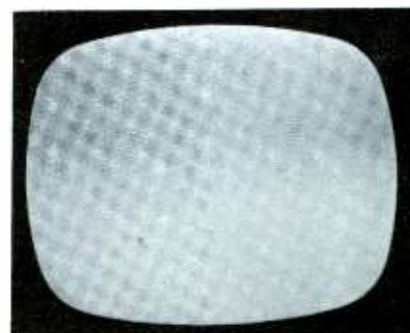

(C) Whiteout or IF blocking.

Fig. 4. Symptoms of AGC trouble.

UNDERSTANDING ANTENNA ROTATORS



1

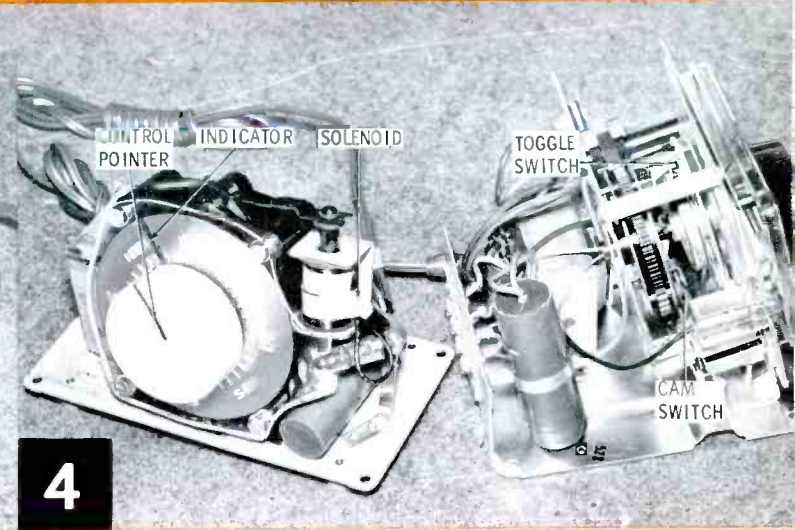

4



2

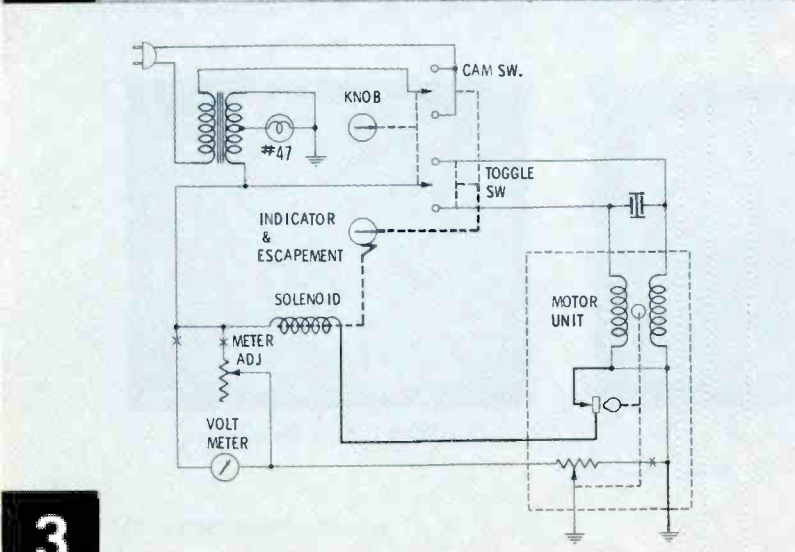

3

1 The brains of any rotator system is the control unit. Its mechanisms and circuits direct the power which actuates and controls direction of rotation. In addition, it has some means of indicating the direction the antenna is pointing.

2 The "upstairs" part of the system contains the brawn and "reporting-in" sections. There are two different styles of motor units — the inline and the offset. In the offset system the motor drives a worm gear, while a ring-gear drive is used in the inline system.

3 The simplified electrical-mechanical diagram shows the differences between an automatic system (which stops itself when it reaches the position selected by the user) and a manual system (wherein the operator must keep the knob depressed until the desired point is reached). The heavy lines show the mechanical and electrical additions needed for the automatic system, which requires more power to reposition the indicator and switch contacts.

4 Turning the selector knob of an automatic system winds a clock-type mechanism which furnishes return power to the indicator. At the same time, electrical connections complete the power circuits to the transformer and the proper motor winding. As the antenna rotates, the leaf switch in the motor unit closes every 6° or 10° (depending on make). This action momentarily energizes the solenoid, releases the escapement hook, and permits the clock spring to drive the indicator and switch contacts one step in the direction of the previously selected position. When this position is reached, a cam opens the switch in the AC line, stopping the motor. Most troubles stem from broken wires, faulty contacts, and defective solenoids.

5 Manually controlled systems are energized by depressing a leaf-type switch. An AC voltmeter, calibrated to indicate orientation of the antenna, measures the voltage drop across the meter adjust control. This voltage varies as the motor turns, due

Nearly everyone knows what a rotator is and what it does. But do you know what makes 'em tick? Here's the lowdown on how rotators work, and a summary of the trouble you're most likely to find.

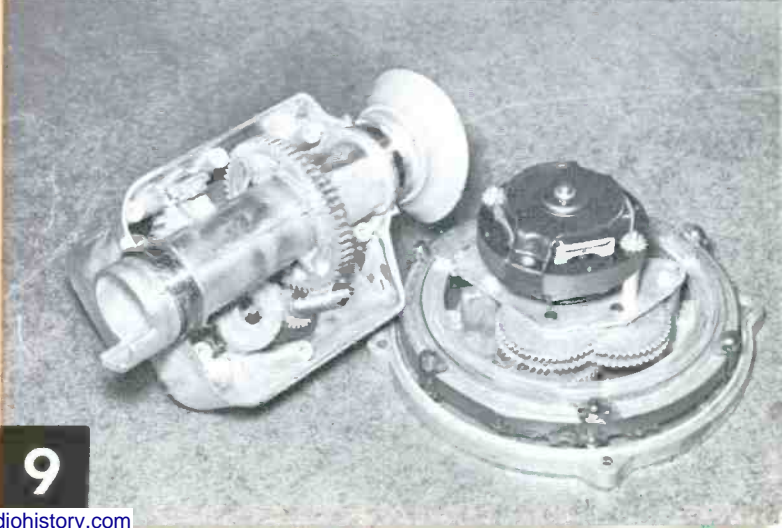
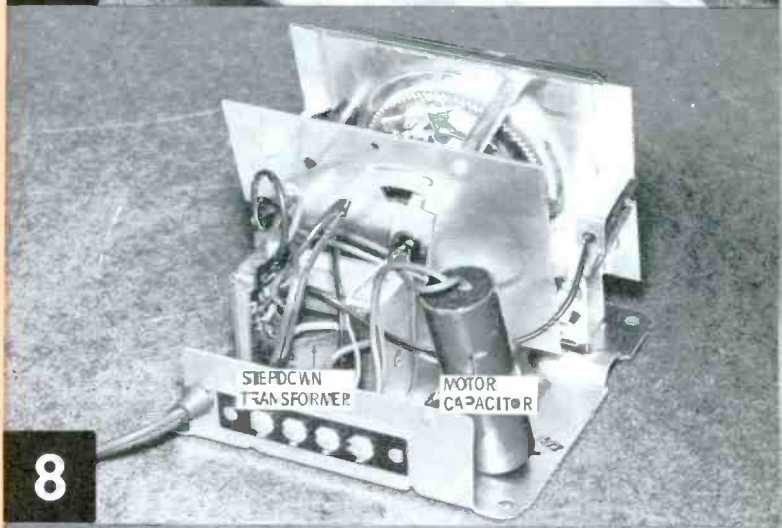
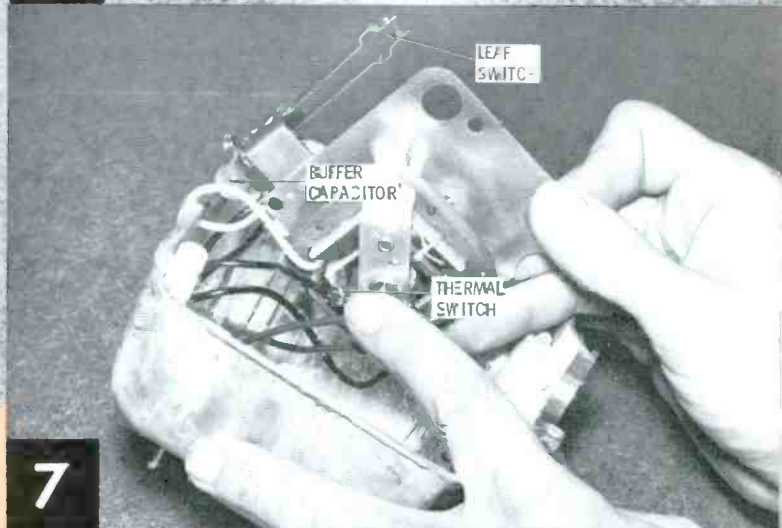
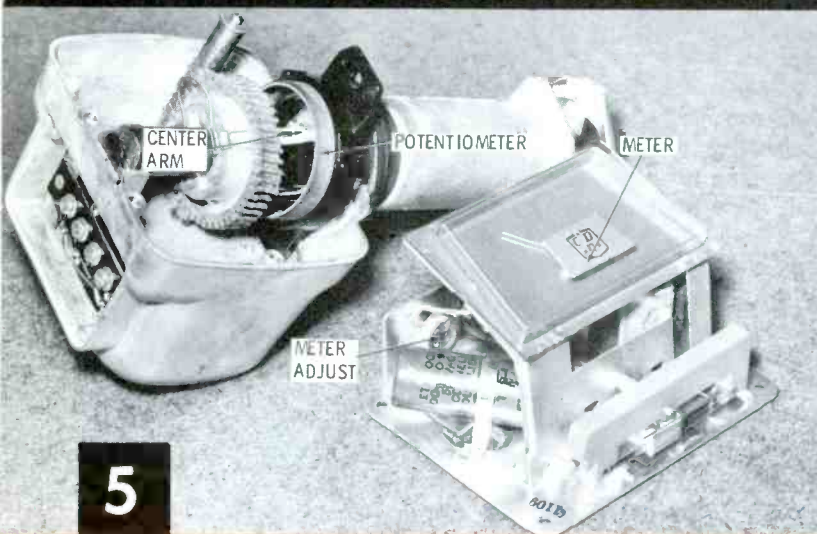

to the voltage division between the *meter adjust* control and a series potentiometer (with rotating arm) inside the motor housing. Normal trouble areas are broken wires, switch contacts, open potentiometer or control, and open meter.

6 The 24-volt capacitor-run motor is the first thing you see when the bell housing of this inline system is removed. The leaf switch, when actuated by the cam, applies a voltage pulse to the solenoid of the indicating mechanism. The built-in mechanical stop limits rotation to just less than 360°. Motors can be checked from the control unit if resistance of the winding is known. Values vary between 4 and 14 ohms, depending on the unit. (Add 1 ohm of resistance for every 100' of rotor cable when calculating the expected reading.)

7 In offset systems, the gear train must be removed to get at the motor. A thermal switch is incorporated in automatic systems to protect the motor windings against burnout during stalls. The leaf-switch contacts in this unit are bypassed by a capacitor in order to reduce pitting. While motors do go bad, most rotator trouble stems from other causes.

8 All units incorporate a step-down transformer which supplies from 24 to 30 volts AC to the motor when under load. Line losses created by excessively long runs must be overcome by paralleling leads. Since capacitor failure is a fairly common trouble, the AC-rated electrolytics (connected in series with the motor windings to increase motor torque) are located in the control unit.

9 Most rotor service will stem from broken leads, faulty electrolytics, and other miscellaneous electrical problems. However, gear trains can also cause trouble. Long exposure to the elements alternately melts and gums grease; as a result, cleaning and lubrication may be necessary. If gears are badly worn or damaged, replacements are readily available and easily installed.

BY

JACK DARR

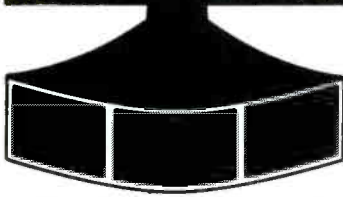

For the technician engaged in industrial or public-address sound work, perhaps the toughest part of his job is the proper selection and placement of speakers. This is always a major factor in the successful completion of a job, since it bears heavily on the attainment of the primary objective—the distribution of good clean sound, at suitable levels, over the whole area to be covered. The speaker arrangement is also an important factor in determining the ease of installation and the profit to be made.

For this reason, each job must be studied as an individual case. Hard and fast rules are quite impractical to apply, because of differences in total area, shape and layout of buildings, type of construction, reverberation characteristics, absorption coefficients of wall materials, and various other factors which cause each new job to be different from previous ones.

For planning purposes, speaker installations can be roughly divided into two classes—one employing a few large, high-powered speakers, and the other consisting of several smaller, low-powered speakers. The

area to be covered and the audio power needed may be the same in either case; it is left up to the technician to decide which type of system (or variation of types) will provide the most satisfactory coverage of the area.

Characteristics of the building itself are a primary factor in determining the type of system used. For instance, a large school or multi-room office building would be a perfect example of a place where many small speakers are needed. On the other hand, a factory area with only one or two very large rooms or buildings (and a comparatively high noise level) is an example of the "few high-powered speakers" category.

To complicate the problem still further, many installations require a combination of large and small speakers. For example, in a factory using a combination music-paging system, the factory rooms themselves require a high sound level to override the noise of the machines; but speakers in lunchrooms, executive offices, etc., should carry a much lower level. Fortunately, there are means of connecting together

different-sized speakers with very little trouble.

Some other installations, which at first glance might seem to be ideally suited for the "high-level, few-speaker" treatment, will upon further testing, turn out to need the exact opposite — the "low-level, many-speaker" technique. A good example is the large auditorium or hall, with walls of highly reverberant material such as brick, stone, or tile, and hardwood floors. An attempt to use high-level sound distribution systems in such buildings will result only in disaster, as the multitude of reflections from the walls and floor will result only in a mishmash of noise.

Typical Installations

We ran into this last-named problem some years ago, while installing a sound system in the local high school auditorium (the floor plan of which is shown in Fig. 1). The first attempts to use conventional portable sound equipment, set up as shown, met with complete failure. Constant complaints from audiences at plays and meetings finally brought action. With the financial backing of the Women's Club, a special sound

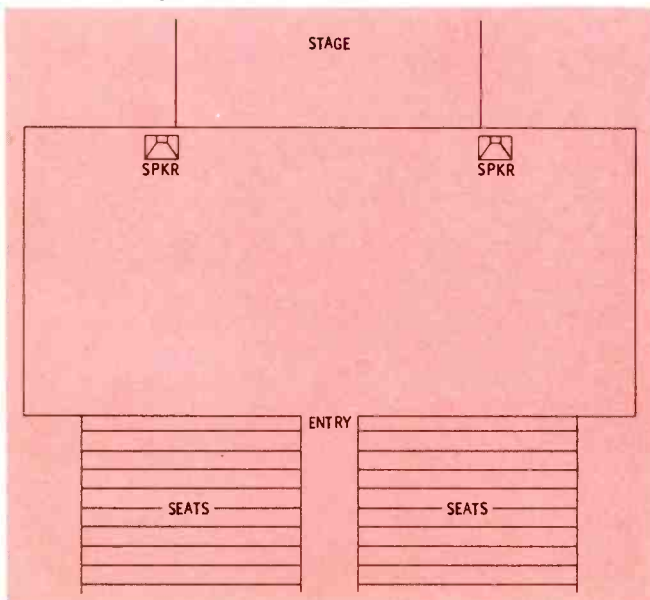

Fig. 1. Adequate sound coverage of this auditorium was difficult to achieve with only the speakers at sides of stage.

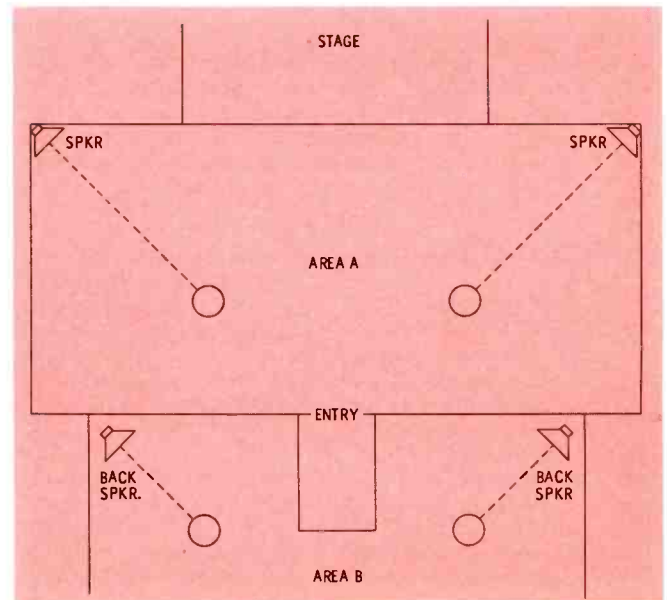

Fig. 2. Separate speakers were finally used for main floor and bleachers in providing better over-all distribution.

INSTALLATION TIPS

with proper speaker placement.

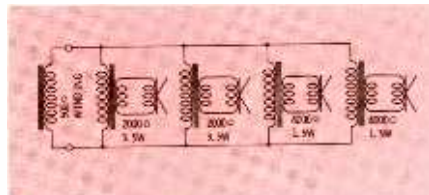

Fig. 3. High-impedance transformers drive the lower-powered speakers.

system was designed and installed. It has been giving good service ever since.

Actual tests were made, using recordings of voices, to check reverberation time (which was an unbelievable 1.3 seconds!), dead spots, and echoes. As indicated in Fig. 2, there are two major areas to be covered. One is the main floor (A), where folding chairs seat a large part of the audience at plays, concerts, and other activities; the other (B) includes a stepped arrangement of "bleacher" seats at the back, used by spectators at events such as basketball games. With two large speakers mounted near the stage, it was impossible to get sufficient sound level into these back seats without encountering unbearably high levels on the floor, together with a monumental acoustic feedback! Therefore, it was decided to divide up the area as shown in Fig. 2.

Area A was covered with sound from two speakers located 15' above the floor, in the front corners of the room. These were housed in specially-built corner baffles which gave them a downward tilt of some 30° from the vertical. Thus, their sound was aimed directly down onto the crowd, which effectively prevented any echo. (A crowd of people is a very good sound absorber!) The baffles were not ported, but were spaced slightly away from the walls at the back to relieve excess pressure. Heavy bars were installed across the speaker opening, to prevent basketballs and other misguided missiles from damaging the speaker cones.

Two smaller box-type closed baffles were built for the bleacher seats

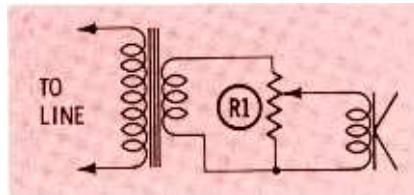

Fig. 4. Wire-wound potentiometer permits adjusting volume at one speaker.

at the rear. These were installed at the front corners of area B, as shown in Fig. 2. Their output was directed backward and downward, so as to strike near the middle of the crowd on either side of the bleachers. Of course, the cone-type speakers used in this installation did not literally "beam" the sound at a specific point, since they have a wide angle of diffusion. However, mounting the speakers at an oblique angle *did* have a very definite bearing on the echo and reverberation problem. By properly angling the different speakers in a multiple system, it is possible to keep the sound reflections from all speakers largely out of phase with one another. This cuts down on the possibility of acoustic feedback. The correct positions are determined most easily in actual practice by experimenting with different angles.

The next problem to be solved was the computation of the audio

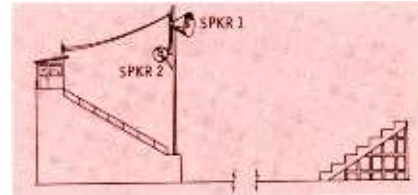

Fig. 5. Two re-entrant trumpets cover opposite sides of football stadium.

power needed to drive the speaker system. Before settling on a total output requirement, we first determined the proper power distribution between the two pairs of speakers. Experimenting with different ratios, we finally decided on a 70-30 distribution. This ratio would provide adequate power to drive the front speakers (which were 50' to 60' from the audience) without "blasting" the eardrums of people in the bleachers 15' to 18' from the rear speakers.

Assuming a total power of 10 watts, we found we would need 3.5 watts in each of the front speakers and 1.5 watts in each rear unit. (If we had later discovered we needed greater or smaller over-all power, we would simply have increased or decreased the ratings of the individual speakers to maintain the original 70-30 ratio.)

The simplest possible method was

•Please turn to page 71

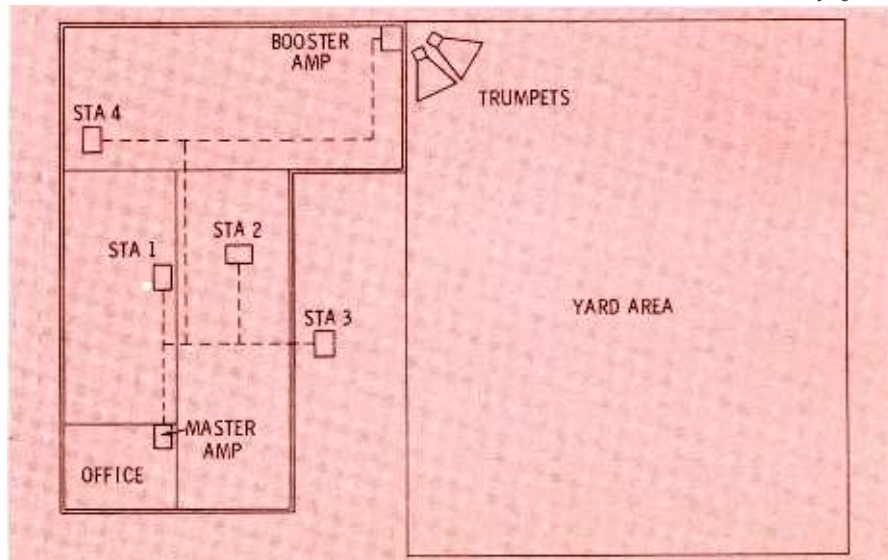

Fig. 6. Intercom system includes a booster amplifier for outdoor paging.

INTRODUCING THE

BLONDER
TONGUE

10th
Anniversary Line

better TV products
for better TV reception
... UHF & VHF

Today — nearly every American family enjoys television's wide range of entertainment and educational programming. Ten years ago this was not so, for there were problems that had to be overcome in order to provide the nation with top quality TV reception — weak signal areas, interference, areas geographically inaccessible to telecasts; areas where many receivers had to operate from a single antenna; UHF areas with peculiar reception problems. Ten years ago, Blonder-Tongue designed and produced its first product, a TV booster, the model HA-1. Immediately it was accepted for the dramatic improvement it brought to fringe area TV reception.

During the 10 year period in which the TV art achieved the advanced state that exists today, Blonder-Tongue was responsible for 22 important patents that expanded the scope and improved the quality of TV reception. Blonder-Tongue TV signal amplifiers, UHF converters, couplers, CCTV cameras and accessories provide better reception to more than 3 million TV receivers in the home, school, motels, hotels, hospitals and industry. To the nation's TV viewers, we dedicate our 10th Anniversary Line.



Profit Builder. Polish or clean every cabinet that comes into the shop. Requires little effort. Builds good will.



Promotion Plans. Effective, timely promotions are one of the big reasons some shops grow while others, who fail to recognize the value of advertising, shrink slowly out of existence.

Now that summer is here, there are several workable angles for promotions based on the theme, "Have your TV serviced while on vacation." This is election year (or hadn't you heard?), bringing political conventions which will attract more TV viewers than the World Series. For those who have early vacations, you can direct a promotional approach toward having the TV all ready for a full season of interest-packed viewing beginning with the conventions.

For those whose vacations fall a little later, you can play up the idea of being all set for the World Series, the return of fall programming, and a better assurance of trouble-free viewing throughout the fall season.

Capitalize on the fact that people on vacation have no objection to their sets being out of the home for an overhaul. Add to this the automatic insurance against burglary, and you're actually doing your customers a favor by storing the set without charge! Arrangements for a "service it during vacation — pay for it in the fall" program will appeal to those who want to use their ready cash for vacation trips.

People know, at least subconsciously, that less TV servicing is done in the summer. Capitalize on this point, too, with advertising copy in the vein of, "We're loafing; you're going on vacation; let's get together." (This campaign could flop if used only as a one-shot deal — it should last all summer.) Another facet of the same theme is, "We've

got lots of time to do a top-notch service job on your TV while you're on vacation." There are plenty of other ideas you can develop with just a little thought.

Most promotions are more successful if there's an added gimmick. How about offering a little folder to be taken along on vacation, with space for logging in mileage, meals, expenses, and events? We could ramble on and on, but it's up to you to develop ideas to fit your own situation — so sit back for an hour or two and get that summer promotion planned.



Parting Thought. Anyone who thinks he is only servicing and not selling soon won't be servicing.



Cut Callbacks. Surely there are no old-timers in the service field who continue to parallel open capacitors, etc., with replacement parts without removing the old components. Many servicemen have had to learn the hard way that this practice can cause a peck of trouble. So, you newcomers, take a word from the wise and *remove* those old parts.

Same tune, different verse: When one portion of a multiple-section component goes bad, replace the entire unit and not just the defective section.



Happy Graduation. It's that time again—time to promote "Give Junior a portable for graduation" if you have a sales department. If not, how about a special offer to check the grad's phono or auto radio at a special rate?

You know that teen-ager has his hand in Dad's pocket. Why not get in on some of Dad's once-in-a-lifetime free spending?

SELECT THE BLONDER-TONGUE TV/FM SYSTEM DESIGNED TO BRING IN THE BEST RECEPTION IN YOUR AREA

NEW BLONDER-TONGUE ALL-CHANNEL TV/FM AMPLIFIER MODEL HAB



Provides high gain (23 db \pm 1 db) on all VHF channels including the FM band. Ideal amplifier for home systems or pre-amplifier for large or small master systems. 69.50 list.

NEW BLONDER-TONGUE SINGLE-CHANNEL ANTENNA MOUNTED TV AMPLIFIER MODEL CB



Enclosed in a weather-proof housing, this versatile performer can be used in the home as a pre-amp or booster to increase signal strength for a single weak channel, or in conjunction with other CB amplifiers to make an economical and powerful multi-channel system. 17 db gain, CH. 2-6; 15 db, CH. 7-13. 52.50 list.

NEW BLONDER-TONGUE B-24 POW-R BOOSTER



Powerful booster or amplified coupler provides sharp, clear pictures on 1, 2 or more TV sets with only one antenna. 10 db gain as 1-set booster, 5 db gain per set as amplified 2-set coupler. No-loss 4-set distribution system with B-T A-104 4-set coupler. 24.95 list.

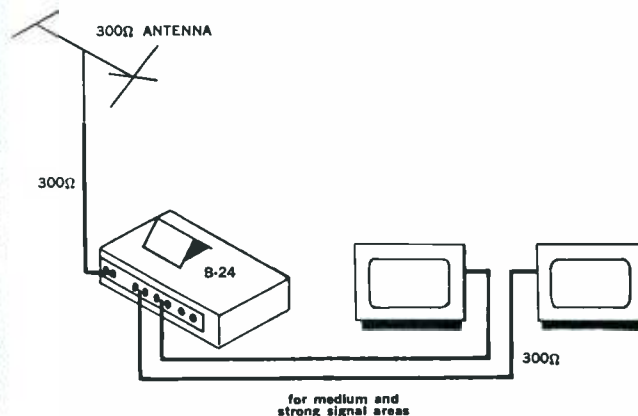
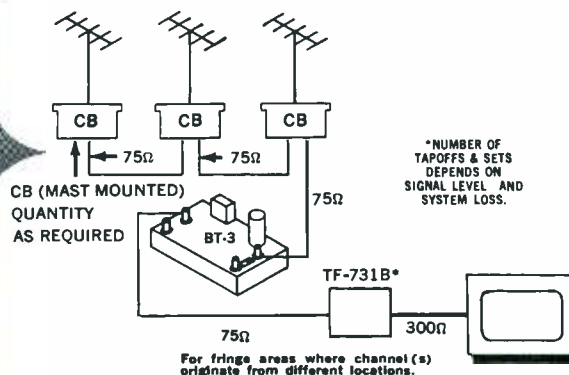
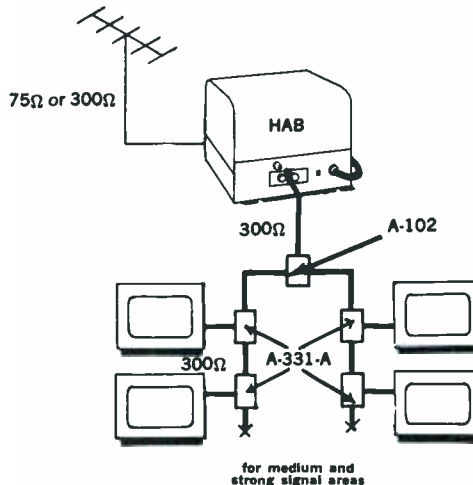

Available at parts distributors. For further information write Dept. PF-6
BLONDER-TONGUE LABORATORIES, INC.
 9 Alling St., Newark 2, N. J.

In Canada: Teleequipment Mfg. Co., Ltd., London, Ont. Export: Morhan Export Corp., N. Y. 13, N. Y.
 hi-fi components • UHF converters • master TV systems • industrial TV cameras • FM-AM radios



RELIABLE REPLACEMENT



TWIST-PRONG ELECTROLYTICS

A satisfactory repair job means a satisfied customer. To keep your customer happy and to prevent costly call-backs you must depend on a reliable replacement. Aerovox AFH Twist-Prong Electrolytics can always be depended on to give long-life and excellent service because they're made better . . . high-purity aluminum foil construction throughout, 85°C operation, improved hermetic sealing and rugged prongs and mounting terminals.

Available in the widest selection of exact-duplicate replacements including printed-wiring and selenium rectifier types. Your local Aerovox Distributor stocks the replacement you need when you need it. Call on him today for all your capacitor requirements.

BUY THEM BY THE KIT . . .

Your Aerovox Distributor offers you special "Stack-A-Lytic" kits (AK-400 and AK-401) with a selection of 8 or 16 popular TV replacements with a FREE handy metal storage rack with stacking features.

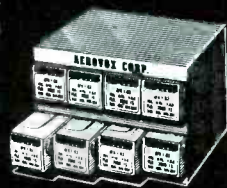

AEROVOX CORPORATION
DISTRIBUTOR DIVISION
NEW BEDFORD, MASS.

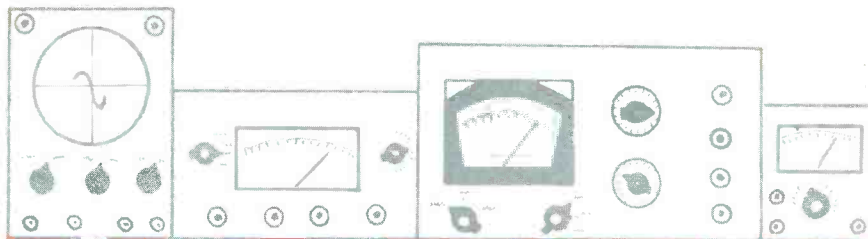

NOTES ON TEST EQUIPMENT

by Les Deane

GDO

No, these initials don't represent a servicemen's organization — they're just the common terminology for "grid-dip oscillator." When a GDO incorporates an indicating device and frequency calibrations, it becomes an instrument known as a "grid-dip meter."

Since we've had some inquiries recently on the applications of such meters, I thought it appropriate to cover a late-model unit in this month's column. The grid-dip meter in Fig. 1 is manufactured by EICO, Long Island City, New York. Their Model 710 comes completely equipped with a set of plug-in coils and an instruction manual.

Specifications are:

1. *Power Requirements* — 105/125 volts, 50/60 cps; power consumption 10 watts; line-isolation transformer provided.
2. *Frequency Range*—eight overlapping bands from 400 kc to 250 mc; tank circuit capacitance-tuned; individual plug-in coils supplied; illuminated tuning dial with eight separate scales.
3. *Panel Meter* — built-in 1 9/16" unit with 500-ua movement, connected in grid return circuit for oscillator operation, and in diode load circuit for detector operation.
4. *Other Features* — OSCILLATOR-DIODE function switch, sensitivity control, and phone jack provided on panel.
5. *Size and Weight* — Steel case 2 1/4" x 2 9/16" x 6 7/8", 3 lbs.

Basically, a grid-dip meter is a tunable RF oscillator with a power-indicating device in its grid circuit. The indicator is usually a DC microammeter, as in the Model 710, or a tuning-eye tube. Design is such that the plug-in coils are always exposed so they can be used as a probe. When the coil is placed in close proximity to a circuit or component under test, the meter can be used to determine the resonant frequency and, indirectly, values of capacitance, inductance, or Q.

When checking out the EICO instrument, I noticed it had an additional

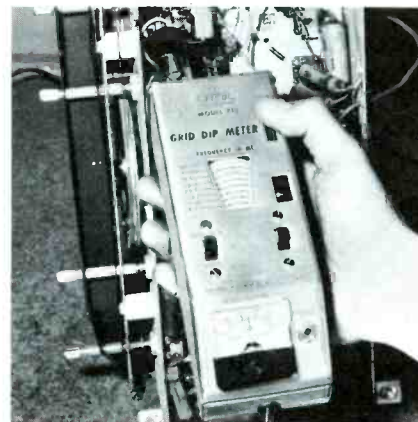

Fig. 1. EICO's Model 710 uses Colpitts oscillator and an RF detector circuit.

switch on its front panel labeled OSCILLATOR-DIODE. With this switch in the oscillator position, the 710 operates as a conventional grid-dip meter; but with the switch in the diode position, plate voltage to the oscillator is disabled and the unit becomes a tuned RF diode detector. In this application, the meter is effectively in the diode load circuit and thus gives a maximum up-scale reading when the instrument is tuned to the frequency of the RF source being investigated.

Another feature of the Model 710 is a special phone jack provided on its



Fig. 2. Model 710 plug-in coils cover frequencies from 400 kc to 250 mc.

Let SYLVANIA help you improve your business—now!

New Home Study Course for Radio-TV
Service Dealers Offers 12
Important Money-Making Chapters:

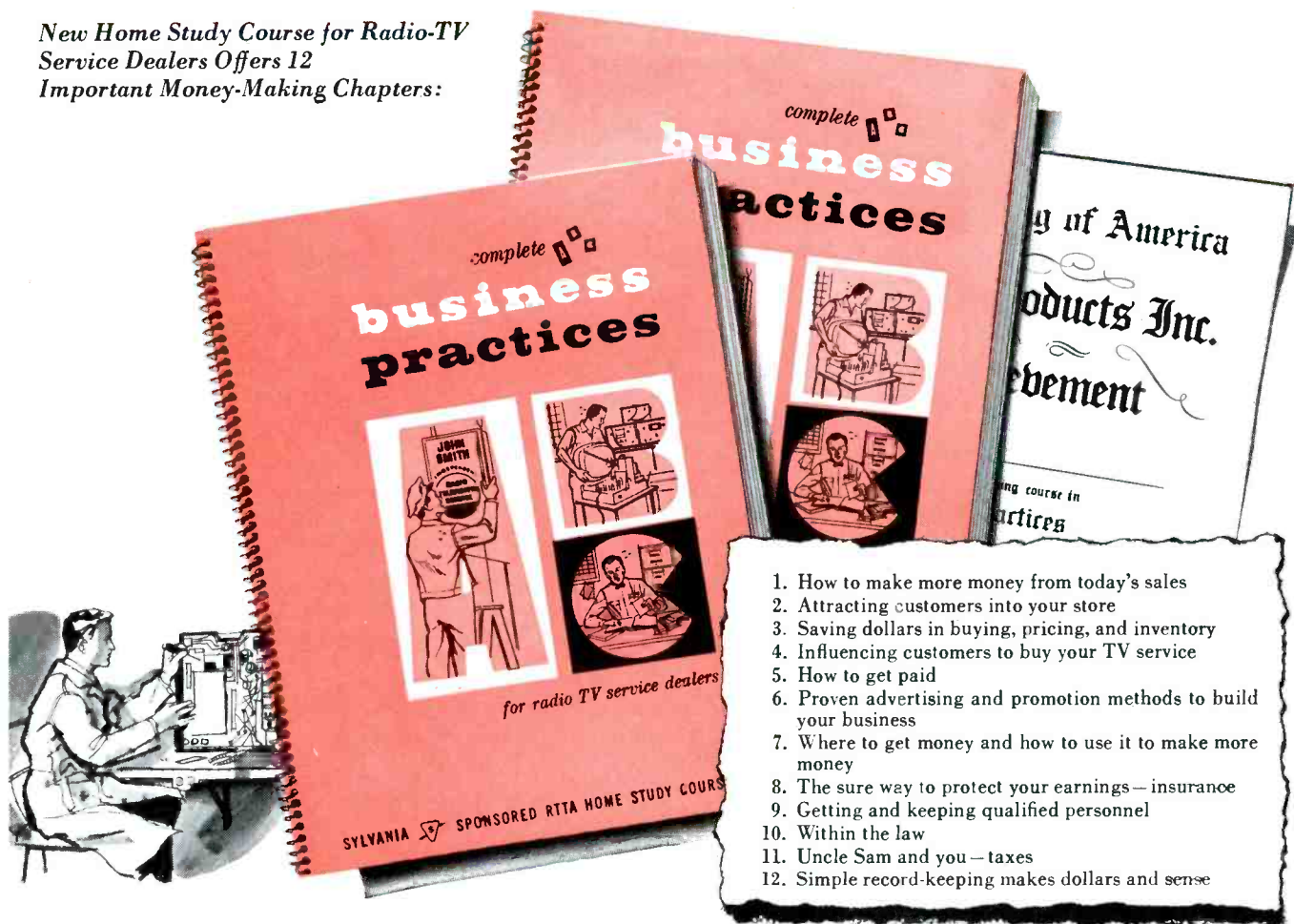

1. How to make more money from today's sales
2. Attracting customers into your store
3. Saving dollars in buying, pricing, and inventory
4. Influencing customers to buy your TV service
5. How to get paid
6. Proven advertising and promotion methods to build your business
7. Where to get money and how to use it to make more money
8. The sure way to protect your earnings—insurance
9. Getting and keeping qualified personnel
10. Within the law
11. Uncle Sam and you—taxes
12. Simple record-keeping makes dollars and sense

As a service dealer you wear two "hats"—(1) you are a technical expert, qualified to repair and maintain electronic equipment, and (2) you are an independent shopowner, a businessman important to the economy of our country.

You can succeed in your profession only if you are thoroughly trained in both service and sales.

SYLVANIA now offers an outstanding, valuable course in "business practices." It's easy to get. Easy to use. Sure to help you build more profits.

A certificate of achievement is awarded on completion of the course. Display it in your shop . . . it tells all your customers that you are a trained serviceman—a trained businessman.

YOUR AUTHORIZED SYLVANIA TUBE DISTRIBUTOR HAS COMPLETE DETAILS. CALL HIM NOW.
CHECK YOUR TUBE STOCK FIRST. AND ASK HIM FOR SYLVANIA TUBES!
Electronic Tubes Division, Sylvania Electric Products Inc., 1740 Broadway, New York, N. Y.

SYLVANIA

Subsidiary of **GENERAL TELEPHONE & ELECTRONICS** 

USING QUIKFREEZE IN ELECTRONIC SERVICING



Available
from your
distributor

USES:

1. Pinpoints defective resistors. Reducing the temperature of specific suspected components causes the trouble to disappear, pinpointing the defective unit.
2. Locates defective capacitors that open intermittently. "Quikfreeze" shrinks elements and causes open condition to reveal itself. (Works especially well with ceramic types.)
3. Locates defective coils in same manner.
4. Use to chill leads of transistors, phono cartridges, crystal diodes, etc., to reduce possibility of heat damage during soldering.
5. Cool thermistors, surgisters, other components whose values differ greatly when hot and cold—to obtain "cold" reading immediately after turning set off.
6. Check out operation of power—tuning mechanisms in auto radios under cold condition—simulating operation under winter driving conditions.
7. Use to cool connections or joints immediately after soldering or unsoldering.

To concentrate spray so that it affects only one component or connection at a time, use EXACT-O-SPRAY needle or tube.

OTHER ELECTRONIC CHEMICALS
Quikleen • Jetkleen • LubeKleen
Quiklube • Rustex

FROM
PLYTEX PRODUCTS, INC.
HOUSTON, TEXAS

panel. When headphones are plugged into this jack, the meter is automatically removed from the circuit and the phones can be used to monitor audible signals. To determine an unknown frequency, for example, the function switch is placed in its oscillator position, and the instrument is tuned until a beat frequency is produced between an unknown source and the GDO signal. When the difference between the two RF signals is very small, the beat frequency will fall into the audible range and will be heard in the phones.

The unit is well shielded except for a round cutout about an inch in diameter at the top end of its steel case. Here, the plug-in coils are inserted into the tuned tank circuit as pictured in Fig. 2. The socket connector has three jacks; however, only two are used for those coils covering frequencies above 2.9 mc. The coils themselves are wound to within a $\pm 5\%$ accuracy on polystyrene forms. Each is identified by an alphabetical letter and the frequency range for which it is designed, except for one high-frequency coil covering the range from 100 to 250 mc. This device is merely a hairpin-shaped inductor without markings.

Many of you may not be aware of the numerous applications a grid-dip meter affords.* The 710 manual tells you how to measure values of capacitors, inductors, and circuit Q. It also explains how to use the instrument to align tuned circuits in receivers and transmitters, how to neutralize a stage or determine the frequency of parasitic oscillations, and how to check an antenna system and the activity or frequency of quartz crystals.

Since measuring the value of a capacitor is of general interest to almost everyone in the field of electronics, you'll be interested in knowing how this simple operation is performed with the EICO Grid-Dip Meter. Although the test is primarily designed for a capacitance range of from 50 to 5000 mmf, smaller values can be calculated by paralleling the un-

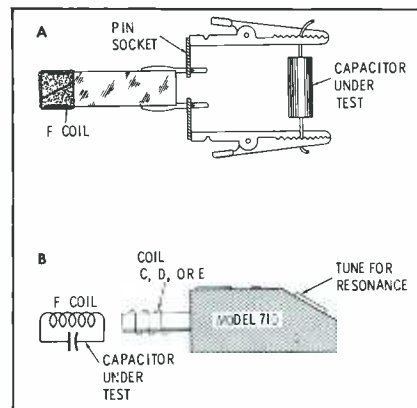

Fig. 3. The grid-dip meter can measure capacitance by checking for resonance.

known unit with a known value so that the combination falls within the range specified.

Measuring the value of a capacitor in the lab, I first connected it across the "F" (18 to 42 mc) coil to form a simple resonant circuit. Two special pin sockets are supplied with the instrument for this connection. Small alligator clips (not provided) should be soldered to the sockets, which are then attached to the pins of the coil (see Fig. 3A).

I next employed the 710 as a GDO, using the other coils one at a time until I found the resonant frequency of the LC network (see Fig. 3B). From the frequency indicated on the 710 dial, I obtained the value of the unknown capacitor by referring to a frequency-vs-capacitance graph given in the instruction manual. When I checked a .001 mfd unit, I obtained a value of .00088 mfd by the grid-dip method. Checking this same component on a capacitance bridge, I found the value to be .0009 mfd, which is very close indeed, considering the distributed capacitance involved.

*See the book entitled "101 Ways to Use Your Ham Test Equipment" published by Howard W. Sams & Co., Inc.

Signal Explorer

Where is most of your time spent when fixing a radio or TV set? It's not in the customer's home, nor in the mechanics of replacing a faulty part, to be sure. So

the answer is, of course, in isolating the trouble to one particular section, stage, or group of components.

There are a number of troubleshooting

TV TUNERS OVERHAULED

ALL MAKES AND MODELS

\$9.95 NET

90 DAYS WARRANTY UHF/VHF \$19.90

SAME DAY SERVICE
ON POPULAR TYPES—48 HOURS ALL OTHERS

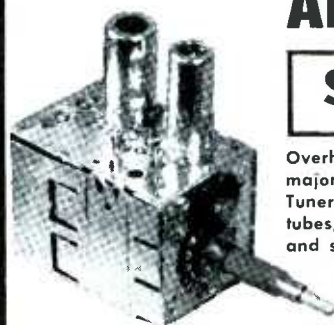

Overhaul charge includes labor and minor parts; tubes and major parts are extra at net prices. Tuner to be overhauled should be shipped complete; include tubes, shield cover and any damaged parts. Quote model and state complaint. Pack well and insure.

WE WILL SHIP C.O.D.—F.O.B. CHICAGO OR TORONTO

Castle TV Tuner Service
5710 N. WESTERN CHICAGO 45, ILL. U.S.A. • 136 MAIN ST. TORONTO 13 CANADA

**Now—more profit from a single sale
...than 20 pairs of single-life “D” cells pay you!**



To recharge, just unscrew cap...



and plug overnight into any 110-120-volt AC outlet.

HEAVY-DUTY SONOTONE Rechargeable Flashlight Battery Cartridge

- A new, multi-use adaptation of the patented Sonotone sintered-plate, nickel-cadmium battery used in space missiles and jets.
- Gives at least 3 hours of strong, continuous light from a single charge with PR-6 bulb—or 1½ hours with full-powered PR-2 bulb.
- Dependable in extreme temperature and weather conditions.
- Can be recharged hundreds of times at about ¼¢ per charge.
- Sturdy, leakproof construction — aluminum jacket — electrically shockproof.
- Full-year guarantee under heavy industrial use — backed by Sonotone's leadership of over 30 years in precision engineering and service.

A completely new concept in long-life flashlight power! Replaces and outmodes any two “D” cells, for any purpose, in end-to-end use. Rechargeable overnight simply by plugging into any 110-120-volt AC outlet. Gives users a lifetime of service — gives you more profit than you make from selling 20 pairs of industrial “D” cells! Retail price, Model FC-3, \$9.95. (Also Standard Model FC-2 for home use—light lasts at least 1½ hours with PR-6 bulb — \$7.95 retail.) Order from your supplier now.

Sonotone © P.R.O. P.
Battery Division, Dept. B10-60
ELMSFORD, NEW YORK

Leading makers of fine transistor hearing aids, ceramic phonograph cartridges, speakers, microphones, electronic tubes, sintered-plate, nickel-cadmium batteries.

JERROLD

MF-2

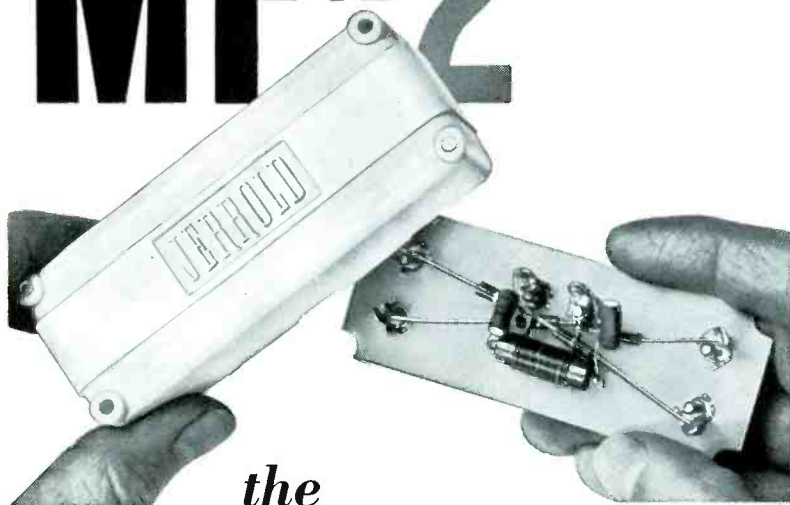

the
2 Set Coupler with GUTS...
now has
TEETH!

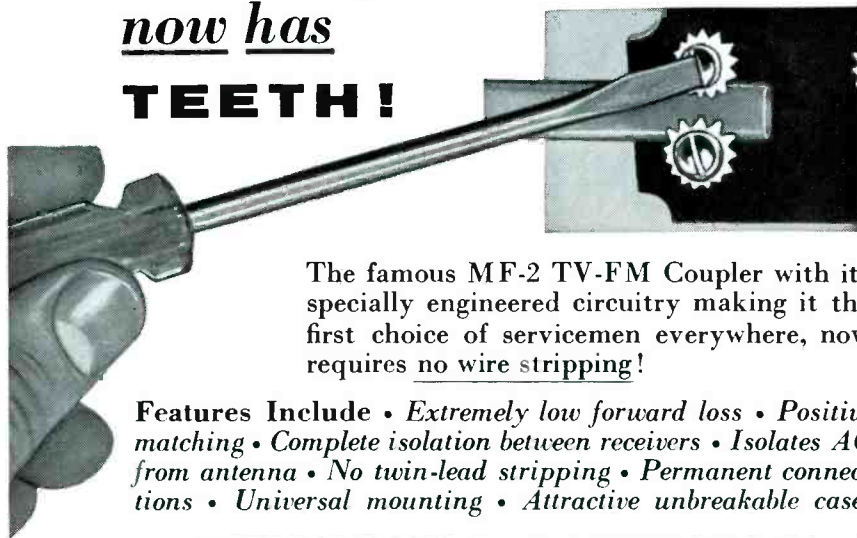

The famous MF-2 TV-FM Coupler with its specially engineered circuitry making it the first choice of servicemen everywhere, now requires no wire stripping!

Features Include • Extremely low forward loss • Positive matching • Complete isolation between receivers • Isolates AC from antenna • No twin-lead stripping • Permanent connections • Universal mounting • Attractive unbreakable case.

**Mounts
anywhere**

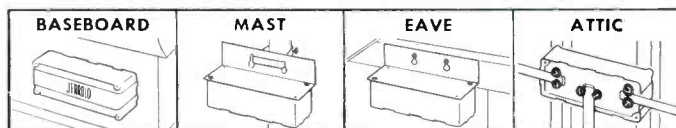

Two additional models available — the M-2 (recommended for UHF). The MF-4 (for 3 or 4 TV-FM sets fed from single antenna).

JERROLD

Order from your Jerrold distributor or write
ELECTRONICS CORPORATION, Distributor Sales Division

Dept. IDS-33 The Jerrold Building, Philadelphia 32, Pa.

Jerrold Electronics (Canada) Ltd., Toronto

Export Representative: CBS International, N. Y. 22, N. Y.

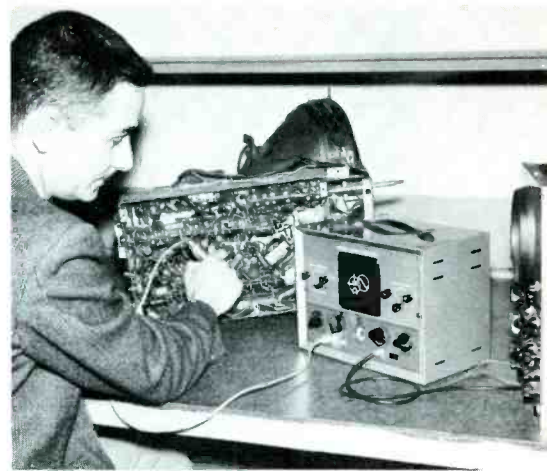

Fig. 4. Precision Electronics' Signal Tracer isolates audio, video troubles.

procedures that can ease the task of isolation, but the most versatile and perhaps most expedient yet devised is known as signal-tracing. Precision Electronics, Inc., of Franklin Park, Ill., has an instrument, the Model 202 Signal Tracer shown in Fig. 4, that helps you trace signals from the antenna to the speaker or picture tube.

Specifications are:

1. **Power Requirements** — 110/120 volts, 60 cps; power consumption approximately 40 watts; panel off-on switch combined with wattage control.
2. **Monitoring Features** — built-in eye tube and 5" speaker plus output jack for monitoring signals with scope; input attenuator, speaker switch, and gain control provided; output cable for scope also supplied.
3. **RF Tracer** — includes sensitive amplifier-detector stage; frequency response to 300 mc; separate plug-in RF probe and cable supplied.
4. **AF Tracer** — includes three-stage preamplifier featuring cascode circuit with over-all feedback; frequency response flat from 2 cps to 300 kc into eye-tube indicator or scope output; separate plug-in audio probe and cable supplied; system may be used as audio amplifier and speaker for testing tuners, phono cartridges, microphones, etc.
5. **Noise Tracer** — special position for noise test provided on function selector; audio probe supplies test voltage; eye tube and built-in speaker used as indicators.
6. **Wattmeter** — power consumption of apparatus under test indicated by eye tube and calibrated watts control; AC receptacle provided on front panel.
7. **Substitution Unit** — built-in speaker and/or transformer available for external use; individual jacks provided on front panel; transformer serves as substitute in either single-ended or push-pull applications.
8. **Size and Weight** — case 11½" x 8½" x 6½", 11 lbs. less probes and cables.

After using the Model 202 in the lab.

NUMBER 4 IN A SERIES OF **CDE** 50th ANNIVERSARY SPECIALS!



**SWEET
DEAL!**

CDE's NEW MINIATURIZED DIPPED MICAS

YOU GET . . .

ALL 500V. 5%	Five CD15-5T22 220 mmfd.
Five CD15-5Q56 56 mmfd.	Five CD15-5T33 330 mmfd.
Five CD15-5Q82 82 mmfd.	Five CD15-5T39 390 mmfd.
Five CD15-5T1 100 mmfd.	Five CD19-5T47 470 mmfd.
Five CD15-5T18 180 mmfd.	Five CD19-5T68 680 mmfd.

Here's a SWEET DEAL from CDE to add dollars to your bank account and time to your crowded day. CDE dipped silver micas save you dollars because they cost less. They perform as well as the best molded silver micas at a fraction of the price; and they STAY dependable too, because their rock-hard phenolic coating effectively seals out humidity.

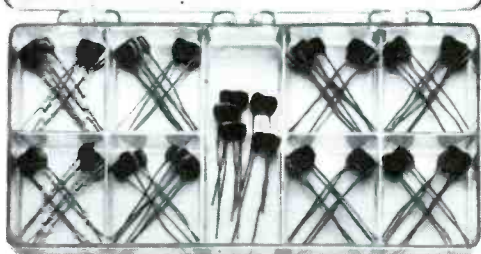

CDE dipped micas save you time because they're TINY. They'll slip into a tight chassis or crowded printed board with ease. They replace ANY mica or ceramic capacitor—and you get all 45 of these 500V., 5%, dipped micas, in a convenient clear plastic box, for only \$10.20. Call or write your distributor. CDE *Distributor Division, South Plainfield, N. J.*



CORNELL-DUBILIER ELECTRONICS DIVISION
Federal Pacific Electric Company

Centralab has the answer

to your *dual* control problems

FASTATCH Dual Radiohms®



No need to fence with dual concentric replacements . . . your problems are solved with CENTRALAB Model F and R controls. Just match front and rear units with proper resistance and taper—cut shafts to length (it's easy with the CENTRALAB SK-2 precision Shaft-Kut Tool)—snap together, and *ouche*, you're ready to go.

You won't be foiled by switch problems, either. Just parry them by snapping on a Fastatch KR line switch if needed.

Fastatch Radiohms enable you to meet the demand for an immense variety of dual concentrics with a minimum of components. (The handy FDK-100 Kit provides coverage of 90% of your dual control requirements.) Ask your distributor for full information about CENTRALAB Model F & R controls.

CENTRALAB products are listed in PHOTOFACTS, COUNTERFACTS, and THE RADIO-ELECTRONIC MASTER.

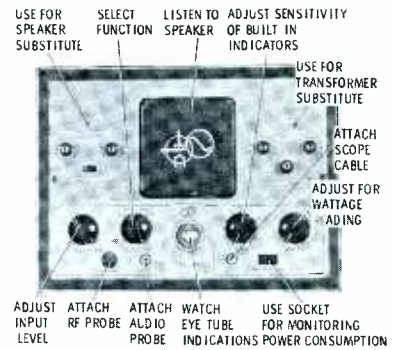

Fig. 5. Front panel of the Model 202 actually tells own operational story.

I soon discovered that its usefulness was not merely confined to troubleshooting conventional radios and sound systems, but extends to transistor portables, TV receivers, test equipment, and just about any other electronic gear you care to mention. Its sensitivity and frequency response impose little or no limitations on the types of signals it can handle, and it has about all you could ask for in the way of indicating devices. Visual presentations, for example, include a panel eye-tube and scope output connection, while aural monitoring is accomplished through the instrument's built-in speaker.

The *Signal Tracer* acts as a convenient sensing device capable of sampling either signals developed within the apparatus under test or those supplied from an external generator source. By probing a circuit at various points and using a little deductive reasoning, one can isolate a fault to a certain stage or even a specific component. About the simplest way to picture the instrument's over-all operating features is to take a closer look at its front panel. The location and use of each item is pointed out in Fig. 5.

Since signal-tracing a radio is very elementary, I thought I would concentrate on checking some of the TV troubleshooting uses outlined in the 202 manual. When tracing the signals in various TV stages, for example, I plugged the RF probe (Fig. 6) into the instrument panel and placed the function selector in its PROBE position. With power applied to both the set under test and the *Signal Tracer*, I tuned in a station and adjusted the input attenuator and gain control as required for each point I explored with the probe.

In the IF strip, I found it best to sample the signal across the cathode resistor of each stage, and to use a scope to



Centralab

B-6002 C.T.L.®

ELECTRONICS DIVISION OF GLOBE-UNION INC.
942F E. KEEFE AVE. • MILWAUKEE 1, WIS.
IN CANADA: P. O. Box 400, Ajax, Ontario

CONTROLS • ROTARY SWITCHES • CERAMIC CAPACITORS
PACKAGED ELECTRONIC CIRCUITS • ENGINEERED CERAMICS

New Decorator TV Lead-In Cable

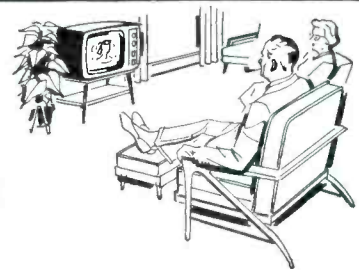

For interiors only. This NEW Belden 300-ohm lead-in cable, No. 8226, replaces unsightly lead-in cable in modern homes. Its neutral color harmonizes and blends into

any room's decorative theme. Available in lengths of 25, 50, 75, and 100 feet. Packaged in pancake coils for easy handling and display.

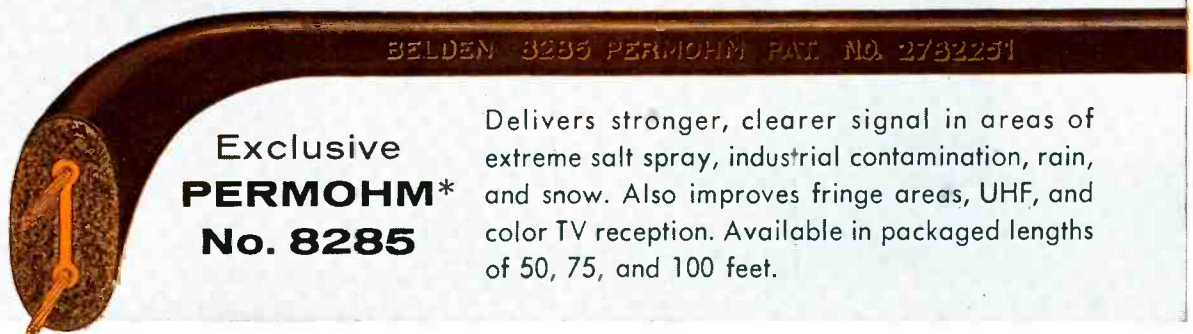

Exclusive PERMOHM* No. 8285

Delivers stronger, clearer signal in areas of extreme salt spray, industrial contamination, rain, and snow. Also improves fringe areas, UHF, and color TV reception. Available in packaged lengths of 50, 75, and 100 feet.



STANDARD 300-OHM LINE
—NO. 8225 Offers low losses at high frequencies. For use with TV and FM receiving antennas. 25-, 50-, 75-, and 100-foot coils; 500- and 1000-foot spools.



WELDOHM* 300-OHM LINE
—NO. 8230 2½ times flex-life and 1½ times breaking strength of ordinary lead-in. 25-, 50-, 75-, and 100-foot coils; 500- and 1000-foot spools.



CELLULINE* 300-OHM LINE
—NO. 8275 Resists abrasion, sun, and wind. Provides strong UHF and VHF TV pictures. 50-, 75-, and 100-foot coils; 500- and 1000-foot spools.



STANDARD 72-OHM LINE
—NO. 8222 For use with all types of receiving antennas at high frequencies. 100- and 500-foot spools.



STANDARD 150-OHM LINE
—NO. 8224 For receiving antennas, matching transformers, and experimental applications. 100- and 500-foot spools.

* Belden Trademark and Belden Patent . . . U.S. Patent No. 2782251



Ask your Belden jobber about this complete line.

CONVENIENTLY PACKAGED FOR DISPLAY AND HANDLING



Power Supply Cords, Cord Sets and Portable Cordage • Electrical Household Cords • Magnet Wire • Lead Wire • Automotive Wire and Cable • Aircraft Wires • Welding Cable

8-3-0



The "Big Picture"

...informative shop talks

by AL MERRIAM

Sylvania National Service Manager

One tool pulls the whole "works"...!

That's the way it is with the new Sylvania TV consoles. When you have to pull the "works"—back cover, chassis, control cluster or even the picture tube—all you need is one ¼" socket wrench...

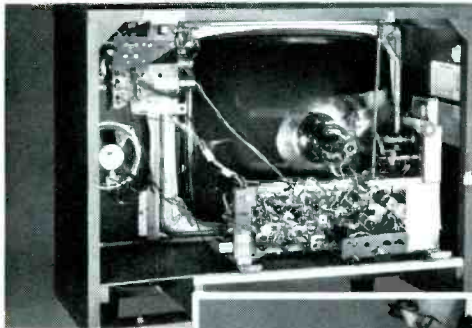
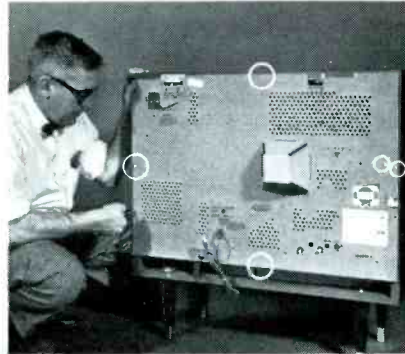

▲ to remove the *five* screws holding the back cover (three less screws than the average cover!).

◀ All the tubes—everything is in plain sight and easy for you to service. If you have to take the chassis to the shop—



one ¼" socket wrench takes out the *two* screws holding the chassis—and the *two* screws on the control cluster bracket. Just pull the plug-in leads for the speaker, for HaloLight® and for the picture tube

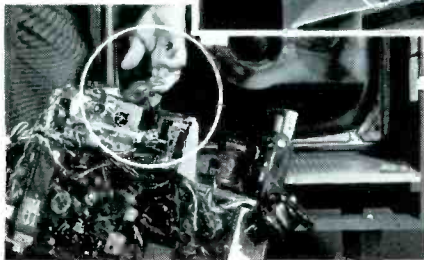

and slide off the yoke connection to the picture tube, and hang it on the special hook on the chassis. Easy as pie, the control cluster unit locks to the chassis, and you're on your way—faster, easier and with no dangling parts to lose or trip over.

The whole job takes an old duffer like me about three minutes. It may take you a few seconds more the first time, but you'll leave me in the dust after that! Here's another tip that pays. Take along some furniture polish to slick up the cabinet—takes just a second, and the folks like those thoughtful "extras." And don't forget about the Sylvania Service Bulletins and Service Clinics! Ask your distributor for the "Big Picture" on the next clinic session in your area, or write me—Al Merriam, Sylvania Home Electronics Corp., Batavia, N. Y.

SYLVANIA

Subsidiary of GENERAL TELEPHONE & ELECTRONICS

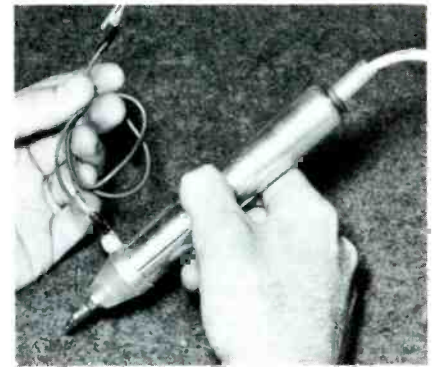

Fig. 6. RF probe for Model 202. Audio probe and scope probe also supplied.

monitor the signal. When encountering a stage without a cathode resistor, I noted the signal could be picked up on the grid; however, this often detuned the circuit. By placing the probe tip on the body of a plate or grid component, I was usually able to detect the signal satisfactorily.

Examining the video and sync sections, I found I could pick up a signal on the grid or plate of each stage and monitor it through the instrument's speaker. The audible frequency present is derived from the 60-cps vertical sync signal. Since the vertical sweep energy likewise produces an audible buzz, the speaker can also be used as an indicator in troubleshooting the vertical oscillator, output, and yoke circuits.

In the horizontal sweep section, I could place the RF probe on the plate of the oscillator and obtain a high-frequency whistle from the Model 202 speaker; but this is not always easy to detect, so I found it more accurate to use the eye tube or scope as an indicator. When signal-tracing beyond the grid of the horizontal output tube, the probe should not be brought in direct contact with high-voltage points; instead, you need only bring the probe near the plate-cap lead or flyback to obtain a usable signal.

The instruction manual pictures typical waveforms found in certain sections of a TV receiver, and also describes methods for aligning FM sets, checking noisy components, and employing the instrument as a wattmeter. After using the Model 202 on a few normally-operating receivers, you'll find it easy to single out the faulty stage or group of components interrupting a signal path. ▲

Have a New Mailing Address?

If so, notify us by the 15th of the month to assure uninterrupted delivery of PF REPORTER.

Please be sure to give us both your old and new address, including your postal zone number. (Or better yet, enclose a current mailing label with your new address.) Send to:

PF REPORTER

Circulation Dept.
2201 E. 46th Street
Indianapolis 6, Ind.

NEW! WINEGARD BOOSTER COUPLER WBC4

Operates 1 to 4 TV Sets
and delivers more signal power.

Amplifies all
channels 2-13
plus FM.



More features, more power, easiest to install

- For operating one set, WBC4 delivers up to 12.5 DB gain all channels. operates 2, 3, or 4 sets with up to 6 DB gain for each set
- Powerful frame grid ECC88 tube, shielded and protected (trans-conductance 12,500 micromhos)
- Ultra low noise figure
- High quality steel housing with baked enamel finish
- Compact, only 4¼" x 3½" x 2½"
- Mounts anywhere, behind TV set, in attic, on baseboard
- Quick disconnect plug for antenna lead-in
- No-strip lead-in terminals
- On-off switch
- Cord and plug for 117 volt - 60 cycle power supply.

Now with one compact package of power, you can install one to four TV sets and get sharper, clearer TV reception even in fringe areas.

Ordinary couplers reduce signal going to the set, but the Winegard WBC4 gives the signal power boost you need for perfect television. Installs quickly, easily - 4 no-strip terminals, for 4 TV sets, 2 on each side.

\$27⁵⁰
LIST



FREE! SPECIAL INTRODUCTORY OFFER

For a limited time only, Winegard is including a Solid Brass Wall Plate and plug free with each WBC4 Booster Coupler. \$3.50 value FREE!

Winegard  **ANTENNA SYSTEMS**

THE WINEGARD COMPANY • BURLINGTON, IOWA
3009-6 SCOTTEN BLVD.

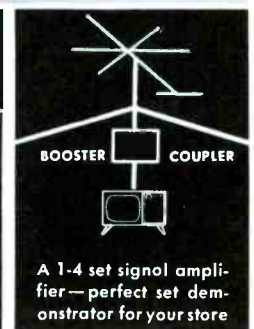
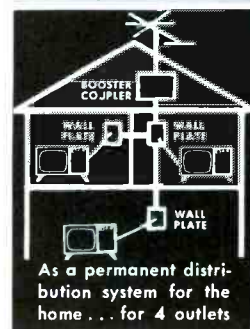
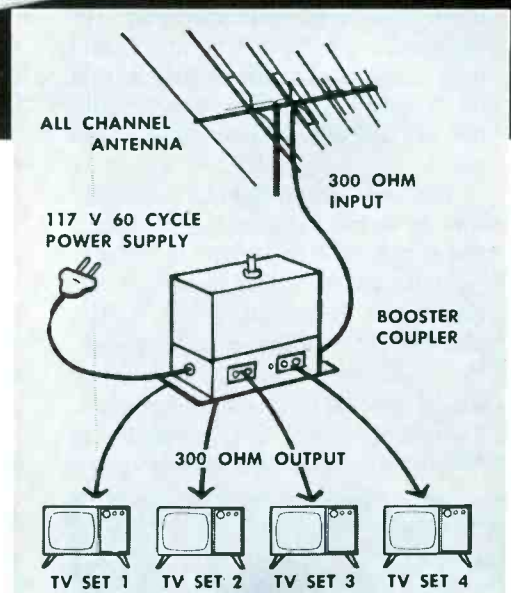

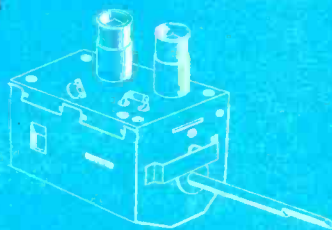

TUNER TROUBLE?

maybe it's mechanical

Knowing the complications involved in working on VHF circuits, we often hesitate to tear into a TV tuner. Yet, it's surprising how frequently a puzzling defect in a tuner turns out to be a simple mechanical problem. Here are a couple of examples gleaned from recent service calls:

In the first case, the customer complained of very poor sound on Channel 6. The sound was both distorted and noisy on this channel, but fine on all others. A good picture was obtained on every locally-available channel, including 6.

While analyzing the situation during the home call, the serviceman discovered that an adjustment of the fine tuning control would clear up the sound. He also noticed something else: Each time the tuner was switched away from Channel 6 and then back again, the sound would be distorted again. This abnormality did not appear on any other channel.

The serviceman figured the defect was probably mechanical in nature, but was baffled as to why it affected only one channel. Not knowing what else to do, he removed the chassis and carried it to the shop for repair. He might have saved himself the trip if he had noticed that the set, a relatively new RCA model, had a fine-tuning knob completely separated

from the channel selector. This arrangement is a clue that the receiver is equipped with a mechanical device for presetting fine tuning on each individual channel.

Back at the shop, the bench man (an old pro) immediately recognized this feature. On hearing the "blow-by-blow" account of the symptoms, he went straight to the trouble. He knew at once the faulty operation had to be associated with the Channel 6 fine-tuning gear and cam assembly (Fig. 1). Switching to 6, he pushed in the fine-tuning shaft to actuate the cam for this channel. It turned normally. Next, he carefully switched off channel and back again. After several such operations, he discovered that the cam seemed to turn slightly as it engaged with the plastic bar that actually fine-tuned the oscillator circuit. A very close examination of this cam revealed a small burr that "caught" each time the cam contacted the fine-tuning arm. This moved the cam and resulted in inaccurate fine tuning. Result—very poor sound. While tricky to find, this one wasn't difficult to cure. A few careful passes at the rough edge with a *Carborundum* stone, and the cam was as good as new.

The second customer's complaint surely indicated tuner troubles; the set operated on the two high channels in the area, but both picture and sound were missing on the two available low-band channels. Replacement of the tuner tubes had no effect on the trouble. Since this series of events frequently stems from a burnt resistor in the RF stage, the chassis was pulled and taken into the shop.

When the turret cover was removed, no evidence of a defective B+ dropping resistor could be found — nor did subsequent resistance checks with a VTVM find any defective resistors. Voltage

checks in the RF amplifier circuit, using a 9-pin adapter, also failed to produce a clue.

A thorough visual check of the oscillator circuit was then made. No burnt resistors or poor solder joints were found; however, the fine-tuning coil was positioned so that removal or installation of the turret cover could have caused the coil to be damaged. Carefully slipping the cover back into place to check this point led to the discovery of an open winding on the coil. The cover had been dragging on the coil near the end connected to C1 (Fig. 2).

Now why, the serviceman wondered, would this defect cause loss of reception only on the low channels? He finally reasoned that the broken coil circuit provided a sufficient amount of capacitive coupling to permit normal operation on high channels; however, it was inadequate for proper oscillator tuning on low channels. It just goes to show that where tuners are concerned, you're liable to run into just about anything.

The open connection was repaired, and the set was again operative on low-band channels. A drop of coil cement on the solder joint provided the necessary insulation to complete the repair. Naturally, the fine-tuning coil was repositioned slightly to prevent its being damaged

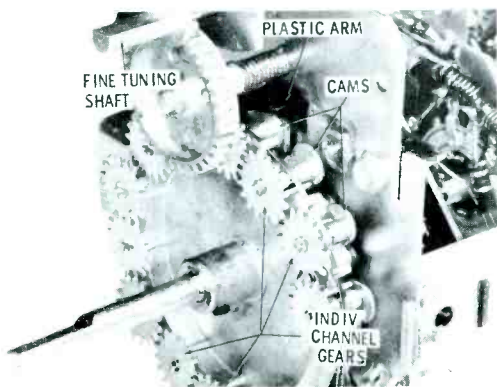

Fig. 1. Cams and gears of preset fine-tuning mechanism in recent RCA sets.

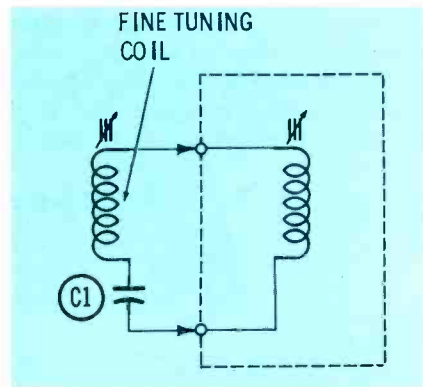

Fig. 2. Turret cover rubbed against coil and caused "open" at point shown.



Why "Experiment"...

with electrical protective devices

when BUSS fuses have proven their dependability?

With the many types of electrical protective devices on the market, perhaps you have asked yourself, "Which line is best for me?"

It doesn't pay to "experiment".

Protective devices that fail to protect or that open needlessly often require a time-consuming call-back that can mean loss of full profit. Your reputation for service and reliability also may suffer.

BUSS and FUSETRON fuses, on

the other hand, do provide dependable electrical protection under all service conditions . . . and have for the last 45 years in the home, in industry and on the farm.

Electronic testing assures dependability.

Every BUSS and FUSETRON fuse is tested in a sensitive electronic device that automatically rejects any fuse not correctly calibrated, properly constructed and right in all physical dimensions.

The time you save, the trouble you avoid, the satisfied customers you keep and the full profit you make are why it's just good business to standardize on BUSS.

For more information on BUSS and FUSETRON Small Dimension fuses and fuseholders, write TODAY for Bulletin SFB.

BUSSMANN MFG. DIVISION

McGraw-Edison Co.

University at Jefferson, St. Louis 7, Mo.

660

BUSS fuses are made to protect - not to blow, needlessly.

BUSS makes a complete line of fuses for home, farm, commercial, electronic, electrical, automotive and industrial use.



18 TARZIAN RECTIFIERS CAN COVER YOUR NEEDS

5 Silicon Rectifiers plus conversion kits

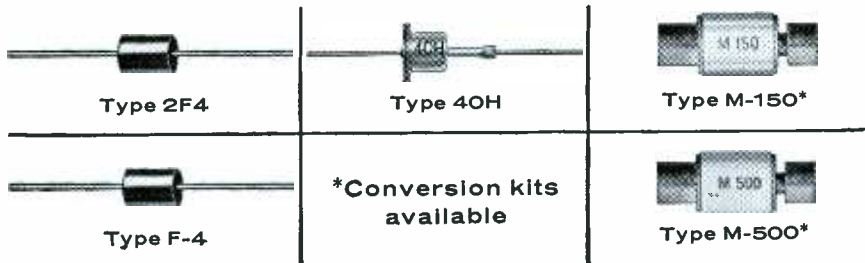

9 Tube Replacement Silicon Rectifiers

Tarzian's 9 standard models of tube replacement rectifiers are directly interchangeable with over 95% of all popular vacuum tube rectifiers.



4 "Condensed-Stack" Selenium Rectifiers

Model 50-75



Model 100-150



Model 200-250



Model 300-500



NEW CATALOG AVAILABLE

Ask your Tarzian sales representative for the new "Distributor Line" Rectifier Catalog. It contains complete details on rating, dimensions, and electrical specifications. Or write Section 4481C.



SARKES TARZIAN, INC.

World's Leading Manufacturers of TV and FM Tuners • Closed Circuit TV Systems • Broadcast Equipment • Air Trimmers • FM Radios • Magnetic Recording Tape • Semiconductor Devices

SEMICONDUCTOR DIVISION • BLOOMINGTON, INDIANA

In Canada: 700 Weston Rd., Toronto 9 • Export: Ad Auriema, Inc., New York

again. A slight retouch of the oscillator tuning on all received channels completed the job.

Antenna Lead-In for Tough Reception Areas

It is easy to get into the habit of thinking that all antenna lead-in is the same, since practically any type will work perfectly the day it is installed. However, there are areas where reception deteriorates rapidly after an outside antenna is installed. In fact, there have been cases in which reception went down at such a rate that, in six months' time, it was poorer than before the antenna was installed. Thorough and careful analysis of these installations revealed only one trouble — a crusty-looking lead-in wire. Areas most likely to be affected in this manner are seashore regions (where spray is often in the air) and industrial districts where humidity tends to run high.

Even in fairly clean areas, the performance of some TV antenna installations has been found to fall off when it is raining or when there is an accumulation of snow. (This trouble occurs because the attenuation factor for wet lead-in is from 10 to 40 times greater than for an equal length of dry lead-in.) In view of this fact, areas with habitually heavy snow or rainfall also present a special antenna-installation problem.

Two types of lead-in wire have proved to be of value in these difficult reception areas — either an open-wire line or a lead-in with extra protective coatings. The open-wire line is not always practical to install, so you may be interested in making acquaintance with some specialized types of insulated twin-lead. Amphenol's *Marine Core* lead-in has each conductor enclosed in a tubular core of polyethylene foam covered by a solid polyethylene jacket; Belden's No. 8285 *Permo-hm* features a thick outer coating of low-loss cellular polyethylene. Either lead-in offers protection from the effects of moisture, salt spray, or industrial contamination that can sap signal strength.

Retrace Lines Not a Video Trouble

The customer's complaint was that the picture was washed out and white lines were visible on the

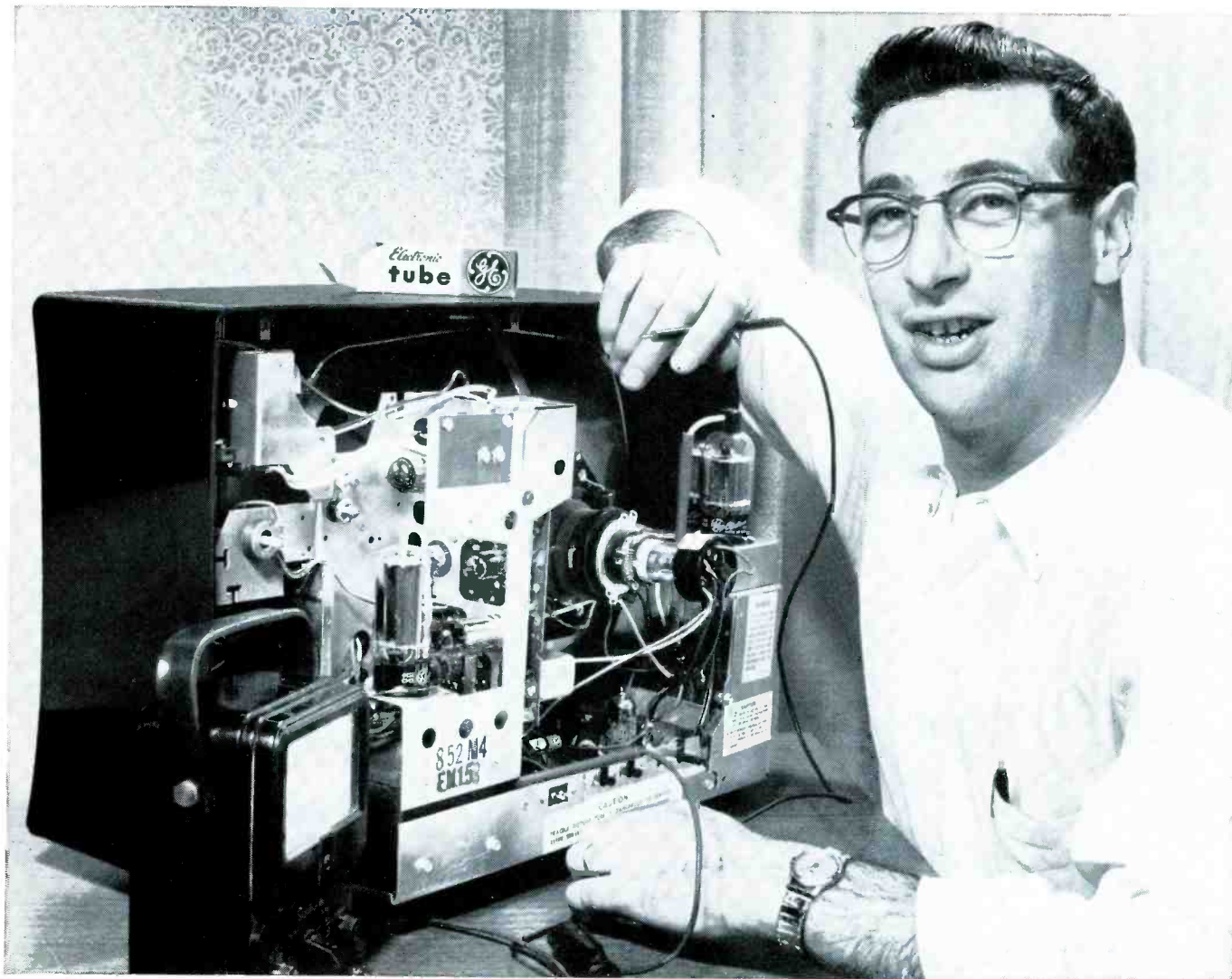

“IT’S A SNAP to get at the chassis in a ‘Designer’”

says Norm Murkoff, Service Manager of Rocket Stores, Inc., Poughkeepsie, N. Y.

“The minute you take the back off any General Electric ‘Designer’ TV receiver the chassis is right in front of you and it’s a snap to get at it,” says Norm Murkoff, Service Manager of Rocket Stores, Inc., in Poughkeepsie, New York.

“Rarely do you ever have to pull the chassis on this set to replace parts or circuit trace so we do 9 out of 10 repairs in the home.

“Because of the higher home completion rate we find we can make more calls and this, of course, means we make more money.

“Another thing we like about the ‘Designer’ is that we can get at both sides of the printed circuitry while the chassis is still in the cabinet.



“Also, the tubes are directly replaceable, fuses are accessible, and you easily get at the key check points. Another thing: the painted schematic on the boards helps us find our way around very quickly.”

Precision Etched Circuitry is the name General Electric gives to its circuitry and it is used in all sets. This circuitry is reliable and uniform so that when you’ve serviced one you never have to puzzle over the next one.

“Designer” TV—called the easiest-to-service set in television! General Electric Company, Television Receiver Department, Syracuse 8, New York.

Progress Is Our Most Important Product

GENERAL  ELECTRIC

SERVICE MASTER... EVERY TOOL YOU NEED 99% OF THE TIME



complete 23-piece kit for radio, TV,
and electronic service calls

2 HANDLES:

shockproof plastic.
Regular 4" length
... 2" Stubby. Inter-
changeable. Patented
spring holds snap-in
tools firmly in place.

9 NUTDRIVERS:

High Nickel chrome
finish, $\frac{3}{16}$ " to $\frac{1}{2}$ "

3 STUBBY NUTDRIVERS:

$\frac{1}{4}$ ", $\frac{3}{16}$ ", $\frac{3}{8}$ "

EXTENSION BLADE:

Adds 7". Fits
both handles.

3 SCREWDRIVERS:

Two slotted ...
 $\frac{3}{16}$ ", $\frac{9}{32}$ "
#1 Phillips

2 REAMERS:

$\frac{1}{8}$ - $\frac{3}{8}$ ", $\frac{1}{4}$ - $\frac{1}{2}$ "

ADJUSTABLE WRENCH:

6" thin pattern,
1" opening

LONG NOSE PLIER:

"Cushion Grip",
 $\frac{2}{4}$ " nose

DIAGONAL PLIER:

"Cushion Grip"
hand-honed
cutting edges

ROLL UP KIT:

Durable, plastic-
coated canvas.
Compact, easy-
to-carry.

Ask your distributor to show you kit 99 SM

XCELITE

XCELITE, INC. • ORCHARD PARK, N. Y.
Canada: Charles W. Pointon, Ltd., Toronto, Ont.

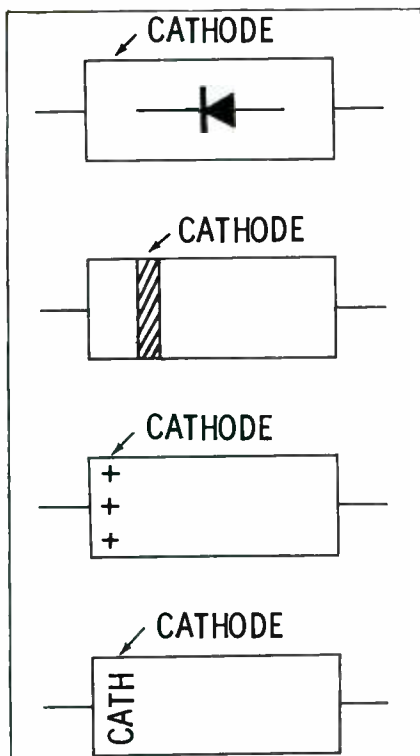

Fig. 3. All these systems are widely
used for marking semiconductor diodes.

screen. The television receiver involved was an older model (Sparton 26SD160). Examining it, the serviceman found that the retrace lines could not be blanked out, nor could the brightness of the raster be reduced by turning down the brightness control. Replacing the video output amplifier failed to produce a cure, so the chassis was taken to the shop for further analysis. The customer was warned at this time of a possible short in the picture tube.

In the shop, routine checks revealed the following circumstances:

1. The chassis had both high and low B+ circuits, with separate rectifiers (a 5U4G and a 5Y3GT).
2. Picture-tube bias and video output circuits were fed by the low B+ supply.
3. Low B+ was supposed to be 135 volts, but measured 90 volts.
4. Replacing the weak 5Y3GT in the low B+ circuit restored the supply voltage and retrace blanking.

The brightness control also resumed normal operation. The picture tube proved to be in excellent shape, much to the customer's relief.

Where's the Cathode?

Determining the cathode terminal of a semiconductor diode is ordi-



take this new
'tool' on every
service call...

especially designed
for your tube caddy

TUBE CADDY-TUBE SUBSTITUTION GUIDEBOOK

by H. A. MIDDLETON
(direct replacements only)

This guidebook is the answer to the many requests by service-technicians for an efficient direct substitution guide which can be carried in the tube caddy. It contains only direct substitutions which can be made without modification of the wiring. All substitutions listed will yield good or excellent results as indicated in the guidebook.

this guidebook will:

- save you time • eliminate carrying needless tube types • enable you to select the best substitution • minimize sales losses because you don't have the right tube.

It will pay for itself on the first service call!

Contains more than 2,400 substitutions:

Receiving tubes 1819
Ruggedized tubes 75
European-to-American 219
American-to-European 297
#272, (actual size 4 1/8 x 6") \$.90

Order this indispensable 'tool' today at
your distributor or from: Dept. PF-6

JOHN F. RIDER PUBLISHER, INC.
116 West 14th Street, New York 11, N. Y.

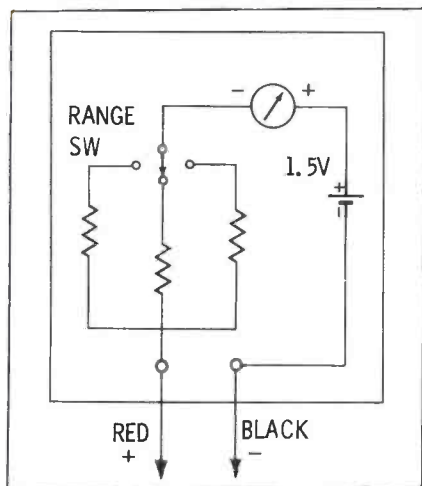

Fig. 4. Determine ohmmeter polarity by checking battery—not colors of leads!

narily a snap, since these units are usually marked to indicate which end is which. (Various methods of labeling in common use are shown in Fig. 3.)

All well and good — but what do you do if the marking is absent or so badly damaged that you can't read it? The answer is that you can easily identify the cathode terminal with the aid of an ohmmeter. To do this, however, you need to know the polarity of the voltage applied to the diode from the meter's internal battery. The magnitude of this voltage is also important. (See Fig. 4.)

Both of these facts can be quickly established if you have two VOM's or VTVM's; simply use the voltage function of one meter to determine the polarity and amount of voltage supplied by the other. If a second meter isn't available, simply disassemble the one meter on hand and make a visual check of its battery.

Avoid using a meter with a battery potential greater than 3 volts, particularly when checking small diodes with low breakdown-voltage ratings. Since some meters use a higher voltage (about 30 volts) on high resistance ranges, you'll stay on the safe side — and get more accurate readings, too — if you always use the R x 10 scale of the meter for diode tests.

To determine the cathode of an unmarked diode, simply connect the ohmmeter leads across it — first one way and then the other. The meter lead previously determined to be negative is connected to the cathode of the diode when the lower of the two readings is observed.



there's
a **C-D vibrator** for every
make and model
car

The C-D brand name on a vibrator is your guarantee of dependable performance, long trouble-free service. Because C-D vibrators are built to last, you can use them with full confidence. That's why it pays to reach for a C-D when a vibrator replacement is called for.

Remember, too, that there's a C-D vibrator type for every make and model car on the road. And the C-D VIBRATOR REPLACEMENT GUIDE makes it quick and easy for you to select the exact type required. Ask your local C-D distributor for a free copy of VIB-3, or write to Cornell-Dubilier Electric Corp., S. Plainfield, N. J.



CORNELL-DUBILIER ELECTRIC CORPORATION
Affiliated with Federal Pacific Electric Company

BEST BUYS IN TEST INSTRUMENTS

EICO®

- Praised by the experts
- Lifetime service guarantee
- Ruggedized mechanical design for utmost accuracy & stability
- Only the latest, finest quality parts used



Color & Monochrome • DC to 5 MC Lab & TV 5" Oscilloscope #460

Wired \$129.50 Kit \$79.95

Features DC amplifiers; flat from DC to 4.5 mc, usable to 10 mc



TV-FM Sweep Generator & Marker #368

Wired \$119.95 Kit \$69.95

Entirely electronic sweep circuit with accurately biased inductor for excellent linearity. Extremely flat RF output.

Dynamic Conductance Tube & Transistor Tester #666

Wired \$109.95 Kit \$69.95

Tests all receiving tubes (picture tubes with adapter), n-p-n and p-n-p transistors.



Add 5% in the West

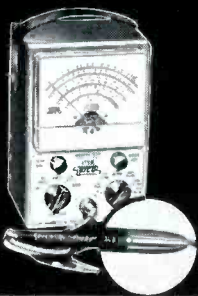

Peak-to-Peak VTVM #232 & Uni-Probe

Wired \$49.95 Kit \$29.95

Uni-Probe — exclusive with EICO — only 1 probe performs all functions: half-turn of probe tip selects DC or AC-Ohms.

In stock at over 1500 distributors in the U.S. and Canada

IMPORTANT NOTE: All EICO kits built according to our instructions, and all EICO factory-assembled equipment, conform to the high standards and specifications published in EICO literature and advertisements. All EICO factory-assembled equipment is completely and meticulously hand-wired throughout — no printed circuitry, each factory-assembled unit is 100% final-tested throughout for each feature and function — no "spot" or "partial" checking. In EICO's final-test techniques, nothing is left to chance.

EICO, 33-00 Northern Blvd., L.I.C. 1, N.Y.

Products, Inc. of Houston, Texas. Sprayed from an aerosol bomb, this chemical really chills whatever it hits. Any sudden change in observed symptoms tells you that you have located a connection which "makes and breaks" as it expands and contracts with temperature changes. Likewise, careful observation of symptoms can help you to spot an abnormal change in the value of a component when chilled — even though no actual break is created in the circuit by the sudden drop in temperature.

For this chemical to be effective in pinpointing a trouble, it must be used in a very concentrated spray so that it affects only one component or connection at a time. Fortunately, the dispenser can be fitted with an *Exact-O-Spray* applicator, which isn't much larger than a hypodermic needle, and really helps you to "zero in" on the target.

Buzit Duzit

Signal injection, long known as an easy way to trace down a defective stage, is again becoming a popular troubleshooting approach to speedier servicing. Modern instruments now make it possible to trace completely through an amplifier, AM or FM radio, or TV video and sound circuits without attaching wires or switching outputs.

One such unit is the *Buzit* Model BZ1 signal tracer by Workman TV Products, Inc., of Sarasota, Florida. The little generator is a transistorized device which produces a 2000-cycle signal rich in harmonics. Because of the wide range of frequencies in this signal, you can trace all the way from the speaker back to the antenna by simply touching the BZ1 to a series of points along the signal path.



BEST BUYS IN CUSTOM

STEREO HI-FI...

EICO®

- Praised by the experts
- Lifetime service guarantee
- Modern "low silhouette" horizontal chassis
- Easy console installation



FM Tuner HFT90 Wired \$65.95* Kit \$39.95*
Cover \$3.95. *Less cover, FET included.
"One of the best buys." — AUDIOCRAFT

AM Tuner HFT94 Wired \$65.95 Kit \$39.95
Includes cover & FET.
"One of the best... Ideal for those wishing to add AM to their systems." — HI-FI SYSTEMS

FM/AM Tuner HFT 92 Wired \$94.95

Kit \$59.95

Includes cover & FET



Stereo Dual Amplifier — Preamplifier HF81

Wired \$109.95 Kit \$69.95

"Outstanding quality... extremely versatile."
— ELECTRONICS WORLD LAB TESTED



Stereo Dual Preamplifier HF85

Wired \$64.95 Kit \$39.95

"Outstanding buy." — THE AMERICAN RECORD GUIDE

Stereo Dual Power Amps

20-Watt Model HF86

70-Watt Model HF87

Wired \$74.95 Kit \$43.95

Wired \$114.95 Kit \$74.95



3-Way High Fidelity Speaker System Semi-Kits HFS-3 & HFS-5

- Complete with factory-constructed enclosure
- Easy to assemble — no gluing or woodworking

HFS-3: unfinished birch, Kit \$72.50 Wired \$84.50; walnut, mahogany or teak, Kit \$87.50 Wired \$99.50.

HFS-5: unfinished birch, Kit \$47.50 Wired \$56.50; walnut, mahogany or teak, Kit \$59.50 Wired \$69.50.

In stock at over 1500 distributors in the U.S. and Canada

EICO, 33-00 Northern Blvd., L.I.C. 1, N. Y. PF-6

Show me how to save 50% on top quality: Hi-Fi Test Instruments Ham Gear. Send free catalog and name of neighborhood EICO supplier. Send free STEREO Hi-Fi Guide.

Name

Address

City..... Zone..... State.....

Add 5% in the West

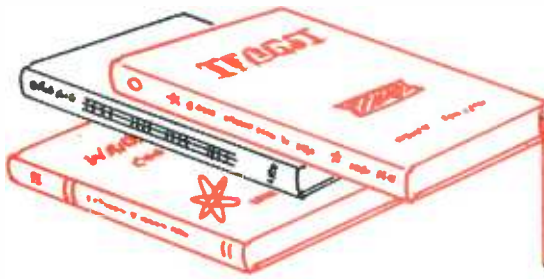

all we want are the FACTS

"GO BY THE BOOK"—BUT ONLY IF YOU'RE SURE THE THEORY APPLIES TO THE CASE AT HAND—BY H. M. LAYDEN

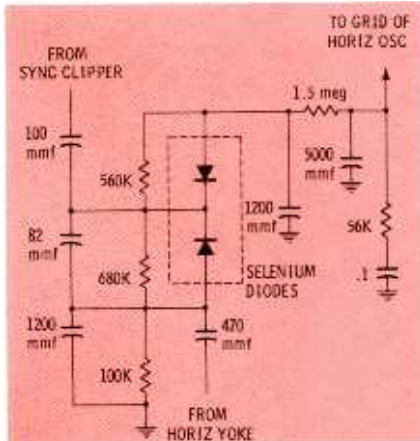

Fig. 1. Horizontal phase detector circuit of General Electric Model 17T025.

Hank Evans was alone in his shop. This day had been one of his more hectic ones, but he had survived. Now he sat relaxed, watching the second rerun of a "Dragnet" episode on a nearly new 17" portable. He had just finished repairing the set, and this viewing session would serve as a test run. He had become adamant about "cooking" repaired sets before giving them the final OK; at least, that was his pretext for his present posture.

The repair had involved the replacement of the matched pair of selenium diodes used in the horizontal phase detector circuit. (See Fig. 1.) A short had developed in one of them, throwing the horizontal oscillator completely out of whack. In fact, manipulating the fine tuning control past a certain point in its range would actually kill the high voltage. Readjusting the control away from this critical point would restore the high voltage, but the picture would not sync in.

Connecting his VTVM to the input grid of the oscillator, he had seen why the high voltage disappeared. The control voltage on this grid was so high that it blocked the oscillator. He reasoned that, when the fine tuning control was adjusted so that the picture carrier was moved higher on the IF response curve, the sync pulses would reach the phase detector at a very high level. Rectification of these strong pulses by the one good selenium rectifier accounted for a control voltage sufficient to cut off the oscillator and kill the high voltage. This job had been very in-

teresting, but it had been a trying one in light of the sardine-packed construction of the set. He was happy that it was back in its cabinet and that he could take a breather at last.

He had not been sitting there long when the voice of Sgt. Joe Friday issued from the set, speaking the famous phrase, "All we want are the facts, ma'am." Hank chuckled to himself at this utterance. It seemed to him that it accurately summed up his workaday life. "TV servicing," he mused, "is a constant probing and searching for the facts. Trouble is, we sometimes shy away from facts which fairly scream for acceptance, because we fear to tread where theory and tradition have erected a sort of detour sign!" He was thinking of what had occurred over at Bob Riser's place that afternoon.

Bob Riser, a young fellow of twenty or so, was a good technician. He was also a "book" man, apt to reject anything that went contrary to what he saw in print. Now, don't get the impression that Hank was hostile to theory. He wasn't. It was just that he believed firmly in what he had learned from experience. In short, he was skeptical of rigid, iron-clad rules.

Riser had called earlier, wanting to know if Hank had a flyback tester he could borrow. Hank said he did, and since he would be passing that way in an hour, promised to drop it off. When he arrived at Bob's shop, he found his young friend wrestling with a width problem. The set, a Motorola TS-118 (Fig. 2), was narrow by about 2" on each side and the raster was dim.

Bob related how he had substituted tubes in the low-voltage and horizontal-sweep sections without success, and that he had then taken voltage readings and found only two

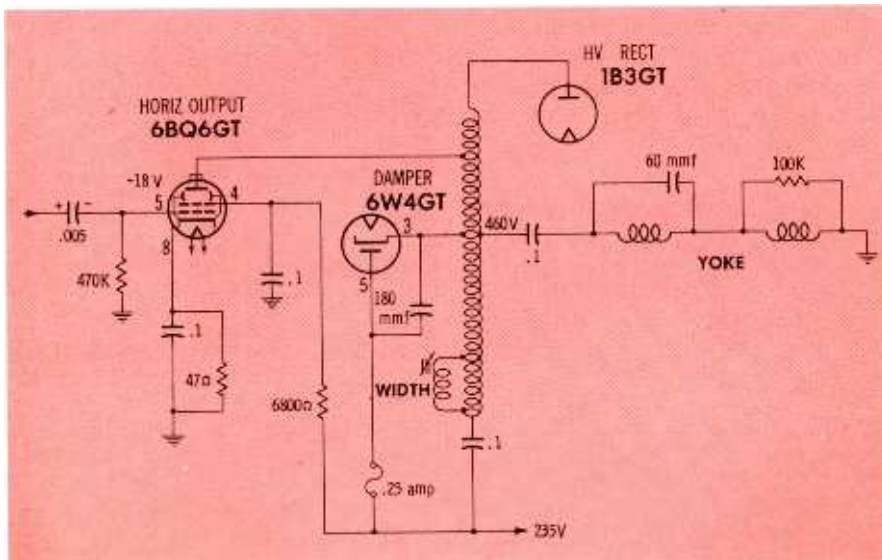

Fig. 2. Horizontal output and high-voltage circuit, Motorola Chassis TS-118.



**Reduce callbacks
to a trickle**

If you've been showered with callbacks, get under an umbrella of Tung-Sol Blue Chip quality. You know a single callback will drown out the profit on the next three service calls. That's why it's a good idea to use Tung-Sol tubes for all radio, tv and hi-fi replacements. They're made to set manufacturers highest original equipment standards so that you can keep your service profits dry and high. Tung-Sol Electric Inc., Newark 4, N. J.

Tell your jobber you'd rather have

ts TUNG-SOL®

Blue Chip Quality

TUBES • TRANSISTORS • DIODES

NEW



Type "PCT" is constructed in strong red cardboard tubes, wax impregnated, one end enclosed, printed circuit board terminals.

Type "PCTL" has insulated lead out top providing for low voltage section. For 65°C operation recommended for table and clock radios, individually packaged, guaranteed for one year.

ALL PLANET capacitors are
 • engineered for quality • guaranteed for one year
Call your DISTRIBUTOR!

PLANET SALES CORPORATION
 225 Belleville Avenue
 Bloomfield, N. J.

which failed to agree with the service literature. Grid drive was about half of the negative 18 volts called for, and boost was 50 volts low.

"I suspect this flyback," he told Hank. Almost in the same breath, he asked, "Did you bring the checker?"

Hank, who was still holding the instrument and making no move to relinquish it, asked, "What facts have you unearthed to support that view—or do you merely have a suspicion?"

"Well, I've checked everything else and the flyback is the only thing left," Bob countered.

Hank placed the instrument on the bench, looked the young man right in the eye, and said: "I'm going to give you some facts of life, but without preaching. Let's just say I feel like an argument and you're elected to hear it."

"Oh-oh! Here we go again," Bob needled, as he planted his frame on one of the high-backed stools.

Hank paid no attention to the ribbing, but went right into his spiel. "Flyback testers, unquestionably, do a great job for service technicians if they are used properly! In some cases, however, wires have to be unsoldered and readings interpolated to make due allowance for inherent differences in inductance. All too often this time goes for nothing because the suspected flyback tests good! Before resorting to the flyback tester, a technician should have something more substantial than a mere suspicion; he should have some reliable facts! It's not enough to say, 'I've checked everything else—it must be the flyback.' When you come right down to it, he has not checked everything else. What he really means by such a remark is that the oscillator seems to be working, and therefore the trouble must be in the flyback. Isn't this what you mean, Bob?" he asked.

His listener fidgeted on his stool, and his ears grew red as he replied, "Well, yes, in a way—but the waveform at the grid of the output tube seemed right even though it was slightly off in amplitude. What other facts do you need? Just what are you driving at anyway?" Bob questioned.

"Driving is the right word, Bobby! The grid drive voltage can, if interpreted correctly, give us the facts I'm speaking of," answered Hank. "For instance, what was the drive



SIGNAL TRACER

Checks all stages from Antenna to Speaker or Picture Tube. Tests microphones, appliances, pickups, transformers, speakers, resistors, condensers, etc.

- Model 202 (with AF Probe) ..Net \$37.50
- Model A Probe (RF Demodulator)Net 4.50
- Model B Probe (RF Demodulator, Amplifier)Net 7.50



VTVM KIT

Easily assembled! Solves numerous problems. Sensitive voltage measurements with negligible circuit loading. Accurate AC voltage ranges for checking line voltages, amplifier power output, frequency response. Positive and negative DC voltage ranges. Checks resistance. Radio, TV servicing; maintenance of electronic equipment; many other uses. Net \$27.95.

PRECISION ELECTRONICS, INC.
 9101-O King Ave., Franklin Park, Illinois

SWITCHCRAFT ADAPTERS

are your answer



To the Problem of Interconnecting 2 Pieces of Equipment with Different Type Connectors

Save Time—No Soldering—Eliminate Make-shift Connections—Provide a Neat Job.

Over 65 different types. Low cost.

Send for Catalog S-590.



5573 N. Elston Ave., Chicago 30, Ill.

Stocked by leading Electronic Distributors

with the plate cap of the output tube removed?"

"Now, wait a minute, Hank!" Bob challenged. "You're not going to stand there and tell me that it's perfectly all right to let an output tube run without a plate load while you make a drive test—or are you?"

"Yes, it is, and I am!" Hank retorted.

"But everyone knows what would happen in such a case," objected Bob. "I know of instances where running an audio output tube without its plate load ruined the tube in a very few minutes!" he added vehemently. "And if I've read about it once, I've read it a thousand times in articles and books," was his clincher.

"I know," admitted Hank, "so have I. And at first blush, the analogy seems to apply; however, the conditions under which the average audio output tube is asked to work are not the same as those under which horizontal output tubes work. For instance, self-biased audio output tubes depend on the cathode current for proper bias. Removing the plate load, or more correctly, removing the plate voltage, removes the plate-current segment of the cathode current and thus seriously lowers the bias. The tube then passes too much screen current, with the result that the screen dissipation ability is exceeded and the tube is quickly ruined.

"But these conditions are not obtained with horizontal output tubes," Hank went on to explain. "The effective bias is not a result of cathode current but is a result of the signal from the horizontal oscillator. As long as the horizontal oscillator is supplying a drive voltage with posi-



"You ever think of getting a remote control unit?"

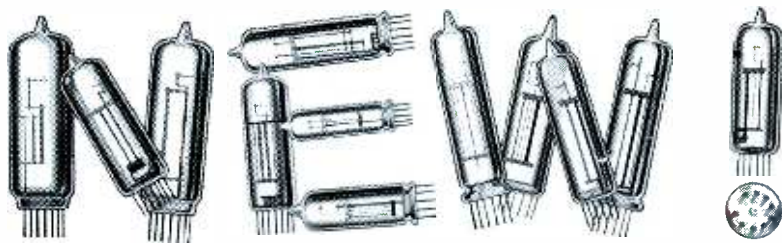

More top-quality tubes from Sonotone

- Complete line of miniature and subminiature tubes for all purposes.
- Featuring many hard-to-get European types!
- Each tube tested and guaranteed for highest quality by Sonotone!
- Sonotone tube production has qualified for the U. S. Signal Corps Reduced Inspection Quality Assurance Program (RIQAP).
- Feature Sonotone for customer satisfaction, top profits!

CHECK THE BIG SONOTONE SELECTION NOW

1AB6	6AJ8	6BY7	6U8	35W4	EAC80/6T8	EF85/6BY7
1AH5	6AL5	6BZ7	6V4	50B8	EBC90/6AT6	EF86/5928-6267
1AJ4	6AM6	6CA4	6V6GT	50C5	EBC91/6AV6	EF89/6DA6
1B3GT	6AN8	*6CA7	6W4GT	50EH5	EBF80/6N8	EF91/6AM6
1L4	6AQ4	6CB6	6X4	5928-6267	EBF89/6DC8	*EL34/6CA7
1M3	6AQ5	6CD6GA	6X8	60EH5	EC91/6AQ4	*EL84/6BQ5
1S5	6AQ8	6CG7	9AQ8	6026	EC92/6AB4	EL90/6AQ5
1T4	6AT6	6DA5	12AT7	7025	ECC81/12AT7	EL95
2AF4A	6AU6	6DA6	12AU7	DAF91/1S5	ECC82/12AU7	EM71
2AF4B	6AV6	6DC8	12AU7A	DAF96/1AH5	ECC83/12AX7	EM80/6BR5
3AF4A	6AX4GT	6DJ8	12AX7	DC90	ECC84	EM81/6DA5
3C4	6BG6GA	6E58	12AX7A	DF91/1T4	ECC85/6AQ8	EM84/6FG6
3V4	6BL7GTA	6FG6	12BA6	DF96/1AJ4	ECC88/6DJ8	EZ80/6V4
5AR4	6BL8	6J6	12BE6	DK92/1L4	ECF80/6BL8	EZ81/6CA4
5J6	6BM8	6J6A	12SN7GT	DK96/1AB6	ECF82/6U8	EZ90/6X4
5U4GB	*6BQ5	6K6GT	0Z4	DL94/3V4	ECH81/6AJ8	GZ34/5AR4
5Y3GT	6BQ6GTB/	6L6GC	16A8	DL96/3C4	ECL80/6AB8	PCC85/9AQ8
6AB4	6CU6	6N8	18DZ8	DM70/1M3	ECL82/6BM8	PCL82/16A8
6AB8	6BQ7A	6SN7GTB	35DZ8	EAA-EB91/	EF80/6BX6	UCL82/50BM8
6AF4	6BR5	6S4A	35EH5	6AL5		
6AF4A	6BX6	6T8				

*Available in Matched Pairs

Sonotone[®]

CORP.

ELECTRONIC APPLICATIONS DIVISION, ELMSFORD, N. Y., DEPT. T10-60
IN CANADA, CONTACT ATLAS RADIO CORP., LTD., TORONTO

LEADING MAKERS OF

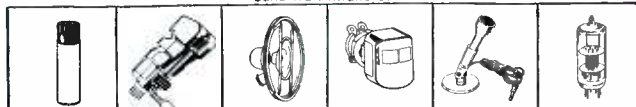

BATTERIES • CARTRIDGES • SPEAKERS • TAPE HEADS • MIKES • ELECTRONIC TUBES



**PROTECTION
where it counts!**

© AMPHENOL ©
MARINE CORE

TWIN LEAD

Are you in a problem area? AMPHENOL's new Marine Core Twin Lead is winning new friends daily by solving reception problems all over America!

In salt-laden air along the coasts, in ultra fringe areas, in cities with heavy industrial contamination and in locations with heavy precipitation, Marine Core gives protection where it counts, consistently bringing in good pictures.

If you have reception problems try Marine Core—find out for yourself how really good it is!

Marine Core is available in 50, 75, 100 and 500 foot coils and in 1000 foot reels. Order by part number 214-103 from your Authorized AMPHENOL Distributor.

AMPHENOL DISTRIBUTOR DIVISION
BROADVIEW, ILLINOIS

Amphenol-Borg Electronics Corporation
www.americanradiohistory.com

tive peaks high enough to cause the proper amount of grid current to flow, the coupling capacitor will charge (as shown in Fig. 2) and set the bias point for the tube. However, if you are worried about the hazard of secondary emission, which I admit is worth worrying about, this can be obviated by tying the plate and screen together with a clip lead." (Fig. 3.)

"I hate to admit it, Hank, but there is the bare possibility that you're right," was the young man's grudging concession. "But," he went on, "since the proof of the pudding is in the eating, let's try out your theory on this dog." He pointed to the set on the bench.

"That's OK with me, Bob, but please don't get the idea that I'm laying claim to this technique—far from it. It's been used for years by factory technicians. Why it has not found widespread acceptance among service technicians, I'll never know; but speaking for myself, it has saved me many an hour and prevented many a headache."

Both of them now gave their attention to the set on the bench. "Start by taking the grid drive reading in the usual way, under load," Hank directed. The VTVM was applied to the grid of the output tube, and it read -9 volts. "Now, let's take that reading with the plate cap of the 6BQ6 removed," Hank said. This time the meter rose to -22 volts. "When the plate cap is in place, something is evidently loading down the horizontal oscillator beyond the point of efficient operation. This could be the flyback windings, the width coil, the yoke, the 1B3, or possibly even the picture tube. The idea now is to watch the effect on the grid drive as these components are disconnected one at a time.

"Let's start with the yoke, which is the most probable culprit and is easiest to get at," Hank continued. "Open one leg of the horizontal yoke winding and we'll get started." This

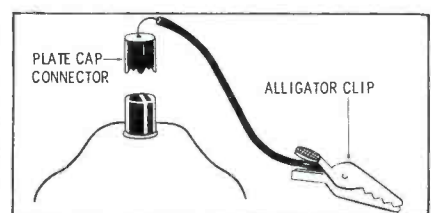

Fig. 3. Test lead for tying together horizontal output plate and screen grid.

was done, and the drive now read -18 volts. "I think that's it, Bob," he said. "Now's the time to go to the flyback tester to confirm what is no longer a mere suspicion, but is a finding in fact!"

The yoke was removed from the neck of the tube and inspected. For a moment, it looked as if a 100K-ohm resistor, which was shunting half the winding, might be the source of trouble. It had a blackened appearance, but when it was lifted from the winding and measured, it was found to be within limits. The flyback tester was connected, and it confirmed that the yoke was lacking in inductance—probably due to shorted turns. "What this set needs," Hank declared, "is a new yoke."

While Bob accepted the verdict, he did not seem entirely convinced. Maybe he was disappointed that the demonstration had not flopped, as he had felt certain it would. Positive proof would have to wait until a replacement yoke was obtained and installed.

Solution

At the moment "Dragnet" ended, while Hank sat musing over the events of the day, the phone rang. He roused himself from his sprawling position, and picked up the receiver. "Television Service," he announced into the mouthpiece, and his ears were greeted with the sound of a male voice fairly bubbling with joy. It was Riser.

"That did it, Hank. This set is perking like new. But how come I never read about this in books?" he wanted to know.

"Probably because even you, my bookworm friend, haven't read all the books," Hank replied. "But you seem to be missing the point, Bob. Don't jump to the conclusion that something cannot be done merely because theory and tradition seem to forbid it. Get all the facts, and let common sense be your guide." ▲

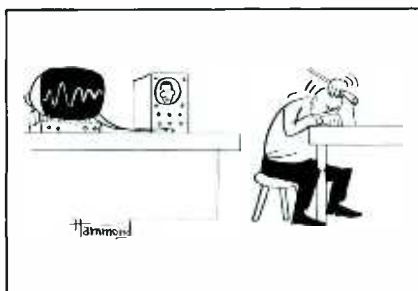

new MILLER 1960 catalog

--176 pages of valuable
reference information for
the service man. Four catalogs in one:



GENERAL CATALOG—lists and describes nearly 1500 items . . . the most complete group of coils available anywhere.

TV COIL REPLACEMENT GUIDE. Cross-references part number of TV mfrs.' set to corresponding Miller Coil number, for quick replacement.

AUTO RADIO REPLACEMENT GUIDE—lists all coils used in auto radios, and the Miller Coils which are exact replacements.

HOME RADIO GUIDE. Saves you many hours in determining the correct replacement for I.F. transformers, chokes, etc. that become defective in thousands of various home receivers.



*If you have not received your copy,
write us direct. Catalog #61.*

EXPORT REPRESENTATIVE:
Roburn Agencies, Inc., N.Y. 13, N.Y.

CANADIAN REPRESENTATIVE:
Atlas Radio Corp., Ltd., Toronto 19, Ont.

J.W. MILLER COMPANY

5917 S. Main St., Los Angeles 3, Calif.

R



NEW TRANSISTORIZED



MODEL PS-3 \$69⁵⁰ net
0-25v. DC variable output voltage

REGULATED DC POWER SUPPLY

NOW service technicians and industrial users can afford the performance of a regulated variable-voltage power supply.

Set It and Forget It—Voltage remains essentially constant at any output voltage setting regardless of load (within ratings) and AC supply voltage fluctuations.

Extremely Low Ripple—Less than 1 MV (.001 V) RMS for all conditions of rated operation . . . less than ½ MV (.0005 V) for AC line voltage between 115 and 120 volts.

Output—0-200 MA, 0-15 volts. 0-100 MA, 0-25 volts.

Regulation—500 MV maximum, for above mentioned ratings.

Input Voltage—110 to 130 volts, 60 cycles.

Sold by Leading Electronic Distributors. Send for Catalog Sheet PS-3

ELECTRO PRODUCTS LABORATORIES

4501-T Ravenswood, Chicago 40 / Canada: Atlas Radio Corp., Ltd., Toronto, Ont.

AT ONE-HALF THE COST!

IMPORTANT NEW SAMS BOOKS

"Using and Understanding Probes"



Helps you get more out of your test equipment! Rudolf Graf shows you how best to use all types of probes in radio-TV servicing. Includes valuable section on special-type electronics probes and their use in industry, agriculture, medicine, etc., for observing, testing, exploring and measuring. Provides a complete understanding of the use of all probe types: direct, isolation, high-voltage, low-capacitance,

rectifying, demodulator, signal-tracing and signal-injection. 200 illustrations; 256 pages; **\$3.95**
5 1/2 x 8 1/4". Only.....

"Servicing Unique Electronic Apparatus"



Cash in on growing new opportunities in electronics servicing. Jack Darr gives you the know-how on such equipment as: Watchmaster watch timer and tester; RF diathermy machines; liquid-flow timers; electronics photoflash units; electric scoreboards; RF heaters; gas-fired boiler controls; garage-door openers; movie sound systems; strobe tuning devices; photoelectric cells; ultrasonic cleaners, etc. Complete; profusely illustrated; 128 pages; 5 1/2 x 8 1/4". Only..... **\$2.50**

.....

Timely for TV Antenna Work



Television Antenna Handbook. A practical guidebook for the antenna installer and serviceman. Thoroughly covers needs of each reception area (primary, secondary, far-fringe). Chapters include: the TV signal, characteristics of basic antennas, commercial antenna types, transmission lines, antenna rotators, installation planning, on-location tests, tools and equipment, towers, masts and guying, roof-top techniques, antenna installation, UHF and color, unusual installations and problems, boosters and multi-set installations, and servicing the antenna system. Most complete and practical book on the subject. 248 pages, 5 1/2 x 8 1/4". 265 illustrations. Only..... **\$3.95**

.....



TV Signal Distribution and Antenna Techniques. Practical and complete information about installation of antenna systems serving two or more TV receivers. Gives procedure and equipment requirements for installations required by hotels, apartments, stores, institutions, trailer parks, community antenna systems. Covers: selection and orientation of antennas, selection of proper distribution systems, reception and special installation

problems, selling systems, making bids and estimates, and other subjects. 176 pages, 5 1/2 x 8 1/4". Only..... **\$2.95**

HOWARD W. SAMS & CO., INC.

Order from your Sams Distributor today, or mail to Howard W. Sams & Co., Inc., Dept. F-30 1720 E. 38th St., Indianapolis 6, Ind.

Send me the following books:

- "Using and Understanding Probes" (PRG-1)
- "Servicing Unique Elect. Appar." (SED-1)
- "Television Antenna Handbook" (TAD-1)
- "TV Signal Distribution" (DSB-1)

\$.....enclosed. Send Free Book List

Name.....

Address.....

City..... Zone..... State.....

(outside U.S.A. priced slightly higher)



Miller Effect

Would you please explain "Miller effect?" I knew what the term referred to at one time, but can't recall its meaning or explanation.

NELSON DEAMICIS

Littleton Colo.

This effect has to do with the fact that the grid-to-plate capacitance of an amplifier tube, multiplied by a factor equal to stage gain, effectively shunts the input capacitance of the tube. In other words, the driving circuit "sees" a total input capacitance of

$$C_{IN} = C(\text{grid-ground}) + C_{GP}(1 + G),$$

where *G* equals the gain of the stage.

Since the value of *C_{GP}* is high for triodes, the value of *C_{IN}* for these tubes is vastly increased by Miller effect. This largely explains why triodes are not favored as high-frequency amplifiers, and also why neutralization of *C_{GP}* is so vital to the operation of the 6BN4 triode RF amplifier in Neutrode TV tuners.

Even though *C_{GP}* is quite low in pentodes (only a few mmf), it's still not low enough to be negligible in video and IF amplifier stages. Remember that the total input capacitance of an IF stage may be less than 20 mmf. Here's the key to why Miller effect causes worry in video IF design: Due to the necessity for a wide range of bias voltages, stage gain varies considerably. This in turn varies the Miller-effect capacitance, tending to detune the input circuit as the bias level is changed. One way of minimizing Miller effect is to introduce degeneration by using an unbypassed cathode resistor.

What Yoke?

We have a Packard-Bell Model 2114 which is minus a yoke. Haven't been able to locate the proper yoke, and PHOTOFACT Servicer 322 doesn't list a replacement. Any help you can give will be greatly appreciated.

DARRELL B. PAULSON

El Paso, Texas

Correct replacements are Halldorson Y-17, Merit MDF-74, Ram Y70F30/3, Rogers GCM303, Stancor DY-14A, Thor-darson Y-17, or Triad Y-20 plus NW-14. You may have to change the damping networks in order to duplicate the values used with the original.

Gang Trouble

I'm having FM trouble in a Capehart Model 1005. AM sensitivity is tops, and a good FM signal can be put through the IF's by signal injection. However, only the strongest FM stations can be heard. All voltage and resistance checks seem OK. Where do I go from here?

VIRGLE MORRIS

Hickory, Ky.

If the AM section works OK, and there is sufficient gain from the converter plate through the FM-IF stages, it can be presumed that the trouble exists either in the FM antenna-input circuit, or somewhere in the FM tuning-gang circuit. Excessive dirt, or a partially shorted rotor plate in the FM tuning gang, seem to be the most logical suspects. Perhaps the mica of the antenna or RF trimmer capacitor is bad. Disconnect the low-resistance coils from the tuning gang when making resistance checks, since an accurate check cannot be made while these are connected.

Doubler Troubler

In the high-voltage doubler circuit of a Sylvania Model 23M-1, the 1.5-meg resistors keep going bad (changing in value) after about 9 months' service. Last time, I replaced C100 and C101 in addition to R101 and R102. Would sure be glad to get some information as to why the resistors change in value.

ALBERT CHOLEWA

LaPorte, Ind.

Excessive current probably accounts for this trouble. Replacing C100 and C101 eliminates them as a possible cause:

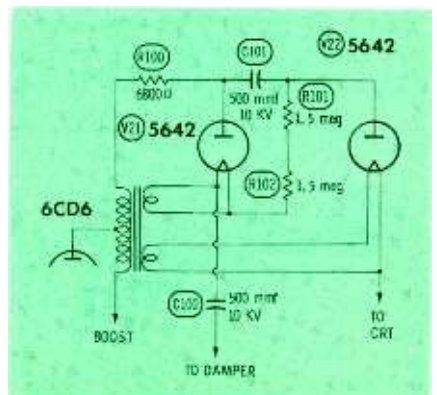

however, this was a good try, since they are high on the list of suspects. Other possibilities are gassy 5642's, excessive beam current due to a defective CRT or improper CRT bias, high-voltage leakage via poor insulation or dirt on the CRT, and various other factors.

Another and perhaps more remote possibility is the type of resistors used as a replacement. None of the resistors used in HV circuits should be wire-wound or otherwise have any inductive characteristics. Always try to use an exact replacement for these units whenever possible.

Spooked

I have a Philco Chassis TV354 with a weak picture and tunable ghost. I sent the tuner in for repair, but got it back with the report that there was nothing wrong. Can this effect be produced by something outside the tuner?

LOREN TIMBERMAN

Springfield, Ohio

This symptom can definitely be caused by trouble outside the tuner. The most likely source is either a defective tube or an open screen bypass capacitor in the video IF strip. This is especially true since you have had the tuner checked and given the stamp of OK. Improper alignment of the IF strip could also cause this trouble; an over-all video IF alignment check would greatly help you to troubleshoot this symptom.

Also, it's conceivable that the antenna system is at fault, even though tunable ghosts are not generally traceable to antenna troubles.

Two, Two Everywhere

Here in New York City we have Channels 2, 4, 5, 7, 9, 11, and 13 — all strong. I have an RCA Chassis KCS47 that gets Channel 2 perfectly — but 2 produces windshield-wiper effect on 4, lines similar to sound interference on 5 and 9, and picture distortion on 13. Any pointers will be greatly appreciated.

JOHN F. SCHINKEL

Richmond Hill, N.Y.

The 21-mc IF system of this set holds the key to your problem. Channel 2 evidently comes in extremely strong in the area where the set is used, producing image frequencies and other spurious beat frequencies which fall within the bandpass of the set's IF circuits when tuned to any of the above-mentioned channels. Make certain that all shields for tubes, tuner, etc., are in place and properly grounded.

Perhaps the over-all video IF response of the receiver has become broadened because of changes in some IF circuit. Make an over-all video IF alignment check as outlined in the PHOTOFACT Folder; any pronounced tilt or dip in the response curve will lead you to the IF circuit at fault. Use a marker to identify the frequency corresponding to the affected area on the curve and then refer to the schematic to see which IF stage tunes to that frequency.

"I certainly wouldn't be without PHOTOFACTS"

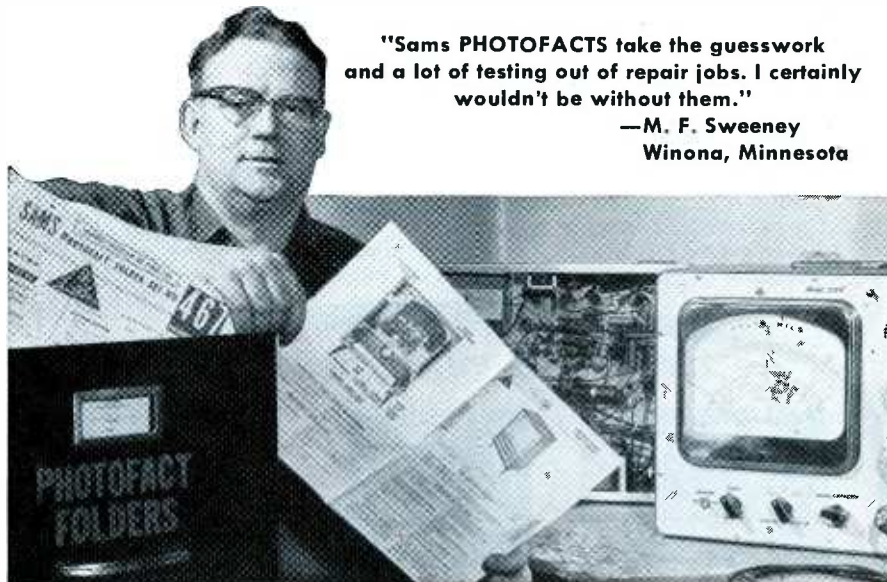

"Sams PHOTOFACTS take the guesswork and a lot of testing out of repair jobs. I certainly wouldn't be without them."

—M. F. Sweeney
Winona, Minnesota

Service Technicians! YOU EARN MORE... YOU RATE with the public when you own the PHOTOFACT® service data library!

You enjoy maximum earnings as the owner of a complete PHOTOFACT Service Data Library! It's inevitable, because no matter how expert you are, you can always save more time on any job, get more jobs done daily—EARN MORE, DAY IN AND DAY OUT...

What's more—as the owner of a complete PHOTOFACT Library, you know your customers' sets best. You can actually show each customer you have the PHOTOFACT Folder covering his very own set. Result: You command public respect and acceptance which paves the way to more business and earnings for you.

HOW TO STAY AHEAD...

Yes, the truly successful Service Technicians are those who own the complete PHOTOFACT Library, who can meet and solve any repair problem—faster and more profitably. And these men keep ahead because they're on a Standing Order Subscription with their Distributors to receive all new PHOTOFACTS as they are released monthly. (They're eligible for the benefits of membership in PEET, too—see below!)

ONLY \$10 DOWN puts the complete PHOTOFACT Library in your shop—and you have up to 30 months to pay. See your Sams Distributor today, or write to Howard W. Sams

NOW IS THE TIME TO JOIN

"PEET"

THE POWERFUL NEW PROGRAM FOR QUALIFIED TECHNICIANS

If you now own a PHOTOFACT Library or plan to own one, you can apply for membership in "PEET." It's the first industry program really designed to build powerful public acceptance for the Service Technician who qualifies. Builds enviable prestige and business for its members. Benefits cost you absolutely nothing if you qualify. Ask your Sams Distributor for the "PEET" details, or mail coupon today.

HOWARD W. SAMS & CO., INC.
1728 E. 38th St., Indianapolis 6, Ind.

- Send me full details on the new "PEET" Program.
- Send full information on the Easy-Buy Plan and Free File Cabinet deal.
- I'm interested in a Standing Order Subscription.
 - I'm a Service Technician full-time; part-time

My distributor is _____

Shop Name _____

Attn: _____

Address _____

City _____ Zone _____ State _____

"SERVICE-ENGINEERED"

TEST EQUIPMENT

helps you make more profit

Jackson

All Jackson test equipment is "Service-Engineered" for service work. It is designed to give you the accuracy you need, combined with speedy, profitable operation. That's why smart servicemen are switching to Jackson. Your distributor will be glad to demonstrate Jackson equipment to you to prove the point.

DYNAMIC® TUBE TESTING

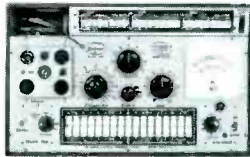

Model 658—Finest service tube tester made. Makes more tests, more accurately and faster.

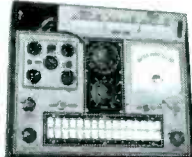

Model 648R—Combines sequence switching with time-proved Jackson Dynamic testing technique.



Model 598—Low cost Dynamic circuit with convenient Lever Switching. Many features.

Power Chart Available for Any of These Tube Testers

ALIGNMENT



Model TVG-2—Combination Sweep-Marker Generator for TV or FM servicing.



Model CRO-2—Finest service 'scope made. Wide band and high sensitivity. Flat to 4.5 MC.

TEST AND MEASURING



Model 590—Accurate 7" VTVM. Fast warm-up. Measures AC and DC Volts and Ohms.



Model 591—Wide Range Capacitance Checker. Checks capacity from 10 uuf to 1000 uf.



Model 655—Wide Range Audio Oscillator. Sine wave output 20 cycles to 200,000 cycles.

TIPS for TECHS

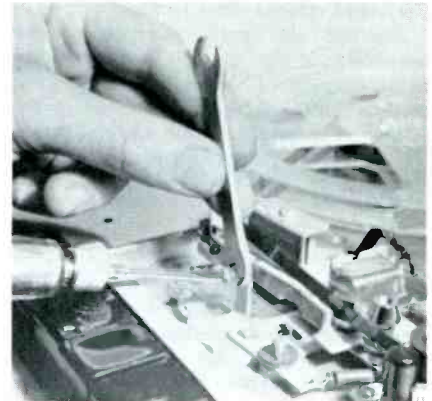

Adjusting Recorder Pad Pressure

Proper pad pressure is essential if a tape recorder is to perform properly. Adjust the pressure pad for firm and intimate contact with the head, but not so tight the tape can't pass easily. Low or erratic output is a common sign of improper pad pressure.

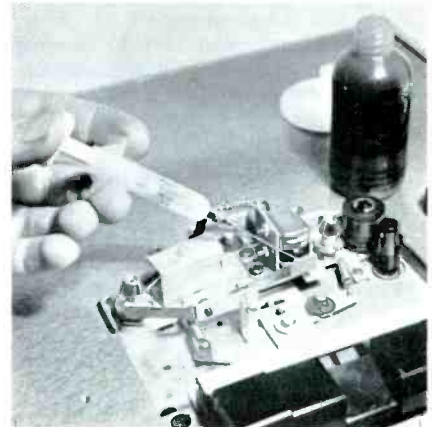

Use Syringe to Doctor Recorder

A medicinal syringe makes it possible to apply lubricant to the head and other parts of a recorder quickly and easily. The needle can reach into tight places that are inaccessible to a brush or cotton swab.

Temporary Repair for Antenna Clip

Should the spring of a TV antenna "clothespin" clip suddenly break, wrap a rubber band around the body until a replacement can be obtained. This will restore the spring action and allow it to be used temporarily.

See your distributor or write: **THE JACKSON ELECTRICAL INSTRUMENT COMPANY**

124 McDonough Street, Dayton 2, Ohio

In Canada: The Canadian Marconi Co.

Jackson



Airbrush for Recorder Cleaning

Tape a length of soda straw or wire spaghetti to an artist's brush and you have an efficient airbrush for cleaning tape recorders. Loosen dust particles with the brush, then blow them away with the soda straw or spaghetti.



Flux-Can Lid Brightens Wires

A slot cut in the edge of a flux-can lid will come in handy for brightening the tip of a wire. To clean and brighten a corroded wire tip, just slip it into the slot and pull it toward you a couple of times. The sharp tin edge will do a fast, efficient job.

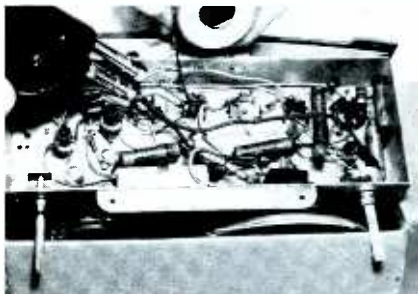

Box Is Chassis "Cradle"

When you have to turn a radio, amplifier, or hi-fi chassis upside down for servicing, a cardboard box makes a handy chassis "cradle." It's much better to rest the chassis in the opening of the box than to lean it against tubes, transformers, and other damageable parts mounted on top.



use **RCA**

"PREMIUM" TUBES

for top reliability in critical industrial applications

Where maximum reliability is a must, protect your equipment by using RCA "Premium" Tubes. These premium-quality tubes are engineered and tested to the most exacting military and industrial standards...they're available from your RCA Industrial Tube Distributor.

Tight quality control in the selection of materials and parts plus stringent and continuous testing maintain the high quality and dependability of every RCA "Premium" Tube. You get more out of RCA "Premium" Tubes because RCA puts more into them.

PROTO-TYPE	"PREMIUM" TYPES
OA2	6073 • OA2-WA • 6073/OA2 • 6626/OA2-WA
2D21	5727 • 2D21-W • 5727/2D21-W
6AK5	5654 • 5654/6AK5-W • 5654/6AK5-W/6096
6AL5	5726 • 5726/6AL5-W • 5726/6AL5-W/6097 • 6663/6AL5
12AT7	6201 • 12AT7-WA • 6679/12AT7
12AU7	5814-A • 5814-WA • 6189/12AU7-WA • 6880/12AU7-A
12AX7	5751 • 5751-WA • 6681/12AX7

The table above lists the "Premium" types pictured above together with their prototypes. For a complete list of RCA "Premium" Tubes, get in touch with your RCA Industrial Tube Distributor. He'll give you immediate, off-the-shelf delivery of any types you may need.



RADIO CORPORATION OF AMERICA
Electron Tube Division
Harrison, N.J.



rebuilding a **BURNED-UP** circuit

by Stan Prentiss

The customer literally yelled "FIRE" as I took his service call over the telephone. After frantic instructions to pull the line plug, fifteen minutes of hard riding brought equipment and body to the scene; but it was no use. This set was roasted (see Fig. 1), and just about anything could be wrong!

Being human, we're all inclined to tell a poor soul who's had this unfortunate experience to go buy another set. But it just might be that he's had "old faithful" for nine or ten years and cherishes it the same way an auto fancier would prize Uncle Henry's first Model T. Then a mess such as this becomes a good challenge to our individual capabilities, and presents an opportunity to pocket a pretty fair service fee if we are successful.

Back to the shop and up on the bench goes old "rare and reeky." There ought to be something here we can salvage! Check to see how many of the receiving tubes are still good, and test the picture tube for "quality" and absence of gas. Now get ready to measure the output of the power transformer *without* DC load. First, go through the burned forward section of the receiver and raise all AC filament wires above chassis so there will be no AC shorts. Remove the low-voltage rectifier from its socket and apply

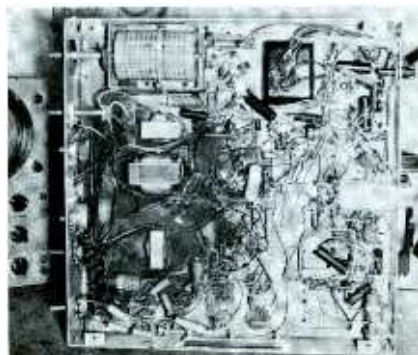

Fig. 1. Fire seared the front section of the chassis, leaving this mess.



Fig. 2. These burned parts were replaced after complete check of chassis.

power to the receiver. With your voltmeter set to AC, measure the stepped-up line voltage to ground from pin 4, and then from pin 6, of the rectifier socket. Refer to the schematic for the correct value of this voltage.

If all's well so far, it may be possible to check the action of the power transformer *under load*. Separate (but don't cut) the burned wires in the singed part of the receiver, and position them so they neither touch one another nor contact the chassis. Measure the resistance at the output of the low-voltage rectifier (pins 2 and 8). Unless there are shorts—and there may not be any—the meter reading should exceed 10K ohms. Replace the rectifier tube and apply power to the set. You should measure full B+ voltage, but you may or may not get a picture. Actually, at this stage, you don't really need one. This is only a quick check to find out what shape the power supply is in, and you shouldn't leave the receiver running in its present condition any longer than necessary to check the B+ voltage.

Shut off power, and rev up the ohmmeter. Carefully measure the value of each potentiometer on the front panel. The fire may have changed the value of perhaps half of them. Reconnect any leads you may have disconnected (the burned ones, too) and make a quick check of the DC resistance of the filter choke. Also have a look at the audio

and vertical output transformers. Chances are, even though these may appear rather well scorched, that only their paper covering has been singed and their internal wiring and insulation is as good as ever. But this you really won't know until the receiver is operating. Therefore, allow for possible replacement of one or more of these units as you prepare to itemize the estimate.

Figure about 50% of the total retail value of the three big inductances; add several dollars for hook-up wire; and also include estimates for a new on-off switch and volume control, three or four front-panel potentiometers, several carbon composition resistors, a few terminal strips, a new bleeder resistor for the low-voltage supply, at least two video or sound IF transformers, several new tubes, and a labor fee you consider reasonable for the job. As for labor on a job of this sort, you can estimate anywhere from 15 to 30 hours, depending on the period you've spent on the estimate, how thoroughly you've decided to do the job, and how much time you have available. In any guarantee, be sure to specify replacement of any new parts that fail in the warranty period, but cash on the barrelhead for any old ones that break down following the repairs. (If there's grief ahead, you'll know in less than two

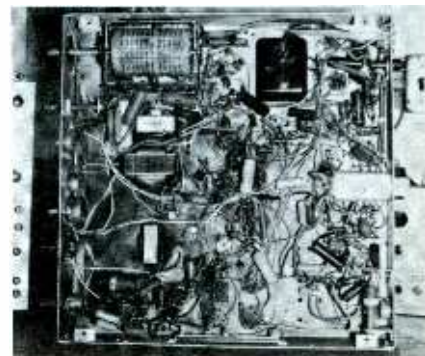

Fig. 3. Careful cleaning and rewiring restored chassis to normal operation.

weeks.) Extra charges for any additional labor that might be involved in further repairs is up to the individual shop.

Actually, not too many old parts in this particular set are in bad enough shape to need replacement. They make a very modest pile (Fig. 2) when heaped together. Surprisingly, even though three transformers were a little charred in the fire, they perform as well as new when the restoration work is completed on wiring, fixed resistors, pots, and tubes. Rewiring is easy — just a matter of point-to-point replacement of all lengths of wire on which the insulation is burned. A touch-up of IF alignment, with special attention to the newly-installed transformer, helps bring back an extra-sharp picture. The chassis looks more presentable when the blackened area is cleaned with a window-washing solution that dissolves much of the soot. Fig. 3 shows the final results.

How It All Happened

You may well wonder how such a holocaust occurred, so here's the story: About two weeks before it happened, a technician was called in to remedy a case of horizontal flopping. A new 6AU6 reactance tube in the horizontal section cured this, but he still noticed a curious ripple in the picture about a third of the way from the top of the screen. It looked almost like a narrow band of diathermy modulation. He suggested to the owner that this be remedied, but was told that the symptoms went away when the receiver was snapped off and back on again. The technician patiently explained that this was a bad sign, that the receiver must not be frequently turned on and off, and that the symptom should be investigated and repaired. The owner said he didn't want to spend any more money just then.

Well, you can see what finally happened. After many years of use, the insulation on the leads inside the set had dried out and become brittle. Apparently, a wire carrying AC line voltage was lying next to a B+ feeder or signal lead, and leakage between the conductors produced the strange symptom. The AC finally arced through both layers of insulation and set off the spark

SYLVANIA

SEMICONDUCTOR

DEVICES

... for high quality, low prices!

- Silicon Rectifiers
- Power Transistors
- Diodes • Transistors

Follow the leaders... the profit leaders in the electronic servicing field! When you have to replace a silicon rectifier or a power transistor, or any diode or transistor, you will find it in the Sylvania line. That's the way to save time, keep costs down and profits up.

For immediate delivery see

your SYLVANIA SEMICONDUCTOR DISTRIBUTOR

NEW service-dealer's "SEMICONDUCTOR COMPLEMENT MANUAL" — only 50¢. Now at your Sylvania Distributor's. A time-saving guide to semiconductor replacements. Gives set manufacturers' parts numbers with corresponding transistor-type numbers for cross-reference. Gives U. S. equivalents of foreign transistor types. Get your copy from your local Sylvania Distributor, or from Sylvania, 1100 Main Street, Buffalo 9, N. Y.

Check your stock and fill in with quality-assured Sylvania semiconductors. Sylvania Semiconductor Division, Woburn, Mass.



SYLVANIA

Subsidiary of **GENERAL TELEPHONE & ELECTRONICS** 

DON'T buy an expensive CAR RADIO (unnecessarily)

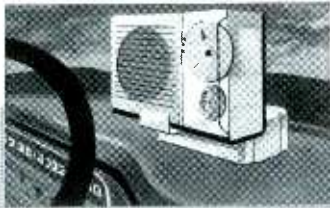

- magnet base**
Instantly removable prevents theft!
- adjustable**
Fits any size pocket transistor large or small
- no antennas!**
Built-in set antenna does the job
- no wiring!**
Even motor suppressor are unnecessary

Cardio master

Converts A Transistor Radio Into A Car Radio

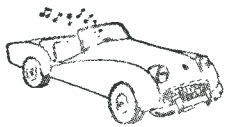

For All Makes of Cars and Trucks

Only \$4.95 with Full Profit Margins



Cardio master is a super powerful permanent magnetic device designed to hold a portable transistor radio in the area of a car's windshield in such a manner as to make it operate as an auto radio. No installation, wiring, additional antennas, or motor suppressors are required. Car's owner can instantly remove a radio from the Cardio master for use as an ordinary portable or to avoid the possibility of theft while the car is parked.

Volkswagen, Opel, Vauxhall, MG, Simca, Fiat, Renault, Ford, Chrysler and General Motors . . . to name a few. Ideal for truck drivers since Cardio master requires no installation, and can be removed instantly.

Increased sale of transistor radio and replacement batteries will add to the BIG profits to be derived from the sale of Cardio master. See your parts jobber or write for bulletin PF-6.

MFG. BY R-COLUMBIA PRODUCTS CO., INC. HIGHWOOD, ILL.

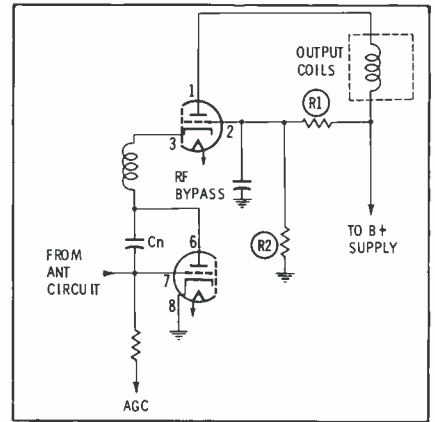

Fig. 4. Schematic of cascode RF circuit, stripped down to bare essentials.

that cost the frugal customer many a hard-earned buck.

When and if you tackle a fireball such as this, allow me to offer two small suggestions: Make sure you'll be paid for the estimate if the customer doesn't give you the work, and be darned sure you're able and willing to see the job through. I've come across one or two "struck by lightning" jobs that were worse, but not much . . .

A Cascode Case

If you've serviced many cascode tuners, you've probably run into more than one case where a grid-circuit resistor in the second section of the dual-triode RF stage burned out as a result of a shorted tube. I recently encountered an interesting twist on this tale, involving a Philco Model 51T2130—one of the oldest TV sets to use a cascode tuner. The case history of this '51 model will give us an opportunity to study the conditions which make this circuit vulnerable to grid-resistor trouble.

Before getting into the "meat" of the case, let's analyze the basic cascode layout with the aid of the simplified schematic in Fig. 4. An outstanding peculiarity of the circuit — at least to the uninitiated — is the fact that B+ is applied only to the plate of the upper or second section. The reason for this feature is simple: The two triodes are hooked in series across the B+ supply, and the same plate current flows through both.

The signal input is from the antenna circuit to the grid (pin 7) of the first section. This stage operates as an ordinary grounded-cathode, grid-driven triode amplifier, with a neutralizing capacitor (Cn) wired

3¢

will start you on a new road to additional profits and happy customers with speaker repair.



Attach this coupon to a Post Card and mail. We will send you the complete story.

Your Name _____
 Company _____
 Street _____
 City _____
 Send to **WALDOM ELECTRONICS INC.**
 4625 WEST 53RD STREET, CHICAGO 32, ILL

ask the "Man-on-the-Roof" why he prefers *South River*

TWO TO A SET

RATCHET TYPE CHIMNEY MOUNT
 Model RT (Galv. Banding)
 Model RT-ST (Stainless Banding)

FASTEST, SIMPLEST, MOST CONVENIENT EVER MANUFACTURED — Mounts in 2 simple steps. Completely factory assembled with no eye-bolts, banding clips, nuts, etc. to handle. Furnished with flat-lay, non-colling banding, heavy gauge embossed, welded steel construction. Forged heat treated Alum. ratchets.

SOUTH RIVER METAL PRODUCTS CO., INC. pioneer & outstanding producer of finest line of antenna mounts
 South River, New Jersey
 Canada: Len Finkler & Co., Toronto

between plate and grid. The output signal appears at the plate and is coupled to the cathode (pin 3) of the second section. This latter stage is a cathode-driven or grounded-grid circuit, meaning that the cathode voltage is varied at an RF rate while the grid voltage is maintained at a constant DC level. A small bypass capacitor is connected between the grid (pin 2) and ground to keep RF signals out of the grid circuit.

The grid is not literally grounded for DC—only for AC. Since the two triode sections are series-connected across the B+ supply and have nearly identical values of dynamic plate resistance, the voltage at pins 3 and 6 will be roughly half of B+, or somewhere around 120 volts. With such a high voltage on the cathode of the second stage, a highly positive grid voltage is also necessary in order to maintain proper bias. The required DC potential is almost always obtained from a resistive voltage divider across the B+ source — for example, R1 and R2 in Fig. 4. If these resistors are fairly equal in value, the voltage at their junction will be in the required 120-volt range. With a little juggling of the resistance ratio between R1 and R2, the set designer can establish the exact grid potential needed for any given circuit.

This divider circuit is the culprit in many cases where replacement of a shorted cascode RF tube fails to restore a set to snow-free operation. A short between pin 3 and the heater is likely to drop the second-stage cathode voltage from a positive 120 volts down to nearly zero. Meanwhile, the grid voltage is held well above 100 volts; so a surge of grid current finds a path back to B+ through R1. Is it any wonder that the resistor overheats?

Sometimes this divider network acts up for no reason other than old age. With B+ bleeder current passing through R1 and R2 for thousands of hours, they may eventually change enough in value to alter the grid voltage and bring on a "snow-storm."

A slight change in the resistance ratio between R1 and R2 might well have a noticeable effect in some cases, but not in others. The seriousness of the symptoms will depend a great deal on the location where the set is used, since the amount

of AGC bias has a great influence on DC voltages in both sections of the cascode circuit. (Remember, since the two triodes are in series, the cathode and plate voltages of the second stage will be affected by any change in plate current of the AGC-controlled first stage.) If the set has an AGC control, it can often be adjusted to mask symptoms of snow or overloading, and a discrepancy in second-stage grid voltage may never be noticed for the life of the set. However, if you have reason to suspect poor performance of a cascode RF amplifier, the bias on

the second triode is worth checking.

Now, About That Philco . . .

With plenty of solid background material under our belts, let's get back to the case history of that '51 set I was telling you about. A new outside antenna had just been installed — mainly to eliminate ignition interference, but also to reduce snow, which had been unusually heavy for the strong signal area in which the set was located. The owner complained that the snow was still not completely cleared up.

The antenna crew had used 72-



FIND TUBE TROUBLES OTHERS MISS!

A New Dynamic Approach

Check over 1300 tubes for

- Cathode Emission
- Grid Emission
- Leakage
- Shorts
- Gas

SENCORE "MIGHTY MITE" TUBE CHECKER

Answers the needs of the fast moving, profit minded serviceman who hates time consuming call backs. A "mite" to carry but a whale of a performer with more efficiency than testers costing much more.

New unique circuitry tests for grid emission and leakage as high as 100 megohms yet checks cathode current at operating levels. Special short test checks for shorts between all elements. The MIGHTY MITE will test every radio and TV tube that you encounter (over 1300!) plus picture tubes. Set up controls as easy as "A B C D" from easy to follow tube chart. New tube charts provided free of charge.

AND check these added Sencore servicing features: • Meter glows in dark for easy reading behind TV set • Stainless steel mirror in cover for TV adjustments • Rugged, all steel carrying case and easy grip handle • Smallest complete tester made.

Model TC109.....DEALER NET **59⁵⁰**

Ask your distributor for the "MIGHTY MITE" with the mirror in the cover

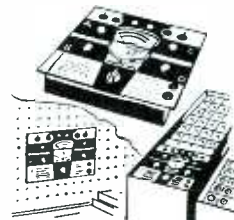

Use it everyday in every way. Especially designed so you can transfer inner chassis to your tube caddy, bench or counter. Only 9" x 8" x 2 1/2".



SENCORE
ADDISON 2, ILLINOIS

3 POPULAR SECO TESTERS
...Top Choice of Service Technicians
EVERYWHERE



COMPLETE, PORTABLE TUBE TESTER

MODEL 107



Provides 3 important tests: amplifier types tested for gain by Dynamic Mutual Conductance method—power types tested for cathode current by Cathode Emission method—all types tested for shorts and grid error by Grid Circuit Test developed and patented by Seco. Dynamic Mutual Conductance Test pre-wired for fast set-up. Cathode Emission Test done by free point pin-selector method—will not be obsoleted. Self-contained in portable case.

MODEL 107—Wired and factory tested \$139.50 NET

NEW! LOW-COST GRID CIRCUIT AND TUBE MERIT TESTER

MODEL 78



Designed expressly for TV servicing—easy to set-up and simple to use, a highly accurate professional tester! Complete coverage of all modern TV tube types as well as all heater type radio tubes including hybrid types, using only 5 sockets. Incorporates patented Seco Grid Circuit Test plus reliable Cathode Emission test, also checks filament continuity and provides open element test. One easy-to-read meter. Two-stage DC amplifier isolates meter from tube under test to protect meter—provides a wide range of load currents and test conditions. Complete in a portable carrying case, with pin straighteners, and index-chart for quick set-up data.

MODEL 78—Wired and factory tested \$69.50 NET

NEW! DYNAMIC TRANSISTOR CHECKER

MODEL 100



This low-cost transistor checker safely tests PNP and NPN transistors either "in or out" of circuit. Covers wide range of types: small signal including "drift" types, medium power; and power types. Provides positive check for "opens," shorts, and gain—condition indicated by means of a visual indicator plus jacks for meter or scope. Also provides GO-NO-GO test at practical currents—and permits matching of similar types. Will not be obsoleted—no set-up or roll charts required! Compact, lightweight, complete, and ready-to-use.

MODEL 100—Wired and factory tested \$19.95 NET

Sold only through Electronic Parts Distributors

Write today for FULL DETAILS

SECO MANUFACTURING
 5015 Penn Avenue South, Minneapolis, Minnesota

NAME _____ PF-60
 ADDRESS _____
 CITY _____ ZONE _____ STATE _____

East Canada: Davaco Agencies, Ltd., Montreal, Quebec
 West Canada: Ron Merritt Co., Vancouver 1, British Columbia

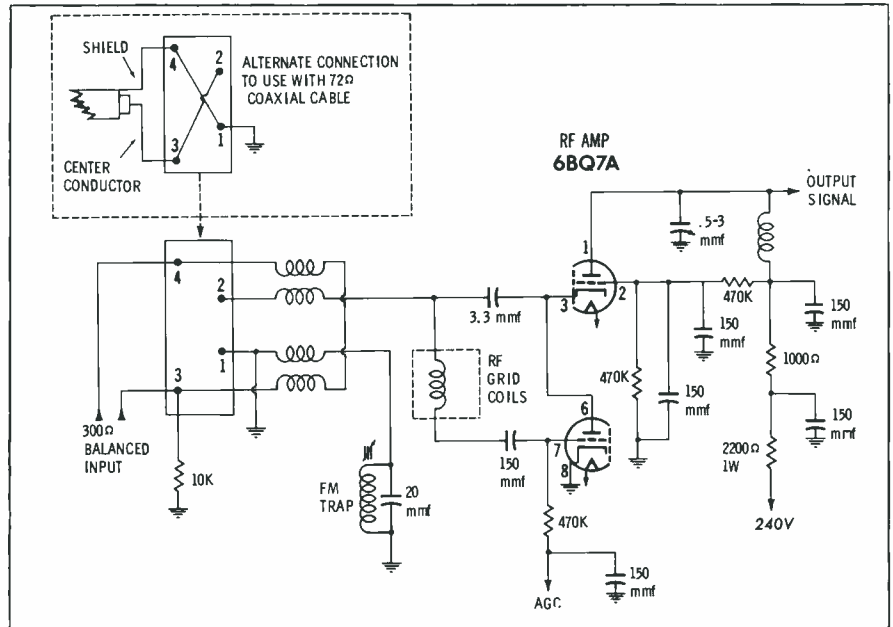

Fig. 5. RF stage of '51 Philco set as actually wired; note coax hook-up.

ohm coaxial cable for the lead-in in order to provide shielding against the interference. Unfortunately, they had mismatched the coax to a 300-ohm folded dipole; furthermore, they had failed to rewire the set's input terminals to receive a 72-ohm unbalanced line (see Fig. 5). The signal "brute-forced" through this double mismatch, and the picture on the screen was quite passable. However, some snow definitely did remain, even after the antenna terminals were properly rewired.

Substitution of all tuner and IF tubes provided no clues to the loss of gain. Glancing at the schematic and the voltage chart, I took a quick round of measurements on the 6BQ7A RF amplifier. With no signal input, I found -0.65 volt on the grid of the first stage — nothing wrong here! On the other hand, the second-stage grid (pin 2) measured

noticeably less than the 110 volts which should have been present at this point. All other voltages were approximately normal; thus, the insufficient positive voltage at pin 2 could only mean an excess of bias on the second stage.

Removing the tuner shield, I looked at pin 2 of the 6BQ7A socket and found two resistors with indicated values of 470K ohms each. According to my ohmmeter, both of them had risen in value to about 850K ohms, and so I promptly replaced them. Taking a look at the screen after this repair, I was still not satisfied that the trouble had been completely cured. I looked more closely at the schematic to see what else might be wrong — and did I get a surprise! The set was actually wired as shown in Fig. 5, with the second RF stage supplied with fixed bias as described

SERVICEMEN KNOW!

Here they pay less and get the best

HUSH®

Chemically-Electronically, engineered for Tuners and Switching Mechanisms.

When New HUSH is applied it will wash-away that dirt, leaving clean and positive contacts protected by a lasting lubricant. New HUSH is made from the finest solvents and it contains Electro-Silicone oils.

Also available—2 oz., 8 oz., 32 oz. containers 6 oz. Spray can **\$2.25 net**

EVER-QUIET®

Since 1949

VOLUME CONTROL AND CONTACT RESTORER

EVER-QUIET is a free-flowing liquid that leaves no powder residue. Scientifically designed to seep around the shaft and penetrate the control or potentiometer, cleaning the contacts and leaving a safe protecting film. Harmless to metals, wire or carbon.

Also available—32 oz. containers 6 oz. Spray can **\$1.59 net**

2 oz. Bottle & dispenser **79c net**



CHEMICAL ELECTRONIC ENGINEERING, INC. Matawan, New Jersey

"Eliminates Soldering"

PERFECT Audio

"PIN-PLUG" CRIMPER

SLIP WIRE IN "PIN-PLUG" INSERT IN TOOL, AND SQUEEZE JOB IS DONE



USE END OF BLADE AS SCREWDRIVER

U. S. Pat. 2,878,698
Canadian Pat. 592,702

USE END OF TOOL TO PUSH ON GROUND CONNECTOR

Useful in making hi-fi, audio and sound, radio, phono, and TV equipment connections.

only **\$1.25** C-rings 1c each

Get the tool that makes solid electrical pin-plug connections without soldering or destroying pin form. Use one end for pin crimping, the other to push on C-ring clamp for braided-shield ground connection. Nothing like it anywhere.

3 models: PT-1 for 3/32" pin diameter; AU-2 for 1/8" pin diameter and installing C rings; LC-3 for 5/32" pin diameter.

Available at your parts distributor.
Another fine product from:

BERNS Mfg. Co.
9853 Chalmers,
Detroit 13, Mich

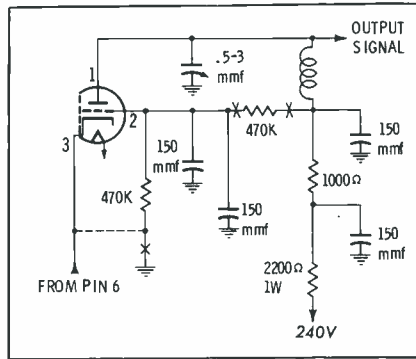

Fig. 6. Schematic gave a different layout, which worked well when tried.

above; however, the schematic (PHOTOFACT Folder 132-10) called for the different arrangement outlined in Fig. 6. Instead of having fixed bias, the second stage was self-biased by connecting a single 470K-ohm resistor between grid and cathode. The voltage divider across B+ was not used at all.

What was this — a factory production change, or the work of some well-meaning but misinformed technician? I decided to browse through a number of old Philco TV schematics in search of an answer. As far as I could tell from these, the self-biasing arrangement was the original circuit used in the oldest cascade tuners built by this manufacturer. In 1952 and later years, Philco changed over to a fixed-bias setup similar to Fig. 5—the same type of circuit still being used by various manufacturers today. Perhaps the set on my bench contained one of the earliest fixed-bias tuners ever to reach production; or, sometime during the long life of this receiver, perhaps someone replaced the original tuner with one from a slightly later model. At any rate, I began to wonder if it might be a good idea to convert the tuner to the form shown in Fig. 6. I tried this simple change — and you should see the picture on this set now! The black, gray, and white tones make an image as pretty as a deluxe glossy photograph.

Mind you, I'm not recommending that all cascade tuners be converted to self-bias. In most units, the resulting change in grid voltage on the second stage is likely to be for the worse instead of the better. This story just goes to show that it sometimes pays to try out an alternate hook-up if you know one has been employed in the specific model on which you're working. ▲



Let's talk about you...

... and the extra profits you're missing, if you haven't added the sale and installation of FANON Intercoms to your regular service business. Low priced and easy to install, you can interest your present service customers in an intercom as a "baby sitter," intercom for kitchen to bedroom, or as a "door-answerer." More than half of service outlets install intercoms in homes, local restaurants, bars, and businesses. Are you getting your share of this extra profit?

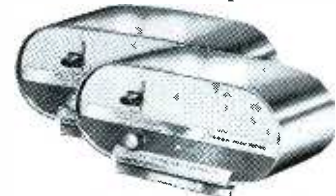

FW-50 FANON WIRELESS INTERCOM

No wiring needed! Simply plugs into standard AC outlet. No hum or buzz. 2-station system \$89.50, list.

"Works where others fail."

OTHER 2-STATION FANON INTERCOMS FROM \$19.95, list.

Ask about the complete line. You profit from sale and installation!

Let us show you what you're missing! Sample folders, specs, displays, etc., plus a BIG glossy photo of our girl Jayne!

FANON

FANON Electronic Industries, Inc.
Dept. PF-6 98 Berriman St., Brooklyn 8, N. Y.

Name _____
Firm Name _____
Address _____
City _____ State _____

RESIST-O-CADDY



FREE! with any of 4 Handy-Pak Carbon Resistor Assortments
20 Values

\$14⁴⁰ to \$28⁸⁰

Dealer Net

•
COMPACT
•
HANDY
•

Plastic Pouch Fits Tube Caddy or Tool Kit

Order from your IRC Distributor



INTERNATIONAL RESISTANCE COMPANY
DISTRIBUTOR SALES DIVISION
414 N. 13th STREET • PHILADELPHIA 8, PA.

'Dual Match'



set coupler

Profit-Wise TV Servicemen
Choose MOSLEY!

PERFORMANCE*

* Nothing satisfies customers as much as performance . . . That's what Mosley 2-set TV couplers provide. Rated **BEST** in quality for weak signal reception by a nationally known independent product rating group. Write today for free literature.

Mosley
Electronics, Inc.
ST. LOUIS 14, MISSOURI



"He got the idea from a science fiction movie."

for power tools to your liking



1/2 H.P. SOUPED-UP SABRE SAW
MODEL 909 ONLY

Only portable electric saw that can cut 4x4's at 45°, 6" board or log, yet cut any pattern, too! Cuts up to 1/2" steel, 2" pipe. Complete with rip guide, circle cutter, 45° tilting base plate and 7 blades.

Say WEN for Drills, Solder Guns, Sanders
5810 NORTHWEST HIGHWAY, CHICAGO 31

Keyed AGC

(Continued from page 25)

the only ones that can produce these symptoms.

How can we definitely determine whether or not the AGC circuit is to blame? Reducing the RF signal input by disconnecting the antenna lead will often restore a picture of sorts if the AGC circuit is at fault. This is a quick and easy check that can be made in the home. On the bench, the fastest check you can make is to ground the AGC line; this generally gives you a fairly positive indication of whether or not you have AGC trouble. If you are still in doubt, *clamp* the AGC line with a variable negative DC supply to simulate the normal AGC bias voltage.

While we're on this subject, it's not always necessary to ground or bias both the RF and IF branches of the AGC line in order to check system operation. One branch (preferably the IF line) is usually sufficient.

Tracing Tools

Once the trouble has been isolated to the AGC section, how do we go about tracing down the offending part or parts? Tube substitution is a foregone assumption. What next?

Voltage Measurements

As for any voltage-supply circuit, the normal troubleshooting process begins by rapidly making a series of voltage tests with a VTVM. We watch only for meter deflection, noting its polarity and degree of swing, without paying any attention to critical measurements. (There'll be time for that later.) In a matter of

Table 1. DC Voltages for Fig. 3 Under Various Trouble Conditions.

AGC Keying V1	K Pin 1	G2 Pin 2	P Pin 3	G3 Pin 6	G1 Pin 7
No signal	55V	120V	32V	21V	55V
Normal	55V	115V	-2.5V	45V	55V
Overload	50V	115V	30V	30V	50V
Whiteout	0V	85V	-205V	4V	0V

1st Video IF V1	G1 Pin 1	K Pin 2	P Pin 3	G2 Pin 6	G3 Pin 7
No signal	32V	38V	140V	180V	35V
Normal	4V	7.5V	145V	145V	7V
Overload	16V	35V	145V	145V	34V
Whiteout	-200V	4V	180V	180V	4V

Video Output V4	K Pin 6	G1 Pin 7	G2 Pin 8	H Pin 9	RF AGC
No signal	.4V	.1V	100V	105V	2.5V
Normal	25V	.5V	100V	170V	-1.2V
Overload	35V	.2V	120V	130V	2V
Whiteout	.5V	0V	90V	90V	-175V

seconds, we can determine whether or not the various tube elements and AGC line junctions have the approximate voltages we expect to find.

When making these quick checks, we must remember that practically all service information shows voltages as they should be with no signal applied. Feeding in signals of various strengths will result in tremendous changes in some of the voltage readings. To prove our point, look at the four sets of voltages in Table 1, derived from the circuit of Fig. 3. In this table, the "normal" condition refers to a video-detector output signal of 3 volts peak to peak. As you can see, some voltages will vary quite radically—others very little.

Waveforms

Every one of the waveforms shown in Fig. 3 can yield important clues in tracing AGC troubles. They can readily be observed by using a direct probe and any service scope.

W1 and W2 verify what you see on the CRT when AGC trouble is present; for example, reduced peak-to-peak amplitudes will provide a snowy picture, and a case of 60-cycle hum bars (caused by heater-cathode leakage in one of the AGC,

PHONE
ED 9-9653

\$7.50

plus parts,
C.O.D. and postage charges

90 DAY
WARRANTY



Precision Tuner Service

ALL TYPES T.V. TUNERS REPAIRED AND ALIGNED TO FACTORY SPECIFICATIONS ON CRYSTAL-CONTROLLED SWEEP GENERATORS

24-HOUR SERVICE ON MOST TUNERS

UHF - VHF COMBINATIONS — \$13.50

See your local distributor or send to:

P.O. Box 272, 601 N. College
BLOOMINGTON, INDIANA

State make and model. Send all parts, tubes and shields

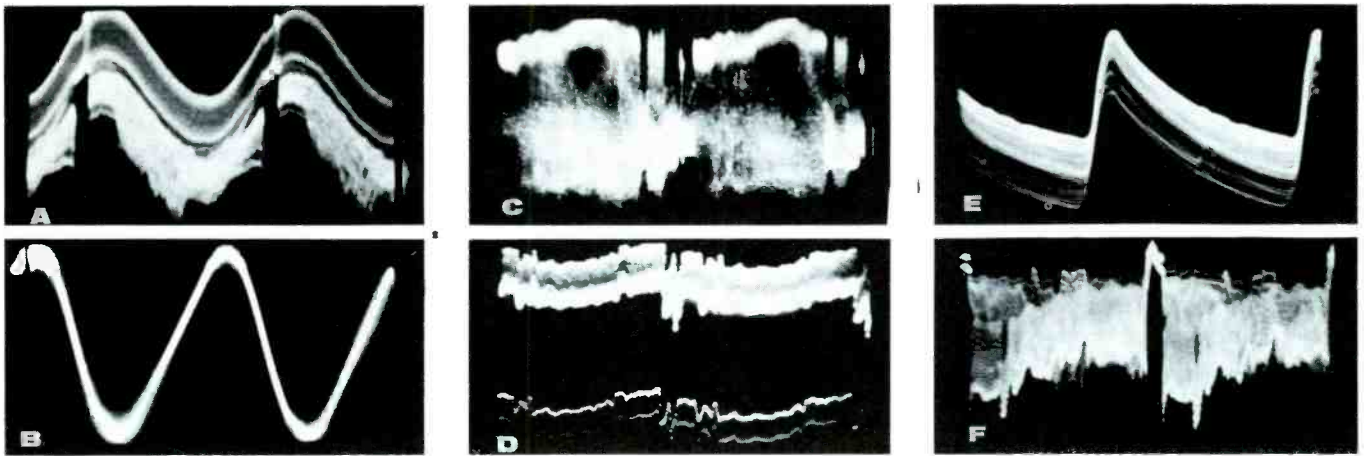

Fig. 5. Waveform distortions due to various AGC troubles described in text.

RF or IF stages) will cause W2 to appear as shown in Fig. 5A. (If the last-named effect were the fault of V5 in Fig. 3, the AGC-line waveform W6 would be distorted into the form shown in Fig. 5B.)

A condition of overdrive, negative picture, or unstable sync due to a lack of AGC bias voltage will also show up in W1 and W2. Fig. 5C shows the highly compressed sync pulses, characteristic of this trouble, which appear when the amplitude of W1 soars to 18 volts peak to peak. Fig. 5D is the same waveform distorted by such heavy overloading that a completely gray picture is produced. Of course, a condition of "whiteout" caused by a complete blocking of the RF and/or IF stages will cause the complete absence of either of these waveforms.

W3 deserves very close checking. The amplitude and shape of this signal has a profound effect upon the tube's conduction and the resultant AGC voltage. Even though most service manuals show W3 at a 7875-cps sweep rate, I personally like to check this waveform at 30 cps so I can see any ripple that might cause erratic AGC action. If you're ever in doubt about the quality of this grid signal, check it at both the vertical and horizontal sweep rates.

Since W3 is derived from W2, it should have the same basic characteristics; however, note that the relative amplitude of the sync pulses is somewhat greater in W3 than in W2. The pulses are accentuated by the peaking network of C32 and R43, a feature peculiar to the Zenith circuit.

The grid signal will vary in ampli-

NEW
SENCORE
Time Saver

**Pinpoint in Seconds...
HORIZONTAL & VERTICAL SWEEP TROUBLES**

Sweep Circuit TROUBLE SHOOTER
MODEL SS105
PROVIDES:

- UNIVERSAL HORIZONTAL OSCILLATOR
- HORIZONTAL OUTPUT CATHODE CURRENT CHECKER
- UNIVERSAL DEFLECTION YOKE
- DYNAMIC FLYBACK TRANSFORMER CHECKER
- VOLTMETER
- UNIVERSAL VERTICAL OSCILLATOR

The missing link in TV service...

SENCORE SS105 SWEEP CIRCUIT TROUBLE SHOOTER

IT'S A... UNIVERSAL HORIZONTAL OSCILLATOR. For direct substitution. No wires to disconnect in most cases. Traces trouble right down to the defective component. Variable output from 0-200 volts, peak-to-peak. Oscillator will sync to TV sync signal giving check on sync circuits.

HORIZONTAL OUTPUT CATHODE CURRENT CHECKER. A proven method that quickly checks the condition of the horizontal output tube and associated components. Adaptor socket prevents breaking wires. Easily replaceable Roll Chart gives all necessary pin, current and voltage data. New Roll Charts are Free.

UNIVERSAL DEFLECTION YOKE. A new, simple way to determine yoke failure accurately—without removing yoke from picture tube. Merely disconnect one yoke lead and substitute. If high voltage (also bright vertical line) is restored, TV yoke is defective.

DYNAMIC FLYBACK TRANSFORMER CHECKER. Merely flip switch to "Flyback Check" and meter will indicate condition of flyback transformer, in degrees of horizontal deflection. Extremely sensitive and accurate; even shows up one shorted turn on flyback.

VOLTMETER. For testing bootstrap, screen and other voltages. Direct-reading voltmeter. 0-1000 volts.

UNIVERSAL VERTICAL OSCILLATOR. Checks oscillator, output transformer and yoke. Merely touch lead to component and check picture on screen.

SS105 is completely self-contained, nothing else is needed. New Improved Circuit... DEALER NET 42⁹⁵

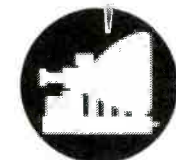

HORIZ. OSC.	VERT. OSC.
HORIZ. O.P. STAGE	VERT. O.P. STAGE
HORIZ. FLYBACK XFORMER	VERT. O.P. XFORMER
HORIZ. DEFLEC. YOKE	VERT. DEFLEC. YOKE

ALL PARTS
SENCORE
MADE IN AMERICA

SENCORE
ADDISON 2, ILLINOIS

tude as the result of variations in signal strength, and also according to the setting of the contrast control (which regulates the gain of the video output stage). In order to know what the amplitude of W3 should be under every signal condition, you *must* consider it in relation to W2. The full amplitude of W2 is impressed across a voltage divider consisting of series resistors R31, R34, and R35; the portion that appears across R35 becomes W3. Considering the values of these resistors, and following Kirchoff's law of voltage division, we should

expect W3 to have approximately one-sixth the amplitude of W2. And, sure enough, the actual peak-to-peak measurements are 60 volts for W2 and 9 volts for W3.

The input signal to the noise-immunity circuit (W4) is opposite in polarity to W3, with sync pulses forming the negative peaks of the waveform. Its amplitude is much lower than that of W3, and is usually variable by means of a FRINGE LOCK, SUPER RANGE FINDER, or similar control. When properly adjusted, W4 has very little effect on either sync or AGC operation, except for

the noise-cancelling feature which comes into play only when strong noise-pulse interference appears in the signal. A lack of amplitude in W4 causes loss of control over tube conduction, while an increased amplitude exerts excessive control and reduces AGC voltages. In the latter case, sync also becomes unstable because the 'BU8 is cut off by the sync-pulse tips in W4.

W5 represents the plate signal of the 'BU8. The amplitude of the keying pulses is about on a par with values typically found in ordinary pentode systems; this amplitude is not as critical as for triode keyers. Shape and timing of the pulses are more important than amplitude—assuming, of course, there's sufficient amplitude to produce electron flow. Since none of the systems shown include any component networks for altering the pulse shape, you can expect the 'BU8 plate pulse in these circuits to be satisfactory if a normal pulse is being generated by the flyback circuit. Excessive ringing in the horizontal stage may produce enough ripple in W5 to influence 'BU8 conduction. (If so, the ripple will be evident along the base line of the waveform.) However, this condition is likely to produce obvious symptoms of trouble and divert attention away from the AGC circuit.

The phase relationship between W5 and W3 has a direct bearing on AGC output. Any phase difference shortens the period of time wherein both conditions for AGC-tube conduction (plate voltage applied and the grid above cutoff) are met; the result is a lower AGC voltage.

W6 is a waveform never given in service manuals, since signal amplitude on the AGC line is negligible in a normally-operating receiver. In Fig. 3, maximum scope gain was used to view W6. The mere presence of any significant

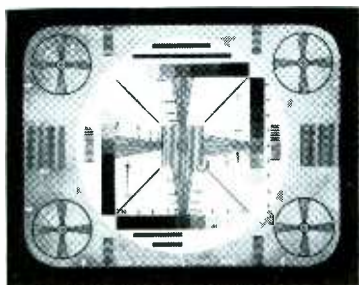

TV TIPS FROM TRIAD

NO. 8 IN A SERIES

"I was doing a little 'government' work for my grandmother last night," said Joe, the Junior PTM as he and Bill prepared to go to lunch. "She's a mystery fan and when one of those dark, low key, scenes is on the screen she has a crooked dirty gray line that wanders down the center of the picture. I've seen it on other sets, but it bothers more on that kind of show."

"I know what you mean," said Bill, "It's a type of malfunction caused by overshoot from sync spiking the blanking pedestal, and this can originate in either the transmitter or receiver if video overshoot is present. Sets without horizontal CRT blanking show it most. Sounds like you'll have to install a little pulse source to keep her happy."

"I wouldn't mind putting in a width coil," Joe said, "with a secondary winding because there is a mounting hole available next to the flyback, but since the set is a three way console I don't want to bring the chassis in, and the way the boss has the scope 'lashed up' for alignment I don't like to have to take it out to her house. If I could take the chassis out, connect up the parts and know I had the blanking polarity right I could do the job in 'jig' time."

"Polarity is no problem," said Bill, "you know that every tap on an autoformer type flyback between boost and the cathode of the damper is positive going with respect to the boost tap, and you can see the 'Start of Winding' of the width coil Primary and Secondary windings. If, for instance, you connect the 'Start' of the primary of the width coil to a more positive point on the flyback than the 'Finish,' the 'Start' terminal of the width coil secondary will be positive with respect to the 'Finish' terminal."

"I didn't know that, and I hope I can remember it when I get there," said Joe, and as his face lit up with a crafty smile, "How about coming along with me tonight?"

"No such thing," said Bill with a laugh, "I know she makes wonderful cake and coffee, but I'm leaving on a long vacation and just won't be available."

* * *

MORAL: You may not remember the polarity relations as Bill outlined them, but Triad explains Flyback polarities in PTM #1 and width coil relations on the Instruction Sheet which is packed "In The Box" with the product. If you would like copies of these charts and sheets drop a line to **Triad Transformer Corporation, 4055 Redwood Avenue, Venice, California**, and we will mail them to you.

Table II. Effects of Capacitor Failures in Circuit of Fig. 3.

Item	Defect	Symptom	Reason
C3	OPEN	Slight Overload	Restores Control of Low-Gain RF Stage
C3	SHORTED	Slight Overload	Restores Control of Low-Gain RF Stage
C9	OPEN	Overload	Introduces Keying Pulse into IF Stages
C9	SHORTED	Slight Overload	Restores Control of Final IF Stages
C10	OPEN	No Effect	Restores Slave Sensitivity Only
C10	SHORTED	Whitout	Increases AGC, Varies With System
C22	OPEN	No Effect	Only Restores Peaking of W3
C22	SHORTED	No Effect	Only slight Reduction of AGC
C23	OPEN	Overload	Will or Alters AGC Keying Pulse
C23	SHORTED	Weak Pix	Increases AGC Pulse and Control Voltage
C24	OPEN	Bends	Compensation of Sync Pulses
C24	SHORTED	Whitout	Restores Bias from Keyer Stage
C44	OPEN	No Effect	Restores Slave Sensitivity Only
C45	SHORTED	Overload	Increases Bias, Cutting Off Keyer

signal on the AGC line indicates trouble, and so a quick scope check of this line can lend a helping hand in many cases. Just for example, Fig. 5B has already shown a 60-cycle hum trouble; also, if C9 opens, you'll get a variation of W5 on the AGC line.

Troubleshooting

Now that we've examined the circuits involved, looked at the symptoms we may encounter, and studied our tools of troubleshooting (voltages and waveforms), let's put this information to work in tracing down several actual troubles.

Overloaded Pix

This is the usual result of insufficient AGC voltage being developed—but the lack of AGC can be due to a variety of causes. In one typical case, making a series of quick voltage checks, we come up with the voltages shown in Table I for an "overload" condition. What happened? A look at the screen tells us we have excessive signal, yet there are 17 volts of bias between the grid and cathode of the first IF! The grid voltage on the video output tube is close to the no-signal value. This keeps the plate and screen voltages of this tube at a low level, in turn holding the voltages on the keyer to almost the same values as for a no-signal condition. It just doesn't add up. We can see the overloaded picture—but where's the signal which is producing it? Clamping the AGC line proves we have AGC trouble; application of -4 volts results in a good picture.

In trying to repair a condition like this without using a scope, we'd just be groping in the dark. Trying component substitutions only leads to mass parts replacement, usually without success. We need a clue—and we find it in W1, which looks like Fig. 5C and measures 18 volts peak to peak. You'd expect such a strong signal to generate considerable negative DC voltage at the grid of V4 (Fig. 3), but *this* waveform is so distorted that it averages out to only -2 volts. Essentially the same waveshape appears for W2, W3, and W4; W5 is okay. What does W6 look like? See Fig. 5E. Here's the key to the whole trouble. There's a 6.5-volt sawtooth on our AGC line—the AC component apparently

lousing up the voltage reading at V1's grid.

Let's substitute for the IF-AGC filter C9. Bingo! Picture restored, problem solved. Incidentally, C9 has a lot more influence on set gain than does C3, the filter in the RF-AGC line.

Here's another example of using a good reasoning and troubleshooting technique to cure a case of overloading: Quick voltage checks at the 'BU8 show 55 volts at the plate (too high!); the same at the grid; and all other voltages on this tube about normal. The picture

is overloaded, so we can expect the IF grid voltage to be abnormally positive—and it is! The highly positive DC voltage at the plate of the 'BU8 is the key to this problem. Waveform analysis shows the grid to have about the same signal as in the last example, but the plate waveform looks like Fig. 5F. Hold it! Here's another key. There's no spike voltage as evidence of keying pulses—just 3 volts peak to peak of distorted video. In Zenith's version of the 'BU8 AGC circuit, the positive DC voltage on the plate will cause the tube to act as an

Transistor Radio Servicing CAN be Highly Profitable



The ONLY Complete Transistor Radio Service Lab

Everything you need for less than \$50



Check Transistors, Diodes, Rectifiers . . .

SENCORE TRC4 TRANSISTOR CHECKER

Accurately checks all transistors in hearing aids, radios and power transistors in auto radios. Tests for opens, shorts, leakage, current gain. Measures forward-reverse current ratio on all crystal diodes. Measures forward and reverse currents on selenium rectifiers. With set-up chart for accurate checking of each transistor. Size, 5x4½x2½". With batteries. DEALER NET **1995**





Replace Batteries During Repair . . .

SENCORE PS103 BATTERY ELIMINATOR

All-new "Transi-Pak," twin to TRC4 Checker above. Provides variable DC voltage to 24 volts; 1.5-volt biasing tap (a "must" for servicing Philco and Sylvania radios). Metered current output, to 100 ma. Handles 200-ma peaks. Two 200-mfd electrolytics provide proper filtering and low output impedance. No hum or feedback problems. Ideal for alignment using station signal; adjust IF slugs for max. current, also ideal for charging nickel-cadmium batteries. Size, 5x4½x2½". DEALER NET **1995**





Find Defective Stage in a Minute . . .

SENCORE HG104 HARMONIC GENERATOR

New signal generator designed primarily for fast signal-tracing of transistor radio circuits. No need to unsolder all transistors. Provides RF, IF and audio signals *simultaneously*, drastically cutting service time. Traces from speaker to antenna. Clear 1000 cycle note signal is heard in speaker from all good stages. Signal weakens or stops at defective stage. Equally as effective for testing TV, hi-fi and other audio circuits also. Size, 3½x4½x1¾". With batteries. DEALER NET **995**



Turn page for other



Time Savers

ALL PARTS



MADE IN AMERICA

SENCORE

ADDISON 2, ILLINOIS

'The Original'



wall-thru

Profit-Wise TV Servicemen Choose MOSLEY!

ECONOMY*

* You'll find using MOSLEY TV accessories to be truly economical because your work and time will command a better price. The more efficient installations result in satisfied customers . . . fewer callbacks! Install MOSLEY accessories—it pays!

Mosley Electronics, Inc.
ST. LOUIS 14, MISSOURI

BERNS PERFECT PIN-CRIMPER

Picture-Tube Repair Tool

Eliminates that hard soldering job.

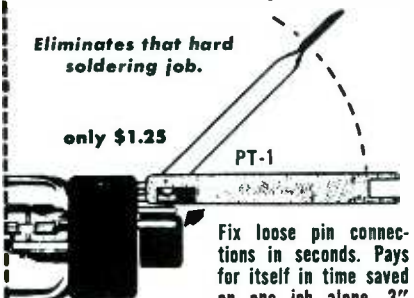

only \$1.25

PT-1

Fix loose pin connections in seconds. Pays for itself in time saved on one job alone. 3" long.

U. S. Pat. 2,878,698
Canadian Pat. 592,702

Intermittent operation of picture tubes due to defective solder connections at socket pins is easily corrected through the use of the Berns Perfect Pin Crimper. Actually a 3-in-1 tool that can also be used as a channel-selector wrench and screwdriver, it serves to notch pins and element leads to provide solid electrical connections. Pin keeps its original form.

3 models: PT-1 for 3/32" pin diameter; AU-2 for 1/8" pin diameter and installing C rings; LC-3 for 5/32" pin diameter.

Available at your parts distributor.
Another fine product from:

BERNS Mfg. Co.
9853 Chalmers,
Detroit 13, Mich

amplifier in the absence of keying pulses—so we still see some sort of output signal. Other manufacturers' circuits, which depend entirely on the keying pulses for conduction, will have no signal (and practically no DC voltage) at the plate when the pulses are removed.

In the case under discussion, a loss of W5 may be due to an open C33, a faulty winding on the fly-back, or trouble in the wiring. Ohmmeter checks put the finger on C33.

Whiteout or Snow

These symptoms indicate conditions exactly opposite from those which cause overdriving. The keyer may be conducting too hard and driving the AGC line too far in a negative direction, or the AGC distribution circuits may not be properly regulating the output of the keyer.

The troubleshooting technique remains the same. We still make rapid voltage measurements, scope checks, critical voltage and resistance measurements, and finally component tests.

Let's see how this approach works on the symptoms shown in Fig. 4C; the resultant voltage readings are listed in Table I. Our rapid voltage checks immediately indicate trouble in the keyer stage. Every voltage swings so far out of line we can't help but notice. There's little need to grab the scope. With voltages like these, it's evident the plate pulse is present—but the blank raster means there won't be any grid signal on the 'BU8. Zero volts on the cathode is the key in this case. If varying the AGC control doesn't increase this voltage, the trouble has to be a shorted C34. Easy, huh?

Let's try another one. This time we have a weak picture; the AGC control varies the picture, but will neither return it to normal nor white it out. The cathode measures 50 volts, screen 115 volts, plate .7 volts, control grid 30 volts, and noise grid 50 volts. All voltages approach the "no-signal" condition with the exception of the plate. We find the IF grid over 6 volts negative with respect to cathode—probably enough bias to account for the weak picture. The detector and video stages reflect a reduced signal by indicating nearly "no-signal" voltages.

The scope shows an undistorted,

but weak, composite video signal for W3, and a 400-volt keying pulse at the 'BU8 plate. Why is so much AGC voltage being developed by the keyer? Time to get an ohmmeter! Finding low ohms at the plate, we're on the right track. Look there—C33's shorted.

Capacitor Failures

Take special note that different types of failures in the same component can produce different symptoms and effects. To illustrate this point, we've grouped capacitor troubles in Table II for your convenience. While this chart should aid you in diagnosing AGC failures, don't rely entirely on the idea that one specific component is always to blame for your trouble. You'll often find that several parts go bad over a period of time, remaining unnoticed until the whole circuit deteriorates enough to produce trouble.

The important thing is to become proficient in AGC troubleshooting. Then, no matter what trouble develops, the systematic and logical procedure outlined here will permit you to breeze through AGC service jobs. ▲

TARZIAN Offers 48-Hour, Direct Factory Service on Tuner Repairs



only \$8.50

Price Effective Jan. 1, 1960

That's right. Net, \$8.50 per unit and \$15 for UV combinations, including ALL replacement parts. 90-day warranty against defective workmanship and parts failure. Tuners repaired on approved, open accounts. Replacements offered at these prices* on tuners not repairable:

- VHF 12 position tuner \$22.00
- VHF 13 or 16 position 23.00
- VHF/UHF combination 25.00
- UHF only 15.50

*Subject to change

 Tarzian-made tuners are easily identified by this stamping on the unit. When inquiring about service or replacements for other than Tarzian-made tuners, always give tube complement . . . shaft length . . . filament voltage . . . series or shunt heater . . . IF frequency, chassis identification and allow a little more time for service. Contact your local distributor or use this address for fast, 48-hour service:

SARKES TARZIAN, Inc.
Att.: Service Mgr., Tuner Division
East Hillside Drive
Bloomington, Indiana

PA Speaker Tips

(Continued from page 29)

used to obtain the desired division of power. Since the audio lines were fairly long, we used the 500-ohm output tap of the amplifier to minimize line drop. For the assumed power output of 10 watts, this winding delivers around 75 volts rms. From the formula:

$$Z = \frac{E^2}{W}$$

we calculated the impedance needed at each speaker to insure that it would assume its share of the power. For the front speakers, the result was

$$\frac{75^2}{3.5} = \frac{5625}{3.5}$$

$$= 1607 \text{ ohms;}$$

for the back speakers, we figured an impedance of

$$\frac{75^2}{1.5} = \frac{5625}{1.5}$$

$$= 3750 \text{ ohms.}$$

When analyzing calculations of this type, remember that the *lowest* impedance will draw the *greatest* current from the constant-voltage line, thus drawing more actual power. Taking advantage of the permissible tolerance in impedance matching, we used standard commercial output transformers of 2000 and 4000 ohms; of course, we made sure that their secondary impedance matched the 4-ohm voice coils of the speakers used. (Refer to Fig. 3.) The parallel impedance of these four transformers works out to very nearly 580 ohms; thus, the impedance match to the 500-ohm output of the amplifier was close enough to be quite usable.

Any desired division of power across a constant-voltage line may be made by this method. The different transformer impedances cause each speaker to carry whatever fraction of the total power is needed at its location. A slight mismatch will be present, but this will be so small as to be unnoticeable.

In some applications, equal power may be applied in all speakers. We made one such installation in the local armory building, which is slightly larger than the high school auditorium, but has the same highly reverberant stone walls. An annual banquet is held there. Several previ-

ous attempts to provide satisfactory sound coverage of this event had failed, due to a high background noise level, talking, laughter, etc. This problem was finally solved by the use of *eight* speakers mounted in box baffles suspended from the roof beams with cones facing downward. These units were equally spaced over the banquet area to spread a "blanket" of sound over the entire crowd. Although a relatively low power level was employed, the sound was satisfactory in all parts of the hall.

One precaution must be observed

when making any kind of multiple-speaker installation in a single large room: All speakers must be in phase! That is, their voice coils must move in and out in unison. Phasing can be very simply checked before installation, by using the old flashlight-battery test. Connect a 1.5-volt battery across each speaker, and see if the voice coil moves outward or inward as the connection is made. Mark the speaker terminals according to some standard code; then, when hooking up, be sure that all like connections are on the same side of the line. This precaution is

 <p>1 Model T-61 New "Speed Check" Tube Tester Kit Kit Net Price \$49.95 Factory-wired Net Price ... \$69.95</p>	 <p>2 Model C-25 New "In Circuit" Capacitor Tester Kit Kit Net Price \$19.95 Factory-wired Net Price ... \$29.95</p>	 <p>3 Model T-5 New Rapid Filament Tester Kit Kit Net Price \$4.50 Factory-wired Net Price ... \$6.50</p>	
<p>... and now PRECISION adds 10 more value-packed kits to the PACO Line</p>			 <p>4 Model SC-1 New Condenser Substitution Box Kit Kit Net Price \$8.95 Factory-wired Net Price ... \$11.95</p>
 <p>5 Model CD-3 New Decade Condenser Kit Kit Net Price \$19.95 Factory-wired Net Price ... \$24.95</p>	 <p>6 Model SR-2 New Resistance Substitution Box Kit Kit Net Price \$8.95 Factory-wired Net Price ... \$11.95</p>	 <p>7 Model RD-5 New Decade Resistor/Divider Kit Kit Net Price \$23.95 Factory-wired Net Price ... \$29.95</p>	
 <p>8 Model ST-45 New AM-FM Stereo Tuner Kit Kit Net Price \$84.95 Semi-kit Net Price \$99.95 Factory-wired Net Price ... \$134.95</p>	 <p>9 Model ST-35 New FM Tuner Kit Kit Net Price \$59.95 Semi-kit Net Price \$69.95 Factory-wired Net Price ... \$89.95</p>	 <p>10 Model L2-U New Wide-Range Two-Way Speaker System Semi-Kit Semi-kit, unfinished Net Price \$59.95 Semi-kit, walnut finish Net Price \$69.95</p>	
 <p>PACO ELECTRONICS CO., INC. 70-31 84th STREET, GLENDALE 27, L. I., N. Y. Kit Division of PRECISION Apparatus Co., Inc.</p>			<p>SEE THESE KITS ON DISPLAY AT ANY LEADING ELECTRONIC PARTS DISTRIBUTOR</p>

important even outdoors; once, when testing a dual speaker setup at a football game, we found that two rows of seats across the field from the speakers were in an almost 100% "cancellation zone" or dead spot! In this area, almost 20' long, the sound was practically absent. This fault was cured by reversing the leads to one of the speakers.

We used a slightly different method of power division when making up a small industrial sound system. Here, the main problem was not the actual division of the sound, but

transmission of the sound energy over existing small wires, and the adjustment to various volume levels at different locations. Using a normal low-impedance circuit, line loss was so great that very low volume was available. However, when we shifted the lines to a 500-ohm impedance by using matching transformers, the volume came up to a very satisfactory level. Tapped transformers were used on this job, and we found that the output levels of different speakers could be adjusted by changing taps to give each location the exact level needed. Only

one problem was encountered: The speaker located in the employees' lunch room sounded too loud because of the low ceiling in this room and the high power level carried in the lines. Therefore, a small wire-wound potentiometer was connected across the secondary, with the speaker's voice coil connected between the slider and one end. This allowed the volume to be regulated quite satisfactorily. A purist might object to this arrangement as being horribly mismatched; but in actual practice, the matching was close enough so that it passed the critical inspection of the factory superintendent (a noted "golden ear") with flying colors!

A different problem was presented by the installation of a sound system at the local football field. The trickiest thing here was to provide sound coverage to both sides of the field. On one side, a concrete stadium seated approximately 2000 people; on the far side, temporary stands could seat another 1000 or so. Here was an obvious place for large, high-powered trumpets. For the usual reason—economy—only two speakers were used. To reach the far side of the field, a 25-watt, 20" re-entrant trumpet was installed as high as possible on one of the poles supporting the field lights at the end of the stadium. (See Fig. 5.) This horn was almost 40' above the ground, aimed at the center of the opposing stands. The normal dispersion of its sound beam at this distance covered the whole length of the far stands. For the nearer side, a 15" re-entrant unit was set 10' lower on the pole and aimed down the length of the stadium. This speaker created a slight feedback problem, since it was aimed directly at the press box which contained the microphone for the system. However, this drawback was solved by putting a glass front on the press box and insulating the sides of the wooden structure with five layers of ordinary corrugated cardboard from shipping boxes. This material provides excellent sound insulation, and has the added benefit of keeping the press box much warmer during cold, windy games! No matching problem existed here, since the two 16-ohm speakers were simply connected in parallel to the 8-ohm output tap on the amplifier. For the

Replace cartridges easier with



ONLY 27 REPLACE OVER 500

The CBS-Ronette line makes cartridge replacement easier through simplification. Only 27 replace more than 500 models. And CBS-Ronette is the exact replacement for over 6,000,000 CBS-Ronette cartridges in the U.S.A.



8-PAGE CATALOG SPEEDS JOB

Photographs and exact-size silhouettes provide quick identification. CBS-Ronette is cross-referenced with 500 cartridges. Simple tables give pertinent data, illustrate and describe various bracket installations.

So ask your distributor for the easier-to-replace quality cartridge . . . CBS-Ronette . . . and for this handy Catalog PF-285.



CBS ELECTRONICS

Danvers, Massachusetts, U.S.A.
A Division of Columbia Broadcasting System, Inc.

*Receiving, industrial and picture tubes • transistors and diodes
audio components • and phonographs*

size and distance involved, a surprisingly small amount of actual power was needed—even during the noisiest games. Seldom did the system use more than 10 watts of power. The reason for this small power demand is the high conversion efficiency of the re-entrant trumpets (around 16% as compared to 3-5% for cone speakers).

A combination setup was worked out for a lumber yard and building-supply house to satisfy two related needs—an intercom network for operation at low volume levels, and a paging system to cover the large area of the outdoor yard. The job was done by first establishing a standard intercom system within the building areas, as shown in Fig. 6. This took care of the first requirement. Then, to permit outdoor paging, a booster amplifier was tied into the system. Rated at 20 watts, this amplifier was used to drive two medium-sized re-entrant speakers installed on a pole near one end of the yard. Housed in a well-ventilated cabinet in the building nearest the pole, the booster amp was allowed to remain on all the time. This eliminated the possibility of someone forgetting to turn it on in the morning, and thus minimized the risk of losing an important call. The input was well fused, and a line ballast was installed in order to drop the supply voltage slightly below normal. With voltages lowered throughout the equipment, tubes and components generally tend to last longer—so we have had very little trouble with this installation.

Signal input for the booster amplifier is taken directly from the intercom network. A matching transformer, connecting the low impedance of the intercom output to the high impedance of the amplifier input, is connected directly to one of the push buttons on the intercom's master station. To make a call, the operator simply depresses the PAGE button and talks in a normal manner. Before the intercom was installed, a telephone used to be located in a small office-shack near the center of the yard; but even with a large gong used for a bell, calls often failed to reach the party needed. This resulted in a man having to be sent out into the yard to locate him. Since the installation of the paging system, no

calls have been missed!

Even on "difficult" installations, the alert technician can spend a small amount of time in making tests and computations, and wind up with a highly profitable job which will enhance his reputation and lead to more work in the future. Use of commonly-available, standard components will save a great deal of money, making it possible to bid on jobs which have been previously deemed impractical for either the potential sponsors or the technician. For example, the speakers used in the auditorium job discussed earlier

were standard radio types rated at 3-5 watts. Comparable PA-type speakers normally selected for this work are rated at 10 watts. When the actual sound load carried by each speaker is never over 2-3 watts, the heavy-duty speakers are unnecessary. The ones in the auditorium job have been in use for over eight years, without a single speaker failure.

Remember—by using head, ears, and slide rule at the same time, you can make more satisfactory installations and can clear more money from your work. ▲



Substitutes FOR ALL ELECTROLYTICS without Arc or Spark!

SENCORE ES102

ELECTRO-SUB

- What more can you ask for? The Electro-Sub not only saves time for any serviceman, engineer or experimenter but insures maximum protection too. Simply select the electrolytic, connect test leads and push surge protector switch.
- How many times have you reached for an electrolytic for substitution to find that value or voltage rating missing?
- How many times have you wanted a value just a little higher to see if you could knock out annoying hum?
- How many times have you had sets that blow fuses, fuse resistors or rectifiers and you did not check all electrolytics because it was too time consuming?
- Have you ever healed a suspected electrolytic by "bridging" it and made a call back that same week on the same trouble?
- Have you ever grabbed an electrolytic that you thought was discharged or watched a customer's dismay as you discharge one?
- Well, here is your answer . . . from the smallest electrolytics used in transistor radios to the largest used in costly Hi-Fi amplifiers . . . complete, safe substitution.

ES102.....DEALER NET 15⁹⁵

ALL PARTS
SENCORE
MADE IN AMERICA

SENCORE
ADDISON 2, ILLINOIS

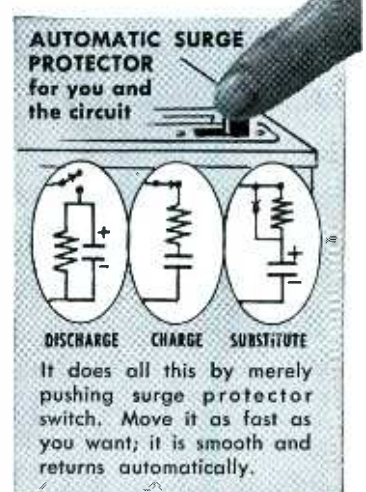

You'd pay more for just the parts than you would for the complete ES102 . . . amazed? See your parts distributor.

QUALITY PRODUCTS! . . . for High-Profit
Sales and Year-Round Business!



2 NEW PRODUCTS FOR TAPE RECORDER MAINTENANCE



"SPOT" LUBRICATING OIL
For pin-point oiling of bearings, shafts and oil holes. "SPOT" is a high grade lubricant that reaches hard-to-get-at bearings with a concentrated spray.

TAPE RECORDER CLEANER
An approved chemical spray that washes accumulated iron oxide from tape recorder heads. The combination of the spray and pin-point applicator results in fast and efficient cleaning of tape recorder heads.



INJECTORALL

INJECTORALL COMPANY
2081 Shore Parkway
Brooklyn 14, New York

6A7 6AG7Y
6A8 6AH4G2
6AB4
6AC7
6AC7Y
6AD7G
6AF3 6.
6AF4 6AH
6AF4A 6AK5

ADMIRAL Supertron Receiving Tubes



5GC8 5EU8
5CL8A 5J6
5CQB 5T8
5CZ5 5U4JB

483 tubes in all, and all first quality!

Fill your tube caddy with new Admiral Supertron receiving tubes. Your assurance of one call profitable service. All highest quality for all makes of TV, Hi-Fi, Stereo and radio replacement service.

ADMIRAL MARK OF QUALITY THROUGHOUT THE WORLD

ADMIRAL NATIONAL SERVICE DEPT.
903 Morrissey Blvd., Bloomington, Illinois

Name _____
Address _____
City _____

For free literature
and full details,
mail this coupon.

PF 60

PRODUCT report

For further information on any of the following items, circle the associated number on the Catalog & Literature Card.

Antenna Distribution Amplifier (42Q)

An all-channel VHF cascode amplifier, using a low-noise ECC88 frame-grid tube, is incorporated in the Winegard WBC-4 *Amplified Booster-Coupler*. This unit feeds signals to as many as four TV or FM receivers from one antenna, providing 6 db gain in each signal channel; in addition, it can be used as a one-set booster to achieve a gain of up to 12.5 db. The WBC-4 can be mounted in any indoor location where it can be plugged into a 117-volt AC supply. List price is \$27.50.

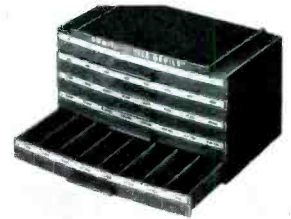

Pencil Irons (43Q)

Kwikie pencil-type soldering irons, made by Kwikheat Mfg. Co., weigh less than 2 oz. and measure 7½" in length. One model, with barrel diameter of ⅜", is used with heating elements up to 35 watts; a larger unit, with ½" barrel, is for 50-watt elements. A wide assortment of interchangeable tips can be furnished, including types with straight, tapered, or bent shanks.



Transistor-Radio Holder for Car (44Q)

A transistorized portable radio can be securely attached to an automobile dash or windshield trim by means of the R-Columbia *Cardio master*, an adjustable holder containing a strong permanent magnet. With the radio just behind the windshield, no external antenna or noise-suppression equipment is ordinarily required for acceptable reception. List price is \$4.95; a counter display of six units is available to dealers for \$17.85.



45-rpm Adapter (45Q)

Been looking for a way to fill up the large center hole in 45-rpm records so you can play them on a three- or four-speed changer? One possible solution is to "fatten" the changer's slender spindle to fit the discs. A new Clevite "Walco" adapter slips over the spindle to increase its diameter and permit convenient manual playing of 45's. List price is 25¢.



TV Antenna Aid (46Q)



The *Rembrandt TV Ghost Eliminator* (All Channel Products Corp.) is designed for use in combination with a conventional indoor or outdoor antenna. It functions as both a line-cord antenna and a dipole, and the signals thus picked up are mixed with the regular antenna signal in various ways (according to switch position and lead orientation) for the

purpose of reinforcing signal strength or cancelling ghost-producing secondary signals. The unit is sold with a money-back guarantee at \$7.95.

High-Gain Antennas (47Q)

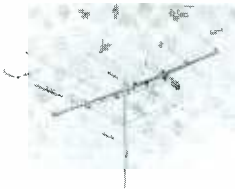

The new JFD *Hi-Fi Fireball* series of TV antennas combines several features of two other models, the *Fireball* and the *Hi-Fi Satellite-Helix*. The basic driven-element assembly consists of a "reverse-phase" low-band dipole teamed with a 600-ohm high-band dipole.

"Quik-Rig" preassembled construction is used in all types. Four models are available in a price range of \$15.30 to \$37.50 (in natural finish) or \$19.50 to \$45.00 (gold anodized).

Audio Wiring Accessories (48Q)



As many as six remote speakers in a home music system can be independently turned on or off from one location with the Mosley FAS-6 *Flush Wall Plate Switch*. Another newly-available accessory is a speaker jack mounted in a wall plate to provide connections for portable extension speakers. The latter unit is offered in two versions—the FAS-1PK with a single jack, and the FAS-11PK with a pair of jacks in tandem.

Power Transistor Mount (49Q)

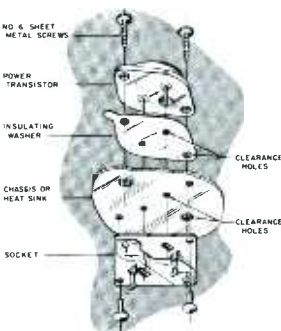

All equipment necessary for attaching a standard-sized power transistor to a heat sink is furnished in a kit available from Motorola Semiconductor Products Div. The parts included are a socket, front and back mounting templates (hole-drilling guides), two #6 sheet-metal screws, an insulated washer, and instructions. Three versions of the kit are available, each with a different type of washer—teflon-coated glass cloth (MK-10), mica (MK-15), or anodized aluminum (MK-20).

Power Transformers (50Q)

Two new types have been added to the Stancor line of exact-replacement TV power transformers. The P-8355 (for numerous General Electric, Hotpoint, Magnavox, RCA, and Spartan sets) supplies 285 VAC to each rectifier plate at an output current of 250 ma DC. Type P-8356 (for Admiral, Motorola, RCA, and Zenith sets) supplies 270 VAC at 260 ma DC. Both transformers incorporate a copper shorting band to reduce the external magnetic field.

LESS SERVICING TIME MORE PROFITS



MODEL 800 Hi Fi Stereo Analyzer

A complete portable audio lab in one unit!

- It's an audio VTVM
- It's an audio signal generator
- It's a harmonic distortion meter
- It's an intermodulation distortion meter
- It's an audio output wattmeter with speaker loads
- It's a DB and noise meter

ONLY \$169.95

Other Winston Time Savers...

250—Color Convergence Dot Generator	\$129.95
620—Transistor Analyzer	89.95
800—HI-FI Audio System Analyzer	169.95
820—Dynamic Sweep Circuit Analyzer	69.95
825—Dynamic AGC Circuit Analyzer	79.95
828—Intermittent Condition Analyzer	89.95
850—Induced Wave Form Analyzer	169.95

See your local parts distributor today!
Literature available upon request.

winston electronics
DIVISION OF JETRONIC INDUSTRIES, INC.
4000 N.W. 28th Street Miami, Florida

SAMS PHOTOFACT INDEX



sent direct
to your shop

FREE

SEND FOR IT!

Yes, now you can have the valuable SAMS MASTER INDEX TO PHOTOFACT FOLDERS and Index Supplements sent direct to your shop at no cost to you! Just mail coupon below and you'll be sure to receive regularly your handy guide to the world's finest service data covering over 33,000 TV, Radio, Amplifier, Tuner Tape Recorder and Changer models. Send for it—it's FREE!

MAIL
COUPON

Howard W. Sams & Co., Inc.
1720 E. 38th St., Indianapolis 6, Ind.

Put me on your mailing list to receive the Sams Photofact Master Index and Supplements

I'm a Service Technician: _____ full time; _____ part time

My Distributor is:

Shop Name: _____

Attn: _____

Address: _____

City _____ Zone _____ State _____

June, 1960

Admiral Corp., National Service Dept.	74
Aerovox Corp.	32
American Television & Radio Co. (ATR)	14
Amperex Electronic Corp.	17
Amphenol-Borg Electronic Corp.	54
B & K Mfg. Co.	19
Belden Mfg. Co.	39
Berns Mfg. Co.	65, 70
Blonder-Tongue Labs	30, 31
Bogen-Presto	18
Bussmann Mfg. Co.	43
CBS Electronics	9, 72
Castle TV Tuner Service	34
Centralab, A Div. of Globe-Union, Inc.	38
Chemical Electronic Engineering, Inc.	64
Cornell-Dubilier Electric Corp.	37, 47
EICO	49
Electro Products Laboratories, Inc.	55
Fanon Electric Co., Inc.	65
General Cement Mfg. Co.	2nd cover
Television Receiver Dept.	45
Injectorall Co.	74
International Resistance Co.	65
Jackson Electrical Instrument Co.	58, 76
Jerrold Electronics Corp.	36
Littelfuse, Inc.	4th cover
Mallory & Co., Inc., P.R.	22-23
Merit Coil & Transformer Corp.	48
Miller Co., J. W.	55
Mosley Electronics, Inc.	66, 70
Motorola, Inc., Parts & Accessories Div.	15
PACO Electronics Co., Inc.	71
Planet Sales Corp.	52
Plytex Products, Inc.	34
Precision Electronics, Inc.	52
Precision Tuner Service	66
R-Columbia Products Co., Inc.	62
RCA Electron Tube Div.	59, 3rd cover
Rider Publisher, Inc., John F.	46
Rohn Mfg. Co.	21
Sams & Co., Inc., Howard W.	14, 56, 57, 75
Sarkes Tarzian, Inc. Semiconductor Div.	44
Tuner Div.	16, 70
Seco Mfg. Co.	64
SENCORE	63, 67, 69, 73
Sonotone Corp.	35, 53
South River Metal Products Co.	62
Sprague Products Co.	10
Switchcraft, Inc.	52
Sylvania Electric Products, Inc. Electronic Tubes Div.	33
Home Electronics Div.	40
Semiconductor Div.	61
Triad Transformer Corp.	68
Tung-Sol Electric, Inc.	51
Waldom Electronics, Inc.	62
Wen Products, Inc.	66
Westinghouse Electric Co. Electron Tube Div.	12-13
Winegard Co.	41
Winston Electronics— Div. of Jetric Industries, Inc.	75
Xcelite, Inc.	46

Latest Jackson Tube Test Data

TYPE	MODEL 64K		MODEL 398		HEATER CURRENT
	TYPE	PLATE	TYPE	PLATE	
6EM7	6.3 20K	AC56 23XZ	6.3 8Z	7	1.1 - 30
6EU7	6.3 23K	A17 22Z	6.3 8Z	7	7.8 - 75
6EU7	6.3 A156	AC79 65XZ	6.3 1 -	2	6.5 - 75
6FE5	6.3 AC145	AC28 65XZ	6.3 1 -	2	3.5 - 4.20
30FE5	6.3 123	156 2-V	6.3 2 -	7	3.5 - 4.20
7543	6.3 247	AC156 18XZ	6.3 2 -	7	3.5 - 4.20

TYPE	MODEL 69K		GRID		HEATER CURRENT
	TYPE	PLATE	TYPE	PLATE	
6EM7	6.4K	284	ac56	18Q	10XY.
6EU7	6.4K	244	ac57	16R	80XY.
6EU7	6.4J	234	ac59	30Q	10XY.
6FE5	6.4J	123	456	22R	70XY.
30FE5	6.4J	123	456	22R	70XY.
7543	6.4J	124	ac456	56R	100XY.

Latest Chart Form 648-23, 398-2, 698-3

ANTENNAS & ACCESSORIES

- 1Q. ALL CHANNEL PRODUCTS CORP.—4-page folder of information on new Rembrandt TV Ghost Eliminator with built-in picture booster. Works with any existing antenna to cancel out unwanted TV signals.
- 2Q. BLONDER-TONGUE — Bulletin (Form M-50-49) on Masterline TV distribution-system products. See ads pages 30, 31.
- 3Q. G-C ELECTRONICS — 8-page Catalog AN-61 covering Citizens band antennas and various accessories. See ad 2nd cover.
- 4Q. JFD—1960 Exact Replacement Antenna Guide for Portable and Toteable TV Sets (20 pages), compiled and edited by Howard W. Sams & Co., Inc. Gives TV receiver model number, manufacturer's antenna part number, and model number of corresponding JFD exact-replacement antenna. Also Form No. 71 brochure illustrating and describing 1960 line of natural silver and gold anodized Hi-Fi Helix antennas, and Form No. 66 covering 1960 series of natural silver and gold anodized Hi-Fi Fireball antennas.
- 5Q. JERROLD—Data sheet on TX series of antenna mixing networks for combining signals from several antennas, mixing or splitting VHF-UHF or TV-FM signals, and related applications. See ad page 36.
- 6Q. MOSLEY—Catalog 60, describing audio and television-antenna accessories; also Form F-1PKM, dealer promotional literature for TV outlet type F-1PK. See ads pages 66, 70.
- 7Q. ROHN—New folder describing complete line of antenna towers and allied accessories; also descriptive literature on heavy-duty communications towers. See ad page 21.
- 8Q. SOUTH RIVER—Newly-revised catalog illustrating company's expanded line of antenna mountings and accessories. See ad page 62.
- 9Q. TACO—Promotional package on new T-Bird line of fringe-area antennas.
- 10Q. WINEGARD—Catalog sheet describing Model WBC-4 Booster-Coupler, which operates one to four TV or FM sets from a single antenna, while boosting gain for each set up to 6 db on all channels. See ad page 41.

AUDIO & HI-FI

- 11Q. EICO—20-page catalog of kits and wired equipment for stereo and monophonic hi-fi, test instruments, "ham" gear, Citizens band transceivers, and transistor radios. Also, "Stereo Hi-Fi Guide" and "Short Course for Novice License." See ad page 49.
- 12Q. FANON—Data on new line of public-address equipment, including 10- and 20-watt transistorized mobile amplifiers as well as various other systems (both fixed and portable) rated at 10, 20, 35, 45, and 70 watts. See ad page 65.
- 13Q. MELLOTONE — Brochure describing stock assortments and new dealer merchandiser display, as well as sample cards designed to help servicemen sell grille fabric.
- 14Q. MERIT—New 30-page 1960 catalog of replacement transformers and components for radio and TV. See ad page 48.
- 15Q. SONOTONE — Information about new low-priced Series 12 crystal stereo cartridges. See ads pages 35, 53.
- 16Q. SWITCHCRAFT — Catalogs S-590 on molded cable assemblies, adapters, connectors, and signal mixers; A-403 on controls, switches, and related audio accessories; S-302 on lever-type switches; and C-501 on jacks, plugs, and microphone connectors. See ad page 52.

BATTERIES

- 17Q. B & K—Bulletin ST9-R on the "PONY" Model PB9 Rechargeable Battery and Plug-in Charger for long-life replacement in transistor radios using 9-volt batteries. See ad page 19.

COMPONENTS

- 18Q. BUSSMANN—Small leaflet designed to fit pocket or tool kit shows you what to charge for every fuse shown in the BUSS TV Fuse Chart. See ad page 43.
- 19Q. CORNELL-DUBILIER — Twist-Prong Capacitor Substitution Cross-Index, Form UPX-260, covering more than 3750 original part numbers of 6 major manufacturers. See ads pages 37, 47.

- 20Q. SARKES TARZIAN (Tuner Div.)—Informative literature on TV and FM tuners. See ads pages 16, 70.
- 21Q. SPRAGUE—36-page Catalog No. C-613 of service-type capacitors, transistors, and test equipment. See ad page 10.
- 22Q. STANCOR—26-page Coil Products Catalog No. CP-100, listing over 500 new RF-IF coils, chokes, etc.

SEMICONDUCTORS

- 23Q. SARKES TARZIAN (Semiconductor Div.)—4-page brochure of technical data on distributor line of silicon and selenium rectifiers, including tube-replacement types and conversion kits. See ad page 44.
- 24Q. U. S. TRANSISTOR CORP. — Data sheets on kit of four different types of germanium PNP transistors for replacement applications in portable radios. Kit lists for \$4.25.

SERVICE AIDS

- 25Q. CASTLE TUNER — Leaflet describing service for all makes and models of TV tuners. See ad page 34.
- 26Q. INJECTORALL — Catalog of complete line of electronic chemicals. See ad page 74.
- 27Q. PRECISION TV TUNER—Information on repair and alignment service available for any type of TV tuner. See ad page 66.
- 28Q. WALDOM—Informative bulletin on the economies and advantages of speaker re-coning; referral to a local re-coning station on request. See ad page 62.

TECHNICAL PUBLICATIONS

- 29Q. CBS—Descriptive flyer PA-276 on revised and expanded Transistor Home-Study Course. See ads pages 9, 72.
- 30Q. HOWARD W. SAMS — Literature describing all current publications on radio, TV, amateur radio, communications, audio and hi-fi, and industrial electronics servicing. See ads pages 14, 56, 57, 75.
- 31Q. SYLVANIA — Bulletin on television, radio, hi-fi, and stereo service literature. See ads pages 33, 40, 61.

TEST EQUIPMENT

- 32Q. B & K—Bulletin ST25-R, digest of information on Model 1075 Television Analyst, Models 1070 and A107 Dyna-Sweep circuit analyzers, Models 550, 650 and automatic 675 Dyna-Quik dynamic mutual conductance tube and transistor testers, and Model 440 CRT rejuvenator-tester. See ad page 19.
- 33Q. ELECTRO PRODUCTS LABS—Catalog sheet describing new low-cost, regulated solid-state DC power supply, Model PS-3, for servicing transistor circuits. See ad page 55.
- 34Q. JACKSON — Information on complete line of Service-Engineered test equipment. See ads pages 58, 76.
- 35Q. PRECISION APPARATUS—Catalogs of PACO hi-fi and test-instrument kits, and of PRECISION/PACE electronic test instruments and panel meters. See ad page 71.
- 36Q. SECO — Helpful bulletin on Troubleshooting TV Deflection Circuits; also complete data on line of specialized test equipment. See ad page 64.
- 37Q. SENCORE—4-page brochure on complete line of time-saver instruments, plus information on the TC109 Mighty-Mite tube tester. See ads pages 63, 67, 69, 73.
- 38Q. WINSTON—Flyers describing complete line of instruments, including an AGC circuit analyzer, intermittent condition analyzer, induced waveform analyzer, rainbow generator, dot generator, sweep circuit analyzer, and audio system analyzer. See ad page 75.

TOOLS

- 39Q. BERNs—Data on 3-in-1 picture-tube repair tool, Audio Pin-Plug Crimper, and Ion adjustable beam bender. See ad page 34.
- 40Q. X-ACTO — 12-page catalog of interchangeable-blade knives and other precision hand tools, including tweezers, forceps, pliers, hand drills, and needle file sets, for use in printed circuit servicing, etc.
- 41Q. XCELITE—Leaflet describing 23-piece Servicemaster kit which contains all hand tools needed on 99 out of 100 service calls. See ad page 46.

How do your customers rate you?



Your reputation is based largely on what happens *after* you leave the scene of each service call. For this reason the name on the tubes you install makes a world of difference. RCA tubes are designed and manufactured to assure customer confidence in you as well as in RCA.

RCA tube quality is your best insurance against call-backs due to premature tube failure.

RCA tube performance puts your workmanship in the best light and protects it through rigid quality control.

RCA's trademark symbolizes a name and reputation customers have respected for decades.

Your customers know that those red-white-and-black RCA tube cartons in your tube caddy represent the most trusted name in electronics. Remember, customer confidence is the cornerstone of your business.

To protect your service reputation before, during and after every service call, make sure your next tube order specifies... **RCA TUBES.**

RCA ELECTRON TUBE DIVISION, HARRISON, N. J.



SIGN OF A SERVICE JOB WELL DONE



The Most Trusted Name in Electronics
RADIO CORPORATION OF AMERICA

