

MAY, 1960

35 CENTS



PHOTOFACT RF REPORTER

Including **Electronic Servicing**

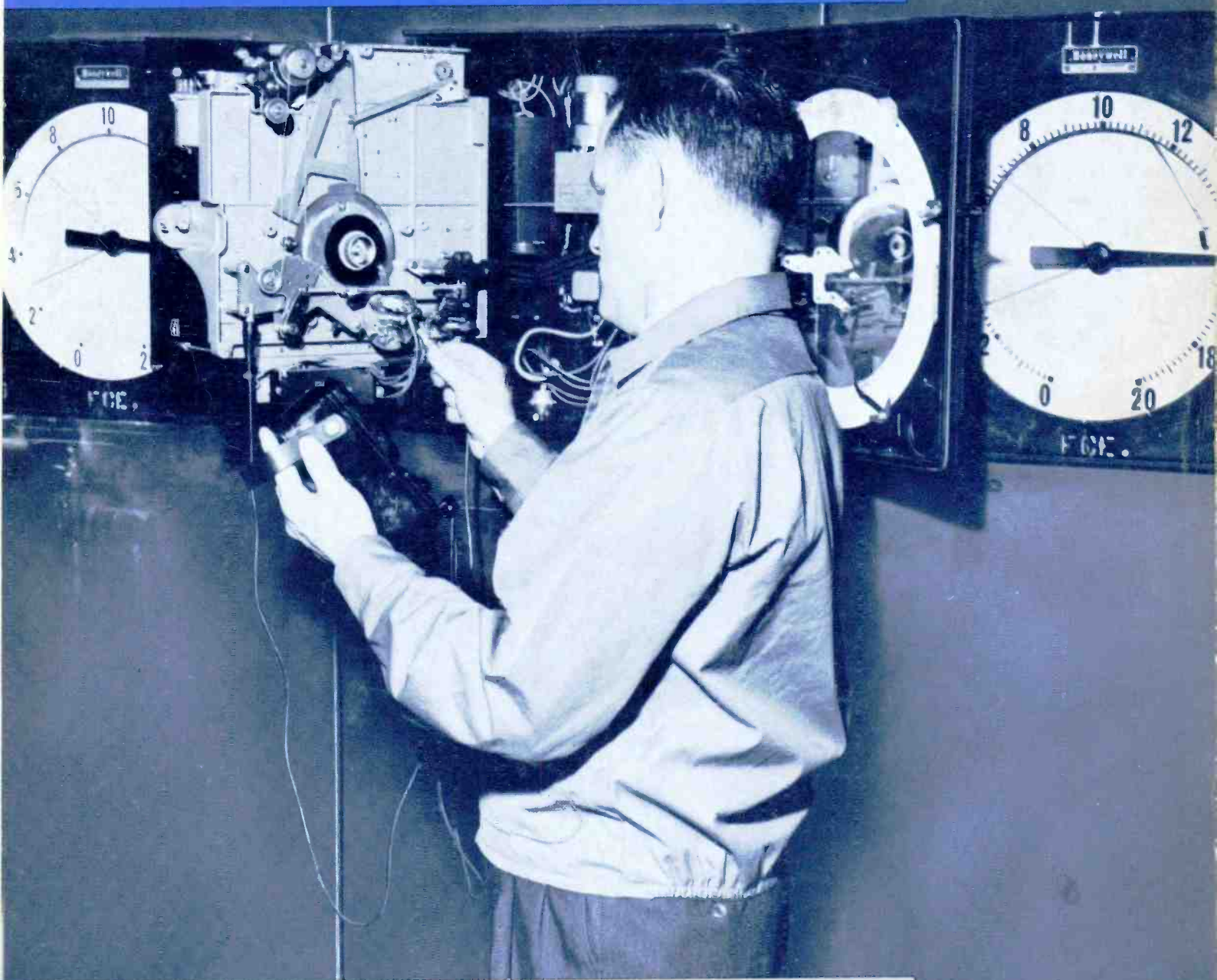

Examining an Industrial Control Device

Care of Tape Transport Mechanisms

That's the Way the Horizontal Sweeps

A Review of Intercom Systems

IA OA 442 1262
WM. M. DAVIS
RADIO & TV. SEC.
118 RIVERSIDE AVE
CANON CITY, COLORADO

NOW...GET G-C EXACT TV REPLACEMENT KNOBS!

FOR ALL LEADING TV SETS

NEW... EACH G-C KNOB NOW IN PROTECTIVE SKIN-PAK ON INDIVIDUAL CARD

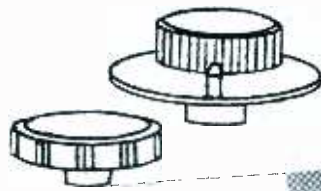

GC ELECTRONICS
No. 27-094
MFG. PART NO.
WT 43X141



GC ELECTRONICS CO. DIV. OF TEXTRON INC. MAIN PLANT
WESTERN PLANT LOS ANGELES 18, CALIFORNIA ROCKFORD, ILLINOIS USA

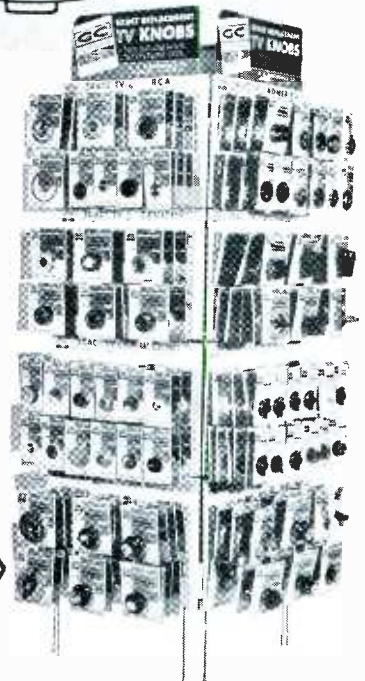

NOW—235 DIFFERENT KNOBS

Now's your chance to pick up some extra money on TV set servicing. Choice of 235 different hard-to-get knobs let you replace all broken or missing knobs. Modern skin-packaging, full identification and list price marking makes it easy and profitable, makes your trade happy too.

LOOK FOR THIS DISPLAY AT YOUR FAVORITE JOBBER!

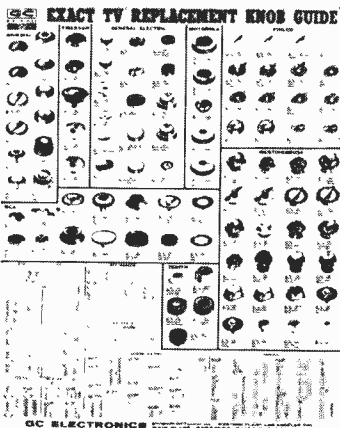

WALL CHART, TOO!

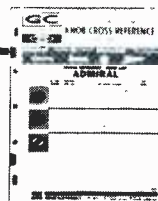

CROSS-REFERENCE GUIDE tells you which knob goes with which set. Includes illustrations, set numbers, list prices, etc.

WRITE TODAY for complete details and literature, all free. Send postcard now.

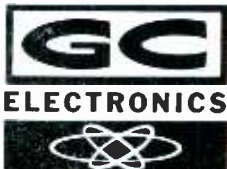

G-C ELECTRONICS CO.

Division of Textron Electronics, Inc.
West Plant: Los Angeles 18, California

Main Plant: ROCKFORD, ILLINOIS, U.S.A.

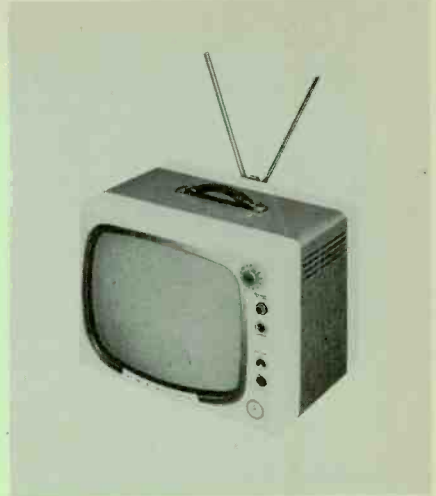
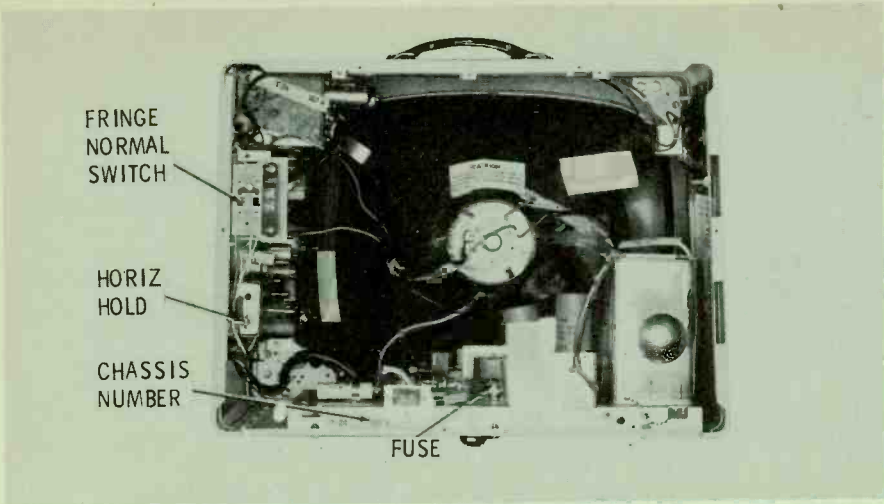

Emerson Model 1524 Chassis 120507A

Here's a 17", 90° VHF portable to represent four models using the same chassis. With provisions for UHF-VHF reception, the chassis number changes to 120508B. All operational controls, with the exception of horizontal hold, are grouped along the right side of the picture tube. The front can be removed to clean the CRT and safety glass by pulling the knobs off, removing three screws from the bottom, and swinging the lower edge out and up.

The 16-tube transformerless chassis consists of a conventionally-wired basic unit containing the power supply and horizontal deflection circuits, and a vertically-mounted printed board containing the remaining circuits. Ample lead length permits either portion of the chassis to be placed on the bench without disturbing the other section. The high-wattage circuits are confined to the right side of the cabinet; in addition, the printed board is mounted far enough away from the side of the louvered cabinet for proper air circulation.

While the markings on the top side of the printed board are of little value to servicemen, those on the bottom are very helpful. Various voltage lines, controls, tube types, tube elements, and alignment frequencies are identified. Also, leads protruding through the bottom of the board are of sufficient length for the connection of test instruments. While the AFC diode is of the solder-in variety, its leads are long enough to permit measurements to be made without removing it from the board. Three fairly rare tubes are used in this section — a 5AS8, an 8EB8, and a 12DB5.

The entire power supply and all circuit-protective devices are mounted on top of the main chassis, where they are easily accessible. A 1¼-amp, slow-blow, Type N fuse is connected in series with the single silicon rectifier to provide B+ protection. Filament protection comes from the rather unusual 1-ohm flexible fusible resistor in series with the AC supply.

Height and vertical linearity adjustments are reached through the hollow shafts of the brightness and vertical hold controls. This reflects a growing trend among manufacturers to make setup adjustments easily accessible to the serviceman, but hard for the customer to reach.

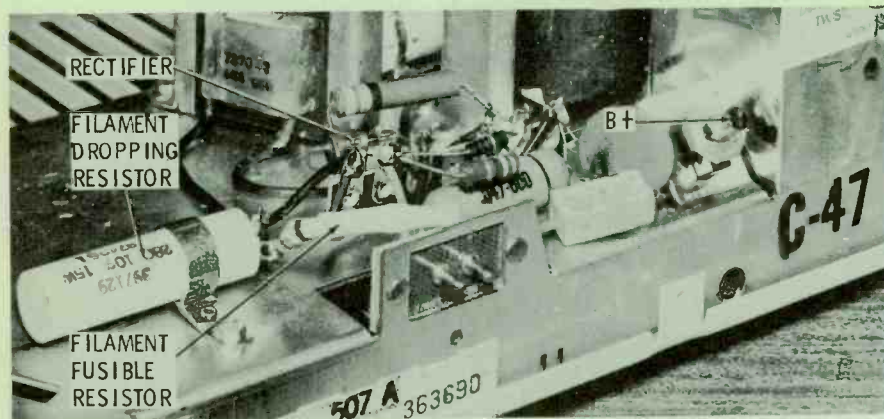
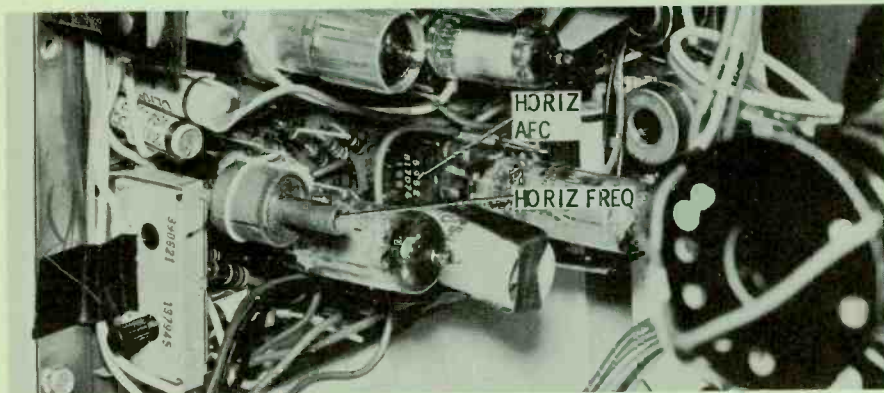



**Motorola Model 21C10CW
Chassis TS-564**

This 21", 90° set is representative of 41 different models using the basic 564 chassis. The TS- series incorporates manual tuning, while the WTS- series is used in the *Insta-Matic* remote-tuning models. The suffix "Y" after the chassis number indicates a VHF-UHF tuner is used. All operating controls are grouped to the right of the picture tube except for the rear-mounted horizontal hold control.

The 19-tube, hand-wired, transformer-powered chassis has an "uncluttered" look, unusual for today's sets. All setup controls and adjustments are easily accessible — with the notable exception of the VHF oscillator adjustments, which require removal of the control panel before they can be reached. Access to the Channel 13 adjustment is through a hole in the right side of the tuner (when viewed from the front), and the Channel 6 adjustment is reached through a hole in the bottom of the tuner shield.

This tuner uses two relatively new tubes — an ECC189/6ES8 RF amplifier and a 6EU8 oscillator-mixer. Even though this tuner incorporates the "do-it-yourself" fine tuning adjustments, remember they are just that — fine tuning adjustments, not individual oscillator coil adjustments. The setup merely positions a cam which rides against the spring-loaded slug of the fine tuning coil.

The chassis incorporates the entire range of protective devices, including the *Tube Sentry*, a 1½" length of No. 26 fuse wire for filament protection, a 5-amp line fuse, and a 4/10-amp, slow-blow N-type fuse for B+ protection. Although the chassis is transformer-powered, there are six tubes connected to form three series-parallel circuits. These are shown in the photo, and also on the tube-placement chart attached to the high voltage cage.

One look at the bottom of the chassis will tell you why we refer to the chassis as being hand-wired rather than conventionally-wired. The use of modules in both the horizontal and vertical circuits is characteristic of the entire '60 line of Motorola sets. There is also a definite trend toward greater use of printed component combinations. This chassis uses six such components. In preparation for servicing one of these chassis, you'll find it helpful to review "Replacing Modular Component Sections" in the January, 1960 issue.

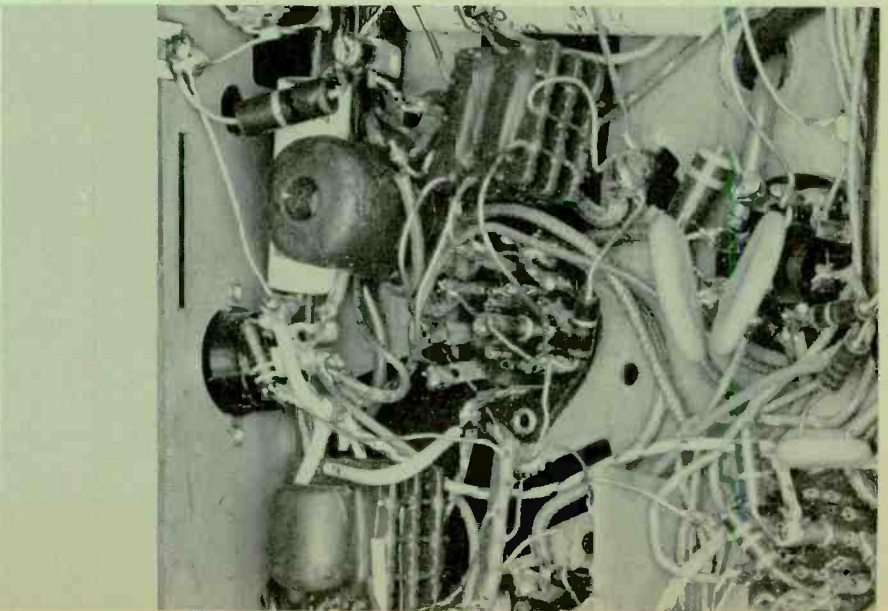
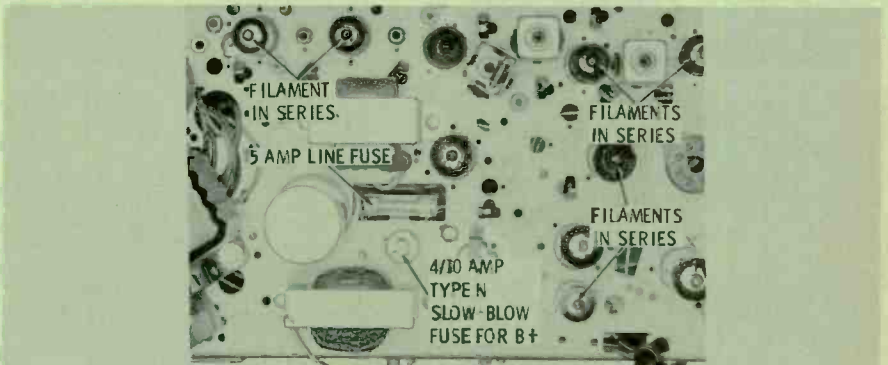
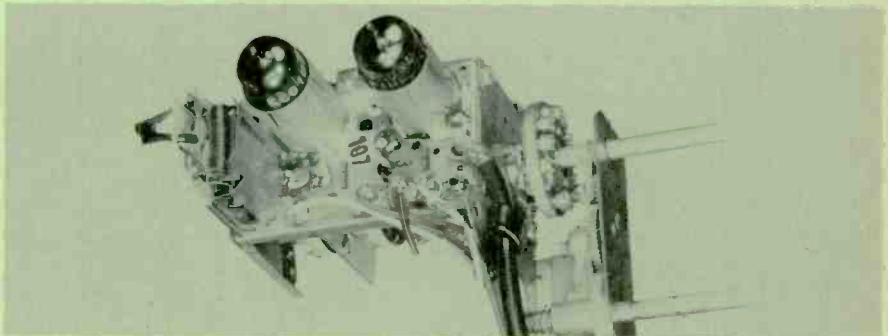
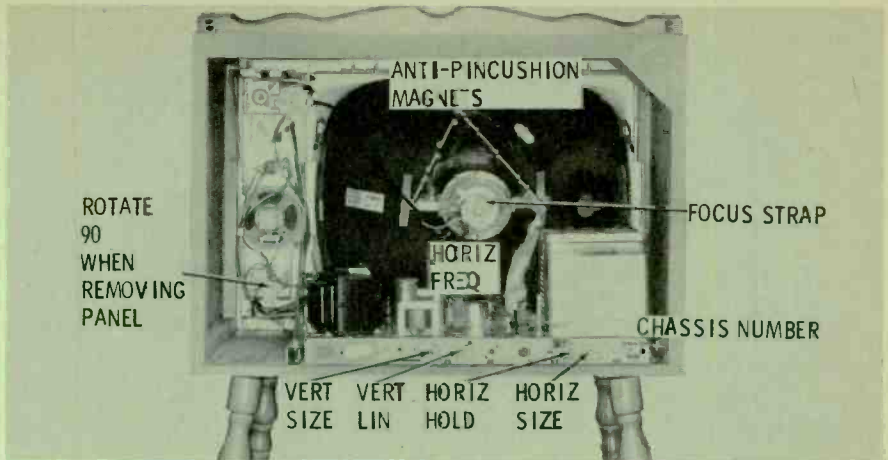

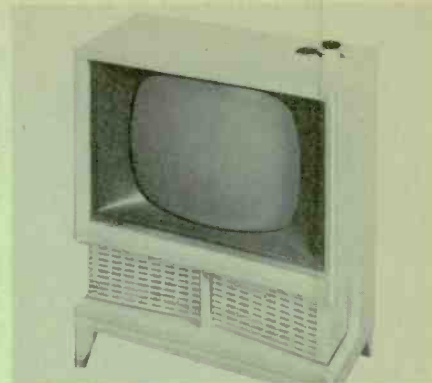
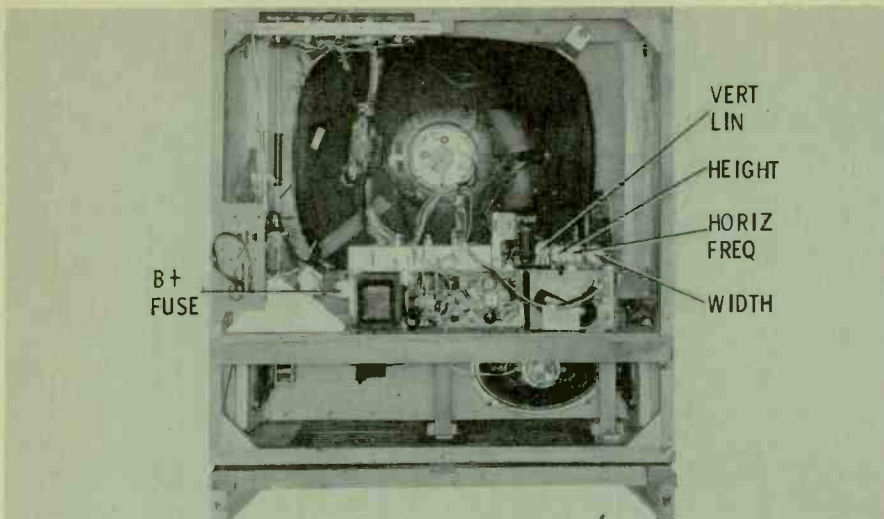

**Philco Model H-4686S
Chassis 10L60**

Meet *Miss America* — that's the name of this 21", 110° swivel-cabinet model. As you can see, all operational controls are located along the right rear part of the top. When the large knob on the right is pressed, it pops up and becomes the channel selector. En route, it flips the switch supplying AC power to the receiver. All controls are labeled for easy identification, including the thumb-wheel knobs protruding through the rear cover.

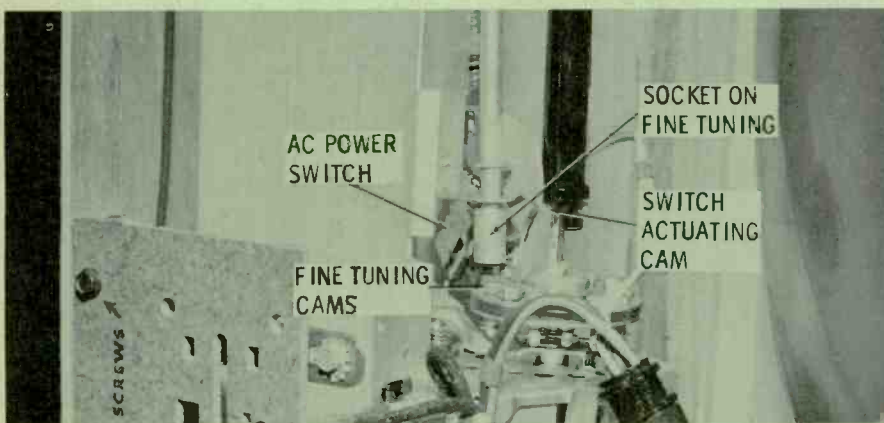

The chassis is an 18-tube unit with a power transformer. Protective devices include a 7/10-amp, N-type, slow-blow fuse in series with the center-tap of the transformer secondary, and a 1½" length of No. 26 wire in series with the filament leads. All circuits except the low-voltage power supply are contained on three printed boards. The IF board is at top left, deflection is at top right, and the remaining circuits are on the board facing the back. Speaker hook-up is a little unusual; the 6" x 9" unit has a 10- to 12-ohm voice coil, while the two 5" units have 8- to 10-ohm voice coils. All three are connected in parallel to match the 3.2-ohm secondary of the output transformer.

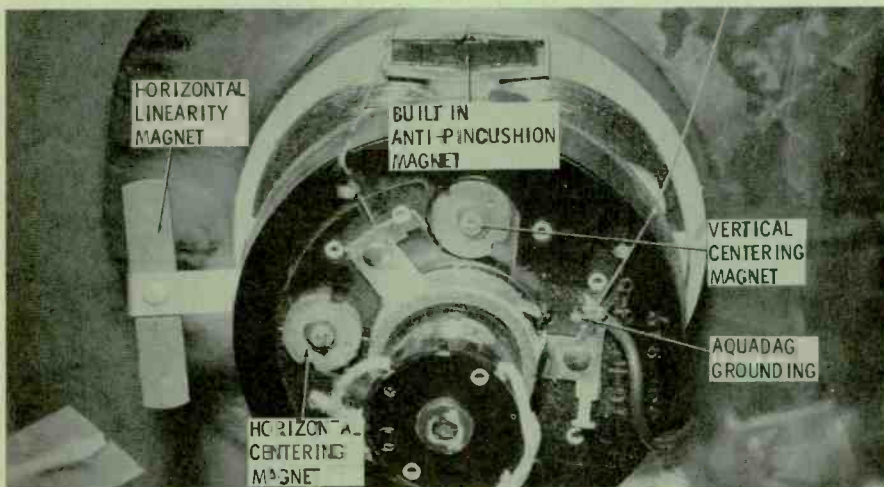

The fine tuning shaft is spring-loaded, and is equipped with a ¼" hex socket on the end. Depressing the fine tuning knob engages the socket with a hex-head cam for the "do-it-yourself" fine tuning adjustment on each channel. The photo also shows the detail of the on/off switch and channel selector. The lateral spacing between the switch plunger and the actuating cam is critical. It must be between 1/64" and 3/64" in the "on" position for the latch-down, pop-up action of the channel selector to operate properly.

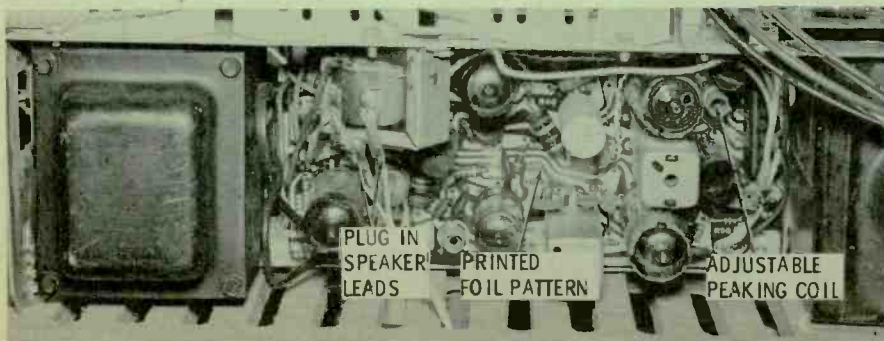

The picture-centering and horizontal-linearity adjustments shown are to be found only in a Philco. Rotating the centering magnet for either "horizontal" or "vertical" moves the beam in the direction indicated. All 110° yokes have built-in anti-pincushion magnets. Another magnet, resembling those used as anti-pincushion devices in earlier models, is used to adjust the horizontal linearity on the right side of the screen.

In addition to the outline of the foil pattern printed on the top side of the board, there are several identification labels to help make servicing easier. An adjustable peaking coil is a feature in this chassis; a very slight adjustment should be made if a symptom of smear is present on *all* channels.

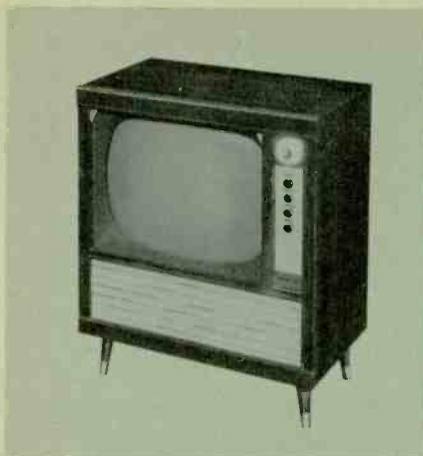

**Trav-Ler Model 921-K-810
Chassis 1150-29**

In viewing the front of this 21", 90° receiver, you'll see there is no provision made to clean the safety glass without first removing the chassis.

When you get the rear cover removed, notice that this design is quite a departure from previous sets produced by this manufacturer. The chassis is shaped in the form of a backward C, and fits up close to the bell of the picture tube. An AGC control and a phenolic shaft from the horizontal frequency slug (serving as the horizontal hold control) are the only adjustments on the chassis itself. A focus strap on the base of the picture tube may be connected from pin 6 to pin 10 or pin 2 (whichever provides the best focus). The control panel to the left of the chassis, which must be removed before the chassis can be taken out of the cabinet, is secured by four 3/8" nuts and one 1/4" metal screw. Removing six 5/16" bolts permits the board containing the chassis and picture tube to be slid out the back.

In the third photograph, the contrast and vertical hold knobs have been removed to reveal the hollow control shafts. Located behind these controls are the vertical-linearity and height adjustments. Being able to reach the latter controls from the front of the set makes it easier to observe their effect on the raster. A snap-in plug must be removed from the side to gain access to the VHF oscillator adjustments.

The 15-tube "hot" chassis incorporates a *surgistor* in series with the AC line to limit tube-filament current during warm-up periods. The bottom chassis includes a silicon-rectifier voltage-doubler power supply, a 3BU8 keyed AGC and sync separator combination, the horizontal AFC and multivibrator, and the vertical deflection circuits. The lump in the spaghetti-covered lead between chassis and control panel is a 1-watt resistor which connects the cathode of the vertical output tube to the vertical linearity control.

The top chassis contains the IF, sound, and video stages. For some reason, the 5.6-ohm, plug-in fusible resistor protecting the silicon rectifiers is also located on this chassis. You can see the top cap has been removed from the last video IF transformer, exposing the 1N87 video detector. To the right is the "in-between" chassis containing the horizontal deflection circuits.

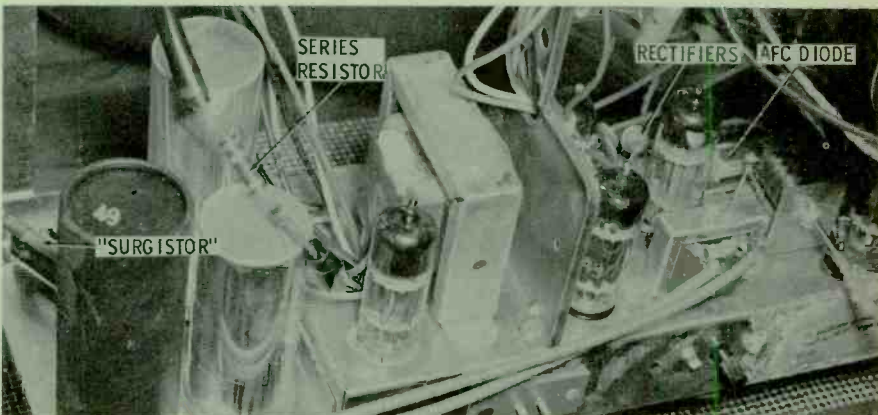
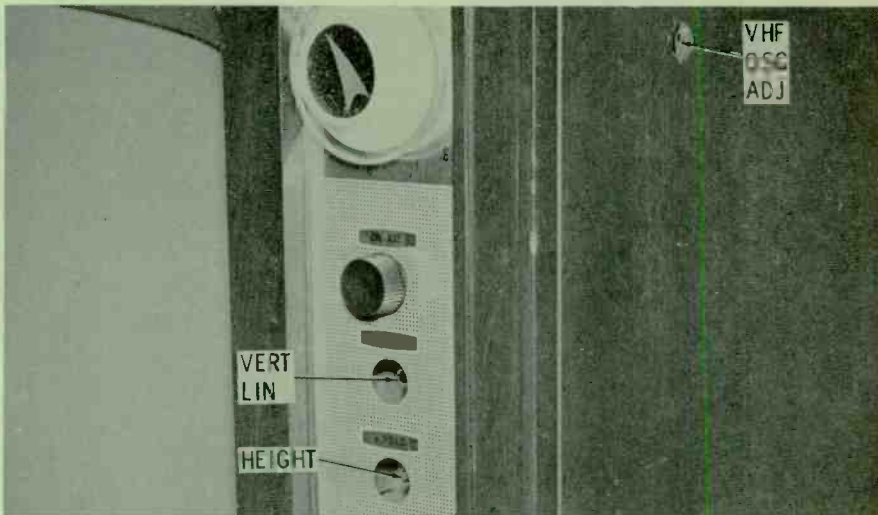

See PHOTOFACT Set 462, Folder 2

Mfr: Silvertone Chassis No. 528.51580

Card No: SI-.51580-1

Section Affected: Raster and sound.

Symptoms: Raster flashes on and off; sound disappears along with raster.

Cause: B+ voltage-divider resistor burned and intermittently open.

What To Do: Replace R45 (470 ohms—1W). Check C2B (20 mfd) for leakage; also check for excessive current drain on 210-volt branch of B+ system.

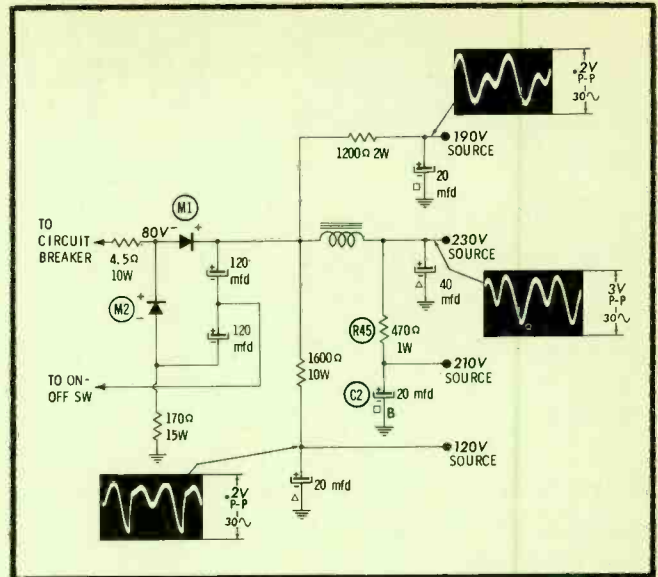

See PHOTOFACT Set 462, Folder 2

Mfr: Silvertone Chassis No. 528.51580

Card No: SI-.51580-2

Section Affected: Sound.

Symptoms: No sound.

Cause: Shorted plate-bypass capacitor in audio output stage.

What To Do: Replace C29 (1000 mmf—2000V).

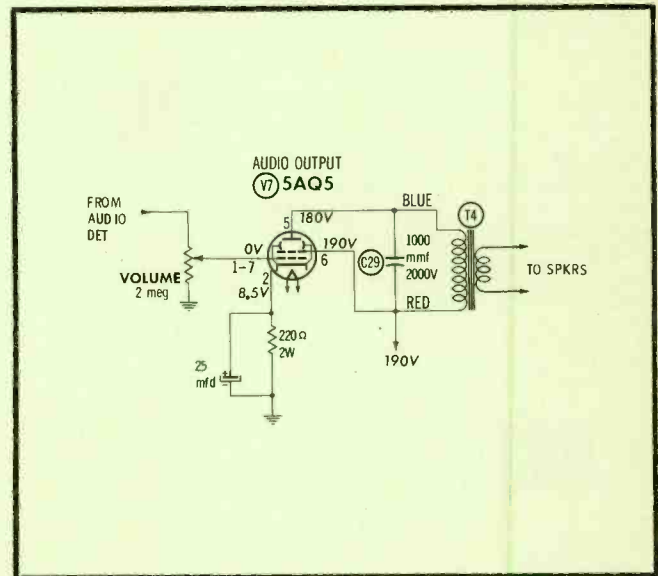

Mfr: Silvertone Chassis No. 528.51580

Card No: SI-.51580-3

Section Affected: Pix and sound.

Symptoms: No picture; no sound.

Cause: Open connection at terminal 1 of sound take-off transformer.

What To Do: Resolder terminal 1 of 4.5-mc sound take-off transformer L8; if this does not cure trouble, replace L8.

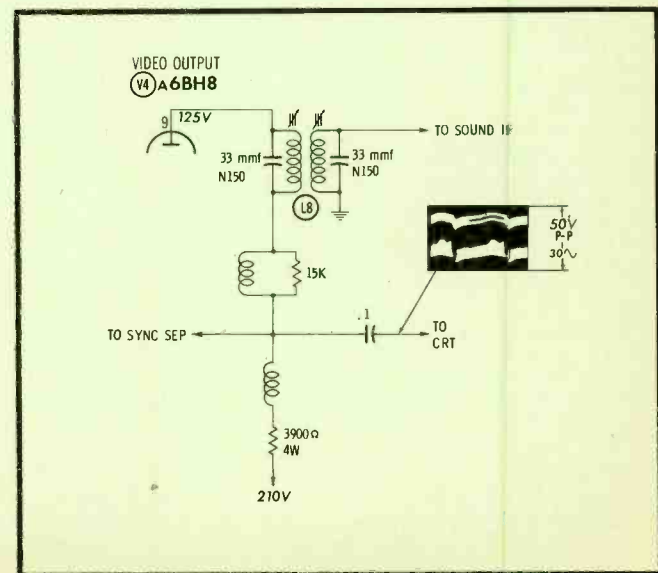

See PHOTOFACT Set 462, Folder 2

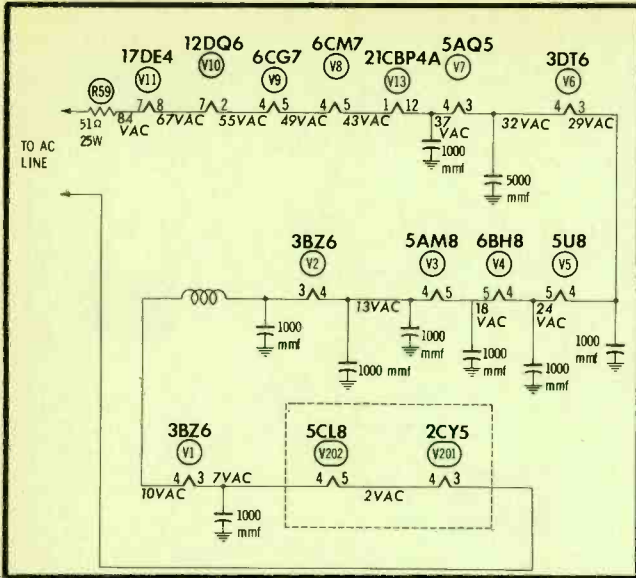

See PHOTOFACT Set 462, Folder 2

Mfr: Silvertone Chassis No. 528.51580

Card No: SI-.51580-4

Section Affected: Raster and sound.

Symptoms: Frequent tube failure, disabling series heater string. When bad tube is replaced, set comes to life; but all tubes glow too brightly.

Cause: Series resistor in heater circuit decreased in value.

What To Do: Replace R59 (51 ohms—25W).

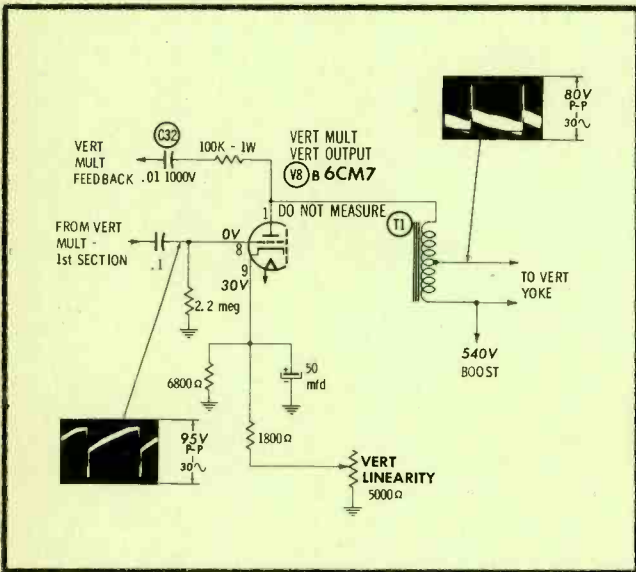

Mfr: Silvertone Chassis No. 528.51580

Card No: SI-.51580-5

Section Affected: Raster.

Symptoms: No vertical sweep.

Cause: Shorted feedback capacitor in vertical multivibrator.

What To Do: Replace C32 (.01 mfd—1000V).

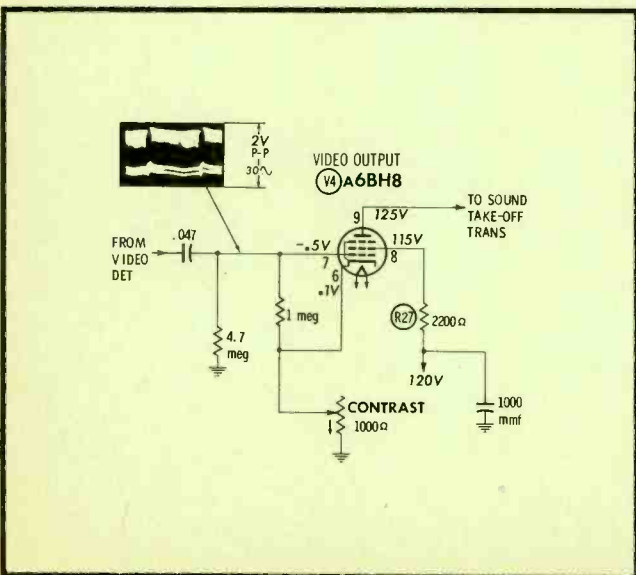

Mfr: Silvertone Chassis No. 528.51580

Card No: SI-.51580-6

Section Affected: Pix.

Symptoms: Normal raster, but no picture.

Cause: Screen resistor in video output stage burned open.

What To Do: Replace R27 (2200 ohms—1/2 W) and check V4A (6BH8).

See PHOTOFACT Set 472, Folder 1

Mfr: Sylvania Chassis No. 1-541-7

Card No: SY 541-7-1

Section Affected: Raster.

Symptoms: No vertical sweep.

Cause: Shorted feedback capacitor in vertical multivibrator.

What To Do: Replace C48 (.0022 mfd—1000V).

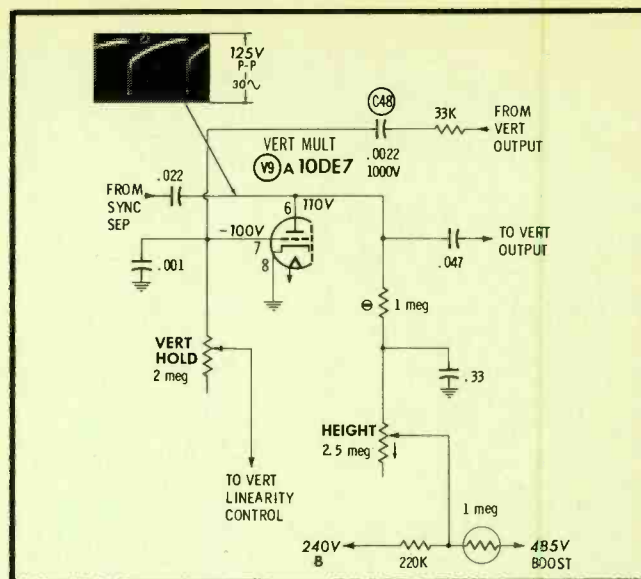

See PHOTOFACT Set 472, Folder 1

Mfr: Sylvania Chassis No. 1-541-7

Card No: SY 541-7-2

Section Affected: Pix.

Symptoms: Intermittent video overloading.

Cause: Open AGC control.

What To Do: Replace R9 (190K).

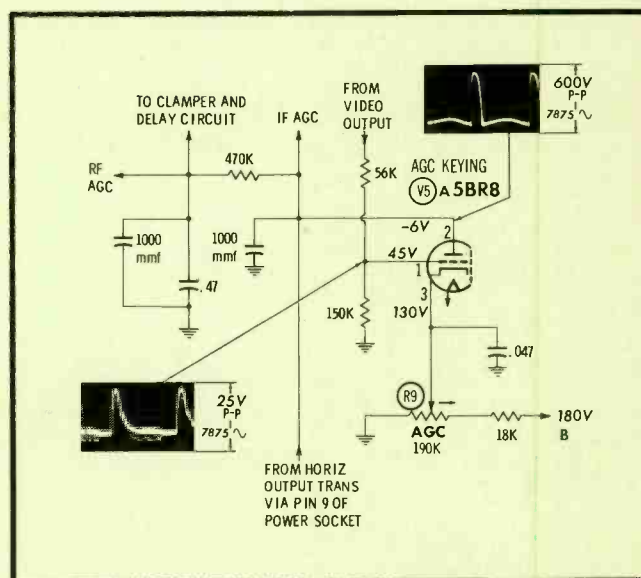

Mfr: Sylvania Chassis No. 1-541-7

Card No: SY 541-7-3

Section Affected: Sync.

Symptoms: Poor vertical and horizontal hold.

Cause: Sync separator plate load resistor increased in value.

What To Do: Replace R49 (100K—1/2 W).

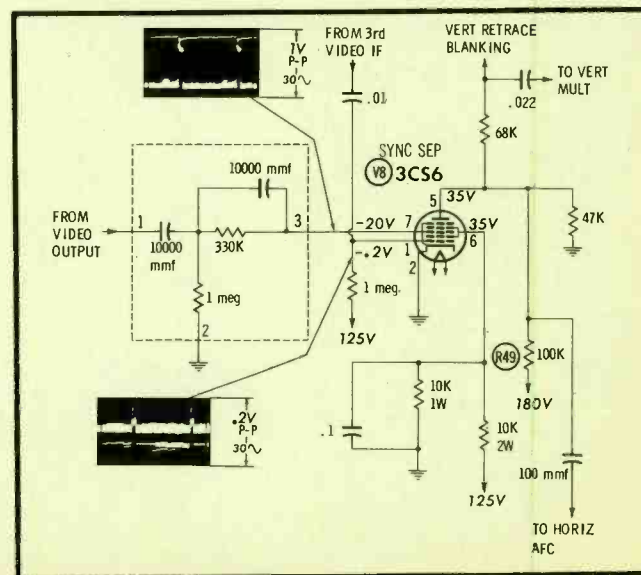

See PHOTOFACT Set 472, Folder 1

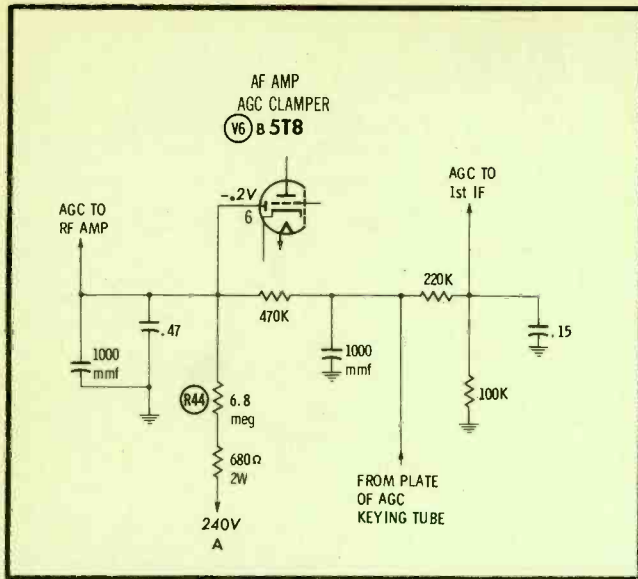

See PHOTOFACT Set 472, Folder 1

Mfr: Sylvania Chassis No. 1-541-7

Card No: SY 541-7-4

Section Affected: Pix.

Symptoms: Gradually increasing amount of snow in picture.

Cause: AGC delay resistor increasing in value.

What To Do: Replace R44 (6.8 meg— $\frac{1}{2}$ W, 5%).

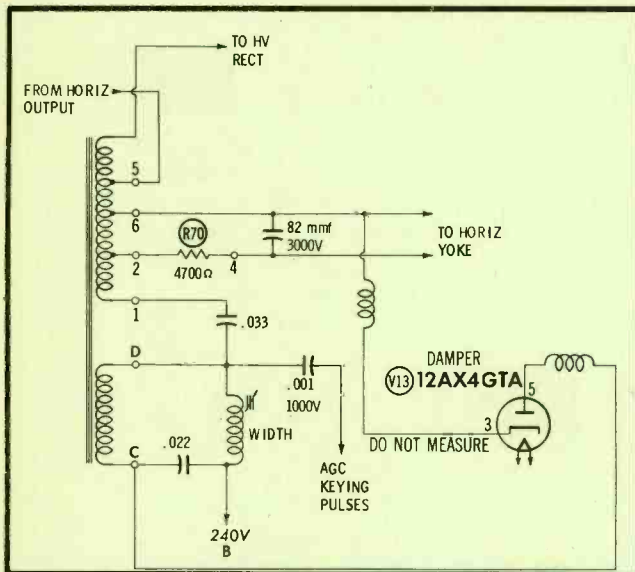

Mfr: Sylvania Chassis No. 1-541-7

Card No: SY 541-7-5

Section Affected: Raster.

Symptoms: Insufficient width in some cases; complete loss of raster and high voltage in others.

Cause: Series resistor in horizontal yoke circuit burned and decreased in value.

What To Do: Replace R70 (4700 ohms— $\frac{1}{2}$ W). Check yoke and C61 (82 mmf—3000V, N750) for defects.

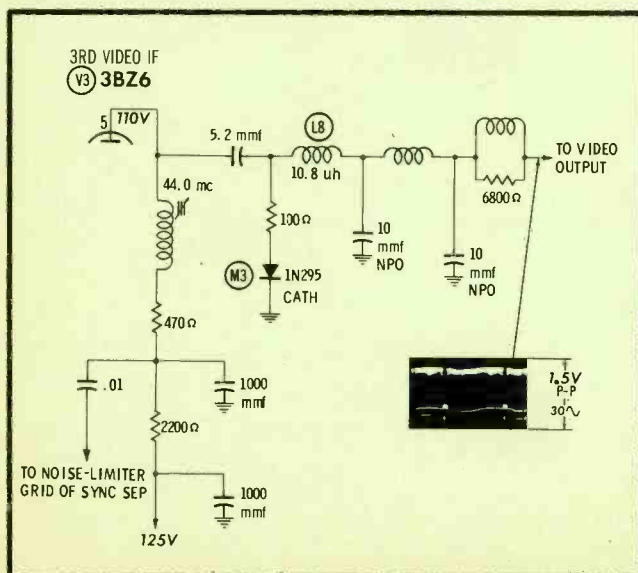

Mfr: Sylvania Chassis No. 1-541-7

Card No: SY 541-7-6

Section Affected: Pix.

Symptoms: No picture.

Cause: Open peaking coil in video detector circuit.

What To Do: Resolder pigtails or replace L8.

52,745,000
IN
OPERATION



ELMENCO

**MYLAR* - PAPER
DIPPED
CAPACITORS**

RELIABILITY

Elmenco dp Mylar*-Paper Capacitors have achieved a reliability that meet missile and computer requirements. They are thoroughly and continually tested during production to insure outstanding performance. For example a 0.1 mfd. dp capacitor operated at full rated voltage and at 105° C will have a life expectancy of more than 7,168,000 unit hours.

MOISTURE-PROOF

Elmenco dp Capacitors are specially processed and vacuum dipped to obtain solid impregnation and a rugged moisture-proof coat designed to withstand 4 times more humidity than the best molded capacitors used in the past.

MINIATURIZED

These capacitors are up to 50% smaller than other brands and can be used in printed circuit and transistor applications.

*DuPont Reg. Trademark

Write for catalog dp 110.

the

**BIG
SWITCH**

is to

MINIATURIZED

ELMENCO

capacitors

AVAILABLE AT ARCO
DISTRIBUTORS EVERYWHERE



ARCO
electronics inc.

64 WHITE ST., NEW YORK 13, N. Y.
Branches: Dallas 19, Los Angeles 35



ELMENCO

**CERAMIC
DISC
CAPACITORS**

RELIABILITY

The use of special ceramic materials in Elmenco Disc Ceramic capacitors impart longer life and greater stability. Higher voltage ratings greatly improve reliability by providing extra reserve for resistance to surges and temporary overloads.

MOISTURE RESISTANT

Elmenco Disc Ceramics are processed with a rugged phenolic coating and high temperature wax impregnation which gives them a superior moisture resistance and physical strength.

SPACE SAVERS

Elmenco Disc Ceramics are smaller than comparable capacitors of the same value. The miniature size is designed to offer greater service convenience with complete safety of operation.

Write for catalog CC115.

See us at the May Parts Show Booth No. 401 and Istanbul Suite No. 1604-05-06A.

NEW

ORANGE-DROP®

DIPPED DIFILM® CAPACITORS FOR EXACT ORIGINAL REPLACEMENT



THIS NEW . . . MINIATURE . . . DIFILM CAPACITOR OUTPERFORMS ALL OTHER DIPPED TUBULAR CAPACITORS!

▲ ±10% CAPACITANCE TOLERANCE IS STANDARD.

SPRAGUE DIFILM *does it again!* First to give you at regular prices the finest molded tubular capacitor made—the DIFILM BLACK BEAUTY . . . and now the newest DIFILM capacitor—the ORANGE-DROP dipped capacitor.

▲ SPRAGUE ORANGE-DROP CAPACITORS are especially made for easy installation in tight spots . . . where only an exact replacement will fit. They are the exact same dipped capacitors used by leading manufacturers in many TV sets.

WHY ORANGE-DROPS BEAT HEAT AND HUMIDITY

Sprague Orange-Drop Mylar* Paper Dipped Capacitors combine the proven long life of paper capacitors with the effective moisture resistance of film capacitors. Their duplex dielectric of kraft paper and polyester film is impregnated with HCX®, Sprague's exclusive hydrocarbon material which saturates the paper and fills voids and pinholes in the film before the HCX polymerizes. The result is a solid, rock-hard capacitor section which is then double-dipped in bright orange epoxy resin for moisture protection. Leads are neatly crimped for easy installation on printed wiring boards.

▲ SPRAGUE ORANGE-DROP CAPACITORS are a natural teammate for the molded Difilm Black Beauty®. Black Beauties, born out of engineering to tough missile standards, are still far and away the best replacement capacitors—better than any other molded or dipped . . . paper, film, or film-paper combination . . . capacitor made for entertainment electronics.

▲ Where a dipped capacitor is called for, no other dipped unit can match the ORANGE-DROP. Your distributor is stocked with all popular ratings in 200, 400, 600, and 1000 volts in handy Sprague Kleer-Paks. Order some today.

*Du Pont Trademark

don't be vague—insist on

SPRAGUE • the mark of reliability

ANOTHER TESTED RELIABLE PRODUCT BY THE WORLD'S
LARGEST CAPACITOR MANUFACTURER

publisher
Howard W. Sams

general manager
Mal Parks, Jr.

editor
Verne M. Ray

associate editors
Leslie D. Deane
Thomas A. Lesh
Joe A. Groves

consulting editors
William E. Burke
Robert B. Dunham
George B. Mann
C. P. Oliphant
Paul C. Smith

art director
Don W. Bradley

advertising & editorial assistants
Georgeanna Caldwell
Marjorie Spiegel
Jean Sekulski

production manager
Robert N. Rippy

circulation fulfillment
Pat Tidd, Mgr.
Constance McCawley, Ass't.

photography
Robert W. Reed

advertising sales offices

midwestern
John Grace, PF REPORTER
2201 East 46th Street, Indianapolis 6, Ind.
Clifford 3-6441

eastern
Cliff Landis
Corning Glass Building,
717 Fifth Ave., New York 22, N. Y.
MUrray Hill 8-6350

western
The Maurice A. Kimball Co., Inc.
2550 Beverly Blvd., Los Angeles 57, Calif.
Dunkirk 8-6178; and 681 Market Street,
San Francisco 5, Calif. Exbrook 2-3365

Address all correspondence to
PF REPORTER, 2201 East 46th Street,
Indianapolis 6, Indiana



Copyright © 1960 by Howard W. Sams & Co., Inc. PF REPORTER is a trademark of Howard W. Sams & Co., Inc. No part of PF REPORTER may be reproduced without written permission. No patent liability is assumed with respect to use of information herein. Acceptance of advertising does not in any manner signify the products, policies and services so advertised have been approved, endorsed or recommended by this magazine.

Indexed in *Electronic Guide* and *Lectrodex*.
Printed by the Waldemar Press Div.
of Howard W. Sams & Co., Inc.



PF REPORTER

including **Electronic Servicing**

VOLUME 10, No. 5

MAY, 1960

Previews of New Sets	1
<small>Emerson Model 1524, Motorola Model 21C10CW, Philco Model H-4686S, Trav-Ler Model 921K810.</small>	
Video Speed Servicing	5
<small>Service hints on the Silvertone Chassis 528-51580 and Sylvania Chassis 1-541-7.</small>	
Letters to the Editor	12
The Electronic Scanner	20
Have HV, No Raster	26
<small>Les Deane Be sure to check the base-pin circuits before deciding the picture tube is bad.</small>	
That's the Way the Horizontal Sweeps	28
<small>Joe A. Groves Knowing the function of every component helps you see the connection between observed symptoms and parts breakdowns.</small>	
Painted Circuits—New Aids for Troubleshooting	30
<small>Thomas A. Lesh Servicing New Designs—Nearly all TV manufacturers who use printed wiring are now placing service information directly on the boards.</small>	
A Review of Intercom Systems	32
<small>Some of the new models will do almost everything except applaud when you speak.</small>	
Dollar and Sense Servicing	34
Tips for Techs	38
Stabilizing Horizontal Sync	40
<small>Milton S. Kiver Shop Talk—The most convenient way to isolate horizontal frequency troubles is to break the oscillator—AFC feedback loop.</small>	
Care of Tape Transport Mechanisms	46
<small>It's easy when you use less oil! Here's a chance to increase your knowledge of tape-drive systems.</small>	
Examining an Industrial Control Device	54
<small>Joe A. Groves A TV man examines a pyrometer used for regulating heat within a tempering furnace.</small>	
Line-Cord TV Antennas	60
<small>Jack Beever Their operating principles are more complicated than you might think.</small>	
Fine Points of Radio Servicing	64
<small>Calvin C. Young, Jr. Quicker Servicing—You can repair radios at a profit if you take the right approach.</small>	
Inside CB Radios	70
<small>Allan Lytel Class D equipment has simple, but stable, transmitter and receiver circuits.</small>	
Notes on Test Equipment	76
<small>Les Deane Lab reports on the Arkay Model MT-50 Multi-Tester and Sencore Model RS-106 Rectifier Trouble-Shooter.</small>	
The Troubleshooter	82
Product Report	100
Free Catalog & Literature Service	104

ABOUT THE COVER

Proverbial "little black boxes" always seem mysterious to those who have no idea what they contain. Our front cover pictures several "big black boxes," the contents of which are described in the Industrial Electronics feature beginning on page 54. You'll be surprised to learn how amazingly simple this control circuitry really is.



Introducing ATR CUSTOMIZED Karadio



Can be installed
in dash or under
dash as desired!

for
small import cars
and
compact U.S. cars



There
is a trim
plate kit for
YOUR CAR!

ATR CUSTOMIZED Karadio

• VIBRATOR-OPERATED with Tone Control

The ATR Customized Karadio is a compact, new, self-contained airplane-styled radio for small import and compact American cars. This economical unit is perfect for all small cars because it can be easily and inexpensively installed in-dash or under-dash on most any make or model automobile—and its powerful 8-tube performance provides remarkable freedom from engine, static, and road noises. ATR Karadios are built to look and fit like original equipment with sleek, modern styling and solid, single-unit construction. They offer many customized features and provide highest quality fidelity—yet cost far less than comparably designed units. The ATR Customized Karadio comes complete with speaker and ready to install... and is the ideal way to add fun and value to your small import or American automobile!



ATR KARADIO
... is ideal
for small import
cars or compact
American cars! Unit is
completely self-contained—extremely compact!
Can be mounted in-dash or under-dash—wherever
space permits! For 6 volt or 12 volt!

SEE YOUR JOBBER OR WRITE FACTORY

• "A" Battery Eliminators • DC-AC Inverters • Auto Radio Vibrators



AMERICAN TELEVISION & RADIO CO.
Quality Products Since 1931
SAINT PAUL 1, MINNESOTA, U. S. A.

Letters to the

EDITOR

Dear Editor:

What is the best way to learn how to interpret scope waveforms? I built my own scope three years ago, but have been able to use it only in alignment work. When it comes to troubleshooting with the scope, I find it almost impossible to determine what components are defective, or to go about analyzing the wave-shape.

DONALD M. CLEMENT

Don's Radio & TV Shop
New Orleans, La.

You have plenty of company! There is no "magic key" to using an oscilloscope; the trick is to become thoroughly familiar with the normal and abnormal signals at specific points in the circuitry.

Some of the most helpful waveform information along this line is contained in the following articles:

"Tough-Dog Sync" series — February through April, 1960

"Scoping Video and Vertical Troubles" — January, 1960

"Scoping Modern TV Circuits (6BU8) — August, 1959

Bimonthly "Across the Bench" columns

These have been supplemented with special articles giving instructions on scope use. See "How to Operate a Scope" (October, 1958) and "Scope-Waveform Calibration" (December, 1957).

Other sources of helpful information are recent Howard W. Sams books, "Know Your Oscilloscope" (KOS-1), "101 Ways to Use Your Oscilloscope" (TEM-2), and "101 More Ways to Use Your Scope in TV" (TEM-7, scheduled for publication this month).

A final tip: In general, use a low-capacitance probe for scoping video, sync, and sweep stages; use a demodulator probe for signal-tracing IF strips. —Ed.

Dear Editor:

Enclosed is a picture of one of the four portable benches we have in our shop. Notice the 6" x 9" hole. This is covered with a piece of heavy plate glass, mortised in so that it is level with the rest of the bench top. By placing a light



under this glass, we have an excellent setup for working on printed boards.

GEORGE OTT, JR.

Ott's Radio and Television

"Service by Experience—

Not Experimenters"

Meadville, Pa.

Aw shucks! Now the boys have no place to hide the "dogs." Like your motto, too. George.—Ed.

Dear Editor:

I have a complete set of PF REPORTER issues (through June, 1959), and would like to offer them to the highest bidder over \$20 plus shipping charges.

They have served me well, but I've digested just about all the information, and would like to make them available to someone who will appreciate their value.

JOHN J. GREELEY

935 - 3rd Street

Rodeo, Calif.

Hope your mailman has a strong back, John. Other readers, please don't write us—it takes a truck to deliver our mail now!—Ed.

Dear Editor:

The case of the TV remote control being actuated by a chain around a boy's neck (*Quicker Servicing*, March) reminds me of the trouble we have been having with our own RCA Wireless Wizard control. We have a small dog with two metal tags secured to his collar by a metal ring. When the dog comes out of the rain or cold and shakes himself, he triggers the remote receiver and turns our set off!

CHARLES N. SNYDER

Fairborn, Ohio

Which proves the old adage, "Every dog has his day." Just so he doesn't interfere with "Captain Kangaroo"!—Ed.

Dear Editor:

In going through the April *Previews of New Sets* column, I notice that you say the Olympic Chassis JRW has a 90° picture tube. Such is not the case; this new set is equipped with a 110° tube.

ANDREW ADLER

Service Manager

Olympic Radio & Television

Long Island City, N. Y.

Okay, we've credited your account in the amount of 20". (Anyone need a cross-eyed proofreader?)—Ed.

Dear Editor:

Thanks for your helpful personal reply to my recent request for aid in troubleshooting a set with no high voltage. I checked the yoke again, as you suggested, and found a short between the horizontal and vertical windings. This trouble didn't show up in my original test, which consisted of merely disconnecting one horizontal-yoke lead and checking resistance across the horizontal windings. Next time, I won't be fooled into thinking that an open or short in a horizontal winding is the only possible trouble.

I have read just about all of the magazines on electronics and honestly find yours to be the best. It actually has more real information, relative to advertising content, than any of the other

• Please turn to page 18

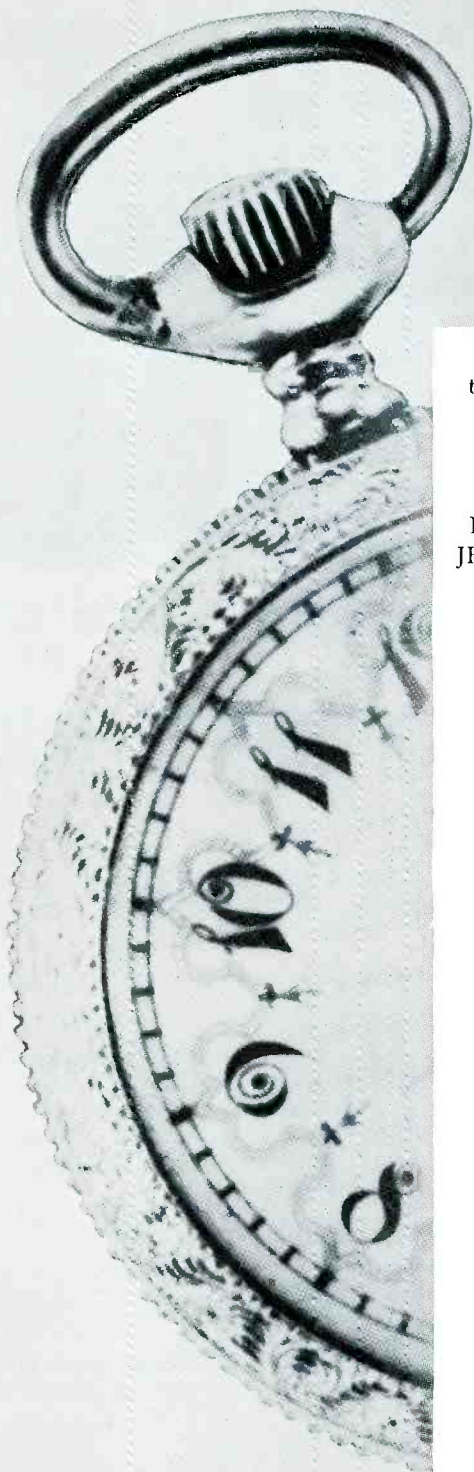

TIME FOR LEADERSHIP

Born barely four years ago, exact replacement portable and tote-able TV antennas are rapidly displacing top-of-the-set indoor antennas as prime money-makers in the servicing trade. Today, they rank in sale volume and profit with many major product lines.

From the day the first OEM* antenna left its production line, JFD recognized the sales potential of exact duplicate antenna replacements and began to build a merchandising plan for its distributor and dealer team. Today this new market concept—the *JFD Exact Replacement Antenna Profit Plan*—is ready for those distributors and dealers with the vision to foresee its bright future.

Under the revolutionary new *JFD Exact Replacement Antenna Profit Plan*, franchised distributors will receive:

1. A free floor Display Bar showing the exact replacement for every portable and tote-able antenna made from 1956 up to 1960—the industry's only and most complete line.
2. Automatic updating of stock with new models added as they are announced.
3. Annual replacement of slow moving numbers with more popular fast selling models.
4. Full distributor discounts with full dealer profit margins based on a true list price.
5. Dynamic advertising and merchandising support the year through in the form of complete listings in Sams Photofact folders and other strong selling aids.

It is our firm conviction that, with the exception of receiving tubes, the TV antenna will require the most frequent replacement during the useful life of a portable or tote-able TV set.

We intend to limit the line to a selected group of dealers and distributors in each area to insure a clean, efficient and profitable operation.

If this aggressive sales idea appeals to your thinking, we cordially invite your consideration of its many benefits.

JFD ELECTRONICS CORPORATION

Brooklyn 4, New York • DEwey 1-1000

THE BRAND THAT PUTS YOU IN COMMAND OF THE MARKET

Turn this page to see the opening trade advertising announcement that will be seen, read and discussed by every service-dealer of vision & importance.

*Original Equipment Manufacturer

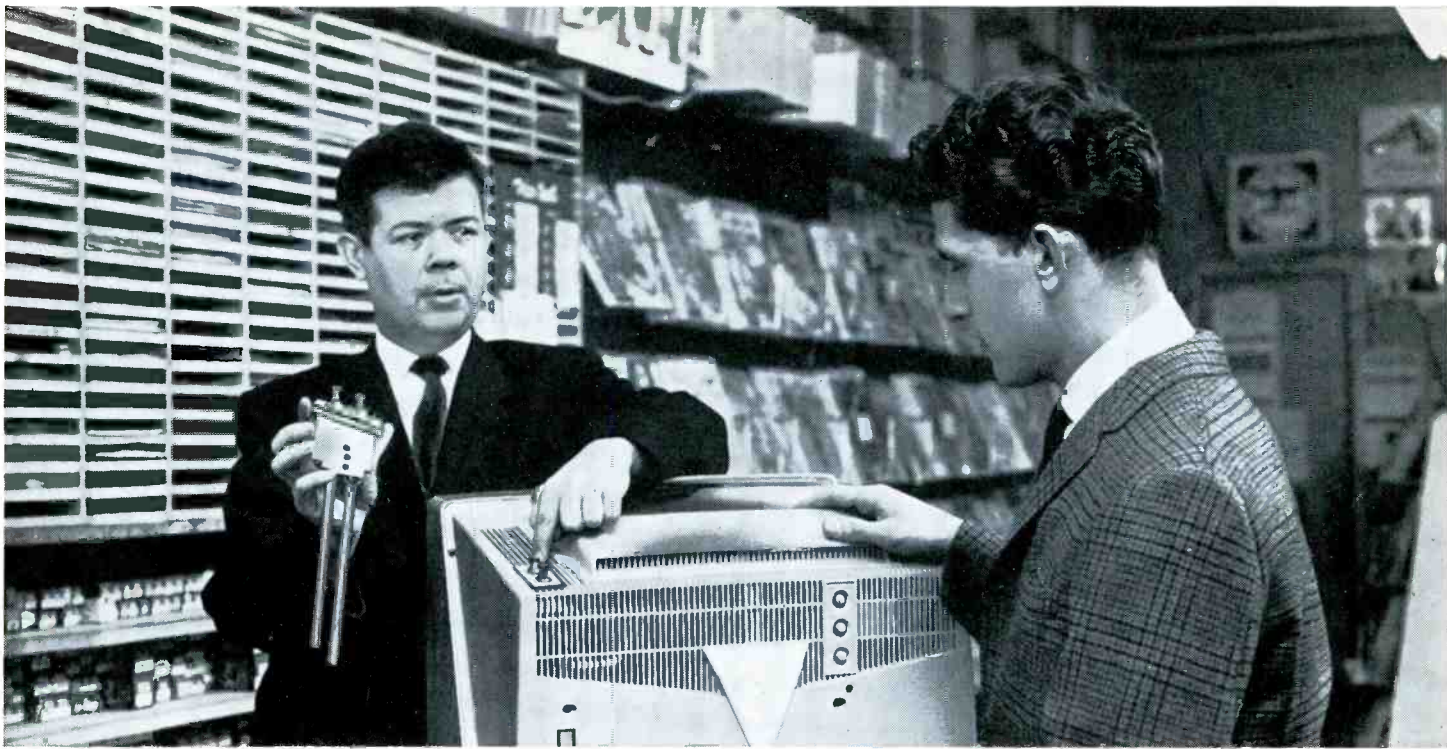

more than a new profit opportunity . . .

JFD OPENS MULTI-MILLION Exact Replacement

the biggest sales building idea in TV antenna sales since the introduction of the indoor antenna!

*The Future
Belongs to those
Service-Dealers
who are ready for it!*

You do not have to be an expert to know that exact replacements are rapidly displacing "catch-all" indoor antennas. This is to be expected since over 60% of all TV sets made today are portable and tote-able types. Result: an estimated 3,500,000 dollars in exact replacement antenna volume in 1960 for those service-dealers equipped to handle it.

Now you the dealer — not the local discounter — can cash in on indoor antenna replacements and prices by stocking and selling JFD Exact Replacement Antennas for all portables and tote-ables.

HERE IS HOW TO START MAKING MONEY TODAY WITH THE JFD EXACT REPLACEMENT PROFIT PLAN

1. Your customer gets the original antenna type that came with his portable or tote-able.
2. You make the legitimate profit you are entitled to on the sale.
3. You make a profit on the servicing required to install the antenna.
4. You bring customers (old and new) back to your shop because only you are equipped to perform this special replacement.

**THE BRAND THAT PUTS YOU IN COMMAND OF THE MARKET
JFD ELECTRONICS CORPORATION**

6101 Sixteenth Avenue, Brooklyn 4, New York

JFD ELECTRONICS CORPORATION
6101 Sixteenth Avenue, Brooklyn 4, N. Y.

Gentlemen:

- I want to participate in the JFD Exact Replacement Profit Plan. Send me full details.
- Also send me the name of my local JFD distributor.

The name of my local JFD distributor is:

.....

NAME _____

ADDRESS _____

CITY _____ ZONE _____ STATE _____

Only \$11.95 PUTS YOU BACK IN PROFITABLE INDOOR ANTENNA BUSINESS

That's all it costs for this PA500 Merchandising Kit* that sets you up overnight as an Exact Replacement Antenna Specialist.

* 5 Popular Exact Replacement Antennas that are currently used on 85% of older portable and tote-ables sold.

* 1960 Guide to all portable and tote-able models made since 1956 with manufacturers set model no. and antenna part no., compiled and edited by Howard W. Sams Co.

* Streamers identifying you as Exact Replacement Specialist for portable and tote-able antennas.

* "How to Sell" planning booklet shows you how to convert Exact Replacement Antenna prospects into profits in your area.



PA500 Merchandising Kit



more than a new merchandising concept . . .

DOLLAR MARKET FOR SERVICE DEALERS

Antenna Profit Plan!

HERE IS HOW TO START MAKING MONEY TODAY WITH THE JFD EXACT REPLACEMENT PROFIT PLAN

LOOK FOR THESE DISPLAYS AT YOUR JFD DISTRIBUTOR . . .

Select your customers' antenna needs from the new JFD Skin-Packaged Display Bar showing 50 Exact Replacements for every portable and tote-able antenna made, up to and including 1960.

. . . AND GET YOUR FREE MERCHANDISING RACK

Compactly designed for wall or counter use . . . free to JFD stocking service-dealers. Simplifies stocking . . . expedites servicing . . . sells customers. Ask your distributor for the JFD PA515 Exact Replacement Antenna Assortment — and your FREE rack.

Remember, next to receiving tubes, the antennas of portable and "tote-able" sets require the most frequent replacement of any component. (It is estimated that during the average 10-year life of a set, its antenna will have to be replaced a minimum of 5 to 6 times.)

Your personal pass-key to this ripe, rich market is waiting for you at your JFD Distributor.

JFD INTERNATIONAL
15 Moore Street
New York, N.Y.

JFD CANADA LTD.
51 McCormick Street
Toronto, Ontario, Canada



PA515

FREE DEALERS' STOCKING RACK



DISTRIBUTORS' DISPLAY RACK



Westinghouse Electric Corp.
600 St. Paul Ave.
Los Angeles 17, California

Gentlemen:

We are constantly seeking improved products to recommend and sell to our customers, and we are pleased to inform you that Westinghouse receiving tubes and picture tubes fall into that category.

We changed over exclusively to Westinghouse tubes approximately January 1st, of this year. Since it was a new product to us, we kept complete records of tube failures and customer call backs. Our call backs due directly to tube failures were reduced by over 50 per cent.

It is with complete confidence that we recommend and sell your quality Gold Star picture tubes. The picture quality is excellent, and the tubes are exceeding our greatest expectations. In the past nine months, we have used approximately 500 picture tubes, and as of now have only replaced three. Two of which were defective out of the carton, and only one failed in actual use. In fact, we are so confident in the life of the picture tube, that we are now guaranteeing our picture tube replacements for three years.

We have gained two things by the use of your tubes. Greater customer satisfaction, and more net dollars for us due to the very minimum amount of tube failures.

Please thank your Engineers and Quality Control Department for the fine product that they are putting in our hands to sell to the consumers.

Sincerely yours,

ACE RADIO & TV SERVICE

Philip Blank
Philip Blank

FR:jd

"call backs
reduced by
over 50%! "

"It is with complete confidence that we recommend and sell your quality Gold Star picture tubes."

"We are so confident in the life of the picture tube that we are now guaranteeing our picture tube replacements for three years."

"We have gained...greater customer satisfaction, and more net dollars for us due to the very minimum amount of tube failures."

We can't think of a thing to add. Except, perhaps, that your local Westinghouse electronic tube distributor will be happy to introduce you to the line. If your distributor doesn't carry them yet, give us his name. We'll send someone over to enlighten the poor fellow.

YOU CAN BE SURE...IF IT'S Westinghouse

Westinghouse Electronic Tube Division, Elmira, N.Y.

CUT BACK on CALL BACKS



AEROVOX MICA CAPACITORS

Why risk call backs when dependable Aerovox Mica Capacitors insure a stay-put repair job. Smart servicemen and technicians everywhere use and depend on Aerovox mica capacitors for "trouble-free" operation. **POSTAGE STAMP MICAS** . . . for all those applications where only the smallest axial lead units will do. Perfect for horizontal and vertical oscillator requirements. All units color-coded and stamped.

HIGH VOLTAGE MICAS . . . designed especially for TV and low power transmitters. You'll find the highest voltages available in these small case sizes. Every unit is tested at twice the rated voltage to insure long-life. Units color-coded and stamped.

DIPPED-MICAS . . . superior in many cases to conventional molded units. High operating temperatures, excellent long-life characteristics. Perfect for printed-wiring assemblies. Smallest physical sizes with unsurpassed performance and stability features. For "off-the-shelf" delivery on all your capacitor requirements see your local Aerovox Distributor.

AEROVOX CORPORATION
DISTRIBUTOR DIVISION
NEW BEDFORD, MASS.

Letters

(Continued from page 12)

publications. While I realize advertising is necessary to help defray publishing costs, "enough is enough."

I get a kick out of the arguments in the *Letters to the Editor* column; actually, I'm broad-minded enough to agree with both sides. Here's to continued success of your publication and all your subscribers, and may we all get along together for the sake of better servicing. After all, the customer comes first.

ROY B. HUNTER

Allen Park, Mich.

Thank you, too, for these kind words. We're happy to know we were of help in solving your service problem. This is in line with our basic policy of doing everything possible for the best interests of our readers. If you're pleased with our handling of editorial material, we feel we're accomplishing our prime purpose.—Ed.

Dear Editor:

Several years ago, I started building the preamplifier described by Robert B. Dunham in your April, 1955 issue. Now I'd like to complete this project, and find I need a copy of the article and a schematic diagram. I would be glad to remit whatever charge you make for this service.

Also, I'd like to take this opportunity to compliment your company on the large number of good publications relating to TV and electronics. I have many of them, and will continue to acquire more as they are published. I like PF REPORTER and look forward to receiving it each month. Keep up the good work.

WILLIAM G. LAYTON

Orlando, Fla.

Lucky you! Those kind words indicate you live right! Full information on this preamp, including a complete schematic, was presented in the June, 1955 issue—and we're sending you one of the last three or four copies available.

Incidentally, a connection from the unnumbered terminal of the equalization switch to the junction of R16 and R20 was omitted in this circuit. Also, as you may have already surmised, B+ filter resistor R34 should be 47 ohms, not 47K ohms as shown.—Ed.

Dear Editor:

This is the day! Never did I think I would live to question any statement by Milton S. Kiver—but here goes:

The March *Shop Talk* column says, "A complete lack of raster on the screen can be due to a defect in either the horizontal sweep system (and high voltage circuit), or in the low-voltage power supply. In the latter case, the sound will disappear along with the raster." I can't agree with the second part of this statement, since I've seen "sound—no raster" symptoms on several sets with defective low-voltage supplies. Two recent examples are a G-E with a corroded ground connection on the power transformer and an Emerson with bad selenium rectifiers

and filters. The sound might have come on a couple of seconds late, but it was there.

G. H. RAYBORN

Rayborn's TV Service
Nocatee, Fla.

How right you are! But don't blame the author—ye olde Ed was responsible! I'd back the statement to the hilt if only the extra little word "often" had been included.

To find out what a severe drop in B+ voltage can do to the raster, turn to "Have HV, No Raster" in this issue.—Ed.

Dear Editor:

It seems to me that you people use a crystal ball or something; the March 1960 cover of yours is so darn close to the truth it hurts, but it still makes for a good belly laugh. I got caught in the same situation last fall (it's hard on front bumpers).

You folks are doing a superb job in your magazine. I've been helped many times by your articles, particularly the "Troubleshooter" and "Video Speed Servicing." The only trouble is it takes me too long to find the issue with the article pertaining to the "dogs," so please send me indexes for the 1958 and 1959 issues.

Thanks loads, and don't change your magazine. I couldn't enjoy it more.

ROLAND BACKFISCH

Valley Radio & T.V.
Golden Valley, N. Dak.

One would expect such "golden" words from Golden Valley. Your indexes are on the way. Roland. Hope they serve you well.—Ed.

Dear Editor:

A new customer recently asked me to work on a CBS Model 7K325 (PHOTOFACT Folder 338-2). He incidentally mentioned, but did not complain about, an odd symptom the set had displayed ever since new. Whenever he turned it on, 15 to 20 minutes would pass before the picture would appear. Sound was normal.

Thinking this fault might be due to a defective CRT, I tried substituting a new one—but the same trouble was still present. HV and accelerating voltage were normal; so were the brightness and retrace-blanking circuits (connected to the CRT cathode) and the video coupling capacitor (at the grid). But when I shorted the grid to ground with a screwdriver, the raster came on clear and bright! Come to find out, the grid was "floating" because a 1-megohm resistor was missing between grid and ground. (It might have been left out during production.) Grid blocking apparently occurred until the set became thoroughly warm inside.

The owner said that several previous servicemen had shrugged off this symptom as "normal."

PETER FIORE

Pete's TV Clinic
Bronx, N. Y.

Bet you're staying busy answering all your calls to this neighborhood!—Ed.

**YOU'LL BE GLAD TO KNOW THAT
AMPEREX AMPLIFRAME TUBES
ARE USED IN THE BEST TV SETS
YOU HANDLE!**



thanks to 6 NEW

**Amperex®
AMPLIFRAMES***

you can look forward to...

1. TV sets with gain to spare!
2. TV sets with greater reliability—**BECAUSE AMPLIFRAMES MAKE CIRCUITS SIMPLER**—have fully proven their reliability in critical military and industrial applications!
3. TV sets that are much easier to service—because the extraordinary uniformity of **AMPLIFRAMES** almost invariably eliminates the necessity for re-alignment when changing tubes!

**OUTSTANDING FEATURES SHARED
BY THE NEW AMPEREX TV-IF
AMPLIFRAME TYPES 6EJ7, 4EJ7, 3EJ7,
6EH7, 4EH7 and 3EH7:**

- 9-pin construction; 2 cathode leads
- Internally shielded
- Low microphonics
- Internally neutralized screen grid.



NOW
all **AMPLIFRAME** IF tubes are automatically mass-produced for maximum uniformity and lower cost

NOW
Ampliframe tubes will provide 55% higher gain-bandwidth product than conventional IF tubes

NOW
compare the performance of Ampliframe tubes with conventional IF tubes and consider what this added design freedom can mean in the sets you service and sell

IF	GAIN	BANDWIDTH
3 x AMPLIFRAME	3500	4.5 mc
3 x Conventional	3500	2.5 mc
2 x AMPLIFRAME	1200	2.5 mc
2 x Conventional	350	2.5 mc

*AMPLIFRAME, a new concept in electron tubes, designed and mass produced exclusively by Amperex, incorporates the unique **FRAME GRID**...the closest approach to the ideal "Physicists' grid"—electrical characteristics but no physical dimensions. The **FRAME GRID** results in:
• higher transconductance per milliamperere • tighter G_m and plate current tolerance • low transit time • low capacitances • lower microphonics • rugged construction

ask Amperex



about Ampliframe tubes for TV and other entertainment applications

Amperex Electronic Corp.
230 Duffy Ave.
Hicksville, L. I., N. Y.

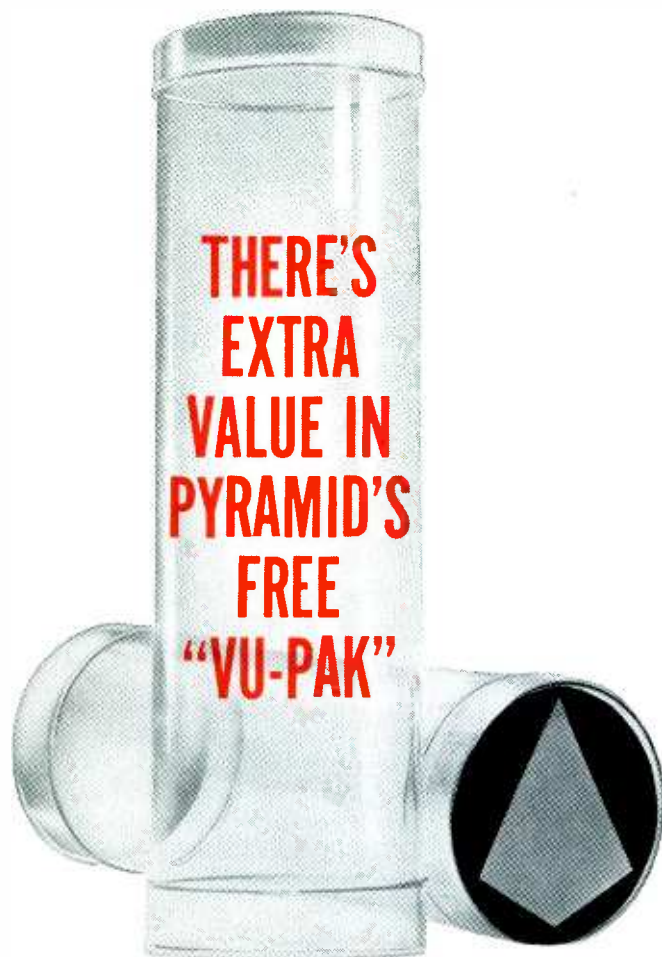

SENSATIONAL NEW CAPACITOR PACKAGE WITH 4+ FEATURES

1. New Way To Buy Highest Quality Capacitors
2. New Vu-Paks Store Electronic Parts In Your Shop
3. New-Vu-Paks Give You Free Identification Labels
4. New Vu-Paks Fit Your Capac-o-mat*

Pyramid, long famous for quality capacitors, has developed another first—the FREE “Vu-Pak”. Now, after an electrolytic twist-mount is installed, you don't discard the package. Use it to store the spare parts and tools that clutter your bench. This transparent plastic package comes with an extra blank label for your handy storage identification. You'll know where everything is—when you need it.

Another Great Service for Servicemen from Pyramid

The *Capac-o-mat holds your Vu-Paks. The Capac-o-mat fits right on your shelf or hangs on the wall. Designed by Pyramid to hold 54 Vu-Paks, it's sturdy and “dust-free”.

SPECIAL—Each Vu-Pak contains one coupon. 50 Coupons enable you to get Pyramid's Capac-o-mat at big, big savings.

See your authorized Pyramid Distributor for your Capac-o-mat and quality Pyramid capacitors.



PYRAMID ELECTRIC COMPANY

DISTRIBUTOR DIVISION: UNION CITY, NEW JERSEY

Factories: Gastonia, North Carolina • Darlington, South Carolina • In Canada: Wm. Cohen, Ltd., 8900 Tanguay St., Montreal • Export: Morhan Exporting Co., 485 Broadway, New York 13, N. Y.

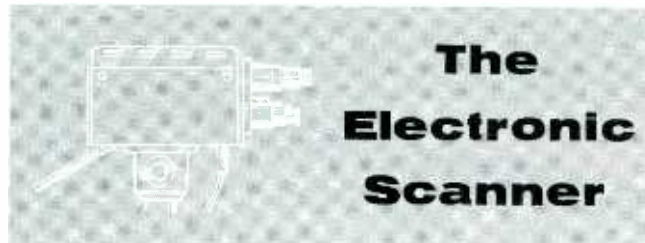

Hats Off to TRT

In line with their plans 'to further develop the skills of the Individual Technician through planned educational programs and special training sessions,' the **Television and Radio Technicians** of Kansas City (Mo.) recently sponsored an 8-hour “TV License Refresher Course” for both members and non-members of the association. During the latter part of March, one-hour sessions were conducted on color TV, hi-fi (including tape recorders and changers), transistors, and AM-FM radio. Another session was devoted to the new Kansas City license law, and three hours to black-and-white TV servicing. Good going, men. This sort of training should be industry-wide.

No Haystack Problem for These Needles

Realizing that many people are somewhat in the dark regarding the choice of replacement phono needles, **Duotone** has published a booklet you can distribute to your customers. The subjects it covers are how to buy a diamond needle, how to know when a needle is worn, how to identify the needle being used, and how to replace a worn needle.

You, Too, Can Be Elected

Sylvania Electronic Tube Div. has published a 50-page “Presidential Convention and Election Handbook” for distribution to the public—compliments of Sylvania Independent Service-Dealers. In addition to including just about everything your customers would want to know about the conventions, and about the “key” men in the upcoming presidential campaigns, special messages in the center and on the back cover of the booklet suggest “electing” the independent radio-TV serviceman (who puts his own name on the front cover) for the job of handling radio and TV troubles. A nice good will builder.

Kit Makes Hit at Crack of Bat

As part of their series of 50th anniversary promotions, **Cornell-Dubilier** is conducting a contest which ties in with the introduction of a compact kit of molded Mylar capacitors. Timed to coincide with the start of the baseball season, the \$6.87 “Hit Kit” contains 35 capacitors in the seven most popular values—as well as contest details, entry blank, and a newspaper mat carrying the baseball theme. The contest involves picking the teams who will lead each league at the end of the 1960 season. Sounds like fun!

No Captive Service

Company policy regarding participation of **General Electric Co.** in television service was clarified in a recent statement issued by Steven R. Mihalic, Product Service Manager for the television receiver department. “We have every intention of providing all possible aid toward maintaining the vitality of independent service organizations. Television receiver servicing traditionally has been done primarily by independent servicers, and this fact is recognized by the newly issued company-wide policy statement.”

Electronic “Brain” Controls Mechanical “Brawn”

A 23-ounce, hand-held portable garage-door operating device was adapted to control a 25-ton bulldozer during the groundbreaking ceremonies for **Delco Radio's** new engineering building in Kokomo. The transistorized transmitter, measuring only 1 1/2" x 2" x 6", sent out 5- to 10-kc signals to start and stop the giant bulldozer in both forward and reverse directions.

50 Million Miles on Batteries

Did'ja ever think you'd see the day when a battery-powered radio transmitter would send radiated signals a distance of 50 million miles? Well it's being done! The Pioneer V, a 26" sphere now orbiting around the sun, contains a 150-watt transmitter which is powered by a storage bank of 28 rechargeable nickel-cadmium type battery cells made by **Sonotone**. In the Pioneer V, 4800 solar converters obtain sufficient energy from the sun's rays to recharge the batteries. The recharging period takes about five hours, broadcasts last for five minutes.



Here is the new Standard Coil Tuner Replacement and Repair Program that enables you to offer better service to your customers at greater profit. Now Standard Coil Products provides the tools that will enable you to cash in on the profitable tuner repair and replacement market.

TUNER REPLACEMENT LISTING IN SAM'S PHOTOFAC

Starting in January, Standard Coil tuner replacement listings will appear in all Sams TV Photofact. Tuner replacement information will be right at your finger tips. Standard Coil is the *only* manufacturer ever to provide this service.

NEW TV TUNER REPLACEMENT GUIDE

Lists original equipment TV tuners with the Standard Coil equivalent replacement for each. Also includes major mechanical replacement parts for all Standard Coil Tuners—those used in original equipment as well as the universal replacement. Eliminates all guesswork—minimizes your tuner repair and replacement problems.

48 HOUR FACTORY GUARANTEED REPAIR SERVICE

Standard Coil's special service department set-up assures factory guaranteed repairs—*on a 48 hour in-plant cycle!* All repaired tuners carry a *six month warranty* on defective workmanship and parts failure (excluding tubes). Gives you more time for additional service calls—promptly returns your customer's set to like new operating condition.

DEFECTIVE TUNER TRADE-IN ALLOWANCE

Tuners which can *not* be repaired can be traded in against a new replacement tuner which carries a full *twelve month factory guarantee*. See your Standard Coil Distributor for complete details on how trade-ins can increase your tuner sales and profits—create greater customer satisfaction.

JUMP ON THE STANDARD COIL PROFIT WAGON TODAY!

For additional details, see your authorized Standard Coil Distributor or write to:

Standard

Coil Products Co., Inc.

2085 North Hawthorne Avenue, Melrose Park, Illinois

May, 1960/PF REPORTER 21

Build new

ADVERTISED IN
LIFE

They all sound
better, longer,
with Mallory
Mercury Batteries



Choose any of today's stylish, compact transistor radios . . . and you'll enjoy a wonderful world of sound wherever you go.

But remember . . . there's a big difference in the batteries you can put in your transistor radio. To get the most enjoyment from your set, be sure to use Mallory Mercury Batteries. These remarkable energy packages developed by Mallory give you extra value:

- Several times longer life than ordinary batteries.
- Steady, full strength power month after month . . . no gradual fading.
- No danger of leaking or damage to your radio.
- No loss of power when your radio is idle.

No wonder leading radio manufacturers recommend them! Always ask for Mallory Mercury Batteries. A dealer near you has them in sizes to fit all popular transistor radios.

New folder tells you how to get the best listening pleasure from your transistor radio. Write to us for your copy.

In Canada, Mallory's Battery Company of Canada, Limited, Toronto 10, Ontario



Mallory Battery Company, Cleveland 7, Ohio
a division of

MALLORY

Battery systems for hearing aids, flashlights, cordless clocks, lanterns, instruments, military electronics.

REACHING 32 MILLION READERS OF LIFE

Here's the kickoff of our promotion program: a full-page ad reaching over 32 million readers of LIFE on May 9 . . . ten million more people when it appears in the May 16 issue of TIME.

service profits

with Mallory Mercury Radio Batteries
... fast selling ... high profit per sale

The 30 million portable radios in use today represent a *giant* service market for \$40 million yearly sales in battery replacement. And it's growing by leaps and bounds . . . over 10 million transistor portables being used now, and 8 million more forecast for this year.

Here's how you can get your share of this booming business. It's the Mallory 1960 Radio Battery Program, that puts you on top of the market with—

A really different battery . . . the Mallory Mercury Battery . . . that gives unequalled customer satisfaction.

Powerful consumer advertising . . . reaching 32 million readers of LIFE, 10 million readers of TIME.

High profit per sale . . . each battery brings you several times as much profit as an ordinary battery.

No "dead" inventory . . . unique Mallory Mercury Batteries stay fresh on your shelf.

The only complete line of batteries for all portable radios.

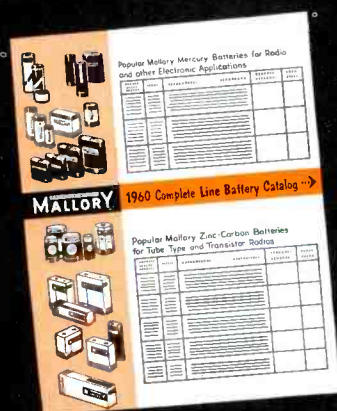

NEW BATTERY CATALOG

Complete line of Mallory Mercury and Zinc-Carbon Batteries . . . sizes, weights, applications.

A BATTERY SALESMAN SITTING ON YOUR COUNTER

New counter dispenser gives you a line of Mallory Mercury Batteries in popular sizes to fit all transistor radios . . . and zinc-carbon batteries for other portable radios.

CONSUMER FOLDER

Colorful folder tells your customer how to "Get More FUN" from his transistor radio with Mallory Mercury Batteries.

Cash in on the big profits. Write us, or ask your Mallory distributor about Mallory's 1960 Radio Battery Merchandising Program . . . and stock a full line of fast-moving, big-selling Mallory Batteries, for the sales that go hand-in-hand with your portable radio service.

Distributor Division
Indianapolis 6, Indiana

P. R. MALLORY & CO. Inc.
MALLORY



ARE YOU STILL BUYING

Lots of people, people who buy them as well as sell them, still judge a speaker by the weight of its magnet. "The heavier the magnet, the better the speaker," so the old rule of thumb goes. And when speakers were all pretty much alike, that was probably as good a way as any to grade them.

But speakers, like everything else in electronics, have changed enormously over the past few years. Magnet manufacturers know so much more today about making magnets. The magnets used by Delco have more highly oriented grain structures. They're premium grade, more efficient.

And Delco has improved every other speaker part—from basket to gasket, voice coil to cone. All these parts are now made with new, stronger materials. They work better together. They stand up longer. And Delco Radio's precision engineering

makes possible better magnetic circuits. The result is a greater range of rich, deep, distortion-free sound—sound that you once could get only from more expensive speakers with far heavier magnets.

Delco Radio sells speakers by the *sound* instead of by the pound. May we suggest you contact your Distributor soon.

Here's why Delco speakers give more sound per pound: Quality controlled premium magnets • Efficient pot design provides extremely short magnetic path with minimum magnetic air gap to minimize stray flux • High quality steel in magnetic circuit • Exacting ratio of cross section area of magnetic air gap to length of air gap gives optimum energy from magnet • Precision manufacture and assembly of parts make possible greater efficiency from magnetic circuit.

SPEAKERS BY THE POUND?



A



B



C

Delco gives you a complete line of Hi-Fi speakers. Illustration A is the 8" Model No. 8007. It offers the most highs, the most lows, the most watts in a medium-priced speaker. Designed for replacement use and high fidelity audio systems.

Delco's most popular auto radio speakers: (B)—Model No. 6112, 6" x 9", and (C)—Model No. 6109, Delco's exclusive 4" x 10". All Delco auto radio speakers are life tested to perform under severest climatic conditions. All, including our full line of rear seat speakers, are equipped with quality controlled, premium Alnico magnets.

DELCO
REPEATABILITY
RADIO
RELIABILITY

Division of General Motors
Kokomo, Indiana

Delco speakers, transistors, transformers and other parts for radios, television and Hi-Fi are available everywhere through Delco Electronic Distributors associated with



HAVE HV NO RASTER

Solutions for "The Case of the Missing Electron Beam"—by Les Deane

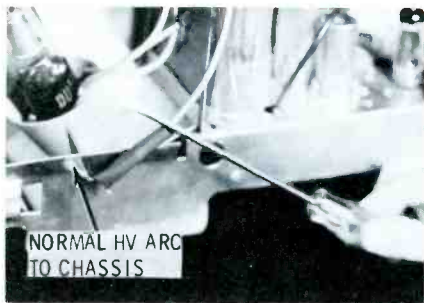

Fig. 1. With no raster, make certain of HV by drawing an arc from the source.

When summoned to patch up a television receiver with no light on the screen and normal sound, you usually look for loss of high voltage—but what do you do when you find HV present? From all indications, a number of technicians are having trouble formulating a systematic isolation procedure to cope with this *not-so-uncommon* problem.

Even the old-timer may have some difficulty pinning down the cause of this symptom if he doesn't know where to begin or what to look for. Ask yourself these questions: How do I isolate this trouble? Is it possible to repair the set in the home? Could I even give the customer an estimate on such a job? (It might be a \$55 picture tube or a 20c capacitor!) Look for the an-

swers to these questions as you read on.

Checking HV

When the raster is gone, but you think high voltage is present, make sure there's *enough* of the *right kind* of voltage before turning your attentions to other possibilities. This you can determine only by using the proper troubleshooting technique. An ideal method would be to measure the potential at the high-voltage anode of the picture tube; this could be done by use of a high-voltage probe in conjunction with an ordinary service voltmeter.

Normal high voltage in modern receivers may range from 9 to 20 kv, depending largely on the size of the picture tube; the average will be in the neighborhood of 15 kv (for 21" receivers) and somewhat less for smaller portables. Although this order of voltage is prescribed, many sets can still operate with as low as 6 kv on the second anode. *By operate*, I mean that visible light will be produced on the CRT, even though it may not fill the entire screen or be bright enough for normal viewing.

When checking for high voltage in the customer's home, most of us rely on a simple arcing test of some

sort. Many prefer to disconnect the anode lead and bring the end connector in close proximity to the chassis. With adequate high voltage, a straight bluish-white arc, ranging in length from 1/2" to 1" and accompanied by a sharp crack, should result from this test (see Fig. 1). However, this little trick may mislead you into thinking that high voltage is inadequate in some sets, especially those of older vintage. With the the anode lead disconnected from the CRT, you may discover more of a curved bluish-red arc resembling the RF normally found on the plate cap of the high-voltage rectifier. If you do, don't jump to conclusions—merely connect the lead back on the tube and check for an arc to chassis, using some sort of tool with an insulated handle. If high voltage is up to snuff, you should obtain a good DC arc. This condition often occurs when the filter capacitance provided by the aquadag coatings of the CRT is removed from the high-voltage output circuit.

High voltage of only 6 kv can produce what might appear to be a snappy arc, but generally the arc gap will be no longer than 1/4". If a check of high voltage indicates that the potential is too low to produce light on the screen, one should naturally troubleshoot the horizontal sweep and high-voltage circuits. The lack of voltage could be due to a defective high-voltage filter capacitor or resistor, an open yoke or yoke-return capacitor, a leaky boost filter or AFC feedback capacitor, a faulty component in the cathode or screen-grid circuit of the output stage, or merely insufficient drive signal from the horizontal oscillator.

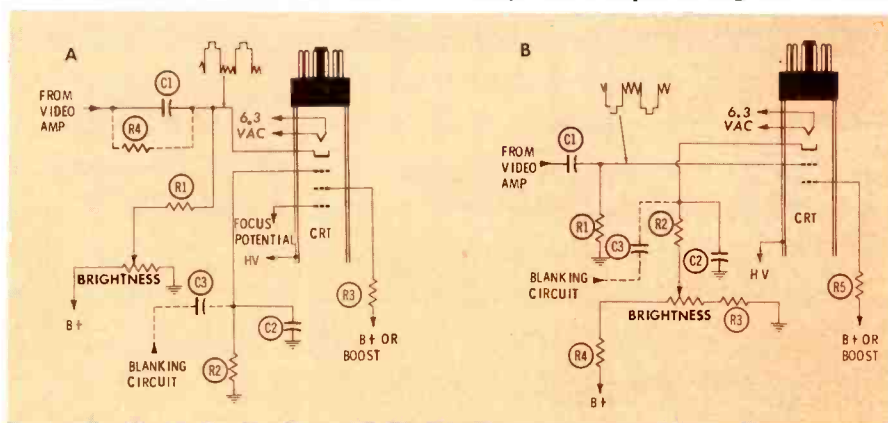

Fig. 2. Do you know the typical operating voltages from these CRT circuits?

• Please turn to page 95

HICKOK

... WORLD LEADER IN ELECTRONIC TEST EQUIPMENT

The unexcelled quality, accuracy and dependability of Hickok electronic test equipment is recognized the world over... a reputation that has been earned through fifty years of specialization in this field.



MODEL 121
\$329.50 NET

HIGH-SPEED CARDMATIC

A modern tube tester for modern tube applications... not only makes critical "fringe" tests, but actually tests such types as 6SN7 and 6BQ6 for pulse operation... exclusive Hickok card-programmed switch—the key to its rapid automatic tests—positively and automatically sets up exact conditions.



MODEL 455A \$74.50 NET

BURNOUT-PROOF VOLT-OHM-MILLIAMMETER

Exclusive Hickok overload cut-out and protection system provides complete safety against accidental burnouts not only for the meter but for all resistors, shunts and other components... any high voltage may be applied directly across any function without danger.



MODEL 123A \$530.00 NET

LAB-ACCURATE CARDMATIC

For fast, accurate and complete testing of complex industrial electronic tubes, including VR and computer tubes... patented Card Reader Mechanism permits over 10 trillion switching circuits... can program special tube tests at any point on characteristic curve.



MODEL 470 \$94.75 NET

ELECTRONIC VOLT-OHMMETER

Specifically designed with an 0 to 0.5 volt DC range for high-sensitivity transistor bias testing... large 7 inch Hickok-built meter gives excellent visibility... in high impact molded phenolic case, complete with time-saving single unit probe.



MODEL 6000
\$197.50 NET

HIGH-SPEED DYNAMIC MUTUAL CONDUCTANCE

Popular small portable tube tester... features the original Hickok developed Mutual Conductance Circuit—the Gm method, long accepted as the industry standard, and instantaneous shorts test... snap-in master socket panel is replaceable to prevent obsolescence.



MODEL 209A \$157.00 NET

TRUE VTVM & CAPACITANCE TESTER

Permits measurements as low as 1 uuf and as high as 1000 uf... 9" indicating meter for high visibility... AC response to 200 MC... ideal for measuring wide ranges of resistance, current and voltage.

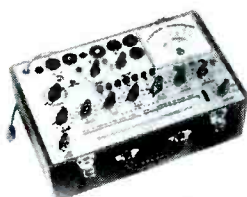

MODEL 800
\$169.50 NET

LOW-COST DYNAMIC MUTUAL CONDUCTANCE

Tube and transistor-diode tester... new leakage and shorts test and new grid current (gas) test feature... low in cost, this tester features the famous Hickok Mutual Conductance Circuit. Lowest cost tester in its completeness and accuracy range.

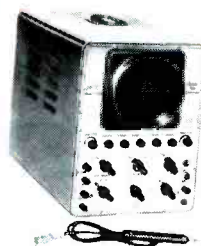

MODEL 675A \$299.90 NET

TV OSCILLOSCOPE

Wide band, high sensitivity... 5-inch scope permits unusual accuracy... features an illuminated calibrated screen... vertical amplifier response within 3 db, DC to 4.5 MC, flat through 3.58 MC color burst frequency... astigmatic control circuit provides a new standard of undistorted trace detail.

THE HICKOK ELECTRICAL INSTRUMENT CO.

**10566 DUPONT AVENUE
CLEVELAND 8, OHIO**

A component-by-component analysis of the horizontal output, damper, flyback, and yoke circuits, with operating theory and troubleshooting tips.

THAT'S THE WAY THE

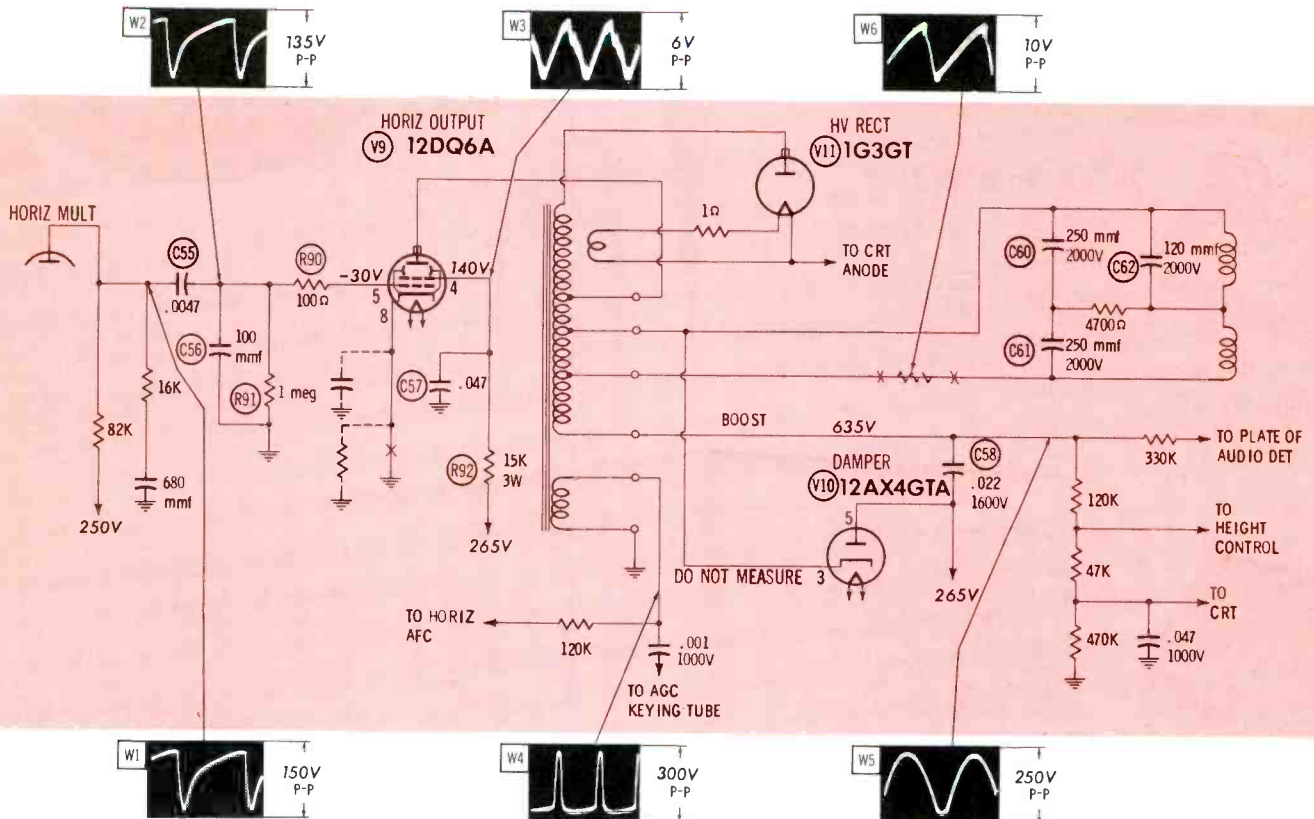

Fig. 1. Horizontal output, damper, and high-voltage circuits of 110° set.

What happens to TV-set performance when a component in the horizontal deflection system changes value? How can a faulty component be located most quickly? Why do circuit changes produce the effects they do? Knowing the answers to these questions can save you endless hours of troubleshooting time.

One good way to find out exactly how component faults reveal themselves in waveforms, voltage readings, and picture symptoms is to make a thorough component-by-component analysis of the horizon-

tal-deflection system used in one of the newest 110° receivers (see Fig. 1). Even though the operating conditions and test measurements won't correspond exactly to those in other sets, a complete understanding of this one circuit will better equip you to analyze any horizontal sweep system you may encounter.

In this discussion, it will be presupposed that the remainder of the set is operating properly, and that the output waveform (W1) of the horizontal oscillator and discharge

circuit is of correct amplitude and frequency. We can then turn our full attention to finding out how the individual components in the horizontal deflection systems work together to produce a linear scan.

Output Grid

The first components to be considered are those in the grid circuit of horizontal output tube V9. One of the more common troubles in this network is a leaky condition in C55. This fault establishes a DC leakage path from the grid to

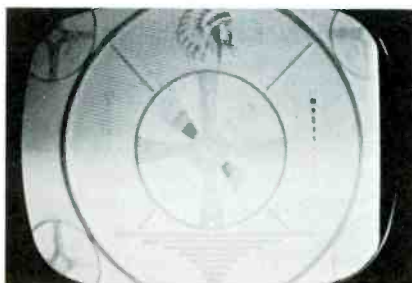

(A) Distorted right edge of raster.

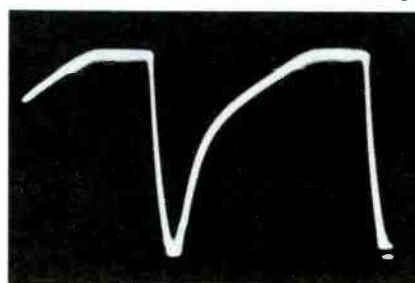

(B) Flattened positive peaks in W2.



(C) Yoke-current waveform distortion.

Fig. 2. Photos showing picture and waveform distortions resulting from leakage in C55.

by Joe A. Groves

HORIZONTAL SWEEPS

B+ through the horizontal-oscillator plate circuit, thereby reducing the negative voltage on the grid. The extreme right side of the raster then becomes flattened, and a slight foldover is likely to become evident as a bright line along the right edge of the raster (see Fig. 2A).

To see why this specific symptom is produced, let's examine one typical case where C55 became leaky enough to produce an ohmmeter reading of 1 megohm across the capacitor's terminals. The DC grid voltage shifted from -30 to -23 volts, and the peak-to-peak amplitude of W2 was reduced from 135 to 120 volts. Fig. 2B explains what happened to the other 15 volts; note that the positive peaks of the waveform are abnormally flattened. This observation indicated that the output tube was being driven into saturation more heavily than usual near the end of each horizontal scanning cycle. Consequently, the yoke-current waveform W6 did not remain linear, but fell off abnormally as it approached the positive peak of each cycle (see Fig. 2C). This means the yoke was receiving insufficient sweep energy to drive the electron beam to the extreme right side of the screen. (Note: W6 was obtained by connecting a 10-ohm resistor in series with the "low-side" lead of the deflection yoke—see dotted-in component in Fig. 1—and then connecting the scope directly across this resistor.)

W2, at the grid of V9, is normally somewhat lower in amplitude than input waveform W1, due to

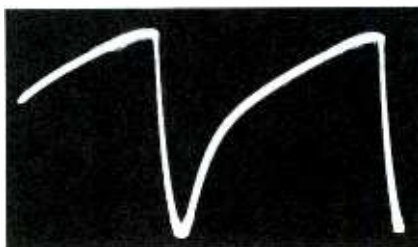
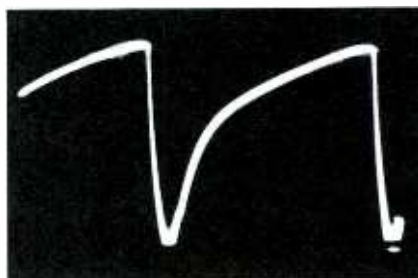

Fig. 3. Distorted W2 (120V p-p) resulting from increase in value of C56.



(A) Sharper positive peaks in W2.

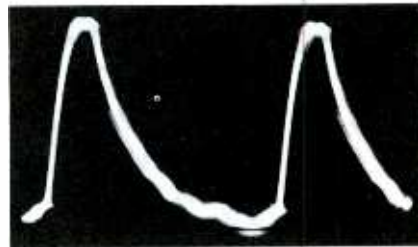

Fig. 5. Signal developed on screen of V9 when bypass capacitor C57 opens.



(B) Drive line and compression.

Fig. 4. Results when R91 equals 2 meg.

AC voltage division across C55 and C56. Altering the capacitance ratio between these two units will affect the amplitude of W2. Many sets, especially those of older vintage, have a trimmer in place of C55 or C56 so that W2's amplitude can be varied to suit the drive-signal requirements of individual receivers. Leakage, or a change in value, in a fixed capacitor can likewise affect W2—but not to advantage!

When C55 is reduced to half its original capacitance (approximately .0022 mfd), W2 still retains its characteristic shape, but it decreases in amplitude to about 125 volts. This causes the output stage to develop less grid-leak bias, and a slight (but noticeable) decrease in negative DC grid voltage is ob-

served. The right side of the raster may be slightly compressed, though probably not as much as in Fig. 2A.

Excessive capacitance in C55 has the effect of increasing the amplitude of W2. This usually produces less noticeable symptoms than a decrease in drive-signal amplitude, since only a slight overscan results. The grid waveform W2 does not change in shape, but increases in peak-to-peak height. This stronger signal produces more grid-leak bias, so the grid voltage becomes a few volts more negative than normal.

A change in value of capacitor C56 will also provide some change in the circuit's operation. If it becomes leaky, it has the same effect as shunting a resistor across R91

• Please turn to page 88



(A) Dim, badly-distorted raster.

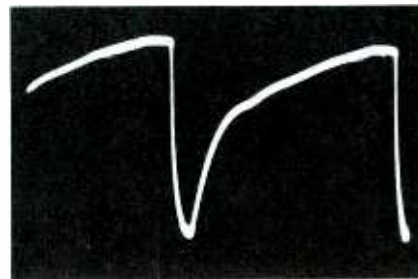

(B) Ripple in drive signal W2.

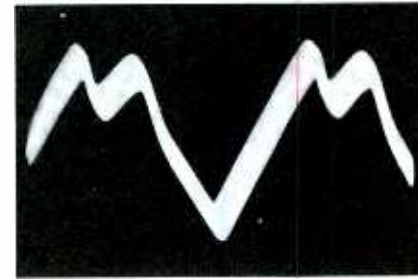

(C) Ripple in screen waveform W3.

Fig. 6. Open boost capacitor may produce these symptoms in some TV sets.



PAINTED CIRCUITS

Several TV manufacturers have taken action to ease the serviceman's task of circuit-tracing on printed wiring boards. All their efforts are based on one simple, but ingenious, idea: Why not put service information directly on the board? Thus, many of the chassis used in 1960-model sets have patterns of lines and symbols marked in brightly-colored paint or ink to help the serviceman find his way.

Each manufacturer has his own distinctive approach to this "painted circuit" technique. Which system suits you best? To help you answer this question for yourself, we have compiled a group of sample illustrations covering a half-dozen different types of painted circuits. Wherever practical, we have given you a chance to try out the various new systems without budging from your armchair.

The Problem

Before finding out *how* to trace painted circuits, let's see *why* they came into being. Here's the key to the situation: Many servicemen are accustomed to relying quite heavily on their ability to trace through actual circuitry for speedy location of components and test points. They

find it helpful to refer to service data from time to time, but they are hampered in troubleshooting if they have to stop and mentally "cross-reference" the actual chassis layout with schematic information and pictorial wiring diagrams at every step of the way. Therefore, even though elaborate service manuals have been provided for TV sets with printed wiring, a large number of servicemen have remained reluctant to work on sets with this type of construction. There's been no way of getting around the fact that most printed boards have the components on one side and the foil conductors on the other. Even under the best conditions, circuit-tracing has been an awkward process involving a great deal of back-and-forth neck-craning—unless the serviceman uses the arrangement portrayed on our January cover, with a light shining through the board from the opposite side.

To get away from this problem, most of the new painted-circuit systems are aimed at placing all necessary service information on just one side of the board. A couple of them do require the serviceman to refer to both sides, but the set designers

have taken special pains to make both sides of the board readily accessible in these cases.

Exactly what do we mean by "accessible"? Should a receiver be designed so that almost any part can be replaced without removing the chassis from the cabinet? Or should the designer's primary goal be *ease* in replacing all components, regardless of whether or not the chassis must be pulled to accomplish a specific job? These two aims are somewhat contradictory, and some sort of compromise must be made every time a new chassis is designed. Therefore, every set maker has his own preferred approach to the ideal of "accessible" TV circuitry.

Speaking of compromises—what items of information should be included in painted circuit data? The space on a printed wiring board is limited, but the manufacturer's ingenuity is not! One basic idea has thus led to the interesting variety of troubleshooting aids described on these pages.

The Solutions

Of the painted circuits which have appeared thus far, two systems utilize the wiring side of the board; four others use the component side;



Fig. 1. Schematic symbols on Westinghouse See-Matic board facilitate circuit-tracing from conductor side.

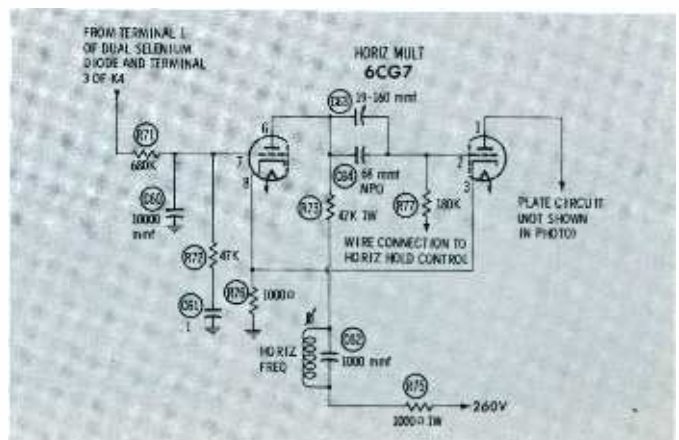

New Aids to Troubleshooting

and still another system makes equal use of both sides.

Westinghouse

One large, horizontally-mounted printed board contains most of the circuitry in 21" Westinghouse sets. The entire chassis, CRT and all, can be pulled out of the cabinet and propped up on the bench to furnish access to both sides of the board. However, work can be done most conveniently on the bottom (wiring) side, so the service information is applied to this surface. Bright yellow schematic symbols indicate the exact positions of all components on the opposite side of the board. The values of resistors and capacitors are placed next to the appropriate symbols, while the manufacturer's part numbers are given for tubes, coils, and other components. All tube-socket pin connections are designated by letter symbols, such as P2 (plate of second tube section) or K_T (cathode of triode section). Yellow circles or dashed-line rectangles enclose all terminals belonging to multi-lug components (except tube sockets). The conductor strips, incidentally, are over-printed in dark green to make the yellow lettering stand out more clearly.

Try putting this *See-Matic* system to use by tracing the horizontal multivibrator circuit in Fig. 1. See if you can spot the symbol for every component shown in the schematic. It's best to start tracing from some easily-established point such as P1 (pin 6) of the tube.

Emerson

Several models introduced this spring incorporate a printed wiring board having service information painted in white on the conductor side (Fig. 2). In addition, the serial numbers of all parts are labeled in black on the component side. As shown in Fig. 3, these sets employ a two-part chassis; a conventionally-wired section is bolted to the floor of the cabinet, and a printed-board section is mounted on the left wall (as seen from the rear). For bench servicing, the serviceman can unfasten the latter unit and lift it completely out of the cabinet. The interconnecting leads are of ample length to allow operation of the set in this position.

The wiring side of the printed board is covered with a sheet of fiber insulating material, which can be removed by prying loose several snap fasteners. The white markings thus uncovered include tube-pin



Fig. 2. Emerson board has tube-pin and test-point information in white.

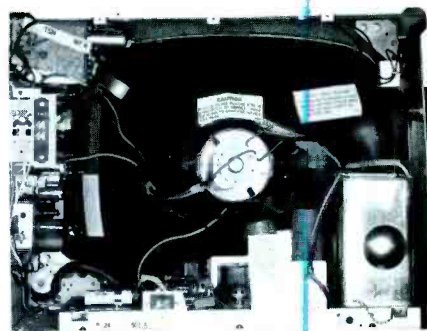

Fig. 3. Set can be operated with vertical chassis removed from cabinet.

designations (note code in Fig. 2), alignment points, B+ sources, control connections, and related information. Each tube-socket location is labeled with the type number and circuit function of the tube, in addition to the letter symbols for individual pins. Numbers from F1 to F11 indicate points of successively higher potential in the series filament string. Notice the wide foil strips with an etched-in pattern of spots; these represent common ground. For simplicity's sake, no further circuit-tracing information is provided. However, the serviceman can follow the circuit paths with minimum trouble by propping the board up on the bench to permit close examination of both sides.

• Please turn to page 92

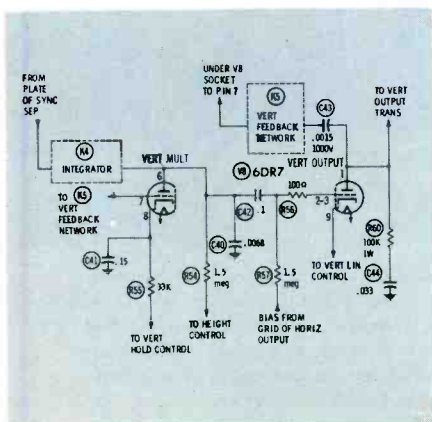
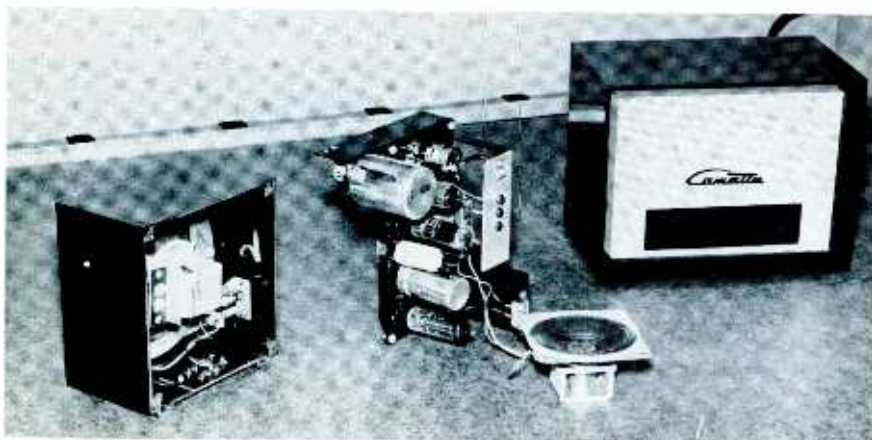

Fig. 4. Lines on Philco board show exact paths of foil conductors between components. Many tie points are named.



Sales, installation, and service of intercommunications systems are logical business enterprises for radio and TV servicemen. To help you keep abreast of this rapidly-growing field, this photo feature describes some of the latest equipment available and how it's used.

A Review of



Simplest of all is the two-station wired system, which provides constant listening at the master and permits the remote to be called from the master. This Webster WC-2 "Comette" unit goes one step further, permitting the remote to either call in or be monitored. Easy to install and economically priced, this system is often used in homes and small businesses.

Versatility and portability are the features offered by "wireless" units that plug in anywhere. This Vocaline system depends on the power wiring to carry the signals between stations, and is thus ideally suited for both home and office use. The units can even be in different buildings (house and garage, for example) as long as both are served by the same power-line transformer.

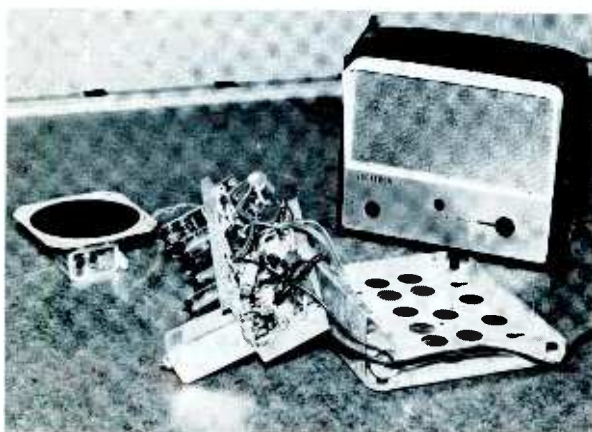

The secret of power-line system operation lies in the oscillator coil. Each unit of the system is a master station in the sense that all have an oscillator and modulator for transmitting, and an RF section, detector, and audio section for receiving. In the TALK position, the oscillator provides an RF carrier which is audio-modulated, then capacitively coupled to the power line. The carrier can be picked up by any other unit connected on the same line, and be detected and amplified.



Completely built-in systems, such as those available from Fanon, provide radio listening and door answering as well as complete intercom coverage. These are being installed during the construction of many new homes. Some systems verge on complete sound installations (such as a school might have), providing AM-FM radio, stereo phono, door answering, patio service, and complete intercommunications throughout the home.

INTERCOM SYSTEMS



More and more, people in business and industry are becoming aware of the usefulness of intercoms like these by Challenger and Talk-A-Phone. Systems can be either simple or complex. They can consist of only one master and one remote, one master and several remotes, or multiple masters intermixed with various numbers of remotes. They can include paging, conference (three or more stations all able to both listen and talk), selective calling (where two stations can talk without being heard by the rest of the stations), or just about anything else needed to meet the requirements.

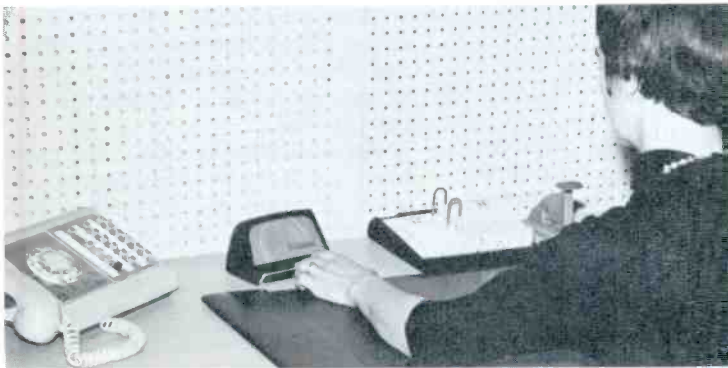

Wired systems like this Talk-A-Phone T-LS-10 usually provide the best service in commercial applications where power lines are heavily loaded and noisy, or supplied from several different transformers. Although the interconnecting wiring may become complex in larger systems, the heart of the system is still a simple audio amplifier chassis. Complex switching circuits are somewhat difficult to trace, but their only purpose is to switch speakers from input to output.

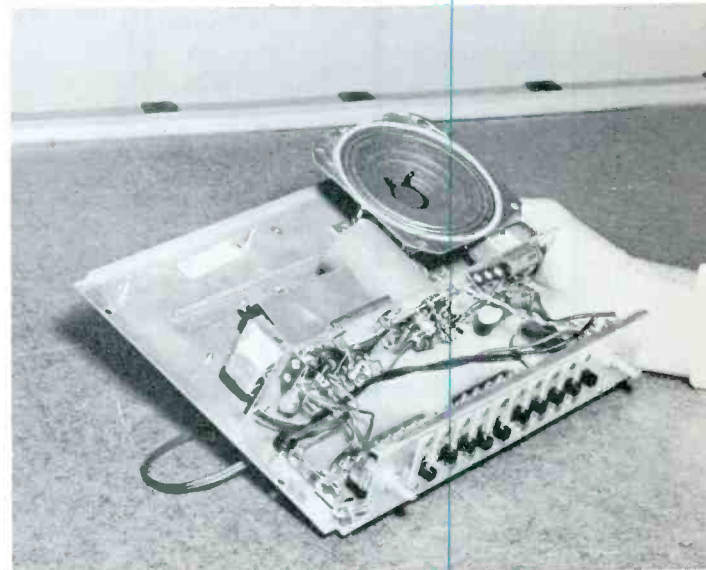

Telephone intercom systems provide maximum privacy, and can also be used in conference setups. Each station is a small PBX, able to select who receives the call. Most of these systems have a single supply to power the system and the buzzer.

3 POPULAR **SECO** TESTERS

... Top Choice of
Service Technicians
EVERYWHERE



COMPLETE, PORTABLE TUBE TESTER

**MODEL
107**



Provides 3 important tests: amplifier types tested for gain by Dynamic Mutual Conductance method—power types tested for cathode current by Cathode Emission method—all types tested for shorts and grid error by Grid Circuit Test developed and patented by Seco. Dynamic Mutual Conductance Test pre-wired for fast set-up. Cathode Emission Test done by free point pin-selector method—will not be obsolete. Self-contained in portable case.

MODEL 107—Wired and factory tested \$139.50 NET

NEW! LOW-COST GRID CIRCUIT AND TUBE MERIT TESTER

**MODEL
78**



Designed expressly for TV servicing—easy to set-up and simple to use, a highly accurate professional tester! Complete coverage of all modern TV tube types as well as all heater type radio tubes including hybrid types, using only 5 sockets. Incorporates patented Seco Grid Circuit Test plus reliable Cathode Emission test also checks filament continuity and provides open element test. One easy-to-read meter. Two-stage DC amplifier isolates meter from tube under test to protect meter—provides a wide range of load currents and test conditions. Complete in a portable carrying case, with pin straighteners, and index-chart for quick set-up data.

MODEL 78—Wired and factory tested \$69.50 NET

NEW! DYNAMIC TRANSISTOR CHECKER

**MODEL
100**



This low-cost transistor checker safely tests PNP and NPN transistors either "in or out" of circuit. Covers wide range of types: small signal including "drift" types, medium power; and power types. Provides positive check for "opens," shorts, and gain—condition indicated by means of a visual indicator plus jacks for meter or scope. Also provides GO-NO-GO test at practical currents—and permits matching of similar types. Will not be obsolete—no set-up or roll charts required! Compact, lightweight, complete, and ready-to-use.

MODEL 100—Wired and factory tested \$19.95 NET

Sold only
through Electronic
Parts Distributors

Write today for
FULL DETAILS

SECO SECO MANUFACTURING
5015 Penn Avenue South, Minneapolis, Minnesota

PF-5

NAME _____
ADDRESS _____
CITY _____ ZONE _____ STATE _____

East Canada: Davoso Agencies, Ltd., Montreal, Quebec
West Canada: Non Merritt Co., Vancouver 1, British Columbia



Spring Cleanup. Nothing is more degrading to a service establishment than a dirty, unkempt appearance. Perpetually clean, unfaded, and well-arranged displays go along with proper lighting and good outside appearance in doing a continuous selling job. Is your shop advertising you—or your competitor?

Follow the tip of the smart housewife who, although keeping her home neat-looking all of the time, still sets aside a time each year for spring housecleaning. Take all those things off the shelf, clean them (and the shelf, too) and replace them in an orderly arrangement. It's time, also, to clean (or paint) those walls, clean the light fixtures, and perk up the shop's outside appearance. Make your establishment sparkle. While you're at it, don't forget that your service trucks are merely extensions of your front door. Perhaps a polish job, or a "redo" of the signs they carry, will supply the added touch they need to speak well of you.

Business is highly competitive. If your entire business isn't a shining example of your abilities, perhaps your competition will look better in the eyes of prospective customers.

Weed Files. Spring is also a good time to weed out your direct mail file. An up-to-date customer list can make the difference between success and failure of a direct mail campaign. Sort the cards, plates, or whatever you use, to be sure the people still live in your service area. This can be done by checking names and addresses in a current directory (mail or phone), thus giving you the assurance that most of the mailing pieces will not end up in the "dead-letter" office.

A personal note from you regarding the time elapsed since you replaced the filter, or installed a new flyback, etc., will indicate your intimate interest in customer satisfaction. If this is impractical, a form

letter or "Let's renew acquaintances" piece may be just the reminder some people need to call for service. Be sure to mention your full range of services: Radio, TV, hi-fi, antennas, etc. They surely require your service for something. Don't you have a radio or something in your home that needs service?

\$ & ¢

Like Contracts? Here's an idea for taking care of those "sound only" jobs you can't repair in the field, but hate to pull in for shop service. Rather than saying the set needs a shop repair which will run from \$20 to \$30, suggest a general overhaul. For a set in reasonably good shape, you can offer the required service work with a 1-year warranty on all parts except the picture tube and a 90-day labor guarantee for about \$35. For \$60 you could offer a complete 1-year guarantee and come out okay. Giving the customer three options helps overcome resistance to the high cost of his immediate service requirements. If one of the service-contract options is taken, you'll have sufficient leeway to put the set into really good shape, and lessen the possibilities of having to service it again during the contract period.

An additional benefit is the possibility you have of renewing the contract, allowing you to further build customer good will and plan for growth of your loyal customer list.

Attention shop owners! An incentive of a dollar or two commission to your outside servicemen is a good way to get them to boost your plans—in addition to improving their "in-home manners!"

\$ & ¢

Wield the Weld. Literal translation—apply psychology to tighten the bond between yourself and your customer. Translation of "psychology"—try to encourage a favorable mental attitude on the customer's

**Now—more profit from a single sale
...than 20 pairs of single-life “D” cells pay you!**



To recharge, just unscrew cap...



and plug overnight into any 110-120-volt AC outlet.

HEAVY-DUTY SONOTONE Rechargeable Flashlight Battery Cartridge

- A new, multi-use adaptation of the patented Sonotone sintered-plate, nickel-cadmium battery used in space missiles and jets.
- Gives at least 3 hours of strong, continuous light from a single charge with PR-6 bulb—or 1½ hours with full-powered PR-2 bulb.
- Dependable in extreme temperature and weather conditions.
- Can be recharged hundreds of times at about ¼¢ per charge.
- Sturdy, leakproof construction — aluminum jacket — electrically shockproof.
- Full-year guarantee under heavy industrial use — backed by Sonotone's leadership of over 30 years in precision engineering and service.

A completely new concept in long-life flashlight power! Replaces and outmodes any two “D” cells, for any purpose, in end-to-end use. Rechargeable overnight simply by plugging into any 110-120-volt AC outlet. Gives users a lifetime of service — gives you more profit than you make from selling 20 pairs of industrial “D” cells! Retail price, Model FC-3, \$9.95. (Also Standard Model FC-2 for home use—light lasts at least 1½ hours with PR-6 bulb — \$7.95 retail.) Order from your supplier now.

Sonotone © P. R. O. C.

Battery Division, Dept. C10-50
ELMSFORD, NEW YORK

Leading makers of fine transistor hearing aids, ceramic phonograph cartridges, speakers, microphones, electronic tubes, sintered-plate, nickel-cadmium batteries.

A rewarding future
awaits you—
if you increase
the scope of your
technical background
RIDER BOOKS

While radio and TV servicing offer a profitable livelihood, there are many servicing opportunities that promise an even more profitable future to the service technician who expands his technical background. Rider offers here a series of books dedicated to this task.

HOW TO USE METERS (2nd edition) by John F. Rider & Sol D. Prenskey Engineers, laboratory and service-technicians—everyone who uses meters in their daily work—will find this revised, expanded and modernized version of the fabulously popular original text absolutely indispensable.

Everything that is new in meter instrumentation will be found in this book. For example, in addition to full coverage of the many types of conventional d-c, high frequency a-c and modulated type VTVM, the digital voltmeter is also discussed in full detail. Also covered are the ultra-high impedance electrometer vacuum tube voltmeter; transistor voltmeter and industrial transducers for voltmeters.

Explains in detail the construction and operation of all types of electrical meters to use for making different kinds of measurements in electronic and electrical equipment and industrial applications. Also explains how to make measurements... namely, where to connect the meters. A section is devoted to multi-phase circuit measurements. #144, \$3.50.

BASIC ULTRASONICS by Cyrus Glickstein. This book utilizing the famous Rider 'picture-book' technique makes the subject of ultrasonics—the new tool of industry—completely understandable. #259, 1 vol. soft cover, \$3.50, #259H cloth, \$4.60.

BASICS OF FRACTIONAL HORSEPOWER MOTORS & REPAIR by Gerald Schweitzer. Fractional horsepower motors are used in—air conditioners, fans, refrigerators, washing machines, dishwashers, sewing machines, record changers, turntables, power mowers, power tools, etc. You can learn the theory of fractional horsepower motors rapidly and easily from this 'picture-book' course. You can readily apply this theory to servicing and maintenance as a money-making career. #286, \$3.90, #286H, cloth bound. \$4.90.

The answer to all tube substitution problems

MASTER RECEIVING-PICTURE TUBE SUBSTITUTION GUIDEBOOK by H. A. Middleton

The fabulously popular Receiving Tube Substitution Guidebook[®] and all four supplements have been reset, expanded and brought up to date in one master book. The original Tube Substitution Guidebooks were considered the most handy and important work books for technicians, engineers and hobbyists—the new Master book, is even more valuable. In one Master Book, that is easy to use, the entire range of all radio and television receiving and picture tubes and their substitutions are at your fingertips. #241—8½" x 11", only \$7.45.

For those who have the original RECEIVING TUBE SUBSTITUTION GUIDE and its SUPPLEMENTS—**RECEIVING TUBE SUBSTITUTION GUIDEBOOK—FOURTH SUPPLEMENT** by H. A. Middleton. Contains the latest receiving tube and picture tube substitutions. #139-4, \$1.35.

READ THESE IMPORTANT TEXTS

R-L-C COMPONENTS HANDBOOK by David Mark, #227, \$3.50.

FUNDAMENTALS OF TRANSISTORS (2nd ed.) by Leonard M. Krugman, P.E. #160, \$3.50.

PRINCIPLES OF TRANSISTOR CIRCUITS by S. W. Amos, B.Sc., #241, \$3.90.

BASICS OF DIGITAL COMPUTERS (Picture Book Course) by John S. Murphy, #196, 3 vols., soft cover, \$8.40; #196-H, cloth, \$9.50.

METALLIC RECTIFIERS & CRYSTAL DIODES by Theodore Conti, #213, \$2.95.

PHOTOTUBES (Electronic Technology Series) #166-33, \$1.80 by Alex. Schure, Ph.D.

GAS TUBES (Electronic Technology Series) #166-24, \$1.50 by Alex. Schure, Ph.D.

At your jobber or bookstore, or order direct



JOHN F. RIDER PUBLISHER INC.
116 W. 14th St., New York 11, N. Y.

part so he'll think you are tops! One of the best ways to develop this feeling is to set a specific time for a service call, *and then be there on time*. One of the main gripes the public has about service revolves around the uncertainty of when the serviceman will arrive.

If you run an efficient service business, you have a reasonable idea of the approximate time required for each call. You also plan the routing of your calls. Putting the two together, you should be able to tell your customers approximately when they can expect you. If your schedule gets thrown for a loop (as it's sure to do at times), phone ahead to explain that you will be late and make a new appointment.

Try it! You'll be pleasantly surprised at the good will it will build.



Objective Study. What is the objective of your business? Servicing for a profit, of course. But, have you given serious thought to how you're going about it? Have you established in your mind, and converted into company policy, just what services you should offer? Have you given consideration to what services are required in the area you serve? A business enterprise which ignores these questions, or one which doesn't constantly keep asking and answering these questions, is doomed to mediocrity or failure.

Remember when television came along? Established radio servicemen gave a shrug of their shoulders, decided they'd better learn how to service TV sets, studied in their spare time, and are now the "granddaddies" of this great TV servicing industry. Since the first "million year" of eleven short years ago, the number of TV servicemen has grown by the thousands. Many shops came into existence with the sole objective of servicing television. Many of these are gone, many more are departing, and even more are struggling along blindly hoping for that magical (and mythical) break that will put them on top of the world.

Business success has a very practical formula, not a magical one. This formula is simply determining the needs of the area in a certain field of endeavor, and then fulfilling these needs. This calls for an *objective study* of the needs, and then a *very objective study* of how to best fulfill them. Some of the questions which must be answered

are: How many TV's are there in the area? Home radios? Portables? Auto radios? Phonographs? Hi-Fi installations? Homes with intercoms? Businesses with intercoms? Small industrial plants with electronic equipment? Businesses and churches with sound installations? How much new construction is going on? Are they installing intercoms? TV antenna systems? Garage door openers?

Are you offering the services required? Are you offering them *when* they are required? What about competition? Should you specialize? Expand the services rendered? Alter hours? What's the correct answer for your area?

There is far more to the operation of a successful business than answering these questions, of course. However, these basic questions *must* be answered continuously. Once answered, you'll have a better idea of how to make your service enterprise profitable. As suggested by some little signs we've seen around, it's up to you to "THINK."



Rattling Skeleton. The old question about transistorized equipment ultimately putting servicemen out of business has cropped up again. This is probably due to the advent of transistorized TV's—and the expected release of even more transistorized equipment in the near future.

When the question first came up a few years ago, absolutely nothing was known about transistor life expectancy (or that of associated components). Since they *theoretically* never went bad, it was assumed they might not. The reduced voltage and current requirements also led some observers to believe that associated components would never go bad, either.

By now, however, we've lived with transistors long enough to become familiar with them. Thousands, or, more likely, millions, of transistors have been *replaced*. No predictable cycle has emerged; they just seem to go bad anytime. And the associated components — they keep going bad, too. It's like the bumblebee—according to all *theory*, it just can't fly . . . *but it does anyway*.

So, Mr. Skeleton, crawl back in your hole. And you, Dad — go ahead and teach Junior the business. It's just like taxes, destined to go on forever.

*"Well I'll be a -----
it really eliminates ghosts!"*

... The exact words used by
TORRIE APPLIANCE CO.
Astoria, N. Y.

after testing the
"Unbelievable"

REMBRANDT
ELECTRIC

TV GHOST ELIMINATOR
with built-in picture booster



\$7⁹⁵

RETAIL,
Fair Traded
Individually Boxed
Mahogany Finish

Another RESEARCH FIRST from ALL-CHANNEL PRODUCTS CORP.

U.S. Patented—
U.L. Approved

Here's the secret: The "Rembrandt" rotates polar-receiving pattern of the existing antenna and phases the ground wave picked up through the electrical system with the sky wave picked up by the antenna.

Not a cure-all...but, in 8 out of 10 locations, will either completely or substantially eliminate all ghosts! Works with any existing antenna: *indoor, outdoor, master or built-in!*

SOLVES the #1 cause of TV customer complaints—builds customer good will. Helps move TV Sets—especially color!

SAVES "no charge" call-backs...gets the chronic complainer "off your back."

STEPS UP your volume—opens old and new doors for profitable summer business. An "add-on" sale to go with every installation! Attaches in just 60 seconds!

And here are other, actual, "on-the-scene" comments, made "before" and "after," by other TV servicemen and dealers who had to be shown:

BEFORE TEST: "It looks to me like another Plug-in Antenna."
AFTER TEST: "Wow! This is for me...you should put a \$12.95 selling price on it. In this area, they will pay anything to get a decent picture."
Kenmar T.V., Bronx, N. Y.

BEFORE TEST: "Fellows—it's electronically impossible."
AFTER TEST: "Well, I guess I don't know what I'm talking about—I'm going back to school!"
Pinehurst T.V., New York, N. Y.

BEFORE TEST: "It looks like another gimmick."
AFTER TEST: "Will cause a boom in T.V. sales. I will sell one with every set and antenna installation."
Harvey Television Co., Astoria, N. Y.

BEFORE TEST: "Someone is always trying to beat the public. Where do you guys get your guts?"
AFTER TEST: "My apologies gentlemen. I'm going to take these out on every one of my calls—it will save me a lot of no charge call-backs."
Guardian Electronics, New York, N. Y.

See it demonstrated at the Chicago Parts Show
Booth 123

**CALL YOUR DISTRIBUTOR TODAY—
OR MAIL THIS COUPON!**

ALL-CHANNEL PRODUCTS CORP.
47-39 49th Street, Woodside 77, New York

ALL-CHANNEL PRODUCTS CORP. Dept. PFR PO-576
47-39 49th Street, Woodside 77, New York

I still don't believe it! You've got to convince me—send me your literature on the TV Ghost Eliminator and the name of nearest distributor (with no obligation).

NAME _____
FIRM _____
ADDRESS _____
CITY _____ STATE _____

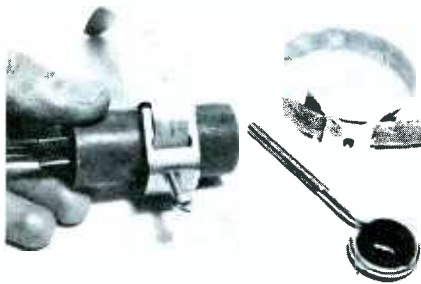

Mast Clamp Mount

If you should happen to find yourself in need of a strap-type electrolytic mounting bracket and discover your supply exhausted, try using an antenna-mast clamp as a substitute. Drill a hole in the chassis to accept a machine screw that will fit the clamp.

Flux Prevents Frozen Lids

Much servicing time is wasted trying to remove the frozen lids from containers of varnish, dope, or service cement. Once the lid is off, a thin coating of soldering paste to the threaded areas of the container and lid will make it easy to open the container the next time.

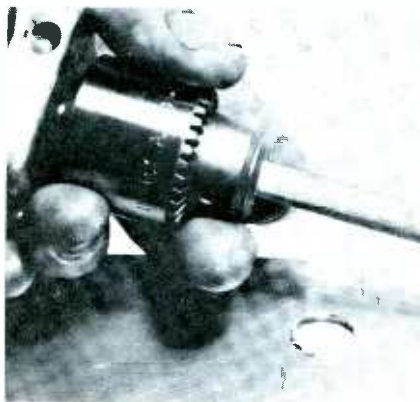

Smooth Ragged Chassis Edges

Coarse-grade emery cloth wrapped around a cotter pin chucked in your electric drill does a fast job of removing ragged edges from a metal chassis. Rough edges remaining after hacksawing or drilling should always be smoothed before parts are mounted. Remember to clean off emery dust to prevent possible future shorts or leakage.

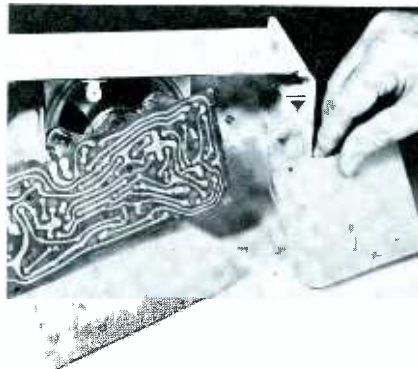

Foam Protects Printed Boards

A small radio chassis with printed wiring is easily damaged when removed from case or cabinet.

Pieces of plastic foam or sponge rubber will protect these relatively fragile chassis when arranged for testing, thereby preventing unnecessary trouble.



Large Clamps as Chassis Holder

When you want to clamp a small chassis in a vertical position, a Mueller #14-C clamp does the job very well. These larger clamps also come in handy for other jobs around the bench — holding objects for soldering, clamping cemented cabinets and recentered speaker cones, and even as pliers for wing-nuts.

Plastic Spray Saves Diagram

Tube-placement diagrams on chassis and cabinets can be kept from deteriorating by spraying them with clear plastic spray. Most diagrams turn brown with age and eventually become unreadable or crumble into pieces. The life of such diagrams will be prolonged, however, if they are treated with a protective coating of the transparent spray.



Fuse Clip Holds Chuck Key

A 1/4" fuse-clip mounting attached to the top of your electric drill with a self-tapping screw makes a convenient holder for the chuck key. Just snap the key into the holder when it isn't in use.



Soldering "Pad" on Iron's Cord

A 3" square piece of fiberboard, faced with coarse sandpaper on one side and asbestos on the other, will eliminate many soldering headaches. The sandpaper side is handy for cleaning and brightening iron tips as well as part leads. The asbestos side keeps the hot iron, solder and parts from scorching the bench. Also, the asbestos doesn't absorb heat, resulting in better soldered joints.



Second Drill Handle

Drill and tap a hole in the top of your electric drill case, chuck a short length of threaded shaft (or a stout headless screw) in the handle of a removable-blade screwdriver, and mount this in the tapped hole. This second handle gives you much better control and leverage for those really tough drilling jobs.

New Decorator TV Lead-In Cable

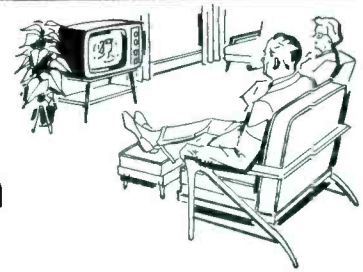

To be introduced at the
Electronics Parts Distributors
Show, May 16-18, Chicago

For interiors only. This NEW Belden 300-ohm lead-in cable, No. 8226, replaces unsightly lead-in cable in modern homes. Its neutral color harmonizes and blends into

any room's decorative theme. Available in lengths of 25, 50, 75, and 100 feet. Packaged in pancake coils for easy handling and display.

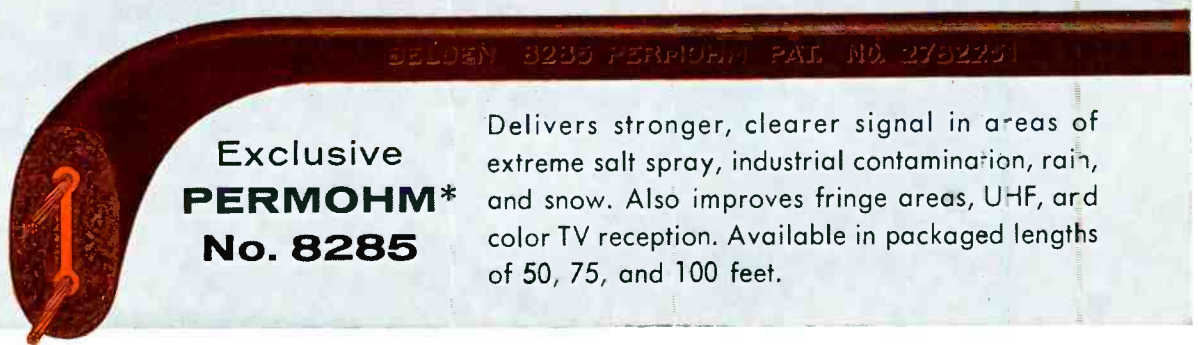

Exclusive PERMOHM* No. 8285

Delivers stronger, clearer signal in areas of extreme salt spray, industrial contamination, rain, and snow. Also improves fringe areas, UHF, and color TV reception. Available in packaged lengths of 50, 75, and 100 feet.



STANDARD 300-OHM LINE
—NO. 8225 Offers low losses at high frequencies. For use with TV and FM receiving antennas. 25-, 50-, 75-, and 100-foot coils; 500- and 1000-foot spools.



WELDOHM* 300-OHM LINE
—NO. 8230 2½ times flex-life and 1½ times breaking strength of ordinary lead-in. 25-, 50-, 75-, and 100-foot coils; 500- and 1000-foot spools.



CELLULINE* 300-OHM LINE
—NO. 8275 Resists abrasion, sun, and wind. Provides strong UHF and VHF TV pictures. 50-, 75-, and 100-foot coils; 500- and 1000-foot spools.



STANDARD 72-OHM LINE
—NO. 8222 For use with all types of receiving antennas at high frequencies. 100- and 500-foot spools.



STANDARD 150-OHM LINE
—NO. 8224 For receiving antennas, matching transformers, and experimental applications. 100- and 500-foot spools.

*Belden Trademark and Belden Patent . . . U.S. Patent No. 2782251



Ask your
Belden jobber
about this
complete line.

CONVENIENTLY
PACKAGED FOR
DISPLAY AND
HANDLING



Power Supply Cords, Cord Sets and Portable Cordage • Electrical Household Cords • Magnet Wire • Lead Wire • Automotive Wire and Cable • Aircraft Wires • Welding Cable

8-3-0

May, 1960/PF REPORTER 39

by Milton S. Kiver

STABILIZING HORIZONTAL SYNC

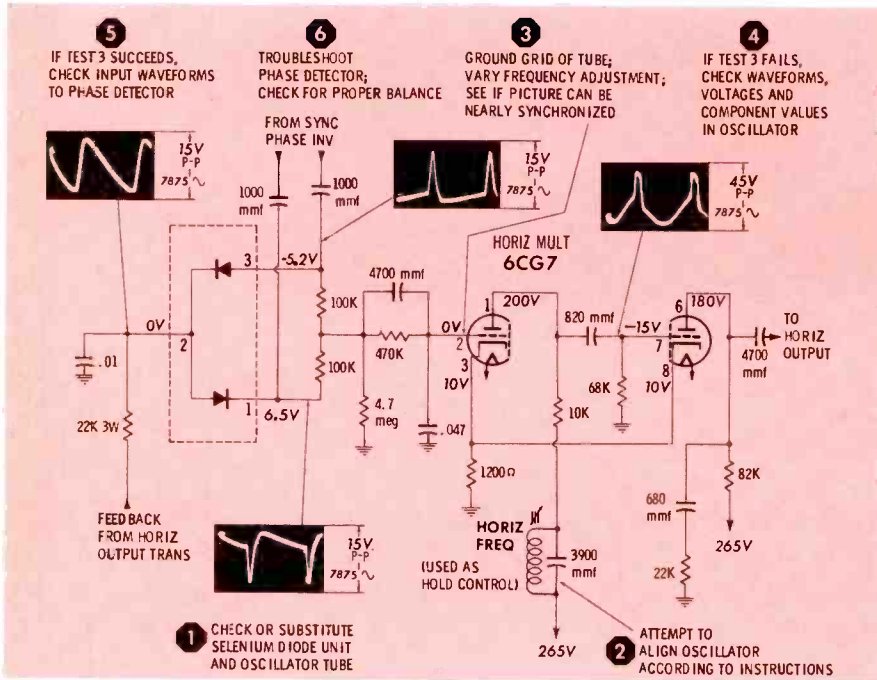

Fig. 1. Off-frequency operation may be fault of either AFC or oscillator.

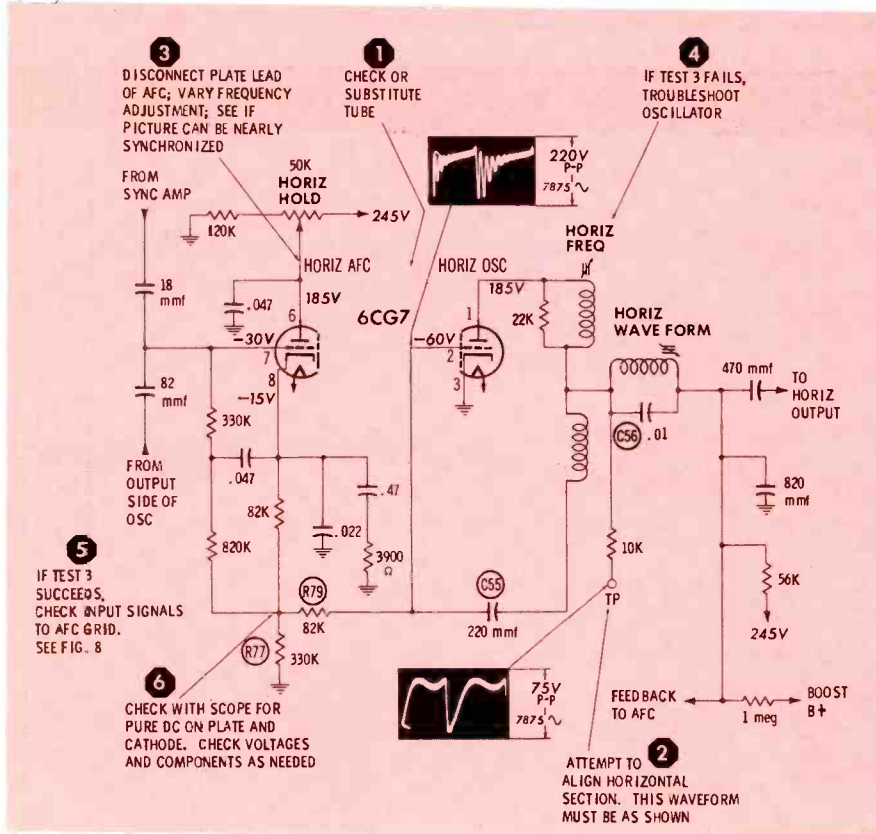
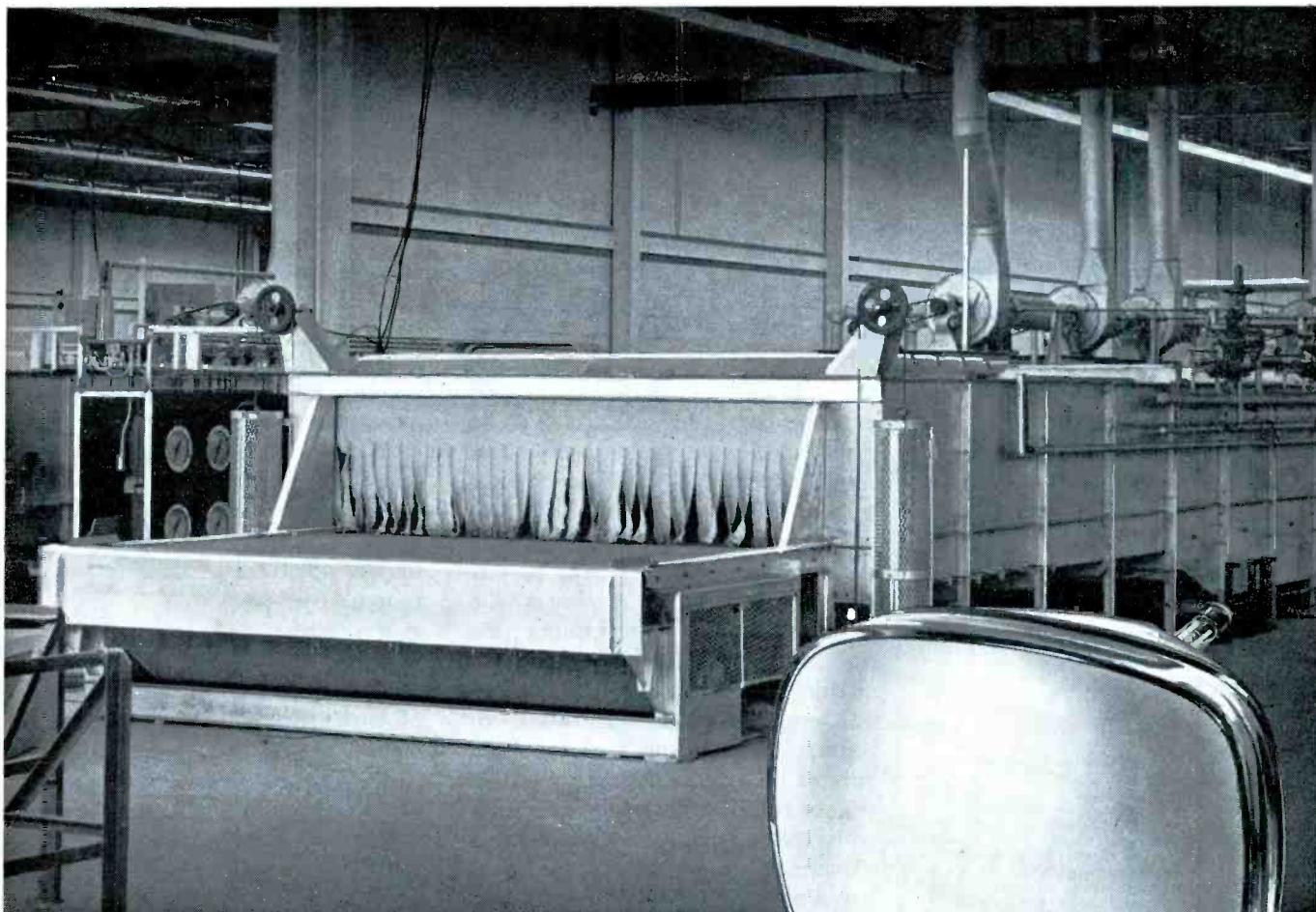

Fig. 2. Try realigning oscillator before making extensive circuit tests.

One major category of horizontal-system defects concerns an image that refuses to lock into synchronization. If the vertical sweep system is being similarly affected, the trouble almost certainly lies in a sync stage or at some previous point in the signal path. However, if only the horizontal system is affected, then attention should be directed first to the horizontal AFC and oscillator circuits. An excellent instrument to employ here is the oscilloscope, supplemented by a VOM or VTVM to measure voltages and resistances. Scope checks are suggested for both the horizontal oscillator and the AFC network, because waveforms will give you a clear idea of what is going on in these circuits. Voltage measurements do not clearly reveal conditions of the all-important signals in the circuit. However, once the waveform at a point has been viewed and found to be distorted or weak, further examination of the circuit with a VOM or VTVM will help explain why this condition exists. The two instruments work very well together, but the sequence of their use is important.

Lock-in troubles include such difficulties as squealing, squegging, ripples throughout the picture, and the "Christmas-tree" effect mentioned earlier—all in addition to the much simpler condition where the image falls into a pattern of diagonal black bars and cannot be stabilized by adjusting the hold control.

As a first step in determining the cause of the trouble, tubes (and semiconductor diodes) should be checked, and the oscillator aligned according to instructions. If the oscillator is thus brought back to normal operation, check to see if all controls and adjustments are set within the middle third of their range. If this requirement is not



Have you ever seen the SYLVANIA "Bakery"?

"Bakery"? An "Oven"? Yes, but not for bread. For Silver Screen 85 Picture Tubes! Giant ovens (Lehrs) — each about one-third the length of a football field — "bake in" the big differences that make Sylvania Silver Screen 85 the finest replacement TV picture tube . . . *second to none!*

The giant ovens heat-treat the glass and bake the phosphor screen and other internal coatings. Important, too—this process removes residual volatile materials such as lacquer and water used in applying the phosphor screen.

This treatment must be done slowly, under careful controls and is very essential to the proper processing of the bulb. This process also assures "stronger" glass,

free of undesired strains. It extends picture tube life by ridding the bulb of contaminants that could later cause inter-element leakage, gassing and loss of emission. The manufacturer who employs expensive equipment such as this can assure you of a consistently top-quality product.

So, when you recommend a replacement picture tube, recommend the finest . . . a Sylvania Silver Screen 85. It gives your customers what they want: better pictures for a longer time. Gives you what you need: profitable TV service calls.

*Electronic Tubes Division,
Sylvania Electric Products Inc.,
1740 Broadway, New York 19, N. Y.*

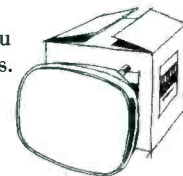

SYLVANIA

Subsidiary of **GENERAL TELEPHONE & ELECTRONICS**



**OUTSTANDING SAMS
SERVICING BOOKS**
available from your local
SAMS DISTRIBUTOR



TV CIRCUIT SERIES BY JESSE DINES

Servicing TV Sweep Systems. Describes the operation, function, and circuit variation of the different types of vertical and horizontal sweep systems common to most TV receivers. Tells how to analyze circuits and troubleshoot the vertical and horizontal sweep systems. Supported by photographs, waveforms, and service hints. 212 pages, 5 1/2 x 8 1/2". No. SSD-1. **\$275**
Only.....

Servicing TV Sync Systems. A practical reference book describing the theory of operation, circuit function, and circuit variations of the many different types of sync separators and amplifiers, horizontal AFC circuits, and horizontal and vertical oscillators. A large section is devoted to troubleshooting with actual photographs of TV picture symptoms and waveforms. 320 pages, 5 1/2 x 8 1/2", illustrated. No. SYD-1. **\$395**
Only.....

Servicing TV Video Systems. Discusses operation of the video-IF amplifier, video-detector, video-amplifier, and the picture-tube stages of a TV receiver. Includes data on color sets and recent changes in video systems. Really helps you master the modern video system; gives you troubleshooting knowhow, helpful servicing hints, methods for improving fringe-area reception, and picture-tube substitution data. 224 pages; 5 1/2 x 8 1/2". No. VID-1. **\$395**
Only.....



Servicing AGC Systems. Describes the operation and circuit variations of the different AGC systems used and servicing techniques that can be applied. Illustrated by actual case histories and photographs of typical symptoms, and troubles. 132 pages, 5 1/2 x 8 1/2". No. AGC-1. **\$175**
Only.....

Printed Circuit Diagnosis Made Easy. Helps you become an expert in servicing printed circuit boards. Practical, simplified approach saves time troubleshooting all types of printed circuits. Explains correct way to interpret and use various styles of data shown in service literature. Describes best procedures to follow when only a schematic diagram is available. Sample problems illustrate each phase of printed circuit troubleshooting. A "must" book for your service library. Illustrated. 64 pages; 5 1/2 x 8 1/2". No. PC-1. **\$100**
Only.....

Marine Electronics Handbook. Leo G. Sand's comprehensive book describes for boat owners the various types of marine electronic equipment available, what each does, and how to perform emergency repairs. For technicians, there is detailed data on circuitry used, as well as installation and maintenance. Special foldouts at back of book include schematics and charts of U.S. shore-based marine transmitter locations. The first and only book on this rapidly developing subject. 264 pages; 5 1/2 x 8 1/2"; illustrated. No. MES-1. **\$395**
Only.....

FREE SAMS BOOKLIST AVAILABLE—ask your Distributor or write us direct

Available from your Sams Distributor
HOWARD W. SAMS & CO., INC.
1720 E. 38th St., Indianapolis 6, Ind.

met, the circuit is still not functioning properly, and the serviceman should make a thorough examination of the AFC and oscillator circuits.

Because a signal is fed back from the output to the input, AFC-oscillator stages form a "closed-loop" system; therefore, they present much the same sort of service problem as an AGC network or an industrial control circuit. A failure in any portion of the system can upset the operation of all its circuits and produce confusing symptoms; to be more specific, it is hard to determine whether off-frequency operation of the sweep section is due to a faulty oscillator or a crippled AFC circuit. The best way to settle this question is to break the closed loop by interrupting the feedback path. Disable the AFC circuit and see if the picture can be temporarily brought back to normal by adjustment of the hold control and frequency slug. If this cannot be done, something is wrong with the oscillator. (An off-value component or a leaky capacitor is frequently the cause.)

If the oscillator *does* respond to the above test, the AFC circuit is probably defective. But before tearing into this stage, use the scope to see if both the input signals (sync pulse and feedback sawtooth) are normal. The input-signal leads should be disconnected one at a time to permit viewing of each waveform separately; then, if both waves appear normal, their simultaneous action on the circuit may be checked.

Another useful test of AFC operation is to rotate the hold control and check for a variation in AFC

output voltage. If the DC voltage on the output side of the AFC stage does not vary, or if it fluctuates in a nonlinear manner, the AFC circuit is not operating properly.

When the horizontal oscillator is a cathode-coupled multivibrator preceded by a phase-detector type of AFC circuit (Fig. 1), the oscillator can usually be made free-running by simply grounding the grid of the oscillator tube's input section. Even with no control voltage applied, it should still be possible to bring the picture momentarily into horizontal sync without rotating the hold control and horizontal-frequency slug beyond the middle one-third of their respective ranges.

If the isolation test convinces you that the AFC stage is behaving abnormally, consider the possibility of unbalance between the two halves of the phase-detector circuit. This includes checking both the positive and negative sync-pulse outputs of the sync phase inverter for approximately equal amplitudes.

Some types of phase-detector circuits, particularly in late-model sets, are not designed to deliver exactly zero control voltage when the oscillator is locked in at the desired frequency. In such cases, disabling the AFC will make it necessary to turn the frequency or hold control toward one end of its range in order to achieve momentary sync. Nevertheless, a free-running frequency of 15,750 cps should be well within the available control range if the oscillator is in normal condition.

The statements in the preceding

TV TUNERS OVERHAULED

ALL MAKES AND MODELS **\$9.95** NET **90 DAYS WARRANTY**
UHF/VHF \$19.90

SAME DAY SERVICE

ON POPULAR TYPES—48 HOURS ALL OTHERS

Overhaul charge includes labor and minor parts; tubes and major parts are extra at net prices. Tuner to be overhauled should be shipped complete; include tubes, shield cover and any damaged parts. Quote model and state complaint. Pack well and insure.

WE WILL SHIP C.O.D.—F.O.B. CHICAGO OR TORONTO

Castle TV Tuner Service

5710 N. WESTERN U.S.A. • 136 MAIN ST. TORONTO 13 CANADA
CHICAGO 45, ILL.

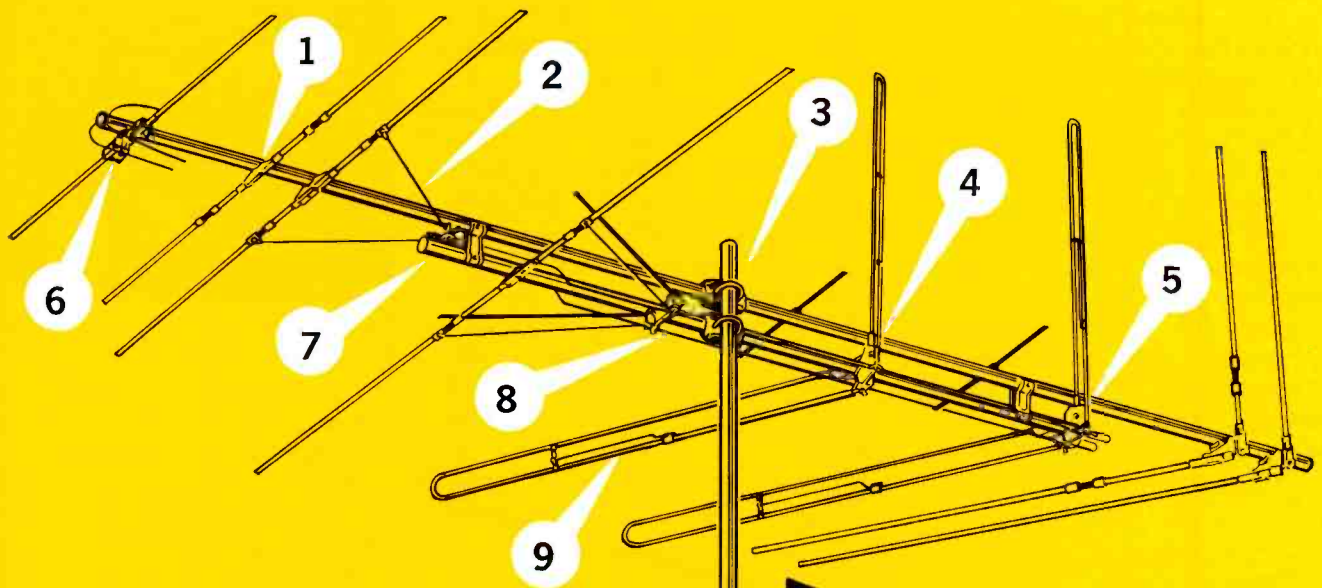

PEAK POWER

TACO

T-BIRD

the antenna with the fringe benefits...

An all-new TV antenna establishing improved standards of performance and reliability, the Taco T-Bird is designed to provide PEAK-POWER for every TV set, everywhere. Refreshingly different in appearance and performance, the T-Bird is jam-packed with new electrical and mechanical features.

Available in three models, 707-5, 707-6, 707-8, the T-Bird is made in plain and anodized aluminum—the right model for every purse and every signal requirement.

GET COMPLETE DETAILED SPECIFICATIONS FROM YOUR DISTRIBUTOR...

THE T-BIRD MAN IS COMING!

Your distributor T-Bird Man is bringing you the complete T-Bird Story—a profit package like you've never seen before—advertising program, consumer mailings, give-aways, and everything you need for the biggest shot-in-the-arm the antenna industry has ever offered! Watch for him! Ask your distributor for him!

- 1 **CRADLE-LOK BRACKETS**
Positive position locking of elements. Reduced element vibration. Longer service life.
- 2 **T-MATCH**
Strengthens elements. Provides electrical characteristics whereby all elements work on all channels. No dead-heading.
- 3 **POWER-GRIP MAST BRACKET**
Positive azimuth orientation. Holds antenna on-the-beam under the most rugged weather conditions.
- 4 **FORWARD-ANGLE BRACKETS**
Positive positioning for important forward sweep. Maintains signal stability.
- 5 **INSULATORS**
Fiberglass and Hi-Impact Butyrate insulators for minimum electrical leakage, greatest mechanical strength.
- 6 **NOSE CONE**
Provides automatic electronic matching of forward director.
- 7 **TRUSSED BOOM**
Additional strength for long-span cross-arm on 707-8 model.
- 8 **SOLID ALUMINUM PHASING RODS**
Air-dielectric — not subject to deterioration or "whipping"
- 9 **SIGNAL INJECTOR**
Positive spacing of elements provides electrical stability throughout VHF range.

TACO

TECHNICAL APPLIANCE CORPORATION,
SHERBURNE, NEW YORK.

paragraph apply equally well to the pulse-width horizontal AFC system (Fig. 2). Conduction of the AFC tube effectively reduces the grid-leak bias of the oscillator, thus helping to establish the operating frequency of the oscillator. If the AFC stage is disabled, the oscillator will tend to slow down; but you should be able to restore its frequency to 15,750 cps by re-touching the horizontal-frequency adjustment. One convenient way of disabling the AFC is to unsolder the plate lead (at pin 6 of the 6CG7 in Fig. 2). In some sets,

including those with printed wiring, it would be more convenient—and just as effective—to unsolder the lead going to the arm of the horizontal hold control (or to B+, if no control is used). The AFC should not be disabled by grounding the junction of R77 and R79, since this action will throw the oscillator far off frequency.

If the oscillator cannot be synchronized with the AFC disconnected, check C55 and C56 by substitution. Then, if necessary, check other components in the oscillator circuit.

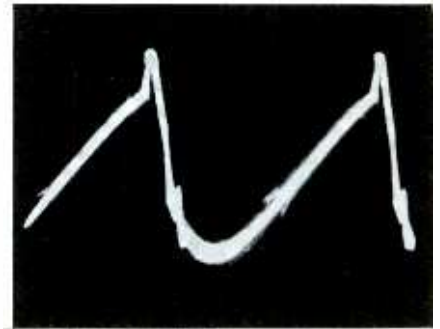

Fig. 3. Combined sync and feedback waveform at pulse-width AFC grid.

Fig. 3 shows the input signal which should be present at the grid of a pulse-width AFC stage — a positive sync pulse superimposed on a sawtooth-like feedback wave. (To view this waveform, a low-capacitance probe is a *must*.) When the horizontal-frequency slug is adjusted, the waveform should change shape as the sync pulse rides up and down on the sharp negative-going slope of the feedback wave. As a further test of AFC operation, check the voltages at the various tube elements, and see how they react to changes in the horizontal hold, frequency, and waveform settings.

Before we end this discussion, mention should be made of one additional type of horizontal instability that gives servicemen a fair amount of trouble—namely, pulling. This symptom shows up as a curvature of vertical lines in the picture, particularly in the upper half of the image. The trouble may be no more than a slight bending of the lines at the top of the picture, or it may affect all parts of the image.

This condition can be caused by a defect either inside or outside the horizontal sweep section. To clearly establish the general trouble area, remove the incoming sync signal from the horizontal AFC stage. Then adjust the horizontal hold control, and any other frequency adjustment at hand, until a picture is momentarily seen on the screen. If the symptom is still present, the defect lies in the AFC or horizontal oscillator stages; if the picture is normal, the difficulty is originating elsewhere.

If the trouble appears to be in the AFC or horizontal oscillator, check these stages by following the procedure just outlined. ▲

COMPARE **QUAM** **SPEAKERS**

feature for feature then decide for yourself which brand gives you the best value and the best performance in every speaker installation

	QUAM	BRAND A	BRAND B
ADJUST-A-CONE SUSPENSION to assure precise voice coil centering and alignment	YES	NO	NO
U-SHAPED POT to give you lowest possible energy loss and accurate magnet alignment	YES	NO	NO
ALNICO V MAGNETS	YES	YES	YES
HUMI-GARD CONE for greater heat and humidity protection in outdoor speakers	YES	NO	NO
AVAILABLE WITH SPECIAL VOICE COILS, SPECIAL FIELDS	YES	NO	NO
ADVERTISED TO THE PUBLIC	NO	YES	NO
LISTINGS IN PHOTOFACETS AND COUNTERFACTS [®] to save you time, assure correct replacements	YES	NO	NO
THIRTY YEARS OF EXPERIENCE in engineering and manufacturing quality loudspeakers under same ownership	YES	NO	NO

Write

for your free copy of the QUAM General Catalog, listing the full line of QUAM speakers for radio-tv replacement, public address, and high fidelity. QUAM speakers are completely manufactured in the United States of America.

QUAM-NICHOLS COMPANY
234 East Marquette Road • Chicago 37, Illinois

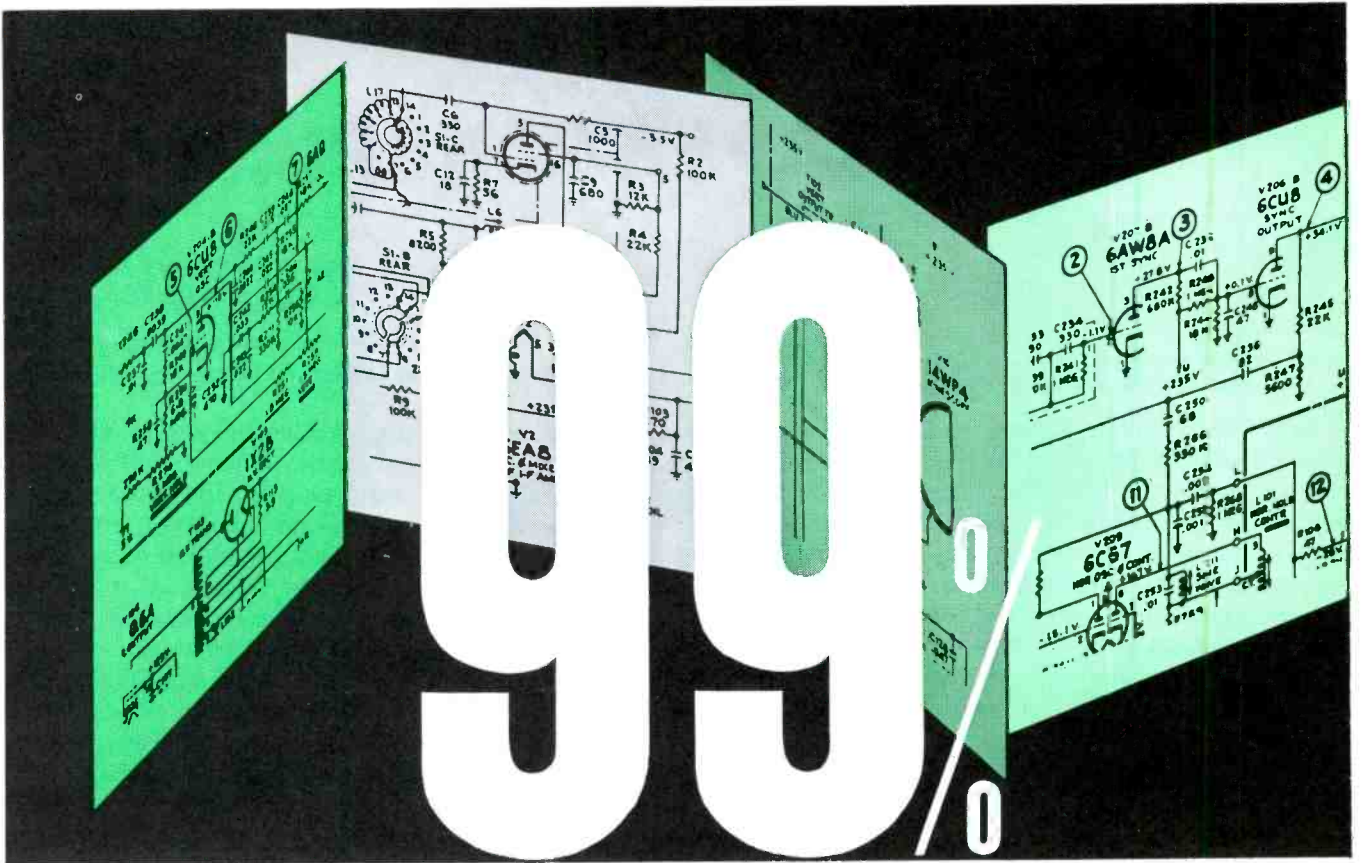

OF
ALL YOUR
REPLACEMENT
CONTROL NEEDS

CLAROSTAT **READY-TO-USE CONTROLS!!**

RTV CONTROLS

Ready for use right from the carton — the right one right in every respect for practically every TV and radio receiver . . . No assembly — factory-made to work right!

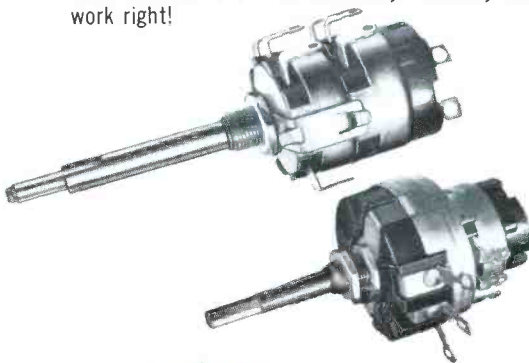

STANDARD CONTROLS

Wire-wound and carbon controls in every popular value. Also duals. Pick-A-Shaft permits right selection — snaps right into place. Ad-A-Switch snaps on with no fuss, no muss.



WRITE FOR COMPLETE CATALOG, OR ASK YOUR DISTRIBUTOR

CLAROSTAT MFG. CO., INC.

DOVER, NEW HAMPSHIRE

In Canada: CANADIAN MARCONI CO., LTD., Toronto 17, Ont.

Care of TAPE TRANSPORT

mechanisms

Suggestions for maintaining capstans, reel-drive systems, and brakes in home tape recorders.

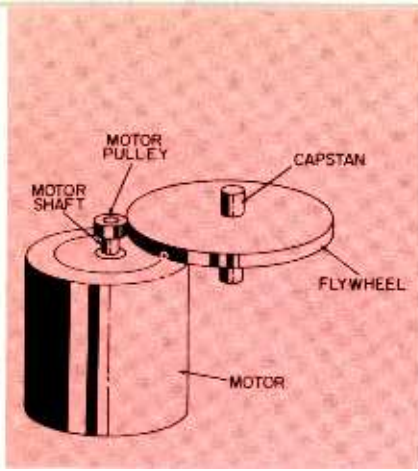

Fig. 1. In the rim-drive system, a puck on the motor shaft drives the flywheel.

Since the shafts, wheels, and bearings of tape transport mechanisms are subject to wear, electronic servicemen are often called upon to solve problems of a purely mechanical nature when repairing tape recorders. Familiarity with common types of capstan, take-up, fast-forward, and rewind drive systems will make such jobs a great deal easier.

Capstan Drive Systems

To the capstan drive system falls the job of transporting the tape past the magnetic head at a constant speed. A pressure (or pinch) roller presses the tape against a rotating shaft called the capstan. To stabilize capstan rotation and provide the most uniform tape speed possible, a flywheel is attached to the capstan shaft. The motor then drives the flywheel by one of the following methods.

Puck-Drive Systems

The high speed of the motor shaft requires some method of speed reduction in the drive system. One such method is the *puck drive*, in which the flywheel rim is driven by friction. In some mechanisms, the flywheel is equipped with a hard rubber tire, and is driven directly by a small-diameter pulley (or puck) positioned on the motor shaft by means of a set screw (see Fig. 1). Another type of puck drive, used in nearly all home re-

corders, employs an intermediate puck roller to drive the flywheel.

For the intermediate puck-drive system, a rubber-tired *idler wheel* is driven by the motor; the idler wheel, in turn, drives the flywheel rim (see Fig. 2). The center bearing of the idler wheel is mounted on a movable plate or lever. Although there may be variations in the mounting of the idler wheel, its purpose is always the same.

A correct wedge angle must be maintained between the motor pulley and flywheel rim in order to exert just enough traction to transmit torque without stalling the motor. Spring tension is also applied to the bearing mounting in the direction of the wedge angle to provide constant idler pressure against both the flywheel rim and the motor pulley.

A major source of trouble in puck-driven mechanisms is the idler wheel. All parts of the idler mounting system should move freely. If necessary, they should be thoroughly cleaned and lubricated.

Most idler wheels have *oilite* bearings and, under normal operating conditions, require no further lubrication. If the bearings do become gummy, making the wheel hard to turn, they should be cleaned with a dry cloth and lubricated with a drop or two of #10 motor oil.

The condition of the rubber idler tires is of utmost importance. In-

discriminate lubrication is a very hazardous practice; oil tends to creep onto the driving surfaces and form a thin film, which causes slippage and deterioration of rubber parts. Oil-contaminated driving surfaces should be cleaned with an alcohol-moistened cloth.

Time and wear will develop a glaze on the surface of rubber tires, resulting in slippage. This glaze may be removed with a chemical developed for the purpose, or by careful sanding. However, by the time a glaze develops, the rubber has probably deteriorated to the point where it would be advisable to replace the wheel.

Belt-Drive System

Two types of belts, composition and rubber, are employed in belt-drive systems. The composition belt is flat and runs between the motor and flywheel as in Fig. 3. A tension roller is usually used to keep the belt taut. This type of drive provides excellent speed stability.

When a round rubber belt is used (Fig. 4), there is no need for a tension roller because the rubber has enough elasticity to remain taut. A rubber belt may eventually become loose, however, causing slippage; or it may develop hard spots and introduce wow. In such cases, it is necessary to replace the belt.

Direct-Drive Systems

Direct-drive systems (Fig. 5)

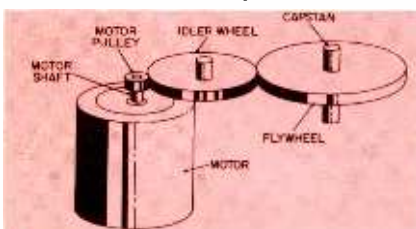

Fig. 2. In idler-drive system, an idler wheel serves as an intermediate pulley.

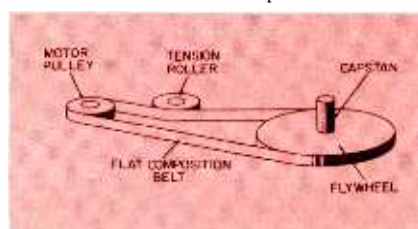

Fig. 3. In a composition-belt drive system, a tension roller keeps belt taut.

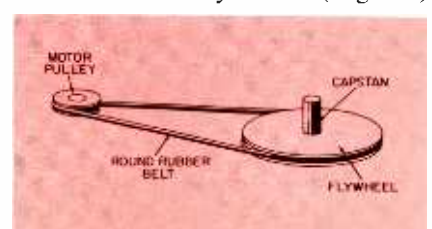

Fig. 4. Elasticity of the rubber keeps belt taut in the rubber-belt system.

I'm loaded with performance, man

(NO SYNC PROBLEMS
WITH ME)



"Visit the CBS Booth 304
and Display Room 657A
at the 1960
Electronic Parts Distributors Show"

"I've got everything you need in a horizontal oscillator: No heater-cathode leakage to throw a TV set out of sync. No microphonism to tear the picture. And long, long life to eliminate call-backs for you."

The new CBS 6CG7 offers you *total reliability* . . . proved in performance by leading TV set manufacturers. You, too, can profit from the *total reliability* of CBS tubes. Just make it a habit always to replace with CBS.

The CBS 6CG7 is a premium-performance tube. Hum-free coil heaters assure long life. And combined with a ring getter and pinched cathodes, they virtually eliminate heater-cathode leakage . . . notorious for causing loss of horizontal sync. Twin top micas and semi-automated precision assembly minimize microphonism. Truly the CBS 6CG7 . . . best in the industry . . . has advanced-engineered features found only in premium-performance tubes.



TOTAL RELIABILITY . . . proved in performance



CBS ELECTRONICS

Danvers, Massachusetts

A Division of Columbia Broadcasting System, Inc.

Receiving, industrial and picture tubes • transistors and diodes • audio components • and phonographs

May, 1960/PF REPORTER 47

use the shaft of a slow-turning motor as the capstan. If there is a flywheel, it is attached directly to the motor shaft. Because this drive operates directly from the motor, there are no idlers or belts to cause trouble.

Take-Up Reel Drive Systems

In any tape recorder, the capstan feeds tape to the take-up reel at a constant rate, but the rotating speed of the reel must be variable for the following reason: When the reel is nearly empty, it has to make more complete revolutions to take up a

given length of tape than when the reel is nearly full. Therefore, tape recorders are equipped with variable-speed take-up drive systems.

Slipping Clutch

One of the most common variable-rate drive systems is the slipping clutch (Fig. 6). Generally, the driving element of the clutch consists of a take-up reel pulley driven at a constant speed, often by the same motor that drives the capstan. Lying on this reel pulley is a piece of felt, which slips on the take-up reel pulley as it drives the clutch

disc. The latter, in turn, drives the take-up reel turntable.

The clutch must be adjusted as specified by the manufacturer. If the correct adjustment cannot be attained, disassemble the clutch assembly and see if the felt disc is worn, dirty, or oily. If so, it should be replaced, and associated parts should be thoroughly cleaned. Changes in temperature and humidity affect the operation of this system.

Slipping-Belt System

Another widely-used method of driving a take-up reel utilizes a cloth belt looped around a polished pulley (see Fig. 7). The belt is driven very rapidly around the pulley, which is attached to the take-up turntable. Because of the high speed of the belt drive, the take-up reel attempts to wind up

...first because they last!

INTERNATIONAL RECTIFIER

Selenium Radio-TV Replacement Rectifiers

Install them for trouble-free service. International Rectifier builds them that way with the advanced techniques and experience that have made us the world's largest supplier of industrial semiconductors. The price is the same as for ordinary rectifiers. The profits come in the call-backs that are eliminated.

INTERNATIONAL RECTIFIER CORPORATION

Distributor Sales Division: El Segundo, Calif.

In Stock at Better Dealers Everywhere

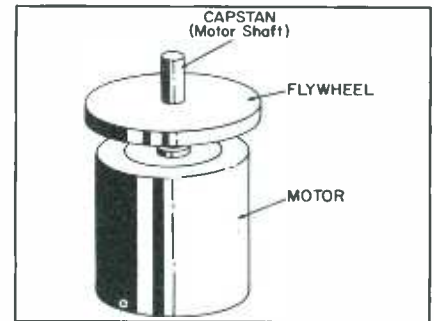

Fig. 5. Capstan fastens to slow-speed motor shaft in the direct-drive system.

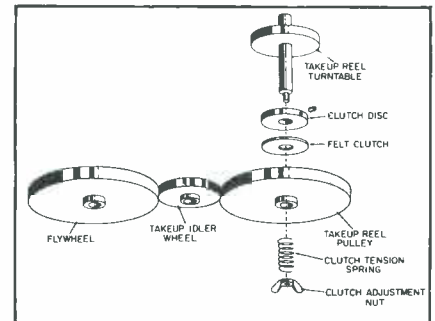

Fig. 6. Pressure against felt washer governs slippage in clutch-drive system.

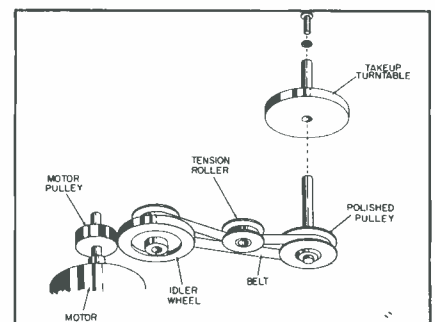

Fig. 7. Pressure of tension roller governs slippage in slipping-belt system.

the people who brought you the



THE LIFETIME GUARANTEE

Utah will renew or replace free this loudspeaker due to any performance failure at any time during the lifetime of the owner. No charge will be made for handling, inspection, labor, materials or servicing for any repair or replacement. Customer pays postage only.



**MORE POWER
PER POUND
SPEAKER** now offer
**MORE SOUND
PER LIFE**

in the revolutionary

utah

LIFETIME SPEAKER

guaranteed

for the life of the owner

24 hours a day, we lay our reputation (and our profits) on the block! We *guarantee* perfection of performance for a lifetime. To do this, we *have* to make the speakers of our lifetime . . . and we do!

Order a Utah Lifetime for your next replacement and see! (All popular sizes and shapes).

utah
LIFETIME
SPEAKERS 

Utah Radio & Electronic Corp., Huntington, Ind.

PROFESSIONAL technicians
 use *Dave Rice's*
OFFICIAL ORDER BOOKS
 for every **TV-RADIO**
 service call



OFFICIAL ORDER BOOK

This is the businesslike approach to service record keeping. TriPLICATE forms serve as order form, invoice and office record, with spaces for complete information on every job. Separate listings for receiving tubes, pix tube, parts, serial numbers, labor and tax charges, signatures, etc. 75c a book, \$6.50 for dust-proof box of 10. In stock at your distributor. Write for your free folder describing Dave Rice's OFFICIAL ORDER BOOKS, including an actual size sample copy of the handy order form.

For customer's prices on every replacement part, plus flat rate and hourly service charge data, regional and national, Dave Rice's OFFICIAL PRICING DIGEST, listing over 63,000 items. \$2.50.

ELECTRONIC PUBLISHING CO., INC.
 180 N. WACKER DRIVE
 CHICAGO 6, ILLINOIS



QUIETROLE
 NON-WEARABLE - NON-CONDUCTIVE
Spray-Pack
 LUBRI-CLEANER
 for
TV Tuners
 AND ALL OTHER CLEANING & LUBRICATION
 WHERE SPRAY APPLICATION IS DESIRABLE

Also available in 2, 4, and 8 oz. bottles with dropper

Either way, make sure it's **QUIETROLE**
 Company

In Canada: CROSS CANADA ELECTRONICS
 67 Ontario St., S., Kitchener, Ont.

Spartanburg
 South Carolina

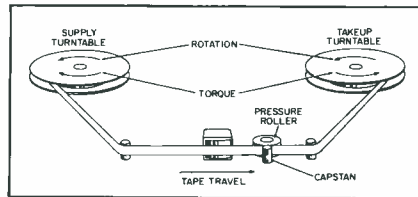

Fig. 8. Torque is reduced by equal series resistance in motor-torque system.

the tape faster than it can be pulled through the capstan. As a result, the tape is wound under tension. Whenever this tension exceeds a predetermined amount, the reel exerts a drag on the take-up turntable; then the drive belt slips on the polished pulley. The tape tension in a belt drive system will vary from time to time, depending on lubrication, temperature, and humidity.

Motor-Torque System

This method of variable-speed take-up drive is accomplished by use of induction motors to drive the take-up and supply turntables. Usually, the motors are so connected that the turntables will rotate in opposite directions when power is applied with no tape threaded. The supply turntable, fixed to the rewind motor shaft, will rotate clockwise; the take-up turntable, fixed to the take-up motor shaft, will rotate counterclockwise (see Fig. 8).

The torques of the motors are adjusted equally by resistors connected in series with each motor when the unit is in *Play* or *Record*. Consequently, both motors operate at reduced torque and are effectively isolated from each other by the capstan and pressure roller, between which the tape is clamped. On the supply-reel side of the system, the capstan and pressure roller exert sufficient pull on the tape to overcome the hold-back tension created by the opposing torque of the rewind motor. On the take-up side, the tape is held under tension because the take-up rate exceeds the feed rate. A loop of tape will be "thrown" on the right side of the capstan whenever any malfunction causes the feed rate to exceed the take-up rate.

Rewind and Fast-Forward Systems

Practically all tape recorders in-

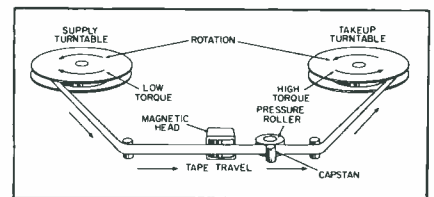

Fig. 9. Torque of take-up motor pulls tape from supply reel in Fast Forward.

corporate a fast-forward and a fast-rewind speed (several times faster than *Play* or *Record* speed) to facilitate handling of the tape.

During both *Fast-Forward* and *Fast-Rewind*, very little back tension is applied to the feeding reel. This allows the tape to be moved rapidly with a minimum of power.

Mechanical Systems

In mechanically-operated systems, a linkage slides the reel shaft or idler shaft into a position where it can be driven directly by the motor instead of through a slipping clutch or belt.

Induction Motor Systems

In induction motor systems, the supply and take-up turntables are driven directly from the motor shaft. In *Fast Forward*, the torque of the rewind motor is greatly reduced by added series resistance. In *Rewind*, resistance is inserted in series with the take-up motor.

In *Fast Forward* (Fig. 9), the take-up motor operates at full torque and the rewind motor at reduced torque, and the tape is simply pulled from the supply turntable. Since the small torque of the rewind motor is applied in a direction opposite from the turntable rotation, the tape is held under continuous slight tension as it is pulled from the reel.

In *Rewind* (Fig. 10), the foregoing operation is reversed.

The hold-back tension during *Rewind* and *Fast Forward* must not be so great that it causes an excessively tight tape wind. If a tightly-wound tape is subjected to a sharp change in humidity or temperature, tremendous tape tensions will be built up on the reel. Each layer of tape contributes a progressively stronger pressure on its adjoining inner layer and will sometimes stretch the tape beyond its yield point, permanently deforming its shape.

NUMBER 3 IN A SERIES OF



50th ANNIVERSARY SPECIALS!



You asked for it!

HIT KIT



35 POPULAR CDE MOLDED MYLAR TUBULARS

NOW – just in time for baseball TV-viewing (and TV-servicing) CDE has the Hit Capacitor Kit *you* asked for: 35 popular molded Mylar* tubulars that “shortstop” call-backs! Quality-proven by two years of consistently dependable replacement service, these high temperature, moisture-resistant “PMs” are the values you need and use every day. And now you can have this convenient assortment—plus a sturdy, plastic parts-or-jewel box—all for the price of the capacitors alone! A real “double-header.” Get *two* “PM Kits” today—one for your shop, another for your service bag—from your CDE Distributor. Cornell-Dubilier Electric Corp., South Plainfield, N. J.

HERE'S THE BOX SCORE

No.	Item	Mfd.
3	PM 6D2	.002
5	PM 6D5	.005
6	PM 6S1	.01
5	PM 6S2	.02
5	PM 6S47	.047
6	PM 6S5	.05
5	PM 6P1	.10
Voltage: 600 VDCW		

Pick the four teams in each major league that you think will be standing in 1, 2, 3, 4-order as of midnight, May 31, 1960 and win \$100 worth of *any* CDE merchandise if the sequence you pick is closest to the actual order. See full contest details in kit.
*DuPont T.M.

ALL FOR ONLY \$6.87



CORNELL-DUBILIER ELECTRIC CORPORATION

AFFILIATED WITH FEDERAL PACIFIC ELECTRIC COMPANY

Now... from Sonotone—

4 Big Improvements

in the quality stereo cartridge

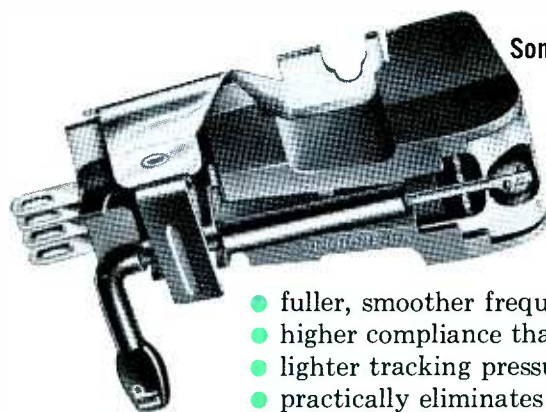

Sonotone 8TA cartridge replaces 8T as industry standard

The new Sonotone 8TA cartridge gives greater than ever stereo performance... has 4 big extras:

- fuller, smoother frequency response
- higher compliance than ever before
- lighter tracking pressure
- practically eliminates dust pile-up

ONLY \$1450*

Sonotone 10T unitized stereo at lowest price ever

New 10T cartridge sells at record low price of \$6.45.* And it covers the complete high fidelity range. 10T's unitized construction makes it easiest to install, easiest to replace. Low price means more sales—more profits.



SPECIFICATIONS

	8TA	10T
Frequency Response	Smooth 20 to 20,000 cycles. Flat to 15,000 with gradual rolloff beyond.	Flat from 20 to 15,000 cycles ± 2.5 db.
Channel Isolation	25 decibels	18 decibels
Compliance	3.0 x 10 ⁻⁶ cm/dyne	1.5 x 10 ⁻⁶ cm/dyne
Tracking Pressure	3-5 grams in professional arms 4-6 grams in changers	5-7 grams
Output Voltage	0.3 volt	0.5 volt
Cartridge Weight	7.5 grams	2.8 grams
Recommended Load	1-5 megohms	1-5 megohms
Stylus	Dual jewel tips, sapphire or diamond.	Dual jewel tips, sapphire or diamond.

*including mounting brackets

Sonotone makes only 6 basic ceramic cartridge models... yet has sold over 9 million units... used in over 662 different phonograph models. For finest performance, replace worn needles with genuine Sonotone needles.

Sonotone[®] .PROC

Electronic Applications Division, Dept. C10-50
ELMSFORD, NEW YORK

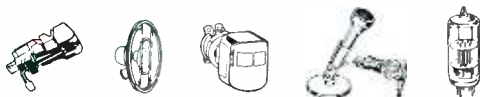

Leading makers of fine ceramic cartridges, speakers, tape heads, microphones, electronic tubes.
In Canada, contact Atlas Radio Corp., Ltd., Toronto

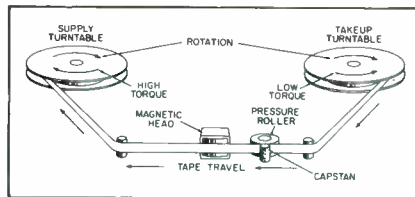

Fig. 10. Situation reverses in Rewind; torque is reduced in take-up motor.

Braking Mechanisms

When a recorder is placed in the *Stop* position, brakes must be applied to the reels as rapidly as possible without damaging the tape. The brake generally consists of a metal wheel which engages a rubber rim on the turntable shaft; however, in some recorders, a rubber or felt pad is pressed against a metal disc on the turntable shaft. The reel from which the tape is being drawn must be stopped first; otherwise, the tape will spill.

Maintenance

Since a recorder's transport section is a mechanical device, an occasional drop of oil is required so that all parts exposed to friction or wear will be kept turning freely. However, since oil on driving surfaces will cause slippage, excessive oiling should be avoided.

The biggest menace to a tape transport mechanism is dust, dirt, and grit particles between the shafts and bearings; when these are present, moving parts will rapidly become worn and scored by friction. Thus, to keep tape recorders in peak operating performance, the transport mechanism must be kept clean. ▲

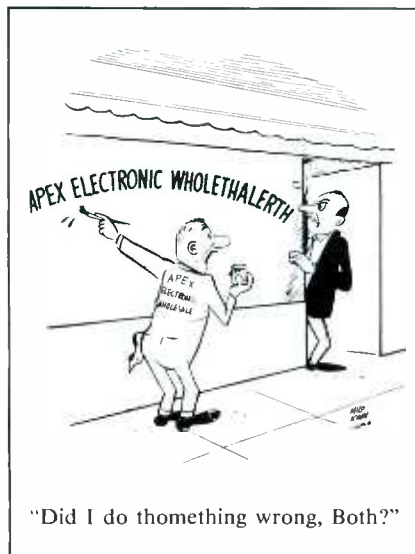

NOW

Make Money on Printed Circuit Repairs

... it's easier than you think with the new

Ungar®

DE-SOLDERING TIPLETS®

You pocket more profit on printed circuit repair jobs with these exclusive interchangeable Ungar De-Soldering Tiplets. Specially shaped to remove 9 out of 10 components! No more improvising with make-shift tools!

Repairs are easier, safer and 70% faster because each triplet is designed to apply just the right amount of heat simultaneously to all soldered contacts without heat radiation damage. No more de-lamination problems! No more ruined printed boards!

Tiplets shown at left are available individually ... List Price 75¢ each, or ...



Special Introductory Kit

Lifetime Metal Case contains #776 Handle, Super Hi-Heat Unit, #857 Slotted Tippet, 3 cup Tiplets and #858 Bar Tippet. List \$7.95

Order from your Electronic Parts Distributor now!

Ungar Electric Tools, Inc.

4101 Redwood Ave., Los Angeles 66, Calif.

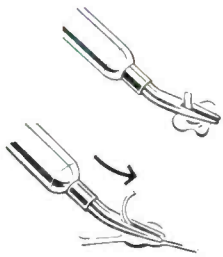
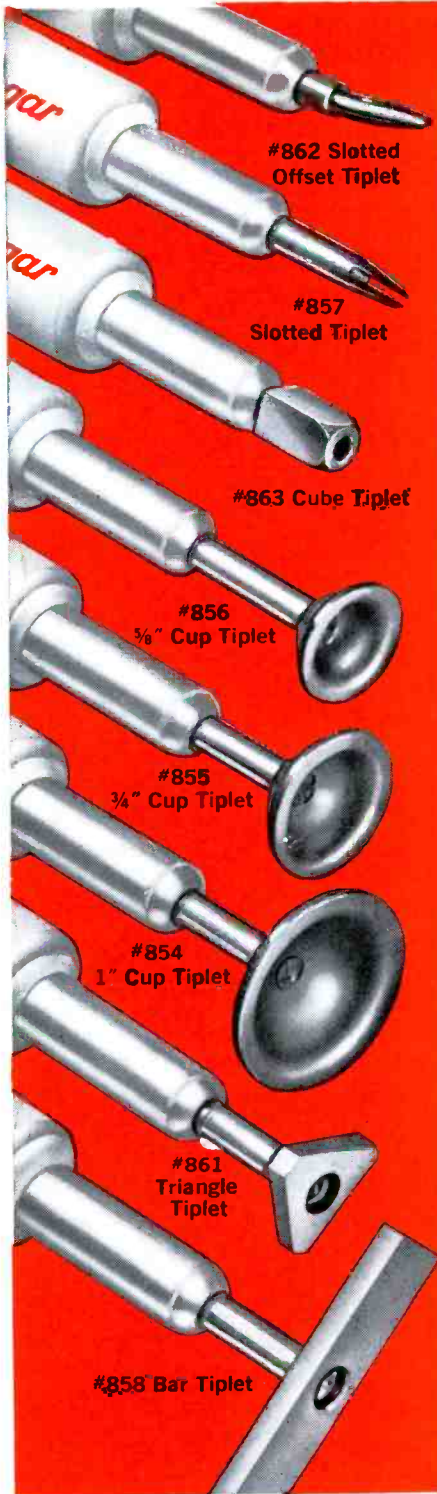

Offset Slotted Tippet straightens leads, tube tabs and small wires bent close to board.

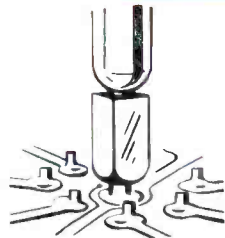

Cube Tippet removes center pins of tube sockets and harness leads.

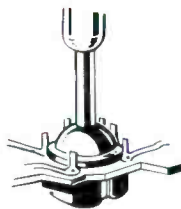

Cup Shaped De-Soldering Tippet removes solder from circular multi-lug components in one operation.

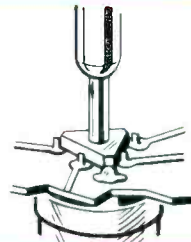

Triangle Tippet melts solder on leads of electrolytic capacitors simultaneously.

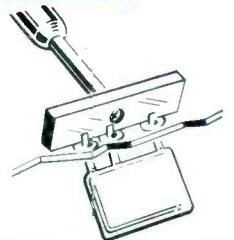

Bar Tippet simultaneously melts solder on all multiple straight line network components.

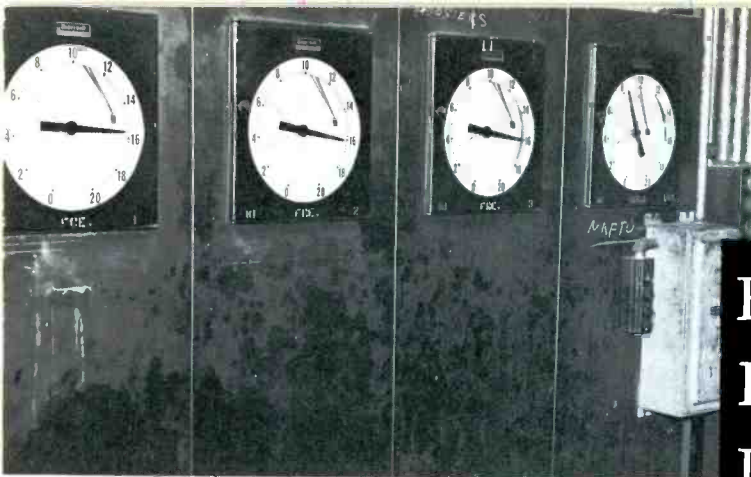

Fig. 1. Regulating scales on front panel can be manually preset to establish desired furnace temperature.

● DETAILS OF A CLOSED-LOOP SYSTEM FOR CONTROLLING HEAT WITHIN A FURNACE FOR TEMPERING STEEL.

EXAMINING AN INDUSTRIAL CONTROL DEVICE

by Joe A. Groves

Perhaps we should paraphrase our title to say, "A TV Technician Sticks His Nose Into the Field of Industrial Electronics." That's exactly what we've done, with the idea of removing the cloak of mystery from a typical industrial system. In order to accomplish this, we have reverted to a familiar style of presentation — converting as much as possible of the industrial jargon into TV men's lingo.

For our subject, we chose a completely automatic control system. This particular unit is used as a pyrometer to control the heat within a tempering furnace, although the same basic type of equipment could just as easily control the speed of a production process, regulate the thickness of a material passing through a rolling machine, measure and maintain a constant

air or liquid flow, or perform any of several dozen other tasks.

When we took our first look at this equipment, what did we find but the proverbial "little black box" of the engineering lab — only this wasn't little! The controls were housed in four black cabinets (Fig. 1), each big enough to crawl into. The only outwardly-visible feature on each panel was a huge regulating scale, complete with a pen to provide a continuous record of temperatures within the furnace.

When one of the panels was opened (Fig. 2), we were on more familiar ground. Looking past an array of cams, steel belts, and such, we spotted a power transformer, some well-shielded tubes, and even a dry cell. The little four-tube chassis inside the big cabinet was the reason we were there. Here was

the heart of the entire system; the next step was to find out how it worked.

We knew this was a closed-loop system. Something at the furnace was supplying a signal to the four-tube amplifier, which was continuously making corrections in the amount of gas being supplied to the furnace so that a constant temperature could be maintained.

While our photographer was busy finding a place where he could take the two photos you've already seen, we were led around the furnace to see the rest of the system. One item was the thermocouple installation shown in Fig. 3; this was the "something" that fed an input signal to the amplifier. Still another unit, a motorized regulating valve on top of the furnace (Fig. 4), controlled the gas flow.

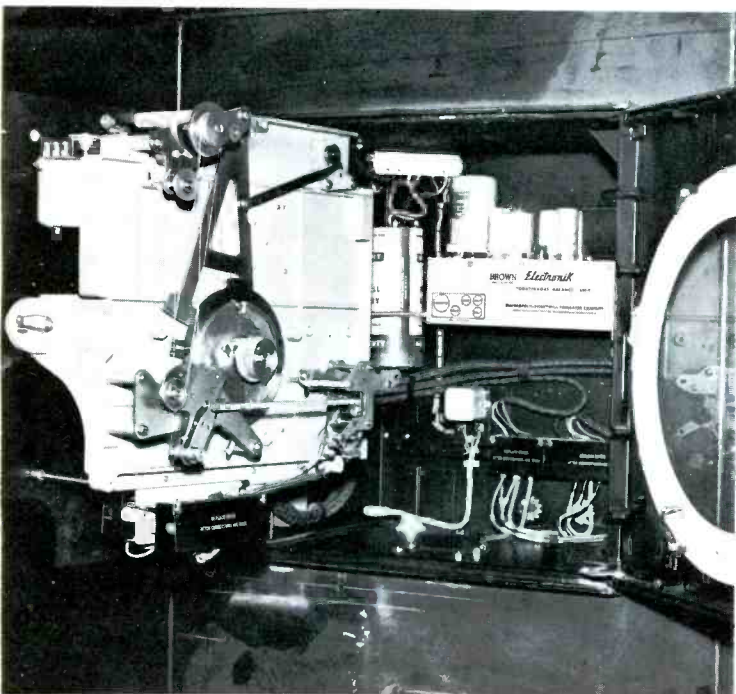

◀ Fig. 2. Front panel swings back to expose control-amplifier chassis and dry-cell reference-voltage source.

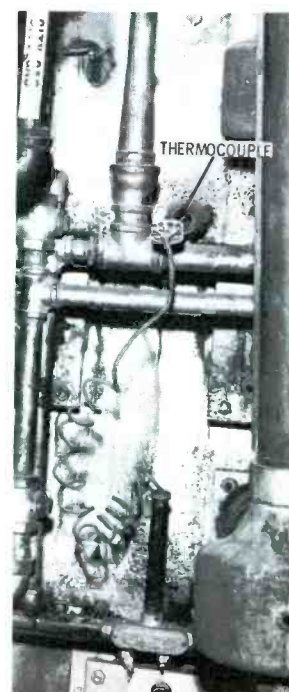

▶ Fig. 3. Furnace temperature is indicated by thermocouple output voltage.

How It Works

Once out of the din of the factory, we were able to analyze the operation of this *ElectroniK* control system (Minneapolis-Honeywell) and sketch the simplified wiring diagram shown in Fig. 5. Everything is based on a comparison of two voltages. One is a predetermined potential regulated by manual adjustment of the instrument to operate at a certain temperature; the second is the output of a sensing device (the thermocouple in this system).

Any difference between the two voltages causes an error signal to be developed by the converter. After being amplified by a three-stage voltage amplifier, this signal is applied to a group of *grid-controlled rectifiers*. One pair of rectifiers conducts more than the other pair, or vice versa, depending on the phase of the error signal—which, in turn, depends on whether the temperature of the furnace is too high or too low. The pulsating plate current of the rectifiers is fed to one winding of the balance motor (a synchro, or selsyn, type of unit rather than a “running” motor), and AC line current is fed to the other winding. As long as an error signal is present, the pulsating DC in the first winding is out of phase with the AC in the second, and the rotor of the balancing motor turns.

As the rotor assumes a new position, it drives a mechanical linkage which energizes a motor-controlled valve to vary the gas flow and simultaneously repositions the slide-wire contactor to bring the system into balance. As soon as its two DC input voltages are equalized, the converter ceases to generate an error signal; then the balancing motor stops rotating and de-energizes the motor of the control valve. This cycling process continues, proportionally opening and closing the gas-flow valve as the temperature within the furnace varies the output voltage of the thermocouple above or below the mean value set by the manual adjustment.

Thermocouple

The thermocouple used as a sensing element in this system is a thermoelectrical device whose output

voltage is directly proportional to the heat applied. It is connected to the control unit through extension leads having the same thermal characteristics as the pickup element. Positive and negative polarities are marked and require the serviceman's careful attention during tests or when making connections into the circuit. The output is rated in microvolts and requires a sensitive instrument for measurement. Thermocouples come in a variety of materials, each having different characteristics and applications.

Motorized Valve

The valve which regulates the gas flow in this system is operated by a reversible electric motor having two different sets of control switches—one for each direction of rotation. This is characteristic of any *proportional* system (one which continuously makes small corrections to control the size of the valve opening). Other systems, in which the valve simply swings back and forth between its fully open and fully closed positions, use motors which rotate to a preset limit point, shut off, and actuate a self-contained switch to reverse the motor current the next time power is applied.

Potentiometer or Pyrometer

Don't look for a variable resistor with a control shaft—the term “potentiometer” has a different meaning in the industrial electronics

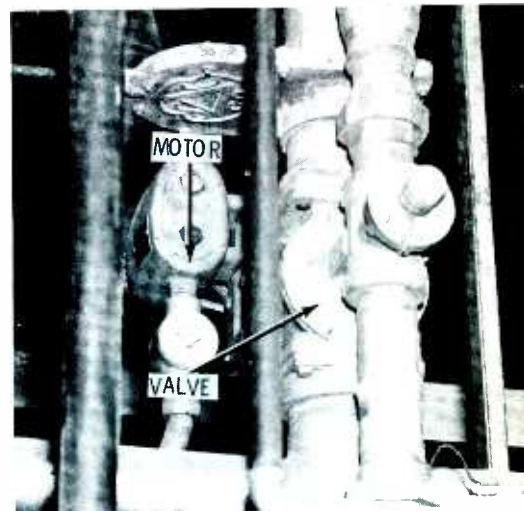

Fig. 4. Control energizes electric motor to adjust gas-flow valve position.

field. This is the name given to the *entire* control unit shown in Fig. 2, encompassing the manually-set scale, recording devices, cams, balancing motor, reference-voltage supply, and—last but not least—the amplifier chassis itself.

Amplifier

The *ElectroniK* amplifier is the “brain” of this continuous balance system. A point to remember when servicing the amplifier unit is that it's no \$19.95 AC-DC radio, but an industrial control device selling for slightly over \$100 less tubes and converter. Even reconditioned units are priced at \$63, so don't give your service away!

The amplifier is a neat, ruggedly constructed little package, as you can see in Fig. 6. When its sche-

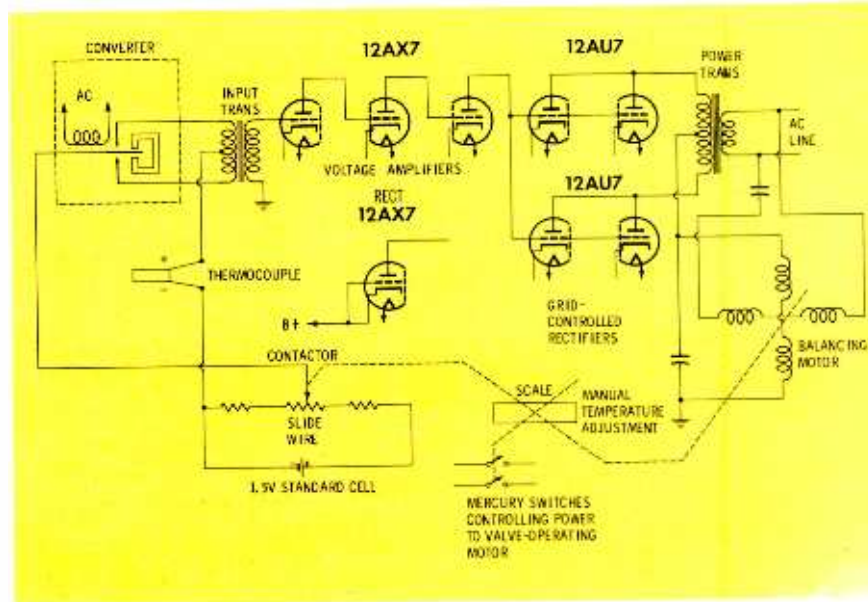

Fig. 5. Simplified wiring diagram of *ElectroniK* continuous control system.

"SERVICE-ENGINEERED"

TEST EQUIPMENT

helps you make more profit



All Jackson test equipment is "Service-Engineered" for service work. It is designed to give you the accuracy you need, combined with speedy, profitable operation. That's why smart servicemen are switching to Jackson. Your distributor will be glad to demonstrate Jackson equipment to you to prove the point.

DYNAMIC® TUBE TESTING



Model 658—Finest service tube tester made. Makes more tests, more accurately and faster.

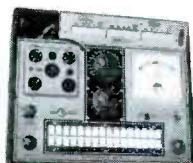

Model 648R—Combines sequence switching with time-proved Jackson Dynamic testing technique.



Model 598—Low cost Dynamic circuit with convenient Lever Switching. Many features.

Power Chart Available for Any of These Tube Testers

ALIGNMENT



Model TVG-2—Combination Sweep-Marker Generator for TV or FM servicing.



Model CR0-2—Finest service 'scope made. Wide band and high sensitivity. Flat to 4.5 MC.

TEST AND MEASURING



Model 590—Accurate 7" VTVM. Fast warm-up. Measures AC and DC Volts and Ohms.



Model 591—Wide Range Capacitance Checker. Checks capacity from 10 uf to 1000 uf.



Model 655—Wide Range Audio Oscillator. Sine wave output 20 cycles to 200,000 cycles.

See your distributor or write: **THE JACKSON ELECTRICAL INSTRUMENT COMPANY**

124 McDonough Street, Dayton 2, Ohio

In Canada: The Canadian Marconi Co.

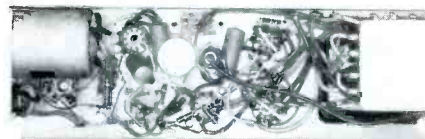



Fig. 6. Bottom view of amplifier reveals simple, rugged construction.

matic is presented in a form more familiar to the TV man, as in Fig. 7, it becomes much easier to analyze. (Note: All voltages given in this figure were taken with a VTVM with the converter removed and no load attached, so the test conditions can be duplicated anywhere.)

The converter, a cousin to the familiar auto-radio vibrator, acts as a "chopper" to change the incoming DC voltages into AC signal with an approximately square wave-shape. When an alternating voltage from the power transformer is applied across pins 1 and 6, the movable reed connected to pin 4 vibrates at a 60-cps rate—alternately making contact with the two opposite ends of the input-transformer primary. The voltage picked off the slide wire by the contactor is fed to the reed, and the output voltage of the thermocouple goes to the center tap of the transformer. When the system is in balance, these two DC voltages are equal; thus, no difference in potential appears across either half of the transformer primary, and no error signal is developed.

If the input voltages are *not* identical, the difference between them will be impressed alternately across the upper and lower halves of the primary winding. The resulting current through the transformer—in one direction through one half of the primary, but in the opposite direction through the other half—causes a 60-cps square wave to be generated and coupled to the first voltage amplifier. The amplitude of this signal is proportional to the difference between the two input-voltage levels. In addition, the phase of the signal changes by 180° whenever there is a reversal of relative polarity between the two inputs.

After the first stage of voltage amplification come two more stages, either of which may include a gain control. The final output of the amplifier is RC-coupled to all four con-

QUALITY IS A SEVEN-LETTER WORD

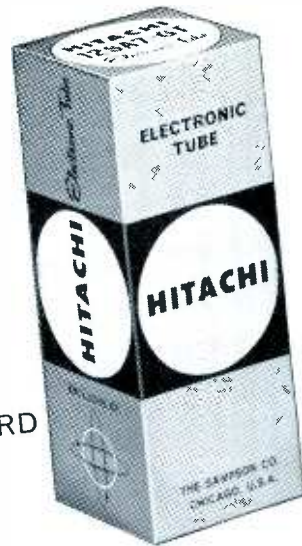

AND SO IS HITACHI

The most important thing about
HITACHI receiving tubes is the way
you've received and approved them

Hitachi tubes have won an important place in the competitive U.S. electronic parts market. We knew they were good. And, judging from the volume of orders (and re-orders) from servicing firms and parts distributors across the country -- everybody does!

Hitachi, Ltd., Tokyo, Japan, is one of the world's largest manufacturers of products ranging from giant turbines to tiny transistors. Its international reputation is based on achievements that include the *Grand Prix Award* for scientific equipment, at the Brussels World's Fair.

Their vacuum receiving tubes are equally out-

standing, performance-proved the world over. Our records show you selling, servicing, satisfying customers with Hitachi. Getting less costly-callbacks. Making a better margin of profit per Hitachi installation than normally possible with tubes of such quality.

Coming Hitachi attractions — they're already here! Unusual new ideas in product development, on view when you visit us at the 1960 Electronic Parts Distributor Show, May 16-18, Conrad Hilton, Chicago—Display Room 644 and Booth No. 886. We invite you to stop in . . . You'll really see something to write (or wire) home about!

THE SAMPSON COMPANY (Est. 1921) ELECTRONICS DIVISION
2244 SOUTH WESTERN AVENUE, CHICAGO 8 • Conrad Hilton — Display Room 644 and Booth No. 886

May, 1960/PF REPORTER 57

**NEWEST
BEST BUYS FROM**



ripple
at full load
is only
0.005%



with new
**Model 1020
POWER &
BIAS SUPPLY**
(Pat. Pend.)
FOR

TRANSISTORIZED EQUIPMENT

Wired \$27.95 Kit \$19.95

- Checks All transistor radios.
- includes power transformer, full-wave silicon diode rectifier circuit, electrolytic capacitor input filter followed by a two-power transistor (2-2N256) cascaded filter circuit providing extraordinary ripple rejection.
- output voltage: 0-30 VDC continuously variable, monitored by dual-range voltmeter (0-6, 0-30 VDC).
- continuous output current capacity: 150 ma @ 0-12 V; 200 ma @ 12-24 V; 300 ma @ 24-30 V.
- 0.5A fuse protects against short circuit.
- comparable in purity of output and in voltage & current capacity to transistorized supplies selling for several hundred dollars.
- ideal for laboratory, development & service work on transistors & transistorized equipment.
- rugged grey wrinkle steel case 5" x 4" x 5 1/2".

**SERIES/PARALLEL
R-C COMBINATION
BOX #1140**

Wired \$19.95
Kit \$13.95

Exclusive with
EICO—1350 possible
combinations!
Switching facilities
permit selection
of any resistance
or capacitance alone, or 1350 combinations
of same in series or parallel. Standard EIA resistance
values (1W) from 15 ohms to 10 megs in decade
multiples of 15, 22, 33, 47, 68, 100; standard
EIA capacitance values (most 600V) from 0.0001
to 0.22 mfd. All 10% accuracy. Open & short
circuit positions provided. Convenient jack-top binding
posts. Compact: 6 1/4" h, 5 1/2" w, 2 3/8" d.



**FAST
TUBE & CRT
FILAMENT
TESTER #612**

Wired \$5.95
Kit \$3.95

Includes batteries



Fast filament checking of series string & all other
TV & radio tubes (9-pin, octal, loctal, 7-pin); 14-
pin, 12-pin, 8-pin CRTs; bayonet & screw-type pilot
lamps; cartridge fuses. Just plug tube into tester
socket, observe indicator lamp—no fiddling with
controls or switches. Self-powered for convenience
& safety. 7-pin & 9-pin miniature tube pin straight-
eners provided. Compact: 6 1/4" h, 3 3/4" w, 2" d.

Compare these best buys at your neighborhood
EICO distributor. For free catalog on 85
models of EICO test instruments, hi-fi &
ham gear, write to Dept. PF-5

EICO Electronic Instrument Co., Inc.
33-00 Northern Boulevard
Long Island City 1, N. Y.

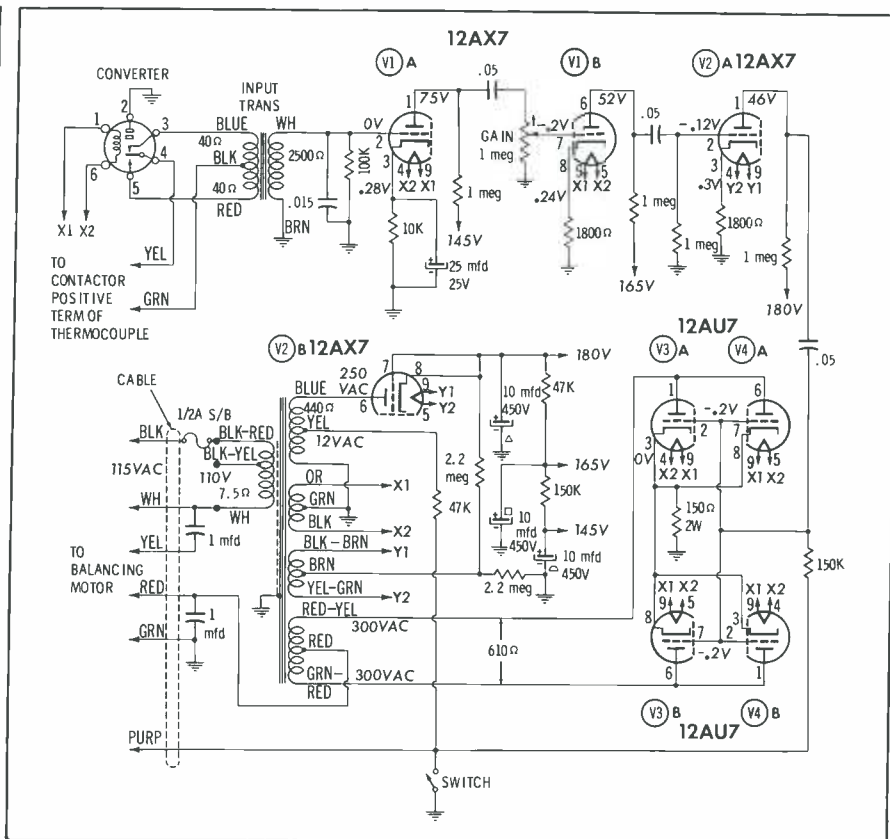

Fig. 7. Detailed schematic of *Electronik* amplifier unit used in pyrometer.

control grids of two 12AU7 dual triodes, in order to regulate the strength of the pulsating DC plate current in all tube sections. Although all four rectifiers share a common cathode resistor, the plates are connected in pairs to the opposite ends of a center-tapped secondary winding on the power transformer. Accordingly, one pair of tube sections receives a 60-cps plate-supply voltage 180° out of phase with that of the other pair. Two of the tube sections conduct on one half-cycle of AC line voltage, and the remaining two sections conduct on the next half-cycle.

When no error signal is fed to the 12AU7's, all four sections sup-

ply equal plate current, and the output to the balancing motor consists of two equal-amplitude pulses for each complete cycle of line voltage. Inside the motor, the magnetic fields around the rectifier and AC windings interact in such a way as to lock the rotor rigidly into position.

Any error signal arriving at the rectifier grids will be in phase with the plate voltage of two tube sections, but out of phase with that of the other two sections. Conduction will thus be increased in one pair of rectifiers and reduced in the other. The signal delivered to the balancing motor will consist of unequal pulses, alternately high and low in amplitude. This produces the same

PHONE
ED 9-9653

\$7.50

plus parts,
C.O.D. and postage charges

90 DAY
WARRANTY

Precision Tuner Service

ALL TYPES T.V. TUNERS REPAIRED AND ALIGNED TO FACTORY
SPECIFICATIONS ON CRYSTAL-CONTROLLED SWEEP GENERATORS
24-HOUR SERVICE ON MOST TUNERS
UHF - VHF COMBINATIONS — \$13.50

See your local distributor or send to:

P.O. Box 272, 601 N. College
BLOOMINGTON, INDIANA

State make and model. Send
all parts, tubes and shields

effect as if the rectifier-output signal had been shifted in phase relative to the AC line voltage. The magnetic fields within the motor then become distorted and force the rotor to change its position. Movement of the rotor mechanically repositions the contactor, thereby bringing the reed of the converter and the center tap of the input transformer into an "in-balance" state.

This cycling process continues up and down with every variation in furnace temperature, maintaining a very close tolerance about the mean contactor voltage originally set as representing the desired operating temperature.

Power Supply

One of the strangest-appearing

things about this unit, to a TV man's eyes, is the puny power supply. Imagine one section of a 12AX7 having enough "guts" to supply DC power for the entire unit! But the demand for B+ is very modest in this equipment. Where fairly heavy current is required (as in the balancing-motor circuit), it is obtained directly from the AC source or power transformer.

Troubles

Some of the most obvious trouble sources are tube failure, shorts in external wiring, thermocouple failure, a weak battery, a defective converter, and motor or switch failure in some circuit external to the am-

plifier. A little less obvious are some of the troubles peculiar to the amplifier, such as open coupling capacitors or defective filters. However, since the input to the amplifier is a 60-cycle square wave, troubleshooting this unit should be right down the TV man's alley. From our knowledge of vertical and audio circuits, we know what hum can do to a 60-cps signal. We are also quite familiar with RC-coupled amplifier circuits.

So what if this equipment does look like a mysterious black box? It's full of the same kind of circuits we have dealt with since the first time we fixed a vibrator-powered auto radio. This industrial field isn't so foreign after all. ▲

Which TV Antenna can do the most for you?

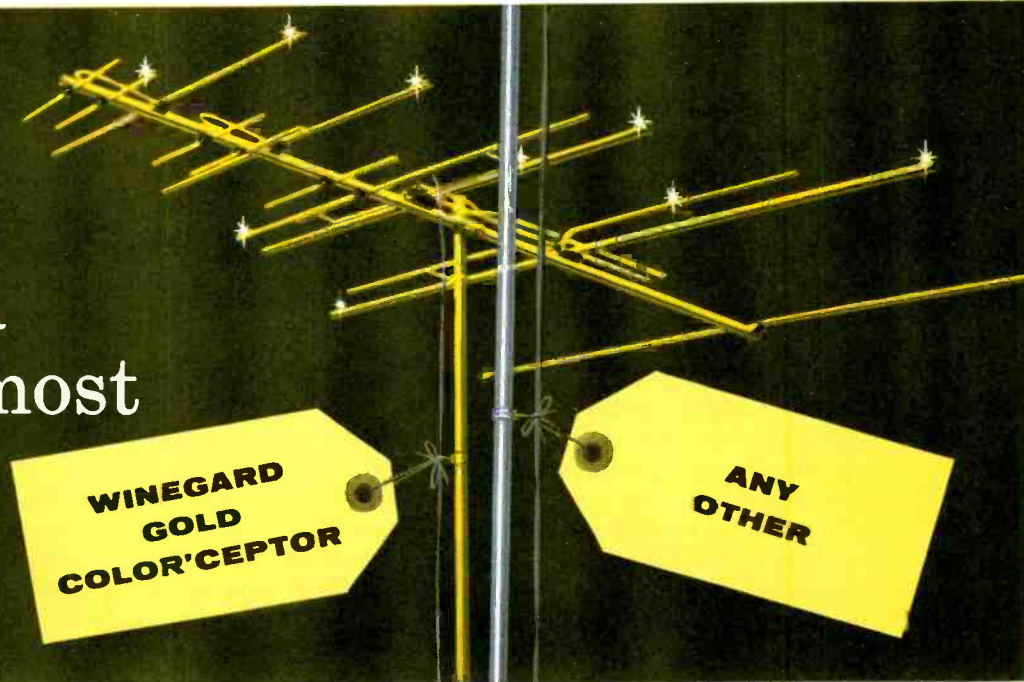

Remember when everybody lit cigarettes with matches that sold for a penny a box? Then along came a lighter at 500 times the cost of matches. Lighters, today, sell by the millions . . . making bigger profits for dealers than matches ever did!

You get the idea. People *do* have the money . . . and when they have a choice, they invariably buy the best . . . even if it costs more. The widespread acceptance of our patented Color'Ceptor *proves* that people also want the *best antenna*. Dealers who offer it to them are *the ones* who make the most money. In fact, Color'Ceptor has gained such *tremendous popularity* that eleven imitations are now masquerading as substitutes!

Now Know This and Make More Money Color'Ceptor outsells others for many reasons: PERFORMANCE—*uniform* high gain over *all* channels, *sharp* directivity, *no* suck-outs, *no* gain roll-off on end channels, *no* spurious side lobes, *uniform* high front-to-back ratio on *all* channels. A HIGH QUALITY OF CONSTRUCTION not found in any other antenna—rides out winds up to 100 mph, yet weighs less, installs quicker and easier. Elements lay flat and neat. Has exclusive non-crush mast clamp and Winegard's 7-cycle bright gold anodizing that doesn't turn green . . . defies salt spray, fuel acids, corrosion. Three models to meet most needs. Has the

most attractive package, best dealer sales aids, by far the strongest national consumer advertising. Has what dealers and their customers *both* want. So good you could build a retail business on Color'Ceptor alone—and *that's been done!*

Any dealer who can sell imitations and other "second-best" antennas will do far better selling the Color'Ceptor. WHY SELL PENNY MATCHES? Get OUT all that's IN this business. Feature Color'Ceptor! Speak to your Winegard distributor or mail the coupon now.



Winegard
ANTENNA SYSTEMS

WINEGARD CO. 3009-4 Scotten, Burlington, Ia.

Send me full Color'Ceptor details.

Name _____

Address _____

City _____ Zone _____

State _____

LINE-CORD TV ANTENNAS

by Jack Beever

What to expect from the least understood type of antenna.

Much commotion has been raised recently among the TV servicing fraternity about the "plug-in" TV antenna, or in general, about any device designed to tap power wiring for TV signals. Unfortunately, advertising claims have raised so much dust that we tend to be blinded. We are inclined to disregard all we hear about these antennas, since some of the claims for them are so fantastic as to be patently absurd. A little calm consideration may clear the air.

First, does the house wiring pick up TV signals? This is probably best answered by settling the question, "What is a TV antenna?" Radiating fields from a transmitting antenna will induce circulating currents in any conductor they reach. This is true of *any conductor*—and house wiring is certainly a conductor. The shortest conductor able to efficiently serve as an antenna is a half-wavelength, oriented broadside to the radiation source and in the electrical as opposed to the magnetic plane. In this country, TV broadcasts have a horizontal electrical plane. The lowest-frequency channel, and therefore the longest wavelength, is Channel 2, with a wavelength of about 17'. A half-wavelength is therefore on the order of 8½'. Conductors of greater length can provide greater pickup, up to 10 wavelengths being feasible in "long-wire" arrays.

But house wiring consists of two wires, like a piece of twin-lead, and as a transmission line at VHF-TV frequencies it is very poor. But—and this is a very big but—its conductors are energized *in phase*, while those in a transmission line are energized *out of phase*. Therefore, house wiring cannot be con-

sidered as a true parallel-pair transmission line, and its loss figures in such an application are meaningless. To a television signal, house wiring actually appears as though it were a single wire, and therefore behaves like a long-wire antenna connected to a resonant feed-line. This requires a little explanation.

The portions of house wiring which produce the greatest signal interception, and therefore the largest circulating currents, will be those orientated most favorably to the signal. Other portions connected to these sections will generally be driven as a one-conductor transmission line, at some high impedance. Losses in such lines are high, and we cannot expect such energy to get very far from the excited sections of the wiring.

In addition to this behavior, the sections of the line acting as transmission lines are not terminated, and they will tend to set up standing waves, resulting in fixed points of high RF potential at specific intervals along the line. At this point, it is wise to try to visualize the complexity of house wiring and the tremendous complexity of the circulating RF currents. First, consider that each section of this wiring (not to mention the plumbing!) is re-radiating fields of its own, so

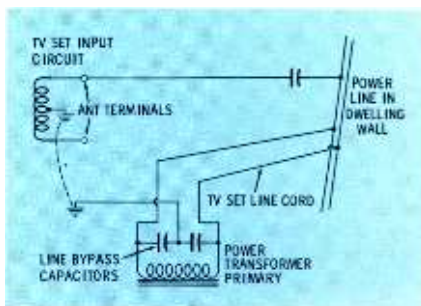

Fig. 1. Electrical circuits for a typical "plug-in" type power-line antenna.

that the interior of a dwelling is an immensely complicated and interwoven pattern of radiation fields. This can be easily demonstrated by holding a "rabbit-ear" dipole and walking around a room while watching the effect of its location and orientation on the picture. It will often be noted that the picture or sound may be cancelled completely at some points. This does not mean that no radiation is present at these spots, but that the fields in those spots are opposite in phase, and add up to zero.

The rabbit ears, of course, are being used to explore the standing waves in space, but equally complex standing waves exist in the house wiring, which is the main contributor for the standing waves in space.

Since VHF energy exists in the house wiring, is there a feasible way of collecting this energy, without collecting 117 volts and several amperes at the same time? The answer is "Yes"—if we use a filter to separate the 60-cps house current from the TV signals above 54 mc. A single capacitor would make an effective filter. The old familiar

$$X_c = \frac{1}{2\pi fC}$$

tells us that a small capacitor can show an impedance of many megohms at 60 cps and only a few ohms at TV frequencies. We can, therefore, connect such a capacitor to the house wiring and provide a path for the VHF currents while blocking the power frequencies. But hold on a minute! At least a 1000-volt capacitor should be used, since we are dealing with deadly currents. It isn't the high-voltage power lines which cause most electrocution deaths; it's the ordinary 117-volt house circuit!

However, having done this, what do we have? Effectively, an extended single-lead antenna with an extremely complex standing-wave pattern. The television set, on the other hand, has a 300-ohm balanced input, requiring two leads. Examine the circuitry of Fig. 1. It shows that the antenna network is not quite as simple as it seems. For one thing, there is a return from either antenna terminal to chassis ground of the TV set, and usually this circuit has an impedance of

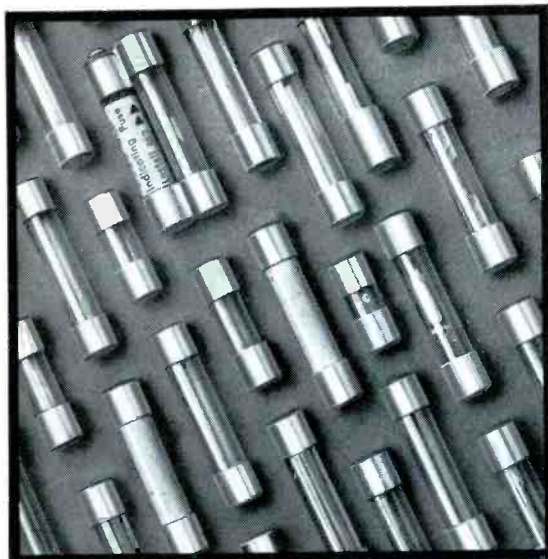

Here are the plain facts!

... why it pays to standardize on BUSS FUSES

IT'S A FACT! BUSS fuses have provided dependable electrical protection under all service conditions for over 45 years in the home, in industry and on the farm.

IT'S A FACT! You never have to stop and explain why you carry BUSS fuses because your customers accept them as the finest available.

IT'S A FACT! Every BUSS fuse you sell or install is tested in a sensitive electronic device that automatically rejects any fuse not correctly calibrated, properly constructed and right in all physical dimensions.

IT'S A FACT! When you sell or install BUSS

fuses, you avoid complaints that your fuses failed to protect or that they opened needlessly.

IT'S A FACT! Selling and installing BUSS fuses saves you time and trouble by avoiding call-backs . . . you keep your full profit and create satisfied customers.

IN SHORT . . . why take a chance with your good name by carrying fuses that might be faulty? Standardize NOW on genuine BUSS fuses. They help you protect your profits and your reputation for service and reliability.

For more information on BUSS and FUSETRON Small Dimension fuses and fuseholders, write TODAY for Bulletin SFB.

BUSSMANN MFG. DIVISION, McGraw-Edison Co. University at Jefferson, St. Louis 7, Mo.

563

BUSS fuses are made to protect - not to blow, needlessly.

BUSS makes a complete line of fuses for home, farm, commercial, electronic, electrical, automotive and industrial use.

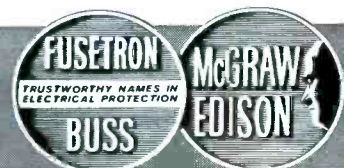

about 75 ohms (unbalanced). In turn, chassis ground is returned to the power line through the line-by-pass capacitors, which have a negligible impedance at VHF-TV frequencies. Bear in mind that both the "antenna lead" of Fig. 1 and the power cord of the TV receiver are merely extensions of the power wiring; and, at VHF, so is the TV set chassis. If a phase difference exists between VHF voltage present in the chassis and the VHF voltage present at the end of the "antenna lead" connected to the house wiring, a current will appear in the TV

set's input coil and the set should operate.

Let us establish a few facts to help us understand how we gain by this arrangement. In the first place, the potential developed across the antenna coil depends on the difference in the signal phases at each end of the coil. If the two sources (the line cord and the antenna lead) deliver currents of the same phase, there will be no potential difference between them and no energy will be developed in the input coil of the TV set. However, the phase of these currents can be

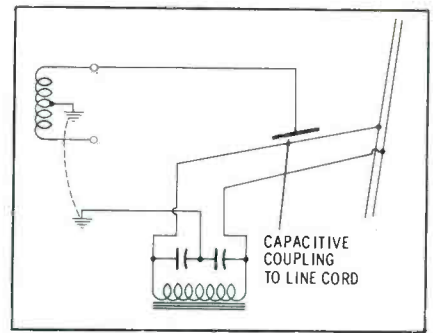

Fig. 2. Circuit for indoor antenna that capacitively couples to power cord.

shifted by merely changing the length of either lead. An added or decreased length of only about 6' is required to shift Channel 4 signals by a full 180°, and only 2½' will do the same for Channel 10.

To see how this works, let us suppose Channel 10 signals on the hook-up of Fig. 1 arrive at the opposite ends of the tuner coil in phase. Then, if we shifted the "antenna lead" connection to a point 2½' away from the connection point of the line cord, this should shift the phase by 180° and should produce a good potential difference across the tuner coil. And this is exactly what we are able to do with the sliding metallic element of Fig. 2.

Actual conditions are rarely as simple as this, since the standing-wave patterns are not the result of a single unterminated ending, but are the results of many such endings. Actually, the points of reinforcement may be much closer together than indicated by the wavelengths involved. In multi-channel use, one usually tries to find the best spot for the weakest channel, or else takes a compromise position—in a way quite similar to the orientation of a rooftop antenna.

Thus far, we have outlined only one of the possible modes of developing signals using the arrangements in Fig. 2. For example, suppose that a null existed at the ground end of the tuner input? The capacitance from chassis to ground would then allow the lead of the "antenna" to act as a monopole working against a ground plane. Since many reversals of polarization exist in the complex standing waves in a dwelling, the monopole can often select a good signal, clear of ghosts. By orientation of the leads, it is

Now Completely SELF-CONTAINED

For Testing & Rejuvenating
BLACK AND WHITE and COLOR including 110° TUBES

NEW CRT 440

CATHODE REJUVENATOR TESTER

B&K

TESTS AND REJUVENATES

all black & white and color picture tubes at correct filament voltage from 1 to 12 V.

TESTS AND REJUVENATES

110° tubes with 2.34, 2.68, 6.3 and 8.4 volt filaments.

TESTS AND REJUVENATES

color picture tubes. Checks each color gun separately same as black & white tubes.

*Used by Thousands of Professional Servicemen
MAKES NEW PICTURE TUBE SALES EASIER*

Gives you more value than ever—all-in-one. Quickly checks and corrects most TV picture tube troubles in a few minutes right in the home without removing tube from set. Gives new useful life to weak or inoperative tubes. Checks leakage. Restores emission and brightness. Repairs inter-element shorts and open circuits. Life test checks gas content and predicts remaining useful life of picture tube. Completely self-contained in leatherette-covered carrying case. Net, \$74⁹⁵

ACCESSORIES for USE ONLY with FORMER B&K Models 400 and 350 CRT



Model C40 Adapter. For use only with all previous B&K Model 400 and 350 CRT's. Tests and rejuvenates TV color picture tubes and 6.3 volt 110° picture tubes. Net, \$9.95

Model CR48 Adapter. For use only with all previous B&K Model 400 and 350 CRT's. Tests and rejuvenates 110° picture tubes with 2.34, 2.68, and 8.4 volt filaments. Net, \$4.95



See your B&K Distributor or Send now for Bulletin ST24-R



B & K MANUFACTURING CO.
1601 W. BELLE PLAINE AVE • CHICAGO 13, ILL.
Canada: Atlas Radio Corp., 50 Wingold, Toronto 10, Ont.
Export: Empire Exporters, 277 Broadway, New York 7, U.S.A.

possible to create quite an effective loop antenna, since the capacitive coupling from "antenna lead" to line cord closes the path to the tuner input circuit.

These are the principles on which these devices work. Now, how effective are they? Shall we compare them to outdoor antennas, or standard dipoles? No—because the ultimate comparison is in strictly practical terms. Does the unit in question perform satisfactorily in its intended application? That is the only point that need be considered!

Wherever indoor antennas are used successfully, it is conceivable to conclude that more signal is available in the area of the receiver than is needed to produce good or usable pictures. Under such conditions, an outdoor antenna will generally produce signals at least 40 db (100 times) higher than the indoor antenna. But the need is not to produce signals of greater strength; it is to produce signals of a desirable nature, that is, free from ghosts or frequency discrimination. Indoor antennas, in general, are characterized by being of the wrong impedance — a fault nullified to some extent by their short leads and very erratic radiation patterns. These characteristics are shared by line-tap antennas.

The whole case boils down to the question of whether or not the power lines will deliver usable signals, or whether the combination of power line and connecting device will. If they do, then they are doing their job. But they do not provide (as some of the author's correspondents have assumed) a tap to some miles-long transmission line which is feeding TV signals along it in the manner of the coaxial-cable links spanning the



country. Nor do they provide more signal than an outdoor antenna. They are simply another form of indoor antenna.

In a series of trials of the adjustable-capacitor type, using conventional indoor antennas as a standard of comparison, the results were generally favorable—but with the peculiarity that the two types of antennas did not offer direct comparisons. In some cases where one worked, the other would not produce a usable picture; in other cases where ghosts could not be removed by the best efforts of one

type, the other did produce clear pictures.

One very unusual application was reported: A line-tap antenna was used in combination with an outdoor antenna to "buck" a ghost signal. Apparently, the prime signal from the house wiring had the proper phase or delay characteristics to produce an out-of-phase signal which effectively cancelled out the signal producing the ghost. This, of course, is an unusual occurrence, dependent on too many variables to be recommended as a standard practice. ▲



B&K MODEL 550 **DYNA-QUIK** DYNAMIC MUTUAL CONDUCTANCE TUBE TESTER

Greatest value for professional servicing! Provides 52 tube sockets to test more tubes faster, easier, with laboratory accuracy. *Measures true dynamic mutual conductance.* Quickly detects weak or inoperative tubes. Sells more tubes. Saves call-backs. Makes more money for you every day.

Tests Each Section of Dual-Section Tubes Separately
Completely tests each tube in seconds. Checks average TV set in a few minutes, in home or shop. Checks tubes for shorts, grid emission, gas content, and leakage. Shows tube condition on "Good-Bad" scale and in micromhos. No multiple switching. Quick-reference listings on socket panel and handy chart. New tube reference charts regularly made available. Patented automatic line voltage compensation. Phosphor bronze contacts. A real professional instrument for only **\$119.95** NET

See your B&K Distributor or Send for Bulletin ST24-R

B&K MANUFACTURING CO.
1801 W. BELLE PLAINE AVE • CHICAGO 13, ILL.

Canada: A-Tar Radio Corp., 50 Wingold, Toronto 10, Ont. • Export: Empire Exporters, 277 Broadway, New York 7, U.S.A.

GET MORE FOR YOUR MONEY



SAVE CUSTOMERS



SELL MORE TUBES





fine points of

RADIO SERVICING

by Calvin C. Young, Jr.



A great many TV servicemen, apparently discouraged by the prospect of "expensive repairs on cheap radios," have been confining their radio-servicing efforts to replacing an occasional tube or installing new filter capacitors. By overlooking other opportunities for radio work, they are missing a source of income—and, I'm afraid, losing customers, too.

If you have drifted away from radio repair and "lost the touch," perhaps this article will rekindle your interest and make you eager to tackle any radio that comes in. Or, if you're a comparative newcomer to the profession and have never gone very deeply into radio servicing, here is your chance to learn more about some troubleshooting procedures the old-timers have found successful.

Making Voltage Checks

If you have determined that all tubes are good, the best starting point for further troubleshooting is a thorough analysis of all key voltages in the set. This is practical, since there are usually only five or six stages. (Consult Figs. 1 through 5 for examples of typical circuits.)

It should go without saying that the place to start checking voltages is at the output of the rectifier. If the voltage at this point is absent or very low, this condition will have

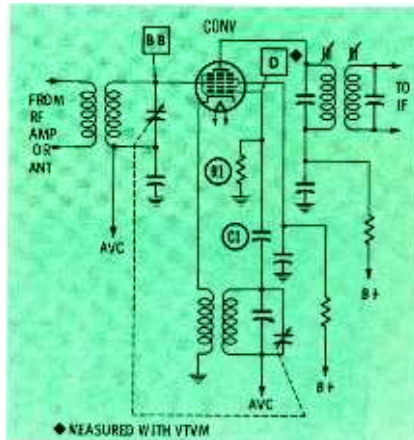

Fig. 2. Converter stage combines functions of both oscillator and mixer.

to be corrected before subsequent checks can be made.

After you have found or established a normal B+ potential, you are ready to make some other voltage checks that will help you to pinpoint the source of the trouble. If the radio under test employs decoupling resistors (even small ones) between the plate-load circuits and B+, measure the voltage difference across the terminals of each one—for example, between points A and B in Fig. 1. The mere presence of a voltage drop across a decoupling resistor tells you that the associated tube is conducting. Also, if you take into account the value of the resistor, the amount of voltage difference tells you approximately how hard the tube is conducting.

Should this test reveal abnormally low plate current in a pentode or tetrode, immediately check the screen-grid voltage of that stage. A deficiency in plate current is often a direct result of low screen voltage. In the event you do find a lower-than-normal reading at the screen, study the screen-dropping resistor closely. Any evidence of burning should prompt you to do the following:

1. Replace resistor

2. Replace bypass capacitor
3. Check tube

Outright replacement of that 25c paper bypass capacitor is easier, and less costly in the long run, than testing it. Once you have disconnected one end for testing, you have only one more solder connection to make in order to install a replacement then and there!

Suppose that the screen-grid check reveals normal voltage, but still there is no plate current. This would be a strong indication that the plate coil of the RF interstage transformer (Fig. 1) is open. A quick check at the plate pin on the tube socket can confirm or deny this suspicion.

If, through some quirk of fate, you find that the plate coil isn't open, check the cathode voltage (point C in Fig. 1). However, leave the VTVM or VOM set to the same voltage range as for the plate-voltage check. This is necessary to protect the meter in case the cathode resistor should happen to be open. When the plate of a tube is connected to B+ and its filament is hot, an open condition in the cathode circuit will cause the voltage at the cathode to rise almost to the level of B+. This effect is due to the high resistance of the meter circuit and the much lower plate resistance of the tube.

What about a case where the

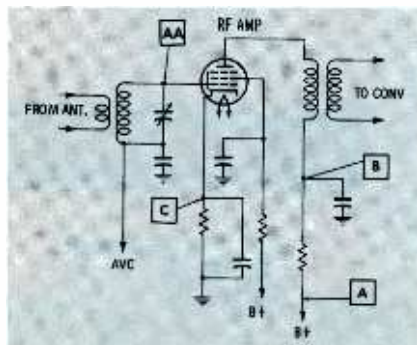

Fig. 1. This stage is typical of RF amplifiers in more elaborate radios.

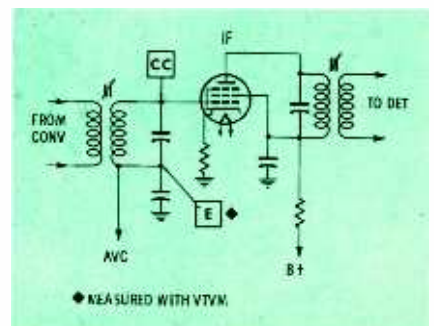
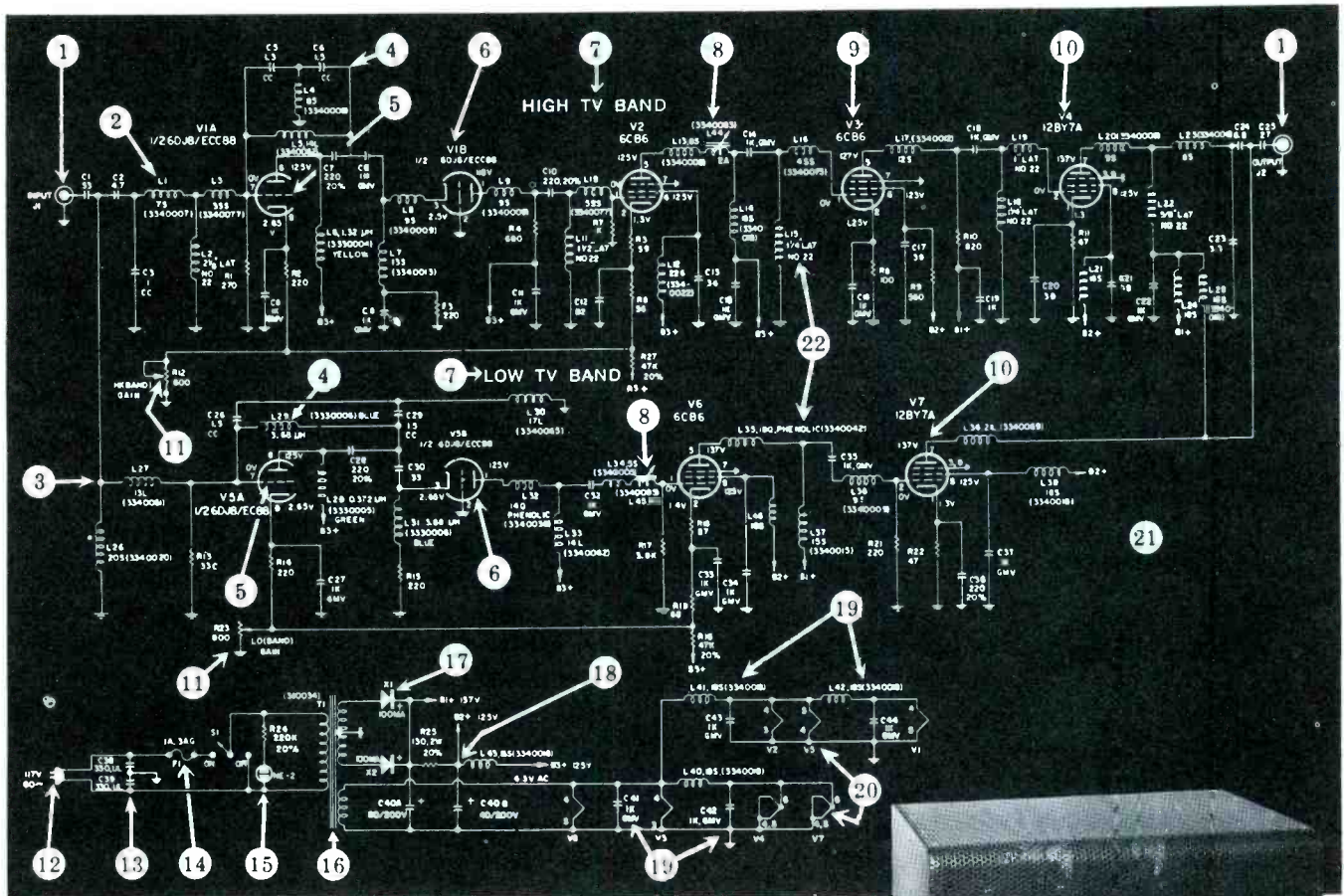

Fig. 3. Most newer radios have only one IF stage, usually wired as shown.

the secret's in the circuit



new...

BLONDER-TONGUE VHF BROADBAND AMPLIFIER model MLA-b only \$142⁵⁰ list

for finest master TV installations - 30 to 150 TV sets

- ① Solderless radiation-proof 75 ohm coaxial fittings.
- ② High-pass signal coupling, 174 to 216 mc.
- ③ Low-pass signal takeoff, 54 to 88 mc.
- ④ Triode neutralization circuit. Patent — U. S. 2,761,023; Canada 535,392.
- ⑤ Premium frame-grid circuitry for minimum noise and maximum gain.
- ⑥ Grounded grid configuration prevents positive feedback and increases stability. Cascade amplifiers provide unusually low internal noise and high gain.
- ⑦ Separate high and low bands of amplification consistent with maximum gain and wide-band response, $\pm \frac{1}{2}$ db any VHF channel.
- ⑧ Separate high and low band tilt controls to compensate for line loss, 6 db range.
- ⑨ Additional stage of amplification to bring up high band gain to same level as low band gain, within ± 1 db.
- ⑩ Operated at less than 60% of maximum dissipation for maximum tube life.
- ⑪ Separate high and low band gain controls, 20 db range.
- ⑫ Low cost operation, draws only 0.43 amps.
- ⑬ Power line filtering network minimizes power line radiation problems.
- ⑭ Fuse protected circuitry.
- ⑮ Pilot light, neon lamp draws negligible current.
- ⑯ Power transformer isolates unit completely from power line.
- ⑰ Solid state rectifiers for longer life, full wave configuration.
- ⑱ Dual filtering network for stable, hum-free operation.
- ⑲ Heater filter networks prevents feedback in heater circuit.
- ⑳ Parallel heaters simplify servicing, increase tube life.
- ㉑ Total amplifier gain 40 db (100 times).
- ㉒ Double-tuned interstage circuitry for maximum gain within desired bandwidth.

Available at parts distributors, for further information write Dept. PF-5



BLONDER-TONGUE LABORATORIES INC.

9 Alling Street, Newark 2, New Jersey

In Canada: Teleequipment Mfg. Co. Ltd., London, Ont. Export: Morhan Export Corp., New York 13, N. Y.

hi-fi components • UHF converters • master TV systems • industrial TV cameras • FM-AM radios

voltage drop across the plate-decoupling resistor is too high? This very often happens in converter stages. If you should ever encounter this condition, check the oscillator grid voltage at point D (Fig. 2), being careful to use a VTVM. If the voltage here is low, plate current will be excessive. By the way, very low grid voltage is an indication that the oscillator isn't oscillating. To find out why, you don't need to measure screen voltage; if it were low or absent, you would already have noted a lack of plate current. The usual culprit

when the oscillator fails is either the oscillator coil, capacitor C1 or resistor R1. Naturally, this presupposes that the tube has been checked and found to be good.

If you are working on an IF stage, the previously discussed pointers about screen, plate, and cathode measurements still apply. You can also monitor the AGC voltage at point E (Fig. 3) as you tune across the broadcast band. This voltage should change from a low negative value on weak stations to a higher negative value (up to -3 to -4 volts) on closer

or more powerful stations. Should your reading on the strongest stations vary from the value normally recorded for those stations, look for weak tubes or low voltages. A relatively high negative voltage on the AVC line when receiving weak signals, or an excessive voltage (up to -30 volts), points to an oscillating condition in the IF or RF stages.

A quick check for open bypass capacitors (using the bridging technique) will usually reveal the cause for the oscillation — assuming, of course, that someone hasn't misaligned the IF or RF circuits.

A check of the voltage at point F (Fig. 4) as you rotate the tuning control will tell you if the detector is working. You should obtain a few tenths of a volt on weak signals and up to -4 to -5 volts on very strong signals. I always attach a VTVM to this point when aligning a radio, rather than using the output of the speaker as an indicator. The IF, RF and converter stages should all be aligned for peak voltage at this point.

The voltage at point G is practically always due to contact potential that develops across the very high grid-load resistance when the audio amplifier tube is operating. Normally this voltage will be only a few tenths of a volt negative with respect to B-minus, regardless of whether the signal being received is a strong or weak one.

The voltage at point H in Fig. 5 should never be positive with respect to the cathode of the tube. In the standard radio, it should never be more positive than B-minus unless connected to B+ through a voltage-divider network. If the grid load resistor is connected to ground (B-minus), the presence of any positive potential at point H indicates either a leaky coupling capacitor or a gassy output tube. Be prepared to find either condition, even if the tube has been checked.

Where and How To Apply a Test Signal

For aligning or signal-tracing RF, converter, and IF circuits, the signal from the generator is normally applied to point AA in Fig. 1, BB in Fig. 2, or CC in Fig. 3. In any case, the signal should be applied

Solve Rough Sweep Output Problems

IN MINUTES

INSTEAD OF HOURS!

NEW **B&K**

DYNA-SWEEP

CIRCUIT ANALYZER

1. Provides composite synchronizing signals (negative or positive) to inject directly in each sync stage.
2. Provides plate drive signal to check complete vertical output circuit, including V.O. transformer.
3. Provides vertical yoke test signal to determine if vertical yoke windings are defective.
4. Provides horizontal plate driving signal to directly drive TV horizontal output transformer circuit.
5. Provides B+ boost indicator.
6. Provides unique high-voltage indicator.
7. Provides sensitive tests for each of the horizontal output components, including H.O. transformer and yoke. Immediately reveals their true condition, good or bad.

Quickly solves tough output servicing problems that have always plagued the TV serviceman. Provides horizontal and vertical sync and driving pulses that make it easy to check out every stage in the sync and sweep sections of a television receiver. Tracks down troubles in the horizontal and vertical output circuit, including defective output transformer and yoke. Checks for shorted turns, leakage, opens, short circuits, and continuity. Gives unique high-voltage indication. Eliminates trial and error replacements. Saves many hours of service work! Pays for itself over and over again.

Model 1070 Dyna-Sweep. Net, \$74.95

MODEL A107 DYNA-SWEEP CIRCUIT ANALYZER
for use with B&K Model 1075 Television Analyst

Functions like the Model 1070 above, but is designed as a companion unit for use only with B&K Model 1075 Television Analyst for driving source. Makes your Television Analyst more useful and valuable than ever. Net, \$54.95



See your B&K Distributor or Write for Bulletin ST24-R

B & K MANUFACTURING CO.
1801 W. BELLE PLAINE AVE • CHICAGO 13, ILL.

Canada: Atlas Radio Corp., 50 Wingold, Toronto 10, Ont. • Export: Empire Exporters, 277 Broadway, New York 7, U.S.A.



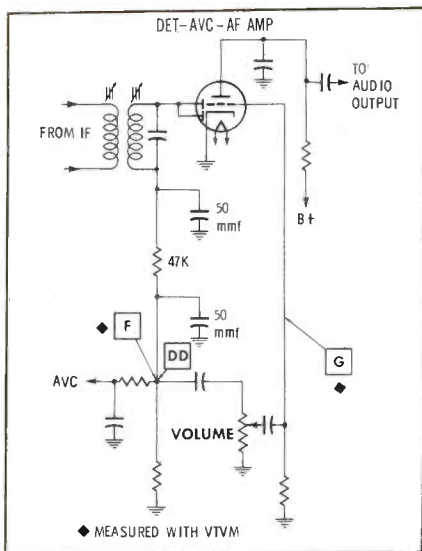

Fig. 4. One tube detects signal, amplifies audio, and develops AVC voltage.

to the desired point through a capacitor (approximately .001 mfd). I've found it extremely handy to use a mica capacitor with an alligator clip permanently attached to one end. This terminal is connected to the test point, and the signal-generator lead is clipped to the opposite terminal; the result is a fairly rigid assembly which won't short out easily.

An audio signal is best coupled into the grid circuit of the audio amplifier (point DD in Fig. 4). A slightly larger capacitor than specified for RF and IF circuits may be used, but isn't essential. Point G isn't recommended for signal injection, since the grid-load resistor is usually somewhere between 4.7 and 10 megohms in value. The impedance of the generator, even when connected through a .001 capacitor, is much lower than this; so applying a signal to point G will lower the grid-load impedance and greatly reduce stage gain.

A signal may be coupled to the audio output stage (Fig. 5) at point H to check out the entire stage, or else at point EE to check

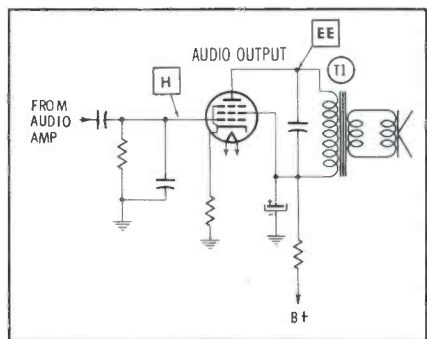

Fig. 5. Typical audio output stage.

the transformer and speaker. In the latter case, the output of the signal generator must be relatively strong in order to be heard. Therefore, the isolation capacitor should be either a .1- or .25-mfd unit. These values have a very low impedance at audio frequencies and will therefore drop little, if any, of the generator signal voltage.

Your Scope Can Save You Time

An oscilloscope can be quite helpful when the sound from a radio has a perceptible buzz content with the volume control set to

minimum. Check the input to and the output from the pi-type B+ filter network. The input signal should be a rather large sawtooth; the output should be a greatly reduced ripple of no distinct shape, having only about a tenth as much amplitude as the signal at the filter input.

The scope can also be a real time-saver on distortion problems. Feed a modulated RF signal into the antenna circuit and check the audio signal at points EE, H, and DD. If the signal isn't a clean sine wave, then connect a detector

yes

STANCOR[®]

has a complete line of
RF-IF COILS

The Stancor name is a synonym for quality and dependability. Just as you rely on Stancor for the best in exact replacement flybacks and yokes, so you can expect the highest standard of performance from Stancor coils. Your parts distributor has them in stock.

CHICAGO STANDARD TRANSFORMER CORPORATION
3501 ADDISON STREET • CHICAGO 18, ILLINOIS

probe to the scope and check the signal at the IF and converter plates. Use maximum scope gain and increase generator gain for these tests. The isolating step can save considerable time in locating the defective stage. Usually, distortion problems are due to open bypass capacitors, bad tubes, or defective IF transformers. Suspect the transformers as a last resort.

Sure the Oscillator Is Really Dead?

If oscillator anode voltage (in other words, the screen voltage of the converter stage in Fig. 2) is

low, and oscillator grid voltage is present but also seems low, you need to perform another test to make certain the oscillator isn't working. Connect the negative lead of your TV alignment bias pack to the oscillator control grid, and the positive lead to "common" or B-minus. Vary the bias voltage from 0 to about -3.5 volts. If the oscillator is not working, the oscillator plate voltage will increase as the grid bias increases. However, if the plate voltage fails to increase, look for trouble in the B+ circuit feeding the converter stage. The pur-

pose of the bias pack in this test is to substitute a DC voltage for the normal grid voltage developed by oscillator action. This reproduces the static (DC) conditions that normally exist when the oscillator is working.

Why Use a VTVM on Grids?

The presence of the \blacklozenge symbol and the notation "measured with VTVM" may have puzzled you. The reason for these instructions is as follows: The impedance of grid circuits is very high, and any type of meter other than a VTVM greatly reduces this impedance by shunting the grid resistor with a relatively low value of meter-input resistance. The altered impedance changes the reading sufficiently to destroy its accuracy. In some cases, the oscillator will stop operating if you connect a low-impedance meter to the grid. Take note that the AVC line also has a high impedance to ground—so all AVC measurements should be taken with a VTVM.

Radio servicing generally isn't as hard to perform as TV work, and it can be most rewarding if you utilize all of the servicing refinements and short-cut troubleshooting methods outlined here.

TV Couplers

We recently had a chance to try out the unusual *Wizard 300* TV antenna couplers made by Charles Engineering, Inc. These units, which slip over an ordinary 300-ohm twin lead and work on an impedance-coupling principle, are one of the simplest multi-set couplers available. We wondered about their performance, so we decided to make a few tests.

In order to set up conditions similar to those in a "Zone 2" signal area, we conducted all tests using a signal strength of around 6000 microvolts. We started with a simple four-branched system such as you might find in any home or one-man service shop, using a direct-reading field-strength meter to terminate the line in the fourth location.

The couplers are made in two parts which clamp together over the antenna lead. A pair of screw terminals provide a connection for the take-off line. Each time we

NOW!

COMPLETE BUSINESS SYSTEMS FOR RADIO-TV SERVICE DEALERS

One-time Carbon Triplicate Forms with Hard 3rd Copy and Numbered Claim Check



FORM No. 125
5 7/8" x 9 3/4"

FORM No. 120
4" x 8"

Sales Books in Triplicate Numbered with Guarantees and Conditions on Reverse Side of Forms

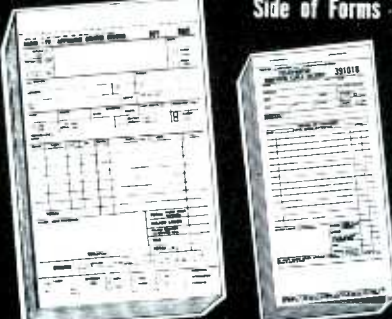

FORM No. 225
5 7/8" x 9 3/4"

FORM No. 104
4 1/4" x 9 1/4"

Supplied Blank or with Your 4 Line Imprint

METAL FILE TRAYS

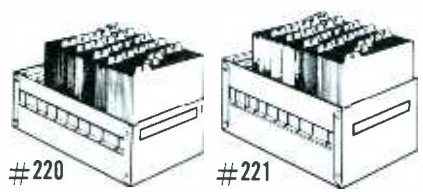

#220
For Forms 120 and 104

#221
For Forms 125 and 225

ALUMINUM COUNTER TRAYS

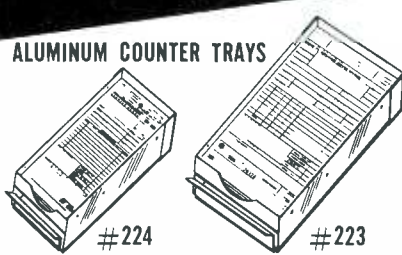

#224
For Form 120

#223
For Form 125

ALUMINUM FORM HOLDERS

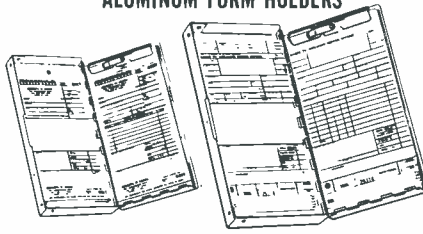

#122 Holder
For Form 120

#222 Holder
For Form 125

VINYL PLASTIC HOLDERS

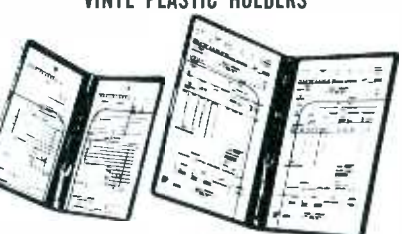

#121 Holder
For Form 120

#126 Holder
For Form 125 and 225

See Them at Your Parts Jobber!

OELRICH PUBLICATIONS

4308 No. Milwaukee Avenue
Chicago 41, Illinois

clamped a coupler across the main line, the signal strength at the meter dropped 1/2 db.

It didn't seem to matter too much what happened at the free end of the added lead-in line. We shorted the conductors together, connected the line to a TV set (good picture, by the way), changed channels—in fact, attached everything we could think of, including a shorted quarter-wave stub. The net result was nothing more than a quiver of the meter.

Thus, we knew that the tap-offs had very little effect on the signal strength at the end of the line. We also knew that a receiver would give a good picture with negligible reaction. But how much signal loss was there in the tapped-off lines? We took the meter off the end of the main line, substituting a 300-ohm resistor in its place, and connected the meter at the termination of one of the tap-off lines. Compared with the main-line signal, there was a loss of 12 db, or 4000 microvolts—but we still had around 1400 microvolts. This was plenty to provide the snow-free picture we could see we had.

We kept adding couplers and lines with the same results noted earlier. Various random lengths of lead were used, with little difference in performance. We slid couplers back and forth along the line and found we could take advantage of periodic "hot spots;" however, as you know, these are effective for only one channel, and the over-all results aren't appreciably affected.

There is a limit to the number of couplers that can be added without spreading the available signal too thin, but this restriction depends on the strength of the input. And, in primary areas, a good outdoor antenna will practically drown you in microvolts. ▲



Auto Radio Control Replacement is Child's Play

with new **Centralab**®

Exact Replacement Controls

22 brand new units
expand the line!



Now more than ever, one source fills all your needs for auto radio replacement controls. Twenty-two new units expand the CENTRALAB line of exact replacements—give you full coverage of every popular radio in use today, including radios used in foreign cars.

But there's more to it than quality! It's more *convenient* to buy from your electronic parts distributor. Auto radio repair business is easier and more profitable when you don't have to make special trips to the auto parts distributor. Your CENTRALAB distributor will have it!

What about on-off switches for push-button radios? CENTRALAB has the most complete line (SP Series) for Plymouth, Dodge, DeSoto, Chrysler, Ford, Mercury, Lincoln, and Hudson.

A complete control replacement guide for TV and auto radios has been prepared by Howard W. Sams & Co., Inc. Order one from your distributor, and see the wide coverage of exact replacement auto radio controls you get from CENTRALAB.

B-6005

Centralab

THE ELECTRONICS DIVISION OF GLOBE-UNION INC.
942 E. KEEFE AVE. • MILWAUKEE 1, WIS.
IN CANADA: P.O. Box 400 • Ajax, Ontario

CONTROLS • ROTARY SWITCHES • CERAMIC CAPACITORS
PACKAGED ELECTRONIC CIRCUITS • ENGINEERED CERAMICS

Inside CB Radios

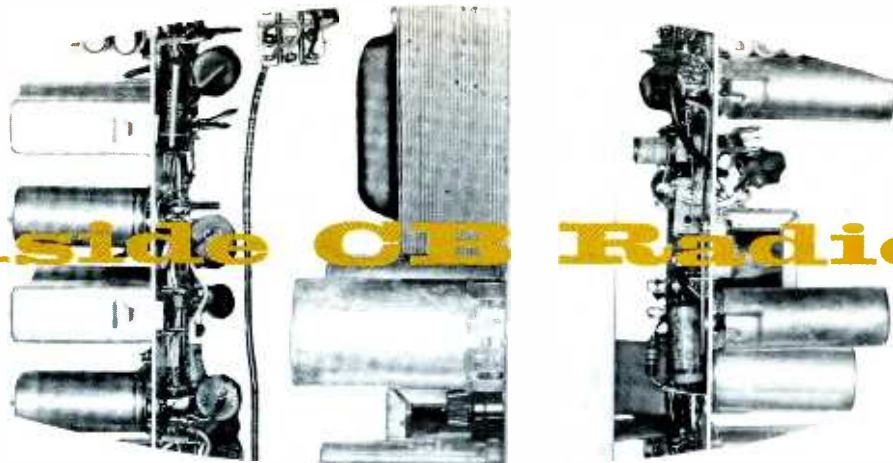

Typical transmitter and receiver circuits for class D Citizens band equipment — by Allan Lytel

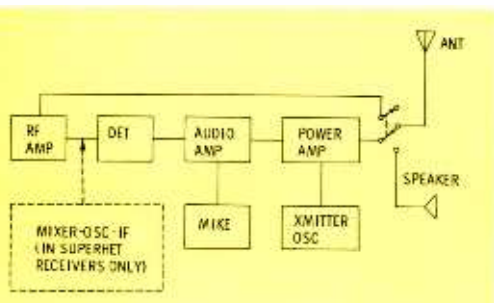

Fig. 1. CB transceiver block diagram.

Use of Class D Citizens band radio (in the 27-mc frequency range) is growing at a rapid rate. Some industry sources predict that over 85,000 licenses will be in effect by June.

An article in the February issue described the frequency bands allocated to CB radio, and also outlined the rules and operating conditions for Class D service. This month, we have prepared a more detailed coverage of some typical circuits found in 27-mc CB equipment.

Much of this Citizens band gear consists of *transceivers*, with re-

ceiver and transmitter sections mounted together as a single unit. Many units have transmitters fixed-tuned to one frequency, while others have selector switches to permit a choice of as many as five different channels. Receivers may also be one- to five-channel types, or they may be tunable over the entire Class D band. Either superheterodyne or superregenerative receiver circuits may be used.

Fig. 1 shows the functional block diagram of a typical transceiver. To understand more thoroughly how the blocks fit together, let's see what each section contains.

Receivers

Superregenerative

Because of its inherently high gain, a superregenerative receiver can produce adequate signal output with only one stage of amplification ahead of the detector. (See Fig. 2.) Therefore, it requires considerably fewer components than a superheterodyne design. The antenna

plugs into the RF amplifier stage, which is coupled to the detector through an RC network including a tuned LC circuit. Both amplification and rectification occur in the detector stage. The amount of positive feedback (which determines the gain of the receiver) is adjusted by means of the REGENERATION control in the detector plate circuit. The volume control, in the same circuit, provides the output to the audio section.

Superheterodyne

Several variations of the basic superhet circuit are in use. Some sets employ straight conversion to a single IF frequency, just as in standard AM receivers; others operate on a dual-conversion principle (as did early UHF-VHF TV receivers). In the latter type of set, two different oscillator-mixer stages are employed. The incoming signal is first converted to a "high-IF" frequency of about 6 mc and then reduced to a lower IF of about 265 kc. Although the dual-conversion system is more prone to frequency-drift problems, it does provide the advantage of practically eliminating image-frequency interference.

As mentioned, various CB units provide either single- or multiple-channel operation. Some receiver sections have continuously tunable front ends to cover the entire 22-channel band. The mixer-oscillator stages are designed to fit the specific requirements of each type of system. Simple tuned-grid tank circuits are used in the "full-band" units, and also in some of the receivers having switch positions for a few specific channels. On the

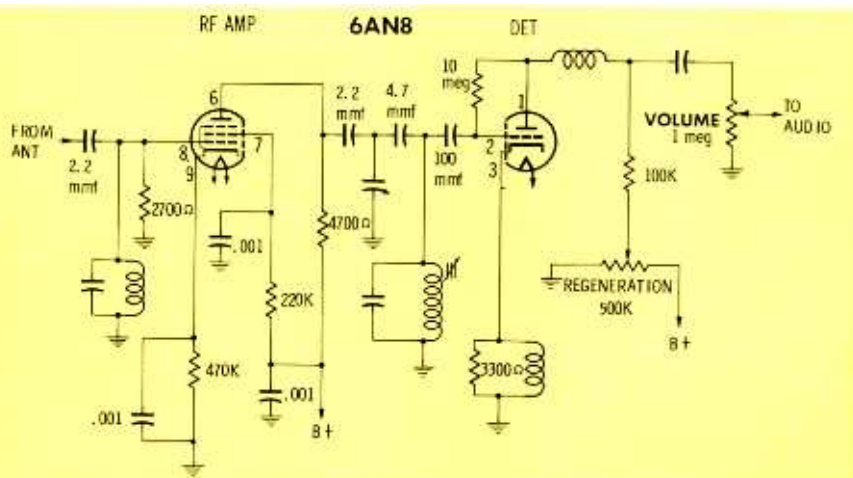

Fig. 2. RF and detector circuits of superregenerative receiver for CB use.

**20% LARGER CATHODE.
HANDLES MORE CURRENT.**

**25% HEAVIER
GRID SIDE ROCS.
A COOLER-RUNNING GRID.**

**FAMOUS 5-PLY
G-E PLATE MATERIAL.
BETTER HEAT CONDUCTION.**

**HIGHER ELECTRICAL RATINGS.
MORE TUBE IN EVERY RESPECT!**

- ✦ 17% higher max plate dissipation than the 6DQ6-A—17.5 w vs. 15 w.
- ✦ 17% higher max screen dissipation—3.5 w vs. 3 w.
- ✦ 25% higher avg DC cathode current—175 ma vs. 140 ma.
- ✦ 25% higher peak cathode current—550 ma vs. 440 ma.
- ✦ 15% higher zero-bias plate current (typ. operation)—345 ma vs. 300 ma.

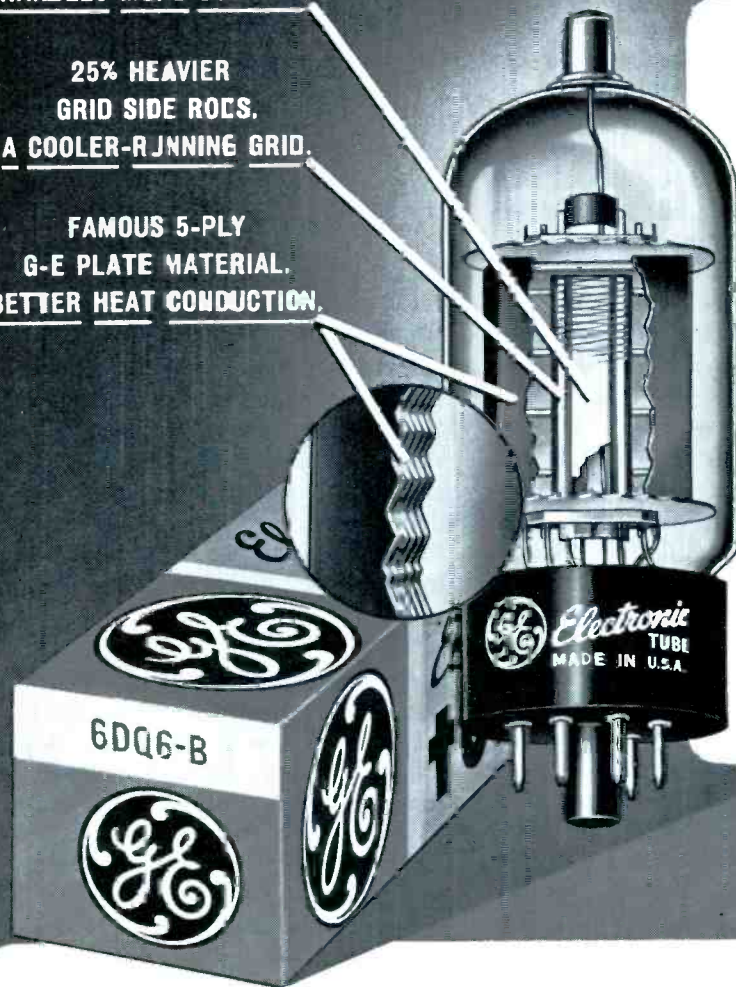

Your Big NEW Business-Builder: G-E 6DQ6-B!

Hand-tailored for servicing the new 23" television sets...
gives you better-than-ever performance in older TV's!

The Service-Designed 6DQ6-E is General Electric's brand-new horizontal-sweep tube with big performance designed in. Example: the 15% higher zero-bias plate-current characteristic gives ample sweep in the new 23" TV sets with their high sweep angles...it also means extra sweep capability in other television sets for extra safety factor, fewer complaints and service callbacks.

Type 6DQ6-B is more dependable in every way...huskier, runs cooler. Check the construction features above! Same improvements apply to new G-E companion types 12DQ6-B and 17DQ6-B. Fully interchangeable with prototypes. See your G-E tube distributor! *Distributor Sales, Electronic Components Division, General Electric Company, Owensboro, Kentucky.*

Progress Is Our Most Important Product

GENERAL  ELECTRIC

311-301

There's More Profit in this Proud Name



"Bargain basement" needles can ruin not only your customer's cherished records, but your reputation as well. Selling cut-rate inferior merchandise at little or no profit is short-sighted when you can move up to *quality* and *high profit* with the respected Clevite "Walco" line.

Clevite "Walco" is a name with a tradition of superiority — one your customers trust through long experience and world-wide acceptance. Every stylus is made to exacting tolerances . . . meticulously inspected to meet rigid standards that assure the ultimate in faithful sound reproduction — and Clevite "Walco" Styli are backed by a written guarantee.

Clevite "Walco" Diamond and Sapphire Needles, chosen as original equipment by America's leading phonograph manufacturers, are *exact* replacements that will perform perfectly in your customer's equipment. So, for "customer insurance" and a better profit potential, sell up to quality needles, *sell up to Clevite "Walco"*.

See your distributor or write Clevite "Walco" today.

CLEVITE 'WALCO'

60 Franklin Street, East Orange, N. J.

other hand, many of the single-channel or few-channel systems use crystal-controlled oscillators for greater stability. The crystal may be located in either the plate-grid or grid-cathode circuit. A few units have facilities for disconnecting the regular tuned-grid tank circuits to permit the use of an external crystal.

Most units are equipped with AVC to control the RF and IF stages. The control voltage is derived at the detector stage, as in normal AM receivers. You may find either a vacuum tube or a crystal diode being used as a detector.

Noise Suppression

CB receivers often employ noise-reducing circuits, which generally fall into two categories. One uses a *noise limiter* that eliminates strong noise signals while a signal is being received. This feature generally consists of a diode or neon lamp connected to the plate of the final IF stage, plus a noise-limiter control which can be adjusted so that the diode will conduct (or the lamp will fire) when a strong signal is received. Activation of the noise limiter clamps the amplitude of the signal fed to the detector. Another device sometimes used as a noise limiter is a series diode in the detector circuit. Overly strong signals drive this diode into cutoff, thus disrupting the signal fed to the audio section.

A more common noise-suppression feature is known as a *squelch* circuit. Its purpose is to block the audio path when no signal is being received, thereby eliminating background hash due to atmospheric and tube noises. One of the several different squelch-circuit configurations in commercial use is shown in Fig. 3. With no incoming signal being received, the IF amplifier conducts heavily and produces a low screen voltage. Note that this voltage is used as a plate supply for the diode. Cathode voltage taken from the B+ supply is adjusted by the squelch control so that the diode does not conduct under "no-signal" conditions. Thus, the noise-signal output of the detector, coupled to the diode's cathode, is prevented from reaching the plate and passing on to the audio

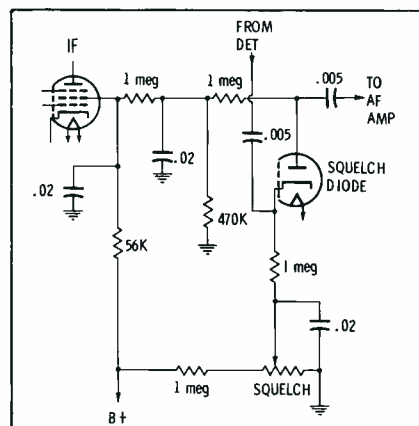

Fig. 3. In absence of received signal, squelch diode keeps speaker silent.

amplifier. However, when a signal is received and passes through the IF amplifier, the screen voltage of this stage increases because of AVC action. The squelch diode then conducts and completes the path of the audio signal from the detector to the audio amplifier.

Transmitters

Crystal-controlled oscillators are used in CB transmitters to obtain the high degree of frequency stability required to meet FCC regulations. In some units, a crystal for any of the 22 available channels can be plugged into the transmitter section to establish the desired frequency without need for further adjustment. Some other receivers require internal tuning at the factory (or field tuning by a properly licensed radiotelephone operator) in order to transmit on any except a preset channel or group of channels.

Fig. 4 shows a crystal-switching arrangement for the oscillator of a three-channel transmitter. Similar switches with up to five positions may be obtained in actual equipment. This crystal oscillator is quite simple; the desired crystal is connected between grid and ground across the grid-leak resistor. The

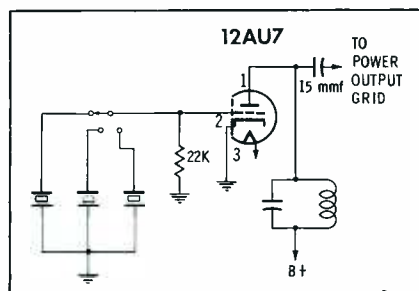

Fig. 4. Crystal switch permits tuning oscillator to any of three channels.

**Firefighting is for
firemen—
not servicemen**



Customers really burn when they have to call you back because of a premature failure. And while you're playing fireman, the profit on your next three service calls goes up in smoke. Tung-Sol tube quality is good insurance against callbacks. They're made to the highest specs of leading radio, tv and hi-fi set manufacturers. You'll find it good policy to keep that caddy full of Tung-Sol tubes. Tung-Sol Electric Inc., Newark 4, N. J.

Tell your jobber you'd rather have

ts TUNG-SOL[®]

Blue Chip Quality

TUBES • TRANSISTORS • DIODES

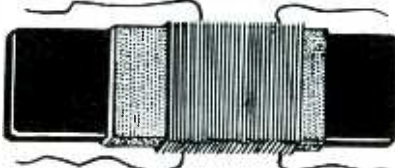

SupereX Replacement
FLAT LOOPSTICK

for Japanese Transistor radios
Model 2FT-397 List \$2.35

Make more money while you do your customer a service! This fabulous Flat Transistor Loopstick actually improves set performance by virtue of its extremely high "Q" . . . is adjustable to match Japanese variable capacitor. Peps up weak stations. Supplied with illustrated, installation instructions. A SupereX exclusive!



YOKE OFF
FROZEN YOKE
REMOVED

Quickly, easily removes yokes frozen on neck of picture tube. The few cents you invest in YOKE OFF can save dollars and headaches. Safe, non-inflammable, easy to use. Don't be without YOKE OFF another day.

Dealer Net \$1.19

EXACT REPLACEMENT PLASTIC
EXTENSION SHAFTS

EXTENDS AND INSULATES ALL STANDARD CONTROLS whether shaft is flatted, splined, split.



Model EXT-S
Dealer Net 36c

Exact Replacement Fine Tuning Shafts

GE FINE TUNER SHAFT

(Exact replacement for GE part number WT69X36; RMU-112)
Model GE-TS List \$1.25

FINE TUNING SHAFTS

Fits all Standard Coil tuners. Sturdy aluminum easily cuts to desired length.

Model SCT-1
360 Turn Type—No Stop
List \$3.25

Model SCT-2
Original Type With Stop
List \$3.25

- Used by
- RCA
 - ADMIRAL
 - PHILCO
 - ZENITH
 - WESTINGHOUSE
 - GE
 - SYLVANIA
 - MOTOROLA
 - EMERSON
 - HOFFMAN

At your parts jobber. If not available, write for name of nearest supplier.



plate tank is broadly tuned to cover the band and does not require adjustment. In single-channel gear, the oscillator may operate at one-half the desired output frequency; the plate circuit is then tuned to double the oscillator frequency. As with other oscillators, the condition of the circuit can be checked by reading the grid-leak bias with a VTVM. Unless the crystal is working properly, there will be no grid signal, no grid current, and no grid bias.

A transmitter RF section (actually the complete transmitter unit except for the modulator) is shown in Fig. 5 as a single tube on a printed-wiring board.

In most transceivers, the modulator and power output stages of the transmitter share circuits with the receiver's audio system. The simple switching required to provide microphone input and transmitter output, or detector input and audio output, effects a substantial savings in cost and maintenance.

Special Considerations

Mobile installations of CB gear in automobiles, aircraft, or marine craft are subject to electrical noise interference which may arise from various sources. These include ignition noise, generator and voltage-regulator hash, wheel or tire static on automobiles, or propeller drive-shaft noise on some marine installations. The noise limiter in the set is effective in reducing the noise level to a usable point, but for reception of weak or distant signals, noise suppression is necessary. In automobiles, and marine installations, the use of regular automotive-type 10K-ohm spark plugs will generally reduce the ignition noise. Bonding the hood to the car with heavy copper braid across the hinges is often effective in reducing noise.

Shielded spark plugs and wiring, as found on most aircraft, are an excellent solution to the noise problem. Generator noise can be eliminated by means of a regular generator-bypass capacitor (a metal-cased, low-voltage unit with a value of from .25 to 1.0 mfd.) Regulator noise can be eliminated by soldering a 1000- to 5000-mmf



Fig. 5. RF stage of CB transmitter on small plug-in printed wiring board.

disc ceramic capacitor across each set of regulator contacts, using the shortest possible connecting leads. Wheel and tire static can be eliminated by installing special spring grounding clips in each hub to provide a good ground across the wheel bearing.

CB and You

You, as a service technician, have a double-barreled stake in CB radio. It is there for your use in dispatching service calls, reaching the shop from remote locations, and special purposes such as antenna installations. But CB has a limited range, and in some parts of the country the band is crowded. This service is *not* meant for, and indeed will not serve as a substitute for, standard two-way radio with its greater power.

From reports of users, this much can be said: CB is quite useful in rural areas with an uncrowded band. In a large city, or in areas with many stations on the air, it has not been an outstanding success as a supplement to regular two-way radio. Even so, flocks of new stations continue to be added.

To the technician, CB radios are a source of repair business as well as a market for tubes and batteries. Under certain conditions (see February article) you do *not* need an FCC license to make repairs, adjustments or tests which affect the operation. But don't forget—if you change, adjust, or repair a transmitter so that the frequency-determining components are replaced, you *must* have the proper FCC license.

The Citizens band is yours to use and profit by. ▲

RCA Electronic Instruments

"PREFERRED BY PROFESSIONALS"

GENERATORS



**WR-46A VIDEO
DOT/CROSSHATCH
GENERATOR**

A "must" for making color-TV static and dynamic convergence adjustments in the home or shop. Derives sync from station-tuned TV set and reinserts highly stable video dot, bar or crosshatch patterns to picture tube grids or video amplifier grids. \$179.50* (complete with cables, instruction book).



**WR-61B
COLOR-BAR
GENERATOR**

For checking overall operation of color-TV receivers and a "must" for adjusting and troubleshooting color phasing and matrixing circuits. Generates signals for producing 10 bars of different colors simultaneously. \$295.50* (complete with cables, TV-input adapter, instruction book).



**WR-99A CRYSTAL-
CALIBRATED
MARKER GENERATOR**

To supply a fundamental frequency carrier of crystal accuracy for aligning and troubleshooting color, black-and-white TV, FM receivers and other electronic equipment operating in 19 Mc to 260 Mc range. \$242.50* (complete with output cable, two phone tips, instruction book).



**WR-49B
SIGNAL
GENERATOR**

For alignment and signal tracing of AM/FM receivers, low-frequency signal tracing and alignment of TV rf/af amplifiers. Six ranges—85 Kc to 30 Mc. Internal 400 cps modulation. Low rf signal leakage! DC blocking capacitors at rf and af output terminals prevent damage to instrument or external circuits. \$79.50* (complete with shielded cable for rf and af output, instruction book).

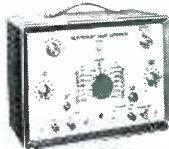

**WR-69A
TELEVISION/FM
SWEEP GENERATOR**

For visual alignment and troubleshooting of TV rf/af/vf circuits and other electronic equipment. IF/video frequency ranges 50 Kc to 50 Mc, TV channels 2 to 13, plus FM range—88-108 Mc. Sweep width 0-12 Mc or more. Output level—0.1 volt or more. Attenuation ratio 60 db or more below maximum output. \$295.00* (including all cables, instruction book).



**WR-70A
RF/IF/VF
MARKER ADDER**

To be used with WR-69A, WR-99A or similar electronic equipment. Eliminates waveform distortion due to overloading receiver during visual alignment techniques by adding markers after the rf signal is demodulated. \$74.50* (complete with cables, instruction book).

SCOPES



**WO-91A
5-INCH, COLOR-TV
OSCILLOSCOPE**

High-performance, wide-band oscilloscope ideally suited for color-TV, black-and-white TV, and other electronic applications. Dual bandwidth (4.5 Mc, 0.053 volts rms/in.), (1.5 Mc, 0.018 volts rms/in.). Internal calibrating voltage and calibrated graph screen. Includes special direct/low cap shielded probe and cable. \$239.50* (includes ground cable, insulator clip, instruction book).

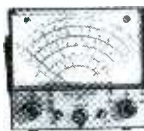

**WV-98A SENIOR
VOLT-OHM-
MYST®**

For making accurate ac and dc voltage measurements as well as measuring resistances from 0 to 1,000 megohms. Measures peak-to-peak values of complex waveforms. Ruggedized, die-cast aluminum case. Large, easy-to-read 6½-inch meter. A fine VTVM for electronic technicians and engineers! Includes special dc/ac—ohms shielded probe and cable. \$79.50* (complete with ground lead, alligator clip, instruction booklet).



**NEW! WV-77E
VOLT-OHM-
MYST®**

To measure AC and DC voltages, 0 to 1,500 volts; resistances from 0.2 to 1,000 ohms. Famous RCA VoltOhmyst quality at a low price! Separate scales, 1½ volts rms and 4 volts peak-to-peak, for accuracy in low ac measurements. Fuse-protected ohms-divider network. Complete with ultrathin probes, long flexible leads, only \$49.95.* (Easy-to-assemble kit, WV-77E(K), only \$29.95*).

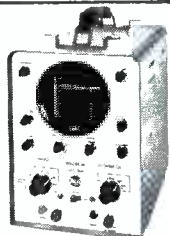

**NEW! WO-33A
SUPER-PORTABLE
OSCILLOSCOPE**

A low-cost all-purpose scope you can carry anywhere—only 14 pounds—ideal for in-the-home servicing of black-and-white and color TV, audio and ultrasonic equipment. High gain and wide bandwidth to handle the tough jobs! Rugged and compact—scaled 3" graph screen. Only \$129.95,* complete with low-cap direct input probe, cable, power cord and cord carrying brackets. (As an easy-to-assemble kit, WO-33A(K), only \$79.95*).



**NEW! WV-38A
VOLT-OHM-
MILLIAMMETER**

To measure AC or DC voltages, 0 to 5,000 volts; resistances 0 to 20 megohms; DC current 0 to 10 amps; power —10 to +50 dbm. Exclusive special ranges for transistor servicing: 1 volt, 250 mv —50 µa and 1 ma full scale. Fuse-protected ohms divider network. Polarity reversing switch. Big meter (5½"). Buy of a lifetime at \$43.95.* (Easy to assemble kit, WV-38A(K), only \$29.95*).



**WT-110A
AUTOMATIC
ELECTRON
TUBE TESTER**

Especially designed for TV and general electron-tube service testing through automatic punched-card selection of correct test conditions on wide variety of tubes. Checks vacuum-tube rectifiers under high-current conditions. \$119.50* (complete with 263 punched cards, 24 blank cards, card punch, instruction book).

There's an RCA test instrument to help you do every job better, and easier—and to save you valuable time. Plus a complete line of test accessories: video multimeters, TV isotaps and bias supplies, probes and cables. See your Authorized RCA Electronic Instrument Distributor for complete information.

*User Price (Optional)



RADIO CORPORATION OF AMERICA

Electron Tube Division

Harrison, N. J.

Table 1

RATED CAPACITANCE	R VALUE	METER READING	EQUIVALENT CAPACITANCE	BRIDGE MEASUREMENT
.001 mfd	110K Ω	.95 volts	.00095 mfd	.00099 mfd
.005	110K	4.9	.0049	.00411
.01	110K	9.6	.0096	.00998
.02	5K	19.9	.0199	.01998
.05	5K	49.6	.0496	.0488
.10	5K	99.2	.0992	.0984
.20	800	198.4	.1984	.1984
.50	800	396.8	.3968	.3968

db calibrations. Incidentally, a chart for converting from AC range to db reading is given in the Arkay manual; it also mentions that when measuring audio power across a 500-ohm load, you need only subtract 8 db from the meter reading for a reasonably accurate indication.

By removing a screw from each corner of the panel, I found that the entire chassis slips out the front of the case. The unit is well constructed and makes use of both foreign and domestic components. One part in particular caught my eye, the dual diode employed to rectify AC voltages so they can be measured by the meter. It is encased in a package no bigger than the nail on your little finger. I noticed, too, that 1% precision resistors were used for all multipliers on the range switch.

Since capacitors are one of the worse troublemakers to the serviceman, you'll be interested in knowing how the Model MT-50 may be used to check these particular components. About the quickest and easiest way to test a typical coupling or bypass capacitor for leakage is to disconnect the end tied to the most negative potential of its circuit, turn the receiver on, and measure DC voltage between the disconnected lead and chassis ground. A good capacitor should not exhibit any DC leakage voltage in this test. Small amounts of leakage, of course, can be tolerated in certain applications; but for grid coupling units, even a small amount can upset circuit operation and cause such symptoms as garbled sound, smeared picture, or unstable sync.

As outlined in the instrument's instruction manual, the Model MT-50 can also be used to determine the capacitance value of most paper and oil-filled units. This is accomplished by the simple test setup shown in Fig. 2. The table accompanying this schematic indicates the test voltages and resistance values required for measuring different ranges of capacitance. With the meter on AC and the range switch placed in its 50-volt

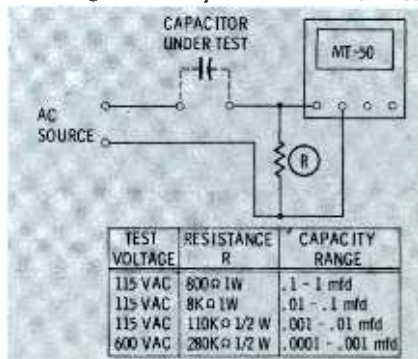
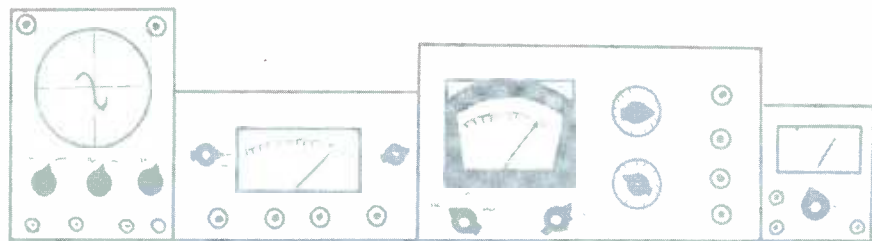

Fig. 2. Simple means to check value of capacitors employing the MT-50.



NOTES ON TEST EQUIPMENT

by Les Deane

Read All

Arkay International of Richmond Hill, New York is currently marketing a new Multi-Tester, the Model MT-50. As seen in the photo of Fig. 1, this all-purpose meter is housed in a black bakelite case and comes supplied with batteries and two heavy-duty test leads with a pencil-like probe attached to each. For those of you who like to build your own instruments, you'll be pleased to learn that, as with all Arkay instruments, the Model MT-50 is also available as a kit.

Specifications are:

1. Power Requirements — five self-contained 1.5-volt batteries, one size "C" and four size "AA" Penlite cells.
2. DC Voltmeter — seven ranges of 0 to 1.5, 5, 50, 150, 500, 1500, and 5000 volts; sensitivity 20,000 ohms/volt; separate jack for 5000-volt measurements on panel; polarity switch provided.
3. AC Voltmeter—seven ranges of 0 to 1.5, 5, 50, 150, 500, 1500, and 5000 volts; sensitivity 5000 ohms/volt; separate jack for 5000-volt measurements provided on panel.
4. Ohmmeter — 0 to 20 megohms in three ranges of $R \times 1$ (center scale 12), $R \times 100$, and $R \times 10,000$; zero-ohms adjust provided on front panel.
5. DC Ammeter — five ranges of 0 to 150 ua, 15 ma, 150 ma, 500 ma, and 15 amps; separate jacks provided on front panel for 500-

ma and 15-amp ranges.

6. DB Meter — six power ranges from -12 to +65 db; zero db equals 1 milliwatt of AC power across 600-ohm impedance (.7746 volts on the 1.5V AC scale); blocking capacitor is provided for input circuit with function selector in output position.
7. Panel Meter — 50-ua movement; large 6" dial with five separate scale arcs; accuracy $\pm 2\%$.
8. Size and Weight — 6½" x 7¾" x 4½"; approx. 3 lbs. with batteries.

Many service meters provide means for measuring AC and DC voltages, resistances, and DC currents; some even include a calibrated db scale for audio power measurements. Things to consider on such an instrument are range limitations, sensitivity, accuracy, readability of scales, polarity reversal provisions, convenience of lead connections, meter safety features, and portability.

After examining the Model MT-50, I would say that its standards are fairly high and therefore well suited for radio and TV servicing. Its full-scale voltage ranges extend from 1.5 volts to 5 kv; its DC current from 150 ua to 15 amps; and its resistance indications up to 20 megohms. When I checked this one particular instrument for over-all accuracy against laboratory standards, I found it somewhat better than average. For DC voltage its accuracy was $\pm 2\%$ or better, and AC measurements were within $\pm 3\%$. Resistance accuracy is generally stated by a certain number of degrees which the meter pointer may deviate from the actual ohmic value. I can safely say that here, too, the accuracy is very good.

The front panel of the meter features three control knobs—ohms adjust on the left, range switch in the center, and function selector on the right. Five of the seven individual pin jacks on the panel are used for extending normal ranges of the meter movement; the other two of course are "+" and "-" or positive and common.

The wide-angle dial face features five separate scales, with black indications for DC and ohms, and red for AC and



Fig. 1. Arkay's new meter is capable of handling wide ranges of E, I, and R.

ANNOUNCING THE NEW ASTATIC NEEDLE LINE

MORE COMPLETE THAN ALL COMPETITIVE LINES COMBINED

IT'S A NATURAL
FOR TOP SALES AND PROFIT!

- Now, for the first, a needle line that gives you EVERYTHING you will ever need — even the hard-to-get EXOTIC styles — no more wasted time and money searching for sources or turning customers down.
- Today's first name in cartridges is tomorrow's first name in needles and cartridges.
- Astatic's quality reputation builds EXTRA sales volume.
- Now buy cartridges and needles from ONE source — single ordering, single delivery, single billing, simplified bookkeeping.

GO BY BRAND...
GO BUY ASTATIC

ASTATIC

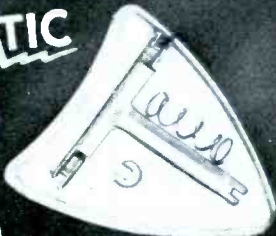

KNOWN
THE WORLD OVER

ASTATIC

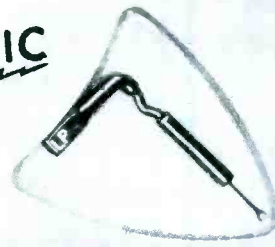

KNOWN
THE WORLD OVER

THE INDUSTRY'S MOST ATTRACTIVE, EASY-TO-USE CATALOG

Write for your free copy on company letterhead.

THE
Astatic CORPORATION, CONNEAUT, OHIO

IN CANADA: CANADIAN ASTATIC LIMITED, TORONTO, ONTARIO
EXPORT SALES: ROBJURN AGENCIES, INC., 431 GREENWICH ST., N. Y. 13, N. Y., U.S.A.

Eliminate call backs...
use dependable,
industry-preferred...



3 WATT SIZE
5/16" x 1/4"

OHMITE
1500 OHMS

5 WATT SIZE
1 1/16" x 1/2"

OHMITE
1500 OHMS

AXIAL-LEAD RESISTORS
Vitreous-enameled, power-type, axial-lead units designed to withstand high temperatures.

LITTLE DEVIL® COMPOSITION RESISTORS
Meet all MIL-R-11A requirements. Available in 1/10, 1/4, 1/2, 1, and 2-watt sizes in all standard EIA values.

BROWN DEVIL® RESISTORS
Vitreous-enameled. In 5, 10, and 20- watt sizes.

TYPE AB POTENTIOMETERS
Resistance material is solid-molded, noise-free. Rated at 2 watts.

FR-7.5 FUSE RESISTOR
For easy replacement in many television receivers. 1 1/2" Tinned wire leads.

WRITE FOR STOCK CATALOG



OHMITE MANUFACTURING COMPANY
3644 Howard Street • Skokie, Illinois

position, the 0 to 15-VDC scale is used. Each voltage mark then corresponds to a unit of capacitance, and it is a simple matter to make the conversion.

Since this arrangement permits the measurement of capacitors with values from .001 to 1.0 mfd, using an ordinary power line as a voltage source, I tried

Rectifier Substitute

The piece of equipment pictured in Fig. 3 may be a little small in size but it can be a big help when it comes to troubleshooting circuits employing rectifiers and diodes. Manufactured by SENCORE of Addison, Ill., the Model RS106 is a combination rectifier and diode substitution unit for use in radio, TV, and hi-fi—as well as for the experimental construction of various electronic circuits.

Specifications are:

1. *Selenium Substitute* — all common radio and TV power types up to 500 ma; panel set-up control selects forward resistance to duplicate original.
2. *Silicon Substitute* — direct replacement for all silicon power types up to 500 ma.
3. *Single Diode Substitute* — all low frequency detectors including crystal types; test of high-frequency types described in manual.
4. *Dual Diode Substitute* — direct replacement for AFC types with common connection of either like or unlike polarities.
5. *Other Features* — function selector switch, .5-amp panel fuse, and three 2' test leads with clips provided.
6. *Size and Weight* — 4" x 5" x 1 7/8"; approx. 1 lb.

Although wholesale substitution of parts is not a recommended nor profitable way to service, there are times when the substitution technique is by far the simplest and quickest way to isolate trouble. Selenium and silicon rectifiers, as well as crystal detectors, are not easily tested, and therefore rightly fall into this classification. Measuring forward and reverse resistance with an ohmmeter, for example, will not always give enough conclusive evidence to warrant a special trip to the distributor, or for you to risk a soldering job that might ruin an otherwise perfectly good component. In addition to finding the *Rectifier Trouble Shooter* convenient to use in this respect, its main advantage is eliminating the necessity for stocking an untold number of semiconductor components.

To get an idea of what is inside the substitution box, refer to the schematic diagram in Fig. 4. Notice that the unit is made up of two switches, a fuse, several resistors, and two silicon diodes. The function selector switch *S1* has five individual positions, representing various wiring combinations that provide electrical equivalents for rectifiers, diodes, and dual diodes. Switch positions on the

it in the lab. The results of my findings are summarized in Table 1. In this experiment, I held the line voltage to approximately 117 volts, and resistor values to within $\pm 5\%$; however, varying line voltage from 110 to 120V AC and resistance to $\pm 10\%$, I noted little error in the over-all indications.



Fig. 3. A new substitution instrument for locating bad diodes and rectifiers.

front panel are clearly labeled and are accompanied by a diagram depicting the correct test lead connections.

The SELENIUM SETUP switch *S2* has ten positions providing a variation of 4.7 ohms to 237.9 ohms in the series resistance. This resistance is added to the circuit of the two 5E4's in order to duplicate the forward resistance of the selenium unit being replaced. The switch is calibrated according to the size of and number of plates for the rectifier. After determining the over-all size and number of plates in the original unit, the switch is rotated until the calibration marks for these two characteristics are lined up. The correct resistance is thus automatically switched into the circuit. It should be pointed out, however, that *S2* is only active when the function selector is in the SELENIUM position, since the rectifiers in the RS 106 are silicon and no additional series resistance is required when substituting for silicon units.

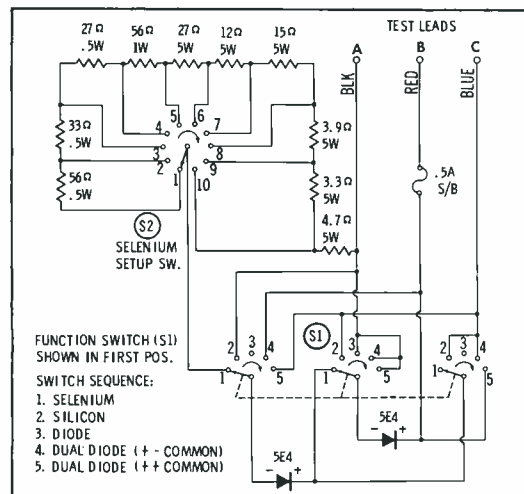

Fig. 4. Circuit of the RS106 incorporates two 500-ma silicon rectifiers.

Just off the press....your "PROFIT BOOK" for 1960



The NEW
MERIT
CATALOG
of tested
Electronic
Components!



erit
Coil and Transformer Corporation
MERIT PLAZA HOLLYWOOD • FLORIDA

two twenty-seven from **4**

Slip this 4-Pak in your kit and you're ready to replace 227 of the most popular cartridges. Webster's new Service Center package consists of 4 plug-in cartridges with sapphire stylus — exact replacement for 8 out of 10 most popular models — plus 11 mounting brackets. And, these are high performance cartridges that satisfy every time.

With the new Webster 4-Pak, cartridge servicing couldn't be easier — and you can carry your inventory in your hand! See your distributor.

NEW WEBSTER **4**-PAK



See us at the Electronic Parts Distributors Show — Room 551A, Conrad Hilton Hotel.

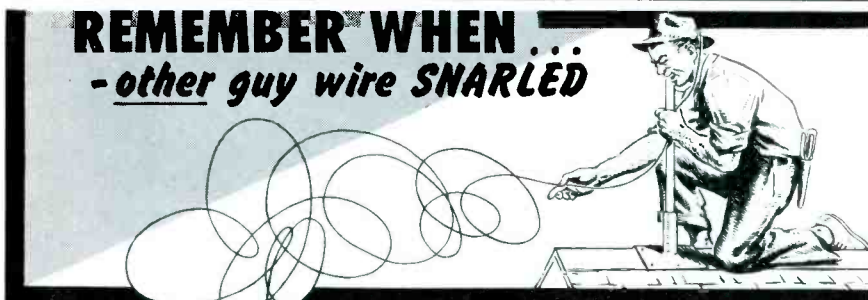

WRIGHT TV GUY WIRE...

- Comes in 50' connected coils
- Has bright, long-lasting galvanized finish

Four strand No. 20 • Six strand No. 20 • Six strand No. 18 • No. 3 — Cushion center
Seven strand — No. 18 Aluminum • All in 50' connected coils

Also on metal and wooden reels

Wholesalers — Stocks nearby

G. F. WRIGHT

STEEL & WIRE COMPANY
WORCESTER, MASS.

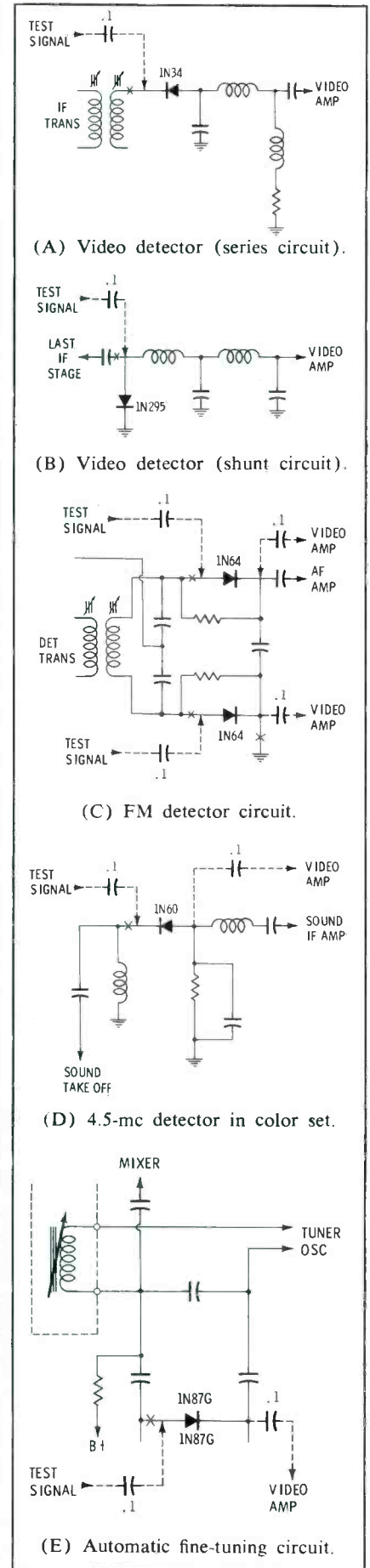

Fig. 5. Methods for checking high-frequency diodes in various applications.

When the instrument is used as recommended, the 1/2-amp slow-blow fuse protects the silicon units within the instrument. In case of overload, this fuse will blow before excessive current has a chance to damage either of the diodes. The 5E4 rectifiers are actually connected in series for the first two function switch positions — SELENIUM and SILICON. This effectively increases the input voltage rating of the substitution circuit to twice the rating for a single unit.

Making use of the RS106 in the lab, I tried it in a number of audio and video detector stages, power supplies, and frequency control circuits. I found it does a fine job in low-frequency detector diode applications, such as substituting for a detector in radio and TV AFC stages. Most transistor portables, for example, employ a crystal diode in the audio detector stage, which the RS106 can replace directly. Since both silicon units in the instrument can be connected to a common test lead, with either like or unlike polarities, it also works well in substituting for those small dual diodes frequently encountered in horizontal AFC circuits.

In cases where a component is suspected of being weak or open, I found I could merely clip the test leads across the original and watch or listen for a change in operation. If there are any indications that the old one is shorted, however, one end should be disconnected before making the substitution.

In troubleshooting high frequency circuits, such as those used in FM-sound or video detector stages, the RS106 is somewhat limited. The impedance of the instrument, due to the length of its test leads and type of rectifiers used, loads and detunes the circuit under test so that high frequency demodulation is next to impossible. To overcome this condition the SENCORE manual recommends that a low-frequency test signal be used in conjunction with the *Trouble Shooter*.

This procedure first calls for a check of the original component by disconnecting the input side of the diode and then applying a relatively low-frequency signal from an audio generator, or a 6.3-volt filament supply, to this point through a .1-mfd capacitor. The output side of the diode is connected through another .1-mfd capacitor to the input grid of the video amplifier stage in the TV set under investigation. When checking a video detector crystal, its output will already go to the video amplifier and therefore this connection will not be necessary. If the output side of the diode is grounded, such as in many sound discriminator or ratio detector circuits, the ground return should be opened before coupling the signal to the video amplifier.

If the diode being tested is good, a dark bar or bars should appear on the picture tube screen. If not, the RS106 is used to make sure that the modulation can be obtained before replacing the suspected diode. Several practical applications of this procedure are illustrated in Fig. 5. ▲

LUGER[®]

BEST DOG-GONE GUN ON THE MARKET!

LUGER ISN'T THE
LOWEST PRICED . . . BUT
ONCE YOU'VE USED
ONE YOU'LL AGREE
IT'S THE **BEST!**

IT CAN'T BE BEAT . . .

- For versatility of tip styles.
- For long tips . . . for short tips . . . for that marvelous feeling of fine balance and tip lightness.
- For compactness in your tool kit.

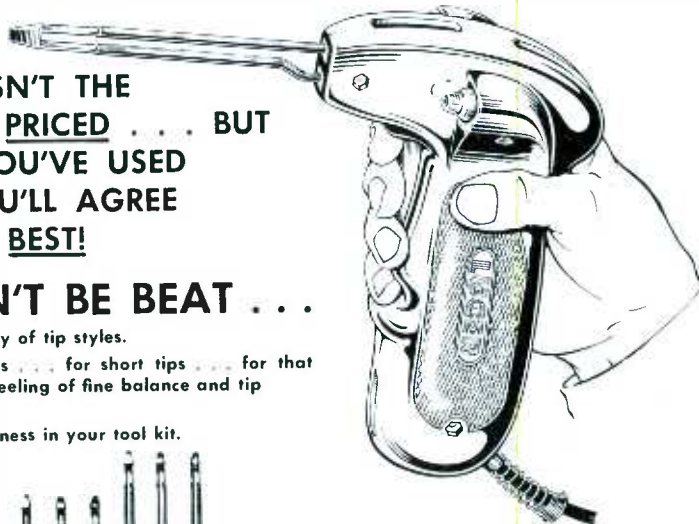

PC1 C1 C2 C3 AB1 AB2 AB3 AB4 AB5 AB6

LUGER OWNERS: If you need a specially shaped tip for your LUGER, send us a sketch and describe its proposed use. We will make one for you FREE.

If your distributor doesn't stock LUGERS, write us for name of nearest one.

ELECTRIC SOLDERING IRON CO., INC.
560 W. ELM ST. -- DEEP RIVER, CONN.

MEET AND BEAT COMPETITION

this money-saving book club way

The best technician is the best informed technician. If you know your work and know it well, you can take on any and all jobs — including the toughest dogs. And you can meet and beat any competitor in the kind of service you offer. But you've got to be up-to-the-minute in know-how and technique. Here's a tried and proven easy way to get the knowledge you need to make good in servicing—the G/L Technicians Book Club. It's already helped over 9,000 technicians. It can help you too.

WHY IT PAYS TO JOIN THIS PRACTICAL BOOK CLUB

- Get the books you need to get ahead—at discounts up to 27%.
- No risk—you send no money—keep only the books you want—pay only for those you keep.
- Acquire a handsome library of practical books, one at a time—no budget strain!



JOIN NOW!

Select one of the books listed on this coupon—accept it at our risk—pay only after you've looked it over.

Select From This List of Cloth Bound Books
JUST OFF THE PRESS List price **\$4.60**

92H	Fundamentals of Semiconductors	\$3.25
85H	How to Get the most out of your VOM	3.35
81H	Printed Circuits	3.35
78H	Rapid Radio Repair	3.35

Plus a few cents postage

GERNSBACK LIBRARY PR 50C
154 West 14 St. ■ New York 11, N. Y.

Enroll me in the Technicians Book Club

Send me the books checked

92H 85H 81H 78H

Name _____
(please print)

Address _____

City _____ Zone _____ State _____

IMPORTANT NEW SAMS BOOKS

"101 More Ways to Use Your Scope in TV"



Here is the sequel to Bob Middleton's first book on the subject, prompted by the insistent demand of readers for still more of the unique and practical help found in the popular "101 Ways" series. This working guidebook for the service technician or for any scope user, stresses the proper interpretation of observed waveforms, Specifies equipment needed, connections required, procedure and evaluation of results for each use. Special notes supplement the uses described. Profusely illustrated.

180 pages; 5½ x 8½". Only..... **\$250**

"Electronics For The Beginner"

This book derives from the author's own experiences in helping his teenage son understand this fascinating subject and rewarding hobby. (Jay Stanley, the writer, is a frequent contributor to leading electronics magazines.) Profusely illustrated, the book includes 15 chapters which progressively introduce the newcomer to the basic fundamentals of constructing electronic devices, such as a "one-hour radio," a pocket radio, a home broadcaster, short-wave tuner, etc. The book is unique in that all the projects described make use of transistors rather than vacuum tubes. This is without doubt the most readable, up-to-date and best book of its type available. 192 pages; 5½ x 8½", hard-bound. **\$395** Only.....



"Servicing Transistor Radios" Vol. 5



The latest volume in this best-selling series; complete data on popular transistor model radios produced in 1958-59. You get the famous Sams Standard Notation Schematics, with CircuitTrace used throughout; full photo views of each chassis; complete alignment data; full replacement parts data—everything you need to be successful in fast-growing transistor radio servicing. Includes

valuable section on special techniques for servicing transistor circuits. With cumulative index for all volumes in the series. 160 pages; 8½ x 11". Only..... **\$295**

"Video Speed Servicing" Vol. 4

Newest volume in Sam Marshall's valuable series. Consists of 456 practical troubleshooting hints for solving hard-to-find faults in many late model TV receivers. All models are indexed by brand name, model and chassis number for quick reference. Each hint is accompanied by an explanatory diagram or schematic. An invaluable shop reference; a real time-saver. 160 pages; 8½ x 11". Only... **\$295**



HOWARD W. SAMS & CO., INC.

Order from your Sams Distributor today, or mail to Howard W. Sams & Co., Inc., Dept. E-30 1720 E. 38th St., Indianapolis 6, Ind.

Send me the following books:

- "101 More Ways to Use Your Scope" (TEM-7)
- "Electronics For The Beginner" (BHJ-1)
- "Servicing Transistor Radios" Vol. 5 (TSM-5)
- "Video Speed Servicing" Vol. 4 (VSM-4)

\$..... enclosed. Send Free Book List

Name.....

Address.....

City..... Zone..... State.....

(outside U.S.A. priced slightly higher)



THE TROUBLESHOOTER

ANSWERS YOUR SERVICE PROBLEMS

Twin Troubles

There are two Bendix Model C174-2 sets on the bench—both with horizontal drift. With the grid of the AFC tube grounded, the oscillator drifts "out of hold" in about five minutes. I've changed every part except L16 (no replacement listed), and even used a negative-temperature-coefficient unit for C49.

EVERT BOERSMA

Grand Rapids, Mich.

Although no replacements were available for L16 at the time PHOTOFAC Folder 111-3 was produced, there are now. But before changing L16, go back and recheck a couple of other things. For instance, the replacement for C49 should be a silver mica capacitor rather than a temperature-compensating ceramic. This circuit wasn't designed for compensation, and isn't likely to be stable unless the temperature coefficient of C49 is practically zero.

When you grounded the grid of the AFC stage, you disabled it only to the extent of removing the input signals. The conduction of the AFC tube could still vary enough to throw the oscillator off frequency. By replacing all components in this circuit, you have pretty well eliminated the possibility of defects in the AFC stage itself—but how about the plate supply voltage? This set uses

boost as a source of plate voltage for both the AFC tube and the oscillator, and the potential on the boost line could be varying as a result of some trouble in the flyback or boost-load circuits.

If these pointers don't lead you to a solution, by all means replace L16.

Warms Up and Out

I have a Webster Model 800 wire recorder that has only 40 volts on the plates of the two AF amplifiers rather than the required 160 volts. I've tried all filters and paper caps in the section, and resistance checks are close. The voltage is OK for about 30 seconds, then down it goes. The power supply and output stage maintain correct voltages.

RALPH MERTZ

St. Louis, Mo.

Sounds as though the filter resistor common to those two plate circuits is increasing in value with just a little current through it. If this resistor remained at its rated 820 ohms, and dropped the voltage to the point indicated, it would be dissipating 50 watts. Replace with a new 820 ohm, ½-watt resistor; then go ahead with voltage checks. If they are still low, measure the cathode voltages on both tubes for a clue to the cause for increased current flow.

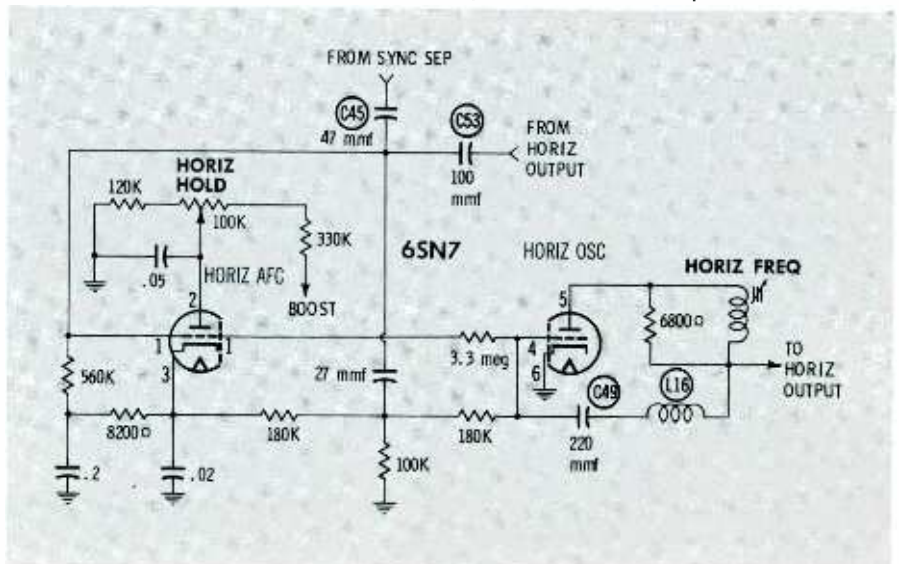

Which Came First?

The boost voltage on the Admiral Chassis 19T1 builds up to 300 volts for a few seconds. It then drops to 150 volts, and the 1200-ohm series resistor gets hot. The B+ to the plate of the damper is only 150 volts, rather than the 245 indicated as normal. I've changed the flyback, yoke, width coil, etc., to no avail.

HARRY T. SCHRADER
Kirkwood, Mo.

The question is whether a short on the boost line is reducing B+ or vice versa. Remove the 3/8-amp fuse supplying the sweep stages. If B+ returns to normal (or higher, because of reduced load) you can start tracing the horizontal and boost circuits looking for a short. Since boost feeds the vertical circuits and CRT anode, don't overlook the possibility of a short in these circuits.

CB Antenna Query

We were recently assigned our license for Class D Citizens band and would appreciate any help you can give on making it more useful. Our present range is about 3 miles, even though we have flat terrain. We are using whips on the trucks and a ground plane antenna at the shop. What are the relative merits of beam and ground plane antennas? What are the correct dimensions for constructing a beam antenna for the 27-mc band?

CARL KOWA
Olney, Ill.

Congratulations for putting electronics to work within the industry. It seems you should get greater range than at present, if there aren't too many obstructions, and if your gear is putting out close to the maximum of 5 watts of power.

"Beam antenna" is a general term covering many types of directional arrays; it doesn't refer to some specific design.

(A yagi is one familiar type falling into the category of beam antennas. There are other types of directional antennas, of course.) Although a properly-aimed beam antenna would provide higher gain, it would seem that such an antenna would be out of the question where mobile units are involved.

Ground-plane antennas, on the other hand, have a nearly circular radiation pattern—but only about half the gain of a single dipole. Their advantage is the reduction of downward radiation and its associated losses, along with a strengthening of the horizontal radiation pattern.

In either case, antennas cut to exact frequencies to be used will give the best results. Generally speaking, quarter- and half-wave elements are used. The Howard W. Sams book, "Handbook of Electronic Tables and Formulas," contains some handy charts and conversion tables to help you determine the exact dimensions for your specific channel's

"I couldn't operate without PHOTOFACTS"

"My Sams PHOTOFACT Library is as important to my service shop as any equipment I own. I couldn't operate without Photofacts."

—D. Conavatchel
Bronx, New York

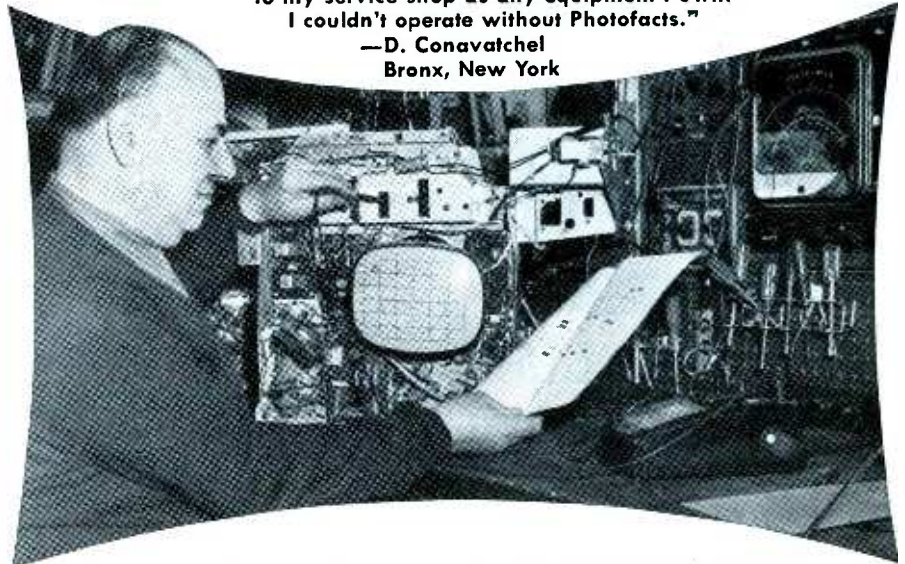

Service Technicians! YOU EARN MORE... YOU RATE with the public when you own the PHOTOFACT® service data library!

You enjoy maximum earnings as the owner of a complete PHOTOFACT Service Data Library! It's inevitable, because no matter how expert you are, you can always *save more time on any job, get more jobs done daily*—**EARN MORE, DAY IN AND DAY OUT...**

What's more—as the owner of a complete PHOTOFACT Library, you know your customers' sets *best*. You can actually show each customer you have the PHOTOFACT Folder covering his very own set. Result: You command public respect and acceptance which paves the way to more business and earnings for you.

HOW TO STAY AHEAD...

Yes, the truly successful Service Technicians are those who own the complete PHOTOFACT Library, who can meet and solve any repair problem—faster and more profitably. And these men *keep ahead* because they're on a Standing Order Subscription with their Distributors to receive all new PHOTOFACTS as they are released monthly. (They're eligible for the benefits of membership in PEET, too—see below!)

For PHOTOFACT Library Easy-Buy Plan details and Standing Order Subscription, see your Sams Distributor today, or write to Howard W. Sams...

NOW IS THE TIME TO JOIN

"PEET"

THE POWERFUL NEW PROGRAM FOR QUALIFIED TECHNICIANS

If you now own a PHOTOFACT Library or plan to own one, you can apply for membership in "PEET." It's the first industry program really designed to build powerful public acceptance for the Service Technician who qualifies. Builds enviable prestige and business for its members. Benefits cost you absolutely nothing if you qualify. Ask your Sams Distributor for the "PEET" details, or mail coupon today.

HOWARD W. SAMS & CO., INC.
1728 E. 38th St., Indianapolis 6, Ind.

Send me full details on the new "PEET" Program. Include full information on the Easy-Buy Plan and Free File Cabinet deal.

I'm a Service Technician full-time; part-time

My distributor is _____

Shop Name _____

Attn: _____

Address _____

City _____ Zone _____ State _____



by MILLER

You can align both tuned circuits from the top of the shield. Unit is designed with tuning cores which have hex holes extending the length of the core. This construction permits aligning tool to pass through one core and engage the other.

The J-Tran comes complete with a new style mounting clip which is part of the shield can.

TOP-TUNED MINIATURE IF TRANSFORMERS

Cat. No.	Item
14-H1	262 kc Input I.F.
14-H2	262 kc Output I.F.
14-H6	262 kc Output I.F.*
14-C1	455 kc Input I.F.
14-C2	455 kc Output I.F.
14-C6	455 kc Output I.F.*
14-C7	455 kc Input I.F. — battery radios
14-C8	455 kc Output I.F. — battery radios
14-C9	455 kc Input I.F. — AC-DC radios
14-C10	455 kc Output I.F. — AC-DC radios
6270	4.5 Mc Input or Interstage
6271	4.5 Mc Ratio Detector

*with diode filter capacitors

TOP-TUNED PRINTED CIRCUIT IF TRANSFORMERS

Cat. No.	Item
16-PH1	262 kc Input I.F.
16-PH2	262 kc Output I.F.
16-PH6	262 kc Output I.F.*
16-PC1	455 kc Input I.F.
16-PC2	455 kc Output I.F.
16-PC6	455 kc Output I.F.*
16-PC7	455 kc Input — battery radios
16-PC8	455 kc Output I.F. — battery radios
16-PC9	455 kc Input I.F. — AC-DC radios
16-PC10	455 kc Output I.F. — AC-DC radios
6270-PC	4.5 Mc Input or Interstage
6271-PC	4.5 Mc Ratio Detector

*with diode filter capacitors

Write for Miller general catalog, and the TV Replacement Guide, or ask for them at your distributor.



J. W. MILLER CO.
5917 S. Main Street
Los Angeles 3, California

EXPORT REPRESENTATIVE:
Roburn Agencies, Inc., N.Y. 13, N.Y.

CANADIAN REPRESENTATIVE:
Atlas Radio Corp., Ltd., Toronto 10, Ont.

frequency. You might also be interested in the book "Radio & Electronics Handbook" (BB-1), which covers antennas, transmission lines, loading, etc. on pages 411 through 490.

Speaking of loading, in our correspondence with manufacturers of CB gear, the point has been stressed that antenna loading is very important. Check to make sure the manufacturer's recommendations have been followed in your installation.

Vertical Round Robin

The Muntz Model 621C has an unusual vertical oscillator-output circuit. Would you please explain its operation?

DOUGLAS ENGLAND

Michigan City, Ind.

Referring to the partial schematic from PHOTOFAC Folder 342-10, let's begin at the instant the sync pulse (shown in W4) is applied to the screen of V7. This causes plate current to decrease due to the lowered screen-grid voltage. The magnetic field built up around the primary winding of T1 then begins to collapse, and the screen grid is driven even further negative, as shown in W6, driving the tube into cutoff.

The action is quite rapid and produces ringing in the circuits of the tube. As a result of the first half cycle of ringing, a high positive pulse appears at the plate. This is coupled to the control grid via C56 and C57, causing a flow of grid current which produces a negative charge on the grid side of C57. Plate current does not flow during this time, even though both plate and control grid are positive, because of the very high negative pulse potential on the screen grid. On the second half cycle of ringing, both plate and control grid go negative as shown in W5. The charge on C57 soon leaks off enough to let the grid voltage rise above cutoff, and the screen voltage returns to a positive value. The tube then begins to conduct, producing the next vertical scan. With the start of conduction, the ringing is damped out, and the plate current is controlled by the rise in grid voltage which occurs as C57 continues to discharge. The vertical linearity control governs the amount of charge placed on C57 during retrace, and the vertical

hold control fixes the bias on the control grid. This bias level influences the frequency of the oscillator. The vertical size control governs the B+ voltage fed to the screen-grid circuit.

Cold Blankets

I've had two General Electric blanket controls (Catalog #BA1C23) in which the 180K-ohm resistors had changed to 400K ohms. Can you explain the circuit, and also tell me if it's OK to use 1-watt resistors to replace the 1/2-watt ones originally used?

VERNON L. LARIMORE

Pensacola, Fla.

Normally, the circuit consists simply of a bimetallic thermal switch which is used in conjunction with either a resistor and switch arrangement or a potentiometer for current control. Replacement of the 180K, 1/2-watt resistors with 1-watt units should cause no ill effects.

Eureka!

I have some information which may enable Robert D. Cheney (March Troubleshooter column) to remove the five evenly-spaced black vertical bars from the screen of an Admiral Chassis 18X4CZ.

The same trouble occurred in a Canadian Fairbanks-Morse set (which uses an almost identical Admiral chassis) after we changed the picture tube. We tried your suggestions, and many more—including a replacement yoke. Finally, we found that radiation from the flyback transformer was being picked up on the cathode lead of the picture tube. The trouble was effectively cleared up by a two-step mechanical operation. First, we made sure that the high-voltage cage was securely mounted to the chassis and grounded to it with a piece of braided conductor. Then we separated the CRT cathode lead from the rest of the cabled leads going to the picture tube, and rerouted it close to the CRT mounting in order to keep it away from the HV section.

ROBERT LORCH

Aylmer, Ont., Canada

The five evenly-spaced black bars are a clue to an oscillation within the set at about five times the horizontal sweep fre-

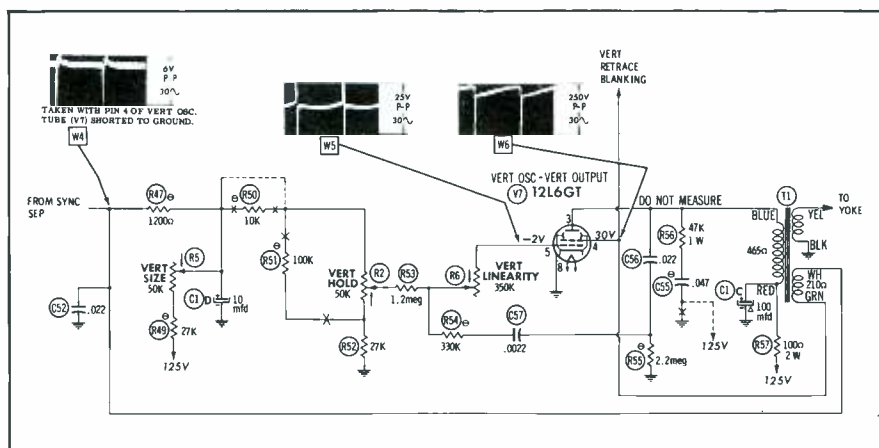

quency, or approximately 75 kc. Since this is close to the resonant frequency of the flyback circuit, we should have been stronger in our suspicion that horizontal sweep radiation was playing a part in creating the trouble. However, we were thrown off by the fact that flyback-circuit oscillations are usually quite highly damped. We've seen sets where each horizontal retrace pulse was followed by enough ringing—and enough radiation—to produce one or two vertical black bars at the left side of the screen; but a complete set of five bars . . . ??? Wonder if the radiated sweep energy was shock-exciting some part of the CRT cathode circuit into 75-kc oscillation?

Killer Caught

A Bendix Model 21KD has no high voltage—unless the horizontal AFC diode is removed! A normal raster is then developed. With the tube in place, I read -28 volts on pin 7, and -.5 on pin 5 (rather than the positive 4.8 volts called for in PHOTOFAC T Folder 183-2). Just how are these voltages produced?

F. E. McCLURY

Hughston, W. Va.

You caught the AFC killing the oscillator for sure—now let's see why. Grab a scope and check the waveforms at pins 5 and 7 of the AFC tube. They should be equal in amplitude and opposite in polarity. In your case, however, I suspect that the positive pulse applied to pin 7 is much greater than the negative pulse going to pin 5. If it is, you'll probably have to go back into the sync phase-inverter stage to locate the cause of your trouble.

To explain the conduction of the AFC diodes: During retrace time, a positive pulse is coupled back from the horizontal output transformer to the common connection of pins 1 and 2. The coupling circuit is designed to modify the waveshape of this feedback signal, changing the pulses into a sawtooth wave having a peak-to-peak amplitude of 10 to 20 volts. The frequency of the horizontal oscillator determines the phase of this sawtooth, which in turn affects the conduction ratio between the two diodes.

The plate of one diode (pin 7) receives a positive sync pulse at the same time the cathode of the other diode (pin 5) receives a negative sync pulse.

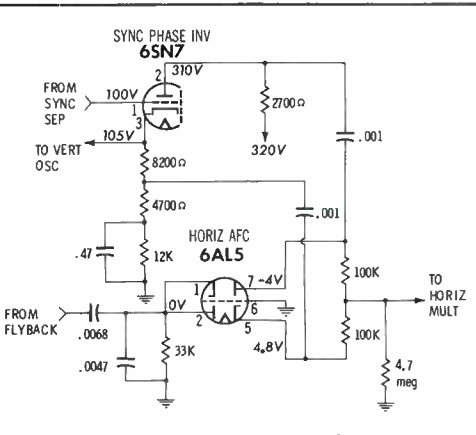

Since both pulses are of equal amplitude, both sections of the dual diode will conduct equally if the oscillator is on frequency. If it is slightly off frequency, one section will conduct more heavily than the other. This state of unbalance produces a difference voltage at the junction of the two 100K-ohm resistors, which is coupled to the oscillator to either speed it up or slow it down as required. If the sync pulses applied to the diode are not equal in amplitudes one section will conduct more than the other. Minor variations can be compensated for by varying the free-running frequency of the oscillator with the hold control. However, in the set you are working on, the AFC unbalance is too great; thus, the oscillator is either being stopped altogether or is being shifted so far in frequency that your high voltage is knocked out.

Works Three Days

A GE Model 17C125 is continually troubled with a narrowing raster and loss of high voltage. Replacing the 25BQ6 restores the width and HV, but the trouble recurs in about three days. The boost drops to about 450 volts and the BQ6 plates turn pink.

I've changed all tubes, flyback, yoke, width and linearity coils, and checked or replaced all capacitors and resistors in the horizontal circuit. Also, I checked out the seleniums and filters.

J. T.

Stockton, Calif.

Production Change Bulletin Folder 201-1 shows pertinent revisions of the basic circuits covered in PHOTOFAC T Folder 194-2. Principal changes are in the horizontal output circuit, and include a different transformer and yoke. Improper components may be causing the excessive tube current and the resultant short life.

Measure the cathode current of the 25BQ6; 90 to 100 ma is normal. If excessive, compare the waveform at the grid with W16 in the manual. If it isn't close to 100 volts peak to peak, additional checks in the oscillator and discharge stages are in order. Measure the bias between grid and cathode of the output tube. It should be about 45 volts.

Calculate screen grid dissipation for another possible clue. Multiplying the



Wake Up to bigger profits

When you sell and install FANON Intercoms to your present service customers, your sales volume can double with a little effort. Showing them how to save steps, time and temper with an intercom can mean a quick sale. Priced for every purse, FANON Intercom systems are ideal for your residential homes and restaurants, bars, stores, etc. in your own neighborhood. 55% of service dealers are doing it . . . are your getting your share of these new profits?



FX-2, TWO STATION SET.

Ultra-sensitive system with 50 feet of cable as low as \$29.95 list. Extra remote units can be added — \$12.50 list. FX-6 and FX-12 multi-station systems for up to 6 or 12 units interconnected for larger installations. Masters start at \$34.95; FC remote station, \$13.25. Rise and shine with FANON! We'll send you samples of folders, specs, displays and a photo of our girl, Jayne!

FANON

FANON Electronic Industries, Inc.

Dept. PF-5, 98 Berriman St., Brooklyn 8, N.Y.

Name _____

Firm Name _____

Address _____

City _____ State _____

voltage drop across the screen resistors by the current through them will give you the wattage of the circuit; 2.5 watts is maximum for a BQ6 tube.

The article "That's the Way the Horizontal Sweeps" on page 28 of this issue should be of further help.

Breaker Troubles

I have two RA-502 DuMont chassis that have identical troubles, and they're giving me fits. The circuit breaker keeps blowing for no good reason. I've checked the current being drawn when the breaker blows; it isn't excessive, and there is no surge.

J. A. RADEMACHER

Long Prairie, Minn.

From all indications, the circuit

breaker itself is probably at fault. Any mechanical defect would make it susceptible to erratic operation. See if replacement doesn't solve your problem.

Eliminate With Negative

I have tried installing a vertical blanking circuit in a Sparton Model 26SD170 without success, and would appreciate any help you can give.

JACK YEAGER

Montague, Mich.

I suggest you review "Vertical Retrace-Line Elimination" in our August, 1958 issue. Since the Sparton has a cathode-fed CRT, a negative pulse at the control grid is the best signal to use for retrace blanking. Check signal polar-

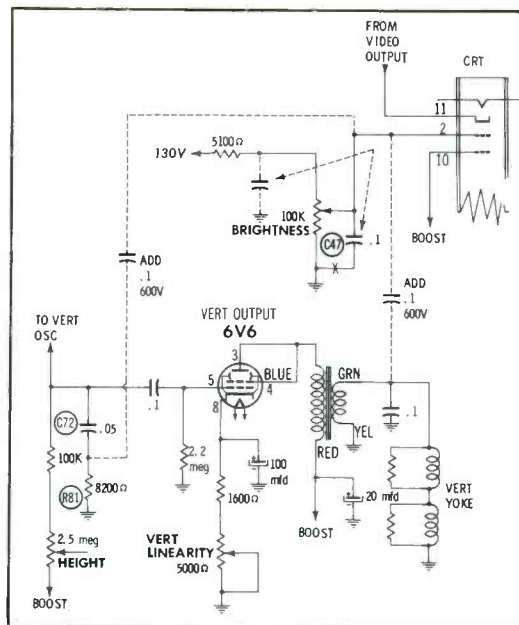

ity at the green lead of the vertical output transformer; if a negative pulse of sufficient amplitude is present at this point, wire in a .1-mfd, 600-volt capacitor as shown in the schematic.

This idea may not work out—either because of wrong pulse polarity, or because the wiring change might affect raster height. In that case, try connecting the blanking-pulse coupling capacitor to the junction of C72 and R81 in the vertical discharge circuit.

Complete the job by transferring C47 to the high side of the brightness control so that it will not attenuate the blanking pulses arriving at the grid. You may have to experiment with different values for the added capacitor and C47 in order to obtain complete blanking at all brightness levels.

Chasing HV

A Motorola Chassis TS-89 has no high voltage. Applying a driving pulse to the grid of the horizontal output tube produces sweep and high voltage. The oscillator isn't working; plate voltage on pin 2 is only 25 volts, and the cathode has 5 volts. All B+ voltages are from 20 to 50 volts low, but I can't find any trouble in the power supply.

EDWARD KOSIBA

Youngstown, Ohio

Your B+ readings are just a little more than 10% low — a little below

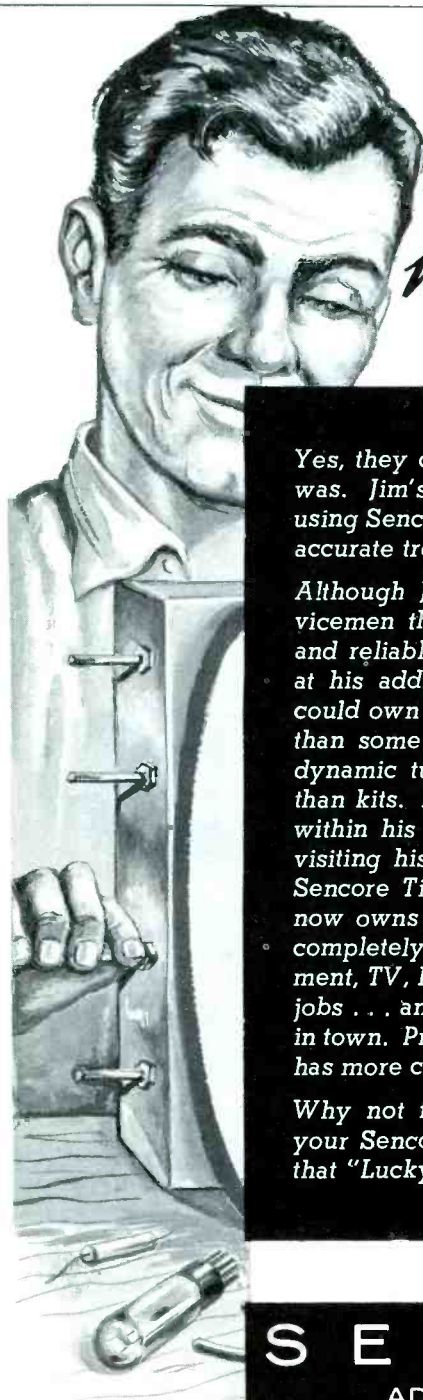
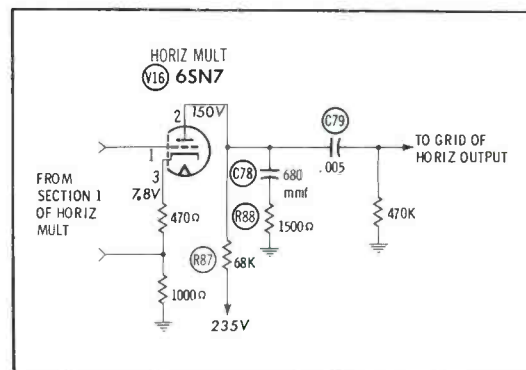

They called him "Lucky"

Yes, they called him "Lucky" . . . and he was. Jim's luck started the day he began using Sencore Time Savers for faster, more accurate trouble shooting.

Although Jim had heard from other servicemen that Sencore units were unique and reliable, he hesitated until a moment at his adding machine told him that he could own the entire Sencore line for less than some other manufacturers offered a dynamic tube tester . . . yes, even less than kits. Now that Jim knew it was well within his budget, he wasted no time in visiting his distributor. Jim bought three Sencore Time Savers that same day and now owns most of the Sencore line. He completely services transistorized equipment, TV, HiFi, radio and even most color jobs . . . and in less time than other shops in town. Profits have jumped and "Lucky" has more customers than he can handle.

Why not follow Jim's example and see your Sencore distributor . . . oh yes, say that "Lucky" sent you.

SENCORE
ADDISON 2, ILLINOIS

the normal for a set the age of this one. But I doubt this is the reason for malfunction of the multivibrator. The reduced plate voltage on V16 can be caused by only three things: (1) excessive plate current, (2) high value of plate load resistance, (3) leaky capacitor (C78 or C79). The first would be caused whenever an oscillator fails, since the stage would conduct as an amplifier rather than having the periodic conduction of an oscillator. This can be ruled out in this case because of the low cathode voltage.

Remove V16. If the voltage is still low, you have a leaky capacitor drawing current through R87 and producing a voltage drop across it. If the voltage returns to normal, this indicates the resistance of R87 is changing under load. When the trouble has been located, don't stop at replacing the obviously defective part; make sure there are no other damaged or faulty parts in the same circuit.

Could Be Knee

The scanning lines are severely compressed in a band about 1" high located one-fourth of the way from the top of the picture in an Admiral Model F23282N. I substituted yoke, transformers, and tubes. What now?

BILL MILLER

Gary, Ind.

I must say your substitutions were logical. Try several tubes of different brands. An unusual knee in the tube's characteristic curve is the most common cause for this trouble.

Skinny Admiral

An Admiral Chassis 17Z3D has insufficient width, and no provisions for increasing horizontal sweep. How can I install a width control?

JOHN R. ZANATH

Aliquippa, Pa.

Width adjustments generally act to decrease horizontal sweep, not to increase it; therefore, adding a control will not solve your problem. You'll have to tackle this job by finding out why the sweep circuit is not up to par. Assuming the B+ power supply is normal, concentrate your troubleshooting within the portion of the circuit reproduced here. A loss of width could be traced to some defective component in the grid-drive or screen circuit of the output

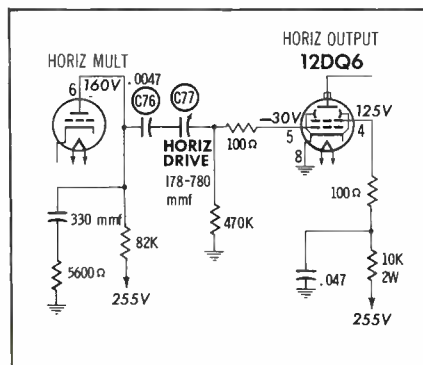

tube. Another possibility is misadjustment of the drive control; this trimmer regulates raster width by varying the division of drive-signal amplitude across C76 and C77. To check the condition of the horizontal discharge and output-grid circuits, take a calibrated scope and see if the peak-to-peak value of the signal at the grid is correct.

Which Way

The owner of a Zenith Trans-oceanic portable radio wants to connect it to a Zenith dual-unit hi-fi set. Would you recommend such? If so, what's the best way to connect it without distortion?

SHIGERU TAKAHASHI

Richmond, Calif.

Don't ask the portable to do the job

of providing the second channel of audio amplification for a stereo system. If you want to feed the portable's output signal into the hi-fi set, you can do that—but not with "hi-fi" results. Not knowing the specific chassis numbers prevents me from giving specific directions; however, taking the signal off at the volume control of the radio and feeding it to the phono-input circuit will probably do the job. Use shielded cable for the hookup. If the radio is an older tube-type unit with a three-way power supply, better stick to battery operation when the radio is connected to the hi-fi. Plugging the transformerless radio into the AC line is likely to result in troublesome hum and an over-all "hot-chassis" hazard.



The missing link in TV service ...

SENCORE SS105 SWEEP CIRCUIT TROUBLE SHOOTER

IT'S A UNIVERSAL HORIZONTAL OSCILLATOR. For direct substitution. No wires to disconnect in most cases. Traces trouble right down to the defective component. Variable output from 0-200 volts, peak-to-peak. Oscillator will sync to TV sync signal giving check on sync circuits.

HORIZONTAL OUTPUT CATHODE CURRENT CHECKER. A proven method that quickly checks the condition of the horizontal output tube and associated components. Adaptor socket prevents breaking wires. Easily replaceable Roll Chart gives all necessary pin, current and voltage data. New Roll Charts are Free.

UNIVERSAL DEFLECTION YOKE. A new, simple way to determine yoke failure accurately—without removing yoke from picture tube. Merely disconnect one yoke lead and substitute. If high voltage (also bright vertical line) is restored, TV yoke is defective.

DYNAMIC FLYBACK TRANSFORMER CHECKER. Merely flip switch to "Flyback Check" and meter will indicate condition of flyback transformer, in degrees of horizontal deflection. Extremely sensitive and accurate; even shows up one shorted turn on flyback.

VOLTMETER. For testing bootstrap, screen and other voltages. Direct-reading voltmeter, 0-1000 volts.

UNIVERSAL VERTICAL OSCILLATOR. Checks oscillator, output transformer and yoke. Merely touch lead to component and check picture on screen.

SS105 is completely self-contained, nothing else is needed. New Improved Circuit... DEALER NET 42⁹⁵

HORIZ. OSC.	VERT. OSC.
HORIZ. O.P. STAGE	VERT. O.P. STAGE
HORIZ. FLYBACK XFORMER	VERT. O.P. XFORMER
HORIZ. DEFLEC. YOKE	VERT. DEFLEC. YOKE

ALL PARTS

SENCORE

MADE IN AMERICA

SENCORE
ADDISON 2, ILLINOIS

Horizontal Sweep

(Continued from page 29)

and decreasing the time constant of the grid-leak circuit. The resulting drop in bias causes the positive peaks of W2 to be flattened slightly more than usual. However, ordinary high-resistance leakage in C56 would cause only a slight decrease in circuit efficiency.

If C56 becomes open, the impedance in the lower section of the AC voltage divider will rise; therefore, the amplitude of W2 will become more nearly equal to that of W1. The DC grid voltage will then be-

come several volts more negative, and the symptoms will be generally similar to those observed when R91 increases in value.

An increase in the capacitance of C56 lowers the amplitude of W2, and also modifies its waveshape as depicted in Fig. 3. Notice the more gradual rise of the positive-going slope and the flattened top of the waveform. This results in a narrower picture with no sign of foldover.

Among other troubles which may develop in the grid circuit of V9 is a change in value of grid-leak re-

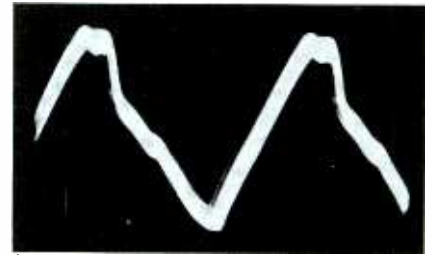

Fig. 7. Moderate ripple in W3 due to decrease in value of boost capacitor.

sistor R91. Doubling its resistance increases the discharge time of the grid-leak network, and thus increases the negative DC grid voltage on V9. The amplitude of W2 is not significantly changed, but the build-up of bias on V9 reduces this tube's conduction period. V9 then takes abnormally long to reach a condition of saturation, and the flat spot on the positive peak of W2 is narrower than normal (see Fig. 4A). The right side of the raster is again compressed (Fig. 4B), but not exactly in the same way as in Fig. 2A. Since the output tube is not being driven into an excessively long period of saturation during positive peaks of the drive-signal waveform, no foldover is apparent at the right side of the raster. However, a faint white vertical line appears near the center of the screen. This symptom, which indicates a slackening in the speed of the electron beam near the middle of each scanning line, occurs because the excessive bias on the output tube prevents it from starting conduction immediately after the end of damper conduction on each scanning cycle.

Although the cathode of V9 in Fig. 1 is connected to ground, many receivers are equipped with a cathode-bias network consisting of a low value of resistance bypassed by a capacitor (dotted-in components in Fig. 1). In case of a decreased-value or open capacitor, degeneration occurs within the tube and lowers the gain of the entire stage. This fault would produce a narrow picture, decreased high voltage, and perhaps circuit failure.

Screen Circuit

In the screen-grid circuit of V9, we note that bypass capacitor C57 and resistor R92 prevent development of much signal voltage. The normal screen waveform W3 has



Spot in a flash...
FAULTY CAPACITORS
AND RESISTORS

A complete range of capacitors and resistors at your command.

SENCORE HANDY 36 SUBSTITUTION UNIT

Serviceman... Engineer... Experimentor... here's a unit that really saves you time. The Handy 36 provides the 36 most often needed capacitors and resistors for fast, on the spot substitution. The 12 position, 3 wafer switch individually selects one of the 36 components. You simply dial the value you want to the exact or closest reading. Substitution is still the only time tested method for determining whether or not a component is faulty while operating in circuit.

Eliminate time wasted in hunting for parts to use in testing. Say goodbye to the soldering mess created by substituting individual components. Put an end to the twisted wires and messy parts you've tossed in parts drawers.

The Handy 36 is simple to use. If a component is suspected of being shorted, open one end and substitute the Handy 36. Or, merely parallel any capacitor or resistor you think is open.

Model H36.....DEALER NET **1275**

Ask any parts distributor for the "Handy 36", accept no substitute.

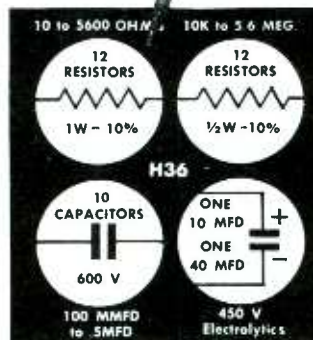

The Handy 36, with new improved circuitry, pays for itself in the first month by saving you those valuable minutes. The parts alone in the H36 would cost you more than the completed unit.



an amplitude of only 6 volts peak to peak.

Fig. 5 shows the 100-volt pulse signal obtained at the screen grid when C57 opens. The fluctuations in signal voltage result in decreased horizontal sweep energy, and the picture tends to have insufficient width accompanied by slight fold-over at the right side. However, the average voltage on the screen increases to 165 volts, as measured with a DC VTVM. W4 then decreases in amplitude to 250 volts, while boost voltage drops to 590 volts.

With 1-megohm leakage in C57, the screen voltage drops only slightly and the amplitude of W3 remains the same; width is narrowed only slightly and boost voltage remains constant. A change in the value of R92 is best detected by measuring screen-grid voltage and observing the effect on the raster, since waveforms are not appreciably affected by this defect. The raster will shrink as shown in Fig. 4B if R92 increases in value to 30K ohms. A reduction of resistance would increase the width.

B+ Boost

Boost capacitor C58 is one of the least-understood components in the entire circuit. Its prime function is to serve as the source for a DC voltage higher than that available from B+, and it receives its charge during conduction of the damper tube. The boost capacitor can be considered to be the actual

boost-voltage source, in the same sense that electrolytic filter capacitors in the low-voltage rectifier circuit act as a source. A short in this capacitor will entirely destroy horizontal deflection, since this failure effectively puts a short directly across the windings of both the yoke and horizontal output transformer. No boost voltage will be developed, but B+ should still be present on the boost line.

An increase in capacitance of C58 will not greatly change the value of DC boost voltage; however, the ripple waveform W5 will

decrease greatly in amplitude. Incidentally, this particular type of receiver has a ripple waveform of exceptionally high amplitude (250 volts peak to peak) on the boost line. In many other sets — older ones in particular—the ripple amplitude will be under 50 volts peak to peak.

An open C58 will cause sweep failure and loss of high voltage in some sets, or a dim raster with multiple foldover (Fig. 6A) in others. Boost voltage will drop to approximately the B+ level, and—if there is any raster at all—bloom-

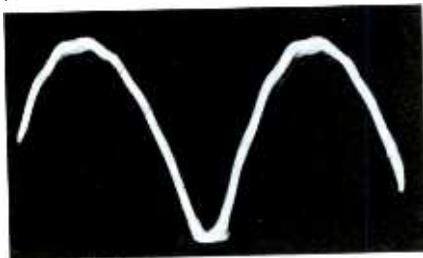

(A) Ripple in boost waveform W5.

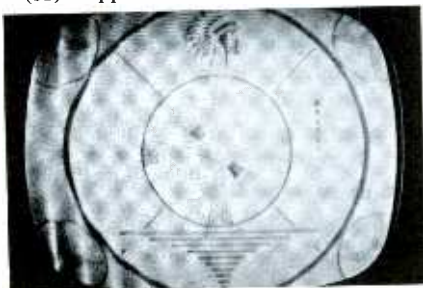

(B) Bars and ripples in raster.

Fig. 8. Symptoms observed when the damping capacitor in the yoke opens.

Substitutes FOR ALL ELECTROLYTICS
without Arc or Spark!

Complete range of electrolytics — 4 to 350 MFD. Connect in any circuit from 2 to 450 V.

SENCORE ES102 ELECTRO-SUB

- What more can you ask for? The Electro-Sub not only saves time for any serviceman, engineer or experimenter but insures maximum protection too. Simply select the electrolytic, connect test leads and push surge protector switch.
 - How many times have you reached for an electrolytic for substitution to find that value or voltage rating missing?
 - How many times have you wanted a value just a little higher to see if you could knock out annoying hum?
 - How many times have you had sets that blow fuses, fuse resistors or rectifiers and you did not check all electrolytics because it was too time consuming?
 - Have you ever healed a suspected electrolytic by "bridging" it and made a call back that same week on the same trouble?
 - Have you ever grabbed an electrolytic that you thought was discharged or watched a customer's dismay as you discharge one?
 - Well, here is your answer . . . from the smallest electrolytics used in transistor radios to the largest used in costly Hi-Fi amplifiers . . . complete, safe substitution.
- ES102.....DEALER NET 15⁹⁵**

AUTOMATIC SURGE PROTECTOR
for you and the circuit

DISCHARGE CHARGE SUBSTITUTE

It does all this by merely pushing surge protector switch. Move it as fast as you want; it is smooth and returns automatically.

You'd pay more for just the parts than you would for the complete ES102 . . . amazed? See your parts distributor.

ALL PARTS
SENCORE
MADE IN AMERICA

SENCORE
ADDISON 2, ILLINOIS

ing will be pronounced. The cathode voltage of the damper will not be filtered; thus, abnormal voltage fluctuations will be reflected back along the boost and B+ lines. The rippled distortion in Fig. 6B shows the effects of this horizontal ringing on the grid-drive signal W2, and Fig. 6C shows a corresponding ripple in the screen waveform W3.

In case the boost capacitance is reduced, W3 will be normal in amplitude, but will reveal an abnormal ripple-voltage waveform (Fig. 7). The boost voltage will drop, and the raster will be compressed

and slightly folded over on the right side, as in Fig. 2A.

Yoke Damping

Capacitors C60, C61, and C62 (across the yoke terminals) are for the purpose of damping oscillatory currents in the horizontal deflection coils. An open damping capacitor will, as a rule, cause enough increase in current to burn up the resistor in the yoke-damping circuit (4700-ohm unit in Fig. 1). Fig. 8A shows that poor damping of yoke current causes ripples to appear on the boost voltage line.

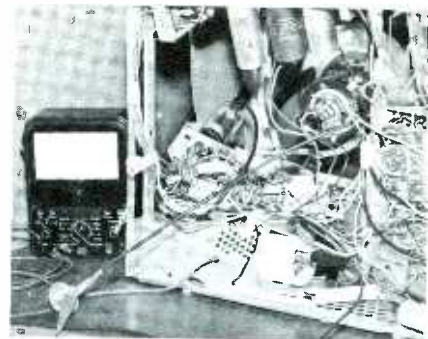

Fig. 9. Test setup for measuring the filament voltage fed to HV rectifier.

This undamped energy can produce both *ringing* and *cross talk* in the yoke. Ringing in the horizontal coils causes an alternate slowdown and speedup of the scanning beam, which results in light vertical lines or bars on the screen. When horizontal ringing is induced into the vertical yoke coils, this effect is termed cross talk. The scanning beam will then be deflected vertically by the spurious horizontal sweep energy, and each horizontal line will be distorted into a ripple-like appearance. Fig. 8B illustrates both of these symptoms.

Optional Features

Some of the refinements found in older sweep-circuit designs, such as width or linearity coils, are not present in most of today's receivers. However, it should be noted that a width coil connected across a low-inductance winding of the horizontal output transformer can do nothing more than absorb energy and therefore reduce width. The linearity coil, a variable filter choke in the boost circuit, regulates damper conduction to provide a smooth transition between the conduction of the horizontal output and damper tubes during each horizontal sweep cycle. Proper adjustment of this coil produces a practically linear scanning-current waveform.

Perhaps it would be well to inject a reminder that the horizontal deflection circuit can be divided into two functional sections for analysis by raster observation. Abnormal conditions appearing in approximately the left half of the raster are characteristically a direct result of trouble somewhere in the damper circuit, while those in the right half are generally produced by circuits affecting the horizontal out-

SENCORE RS106 RECTIFIER TROUBLE-SHOOTER

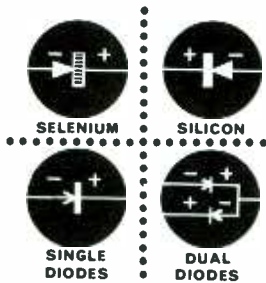

Instant, Direct Substitution for . . .

SELENIUM RECTIFIERS. Substitutes for all types used in Radio, TV and other electronic devices up to 500 ma.

SILICON RECTIFIERS. Types found in many new TV sets.

SINGLE DIODES. With exception of some used in high frequency circuits.

DUAL DIODES. Types used in sync Discriminator circuits. Third test lead is provided for center connection.

Sencore has simplified trouble shooting rectifiers and diodes with this unique substitution unit. The RS106 gives you a positive check everytime . . . Substitute for suspected rectifier or diode . . . watch picture or listen to sound and you'll know in seconds whether or not the rectifier or diode should be replaced. No guess work, no soldering mess, no time lost. The RS106 actually costs less than having loose rectifiers and diodes in the shop for testing and is worth many times more.

- Rectifiers & Diodes at your finger tips for fast substitution
- Protected by 1/2 amp. Slow Blow Fuse.

RS 106
DEALER NET. . . **1275**

Ask your Distributor to show you the RS106.

ALL PARTS
SENCORE
MADE IN AMERICA

SENCORE
ADDISON 2, ILLINOIS

put stage. The border between these two areas is the zone where drive lines, or symptoms of poor linearity, develop as a result of incorrect timing between the damper ceasing to conduct and the horizontal output tube beginning to conduct.

Some receivers, especially the older models, employ an isolated-secondary type of horizontal output transformer rather than the more efficient autoformer shown in Fig. 1. The main difference in the two circuits is in the connection of the damper tube; in the isolated-transformer circuit, the transformer secondary is connected to the damper plate rather than the cathode. However, component functions and test results are quite similar for both styles of circuits.

High Voltage

A by-product of the horizontal deflection system is high voltage. When the horizontal output tube is cut off at the end of the scanning period, there is an instantaneous increase in the tube's plate voltage, as well as in the cathode voltage of the damper. This increase, reinforced by the collapse of the magnetic field in the yoke and output transformer, produces a high-amplitude positive-going pulse which is stepped up in the transformer and connected to the plate of the high-voltage rectifier. At the same time, the pulse also shock-excites the horizontal-output circuit into temporary oscillation; as a result, the positive pulse is followed by a high-amplitude negative pulse which drives the damper tube into conduction and thus recharges the boost capacitor. Here is an important point to remember: If the boost voltage is correct, you can assume that a satisfactory high-voltage pulse is being developed by the circuit. The cause of high-voltage trouble is thus isolated to the HV circuit itself.

In replacing a horizontal output transformer, the installer may neglect to provide sufficient coupling for the filament winding—resulting in insufficient heater current for the high-voltage rectifier. Consequently, the set develops insufficient high voltage. If this condition is sus-

pected, the filament voltage can be measured with a regular 1000-ohm-per-volt AC meter. *Extreme caution* must be used in making this measurement. The leads must be attached while the set is turned off, and leads and clips must be positioned so that the high-voltage DC present in the test circuit does not arc to ground (see Fig. 9). When measuring the voltage, set the meter to the 2.5- or 3-volt scale prior to turning the set on. Typically, normal voltage measurement under these conditions will be from .8 to 1 volt AC.

Conclusion

This part-by-part analysis of a typical horizontal sweep system should provide help in interpreting the meaning of incorrect waveform and voltage readings encountered in service work. The reader is encouraged to analyze the results of component-value changes and misadjustments in other horizontal circuits, using his own test equipment. A better understanding of the circuit's reaction to changes, and a more thorough knowledge of testing techniques, are guaranteed to make servicing easier. ▲



FIND TUBE TROUBLES OTHERS MISS!

A New Dynamic Approach

Check over 1300 tubes for

- Cathode Emission
- Grid Emission
- Leakage
- Shorts
- Gas

SENCORE "MIGHTY MITE" TUBE CHECKER

Answers the needs of the fast moving, profit minded serviceman who hates time consuming call backs. A "mite" to carry but a whale of a performer with more efficiency than testers costing much more.

New unique circuitry tests for grid emission and leakage as high as 100 megohms yet checks cathode current at operating levels. Special short test checks for shorts between all elements. The MIGHTY MITE will test every radio and TV tube that you encounter (over 1300!) plus picture tubes. Set up controls as easy as "A B C D" from easy to follow tube chart. New tube charts provided free of charge.

AND check these added Sencore servicing features: • Meter glows in dark for easy reading behind TV set • Stainless steel mirror in cover for TV adjustments • Rugged, all steel carrying case and easy grip handle • Smallest complete tester made.

Model TC109.....DEALER NET **59.50**

Ask your distributor for the "MIGHTY MITE" with the mirror in the cover



Use it everyday in every way. Especially designed so you can transfer inner chassis to your tube caddy, bench or counter. Only 9" x 8" x 2 1/2".



SENCORE
ADDISON 2, ILLINOIS

Painted Circuits

(Continued from page 31)

Philco

Service information is carried on the component side of the printed boards in most Philco models, since this surface is much more easily accessible than the wiring side. (See *Previews of New Sets*, November, 1959.) Bright blue or purple lines (see colored areas in Fig. 4) indicate the exact paths of the foil conductors on the opposite side of the board. Other servicing aids include tube type numbers and circuit functions, component serial

numbers, and words to describe the electrical locations of lugs where wires are fastened to the board. As a further help, most of the sockets for unshielded tubes have built-in test jacks.

Once you have established a known starting point, you can trace for some distance by following the conductor paths from one component to the next. Try this technique on the vertical sweep circuit shown in Fig. 4. Since you'll have to go through this "practice run" without reading resistor color codes or looking at the board from different

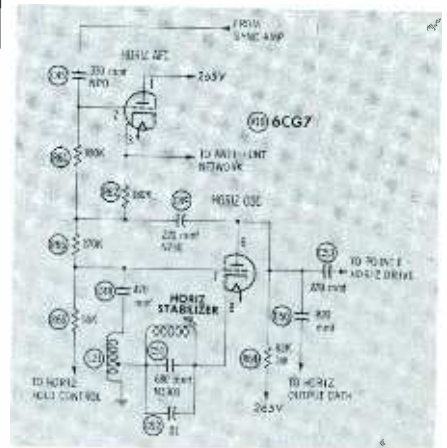
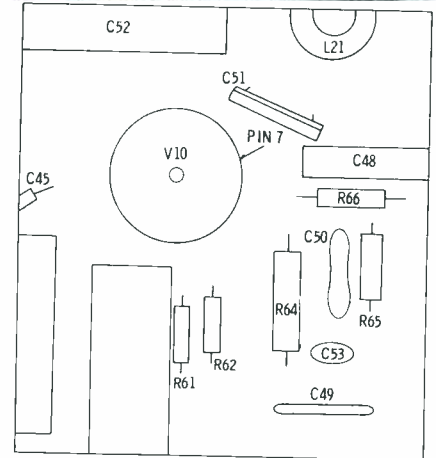
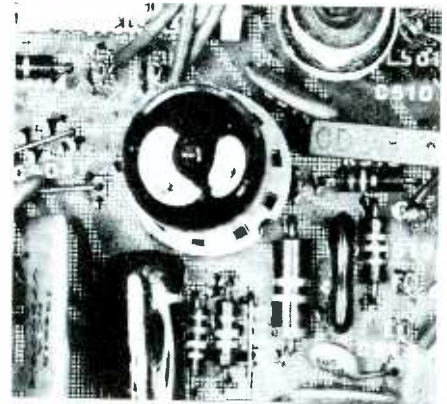

Fig. 5. System used by RCA also employs replica of conductor pattern.

angles, we have provided a component-location diagram to assist you. However, you can trace most of the circuits in an actual set with no aid other than a schematic.

Here are a few additional clues: Remember to count tube pins counterclockwise around the top side of the socket. Also keep in mind that R56 and the upper lead of C42 are hidden by overlying wires. Finally, note that the connection from K5 to pin 7 of V8 dives under the keyway of the tube socket.

RCA

The printed boards in current

Check TUBES, VIBRATORS THE SENCORE WAY

FAST
ACCURATE
TROUBLE
SHOOTING



America's Most Popular Tube Tester
more than 25,000 now in use

SENCORE LC3 LEAKAGE CHECKER

Whips those "tough dog" tube troubles . . .

Ask any serviceman who owns one . . . or try one for just one day of servicing in your shop. You'll see for yourself how much time the LC3 can save you. Checks for leakage between all elements, whether caused by gas, grid emission or foreign particles. Also checks leakage on all capacitors with voltage applied—including electrolytics. Provides instant filament checks in "Fil-Check" position—no need for a second filament checker. One spare pre-heating socket and new roll chart prevent obsolescence. New charts provided—no charge. Leakage sensitivity, 100 megohms, control grid to all other elements; 50,000 ohms, heater to cathode. Size, 7x6x3½". Wt., 3 lbs. For 110-120 volts, 60 cycle AC. DEALER NET **28⁹⁵**

NOW . . . checks 172 tube types—more than any other checker of this type.

NEW . . . replaceable Roll Chart prevents obsolescence.

Check Filaments of All Receiving Tubes and Picture Tubes



FC4 FILAMENT CHECKER

For fast, easy checking of all tube filaments, without pulling chassis. Neon light goes out if tube filament is good. Also acts as continuity and voltage tester. Neon lamp glows when 115 v. AC is applied by heater cord, providing a check on power to TV set. Size, 3½x4x1". With leads. DEALER NET.....**2⁹⁵**

Check 3- and 4-Prong Vibrators . . . Faster, Easier



VB2 "VIBRA-DAPTOR"

Plugs into any tube checker; ideal for use with LC3 above. To check 6-v. vibrators, set for 6AX4 or 6SN7; for 12-v. vibrators, set for 12AX4 or 12SN7. Two No. 51 lamps indicate whether vibrator needs replacing. Instructions on front panel. Steel case. Size, 1½x1½x3". DEALER NET.....**2⁷⁵**

See your Parts Distributor NOW!

ALL PARTS
SENCORE
MADE IN AMERICA

SENCORE
ADDISON 2, ILLINOIS

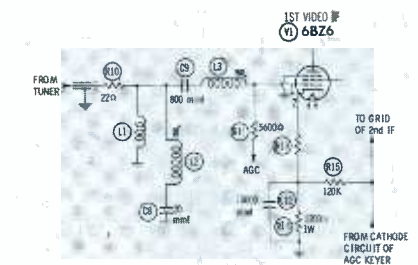
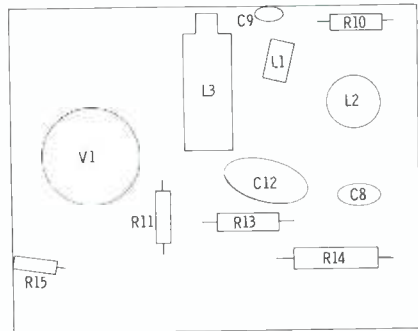

Fig. 6. General Electric boards have a highly simplified wiring diagram.

RCA models are also mounted with the component side within easiest reach (see October *Previews*); so this is where you'll find the painted circuit data.

As in Philco sets, the basic information consists of a replica of the conductor strips on the opposite side of the board—but RCA's lines are in a "screened" pattern of white dots instead of being in solid color. Serial numbers of components are given, as well as code letters to designate the connecting lugs for interchassis wires. Some tube sockets are equipped with test jacks.

The horizontal oscillator-AFC circuit in Fig. 5 will give you some practice in tracing RCA's new painted boards. Something you can't see, but should know, is that the return lead from the left end of C52 passes under the component body for most of its length before returning to pin 8 of V10. Also be on guard for other conductor lines (such as the one at the top of R65) which dive under components and emerge on the other side.

Admiral

Some of the newest Admiral sets have a painted wiring diagram extremely similar to the arrangement used by RCA. If you master one system, you will have no trouble with the other.

Sylvania

Another painted wiring system very similar in appearance to RCA's is found in the Sylvania Chassis 547-1, a 17" portable introduced this spring. In addition to conductor-path and part-number information, the board in this chassis carries the type numbers of all tubes.

General Electric

The present G-E models have two printed boards—one mounted horizontally, the other vertically. (See February *Previews*.) Both sides of both boards are accessible after removal of the "wrap-around" back cover, but most troubleshooting is done more conveniently from the component side. Accordingly, the painted service information consists of a diagram showing the connections between component leads.

G-E does not use an exact pictorial reproduction of the conductor strips, but has worked out a

Transistor Radio Servicing CAN be Highly Profitable

The ONLY Complete Transistor Radio Service Lab

Everything you need for less than \$50

Check Transistors, Diodes, Rectifiers . . .

SENCORE TRC4 TRANSISTOR CHECKER
 Accurately checks all transistors in hearing aids, radios and power transistors in auto radios. Tests for opens, shorts, leakage, current gain. Measures forward-reverse current ratio on all crystal diodes. Measures forward and reverse currents on selenium rectifiers. With set-up chart for accurate checking of each transistor. Size, 5x4½x2½". With batteries. DEALER NET..... **1995**

Replace Batteries During Repair . . .

SENCORE PS103 BATTERY ELIMINATOR
 All-new "Transi-Pak," twin to TRC4 Checker above. Provides variable DC voltage to 24 volts; 1.5-volt biasing tap (a "must" for servicing Philco and Sylvania radios). Metered current output, to 100 ma. Handles 200-ma peaks. Two 200-mfd electrolytics provide proper filtering and low output impedance. No hum or feedback problems. Ideal for alignment using station signal; adjust IF slugs for max. current, also ideal for charging nickel-cadmium batteries. Size, 5x4½x2½". **1995**
 DEALER NET.....

Find Defective Stage in a Minute . . .

SENCORE HG104 HARMONIC GENERATOR
 New signal generator designed primarily for fast signal-tracing of transistor radio circuits. No need to unsolder all transistors. Provides RF, IF and audio signals *simultaneously*, drastically cutting service time. Traces from speaker to antenna. Clear 1000 cycle note signal is heard in speaker from all good stages. Signal weakens or stops at defective stage. Equally as effective for testing TV, hi-fi and other audio circuits also. Size, 3½x4½x1¾". **995**
 With batteries. DEALER NET.....

Turn page for other

SENCORE

Time Savers

ALL PARTS

SENCORE

MADE IN AMERICA

SENCORE

ADDISON 2, ILLINOIS

Two Fellows who want to work for you.

VG-1 Voltage Gauge



Quickly tells you what the voltage is at the flyback transformer.

\$1.98 Dealer Net

Model 50-A Inductive Winding Tester



Tried and proved—the best transformer tester you can buy at any price.

\$19.95 Dealer Net

B & M ELECTRONIC MFG. CO.
2516 Dodge Avenue
Fort Wayne, Indiana

3¢

will start you
on a new road to
additional profits
and happy customers
with speaker repair.

**WALDOM
RECONING**

Attach this coupon to
a Post Card and mail.
We will send you the
complete story.

Your Name _____

Company _____

Street _____

City _____

Send to **WALDOM ELECTRONICS INC.**
4625 WEST 53RD STREET, CHICAGO 32, ILL

simplified system of straight, narrow lines to represent the conductive paths. Short, arrow-like symbols designate grounded leads, thus eliminating the need for showing the complete route of the common-ground conductor strips. Type numbers of all tubes are placed next to the sockets. The servicing information is printed in yellow; additional numbers and lines, for use during production, are in white.

The first video IF stage of the U4 chassis (Fig. 6) is on the vertically-mounted board. The side shown in this photograph faces "in-board" (toward the neck of the picture tube); note that the tube sockets are installed to allow plugging in the tubes on the opposite, or "outboard," side. The horizontally-mounted board is more conventionally arranged, with tubes on the same side as the components.

Motorola

The only printed-circuit TV set in the Motorola line, the Model 17P6 portable using Chassis TS-433, is radically different from any of the other sets discussed thus far. The differences stem mainly from the unusual layout of Motorola's *Placir* chassis, with conductor strips on *both* sides of the board. Service information is freely applied to both top and bottom surfaces, and the set is arranged for easy accessibility to either side. The board, which lies across the floor of the chassis, is equipped with a series of snap-in connectors (Fig. 7) so that it can be completely unplugged and slid out of the cabinet for component replacement. For troubleshooting with power on, the serviceman may remove the wrap-around cabinet from the chassis frame; or, if he prefers, he can unscrew the entire snap-in conductor assembly, unfold its long connecting leads, and operate the set while the board is completely outside the cabinet. The electrical functions of all the snap-in connectors are plainly labeled as an additional aid to servicing.

A close-up view of the board's under surface (Fig. 8) reveals the tube type numbers and "pin 1" designations etched directly into the copper foil at each tube socket. Unfortunately, this photo doesn't do justice to Motorola's painted-

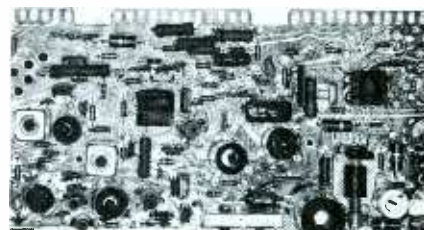

Fig. 7. Printed board in a Motorola portable can be completely unplugged.

circuit system, in which the various conductor strips are overlaid with brilliant red, green, and yellow markings. The idea is to simplify circuit-tracing by providing a near equivalent to the color-coded hook-up wire employed in conventionally built sets. As an extra convenience, the paths of conductors on the opposite side of the board are indicated by black lines. This last feature is especially helpful in tracing paths between component leads on the upper side of the board, particularly when the chassis has not been separated from the cabinet. For extensive troubleshooting, however, the serviceman will probably need to disassemble the set to the point where he can freely examine both sides of the board.

In Fig. 8, note the spotted appearance of the conductors. The ground strips are bare copper, etched with a checkerboard pattern; most of the other leads (except heater circuits) carry painted codes involving several combinations of dots. The coding system, although unfamiliar at first, becomes understandable with a little practice.

What of the Future?

The idea of adding service data to printed wiring boards has almost endless possibilities. We can expect future models to include refinements of the systems introduced this year—greater legibility, more information, etc.—and we probably will also be seeing brand-new systems with a wholly different approach. ▲

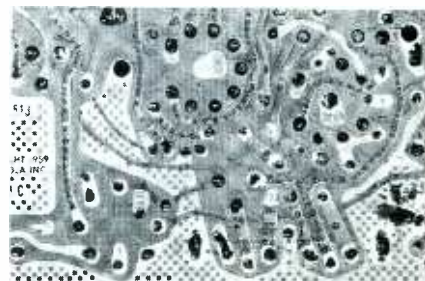

Fig. 8. Tube type numbers and pin-1 markings are etched directly into foil.

Have HV, No Raster

(Continued from page 26)

You should keep in mind that a breakdown in a sweep component will not always completely kill high voltage. In some receivers, for example, an open horizontal winding in the yoke or an open yoke-return capacitor will permit enough high voltage to be developed so that you can draw an arc. Then, provided vertical sweep is still operative, a vertical line will appear down the center of the screen. It's interesting to note that boost voltage will often increase under these conditions, rather than decreasing as you might expect it to do. A faulty damper circuit has also been known to permit high voltage without sweep in a few receivers.

There may be times when you assume that high voltage is normal at the picture tube anode, when it is actually RF or alternating in nature. In this case, the arc will usually have plenty of length but will appear bluish-red and have a tendency to bend or curve. Another symptom to look for is multiple arcing from the outer coating of the CRT to chassis, even though a suitable ground strap is in position. The most common cause for this condition is a shorted high-voltage rectifier tube.

Elementary Causes

"Never overlook the obvious!" an experienced serviceman told me years ago. This wise advice has been recalled to my mind time and time again as I needlessly pulled a chassis into the shop, or wasted considerable troubleshooting effort, before finding some ridiculously simple thing wrong with a set. You should be especially careful to heed these words when dealing with the trouble symptoms of high voltage but no raster.

As an example, if you walk into a customer's home where there are children, or do-it-yourself fans, be on the lookout for some elementary cause such as a turned-down brightness control or a TV-PHONO switch in the wrong position. These can easily be overlooked by the customer and the serviceman, especially if the adjustments are located on the back of the set.

Another point is to check all con-



it's the radio-tv
serviceman's
"best friend"!

KESTER SOLDER



KESTER "RESIN-FIVE" FLUX-CORE SOLDER enjoys almost 100% acceptance by the radio-television-electronics service industry. Servicemen like its fast action and easy application . . . its non-corrosive, non-conductive activated flux does a perfect job every time.

Send for detailed information on Kester "Resin-Five" Flux-Core Solder.

KESTER SOLDER CO.

4228 Wrightwood Ave., Chicago 39, Illinois
Newark 5, N.J., Anaheim, Calif., Brantford, Canada

OVER 60 YEARS' EXPERIENCE IN SOLDER AND FLUX MANUFACTURING

BERNS PERFECT PIN-CRIMPER

Picture-Tube Repair Tool

Eliminates that hard soldering job.

only \$1.25

PT-1

Fix loose pin connections in seconds. Pays for itself in time saved on one job alone. 3" long.

U. S. Pat. 2,878,698
Canadian Pat. 592,702

Intermittent operation of picture tubes due to defective solder connections at socket pins is easily corrected through the use of the Berns Perfect Pin-Crimper. Actually a 3-in-1 tool that can also be used as a channel-selector wrench and screwdriver, it serves to notch pins and element leads to provide solid electrical connections. Pin keeps its original form.

3 models: PT-1 for 3/32" pin diameter; AU-2 for 1/8" pin diameter and installing C rings; LC-3 for 5/32" pin diameter.

Available at your parts distributor.
Another fine product from:

BERNS

Mfg. Co.
9853 Chalmers,
Detroit 13, Mich

TARZIAN Offers 48-Hour, Direct Factory Service on Tuner Repairs

only
\$8.50

Price Effective Jan. 1, 1960

That's right. Net, \$8.50 per unit and \$15 for UV combinations, including ALL replacement parts. 90-day warranty against defective workmanship and parts failure. Tuners repaired on approved, open accounts. Replacements offered at these prices* on tuners not repairable:

VHF 12 position tuner	\$22.00
VHF 13 or 16 position	23.00
VHF/UHF combination	25.00
UHF only	15.50

*Subject to change



Tarzian-made tuners are easily identified by this stamping on the unit. When inquiring about service or replacements for other than Tarzian-made tuners, always give tube complement . . . shaft length . . . filament voltage . . . series or shunt heater . . . IF frequency, chassis identification and allow a little more time for service. Contact your local distributor or use this address for fast, 48-hour service:

SARKES TARZIAN, Inc.

Att.: Service Mgr., Tuner Division
East Hillside Drive
Bloomington, Indiana

nections that might come loose and result in a loss of raster. Make sure the picture-tube socket is properly positioned on the base; if a brightener is employed, check its connections, too. Examine the yoke leads and, if a plug is used, see that it is inserted correctly into the yoke socket. Also take a look at the picture tube anode connector; excessive dirt may be causing high voltage to leak or arc over to the aquadag.

If a do-it-yourselfer has recently been down to the drugstore to check his tubes, or if he's pulled the

chassis to clean the screen, be on the lookout for a misadjusted ion trap. In performing his "repair," he might have nudged the trap just enough to deflect the raster right off of the screen. Don't pull a boo-boo almost as bad, however, and go turning and sliding the trap before you're reasonably sure this is actually the trouble. Make a few preliminary checks of the CRT and its operating voltages first.

In certain receivers employing keyed AGC and DC coupling to the picture tube cathode, an inoperative AGC system can some-



Fig. 3. Two quick cures for any faulty connection at the base pins of a CRT.

times cause a blackout of the TV screen. To check for this possibility, merely advance the brightness control and adjust the tuner to a non-operating channel; if raster is restored, troubleshooting of the RF, IF, video, and AGC stages is in order.

Picture-Tube Circuitry

Another very probable reason for "high voltage, no raster" is a fault in the beam-controlling circuits of the CRT. As a quick check to see if the tube is conducting, remove the high-voltage lead and arc the connector to the anode. If no current is being drawn, you'll find that only a single spark will jump to the anode cap; when current is drawn, the arc will be continuous. You can also measure high voltage while varying the brightness control setting. When the tube is delivering normal beam current, you should note a decrease in high voltage of from 5% to 10% at maximum brightness.

A couple of typical picture-tube circuits are shown in Fig. 2. In section A of this figure, the video amplifier is driving the cathode element of the tube; therefore, an input signal with positive-going sync pulses is required. In Fig. 2B, the signal goes to the grid instead of the cathode—so it is inverted in polarity. Although both illustrations show the brightness control connected in the cathode circuit, some receivers have a grid-connected control.

CRAFTSMANSHIP

SETS A JEWEL IN
EVERY  **Ronette**
STYLUS

... FOR SUPERIOR,
TROUBLE-FREE PERFORMANCE

The dependable quality of CBS-Ronette cartridges has many facets, of which jeweled styli is an important one. All 27 models are jeweled.

These 27 cartridges replace over 500 others . . . with noticeably improved performance. They also provide exact like-new replacements for six-million-plus CBS-Ronette cartridges now in use in the U. S. A.

A complete catalog and cross-reference chart makes choosing the proper replacement quick, easy and sure. So ask your distributor for catalog PF-285. And be sure to ask him always for CBS-Ronette, the quality cartridge.



CBS ELECTRONICS
Danvers, Massachusetts, U. S. A.
A Division of Columbia Broadcasting System, Inc.

Receiving, industrial and picture tubes • transistors and diodes
audio components • and phonographs

Typical operating voltages of modern CRT's place the grid at approximately 15 to 70 volts negative with respect to the cathode. This does *not* mean, however, that the grid will always be negative with respect to chassis ground. In many cases, you'll find the grid near ground (zero) potential, but it is maintained at anywhere from 5 to as high as 100 volts above ground in some sets. (This is especially true of sets with DC coupling from video amplifier to CRT.) Thus, the easiest and most accurate way to check CRT bias is to measure the voltage difference between grid and cathode. Manipulation of the brightness control should vary the bias reading by at least 1 to 40 volts—often much more.

If the video amplifier is DC coupled to the picture tube cathode and you find cathode bias abnormally positive, always check to see if the video amplifier tube is conducting. If this stage is blocking due to signal overload, incorrect bias, etc., its plate voltage will be high and the CRT cathode will go too positive for the picture tube to produce a visible raster.

Taking a look at other elements of the tube, you'll normally measure somewhere between +200 and +500 volts on the accelerating grid. For those tubes employing electrostatic focus (see Fig. 2A), you're likely to find just about any measurement from zero to +600 volts on the focus anode. Trouble in this circuit results in poor focus, but I've never seen it cause a complete loss of raster. The filament circuit, of course, demands a potential of from 6 to 7 volts AC. If a brightener is used, the supply voltage may be as high as 9 or 10 volts. An intermittent trouble in this circuit may result from a bad connection at the CRT base.

Getting right down to the bare facts about specific faults which might cause the picture tube to be cut off, let's first examine the grid-cathode circuit. The bias on the tube will be increased by either a positive-going shift in cathode voltage or a negative shift in grid voltage. When the bias reaches approximately 70 volts, the average CRT will be driven into cutoff, and no light will appear on the screen.



OXFORD
... the Leader

WALTZ ME AROUND AGAIN, WILLIE!

OXFORD SPEAKERS
... Preferred for original equipment,
... Proven for replacement.
Our catalog is available upon request.

A phrase aimed for increasing your profits. Since the original equipment manufacturer demands speakers to the most exacting electrical characteristics . . . and demands OXFORD . . . **W-4Y DON'T YOU?** Oxford, major suppliers for original equipment provides the finest replacement speakers for any and every application. A complete line for your every need.

OXFORD Components,
A Division of Oxford Electric Corp.
556 West Monroe St., Chicago 6, Illinois

Oxford Speakers are available from recognized electronic parts distributors.

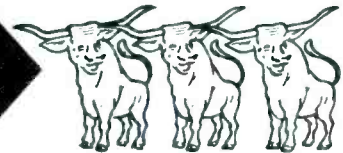

During MAY PARTS SHOW VISIT Display Room #557A

"Eliminates Soldering"

PERFECT *Audio*

"PIN-PLUG" CRIMPER

SLIP WIRE IN "PIN-PLUG," INSERT IN TOOL, AND SQUEEZE . . . JOB IS DONE



USE END OF BLADE AS SCREWDRIVER

U. S. Pat. 2,878,598
Canadian Pat. 592,702

USE END OF TOOL TO PUSH ON GROUND CONNECTOR

Useful in making hi-fi, audio and sound, radio, phono, and TV equipment connections.

only **\$1.25** C-rings 1c each

Get the tool that makes solid electrical pin-plug connections without soldering or destroying pin form. Use one end for pin crimping, the other to push on C-ring clamp for braided-shield ground connection. Nothing like it anywhere.

3 models: PT-1 for 3/32" pin diameter; AU-2 for 1/8" pin diameter and installing C rings; LC-3 for 5/32" pin diameter.

Available at your parts distributor.
Another fine product from:

BERNS Mfg. Co.
9853 Chalmers,
Detroit 13, Mich

BIG MONEY
CONVERT TAPE
RECORDERS TO
4 TRACK STEREO



Robins M/M 5Q17
(1/4 track)

ROBINS M/M exact replacement and conversion tape heads now available from your local parts jobber. 75% of all 2 track machines come equipped with M/M "B" series heads. ROBINS M/M 5Q17 (1/4 track) is an exact replacement for these.

Conversion can frequently be made by simply replacing a "B" head with a "Q" head. Send coupon for latest FREE NEW 16-PAGE REPLACEMENT GUIDE & CATALOG. AVAILABLE FROM PARTS JOBBERS.

ROBINS Industries Corp.
Flushing 54, N.Y.
Att: Mr. OSTRI



Please send FREE New Replacement Guide and Catalog to:

Name.....
Address.....
City.....
Zone..... State.....

RESIST-O-CADDY



FREE! with any of 4 Handy-Pak Carbon Resistor Assortments
20 Values

\$14⁴⁰ to \$28⁸⁰

Dealer Net

• COMPACT

• HANDY

• Plastic Pouch Fits Tube Caddy or Tool Kit

Order from your IRC Distributor



INTERNATIONAL RESISTANCE COMPANY
DISTRIBUTOR SALES DIVISION
414-N. 13th STREET • PHILADELPHIA 8, PA.

I'm walking on air...



Just had my annual medical check-up. (Smart move.) I'm making out a check to the American Cancer Society, right now—that's a smart move, too.

Guard your family!
Fight cancer with
a checkup and a check!

AMERICAN CANCER SOCIETY

If the cathode voltage seems suspiciously high in a circuit such as Fig. 2A, check the video coupling capacitor C1 for leakage or a short.

A leaky video coupling capacitor in a grid-driven CRT circuit (C1 in Fig. 2B) will raise the grid voltage instead of the cathode voltage. Then, instead of becoming blanked out, the raster will usually be too bright, and the brightness control will have little or no effect.

The tube may also cut off if resistors R1 or R2 in either circuit become open or increase considerably in value. The same is true for the brightness control and resistors R3 and R4 in Fig. 2B. If C2 (Fig. 2A) is leaky or shorted, or R4 should short or decrease in value, no light will appear on the screen either. Always make sure that B+ is applied to the brightness control and that there is continuity in both grid and cathode return circuits.

Unless a B-minus supply is employed in the receiver, the grid has little chance of going abnormally negative. Weird things have been known to happen, however, involving retrace-blanking circuits. A quick and easy way to eliminate this possibility is to merely disconnect the blanking network from the picture-tube circuit and check operation. If C3 (Fig. 2B) is shorted or leaky, for example, the cathode will go positive and thus cut the tube off.

Another cause of the "no-raster" symptom stemming from the picture-tube circuitry is an open or excessively high-value resistor in series with the accelerating grid circuit. This component corresponds to R3 in Fig. 2A and R5 in Fig. 2B. In a few of the older sets, DC restorers have been known to step out of line and upset CRT bias enough to darken the screen. This is usually easy to pin down by disconnecting the restorer stage — provided the grid return circuit of the CRT remains intact.

Bad CRT

When high voltage and all potentials at the picture tube socket seem to be normal, you will naturally suspect the tube itself. But before blaming the tube—or perhaps even before taking voltage measurements at the base pins—

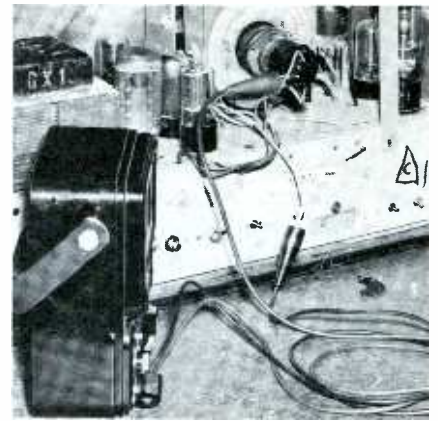

Fig. 4. If CRT socket permits, here's one easy way to measure cathode current.

it's a good idea to give the base of the tube a slight jar. After determining that high voltage is adequate and the filament is lit, turn up the brightness control and tap lightly a few times on the base with the handle of a small tool. If the tube is defective, the raster may "intermit," or multiple flashes of light may appear on the screen. Since it's very common for an open or shorted element in a CRT to produce this symptom, be sure to check this point early in your isolating procedure.

When the picture tube is the apparent offender, it's also a good idea to eliminate any possibility of an open or high-resistance connection at the base pins. This sort of trouble can usually be corrected by heating the pins one by one, or by using a crimping tool (Fig. 3). Incidentally, if there is not enough solder within a pin, don't hesitate to replenish it; but be careful, of course, not to let excessive solder harden on the outside of the pins.

Since the picture tubes in most of the newer receivers incorporate a straight gun, the ion trap or beam bender is becoming obsolete. Nevertheless, there are still quite a number of receivers in the field that make use of this device, and I would like to remind you again of its trouble potential. As for trap adjustment, you'll generally find two different positions on the neck of the CRT that will produce light on the screen; the proper location is the one nearest the tube base. When you suspect that a trap is demagnetized or too weak to yield a raster, try a substitute. If only a small part of the raster becomes visible after repositioning the unit, the gun

in the CRT may be damaged or out of alignment; the tube should be replaced in such cases.

Faults in a picture tube such as opens, shorts, leakage, gas, and low emission are easily detected by using a commercial CRT tester or substituting a bench check tube. Since heater-to-cathode leakage can sometimes cause a dark screen, you might consider feeding heater voltage to the CRT through an isolation transformer to alleviate this difficulty. Certain brighteners containing isolation transformers are now available in different models for use in either series or parallel heater circuits.

For low emission, a brightener can be employed, or perhaps the cathode can be reactivated by an instrument designed for this express purpose. If a meter with a low enough DC current range is available, you can measure cathode current (which under normal circumstances will be representative of total beam current) with little trouble. On tube sockets that have a removable back piece, the cathode connector and lead can be slipped out of the socket and the meter series-connected as illustrated in Fig. 4. If chassis wiring is exposed, another alternative would be to connect the meter in series with the cathode return circuit at a convenient terminal strip.

Due to the wide variations in tubes and their operating voltages, it is impractical to formulate an average or standard value for cathode current. Most often, however, a raster will not be completely extinguished until this current falls below 10 or 20 microamps. Such a test should be performed with the receiver tuned to an inactive channel and the brightness control advanced. Normally operating tubes may produce readings as high as 200 microamps or even more.

Troubleshooting Summary

- (A) Make sure HV is normal
- (B) Check elementary causes
- (C) Tap base of CRT
- (D) Heat or crimp pins
- (E) Measure CRT base voltages
- (F) Test or rejuvenate CRT
- (G) Sell 'em a new tube! ▲

COMING NEXT MONTH

PA Speaker Installation Tips

How often have you been irritated by reverberations which muffle PA-system announcements? Such acoustical problems are caused by improper speaker placement and phasing—the subject of this commercial sound feature.

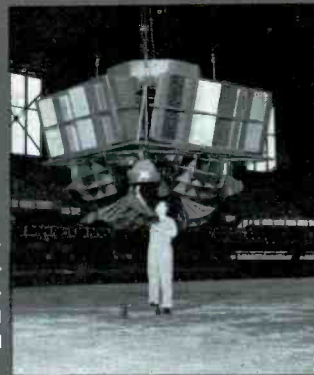

A Key to Keyed AGC

If you haven't been able to open the door to successful troubleshooting on those tricky '808 circuits, you'll want to try this "master locksmith's" technique.

Servicing Antenna Rotators

Rotators are often the perfect solution to obtaining good reception in a multiple-station area. But have you ever seen the "insides" of one—do you know what makes 'em tick? If not, this picture story is for you.

Music and Hi-Fi Troubleshooting

It isn't the circuitry that makes hi-fi servicing tough—it's trying to interpret the jargon of "golden ear" customers into more familiar terminology. The fundamental principles outlined in next month's "Audio Facts" column will help.

... plus all the regular PF REPORTER departments, including:

Quicker Servicing—with a collection of unusual TV troubles and their cures, as well as a couple of "solid" servicing hints.

Across the Bench—and how the author restored an "oldie" to life after it turned arsonist!

Previews of New Sets—Muntz 21CP-3M, Westinghouse H-P3300U, Silvertone 106DS, Zenith E2755W.

Video Speed Servicing—Airline GTM-4213A and Motorola TS-561.

Notes on Test Equipment—lab reports on the EICO Model 710 grid-dip meter, EMC Model 109 VOM, and Grommes Model 202 signal-tracer.

and *The Troubleshooter*, *Dollar & Sense Servicing*, *Tips for Techs*, *Product Report*—an editorial lineup true to PF REPORTER traditions. Don't miss it!

TO ENTER A NEW OR RENEWAL SUBSCRIPTION,
SIMPLY FILL IN AND MAIL THE
COUPON BELOW.

Please enter my subscription to PF REPORTER for:

- 1 Year \$4.00 2 Years \$7.00 3 Years \$9.00

Above rates apply only in U.S.A., its possessions, and Canada. All other countries:
1 year \$5.00, 2 years \$9.00, 3 years \$12.00

- Bill Me Remittance Enclosed Extend Present Subscription

Give to your parts distributor or mail to
PF REPORTER, 2201 E. 46th St., Indianapolis 6, Ind.

Please Check Your
Business Classification

Name _____

Independent Radio, TV Serviceman Owner, Mgr.

Firm _____

Retailer with Service Department Service Mgr.

Address _____

Industrial Electronics Service Employee

City _____ Zone _____ State _____

Other (Specify occupation and title) _____

PRODUCT report

For further information on any of the following items, circle the associated number on the Catalog & Literature Card.

CRT Brightener Package (46P)



Antronic Corp. is now including a special premium with quantity purchases of Anchor picture tube *Brighteners*. Packaged in each cellophane-wrapped TEN-PAK of *Heart-O-Gold Brighteners* is the *MAGNA-Lite*, a \$4.95 (retail) light with 5-power magnifier, built-in measuring gauge, and 2-lens objective. Dealer net for the complete package is \$8.90 net.

Ceramic Disc Capacitors (47P)

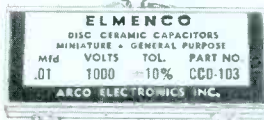

Included in Arco Electronics' complete new line of CCD "space-saving" ceramic disc capacitors are these general-purpose miniature units which come in plastic boxes of five. Values range from 5 mmf to .03 mfd, $\pm 10\%$, 1000 WVDC. Type 3CCD units are rated at

3000 volts, type 6CCD at 6000 volts. A complete line of temperature-compensating ceramic disc units are also available.

Ion Trap Magnet (48P)

Designed to replace beam benders of the conventional single-magnet type, the Berns *Ion* has two adjustable magnets clamped over a metallic sleeve $1\frac{3}{4}$ " long. The front magnet is rotated as an initial coarse adjustment, and the rear one as a final adjustment, to obtain a magnetic field of the precise strength and shape required. The device has a suggested list price of \$7.95.



Compact Microphones (49P)

Four new types have been added to Astatic's 330 Series of microphones. Two of these—the high-impedance 335H (\$26.50) and low-impedance 335L (\$23.50)—are dynamic units. The others are both high-impedance ceramics with a list price of \$17.90; one (the 333) has a frequency range of 30-12,000 cps for general audio work, while the other (331) has a response of 300-5000 cps for communications use.

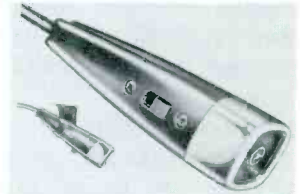

Semiconductor Information (50P)

Sylvania has just issued a *Semiconductor Complement Manual* which lists numerous models of American and foreign entertainment equipment, the transistors and diodes used in each model, and the transistor or diode type recommended as a direct replacement in each individual case. Price is 50c per copy.

GET
ON
THE
RIGHT
TRACK

STOP

in at
room 609 A
parts show

DUOTONE

DIAMOND NEEDLE
New Jersey
In Canada: Chas. W. Palmer, Ltd., Toronto

Four-Way Pocket Tool (51P)



The four-in-one Xcelite Model 600 tool has a removable, double-ended blade with a slot-type tip at one end and a Phillips tip at the other. When the blade is taken out, the empty receptacle is usable as a 7/16" hex-nut driver. At the other end of the red plastic handle is a 1/4" hex socket. A pocket clip is also attached to the handle.

Kit for Citizens Band (52P)



No retuning, other than changing crystals, is necessary to shift the frequency of the EICO Citizens band transceiver. Three models, with different power supplies, are available. Model 760, for 117VAC only, has a list price of \$59.95 in kit form or \$89.95 wired. Models 761 and 762 — one for 117 VAC/6 VDC and the other for 117 VAC/12 VDC—are each priced at \$69.95 (kit) or \$99.95 (wired).

Back-to-Back Controls (53P)



A new series of stereo balance controls, each consisting of twin potentiometers welded back to back, has been introduced by Clarostat to meet special mounting requirements in some stereo systems. Composition-element controls are available in a resistance range of 500 ohms to 10 megohms, with

power ratings from 1/2 to 2 watts; 2- to 4-watt wire-wound units are also supplied in resistances of 1 to 100K ohms.

Set of Substitution Boxes (54P)

The Sencore *Substitution Service Lab* is a combination of the following three instruments: Model H36 *Handy 36* R-C substitution unit, Model ES-102 *Electro-Sub* for temporarily replacing electrolytic capacitors, and Model RS106 *Rectifier Trouble-Shooter* for substitution testing of selenium and silicon rectifiers and diodes. Dealer net price of the complete set is \$41.45.

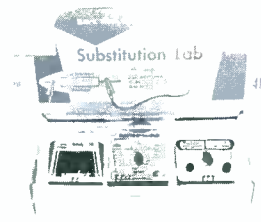

Heavy-Duty Recording Tape (55P)

Scotch brand No. 311 magnetic tape (made by Minnesota Mining and Manufacturing Co.) has a new type of backing material called *Tenzar*, which is said to stand up better than an acetate backing under hard or continuous use; however, it is competitive in price with acetate tapes. (List prices are \$2.40 for a 600' reel and \$3.75 for 1200'.)

The two edges are differently colored as an aid in handling dual-track recordings.



15" Speaker (56P)

The low-cost *Wolverine* series of loudspeakers made by Electro-Voice has been expanded to include a 15" unit, Model LS15. Specifications are: Impedance, 8 ohms; resonant frequency of cone in free space, 35-45 cps; EIA sensitivity rating, 46 db; power-handling capacity, 20 watts "program power" or 40 watts peak; dimensions, 5 3/8" deep and 15 1/8" in diameter (with 13 3/8" baffle opening); weight, 11 lbs.

YOU CAN ALSO DO THE BIG JOBS WITH WIZARDS



HOME - 7 Outlets - One Antenna - No Amplification: Residence of Bob Barker, MC of the popular daytime NBC show Truth Or Consequences.



HOTEL - 120 Outlets - One Antenna - One Amplifier: The Montecito - 6650 Franklin, Hollywood, California.

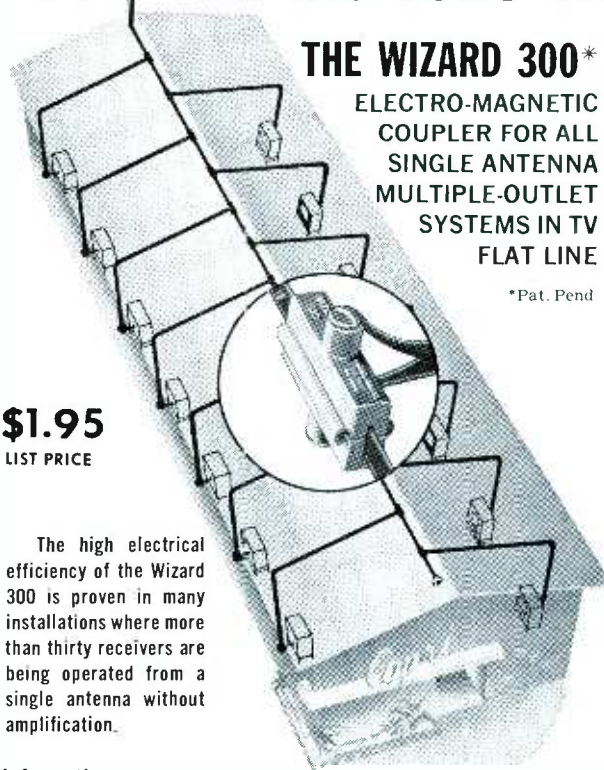

THE WIZARD 300*

ELECTRO-MAGNETIC COUPLER FOR ALL SINGLE ANTENNA MULTIPLE-OUTLET SYSTEMS IN TV FLAT LINE

*Pat. Pend

\$1.95
LIST PRICE

The high electrical efficiency of the Wizard 300 is proven in many installations where more than thirty receivers are being operated from a single antenna without amplification.

Information on any of the above jobs and a brochure covering Wizard System installations is available. Write Dept. PF-50

CHARLES ENGINEERING, INC.
6053 Melrose Avenue • Los Angeles, California



HOUSING PROJECT - 2,549 Wizards Installed To Date: L.A. Housing Authority, Los Angeles, California.



APARTMENT - 39 Outlets - One Antenna - No Amplification: The Del Rio - 10236 Old River School Road, Downey, Calif



APARTMENT - 48 Outlets - Two Antennas (24 Outlets each) - No Amplification: The Paramount Riviera - 12447 Paramount Blvd., Downey, California.

For 1960 It's ...

"COMPACT"

tools by
VACO[®]
for the
Electronic Service Trade

• "Compact" in Size: they fit the pocket

• "Compact" in Price: they fit your pocketbook too



HK-17 Hex Key Set
\$1.00 net



ND-141 Combination
Screw & Nut Driver
\$.79 net



DE-810 Double
Nut Driver
\$.79 net



SP-19 Probe
\$.95 net



AN-2 Tester
\$.79 net



A-85 Pencil
Type Driver
\$.60 net



PK-8 Nut Driver
\$.48 net

Ask Your
Parts Jobber or
Your Jobber Salesman

VACO PRODUCTS COMPANY
317 East Ontario Street, Chicago 11, Illinois
In Canada: Atlas Radio Corp., Toronto 19, Ontario

SAVES
your back...
SAVES
your time...

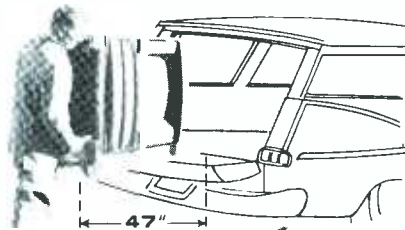

YEATS

SHORTY DOLLY
for
RADIO and TV

just 47 inches high for STATION WAGONS
and PANEL PICK-UPS



FOLDING PLATFORM
15 1/4" x 24 1/2" top.
Snaps on or off.
(Platform only)
\$11.95

Designed for TV, radio and appliance men who make deliveries by station wagon or panel truck... the short 47 inch length saves detaching the set for loading into the "wagon" or pick up. Tough, yet featherlight aluminum alloy frame has padded felt front, fast (30 second) web strap ratchet fastener and two endless rubber belt step glides. New folding platform attachment, at left, saves your back handling large TV chassis or table models. Call your YEATS dealer or write direct today!



YEATS
Model No. 5
Height 47"
Weight 32 lbs.



FURNITURE PAD

"Everlast" COVER AND PADS

YEATS semi fitted covers are made of tough water repellent fabric with adjustable web straps and soft, scratchless white flannel liners. All shapes and sizes — Write



TV COVER

YEATS

APPLIANCE DOLLY SALES COMPANY

2103 N. 12th STREET MILWAUKEE WISCONSIN

Speaker Cement (57P)

Chemtronics *TV-Radio Cement* (Cat. No. 502-2) is a clear, quick-drying fluid recommended for repairing speaker cones, cementing bakelite and glass (as when refastening loose tube bases), repairing plastic parts, and various similar uses. A 2-oz. bottle, with applicator brush attached to inside of cap, is priced at 55c.



High-Power Transistors (58P)

Delco Radio 2N1522 and 2N1523 power transistors both have a maximum collector-current rating of 50 amps. Maximum collector-diode (base-to-collector) voltages for these units are 50 and 80 volts, respectively. Other new high-power transistors are the 2N-1520 and -21 (maximum collector current, 35 amps) and the 2N1518 and -19 (25 amps).



Audio Cable (59P)

A low-loss shielded cable for interconnecting hi-fi components, Belden Type 8421, has cellular polyethylene insulation and spiral, tinned-copper shielding. Also newly available is a shielded cable with three No. 32 AWG conductors, for making connections to three-terminal stereo phono pickups.



Low-Cost Tube Tester (60P)

Tubes can be checked for emission, shorts, leakage, and open elements in the EMC Model 211 tube tester, manufactured by Electronic Measurements Corp. The impact-resistant bakelite case is 6 3/4" x 5 1/4" x 2 1/4" in size; weight of the unit is less than 3 lbs. Price is \$14.90 in kit form or \$22.90 if factory-wired.



Hi-Fi Accessories (61P)

Four new types of control accessories for audio systems have been introduced by Switchcraft. All are housed in 2" x 2" x 1" tan boxes designed for mounting on walls or speaker cabinets. No. 669 (shown; \$6.50 list) is a *Stereo-Level Control* with two ganged 1-megohm potentiometers; No. 666 (also \$6.50) is an L-pad *Speaker Volume Control*; No. 667 (\$4.25) is a three-position *Speaker Selector Switch*; and No. 668 (\$6.25) is a *Stereo Selector Switch* with three pairs of inputs.



Audio Circuit Data (62P)

The 33-page *Audio Designers Handbook* recently issued by Amperex contains a list of over-all performance criteria for high-fidelity amplifiers, design information on individual audio stages, 14 pages of schematics showing suggested circuit layouts for monophonic and stereo amplifiers, and a *Selector Guide* to help in choosing the correct tube type for a given application. Price is \$1.50 per copy.

Citizens Band Antennas (63P)

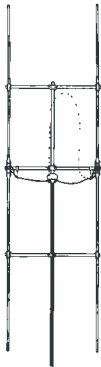

Vertically-polarized beam antennas for Class D Citizens band operation are supplied by Winegard in three models, all equipped with connectors for 50-ohm coaxial lead-in. Omnidirectional Model MB27-0 has 3 db gain with reference to a ground-plane antenna; Model MB27-B offers bidirectional response, with 6 db gain and a half-power angle of 95°; and Model MB27-U has 8 db gain in one direction, with a half-power angle of 60° and front-to-back ratio of 3:1. List price for all models is \$35.55.

Auto-Radio Speaker Fader (64P)



A miniature 5-watt wire-wound potentiometer, 1 3/32" in diameter, is incorporated in the Centralab WK-300 "Fader" Control Kit for use with dual-speaker installations in automobiles. All necessary hardware is also furnished, including an aluminum dial plate with black finish, a "push-on" knob, and self-tapping mounting screws.

Tool Holder (65P)



The wall-mounted G-C Tool Kaddy (Cat. No. 9525) holds a dozen assorted servicing tools by means of spring-loaded clips, thus providing "snap-in, snap-out" operation. The clips automatically adjust themselves to maintain a tight grip on objects ranging in size from an alignment tool to a hammer. Net price is \$1.49.

New Tape Oxide Formula (66P)



All Reeves Soundcraft magnetic recording tapes—both Mylar and acetate—will hereafter be coated with a new FA-4 oxide which provides greater recording efficiency at high frequencies. This oxide improves the treble response in new, low-speed four-track stereo tape systems, as well as in older recorders operating at higher tape speeds.

Silicon Rectifier Information (67P)

The *Silicon Rectifier Handbook* published by Sarkes Tarzian, Inc., normally priced at \$1, is currently being made available at 50c. Seven chapters cover semiconductor theory, manufacturing methods, rectifier characteristics, various rectifier circuits, test circuits, rectifier and filter circuit design, and application techniques. A supplementary section lists all types of Tarzian silicon rectifiers.

Wall-Mounted Antenna Outlets (68P)

When a series of Mosley FD-1PK antenna outlets are connected to a common TV or FM antenna lead, a single receiver can be plugged into any outlet with results equivalent to a direct twin-lead connection. Inserting the connector automatically opens the antenna circuit beyond the outlet in use, thereby preventing signal losses that might occur if the unused stub end of the twin lead were not disconnected. Each outlet comes complete with plug, mounting bracket, and flush-mounting wall plate of brown or ivory plastic.

A.C. to D.C. POWER SUPPLY



... just what you need FOR TESTING TRANSISTORS

Plug this instrument into any 60 cps, 95/130 volt circuit and get a stabilized source of direct current, adjustable over a range from 0 to 45 volts DC, with current output 0/2.5 amperes. Filtered direct current output range 0/45 volts 0/2.5 amperes is continuously adjustable and stabilized $\pm 1\%$ at any setting regardless of alternating current fluctuation. Voltage regulation is approximately 5% between full load and no load at full voltage setting. This DC Power Supply instrument is ideal for use in transistor testing, circuit testing, to provide regulated voltage for light testing, eliminates the need of batteries by supplying exact DC voltage required.

Write for Bulletin 17-BLO1 which gives full details and models available.

SAA 3402-1850

ACME ELECTRIC CORPORATION
945 WATER STREET CUBA, N. Y.
West Coast Plant: 12822 Yukon Avenue, Hawthorne, Calif.



SAMS PHOTOFAC INDEX



sent direct to your shop

FREE

SEND FOR IT!

Yes, now you can have the valuable SAMS MASTER INDEX TO PHOTOFAC FOLDERS and Index Supplements sent direct to your shop at no cost to you! Just mail coupon below and you'll be sure to receive regularly your handy guide to the world's finest service data covering over 33,000 TV, Radio, Amplifier, Tuner Tape Recorder and Changer models. Send for it—it's FREE!

MAIL COUPON

Howard W. Sams & Co., Inc.
1720 E. 38th St., Indianapolis 6, Ind.

Put me on your mailing list to receive the Sams Photofact Master Index and Supplements

I'm a Service Technician: _____ full time; _____ part time

My Distributor is:

Shop Name: _____

Attn: _____

Address: _____

City _____ Zone _____ State _____

FACTS



to help you sell more
RCA Silverama Picture Tubes

... the All-New replacement picture tubes that command premium price and profits.

Here are the facts—proof that RCA Silverama is your customers' best picture tube buy.

1 FREE OF GLASS DEFECTS. Glass cord lines, scratches, chips, or buffed faceplates are common defects found in many brands of tubes made with used glass. Surest way to avoid these defects and also obtain the latest optical advances in faceplate engineering: an All-New RCA Silverama!

2 ALL-NEW. Of the three largest-selling brands of replacement TV picture tubes, only RCA Silverama is guaranteed 100% all-new—new glass, new gun, new phosphor, new everything! You'll get written proof—right on the warranty card.

3 FINEST SCREEN QUALITY. Advanced screen coating and bonding processes combined with RCA's giant vibration-free screen settling machines assure the maximum in picture screen quality and uniformity.

4 RCA "KNOW-HOW". RCA's continuous product research and advanced design engineering have resulted in RCA Silverama picture tubes being steps ahead of all other brands.

5 WORLD'S FINEST. RCA Silverama is manufactured in the world's most modern manufacturing plant using all-new premium-quality materials. Result? RCA Silverama is the world's finest picture tube.

© Silverama



RADIO CORPORATION OF AMERICA

Electron Tube Division

Harrison, N. J.

dealer-serviceman's fuse rack . . .

. . . for wall mounting

LITTELFUSE

most needed



most wanted

. . . the FUSEMASTER!



dealer-serviceman's fuse requirements at a glance