

DECEMBER, 1958 35 CENTS



**PHOTOFACT**  
**PF**®

# REPORTER

including **Electronic Servicing**



**CHILDREN'S HOME**  
**GENERAL PROTESTANT**  
**ORPHAN ASSOCIATION**  
FOUNDED 1867  
1404 S. STATE ST.

**TV-R**  
**SERV**

**This Month's Highlights**  
**IF Alignment Made Easy**  
**Helpful Hints for PC Servicing**  
**Troubleshooting by Waveform Analysis**  
**Plus December Supplement To Sams Master Index**

1A 5H 635 1260E  
WM M DAVIS  
118 RIVERSIDE AVE  
CANNON CITY COLO

# HOW TO BUILD BUSINESS

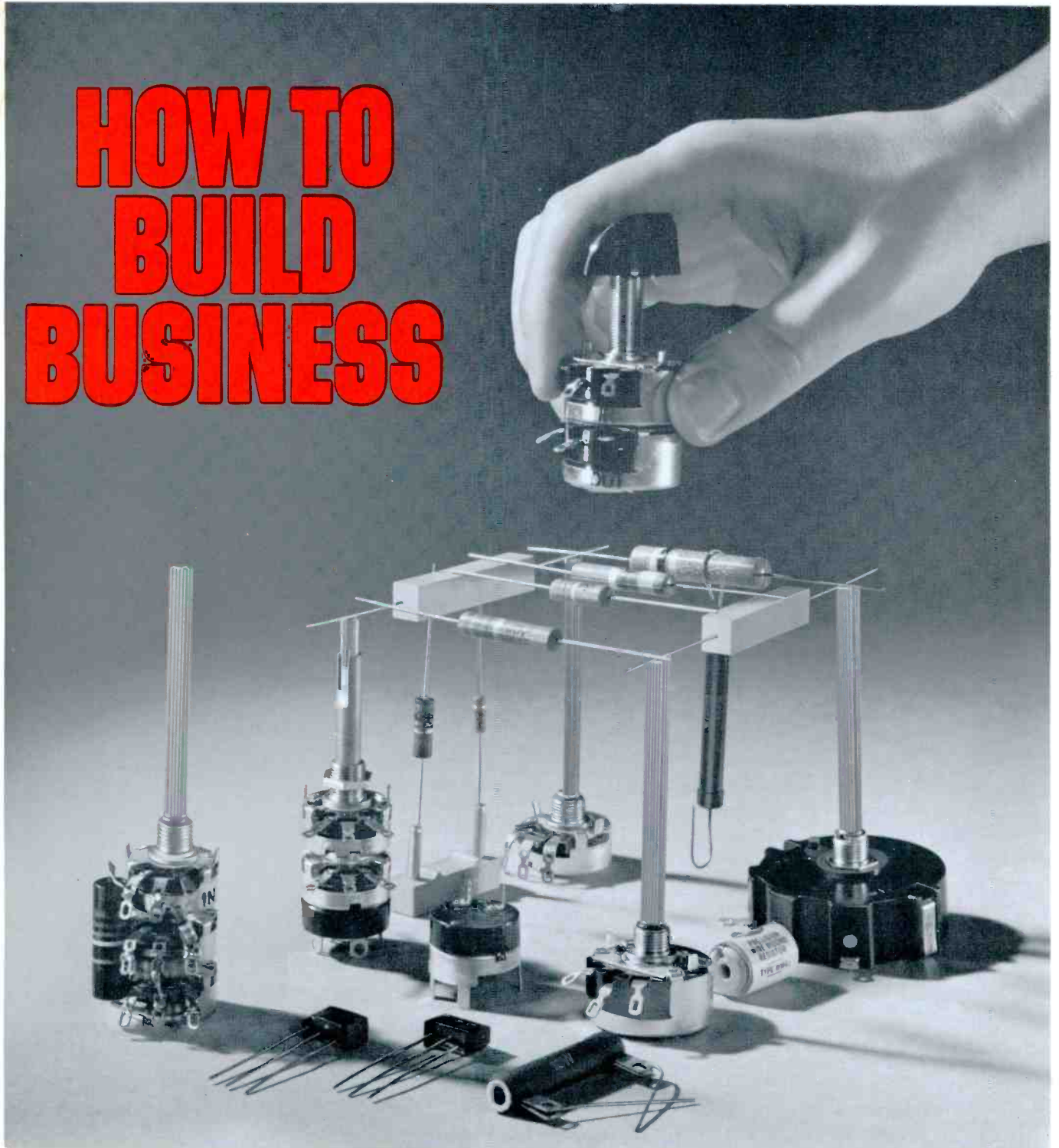

It was the head of a large Radio-TV sales-service organization talking: "Why do we replace with IRC parts? Many reasons why. I'll give you one big one. When a set is under warranty the manufacturer makes good on the parts but don't forget we're on the hook for our labor. Defective replacements could ruin our profits, drive our good customers away."

Save time wasted on unnecessary callbacks and unnecessary reordering. Build your business soundly with reliable IRC parts—sold through reliable IRC Distributors.

*For more information, write for Catalog DLR-58.*



**INTERNATIONAL RESISTANCE COMPANY** • Dept. 3611, 401 N. Broad St., Phila. 8, Pa. • In Canada: International Resistance Co., Ltd., Toronto, Licensee.

# PREVIEWS of new sets

**General Electric**

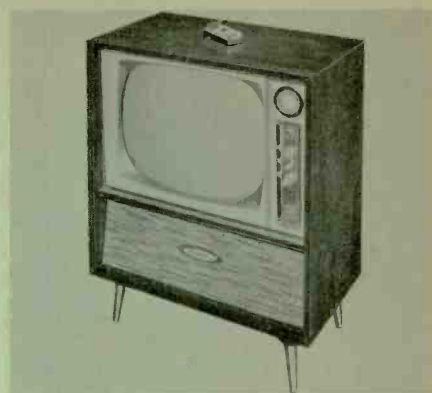
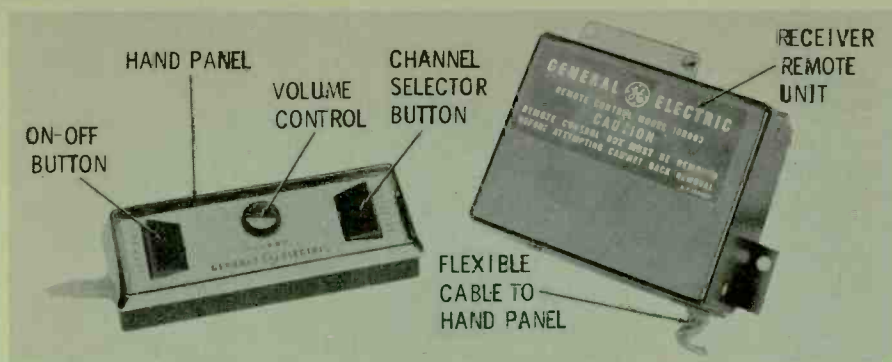

**General Electric Model 21C2550 Chassis U3**

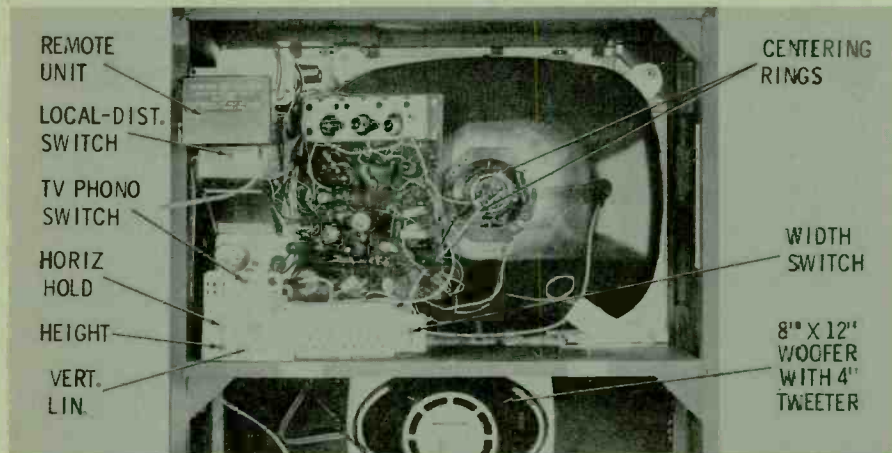

Major features of this new 21" console include pushbutton tuning for all VHF channels, 3-way remote control, coaxial speaker system, and 110° picture tube. The hand panel of the remote assembly permits the user to turn the set on or off, select channels, and adjust volume continuously. A four-wire flexible cable connects the hand panel to the receiver's remote unit. This unit, containing only a transformer, relay switch, and thermal cutout, plugs into the rear of the set directly behind the tuner.

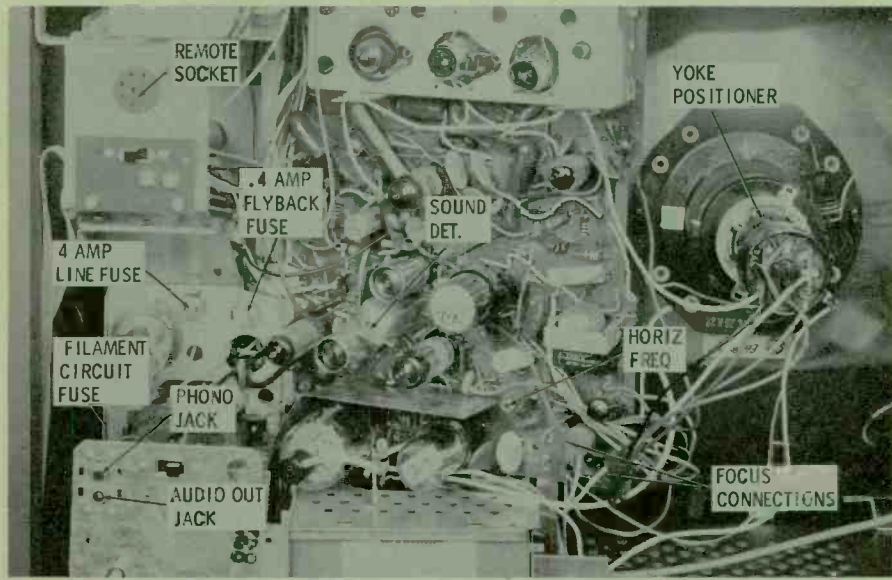

Removing the back from the set, you'll find all of the somewhat vertically-styled chassis mounted on the left side of the cabinet. The large printed wiring board, serving almost all circuits except the power supply and tuner, is placed on an angle following the contour of the picture tube. Service adjustments and tubes are all well exposed with the exception of the 1J3 high-voltage rectifier. This tube is housed in the cage below the printed board. Although it may not appear so, the picture tube and chassis can be removed from the cabinet as one complete assembly. The tube can then be separated from the chassis for easier bench servicing if desired.

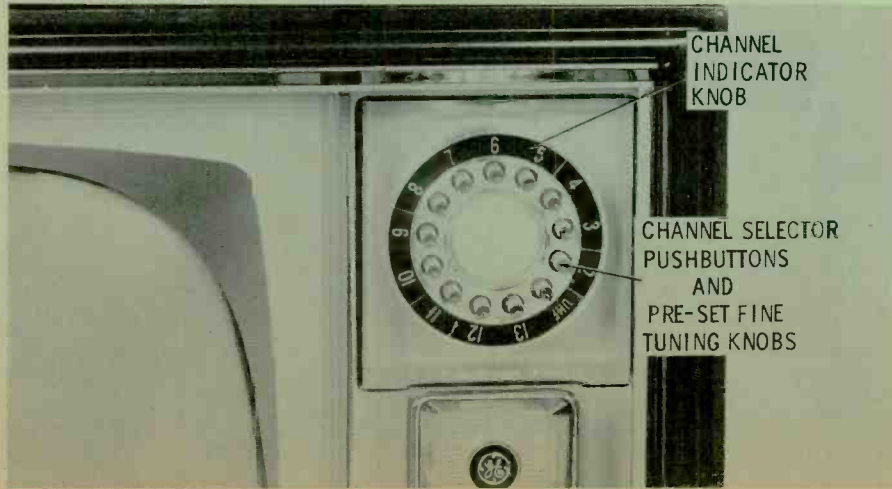

Taking a closer look at the transformer-powered chassis, you'll find some newcomers in the tube lineup. In the third video IF stage, for example, the manufacturer has made use of a 6W6. Others that might be mentioned are the 12DQ7 in the video output stage and the 6DN7 vertical oscillator-output tube. The parallel filament circuit for all tubes is fused by a short piece of #26 wire located on a terminal board in back of the power transformer. The yoke positioner pointed out in the photograph can be loosened by using long-nose pliers to slip the end of the spring up and over the bend in the ring clamp. Terminal connections for the focusing anode of the picture tube are located in the lower corner of the wiring board.

The small pushbuttons around the channel indicator select VHF channels 2 through 13 and a UHF position for sets incorporating this feature. Fine tuning for each channel is a "one-set-and-forget" operation. Each button screws in and out as a fine tuning adjustment. Once they have been set up, the tuning device is automatically positioned whenever the channel is selected. For automatic channel selection using the remote control system, all buttons for non-operating channels should be screwed out. The motor-driven tuner will then select only the active channels chosen.



## Hoffman Model SP3531 Chassis 341

A hardwood cabinet, *Dyna-Touch* automatic tuning, and a 90° picture tube are featured in this 21" model from the *Signature Series* line. Removing the rear cover from this particular set, you'll find the transformer-powered chassis mounted upright along the left side of the cabinet. It has conventional wiring throughout and makes use of a Standard Coil VHF turret tuner. All service adjustments are on the rear apron of the chassis as shown. The AREA CONTROL is an AGC potentiometer electrically positioned in the plate circuit of the triode keyer.

You'll find no manual channel selector with sets having the *Dyna-Touch* feature. The motor-driven tuner automatically selects channels by a touch of the bar knob on the front panel. To preset or index the automatic tuner, remove the push-on type selector bar and lift the small panel door upward. The index buttons are pressed in for desired channels and pulled out for all others. VHF oscillator adjustments are accessible through the front of the cabinet and may be set one at a time as the tuner turret is rotated.

A 3-amp slow-blow fuse is physically located on top of the chassis near the rear, and is electrically in series with the AC input line. Directly in front of the fuse is a thermistor which acts as a surge-limiting resistor to control warm-up. This component should normally measure about 79 ohms when cold. A special push-pull switch labeled SYNC LOK is operated by the shaft of the brightness control. Another somewhat hidden feature of this chassis is the automatic spot-extinguisher switch found as part of the on-off switch on the volume control.

Since it takes a little doing to remove the safety glass on this model, you might heed the following. First, remove the rear cover from the set and disconnect the two *Dyna-Touch* switch leads from the terminal board on top of the chassis. While you're at it, also free the loop pointed out in the photograph. After removing the push-on control knobs, lift the front panel up and out of its bottom trim strip. To prevent damaging the cabinet, the control panel should be completely removed, not merely tilted to one side, when taking out the glass. Next, remove the four Phillips-head screws holding the top metal trim and remove the strip. Tilt the glass outward at the top; then pull it up and out of the lower trim piece.

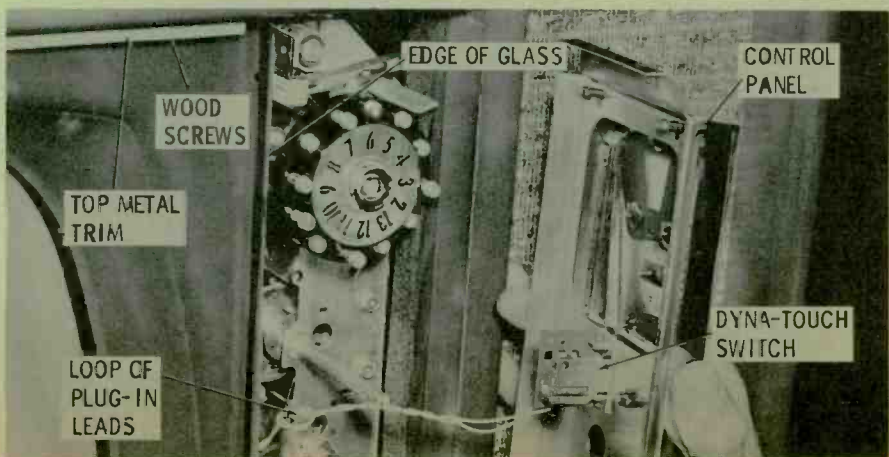
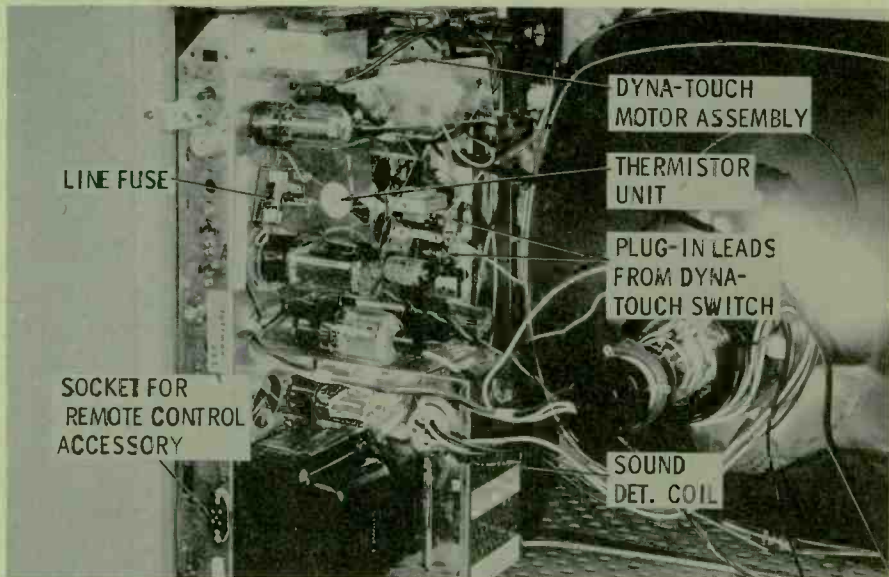
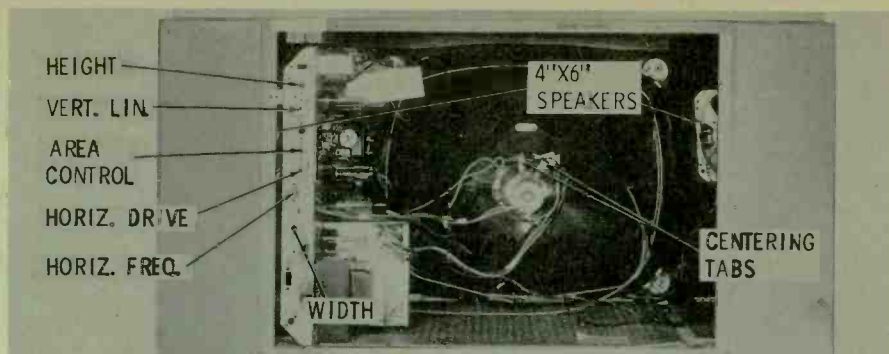

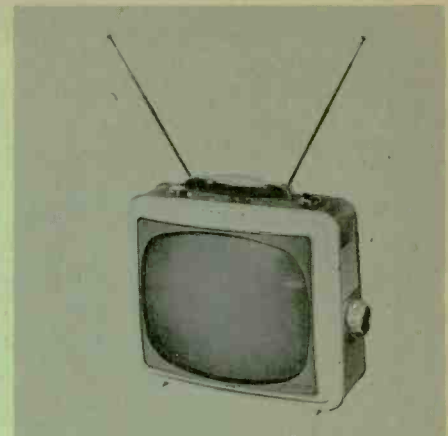
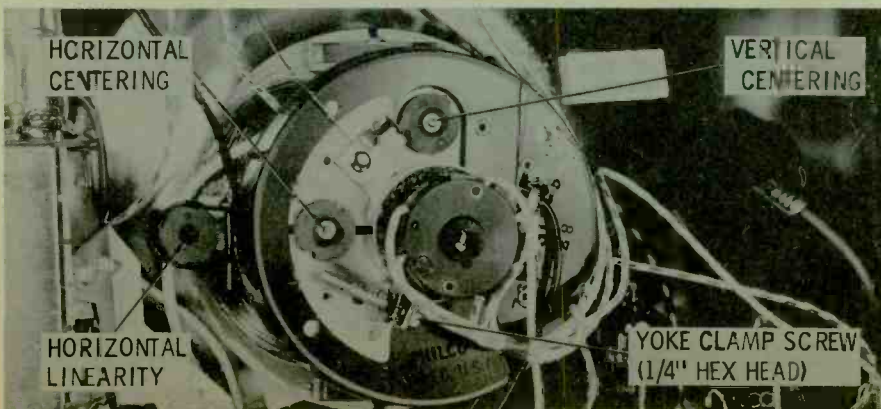
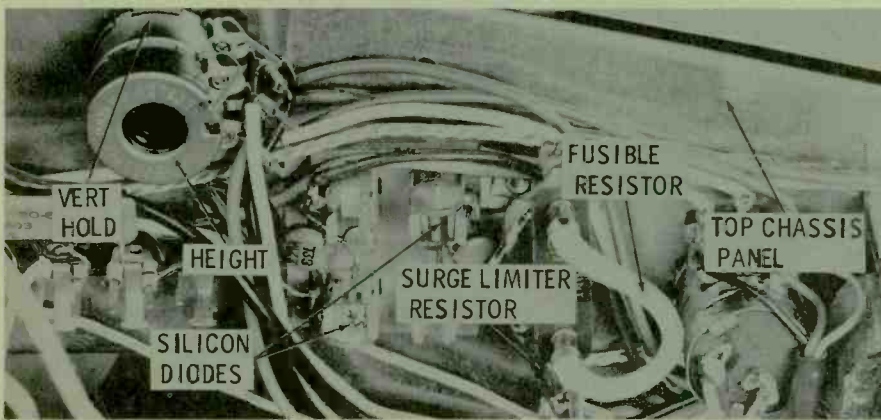
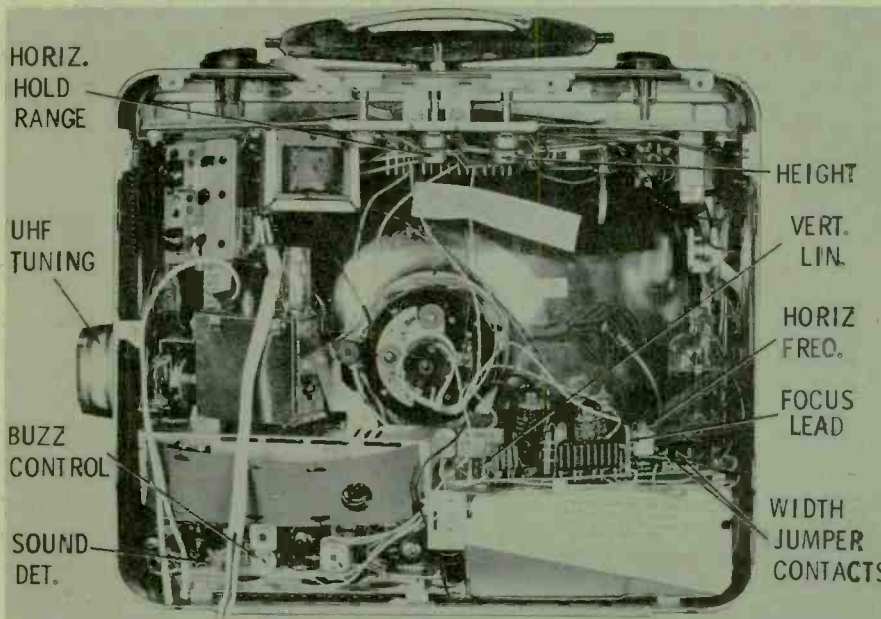

## Philco Model UG3050GL Chassis 9H25U

The first time you are called on to service this receiver, you may not be in the customer's home. Instead, he may come strolling into the shop with it in one hand like a brief case. This particular *Slender Seventeen* incorporates the new short-neck 110° picture tube and both VHF and UHF tuners.

The *Scan-Tenna* assembly is a combination carrying handle and rotatable antenna. The antenna elements telescope into the handle and can be tilted up or down.

With the back removed, you'll find that the chassis forms a frame around the 17DAP4/SF17 picture tube. Three separate printed wiring boards are employed — one for the IF stages, one for the video and sound sections, and one for the sweep circuits. Horizontal hold range and height adjustments are positioned as rear sections of the two conventional hold controls. Each may be adjusted with the use of a thin screwdriver through the shaft of the front control section. Picture width may be increased by placing a jumper across the two outside terminals on the sweep board.

The "hot" chassis features two silicon rectifiers in a voltage doubler B+ supply. Both are tucked under the top chassis panel, where you'll also find the B+ and series filament resistors. The plug-in fusible unit has a value of 5.6 ohms, while the surge limiter should measure about 200 ohms cold and 3.5 ohms hot. In sets featuring only a VHF tuner, however, the resistor used will have a value of 400 ohms cold and 10 ohms hot.

Picture centering is accomplished by rotating two magnets, which are imbedded in the yoke assembly as shown. Horizontal linearity correction is also a magnet adjustment located just to the left of the yoke. Although they appear to require special alignment tools, these magnets can usually be turned with your fingertips.

You might keep in mind that the 1G3 high-voltage rectifier has a short bulb and should be replaced only with the same type. A taller 1B3 will come too close to the flyback transformer and usually cause arcing. All other tubes in the set are of the special 450-ma series-string variety. Since you may not have these tubes in your caddy yet, here's the entire lineup:

- |                           |                      |
|---------------------------|----------------------|
| 3 CY5-RF amp.             | 4CS6-sound det.      |
| 6BR8A-conv.               | 12ED5-audio out      |
| 3AF4A-UHF osc.            | 13DE7-vert. osc/out  |
| 4DE6-1st IF               | 2EN5-hor. phase det. |
| 4 DE6-2nd IF              | 9AU7-hor. osc.       |
| 6AM8A-IF/vid. det.        | 17DQ6A-hor. out      |
| 8AW8A-vid. out/noise inv. | 17D4-damper          |
| 12AZ7A-sound IF/sync      | 1G3-HV rect.         |



**Setchell-Carlson Model P65  
Chassis C105**

This new portable with top tuning features a combination horizontal and vertical chassis built around the neck of the picture tube. All tubes are easily reached with the cabinet back removed. This includes the 6DQ6 horizontal output tube, the 6AX4 damper, and the 1G3 high-voltage rectifier which are out in the open and not housed in a separate compartment. All service adjustments are shown in the rear cabinet view. Don't bother to look for horizontal frequency, drive, linearity, or width, because they are not used.

Taking the chassis out of the cabinet by removing four screws from the bottom and resting the entire assembly on its side, we can examine the conventional-type wiring of the lower chassis section. Although the set contains two silicon rectifiers, it also employs a power transformer with secondaries isolated from the line. Filaments of all tubes except the picture tube are connected in a conventional parallel arrangement. 1N60 crystal diodes are employed in the video detector and horizontal phase detector stages, thus reducing the number of receiving tubes to only 15, not counting the high-voltage rectifier and picture tube.

One unusual feature of this receiver is its special PIX TUBE SAVER jack located at the rear corner of the bottom chassis near the power transformer. When the picture tube ages and is slow in warming up or lacks enough brightness, the user or serviceman merely inserts the "saver" plug into the chassis jack as shown. This acts as a built-in booster which increases cathode emission by stepping up the heater voltage. Voltage for the filament circuit of the CRT is supplied from a special 7- to 8-volt tap on one winding of the power transformer. This voltage is reduced, however, by a 3-ohm resistor connected in series with the heater and in parallel with the *saver* jack. The *saver* plug shorts out the dropping resistor, thus permitting all of the supply voltage to be applied across the heater.

The vertically mounted sections of the chassis consist of two plug-in units that can be entirely removed from the bottom horizontal section. To free either plug-in unit, remove the two hex nuts under the lower chassis, and unplug the contact strip by lifting up on the whole assembly.

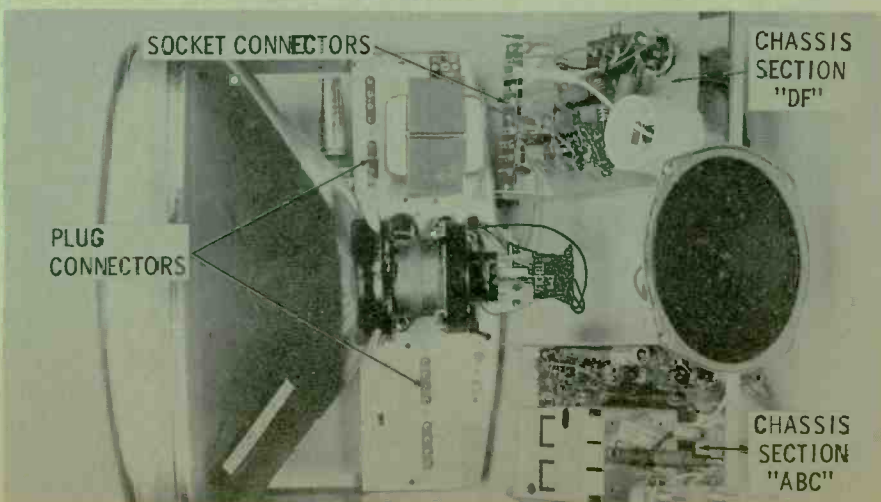
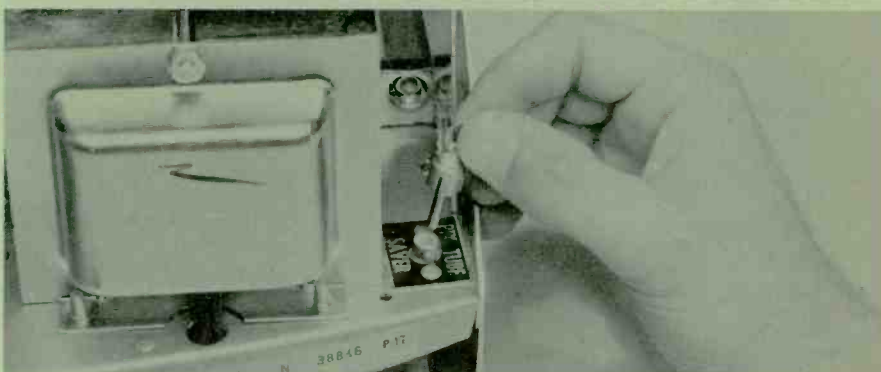
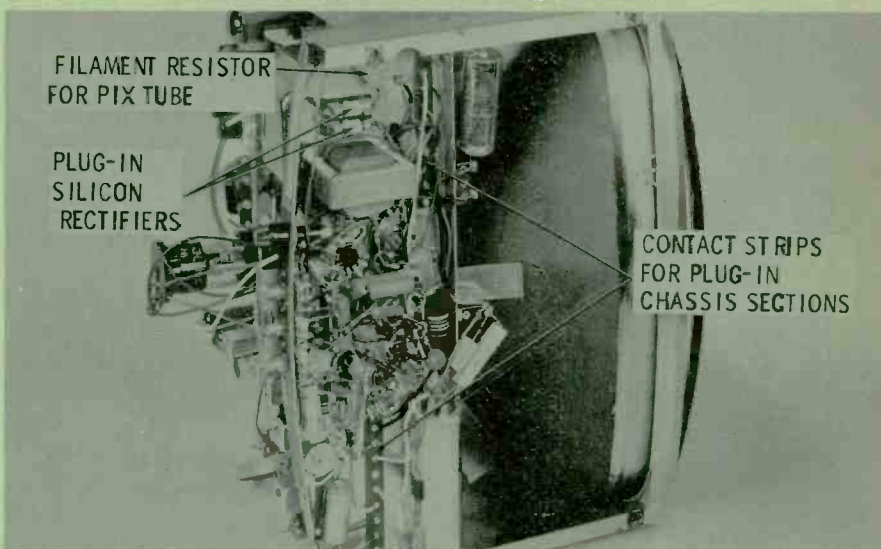
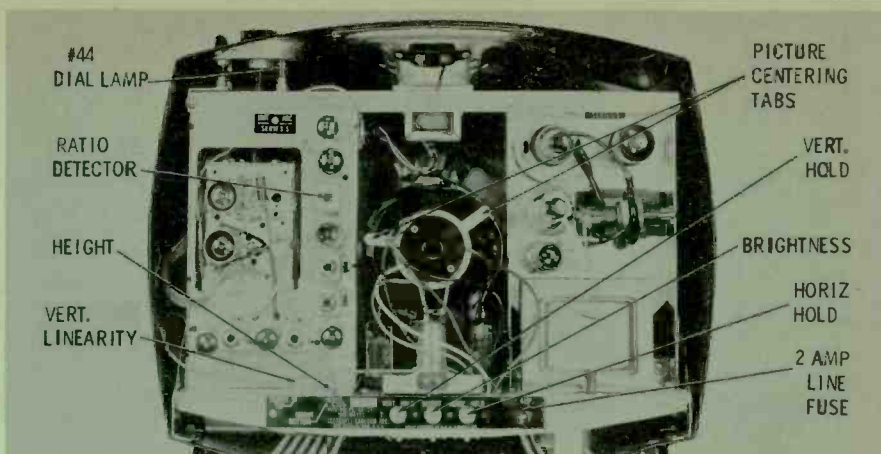

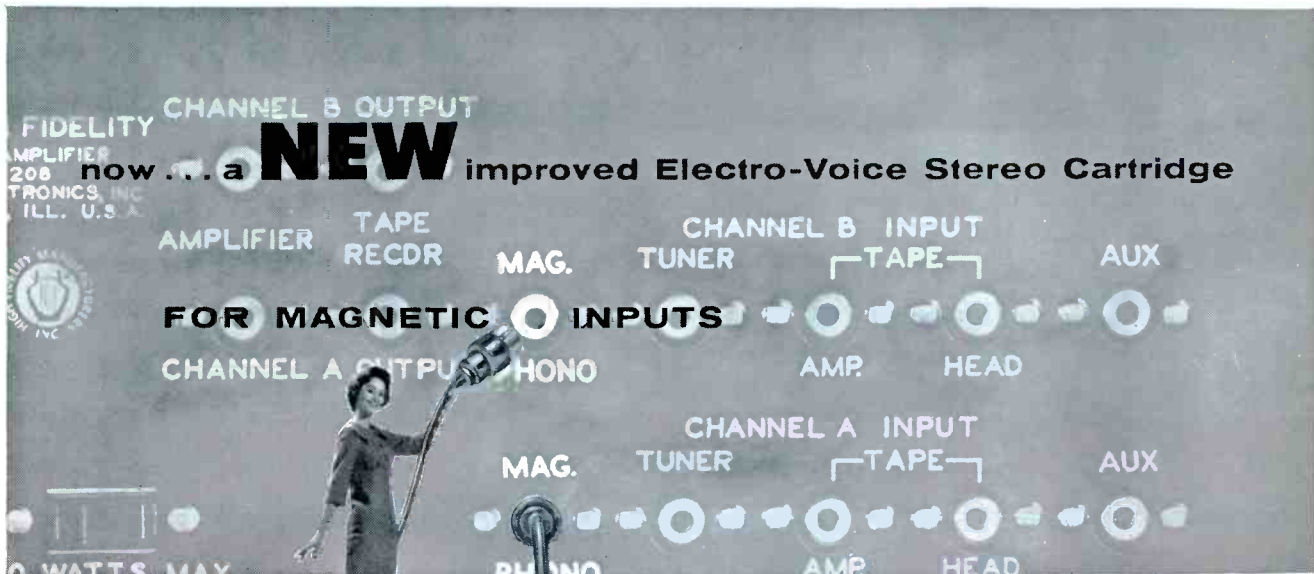

# E-V MAGNERAMIC STEREO CARTRIDGE

From E-V, first with a stereo cartridge, comes a new improved stereo cartridge design. Just like E-V's first cartridge . . . only better . . . and, BY ACTUAL TEST, superior to any other stereo cartridge.

HERE'S WHY: THE E-V MAGNERAMIC HAS THE

## HIGHEST

**VERTICAL & HORIZONTAL COMPLIANCE**  
gives you better tracking . . . longer record wear

## BEST

**CHANNEL SEPARATION**  
gives you over 25 db between channels

## FLATTEST

**RESPONSE**  
gives you full range frequency response flat from 20 cps to beyond audibility

## Lowest

**HUM AND RUMBLE**  
far below other stereo cartridges



## THE E-V MAGNERAMIC STEREO CARTRIDGE

plugs into any magnetic input; PZT Ceramic elements deliver flat response to RIAA Standards. Step up to the excitement of stereo . . . step up to Electro-Voice Stereo . . . the industry's standard. Over a half-million in use, *more than the total of all other stereo cartridges combined*, attest to its acceptance as stereo's standard. Choose either the E-V MAGNERAMIC or the standard Electro-Voice Stereo Cartridge for non-magnetic inputs.

21 MD Stereo Cartridge, with 0.7 Mil Diamond Stylus, net \$19.50 . . . 26 MDST Stereo Turnunder Cartridge, with 0.7 Mil Diamond (Stereo) Stylus, and 3-Mil Sapphire (Monaural) Stylus for 78 R.P.M.'s, net \$22.50 . . . 21 MS Stereo Cartridge, with 0.7 Mil Sapphire Stylus, net \$9.90 . . . 26 MST Stereo Turnunder Cartridge, Linear Velocity, with 0.7 Mil Sapphire (Stereo) Stylus, and 3-Mil Sapphire (Monaural) Stylus for 78 R.P.M.'s, net \$12.90

### GOOD STEREO DEPENDS ON THESE VITAL FEATURES:

FREQUENCY RESPONSE	15-20,000 cps flat (Westrex LA)
ELEMENTS	2 PZT Ceramic
OUTPUT VOLTS	20 mv. Nominal
COMPLIANCE	$2 \times 10^{-6}$ cm/dyne
WEIGHT	3.4 Grams
TRACKING FORCE	4-6 Grams
CHANNEL SEPARATION	25 db @ 1 KC
MOUNTING	EIA(RETMA) Standard $\frac{1}{2} \times \frac{3}{16}$ " Center
STYLUS	.7 MIL (Diamond or Sapphire)
OUTPUT TERMINALS	STD. .050 Connectors
IMPEDANCE OR LOAD	22,000 ohm or higher magnetic input

See your high fidelity specialist or write Dept. PP

**Electro-Voice**® INC., BUCHANAN, MICHIGAN

Over 1/2 Million in Use . . . More Than All Others Combined



**NEW!**

# ISOFARAD<sup>®</sup>

## Constant-Capacitance Film Capacitors



**For equipment applications  
where the best is none too good**

- ★ for performance far above and beyond ordinary plastic-film or paper capacitors
- ★ for unmatched capacitance and retrace stability
- ★ for highest insulation resistance

● Sprague's new ISOFARAD Film Capacitors have the best temperature/capacitance stability at the lowest cost. The Sprague patented plastic film dielectric in these capacitors has practically no capacitance change over operating temperature ranges up to +85° C . . . making them ideal for TV, radio, circuit design work in the laboratory, precision amplifiers, laboratory instruments and industrial electronic equipment.

● They're the *only* capacitors that will work every-time in synchroguide circuits in color TV receivers . . . the *only* answer to many a TV set that's a drifter.

● Here's the kind of performance you can expect with ISOFARAD Capacitors: from 25° C (room temperature) to +80° C, their capacitance will not change by more than 1%. These capacitors have such good retrace characteristics that there is prac-

tically no permanent change in capacitance even with repeated temperature cycling. As for insulation resistance, it's so high it can't be measured on ordinary service equipment.

● When used for replacement applications in TV horizontal circuits, where drift is a problem, they consistently better original set performance.

● You'll find Sprague's new ISOFARAD Capacitors cost you less and perform better in most circuits than comparable silvered mica capacitors. What's more, they're available in capacitor ratings up to .33 MF which is far beyond the silvered mica range. And every capacitor is rated at 500 volts d-c working!

● For complete listings, write for Bulletin M-755 to Sprague Products Company, 105 Marshall Street, North Adams, Massachusetts.

**don't be vague...insist on**

# SPRAGUE<sup>®</sup>

*world's largest capacitor manufacturer*

**SPRAGUE RESEARCH IS CONSTANTLY PRODUCING NEW AND BETTER CAPACITORS FOR YOU**



**publisher**  
Howard W. Sams  
**general manager**  
Mal Parks, Jr.  
**editor**  
Verne M. Ray

**associate editors**  
Leslie D. Deane  
Thomas A. Lesh  
Calvin C. Young, Jr.

**consulting editors**  
William E. Burke  
Robert B. Dunham  
George B. Mann  
C. P. Oliphant  
Poul C. Smith

**art director**  
Don W. Bradley

**editorial assistant**  
Georgeanna Coldwell

**adv. production**  
Carol B. Gadbury

**circulation fulfillment**  
Pot Tidd, Mgr.  
Ann Mathews, Ass't.

**photography**  
Robert W. Reed

**advertising sales offices**

**Midwestern**

PF REPORTER  
2201 East 46th Street, Indianapolis 6, Ind.  
Clifford 1-4531

**Eastern**

Paul S. Weil and Donald C. Weil  
30-01 Main Street Flushing 54, New York  
Independence 3-9098

**Western**

The Maurice A. Kimball Co., Inc.  
2550 Beverly Blvd., Los Angeles 57, Calif.  
Dunkirk 8-6178; and 681 Market Street,  
San Francisco 5, Calif. Exbrook 2-3365

**Address all correspondence relating to circulation and editorial to PF REPORTER, 2201 East 46th Street, Indianapolis 6, Indiana**

Copyright 1958 by Howard W. Sams & Co., Inc. No part of the PF REPORTER may be reproduced without written permission. No patent liability is assumed with respect to the use of information contained herein.

As a magazine devoted to public service to the entire electronics industry, it is the obligation of PF REPORTER with Electronic Servicing to present to its readers all legitimate advertising in this field. Acceptance of advertising does not in any manner signify the products, policies and services so advertised have been approved, endorsed, or recommended by this magazine.

## NEXT MONTH

**Servicing Sync Circuits**  
Descriptions and photos of trouble symptoms as they relate to specific component faults.

**Mobile Radio Installation**  
A picture story showing techniques used to install various radio communication units.

**Low-Voltage Power Supplies**  
The heart of every electronic unit is the B+ source. Do you know all you should about it?



# PF REPORTER

including Electronic Servicing

## CONTENTS

<b>Previews of New Sets</b>	<b>1</b>
Advance information on four '59 TV sets.	
<b>Video Speed Servicing</b>	<b>5</b>
Service hints for Motorola and Sylvania Chassis.	
<b>Letters to the Editor</b>	<b>12</b>
<b>Across the Bench</b> Stan Prentiss	<b>16</b>
What to do for ailing RCA KCS47's.	
<b>IF Alignment Made Easy</b> Mike Martynec	<b>18</b>
When and how to do the job.	
<b>Dollar &amp; Sense Servicing</b>	<b>20</b>
<b>Audio Facts</b> Alan Andrews	<b>24</b>
How to track down hi-fi component troubles.	
<b>Helpful Hints for PC Servicing</b> Fred Howard	<b>26</b>
Case history reports of the author's technique for making printed-circuit repairs.	
<b>Quicker Servicing</b> Calvin C. Young, Jr.	<b>28</b>
Fusible resistor guide; antenna performance demonstrator; triple control burnout in a color set.	
<b>Troubleshooting by Waveform Analysis</b> Robert G. Middleton	<b>36</b>
Testing video circuit response with a scope and signal generator.	
<b>The Troubleshooter</b> Thomas A. Lesh	<b>44</b>
<b>Notes on Test Equipment</b> Les Deane	<b>48</b>
Lab reports on a field-strength meter, VTVM, and picture tube tester-reactivator.	
<b>Product Report</b>	<b>70</b>
<b>Free Catalog &amp; Literature Service</b>	<b>72</b>
<b>Supplement to SAMS Master Index</b>	<b>73</b>
1958 Subject Reference Index	Check 24Y on Literature Card

## ABOUT THE COVER

This month's theme is rather obvious, "The joy is in the giving." When the picture-taking was all over, a 5-year old lass, who had been curiously eyeing the proceedings, slowly approached our costumed serviceman. With her head quizzically cocked to one side, mouth slightly agape, and eyes wide with wonder, she managed to squeak in a small, half-sure voice, "Hi, Santa." The resulting size of the lump in ol' Santa's throat we'll leave to your imagination.

MERRY CHRISTMAS!



USE HANDY CARD AT BACK TO ENTER YOUR SUBSCRIPTION

# PROTECT ALL ELECTRONIC TUBES

WITH

# ATR

## Electronic Tube PROTECTOR

Designed To Protect All Electronic Tubes in TV or Hi-Fi Sets, Amplifiers, and Similar Electronic Equipment. Will Double or Triple Tube Life Including Picture Tubes.



ATR Electronic Tube Protectors will double or triple the life of all electronic tubes including picture tube in TV or Hi-Fi Sets, Amplifiers, Electronic Organs, and other similar electronic equipment. The ATR Electronic Tube Protector utilizes a thermal cushion-action principle which also protects all other components by eliminating initial damaging surge currents. The ATR Electronic Tube Protector can be used with any electronic equipment having input wattage of 100 to 300 watts.

SEE YOUR JOBBER OR WRITE FACTORY

✓NEW MODELS ✓NEW DESIGNS ✓NEW LITERATURE  
"A" Battery Eliminators, DC-AC Inverters, Auto Radio Vibrators



AMERICAN TELEVISION & RADIO CO.  
Quality Products Since 1931  
SAINT PAUL 1, MINNESOTA, U. S. A.

## Letters to the EDITOR

Dear Editor:

Is it possible to get back issues of *Video Speed Servicing* — that is, those which were published before the feature appeared in PF REPORTER?

H. L. PAYTON

Seattle, Wash.

*Yes, these have been compiled into two volumes. Limited quantities of Vol. 1, in loose-leaf binders, may be purchased at \$4.95 each. Bound editions of Vol. 2 are \$2.95.—Ed.*

Dear Editor:

Here is a servicing tip that overcomes the annoying problem of keeping the deflection yoke up tight against the bell of a test picture tube such as the 8XP4. For a long time, I have been using an old dual ion trap with the magnets removed. Its springs grip the neck of the tube tightly enough to keep the yoke where it belongs — much simpler than using jigs, brackets, clamps, etc., as described in many published items.

DAVID GREENE

Philadelphia, Pa.

*A simple clamp is a highly effective holding device, as we can testify from long experience in our own labs. A suitable type of clamp was described and pictured on page 59 of our June, 1956 issue.*

*The only drawback is that the tube must depend on the yoke for support, a tough situation in newer TV sets where the yoke is neither attached to the chassis nor equipped with long enough leads so that the check tube will rest on the bench. Even though jigs and brackets are somewhat complex, they have the advantage of keeping a firm grip on the entire check-tube assembly.*

*"Floating" yokes are generally fastened to the picture tube by pinch clamps equipped with rubber pads. These devices are ideal for keeping yokes anchored on the neck of any picture tube, including a check tube.—Ed.*

Dear Editor:

Why do the ads in PF REPORTER so often portray TV servicemen wearing bellhop uniforms? I wonder if other servicemen resent this as I do. In these parts, our servicemen are rather well-dressed.

Name withheld by request

*We go along with the comments set forth in "Dollar & Sense Servicing" last August under the heading, "Right Dress." Briefly, this point of view maintains that either uniforms or "dress-up" clothes are appropriate; which you use depends on the impression you wish to create.—Ed.*

Dear Editor:

The October issue is very good, especially the article by Stan Prentiss about the old Philco set. This treatment of a volume-produced TV receiver is the best yet, and it should be repeated on other highly popular brands such as Zenith and RCA. Don't bother with sets that haven't reached the market in large volume.

As for marking a chassis with the correct PHOTOFAC Set number, we have been doing this on every set we have repaired since the first issue of PHOTOFAC came out. We mark both the chassis and the rear cover of the cabinet with red crayon.

JOSEPH G. ARTZNER

Malvern, Ohio

*This just proves what we've always thought — old TV sets never die. Stan Prentiss will continue his series on popular old sets — see the RCA KCS47 coverage in this issue.—Ed.*

Dear Editor:

I liked the *TV Hospital* idea in the October *Dollar & Sense Servicing* column. Lately, I've been using the enclosed card in my own business. It has caused a lot of talk, and I now have almost twice as much work as I used to have.

CHARLES H. BOND

South Braintree, Mass.

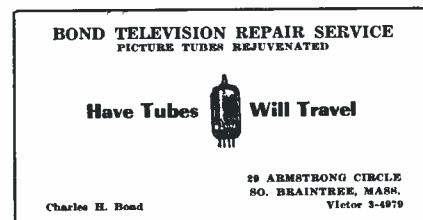

'Nuff said?—Ed.

Dear Editor:

I would like to contribute a few suggestions for names that might be given to service shops specializing in hi-fi or commercial sound: High, Wide and Fi; Sound Sound; Dr. Sound; or Guy-Fi Sound.

ROBERT D. LAYTON

Hemet, Calif.

*Like we've always said, our readers are highly imaginative.—Ed.*

Dear Editor:

I found your article on *Pocket-Sized Portables* (July, 1958) so interesting that I decided to look up the circuit of the General Electric Model 766A radio. However, this receiver was not listed in the *Master Index* to PHOTOFAC *Folders*.—Why?

RICHARD RUFER

Hayward, Calif.

*Very simple: It's a brand new receiver! The PHOTOFAC Folder was being prepared at the time our article was written, and was recently issued as Set 417, Folder 5.—Ed.*

As announced in the September issue, PF REPORTER subscription rates increase to \$4.00 per year effective Jan. 1, 1959. By acting before this date, you can extend your current subscription at the present, lower rates. A handy order card is bound in at the back of this issue for your convenience.

# ready, willing and able

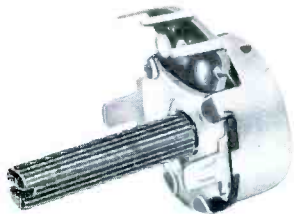

**"TAB-MOUNT" CARBON POTS**  
SERIES B-47

Designed to meet the fast-growing tab-mounted carbon pot replacement needs. A wide selection of the most popular resistance values. Rated at  $\frac{1}{2}$  watt. Universal-type phenolic knurled shaft, slotted, 1" long. Easily cut or altered to suit individual needs.

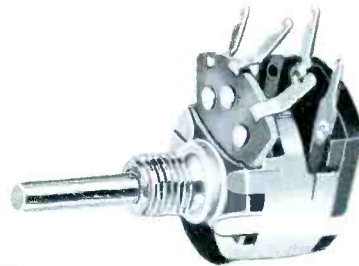

**MINIATURIZED CARBON POTS**  
SERIES 44 & 44S

The right replacement for transistorized circuits, portable radios, hearing aids, and other miniaturized applications. 0.2 watt.  $\frac{2}{32}$ " diameter. Available with or without switch. Made in most popular values and tapers.  $\frac{1}{8}$ " diameter shaft,  $\frac{1}{2}$ " long.



more good reasons for  
always saying:



CLAROSTAT MFG. CO., INC., DOVER, NEW HAMPSHIRE

Mr. TV-Radio Service Dealer: MEET THE CHALLENGE

with this **REVOLUTIONARY,**

**RAYTHEON**

**TUBE**

**MART**

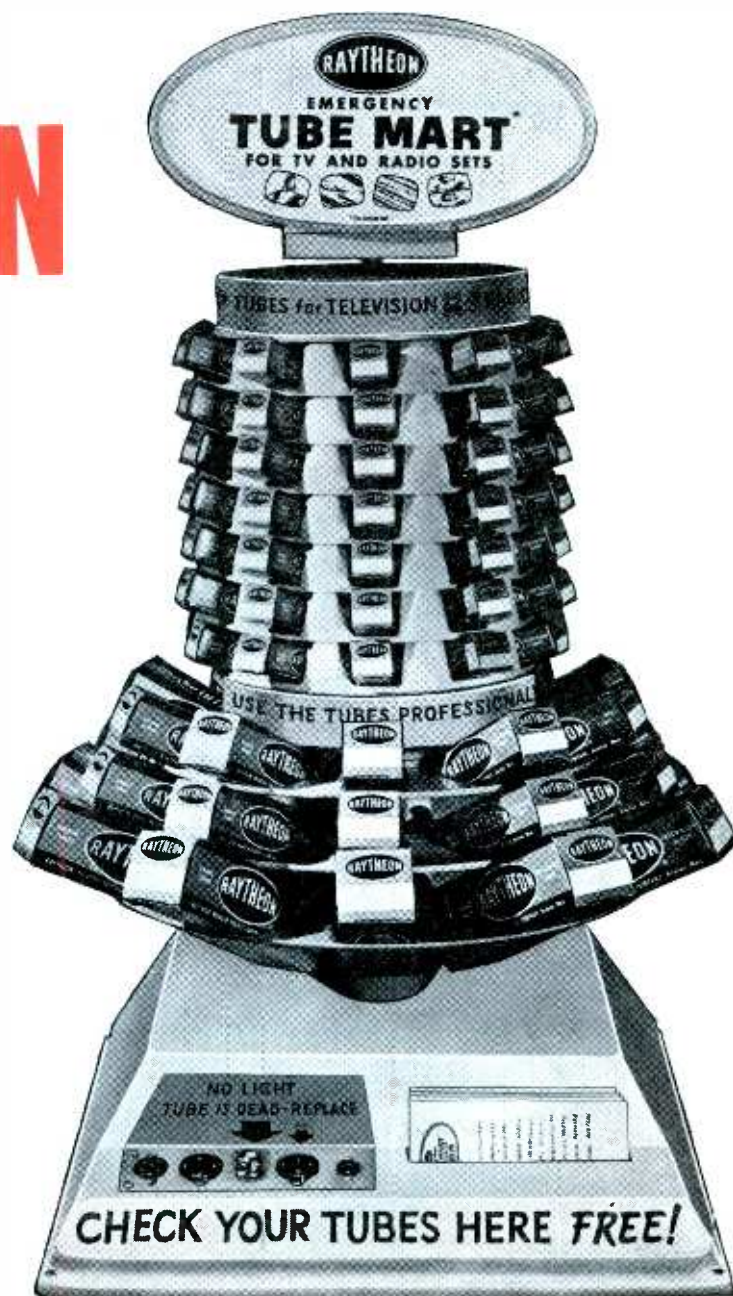



## of the Corner Store Tube Tester

# NEW, PROFIT-MAKING

The new RAYTHEON TUBE MART puts the profits where they belong – in the pockets of Service Dealers like yourself....

As a RAYTHEON TUBE MART AGENT *you* gain:



**TOP PROFITS FROM TUBE SALES**



**CREDIT FOR HELPING SET OWNERS**



**EXTRA SERVICE BUSINESS**



**NEIGHBORHOOD ADVERTISING**

Here's all you do. Place these handsome Raytheon Tube Marts in your neighborhood stores. Keep them stocked and earn a continuous flow of profits. You'll increase your servicing business, too, because each Tube Mart holds your imprinted leaflets — that direct customers to you for TV-Radio service.

It's easy to place Raytheon Tube Marts in profitable locations because you offer the shop owners a new source of extra profit.

For the complete story on how to become the money-making Raytheon Tube Mart Agent in your neighborhood, call your Raytheon Tube Distributor today.



**DISTRIBUTOR PRODUCTS DIVISION**  
RAYTHEON MANUFACTURING COMPANY

Newton 58, Mass., 55 Chapel Street • Chicago, Ill., 9501 Grand Ave. (Franklin Park)  
Atlanta 6, Ga., 1202 Zonolite Rd. N.E. • Los Angeles 16, Calif., 5057 W. Washington Blvd.



# across the

# BENCH

by Stan Prentiss

## RCA Chassis KCS47

Although these fine old receivers are going into their ninth year of operation, we still find them on the bench from time to time. There must have been a fabulous number of these sets made. After I finish repairing one of them, hardly any time passes before I'm back at work on another. There are several versions of this excellent old chassis, designated by different suffix letters. For a complete cross-reference guide to various models and chassis in the KCS47 production run, refer to Table I.

Tunable buzz in the audio and tendency toward loss of horizontal sync have both been common complaints in these receivers, especially since they have reached a ripe old age. Unfortunately, there are no quick cures; about the only remedy I've discovered is a good, long session of checking voltages and waveforms to find defective parts.

Since the PHOTOFAC Folders for this chassis series didn't include waveform pictures, I have assembled a series of normal waveforms taken from the "A" version. All of these patterns, presented in Fig. 1, were taken in a medium-to-high signal area with an oscilloscope having a flat vertical frequency response from DC to 4.5 mc. A low-capacitance probe was used wherever necessary. The peak-to-peak voltage amplitudes listed for each waveform may be used for reference if your local signal conditions and your test equipment's capabilities are taken into consideration.

I recently serviced two KCS47's that had the characteristic troubles I mentioned. The first one was guilty of picture flickering, tearing, and occasionally a complete loss of video. The sound had a buzz that varied with the setting of the fine tuning control and was always loudest when there was a considerable quantity of black in the picture. The second receiver also buzzed in the same manner, and it invariably lost horizontal sync when the televised scene changed from the program to a commercial. Both receivers lost sync when the contrast control setting was reduced. Let me show you what procedure I followed in correcting these faults.

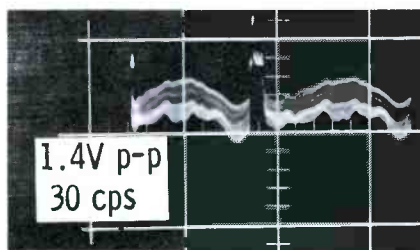

(A) Grid (pin 1) of second video IF.

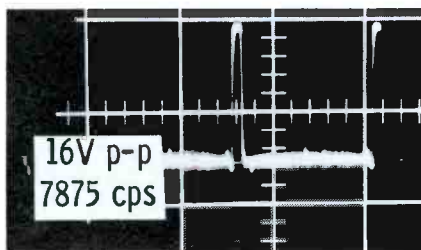

(F) Same as (E) at higher sweep rate.

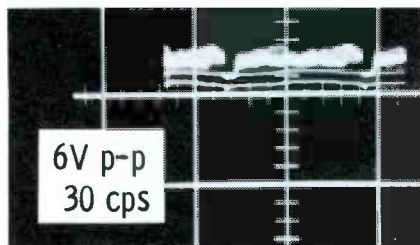

(B) Output (pin 7) of video detector.

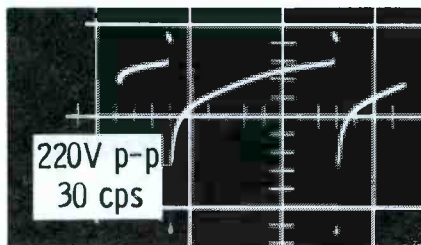

(G) Grid (pin 5) of vertical oscillator.

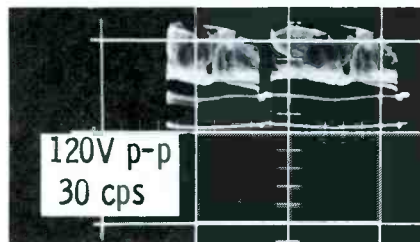

(C) Plate (pin 6) of video output tube.

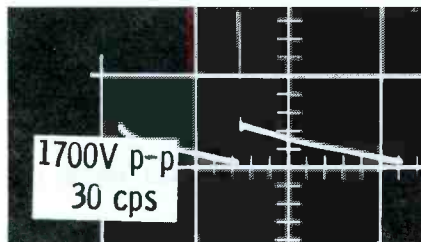

(H) Plate (pin 3) of vertical output.

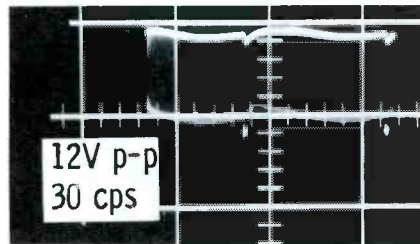

(D) Grid (pin 7) of sync amplifier.

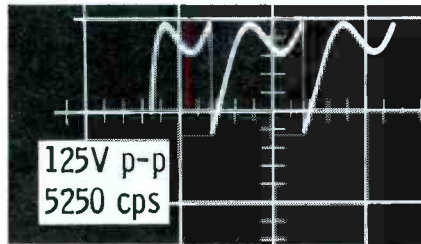

(J) Lug C on horizontal oscillator coil.



(E) Plate (pin 6) of sync amplifier.

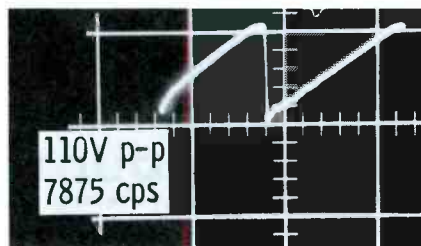

(K) Grid (pin 5) of horizontal output.

Fig. 1. Waveforms observed in RCA Chassis KCS47A during normal operation.

**TABLE 1—VERSIONS OF RCA CHASSIS KCS47**

Chassis Suffix	Models Where Used
None; T	6T53, 6T54
A; AT	6T64, 6T65, 6T71, 6T74, 6T75, 6T76
B	7T103, 7T104
C	7T112, 7T122, 7T123, 7T124
D	7T132
E	16T152
F	7T103B, 7T104B
G	7T112B, 7T122B, 7T123B, 7T125B
GF2	7T111B

**Begin with Power Supplies**

In any electronic troubleshooting procedure, it's a good rule to check power-supply voltages as the next step after testing tubes. Circuits can't function right unless they have proper DC operating potentials. In the KCS47 chassis, there are three B+ voltages (none negative) with plenty of electrolytics for ripple filtering. Two of these voltages, the 370- and 115-volt supplies, are relatively constant regardless of signal conditions. However, the intermediate 200-volt supply is subject to considerable change when signal is applied. This shift in voltage is due to a changed conduction level in the RF amplifier, all four IFs, and the first video amplifier, all of which are connected to the 200-volt supply.

With the antenna disconnected, the intermediate B+ supply is just about 200 volts. A fairly strong input can cause this potential to rise to at least 250 volts. This normal variation can cause quite a bit of confusion when troubleshooting this branch of the B+ circuit. Fortunately, though, it is usually rather

easy to spot the culprits responsible for defects here.

First, determine if the voltages at the other two power-supply taps are normal. If not, pull the 5U4G rectifier tube and make sure that the RMS readings on plate pins 4 and 6 of the socket are at least 350 volts (measured from each pin to ground). A correct reading at this point is a clue that the power transformer is operating properly, at least when not under load.

Further investigation should begin at the filter capacitors and proceed, if necessary, to other principal points in the B+ circuit. Uniformly low readings mean leakage or a partial

the plate and screen circuits of tubes supplied from the latter. Before you permit the power supply to pass inspection, check the ripple waveforms on the various B+ lines to make dead certain that the various filter capacitors are doing a good job of removing hum and pulse interference.

**Check the IF's**

When you are satisfied that the power supply is working normally, connect an antenna to the set and measure the DC voltages at the grids of the first three video IF amplifiers. VTVM readings ranging from —3 to —5 volts indicate that these

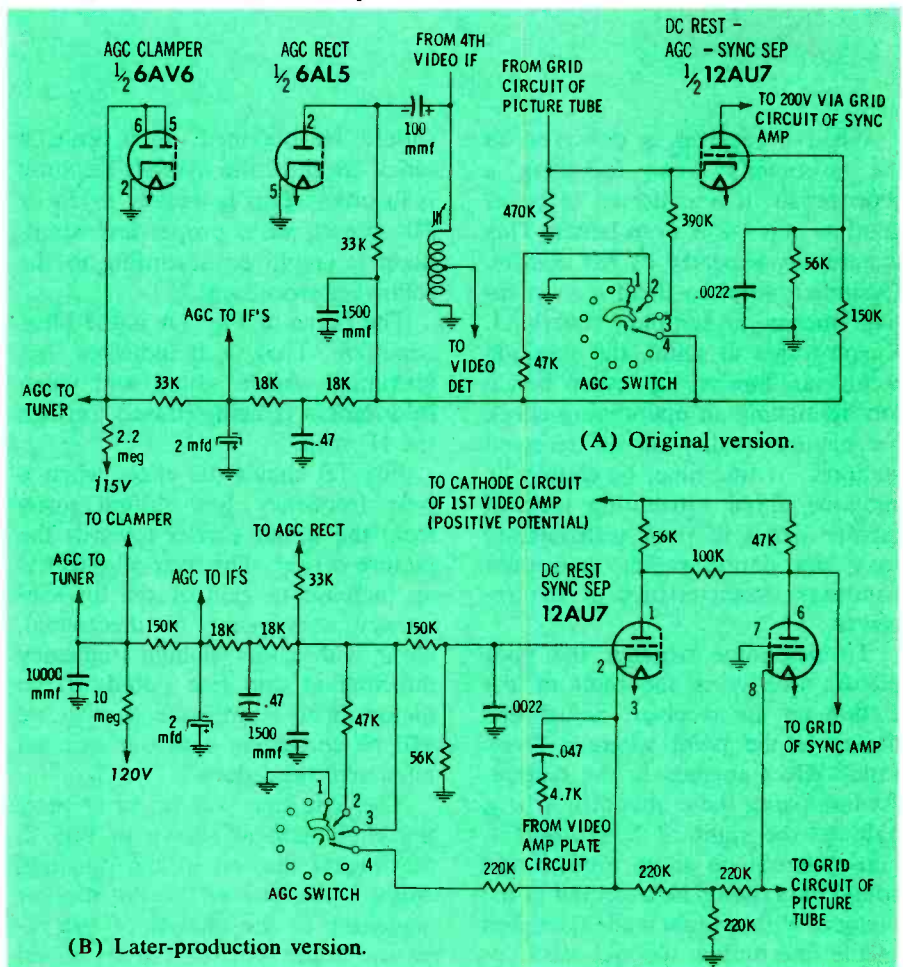

**Fig. 3. AGC circuit of RCA's KCS47.**

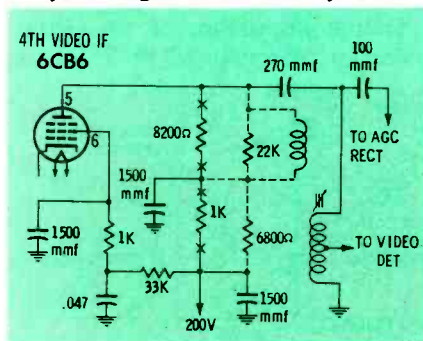

**Fig. 2. Modifications to fourth video IF circuit of RCA Chassis KCS47.**

short from the power supply to ground, while abnormally high readings indicate an open condition in a load circuit which normally draws heavy current.

Under usual conditions, the 370- and 115-volt supplies measure well within a 5% tolerance. If they are okay, but the 200-volt supply seems suspiciously low or high, you can immediately turn your attention to

stages are operating and that there is no DC leakage through their coupling capacitors. At this point, if you wish, you can apply a demodulator probe to the plates of the video IFs and see if the waveform shapes and amplitudes are anything like those shown in Fig. 1A. If they aren't, better recheck the IFs to find out why. By the way, don't be in a hurry to

• Please turn to page 63

*how to check and improve  
the performance of TV sets*

**by Mike Martynec**



# alignment made easy

When a receiver is delivered to the customer's home following a shop repair, it is expected to be as good as new — or even better. This is naturally expected by Mr. & Mrs. Customer, since to them a shop repair means a complete overhaul. Keeping this in mind, the thinking technician finishes up every bench job by making an operational check for picture quality on all received stations. At this time, he should be cautious about attributing lack of picture detail to poor transmission from the station rather than poor bandpass characteristics of the receiver.

To determine whether the poor picture quality is the fault of the station or the receiver, adjust fine tuning to the point where a "wet-sand" effect appears in the picture. At this point, there should not be a halo to the right of large objects, audio should be at its loudest and sound bars should be observed in the picture. With a slight readjustment of the fine tuning, the wet-sand appearance and sound bars should disappear and a sharp, crisp picture

should be obtained. If it isn't, a quick check of the over-all response is in order. This is usually a 15- or 20- minute job if proper test equipment is employed according to the following procedure.

The curve of Fig. 1A is the ideal condition. That is, it indicates that maximum usable sound and video information is being passed through the IF strip.

Fig. 1B shows the effect when a pole frequency has shifted away from the sound carrier towards the picture carrier. The over-all effect is an increase in gain of the low-frequency component of the signal, along with a loss of high frequency information and fine detail in the picture. This is, in essence, what we will be correcting with our over-all alignment procedure.

The first step will be to connect the equipment as shown in Fig. 2. Starting at the left of the drawing, connect the ground of the marker generator to the chassis of the receiver. If the receiver chassis is tied to one side of the AC line, use an isolation transformer to protect the

receiver and test equipment. The marker output is clipped to the receiver chassis near the mixer plate output or near the grid of the first video IF stage. This connection may be moved slightly, depending on how much marker injection is realized.

Fixed bias is connected to the AGC line to prevent overloading and to insure normal operation for the gain-controlled stages in the tuner and video IF strip. In older receivers, where AGC is developed at the video detector, 2 to 3 volts of bias is ample. However, keyed AGC circuits may require more bias for proper operation. (See service literature for correct bias levels.)

The scope ground is tied to chassis ground, and the scope input connected to the video detector load resistor. This point is frequently called the "looker point." Horizontal sweep for the scope will be supplied from the sweep generator. This automatically synchronizes the scope's horizontal trace with the sweep frequency of the generator signal.

Output impedance of the sweep generator, normally 52 or 75 ohms

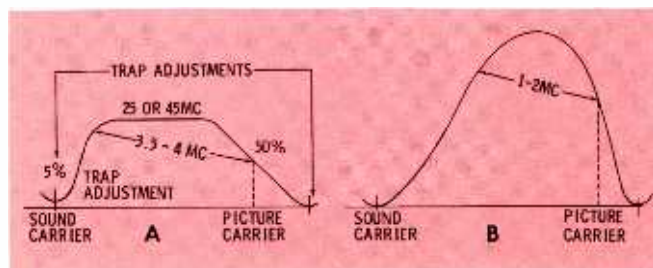

**Fig. 1. Over-all IF response curves.**

(A) Ideal curve—broad, flat top. (B) Excessive low-frequency gain.

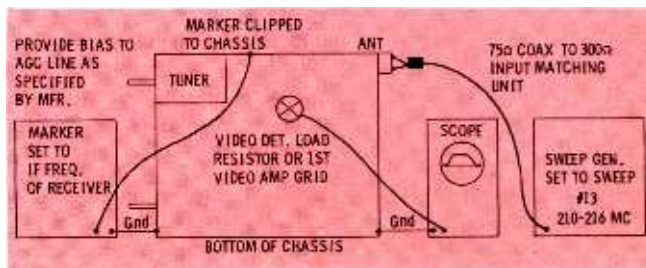

**Fig. 2. How to connect test equipment to receiver for an IF alignment job.**



unbalanced, is matched to the 300-ohm balanced antenna input of the receiver through a simple resistive network (see Fig. 3). The sweep is adjusted for a center frequency of 213 mc so that it will cover Channel 13. Sweep width will be at least 6 to 8 mc to insure viewing the total response curve.

All necessary test equipment is now properly connected. With the receiver tuned to Channel 13, adjust the sweep generator center-frequency dial until a response curve appears on the scope screen. During this operation, you may experience several similar curves. Choose the one nearest the Channel-13 calibration point. Now, converge the retrace curve, using the phase control on the sweep generator. Decrease marker and sweep outputs to a value that will still allow the response curve to be seen at maximum usable scope gain. Adjust bias to the level specified in the service literature. By increasing the output of the sweep generator, it will usually be possible to flatten out the top of the response. This is misleading and shows that overloading is occurring. Ease up on sweep generator output until the response curve does not change shape when the gain is reduced or increased slightly. Now inject just enough marker to see the pip, and you are ready to make adjustments. For those who have not set up for alignment before, the foregoing may appear awkward at first; but, after 2 to 3 setups, it will take less than 5 minutes to do.

From the service data, obtain sound and picture IF frequencies along with any trap-alignment procedures. Assuming the curve of Fig. 1B is realized, adjust the mixer-plate and video IF points slightly to determine which one controls the high-frequency end of the bandpass curve. A slight adjustment should cause the response to approach that shown in

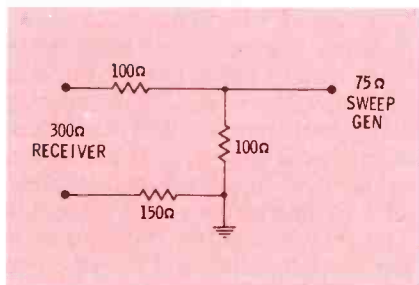
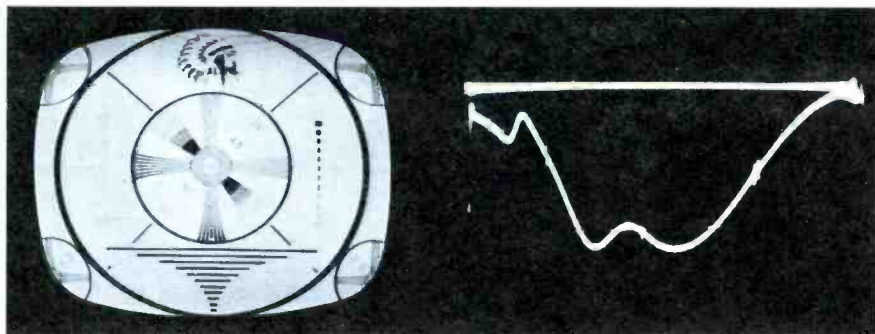
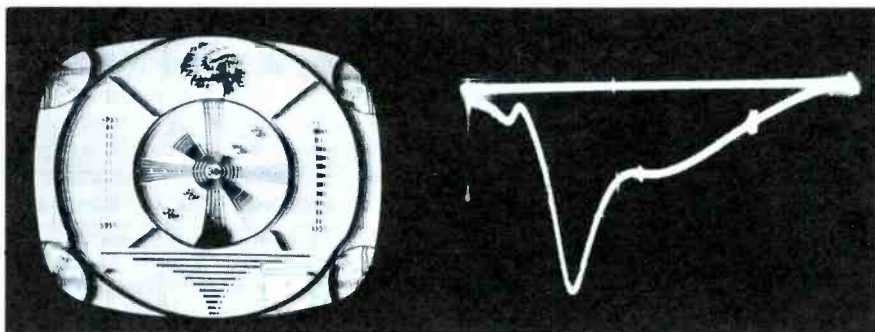

Fig. 3. This resistive network matches generator output to receiver input.



Clarity of detail, absence of ringing, and a lack of smear in large areas indicate that test pattern is normal.

In a normal IF response pattern, the video carrier is at 50% of peak amplitude and sound carrier is at 10%.



When picture detail is fuzzy but the scanning lines are sharp, a loss of high-frequency response is indicated.

Attenuation of high video frequencies will occur if the IF response curve shows poor gain near sound carrier.

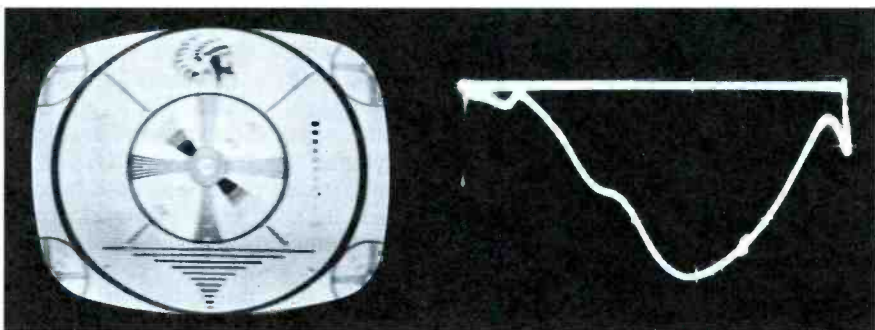

Ringing and smear result when high-frequency response is excessive and low-frequency response is insufficient.

Peak indicates excessive high-frequency response, while flattened portion indicates poor low-frequency response.

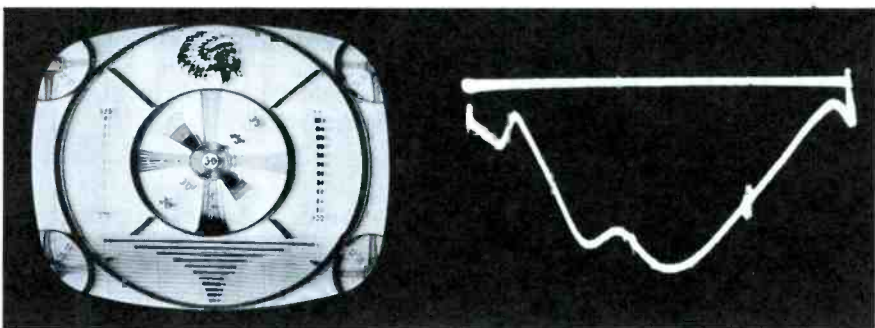

If low- and high-frequency response are both excessive, a combination of smear and ringing will be produced.

The video-carrier marker falls too high on the curve, which is peaked more on the low side than on the high side.

Fig. 1A. A touch-up of the other adjustments should then produce a normal curve. Be sure to set the traps as specified by the technical data. Uncouple the test equipment and air-check the receiver. Set the fine tuning control to the center of

its range and retune the local oscillator on each channel to obtain best sound and picture. You will be pleased with the results! After 2 to 3 over-all alignments you will very likely become "alignment happy," but this will soon wear off. ▲

SPECIAL  
ANNOUNCEMENT  
TO THE USERS

OF THE **B&K**

MODEL 1000  
**DYNA-SCAN**

Now for only **\$89<sup>95</sup>**

YOU CAN HAVE YOUR  
Model 1000 Dyna-Scan

**CONVERTED  
BY THE FACTORY**

to the latest  
SIGNAL INJECTION  
DIRECT VIEWING

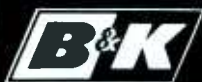

MODEL 1075

**TELEVISION  
ANALYST**

(described on opposite page)

This unique plan has been set up, through the cooperation of B&K Distributors, to make it easy for you to obtain all the features and benefits of the sensational new B&K "1075" TELEVISION ANALYST at lowest possible cost!

Your converted unit will have the regular guarantee like a brand new instrument.

It proves again how we work to improve but not to obsolete your B&K equipment.

This conversion service is available through your B&K Distributor—or write to us.

Dept. R



**B&K MANUFACTURING CO.**  
3726 N. Southport Ave. • Chicago 13



**A Lot of Talk.** Commercial and industrial two-way radio systems are operating all around you, often in places you may not realize. Congestion in the frequency bands used by these services has become so severe that "split-channel" operation has been adopted; that is, bandwidths have been cut in half to accommodate double the number of stations. The industry is now busy changing over from the wide-band to the narrow-band system.

Typical of the uses recently found for two-way radio is the system used on city transit buses in Rochester, N. Y. Mobile units in all buses allow the drivers to keep in touch with dispatchers at the bus company's offices. Since all emergencies, breakdowns, and traffic delays are reported promptly, the dispatcher can readily reroute buses to close up gaps in service and prevent the "bunching up" of buses caused by traffic jams.

Are you interested in servicing mobile radio? Before you are allowed to touch the inside of a transmitter, you need to obtain at least a second-class radiotelephone license from the FCC. In case you have wondered, this license *does not* require that you learn Morse code, as would be necessary for a radiotelegraph license.



**Man At the Front.** After finishing a series of house calls, have you ever felt as if you've been up in the front lines fighting a battle? In a sense, that's what you've been doing, for the serviceman is spearheading the electronic industry's drive to make its products more useful to the public.

Among all highly-trained technical people, the serviceman stands alone as one who must be able to deal effectively with human beings as well as mechanical devices. In

connection with their recent All-American Awards program, Mr. Irvine D. Daniels of General Electric Co. put it this way: "The serviceman must not merely solve highly intricate electronics problems—but must tailor the solutions to the personalities, needs, and desires of individuals." The most brilliantly designed equipment is a flop without someone to keep it functioning well enough for the owner to get his money's worth.

Difficulties are bound to arise when complicated electronic devices are put into the hands of the non-technically-minded public; but, with the serviceman doing his part to supply practical answers for these problems, further electronic developments even more revolutionary than TV will be able to take their place in American life.



**Lemon.** Pity the customer whose new TV set has several failures during the first few months. About the time of the third or fourth breakdown, he may unhappily conclude that the set is hopelessly defective and that he's been stung.

If he's following this train of thought, admit that he has had an unusual run of bad luck; but point out that there's no reason why the set should be doomed to a lifetime of trouble. Explain that all the trouble may have been "smoked out" (but don't talk *too* optimistically, since another defect or two may be lurking under that chassis).

When you encounter a set whose sorry history has earned it the label of "lemon," give it a more thorough going over than usual. Take time to determine if any circuits are unusually critical in adjustment or otherwise border on defective operation. You may lose a few dollars on the job, but the money will be well spent if you make a friend out of the customer.

**NEW  
COMPLETE**

**DIRECT  
VIEWING**

# TELEVISION ANALYST





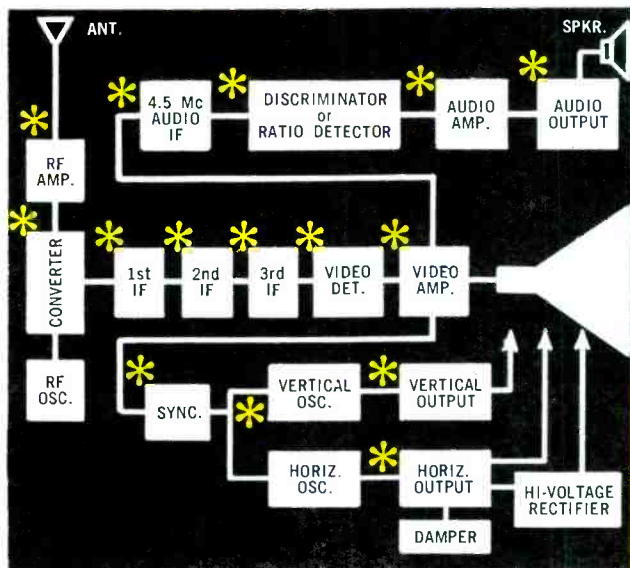
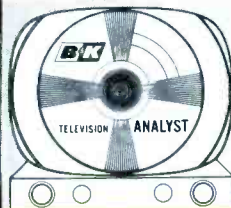

*test each stage  
SEPARATELY*



and watch the  
← result on the  
TV set itself



**UNIQUE NEW SIGNAL-INJECTION TECHNIQUE**  
*Saves TV Trouble-Shooting Time and Work*

-  **R.F.** Supplies complete r.f. and i.f. signals with video and audio modulation to quickly trouble-shoot each stage in each of the sections of the TV receiver. Enables you to check the r.f. sensitivity and AGC settings of TV receivers.
-  **VIDEO** Reproduces a complete test pattern on the screen of the TV picture tube and injects signals into each video stage of the TV receiver for fast, visual trouble-shooting and correction—anywhere, anytime. Makes it easy to check bandwidth, resolution, shading and contrast capabilities of the TV set.
-  **SYNC** Provides composite signal, sync positive and negative.
- SWEEP CIRCUIT DRIVING PULSES** Provides separate vertical and horizontal driving pulses for trouble-shooting deflection circuits.
- INTERMITTENTS** Test signal injection also aids in locating intermittent troubles.
-  **AUDIO** Provides a 4.5 mc sound channel, FM modulated with approximately 25 kc deviation. (This audio carrier is modulated either from a built-in 400 cycle tone generator, or from your own external audio source.) Injection of the 400 cycle tone signal simplifies trouble-shooting of the audio section.
-  **COLOR** Enables you to trouble-shoot and signal trace color circuits in color TV sets.  
Generates white dot and crosshatch patterns on the TV screen for color TV convergence adjustments.  
Generates full color rainbow pattern of orange, red, magenta, blue, cyan, green to test color sync circuits, check range of hue control, align color demodulators, etc.
-  **SET ADJUSTMENT** Enables you to check and adjust the vertical and horizontal linearity, size and aspect ratio of television receivers.



**NEW**



**MODEL  
1075**



**QUICK, DIRECT, COMPLETE TV TROUBLE-SHOOTING**

Now, by point-to-point signal injection and test pattern reproduction, you can easily trouble-shoot and signal trace *any stage throughout the video, audio and sweep sections* of black & white and color TV receivers. With the remarkable new Model 1075 B&K TELEVISION ANALYST, you can quickly isolate and diagnose TV troubles (including intermittents). By use of the generated test pattern, you can *actually see* the condition directly on the picture tube of the television set itself. No external scope is needed. The TELEVISION ANALYST is practically a *complete TV service shop in one instrument!* Net, \$259<sup>95</sup>



See your B&K Distributor or write for Bulletin AP 12-R

**B & K MANUFACTURING CO.**  
3726 N. Southport Ave. • Chicago 13, Illinois

Canada: Atlas Radio Corp., 50 Wingold, Toronto 10, Ont.

Export: Empire Exporters, 458 Broadway, New York 13, U. S. A.

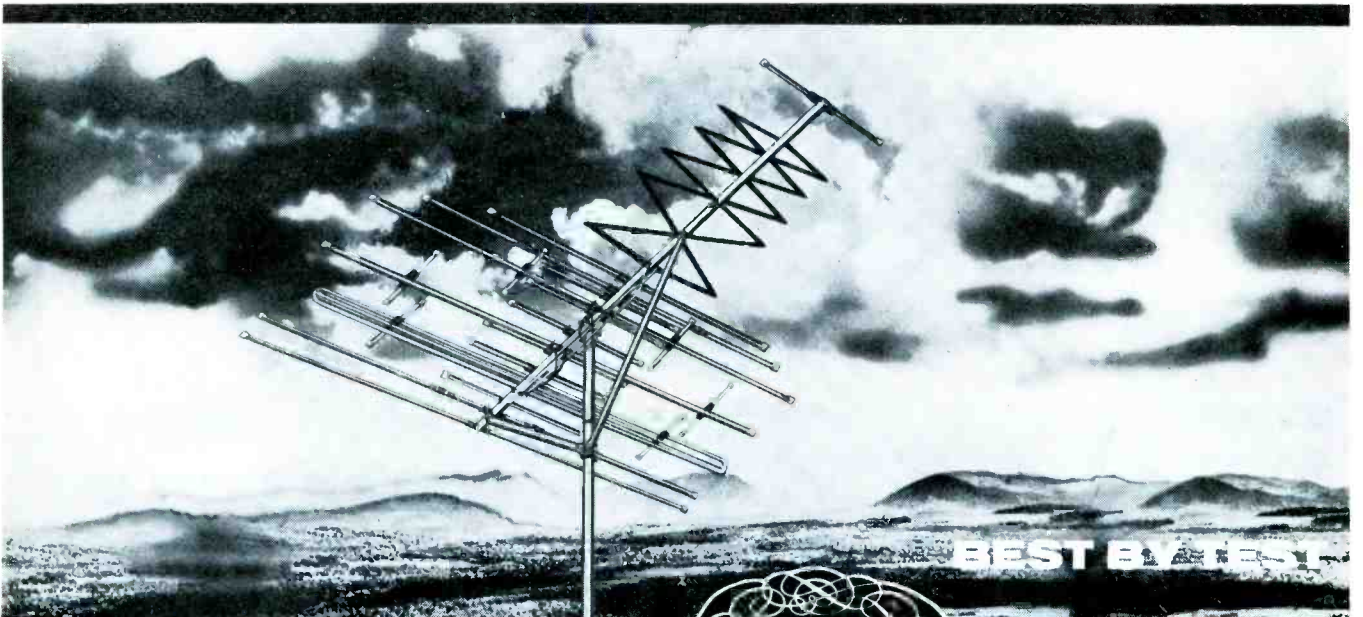

**WHAT EVERY SERVICEMAN SHOULD KNOW ABOUT THE**



**SATELLITE-HELIX**



**1. BALANCED SLEEVE DIPOLE DESIGN!** Shrinks the miles and flattens the mountains. Boosts gain up to 37% over larger fringe antennas. Provides 15 to 1 front-to-back voltage ratio on channels 2 to 6, and 18 to 1 on channels 7 to 13.



**2. 28-ELEMENT "SEARCH LIGHT" DIRECTIVITY!** Multiple driven dipoles pile up needle-sharp directivity that pinpoints distant stations, sidesteps ghosts and interference for flawless picture definition.

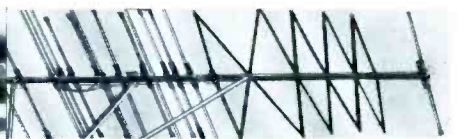

**3. FLAT MICROWAVE HELICAL SECTION!** Each individual non-linear additive collector is tuned separately for highest gain and sharpest directivity on each of the 7 high band channels.



**4. 15 INCH ALUMINUM DOWELS!** Reinforce all elements over 30 inches in length. Rigidize elements against sag or sway. Keep antenna working and looking like new.



**5. DOUBLE U-BOLT FOR DOUBLE-STRENGTH!** Grips crossarm powerfully to mast. No shift or slip. Keeps antenna on station beam even in gale-force winds.



**6. ONE INCH TUBULAR BOOM BRACE!** Full size, full length construction. Rigidizes crossarm, prevents twist or droop. Heavy gauge one inch o.d. aluminum tubing.



**7. SEAMLESS ELEMENTS!** Six 1/2 inch diameter seamless elements impart extra strength as well as improve electrical conductivity.



**8. ALCOA ALUMINUM!** Made of 100% aircraft aluminum by ALCOA - world's top-quality producer - for permanent corrosion-resistance.



**9. NATIONALLY ADVERTISED!** Dramatic ads all season long in Progressive Farmer, and other national and local TV, radio and newspaper media send ready-to-buy prospects into your store. Plus big co-op advertising allowances.



**10. SPECTACULAR INCENTIVES!** Yours free! Costly card table and chair sets, hand-painted portraits, aluminum chaise lounge and chair patio sets. No coupon collecting. No contests. Every dealer wins.



**11. YOUR HARVEST OF PROFIT!** The most dynamic merchandising package ever put to work to nail down bigger and better TV antenna sales for service dealers.

**NOW MORE THAN EVER** - It pays to specify a JFD area-engineered Helix Color-tenna (with new Balanced Sleeve Dipole design) for every market. **Call or visit your JFD distributor now.**

**JFD Electronics Corp**  
 6101 Sixteenth Ave Brooklyn 4, New York

JFD International  
 15 Moore Street  
 New York, New York

JFD Canada Ltd.  
 51 McCormack Street  
 Toronto, Ontario, Canada

- SATELLITE HELIX**  
Deep fringe
- POWER HELIX**  
Fringe
- STAR HELIX**  
Near Fringe
- SUPER HELIX**  
Secondary
- JUNIOR HELIX**  
Primary

ownership of a complete and currently maintained  
**PHOTOFACT SERVICE DATA LIBRARY**  
**SPELLS SUCCESS FOR SERVICE TECHNICIANS**

*here's actual proof from the men who know!*

**"PHOTOFACT more than doubles the amount of work a shop can turn out. The time saved by their use is inestimable...cuts labor costs, too..."**

—Warren G. Kunkle, Denver, Colorado  
 (Operator of Warren G. Kunkle & Co.—  
 in business for over 27 years)



**HERE'S MORE PROOF...FROM COAST-TO-COAST**

**VIRGINIA**

"I have been using PHOTOFACT since it started, I believe that was in 1946. I don't see how I could do without it..."

—Glen Edwards  
 Norton, Va.

**PENNSYLVANIA**

"PHOTOFACT cuts servicing time in half..."

—Norman E. Rick  
 Reading, Pa.

**NEW YORK**

"It's the only complete circuit data service available to the industry..."

—Herbert Cook  
 Rochester, N. Y.

**KANSAS**

"I find I can save 50% of my time by using PHOTOFACT for everything—alignment, replacement parts, schematics, etc. In fact, if anything happened to my PHOTOFACT and I couldn't replace them, I think I'd just close my shop."

—Charles F. Burket  
 Elkhart, Kansas

**CALIFORNIA**

"We use PHOTOFACT daily. I don't believe we could conduct a first-class service shop without them. They are a time saver. With them, you can get to the base of your troubles in a hurry."

—P. W. Earls  
 Fallbrook, Calif.

**OHIO**

"I consider PHOTOFACT indispensable in daily use on practically every set which comes to the shop..."

—Dwight L. Benson  
 Edison, Ohio

**TEXAS**

"Sams PHOTOFACT is the easiest and fastest method I have found..."

—Leroy Holloman  
 Odessa, Texas

**IOWA**

"I would find it impossible to give consistently reliable service without a complete PHOTOFACT file of service information."

—Ralph L. Reints  
 Ottumwa, Iowa

(These are just a few of the hundreds of "Success with PHOTOFACT" letters in our files)

**NEW! EASY-BUY PLAN**

—the money-saving way to build your complete profit-making PHOTOFACT Library!

NO INTEREST—NO CARRYING CHARGE—AS LITTLE AS \$10 DOWN

*free!*

VALUABLE STEEL FILE CABINETS FOR REGULAR PHOTOFACT SUBSCRIBERS AND PHOTOFACT LIBRARY PURCHASEES

**GET THE FULL DETAILS**



**SEE YOUR SAMS DISTRIBUTOR TODAY, or write to Howard W. Sams for details**



**HOWARD W. SAMS & CO., INC.**

2201 E. 46th St., Indianapolis 6, Ind.

- Send details on PHOTOFACT Easy-Buy Plan and FREE File Cabinet offer.
- I'm a Service Technician:  full-time;  part time

My Distributor is: \_\_\_\_\_

Shop name \_\_\_\_\_

Attn. \_\_\_\_\_

Address \_\_\_\_\_

City \_\_\_\_\_ Zone \_\_\_\_\_ State \_\_\_\_\_

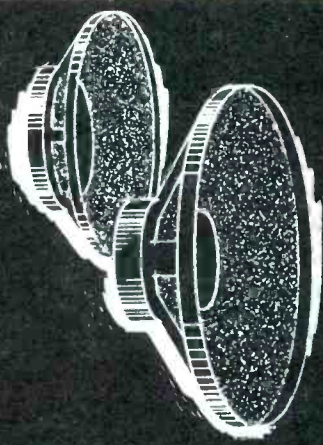

## AUDIO FACTS

### servicing

# HIFI

## equipment

### part 2

by Alan Andrews

Hi-Fi systems are usually made up of a number of individual units which are interconnected through cables and switches and operate together to reproduce full-range sound. All hi-fi rigs contain a speaker system, a power amplifier, a preamplifier, and either a phonograph or an AM-FM tuner. Deluxe outfits may have both a phonograph and an AM-FM tuner as well as a tape recorder. Trouble occurring in one unit can interfere with the operation of other units; thus, before a trouble can be corrected, it must be localized to a specific unit. Once this has been accomplished, only the faulty unit need be considered. Troubles encountered in a hi-fi system fall into four main groups: no output, distortion, hum, and noise. This article will present methods for recognizing and isolating troubles in these categories.

#### No Signal Output

When the customer's complaint is no signal output, the first thing to determine is whether or not the condition exists for all signal inputs. If, for example, records can be played normally but no radio programs can be received, then the tuner is probably at fault. However, if there is no output when any signal source is being used, the trouble must be in some unit common to all signal inputs.

If the speakers are completely dead (no output at all, not even hum), the fault is in either the

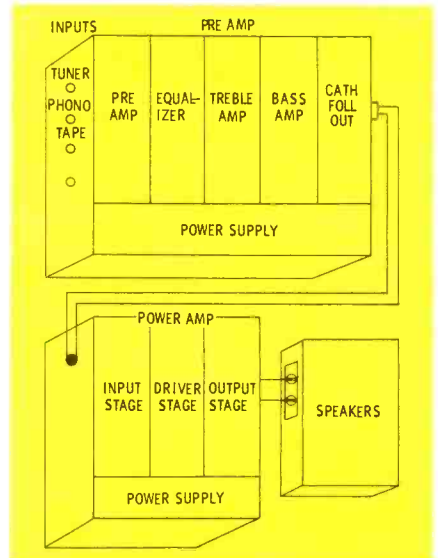

Fig. 1. Block diagram of hi-fi system is handy guide for localizing trouble.

power supply or in the speaker system. However, if noise or hum is coming from the speaker, the fault is most likely to be found in the circuits ahead of the speaker.

Signal substitution can be used to localize the trouble to a specific section of the system. Consult the block diagram in Fig. 1. Starting at the output, the test signal can be connected to the speaker terminals to make sure the speaker is not at fault. Then it may be applied at the input and output of each successive stage (working back from the speaker) until the signal is no longer heard. This procedure will isolate the trouble to a single stage, thus simplifying the process of locating the

• Please turn to page 58

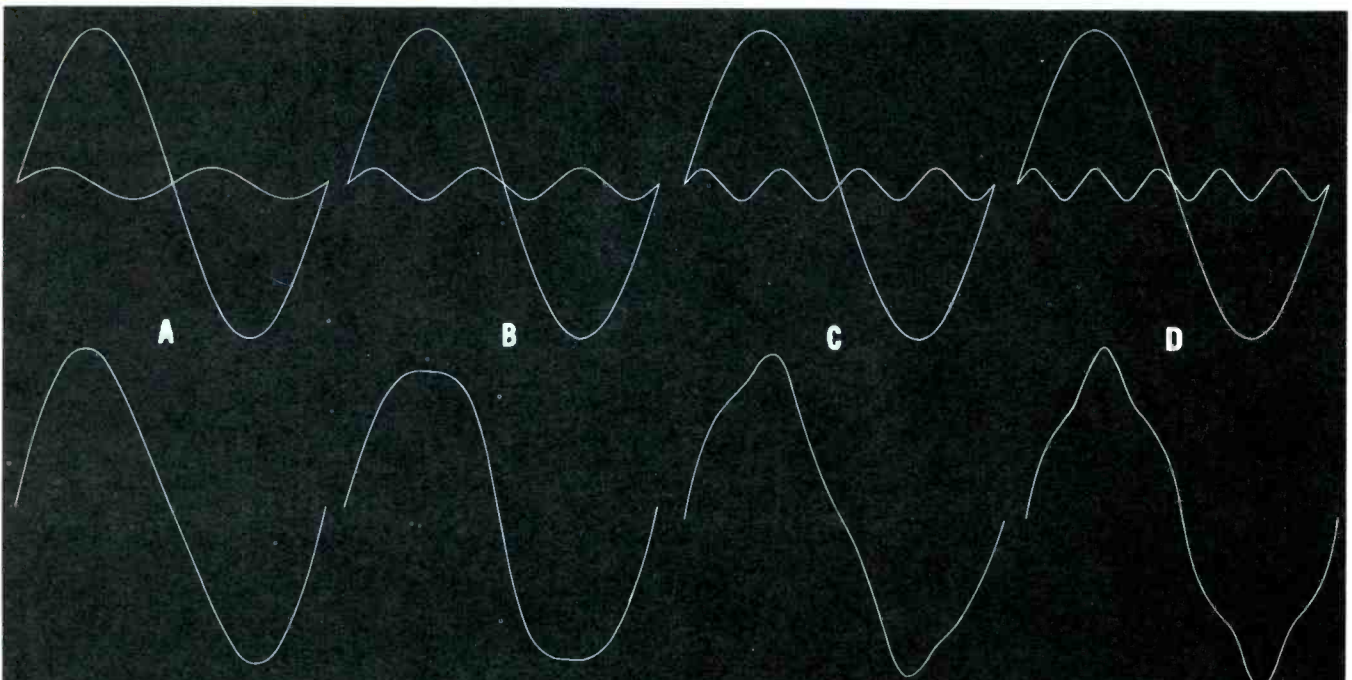
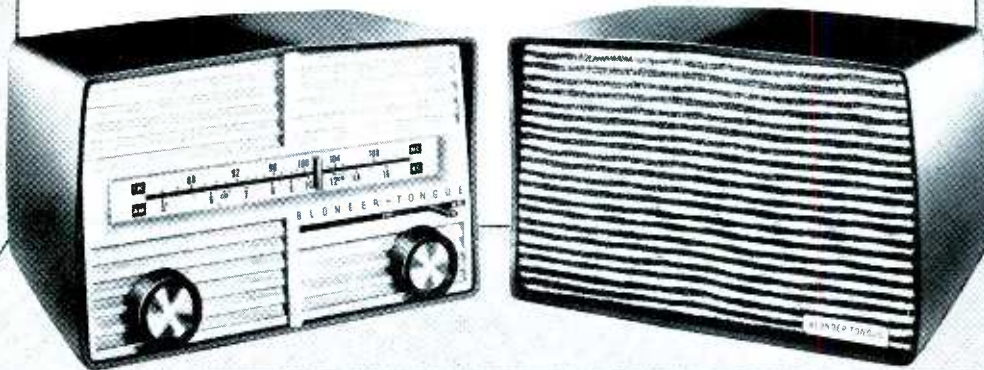

Fig. 2. Examples of harmonic distortion. (A) Second (B) Third (C) Fourth (D) Fifth

# BLONDER-TONGUE ENTERS HI-FI FIELD



## WITH SALES AND MARKETING PLAN



## TAILORED FOR SERVICE-DEALERS

### FOUR EXCITING NEW B-T HIGH FIDELITY COMPONENTS

Blonder-Tongue high fidelity is engineered and built by a company whose name you have learned to respect for quality, and whose TV products have proved their worth and reliability over many years. Styling is modern, crisp, compact. Pricing realistically-keyed for volume sales—a complete system, tuner, amplifier and speaker—can be sold for about the price of a portable TV set...at a bigger profit for you.

**Model T-88 FM-AM TUNER**—Sensitivity of higher priced tuners; drift compensated circuit for frequency stability; super sensitive AM section for all areas. **64.50**

**Model A-1 DELUXE HIGH FIDELITY AMPLIFIER**—4 unique frequency controls cover entire audio range. Full function selection. **77.50**

**Model SS-2 TWIN SPEAKERS IN ENCLOSURE**—Ideal as auxiliary or second stereo speaker. **15.95**

**Model R-98 DELUXE FM-AM RADIO**—Quality radio—high sensitivity on FM & AM. **64.50**

### BOLD NEW MARKETING PLAN BUILDS PROFITS FOR YOU

There's an authorized B-T high fidelity distributor in your territory who will stock and help you sell B-T high fidelity components. A powerful advertising and promotion program

will build traffic and focus attention on your operation, setting you up as the expert to whom the consumer can turn for advice and assistance in high fidelity and stereo conversion.

*For full hi-fi profits, contact your B-T high fidelity distributor today, or write direct.*



**BLONDER-TONGUE LABORATORIES, INC.**

9 ALLING STREET, NEWARK 2, NEW JERSEY

*Dept. PF-12*

*Master TV Systems  
Industrial TV Systems  
UHF Converters • Amplifiers*

# helpful hints for

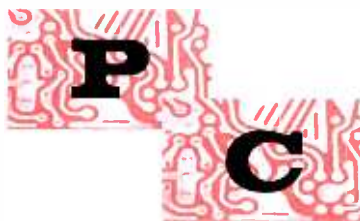

# servicing

with typical examples to guide  
you in your own work

by Fred Howard

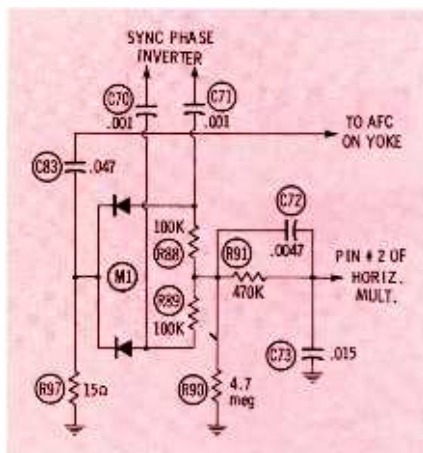

Fig. 1. Selenium-diode horizontal AFC circuit in Admiral Chassis 19YP4PRS.

Printed circuits are here to stay, so it's up to us to find efficient ways of servicing them. Essential test instruments for printed-circuit work include not only a reliable scope and VTVM, but also a good capacitance-resistance checker—one that measures power factor, capacitance, insulation resistance and leakage. If you are still checking the latter two characteristics with an ohmmeter, you are making it hard for yourself. The scope and VTVM are needed to get you as close to the defective part or parts as possible; then you can start checking individual parts. To do this on a PC board, don't start clipping parts and soldering new ones in their place. This practice is not only time-consuming, but can result in other troubles of your own making.

Watch me while I perform some typical PC service jobs. I won't go into any detailed discussions of trouble symptoms and their causes, but I'd like to show you how defective parts are located and new ones are installed.

For our first job, let's examine an

Admiral Chassis 19YP4PRS. According to the customer, the picture is a "scrambled up mess," while the sound is okay. After making several checks with the scope, I know that the trouble is located in the horizontal AFC section. I even have a hunch that the dual selenium diode (M1 in Fig. 1) is the culprit. After unsoldering one of the end terminals, I test this diode section for both forward and reverse resistance with an ohmmeter. The first diode seems to be OK, so I'll unsolder the other end lead of M1 and test the other diode section. Sure enough, this one is defective. When I clip in a new dual selenium unit, the trouble disappears.

Now we have the problem of permanently installing the new component. First, I pick out a drill bit just the same size as the diode lead wire. Inserting it in the old "egg beater," I drill a hole in each of the solder-filled eyelets from which I have removed a lead. Insertion of parts is now a very simple matter. I poke the

leads of the new component through the drilled out holes, bend over about 1/8" of lead wire, and solder.

While I think of it, I would like to mention a word or two about soldering. I use a 100-watt gun or iron and employ the tap method. That is, I get my iron hot—then, holding the solder next to the wire lead, I tap the wire lead without touching the foil. If a one-second tap or touch is not sufficient, I try one more. Never hold your iron on the lead or terminal while it is heating up. *First* make sure it will melt solder; then apply it to the terminal.

If I had been in more of a rush to complete this job, I might have figured that the dual diode was probably bad—so I might as well go ahead and clip it out before testing, rather than going to the trouble of unsoldering the leads. Of course, I would be taking the risk of ending up with a perfectly good diode having leads too short for reinsertion into the circuit, but this situation

• Please turn to page 56

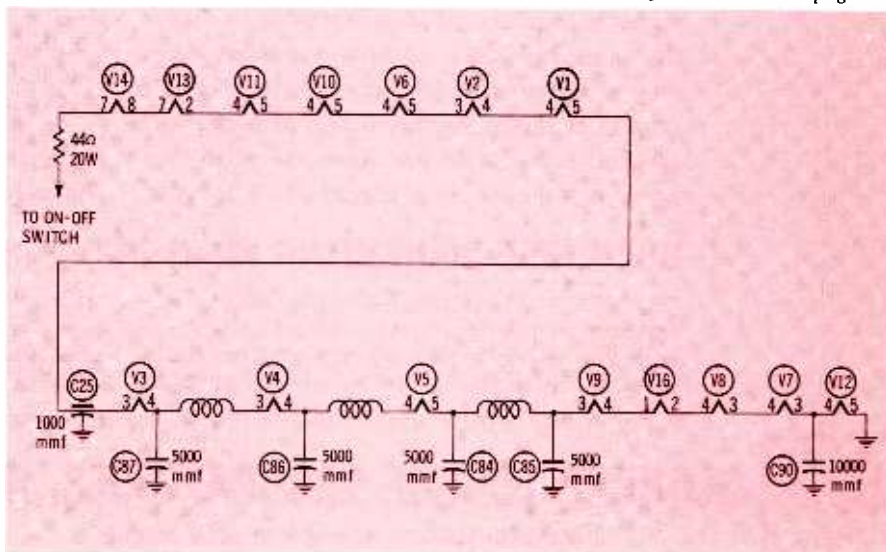

Fig. 2. Heater-cathode leakage in V5 caused V9, V16, V8, V7 and V12 to go out.



**Sylvania comparisons point out—**

# The big difference in Picture Tubes!

Here's the inside story on why local "off-brands" don't measure up to Silver Screen 85® standards

If you're like most dealers, you know off-brand tubes don't have the same quality standards as first-line tubes. To help you see how big the difference is, Sylvania purchased a nationwide sample of sixty 21YP4A's made by 19 different local tube makers. These tubes were put through the same production tests that all Sylvania tubes must pass.

**Not a single local off-brand passed all 54 mechanical and electrical tests!** Many of these were minor defects making little or no difference in whether or not the tube "lit up." But look how loose manufacturing controls can affect the important features of light output, focus, and life!

## LIGHT OUTPUT

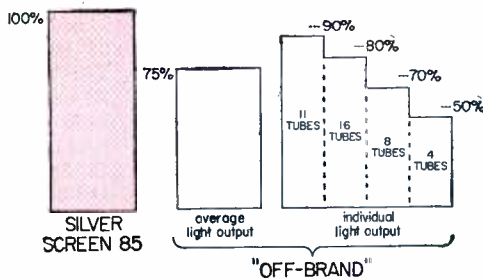

So far, 39 off-brand tubes have been compared with the *minimum* light output of Silver Screen 85. Five additional tubes couldn't even be tested. Eleven tubes were less than 90% as bright as the minimum for Silver Screen 85; 16 were less than 80%; 8 were less than 70%; and 4 were *less than* 50% as bright. Since most Silver Screen 85 tubes average as much as 125% of minimum standards, the difference becomes even greater. Small wonder that Silver Screen 85 is the easy way to more satisfied customers.

## FOCUS

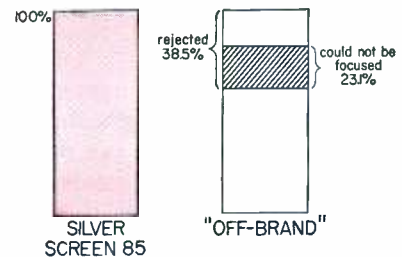
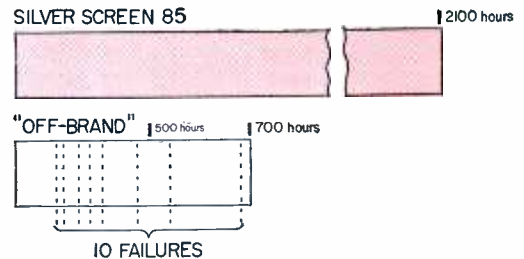

Chart 2 shows how these same 39 tubes stacked up to registered limits on focus voltage. 38.5% were rejected under these limits. Over half of all those rejected could not be focused in a TV receiver. Small wonder then that "Silver Screen 85" pictures are sharper, brighter, clearer.

## LIFE TEST



Nineteen off-brand tubes were placed on Sylvania's standard 2000-hour life test. Chart 3 tells you how fast these tubes developed slow-heating cathodes. Over half, or ten units, failed to go beyond the 700-hour mark. Small wonder then that Silver Screen 85 gives you less troublesome callbacks.

Of all the off-brand tubes tested, Sylvania engineers estimate that 43% probably would not have operated properly in a TV set. Why gamble your reputation, customer satisfaction, and success. It's just *good business* to sell up to "first line" picture tubes; Silver Screen 85 picture tubes.



# SYLVANIA

SYLVANIA ELECTRIC PRODUCTS INC.  
1740 Broadway, New York 19, N. Y.  
In Canada: Sylvania Electric (Canada) Ltd.,  
University Tower Bldg., Montreal

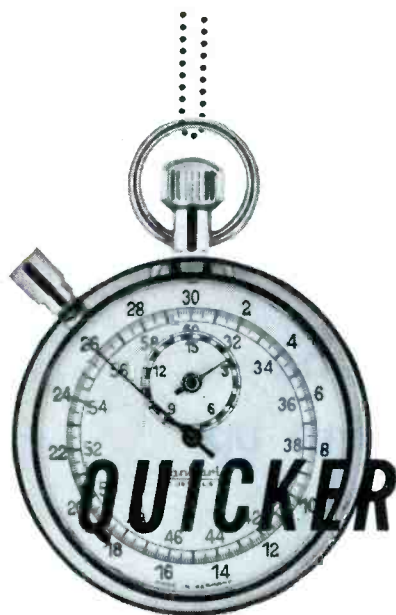

# QUICKER SERVICING

By Calvin C. Young, Jr.

This business of home service calls is getting more complicated with the passage of time. I can remember when a service kit needed only 6 or 7 tools, a cheater cord, ¼- and 5-amp fuses and 12 to 15 tubes.

As things stand now, you need a complete set of standard tools, an-

other set of very short ones, and a third set of very long ones, in addition to well over 100 different tube types, 14 to 15 different fuse types, and 6 or 8 values of fuse resistors for B+ circuits in sets using metallic rectifiers. If your service kit is large enough and if you get your "Wheaties" regularly, you can man-

age to carry most of the things necessary to complete most normal service calls.

Try and visualize if you can, a technician on a recent home service call, loaded down with a kit of 300 tubes; a fuse caddy with 15 styles of fuses; a complete assortment of fusible resistors (4.7 through 9 ohm); sets of pigtail, plug-, and clip-in rectifiers; a filament tester; a complete set of standard, long, and short nutdrivers; a normal compliment of screwdrivers, Phillips drivers, diagonal and long-nose pliers; a soldering gun; and finally, a set of alignment tools and a drop cloth. With this assortment, how can he fail to fix that little portable?

Fail he did, though — even after he had located the trouble (a shorted rectifier which he replaced), the repair couldn't be completed. Why? The fusible resistor was open and all the markings on it were in Greek (no, not really, but they might just as well have been). The number

TABLE I—CROSS REFERENCE GUIDE ON FUSIBLE RESISTORS

Manufacturer	Part No.	Value Ohms Watts	Manufacturer	Part No.	Value Ohms Watts	Manufacturer	Part No.	Value Ohms Watts	
Admiral	61A19	7.5 5	Hoffman	4762	7.5 *	Sonora	43-1009	5 5	
	61A28-3	5 5	Hyde Park	25B1011	7.2 5		24-1073	5 5	
	61A19-2	7.5 5	Magnavox	240074-1	5 *		431007	7.5 5	
Airline	259V002H01	7.5 *		240601-1	7.5 5		431008	7.5 5	
	43X380	7.5 5		24077-1	5 5		25B1011	7.2 5	
	R-1409	5.5 5	Majestic	B-6,326-1	7.5 5		S431007	7.5 5	
	259V004M01	4.7 5	Meteor	S431007	7.5 5		T43-1007	7.5 5	
	20E1042	7.5 5		24-1073	5 5		R1409	5.5 5	
	B154089-1-6	7.5 5	Motorola	17K738862	7.5 5		Spartan	240074-1	5 5
	46M-23018	9 5		17K742136	5 5		Sparton	PA4227	7.5 5
46M-22301	9.1 5		17A711500	7.5 5	Sylvania	187-0053	4.7 5		
46M-20681	5.6 5		17A711027	7.5 5		187-0028	7.5 5		
Ambassador	24-1073	5 5		1K711574	5 5		189-0046	4.7 5	
	Artone	24-1073	5 5	1K711027	7.5 5	Trav-Ler	F6-1	5.6 5	
	24B1116	4.7 5	1K1027	7.5 5	F6		5 *		
Bendix	268021-1	5.6 5	17A791166	7.5 5	F8		7.5 5		
Capehart	453924B-1	7.5 5	17A791696	5 5	Truetone	TV-F-6	5 5		
CBS	31000472	7.5 6	17A700149	5 5		024-201116	4.7 3		
Corenado	TRP-28	4.7 5	17A791166	7.5 3		43X380	7.5 5		
	46M-25577	4.7 5	Muntz	RW-005-13		5 5	224-200002	10 10	
	46M-23018	9 5	Olympic	RE 3823		7.5 5	24B1116	4.7 5	
	24B1116	4.7 5		R-1409	5.5 5	46M-23018	9 5		
Crosley	024-201116	4.7 3	Philco	33-1366-3	5.6 5	46M-25577	4.7 5		
	154089	7.5 5		33-1366-2	5.6 5	46M-20681	5.6 5		
	Durr ont	02310001		7.5 5	33-1366	4.7 *	43X380	7.5 5	
Emerson	394158	5 5	RCA	100117	5.6 5	Wells Gardner Westinghouse	V-16023-1	7.5 5	
	397118	6 *		103824	4.7 5		259V002M01	7.5 5	
Firestone	24B1116	4.7 5			100117		5.6 4	259V004M01	4.7 5
	46M-23018	9 5	Raytheon	46M-23018	9 5		259V002H01	7.5 5	
	43X380	7.5 5		46M-22301	5.6 5		Zenith (1)	63-3287	6 5
Hallicrafters	024-201116	4.7 3	Sentinel	240074-1	5 *	63-3269		7.5 5	
	24-1116	4.7 5		240601-1	7.5 5	63-3644		6 5	
	24B1116	4.7 5		20E1042	7.5 5				
	24-1073	5 5		B154089-1-6	7.5 5				
	24B1011	7.2 5	Silvertone	24-1116	4.7 5				
25B1004	7.5 5		43-1011	5 *					

\* Wattage Not Given by Mfr.  
(1) Original Not Declared as Fusible by Mfr.

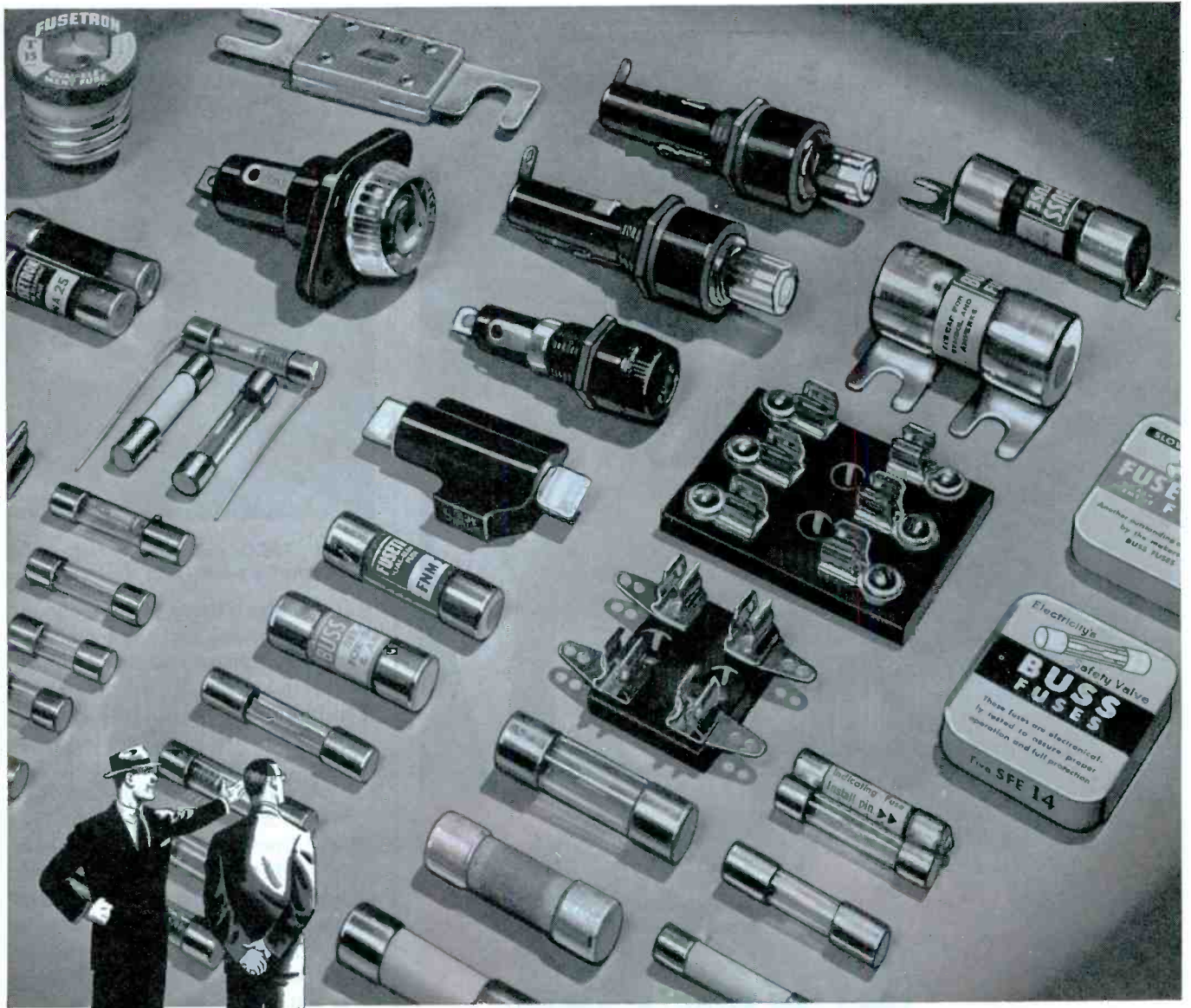

## **BUSS FUSES** help you avoid adjustments and call-backs.

Faulty fuses can cause trouble for you and your customers by failing to protect — or by blowing needlessly . . . but, with BUSS fuses you can be sure of dependable protection under all service conditions.

Every BUSS fuse you sell or install is tested in a sensitive electronic device. Any fuse not correctly calibrated, properly constructed and right in all physical dimensions is automatically rejected.

That's why BUSS fuses provide maximum protection against damage due to electrical faults. Users are safeguarded against unnecessary repair bills, — and your reputation for quality and service is protected.

Equally important, BUSS fuses eliminate needless blows that irritate users and require adjustments or call-backs on the part of sales and service organizations.

Protect yourself against faulty fuses causing trouble by relying on BUSS fuses. To meet service needs, there is a complete line of BUSS fuses available.

For more information on the complete line of BUSS and FUSETRON Small Dimension Fuses and Fuse-holders . . . Write for bulletin SFB. Bussmann Mfg. Division McGraw-Edison Co. University at Jefferson, St. Louis 7, Mo.

*BUSS fuses are made to protect — not to blow, needlessly*



MAKERS OF A COMPLETE LINE OF FUSES FOR HOME, FARM, COMMERCIAL, ELECTRONIC, AUTOMOTIVE AND INDUSTRIAL USE.

98 — COUNT 'EM — 98

# EXACT FACTORY AUTO RADIO CONTROL REPLACEMENTS

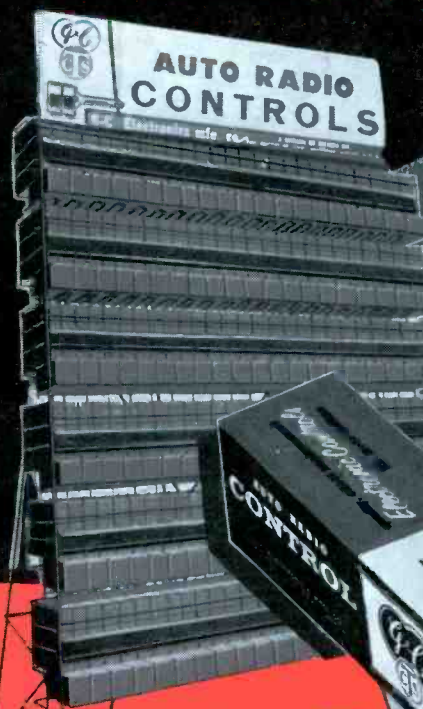

✓ EASY TO INSTALL!

✓ EXACT FACTORY  
REPLACEMENTS!

✓ CAR RADIO SERVICING  
MADE EASY!

## AUTO RADIO CONTROLS

LOOK FOR  
THE G-C CONTROL  
DISPLAY AT  
YOUR JOBBER

Everything you need for profitable replacement is included in this new G-C CTS Auto Radio Control line. A total of 98 exact factory models makes it easy to service 199 different auto makes and models quickly. New G-C Replacement Guide tells you what to use and where. See your G-C jobber now!

FREE New G-C Replacement Guide, write today!

# G-C ELECTRONICS MFG. CO.

division of G-C Textron Inc.

Western Plant: Los Angeles 18, California • Main Plant: ROCKFORD, ILLINOIS. U.S.A.



Fig. 1. TACO comparison test setup demonstrates need for a new antenna.

100117 doesn't say a thing about ohms and watts, and the technician knew that replacement with too high a resistance value would only cause it to fail in an hour or two. He also realized too low a value would not provide the proper protection. So, the job wasn't completed.

When similar reports were received from some of our readers along with a request for a chart on fusible resistors, the author began a set by set survey and used it to prepare the Cross Reference Guide given below. With this data to help you, you'll have no trouble completing more repairs in the home.

### Antenna Comparison Test Speeds Sales

Have you ever wished that you could visually demonstrate to your customer the improved results he would get with a new antenna system. If you have, but are stymied by the sure knowledge that such a project would require a prohibitive amount of time — rejoice! Such a demonstration is now possible and will take less than 10 minutes of your time. The TACO *Comparator* test setup illustrated in Fig. 1 permits the new antenna to be raised to a height of about 20', where it can be oriented for optimum reception by merely twisting the lower mast section. If you will examine the installation layout in Fig. 2 and follow along with me, I'll show you how one man can make the installation in the least possible time.



The aluminized picture tube was a General Electric "first." Unequaled experience in aluminizing techniques puts G-E tube quality well ahead. Example: in the picture below, a G-E inspector, using a "Q" meter, carefully checks the thickness of the aluminum coating in all areas of Black-Daylite face plates. Coating at any point must not be too heavy for a bright picture, or so thin that ion burn can result. Pays off in a superior picture over the entire screen!



**BLACK-DAYLITE**  
ALUMINIZED PICTURE TUBE

# YOUR CUSTOMERS KNOW AND WANT THIS QUALITY TUBE WITH THE FAMOUS NAME!

Best-known name in picture tubes—behind it, years of General Electric marketing effort and millions of dollars of consumer advertising!

Best-liked, most-wanted tube, because Black-Daylite brightness, sharpness, and fine contrast are familiar to television owners everywhere!

Please your customers by installing the picture tube they prefer! It's the sure way to hold present business and build new. Remember . . . you pay no

more for Black-Daylite quality! Your General Electric tube distributor has these top-performance, fast-selling tubes in a wide range of types. Phone him! *Distributor Sales, Electronic Components Division, General Electric Company, Owensboro, Kentucky.*

*Progress Is Our Most Important Product*

**GENERAL  ELECTRIC**

11-13-202

# A Profitable New Field!

## INDUSTRIAL ELECTRONIC SERVICING

with  
**OHMITE**<sup>®</sup>  
QUALITY  
Components

Industrial electronic servicing is profitable new business for you. Especially when you stock and replace with dependable Ohmite components . . . the line your industrial customers know and prefer. Service such industrial equipment as mobile radio, aircraft and marine radar and radio, electronic controls for factory processes and automation, industrial P.A. and intercom systems, and—medical and dental electronics.

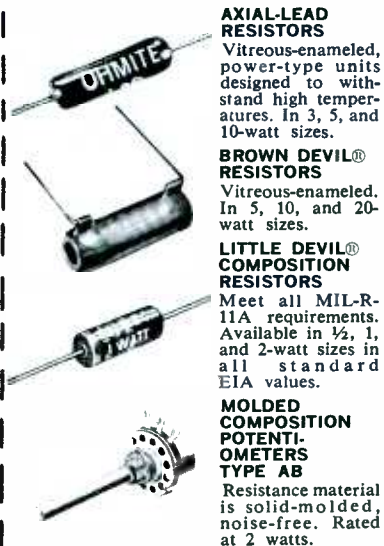

### AXIAL-LEAD RESISTORS

Vitreous-enameled, power-type units designed to withstand high temperatures. In 3, 5, and 10-watt sizes.

### BROWN DEVIL<sup>®</sup> RESISTORS

Vitreous-enameled. In 5, 10, and 20-watt sizes.

### LITTLE DEVIL<sup>®</sup> COMPOSITION RESISTORS

Meet all MIL-R-11A requirements. Available in 1/2, 1, and 2-watt sizes in all standard EIA values.

### MOLDED COMPOSITION POTENTIOMETERS TYPE AB

Resistance material is solid-molded, noise-free. Rated at 2 watts.

Write for Stock Catalog 28

# OHMITE<sup>®</sup>

DEPENDABLE  
RESISTANCE  
UNITS

OHMITE MANUFACTURING COMPANY  
3644 Howard Street, Skokie, Illinois

First of all, join two 10' mast sections with the guy ring positioned above the bulge on the bottom end of the upper section of mast. The guy ropes are already secured to the ring and require no attention at this point. Now, attach the antenna (to which a 50' coil of lead-in wire has been connected) to the upper end of the top mast section. With the bottom end of the 20' mast centered in the triangle formed by the three guy anchors, attach the two spread guys to their respective anchors. Dig the bottom of the mast into its assigned spot and walk the 20' assembly up. Now, holding onto the remaining guy tightly, walk to the third guy anchor and secure the rope. Back off and sight the mast to see if it is as nearly vertical as possible.

For the final step, take the other end of the lead-in, which has the *Comparator* switch assembly attached to it, into the customer's home and attach his existing antenna wire to the open terminals of the switch box. Now, attach the short wire from the switch to the antenna input terminals of the receiver and you are all set for the sales-clinching demonstration. By simply sliding the switch back and forth, you can show the customer the improvement a new, correctly-installed antenna can make in the operation of his receiver.

### Chain Reaction in RCA Color Set

Multiple component failures that result from the effects of a former trouble are not uncommon. However, when it involves three dual-concentric controls, all of which affect the convergence of a color set, that's another matter.

An example of this concerns an RCA color receiver (CTC5A chassis) which had no vertical sweep. When tube replacement and control adjustment failed to cure the problem, the chassis was taken into the shop for further analysis and repair. The picture tube setup (21AXP22, convergence assembly, deflection yoke, purity magnet and blue-lateral corrector) was not disturbed because a suitable yoke was on hand in the shop for bench operation.

It took only a few minutes to locate the reason for no vertical deflection. Voltage and resistance

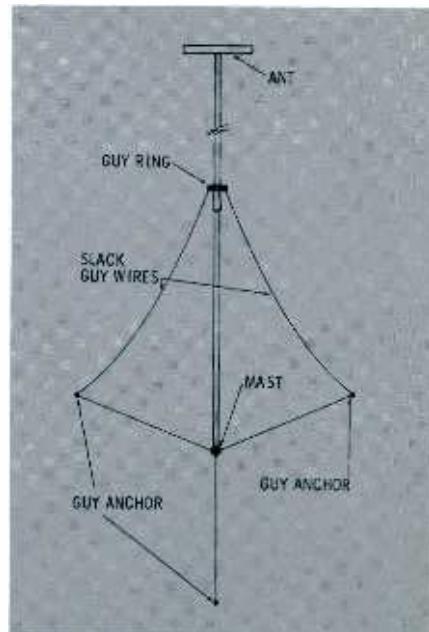

Fig. 2. Comparison tester can be erected on any plot of ground 10' by 30'.

measurements revealed an open cathode circuit in the vertical output stage. A study of the schematic (Fig. 3) resulted in a rather rude awakening. For the circuit to be completely open, three controls connected in parallel all had to be open.

The DC controls in the horizontal output stage were good, as evidenced by the presence of the bright horizontal line on the screen of the 21AXP22. (Note the fuse in the horizontal output cathode circuit, providing protection for the DC controls as well as the flyback and other horizontal output components.)

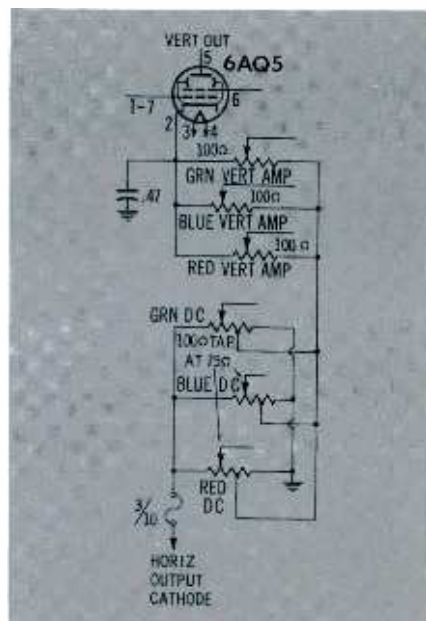

Fig. 3. Vertical amplitude controls are cathode load for vertical output stage.

*For ultimate quality in audio amplification*

## Tung-Sol audio tubes now twin-packed in matched pairs by the manufacturer

Now you can come as close to faultless sound reproduction as the design and circuitry of your hi-fi equipment will permit. Tung-Sol 5881 and 6550 beam-power amplifier tubes are factory-matched to very tight performance limits and twin-packed to help you achieve lowest distortion levels at all volume levels.

Use of Tung-Sol 5881 and 6550 tubes has long been associated with ampli-

fiers of the very finest design. These tubes have always been produced to closest possible tolerances with cathode current ranges held to an absolute minimum.

Now, in twin-packed pairs, they assure the hi-fi enthusiast and the commercial sound engineer of replacement tubes that will provide new standards of performance—a feature of special importance with the newest amplifiers

and loudspeakers, particularly binaural sound equipment.

Service dealers will find the use of these tubes for replacement a source of profitable customer appreciation. Tung-Sol Electric Inc., Newark 4, N.J.

 **TUNG-SOL**



### 5881

For service in amplifiers of up to 50 watts.

### 6550

For service in amplifiers and commercial audio equipment of up to 100 watts.



# GOLD RUSH

Burton Browne / New York

## the Gold Rush is on to Pyramid's new "Gold Standard" $\pm 10\%$ Mylar® Capacitors

You don't need a shovel or geiger counter to strike **PAY DIRT** in the radio and TV service and replacement field. Pyramid offers you, the Service Technician for your everyday use, a new **HIGH RELIABILITY** capacitor with critical tolerance of  $\pm 10\%$ , featuring non-hygroscopic Mylar dielectric. This construction also provides high resistance to moisture plus high insulation resistance.

The Pyramid "**GOLD STANDARD**" Mylar capacitor "absolutely guarantees" the reliability that makes other types of by-pass and coupling capacitors obsolete.

Now sold at a price competitive with common paper capacitors, Pyramid's "**GOLD STANDARD**" Mylar capacitor is available in: (1) standard capacity values (2) standard voltage ratings (3) standard capacity tolerance of  $\pm 10\%$ , previously available only on special order at premium prices.

The **GOLD RUSH** to Pyramid "**GOLD STANDARD**"  $\pm 10\%$  Mylar capacitors is sweeping the radio and TV replacement field. See your Pyramid distributor today for all your capacitor requirements or for new catalog sheet, write to: "**GOLD STANDARD**" Assayers Office, Pyramid Electric Company, North Bergen, N. J.



# PYRAMID

®DU PONT REGISTERED TRADEMARK



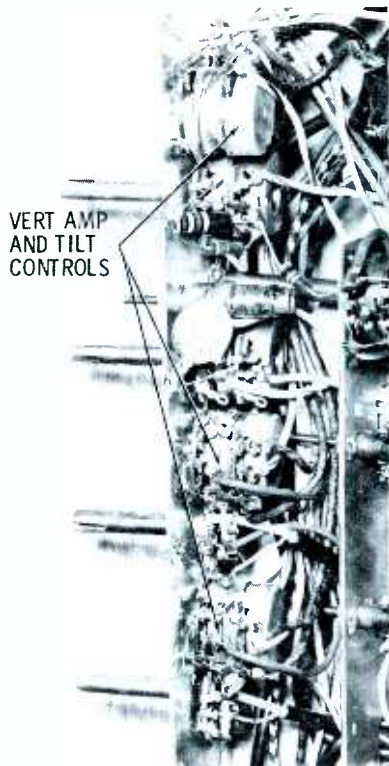

Fig. 4. Vertical amplitude controls consist of three dual concentric controls.

Pursuing the vertical trouble further, a thorough visual check of the printed board was made. The conductor to the cathode (pin 2) of the 6AQ5 had been patched at some previous time. At this point, the 6AQ5 was placed in a laboratory-type tube tester and thoroughly checked for shorts, leakage, gas, emission, and GM. No defects were found. With this knowledge, it was a simple matter to reconstruct the events leading up to the failure. First of all, a 6AQ5 (most likely the original) shorted and blew out a section



Fig. 5. Pigtail-type  $\frac{1}{8}$ -amp fuse is easily installed in 6AQ5 cathode circuit.

of foil. Naturally, this happened only after a considerable amount of current had passed through the three cathode controls. A new tube was installed, the foil was patched and the set worked okay. The cathode controls had not failed yet; they had only been scorched by the current that opened the foil. The set was placed in operation and functioned normally for awhile; however, the scorched controls were constantly being tortured by the normal cathode current. Finally they failed and caused loss of vertical sweep. The three dual controls (Fig. 4) were not only time consuming to replace, they were hard to obtain. Actual replacement time, (6 electrical connections to each control) was a little over an hour. Total shop time on this job was about 2 hours, considering actual replacement and analysis time.

Because these controls affect dynamic convergence to a large degree (they are the entire vertical convergence panel), the set had to be completely reconverged. Naturally, this all added up to a sizeable repair bill, making it necessary to explain the entire sequence of events to the customer.

The technician had foreseen the customer's concern that the trouble might recur and had taken positive action to prevent it. He had noticed the 3/10-amp fuse in the cathode circuit of the horizontal output tube and got the idea to install one in the vertical stage. Because the idea was to protect the controls, a little math was employed to figure just what rating the fuse should have. Using the formula  $P=I^2R$ , the maximum safe current through the three controls was calculated to be approximately 200 ma. A check of the tube manual revealed that the 6AQ5 could pass as much as 49 ma in vertical output service, so a  $\frac{1}{8}$ -amp fuse was installed (see Fig. 5). This would provide adequate protection for the controls and also insurance against fuse failure every time the tube developed a little leakage or gas content.

The next time you have a CTC5 series chassis in the shop for any type of repair, install a  $\frac{1}{8}$ -amp fuse in the vertical output cathode circuit and protect your customer against a similar experience. ▲

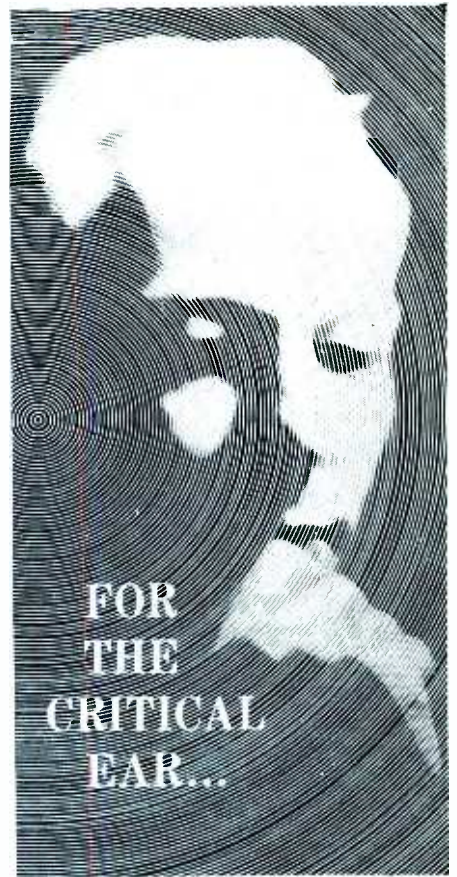

FOR  
THE  
CRITICAL  
EAR...

the incomparable

**SHURE**  
PROFESSIONAL

*Stereo Dynetic*  
CARTRIDGE

The Shure Stereo Dynetic Moving-Magnet Cartridge is designed and made specifically for the listener who appreciates accuracy and honesty of sound. It separates disc stereo sound channels with incisive clarity. It is singularly smooth throughout the normally audible spectrum...and is without equal in the re-creation of clean lows, brilliant highs, and true-to-performance mid-range.



MODEL M3D

Fits 3 and 4-lead transcription type and record changer stereo arms. Completely compatible, plays monaural or stereo. 10-second stylus replacement.

Individually tested to meet or exceed these specifications: Frequency response, 20 to 15,000 cps. Output level, 5 mv at 1,000 cps. Compliance, 4.0 x 10<sup>-6</sup>cm per dyne. Channel separation, more than 20db throughout the critical stereo frequency range. Recommended tracking, 3 to 6 grams.

that puts an end to profitless service call-backs. cartridges are checked electrically, mechanically  
*Note to Service Technicians:* Shure Stereo-Dynetic and acoustically to insure trouble-free performance

Literature available: Department 15-L

**SHURE BROTHERS, INC.**  
222 Hartrey Avenue, Evanston, Illinois

# troubleshooting *by WAVEFORM* analysis

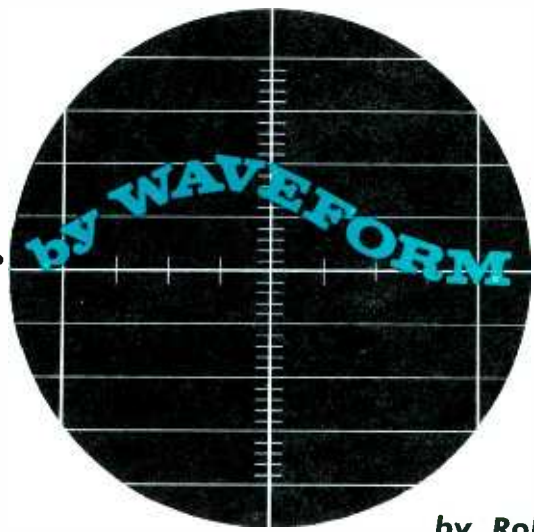

## Using a generator and scope to test video circuits

by Robert G. Middleton

To make practical use of a scope in troubleshooting, you have to know how to read the messages conveyed by the waveforms. Once you learn to recognize various types of distortion and their causes, you can often put your finger directly upon a faulty circuit or component.

To illustrate what can be accomplished by proper waveform analysis, let's apply a test signal of known characteristics to the input of a typical video amplifier and use a scope to examine the output. We can demonstrate that certain defects in the amplifier will produce frequency distortion of the test waveform. Such distortion is a clue that the circuit faults will also distort the video signal and produce a poor TV picture.

### Test Setup

The video detector circuit must be included in our analysis, since its peaking coils and load resistor are also an important part of the video-amplifier input circuit. Accordingly, we will apply the test signal at the input of the detector as shown in Fig. 1. A signal generator with a

built-in modulator is being used in this illustration. If your generator does not include a modulator, you can use an external one; connect it as in Fig. 2.

The signal generator is tuned approximately to the IF frequency of the receiver, and its output is modulated by the signal from the square-wave generator as illustrated in Fig. 3. We can regard the square-wave generator as a switch that abruptly keys the IF signal off and on.

A low-capacitance probe is used with the scope in Fig. 1, and the picture-tube socket is unplugged in order to eliminate its input capacitance from the video-amplifier output circuit. For all practical purposes, the input capacitance of the probe substitutes for the input capacitance of the picture tube during the tests. If the receiver has a series heater string, a dummy tube such as a 6SN7 with all but the heater pins cut off can be substituted for the picture tube.

The frequency response of the scope must be at least as good as that of the video amplifier; this

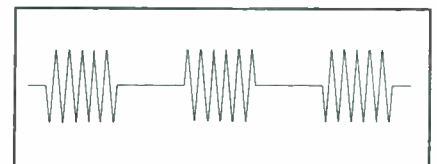

Fig. 3. Appearance of carrier modulated by audio-frequency square wave.

means that it should be flat up to about 4 mc. A narrow-band scope is useless in this type of test work.

### High-Frequency Test

Start the test by modulating the IF carrier with a 100-kc square wave. Fig. 4 shows several ways in which the test signal may become distorted in passing through a video amplifier. We are primarily concerned with studying the distortions in these waveforms and seeing how they can help us to localize faults to specific circuit components. Look at Fig. 4B and note that the square wave has rounded corners with sawteeth. This dual distortion is caused by the following circuit actions:

1. Insufficient high-frequency response in one of the peaking-coil circuits, which rounds off

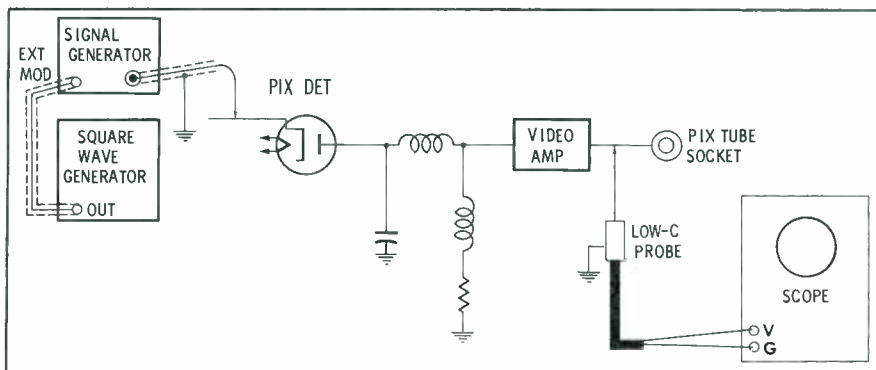

Fig. 1. Setup for testing video amplifier with square wave generator and scope.

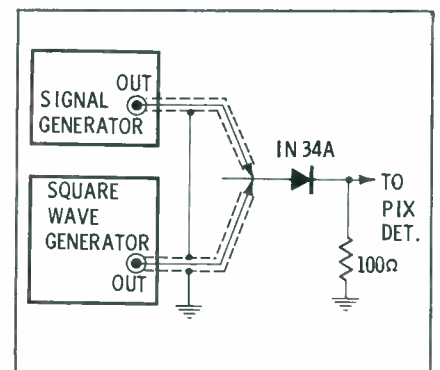

Fig. 2. External square-wave modulator.

# HOW TO CREATE MORE CONFIDENCE IN YOUR SERVICE BUSINESS



**FREE!** Colorful comic books, window streamers, window display to help tell your customers all that goes into servicing TV sets!

It takes a lot of work, costly equipment and know-how to be a radio and TV serviceman. No one knows this better than you. But, chances are, your customers *don't!*

But now you can give them an insight into your work with this free "The Story Behind TV Service" kit that tells how complicated your job is . . .

how much study it required to learn . . . and how expensive it was getting started. Told in interesting cartoon technique, the booklets are something everyone will read—and understand!

So put these good-will ambassadors to work building consumer confidence for you.

## CALL YOUR WESTINGHOUSE DISTRIBUTOR

YOU CAN BE **SURE**...IF IT'S **Westinghouse**

Electronic Tube Division • Elmira, New York



**Now YOU can get  
TUNERS  
repaired, or replaced,  
in a hurry!  
Send them to TARZIAN!**

● Sarkes Tarzian, Inc., announces a new tuner repair service and factory replacement program for Tarzian-manufactured tuners. Distributors, dealers and servicemen will welcome this direct factory service program which is designed to take delay and confusion out of the tuner repair business.

We're set up to offer a 48 hour service from the date of receipt to shipment to you.

Cost is reasonable, too. Only \$7.50 per unit (\$15 for UV combinations) and that includes ALL replacement parts! Both repaired — or exchange units if available from stock — carry a 90 day warranty against defective workmanship and part failure.

Replacements will be offered at these current prices\* on units not repairable:

- VHF 12 position tuner... \$17.50
- VHF 13 or 16 position tuner..... 19.50
- VHF/UHF combination. 25.00
- UHF only..... 15.50

\*Subject to change

When inquiring about tuner service, always refer to tuner by part number. When inquiring about direct replacements for tuners other than Sarkes Tarzian-manufactured, please indicate tube complement, shaft length, filament voltage, series or shunt heater. Use this address for quickest service:

**SARKES TARZIAN, Inc.**

Att: Service Mgr., Tuner Division  
East Hillside Drive  
Bloomington, Indiana



TARZIAN Electronic Product and Services Include TELEVISION TUNERS . . . SELENIUM AND SILICON RECTIFIERS . . . BROADCAST EQUIPMENT . . . AIR TRIMMERS . . . TV STATIONS WTTV and WPTA, and RADIO STATION WTTS.

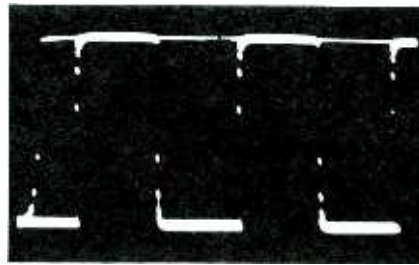

(A) 10 kc

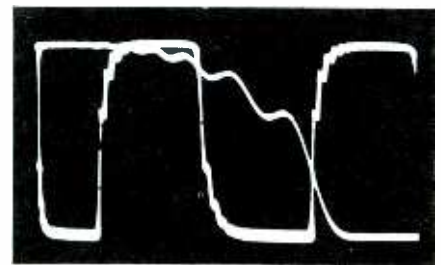

(B) 100 kc

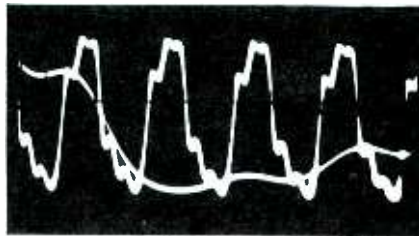

(C) 500 kc

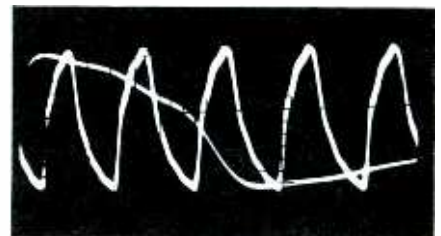

(D) 500 kc

Fig. 4. Output of video amplifier with over-peaked and under-peaked stage.

corners (Fig. 5).

2. Excessive high-frequency response in another of the peaking-coil circuits, which causes ringing and produces a jagged trace (Fig. 6).

When a circuit with fault No. 1 is followed or preceded by a circuit with fault No. 2, their combined action causes the output square wave to have rounded edges with superimposed sawteeth as in Fig. 4B.

The simplest way to locate the source of ringing in a video amplifier is to touch the peaking coils one by one. This adds a certain amount of stray capacitance and thus reduces high-frequency response. In other words, we can deliberately distort the over-all square-wave reproduction. If the ringing disappears, we can conclude that the part of the circuit being touched has excessive gain at high frequencies. Making the "touch test" on a circuit with normal or deficient high-frequency response would result in only slight attenuation of the ringing, but it would tend to produce more severe rounding of the waveform edges.

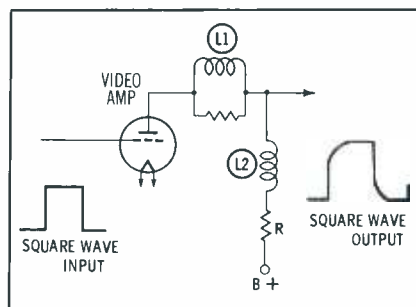

Fig. 5. Poor high-frequency response causes round corners on the wave.

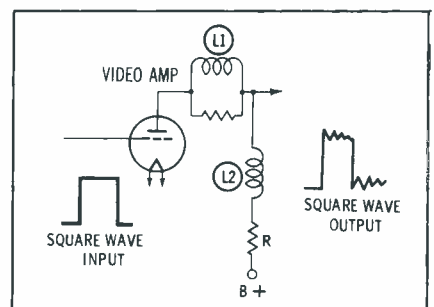

Fig. 6. Excessive high-frequency response causes distortion known as ringing.

In cases where ringing is not traceable to peaking-coil trouble, we can sometimes remedy the condition by increasing the value of the plate-load resistor (R in Fig. 6). The ringing can usually be minimized but not completely eliminated. Increasing the load-resistor value past a certain point will have little effect on ringing, but it will have an objectionable effect on corner-rounding. Hence, choosing the right value must be somewhat of a compromise.

We can sometimes compensate for excessive rounding of waveform corners by decreasing the value of the plate-load resistor R (again assuming that there is no peaking-coil trouble). This is also a compromise procedure. Decreasing the load-resistor value past some point will result in little improvement of corner-rounding, but may cause a rapid increase in ringing.

Remember, the picture-detector load resistor and peaking coils are just as important as the plate loads of the video amplifiers in determining over-all frequency response. Best picture quality will be obtained when



## THE WIRE YOU NEED

- for EVERY ELECTRONIC application
- Correctly Rated—Quality Controlled
  
- for positive performance
- for the most complete line for all electronic applications
- for most advanced construction designs, insulations, and shieldings correctly service-rated
- for dependable uniformity under strictest quality control
- for complete information in an easy-to-read catalog
- for fast service

*You Can Depend on Belden . . . Ask Your Belden Jobber*

One Wire Source for  
Everything Electrical & Electronic

**Belden**  
WIREMAKER FOR INDUSTRY  
SINCE 1902  
CHICAGO



Magnet Wire • Lead Wire • Power Supply Cords,  
Cord Sets and Portable Cord • Aircraft Wires  
Electrical Household Cords • Electronic Wires  
Welding Cable • Automotive Wire and Cable

08A0218

**SENCORE**  
*Another Sencore Time-Saver*  
**Handy "36"**  
**R-C Substitution Unit**



**"36"**  
**Most Often Needed Components At YOUR Fingertips!**

3 pole, 12 position switch individually selects one of the "36" components for direct substitution.

Contains:  
 ★ 12—1 watt 10% resistors from 10 ohms to 5600 ohms  
 ★ 12—½ watt 10% resistors from 10K ohms to 5.6 megohms  
 ★ 10—500 volt capacitors from 100-mmf. to .5 mf.  
 ★ 1—10mf., 450V Electrolytic  
 ★ 1—40mf., 450V Electrolytic

**ONLY \$1275 DEALER NET**

Completely isolated

**POPULAR SENCORE PRODUCTS**

- Transistor Tester
- Leakage Checker
- Filament Tester
- Voltage Regulator
- Bias Supply

★ For Shop, Lab, or outside service AVAILABLE AT ALL PARTS DISTRIBUTORS!

**SERVICE**  
**INSTRUMENTS CORP.**  
 171 OFFICIAL RD., ADDISON, ILL.

★ Cut out this ad now for further information.



**SUITS NEED PRESSING—  
 MERIT DEFLECTION YOKES  
 DO NOT!**

Merit deflection yokes are cosine wound TO FORM, not pressed. Pressing can lead to distortion and poor focusing. Pressing after winding frequently causes breakdown.

**MERIT COILS AND TRANSFORMERS  
 HAVE "BUILT-IN" ADVANTAGES.**



Each Merit yoke is  
 100% LIVE TESTED

COMPARE IT WITH  
**MERIT**  
 MERIT COIL AND TRANSFORMER CORP.  
 MERIT PLAZA • HOLLYWOOD, FLORIDA

the 100-kc square wave is reproduced with as little distortion as possible.

Ringing will cause ghostlike images following sharp edges of objects in the picture. For example, a black edge will be followed by a white line or negative ghost, and vice versa. Severe ringing generally results in multiple ghosts. (Note the symptom pictured in Fig. 7A.)

Corner-rounding causes blurred, poorly-defined edges in the picture. Excessive rounding often results in smear at the edges of objects in the picture, as shown in Fig. 7B.

**Low-Frequency Test**

To check the low-frequency response of the video section and to show up any faults in the coupling and decoupling circuits, adjust the square-wave generator to modulate the IF carrier at a 60-cps rate. The test setup will be the same as before, except that we are now driving the picture detector with a 60-cps square wave instead of the 100-kc signal.

The kind of distortion most commonly found in this test is a downhill tilt of the reproduced 60-cps square wave. This is caused by too short a time constant in the grid-coupling, plate-decoupling, screen-bypass, or cathode-bypass circuits. Basic low-frequency square-wave distortions are shown in Figs. 8 and 9. This type of fault may be localized by bridging a 0.1 mfd capacitor across each of the grid-coupling capacitors while watching the pattern. If the tilt disappears or is reduced, more coupling capacitance is needed.

You can localize bypassing and decoupling faults in the same manner. Sometimes, the capacitance may be too low in two or even three circuit branches. If you observe uphill tilt in the square wave, as shown in Fig. 8, check the condition of the low-frequency boosting circuit found in some video amplifiers. This is the only circuit in which an incorrect time constant will cause an uphill tilt.

Output waveforms with convex or concave tops, like those in Fig. 9, are caused by low-frequency peaks or dips. This fault is less common than a simple tilt, but it is sometimes observed when low-frequency decoupling is insufficient. Combinations of tilted and curved tops are

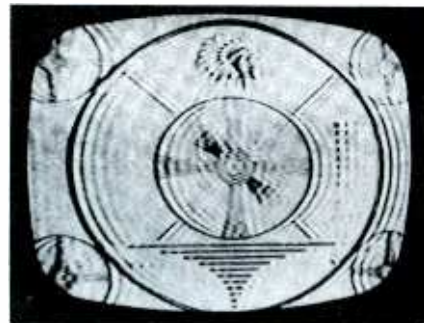

(A) Excessive gain at high frequencies.

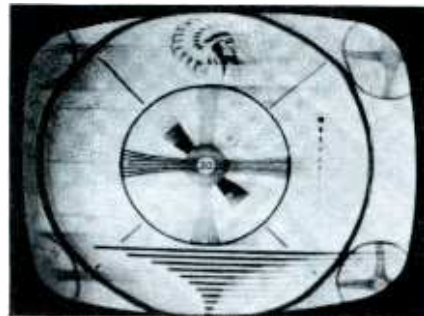

(B) Deficient gain at high frequencies.

**Fig. 7. Trouble symptoms resulting from frequency distortion in video amplifier.**

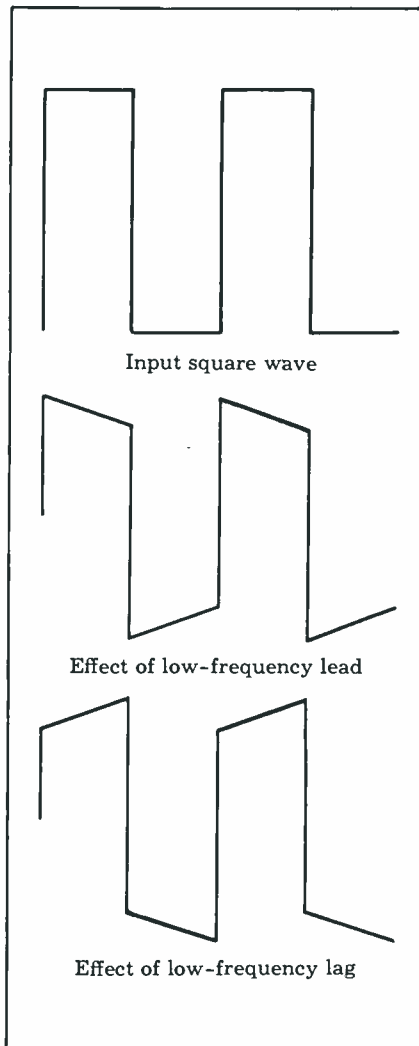

**Fig. 8. Results of phase distortion produced by poor low-frequency response.**

# NEW WESTINGHOUSE GOLD STAR PICTURE TUBES...

*Built 3 ways better  
to put  
customer confidence  
in your  
selling picture!*

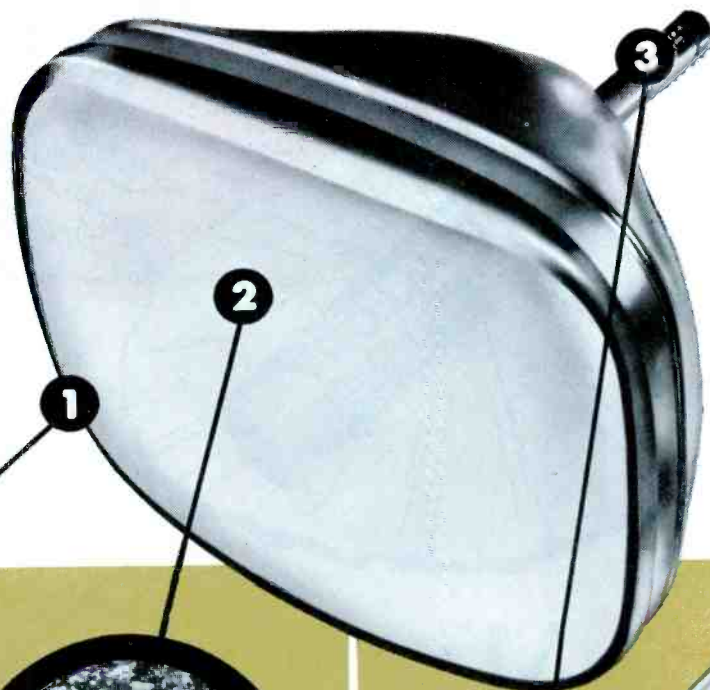

**More Rigid Testing.** Before this amazing new design was approved for distribution, a stock model Gold Star tube actually underwent 25,000 hours of continuous operation in the famous locked TV "Torture Test." It was still 80% as good as new when checked!



**New Aluminizing Method** provides a far smoother coating—not uneven "hill-and-valley" coating found in other tubes. This gives absolute maximum reflection . . . more usable light from the screen . . . a 20% brighter, sharper picture with greatly improved contrast.



**40% More "Getter"** in Electron Gun. Revolutionary design distributes 40% more protective material over inside of tube. Greatly reduces aging . . . keeps picture brighter longer. And all elements of the Gun are cleaned ultrasonically for superior performance.

*Put customer confidence in your service business. Call your Westinghouse Distributor about new Gold Star Tubes today.*

**YOU CAN BE SURE...IF IT'S Westinghouse**

Electron Tube Division • Elmira, New York

December, 1958/PF REPORTER 41

**made to withstand  
moisture and humidity**

... another  
**P. R. MALLORY & CO. INC.**  
**MALLORY**  
service-engineered  
product



# MALLORY

## "Gem" Capacitors

Nature's frog . . . and Mallory's "Gem" capacitors . . . are both capable of withstanding extremes of moisture and humidity. That's why Mallory Gem Capacitors are always your best choice for service replacements.

Mallory "Gems" are available in a complete range of standard capacity and voltage ratings. You'll find exact replacements for every circuit requirement. The closely checked tolerances of Gems assure correct circuit performance.

Insist on Mallory "Gems". They're a gem of a capacitor! Get them from your Mallory Distributor, in the self-service "5-pack."

**P. R. MALLORY & CO. Inc.**  
**MALLORY**

P. R. MALLORY & CO. Inc., INDIANAPOLIS 6, INDIANA

- Capacitors
- Vibrators
- Resistors
- Power Supplies
- Mercury and Zinc-Carbon Batteries
- Controls
- Switches
- Filters
- Rectifiers

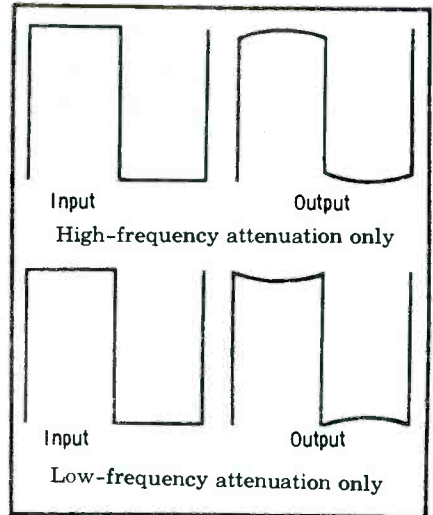

Fig. 9. Curved tops on square waves caused by unevenness in response.

occasionally caused by faulty coupling and decoupling circuits.

Appreciable tilt in a 60-cps square-wave pattern corresponds to nonlinearity of the gray scale in various parts of the picture. Consider a large wall or background scene with an over-all medium-gray tone. If tilt is occurring, the shade of the background will not be uniform but will vary from light to dark (or vice-versa) between the top and bottom of the screen.

This introduction to practical waveform analysis shows the great value of this method of troubleshooting. The technique can be applied to many other receiver circuits such as the sync, sweep, and sound systems—but that's another story. ▲



### Planning To Move?

If so, notify us by the 15th of the month to assure uninterrupted delivery of PF REPORTER.

Be sure to include both your old and new address. (Or better yet, enclose a current mailing label with your new address.) Send to:

#### PF REPORTER

Circulation Dept.  
2201 E. 46th Street  
Indianapolis 6, Ind.



# NEW Silicon Rectifier

Built for Reliability—Priced for Economy

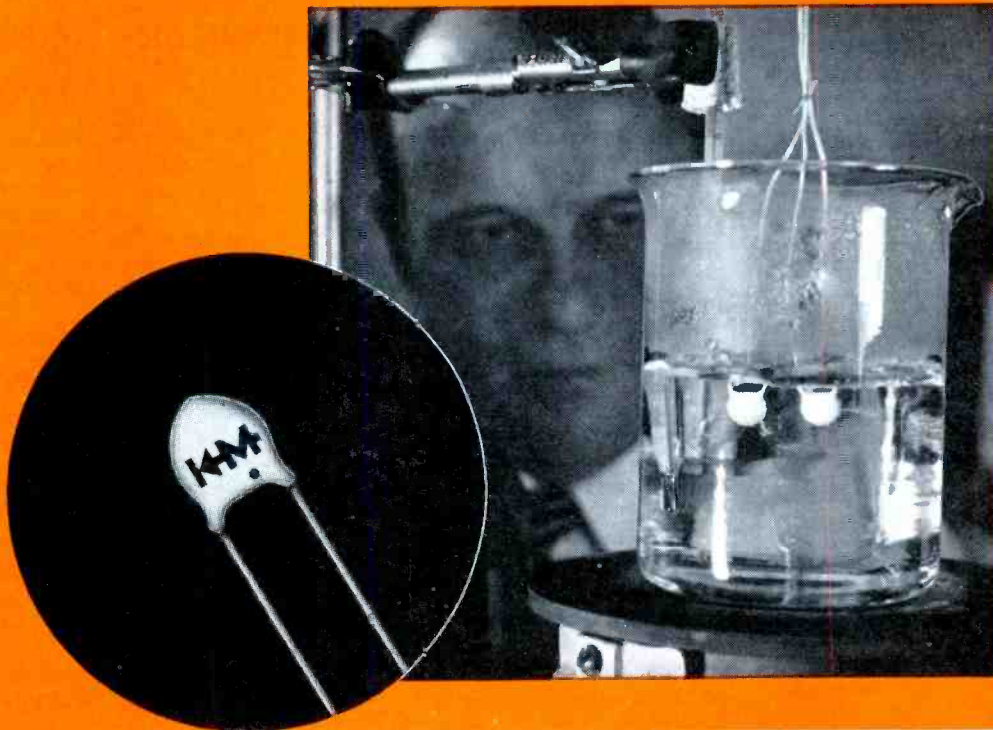

After 500 hours in boiling water, the new Mallory silicon rectifier is still going strong! That's just one of the ways we've proved that this new rectifier, product of Mallory semi-conductor research, gives you superior reliability and humidity resistance—at a price that is practical and profitable for TV and radio service jobs.

**New Moisture-Proof Design**, using unique Mallo-Seal\* encapsulation, enables the rectifier to pass *four times* the tropical torture of military humidity tests . . . without a single failure.

**New Performance.** Compare these figures: reverse leakage less than 250 microamperes; forward drop less than 0.5 volt; no drop in characteristics after 2000-hour life test at 85° C ambient.

**New Reliability.** No premature failures, no call-backs—because 100% inspection assures quality in every rectifier.

**New Economy.** Highest quality and reliability at a new low price for commercial silicon rectifiers.

Several models are available: the encapsulated type for conversions, a plug-in model for sets already using silicon conversions—and a line of "top hat" and stud mounted models for military and industrial use. See your Mallory distributor soon for complete details.

\*Trade Mark, P. R. Mallory & Co. Inc.

- Capacitors
- Vibrators
- Resistors
- Power Supplies
- Mercury and Zinc-Carbon Batteries
- Controls
- Switches
- Filters
- Rectifiers



you learn **MORE**  
from a **SAMS BOOK**

over 1,000,000 bought to date

**NEW BOOKS JUST OUT!**



**"101 Ways to Use Your Sweep Generator"**

Robert G. Middleton's fine new book shows you the multiple applications possible with a sweep generator

A complete and practical guide to the fullest use of your sweep generator. Each application is covered concisely, with full data on connections required, additional equipment needed, proper test procedure and evaluation of results. Specific sections cover use of the sweep generator for checking and calibrating test equipment, antenna measurements, RF and IF alignment and measurements, special uses in color receiver tests, etc. Over 250 illustrations, waveforms and diagrams. Invaluable for technicians, engineers and students. 148 pages; 5 1/2 x 8 1/2". Only.....\$2.00



**"Servicing Transistor Radios"...Vol. 2**

Complete analysis of 60 popular transistor radio models—helps you become an expert on transistorized radios

You'll save time, you'll earn more on Transistor Radio repairs with this complete data on 60 late models. Based on actual lab analysis of each set. You get the famous Sams Standard Notation schematics; full photo views of each chassis; complete alignment data; full parts replacement information—everything you need to be successful in fast-growing transistorized radio servicing. Includes valuable section on transistor circuits in general, along with useful troubleshooting chart. Here's a "must" for your bench. 160 pages, 8 1/2 x 11". Order now! Only.....\$2.95



**"Television Tube Location Guide"...Vol. 8**

Latest volume in this invaluable series, covering tube location data in TV sets produced in 1957-1958

Only publication of its kind—shows position and function of tubes in each model; just find the trouble and replace defective tubes without removing chassis! Has all these "extras": shows major component placement; signal path; pin orientation on socket; series string filaments; fuse location; includes tube failure check charts; cumulative index from Vol. 4 (1952) on. 196 pages; 5 1/2 x 8 1/2"; comb binding. Only.....\$2.00

**HOWARD W. SAMS & CO., INC.**

Order from your Sams Distributor today, or mail to Howard W. Sams & Co., Inc., Dept. 3-M8 2201 E. 46th St., Indianapolis 6, Ind.

Send me the following books:

- "101 Ways to Use Your Sweep Generator"(TEM-1).
- "Servicing Transistor Radios," Vol. 2 (TSM-2).
- "Television Tube Location Guide," Vol. 8 (TGL-8).

\$.....enclosed.  Send Free Book List

Name.....

Address.....

City.....Zone.....State.....

(outside U.S.A. priced slightly higher)

# THE TROUBLESHOOTER

ANSWERS YOUR SERVICE PROBLEMS

**Down in the Valley**

I have a cabin along the bank of a river at the bottom of a thousand-foot canyon. Can I run a thousand feet of line from an antenna at the canyon rim and get a signal at the cabin? I hope it's possible.

CHESTER WISNIEWSKI

Rio Vista, Calif.

Unless you move the cabin to the canyon rim, you'll probably have to install a broad-band VHF amplifier at the antenna site and feed its output into your transmission line. (Several weatherproof am-

plifier units are available for the purpose.) This will require AC power, but you should have little trouble in running a power line up to any site that can be reached by the TV transmission line. Unless you are using coaxial cable for the signal, avoid running the two lines close together.

If the signal at the antenna site is good and strong, you might be able to obtain a usable signal at the cabin without an amplifier. The loss in 1000' of line is bound to be tremendous, but you can minimize it by using a type of lead-in with a very low attenuation factor. Open-wire line would be your best choice.

**No Raster**

A Trav-Ler Model 1710 had sound but no high voltage. After long efforts to repair the trouble, I finally took a substitution box and tried different values of capacitance in place of C43. When I reduced the value to 500 mmf, I got a raster. The grid voltage of the horizontal output tube, which had been only —5 volts, went to the correct value of —33 volts. Restoring C43 to the original value of 1000 mmf caused the raster to go out again. Would you explain why this small change in value made so much difference in operation?

FRANK MASSI

Oak Park, Ill.

C43 is a load for the oscillator as far as AC signal voltages are concerned; in other words, the output sawtooth signal is developed across this capacitor. For C43 to do its job properly, the capacitance ratio between it and the coupling capacitor C45 must be correct according to the design of the set. Since you had to lower the value of C43 to restore operation, I suspect that C45 may have decreased in capacitance. Try replacing both units with new ones having the same values as called for on the schematic.

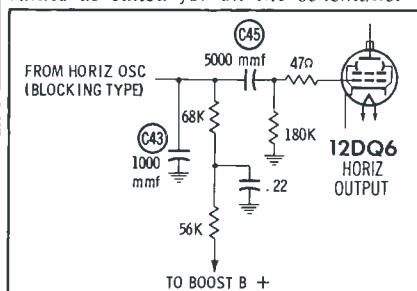

**Tuner Adjustments**

I am unable to align the continuous tuner on a Raytheon Model M1611 so that it will receive all available channels. When it is adjusted to receive both sound and picture on Channel 2, I lose Channel 6. The same thing happens with Channels 7 and 13 on the high band.

Could there be some error in the alignment instructions given in PHOTOFAC Set 147, Folder 9 for this set? The directions read, "Turn the tuning control until the tuning core carriage is at the top of its stroke. Preset the tuning cores 1.6" above the coil-mounting strip." When this is done, the cores are completely clear of the coil forms. They do not re-enter until the carriage has traveled part of the way down.

JOHN L. WOOD

Long Beach, Calif.

As shown in the drawing, the measurement of 1.6" should be taken from the tips of the core adjustment screws to the coil-mounting strip, which is a phenolic board imbedded in the top cover of the tuner. If the cores themselves are positioned 1.6" above the mounting strip, they will be too high — as you have discovered.

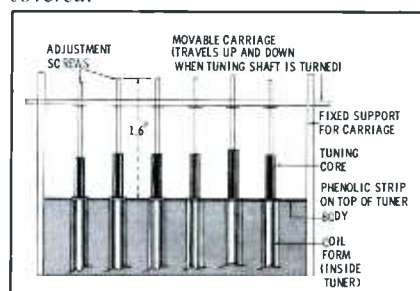

# Now—Kit or Wired

A new  
**VoltOhmyst**  
 Kit  
 for only  
**\$29<sup>95</sup>\***

RCA WV-77E VOLTOHMYST  
 (completely wired and cali-  
 brated for only \$49.95\*)

\*User Price (Optional)



Look what you get in the  
 Easiest-to-assemble VTVM ever!

- Meter electronically protected against burnout—PLUS—ohms-divider network fuse-protected. Unit is burnout proof!
- Ultra-slim probes and flexible leads—easy-to-use in those tight spots!
- Cables can be stored in plastic holder attached to handle for increased portability! (Plenty of room for power cord, too!)
- Separate scales for 1½ volts rms and 4 volts peak-to-peak assure rated accuracy on low ac readings!
- Famous RCA VoltOhmyst circuit means excellent stability under conditions of line voltage fluctuation—PLUS—special circuit to minimize effects of contact potential change!
- Easier, faster-to-read scales—meter scale color-coded to match range switch!
- Extra-rugged 400-microampere meter movement!
- Case completely shielded for protection against rf fields!
- Voltage-divider networks use 1% tolerance deposited-carbon resistors!
- Front panel is brushed aluminum—all lettering is acid-etched to last the life of the unit!

Both kit and wired unit  
 available for immediate  
 delivery from your  
 local RCA Distributor!

TV service technicians, hams, hobbyists—now you can buy the easiest-to-assemble VTVM kit ever made! Step up and meet the new RCA VoltOhmyst which incorporates the famous RCA VoltOhmyst quality, accuracy, and performance—an instrument you'll be proud to display "on the job!"

You get simplified step-by-step instructions, laminated circuit board construction, oversized drawings—all the help needed to accomplish mechanical and electrical assembly faster than you've ever believed possible!

You can buy this instrument, kit or wired NOW "off the shelf" at your local RCA Distributor. Either way, you are assured of an instrument which can give you long, dependable performance. See the RCA WV-77E VoltOhmyst Kit today!

## SPECIFICATIONS

### Ranges:

DC and rms—1½ volts to 1500 volts full scale in 7 overlapping ranges

Peak-to-peak—4 volts to 4000 volts full scale in 7 overlapping ranges

Resistance—from 0.2 ohm to 1000 meg-ohms in 7 overlapping ranges. Zero-center indicator for discriminator alignment

Accuracy—±3% of full scale on dc ranges  
 ±5% of full scale on ac ranges

Frequency Response—flat within ±½ db, from 20 cycles to 500 Kc on all ranges up to and including 400 volts peak-to-peak

Input Resistance—11 megohms with probe and cable



**RADIO CORPORATION OF AMERICA**  
 Electron Tube Division  
 Harrison, N. J.

# sales without selling

16 million worn out antennas are due for replacement. Here's how you can get this extra business on your regular service calls...



## 1 LOOK UP!

Look up at your customer's antenna before every service call. See if there are missing or sagging elements, corrosion or other signs of a worn out TV antenna.

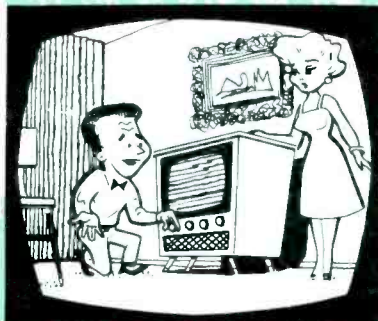

## 2 TALK UP!

Tell your customer what you've seen... also how an antenna loses up to 50% of its efficiency after three years. Explain how much clearer their TV picture will be with a new antenna.



## 3 PUT UP!

Stock CLEAR BEAM Do It Yourself Kits on your truck. Make the installation while you're there... or sell kits outright to Do It Yourselfers. Either way you'll pick up extra profits.



Complete Installation Kits for  
Every Popular Antenna  
Conicals — Arrows — Yagis —  
Inlines



**CLEAR BEAM** ANTENNA CORP.,  
CANOGA PARK, CALIF.

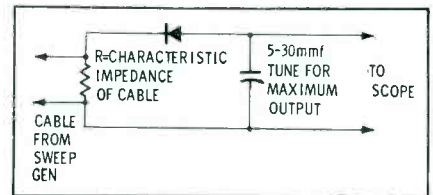

### Checking Alignment Setups

I would like to have a circuit to check my sweep and marker generators, as well as my scope, just before aligning a set. I've heard of a circuit which allows the technician to put an IF curve on the scope and move a marker over it. This is a quick way to find out if the alignment equipment is working as it should.

HUGH O. BUTTS

Des Moines, Iowa

*The simplest solution would be to keep a spare TV set around the shop and use its IF strip as a standard. Once you have "calibrated" its alignment curve using a generator and scope of known good quality, you could use this set to recheck your test equipment from time to time with a minimum of trouble.*

*To see whether or not the output of the sweep generator is flat over the entire IF band, you might apply its output to the scope through a detector circuit having a flat response across this frequency range. (The schematic shows a detector which should be suitable.) Connect and operate the test equipment just as though you were performing a regular alignment. Instead of obtaining a typical IF response, however, you should expect a rectangular-shaped pattern formed by a lower base line and a trace above it representing the output of the generator. Any curvature or slope in the top trace is an indication of uneven output from the generator or distortion in the scope amplifier.*

### Buzz

Severe 60-cps buzz in an RCA Chassis KCS88BX can be stopped only by pulling the vertical multivibrator or output tube. Tube substitution does not help, nor does replacement of the vertical output transformer.

RICHARD BARNUM

Oakfield, N. Y.

*The interference is most probably being carried from the vertical section to the audio section by way of the 210-volt B+ line. Check to see if any of the filter capacitors on this line (especially those in the cathode circuit of the audio output tube) have decreased in value or become open. If you have a scope, first check the waveform on the 210-volt line for any evidence of 60-cps pulse voltage.*

*If you don't find B+ filter trouble, search the chassis to see if any vertical circuit components are physically close to audio components. Leakage or electromagnetic coupling between these two sections of the receiver could account for the buzzing.*

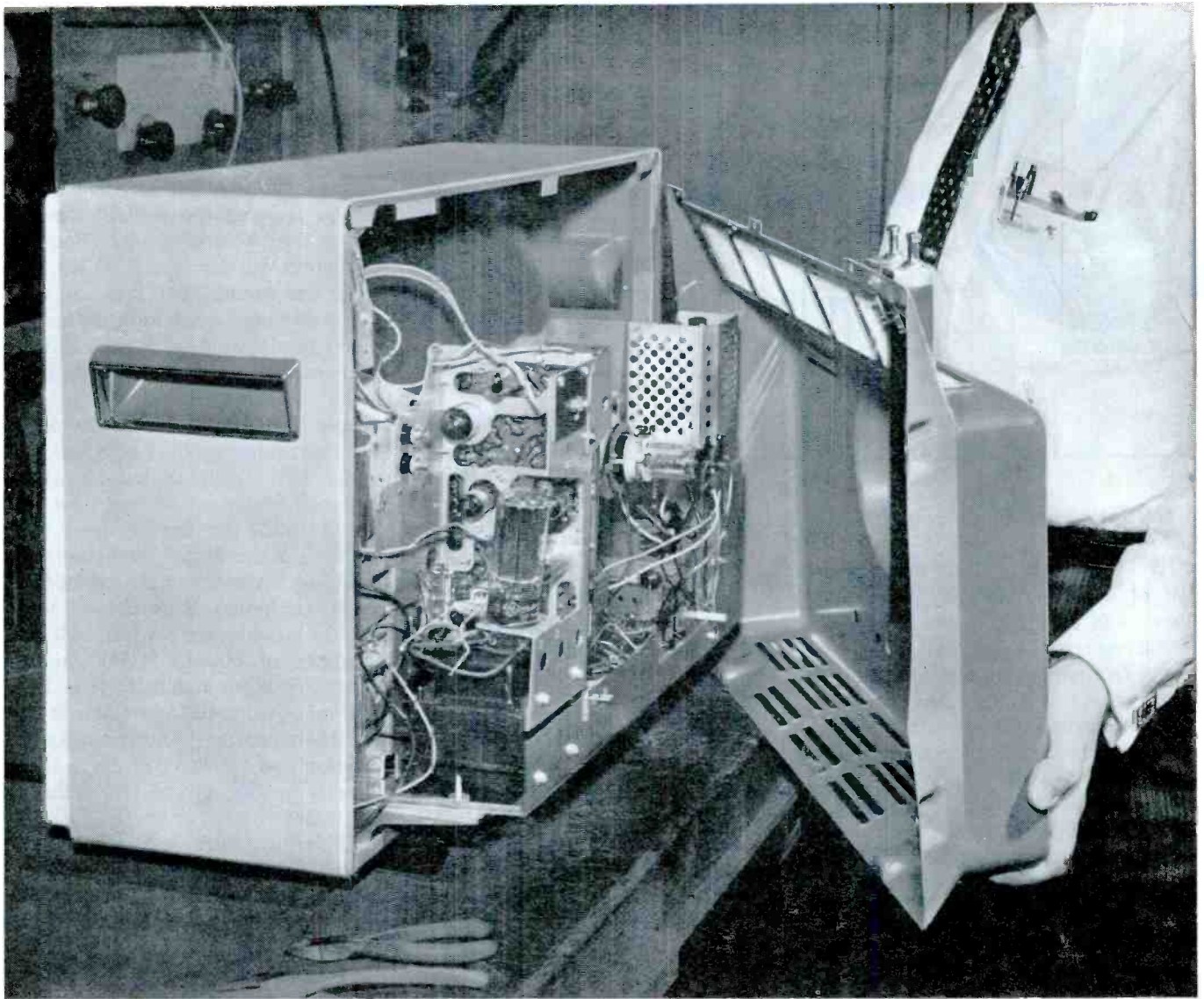

Take the back off the General Electric "Designer" TV set and you can **do 85%-90% of service jobs without pulling the chassis**

*You cut your time-per-repair by up to 40% . . . make more calls—and money—in the same amount of time!*

Take off the back and there you are—in easy reach of up to 90% of service jobs. Look at the chart!

**Look inside!** Both sides of the reliable printed circuit boards are easy to reach for service.

No series string filaments—no extension cables needed . . . the new "Designers" are certainly the easiest-to-service sets in all television. You'll wish every set was a General Electric "Designer."

*Progress Is Our Most Important Product*

**GENERAL  ELECTRIC**

TEN TYPICAL JOBS THAT CAN BE DONE WITHOUT REMOVING THE CHASSIS				
JOB	G-E "Designer"	Set A	Set B	Set C
Replace most resistors	yes	no	no	no
Replace most capacitors	yes	no	no	no
Replace deflection yoke	yes	no	no	no
Replace video detector	yes	yes	no	no
Replace audio detector	yes	no	no	yes
Replace horizontal phase detector	yes	no	yes	yes
Replace power rectifier	yes	no	no	yes
Adjust tuner oscillator	yes	no	yes	yes
Replace inter-stage transformers	yes	no	no	no
Replace size and linearity controls	yes	no	yes	yes

General Electric Co., Television Receiver Dept., Syracuse, N. Y.



## NOTES on test equipment

informative reports from the lab

by Les Deane

### What's Your TV Strength?

By TV strength, I don't mean the size of set you can pick up and carry—I'm referring to the strength of the received signal. To do the best job when orienting antennas, checking boosters and lead-in, locating maximum signal areas, and comparing antenna systems, the TV serviceman needs an instrument which will enable him to measure signal intensities. Recently introduced by Simpson Electric Co., the field strength meter pictured in Fig. 1 is designed for power-line or battery operation on both VHF and UHF bands.

Specifications and features are:

1. Power Requirements — 117 volts 60 cps, self-contained rechargeable 6-volt battery (optional accessory), or 6-volt auto battery; power consumption approx. 18 watts; separate AC and DC fuses provided.
2. Signal Frequencies — tunable range for all television channels 2 through 83; meter indicates video carrier



Fig. 1. Simpson's new 498-A field strength meter can be substituted for the tuner used in any television receiver.

3. Sensitivity — minimum signal less than 10 uv to 50,000 uv; accuracy better than  $\pm 6$  db on VHF and  $\pm 8$  db on UHF.
4. Signal Output — special jacks on rear panel provide monitoring of 40-mc IF signals and audio modulation.
5. Size and Weight —  $11\frac{3}{8}$ " x  $7\frac{3}{8}$ " x  $9\frac{1}{2}$ "; 14 $\frac{3}{4}$  lbs. less battery.

To help familiarize you with the instrument, I chose the front-panel photo in Fig. 2. Functions of the various controls can best be outlined by a description of the operation for one particular application. Suppose, for example, you wanted to measure the signal strength of several different VHF channels at one point in an antenna distribution system. (I actually performed this operation in our lab.)

First, I connected the AC cord to an outlet on the bench and applied power to the meter by placing the power selector switch in the AC position. Using a short piece of 300-ohm twin lead, I made a connection

between the antenna outlet and the VHF input terminals on the front panel of the Model 498-A. I next set the frequency calibration switch and the VHF channel selector to the first channel number that I intended to receive and measure.

After the unit had warmed up, I slowly reduced the signal attenuator or level control until I obtained deflection on the meter. When the VHF fine tuning knob was adjusted for maximum signal indication, the meter needle went off scale. I quickly increased the input attenuation to lower sensitivity and bring the needle back on the scale. Rocking the fine tuning again, I watched the meter until maximum deflection was obtained. Attenuation was then reduced until the needle read full scale, and the signal strength from markings around the attenuator knob was noted. This control (see Fig. 2) is calibrated for full-scale indications of 100 to 50,000-microvolts. For input signals of less than 100 microvolts, the attenuator is set to its maximum counterclockwise rotation and the signal strength read directly on the zero to 100 scale of the meter.

Checking other features of the Model 498-A, I found both an audio and an IF output jack located on the rear panel of the instrument (see Fig. 3). The audio output connector is a regular two-conductor phone jack. Using a pair of high-impedance headphones, this point can be used to monitor either TV sound modulation or the 60-cycle buzz produced by vertical sync. Although TV sound for channels 4, 6 and 13 cannot be picked up in this type of monitoring, sync buzz can be heard

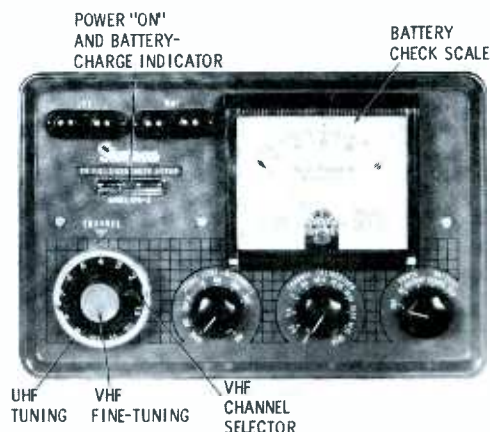

Fig. 2. Front panel of the Model 498-A features VHF-UHF tuning and a large  $4\frac{1}{2}$ " meter with 50-microamp movement.

# FASTEST

Now, in New Triplett Model 3414 you will recognize another answer to a long standing need—a FASTER, more versatile tube tester.

- \* All switch settings can be made before the tube warms up; you are ready to test as soon as the filaments reach proper temperature.
- \* Rejects burned-out tubes instantly without waiting for the filament to heat.
- \* Complete flexibility for new tube setups; plus the non-obsolence factor.
- \* A few simple switch settings give the complete and accurate story of tube capabilities.
- \* Modified plate conductance circuit—for closer correlation to tube characteristics.

Neon Indicator shorts test—NEW, fast and accurate. Slightest inter-element shorts show while the cathodes are hot.  
 New variable leakage test from 0.3 megohms to over 3 megohms.  
 Checks all today's and tomorrow's tubes (including new series filament tubes). .With BV adapter TV picture tubes can be tested in the set.



**\$79<sup>50</sup>**  
NET

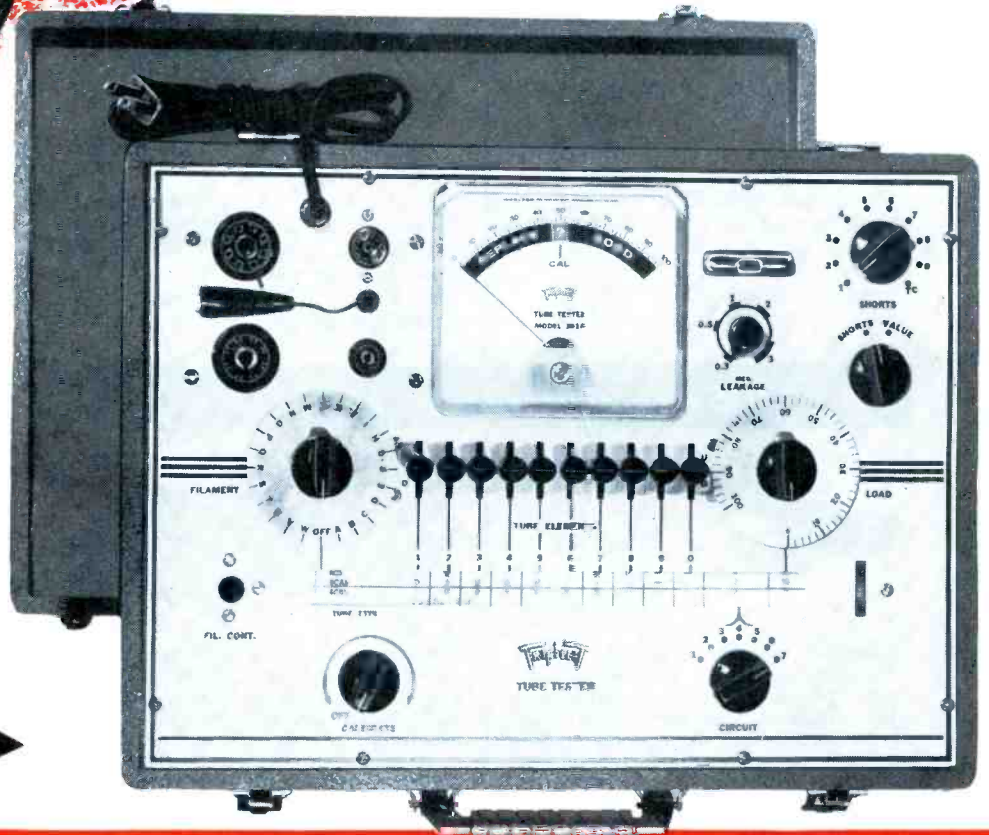

Two other Triplett testers—

Burton Browne Advertising



To the left Model 3423

New Model 690-A Transistor Tester  
 Leakage and Gain test for all low and medium power PNP and NPN type transistors—\$29.50 net.



For full information see your Triplett distributor or write

TRIPPLETT ELECTRICAL INSTRUMENT COMPANY • BLUFFTON, OHIO

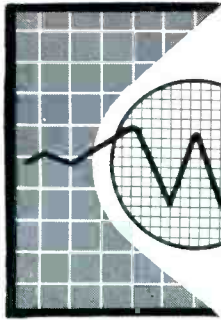

# TIME SAVING MULTIPLE USE also STICKLEBACK TOOLS

FOR HUNDREDS OF JOBS IN THE SHOP—AT HOME—IN INDUSTRY

Cut any size or shape hole in wood, plaster, plywood, plastic, masonite, etc., twice as fast as any conventional tool. Can be used for drilling, sawing or routing. Try one at your parts distributor.

## DRILL ROUTERS



DRILL  
OR  
SAW

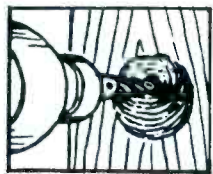
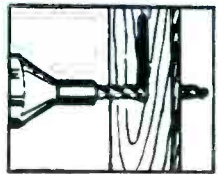

ROUT

For power tools, fit any 1/4" chuck. Six sizes from 2 3/4" long, 1/4" diam. (No. 588-01, \$2.35 List) to 7" long, 1/2" diam. (No. 588-06, \$5.40 List)

## DRILL SAWS



For hand use. Five sizes from 4 3/4" long, 1/8" diam. (No. 586-00, \$1.63 List) to 15" long, 1/2" diam. (No. 586-04, \$5.40 List)

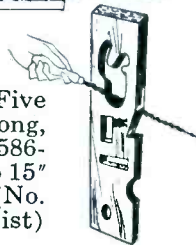

## FILE RASP

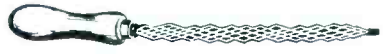

Three times as fast as an ordinary file. Can be used as a plane. Has coarse side for rough work, fine side for finishing. Part No. 587, List Price \$3.25.



## STRIP-ER-CLIP WIRE STRIPPER

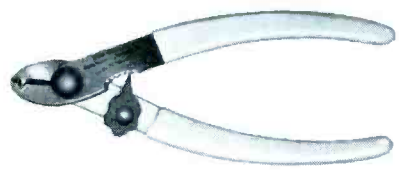

Compact, efficient unit that is perfect for your tool case. Gets into tight places and does a clean, fast job without damaging the wire strands. Special 7-stop gauge quickly adjusts to any wire size from 14 to 26 gauge. Has heavy insulated grips. Part No. 595, List Price \$2.30.

## TEKNI-LABELS

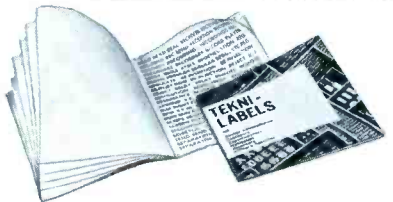

Handy decals that give your electronic equipment a professional appearance. Sets in black or white (each with hundreds of titles) for receivers, transmitters, television, dial marking, audio-hi-fi, panel markings (gold only), receiving tubes, etc. Only \$1.35 net per set.

**FREE:** Walsco's new 64 page catalog with thousands of tools, chemicals and items for hi-fi, radio and TV servicing. Ask your distributor or write Walsco for your copy.

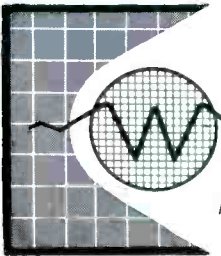

**Walsco** ELECTRONICS MFG. CO.  
A Division of Textron Inc.  
West Coast Plant: Los Angeles 18, California  
MAIN PLANT: 102 W. GREEN ST., ROCKFORD, ILL., U.S.A.  
In Canada: Atlas Radio Corporation, Toronto 10, Ontario

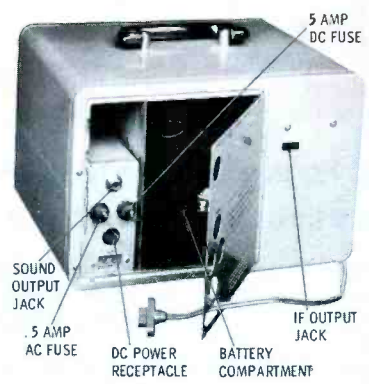

Fig. 3. Rear panel features of the meter include audio and IF output jacks.

on all channels, which is especially useful when you want to distinguish between transmitted signals and interference.

To test the operation of the instrument's tuner, or to substitute for a conventional TV tuner, a separate IF signal is available from the IF output jack shown in Fig. 3. This signal is a modulated 40-mc IF carrier which may be used to drive the first video IF amplifier of any receiver operating in the 40-mc range. Since testing the output of a TV tuner using a substitution method would be of great assistance to the serviceman, I thought you might like to see how simple it really is.

Using a special plug supplied with the instrument, and a short piece of coaxial cable, I coupled the IF signal from the rear of the meter to the first IF stage of a receiver. In the receiver, I unsoldered the tuner lead at the grid of the first IF tube and connected the test cable in its place.

With the set and meter both operating, I was able to tune in all available channels and reproduce picture and sound without a bit of help from the receiver's tuner. The arrangement for this substitution trick is pictured in Fig. 1.

### Troubleshooting with "Junior"

The vacuum-tube voltmeter shown in Fig. 4 is manufactured by RCA Components Div., Camden, N. J. Designed for radio and TV, as well as industrial service work, the Model WV-77C Junior VoltOhmyst comes complete with AC-DC-ohms probe and cable, attached ground lead, and operator's manual.

Specifications and features are:  
1. Power Requirements — 105 to 125





Fig. 4. RCA's new Junior VoltOhmyst incorporates meter burn-out protection.

- volts, 50 to 1000 cps; power consumption 5 watts; one self-contained 1.5-volt battery.
- AC Voltmeter — rms ranges 0 to 3, 12, 60, 300, and 1200 volts with separate scale for 0 to 3 volts; frequency response 30 cps to 750 kc  $\pm 1$  db for 1000-ohm source, and to 3 mc  $\pm 1$  db for 100-ohm source; accuracy  $\pm 5\%$  of full scale deflection; input impedance up to 60-volt range .2 megohm, for 300-volt range 1 megohm, and for 1200-volt range 2 megohms; maximum combined AC-DC input 1800 volts.
  - DC Voltmeter — ranges 0 to 3, 12, 60, 300, 1200 volts; accuracy  $\pm 3\%$  of full scale on + volts and  $\pm 5\%$  on — volts; input resistance 11 megohms.
  - Ohmmeter—ranges R x 1, 100, 1000, 100K, and 1 meg, center scale 10; zero- and ohms-adjust controls on front panel.
  - Size and Weight — 8" x 5 $\frac{3}{8}$ " x 4 $\frac{1}{2}$ " ; 4 lbs.
  - Accessories — RF probe for extending frequency response to 250 mc; high-voltage probe increases DC range to 50,000 volts.

Before twisting any knobs on this Junior VoltOhmyst, I wanted to examine its inner construction. In so doing, I found that the entire chassis, which is attached to the front panel, comes out of the metal case after removing four small Phillips-head screws from the front panel and one large screw from the rear of the case.

The instrument utilizes two dual-section tubes—a 12AL5 and a 12AU7. One diode section of the 12AL5 is used as an input detector for AC voltages, while the other serves as a rectifier in the B+ circuit. The two triode sections of the 12AU7 are employed as DC amplifiers in a push-pull bridge circuit.

In the course of examining this particular meter from a design standpoint, and actually using it to

# SAVE TIME! SAVE TUBES!

**New Vis-U-All  
Picture Tube  
Reactivator  
ends guesswork . . .  
"magic eye" tells  
when to stop!**



Model V200 10" high, 6" wide, 5" deep

Now test and reactivate all types of picture tubes, including 110°, quickly, efficiently, without worry or guesswork. Vis-U-All's exclusive, time-saving, tube-saving "magic eye" shows you tube's reaction to voltage as it's applied, tells you when to stop reactivating to prevent ruining with overdose. And for accurate test of tube, it measures *second* anode beam current. Convenient AC interlock included. Compact, easy-to-carry steel cabinet with instructions inside door.

**Only  
\$59.95**

Slightly higher in West

## ASK FOR DEMONSTRATION OF VIS-U-ALL V200 NOW AT YOUR DISTRIBUTOR

<b>ALASKA</b> FAIRBANKS Polar Electronic Supply Co.	<b>LOUISIANA</b> NEW ORLEANS Lee's Electronic Supply SHREVEPORT Lavender Radio & TV Supply, Inc.	<b>NORTH DAKOTA</b> FARGO Lew Bonn Co.
<b>ARIZONA</b> TUCSON R. C. Television Co.	<b>MARYLAND</b> BALTIMORE Revacto of Maryland, Inc.	<b>OHIO</b> AKRON Warren Radio Co. CLEVELAND Warren Radio Co. COLUMBUS Hughes Peters, Inc. DAYTON Spreco, Inc. Scotts-Friedman Co. LIMA Hutch & Son SPRINGFIELD Eberle's Radio Supply TOLEDO Warren Radio Co. CINCINNATI Warren Radio Co.
<b>ARKANSAS</b> FORT SMITH Wise Radio & TV Supply, Inc. LITTLE ROCK Carlton Whise. Radio & TV Supply	<b>MASSACHUSETTS</b> WEST PEABODY Aladdin Electronic Supply, Inc. NEW BEDFORD Burns Electronic Supply Co. ALLSTON CRT Electronic Supply MEDFORD Durrell Distributors LYNN Des Roberts Elect. Supply WALTHAM Linear Electronic Co. MELROSE Melrose Sales Co. QUINCY Pilgrim Electronic Supply JAMAICA PLAIN Tee-Vee Supply Co. LAWRENCE Young & Young BOSTON Arvedon Distr., Inc. Louis M. Herman Co., Inc. O'Donnell Electronic Supply Co.	<b>OKLAHOMA</b> OKLAHOMA CITY Johnson Wholesale Electronics TULSA S & S Radio Supply
<b>ARK.-TEX.</b> TEXARKANA Lavender Radio & TV Supply	<b>MICHIGAN</b> ANN ARBOR Purchase Electronics BATTLE CREEK Warren Radio Co. BENTON HARBOR Benton Electronic Supply Co. FERNDALE Erickson's Electronic Whse., Inc. FLINT Radio Tube Merchandising Co. GRAND RAPIDS Radio Electronic Supply Co. Warren Radio Co. JACKSON Matteson Electronics KALAMAZOO Warren Radio Co. LANSING Offenhauer Company MUSKEGON Electronic Distr., Inc.	<b>PENNSYLVANIA</b> ELKINS PARK A. G. Radio Parts Co. HARRISBURG D & H Distr. Co., Inc. POTTSVILLE Schuykill Elect. Distr., Inc. WILKES BARRE Shelbourne Electronics, Inc. PHILADELPHIA Radio Electronic Service Co.
<b>CALIFORNIA</b> BURBANK Andrews Electronics GLENDALE Western Electronic Supply Corp. INGLEWOOD Cook Electronics SAN DIEGO Nystrom Brothers Co. VENTURA Wholesale Electronic Supply	<b>CONNECTICUT</b> NEW LONDON Aikens Electronic Supply HARTFORD Signal Center, Inc.	<b>RHODE ISLAND</b> PROVIDENCE C. E. Paul Co.
<b>FLORIDA</b> HIALEAH Sanders Electronics Co.	<b>ILLINOIS</b> CHICAGO Electronic Parts Center Howard Electronic Sales Radio Parts Company S & H Electronics OAK PARK Melvin Electronics, Inc. SPRINGFIELD Wilson Electronics Supply Co. WAUKEGAN Waukegan Radio Supply	<b>SOUTH CAROLINA</b> COLUMBIA Dixie Radio Supply
<b>INDIANA</b> ELKHART Warren Radio Company EVANSVILLE Hutch & Son, Inc. HAMMOND Broadwin TV & Radio Co. INDIANAPOLIS Brown Distr. Co., Inc.	<b>IOWA</b> CEDAR RAPIDS Iowa Radio Supply Company	<b>TENNESSEE</b> MEMPHIS Lavender Radio & TV Supply, Inc. NASHVILLE Electra Distr. Co.
<b>KENTUCKY</b> HOPKINSVILLE Randolph & Hale, Inc. LOUISVILLE Arcby Electronics, Inc. PADUCAH Warren Radio Co.	<b>MINNESOTA</b> DULUTH Lew Bonn Co. MANKATO Lew Bonn Co. MINNEAPOLIS Lew Bonn Co. ST. PAUL Lew Bonn Co.	<b>TEXAS</b> AMARILLO R & R Electronic Co. AUSTIN Electronic Headquarters DALLAS Adleta Co. FORT WORTH Byron's Radio & TV Supply United Electronic Supply Co., Inc. HOUSTON Applebaum & Co. SAN ANTONIO Modern Electronics Co. SHERMAN Lavender Radio & TV Supply, Inc. TYLER Lavender Radio & TV Supply, Inc. VICTORIA Lavender Radio & TV Supply, Inc. WACO Best Electronics WISCONSIN LA CROSSE Lew Bonn Co.
<b>NEW JERSEY</b> NEW BRUNSWICK Bay Electronic Distr. ELIZABETH Leader Electronics	<b>NEW YORK</b> NEW YORK 53 Bay Electronic Distr. BROOKLYN Bay Electronic Distr. FLUSHING Bay Electronic Distr. HICKSVILLE, L.I. Bay Electronic Distr.	

If your distributor is not listed, please have him write to us.

**VIS-U-ALL PRODUCTS COMPANY**

303 Fuller Ave., N.E.  
Grand Rapids, Mich.

**NOW AVAILABLE**  
at your local distributor

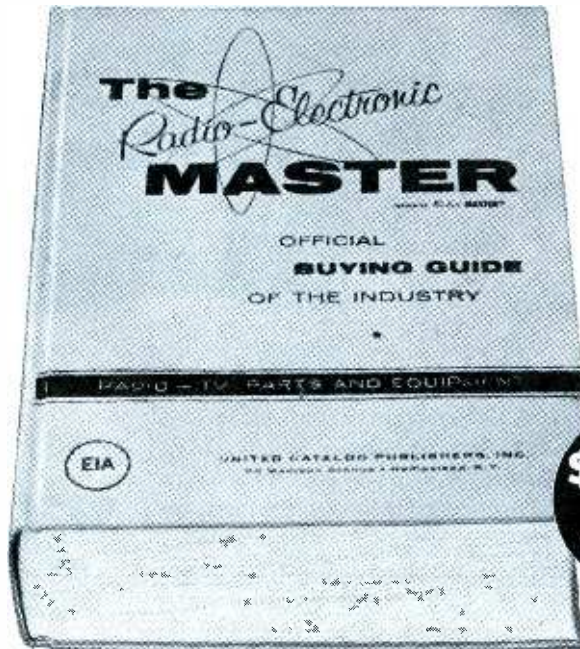

**1,536**  
pages

**\$3.50**  
At parts distributors  
\$4.50 in Canada

# 1959 RADIO-ELECTRONIC MASTER

World's largest buying guide  
of TV-Radio - Electronic - Audio Products

**1536**

pages of complete descriptions, specs, illustrations, prices

**150,000**

items including all latest products of

**350**

manufacturers systematically arranged in

**18**

product sections for easy reference

**THE MASTER MEANS MORE PROFITABLE OPERATION  
FOR SERVICE TECHNICIANS**

The MASTER covers 150,000 items necessary to radio-TV-audio servicing. It offers thousands of other products that can lead to extra income in hi-fi, sound and industrial servicing. Includes hundreds of new items that are indispensable in

servicing—new color TV test instruments, new transistor types, new subminiature and printed circuit components. Invaluable at the bench, over-the-counter, or in the field. You can buy, sell and bill direct from the MASTER... it shows list prices!

for replacement parts, installation equipment...

**YOU'LL FIND IT FASTER IN THE '59 MASTER**

At your local parts distributor, or write for list



**FREE**... Valuable 24-page panel lamp chart at your MASTER distributor, or write direct enclosing 10¢ for handling.

**THE RADIO-ELECTRONIC MASTER** 65-A Sewell Street, Hempstead, N. Y.

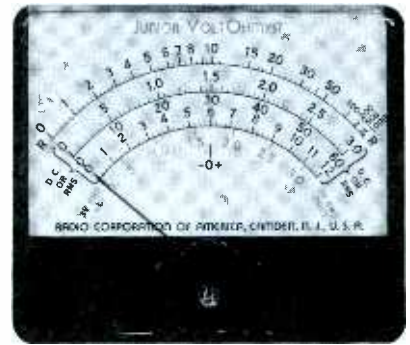

Fig. 5. Meter face of Model WV-77C indicates its versatility as a tester.

troubleshoot a few chassis, I made a number of AC and DC voltage measurements on all scales and found the accuracy of each to be well within the limits stated in the specifications. The small divisional markings for each scale (Fig. 5) and the zero-center calibration point are features which make the Model WV-77C very useful in discriminator alignment work and for bias measurements.

Since I also measured resistances but found no mention of the ohmmeter accuracy in the manufacturer's manual, I decided to check this feature myself. For standards, I selected five precision-type resistors with values equal to center scale readings for each range (10 ohms, 1000 ohms, 10,000 ohms, 1 meg, and 10 meg).

I found the ohms indications very satisfactory on all ranges; in fact, with the zero and ohms adjustments set properly, accuracy of the 200-microamp movement was better than 1% on all ranges.

The test probe supplied with the Model WV-77C is shown in Fig. 6. This unit is designed to minimize capacitance loading and features a built-in switch to permit quick adaptation for either DC voltage or AC-ohms measurements. If you desire to attach the probe to any point, an

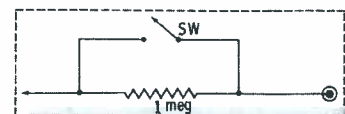

Fig. 6. Schematic and photo of the test probe supplied with the VoltOhmyst.

alligator clip which slips over the tip is also provided.

**Picture Tube Bad?—Shoot It!**

By using the handy portable instrument pictured in Fig. 7, you may save both your time and your customer's money. Known as the Model 200 CRT tester-reactivator produced by Vis-U-All Products Co. of Grand Rapids, Mich., it is used to test and rejuvenate all types of television picture tubes including the newer 110° types.

Specifications and test features are:

1. Power Requirements — 105 to 125 volts, 50/60 cps; power consumption under test approx. 12 watts; panel lamp serves as fuse; safety interlock cord supplied.
2. Emission Test — measures beam current to phosphor screen; emission indicated on 4½" meter; plug-in test cable and 110° socket adapter provided.
3. Bias Test — fixed negative voltage applied between grid and cathode to check cutoff point and condition of grid aperture.
4. Life Test — relative meter indication of active cathode coating remaining.
5. Shorts Test — filament-to-cathode and grid-to-cathode shorts indicated by neon panel lamps; grid-to-cathode shorts may be burned off.
6. Rejuvenation — voltage applied to cathode reactivates coating; "magic eye" on front panel indicates response to treatment.
7. Size and Weight — 10" x 6" x 5", 6½ lbs. complete.

Using four defective TV picture tubes, each of which produced the familiar trouble symptom of dim raster and washed-out picture, I made several experiments with the Model 200 to evaluate its capabil-

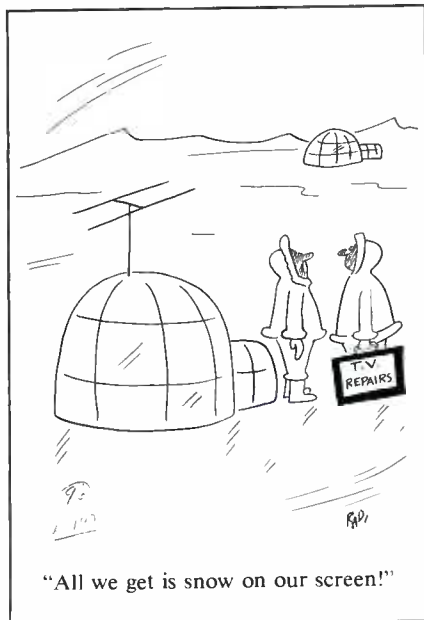

**"MAYBE HE SHOULD PLAY SOMETHING LESS FRIGHTENING 'TILL HE GETS USED TO STEREO SOUND"**

For sheer realism, you just can't beat a Webster Stereo-Ceramic cartridge! But, be realistic... stereo is now beyond the novelty stage. New stereo discs are being released daily — in ever-increasing numbers. So when you replace a cartridge, sell your customer on a Webster Stereo-Ceramic. Tell 'em it plays standard LP's and 78's in addition to the new stereo discs. They'll marvel at the improved performance. And, you'll appreciate the easy installation with one universal mounting bracket that fits any standard arm.

**REPLACE WITH WEBSTER... IT PAYS!**

stereo-ceramic ...



**SC-3D Stereo turn-under**  
— with .7 mil diamond  
and 3 mil sapphire styli.  
**\$25.00\***



**SC-2D Stereo single needle**  
— with .7 mil  
diamond stylus.  
**\$22.50\***



**MC-2 78 rpm single needle**  
— with 3 mil  
sapphire stylus.  
**\$7.50\***

\* List prices — standard discounts apply.

**ELECTRONICS DIVISION**  
**WEBSTER ELECTRIC**  
**RACINE · WIS**



franklin adv. Y-128R

**NEW**  
**IMPROVED**  
**SENCORE**  
**LC3**  
**Leakage Checker**

*Another Sencore Time-Saver*

Check these outstanding New Features

Now — For the first time . . .

Checks 156 different tube types — more than any other "grid circuit" type checker. Includes UHF and latest type tubes.

Checks picture tubes without removing tube from cabinet or chassis.

New Roll Chart prevents absence — just dial the tube type and save time. Chart is easily replaced at no extra cost.

Dynamic Filament checks including heater to cathode leakage & shorts — no need for a second filament tester.

Two spare preheating sockets to cut down testing time.

Capacitor checks simplified.

The LC3 provides all these new improved features in addition to those employed in earlier leakage or "grid circuit" testers. A must for any TV service technician.

**PRICE** **\$28.95**  
 DEALER NET  
*Really Whips Tough Dogs*

**SERVICE**  
**INSTRUMENTS CORP.**  
 171 Official Rd. • Addison, Ill.

In stock at your local parts distributor

Cut out this ad now for further information



Fig. 7. Vis-U-All 200 performs four tests and reactivates picture tubes.

ities. When I advanced the contrast and brightness controls during two preliminary tests, the white portions of the picture would turn a silvery gray. This is sometimes known as the "Zombie effect" and occurs quite often in tubes having low emission or gas.

Without going into details about operating procedures, which incidentally are printed inside the detachable lid, the results of my lab

findings are as follows: The original emission test reading on the meter was less than .1 for all four tubes — an indication of very low emission. Indications were that one of the tubes had internal shorts. I was able to successfully reactivate three of the four "guinea pigs" and restore their emission to a reading of between .2 and .4 in the good area of the meter scale.

In the case of the shorted tube, I

**Grips the screw!**  
**Drives it too!**

**Quick-Wedge**  
**SCREW-HOLDING**  
**SCREWDRIVER**

2" to 14" blades, 4 bit sizes.  
 Available with shockproof plastic covered tubing  
 Unconditionally guaranteed

**ASK FOR IT AT YOUR DEALER**  
 Kedman Co., 233 South 5th W.,  
 Salt Lake City, Utah

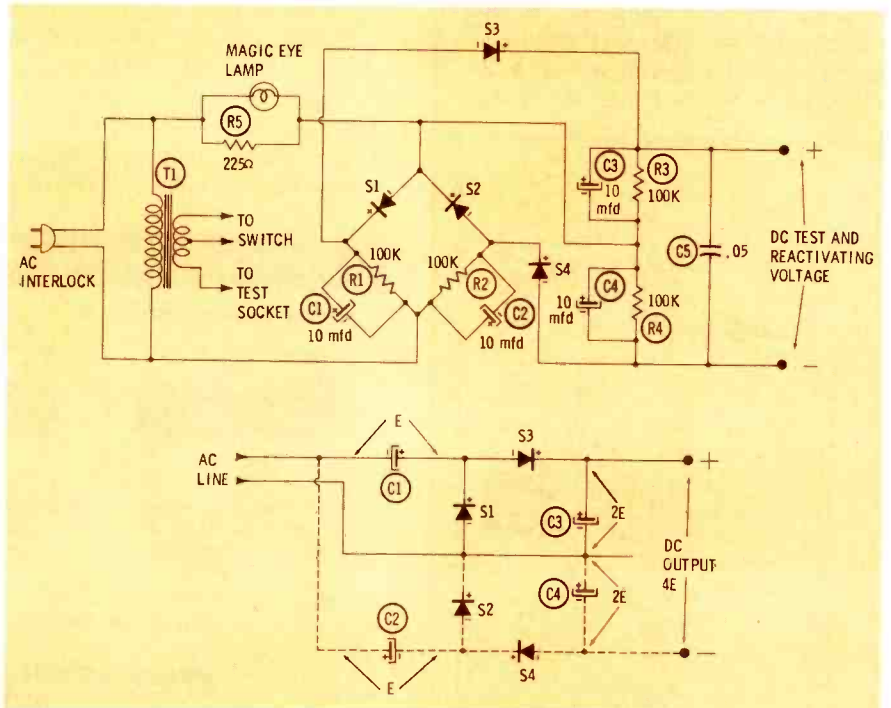

Fig. 8. Power supply for Model 200 (A) Complete Circuit. (B) Simplified diagram.



Fig. 9. This Vis-U-All adapter plugs into test cable and fits new 110° tubes.

placed the function selector in the REACTIVATE position and was able to burn off the short between grid and cathode, but the one between filament and cathode remained. This tube was not ready for the cash can, however, for by merely isolating the filament circuit from ground with a small 6.3-volt transformer, the tube could be operated satisfactorily.

The thing that impressed me most about the design of the Model 200 was its power supply circuit, which obtained approximately 560 volts DC from the AC line. Since I didn't happen to have a schematic of the instrument, I removed the case and drew the power circuit schematic shown in Fig. 8A.

I found that the instrument employed four silicon rectifiers and four electrolytic capacitors in two voltage doubler circuits, one from each side of the power line. Since it was somewhat difficult to recognize a familiar circuit design from Fig. 8A, I simplified the arrangement into the style of Fig. 8B. That portion in solid lines represents a simple doubler network such as might be found in any television receiver. With one side of the AC line as reference, the instrument also makes use of a second doubler, shown by the broken lines in Fig. 8B. Thus, we have two rectifier circuits—one positive and one negative with respect to the common side of the AC line. By adding these two outputs in series, a potential of 560 volts, or about 4 times the peak AC input voltage, is available for use in the tester and reactivator circuits.

Other interesting features of the Model 200 are the "Magic Eye" indicator on the front panel, which tells the operator when the tube has had enough reactivating voltage, and the convenient adaptor socket (Fig. 9) for testing 110° tubes.

## Focus on Profits

with  
**Centralab**  
**Model B**  
**Controls**

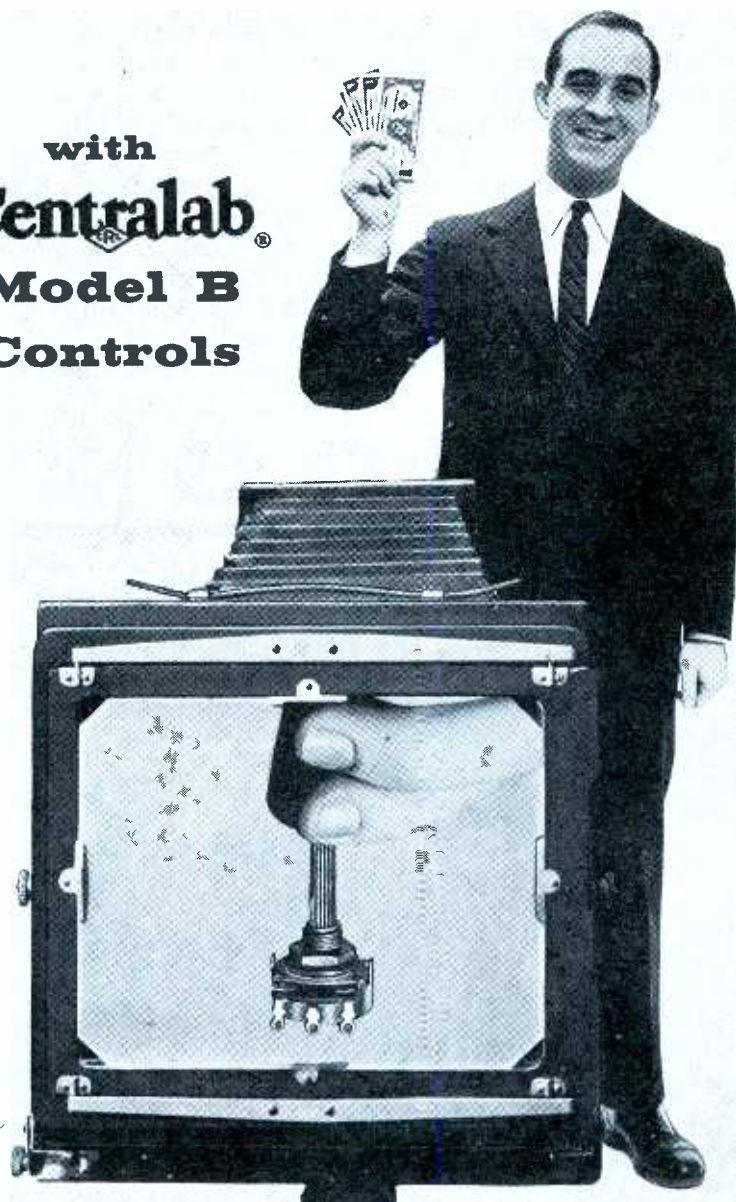

Enlarge your income and develop a long list of satisfied customers. It's easy with Centralab Model B Radiohms in the picture.

This is a replacement carbon control that adapts readily to virtually any application. Universal, fluted, knurled-type shaft fits all knobs—split knurl, shallow flat, deep flat, half-round, round, etc.

AC Line switches snap on, to convert control to switch-type unit.

There's nothing negative about Model B's . . . and you'll get a double exposure of profits. Order today from your Centralab distributor.

Centralab products are listed in COUNTERFACTS and PHOTOFACETS.

**Centralab**   
B-5804

A DIVISION OF GLOBE-UNION, INC.  
942 M.E. KEEFE AVE. • MILWAUKEE 1, WIS.  
In Canada: 804 Mt. Pleasant Rd. • Toronto, Ontario

**CONTROLS • SWITCHES • PACKAGED ELECTRONIC CIRCUITS  
CERAMIC CAPACITORS • SEMI-CONDUCTOR PRODUCTS**

## PC Servicing

(Continued from page 26)

wouldn't discourage me. Here's a good method you can use to mend a clipped lead: Take a piece of #22 tinned wire about 3" or 4" long, and get a small drill bit like I was using awhile ago. Wrap the wire around the bit as close as you can, until you have a little spiral about 1/4" long. Take this little sleeve, slip one end over the remaining part of the component lead, and attach the other end to the stub of lead wire that

projects from the PC board. Press the coil against the wire stubs with long-nose pliers. Now solder the connection by applying an iron to the middle of the sleeve.

There are times when it becomes downright exasperating to locate a part on a PC board. You know what I mean if you've ever used the Braille system (with the aid of a strong light) to find your way around in a circuit. I have even been misled into unsoldering the wrong part, but I now have a technique for avoiding needless unsoldering. Try

the following idea: Take a piece of insulated #14 or #12 solid wire 10" long, and bend it double. Now you have a pair of calipers. Working on the component side of your PC board, choose a reference point. You may be able to locate a certain part that is conspicuous on both sides of the board, or perhaps you can find an unused hole and insert a small piece of spaghetti through it. Spread open your calipers so that one end touches the lead you want to unsolder and the other end is at the reference point. Repeating this procedure on the reverse side will enable you to locate the exact spot. Use a sharp instrument to make a small X on the board at the reference point; then, when you go back to work after a break, you will know exactly where to start in. By cutting off 1/4" of insulation and sharpening each end of your calipers, you can use them as a jumper to check for cracks, etc., in the printed wiring.

Our next set, by coincidence, is another Admiral — a Chassis 17Z3DB this time. The complaint is no sound and no raster. Removing the back cover, we see that most of the tubes light up, but that 5 of them don't. At first glance, this looks like a simple deal — one of these 5 tubes must be open. However, actual tests show them all to be good. Well, now, what have we here? All the tubes in this set are in one series string (see Fig. 2). Since only 5 are unlit, we can suspect that they are not receiving heater voltage because of a short to ground at some intermediate point in the string. Studying the schematic, I find that the unlit tubes are V12, V7, V8, V16, and V9. The rest of the tubes glow with about normal brilliance. The fusible resistor in this particular set is soldered in place, so I clip it and pull V12, the last tube in the string. Now I bring my C-R tester into play. When I connect it to pin 7 of V14 and ground and set it for an insulation-resistance check, it shows a short. At this point, I begin to think that one of the 9 capacitors in that string might be giving trouble. However, I decide to wait until later to check these, and I start pulling tubes one at a time. When I remove V5 (a 5AM8), the short disappears, indicating that either V5, C84 or C85 is defective. Further tests with the

# GREGG

## SOLDERING GUNS

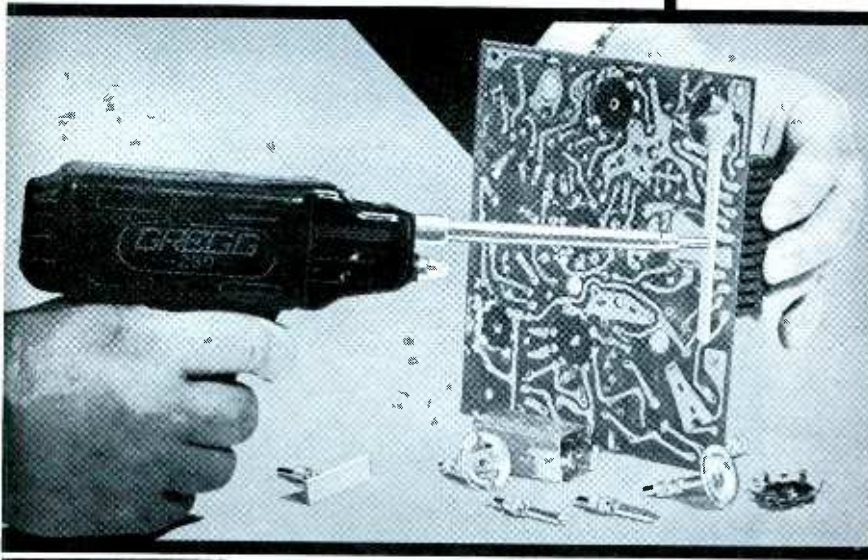

**REPLACE  
PRINTED  
CIRCUIT  
COMPONENTS  
IN A FLASH**

Gregg's Solder Tip Kit\* is a must for printed circuit repairs! It is invaluable to unsolder several terminals simultaneously, removing components safely and quickly. Kit has four interchangeable tips for tube sockets, IF transformers,

electrolytic condensers and two sizes for condenser resistor boards. Each tip contains its own heating element which distributes the proper heat over its entire surface. Pays for itself on the first job!



MODEL 250A

### AMERICA'S FINEST GUN

- Two second heating — no waiting. Heat is generated right at the soldering point.
- Permanent alloy tip does away with filing and cleaning — just a wipe and it's ready. Outlasts copper tips 5 to 1.
- Single barrel construction — reaches into deep places without damage to wiring or components. Rigid tip makes it easy to remove wires and clean terminals while hot. Other barrels available in 6", 8", 10" and 12" lengths.

WRITE FOR FREE  
BOOKLET ON REPAIRING  
PRINTED CIRCUITS

**GREGG** electric sales, co.  
620 essex st., lawrence, mass.

\*Pat. Appl'd for.

C-R checker reveal that, even though V5 checks OK on my tube tester, there is a high-resistance leakage from heater to cathode in the diode section. This cathode (pin 7) goes directly to ground through the secondary of the last IF transformer, which has a very low resistance. My C-R tester (which can detect leakage resistances as high as 2.5K megohms) clearly shows the triode section to have heater-to-cathode leakage. By unplugging tubes, we are able to check the nine heater - to - ground capacitors for shorts without disconnecting a single one. We do this, just in case one is bad; however, they all pass the test.

Notice that we manage to solve the last case without ever having to touch the PC board with a soldering iron. This serves to illustrate that, when you are troubleshooting a printed circuit (or anything else for that matter), it pays to use your scope and VTVM to get you as close to the trouble as possible, and then to study your schematic for a while. Believe it or not, you will often find that you are able to check a dozen or more parts by unsoldering only two or three connections at the most.

Speaking of soldering, you remember that old 100- to 200-watt soldering iron you put away? Yes, the one with a big chunk of copper on one end! Dig it out—you may be able to use it for unsoldering controls and electrolytics. Get a copper disc about the size of a half dollar. If you want, cut it into a horseshoe shape. Now mount this on the end of your old iron by tapping threads into the tip and then fastening the disk onto it with brass screws. Tin the whole thing, letting solder flow over both sides of the disc and the tip of the iron. Of course, if you're not an avid do-it-yourselfer, you can avail yourself of one of several good printed-circuit soldering kits now on the market.

All in all, PC servicing isn't any more difficult than other types of servicing; it just takes other techniques. You will be seeing more and more sets with PC boards, so if you plan to continue to offer fast, efficient service, you'd better spend a little time to develop a good trouble analysis and repair technique. On to better and faster servicing—with thorough, rather than rash action! ▲

It's just **one** of the **thousands** of "Exact-Duplicate" replacements **AEROVOX** can supply!

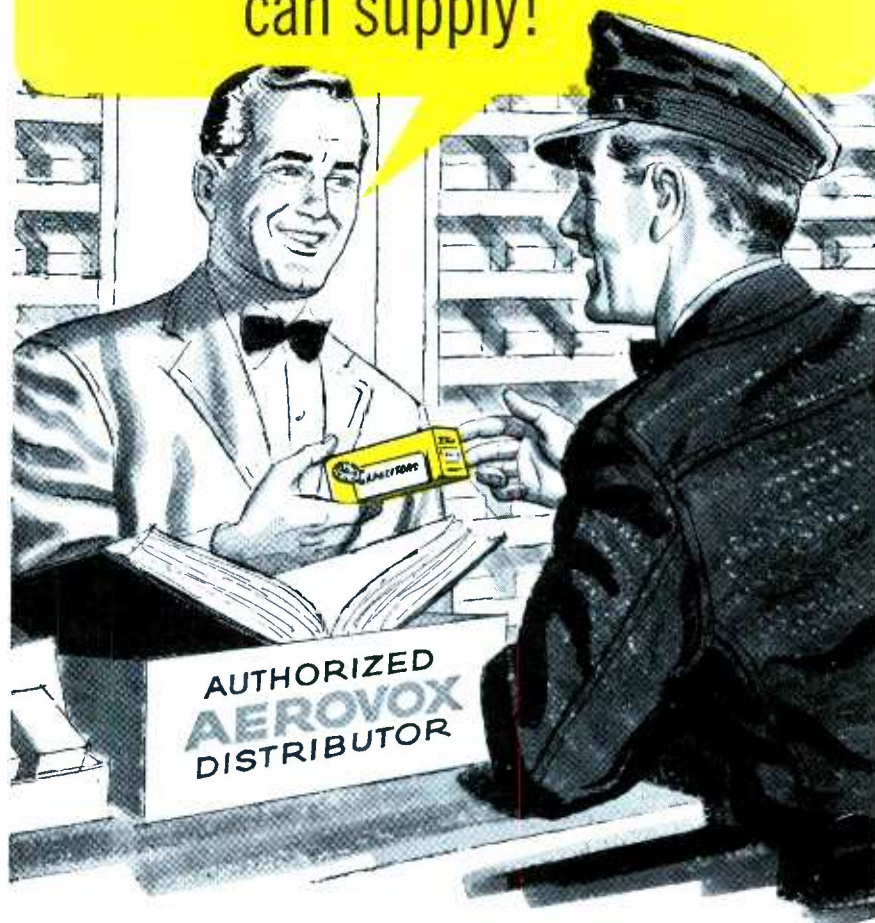

No need to chase all over town for the right replacement... no need to improvise with two units. Your local Aerovox Distributor is your "one-stop" source of supply. He stocks the complete line of Aerovox AFH capacitors. From his extensive stock of almost one thousand "exact-duplicate" capacitors you can choose the right replacement in short order.

Equally as important — all Aerovox AFH twist-prong electrolytic capacitors offer the very latest refinements... 85°C operation, improved hermetic sealing, sturdy terminals and prongs (including units for printed-wiring applications), and high-purity aluminum foil or composite plate construction throughout.

*Ask your local Aerovox Distributor for your free copy of the all new Servicemen's Catalog.*



**AEROVOX CORPORATION**

DISTRIBUTOR DIVISION

NEW BEDFORD, MASS.

## Audio Facts

(Continued from page 24)

faulty part by visual observation or by voltage and resistance checks.

Headphones with alligator clip leads are handy for signal tracing. Also, high-impedance crystal phones with good high-frequency response can be used most effectively. A capacitor connected in series with one lead will protect the phones and the technician during plate-circuit tests. When phones are used as an indicator, a slightly different signal-tracing

method is used. The signal is applied to the input of the pre-amp during the entire test, and the phones are moved from stage to stage.

The first test point is across the speaker terminals. If there is output from the phones, the speaker is at fault; but, if there is no output, the serviceman should work back through the system with the phones until a signal can be heard. It can then be assumed that the trouble is in the circuit immediately following the point where a signal is first picked up.

Any number of specific troubles could cause lack of signal output. Some examples are bad tubes, broken wires, poor solder joints, poor switch or connector contacts, burnt or wrong-value resistors, open coils, open or shorted capacitors, and shorts between the conductors and shields of connecting cables. Each is a separate condition that must be found and fixed independently. In this respect, hi-fi servicing is no different from radio and TV repair.

When a faulty component is found, it should be replaced with a duplicate of the original whenever possible. Good hi-fi is a result of precise design; therefore, exact values should be used (even for filter components) so as not to disturb the balance or stability of the unit being repaired. If the system is a new one, the technician should look for improper lead connections and misadjusted switches and controls before using the signal-tracing tests.

### Distortion

Several different types of distortion can occur in audio systems, the most prevalent of which are:

1. Harmonic Distortion—Nonlinear operation of an amplifier results in the generation of harmonics which are not part of the input signal. The harmonics are whole-number multiples of the frequencies from which they are produced and therefore do not sound discordant.

2. Intermodulation Distortion — In a nonlinear amplifier, the various frequencies making up the audio signal also beat together to produce sum and difference frequencies that are not present in the input signal. These additional frequencies have no harmonic relationship to the signal and are more annoying than those which produce harmonic distortion.

3. Frequency Distortion — A perfect audio amplifier would give equal amplification to every audio frequency; however, practical amplifiers have response curves which drop off at both the high and low ends of the audio range. This unequal amplification is called frequency distortion; when such a condition exists, we say that the frequency response is poor.

Listening to a system may often give the serviceman some idea of the

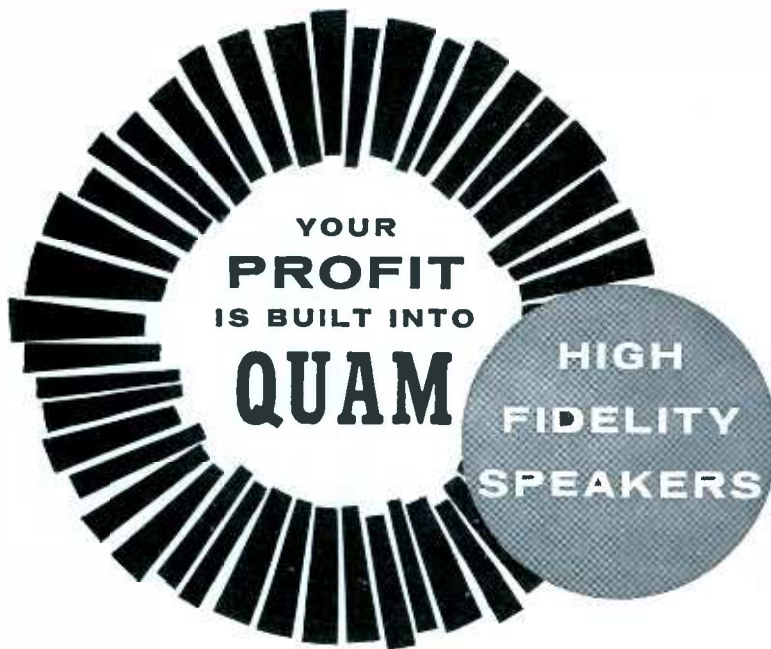

Quam Hi-Fi Speakers are the List Price line. They are never promoted to the public at "audiophile net," or some similar phrase which deprives you of the opportunity to make your legitimate profit. When you sell and install Quam High Fidelity speakers, you come out way ahead on the deal.

So does your customer. The speaker he buys from you at list compares favorably with any other hi-fi speaker at the same dollar cost net. **That's because**

1. The design of Quam speakers emphasizes performance rather than non-functional decorative features.
2. Quam Hi-Fi Speakers represent the accumulated skill and experience of thirty years of fine speaker manufacturing.
3. Quam's position as the world's largest exclusive speaker manufacturer permits many production economies to be passed along to you and to your customer.

See your Quam distributor for complete information about the full line of Quam Hi-Fi Speakers—extended range, tweeters, woofers, coaxials. *Quality* is built into every one of them—and so is your profit!

## QUAM-NICHOLS COMPANY

234 East Marquette Road • Chicago 37, Illinois  
CANADA:

A.T.R. Armstrong, Ltd., 700 Western Road, Toronto 9, Ontario  
D. Eldon McLennan, Ltd., 1624 W. Third Avenue, Vancouver 9, B.C.



type of distortion for which he should look. Harmonic distortion may not be too objectionable to many listeners because it causes only minor changes in the sound. For instance, it might cause a violin to sound differently but still not displeasing. Intermodulation distortion most often sounds discordant because new frequencies are produced. Frequency distortion shows up as insufficient bass or treble, but does not otherwise alter the tone quality.

Next, the serviceman should determine whether the distortion exists on all program sources or just on one. How about the program material — is it distorted? If so, there is no need to look any further than the signal source, whether it be phono, tape, tuner, or microphone. When distortion exists for all volume levels, it can be assumed that it originates ahead of the volume control; but, if the distortion varies with different volume settings, then it is being introduced in a stage following the control.

To check for harmonic distortion, the system should be adjusted to produce its maximum rated output. An audio oscillator, set at about 1,000 cps, can be used to supply a steady input signal. Such a strong signal from the speaker would be extremely annoying, so a dummy load should replace the speaker for these tests. For such purposes, the audio technician should have available resistors of 4, 8, and 16 ohms with power ratings of at least 50 watts.

An audio VTVM or wattmeter connected across the resistor will show the output level being produced. A wattmeter will indicate the power output directly, but this type of meter may not always be readily available. Fortunately, an audio VTVM can be used almost as easily. By using the information in Chart I, one can determine the proper voltage for each of the most popular power ratings. For example, a 20-watt amplifier using an 8-ohm load is producing full power output when the reading across the output load is 12.6 volts. For ratings not shown in the chart, the power formula  $P=E^2/R$  can be used. Thus, a 12-watt amplifier with a 16-ohm speaker would require 13.85 volts to develop its rated output.

# WRIGHT WIRE STRAND PERFORMS LIKE A KING AND IS NON-SNARLING



Wright TV Guy Wire Strand is your guard against irritating snarls. Each concentric coil measures two feet. You save money in buying antennas. Greater flexibility, heavily galvanized continuous connected coils. Prompt delivery from stocks in Worcester, Chicago, New Orleans, Dallas, Los Angeles, San Francisco and Portland, Oregon.

Non-Snarling Pre-Measured Wire Strand Sold only through Wholesale Distributors.

## G. F. WRIGHT STEEL & WIRE CO.

235- Stafford St. • Worcester, Mass.

## SUBSTITUTE PARTS WITH-OUT SOLDERING

Quickly with Easily Has 1001 Uses!

**NEW** E-Z-Hook "SUB" Connectors

Connect a speaker, or

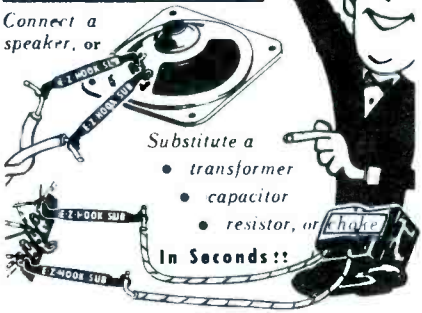

Substitute a

- transformer
- capacitor
- resistor, or diode

In Seconds!!

- ★ Makes connections instantly!
- ★ Won't pull off!
- ★ Insures positive contact!

Saves time, money and parts in servicing, experimenting, instructing and production.

**E-Z-HOOK SUB**

No. 71-1 SUB Only 69¢ ea.

Six Colors! - for Easy Lead-Identification



ORDER THROUGH YOUR PARTS DISTRIBUTOR

E-Z-HOOK TEST PRODUCTS

Dept. F, 1536 Woodburn Ave.

Covington, Ky.

## NEW... SENCORE "Electro-Sub"



### Check all ELECTROLYTIC CAPACITORS in Seconds!

Merely select the electrolytic and substitute it. 10 big electrolytics from 4 to 350 Mfd. to safely substitute in any circuit from 2 to 450 volts.

- ★ ★ ★ COMPLETELY SAFE—no arc or spark when connecting or disconnecting.
- ★ ★ ★ AUTOMATIC CAPACITOR DISCHARGE — within seconds after releasing test switch by unique surge protector circuit.
- ★ ★ ★ NO CAPACITOR HEALING — surge protector circuit prevents accidental healing of capacitor being "bridged" in service work.

Carry it anywhere—measures only **only \$15.95** DEALER NET

4 3/4" H x 4 3/4" W x 2 1/4" D

Less than you pay for the individual capacitors.

**SENCORE SERVICE**

INSTRUMENTS CORP.

171 OFFICIAL ROAD ADDISON, ILL.

Another SENCORE "Time-Saver"!

**CHART I—AUDIO VOLTAGE OUTPUTS AT VARIOUS POWER LEVELS**

Rated Maximum Output in Watts	Voltage for 4 Ω Load	Voltage for 8 Ω Load	Voltage for 16 Ω Load
5	4.5	6.3	8.9
10	6.3	8.9	12.6
15	7.7	11.0	15.5
20	8.9	12.6	17.9
25	10.0	14.1	20.0
30	11.0	15.5	21.9
50	14.1	20.0	28.3

You get these *plus* features with STANCOR

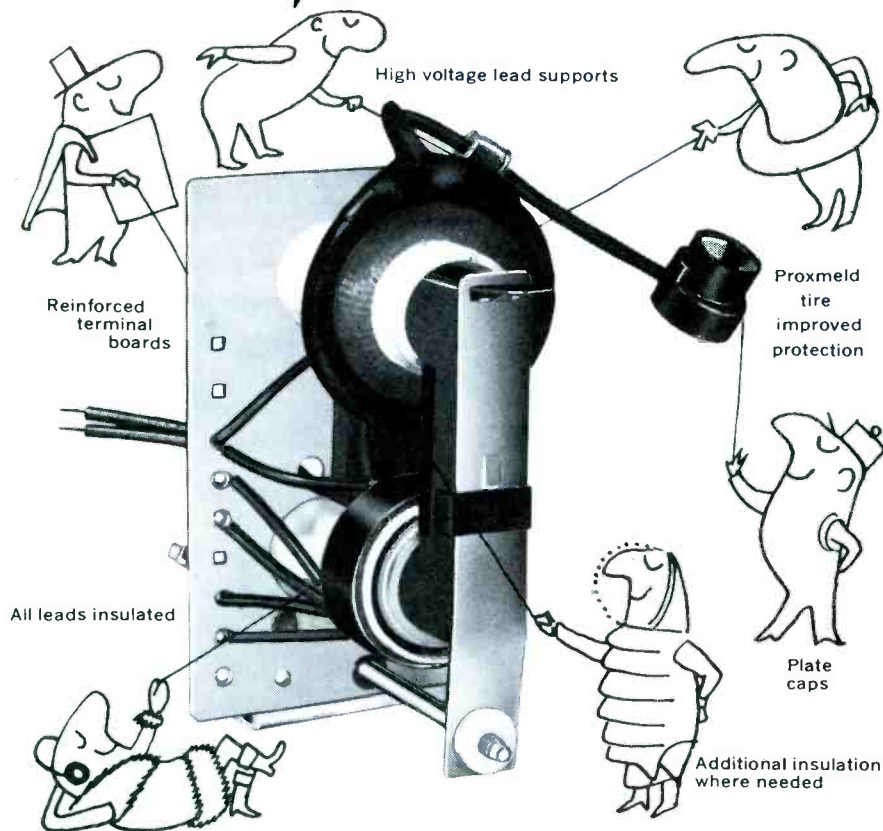

Stancor, the pioneer in the field of exact replacement flybacks, now goes one step further. The Stancor replacement represents an *improvement* over the original manufacturer's units. Additional features—like those above—are added when necessary to insure optimum performance. Stancor flybacks are engineered and improved replacements to help make your work more efficient and more reliable.

**FREE**—Catalog sheets listing detailed application information on the newest Stancor exact replacement television transformers. See your Stancor distributor or write us for your free copy.



**CHICAGO STANDARD TRANSFORMER CORPORATION**

3503 Addison Street • Chicago 18, Illinois

Export Sales: Roburn Agencies, Inc. • 431 Greenwich Street • New York 13, N. Y.

Checks for harmonic distortion can be made by using an oscilloscope and either a sine- or square-wave audio generator. With the generator connected to the phono or microphone input terminals, turn the volume control to maximum and increase generator output until maximum rated power is reached. The waveform at various parts of the circuits can be checked with a scope, starting either at the input or at the speaker. Several examples of harmonic distortion are shown in Fig. 2 for purposes of comparison. The exact degree of harmonic distortion present in an amplifier can be measured with a harmonic distortion analyzer. Basically, this instrument indicates the amplitude of the harmonics being introduced in comparison to the total signal amplitude. It is calibrated in percentage of distortion.

Intermodulation troubles are best checked with an intermodulation distortion analyzer. This instrument functions by applying two sine-wave signals of different frequencies (one high, one low) to the amplifier under test. The amplitude of any additional frequencies produced by interaction is then measured with respect to the two original signals. Examples of intermodulation distortion are shown in Fig. 3. Notice that, in addition to altering the shape of the original signal, the distortion actually creates a discordant signal which falls within the audio spectrum. Both

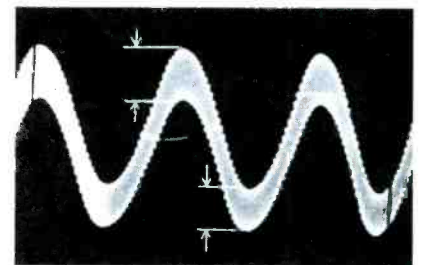

(A) Mixture of 60- and 3,000-cps signals producing 12% distortion.

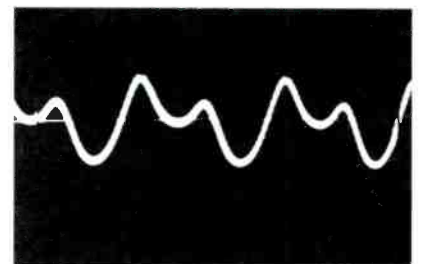

(B) Waveform of spurious signal component due to intermodulation.

**Fig. 3. Intermodulation distortion.**

harmonic and intermodulation distortion analyzers will be described in more detail in a later article.

When the system seems to lack normal frequency response, make sure all controls are properly adjusted. Equalization, tone, loudness, and speaker controls all vary the frequency response, and improper settings will therefore result in uneven response. Incidentally, bear in mind that apparent frequency response is poorest at low signal levels because of the way our ears react to the different levels of sound.

Phono cartridge response can be checked with a test record that provides constant output over a wide range of audio frequencies. Output from the preamplifier at each frequency can be read with an audio VTVM or wattmeter. Be sure the equalizer switch is correctly set and that bass and treble controls are adjusted to the FLAT position. If a linear response is not obtained across the audio band, connect the signal generator to the phono input of the preamplifier and vary its frequency over the same range covered by the test record. (Note! The output of the generator must be flat over the audio spectrum.) If a linear response is produced when the generator signal is applied, the phono cartridge obviously must be defective. However, if the response to the generator signal is also nonlinear, the cause may be in the pre-amp. The same response test can be used to check the power amplifier and speaker system. Once the distortion has been isolated to a single unit, stage-by-stage tests can be made for further isolation of the defect.

#### Hum

Normally, hum refers to an audio output at either the AC-line or power-supply ripple frequency (60 or 120 cps). The latter is more objectionable because it is more easily heard. In order to locate the source of the hum, determine first whether or not it exists for all signal inputs. Most cases of hum will originate in the phonograph, so this unit should be checked with extra care.

If the hum is not originating in the phonograph or other signal source, use one of the signal-tracing methods previously described to locate the exact source. One method of

"FELLAS—THERE'S GOLD IN THESE

# C-D TWIN TREASURE CHESTS"

- **FILLED WITH C-D CAPACITORS**

the finest you can use to establish customer confidence.

- **FASTER CAPACITOR TURNOVER**

because you'll always have the fast movers on hand.

- **SPEEDS UP YOUR WORK**

because replacements are easy to identify, always handy.

- **HANDSOME METAL CABINETS**

make shop neater, prevent misplaced pieces.



#### SUGGESTED CONTENTS:

**TWIST-PRONG SECTION CONTAINS** 12 popular C-D "Preferred Type" Twist-Prongs (and room for 6 more)

**TUBULAR SECTION CONTAINS** 16 popular C-D "Blue Beaver" Tubular Electrolytics

73 PM Mylar Tubulars

**BOTH CABINETS ARE FREE. YOU PAY ONLY FOR THE PREFERRED C-D CAPACITORS.**

**YOUR COST: \$49.95**

See C-D's "Treasure Chests" at your Cornell-Dubilier distributor or write to Cornell-Dubilier Electric Corporation, South Plainfield, N. J., Department PF12



Consistently Dependable  
**CORNELL-DUBILIER**  
SERVICE CAPACITORS

isolating hum consists of shorting out or disconnecting signal points in a logical order. To begin with, disconnect the input to the power amplifier. If hum remains, the trouble is in the output amplifier. If the hum stops when the input to the power amplifier is removed, then it is obviously being introduced prior to that point. Individual stages can be checked by shorting grid and plate circuits to ground through a large capacitor. If the hum remains when a given point is shorted, it must be originating after that point. Success-

sive shorting of signal points should disclose where the hum is being introduced.

Don't forget the possibility that hum might come from the power supply and actually be introduced into all stages. Power-supply hum is almost always at 120 cps. Bridging an electrolytic capacitor from B+ to ground should indicate whether or not power-supply filtering is adequate.

Hum can also be caused by other things, some of which are: Transformers or motors positioned too

close to a pickup arm, heater-to-cathode short or leakage in tubes, unbalance in push-pull stages, a misadjusted hum-balance control, poor or broken ground connections, defective shields, leakage across tube sockets (especially in low-level circuits), trouble in a feedback loop, and improper lead dress. Faulty components which could cause hum include power supply filter capacitors, resistors or chokes; cathode or screen bypass capacitors; and faulty rectifier tubes. In a few cases, reversing the AC line plug may help to reduce mild forms of noise that sound like hum.

### Noise

To track down the source of noise, first check to see if it is being introduced by a signal source. Noise is very often introduced from worn records or styli, or by static interference from a tuner. Second, stop and think! What kind of noise is it? Is it steady or intermittent, is it a form of hiss or other steady noise, or does it crackle and pop irregularly? Quite often, the character of noise helps to pinpoint the actual trouble.

If noise occurs only when a switch or control is varied, look for trouble such as dirty or pitted contacts in that component. Tubes often have noise-producing defects that do not show up on a tube tester. Low-level amplifiers in particular are best checked by replacement with tubes of known good quality. Misadjusted treble controls can result in too much hissing, especially when the treble setting is too high. If the control is already adjusted correctly, decreasing the treble will often lessen the noise; but this is not a suitable remedy because high-frequency audio signals are also reduced in the process.

Motorboating is a type of noise which can be caused by an open screen bypass capacitor or control grid resistor, or else by insufficient decoupling. Although howling and whistling can result from parasitic oscillations in any stage, one of the most common causes for this type of disturbance is a component failure within the feedback loop of the power amplifier. The actual circuit location of the noise introduction can be determined by the same methods used for locating hum. ▲

**Our  
Guarantee  
is printed  
on our  
product**



**On every packaged PLANET electrolytic capacitor sold through distributors you will find this statement:**

### **GUARANTEED FOR ONE YEAR**

Because PLANET CAPACITORS ARE "ENGINEERED FOR QUALITY", because they are carefully controlled through all stages of production and because the finished product is given a 100% electrical and mechanical check—our one-year guarantee is not only made possible, but is conservative.

Actually thousands and thousands of Planet capacitors five, six and even seven years old are performing excellently, every day, in TV and radio sets all around the world. When you solder a Planet capacitor into a circuit your guarantee of satisfactory performance is right there in front of you—and will be in the circuit for a long, long time. So when you order capacitors—order PLANET.

## **PLANET SALES CORPORATION**

**227 BELLEVILLE AVE.**

**BLOOMFIELD, NEW JERSEY**

## Across the Bench

(Continued from page 17)

try RF or IF realignment. I find that these sets generally don't need it.

Be on guard if the plate voltage of the 4th video IF tube doesn't check exactly as shown on your schematic. You may find that the wiring in the plate-load circuit is not what the diagram says it should be. Earlier models of the KCS47 chassis have an 8200-ohm resistor in series with a 1000-ohm unit, but later models have a combination of a 36-microhenry peaking coil shunted by a 22K-ohm resistor connected in series with a 6800-ohm resistor (see Fig. 2). Since these receivers were built during the early part of the Korean War, when parts were sometimes temporarily in short supply, you may also find slight changes in component values from set to set. (For instance, groups of parallel resistors were even made up to supply the desired values. It works, but it's expensive!)

The aforementioned changes will have some effect on plate voltage — enough to account for a seemingly out-of-tolerance condition, but not enough to explain radical departures from normal values. If something is seriously wrong, remember that someone may have made some ill-advised field changes during the long life of the receiver. Perhaps some misguided individual, noticing the presence of the shunt peaking coil in the fourth IF circuit of most KCS47 chassis, might have decided to in-

stall this coil in the occasional receivers that lacked it. If he neglected to change the 1000-ohm series resistor to 6800 ohms at the same time, he would have reduced the total DC plate-load resistance from the original 9200 ohms down to about 1003 ohms. Since there wouldn't be much of an IR drop across the resulting combination, the plate voltage with no signal applied would move up from the customary 125-volt level to the neighborhood of 180 volts.

## Start Digging In

Before wrestling with some of the more complex circuits, you might do well to make a few "quickie" checks of various large paper capacitors used for coupling and bypass purposes in the IF, video and sync stages. Use a capacitance checker, or test for leakage with a VTVM while the receiver is on. (Remember, this is done by cutting loose or unsoldering the end of the capacitor that is nearer ground potential, and then bridging the meter between this dis-

# NEW from *South River*

## NOW MAKE IT EASY FOR YOURSELF



With SOUTH RIVER'S  
NEW Antenna Mountings  
designed for faster, easier  
television antenna  
installations!

THE MOST CONVENIENT ROOF TOP MOUNTING AVAILABLE.  
CHECK THESE TIME AND MONEY SAVING FEATURES.

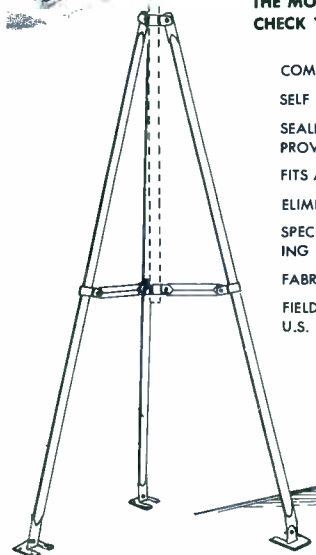

- COMPLETELY PRE-ASSEMBLED.
- SELF SUPPORTING AT ALL TIMES DURING INSTALLATION.
- SEALING COMPOUND PERMANENTLY AFFIXED TO ADJUSTABLE FEET TO PROVIDE A POSITIVE, LEAK-PROOF INSTALLATION.
- FITS ALL PEAK OR FLAT ROOFS.
- ELIMINATES GUY WIRES, TURNBUCKLES, ROOF HOOKS & GUY CLAMPS.
- SPECIAL, HARDENED, SCREW NAILS INSURES STRONG, RIGID FASTENING TO ROOF.
- FABRICATED OF HOT DIP GALVANIZED STEEL TUBING.
- FIELD TESTED BY THOUSANDS OF INSTALLATIONS THROUGHOUT THE U.S. FOR OVER FIVE YEARS.

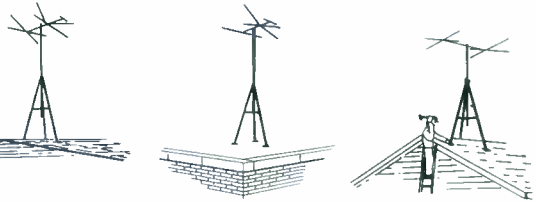

SAVE LABOR COST ON EACH ROOF INSTALLATION! NO ADDITIONAL MAN NEEDED ON ROOF!!

AVAILABLE IN TWO SIZES. MODEL BT-5 USED WITH A 1 1/2" O.D. X 5' MAST MAKES A 7 FOOT INSTALLATION.  
MODEL BT-10 WHEN USED WITH A 1 1/2" O.D. X 5' MAST MAKES A 9 FOOT INSTALLATION AND WHEN USED WITH A 10 FOOT MAST MAKES A 13 FOOT INSTALLATION.

MODEL No.	DESCRIPTION	LIST PRICE
BT-5	Bantam Tower (less mast)	\$7.25
BT-10	Bantam Tower (less mast)	\$9.95

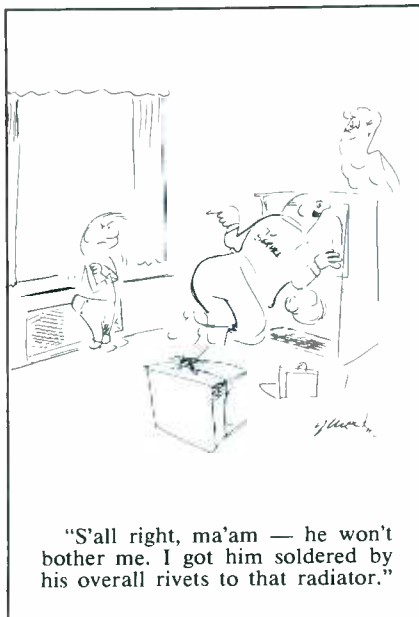

"S'all right, ma'am — he won't bother me. I got him soldered by his overall rivets to that radiator."

*South River* SOUTH RIVER, NEW JERSEY  
METAL PRODUCTS CO., INC.  
PIONEER AND OUTSTANDING PRODUCER OF THE FINEST LINE OF ANTENNA MOUNTINGS

Write for Complete Catalog

CANADA: LEN FINKLER & CO., TORONTO

**BERNS PERFECT PIN-CRIMPER**

**"A Handy 3-in-1 Tool"**



only \$1.25

- QUICK
- POSITIVE
- EFFECTIVE

ELIMINATES SOLDERING socket pins of picture tubes or any other tube. Pin keeps its original form.

USE WRENCH to change channels.

USE BLADE as screwdriver.

IT'S DANDY... IT'S HANDY  
"you'll like it"

Available at your parts distributor.  
Another fine product from:

**BERNS Mfg. Co.**  
9853 Chalmers,  
Detroit 13, Mich

connected end and ground. Any DC reading other than zero indicates leakage.) It's especially wise to check the following capacitors: The .047 in the fourth video IF, the .1 between the two video amplifier stages, the .1 in the picture-tube cathode circuit, the .0022 at pin 2 of the 12AU7 DC restorer, the .47 at the cathode of the sync amplifier, and the .01 at the input to the vertical integrator. Some of the other capacitors in the video output stage might also bear checking.

Change any defective capacitors and restore all connections; then make spot-checks of resistors in the video and sync stages and replace any that have either increased or decreased in value. At this point, you are about ready to tackle the really tough circuits in the receiver.

**Automatic Gain Control**

The AGC system of the KCS47 has some interesting features that can turn into service headaches. Basically, this circuit consists of a network for rectifying and filtering the IF output voltage; however, it also has some accessory items, including a three-position area switch and a tie-in with a combined DC restorer and sync separator. Considered as a unit, this whole circuit is one of the principle roots of the KCS47's troubles.

The original design employed one section of a 12AU7 twin triode for the DC restorer-sync separator func-

tion, but this circuit was expanded (in the KCS47T and later chassis) to include both halves of the 12AU7. The early- and late-production versions are shown in Figs. 3A and 3B, respectively. In the former, the left-over half of the 12AU7 is a sync amplifier, and a 6J5 is used as a vertical oscillator. These two functions were taken over by a 6SN7GT in the revised chassis.

In general, the AGC line itself does not change greatly in design from one chassis to the next. The

**THE MAXIMUM ANTENNA FOR ALL AREAS!**

**RMS WAVEBOOSTER 1000 SERIES ANTENNAS**

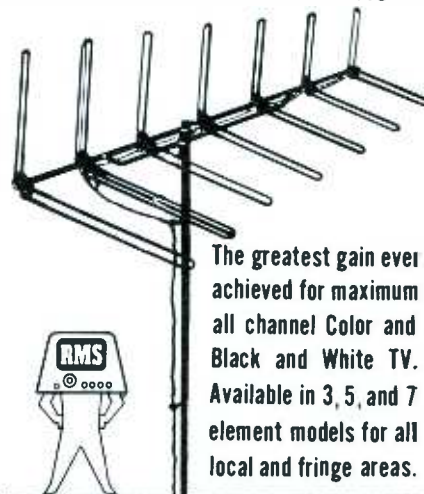

The greatest gain ever achieved for maximum all channel Color and Black and White TV. Available in 3, 5, and 7 element models for all local and fringe areas.

Licensed under United States Pat. Nos. 2,691,730 and 2,817,085 and 2,821,711 of Channel Master Corp.

**MAXIMUM CONSTRUCTION**



New bridged stress proof Super high impact Styrene Plastic insulators. Extra reinforced sleeved elements.

for complete details and free catalog write to

**Radio Merchandise Sales Inc**  
New York 62, N. Y.

**TRUE UNIVERSAL FUSED RESISTOR**

- SIMPLE PLUG IN
- NO WIRING NECESSARY



**NEW IMPROVED Fuse-Bar**  
By WORKMAN TV, INC

**CURRENT SENSITIVE RESISTOR DOES THE TRICK!**

- UNIVERSAL REPLACEMENT FOR ANY VALUE FUSED RESISTOR FROM 1Ω TO 70Ω
- WILL REPLACE 5, 10, 15 OR 25 WATT FUSED RESISTOR
- REPLACE FUSE ONLY ON FUTURE OVERLOADS
- AVAILABLE AT YOUR FAVORITE PARTS JOBBER

**99¢** DEALER NET

MFD. BY **WORKMAN TV INC.** TEANECK, N.J.



sync-pulse tips in the IF output signal cause conduction of the AGC rectifier diode, thus charging the 100-mmf coupling capacitor in the polarity shown in Fig. 3A. Between pulses, this capacitor discharges through the AGC filter network and thereby produces a negative DC voltage which is applied to the RF amplifier and the first three video IFs as bias.

The AGC bias voltage is not fed to the tuner in full strength, but first goes through a delay network con-

sisting of a series resistor (either 33K or 150K) and a connection to the lowest B+ voltage through a 2.2- or 10-megohm resistor. A positive voltage is introduced by this circuit for the purpose of opposing the negative AGC bias voltage. When signal strength is high, the AGC voltage reaching the tuner is still negative — but less so than the IF bias. Whenever the output of the AGC rectifier decreases to a certain level, it is completely neutralized by the positive delay voltage. Then the tuner bias drops to zero and allows the RF amplifier to run "wide open." With further decreases in AGC rectifier output, the tuner AGC line attempts to go positive, but this is prevented by conduction of the clamper diodes. As long as these conduct, the tuner bias is held at a fraction of a volt above ground potential.

Some explanation of the dual-purpose DC restorer-sync separator circuit is in order before we attempt to understand how it affects AGC action. In the circuit of Fig. 3A, a sample of the composite video signal (with negative-going sync pulses) is fed from the grid circuit of the picture tube to the cathode (pin 3) of the 12AU7. Since the grid of this triode section is returned to the AGC line and has no AC signal applied, the stage operates virtually the same as a grounded-grid amplifier. The tube conducts heavily on negative

sync-pulse tips, producing negative output pulses in the plate circuit. These are fed to the sync amplifier stage.

The conduction of the 12AU7 during sync pulse time serves to clamp the negative peaks of the picture-tube grid signal at a fixed level. In this respect, the circuit acts the same as a conventional diode-type DC restorer; that is, it clamps the bias on the picture tube in such a way that beam cutoff will occur at the black level (provided brightness



**Antenna**



**4 Sets**

**MOSLEY**  
**4-Set Coupler**



**MOSLEY 904**  
**4 SET COUPLER**

LOW LOSS  
EFFECTIVE ISOLATION  
EFFICIENT SIGNAL  
DISTRIBUTION

Owners of Duplex or 4-unit Apartment Buildings will want you to install Mosley 4-Set Couplers!  
Here's a Big profit-maker in a Big market!  
Mosley 904, 4-Set Coupler  
**\$6.25 List**  
Another Mosley Premium Quality TV Accessory!



**Mosley**  
*Electronics, Inc.*  
8622 ST. CHARLES ROCK ROAD  
ST. LOUIS 14, MISSOURI

(Advertisement)



latest **JACKSON** tube test data

MODEL 648		MODEL 749		MODEL 115/715/561	
TUBE TYPE	FIL. D.	TUBE TYPE	FIL. D.	TUBE TYPE	FIL. D.
6DR7	6.3 126 A45	6DR7	6.3 4 2X 13	6DR7	6.3 3 20 2LR
	A127 A89 42KZ		2 67 8		40 4NR
6EM5	6.3 129 B346 22W	6EM5	6.3 4 6 139	6EM5	6.3 4 12 7JKS
13DR7	12.6 126 A45 33VW	13DR7	12.6 4 2X 13	13DR7	12.6 3 20 2LR
	A127 A89 42KZ		2 67 8		40 4NR
7060	12.6 A127 AC689* 50WZ	7060	12.6 4 X 678	7060	12.6 20 2LR
	A45 56V		4 X 12		32 4JNQ
TUBE TYPE	SEC.	TUBE TYPE	SEC.	TUBE TYPE	SEC.
6DR7	6.3 4 2X 13	6DR7	6.3 4 2 67 8	6DR7	6.3 3 20 2LR
6EM5	6.3 4 6 139	6EM5	6.3 4 6 139	6EM5	6.3 4 12 7JKS
13DR7	12.6 4 2X 13	13DR7	12.6 4 2X 13	13DR7	12.6 3 20 2LR
	2 67 8		2 67 8		40 4NR
7060	12.6 4 X 678	7060	12.6 4 X 678	7060	12.6 20 2LR
	4 X 12		4 X 12		32 4JNQ

Latest Chart Form 648-20, 115/715/561-10, 49-4



VHF or UHF

## TV TUNERS REBUILT

### ALL MAKES & MODELS

THOUSANDS OF TUNERS IN STOCK

**EXCHANGED OR OVERHAULED**  
**\$9.95 NET** Price includes WORN parts only. Replacement tubes and smashed or missing parts are charged extra.  
Combination UHF/VHF Units **\$19.90**  
**90 DAYS WARRANTY**

ALIGNED TO ORIGINAL STANDARDS USING THE FINEST EQUIPMENT. ALL WORK PERFORMED BY TUNER EXPERTS WITH YEARS OF EXPERIENCE IN THE TUNER FIELD.

**FAST SERVICE** EXCHANGE OR OVERHAULED TUNER SHIPPED WITHIN 48 HOURS, IN MOST CASES.

Forward Tuner with All Smashed Parts: Quote Make and Model F.O.B. Chicago or Toronto  
We will ship C.O.D.

## Castle Television Tuner Service

1723 W. LUNT AVE.,  
CHICAGO 26, ILL.

**U.S.A.**

152 MAIN ST.  
TORONTO 13, ONT.

**CANADA**

Suppliers of rebuilt TV Tuners to leading manufacturers, technicians & service dealers, coast to coast. Original and Only Complete TV Tuner Service covering the North American Continent.

and contrast controls are properly adjusted), regardless of shifts in the average background brightness level of the televised scene. AGC voltage is applied to the grid (pin 2) of the 12AU7 to regulate the conduction level of this tube, thus insuring proper sync separator action at practically all signal input levels.

The AGC switch provides additional compensation for differences in signal strength. The maximum counterclockwise position is for use in normal signal areas. If pulse-type noise interference is present, the

switch may be turned to the next position in order to shunt a 47K-ohm resistor from the AGC line to ground. This extra resistor shortens the time constant of the AGC filter and thus prevents excessive AGC buildup by the noise pulses. In the third position of the switch, the AGC line is shorted to ground so that the RF, IF and sync circuits can be operated with minimum bias. In this position, overloading and picture distortion can result if signal strength at the tuner input exceeds 200 microvolts.

The circuit in Fig. 3B uses two sections of a 12AU7 in a bridge arrangement for the DC restorer-sync separator function. The first section is similar to its counterpart in Fig. 3A, while the second section is operated as a true grounded-grid stage with approximately the same cathode input and plate output signals as the first section. An important advantage of the two-stage circuit is better control of the bias on the sync amplifier, resulting in improved operation of this stage. AGC switch wiring in Fig. 3B is slightly different from that in Fig. 3A, but the two versions of the circuit have the same basic function.

### AGC Repairs

Now that you know a little more about how this circuit works, repairs should be a bit easier. Just one caution: If you come up with some doubtful looking resistance readings in this circuit, look at the resistors in the set and see if they are the same as called for on the schematic. Remember that a number of different values are frequently found in the same application in varicous KCS47s.

In checking resistors and capacitors in this AGC circuit, are you wasting your time? Not by a long shot, when you're working with an old set, and particularly on a circuit that repeatedly gives trouble. You want action? Get out the capacitance checker and disconnect the 2-mfd electrolytic used as an

## DESIGNED FOR THE NEW BUSINESS RADIO SERVICE



### COMCO'S ALL NEW "580 FLEETCOM" VHF-FM MOBILE RADIO

The new "580" is compact, light weight, has high performance, and features an original concept in Mobile equipment packaging by combining the control head, speaker, and transistorized power supply in one small easily mounted case assembly.

**\$398** f.o.b. factory

#### FEATURES

- ★ HIGH PERFORMANCE... meets "split channel" technical requirements, all FCC and FCDA requirements.
- ★ FULL POWER OUTPUT... 35 Watts in 25-50 Mcs. 25 Watts in 144-174 Mcs.
- ★ BUILT-IN RELIABILITY... Preproduction Models field tested in 5 states and 3 foreign countries before starting production.
- ★ SMALL AND LIGHT WEIGHT... Chassis in case 13" x 9 3/8" x 5 1/2". Control-power Supply-Speaker case 5" x 5" x 3 3/8". Complete Mobile installations 24 lbs.
- ★ EASY TO INSTALL... "Two-unit" package so small most installations are under dash.
- ★ EFFICIENT... Transistor power supply gives high efficiency. Total standby drain 5.25 amp.
- ★ INTERCHANGEABLE CHASSIS... Mobile transmitter-receiver chassis instantly interchangeable with base stations in simplex systems.

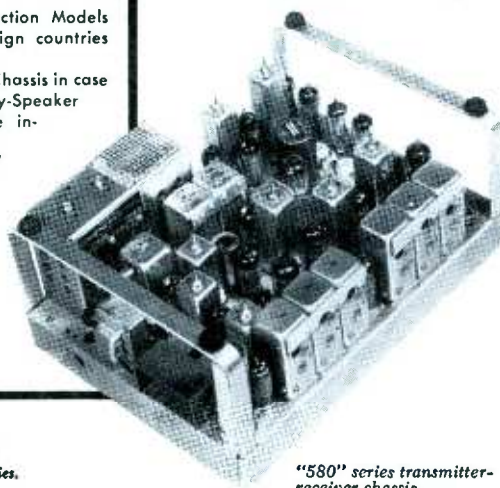

"580" series transmitter-receiver chassis.

**ATTENTION DEALERS!**  
Write for available territories.

DESIGNERS AND MANUFACTURERS OF **COMCO** RADIO COMMUNICATIONS EQUIPMENT

**COMMUNICATIONS COMPANY, Inc.**

FOUNDED 1928 CORAL GABLES, MIAMI 34, FLORIDA



"He feels that ladders are dangerous — so he works from the inside."



AGC filter. In the first of those two KCS47s I recently operated on, this fellow had a nasty intermittent short. Its brother in the second set was as open as a severed cable. The other big AGC filter capacitor, a .47-mfd unit, also ought to be checked. When you hook up the capacitance checker and apply 200 volts (the rated voltage), it's often evident that this .47's dielectric has some pretty big holes. While checking AGC capacitors, don't forget the .0022 at the grid of the DC restorer-sync separator. If it changes value or becomes leaky, the AGC voltage will be affected.

### Other Circuits

If the audio output of a KCS47 is weak or full of buzz, it's wise to check and repair the AGC circuit before digging into the sound section. Restoring AGC bias to a normal level often clears up the sound. Here's why: This set is a split-sound type with a 21-mc sound IF, and the sound takeoff point is a tap on the secondary of the third IF transformer. An incorrect AGC voltage tends to cause distortion of the IF response curve, and the 21-mc sound IF carrier may ride too high or too low on the slope. An excess of this carrier at the takeoff point causes buzz; if it rides too low on the curve, weak sound will result.

Before giving the sound section a clean bill of health, rotate the fine tuning control through its range on each active channel. Any buzz indi-

### PRESS TIME FLASH!

Controlling interest in the Bobbs-Merrill Co., 120-year old book publishers of Indianapolis and New York, has been acquired by Howard W. Sams & Company, Inc.

The Bobbs-Merrill firm will retain its present identity, with Howard W. Sams directing its activities as Chairman of the Board.





Included in the firm's 1250 active book titles are trade, juvenile textbooks, as well as a complete line of legal volumes, digests and statute compilations.

**MAKE SURE IT FITS!**

# OXFORD SPEAKERS

You obtain the finest sound reproduction when you select the proper speaker for the specific application. Each OXFORD SPEAKER is "tailor-designed" to actually "fit the need."

Specify OXFORD when you next require quality speakers. Remember: Oxford quality has consistently been superior for over thirty years.

<p><b>RADIO &amp; TV SPEAKERS</b></p>  <p>OXFORD Speakers are used by more original set manufacturers — find out why!</p>	<p><b>OUTDOOR SPEAKERS</b></p>  <p>For rugged steady performance under any conditions, OXFORD Weather-proof speakers will meet the need.</p>
<p><b>DUAL CONE HI-FI SPEAKERS</b></p>  <p>Oxford's newest development to provide maximum performance. For Hi-Fi and rear deck applications.</p>	<p><b>PORTABLE RADIO SPEAKERS</b></p>  <p>More Oxford speakers are used in portable sets than ever before — there must be reasons!</p>



Our new catalog is available write for yours NOW!

**OXFORD Components, Inc.**  
Subsidiary of Oxford Electric Corp.  
556 West Monroe Chicago 6, Ill.  
Exports: Babson Agencies, New York City  
In Canada: Atlas Radio Corp., Ltd., Toronto

**YOUR BEST BUY!**

# VITREOUS ENAMELED RESISTORS

**PRIDE of the industry**

Your jobber has them or can get them for you.

**MILWAUKEE RESISTOR CO.**

700 WEST VIRGINIA STREET  
MILWAUKEE 4, WISCONSIN

for servicing transistorized equipment

**EICO®**

**LOW RIPPLE**

battery eliminator & charger



#1060

Kit \$38.95

Wired \$47.95

- Percent ripple (proportional to current drawn) down to 0.3% @ 2 amps, only 1.5% @ 10 amps (12v range) for operating transistor, "hybrid", or any battery-powered equipment.
- Continuous voltage adjustment with Variac-type transformer.
- 2 ranges: 0-8V: 10 A cont., 20 A int.; 0-16V: 6 A con., 10 A int.
- 6 exclusives: simultaneous monitoring by separate voltmeter & dual range ammeter, automatic switching of ammeter to appropriate current range, tilted meter panel, all-steel rugged cabinet, optional wall-mounting feature, industry's lowest price.
- Pi-type heavy-duty filter circuit employing an oversized choke & a dual 5000 mf-20 V electrolytic capacitor (10,000 mfd total) takes full continuous and intermittent current output. Heavy-duty selenium rectifiers.
- Fused primary; automatic reset overload relay for secondary.

See the 50 EICO models IN STOCK at your neighborhood distributor. Write for FREE Catalog PF12

**EICO®** Prices 5% higher in West.  
EICO, 33-00 Northern Blvd., L.I.C. 1, N. Y.

**Popular and Fast Moving . . .**

**"ILLINI ELECTROMITE CONDENSERS"**

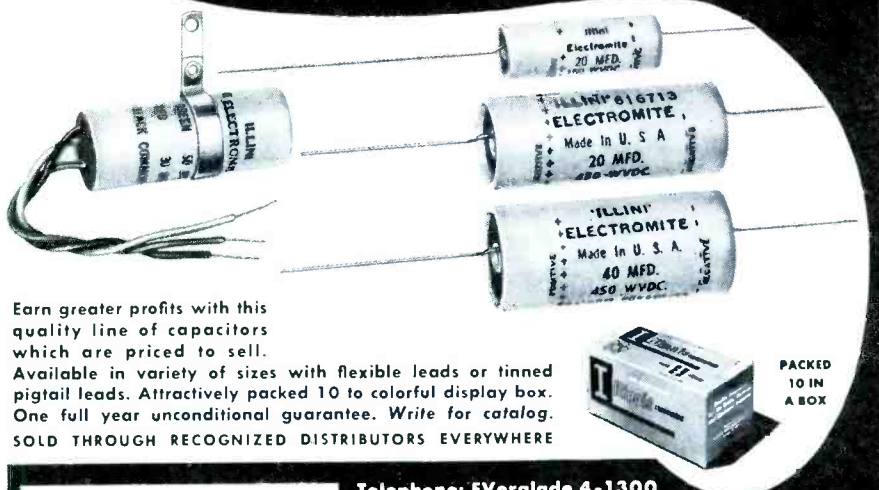

Earn greater profits with this quality line of capacitors which are priced to sell. Available in variety of sizes with flexible leads or tinned pigtail leads. Attractively packed 10 to colorful display box. One full year unconditional guarantee. Write for catalog. SOLD THROUGH RECOGNIZED DISTRIBUTORS EVERYWHERE

Telephone: EVerglade 4-1300

**ILLINOIS CONDENSER COMPANY**  
1616 N. Throop Street • Chicago 22, Illinois

**WILL YOUR REPLACEMENT Fuse Resistor BURN OUT AGAIN?**

Not if you use — **The NEW SENCORE "FUSE-SAFE" CIRCUIT TESTER**

*Another Sencore Time-Saver*

Save costly call backs by testing the circuit before replacing fuse, fuse resistor or circuit breaker.

Individual scale for each value fuse resistor — no interpretation, just read in red or green area.

- ★ Measures line current and up to 1100 watts of power at 115 volts using line cord and socket.
- ★ Two convenient current ranges — 0 to 2 amps and 0 to 10 amps. Test leads clip in place of fuse or fuse resistor.
- ★ 5 ohm, 10 watt resistor prevents TV circuit damage and simulates operating conditions.

As Recommended by Leading Manufacturers

Mfg. by **SENCORE SERVICE INSTRUMENTS CORP.**  
171 OFFICIAL RD., ADDISON, ILL.

**\$8.95** DEALER NET  
MODEL FS-3 AC-DC or both as needed for Fuse Resistor Circuits

Cut out this ad now for further information

*Dave Rice's*

**OFFICIAL ORDER BOOK**

for every TV-Radio service call

**CONVENIENT! EASY TO USE!**

Simplify your record-keeping with these convenient triplicate forms. They serve as order form, invoice and office record, with spaces for complete information on every job. Separate listings for receiving tubes, picture tubes, parts, serial numbers, labor and tax charges, etc. 75c a book, \$6.50 for money-saving dust-proof box of 10.

**Dave Rice's Official Pricing Digest**

Shows flat-rate and hourly service charges based on regional and national averages, plus up-to-date list or resale prices on over 63,000 components. \$2.50 per copy.

In stock at your distributor

**ELECTRONIC PUBLISHING CO. INC.**  
180 North Wacker Drive Chicago 6, Illinois

cates that a touch-up of the sound IF or discriminator transformer might still be needed. If no buzz is evident, but the sound is "mushy" except at one extreme of the control's rotation, this is a sign that the local oscillator slugs need readjusting.

I have found that most parts in the sound section of the KCS47 seldom need changing, but occasionally come across leaky coupling capacitors in the audio amplifier stages of these sets. The .0022 across the primary of the output transformer sometimes gets leaky, too.

The horizontal sweep circuits of these receivers need an overhaul now and then. You'll often find that one or more of the DC voltages in the pulse-width, AFC-oscillator circuit read low, particularly in the grid or cathode circuit of the AFC stage. If you suspect horizontal trouble but are not sure where to hunt for it, start by looking at the output tube grid waveform. If it is distorted, the trouble is probably back toward the oscillator stage — or it could be in the cathode or screen circuit of the output tube. Incidentally, be sure that the output tube grid voltage is no less negative than —26 volts, and that the screen voltage reads at least 300 volts.

The capacitor shown as C98 in Fig. 4 will often produce a slow drift in horizontal frequency. Other units which can cause this trouble are C97, C99 and C100. When replacing these units, I prefer mica to paper or ceramic dielectric because the former is somewhat more stable and should last almost indefinitely.

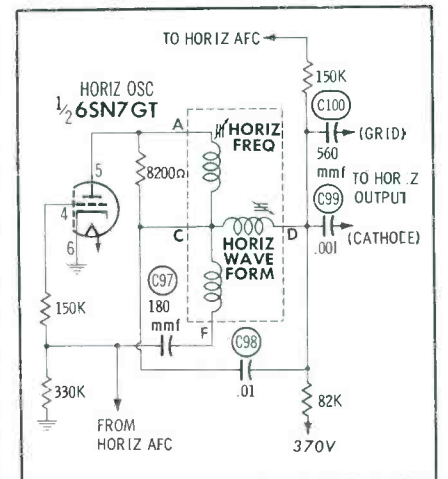

Fig. 4. C98 in horizontal oscillator causes frequency drift if defective.

In the vertical circuit, you will occasionally find a leaky coupling or bypass capacitor. When the coupling capacitor between the integrator and the oscillator goes bad, it can cut off the oscillator or throw it considerably off frequency. Any one of the paper tubular units connected to the vertical output transformer will fail occasionally, causing a variety of symptoms. However, the capacitors in the vertical circuit are not so prone to defects that I would recommend a special effort to test them with a capacitance checker. Waveforms and DC voltages are generally an adequate guide to vertical circuit troubles.

#### A Last Resort

If an early-production KCS47 (one using the sync circuit shown in Fig. 3A) loses horizontal sync at low settings of the contrast control, you may find that no amount of troubleshooting seems to help the situation. In this particular case, there is one final step you can take: Change the value of resistance between the cathode (pin 3) of the sync separator and ground. You can try substituting a number of different values until you find one that improves synchronization. I always prefer to avoid this sort of thing if I can, but I make an exception in this one case. As I pointed out before, this sync separator circuit has already been subjected to some changes in component values. The PHOTOFAC Foider for the original KCS47 calls for a cathode resistance of 470K ohms, but values up to 680K are found in some individual sets of this model run.

Of course, the object of altering the sync circuit is to insure that the horizontal oscillator will receive usable sync pulses at all settings of the contrast control. Therefore, an oscilloscope should be connected through a low-capacitance probe to the plate of the sync amplifier in order to demonstrate the effect of various resistor changes on the sync output signal. As different resistance values are switched into the circuit, watch for a definite increase in waveform amplitude. You can usually find some value of sync-separator cathode resistance at which the horizontal sync becomes sufficiently stable to allow the set to be returned to its owner. ▲



*For my Money*  
**XCELITE Tools are**  
*the Finest!*

... Superbly made and designed for Radio, T.V. and Electronic Technicians. *See your Distributor* ... only one quality ... the finest — whether you choose individual items or the handy kits ...

**Use the Tools the Professionals use!**

**XCELITE, INCORPORATED**  
ORCHARD PARK, NEW YORK  
Canada: Charles W. Pointon, Ltd., Toronto

**XCELITE**  
*Quality Hand Tools*  
PREFERRED BY THE EXPERTS

**NEW!** ON THE SPOT CHECK OF HORIZONTAL OUTPUT CIRCUIT!  
—ends most common cause of callbacks!



**SECO HC-6 CURRENT CHECKER**

- PLACE IN CIRCUIT IN SECONDS — NO DISCONNECTING OF CATHODE
- FAST, ACCURATE WAY TO ADJUST HORIZONTAL DRIVE AND LINEARITY

This new, low-cost current checker provides a positive, on-the-spot method of checking and adjusting TV horizontal output circuits — eliminates one of the most common causes of callbacks. Can be placed in circuit in seconds — without disconnecting cathode — immediately indicates whether horizontal output tube cathode current is within manufacturer's recommended limits. Insures proper picture focus, width, and stability with minimum cathode current — helps prevent premature failure of horizontal output transformer and in some cases failure of power transformer and rectifiers. HC-6 is valuable as a fast, accurate indicating device when adjusting horizontal drive and linearity. A "must" on all TV horizontal tube, transformer, or yoke replacement jobs — may also be used to balance hi-fi audio output tubes. Compact — inexpensive — easy to use — the HC-6 is a time-saving, money-making addition to your service kit. **\$1295** NET

See your distributor . . . or write to:

**SECO** SECO MANUFACTURING CO.  
5015 Penn Ave. S., Mpls., Minn.

**NEW! IMPROVED!**  
**SENCORE**  
TRC4  
**TRANSISTOR CHECKER**

*Another Sencore Time-Saver*

America's newest, most popular test instruments

**NOW CHECKS:**

- ★ **Transistors** for opens, shorts, leakage and current gain. Includes new gain test on power transistors.
- ★ **Crystal Diodes** checks forward to reverse current ratio on all diodes.
- ★ **Selenium Rectifiers** checks forward and reverse currents.

Controls are accurately set for each transistor by referring to replaceable set-up chart on rear. Test leads or socket provides for fast hook-up. See your parts distributor.

**ONLY \$1795**  
Dealer Net  
Cannot become obsolete. Approved by leading manufacturers.

**SENCORE** Mfg by **SERVICE INSTRUMENTS CORP.**  
171 OFFICIAL RD., ADDISON, ILL.

Cut out this ad now for further information

**NEW**  
**HICKOK**  
**TRANSISTOR-RADIO**  
**TESTER**



Model 810

### 3 TESTERS IN 1

- ★ Tuned Receiver
- ★ AM Generator
- ★ Transistor Tester

Specifically designed with all necessary features for complete troubleshooting of transistor radios. Almost all portables made today are transistorized. With the 810 you can profit immediately from service in this large, new field. The instruction book included contains an easy-to-learn course in transistor radio servicing. Now, any serviceman can quickly troubleshoot and profitably repair transistor radios.

**TUNED RECEIVER**—200 to 500 KC for troubleshooting IF. 550 to 1600 KC for troubleshooting RF. A cathode follower input probe minimizes loading. Loudspeaker indicator for signal tracing.

**AM SIGNAL GENERATOR**—200 to 575 KC for IF alignment. 550 to 1600 KC for RF alignment. 400 cycle audio output for signal injection.

**TRANSISTOR TESTER**—Test circuit for checking transistors—leakage and gain.

The 810 will pay for itself in a short time . . . and give you many years of accurate, dependable service.

**\$109<sup>90</sup>**  
**NET**

**Now is the time to...  
 TRADE UP TO A HICKOK**

Ask for a demonstration of the new 810 from your Authorized Hickok Distributor.

**THE HICKOK ELECTRICAL INSTRUMENT CO.**  
 10514 Dupont Ave. • Cleveland 8, Ohio

# PRODUCT r e p o r t

For further information on any of the following items, circle the associated number on the Catalog & Literature Card.

### Tube Merchandiser (No. 41Y)

A filament-continuity checker and a "lazy Susan" rack holding 100 tube types are included in the "Tube Mart" counter merchandiser unit being offered to radio-TV service dealers by Raytheon. Designed for placement in drug stores, supermarkets, etc., the display stands 30" high and has a base 15" square. A built-in literature rack is filled with folders that direct the customer to call the sponsoring dealer if tube replacements fail to repair his set.



### Phono Cartridge Tool (No. 42Y)

A special tool for installation or removal of phono cartridges, G-C Mini-Hold, grips mounting screws as it drives them. Two sizes are available — 2 $\frac{7}{8}$ " long (No. 9346; \$3.30 list) and 6 $\frac{3}{4}$ " long (No. 9347; \$3.75 list).



### Electrolytic Capacitors (No. 43Y)

Arco Electronics, Inc. has introduced a new line of electrolytic capacitors including single, double and triple units rated at 150 or 510 WVDC. All types are equipped with pigtail leads except for one 120-mfd, 150V twist-prong capacitor. Each *Arco*lytic is encased in an insulating cardboard sleeve with mounting strap attached.

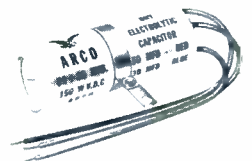

### Stereo Conversion Kits (No. 44Y)

Each of the three Fanon kits for converting phonographs to stereo operation includes an amplifier and two speakers in a single cabinet, a stereo turnover cartridge, and necessary mounting accessories. STK-4, with two 4" speakers, lists for \$39.95; STK-5, with 8" woofer and 3" tweeter in fabric-covered cabinet, is \$49.95; and STK-10, same as STK-5 but in mahogany cabinet, is \$59.95.



### Picture Tube Repair Tool (No. 45Y)

Intermittent operation of picture tubes due to defective solder connections at socket pins is easily corrected through use of the *Perfect Pin Crimper* made by Berns Mfg. Co. Actually a 3-in-1 tool which also serves as a channel-selector wrench and screwdriver, it serves to notch pins and element leads to provide solid electrical connections. Price is \$1.25.



### Communications Radios (No. 46Y)



A single dash-mounted unit contains all controls, speaker, microphone jack, and transistorized power supply for 580 Series *Fleetcom* two-way mobile radios built by Communications Co., Inc. All transmitter and receiver circuits are in another unit designed for underdash mounting. Systems are available for regular or split-channel operation on 25-50 or 144-174 mc. Each mobile unit costs \$398.00, and base stations are \$430.00.

### Audio Tubes in Pairs (No. 47Y)



Matched pairs of Type 6550 and Type 5881 audio power amplifier tubes, tested at the factory for similarity of characteristics, are being marketed by Tung-Sol. Matching is claimed to be effective in minimizing distortion. The 5881's are used in amplifiers rated at less than 50 watts, while 6550's are for amplifiers and commercial sound equipment with outputs up to 100 watts.

### Microphones (No. 48Y)



This 2-oz. miniature dynamic lavalier microphone, Electro-Voice Model 649A, is a low-impedance unit with a frequency range of 60 to 12,000 cps. The Model 727 *Stim Ceramic*, another newly-designed microphone, is suitable for public-address or general use. An improved type of inexpensive ceramic microphone for home recording, Model 718, features a case that can be set upright on a flat surface.

### Conversion Offer (No. 49Y)

For \$89.95, the owner of any B & K Model 1000 *Dyna-Scan* can have his distributor return it to the factory for conversion into a Model 1075 *Television Analyst*. Horizontal and vertical deflection drive signals, which can be applied to the grids of TV sweep output stages in place of the regular oscillator signals, are among the signals developed for point-to-point signal injection testing techniques. With the converted instrument, troubles in the video, audio, RF, IF, sync, and sweep sections may be quickly isolated.

### Short-Wave Receiver (No. 50Y)



The National NC-60 *Special* short-wave communications receiver covers the range from 540 kc to 31 mc in four bands. A bandsread (vernier) knob is usable on all frequencies. Tube complement includes a 12BE6 converter, 12BA6 IF-BFO, 12AV6 detector-AVC-audio, 50C5 audio output, and 35W4 rectifier. The cabinet is finished in black and grey enamel. List price is \$59.95.

### Imported Tubes (No. 51Y)



Hitachi brand receiving tubes are being distributed in this country by Electronic Utilities Co., Division of The Sampson Co. These tubes, engineered to meet American standards, are available in a wide range of types. All carry a 90-day guarantee.

# When Converting Your Phono to Stereo Use ...

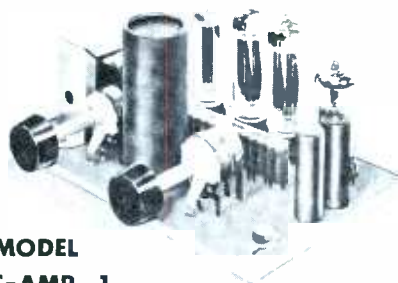

MODEL  
PAC-AMP-1

## The ERIE AUDIO-AMPLIFIER KIT

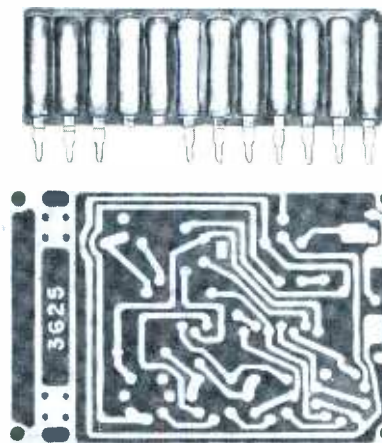

### featuring "PAC" and an ERIE Printed Wiring Board

#### With these Plug-in Components:

- ERIE "PAC" (Pre-Assembled Components)
- ERIE PRINTED BOARD
- OUTPUT TRANSFORMER
- FILTER CAPACITOR
- VOLUME CONTROL and SWITCH
- TUBE SOCKETS
- CAPACITORS
- TONE CONTROL
- TUBES

#### SPECIFICATIONS FOR ERIE STANDARD AUDIO-AMPLIFIER

- Frequency Response: 30 cycles to 12,000 cycles +0, -3.5 db.
- Sensitivity: 0.56 volt RMS (input at 1 KC) for 2 watt output.
- Power Output: 2 watts • Input Impedance: 2 megohms.
- Output Impedance: 4 ohms • AC Power Consumption: 17 watts.
- Overall Dimensions: 6 3/8" L x 4 3/16" W x 3 7/8" H.
- Shipping Weight: 2 lbs.

See and hear it at your local distributor  
or write for nearest source.



December, 1958

Advertiser	Page No.
Aerovox Corp. ....	57
American Television & Radio Co. (ATR) ..	12
B&K Mfg. Co. ....	20, 21
Belden Mfg. Co. ....	39
Berns Mfg. Co. ....	64
Blonder-Tongue Labs ....	25
Bussmann Mfg. Co. ....	29
Castle TV Tuner Service ....	65
Centralab, A Div. of Globe-Union, Inc. ...	55
Chicago Standard Transformer Corp. ....	60
Clarostat Mfg. Co., Inc. ....	13
Clear Beam Antenna Corp. ....	46
Communications Co., Inc. ....	66
Cornell-Dubilier Electric Corp. ....	61
EICO ....	67
Electronic Publishing Co. ....	68
Electro-Voice, Inc. ....	9
Erie Resistor Corp. ....	71
E-Z-Hook Test Products ....	59
General Cement Mfg. Co. ....	30
General Electric Co.—Electronic Components Div. ....	31
General Electric Co.—Television Receiver Dept. ....	47
Gregg Electric Co., Inc. ....	56
Hickok Electrical Instrument Co. ....	70
Illinois Condenser Co. ....	68
International Resistance Co. (IRC) ....	2nd Cover
JFD Electronics Corp. ....	22
Jackson Electrical Instrument Co. ....	65
Kedman Co. ....	54
Littelfuse, Inc. ....	4th Cover
Mallory & Co., P. R. ....	42, 43
Merit Coil & Transformer Corp. ....	40
Milwaukee Resistor Co. ....	67
Mosley Electronics, Inc. ....	65
Ohmite Mfg. Co. ....	32
Oxford Components, Inc. ....	67
Planet Mfg. Co. ....	62
Pyramid Electric Co. ....	34
Quam-Nichols Co. ....	58
RCA Electron Tube Div. ....	45, 3rd Cover
Radio Merchandise Sales, Inc. ....	64
Raytheon Mfg. Co. ....	14-15
Sams & Co., Inc., Howard W. ....	23, 44
Sarkes Tarzian, Inc. (Tuner Division) ....	38
Seco Mfg. Co. ....	69
Service Instruments Corp. ....	40, 54, 59, 68, 69
Shure Brothers, Inc. ....	35
South River Metal Products Co. ....	63
Sprague Products Co. ....	10
Sylvania Electric Products, Inc. ....	27
Triplett Electrical Instrument Co. ....	49
Tung-Sol Electric, Inc. ....	33
United Catalog Publishers, Inc. ....	52
Vis-U-All Products Co. ....	51
Walsco Electronics Mfg. Co. ....	50
Webster Electric Co. ....	53
Westinghouse Electric Co.— Electron Tube Div. ....	37, 41
Workman TV, Inc. ....	64
Wright Steel & Wire Co., G. F. ....	59
Xcelite, Inc. ....	69

**ACCESSORIES**

1Y. **E-Z HOOK**—Convenient reference sheet titled, "How to Build the Five Most Useful Scope Probes," with schematics, mechanical component layouts, etc. See ad page 59.

**ANTENNA SYSTEMS**

2Y. **BLONDER-TONGUE** — Catalog sheet on 2-set, 4-set, UHF-VHF, and Hi-Lo antenna couplers (Form No. EM-100). See ad page 5.

3Y. **CLEAR BEAM**—Literature on full line of FM antennas and do-it-yourself antenna kits. See ad page 46.

4Y. **RADIO MERCHANDISE SALES** — Color brochure on 1000 series "Wave-booster" antenna. See ad page 64.

5Y. **WESTBURY** — Catalog 89 featuring all-transistorized broadband amplifier Model ABB 9/10 for community TV systems.

**ANTENNA TOWERS**

6Y. **KTV TOWERS** — 4-page multicolored brochure showing tower construction features, plus mounting and installation equipment.

**AUDIO & HI-FI**

7Y. **ELECTRO-VOICE** — Catalog No. 126 on public-address and general-purpose microphones. See ad page 9.

8Y. **ORRADIO INDUSTRIES** — Cross-reference chart on recording tape showing comparable catalog numbers for each type of tape and giving the time for all size tape reels and lengths at all speeds. Also, "IRISH Wire Wobbler," attractive 3-color display card illustrating recording tape, which identifies the store as a recording tape dealer.

9Y. **UTAH RADIO** — New stereo catalog for speakers and enclosures with speaker systems for stereo.

10Y. **WALSCO** — Phono conversion data and wall chart. See ad page 50.

**CAPACITORS**

11Y. **CORNELL-DUEILLIER** — Data on service shop storage chests for capacitors. See ad page 61.

12Y. **SPRAGUE** — "ABC's of Ceramic Capacitors," a comprehensive brochure on theory and applications. See ad page 10.

13Y. **TOBE DEUTSCHMANN** — Cross-reference chart for twist-prong capacitors, a 24-page booklet providing over 3,525 listings of "Preferred" Tobe twist-prong and tubular electrolytics to replace 5 other major-brand types.

**CARTRIDGES & NEEDLES**

14Y. **CBS-HYTRON** — "Hints on Using The Columbia CD Stereo Cartridge"

**COMMUNICATIONS**

15Y. **COMMUNICATIONS CO.** — Information on new 2-way mobile radio system for communication between shops and service trucks. See ad page 66.

**COMPONENTS**

16Y. **CENTRALAB** — "Packaged Electronic Circuit" guide. See ad page 55.

**CONTROLS**

system controls, pads and attenuators. 17Y. **CLAROSTAT**—Form #751773 on sound See ad page 13.

18Y. **IRC** — Form S-035C, Dir-58 replacement parts catalog. See ad 2nd cover.

**FUSES**

19Y. **BUSSMANN** — Quick reference catalog to all types of fuses used in the electronic industry (Bulletin SFUS). See ad page 29.

**SERVICE AIDS**

20Y. **DE-RO ELECTRONICS** — Illustrated catalog on line of TV and hi-fi aids.

21Y. **GREGG ELECTRIC** — Folder giving complete details on printed circuit repairing. See ad page 56.

22Y. **ROGERS** — Literature on the "Tel-A-Turn," new TV chassis rack designed to cut down repair time, eliminate struggling with heavy, hard-to-handle chassis, and permit full rotation and locking in any position.

23Y. **SHELL** — TV Troubleshooter's Guide.

**TECHNICAL PUBLICATIONS**

24Y. **PF REPORTER** — 1958 Editorial Subject Reference Index.

25Y. **HOWARD W. SAMS** — Descriptive literature on all Howard Sams books covering servicing of TV, radio, hi-fi, etc. Includes data on latest books, "Servicing Transistor Radios, Vol. 2," "Tube Location Guide, Vol. 8," "101 Ways to Use Your Sweep Generator," "Know Your Oscilloscope." See ads pages 23, 44.

**TEST EQUIPMENT**

26Y. **B&K**—Bulletin AP12R gives helpful information on new point-to-point signal-injection techniques with Model 1075 TV "Analyst"; other bulletins describe "Dyna-Quick" Models 500B, 650, and automatic 675 portable dynamic mutual conductance tube and transistor tester, plus Model 400CRT cathode rejuvenator tester. See ads pages 20, 21.

27Y. **EICO** — New 20-page catalog shows how to save 50% on professional test instruments, hi-fi, and "ham" equipment in both kit and factory-wired form. See ad page 67.

28Y. **HICKOK** — New short-form catalog of 1959 testers. See ad page 70.

29Y. **RCA** — Form 3F764 on currently-available instruments. See ads pages 45, 3rd cover.

30Y. **SECO** — New 2-color folder showing complete line of test equipment and service aids. See ad page 69.

31Y. **SERVICE INSTRUMENTS** — New multicolored catalog includes photographs of each Sencore product in use, contains complete information and schematics. See ads pages 40, 54, 59, 68, 69.

32Y. **TRIPLETT** — Special bulletin on new tube tester, Model 3414. See ad page 49.

**TOOLS**

33Y. **KEDMAN** — Catalog sheet describing 4 screwdriver displays and specifications on 14 kinds of screwdrivers in the company's line. See ad page 54.

34Y. **VACO** — 12-page, 2-color catalog on special service tool and solderless terminals.

35Y. **XCELITE** — Catalog of hand tools for electronic servicemen. See ad page 69.

**TRANSFORMERS**

36Y. **CHICAGO STANDARD** — 100-page TV Transformer Replacement Guide, cross-referenced for over 7,000 chassis of 98 manufacturers. See ad page 60.

**TUBES**

37Y. **GENERAL ELECTRIC** — New brochure on G.E. tubes: "Here's Why General Electric Receiving Tubes are Better," and "Receiving Tube Interchangeability." See ads pages 31, 47.

38Y. **RAYTHEON** — Revised 14-page Television Picture Tube Characteristics booklet includes data on aluminized black-and-white and color tubes, face-plate deflection angle, bulb dimension, ion-trap requirements and basing diagram. See ad pages 14-15

39Y. **SYLVANIA** — European-American Receiving Tube Replacement Guide. See ad page 27.

40Y. **Vis-U-All** — Tube Substitution Guide. See ad page 51.

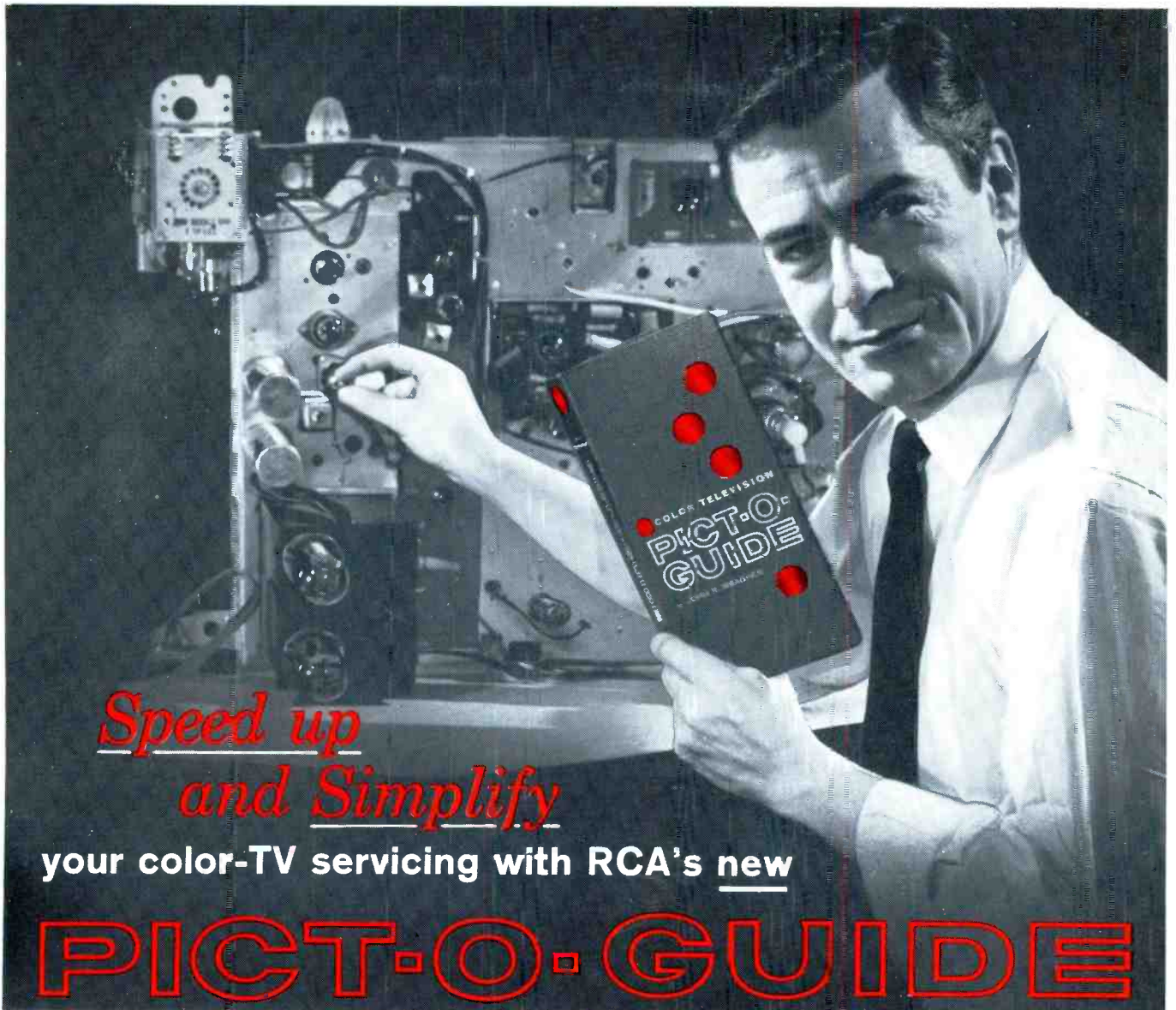

*Speed up  
and Simplify*

your color-TV servicing with RCA's new

# PICT-O-GUIDE

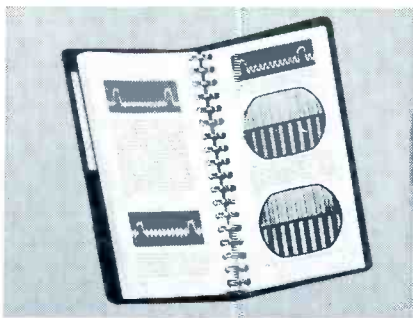

AVAILABLE THROUGH YOUR RCA TUBE DISTRIBUTOR

Or, fill out the coupon below and forward with \$4.50 in check or money order payable to Radio Corporation of America for each Color TV PICT-O-GUIDE ordered.

RCA Commercial Engineering  
415 South 5th St., Harrison, N. J.

Gentlemen:

Enclosed please find check  or money order   
for ..... Color-TV PICT-O-GUIDES. Send to:

Name .....

Address .....

City ..... Zone ..... State .....

It's chock-full-of practical information and illustrations—  
just what you need for profitable color-TV servicing.

If you are planning to build your share in the business of color-TV servicing, you are sure to find RCA's Color-TV Pict-O-Guide the most useful "bench" friend you have ever had. Whether you are "learning" or are already "doing", the clearly written descriptions, step-by-step instructions, diagrams, and full-color photographs of trouble symptoms make this valuable book a "must"! It was prepared and written by John R. Meagher, RCA's well known authority on TV servicing techniques. Get your copy today!

New Color-TV Pict-O-Guide contains sections on:

Color Mixing · RCA Compatible Color TV System · Purity · Troubleshooting Convergence · Gray-Scale Tracking · Color Operating Controls · Antenna Considerations · RF-IF-Bandpass Alignment · Color-Bar Patterns · Color Test Equipment · Signal Tracing · Interference · "Green Stripe" Test Signals



**RADIO CORPORATION OF AMERICA**

**Electron Tube Division**

**Harrison, N. J.**

we see our customers  
as ...



that hold tenaciously to their profit and  
give bonuses in customer service.

LITTELFUSE

Des Plaines, Illinois

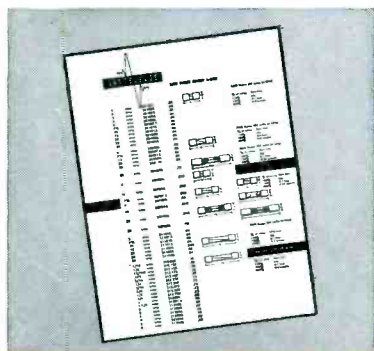

Littelfuse  
illustrated  
Price sheet L-358