

APRIL • 1958 25 CENTS

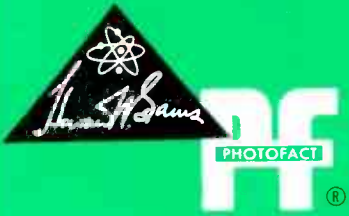

REPORTER

FOR THE ELECTRONIC SERVICE INDUSTRY

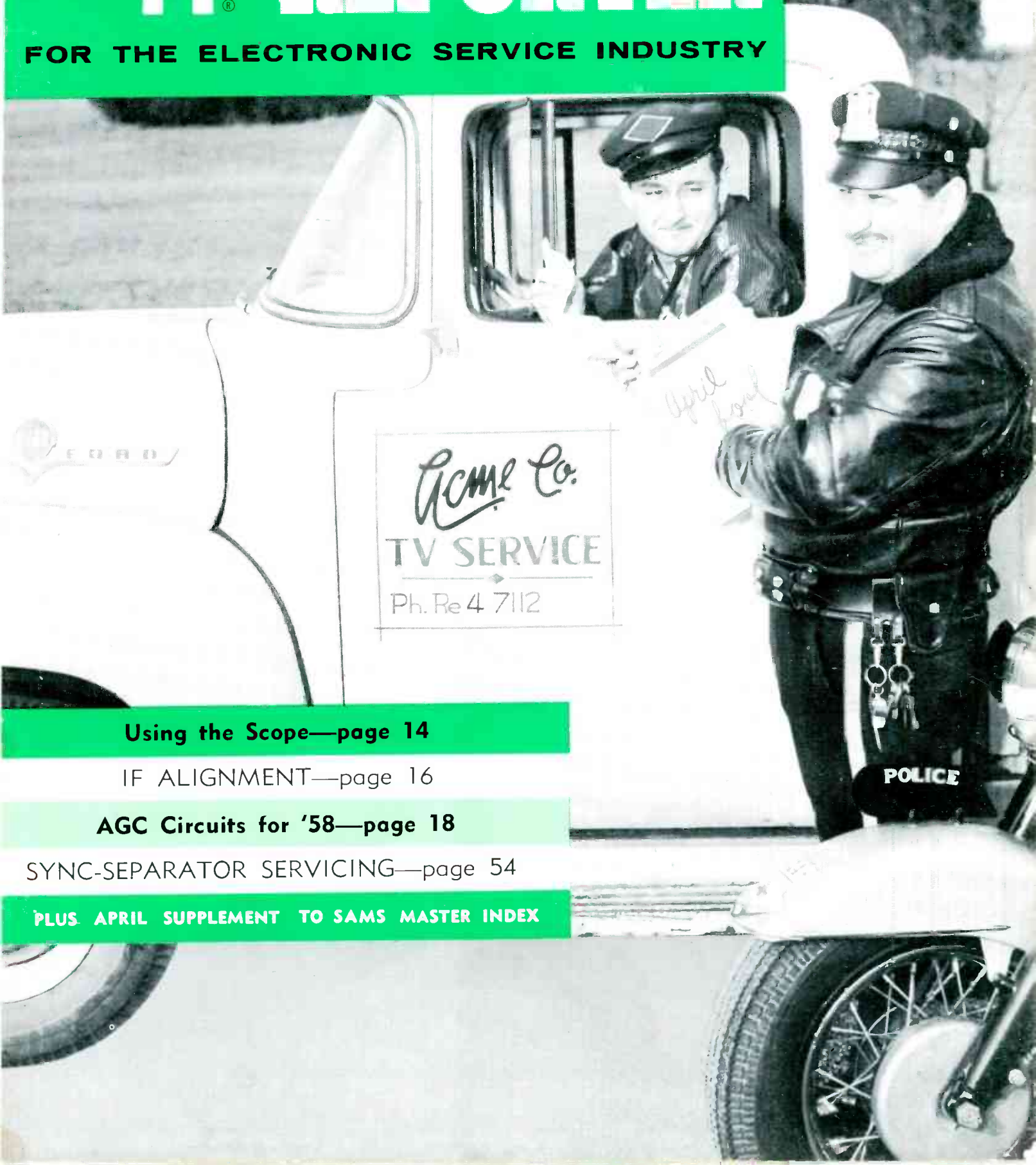

Using the Scope—page 14

IF ALIGNMENT—page 16

AGC Circuits for '58—page 18

SYNC-SEPARATOR SERVICING—page 54

PLUS APRIL SUPPLEMENT TO SAMS MASTER INDEX

TOPS FOR TV



NEW UNIVERSAL wire wound controls

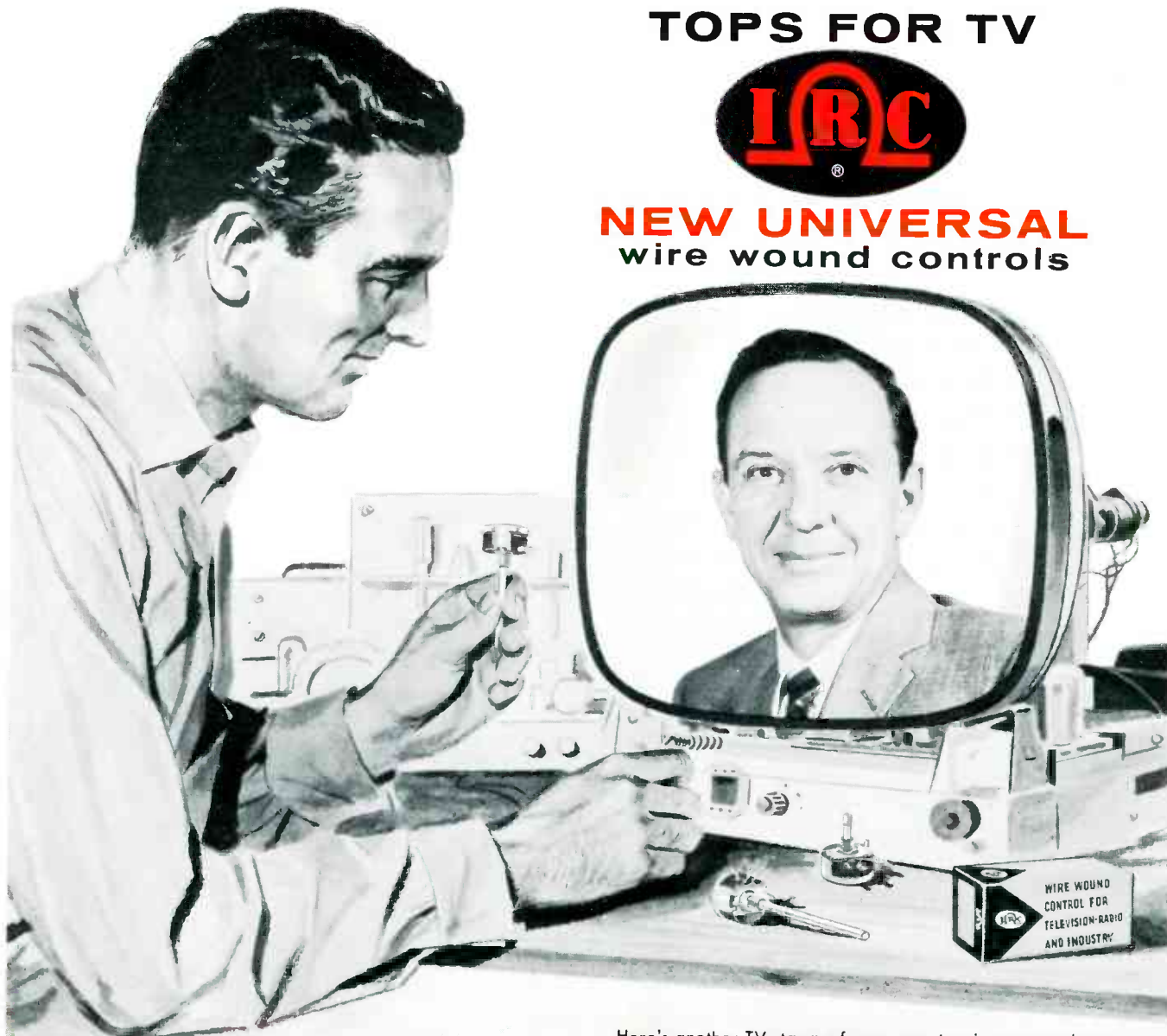

3 IRC BASIC TYPES

TYPE WPK—3" Universal Knobmaster Shaft; fits flatted and knurled knob types; 1/4" long bushing for greater coverage.

TYPE WP—3" full-round 1/4" dia. shaft; 3/8" long bushing; specially suited to industrial requirements.

TYPE WPS—3/4" long, screw-driver slotted & knurled shaft; 1/4" long bushing; ideal for rear apron or front panel concealment controls.



Here's another TV star performer sure to win your applause. New IRC Universal Wire Wound Controls handle 2, 3 and 4 watt requirements. They eliminate the need for multiple types and give greater power handling margins for 2 and 3 watt needs. Look at these features:

SMALL SIZE is same as average 2 watt control; fits more replacement needs.

EXTRA STURDY with completely enclosed element; molded base housing, sturdy rear cover construction.

56 STOCK VALUES in wide assortment covering 2 ohms to 25K ohms.

CENTER-TAPPED TYPES in a variety of 12 values from 10 to 200 ohms.

12 RIGHT & LEFT HAND TAPERED CONTROLS with greater current capacity at no extra cost.

ELEMENTS COMPATIBLE WITH CONCENTRIKIT SYSTEM for fast field assembly of singles and concentric duals; can combine with carbon units.

AVAILABLE AS MULTISECTIONS in 13 values of rear sections; provide standard dual controls.

SPST & DPST SWITCHES MAY BE FIELD ATTACHED.

FINE APPEARANCE with quality performance; an outstanding TV star!

ORDER FROM YOUR IRC DISTRIBUTOR

John Daly, Star of ABC-TV's "John Daly and the News," Monday through Friday, 7:15-7:30 PM EST

INTERNATIONAL RESISTANCE CO., Dept. 364, 401 North Broad Street, Philadelphia 8, Pennsylvania

Cut testing time in half— DOUBLE TUBE SALES

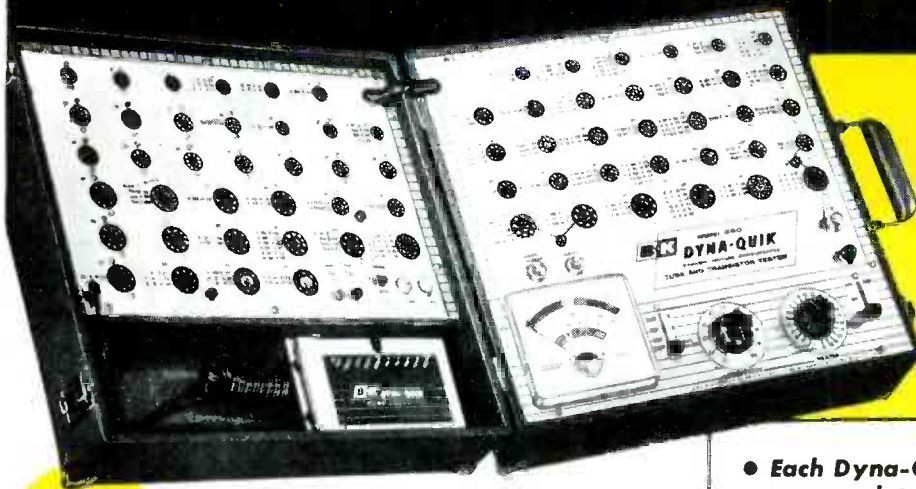

B&K
DYNA-QUIK

*Makes Money for
Servicemen Everywhere*

**NEW
MODEL
650**

Fastest, Most Complete, Portable **DYNAMIC MUTUAL CONDUCTANCE TUBE & TRANSISTOR TESTER**

Checks over 99% of the tubes most widely used in television receivers, plus popular home and portable radio tubes. Tests over 500 tube types. Lists over 125 tube types, with settings, on socket panels for maximum operating speed. Complete listing in fast telephone-index type selector. Includes 16 spare sockets and sufficient filament voltages for future new tube types. Tests each section of multiple tubes separately for Gm—Shorts—Grid Emission—Gas Content—and Life. Provides instantaneous Heater Continuity check. Shows tube condition on "Good-Bad" scale and in micromhos. Special bridge assures automatic line compensation. No multiple switching—No roll chart. Includes pin straighteners. Transistor Tester checks junction, point contact and barrier transistors, germanium and silicon diodes, selenium and silicon rectifiers. Net, **\$169⁹⁵**

- Each Dyna-Quik Tube Tester completely tests each tube in seconds
- Eliminates substitution testing
- Shows customer true condition and life expectancy of tubes
- Sells more tubes right on-the-spot
- Cuts servicing time, wins customer confidence
- Saves costly call-backs, brings more profit

One extra tube sale on each of 5 calls a day pays for the Dyna-Quik in a few weeks.

NEW MODEL 500B *Money-Making Portable* **DYNAMIC MUTUAL CONDUCTANCE TUBE TESTER**

Thousands of the famous B&K Dyna-Quik are in profitable use today by service technicians everywhere. Servicemen say: "Best tube tester I've ever owned for speed and dependability!" "Makes money. Really indispensable!" "Have two...one for the shop and one for house calls!"

Now, with more tube sockets, the new Model 500B makes it easy to test more tubes faster and make more money. Accurately quick-checks most of the TV and radio tubes usually encountered in everyday service work. Tests tubes for shorts, grid emission, gas content, and leakage. Measures true dynamic mutual conductance with laboratory accuracy in the home or shop. Makes complete tube test in seconds, tests average TV set in a few minutes. Quickly detects weak or inoperative tubes. Shows tube condition on "Good-Bad" scale and in micromhos. Life Test shows customer the tube life expectancy. Makes it easy to sell more tubes right-on-the-spot.

One switch tests everything. No multiple switching. No roll chart. Automatic line voltage compensation. 7-pin and 9-pin straighteners. New tube reference charts are made available by the factory at regular intervals. Net, **\$129⁹⁵**



2 additional tube sales per call on an average of 5 calls a day can increase your income as much as \$50.00 per week

See your B & K Distributor,
or write for Bulletin AP10-R

B&K

B&K MANUFACTURING CO.

3726 N. Southport Ave., Chicago 13, Illinois

Canada: Atlas Radio Corp., 50 Wingold, Toronto 10, Ont.

Export: Empire Exporters, 458 Broadway, New York 13, U.S.A.

Reputation Builder #6: it pays to be honest about delays



- Break delivery promises . . . and you build business for your competition.

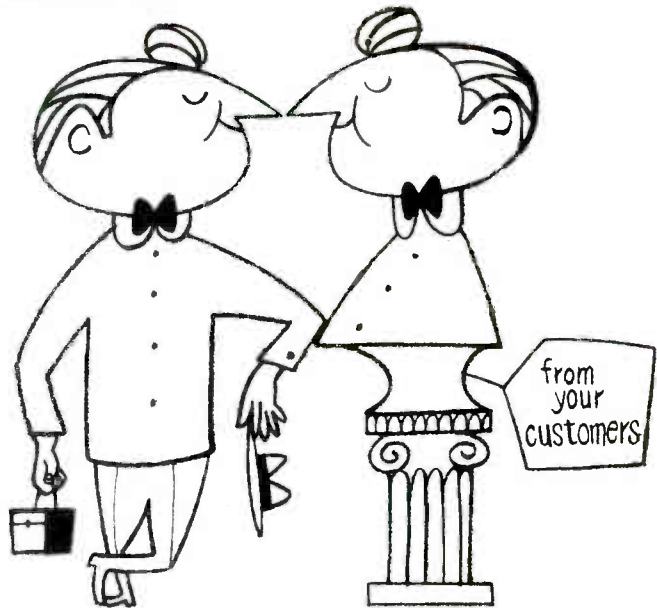

- But . . . keep customers informed of progress and you'll find them with you . . . not against you.

make "on the spot" repairs with Sprague "Universal" Ceramic Capacitors

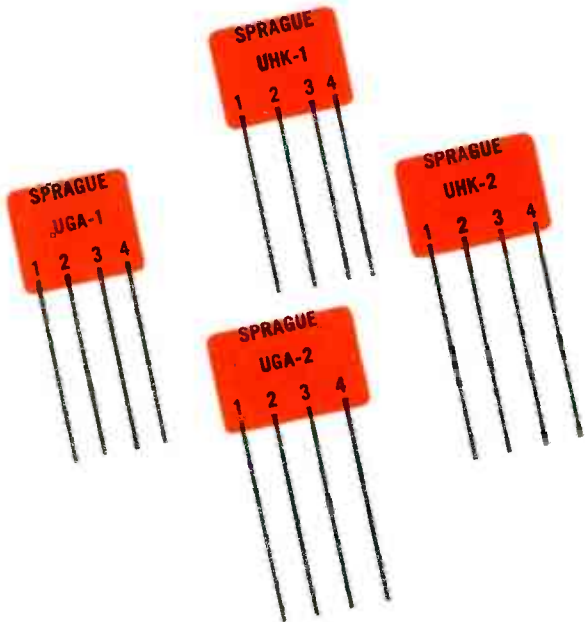

don't be vague . . . insist on

- Another way to build and hold a reputation is to insist on top quality replacement parts. Callbacks due to replacement failures not only cost you *money* . . . they also cost you customers! Replace with less than the best and you place your reputation at stake. In capacitors, the best is *Sprague*.
- Take "Universal" Ceramic Capacitors, for example. "Universals" are capacitor replacement miracles . . . just four of these remarkable capacitors in your emergency parts kit meet 90% of all ceramic replacement needs . . . take the place of forty-two regular capacitors with capacitance values from 400 μF to .015 μF . Handy reference card packed with each "Universal" tells you how to wire the leads to get the capacitance you need. "Universals" make excellent replacements for molded mica, ceramic tubular, ceramic disc, and paper tubular capacitors in many applications. You can't afford to be without them. They're a sure way of keeping your customers happy with quick service!
- Get your copy of Sprague's latest radio and TV service catalog, C-612. Write Sprague Products Co., Distributors' Division of Sprague Electric Company, 105 Marshall Street, North Adams, Mass.

SPRAGUE®

world's largest capacitor manufacturer

SPRAGUE RESEARCH IS CONSTANTLY PRODUCING NEW AND BETTER CAPACITORS FOR YOU

PUBLISHER
Howard W. Sams
GENERAL MANAGER
Mal Parks, Jr.

EDITOR
Verne M. Ray

ASSOCIATE EDITORS
Leslie D. Deane
Thomas A. Lesh
Calvin C. Young, Jr.

CONSULTING EDITORS
William E. Burke C. P. Oliphant
Robert B. Dunham George B. Mann
Paul C. Smith

ART DIRECTOR EDITORIAL ASSISTANT
Don W. Bradley Pat Moriarity

PHOTOGRAPHY CIRCULATION
Robert W. Reed Pat Tidd

ADVG. PRODUCTION
Carol B. Gadbury

ADVERTISING SALES OFFICES

MIDWESTERN
PF REPORTER,
2201 East 46th Street, Indianapolis 5, Ind.
Clifford 1-4531

EASTERN
Paul S. Weil and Donald C. Wejl,
39-01 Main Street, Flushing 54, New York.
Independence 3-9098.

WESTERN
The Maurice A. Kimball Co., Inc.
2550 Beverly Blvd., Los Angeles 57, Calif.
Dunkirk 8-6178; and 681 Market Street,
San Francisco 5, Calif. EXbrook 2-3365.

Published monthly by Howard W. Sams & Co.,
Inc., at Indianapolis 5, Indiana.

Entered as second class matter October 11,
1954, at the Post Office at Indianapolis, Indiana,
under the Act of March 3, 1879.

Copyright 1958 by Howard W. Sams & Co., Inc.
No part of the PF REPORTER may be reproduced
without written permission. No patent
liability is assumed with respect to the use of
information contained herein.

Subscription prices in U.S.A. and possessions:
1 yr., \$3.00; 2 yrs., \$5.00; 3 yrs., \$7.00. In
Canada and Pan America: 1 yr., \$3.60; 2 yrs.,
\$6.00; 3 yrs., \$8.50. Foreign subscriptions:
1 yr., \$6.00; 2 yrs., \$11.00; 3 yrs., \$15.00.
A limited quantity of back issues are available
at 35c per copy.

next month

FINE POINTS IN COLOR SYNC SERVICING

Loss of color sync is one of the more
common troubles encountered in color
TV work—yet, it is one of the most
difficult to correct. This article will
acquaint you with basic circuit opera-
tion and hints for troubleshooting.

SOLUTIONS TO YOKE REPLACEMENT PROBLEMS

When you install a recommended yoke
replacement, it's only natural to expect
it to work as well as the original once
did. It will, if you're fully cognizant of
certain facts and follow instructions cor-
rectly—which is exactly what this fea-
ture is about.

HINTS ON RECORD CHANGER SERVICING

The need for expert changer service
is greater now than ever before. If
you're out to get your share of the
business and want to know more about
changer mechanisms plus some com-
mon troubles and their cures, meet us
right here next month.

VOLUME 8, No. 4



APRIL, 1958

PF REPORTER

FOR THE ELECTRONIC SERVICE INDUSTRY

CONTENTS

About The Cover	65
Letters to the Editor	6
Shop Talk	12
Development of broad band conical and yagi antennas.	Milton S. Kiver
Using the Scope for Signal Tracing	14
Consideration for source impedance will help you in making waveform analyses.	Robert G. Middleton
Behind the IF Alignment Scene	16
How to align video IF's.	
AGC Circuits for '58	18
Zenith and Admiral designs and how they work.	Thomas A. Lesh
Dollar & Sense Servicing	20
The Troubleshooter	22
Quicker Servicing	26
Unusual CRT defects; multiple outlet strips; combatting the do-it-yourself menace.	Calvin C. Young, Jr.
Notes on Test Equipment	30
Flyback and yoke tester, VOM, transistor checker, vibrator tester.	Les Deane
Stock Guide for TV Tubes	38
Audio Facts	40
Basic speaker constructions; Hoffman 1110 AM-FM tuner; new audio products.	
Servicing Industrial Electronics	46
Devices for determining width and contour.	Melvin Whitmer
Let's Talk Business	50
Got a guarantee problem? This'll help.	Art Margolis
Troubleshooting Sync Separator Systems	54
Product Report	77
Free Catalog & Literature Service	80
Supplement to SAMS Master Index	81

SUBJECT REFERENCE INDEX

ANTENNAS		Height, insufficient	22
Conical	12	Intercarrier conversion	22
Coupler vs. switch	8	Jitter	22
Stacked	62	Picture tube, odd defects	26
Yagi	65	Probes, using different types	15
AUDIO		Signal tracing with scope	14
Hi-fi amplifier, GE Model PA 20 ..	44	Sync separator, troubleshooting ..	54
Speakers, cone type	40	Tubes in wrong sockets	28
horn type	42	Vertical blanking bar	
BUSINESS		as troubleshooting aid	54
Carry-out service	20	Waveforms in sync separator	58
Guaranteeing service work	50	TEST EQUIPMENT	
Non-technical language	20	Demodulator probe, where to use ..	75
Premiums, advertising	20	Direct probes	15
Trade-ins	20	Flyback and yoke tester, EICO Model 944	30
CIRCUITS AND DESIGNS		Low-capacitance probe, where to use	76
AM-FM tuner, Hoffman Chassis 1110	42	Transistor-rectifier checker, Sencore Model TRC4	34
AGC circuits using 6BU8, in Admiral Chassis 16J1	72	Vibrator checker, EMC Model 906	36
in Zenith Chassis 15A25	14	VOM, Precision Apparatus Model 120M	32
in Zenith Chassis 17420	69	THEORY	
FM preamplifier, Jerrold "Range Extender"	44	Antennas, broad-band	12
FM tuner, Miller Model 560	45	stacked	62
COMPONENTS AND MATERIALS		Cable impedance	74
Multiple AC outlets	28	Photoelectric measuring devices ..	44
Newly introduced	77	Speakers, construction	40
SERVICING		Thickness measurement	46
Aligning TV IF	16	TUBES	
Buzz caused by picture tube	26	Stock guide	38
Do-it-yourselfers	28	6BU8 AGC amplifier	14
Dummy antenna, application for ..	17		

USE HANDY CARD AT BACK TO ENTER YOUR SUBSCRIPTION

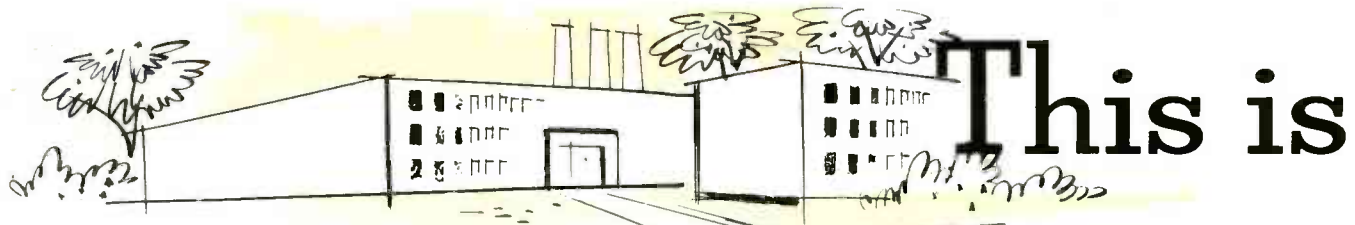

This is

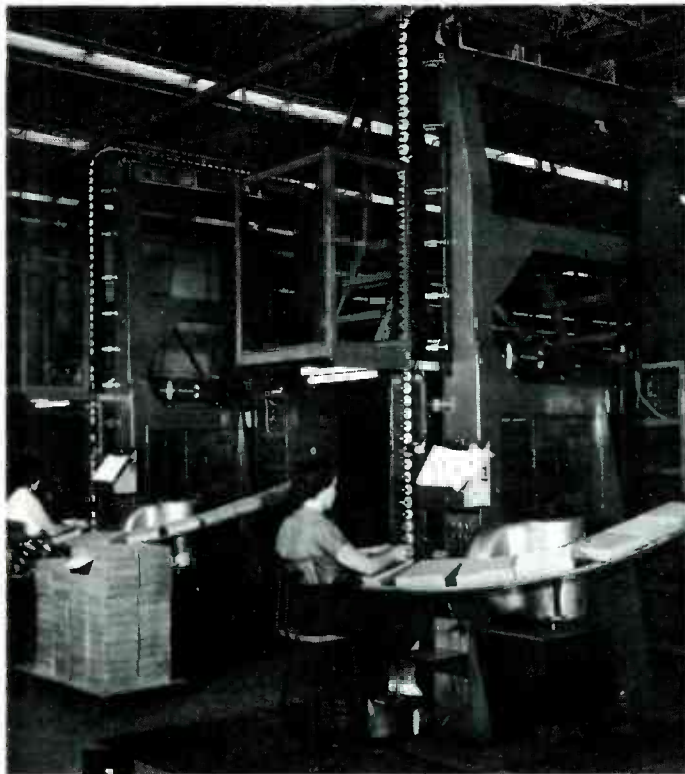

1 Overall view of two automatic testers highlights "chain belt" where tubes are preheated in preparation for tap tests. Operator loading tubes checks pins for straightness.

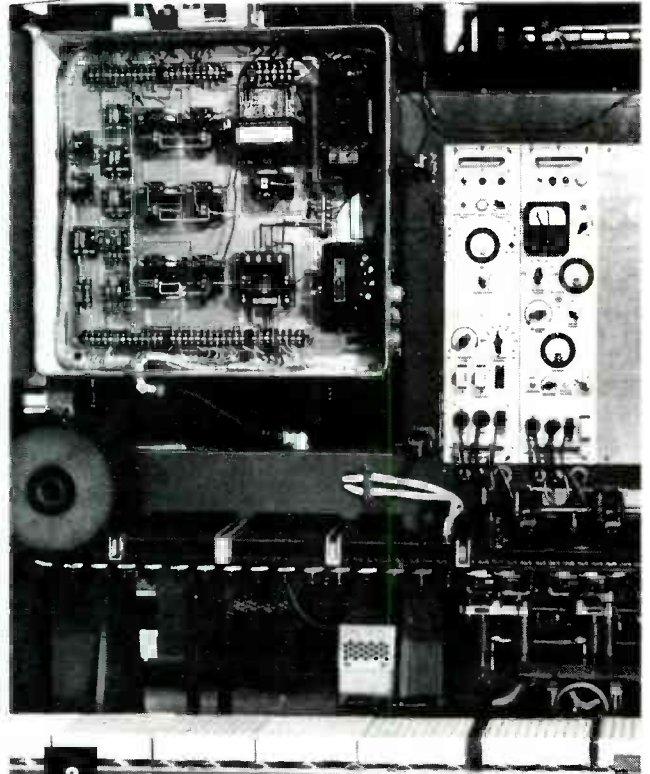

2 Electronic brain of the tester is designed by Sylvania so that any tube type can be tested simply by plugging in its proper adapter (about the size of a pack of cigarettes).

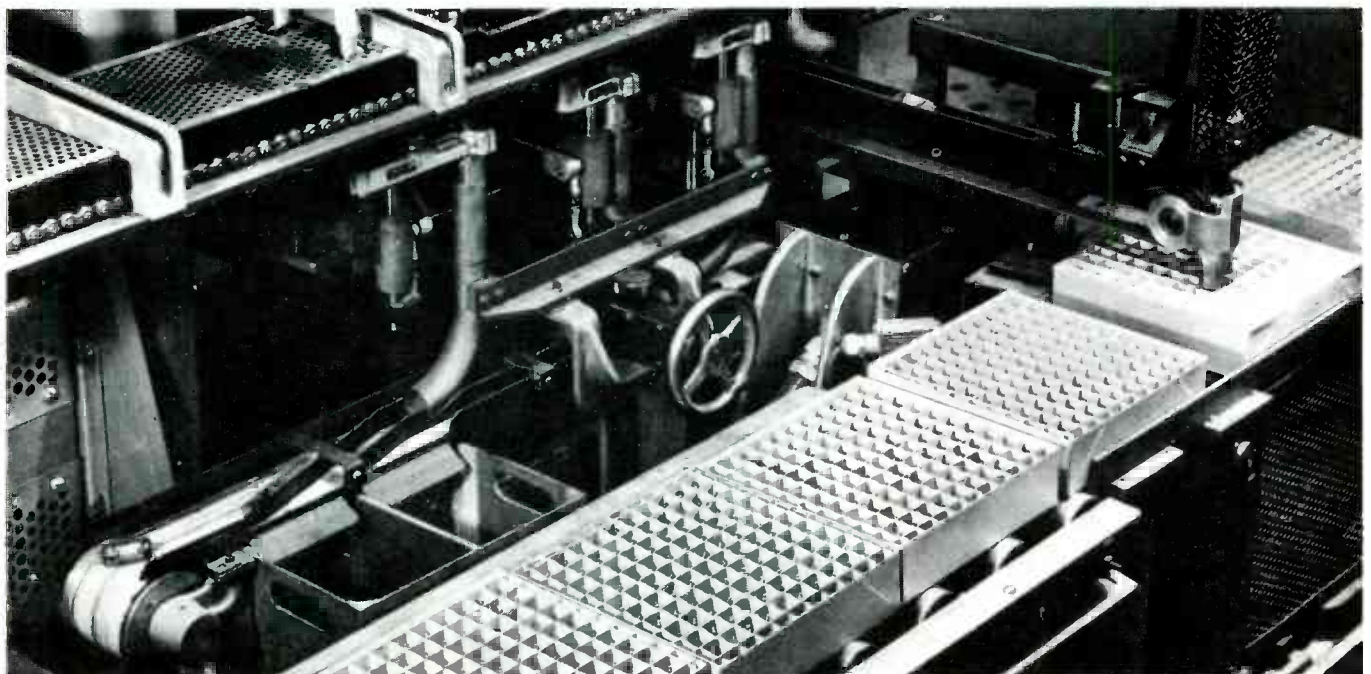

4 —Automatic unloading of "good" tubes into cartons comes after all tests have been made and "inoperatives" separated. Rejects are dropped to conveyor belt, collected into bins, and scrapped.

Sylvania Williamsport

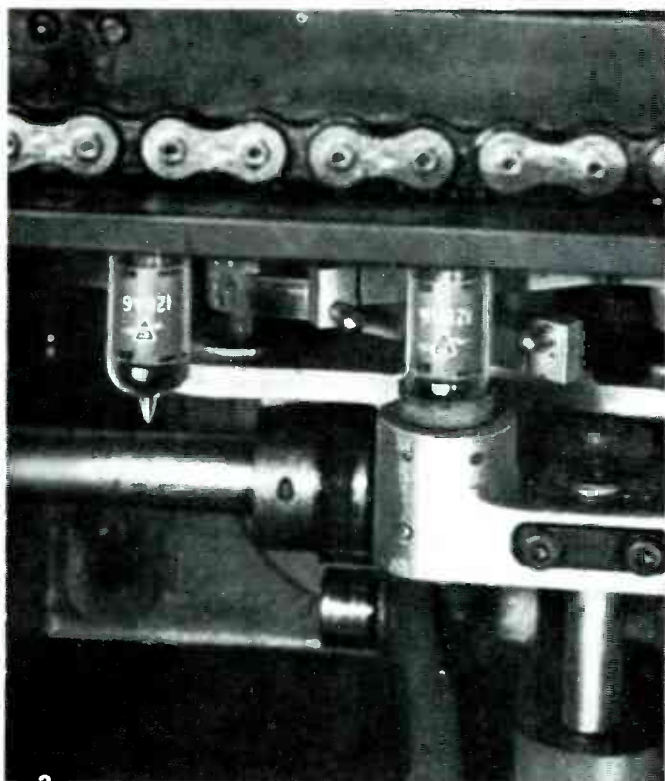

3 Close-up of tap test position. Here each tube is automatically tapped with 100 g (100 times gravity's force). Tube is tapped in two positions in two planes 90° apart—first for opens; second for shorts.



5 —Testing the tester. As a constant check on the accuracy of the automatic tester—samples from each lot tested, are retested on similar equipment used as a standard. Records are kept of all tests serving as data to feed back to design, manufacturing, and quality-control groups.

— where automation is at work to keep your tube stock free from “inoperatives”

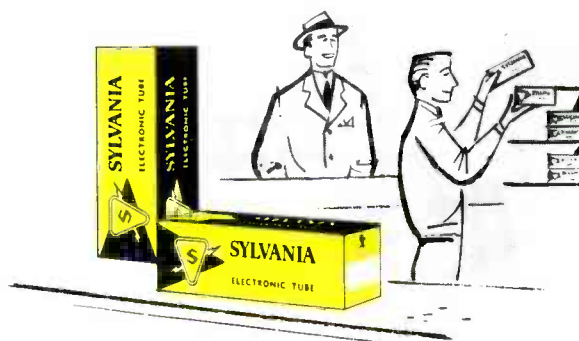

FOR every four thousand tubes tested at Sylvania's plant in Williamsport, Pa., not more than one “inoperative” will escape Sylvania's automatic testing “dragnet” or reach your shelves.

Like Williamsport, all major tube-finishing plants are equipped with automated testers designed and built by Sylvania. Automation makes it possible to test each tube individually and more efficiently for *opens, shorts, leakage* and *emission*. As a result, Sylvania maintains the industry's lowest percentage of inoperatives. For you this means more efficient and profitable servicing—bothersome, time-consuming returns are kept to an absolute minimum.

Why not try using Sylvania exclusively as many dealers do? You'll find that's the best way to profit from Sylvania's exclusive testing program.



SYLVANIA

SYLVANIA ELECTRIC PRODUCTS INC.
1740 Broadway, New York 19, N. Y.
In Canada: Sylvania Electric (Canada) Ltd.
University Tower Bldg., Montreal

LIGHTING • TELEVISION • RADIO • ELECTRONICS
PHOTOGRAPHY • ATOMIC ENERGY • CHEMISTRY-METALLURGY

BURGESS BATTERIES
FOR TRANSISTOR AND TUBE MODEL RADIOS

Highest Quality—Longer Shelf Life
IT'S EASIER TO SELL THE BEST!
Depend on **BURGESS** the Complete Line

BURGESS—always the best in batteries for tube model portable radios—now leads the field again with the finest batteries for transistor model portable radios! You will prefer Burgess Batteries because they're fresher when you get them—fresher when you sell them. Stock and sell the Burgess Line! You're assured of money-making initial sales, plus more of that important repeat business!



BURGESS BATTERIES Are Pre-Sold by An Aggressive National Advertising Program in Leading Consumer Publications, Metropolitan Newspapers and Outstanding Sunday Supplements.

Plus

Jet Propelled Promotional Materials
KEYED TO

**1958 BURGESS PORTABLE RADIO
BATTERY PROGRAM**



NEW "FRESHER" RETAIL "SALESMEN"

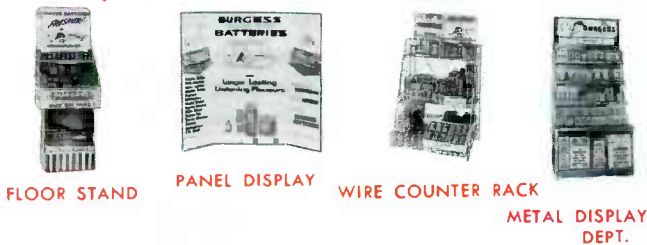

FREE! "FRESHER" Sales Promotion Aids



Contact your BURGESS Distributor for Full Details TODAY!

BURGESS BATTERIES
BURGESS BATTERY COMPANY
FREEPORT, ILLINOIS

Letters to the
EDITOR

DEAR EDITOR:

How about a pictorial coverage on removal of TV chassis, presented in "Servicing New Designs?" As it is now, the technician who services all makes is losing much valuable time in what should be a simple procedure. Several times, I've removed the entire chassis when it wasn't necessary.

R. P. DARYMAN

York, Pa.

A good suggestion—we'll keep a sharp eye out for chassis-removal problems in new sets and will present information on them when called for.—Editor

DEAR EDITOR:

I had a call the other day that reminded me of your February, 1957 cover. Repaired an Atwater Kent 66 that still had 5 original tubes. The bottom of the chassis had never been removed before.

Out here I have been called upon to service an amazing amount of equipment. I will list a few that come to mind offhand: basketball scoreboards; fire eyes and complex controls for corn dryers; fuel fire eye and control circuits for boilers; stoker and furnace controls; coin meters; P. A. systems; tape recorders; electric trains; electric fences; electric organs; organolas; chimes; guitar amplifiers; battery chargers; ignition testing equipment... you name it, they drag it in.

GLEN A. MILLER

Titonka, Iowa

Who says things get dull in the country?—Editor

DEAR EDITOR:

Your recent series on "Resonant Circuits" was very informative, but could you give me more information about the mathematical symbols used in the formulas?

LEONARD KLEMONS

Holly Hill, Fla.

All articles in the series included a full explanation of all symbols except the powers of ten. You can get a briefing on this subject from various math books available at your local library or school. One very clear explanation is found in "Mathematics for Electricians and Radiomen" by Nelson M. Cooke.—Editor

DEAR EDITOR:

In leafing through the October, 1957 issue, I noticed the schematic of the balancing circuit on page 76. The ac-

**SERVICE MAN — SALESMAN — DEALER — JOBBER
HOME WORKSHOPPER — PROFESSIONAL REPAIRMAN**

THEY ALL SAY

It's a Honey!



MODEL #100

**THIS NEW
100 WATT
"Quick Hot"
SOLDERING GUN by**



This lowest priced electronic soldering gun on record has other exclusive features that would make it preferred regardless of price.

- It's smaller, slimmer, more compact — beautifully balanced — handy as your hand.
- It's lighter — weighs only 19 ounces. Doesn't tire you.
- Heats in 3 seconds on ordinary 110-120 Volt AC, 60 cycle.
- Cools quickly too when trigger is released.
- Has automatic spotlight that's focused on the tip.
- Has long reach, long life soldering tips that are replaceable and interchangeable with hot-cutting or flat iron finish-repair tips.
- Sturdy, ebony black plastic handle and housing are heat and impact resistant.

**And only
\$5.95
LIST**

IDEAL FOR 90% OF ALL YOUR SOLDERING REQUIREMENTS

OTHER WEN POWER TOOL LEADERS



**\$29.95
LIST**

**2 SPEED
3/8" POWER DRILL**

1000-3000 RPM as needed, on 120 Volt AC/DC. Speed change quick, positive. Provides just the right speeds for different jobs. Geared Jacobs chuck. All you need in an electric drill in this 1 tool. With attachments — it is a whole work shop.



**\$29.95
LIST**

**8 SAWS IN 1
POWER SAW**

Has no equal. Cuts almost anything smoothly, swiftly — 2 x 4's in seconds, 1/2" steel, plastics, conduits. Cuts circles, scrolls, dovetails, straight lines or angles. Makes own starting holes. Blows sawdust off guide lines. 3 blades, coarse, medium, fine. Operates on 110-120 Volt AC/DC.

WEN



PRODUCTS, INC. 5808 NORTHWEST HIGHWAY, CHICAGO 31, ILL.

(Export sales, Scheel International, Inc., Chicago)

ALL WEN PRODUCTS ARE SUPERBLY MADE — U.I. APPROVED — FULLY GUARANTEED

Presenting

New **SATELLITE** Antenna
with amazing rotating BALL—
rotates 360° in every direction
to mount anywhere on any car!

**MOUNTS TOP OR SIDE COWL, TOP FENDER,
SIDE FENDER, REAR DECK OR ROOF.**

The "SATELLITE" is truly out of this world, because no other antenna in the world is more versatile, more beautiful or more durable.

MOUNTS EASILY, QUICKLY FROM THE OUTSIDE!

New, simplified split-washer mounting base twists easily into position beneath cowl. Reduces installation costs.

MAST ADJUSTS TO ANY DESIRED ANGLE!

As the "SATELLITE BALL" rotates 360° in every direction, the mast may be set at any angle you prefer. Locks permanently into position.

HI-QUALITY MATERIALS AND CRAFTSMANSHIP!

Triple chromed, 3 section mast with sturdy, anti-rattle construction, extends to 57". 100% shielded Mylar cable. Made by the world's largest maker of automobile antennas ... and guaranteed in writing for the full life of the car. No wonder ... It's tops for 58!

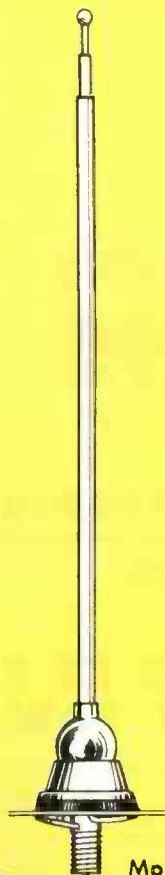

Model BT-1

MODEL	SEC.	LEN.	CABLE
BT-1	3	25"-57"	48"

The TENNA Manufacturing Co. 7580 GARFIELD BLVD.
CLEVELAND 25, OHIO

companying article says something to the effect that "when A and B are equal" a balance will be achieved. I presume you mean that when there is no voltage difference between A and B the meter will not read, showing a null indication. But the only way a null could be reached would be to return the arm of the pot to the bottom end (point X). This, of course, would just short out the meter and the thermocouple. Is the diagram correct, or have I missed something?

M. G. GOLDBERG

St. Paul, Minn.

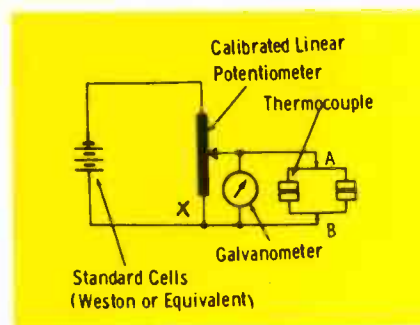

The circuit is correctly drawn, but one sentence in the associated text is misleading. Actually, the condition of no current flow through the galvanometer occurs when the potential developed by the thermocouple is equal and opposite to the potential tapped off across the calibrated linear potentiometer. Once this null reading is obtained, the actual value of voltage being developed by the thermocouple is read directly from the calibrated dial.—Editor

Dear Editor:

In our area, most antenna installations include a low-band unit covering Channels 4 and 6 and a separate single-channel yagi for Channel 10. I've had many an argument about which system is best for connecting the two antennas to the TV set. I am in favor of using a high-low band coupler on the mast with a single twin lead, but another serviceman prefers two separate leads (one from each antenna) connected to a switch on the back of the set. He says it results in less snow. I've seen both, and personally, they look the same to me. What is your opinion?

BERT SENEAL

Pisek, N. D.

Provided that there is little signal loss in the switch, the double lead-in system is theoretically the best. Regardless of what type of coupler you use in the single lead-in system, there is a certain amount of insertion loss which means less signal delivered to the receiver.

Of course, the difference in signal strength at the set should be very small—only a couple of db. For this reason, you probably wouldn't notice the difference by looking at the picture. If you were to use a good field strength meter to check both systems at the same location, the two-line system should prove slightly better.—Editor

**NEW
COMPLETE**

**DIRECT
VIEWING**





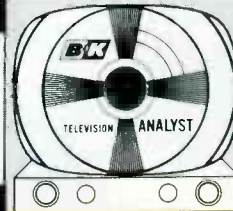
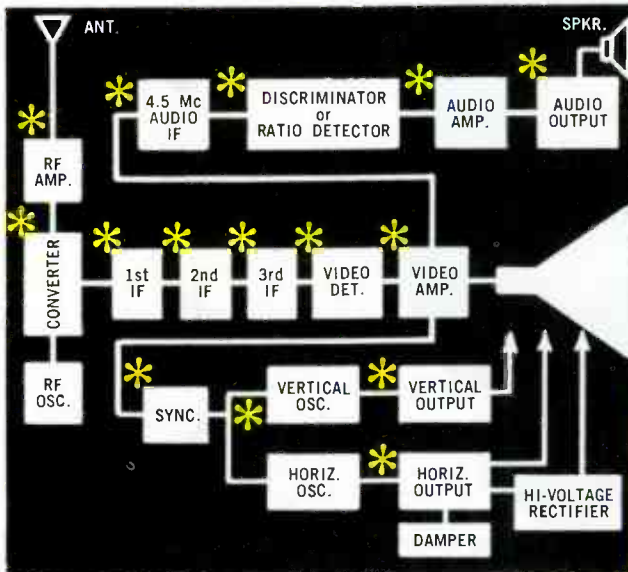

TELEVISION ANALYST

**test each stage
SEPARATELY**



and watch the
result on the
TV set itself

**UNIQUE NEW SIGNAL-INJECTION TECHNIQUE
Saves TV Trouble-Shooting Time and Work**

-  **R.F.** Supplies complete r.f. and i.f. signals with video and audio modulation to quickly trouble-shoot each stage in each of the sections of the TV receiver. Enables you to check the r.f. sensitivity and AGC settings of TV receivers.
-  **VIDEO** Reproduces a complete test pattern on the screen of the TV picture tube and injects signals into each video stage of the TV receiver for fast, visual trouble-shooting and correction—anywhere, anytime. Makes it easy to check bandwidth, resolution, shading and contrast capabilities of the TV set.
-  **SYNC** Provides composite signal, sync positive and negative.
- SWEEP CIRCUIT DRIVING PULSES** Provides separate vertical and horizontal driving pulses for trouble-shooting deflection circuits.
- INTERMITTENTS** Test signal injection also aids in locating intermittent troubles.
-  **AUDIO** Provides a 4.5 mc sound channel, FM modulated with approximately 25 kc deviation. (This audio carrier is modulated either from a built-in 400 cycle tone generator, or from your own external audio source.) Injection of the 400 cycle tone signal simplifies trouble-shooting of the audio section.
-  **COLOR** Enables you to trouble-shoot and signal trace color circuits in color TV sets.
Generates white dot and crosshatch patterns on the TV screen for color TV convergence adjustments.
Generates full color rainbow pattern of orange, red, magenta, blue, cyan, green to test color sync circuits, check range of hue control, align color demodulators, etc.
-  **SET ADJUSTMENT** Enables you to check and adjust the vertical and horizontal linearity, size and aspect ratio of television receivers.



**NEW
B&K
MODEL
1075**



QUICK, DIRECT, COMPLETE TV TROUBLE-SHOOTING

Now, by point-to-point signal injection and test pattern reproduction, you can easily trouble-shoot and signal trace *any stage throughout the video, audio and sweep sections* of black & white and color TV receivers. With the remarkable new Model 1075 B&K TELEVISION ANALYST, you can quickly isolate and diagnose TV troubles (including intermittents). By use of the generated test pattern, you can *actually see* the condition directly on the picture tube of the television set itself. No external scope is needed. The TELEVISION ANALYST is practically a *complete TV service shop in one instrument!* Net, \$259⁹⁵

B&K

See your B&K Distributor or write for Bulletin 1075-R
B & K MANUFACTURING CO.
3726 N. Southport Ave. • Chicago 13, Illinois

Canada: Atlas Radio Corp., 50 Wingold, Toronto 10, Ont. Export: Empire Exporters, 458 Broadway, New York 13, U. S. A.

NO SCREWBALL

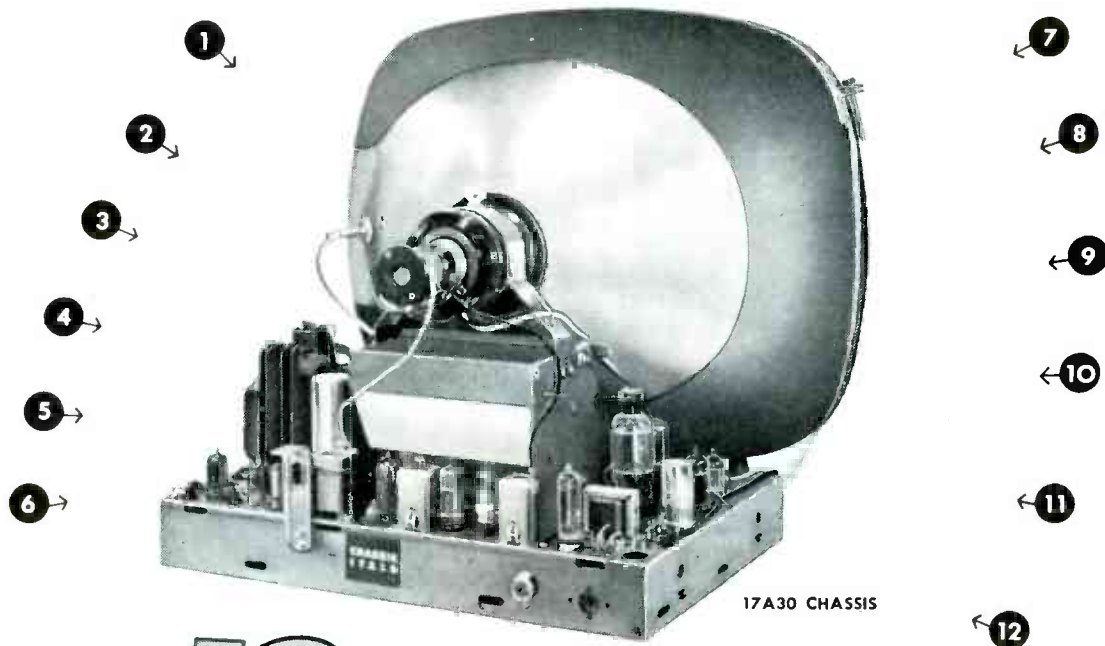

17A30 CHASSIS

12 REASONS WHY THE HANDCRAFTED "SERVICE SAVER" HORIZONTAL CHASSIS

in Zenith TV means more satisfied customers
for Zenith Dealers and Servicemen

- | | |
|--|---|
| <p>1 21-INCH PICTURE TUBE mounted to chassis.</p> <p>2 SHORT NECK 90° TUBE...no 110° linearity or yoke problems.</p> <p>3 FIN-COOLED POWER TRANSFORMER has 185% more cooling surface.</p> <p>4 TECHNICAL CONTROLS on front of chassis for ease of adjustment... no mirrors required.</p> <p>5 ALL ALIGNMENT adjustments on top of chassis.</p> <p>6 ALL CIRCUIT TUBES accessible for service without removing the chassis.</p> | <p>7 TUBES ARE PLACED in logical circuit sequence.</p> <p>8 NO PAPER ENCASED BYPASS CONDENSERS... all are plastic or ceramic molded.</p> <p>9 NO HIDDEN PARTS... all are easily replaced.</p> <p>10 NO PRINTED CIRCUITS... all connections are hand soldered.</p> <p>11 PRECISION BUILT, rugged horizontal chassis.</p> <p>12 NO SHORTCUTS to impair the reliability.</p> |
|--|---|

OUT OF CONSIDERATION FOR SERVICEMEN WE USE

NO PRINTED CIRCUITRY

IN THE CHASSIS

Every servicing dealer knows that printed circuitry in a television chassis often leads to costly servicing and may also cause service delays. Zenith's handcrafted standard circuitry in television means greater operating dependability and fewer service headaches.

CONSTRUCTION

**...THAT'S WHY
ZENITH TV
NEEDS LESS
SERVICE ...
IS EASIER TO
SERVICE!**

**WE THINK IT'S
WORTH THE EXTRA
COST AND EXTRA
CARE OF HANDCRAFTED
STANDARD CIRCUITRY
TO GET THE BEST
PERFORMANCE
AND LEAST
SERVICE HEADACHES
AND SO DO THOUSANDS
OF DEALERS WHO
WOULD SOONER
SELL CUSTOMER
SATISFACTION
THAN A PRICE TAG!**

QUALITY BY

Zenith

the Royalty of Television®

The quality goes in before the Zenith name goes on.
Backed by 39 years of leadership in radionics exclusively.
Also makers of Radio, High Fidelity Instruments and fine Hearing Aids.



ZENITH RADIO CORPORATION
Chicago 39, Illinois

ShopTalk

MILTON S. KIVER

Author of . . .
*How to Understand and Use TV Test Instruments
 and Analyzing and Tracing TV Circuits*

Most of the antennas described thus far in this series have been, in the main, narrow-band antennas. This means that in areas containing a relatively large number of television stations, or where the stations are on widely separated channels, more than one antenna would be required. This would not only be more costly, but would also complicate the mounting structure and introduce difficulties and some losses when the signals from the various antennas were combined. A single wide-band antenna would alleviate many of these difficulties, in addition to presenting a much neater appearance on the roof.

One of the first attempts at broad-banding the dipole was made by increasing the diameter of the rods (Fig. 1). This broadened the frequency spectrum over which the characteristic impedance remained fairly constant. The value of the impedance, however, dropped below that of a conventional dipole. Another attempt at the same goal was made by using a conical antenna (Fig. 2). The length of each cone is on the order of $.365\lambda$; cone angle determines the characteristic impedance of the array, starting with a value near 1000 ohms when the angle is small, and gradually de-

creasing to about 150 ohms when the angle reaches 60° . By properly selecting the cone angle, an impedance which matches existing transmission lines can be developed. Furthermore, the bandwidth over which the input impedance of a conical remains constant is greater than for the array of Fig. 1.

One difficulty with the conical, however, is its bulkiness. This is only partially eased if wire screening is substituted for the metal cone. A structure which is simpler to handle and which still retains much of the conical's bandwidth is the array shown in Fig. 3. In this unit, two or three rods are fanned out, coming together at one end to form a junction for the lead-in input. If a very high input impedance is desired, the length of each set of rods is made equal to one wavelength. However, for a value in the neighborhood of 300 ohms, quarter wavelength rods can be employed. Here, again, the impedance will depend on the angle encompassed by the fanned elements; generally, this is kept between 40° and 50° .

Although this array is not a true conical, but a derivative of it, the name conical is still applied to it commercially.

The response pattern for this

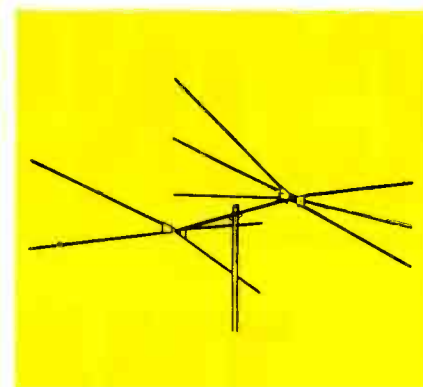

Fig. 3. Brach 6-bar dipole design is a derivative of the cone shape in Fig. 2.

array is similar to that of a simple dipole, i.e., a figure 8. Frequency response tends to remain fairly uniform for a bandwidth of about 30% each side of the center frequency. This enables one conical to be used for the entire low band. However, if the same antenna is used to receive the upper band, its response tends to break up into the multi-lobed pattern shown in Fig. 4. Thus, in spite of its wider bandwidth, we apparently are still faced with the prospect of needing two separate conicals to cover all the VHF channels.

The solution universally adopted to overcome this limitation is shown in Fig. 5, in which the two sets of elements have been bent or veered forward. This has the effect of slightly reducing the forward response at the low frequencies, but it also modifies the high-frequency pattern break-up so that a single all-band VHF array now becomes feasible. Here is what happens. When the conical rods extend straight out, an array cut for the low channels produces the high-frequency response shown by the dotted lines in Fig. 6. Now, if we bend the rods for-

• Please turn to page 61

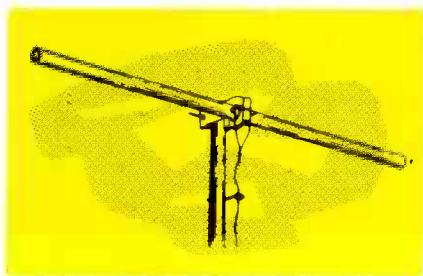

Fig. 1. Increasing the diameter of the dipole rod broadens frequency response.

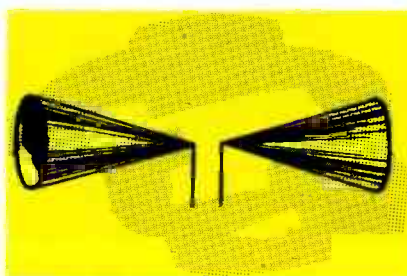

Fig. 2. Cone-shaped dipole has broad response, good impedance characteristic.

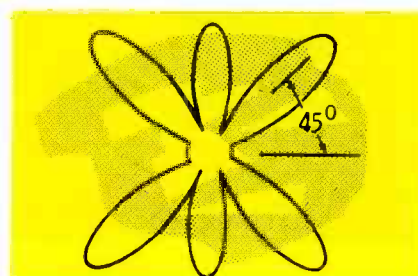
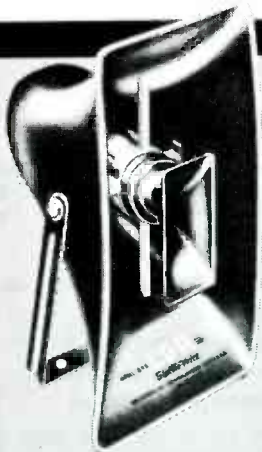

Fig. 4. Response pattern of a low-band conical dipole on the high band.

**You Profit More When
You Sell the Finest!**

Electro-Voice®



Model 848 CDP for the biggest jobs. 25 watts, 16 ohms. Response: 175-10,000 cps, crossover at 1000 cps. Sensitivity rating, 52 db. Size, 10½" x 20½" x 20". Wt., 12 lbs. List.....\$75.



Model 847 CDP. 12 watts, 16 ohms. Response, 250-10,000 cps, crossover at 1500 cps. Sensitivity rating, 51 db. Size, 11¾" x 7¾" x 10½". Wt., 6½ lbs. List.....\$46.33.



E-V Model 664

**CDP—the Speakers With a Difference:
Greater Intelligibility, More Coverage**

CDP SPEAKERS—Compound Diffraction Projectors—reach more people more clearly. Because they do a better job, they help build your reputation for dependability.

CDP units consist of two coaxially-mounted diffraction horns working from opposite sides of a single diaphragm over a 120° polar pattern. They deliver 2½ more octaves of sound reproduction—essential for highest intelligibility—than conventional P. A. Horns.

**Step Up Your Sales With the World's Finest P.A.
Microphone E-V 664 High-Fidelity Cardioid Dynamic**

UNIQUE E-V "VARIABLE D"™ gives you amazing versatility, highly directional sound selectivity, smooth, peak-free response at all frequencies from 40 to 15,000 cps, no boominess. GUARANTEED to outperform any other P. A. cardioid or YOUR MONEY BACK! List price, \$85.00.



Model 636 slim dynamic omnidirectional microphone. 60-15,000 cps response range. List.....\$72.50.



Model 623 dynamic omnidirectional microphone. 60-12,000 cps response range. List.....\$57.00.

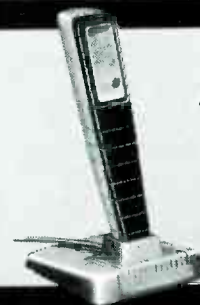

Model 927 crystal omnidirectional microphone. 60-8000 cps response range. List.....\$22.50.

Electro-Voice

ELECTRO-VOICE, INC. • BUCHANAN, MICHIGAN
Export: 13 East 40th Street, New York 16, U.S.A. Cables: ARLAB

Ask a Broadcast or Recording Engineer about E-V Microphones. Write TODAY for A B C's of Microphones, Dept. R-84.

using a scope for SIGNAL

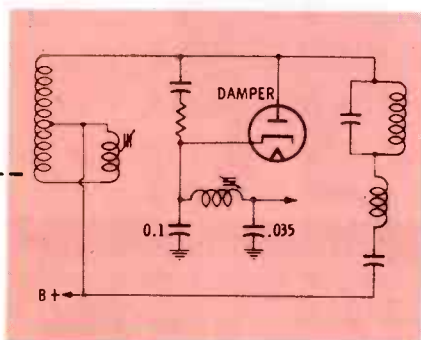

Fig. 1. A direct probe can be used to check the waveform and p-p voltage at the damper cathode because of the relatively high .1 mfd shunt capacitance.

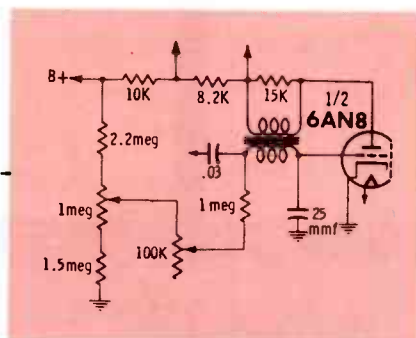

Fig. 2. Circuit disturbance and waveform distortion results from use of direct probe in this circuit because impedance is only a few mmf.

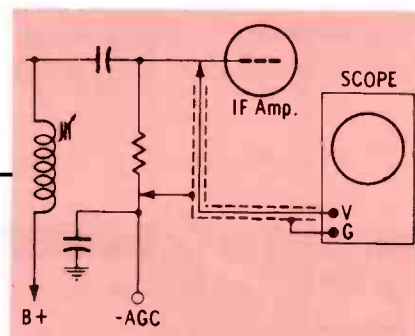

Fig. 3. Distortion with use of direct probe is the result of circuit detuning, regeneration, and tube overload on the regenerative peak.

A signal is characterized not only by its frequency (or frequencies), but also by its voltage. The range of voltages encountered in TV signal-tracing work is very great, extending from a few microvolts (when checking receiver sensitivity) to 30,000 volts (used for beam acceleration in some picture tubes). The voltages with which the technician works may be either AC or DC, and often are a combination of both. AC voltages may be simple sine waves, or they may be comprised of a number of sine waves. In the latter instance the waves may be harmonically related in given phases (as in square or sawtooth waves), or they may be an arbitrary mixture (as are the horizontal and vertical voltages in a sync-separator circuit). The DC voltages may be pure or pulsating; but in the interest of simplicity, we break down a pulsating DC voltage into a pure DC voltage and its AC component(s).

Source Impedance

But experience proves that all the difficulties which are encountered at the service bench due to the laws of field behavior and waveform composition are slight by comparison to the difficulties presented by the laws of source impedance. The impedance of a source is of primary importance in signal-tracing procedures, yet

few technicians give this fact any consideration whatsoever.

To briefly point out one or two of the consequences which stem from a disregard of source impedance, consider a situation in which the technician attempts to trace an IF signal with a demodulator probe, wherein a substantial deflection is obtained on the scope screen at the grid of the first IF stage and little deflection is obtained at the grid of the second IF stage—yet the IF amplifier is operating normally. The conclusion drawn from the signal-tracing procedure is misleading because the difference between the two source impedances was completely ignored. As will be shown, proper test procedures are available to accommodate the various source impedances encountered in signal-tracing work.

Again, consider a situation in which the technician attempts to check the response of a two-stage video amplifier by applying a video-frequency sweep signal at the input of the amplifier and using a demodulator probe and scope to check the signals present at the plates of the two stages. The scope would indicate that the high-frequency response of both stages is poor, although they may be operating normally, simply because the test is being conducted

without proper regard for the source impedances. Once again, let it be said that proper test procedures are readily available.

Frequency Response

When a scope is used in signal-tracing tests, the operator too often fails to take into account the limitations of the test equipment with respect to the circuit under test. It should be an obvious fact to everyone that a test instrument must have better response than the circuit under test if the results are to be valid. Yet many technicians, who are fundamentally aware of this axiomatic principle, will try to signal-trace an IF amplifier having a bandwidth of 4 mc with a demodulator probe having a bandwidth of 50 kc, or will try to signal-trace the amplifier with a scope having a bandwidth of 500 kc and then become confounded because the composite video signal appears on the scope screen in highly distorted form.

We hasten to add, to avoid misunderstanding, that merely because an IF amplifier has an operating frequency of 45 mc, the scope must respond to this frequency. The scope amplifier should have a frequency response which is only slightly greater than the bandwidth of the IF amplifier (approximately 4 mc). This relaxation of scope response require-

TRACING

by Robert G. Middleton

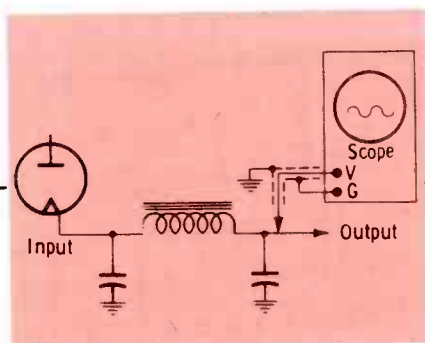

Fig. 4. A direct probe is suitable for checking B+ ripple because the shunting effect of the probe is negligible in comparison with the filtering capacity.

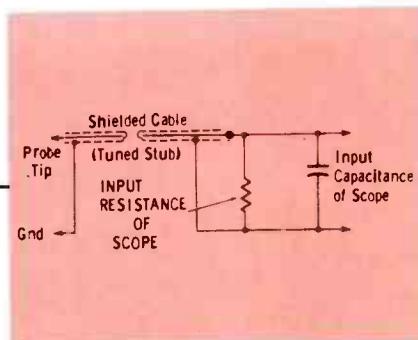

Fig. 5. Since input resistance is high and input capacitance low (typically 2 megohms and 20 mmf), the input cable acts as open stub for certain frequencies.

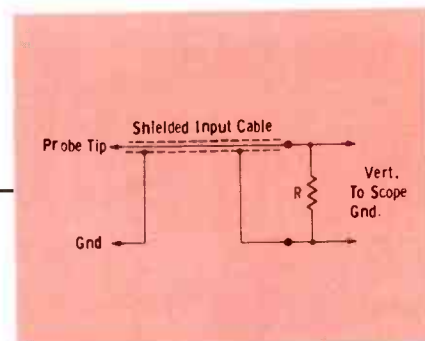

Fig. 6. When a shielded input cable is quite long, standing wave distortion can be eliminated by using a suitable terminating resistor at scope input terminals.

ments comes about because a demodulator probe is used in such tests—but there are some very definite requirements for the probe, on the basis of the following considerations: The probe must not load the circuit, or the input impedance of the probe should be at least ten times higher than the source impedance of the IF circuit. Just what is meant by this principle is explained in detail at a later point. Secondly, the demodulating capability of the probe must be such that wave envelopes from 60 cps to 4 mc are accommodated. This is a point which has received little attention in service literature and is responsible for woeful confusion, controversy, misunderstanding and inefficiency. If this discussion accomplishes no other purpose, it is of the greatest importance that the reader gains an understanding of what probe demodulating capability means and how it affects his signal-tracing work at the service bench.

Probe Applications

Considering the term "signal" in its broadest sense as including all the operating waveforms in the TV receiver such as RF, IF, video, sync, sweep, AGC, audio and blanking, there are a considerable number of signal-tracing tests

which can be made by direct application of the scope input cable (or by means of a direct probe).

When a direct probe rather than a low-capacitance probe is used, the internal impedance of the circuit must be sufficiently low so that the 100 to 150 mmf of cable capacitance will not load, detune or otherwise disturb normal circuit operation in such manner as to distort the reproduced waveform. This is a treacherous point for the beginner, and one which often causes even trained technicians much difficulty. For example, a direct probe can be used satisfactorily to test the waveshape and peak-to-peak voltage at the cathode of the damper tube shown in Fig. 1, but serious circuit disturbance and waveform distortion results if the direct probe is used to detect the waveform at the grid or plate of the vertical oscillator shown in Fig. 2. The beginner sometimes expects the reverse situation because he reasons that the frequency of the damper waveform is 15,750 cps, while the frequency of the vertical waveform is only 60 cps. What is overlooked is that the damper cathode works into a capacitance of 0.1 mfd and the shunting of an additional 150 mmf is negligible, while the grid capacitance of the

vertical-oscillator tube and its associated load is only a few mmf and an additional shunt of 150 mmf across the grid-ground circuit constitutes severe loading. The waveform, having a complex shape, has frequency components considerably higher than 60 cycles.

Naturally, when the direct probe is used, the signal voltage must not exceed the voltage-handling capability of the scope. For example, the voltage across the deflection coils in Fig. 1 is on the order of 1,500 p-p volts, which will overload the vertical amplifier in the scope and cause severe distortion of the reproduced waveform. Furthermore, it is not unlikely that the scope input circuit will be damaged by application of such signal voltages; thus, a suitable type of attenuating probe must be used to reduce the amplitude of the signal voltage applied to the scope amplifier.

Most of you are familiar with the fact that the application of a direct probe at the output of the video detector sometimes causes circuit disturbances which may even throw the system into oscillation. Although alignment instructions often recommend that a resistive isolating probe be used for

• Please turn to page 73

behind the IF ALIGNMENT scene

Video IF alignment is no simple task—one must have a full understanding of his test equipment, various alignment procedures and what's to be expected when following these procedures. In actual practice, the average TV receiver will seldom require complete alignment; therefore, individual peaking of coils can often be skipped, permitting an immediate sweep alignment or over-all video IF response check to be made. In this respect, a clearer explanation of various procedures and possible response indications will help reveal to the technician some things he may encounter behind the alignment scene.

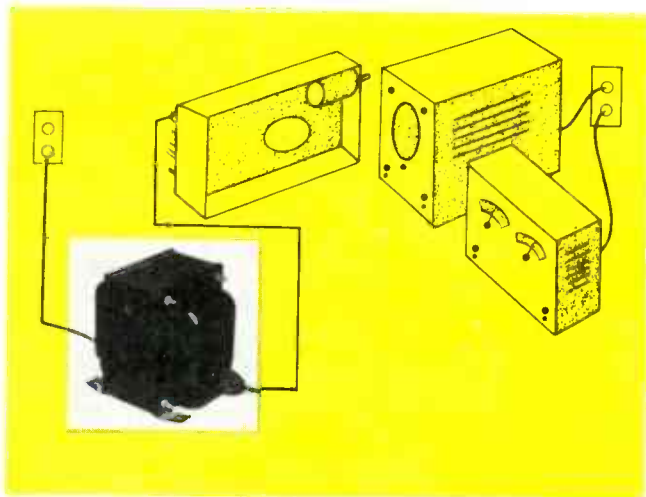

Play Safe

In so many receivers these days, especially portables, one side of the AC power line is connected directly to chassis. If this be the case, *always* use an isolation transformer when servicing or performing alignment. Eliminate the possibility of damaging your valuable instruments and the chance of serious injury to yourself.

As illustrated in the diagram, the TV chassis should be isolated from the line but not the other pieces of equipment. The scope and generator are isolated through their own power supplies.

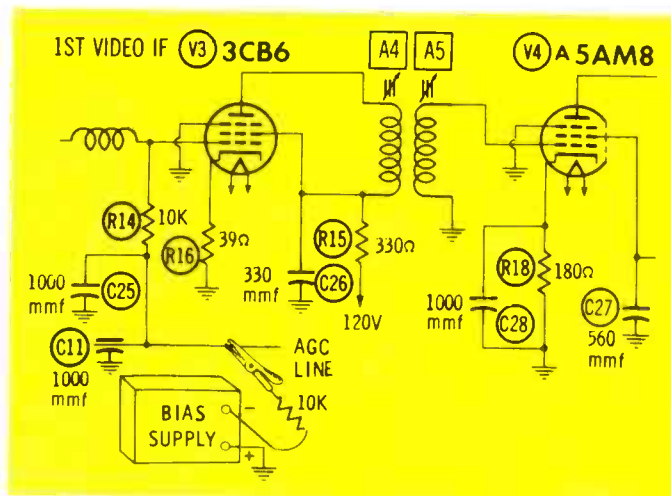

Fixed Bias

Alignment instructions usually call for a fixed bias potential on the AGC line. A simple battery arrangement or a commercial bias supply may be used for this application. The voltage required is usually about 3 to 4 volts DC and in some cases a series resistor of about 10K ohms may be specified for isolation purposes. The amplitude of the response curve will normally change as this clamping bias is varied; however, if the shape of the curve alters, trouble such as IF regeneration may be indicated.

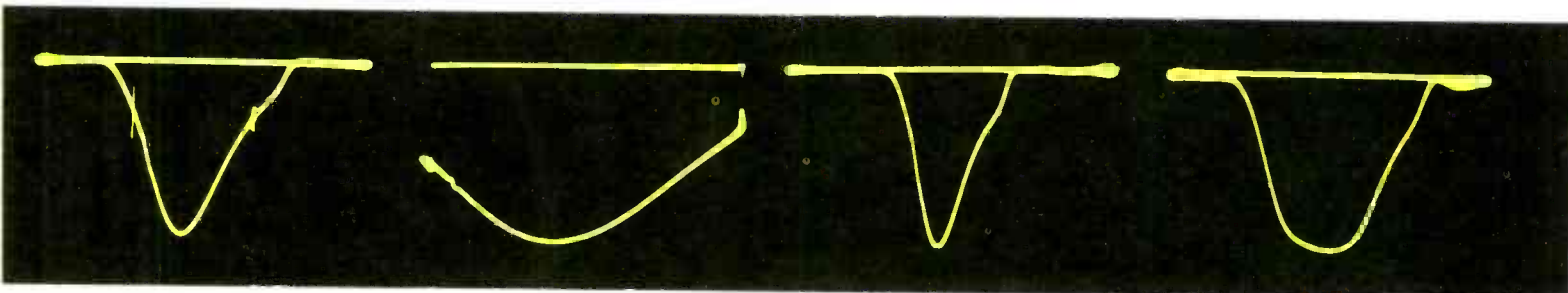

Modern Curves

The IF circuits of many late-model receivers are no longer designed to produce flat-topped or double-peaked curves—but rather a pattern known as a "Gaussian response."

Markers may be obtained by using the internal provisions of the sweep generator, from a separate marker generator, or a combination thereof. If a separate generator is used, connect its output to the external marker jack of the sweep generator or loosely couple it to the point of sweep injection.

Too Much or Too Little

If the sweep width of the generator is too narrow, the response curve may appear as shown at upper left, and the entire response will not be visible. This is because the frequency swing of the generator does not exceed the IF frequency response limits so that zero response points are displayed. If sweep width is too great (as shown at upper right), it may be equally difficult to compare the curve with that given in the alignment instructions because of the differences in the curvature of the slope; that is, the narrow curve shown above would seem to indicate that response drops off much more rapidly than is actually the case. In addition, marker indications will be less visible and will have more of a tendency to distort the steep slopes of the curve. Normally, the sweep width should be as near as possible to that called for in the alignment instructions, but not less than 7 nor more than 12 mc under any circumstances.

Too Much Poop

This response curve represents a form of distortion produced by IF overload and may lead you to think that response is better than it actually is. In order not to overdrive the system with the sweep signal, increase the gain of the scope and reduce the generator output until a change in waveshape is no longer noticed. Do not apply the marker signals until you obtain a reasonably normal response, and remember to maintain adequate ground contact between receiver chassis and equipment.

Generator Coupling

The hot lead of the generator is usually connected to a floating shield placed over the mixer-oscillator tube of the tuner. In this way, both sweep and marker signals can be capacitively coupled into the receiver system. Ideal for this operation is a piece of tubular-shaped metal flanged for ease in making generator connections. The piece shown can be adjusted to fit either 7- or 9-pin miniature tubes.

Tuners sometimes employ a telescoping captive shield which makes use of a floating shield difficult. A handy "gimmick" for this situation is a thin metal shim which can be insulated with tape and easily slipped between the original shield and the tube envelope.

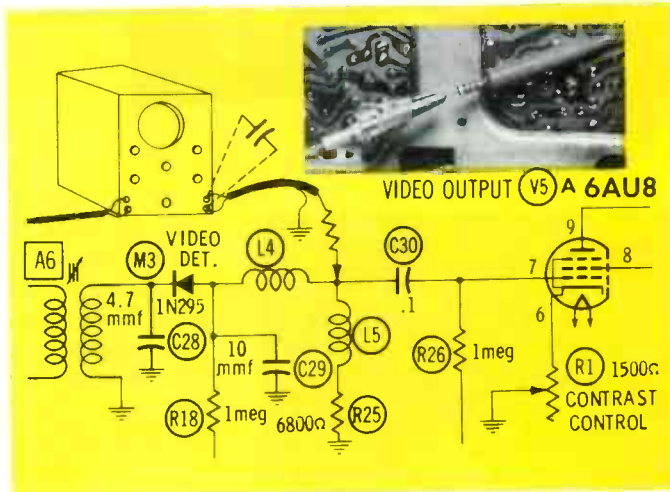
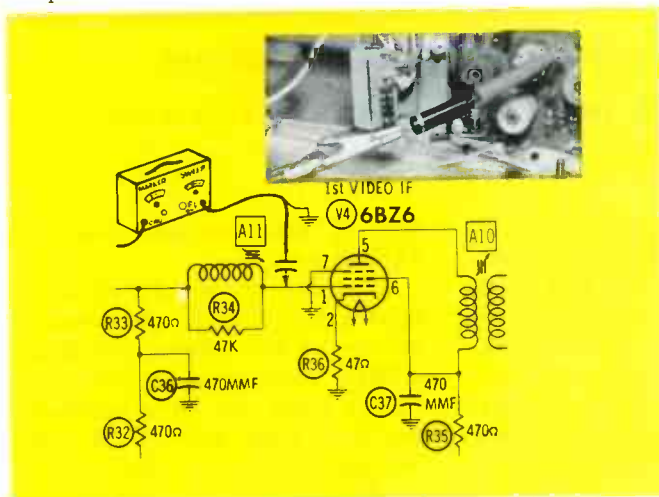
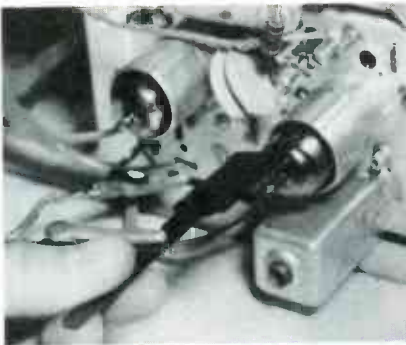

"Dummy" Antenna

Alignment procedures often specify that the sweep signal be injected at the tuner output or IF input, and in these cases a "dummy antenna" is usually called for. This can be in the form of a resistor, capacitor or inductor and is connected between the generator and the receiver to provide an impedance coupling which will neither load nor detune the input circuit. Usually, a capacitor of about .001 mfd is used in this application. The word "direct" under dummy antenna instructions naturally means that the hot generator lead is connected directly to the specified point.

IF Looker Point

To view the frequency response of the video IF system, the vertical input leads of the scope are connected across the video detector load resistor. It's a good idea to connect a resistor of about 10K ohms in series with the scope lead as shown unless, of course, the instructions call for a special isolation network at this point. If marker indications are not as sharp as they should be, try placing a capacitor of from 500 to 5000 mmf directly across the vertical input terminals of the scope. Remember also to apply a sweep signal from the generator to the horizontal input terminals and to set the sweep selector of the scope for external drive.



Off the Beam

The sweep generator is normally tuned to the center frequency of the IF bandpass, which is usually in the neighborhood of either 24 or 44 mc, depending on the receiver. If the frequency setting of the generator is slightly off, the response curve may not appear at the center of the scope trace. The horizontal reference line on the screen is produced by an internal blanking feature of the sweep generator. If blanking is not used, the curve will be formed by trace and retrace.

Troublesome Intruder

This photo illustrates what happens when a response curve is modulated by horizontal sweep energy. If such a pattern is encountered, check for adequate shielding around the high voltage section. In some receivers, this interference can be eliminated by merely removing the horizontal oscillator tube. In series-filament receivers, the oscillator may be disabled by shorting out a grid resistor or substituting a dummy tube. The output tube should be externally biased.

Front-End Freaks

Weird shapes or odd peaks in a response curve may be a direct result of local oscillator interference. When this condition arises, use a jumper to short across the antenna terminals—then select a channel on which the least distortion is obtained. If this doesn't work, it may be necessary to disable the tuner oscillator by using a dummy converter tube (oscillator plate pin removed) or by following any suggestion given in the alignment instructions.

Marker Mess

Don't let your marker signals spoil a good response. Keep the generator output low—you need only enough to produce a very small indication on the scope screen. When viewing a sound trap marker in the dip of a curve, however, it may become necessary to reduce sweep width and increase both marker output and scope gain. If gain of the receiver is too low to facilitate trap adjustment, temporarily reduce AGC bias or ground the clamped point to chassis.

AGC

circuits for 1958

Newly-popular- BU8 stages and how they work by T. A. Lesh

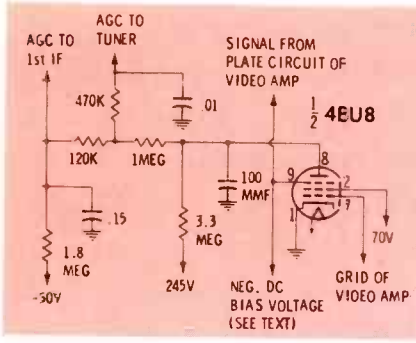

Fig. 1. Simplified schematic of 4BU8 circuit in Zenith Chassis 15A25.

Important new trends in AGC circuit design are revealed by a close look at the 1958 television receivers. Biggest news this year is that several manufacturers have designed circuits which make use of the recently-introduced 6BU8 tube. This type is somewhat similar to an ordinary pentode except

that the plate and suppressor grid are both split into two parts which are brought out to separate base pins. Thus there are two distinct plate-current paths in the tube. The two different electron streams can be controlled simultaneously by the common "inner control grid" and also individually by the two separate "outer control grids" which take the place of the suppressor.

One pentode section is intended for use as a sync separator and the other as an AGC amplifier. The two main input signals are applied to the outer grids, and a special low-level noise-cancelling signal is fed to the inner grid so that it will exert control over the AGC section as well as the sync section. The most significant result of this arrangement is a new

type of noise-immune amplified AGC system.

What with three different input signals, two outputs, and assorted sources of DC reference voltage, a 6BU8 circuit can be very difficult to trace out on a schematic the first time you do it. (It's like separating a tangled mass of vines!) To simplify matters, only the AGC section of the tube will be described at this time. The sync circuitry is very much like that of a pentagrid-type sync separator, and if you have had previous experience with a 6BY6 or 6CS6, you will be on familiar ground in the sync section of the 6BU8. You will also have a head start on understanding the new AGC circuits.

The 6BU8 was introduced in Zenith TV sets about two years ago, and a modified form of the original circuit is found in the 15A chassis series for 1958. Other new Zenith chassis (the 17A series) use a completely redesigned AGC circuit with the 6BU8. Several other manufacturers, including Admiral, Motorola, and DuMont, have also introduced their own versions of the noise-limited AGC circuit this year.

Zenith Chassis 15A25

A 4BU8 is used in this new portable receiver, which has a 450-ma series heater string. A simplified schematic of the AGC circuit is given in Fig. 1. The noise-cancelling signal, including video information and negative-going sync pulses, is tapped off at

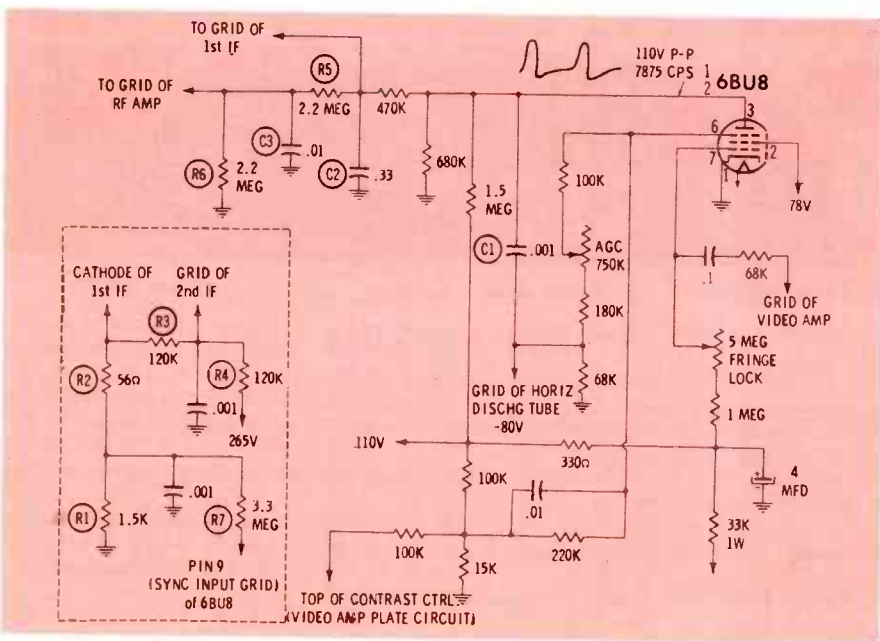
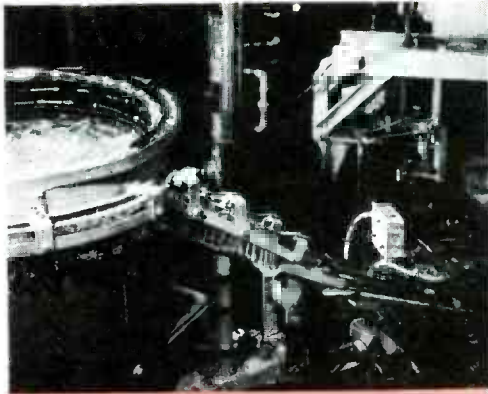
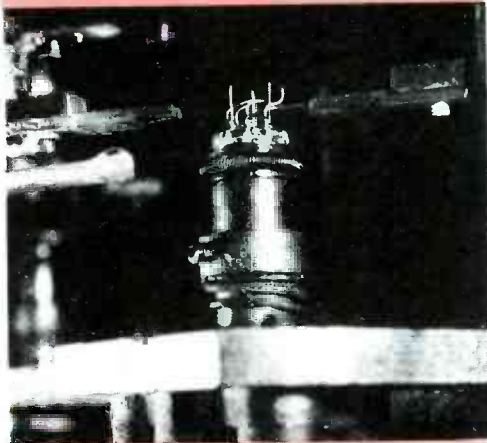

Fig. 2. Keyed 6BU8 circuit and cathode of 1st IF stage in Zenith 17A20.

Please turn to page 68



Cylindrical machine at left gently vibrates glass tube envelopes, urges them to climb inside track and automatically feed down ramp to tubulating machine. Tubulating machine etches tube type on envelopes, cuts glass to precise tube size, attaches exhaust tube to envelope to allow creation of a perfect vacuum.



Close up of the button on which tube elements are mounted. Fingers, left and right, move in to swiftly make complicated bends which must be kept extremely precise to insure proper positioning of tube's elements.



This exhaust machine seals the glass envelope to the stem of the mounted tube. Pumps then create a perfect vacuum in the tube, the inside parts are "bombed" (heated white hot) and the getter is then flashed to allow this perfect vacuum to be retained during life. Tubes are automatically discharged after they have been tipped, then slide down a ramp to a conveyor and are carried to the next operation.

IT'S NOT HUMANLY POSSIBLE



To Make **RAYTHEON TUBES** AS GOOD AS THEY ARE

Here at Raytheon, we think we have the most skillful people in the industry, yet their combined skill alone couldn't make Raytheon TV and Radio Tubes as good as we make them. It takes hundreds of thousands of dollars worth of special instruments and machinery as well.

Pictured are but a few of the many automatic precision machines and delicate instruments that are needed to create the matchless quality of Raytheon Tubes; precision machines that build into Raytheon Tubes their superb physical perfection; delicate instruments that test and safeguard not only the quality of the finished tubes but the thousands of components that are part of the whole.

Much of this fine machinery was designed and built by our own skillful people — exists only in the Raytheon plants. That's why Raytheon TV and Radio Tubes receive rigid quality control tests exclusive to Raytheon. That's why Raytheon TV and Radio Tubes are truly RIGHT . . . for SOUND AND SIGHT!

Buy them from your Raytheon Tube Distributor.

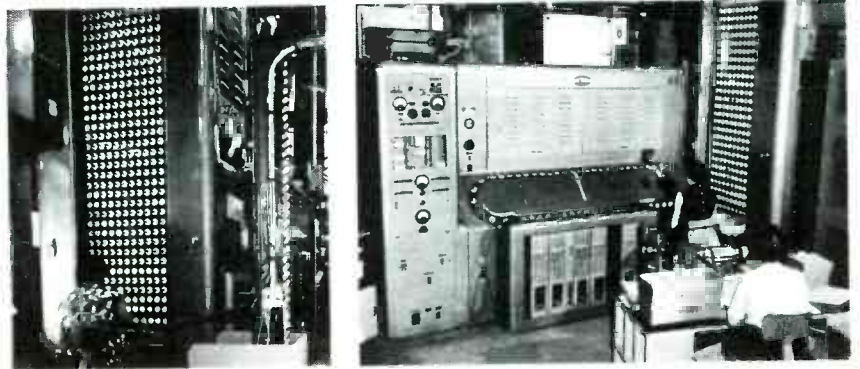

Left: Note the conveyor bringing the finished tubes from the exhaust machine to this rotary aging rack. The aging rack operates the tubes for 1/2 hour to eliminate early tube failure. Voltages are applied to stabilize the characteristics and season the tubes so that uniform results will be obtained through life. High voltages are applied to eliminate any weak tubes.

Right: This Raytheon designed machine performs many complicated tests — tests formerly dependent on human judgment — and automatically eliminates tubes not up to Raytheon standards of quality and performance.



RAYTHEON MANUFACTURING COMPANY

Receiving Tube and Semiconductor Operations

NEWTON 58, MASS.
55 Chapel Street

CHICAGO, ILL.
9501 Grand Ave. (Franklin Park)

ATLANTA 6, GA.
1150 Zonolite Rd. N.E.

LOS ANGELES 7, CALIF.
2419 So. Grand Ave.

Raytheon makes
all these

Receiving and Picture Tubes, Reliable Subminiature and Miniature Tubes,
Semiconductor Diodes and Transistors, Nucleonic Tubes, Microwave Tubes.





Trade-In Blues. The average TV dealer junks 25% of his trade-in sets outright, services and resells another 42%, resells 20% "as is," and still has 13% in stock, according to a recent survey by *Electrical Merchandising* magazine. A dealer can ill afford to give high trade-in allowances if either the "junkier" or "on-hand" categories in his used-TV inventory run higher than these average figures. Even if lower-than-average allowances are offered for used sets in good condition, these sets are no better than junk if they don't keep moving out of the shop at more than a "giveaway" price.



Test Your Tact—II. By the time you decide to take a set back to the shop instead of fixing it in the home, you may already have determined that the trouble is some mysterious-sounding ailment such as a "bad ringing coil," "misaligned discriminator," or "shorted turns on the flyback." A diagnosis of this type sounds crystal-clear to you, so you're probably tempted to give the customer the exact technical definition of the trouble and let it go at that. The public is accustomed to such pronouncements from doctors, but, unfortunately, not from TV men. You have to convince the customer that you're not giving him some smooth line of double-talk just to get the set out of the house so that you can run up a big repair bill.

The only solution is to translate TV jargon into something the non-technical mind can grasp. How good are you at this? Try your hand at explaining the terms given above, using simple language. Here's a tip: Relate the trouble to some symptom which the customer can see or hear. This will help you get your point across.

Thank-You Gift. In many lines of business, inexpensive premiums such as ball-point pens or windshield scrapers (usually imprinted with an advertising message) are frequently given to good customers in appreciation for business, or to new prospects as an introduction. Oddly, service shops don't seem to take too much advantage of this effective form of advertising.

We recently saw a gadget that would make an excellent promotional item for the TV trade. Called the "Programinder," the device is a slab of plastic with rows of holes somewhat like those on a cribbage board. The holes correspond to squares in a chart which lists the various times of day and days of the week. Plastic pegs of various colors are inserted into the holes to remind the user which channel to tune in at which time in order to catch his favorite programs.

Along a similar line, the printed matter sent out as direct mail advertising can take the form of something useful which the customer will want to keep. For example, A-1 TV & Appliance, Phoenix, Ariz., has mailed out 7,000 copies of this "Emergency Phone

NAME		TELEPHONE NUMBER
A-1 TELEVISION SERVICE		AMherst 6-1348 AMherst 6-8823
Doctor		
Donut		
Druggist		
Police		Alpine 4-1101
Sheriff		Alpine 6-6941
Fire Dept.	City	Alpine 3-1191
Fire Dept.	Rural	AMherst 5-5242
Garage		
Baby Sitter		
Civil Defense	Radio Bicycle Dial Numbers 640 - 1240	BRIDGE 5-6461
A-1 TELEVISION EMERGENCY PHONE CARD		

Card" (measures 8½" × 11") which fits inside the telephone book. (Note that the shop's phone numbers are plainly displayed.) Opposite side of the card describes the services offered by the shop and states its qualifications for giving "A-1" service.

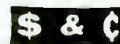

Carry-Out Service. If you're located on a busy street, a stream of commuter traffic probably passes by your shop every day. You can pull in some of that traffic by starting work a little earlier than most people, and putting up a sign with a legend like this:

We'll Repair Your Radio or Portable TV

OPEN 7:30

Leave It With Us On Your Way To Work

Pick It Up FIXED On Your Way Home

As for parking facilities, all you really need are a few convenient spaces that customers can slip into for a few minutes. However, if you have plenty of room around the shop, you could borrow an idea from modern banks and laundries—and install a drive-in window!

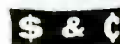

Tele-critics. On some future service call, you may find a "bug" or sensing device mounted on the tuner shaft of the TV set. Its purpose will be to determine which channel is being received and to relay this information over telephone wires to the offices of the American Research Bureau. Eventually, ARB plans to install a few thousand "bugs" in sets belonging to statistically-chosen "typical" viewers. Their choice of channels will be checked by a computer in ARB's central office to help networks and advertising agencies find out how popular the various TV shows are.

Shortly after the above "instant ratings" system was announced, the British topped it with "instant criticism." One of the commercial telecasting companies over there laid plans to install push-buttons on the sets of a small group of typical viewers. Whenever the program got displeasing, the viewer would be invited to push the button—sounding a loud Bronx cheer in the TV studio and thus leaving no doubt as to the rating of the show.

... for bigger sales,
the big new

Super "8"

It's brand new! Extra heavy. The King-size "8" Ball, for today's king-size market . . . but at a regular price! Popular, proved ball mount . . . adjusts up to 35°. Sleek and modern for today's cars. Triple chrome plated. 4 sections extend to 57". 54" lead cable. Outside, one-man installation. Boost your profits with this King of new antennas. Order the Model TCF-4 Super "8" today!

watch

w a r d

**WARD
PRODUCTS
CORP.**

1148 Euclid Avenue, Cleveland 15, Ohio
Division of The Gabriel Company
In Canada: Atlas Radio Corp., Ltd.,
50 Wingold Ave., Toronto, Ontario

the troubleshooter

answers your service problems

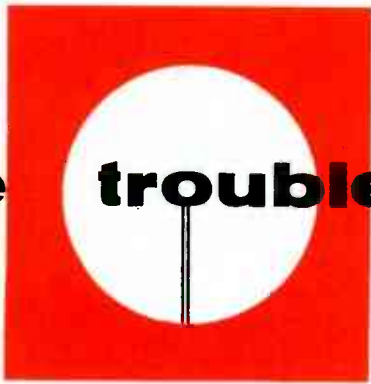

Intercarrier Conversion

I decided to modify a General Electric Model 810 to intercarrier sound, following the instructions given in the November, 1956 PF REPORTER. Woe is me! I installed the take-off coil, IF transformer and new 4.5-mc discriminator transformer, and was going along fine until I got to the 6AQ7GT tube, which is a combined dual-diode discriminator and AF amplifier. This tube has a common cathode for both diodes, so it can't be rewired to work with the new transformer. Can I hook this tube up in some way to function as a 4.5-mc discriminator, or should I put in a 6T8 or something else in its place?

HAROLD S. VANDEMAN
San Bernardino, Calif.

The simplest solution would be to substitute a pair of crystal diodes (such as 1N60's) for the diode sections of the 6AQ7GT. Forward and back resistances of the two diodes should be matched as closely as possible for best results.

If you run into persistent buzz troubles or alignment difficulties, we suggest that for better results, you wire up the circuit as a ratio detector instead of as a discriminator. Follow the circuit included with the ratio-detector transformer.

High-Voltage Circuit

I have seen TV sets in which the high voltage increases by as much as 3,000 volts when the horizontal windings of the yoke are disconnected from the flyback transformer. Is this normal?

JOHN BENNETT
Stockton, Calif.

No two designs of high-voltage circuits will work exactly alike, and disconnecting the yoke will bring about different results in different receivers. In some sets, the high voltage will be killed entirely; in others, it will continue to be developed because a resonant condition still exists between the inductance and distributed capacitance of the flyback. Taking away the yoke reduces the load on the flyback, and the value of the high voltage sometimes (but not always) increases as a result.

Lack of Height

A General Electric Model 21C201 had insufficient vertical sweep (raster only

8" high on a 21" tube). Linearity was reasonably good, sync was all right, and all voltages and resistances in the output stage were within tolerances. I checked all capacitors in this circuit by substitution, but to no avail. Then I discovered that with C91 disconnected the vertical sweep would increase, filling the screen and overscanning at the bottom. By increasing R85 from 3.9 meg to 10 meg, I was able to eliminate the excessive overscan with the vertical size control. The circuit now works perfectly—but I know I have not solved the original trouble. How can I do this?

F. E. MCCLUNG
Hugheston, W. Va.

Congratulations on wanting to stick to this job until you locate the real trouble. C91 and R89 supply a negative feedback signal to the grid of the output tube, and signal amplitude at the grid will naturally increase if they are disconnected. The signal will also become nonlinear, but the waveform can be partially straightened out by changing resistance or capacitance values in the multivibrator-output coupling circuit.

To get to the root of the trouble, find out why the sweep was inadequate to begin with. Restore the original C91 and R85, and check the grid waveform of the output tube. If its peak-to-peak value is less than approximately 35 volts, the multivibrator may be defective and not putting out enough drive signal. In case the grid waveform is normal but the plate waveform (measured between the green lead of the output transformer and ground) is low in amplitude, check the output stage again for trouble that might not have shown up during the first round of voltage and resistance measurements.

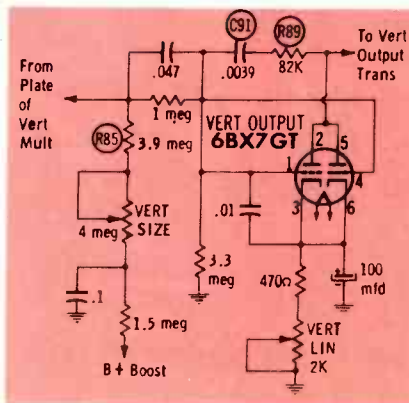

Horizontal Jitter

On a Silvertone Chassis 456.150-22 the picture has the horizontal jitters and also occasional pulling. The jitter can be stopped temporarily by adjustment of the brightness, contrast, or horizontal hold control. I have checked all resistors and capacitors in the horizontal circuits, and have also replaced all tubes in these stages. All voltages including B+ seem to be normal. After being turned on, the set is OK until it warms up; at times, it may operate for ten minutes or more before acting up.

HENRY SMITH
Culver City, Calif.

Repairing a stubborn case of horizontal jitter can be extremely difficult, and a methodical step-by-step procedure is essential in finding the trouble.

Although the horizontal AFC stage is the most likely suspect, you will save time if you make sure that operation of the horizontal oscillator is normal. Set the horizontal locking range and drive trimmers at one-quarter turn from the maximum closed position, and adjust the horizontal frequency and waveform slugs to obtain peaks of equal height in the combined sine and sawtooth waveform present at terminal C of the oscillator coil. If the proper waveform cannot be obtained without turning a slug beyond the center one-third of its range, the capacitors connected to terminals C, D, and G of the oscillator coil should be replaced one by one until operation within the normal range is restored. If this step is not carried out, the ratio of inductance to capacitance in the oscillator tuned circuit will be incorrect and the stability of the circuit will suffer.

After the oscillator has been correctly adjusted, check the AFC stage. One possible trouble is an open bypass capacitor in the plate or cathode circuit—indicated by a waveform amplitude of more than the normal 2 or 3 volts at plate or cathode. Other capacitors in the AFC stage, such as the sync and sawtooth input coupling capacitors, could also cause horizontal jitter if they become defective.

—And Vertical Jitter Too

An Admiral Chassis 22P2 came into the shop with vertical jitter. After disconnecting the integrator from the vertical oscillator, I found that the raster still bounced as much as ever. I checked all resistors and capacitors in the vertical circuits by substitution, and even tried a new blocking transformer, but I have not yet solved the problem.

ELMO ROBLEDO
East Chicago, Ind.

I've had similar troubles in several sets that use this same type of circuit and found that replacement of the vertical output transformer cured the jitter in each case. The trouble seems to be a minor defect such as a couple of shorted turns.

FREE! from **HOWARD W. SAMS...**

these valuable all-steel file cabinets with your purchase of
PHOTOFACT *the world's finest TV-Radio Service Data*



NOW—FOR PHOTOFACT

SUBSCRIBERS! You can get these File Cabinets **ABSOLUTELY FREE** from Howard W. Sams if you are a regular subscriber to PHOTOFACT and buy each Set as issued monthly...

NOW—FOR PHOTOFACT LIBRARY PURCHASERS!

You can get **FREE** File Cabinets as you complete your PHOTOFACT Library. What's more, you can own the PHOTOFACT Library the **NEW EASY-BUY WAY:**

There's no interest. There's no carrying charge. And Howard W. Sams will give you **ABSOLUTELY FREE** all the steel file cabinets you'll need for your Library.

Take advantage of this money-saving opportunity. See your Sams Distributor today, or write to Howard W. Sams for full details...



HOWARD W. SAMS & CO., INC.
2201 E. 46th St., Indianapolis 5, Indiana

- Send me full details on your FREE File cabinet offer and EASY-BUY Plan.
- I'm a Service Technician: full time; part time

My Distributor is: _____

Shop Name: _____

Attn.: _____

Address: _____

City _____ Zone _____ State _____

FREE file cabinets

NEW easy-buy plan

get the
details
NOW

B+ Leakage to AGC Line

I have a Muntz Model 2055 in which the voltage on the 135-volt low-B+ line measures only 80 volts. This line is connected to the power supply through the audio output tube. One by one, I pulled out all tubes having plates returned to 135 volts, but the B+ voltage did not rise until I pulled out the second video IF. I burned out a couple of 82-ohm cathode resistors in this circuit while trying to find the trouble, and even replaced the tube socket in an effort to eliminate any leakage path that might exist across it. The plate load resistors of all the IF tubes, which are supposed to be 680 ohms, measure only 1 ohm each. A highly positive voltage is present on the AGC line, and it was not eliminated by replacing all resistors in that circuit.

L. P. SCOTT

Los Angeles, Calif.

Keep on making an exhaustive check for leakage between the low-B+ line and the AGC line, since this is the most probable cause of your trouble. The most likely leakage paths which you have not already investigated are across the interstage transformer between the first and second IF, through the tuner-to-IF coupling capacitor, or across the socket of the first IF tube. If the trouble is not in any of these, try to isolate it by disconnecting one section of the 135-volt line at a time and rechecking the B+ and AGC voltages. Incidentally, have you tried new IF tubes? The 5-ohm reading across the plate load resistors has us completely baffled; all we can think of is that some ill-advised rewiring may have been done in the IF strip.

Video Response

I understand that the operation of a video amplifier can best be checked by using a square wave generator and scope. How should one connect the generator? Directly to the grid of the amplifier? How about the scope? Directly to the plate of the amplifier? Should the picture tube socket be disconnected?

A. D. MEIHOFF

Oceanlake, Ore.

A square wave generator and scope are excellent for checking video amplifier response, but the requirements for the equipment are strict. Scope response must be relatively flat to 4.5 mc, and the output of the square wave generator should be relatively constant from 30 cps to 30 kc.

In connecting the equipment, a network must be used to match the generator-cable impedance to the grid-load impedance. The oscilloscope can be connected across the plate load of the amplifier. Interpreting the waveform obtained on the scope screen is another story—a long one. It involves phase and frequency distortion, which are fully explained in an article, "Waveform Analysis," appearing in Howard W. Sams 1958 TEST EQUIPMENT ANNUAL.

Horizontal Shrinking

On an RCA Model 21T7375, the picture shrinks horizontally so that the black edges show. The effect is sometimes more noticeable on Channels 7 and 11 than on the others, and the shrinkage seems to be gradual. Power supply, horizontal oscillator, and horizontal output tubes have been changed and all others check OK.

BRIAN CHIN

New York, N. Y.

Have you made substitution checks of the high voltage rectifier and damper tubes? A tube tester could have failed to reveal a defect causing shrinkage.

Check the horizontal drive signal waveform when the picture looks normal and again when the shrinkage is present. If the drive signal is normal in both cases, the trouble is probably in the horizontal sweep circuit. If it is incorrect whenever shrinkage is noticed, look for defects in the horizontal oscillator circuit.

A marked departure from the normal boost B+ voltage of 580 volts could also be a symptom of horizontal sweep trouble, or it might indicate that one of the external circuits using boost voltage (vertical oscillator or picture tube accelerator grid) is placing an excessive load on the boost supply.

Slight shrinkage could conceivably be caused by insufficient AC line voltage. You might investigate whether or not this voltage ever drops much below the normal value of 117 volts.

Bad Case of Bends

"Suffering From the Bends" in the January issue reminded me of a case I ran across recently. The picture on a Philco Model 52T-2256 contained severe bending; it looked like Fig. 1 in the aforementioned article except that there was no hum modulation. I spent several hours checking components, voltage and resistance measurements and waveforms, but everything seemed OK.

Then, by a streak of good luck, I noticed a slight arcing sound which I was able to trace to a ground post near the horizontal AFC tube. Several components in the cathode circuit were grounded at this point. Suspecting a bad connection, I shorted the post to chassis—sure enough, the bending disappeared. The riveted ground post had

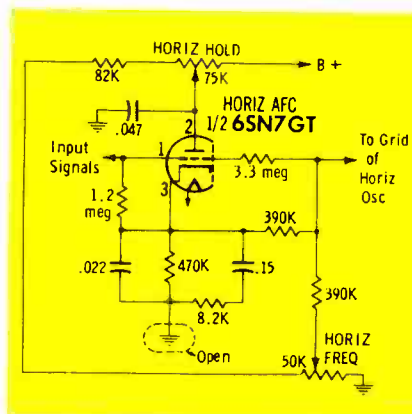

evidently become corroded enough to break the connection, but not enough to be seen.

B. GIULIANO

Fontana, Calif.

This was a tough one indeed. Unlike most pulse-width horizontal AFC circuits, this Philco design has two parallel resistive paths to ground from the cathode of the AFC tube; thus, the bad ground connection in one path did not cause the cathode to "float" but only increased the total resistance. The presence of the sneak circuit through the two 390K-ohm resistors and the horizontal frequency control would have made it necessary to interpret meter readings very accurately to suspect any trouble. For instance, the voltage reading at the cathode might have seemed plausible even though it was far enough off the correct value to cause severe bending.

Horizontal Pulling

I have a Raytheon Chassis 21T19 in my shop. When it first came to me, the horizontal oscillator was running wild. I replaced the stabilizer coil, and the circuit worked OK for two or three days. Then it began to pull from right to left—first at the top, and then in the middle. Readjusting the stabilizer coil and trying different coils has not helped.

R. L. HOTZ

Springville, Iowa

Pulling again! This symptom sometimes baffles even the best of technicians. In fact, it is so troublesome that we devoted a full-length article to the subject. See "Suffering From the Bends?" in the January, 1958 issue.

In servicing the pulse-width blocking oscillator in your Raytheon set, you would save much time by doing a little signal tracing. Use a scope to check the sync pulses arriving at the AFC stage. If they are normal, the pulling is probably due to unstable operation of the AFC-oscillator circuit itself, and you can go ahead and make a thorough check of the components in this circuit. Especially check the capacitors for leakage or abnormal change of value with temperature.

If something is wrong with the sync pulses, the source of trouble might be anywhere in the sync, video, AGC, IF, or RF circuits. More signal tracing would help you find the exact location of the faulty stage; for example, you could learn a lot by observing the composite video signal at the input of the sync separator. One fault to watch for in this signal is the presence of 60-cps hum, which indicates trouble such as heater-to-cathode leakage in an RF or IF tube.

Here's a final clue: Check for leakage in the capacitors in the AFC grid circuit, including the one which couples a signal from the sync amplifier. Leakage in any of these capacitors would cause the AFC grid voltage to vary, producing instability in the oscillator.

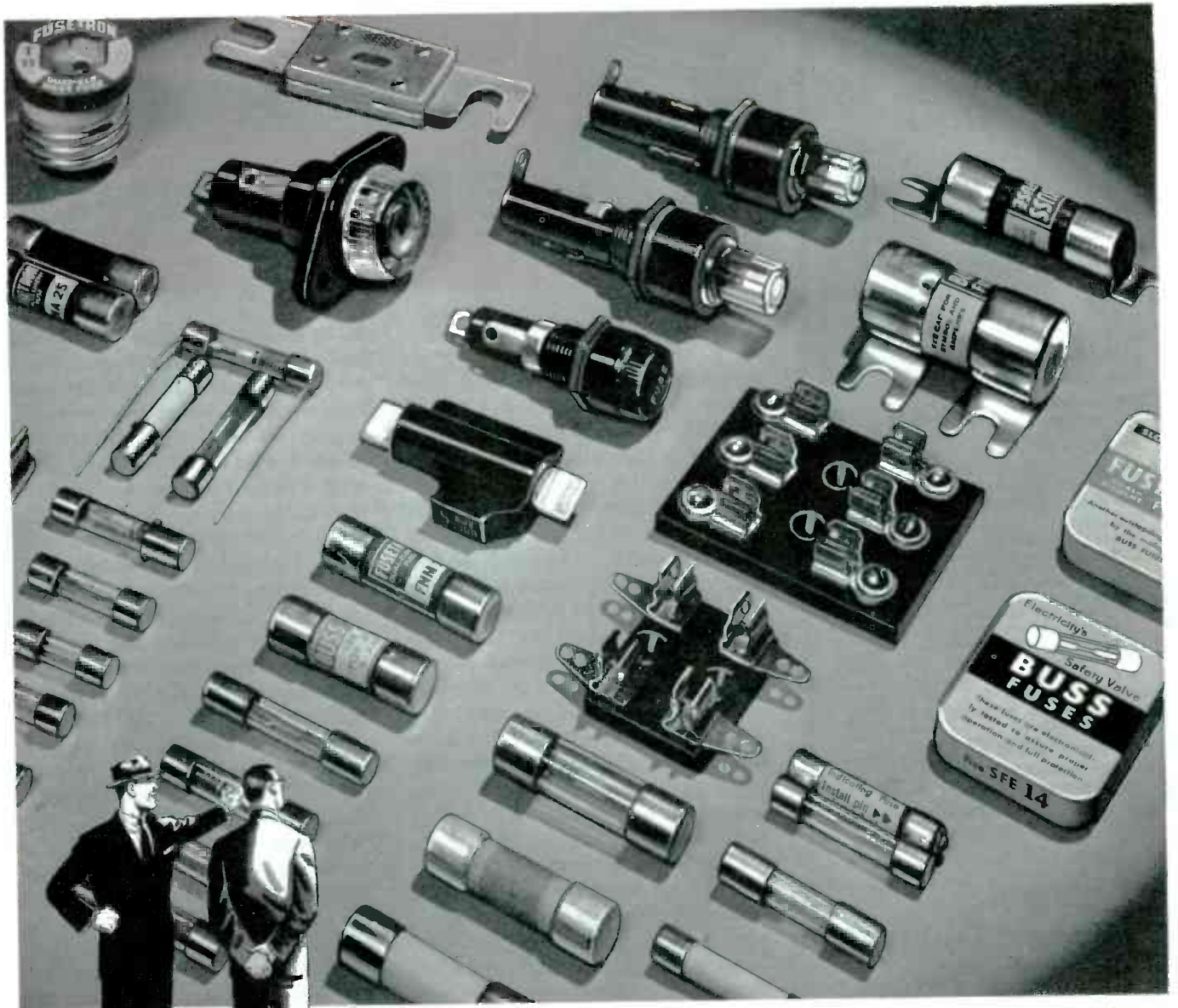

BUSS FUSES help you avoid adjustments and call-backs.

Faulty fuses can cause trouble for you and your customers by failing to protect — or by blowing needlessly . . . but, with BUSS fuses you can be sure of dependable protection under all service conditions.

Every BUSS fuse you sell or install is tested in a sensitive electronic device. Any fuse not correctly calibrated, properly constructed and right in all physical dimensions is automatically rejected.

That's why BUSS fuses provide maximum protection against damage due to electrical faults. Users are safeguarded against unnecessary repair bills, — and your reputation for quality and service is protected.

Equally important, BUSS fuses eliminate needless blows that irritate users and require adjustments or call-backs on the part of sales and service organizations.

Protect yourself against faulty fuses causing trouble by relying on BUSS fuses. To meet service needs, there is a complete line of BUSS fuses available.

For more information on the complete line of BUSS and FUSETRON Small Dimension Fuses and Fuseholders . . . Write for bulletin SFB. Bussmann Mfg. Division McGraw-Edison Co. University at Jefferson, St. Louis 7, Mo.

BUSS fuses are made to protect — not to blow, needlessly



MAKERS OF A COMPLETE LINE OF FUSES FOR HOME, FARM, COMMERCIAL, ELECTRONIC, AUTOMOTIVE AND INDUSTRIAL USE.

SENCORE
Another Sencore Time-Saver
Handy "36"
R-C Substitution Unit



"36"
Most Often Needed Components At YOUR Fingertips!

3 pole, 12 position switch individually selects one of the "36" components for direct substitution.

Contains:

- ★ 12—1 watt 10% resistors from 10 ohms to 5600 ohms
- ★ 12—½ watt 10% resistors from 10K ohms to 5.6 megohms
- ★ 10—600 volt capacitors. Completely isolated from 100-mmfd. to .5mfd.
- ★ 1—10mfd., 450V Electrolytic
- ★ 1—40mfd., 450V Electrolytic
- ★ For Shop, Lab, or outside service

AVAILABLE AT ALL PARTS DISTRIBUTORS!

SENCORE SERVICE
INSTRUMENTS CORP.
 171 OFFICIAL RD., ADDISON, ILL.

ONLY \$1275 DEALER NET

POPULAR SENCORE PRODUCTS

- Transistor Tester
- Leakage Checker
- Filament Tester
- Voltage Regulator
- Bias Supply

Cut out this ad now for further information.



QUICKER SERVICING

by Calvin C. Young, Jr.

Peculiar Picture Tube Troubles

How often have you told a customer his picture tube was weak, resulting in a picture too dim to watch? In cases like this, it is our suggestion that you do not try to justify all picture tube replacements with the "old song" that they are weak. While this is the way most picture tubes fail, there are other types of failures which should be brought to the customer's attention. Instead, say it has developed gas, is shorted, won't focus, or has an open element as the case might be. This will keep the customer from developing the idea that the only way picture tubes fail is by wearing out from old age.

Our reason for making this suggestion stems from recent encounters with two different troubles that almost defied solution. In each case, just as the technician was running out of new ideas and patience, he decided (having a sixth sense for these matters) to try a substitute picture tube. Lo and behold—the troubles were cured!

In the first case (a 21" Sylvania), the symptom was arcing in the picture when the brightness was turned up. At any usable brightness level, the effects of a pronounced arcing could be seen in the picture and heard from the speaker. Replacement of the HV filament resistor, flyback, yoke, 500-mmfd 20-KV capacitor, 1B3 tube socket, HV filament and yoke wiring were of no avail. In addition, the receiver was operated in a darkened room for a considerable period before the picture tube became suspect.

The second case was even harder to diagnose. A buzz developed when the brightness control was advanced. The trouble seemed to begin after the set was

in operation for about an hour, and then became progressively worse. After 2 or 3 hours, the buzz became so severe at any viewable brightness level that the set had to be turned off. This set, a CBS with a drop-down vertical chassis, was quite difficult to service for this trouble because of the series-string filament design which made it necessary to remove AC power each time a tube was substituted. In an effort to isolate the buzz, all RF, IF, video and audio tubes were checked by substitution. This failing, the technician surmised that the trouble was somehow associated with the picture tube, so the set was taken into the shop. The outer coating of the picture tube was checked carefully to make sure it was grounded, since radiation produced by arcing at the coating could be picked up and amplified.

The next step was to remove the chassis, separately-mounted tuner, and picture tube—a process that involved more than ¾ of an hour. After substitution of a 5AXP4 test tube for the picture tube, the buzz was no longer apparent. Evidently, there was a small gap between the inner coating and the forward end of the electron gun structure which was becoming wider with an increase in heat and closing up at near room temperature.

Somehow or other, this customer's mind was ingrained with the thought that "Old picture tubes never die—they just fade away," and it took some doing to explain the need for a new one.

Multiple AC Outlet Strips

Having enough AC outlets of the right type is always a problem in a TV-radio service shop. The problem develops because several pieces of test equipment, a soldering iron or gun, hand drill and other electric devices may be used

Channel King[®]
INDOOR TV ANTENNA



Extends to 42"
 Retracts to 0"

THE TRULY UNIQUE AND
 ADVANCED
 INDOOR ANTENNA

HIGH PROFIT SALES

- ☞ Hands NEVER touch Antenna arms
- ☞ SINGLE DIAL adjusts arms and signal
- ☞ FAST, positive wider range tuning
- ☞ UNBREAKABLE, flexible stainless steel arms
- ☞ COMPACT, attractive appearance
- ☞ 6 Rich Color Choices

See your Distributor . . . Or write for Literature and Specification Sheets
MARJO TECHNICAL PRODUCTS COMPANY
 1152 E. Henry Street, Linden, N. J.

Use Delco Radio Service Parts!

8-inch "Hi-Fi" speaker, No. 8007 offers the most highs, the most lows, the most watts in a medium-price speaker. Designed for replacement use and high fidelity audio systems.

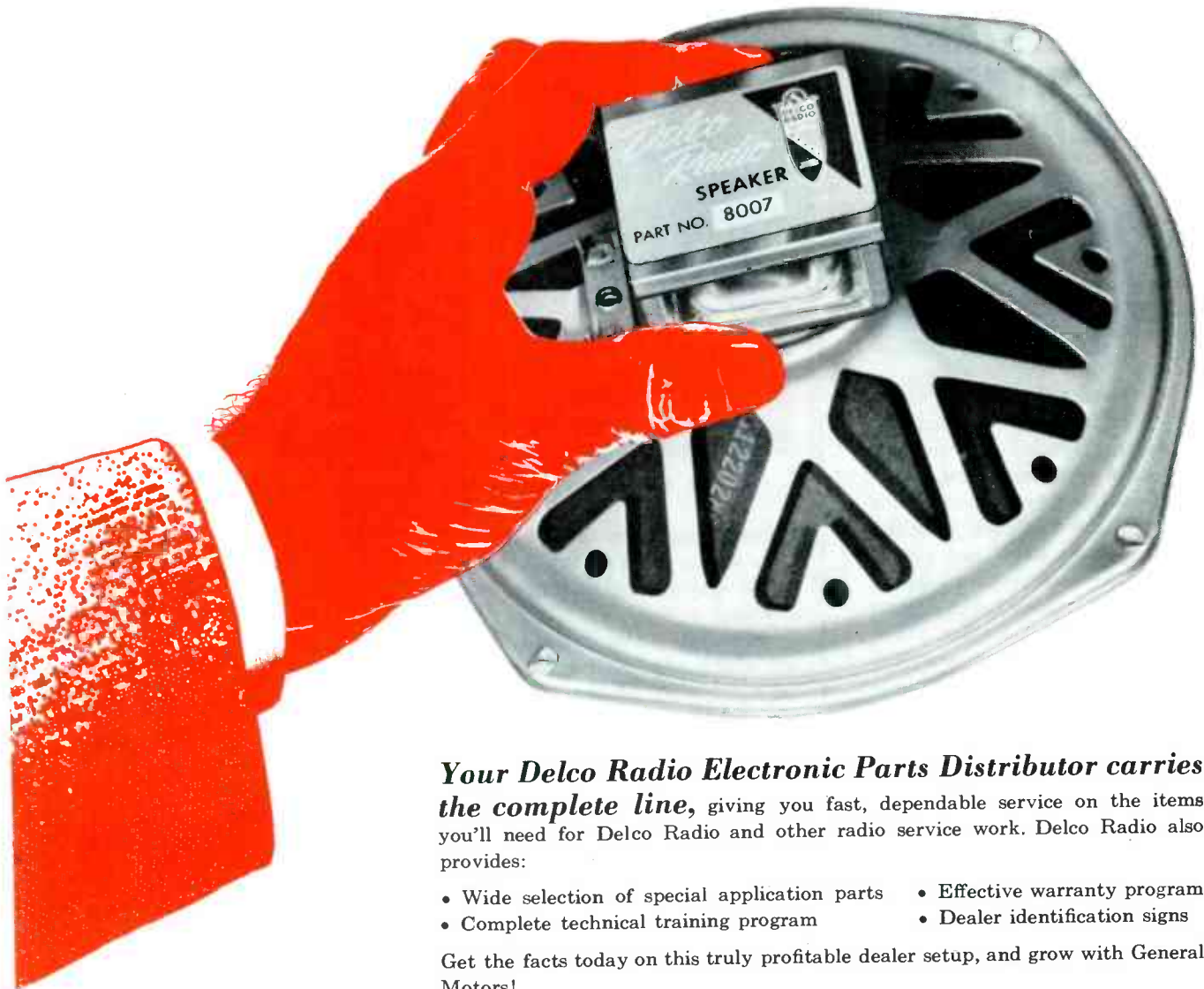

Your Delco Radio Electronic Parts Distributor carries the complete line, giving you fast, dependable service on the items you'll need for Delco Radio and other radio service work. Delco Radio also provides:

- Wide selection of special application parts
- Complete technical training program
- Effective warranty program
- Dealer identification signs

Get the facts today on this truly profitable dealer setup, and grow with General Motors!

Available everywhere through Electronic Distributors associated with . . .



DELCO RADIO

DIVISION OF GENERAL MOTORS, KOKOMO, INDIANA

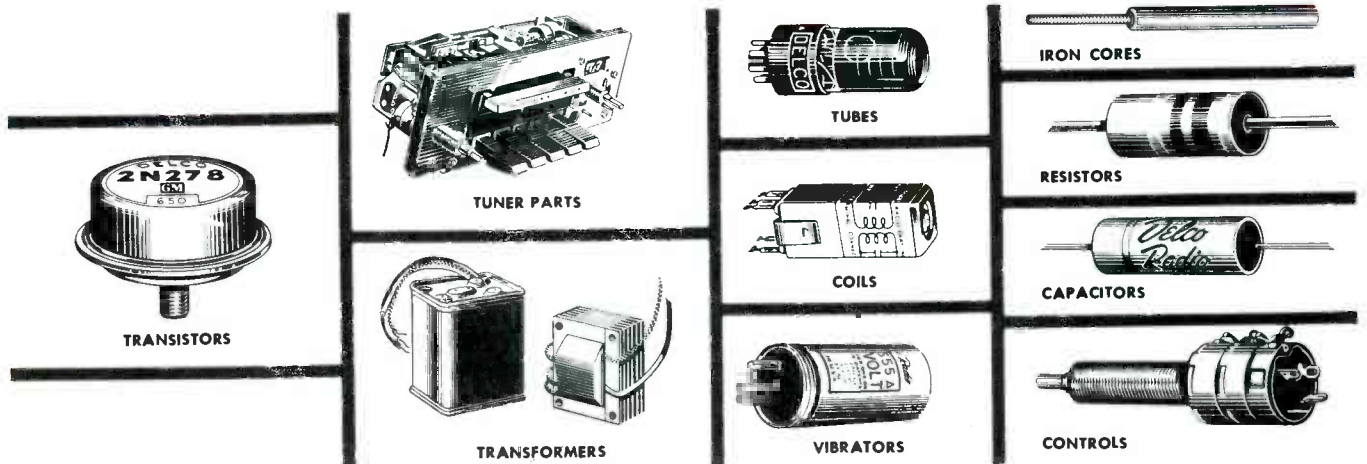

TRANSISTORS

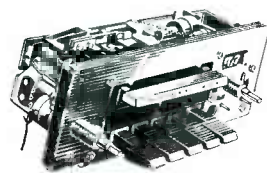

TUNER PARTS

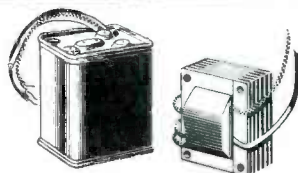

TRANSFORMERS



TUBES



COILS



VIBRATORS



IRON CORES



RESISTORS



CAPACITORS



CONTROLS

A Profitable New Field!

INDUSTRIAL ELECTRONIC SERVICING

with
OHMITE[®]
QUALITY
Components

Industrial electronic servicing is profitable new business for you. Especially when you stock and replace with dependable Ohmite components . . . the line your industrial customers know and prefer. Service such industrial equipment as mobile radio, aircraft and marine radar and radio, electronic controls for factory processes and automation, industrial P.A. and intercom systems, and—medical and dental electronics.

AXIAL-LEAD RESISTORS

Vitreous-enameled, power-type units designed to withstand high temperatures. In 3, 5, and 10-watt sizes.

BROWN DEVIL[®] RESISTORS

Vitreous-enameled. In 5, 10, and 20-watt sizes.

LITTLE DEVIL[®] COMPOSITION RESISTORS

Meet all MIL-R-11A requirements. Available in 1/2, 1, and 2-watt sizes in all standard EIA values.

MOLDED COMPOSITION POTENTI- METERS TYPE AB

Resistance material is solid-molded, noise-free. Rated at 2 watts.

Write for Stock Catalog 28

OHMITE[®]

DEPENDABLE
RESISTANCE
UNITS

OHMITE MANUFACTURING COMPANY
3644 Howard Street, Skokie, Illinois

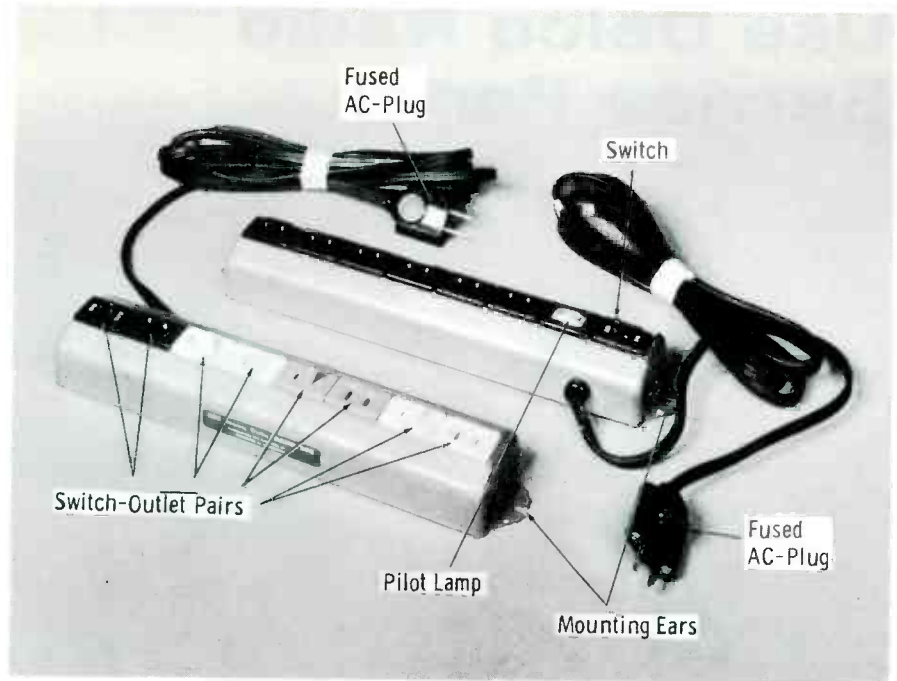

Fig. 1. Multiple AC-outlet strips such as these are useful bench additions.

in servicing from one to three TV sets and several radios at the same time on a single, large service bench.

Multiple outlet strips, two styles of which are illustrated in Fig. 1, are products of the C.B.C. Electronics Co., Inc. One of these strips features four separately-switched outlets, each switch-outlet combination in a different color for ease of identification. This type of strip would be very useful for the control of several pieces of test equipment from a single point. Another excellent use would be the final test bench where several sets could be operated in cycles, using the C.B.C. strip for a switch center.

The other strip features six outlets, all controlled by a single switch, and a pilot light to indicate whether or not the strip is on. This strip can be used on the front of the bench to provide handy outlets for solder gun, hand drill and sets under test.

Both strips have ears for convenience in mounting and, in addition, contain a heavy-duty AC cord and fused plug. Both styles are rated at 15 amps—115V for continuous duty.

The Do-It-Yourself Menace

We want to emphasize the do-it-yourself menace presented in the March article, "Do-It-Yourselfers are Soldering Now." Always

be alert, when questioning the customer about the trouble symptom, for any hint that he has been checking tubes, making adjustments or just "monkeying around" with the set.

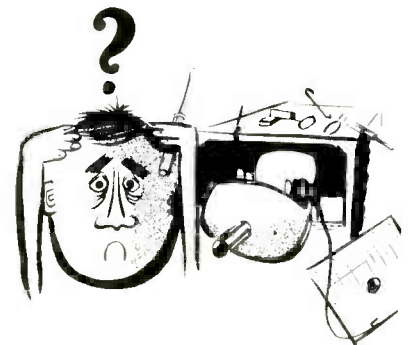

If the customer has been at work on the set, check to see that each tube is firmly installed and that the correct tubes are in each socket. On two separate occasions in the last 10 days the author has completed a service call by simply correcting tube location changes made by a do-it-yourselfer. In one case, a 6AV6 had been substituted for a 6AU6, apparently because the customer or drug store tube sales expect couldn't read the identification on the old tube. In another case, 6W4 and 6BQ6 tubes had been switched so that no horizontal sweep or high voltage was developed.

There are several other little ways in which the customer can cause troubles by trying to fix a

set himself, and you should be on guard against them. One of these is the switching of the plate-cap leads for the horizontal output and high voltage rectifier tubes, or of the output-tube plate and damper cathode leads. Another example of this switching will be found in the video IF strip, where different tube types may be employed in different stages; i.e., the first two stages using 6BZ6's and the last stage a 6CB6. Still another thing to be on the lookout for is loose tubes inside tube shields. I'm sure that many of you have had a tube come out of its socket when installing the shield, especially on tuners where the shield has to be pushed rather hard to make it snap in place. The customer, not being familiar with this, simply quit when the set failed to work after the tube was installed. This very thing happened to me just recently, in fact, and by simply removing the shield from the 6J6 local oscillator and reinstalling the tube and shield, a set was repaired.

Incidentally, you may wonder what was actually wrong with a set that caused a do-it-yourselfer to mess with it in the first place, seeing that a mere switching of tubes, etc. restores normal operation. You may never find out, but in all probability, the customer has replaced several tubes, and one of them was the original culprit.

One further hint—a good many of the operators who own and supply self-service tube testers place an identifying paint spot on the keyway of octal-based tubes or on the base of miniature types. This is a good tip-off that the customer is an active do-it-yourselfer and a warning for you to be on guard. ▲

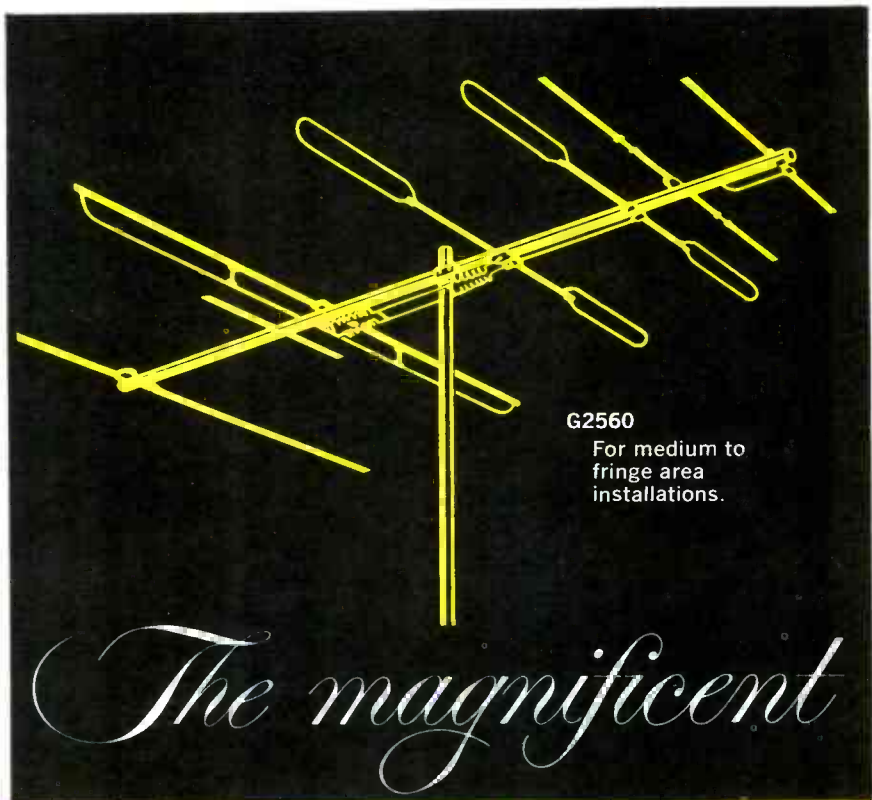

G2560
For medium to fringe area installations.

The magnificent

TACO *Topliner*
GOLDEN

without equal for performance,
quality and value

THE ANTENNA FEATURED ON
DREW PEARSON'S FAMOUS TV PROGRAM

"NEW HORIZONS"

LOOK FOR THE NEW TACO "QUIKIE"

THE COMPLETE ANTENNA SYSTEM
IN A SINGLE CARTON THAT INSTALLS
IN 10 MINUTES WITH NO FUSS, NO MUSS...

Write for details...

TACO *Topliners*
Trade-mark

TECHNICAL APPLIANCE CORPORATION, SHERBURNE, N. Y.
In Canada: Hackbusch Electronics, Ltd., Toronto 4, Ont.

notes on TEST EQUIPMENT

Informative reports from the lab

by Les Deane

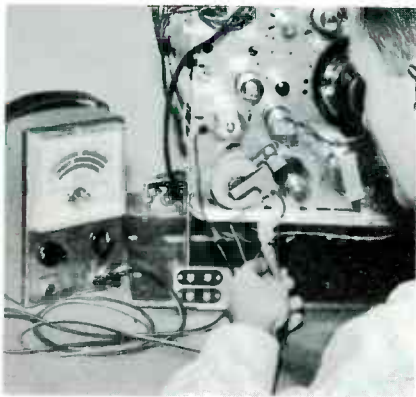

Fig. 1. EICO Model 944 is useful in testing flyback transformers and yokes.

Sweep Analyzer Speeds Troubleshooting

A recently-developed EICO instrument for use in checking major sweep components of a TV receiver, pictured in operation in Fig. 1, is identified as the Model 944 Flyback Transformer and Yoke Tester.

Specifications and test features are:

1. Power Requirements—105/125 volts AC, 50/60-CPS; transformer provides line isolation.
2. Shorts Test—checks flyback transformer and yoke windings for shorts; test signal approximately 600-cps; test voltage 100 volts RMS.
3. Continuity Test—checks flyback transformers, yokes, and other components for continuity; test voltage 60 volts RMS; test leads provided.
4. Meter—4½" 50 μa panel type; internal resistance 2000 ohms; three separate "GOOD-BAD"

scales plus one linear scale of 0 to 100 provided.

5. Size and Weight—8½" × 5" × 5", 5 lbs.

Having had the opportunity to use this particular instrument the other day, I thought our readers would be interested in seeing exactly how it operates. Before laying a hand on the unit, I naturally consulted the operating instructions, and found the test procedures simple, although certain steps must be taken before an accurate check of a flyback or yoke can be realized.

First, I decided to check out a good flyback in a modern TV chassis, and following instructions, I removed power from the receiver and disconnected the plate leads

of both the high voltage rectifier and horizontal output tubes. Next, I removed the high voltage rectifier tube from its socket and unplugged the deflection yoke. Had the system employed a width coil, I would have disconnected one side from the circuit. Performing these operations completely unloaded the transformer, and the instrument could now give a true indication as to this component's worth.

After permitting the Model 944 to warm up for a full minute, I placed the selector switch in continuity position and adjusted the calibration control until the meter pointer came to rest at the line marked "air core cont. cal" on the upper meter scale. With test leads disconnected from the instrument, this calibration procedure is to be followed for all continuity tests of both air core and iron core units.

Attaching the test leads between the front panel binding posts and the ends of each winding on the flyback, I found that the meter pointer registered in the "good" area in each case. Had the pointer remained stationary or registered anywhere in the "bad" region of the continuity test scale, an open or very high resistive winding would have been indicated.

To complete the flyback test, I next set the selector switch in the shorts position and adjusted the calibration control until the pointer came to rest at the line

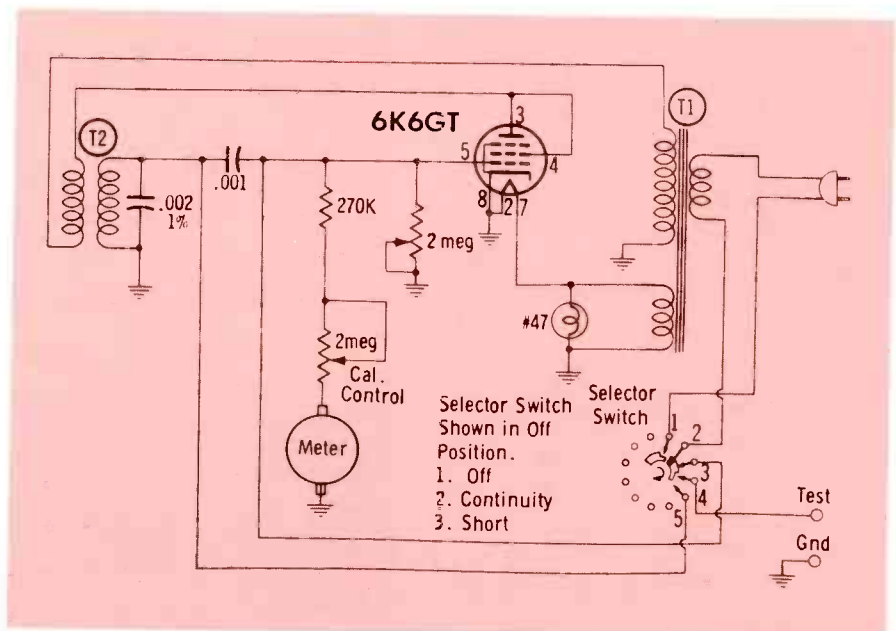

Fig. 2. Schematic diagram of the EICO Model 944 indicates that the unit operates on the grid-dip principle and uses a triode-connected 6K6 oscillator circuit.



NEW TRIPLETT MODEL 630-PL \$44.50 net

new... most easy to read



- Clear, unbreakable, shadowless front for instant wide vision.
- 5 to 500,000 cps on A.C.
- Continuous resistance reading from 0.1 ohms to 100 megohms.
- Polarity reversing switch.
- Only one (king-sized) switch selects both circuit and range —minimizes wrong settings, burnouts.

Only Triplet affords you such a wide choice of VOMs. Whatever your application—broad or limited—there is a Triplet VOM particularly suited for it.

the mighty nine + two

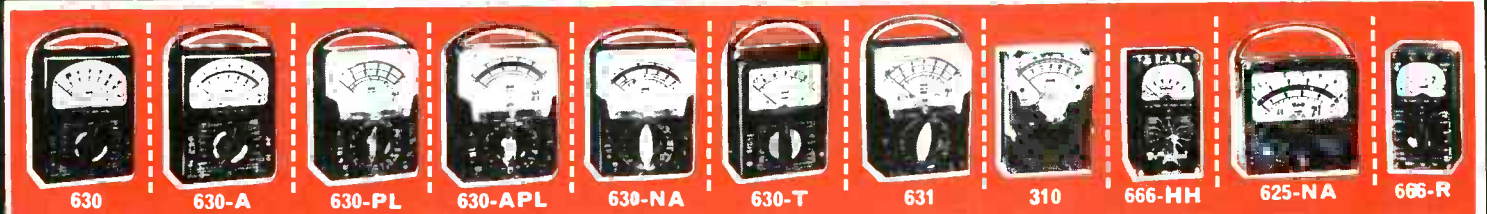

KRYLON

faster...easier
more efficient



KRYLON Crystal-Clear Acrylic Spray Coating

... standard equipment for TV and radio servicemen.

- Prevents corona in high voltage section
- Keeps lead-in connections tight
- Prevents rusting and pitting of antenna
- Goes on in seconds—dries in minutes



KRYLON Spray Enamels

(19 decorator colors) ... perfect for touchup and maintenance work ... covers practically any surface ... dries in minutes.



KRYLON Varnish Sprays

... HIGH-GLOSS and SATIN-FINISH (alcohol and hot liquid resistant) for professional finish ... dries in minutes.



KRYLON Dulling Spray

... a "must" in TV, movie and photographic studios.

- Eliminates glare, bothersome high-lights
- Simplifies lighting arrangements
- Easy to apply ... sets in seconds
- For both black and white and color use



KRYLON Foaming Window Spray

... removes finger marks and dust from TV masks and screens ... good antistatic properties.



KRYLON Rust Release Penetrating Oil Spray

... instantly, easily frees rusty bolts and nuts and "frozen" parts ... lubricates as it penetrates.



The choice of professionals

Call your jobber or write

KRYLON, INC., NORRISTOWN, PA.

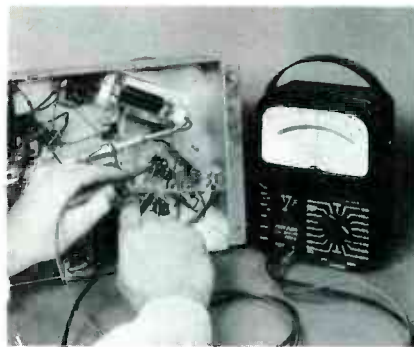

Fig. 3. Precision Apparatus Model 120M has mirrored scale and 44 total ranges.

marked "iron core cal." For air core units, the "air core cont. cal" point is used for calibration as in the continuity procedure. For an over-all shorts test of 70° to 90° flyback designs, the test leads are connected between the two floating plate-caps (across the high voltage section of the primary winding). When checking older type flybacks (used in less than 70° deflection circuits), the technician is instructed to connect the test leads across the entire primary winding; i. e., from the B+ boost terminal to the high voltage rectifier plate lead.

When performing this shorts test, I noted that the meter pointer gave an indication in the "good" region slightly higher than the original calibration point on the "Xfmr short test" scale. Naturally, this meant that the entire flyback had passed the shorts test, since a short anywhere in the unit would have been detected in this single operation. Continuing my examination, I found that both vertical and horizontal windings of a deflection yoke can be checked for continuity and shorts in a like manner. The operator must remember, however, to disconnect all shunt resistors and at least one side of the yoke.

Mirrored-Scale VOM

Especially designed for a wide range of accurate measurements, the Model 120M being used in Fig. 3 is manufactured by Precision Apparatus Co., Inc. of Glendale, Long Island.

Specification features and ranges are:

1. Power Source—three self-contained batteries, two 1½-volt units replaceable with standard flashlight cells and one 15-volt miniature battery.



Fig. 4. Close-up of 120M meter shows mirrored scale which eliminates parallax.

2. Panel Features—5¼" 50 µa meter, accuracy 1%; function switch for ±DC, AC or ma; range selector switch with special "transit" position; ohms adjustment control; 2 standard test jacks and 5 special jacks for extended ranges.
3. DC Voltmeter—8 ranges of 0 to 1.2, 3, 12, 60, 300, 600, 1200 and 6000 volts; sensitivity 20,000 ohms/volt; accuracy ±1.5% on all ranges to 1200V, ±2.5% on 6000V range.
4. AC Voltmeter—8 RMS ranges of 0 to 1.2, 3, 12, 60, 300, 600, 1200 and 6000 volts; sensitivity 5000 ohms/volt; accuracy ±3% on all ranges to 1200V, ±4% on 6000V range.
5. AC Output Meter—ranges same as AC voltmeter; special output jack provided with 600V blocking capacitor; 8 db ranges from -20 to +77, zero db corresponds to 1 milliwatt of AC power across a 600-ohm impedance, 2 direct-reading scales provided on meter.
6. Ohmmeter—5 ranges of R × 1/10 (center scale 2 ohms), R × 1, R × 100, R × 1000, and R × 10,000 up to 20 megohms; accuracy within 3% of scale length; zero adjustment provided.
7. DC Ammeter—7 ranges of 0 to 60 µa, 300 µa, 1.2 ma, 12 ma, 120 ma, 600 ma and 12 amps, separate 12-amp jack provided on front panel.
8. Size and Weight—5⅜" × 7" × 3⅜", 4 lbs complete with batteries and test leads.

When using this particular meter in several lab experiments, the first design feature to draw my attention was its wide-angle mirrored scale. A close-up of the meter face is shown in Fig. 4. The mirrored slot near the center of

Now

this

Greenohm*

has

“everything...”



Vitreous Enamel Coated GREENOHM V POWER RESISTORS

Yes, NOW! All the outstanding quality and performance of the famous Clarostat “Greenohm” Power Resistors in a glass-smooth, vitreous-enamel-coated unit. It’s the new Clarostat “Greenohm V” Power Resistor made to MIL-R-26C specifications and available in 5- to 200-watt sizes. Resistance values to 900K ohms. Wide selection of mountings.

- ★ Available in fixed and adjustable types.
- ★ $\pm 5\%$ tolerance for resistance values of 50 ohms and over; $\pm 10\%$, 49.9 ohms and under. Closer tolerances available on special order.
- ★ Welded connections to terminals. Sturdy terminals.
- ★ Many variations available to your needs.

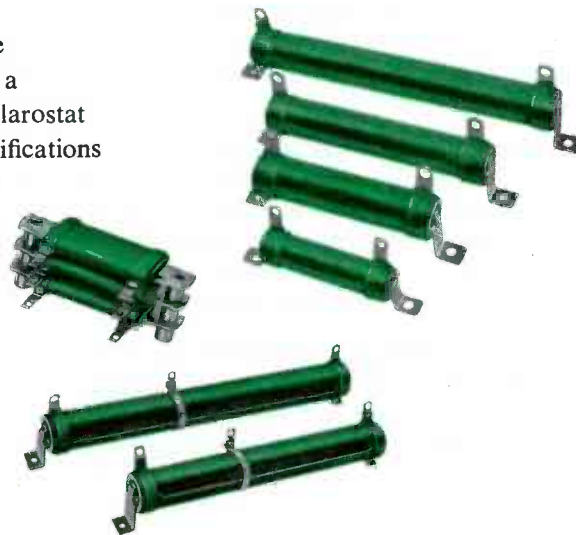

Standard and stocked GREENOHM V resistors are available from your Clarostat distributor.



*Reg. U.S. Pat. Off.

Controls and Resistors

CLAROSTAT MFG. CO., INC., DOVER, NEW HAMPSHIRE

In Canada: CANADIAN MARCONI CO., LTD., TORONTO 17, ONT.



TELECOUPLERS

STOCK & DISPLAY BOTH!

COLORCOUPLERS



let your Customers choose!

Only AMPHENOL provides a choice in fine TV set couplers. Color-Couplers and Tele-Couplers are different in design and price range, but alike in superb performance. Stock and display both for maximum sales!

TELECOUPLER has an improved distributed line parameter of bifilar coiled transmission lines which isolate the signals and distribute them equally to each set with near perfect impedance matching. Telecouplers are available as 2 set model 114-088 and 3 & 4 set model 114-090; suggested list prices are \$3.75 and \$5.75 respectively.

COLORCOUPLER employs balanced resistive networks to accomplish excellent impedance matching, flat signal response, low loss and effective isolation. Colorcouplers can be mounted vertically or horizontally and have built-in twin lead strain relief. Available as 114-097 (2 set), 114-098 (3 set) and 114-099 (4 set) models; suggested list prices are \$2.95, \$3.95 and \$4.95 respectively.

For sales action over your counter and for assured customer satisfaction through reliable performance, buy both of AMPHENOL's couplers—Telecoupler and Colorcoupler!

AMPHENOL ELECTRONICS CORPORATION
chicago 50, illinois

the face increases the accuracy of meter reading by eliminating parallax. In making use of this feature, the technician should view the meter needle and its reflection as a single image.

The meter itself has a laboratory accuracy of 1%, using a full double-bridge circuit and D'Arsonval movement. Its face has six separately scribed arcs providing readings for a total of 44 AC and DC ranges. Other desirable features are the polarity-reversing switch for DC measurements and the "transit" position on the rotary range selector, incorporated to protect the meter movement when the instrument is not in use.

Although the specifications given for this instrument point out its obvious servicing applications, I found two interesting discussions in the instruction manual covering leakage measurements of paper, mica and electrolytic capacitors using the ohmmeter function of the instrument.

Portable Component Checker

Service Instruments Corp. (Sen-core), Addison, Ill. is now marketing a completely new instrument known as the Model TRC4 Transistor and Rectifier Checker. Pictured in Fig. 5, this lightweight portable unit will check transistors, crystal diodes, and selenium rectifiers. Instruments of this nature are becoming of greater interest to the service technician because of the increasing use of transistors in portable and auto radios—and perhaps soon in TV receivers.

Specifications and test features are:

1. Power Source — one self-con-

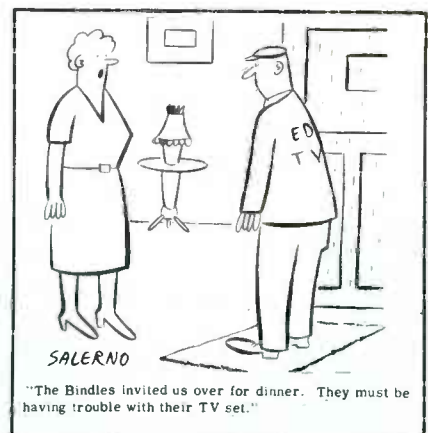

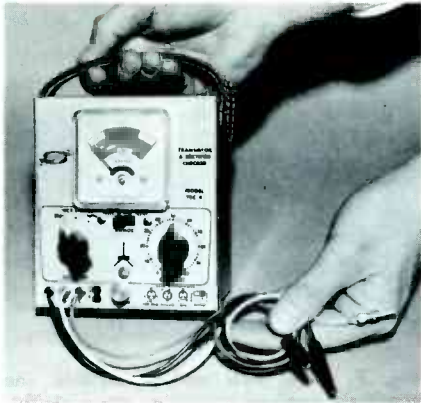

Fig. 5. Sencore TRC4 checks transistors, crystal diodes, and selenium rectifiers.

tained 6-volt battery, universal replacements available.

2. *Panel Features*—PNP/NPN/RECT-DIODE selector switch; range switch for high- or low-power transistors; gain control and test button; gain-leakage meter, one standard-base transistor socket plus separate emitter, base, and collector test leads.
3. *Transistor Tests*—measurements of p-n-p and n-p-n units for leakage current and amplification factor (Beta); special test for power transistors and noise level checks; setup chart provided.
4. *Diode and Rectifier Tests*—forward-to-reverse resistance ratio indicated in terms of current flow for all crystal diodes and selenium rectifiers; gain button serves as polarity-reversing switch; test leads provided.

In my examination of the Model TRC4, I thought it might be well to see what indications the instrument provided for both good and defective transistors. Selecting two commercial units (one defective and the other of known good quality) from a supply used for transistor research work, I proceeded with the tests, following the instructions outlined in the manual and setup chart supplied with the instrument.

Since the cat-whisker leads on both transistors were long and not yet fashioned for socket insertion, I used the test leads for the sake of convenience. The first unit I checked was a type 2N44, and after removing the chart from a slot on the rear of the instrument, I looked down the list of transistors until I found the corresponding setup information. The first

JUST PLAIN FACTS!

We're not going to shout exaggerated claims about our product . . . we respect your experience . . . we simply want to present plain facts about why Astron's "Safety Margin"* capacitors give you top performance . . . every time.

- ① Astron "Safety Margin"* Material Control: 99.99% pure aluminum foil for low leakage, premium quality paper for high dielectric strength, hermetic sealing for reliability in all climates, our exclusive impregnation and electrolytes for long life.
- ② Astron's "Safety Margin"* Construction: Contamination free assembly to eliminate corrosion, long impregnation cycles for low leakage, heat-aging for reliability.
- ③ Astron "Safety Margin"* Quality Control: 100% incoming material inspection, "floating inspection" by military sampling methods, "in-line testing" of every unit PLUS a 100% final quality control inspection.

The extra "Safety Margin" is our investment in your business — do away with costly call-backs — insist on Astron capacitors.

*Trade Mark



ASTRON

C O R P O R A T I O N

255 GRANT AVENUE, E. NEWARK, N. J.

WEST COAST: 4109 BURBANK BLVD., BURBANK, CALIF.

Another Sencore Time-Saver

the **ALL NEW**
SENCORE
Align-O-Pak
TV
BIAS SUPPLY



For **BLACK and WHITE**
and **COLOR**

Just Dial any DC Voltage from 0 to 18 volts positive or negative—For AGC trouble shooting and alignment—Do away with messy bias batteries.

Completely isolated. Recommended by TV manufacturers. Wire wound control for calibration accuracy. For AGC trouble shooting, connect to AGC buss and vary voltage from 0 to 18 volts negative. If picture stabilizes at any voltage, AGC is defective. Complete with test leads.

MODEL BE3
\$785
Dealer Net
Leather Carrying Case...\$2.95

Mfg by **SENCORE**

SERVICE
INSTRUMENTS CORP.
171 OFFICIAL RD. ADDISON, ILL.

POPULAR SENCORE PRODUCTS

- Transistor Tester
- Leakage Checker
- Filament Tester
- Handy "36"
- Vibra-Adapter

Grips the screw!
Drives it too!

Quick-Wedge
SCREW-HOLDING
SCREWDRIVER

2" to 14" blades, 4 bit sizes.
Available with shockproof plastic covered tubing
Unconditionally guaranteed

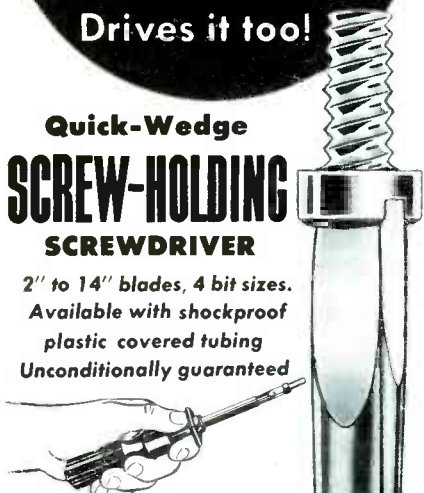

ASK FOR IT AT YOUR DEALER
Kedman Co., 233 South 5th W.,
Salt Lake City, Utah

column on the list told me that the unit was a p-n-p type; therefore, I placed the selector switch in the appropriate position. Next, I set the gain control to the value shown in the right-hand column, which in this case was 47.

With the range switch in the "all other tests" position, I then connected the red test lead to the collector element, the black to the emitter, and the yellow to the base. The center column of the setup chart indicates the proper scale on which to read leakage current; in this instance it was the scale marked "C." The transistor passed this test with flying colors, since the meter needle moved only slightly, remaining in the green or good area and indicating that the component had no excessive leakage and was not open.

The next phase of the test was a relative gain measurement. Leaving the 2N44 connected as for the leakage test, I then depressed the gain button located in the lower center of the front panel and noted the meter reading on the top scale. Once again, the meter registered in the green region of the scale, thus proving the unit possessed a satisfactory gain characteristic.

I also performed the leakage and gain tests on the defective transistor, which was a 2N35, and found the unit to be shorted. On both tests the meter needle banged the right-hand pin stop.

To give the reader an insight into the physical construction of this Sencore Checker, its major circuit components are identified in the chassis view of Fig. 6.

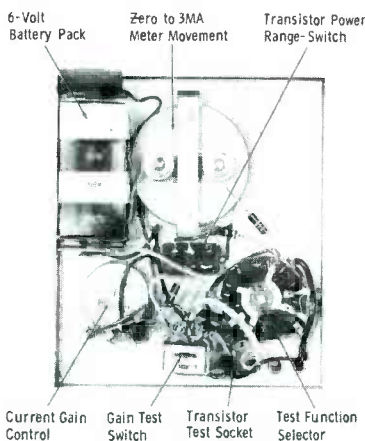

Fig. 6. Chassis view of the Model TRC4 showing its major circuit components.

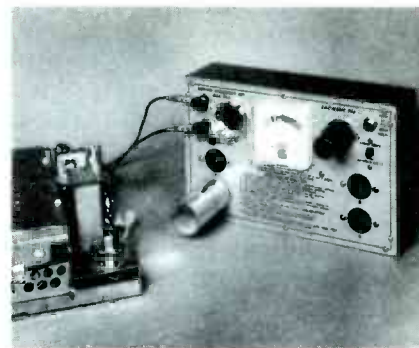

Fig. 7. EMC 906 makes possible the complete analysis of almost any vibrator.

There's a lot of Vibrators On the Road!

One of the most common causes of auto radio failure is an inoperative or defective vibrator. In the average service shop, vibrator testing usually consists of exchanging the suspected unit with a suitable replacement. With so many various types now in use, however, the old reliable substitution method bogs down unless you maintain a complete stock of replacements. Furthermore, it is entirely possible that some circuit defect has resulted in damage to the vibrator. Who wants to risk a new replacement to find this out? To help solve the problem, Electronic Measurements Corp. (EMC), N. Y. C., has recently introduced their Model 906 Vibrator Checker. Pictured in Fig. 7, the instrument is available in either a kit or factory-wired form.

Specifications and test features are:

1. **Power Requirements**—Battery eliminator equipped with an ammeter having at least a 5-amp range and DC variable from 4 to 12 volts.
2. **Panel Features**— "good—bad" indicating meter; 6V–12V selector switch; input power supply terminals; shunt or separate drive selector; input voltage button for monitoring starting and test voltages; 5 vibrator test sockets; octal socket for rectifier tube; operating instructions printed on the panel.
3. **Components Tested**—most all 6- or 12-volt vibrators of either the interrupter or synchronous types.
4. **Short and Start Test**—checks vibrator for short or open using power supply ammeter, and for proper starting under con-

trolled low-voltage conditions.

5. *Quality Test*—checks vibrator output under normal operating voltage; direct indications on “good-bad” meter scale; separate scale calibrations provided for interrupter and synchronous types.

I was able to obtain a Model 906 for some work on auto radios recently, and, while this involved tests outside the normal scope of servicing, I became acutely aware of the unit’s advantages in the everyday servicing of vibrator-operated equipment. I found that the circuit of the tester duplicates the electrical characteristics of a typical vibrator power supply, and with a suitable power source, can be used to accurately determine the true condition of most any questionable vibrator.

The test setup for the instrument is illustrated in Fig. 8. In the operating instructions, mention is made of the fact that when testing an interrupter or nonsynchronous vibrator, a suitable rectifier tube must be used. As many of us know, the interrupter type merely converts DC voltage into AC square-waves and thus requires an additional circuit for rectification. The synchronous vibrator, on the other hand, is equipped with an extra set of contacts needed for voltage conversion.

Synchronous units are seldom encountered in late-model radios, but they can always be spotted—the absence of a power rectifier tube on the chassis is a dead giveaway! It might also be well to remember that all vibrator type numbers having a “G” prefix are 12-volt units. ▲

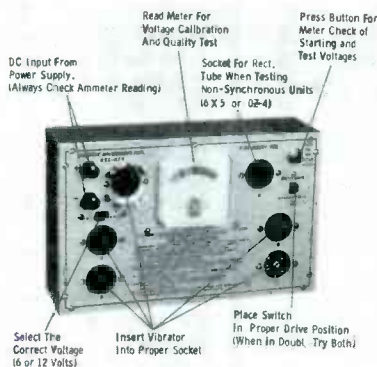

Fig. 8. Test setup using the Model 906, showing connections and panel features.



VERSATILE . . .

Aerovox Hi-Q disk capacitors are excellent replacements for molded mica, ceramic-cased tubulars, and paper tubular capacitors in many applications, such as by-pass and filtering. These versatile disk ceramic capacitors help you to do a better service job faster. They're available in a wide variety of types and sizes from by-pass and coupling types to temperature compensating types to vibrator buffer units. Your local Aerovox Distributor stocks the complete line of Aerovox ceramic capacitors along with thousands of other top quality Aerovox capacitors.



RUGGED DEPENDABILITY . . .

High-voltage “Cartwheel” ceramic capacitors capable of providing long and dependable service life while withstanding rugged high voltages. Available in a new universal type (UV) with interchangeable terminals in 5 styles for use in filter and by-pass applications in TV high voltage power supplies. Available from your local Aerovox Distributor in 10,000, 20,000 and 30,000 volt sizes at 500 mmf.



Ask your local Aerovox Distributor for your free copy of the latest Aerovox Servicemen's Catalog.

AEROVOX CORPORATION

DISTRIBUTOR DIVISION

NEW BEDFORD, MASS.

STOCK GUIDE for TV tubes

The chart on this page lists virtually all tube types employed in TV receivers and includes figures which state the number of tubes of each type you could expect to find among a random sampling of 1,000 tubes taken from all TV sets now in service. A dash shown in place of a figure in the "No. of Units" column indicates a new or rarely-used tube which is used considerably less than once in 1,000. If you are stocking a tube caddy or a small shop, we suggest that you concentrate on the types for which figures are listed.

The information in the chart is purely

statistical and should not be considered as a recommendation to stock a specific number of tubes of each type. However, you can combine the statistics with your own experience and come up with information tailor-made to your own needs. Be sure to consider the following factors:

1. Relatively high failure rate of certain types such as RF amplifiers and power output tubes, requiring that larger stocks of these types be kept than a literal reading of the chart would indicate.

2. Specialization in particular makes of sets—for example, regionally popular brands. As a national publication, PF REPORTER necessarily gives nationwide averages based on all brands of receivers.

Redesigned "A" and "B" versions of tubes can almost always be used in place of their prototypes. All type numbers (or "A" or "B" suffixes) marked with an asterisk are 450-ma series-string types now in actual use. A dagger indicates a 300-ma series-string tube, employed only in General Electric or Hotpoint 9" portable sets.

TUBE TYPES	NO. OF UNITS	TUBE TYPES	NO. OF UNITS	TUBE TYPES	NO. OF UNITS	TUBE TYPES	NO. OF UNITS	TUBE TYPES	NO. OF UNITS
1AX2	—	*5BQ7A	—	6BC5	5	6CN7	1	†9U8	—
1B3GT	41	5BR8	1	6BC7	—	*6CQ8	—	†10C8	—
1G3GT	—	5BT8	—	6BC8	1	6CS6	3	10DE7	1
1J3	—	5CG8	1	6BD4/-A	—	6CS7	1	12AT7	9
1V2	1	5CL8	1	6BE6	6	6CU5	—	12AU7/-A	29
1X2A/-B	9	5CM8	—	6BF5	1	6CU6	3	12AV5GA	—
2BN4	1	5CQ8	—	6BG6G	3	*6CU8	—	12AV7	2
2CY5	1	5CZ5	1	6BH8	1	6CX8	—	12AX4GT/-A	8
3A2	1	5DB4	—	6BJ7	—	6CY7	—	12AX7/ECC83	5
3A3	1	5DH8	—	6BJ8	—	6CZ5	—	12AZ7	1
3AL5	2	5J6	1	6BK4	—	6DB5	—	12B4A	2
3AU6	4	5T8	2	6BK5	1	6DC6	—	12BH7/-A	12
3AV6	—	5U4GA/-B	42	6BK7A/-B*	6	6DE6	2	12BK5	1
3B2	—	5U8	5	6BL4	—	6DG6GT	1	12BQ6GA	—
3BC5	1	5V3	—	6BL7GT	6	6DK6	—	12BQ6GTA/-B	1
3BN6	3	5V6GT	1	6BN4	1	6DN6	—	12BR7	—
3BU8	1	5X8	1	6BN6	6	6DS5	—	12BV7	—
3BY6	—	5Y3GT	2	6BN8	—	6DQ6/-A	2	12BY7/-A	11
3BZ6	4	6AB4	1	6BQ5/EL84	—	6DT6	1	12BZ7	—
3CB6	11	6AC7	4	6BQ6G/-A	2	6J5	3	12C5/12CU5	1
3CF6	1	6AG5	5	6BQ6GTA/B	18	6J6	21	12CA5	1
3CS6	1	6AG7	2	6BQ7A	15	6K6GT	7	†12CT8	—
3DK6	—	6AH4GT	3	6BR8	—	6M3	—	12CU6	1
3DT6	2	6AH6	5	6BS8	1	6S4/-A	1	12D4	—
*4AU6	—	6AK5	2	6BU8	1	6SL7GT	1	12DB5	—
*4BC5	—	6AK6	—	6BV8	—	6SN7GT/-B	63	12DQ6/-A	4
4BC8	1	6AL5	58	6BW8	—	6SQ7	2	12L6GT	2
4BN6	—	6AM8/-A	3	6BX7GT	1	6T8	12	12R5	—
4BQ7A	2	6AN8/-A*	6	6BY6	2	6U4GT	—	12SN7GTA	3
4BS8	—	6AQ5/-A*	15	6BY8	—	6U8/-A*	17	12W6GT	1
*4BU8	—	6AR5	1	6BZ6	4	6V3A	2	*17AV5GA	—
4BZ6	—	6AS5	3	6BZ7	4	6V6GT/-A	13	*17AX4GT	—
4BZ7	—	6AS6	1	6BZ8/X155	—	6W4GT	18	*17D4A	—
*4BY6	—	6AS8	1	6C4	7	6W6GT	10	*17DQ6A	—
*4CB6	—	6AT6	2	6CA7/EL84	—	6X8	7	†17H3	—
4CS6	—	6AT8/-A	2	6CB5A	1	6Y6G	1	†18A5	—
*4DT6	—	6AU4GT/-A	3	6CB6/-A†	116	7AU7	3	19AU4/-A	2
5AM8	1	6AU6/-A†	87	6CD6G/-A	2	*8AU8	—	25AV5GA	—
5AN8	1	6AU8	3	†6CE5	—	*8AW8A	—	25AX4GT	1
5AQ5	3	6AV5GA	3	6CF6	2	*8BH8	—	25BK5	1
5AS4	—	6AV6	14	6CG7	8	*8BN8	—	25BQ6GTA/-B	3
5AS8	—	6AW8A	6	6CG8	1	*8CG7	—	25C5	—
5AT8	2	6AX4GT/-A	13	6CH8	—	*8CM7	—	25CD6G/-B	1
5AV8	—	6AX5GT	1	6CL5	—	*8CN7	—	25CU6	—
5AU4	—	6AX8	—	6CL6	3	*8CS7	—	25DN6	1
5AW4	—	6AZ8	—	6CL8/-A*	—	*8CX8	—	25EC6	—
5B8	1	6BA6	7	6CM6	—	*8SN7GTB	—	25L6GT	4
5BE8	—	6BA8A	1	6CM7	3	†9CL8	—	25W4GT	1
5BK7A	1								

**If it's worth
engineers'
time...**

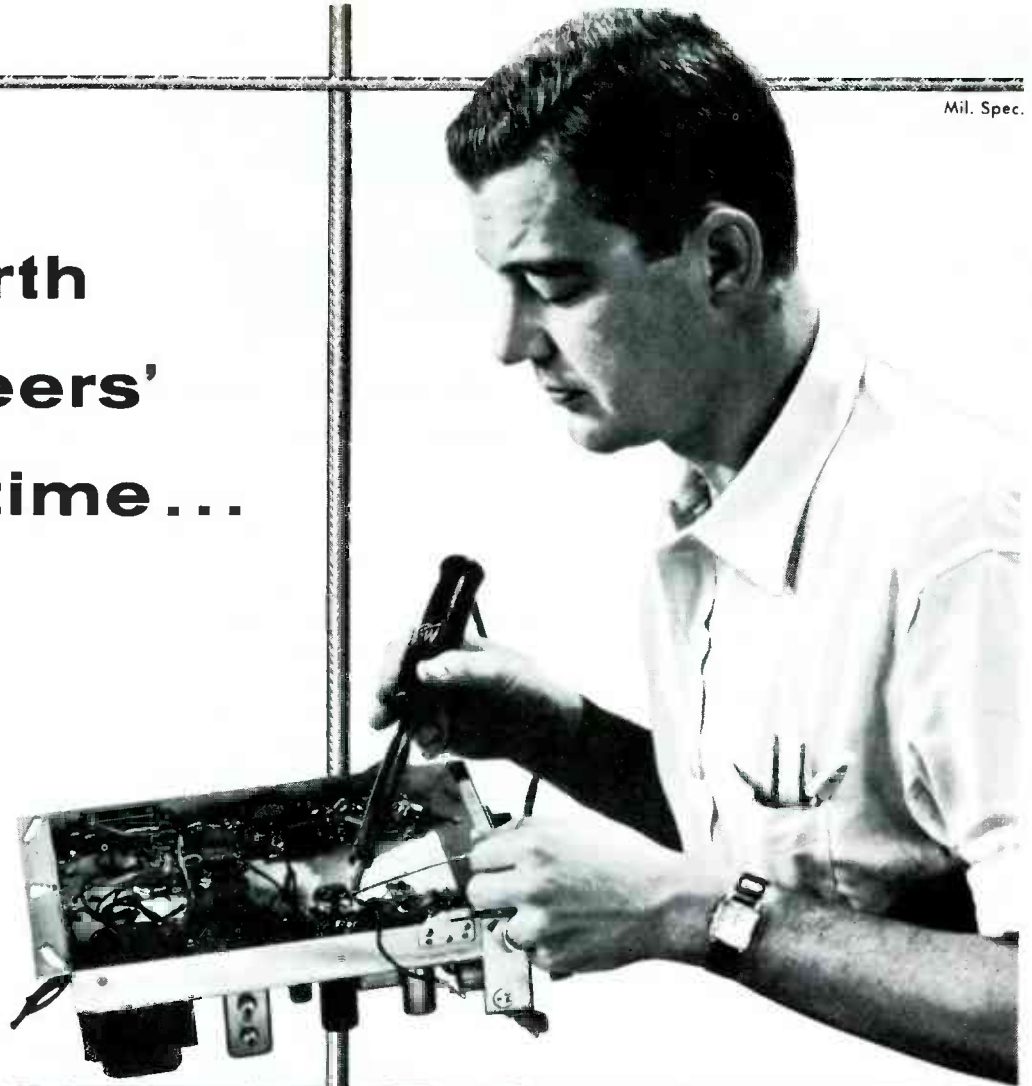

Mil. Spec.

Belden
ELECTRONIC
WIRE

The complete packaged line
—easy to use. Be sure of
the right wire engineered
for the job.

There are 1001 Belden
wires for every Radio and
Electronic requirement.

**...it's worth
engineered
electronic wire**

Belden
WIREMAKER FOR INDUSTRY
SINCE 1902
CHICAGO

6-8

Magnet Wire • Lead and Fixture Wire • Power Supply Cord, Cord Sets and Portable Cord • Aircraft Wires • Welding Cable
Electrical Household Replacement Cords • Electronic Wires • Automotive Replacement Wire and Cable

audio

facts

- Speaker Fundamentals
- AM-FM Tuner Servicing
- Products for Profit

by Calvin C. Young, Jr.

Speaking of Speakers . . .

While we all look upon speakers as sound reproducers, not too many of us are thoroughly familiar with the intricacies of their construction, operation, and application. In this column, therefore, we will acquaint you with as many of their basic principles and concepts as possible, thus enabling you to choose the best speaker for each particular application and to intelligently advise hi-fi and PA system prospects on the types of speakers that will best fill their needs.

This month, we'll cover only the basic construction of cone-type and horn-type loudspeakers. Variations in construction practices, plus operation and applications of speakers, will be presented in subsequent installments.

Conc-Type Reproducers

First of all, let's examine the basic physical construction of cone-type speakers. These units actually consist of two assemblies—a nonmoving or supporting member and a moving member. The nonmoving portion (Fig. 1) is made up of a speaker frame (basket) and magnet assembly. The basket acts as a housing for the moving member, a mounting frame for the magnet, and provides a means for mounting the entire speaker in a suitable enclosure. Since we have classed the basket as a nonmoving member, suffice it to say that it must be sufficiently heavy and rigid in construction so that it will not move or vibrate, even under high power applications. The magnet assembly, being affixed to the basket, must be positioned in such a way that a perfect alignment between the moving and nonmoving members can be obtained.

The moving member consists of the cone, voice coil, spider suspension, annulus suspension and dust cover—all of which are pointed out in Fig. 2. The cone is the piston that causes the movement of air necessary to produce sound; the voice coil is a wire solenoid attached to the cone in such a way that electrical signals can be converted into changes in magnetic energy, which will then effect cone movement; the spider suspension provides a means of attaching the center of the cone to the basket and holding the cone in alignment while permitting it to move in and out freely; the annulus suspension secures the outer edge of the cone to the basket and permits cone movement which is identical to that provided by the spider suspension; the dust cover prevents dust or dirt particles from getting into the magnet slot and thus restricting voice coil movement.

When assembled, the speaker components have the relationship shown in the cutaway drawing of Fig. 3. Notice that the voice coil and the portion of the cone to which it is affixed are in alignment with the narrow slot in the magnet structure. With clearances of only a few thousandths of an inch between the voice coil and magnet, it is easy to understand the need for precision in this alignment during the complete to and fro excursions of the voice coil.

When the fields of the voice coil and speaker magnet are aiding, the cone will travel in one direction; when the fields are opposing, it will move in the opposite direction. A speaker cone that has a $\frac{1}{2}$ " excursion limit can move $\frac{1}{4}$ " in either direction. Any signal that tends to effect cone movement in excess of the excursion limit will result in distortion. The spider suspension is mounted well beyond the forward surface of the magnet so that normal forward and rear excursions will not be impeded by the spider, nor will the spider strike the frame.

With these facts in mind, it is easy to see that the spider suspension plays an important part in the operation of cone-type speakers. The annulus suspension

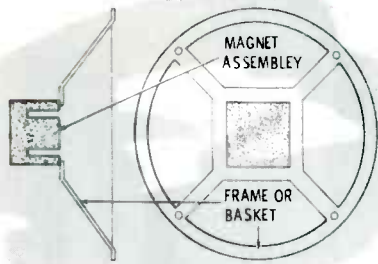

Fig. 1. Side and rear views of the non-moving portion of a speaker.

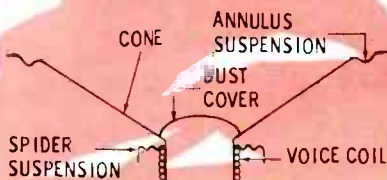

Fig. 2. Moving portion of speaker includes voice coil, spider and cone.

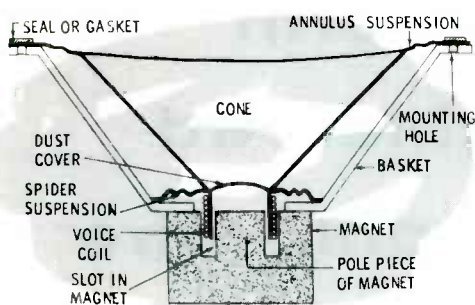

Fig. 3. Cross-section shows relationship between moving, nonmoving members.

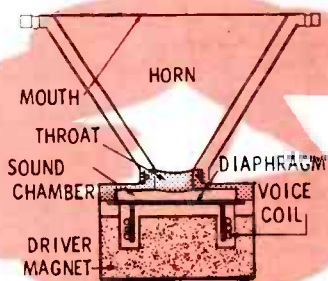
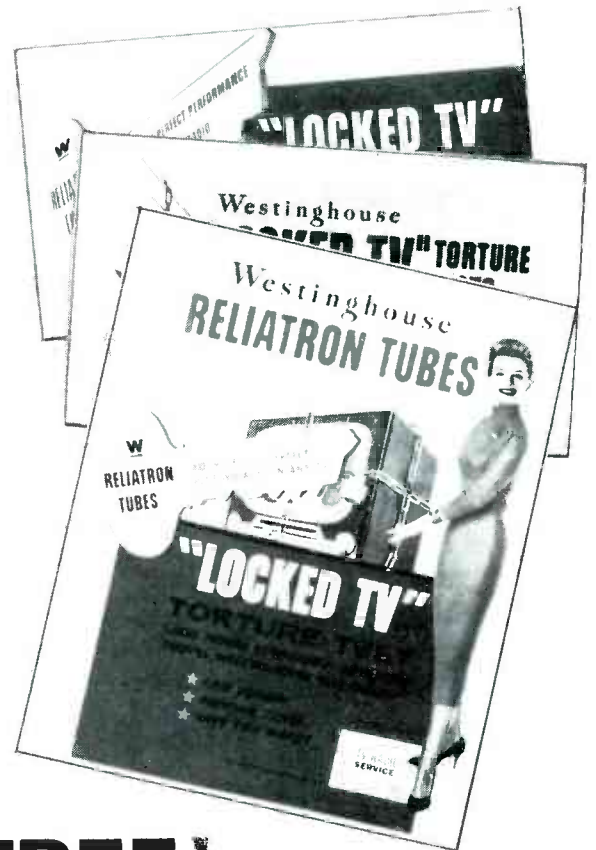

Fig. 4. Cross section of horn-type shows relationship of essential elements.

WESTINGHOUSE HELPS TV SERVICEMEN "GET A FAIR SHAKE!"



FREE!

"Build Consumer Confidence" Promotion

Today most people are unaware of the buy they get in TV and radio service. Now, Westinghouse helps you educate them with a program designed to win you friends and influence sales! You get a complete kit *free!* Keystone of the promotion is the mailing piece shown left. It describes how many hundreds of parts there are to check . . . how much knowledge it takes to be a serviceman . . . equipment costs . . . etc. It shows how TV servicemen, like doctors and lawyers, constantly study to keep up with advances. In addition you get window displays, streamers, everything you need—all free! Don't wait, put this promotion to work for you now . . .

CALL YOUR WESTINGHOUSE DISTRIBUTOR

YOU CAN BE SURE...IF IT'S Westinghouse
Electronic Tube Division • Elmira, New York

**SPOT
INTERMITTENTS
FAST!**



\$89⁹⁵
NET

NEW
Wintronix
**INTERMITTENT
CONDITION
ANALYZER**

Makes any TV or Radio Super-Sensitive to Intermittents & Noisy Components . . .

NO WAITING 



NO "COOKING"

NO "FREEZING" 

Save valuable time and bench space when troubleshooting intermittents. Just connect output of Model 828 to Radio or TV receiver antenna terminals, and use exclusive "Electro-Wand" (for tubes) or "Electro-Probe" (for components) to quickly pinpoint intermittent or noisy tubes, capacitors, resistors, coils, transformers, defective connections, etc. No direct circuit connection needed.

Special Wintronix circuit immediately makes any receiver super-sensitive to intermittents. Lets you *hear* intermittents through built-in speaker. Reduces callbacks by detecting borderline components *before* they fail.

See the Wintronix Model 828 at your local parts distributor or write for free literature.

**WINSTON
ELECTRONICS INC.**

4312 Main St., Phila. 27, Pa.

is no less important since its job is similar to that of the spider, the main difference being its use at the outer edge of the cone instead of the inner.

As an additional aid in keeping out dust, a gasket (usually paper and also serving as a mounting cushion), is cemented to the outer perimeter, outside the annulus suspension, where it provides an air seal between the speaker and enclosure.

Horn-Type Reproducers

The basic principles just outlined are generally applicable to cone-type sound reproducers; however, there are applications requiring greater power output or higher frequency response than can be obtained with a cone-type unit. In such cases, a horn-type reproducer may be called for.

In horn-types, just as in cone-types, we find that there are non-moving and moving members. In the horn-type, however, the non-moving portion makes up the major part of the entire unit. The moving portion consists of the diaphragm and voice coil (see Fig. 4.) and, as illustrated, is small in comparison to the moving portion of a cone-type speaker. The nonmoving portion is generally considered as two units; i. e., the horn which has no moving parts and the driver which contains the moving member. Actually, if we wish to draw a close analogy between the actions of the cone- and horn-types, we would have to consider only the driver portion of the horn-type unit.

The throat of the horn is attached to the driver so that sound generated by the diaphragm is coupled to the horn. The result of this action very closely parallels that obtained when using a megaphone; a soft sound applied to the throat is effectively amplified and a loud sound is heard from the mouth. The diaphragm functions as the air-moving piston and is caused to vibrate by interaction between the magnetic fields of the voice coil and the driver magnet.

The primary purpose of the sound chamber, also shown in Fig. 4, is to provide the best possible coupling between the diaphragm and the throat of the horn. Thus, by the use of a sound

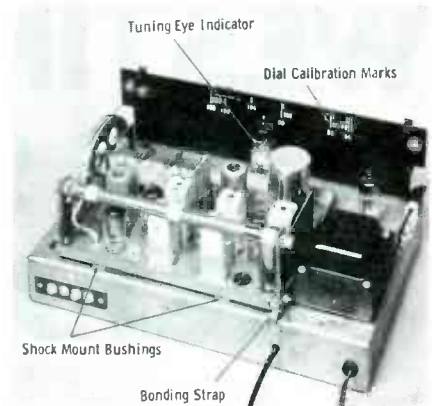

Fig. 5. Hoffman tuner uses subchassis, tuning eye and dial calibration marks.

chamber and a throat which is smaller in diameter than the diaphragm, the effective throat velocity can be much greater than that which would be obtained if the diaphragm were located at the throat and worked directly into the horn itself.

Since horn-type reproducers are used in a wide variety of applications, the physical size of both horn and driver may vary considerably. Other variations involve the size, shape and material of the diaphragm as well as the size and strength of the driver magnet, and the size and impedance of the voice coil. These are governed primarily by the frequency and power output requirements of the unit and will be dealt with at another time.

**Servicing the Hoffman
AM-FM Tuner**

Since hi-fi units are becoming more popular, we are presenting some service facts on a tuner of the type which will be encountered in a great many of the packaged units now being sold; namely, a Hoffman chassis 1110.

One of the first things that caught our attention about this unit was the calibration marks on the rear of the dial panel (Fig. 5). Marks for both AM and FM are provided to assist the technician in obtaining proper tracking even though the dial scale may not be available at the service bench. Fig. 5 also shows that the tuning indicator (Amperex EM81/6DA5) is mounted immediately behind the center of the dial panel. The tube plugs into a 9-pin miniature tube socket and is clamped to the dial panel for rigidity.

Another noticeable feature of

SANDY SAYS!
"KURE-ALL fits ALL TV Picture tube sockets!"

\$650
 LIST

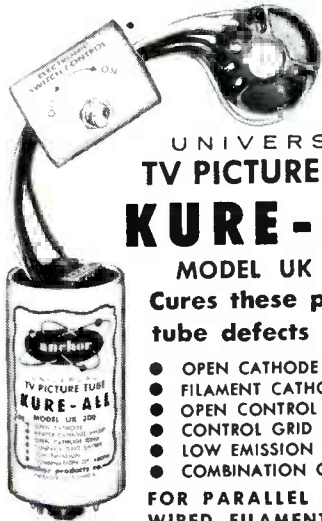

UNIVERSAL TV PICTURE TUBE KURE-ALL

MODEL UK 200
Cures these picture tube defects

- OPEN CATHODE
- FILAMENT CATHODE SHORT
- OPEN CONTROL GRID
- CONTROL GRID SHORT
- LOW EMISSION
- COMBINATION OF ABOVE

FOR PARALLEL OR SERIES WIRED FILAMENT CIRCUITS

anchor products co.
ELECTRONIC COMPONENTS
 2712 W. Montrose • Chicago 18, Ill.

FREE Information About This

BUSINESS OPPORTUNITY



key to car radio service market

How many car radios have you serviced lately? Most service operators are missing this tremendous market because they have no regular contact with car owners!

This VIS-U-ALL Auto-Radio Service Merchandiser literally moves your shop into the gas stations and garages where car owners must go. It multiplies your sales of parts — booms your repair volume, too. And without increasing your overhead!

Let us tell you how easy it is to increase your net profit by \$50 a week. See distributor or write us.

VIS-U-ALL products company
 303 Fuller N.E., Grand Rapids 3, Mich.

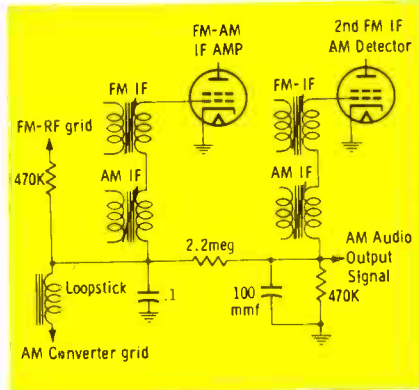

Fig. 5. Partial schematic of AVC-AGC circuit used in Hoffman AM-FM tuner.

this tuner is the shock-mounted subchassis which includes the entire tuner circuit. The low-voltage rectifier and tuning-eye circuits are mounted on the main chassis. The shock-mounted section is bonded to the main chassis at several points with strips of flexible braid material to assure proper grounding, and these connections must be both physically and electrically solid if trouble is to be avoided.

Examination of the complete schematic reveals that both AVC and AGC voltages (for AM and FM, respectively) are coupled along the same network to the control grid circuits. On AM, the AVC voltage, which is a result of conduction in the grid-to-cathode circuit of the AM detector (2nd FM IF amplifier), is developed across a 470K-ohm resistor and 100-mmf capacitor (Fig. 6). This varying audio voltage is then filtered by the combination of the 2.2-megohm resistor and the .1-mfd capacitor and applied to the grids of the AM converter and IF amplifier stages.

On FM operation, the combination of the 470K-ohm resistor and 100-mmf capacitor in the grid circuit of the 2nd FM IF amplifier cause a certain amount of grid current to flow on the higher-amplitude signals. This develops the FM AGC voltage (also filtered by the 2.2-meg and .1-mfd units) which is applied to the RF and 1st IF amplifier stages. Since the 2nd FM IF amplifier has a certain amount of grid current flowing, a partial limiting action takes place, helping the ratio detector (a self-limiting detector) to accomplish its job.

If a tunable hum is encountered

FOR TOP-O'-CHASSIS SERVICING

locates defective stage in less than 5 minutes for average TV receiver.



NEW FROM Wintronix

MODEL 850

INDUCED WAVEFORM ANALYZER

complete with "Phantom Probe" and attachments

ONLY \$169⁹⁵

Localize troubles in TV, radios, amplifiers, etc., right from the top of the chassis . . . and without making a single direct connection to the circuit! The new Wintronix Model 850 does all this by the modern, easy-to-use Induced Waveform method. Helps you quickly spot those often overlooked tube and circuit defects that mean callbacks or extra troubleshooting.

Simply connect the output of the Model 850 to any 'scope, then slip the Phantom Detector Probe successively over each tube in the receiver under test. By viewing the waveform of the received signal (from b'dcast station or generator) at each stage, you quickly localize troubles to the offending stage. Works equally well for RF, IF, video, sync, and audio circuits. A real time and trouble-saver for portable TV.

See and try the new Wintronix Induced Waveform Analyzer at your local Wintronix dealer or write for free literature.

WINSTON ELECTRONICS INC.,

4312 Main St., Phila. 27, Pa.

SAVE TV REPAIR TIME!

WITH HOWARD W. SAMS "Television Tube Location Guides"



shows position
and function of
all tubes in
thousands of
TV sets...

**JUST FIND THE
TROUBLE AND
REPLACE TUBES
WITHOUT REMOV-
ING CHASSIS!**

YOU GET ALL THIS HELP:

- Shows tube type and function
- Shows major component placement
- Charts are oriented as you view chassis
- Identifies unknown chassis quickly
- Speeds tube checking
- Locates tube in "wrong" socket
- Over 500 models covered in each Guide
- Convenient size for pocket or caddy
- Complete cumulative index in each Guide

"EXTRAS" NOW IN VOL. 7

- Shows signal path
- Shows pin orientation on socket
- Shows series string filaments
- Includes tube failure check charts
- Shows fuse location



OWN THEM ALL—THEY HELP YOU EARN MORE

VOL. 7. Covers TV receivers produced in 1956-1957. 204 pages. Only... **\$2.00**

VOL. 6. Covers TV receivers produced in 1955-1956. 236 pages. Only... **\$2.00**

VOL. 5. Covers TV receivers produced in 1953-1954. 200 pages. Only... **\$2.00**

VOL. 4. Covers TV receivers produced in 1952-1953. 192 pages. Only... **\$2.00**

VOL. 3. Covers TV receivers produced in 1951-1952. 192 pages. Only... **\$2.00**

VOL. 2. Covers TV receivers produced in 1950-1951. 208 pages. Only... **\$2.00**

VOL. 1. Covers TV receivers produced in 1948-1949, 1950. 208 pages. Only... **\$2.00**

SEE THESE BOOKS AT YOUR SAMS
DISTRIBUTORS OR MAIL COUPON

**SEND
TODAY!**

FREE TRIAL COUPON

Howard W. Sams & Co., Inc.; Dept. 3-DB
2201 E. 46th St., Indianapolis 5, Ind.

Send me book(s) checked at right for 10 days
FREE examination. In 10 days I will pay for
the book(s), plus few cents delivery cost, or
return postpaid.

We pay delivery costs if you remit with
the coupon; same return privilege.

- Vol. 7
- Vol. 6
- Vol. 5
- Vol. 4
- Vol. 3
- Vol. 2
- Vol. 1

Name _____

Address _____

City _____ Zone _____ State _____

(Outside U.S.A. priced slightly higher)

on the high end of the AM band, connect an external ground wire to the ground lug on the antenna terminal. This will eliminate hum pickup of stray 60-cps signals radiated by unshielded electrical appliances in the vicinity.

If a detuning effect is encountered when switching from FM to FM-AFC, check the alignment of the IF and detector transformers. Adjustment of the detector transformer secondary should be checked before proceeding with any of the IF adjustments.

Products for Profit

Hi-Fi Amplifier

The recently-introduced General Electric Model PA-20 hi-fi amplifier is a one-piece unit featuring both preamplifier and power amplifier circuits.

Specifications given by the manufacturer are as follows:

Power output: 20 watts, nominal at all mid-range frequencies.

Frequency response: 20-20,000 cps. Harmonic distortion: Less than 1%.

Hum and noise: 60 db below 20 watts on phono input, weighted; 75 db below 20 watts on high level inputs, weighted.

Sensitivity (phono input): 5 to 7 millivolts for full power output. Inputs (selector switch): Low MAG, High MAG, Rad-TV, AUX-1, AUX-2.

Outputs (Jacks and terminal board): Tape—ahead of tone controls, 10,000 ohms impedance at 1000 cps; Preamp (for use with additional power amplifier)—output after tone controls; Speaker—4, 8 and 16 ohms.

Two 117 VAC sockets, one switch controlled, are also provided for auxiliary equipment.

Front panel controls consist of function selector, loudness, rumble filter, bass, treble, level and on-off. In addition, two screw-driver type controls (input signal level adjustments) are provided for AUX-1 and Rad-TV inputs.

Current feedback is employed so that a damping factor of about 5 is obtained along with low distortion and good transient response. The loudness control is compensated (Fletcher-Munson) to assure musical balance at all intensity levels. Accurate phono equalization is provided so that practically all low and high out-



General Electric Amplifier Model PA 20

put cartridges may be used in conjunction with this amplifier.

The size of the entire unit (15" wide, 4½" high, 12½" deep) is such that it may be used in locations such as a bookshelf, step table or panel-mounted in a built-in system.

The suggested price of \$99.95 makes it possible for a servicing dealer to use it as the central unit for a customer's home music system, making a nice profit for himself.

FM Preamplifier

The Jerrold FM "Range Extender" is a wide-band preamplifier designed to act as a booster for all FM signals. This unit is available in two models with options of indoor or antenna mast mounting, and 24-volt remote or 117-volt local operation.

Additional features are outputs of either 300 or 75 ohms, frequency response essentially flat from 88 to 108 mc, maximum gain of 25 db, undistorted signal output of .5 volts RMS, and both input and output matched to a VSWR (Voltage Standing Wave Ratio) of less than 1.4.

Model DSA-FM is a package unit containing a Model 401A-FM preamplifier and a Model 405P remote power supply. Housed in an "Iridite" finished weatherproof cabinet, the 401A-FM is intended for use at the antenna, where full advantage can be taken of the antenna signal before transmission line losses and noise pickup are incurred. This setup is recommended for deep fringe area installations, where coaxial cable or more than 60 feet of twin-lead is used. For home installations, the 405P is equipped with a "set controlled" switch so that the power supply and preamplifier can be



J. W. Miller Model FM 560 Tuner

operated from the FM tuner.

Model 406A-FM is designed for continuous indoor service and is supplied with an internal 117V power supply. The light gauge, perforated steel housing has a trap door for easy access to tubes and alignment slugs. This unit is recommended for use in normal and semi-fringe areas.

The technician should find a ready market for one of these units in customers who own hi-fi FM tuners and are not getting completely noise-free reception, or who are plagued with a weak signal condition. These FM boosters should also make it possible to sell a complete system of tuner, antenna, and booster to the hi-fi addict who, up to now, has been just out of FM reception range.

FM Tuner

The Model 560 FM tuner, just introduced by the J. W. Miller Co., has many features normally associated with a much more expensive unit. Among these are fly-wheel tuning, complete shielding, edge-lighted dial, and tuning-eye indicator.

Technical specifications listed by the manufacturer reveal a sensitivity of 3 microvolts for 20 db of quieting, frequency response of ± 5 db from 20 to 20,000 cps and local oscillator radiation within the limits specified by the FCC.

A grounded grid RF amplifier, two IF stages, one limiter stage and a Foster-Seeley discriminator are teamed with a combination AFC and tuning-indicator circuit for ease of station selection, minimum drift, and maximum performance. Two signal outputs, one controlled by the volume control, are teamed with two AC outlets, one controlled by the switch on the volume control. A net price of \$59.95 makes this an ideal tuner for use in expanding existing hi-fi systems to include FM, or as a part of initial installations of custom and built-in systems. ▲



"EMERGENCY CALL GUS!—LADY SAYS THEIR HI-FI'S GONE HAYWIRE AND HER HUSBAND IS THREATENING TO FIX IT HIMSELF!"

The lady's right Gus — her husband can't compete with a trained technician and his stock of

Webster cartridges. And the whole family will be happier with the results — the renewed life found in their records.

There's more money in it for you too because there's never an unhappy customer.

BUY WISELY...BUY WEBSTER!



Model B202—3-speed; push-in mounting; clip-mounted needles.

Free—large print of this Lichy cartoon suitable for framing. Request on your own letterhead.

ELECTRONICS DIVISION

WEBSTER  ELECTRIC
RACINE · WIS



ELECTRONIC YARDSTICKS

part 8 Servicing Industrial Electronics

by Melvin Whitmer

Dimensions have been measured by simple devices for a great many years; however, as industry grew the exact science of electronics was called upon more and more to provide accurate high-speed measurements under the most difficult conditions. This month we will describe various methods of sensing thickness, length, width, diameter, and contour.

Thickness Measurement

Previously, we discussed an ultrasonic method for measuring the wall thickness of a steel cylinder. When thickness measurements must be made from only one side of the object, vibration reflection provides the quickest method. For example, it would be difficult to place a caliper on both sides of a ship's hull to measure its thickness! However, by using a portable ultrasonic gauge, the thickness can be de-

termined at a great many points along one side of the hull. The "Audigage" is such a device; it transmits a variable frequency sound wave through the material under test. Sound travels at specific velocities, depending upon the medium (air, water, metal, etc.). Velocity varies with the type of material, and when sound waves pass from one medium to another, part of the signal is reflected. For thickness measurements, the signal is reflected from the opposite face of the material under test, and when the wavelength of the applied signal is the same as the thickness of the material, a resonant condition will exist. The resonant condition is detected by listening for a zero beat and reading a millimeter.

Servicing ultrasonic equipment is no more complicated than servicing a good radio. One par-

ticular experience will show the type of problems to be expected. A unit came into the service shop with the complaint that it never gave the same thickness reading twice. Naturally, as with any electronic gear, the first suspects were the tubes. After replacing them with substitutes of known quality, the unit was tested using a block having a known thickness. It now read the same each time, but the readings were incorrect! Moving to a calibration bench with four thickness standards (blocks of known thickness), it was found that the high end of the dial was nearly correct, but the low end (thicker readings) was off almost 30%. Since this instrument is calibrated by adjustment of trimmer and padder capacitors, the experience gained in aligning many radios came in handy. The instrument was soon tracking and

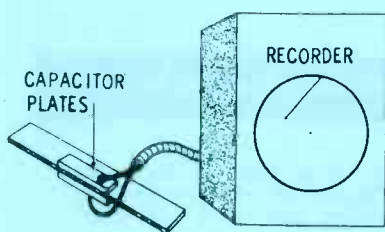

Fig. 1. Capacitance sensor used for the control of material thickness.

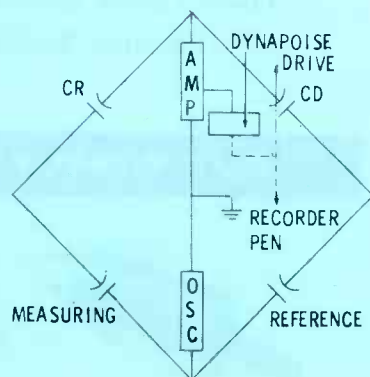
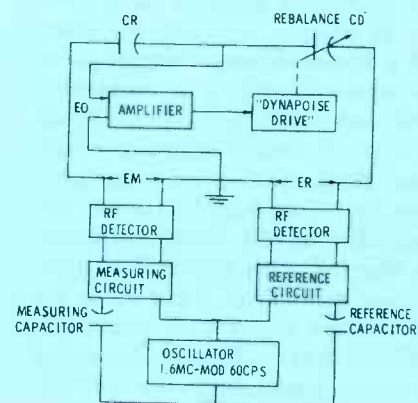

Fig. 2. Application of a simplified bridge in a Dynapoise system to detect, record, and make corrections for changes in capacity.



readings were accurate on all parts of the dial.

Capacitance Sensor

In the linoleum and other plastics industries, the thickness of a pressed sheet is difficult to control. Some method of automatic control over the pressure applied to the rollers must be used, since a slight change in temperature or composition will change the thickness of the finished products.

Plastics are generally good insulators with high dielectric constants; therefore, thickness variations can be detected by sensing the change in capacitance when the material is moving between two plates. Fig. 1 shows the relationship of the plates and the material. The dielectric change is measured by placing the capacitor, formed by the plates on each side of the plastic, in a bridge circuit to which a high frequency radio wave is applied. Since the bridge contains reference capacitors, any variation in the sensing capacitor will unbalance the bridge and generate an error signal.

Fig. 2A shows the simplified bridge circuit used in a sensing and recording unit. The oscillator signal travels two different paths to reach the amplifier. When the signals arriving at the amplifier have the same amplitude but opposite phases, the amplifier input signal will be zero. A change in the measuring signal will develop an error voltage whose polarity as well as amplitude will indicate the direction and magnitude of the change. The amplified error drives a pair of solenoids which

provide the motive force for the recorder pen and balance capacitor C_D .

The block diagram of Fig. 2B shows the intermediate units used in the instrument. The 1.6-mc oscillator signal, amplitude modulated at 60 cps, is applied simultaneously to measuring and reference circuits, where switches provide a variety of ranges. The values of the measuring and reference capacitors determine the amount of signal that eventually arrives at the detectors. When the detected 60-cycle signals meet at the amplifier input, they tend to cancel out; however, any difference between the two signals will be amplified and used to reset C_D , so that the output will again be zeroed.

The "Dynapoise Drive" uses a pair of solenoids to adjust the value of the measuring capacitor. As shown in Fig. 3, two iron bars are suspended within their respective coils; thus, if the current in either coil changes, the bars will move and cause the setting of the capacitor to change.

Plating Thickness

A plating company found it necessary to change the procedure for applying chromium to copper. Previously, copper was plated with nickel before the chromium was applied. A shortage of nickel forced the company to apply the chromium directly. The new process worked very well, but the laboratory division experienced difficulty in measuring the thickness of the plating. The previously satisfactory tests were now giving erratic results. An "anodic" solu-

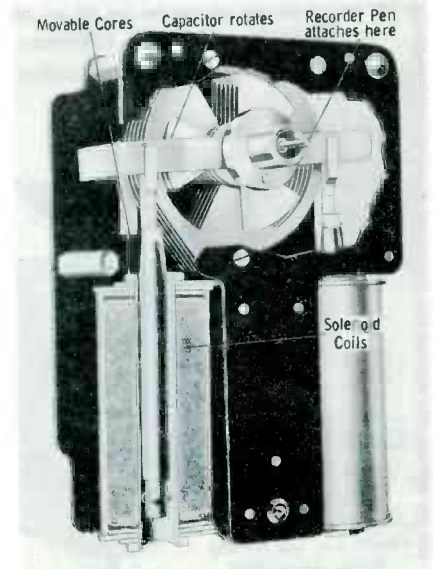

Fig. 3. Setting of balance capacitor (C_D) is changed as solenoid current changes.

tion method was suggested, and preliminary tests proved it to be accurate for the measurement of chromium plate on copper. Now a sample of each batch is sent to the laboratory and tested for plating thickness by this reliable procedure, and the product again offers uniform plating of a specified thickness.

The "anodic" method relies on the time necessary to remove the deposited material with a given current and electrolyte. A test cell similar to that shown in Fig. 4A is placed over the sample to be tested and is then filled with electrolyte. The gasket determines the area to be deplated and the instrument controls the current. After all of the deposited metal has been removed, the voltage across the cell rises sharply and turns off the timer.

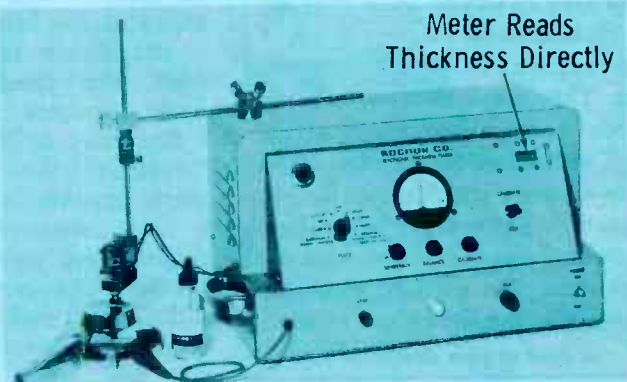
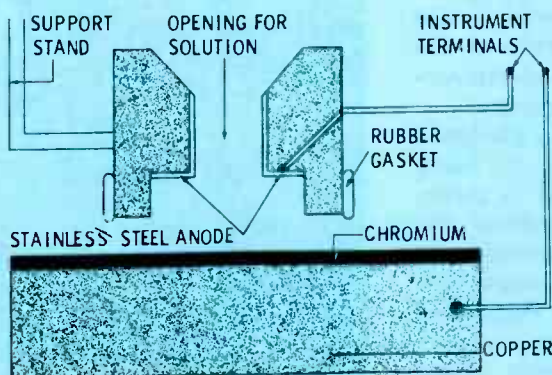

Fig. 4. Plating thickness is determined by measuring deplating time. Drawing shows details of test cell used to apply electrolyte to the plated metal.

Another Sencore Time-Saver

"VIBRA-DAPTOR"

MODEL VB-2

2 ADAPTORS IN

Checks Both Three and Four Prong Vibrators

• Merely plug into any tube checker. Set for 6AX4 (or 6SN7) for 6 Volt Vibrators and 12AX4 (or 12SN7) for 12 Volt Vibrators.

• Two lamps viewed through top of adaptor indicate whether or not Vibrator needs replacing. • Rugged — Made of steel.

• Replaceable but unbreakable #51 indicating Lamps. • Operates easily with Sencore LC2 Leakage Checker. • Complete instructions screened on front.

ONLY \$275

DEALER NET

POPULAR SENCORE PRODUCTS

- Transistor Tester
- Leakage Checker
- Filament Tester
- Handy "36"
- Vibra-Daptor

At leading distributors everywhere

MANUFACTURED BY **SERVICE INSTRUMENTS CORP.**

171 OFFICIAL RD. ADDISON, ILL.

■ Cut out this ad now for further information. ■

The instrument shown in Fig. 4B controls the current by switching precision resistors in series with the test cell and a regulated voltage. The change in current is necessary to maintain a constant amount of deplating per unit of time, thus enabling the timer dial to be calibrated for direct readings of thickness. In this way, operator time is not wasted by having to refer to charts or graphs to determine thickness.

When called upon to service this unit, the technician will probably be told how the instrument is acting as far as deplating is concerned; therefore, a knowledge of the principle of operation is essential. The manufacturer provides balance and calibration data, but the remainder of the service is essentially the same for all precision instruments. Replace tubes after 2,000 hours rather than wait for a breakdown—and make sure to use only the industrial, ruggedized versions. In tracing a malfunction, do not move parts around as this weakens leads and increases the possibility of future breakdowns. Replace any defective part with parts of identical values and ratings.

Perimeter Control

Newspapers are printed on long continuous rolls of paper, but when printing is completed, the paper is cut into uniform pages. Food labels are cut from a continuous roll, yet each label is complete and cut at the same point. This is not controlled mechanically since every mechanical operation has a small error or tolerance, and after 500 cuttings, these errors could add up to such an amount that the newspaper pages or the labels would be cut in the middle rather than at the edge. For precision, electronics again provides the answer.

Referring to Fig. 5, a photocell "watches" the paper, a black mark appears, a signal is given, a razor sharp blade slices the paper—and another precise cut is made. The photocell—most versatile of all industrial controls—senses changes in color, opaqueness and shape at speeds which are truly "quicker than the eye." The photocell is mounted to receive the reflected light from the

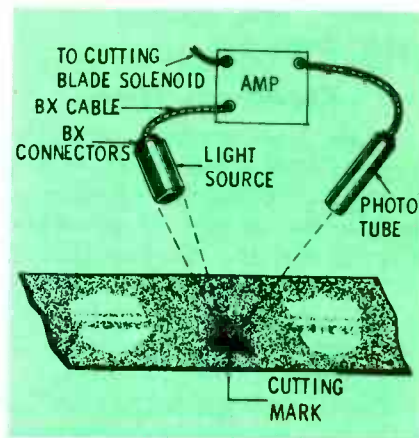

Fig. 5. Precise cutting of labels is accomplished with dual phototube control.

paper, and when the black mark appears the light reaching the photocell is greatly reduced. The pulse generated by the photocell is amplified and used to actuate an "industrial muscle" which moves the cutting blade.

Cutting irregular shapes automatically by following a pattern requires the discriminating "eye" of the photocell. The pattern in Fig. 6 is "traced" by two photocells whose signals direct the acetylene cutter and the photocell positioning motors. The amplifier is adjusted to produce a zero signal when half the photocell is shaded by the pattern. When more or less than half the cell is covered, a signal is transmitted to the positioning motors which move the photocell toward the half-way mark. By placing the sensitive planes of the photocells at right angles as shown in Fig. 6, every change in contour can be followed exactly. The serviceman has a real job here. A weak tube, a weak photocell or a

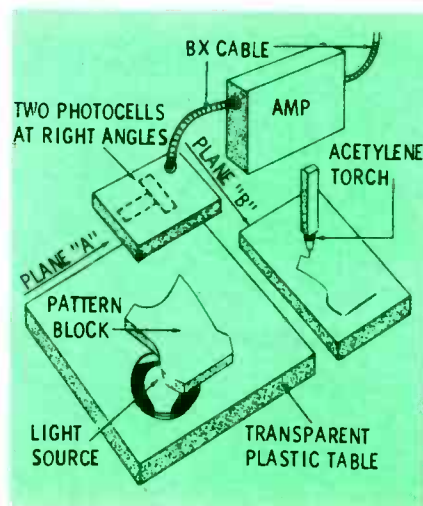

Fig. 6. Pair of phototubes guide acetylene torch in cutting precise pattern.

Dave Rice's

OFFICIAL ORDER BOOK

for every TV-Radio service call

CONVENIENT! EASY TO USE!

Simplify your record-keeping with these convenient triplicate forms. They serve as order form, invoice and office record, with spaces for complete information on every job. Separate listings for receiving tubes, picture tubes, parts, serial numbers, labor and tax charges, etc. 75c a book, \$6.50 for money-saving dust-proof box of 10.

In stock at your distributor

ELECTRONIC PUBLISHING CO. INC.

180 North Wacker Drive Chicago 6, Illinois

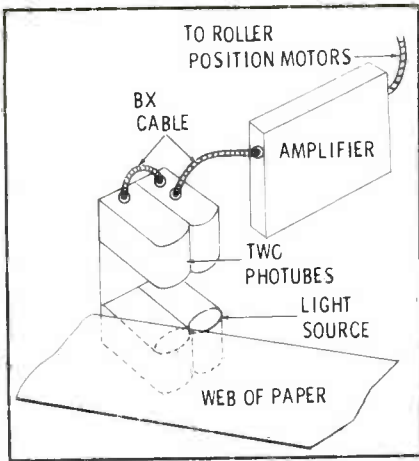

Fig. 7. Pair of phototubes are used to control color register during printing.

change in a component value and the machine starts cutting odd-shaped figures!

Another application where photocells provide the only fast, reliable service is in conjunction with a side register control. Used in multiple color printing, this control keeps the edge of the paper on the same line as it passes under a press roller. In Fig. 7, the phototubes are adjusted to receive only half the available light, thus providing for a signal of either polarity to be used for repositioning the paper. Adjustment of the side register control assures proper color registration during the printing process.

The intensity of the light source in Fig. 7 can be varied by use of different sized light bulbs. To insure long phototube life, the light intensity should be the least needed for reliable operation. Since the phototube cathode emits electrons when exposed to light, its life is dependent on the emission required and the light source used. Very often a photocell light source will burn out, and an inexperienced person will replace the bulb with one of a higher intensity because he reasons that the increased availability of light will improve the operation. Where fine detail must be detected, a bright light is necessary—but such applications require frequent phototube changes. When servicing phototube equipment, be sure to remember this when checking the light source. The customer will be pleased if you can tell him how to save repeated replacement costs—but be sure the operation with less light is satisfactory. ▲

**Big power
in a small model**

Centralab
Wirewound
Radiohms®



Get off to a fast start with Centralab Model W'W and W'N Wirewound controls. They sport 5 watts power in a 2-watt size chassis—in short or long shaft styles. Now one small size takes care of 2, 3, 4 and 5 watt replacements in tv, hi-fi, home and auto radio sets. You really cut inventory and save time with these versatile Radiohm® controls.

And don't forget—you can race off to still more profits when you use Centralab Wirewounds in their many industrial applications.

Ask your Centralab distributor for your *free* copy of Centralab's Catalog 30, giving full details about these and other top quality Centralab components.

Centralab
B-5823 

A DIVISION OF GLOBE-UNION, INC.
942D E. KEEFE AVE. • MILWAUKEE 1, WIS.
In Canada: 804 Mt. Pleasant Rd. • Toronto, Ontario

**SWITCHES • PACKAGED ELECTRONIC CIRCUITS • CERAMIC CAPACITORS
CONTROLS • ENGINEERED CERAMICS • SEMI-CONDUCTOR PRODUCTS**

Let's Talk Business

CALLBACKS BENEFIT OF THE DOUBT PERSONALITY HONEST DEALING BAD SERVICE CALL BACKS DEFECTIVE NEW TUBE

GOOD SERVICE + INSURANCE = GUARANTEE

solving the **GUARANTEE HEADACHE**

by Art Margolis

I stood up from behind the 17" Muntz and wearily told the housewife, "Looks like you need some more work on this set."

She barked back, "I don't care, fix it—but I'm not paying another cent. I gave you people \$46.00 during the last six months and that's it! Your work is supposed to be *guaranteed!*"

I tried to explain that there were thousands of different parts and connections in her TV set and all we could guarantee is the work we did, not the entire set. She wouldn't listen!

What would you do in a case like this?

I know of one TV repair shop that doesn't give *any* guarantee, just to avoid this type of situation. I know of another that gives a ten day *parts only* guarantee. I am very much aware of these outfits because we are constantly picking up their ex-customers.

In my opinion, they are wrong. They lose their hard-won customers needlessly. If a common-sense guarantee program is formulated, guarantees can be handled to the profit and satisfaction of everyone concerned. Here is ours in five words. Ninety days, parts and labor.

The wording is loose—purposely so. Our firm has found that a guarantee—rather than being a grim, strict, law-enforced contract—is really a flexible, common-sense, good-will agreement. We have found that the actual carrying out of a guarantee requires making the rules fit each individual case.

How to Charge for It

The first step in solving the

guarantee headache is making sure you get paid for it. In our price structure (service charge and bench fee), we include the money it's going to cost us to guarantee our work. We computed our guarantee cushion by figuring out the amount of money it costs us to perform free calls, and raised our prices accordingly. This extra money is set aside as a guarantee "pot."

In actual practice it works like this. A 21" Capehart bench job had an intermittent case of horizontal phasing. Every five or ten minutes the picture would pull horizontally until the left side was on the right, the right on the left, and a black bar down the center. The symptom could be cleared up temporarily by adjustment of the horizontal frequency control.

I went through the horizontal circuits with meter and scope—all looked well. Then I discovered a horizontal centering magnet around the CRT behind the yoke. I found that recentering the picture made the horizontal frequency more stable. By centering the picture incorrectly with the magnet, then compensating with adjustments of the frequency and

phase controls, the horizontal would still hold but was not stable. I set the magnet for maximum stability and the intermittent disappeared. The set was checked for two days, passed with flying colors, and was delivered.

Two weeks later the same Capehart looked up at me from the bench. The service tag read, "Customer says the same horizontal sync condition. It has never been perfect, although somewhat better." I checked it. Sure enough, the customer was right. It still had (although less severe) intermittent horizontal sync—but now the attacks occurred every few hours instead of every five or ten minutes. I waited for a good attack. At its onset I began probing with the scope. At the horizontal sync output I found a good-looking waveshape. I crossed over a 100-mmf capacitor (Fig. 1) and the wave shrank down to practically a straight line. After replacing this component, the wave came through fine.

We don't feel that to charge twice in a case like this is sensible. It was obvious to all concerned that the set, whether a tough intermittent or not, was not fixed in the first place. This TV was returned with no charge for the horizontal sync work, and the cost was chalked up against our guarantee fund.

When to Bend

While the last case was a guarantee repair to which the customer was entitled, there are cases where circumstances work against you; where although you are technically not at fault, the smart thing to do is render a free service call.

Like a 21" Magnavox that I repaired. The tag read, "No brightness." Using a screwdriver, I detected the presence of high voltage, but a HV probe and meter showed it to be only 4KV. By simultaneous manipulation of the brightness control and ion trap I was able to discern a dull, blooming picture. I checked the HV transformer with an ohmmeter, which signified the possibility of shorted turns. The transformer was changed, and after a complete performance check the set was returned. Not more than a

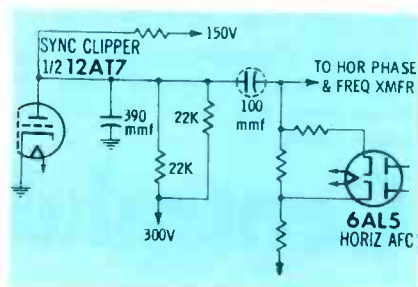

Fig. 1. The 100-mmf sync-coupling capacitor was changing value and causing intermittent horizontal sync stability.

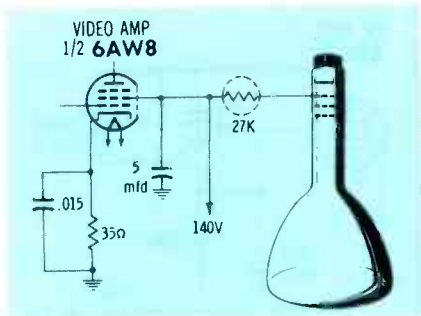

Fig. 2. An open resistor in the CRT grid and a defective flyback were identical troubles to the customer's eye.

week later it was back. The tag read, "Customer says same thing." I checked the HV—this time the meter read 15KV as it should.

I checked voltages at the CRT base. Instead of the 140 volts the schematic called for on the CRT grid, I read zero. With the 100 volts or so present at the cathode, the tube was heavily biased, causing the electron beam to be cut off. I checked back along the CRT grid line. As shown in Fig. 2, there was a 27K resistor that went directly to B+ and the voltage was normal on its other side. I measured the resistor—open! A new one did the trick.

Actually, the repair took only about five minutes, so the bill was going to be minimum. But here was a symptom that to the set owner's untrained eye looked exactly the same as the one experienced only a week before. To try to explain is almost useless—the customer simply cannot understand.

Where to Draw the Line

You must, however, know when to draw the line. If you let your philanthropic nature get the best of you, you'll go broke fast. An occasional bending to the customer's natural desire not to spend money can pay off in loads of good will, but you must stop the bending before the break.

For TV service, our firm has changed the slogan, "the customer is always right" to "the customer is usually right." And every now and then we become involved with a guarantee hog.

The set owner with the 17" Muntz mentioned at the beginning of this article is in this category. The first time I saw her Muntz, it was on the bench for no audio or video—the raster was

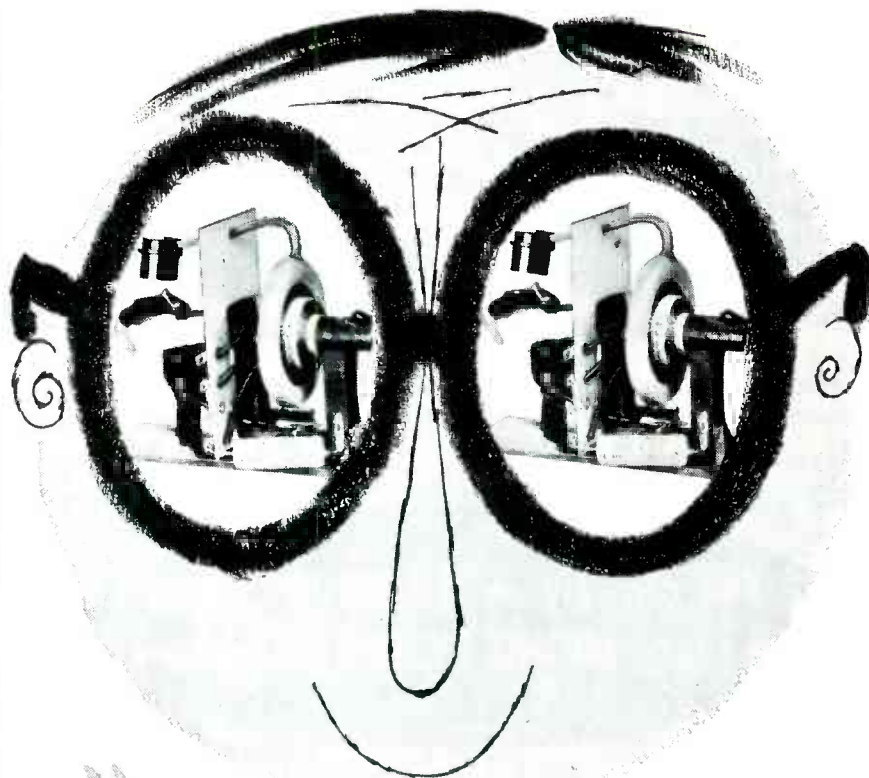

Seeing Double?

**SURE...THEY LOOK ALIKE BECAUSE
THEY ARE EXACTLY ALIKE**

Each Merit product of the same type is exactly the same as another—both in construction and appearance.

COMPARE IT WITH MERIT

Take a Merit product off the shelf. Compare it with any other similar product on the market. You'll find Merit *is* superior!

COMPARE IT WITH MERIT

Only Merit live tests its products to insure uniform quality.



MERIT

MERIT COIL AND TRANSFORMER CORP
MERIT PLAZA • HOLLYWOOD, FLORIDA

OK. I found a shorted 6BC5 right off and replaced it, but still could get no signal. I took the tuner apart and found two charred resistors, a 100 ohm and a 220 ohm leading from the plate circuit of the RF amp to B+. (See Fig. 3.) After installing new resistors, the sound and picture came back on; however, it was weak. Checking voltages in the RF circuit, I found that the screen of the 6BC5, instead of being 100 volts, was only 40 volts. Then I found that resistance from this point to ground

was less than 1K. The tuner came apart again and I found the 6BC5 screen bypass to ground was the 1K short. It was replaced, after which the audio and video came on beautifully.

During the next six months a few other house calls were made for normal tube replacements. Then came the day when she decided she had paid enough money for awhile, and that the repairs from then on should be on the house. Her theory was, "If you did work on the set you

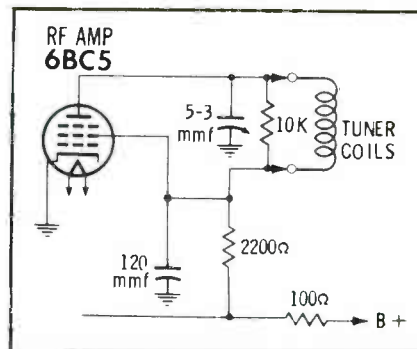

Fig. 3. The 120-mmf screen bypass became leaky, and the excessive current burned two resistors in the B+ path.

should have been able to tell this trouble was going to happen." This time there was intermittent loss of vertical sweep. It was completely different from any of her other troubles. She absolutely refused to pay for the new work. Here was the rare case where I had no choice; though the customer is usually right, now she wasn't. I drew the line—but fast!

Don't Drag Out the Call

Where the customer may always be right though, is in her gripe: "Sure, you came within an hour the first time I called, but this time you took three days."

Naturally, there is a reluctance to dash back on a guarantee call. The cash calls are a lot more appetizing. However, we've found that if you honor your guarantee fast and don't let the call-backs hang up, you'll create a favorable impression.

In fact, the rendering of the recall itself can reclaim a lost, dissatisfied customer. Consider, for example, the owner of a 12" Emerson who had decided we were not for him. His chassis had been pulled to the shop. The complaint: "No high voltage, slight odor." I began checking resistance to ground at B+ points. At the damper cathode I found less than 2K, while the schematic called for infinity. One by one I eliminated the damper tube, some resistors and capacitors. On the other side of a 1500-ohm resistor, the last one I checked, the resistance plummeted to zero. As you can see from the partial schematic in Fig. 4, the resistor connected to a tap on the vertical output transformer. The winding had shorted to the laminated iron core.

You can rely on QUAM SPEAKERS in every SOUND SYSTEM installation

You get trouble-free operation and excellent sound reproduction with Quam Adjust-a-Cone Public Address Speakers. Their wide frequency response range and heavy rugged construction assure you of complete customer satisfaction.



Quam—and only Quam

- Lowest possible flux loss
- Accurate magnet alignment
- Precise centering and voice coil alignment
- Greater heat and humidity protection in outdoor speakers

— gives you these important benefits:

- made possible by the patented U-Shaped Pot
- because of the patented Adjust-a-Cone Suspension
- with the new exclusive Humi-Gard Cone

Over 25 years of engineering "know-how" is built into every Quam speaker. EIA standards are rigidly adhered to, your assurance of top quality and performance.

Write for your free copy of Catalog S-757, describing the complete line of Quam Public Address, Outdoor and Intercom speakers.

QUAM, the quality line for all your speaker needs

QUAM-NICHOLS COMPANY

234 EAST MARQUETTE AVENUE • CHICAGO 37, ILLINOIS

In Canada: A. T. R. Armstrong, Ltd., 700 Weston Road, Toronto 9, Ontario
D. Eldon McLennan, Ltd., 1624 W. Third Avenue, Vancouver 9, B.C.

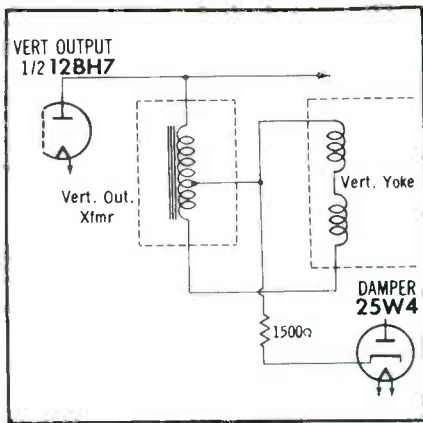

Fig. 4. A defective vertical transformer caused loss of HV but a new yoke and some tubes made the bill healthy.

With a new transformer installed, the high voltage crackled back on and the raster brightly made its appearance; but in spite of this there was not quite enough vertical sweep. I took a deep breath and started in on this new condition. An hour later I was still at the same point. All voltages, resistances and wave shapes were seemingly correct. I reasoned that perhaps the replacement was defective. I sent down to the parts house for another; however, the new one did the same thing. I began the tedious substitution method. That did it—when I replaced the yoke, the picture swept out all the way.

During the final checkout, a couple of IF's needed changing; the resultant bill was a healthy one—too healthy for the outspoken set owner. He paid, but said, "You people charge too much for such an old set. I sure won't call you again!"

He went back on his word though, a week later, as he claimed on the phone, "Since you returned the set, the pictures haven't been as good as they were before."

Luckily, I had a serviceman working in his neighborhood. Probably not more than ten minutes elapsed from the customer's call to the serviceman's arrival. He found the picture was not good, and there was a reason. The set owner had installed a new window antenna outside his apartment and had run the lead-in beneath a metal storm sash. Our tech fixed that in a hurry. Since the delivery was still so fresh and the customer fit to be tied, the service-

man used his head and waived the service charge. Almost immediately, I received another call from the set owner. His tone had changed. "I'm sorry I acted the way I did. You people are a little high, but it's worth it for the terrific service."

This example stresses the importance of living up to a guarantee immediately. It takes the pressure off the entire situation, and if there is need for additional charges, they somehow become

easier to collect. We try to give each set owner a comfortable, satisfied feeling about us, like their favorite department store does. This can be done with a sensible guarantee program. It's not hard to do either—just a few rules to follow. First—charge for the guarantee; then use common sense and bend a little to satisfy your customer's wishes. Next—draw your bending line so you won't break—and finally, do the work immediately, if not sooner! ▲



The Capacitor Package that means Quality

1 year service guarantee

When you see this package in the familiar red and black box, you know it contains "trouble-free" Planet capacitors—mechanically and electrically tested throughout manufacture. This rigid system of quality control makes our unconditional one-year guarantee possible. But making Planet capacitors correctly from the start means reasonable prices too!

PLANET SALES CORPORATION

225 BELLEVILLE AVENUE
BLOOMFIELD, N. J.

Write for Catalog listing specifications on stock items.

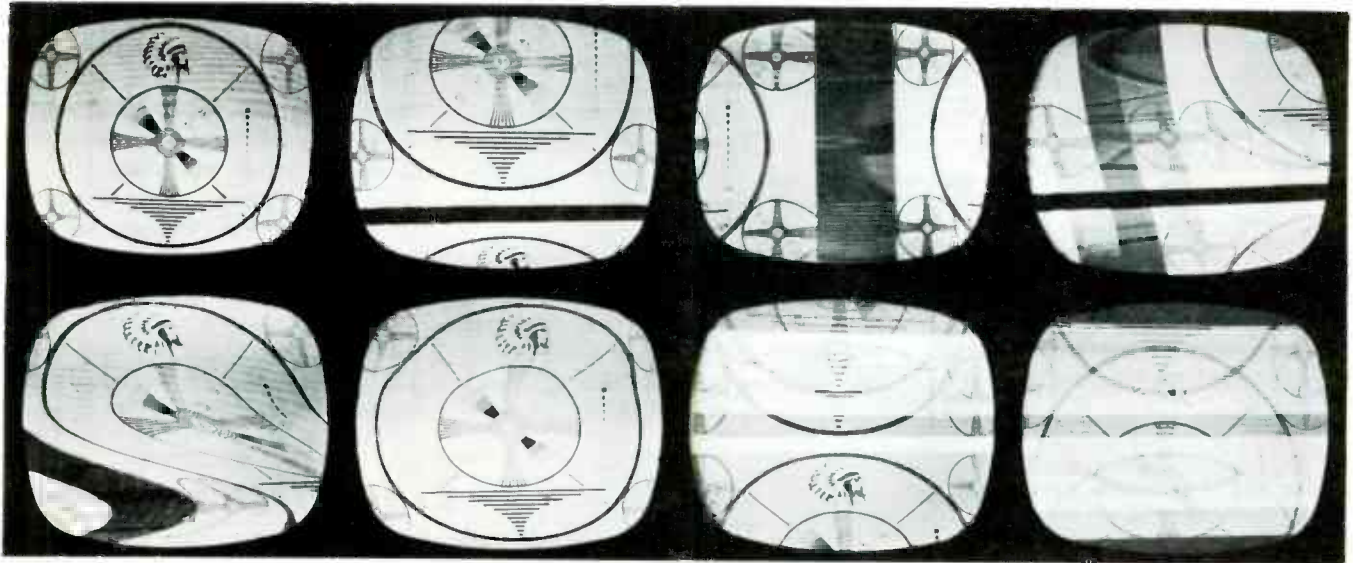
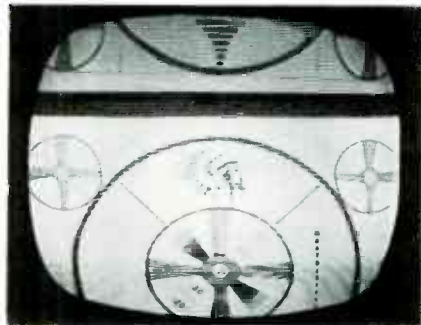

Fig. 1. Picture troubles resulting from a fault in the sync separator circuit.

TROUBLESHOOTING SYNC SEPARATOR SYSTEMS

Distinguishing Between Video and Sync Troubles by Jesse Dines

When the sync separator system of the TV receiver is not functioning properly, the picture symptoms may vary from slight horizontal "pulling" or an occasional vertical roll to a complete loss of both vertical and horizontal synchronization. Fig. 1 shows all of the possible picture troubles which can result from a



(A) Normal blanking bar.

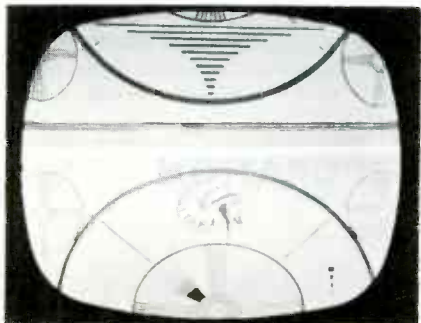

(B) Abnormal blanking bar.

Fig. 2. Appearance of the vertical blanking bar helps to isolate sync troubles.

faulty sync stage. Following is a list of the more common trouble symptoms:

1. Loss of vertical synchronization or picture roll (Fig. 1B).
2. Loss of horizontal synchronization or picture tearing (Fig. 1C).
3. Loss of vertical and horizontal synchronization (Fig. 1D).
4. Horizontal "pulling," where the picture is constantly on the verge of tearing or where there is erratic horizontal movement (Figs. 1E & F).
5. Vertical "jitter," where the picture is constantly on the verge of rolling (Figs. 1G & H).

Distinguishing Between Video and Sync Troubles

It is important to know whether loss of sync is caused by a fault in the sync system or in the video stages preceding it. An easy way to determine this is as follows: Rotate the vertical hold control slightly so that the vertical blanking bar is visible (Fig. 2). Since the blanking signal contains equalizing and vertical sync pulses which fall in the blacker than

black region, part of the bar should be darker than the rest, as shown in Fig. 3. To see this more clearly, it may be necessary to increase picture brightness and reduce the contrast. The blanking bar should be held as steady as possible so that it may be closely observed.

If sync pulses are present in the blanking bar, these will be darker than the darkest picture elements

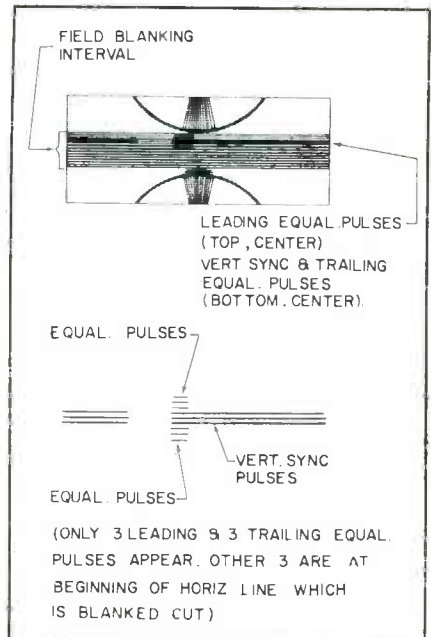

Fig. 3. An analysis of the vertical blanking bar shows how it should appear.

EDITOR'S NOTE: The material in this article is based on a chapter from the book *Servicing TV Sync Systems* (\$3.95), by Jesse Dines, a recent publication of Howard W. Sams & Co., Inc.

(Fig. 2A). The presence of normal sync pulse effects here indicates that the sync trouble lies in the sync separator or deflection oscillator circuits. If these sync pulses are not normal, it can be assumed that the fault exists in the front end, video IF, or video amplifier. For example, the trouble shown in Fig. 2B (where the sync pulses can hardly be seen or do not appear at all) was due to poor low-frequency response in the video amplifier stage.

General Troubleshooting Hints

When a picture tears horizontally and also rolls vertically (whether it be continuous or intermittent), the following is suggested as a general troubleshooting procedure to isolate the trouble. Adjust the horizontal hold control to prevent the picture from tearing and then adjust the vertical hold control to prevent the picture from rolling. If the picture locks in horizontally but continues to roll vertically, there may be a fault in the vertical integrator or vertical oscillator; if the reverse happens, then the trouble is possibly in the horizontal AFC or horizontal oscillator circuit.

If adjustment of these controls does not correct the tearing or rolling, then check to see whether or not sync pulses are being fed to the sync separator system. This can be done as described above, by observing the vertical blanking bar.

There is one simple, quick way to isolate a defective sync-separator stage, and that is to connect an ordinary test lead (through a 0.1-mfd capacitor) to the audio amplifier grid. The other end of the lead is used as a probe for injection of various signals into the audio circuit. First, feed in a signal from the video amplifier plate. If the video amplifier and all previous stages are operating properly, then a harsh buzz caused by the sync pulses will be heard in the loudspeaker.

With the same end of the lead, follow the sync pulses through the sync-separator circuit by touching the lead to the input and output of each succeeding sync stage. If a point is reached where sync pulse buzz is no longer heard,

When a Serviceman Needs a Friend



He naturally turns to Pyramid's CRA-2 Capacitor-Resistor Analyzer . . . because with this versatile, multi-purpose test instrument, all the guesswork is taken out of trouble shooting. Perfect for work in industrial and military electronics, black and white, and color television, and all other related fields. The CRA-2 incorporates the most advanced test features:

- "Quick Check" in circuit test for Open Circuits, Short Circuits, Intermittents, High RF Impedance, and High Power Factor.
- Speedy accurate checks for Capacitance, Power Factor, Resistance, Insulation-Resistance and Leakage Current.
- Precision meter for accurate readings of Leakage Current, Applied Voltage and Insulation Resistance.
- Combined Wien and Wheatstone Bridge.
- Accurate Vacuum-Tube Ohmmeter Circuit.

Write today for complete information about the Pyramid CRA-2 Capacitor-Resistor Analyzer. Remember! When a serviceman needs a friend, he can always depend on Pyramid.

CAPACITORS — RECTIFIERS
FOR ORIGINAL EQUIPMENT — AND REPLACEMENT

PYRAMID
ELECTRIC COMPANY
North Bergen, New Jersey

... another
MALLORY
 service-engineered
 product

CONVENIENT CARD-PACK
 Buy Discaps on these handy cards
 . . . fits standard 3" x 5" file
 drawer . . . 5 capacitors per card
 —tabbed for easy identification.



Now available for service use

MALLORY- RMC DISCAPS®

High-quality ceramic capacitors

Long preferred in industrial electronics and by equipment manufacturers, Mallory-RMC Discaps are now ready for you to use on service jobs whenever you need dependable performance in even the most critical applications.

You're sure of tested quality—for Discaps are made under the most rigid quality controls, from basic raw materials to the finished unit. Every capacitor is tested for power factor, capacity, leakage resistance, and dielectric strength.

Discaps . . . made by the world's largest manufacturer of ceramic disc capacitors . . . are now available in the most popular ratings from your Mallory Distributor. See him today.



- Capacitors
- Vibrators
- Resistors
- Power Supplies
- Mercury and Zinc-Carbon Batteries
- Controls
- Switches
- Filters
- Rectifiers

then the faulty component lies between there and the previous check point.

If the tubes are found to be good, a leaky coupling capacitor is always a prime suspect. Cathode-bias and plate-load resistors also should be checked because of their tendency to change value. Because bias and plate voltages in sync-separator stages are very critical in determining cutoff and saturation characteristics, any component part which changes value—even slightly—could easily produce sync instability. Twin triodes such as the 12AU7, which are often used as sync separator stages, tend to produce sync instability even if cathode emission changes only slightly.

Before tackling a sync problem, one should vary the vertical hold, horizontal hold, contrast, brightness, and channel selector controls to help isolate the trouble to one section of the receiver. If variation of the horizontal hold control has no effect, or is very critical, and vertical hold is normal, then the trouble is in the horizontal AFC or horizontal oscillator sections. However, if vertical hold is critical and horizontal sync is unstable or does not exist, then the trouble is in either the video or sync separator sections.

The contrast control should be varied over its entire range. Normal action should produce a picture of proper contrast at a point which is usually somewhat less than maximum. If this action is not normal, or if varying the contrast control results in a loss of sync, then trouble in the video section of the receiver should be suspected. By rotating the brightness control toward the low end of its range, one should be able to blank out the screen. If it does not blank out and loss of sync remains, then the trouble may be caused by a faulty CRT or by trouble in the associated circuitry.

Checking Waveforms

The input signal to a sync separator system is more or less the same for all receivers. Specifically, it is a composite video signal. If the first sync-separator stage is functioning properly, very little video will remain in the output waveform. Each succeeding separ-

rator stage amplifies the sync pulses and clips off any video which is not removed by the previous stage. When a scope is being used to check waveforms in the sync separator system, the presence of both vertical and horizontal sync pulses must be ascertained, since it is quite possible for a defective stage to reproduce one set of sync pulses properly while not doing the same for the other set. Thus, the scope is set to a frequency of 60 cps (or 30 cps when two cycles are to be observed) to observe vertical sync pulses and to 15,750 cps (or 7,875 cps when two cycles are to be observed) to observe horizontal sync pulses.

Most set manufacturers indicate the input and output waveforms of the sync-separator stages. Fig. 4 shows these circuits in the Olympic Model 21TC54; Fig. 5 shows their normal input and output waveforms. W1 and W2 are the V10A grid waveforms for the 30 cps and 7,875 cps sweep frequencies. W3 and W4 are the V10A plate (and V10B grid) waveforms, and W5 and W6 are the V10B plate waveforms.

In waveform W1, the video signal appears as an irregular white mass which makes up most of the negative portion of the waveform. The blanking level is marked by a thin white horizontal line (located directly above a thin black line) appearing at the bottom portion of the sync pulses. The two vertical white lines are the vertical sync pulses; the area between them has a filmy or ribbon-like appearance, which is due to the presence of closely-spaced horizontal sync pulses.

The horizontal sync pulses are seen in waveform W2. The 7,875-cps scope frequency used to observe W2 gives the impression that waveform W1 is being viewed with the horizontal gain of the scope increased to many times its original value. The horizontal line appearing above the video signal in W2 marks the blanking level. Waveforms W1 and W2 have approximately the same amplitude; the precise amplitude depends upon the setting of the contrast control which is located in the cathode circuit of the video amplifier.

... another
MALLORY
service-engineered
product

**Sign of Dependable
Auto radio servicing...**

Mallory Gold Label Vibrators



No service-dealer likes to see a job come back—especially when it means pulling the car radio out a second time.

Avoid doing "2 jobs for the price of 1"—by installing a Mallory Gold Label Vibrator. These are especially designed for an extra measure of service, even under rugged working conditions. The unique buttonless contact design by Mallory assures fast, positive starting every time... and, this is the quietest vibrator ever made.

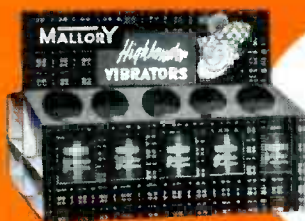

For economy service jobs, choose Mallory Highlander vibrators... second only to Gold Label in quality. Get them in the handy 10-pack carton.

Your nearby Mallory Distributor carries a complete assortment of both these leading vibrator lines.

- Capacitors
- Controls
- Vibrators
- Switches
- Resistors
- Rectifiers
- Power Supplies
- Filters
- Mercury and Zinc-Carbon Batteries

P. R. MALLORY & CO. Inc.
MALLORY

P. R. MALLORY & CO. Inc., INDIANAPOLIS 6, INDIANA

NEW! IMPROVED!

SENCORE
TRC4
TRANSISTOR CHECKER

Another Sencore Time-Saver

America's newest, most popular test instruments

NOW CHECKS:

- ★ **Transistors** for opens, shorts, leakage and current gain. Includes new gain test on power transistors.
- ★ **Crystal Diodes** checks forward to reverse current ratio on all diodes.
- ★ **Selenium Rectifiers** checks forward and reverse currents.

Controls are accurately set for each transistor by referring to replaceable set-up chart on rear. Test leads or socket provides for fast hook-up. See your parts distributor.

ONLY \$17.95
Dealer Net

SERVICE
Mfg. by **INSTRUMENTS CORP.**
171 OFFICIAL RD., ADDISON, ILL.

Cannot become obsolete. Approved by leading manufacturers.

Simple to operate

Cut out this ad now for further information

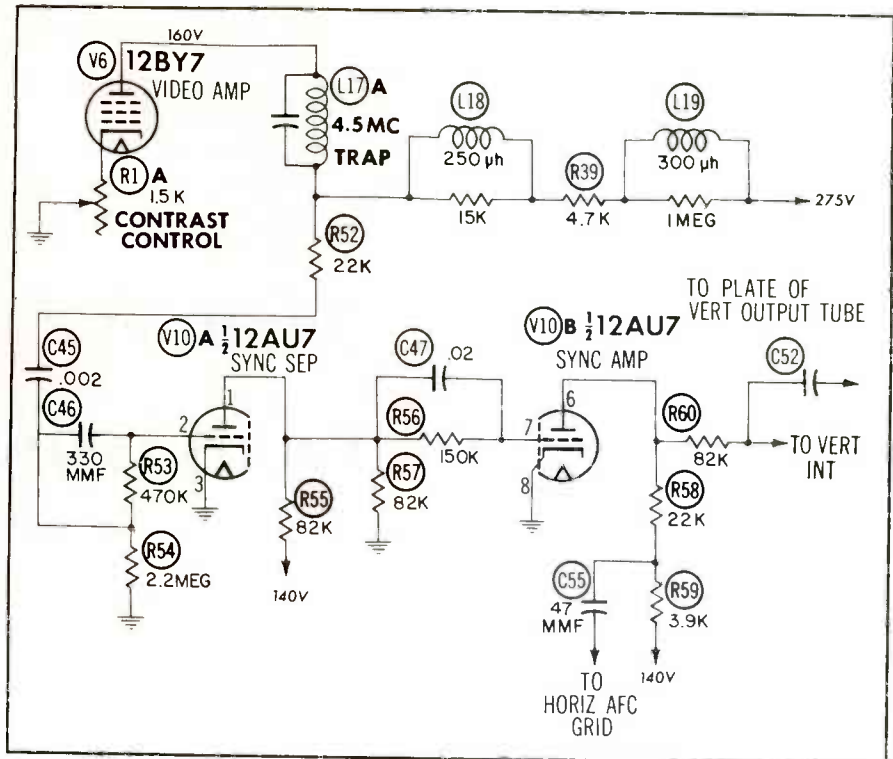
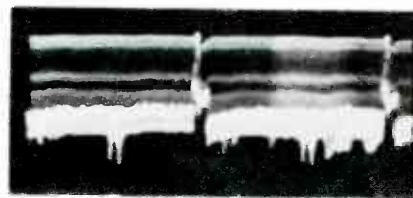

Fig. 4. Sync separator circuit used in the Olympic Model 21TC54 TV receiver.

Waveform W3 (30 cps) appears at the V10A plate. The two vertical pulses are clearly seen. The fact that there exists an irregular fringe at the bottom of the waveform, which is caused by variations in the height of the horizontal sync pulse (existing between vertical sync pulses), indicates that there is horizontal pulling in

the picture. The individual horizontal sync pulses are seen in waveforms W3 and W4 at the 7,875 cps rate. The p-p amplitude of W3 and W4 is about 35 volts. This voltage is practically constant, under normal conditions, for any amplitude of incoming signal.

The 30-cps waveform at the



(W1) Grid of V10A at 30 cps

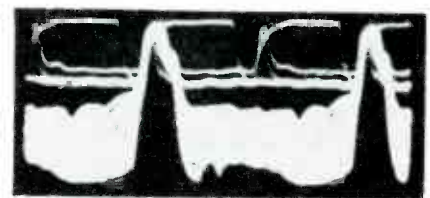

(W2) Grid of V10A at 7,875 cps

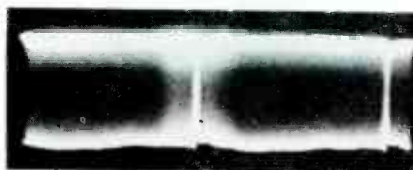

(W3) Plate of V10A at 30 cps



(W4) Plate of V10A at 7,875 cps

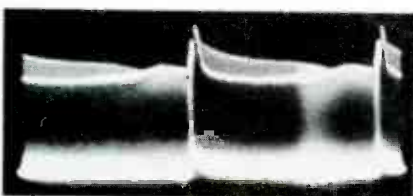

(W5) Plate of V10B at 30 cps

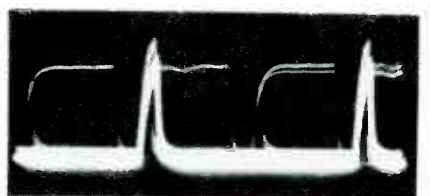

(W6) Plate of V10B at 7,875 cps

Fig. 5. Normal waveforms observed at various points in the circuit of Fig. 4.

YOUR BEST BUY!

FUSE RESISTORS

...FROM THE
ORIGINATOR

Your jobber has them or
can get them for you.

**MILWAUKEE
RESISTOR
CO.**

700 WEST VIRGINIA STREET
MILWAUKEE 4, WISCONSIN

V10B plate is shown in W5. Note the similarity of this waveform to W3, with the exception that the vertical sync pulses in W5 are positive instead of negative. The top portion of W5 is sawtooth-like because of feedback from the vertical oscillator stage through C52 (Fig. 4A); note that many receivers do not contain feedback, which results in a level waveform. If the oscillator stage is inoperative, the top of waveform W5 will appear level except for two vertical sync spikes. Waveform W6 is the 7,875-cps V10B plate waveform; its p-p voltage is about 60 volts.

An incorrect waveform observed at a test point is one which deviates from the waveform given by the set manufacturer. How much the waveform differs depends upon the type and function of the component which becomes defective, the extent of its faultiness, and the type of sync separator circuit in question. To include every type of faulty waveform here would be impossible since they are too numerous. However, typical examples are shown which may be used as a guide in analyzing all waveforms.

In Fig. 6, waveform W7 shows the signal at the V10A grid (7,875 cps). Compare it with W2 in Fig. 5 and note that the height of the horizontal sync pulse is severely limited. This is known as sync compression. Although practically any component in the video or AGC system of the receiver can cause such a trouble, this particular one was caused by a reduction in AGC voltage, which resulted in the overloading of the video amplifier stage. As the contrast control is advanced, the effect gets worse, although the p-p voltage of 80 volts does not change.

Fig. 7 is a comparison of sync pulse amplitude with the over-all amplitude of the composite video signal—both for a normal signal and for a condition where the sync is compressed. Note that the height of the sync pulse should be equal to 25% of total signal amplitude. In sync compression, the sync signal amplitude is only about 10% of the total signal. Sync compression usually results in vertical instability, although

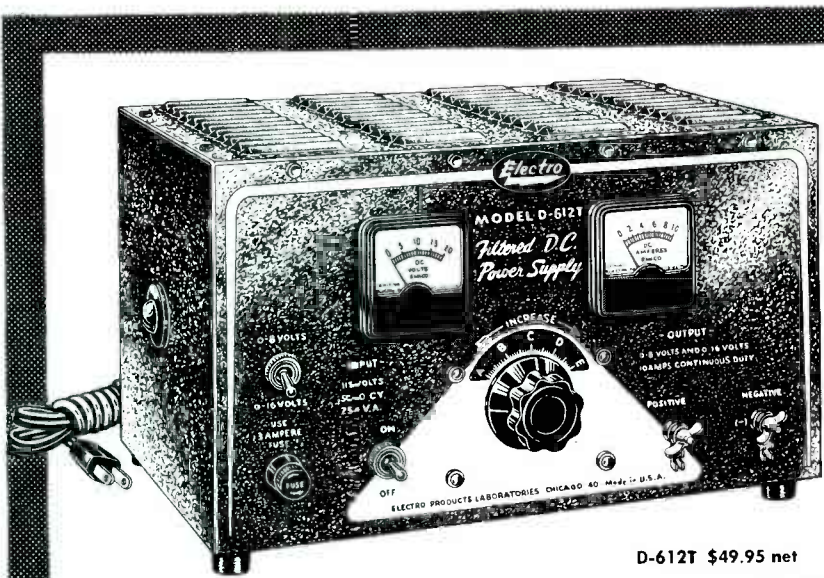

D-612T \$49.95 net

why buy more when ONE Electro Power Supply operates ALL...

Transistor auto radios
Transistor portable radios
Tube vibrator auto radios

Hybrid tube auto radios
Aircraft radios
Marine radios

1, 10-1 1/2% AC Ripple
Two Variable DC Ranges 0-8 and 0-16 volts

The D-612T is specifically engineered to service newly designed radios and electronic equipment in addition to operating older standard equipment. Why buy power supplies that will be outmoded in one year when you can buy one D-612T that not only does the work of several today but will handle equipment of tomorrow? Use coupon below to cash in on these new fields to make more money. Save time, trouble and bench space with the D-612T . . . pays for itself over and over.

- 10 amperes continuous duty up to 12 volts • Up to 21 volts for transistor portable radio loads • Patented EPL conduction cooling lowers cost per ampere output and lengthens life of unit.

At better Parts Jobbers everywhere

✓ CHECK AND MAIL COUPON FOR ALL THE FACTS



Everything for
DC Servicing

- H 6/12 v. 20/10 amps.
- EFB 0-32 v. at 4 amps.
- NFB 0-32 v. at 15 amps.
- GFA 0-125 v. at 10 amps.

ELECTRO PRODUCTS LABORATORIES

4501-R Ravenswood, Chicago 40, Ill.
Canada • Atlas Radio Ltd., Toronto

Send bulletin(s) on model(s) checked

- D-612T, 0-12 v. at 10 amps.
- Send name of nearest jobber

Name _____

Firm _____

Address _____

City _____ Zone _____ State _____



TV ANALYZER



- SIMPLE TO USE
- PORTABLE
- TESTS TUBES
- TRACES SIGNALS
- INDICATES FIELD STRENGTH

ALLOWS TOP-SIDE CHECKING WITHOUT ANY PHYSICAL CONNECTION



The most versatile test instrument ever offered to the TV service industry. The first all-purpose tester designed specifically for TV work. With a minimum of controls, and extremely simple operation, this instrument is invaluable in the shop, and is a reputation and business builder when taken out on calls. Using simplified wave-form analysis, it allows complete antenna to CRT and speaker checking of TV sets from top-side and without any physical connection. You can use it to test tubes in their circuits; to check antenna signals and orientation; to check progressive gain through various stages. Tuned circuits for both black and white, and color frequencies, and for testing other types of electronic equipment including transistor radios when used with the special Transistor-Radio Accessory Probe TRP-I.

VERSATILE PROBE

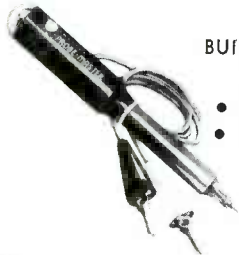

BUILT-IN CAPACITIVE NETWORK

- TWO CLIPS
- NEON BULB



Capacitive network allows by-passing of stages, checks open condensers, couples signals from one stage to another in any circuit which self-generates a signal, isolates defective stages, eliminates time-consuming condenser substitution; also may be used as a neon checker.

ASK YOUR DISTRIBUTOR OR WRITE



W 7

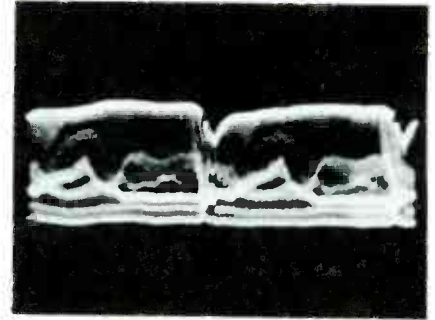

W 8

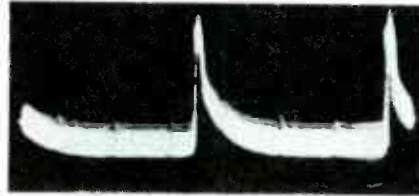

W 9

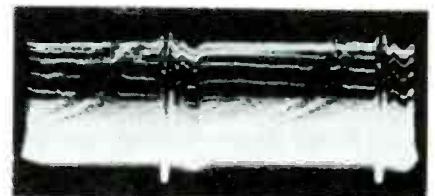

W 10

Fig. 6. Abnormal waveforms (Fig. 4). Compare these with waveforms in Fig. 5.

horizontal instability can also result. Horizontal instability is not often encountered because of the stabilizing effect produced by the horizontal AFC system.

Waveform W8 in Fig. 6 shows the V10A plate waveform (at 30 cps) when coupling capacitor C45 (Fig. 4) is leaky. This waveform is contaminated with video when the video should be absent, as the normal waveform W3 indicates. The picture symptoms for this trouble are horizontal pulling and slow vertical roll, neither of which grows worse at higher settings of the contrast control. The range of contrast in the picture is normal because the IF and video stages are not being overloaded.

Because C45 is leaky, it cannot hold a sufficient charge, which results in the production of insufficient grid-leak bias voltage. This

shifts the composite video signal closer to the zero voltage axis of the e_{k-i} curve and thus permits most of the video to pass through V10A without being cut off.

There is direct coupling between V10A and V10B. V10B develops grid-leak bias through C47 and R56. If C47 shorts, then V10B will not develop grid-leak bias, and the signal amplitude at the grid will be only a fraction of a volt. As shown in Fig. 6, waveforms W9 and W10 appear at the V10B plate when this fault occurs. (Compare these to the normal waveforms in Fig. 5.) Waveform W9 is essentially a sawtooth, since it results from vertical oscillator feedback to the V10B plate through C52; note that most of the sync pulse amplitude present in W5 is absent in W9. The p-p amplitudes of waveforms W9 and W10 are only 5 volts and 0.3 volt, respectively, whereas their amplitude should be about 60 volts.

Troubleshooting sync separator systems often requires that a waveform analysis be made. Since this can be difficult and time-consuming, you want to be sure that the trouble is isolated to this section; therefore, it is suggested that you follow the procedures outlined in the first part of this discussion whenever you are confronted with a sync problem. If you then find that the trouble is confined to the sync separator system, perform a waveform analysis and let common sense be your guide. ▲

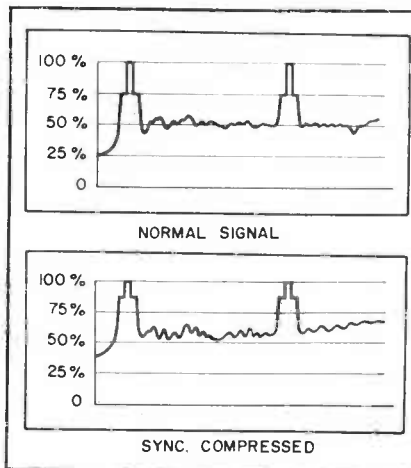

Fig. 7. A comparison of sync amplitude in normal and abnormal video signals.

Shop Talk

(Continued from page 12)

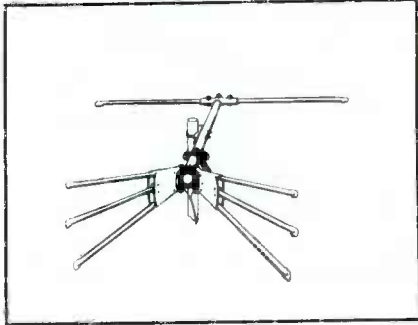

Fig. 5. Response of this Trio conical is improved by veering elements forward.

ward, we tend to shift all but the rear lobe forward with the result that the forward response is greatly improved. (We could, if we wished, consider the lobes pointing in the forward direction as being pushed together.) This increase comes at the expense of reception in the opposite direction, but this is generally unimportant because most arrays employ a reflector anyway. Thus, we now have an antenna which, although cut for the low band, possesses a very usable response pattern over the high band.

One deleterious effect of the forward bending of the elements is that the area across the array, known as the aperture, is reduced. As previously mentioned, this is done at some sacrifice in gain on the lower channels; however, it is more than offset by the improvement in over-all response.

It is interesting to note that the

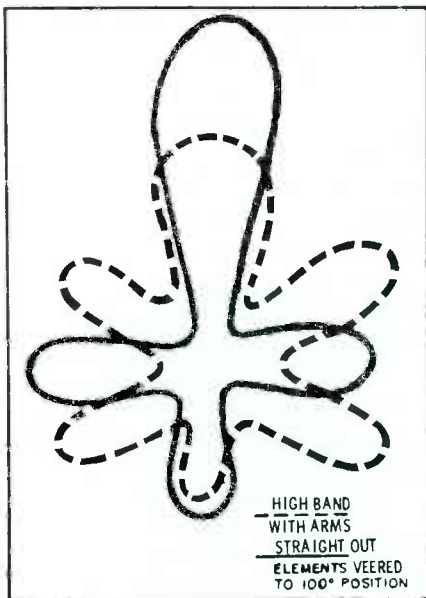
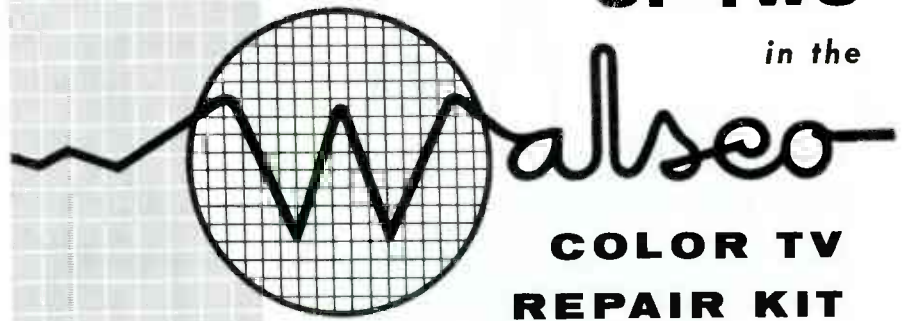

Fig. 6. High-band response patterns with elements straight and veered forward.

**SPECIAL!
FIVE TOOLS FOR
THE PRICE
OF TWO**

in the



**COLOR TV
REPAIR KIT**

This kit contains the five tools you must have to service any color TV set . . . at the price you would normally pay for just two of them! In the kit are



KIT #2599

- Color TV Degaussing Coil #2590 to eliminate stray fields prior to purity adjustments. With momentary switch to de-energize coil without pulling plug.
- Color TV Interlock Cheater #2548 with special design that permits safe insertion of high voltage probe.
- Color TV Grid Grounding Box #2595 for convergence and matrix adjustments with special "insulation piercing" terminals.
- Color TV Color Viewer #2596 with balanced optical filters that permit accurate color phase and matrix adjustments . . . without using an oscilloscope.
- Color TV Alignment Tool #2589 for making simultaneous, separate adjustment of concentric controls.

You get the complete kit for \$21.90 Dealer Net . . . the regular cost of the Degaussing Coil and Grid Grounding Box alone! The Interlock Cheater, Color Viewer and Alignment Tool **FREE!**

 NEW! Master Printed Circuit Repair Kit #12K List Price \$13.25	 NEW! Standard Printed Circuit Repair Kit #13K List Price \$8.25	 NEW! "Lucky" 13 Alignment and Specialty Tool Kit #582 List Price \$14.55
--	--	--

WALSCO ELECTRONICS MFG. CO.

A Division of Textron Inc.

102 WEST GREEN STREET, ROCKFORD, ILLINOIS, U.S.A.
 WEST COAST PLANT: LOS ANGELES 18, CALIFORNIA
 In Canada: Atlas Radio Corporation, Toronto 10, Ontario

XCELITE Hand Tools
PREFERRED BY THE EXPERTS

Featuring
QUALITY

See Your
Distributor!



**A TECHNICIAN
MUST HAVE PROPER
HAND TOOLS . . . and
XCELITE DISTRIBUTORS HAVE THEM!**

XCELITE hand tools are made especially for the professional Radio, T.V. and Electronic technicians . . . pliers for example, made of the finest steel, with perfectly matched tips and all cutting edges induction hardened and hand honed . . . fully polished heads and jaws. Available in a variety of regular or special types and sizes for greater utility and performance . . . remember XCELITE for the finest tools first!

Call or see your distributor today . . . get acquainted with the complete line of XCELITE quality tools.

XCELITE, INCORPORATED
Dept. Q, Orchard Park, N. Y.
In Canada: Charles W. Pointon, Ltd.
6 Alcina Ave., Toronto, Can.

For Originality
LOOK TO **XCELITE**

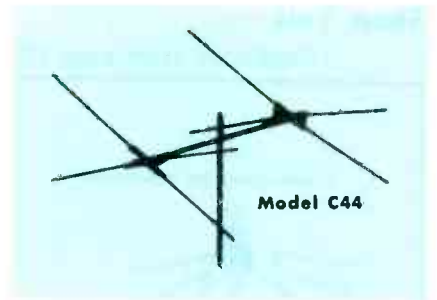

Fig. 7. Clear Beam conical with 2 sets of forward elements, X-type reflector.

position of the various side lobes on the high-frequency response will vary as the angle between the conical elements changes. By altering this angle, we can move the side lobes to positions where signals arriving from either side will develop a sizeable voltage in the array. By the same token, we can use the same facility to shift the nulls between the side lobes, thereby eliminating any undesired ghost signals that may be arriving from the sides. Some commercial models have a forward angle which can be adjusted at the time the array is installed. The best angle is selected by trial and error and then locked into this position.

Commercial conicals will be found with two elements, front and rear, as shown in Fig. 7, or with three elements forward, as in Fig. 8. Sometimes, with three elements, the center one is made shorter in order to enhance reception on the high channels without noticeably affecting low band operation. In still another variation, the conical elements have a small high-band rod positioned in front of them (Fig. 9). The rod is not connected into the system, so it serves as a director, principally for the high band. In this function, it improves the gain at these frequencies, and at the same time tends to reduce side and rear lobes considerably.

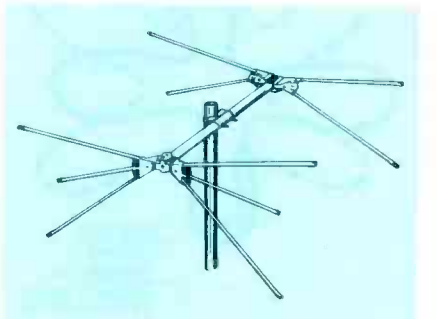

Fig. 8. Shorter center rods on this Telco unit improve high frequency response.



Popular and Fast Moving . . .

"ILLINI

ELECTROMITE
CONDENSERS"

Time Tested
Quality



Earn greater profits with this quality line of capacitors which are priced to sell. Available in variety of sizes with flexible leads or tinned pigtail leads. Attractively packed 10 to colorful display box. One full year unconditional guarantee. Write for catalog. SOLD THROUGH RECOGNIZED DISTRIBUTORS EVERYWHERE



Telephone: EVerglade 4-1300

ILLINOIS

CONDENSER COMPANY

1616 N. Throop Street • Chicago 22, Illinois

the specs are the proof . . .
the **BEST BUYS** are **EICO**
for COLOR & Monochrome TV servicing

**NEW TV-FM SWEEP
GENERATOR &
MARKER #368**

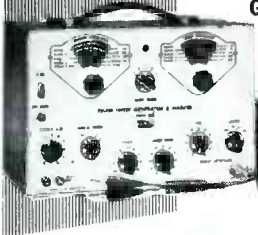

368
Factory-wired
and tested
\$119.95
Also available
as kit
\$69.95

Entirely electronic sweep circuit (no mechanical devices) with accurately-biased inductor for excellent linearity. Extremely flat RF output; new AGC circuit automatically adjusts oscillator for maximum output on each band with minimum amplitude variations. Exceptional tuning accuracy; edge-lit hairlines eliminate parallax. Swept Oscillator Range: 3-216 mc in 5 fundamental bands. Variable Marker Range: 2-75 mc in 3 fundamental bands; 60-225 mc on harmonic band. 4.5 mc Crystal Marker Oscillator, crystal supplied. Provision for External Marker. Sweep Width 0-3 mc lowest maximum deviation to 0-30 mc highest maximum deviation. 2-way blanking. Narrow range phasing. Attenuators: Marker Size, RF Fine, RF Coarse (4-step decade). Cables: output, 'scope horizontal, 'scope vertical. Deep-etched satin aluminum front-panel; rugged grey wrinkle steel case.

See the 50 EICO models of tests instruments and hi-fi equipment IN STOCK at your neighborhood distributor. Write for FREE Catalog PF-4

Prices 5% higher on West Coast



33-00 Northern Blvd.
Long Island City 1, N. Y.

**SUBSTITUTE PARTS
WITH-OUT SOLDERING**

Quickly with Easily

NEW E-Z-Hook
"SUB"
Connectors

Connect a speaker, or

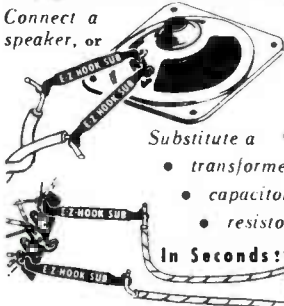

Substitute a

- transformer
- capacitor
- resistor, or choke

In Seconds!!

- ★ Makes connections instantly!
- ★ Won't pull off!
- ★ Insures positive contact!

Saves time, money and parts in servicing, experimenting, instructing and production.

E-Z-HOOK SUB

No. 71-1 SUB Only 69¢ ea.

Six Colors! - for Easy Lead Identification



ORDER THROUGH YOUR PARTS DISTRIBUTOR
E-Z-HOOK TEST PRODUCTS
Dept. F, 1536 Woodburn Ave.
Covington, Ky.

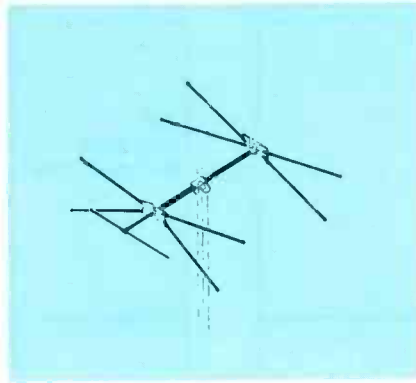

Fig. 9. Parasitic rod at front of Tenna conical improves high band response.

The gain of a single conical with reflector is about the same as that for a folded dipole and reflector. Actually, as we have noted, the principal advantage of this type of antenna is the flatness of its response over a wide range of frequencies, permitting one array to be utilized for both low- and high-band VHF reception.

Antenna Stacking

We have seen that the gain of an antenna can be improved 4 or 5 db by adding a reflector. Still another way to increase gain is by stacking, i. e., by mounting one array above another and then connecting them by means of a suitable transmission line or rods. Stacking will raise the gain of the array by 3 or 4 db. In addition, the vertical directivity becomes sharper, rendering the antenna less susceptible to extraneous noise signals arriving from points above or below the level of the array.

This matter of vertical directivity is seldom mentioned because we are not ordinarily concerned with it. Much more important is the horizontal directivity, and antennas are fashioned primarily to

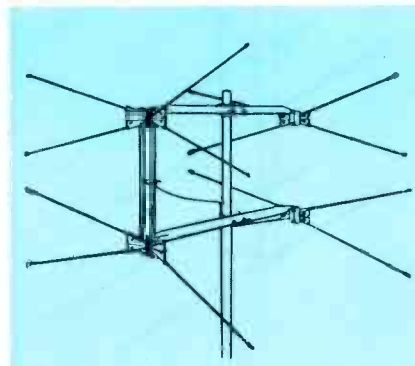
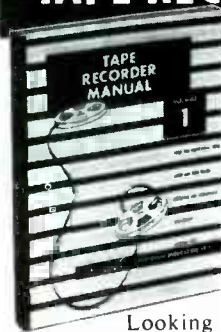

Fig. 10. C-D stacked conical uses center feed—separation of units is about $\lambda/2$.



get the straight facts
on current model
TAPE RECORDERS



Howard W. Sams
**"TAPE
RECORDER
MANUAL"**

VOL. 1

Looking for unbiased facts about various makes of tape recorders? This is the book that shows you the "inside story"—no sales pitches—just down-to-earth descriptions and illustrations of all mechanical and electrical features and how they work.

Sams "Tape Recorder Manual", Vol. 1, covers tape recorders and players produced in 1956 and 1957 by the following manufacturers: Ampex, Bell-Sound, Columbia Records, Ekotape, Ellamac, Magnecord, Silvertone, V-M and Wilcox-Gay.

Presents complete authoritative data on each model: exclusive "exploded" views of all mechanical parts; details of each adjustment and control; complete operating instructions; photographs of all external and internal parts; complete wiring diagrams and replacement parts lists. Includes tips on how to avoid and cure troubles such as wow, flutter, failure to erase and others. Shows you how to disassemble and assemble each recorder and how to check for source of trouble. A valuable book for everyone interested in tape recorder design, operation and servicing. 148 pages; 8 1/2 x 11"; profusely illustrated.

PRICE ONLY **\$2.95**

SEE THIS AUTHORITATIVE BOOK AT YOUR SAMS DISTRIBUTOR OR MAIL COUPON TO HOWARD W. SAMS

FREE TRIAL COUPON

Howard W. Sams & Co., Inc., Dept 3-DD8
2201 E. 46th Street, Indianapolis 5, Ind.

Send me Sams "Tape Recorder Manual" Vol. 1, for 10 days FREE examination. In 10 days I will pay for the book, plus small delivery cost, or return postpaid. We pay delivery costs if you remit with this coupon, some return privilege.

Name.....
Address.....
City..... Zone..... State.....
(outside U. S. A. priced slightly higher)

IMPROVE your AMPLIFIER in 5 ways



with the
**AmpereX®
GZ34/5AR4**

RECTIFIER

A LOW-IMPEDANCE, INDIRECTLY HEATED, FULL-WAVE RECTIFIER WITH 250 MA OUTPUT CAPACITY

The unique AMPEREX GZ34 replaces without circuit changes, in the majority of amplifier circuits, an entire line of popular, heavy-duty 5-volt rectifiers—5U4G, 5V4G, 5T4, etc.

— with the following benefits:

- Better voltage regulation due to lowered power supply impedance;
- Higher power supply output voltage for more power;
- Added filter condenser protection due to reduced surge;
- Cooler operation due to lower voltage drop;
- Protection of costly power output tubes through delayed warm-up.

OTHER AmpereX TUBES FOR HIGH-FIDELITY AUDIO APPLICATIONS:

EL84/6BQ5	9-pin power pentode; 17 W PP
6CA7/EL34	High-power pentode; 100 W PP
EF86/6Z6	Low-noise high- μ pentode
ECC81/12AT7	Low-noise medium- μ dual triode
ECC82/12AU7	Low-noise low- μ dual triode
ECC83/12AX7	Low-noise high- μ dual triode
ECC85/6AQ8	High- μ dual triode for FM tuners
EZ80/6V4	9-pin rectifier; cathode; 90 ma.
EZ81/6CA4	9-pin rectifier; cathode; 150 ma.

At All Leading Electronic Parts Distributors

**AmpereX
ELECTRONIC CORP.**

230 Duffy Ave., Hicksville, Long Island, N.Y.

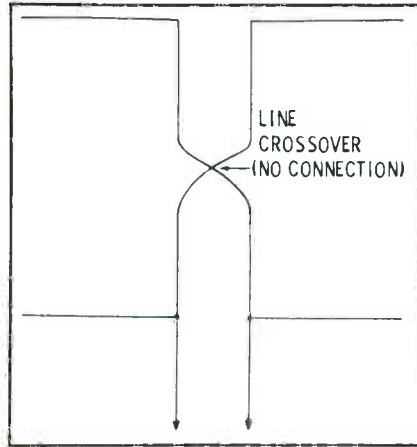

Fig. 11. A second method of interconnecting conicals in a stacked array.

possess the most desirable pick-up pattern in this direction. However, in areas where the signal level is fairly weak, stacking not only improves the over-all gain, but it also keeps the reception of impulse noises and other extraneous signals to a minimum, thereby improving the signal-to-noise ratio at the receiver input.

Stacked antennas are generally separated by a distance of one-half wavelength. They are then interconnected by two rods, either as shown in Fig. 10 or Fig. 11. In Fig. 10 the transmission line connects to a point equidistant from the two arrays, assuring that the two signals will be in phase. The method of interconnection shown in Fig. 11 will provide an in-phase condition only for frequencies at

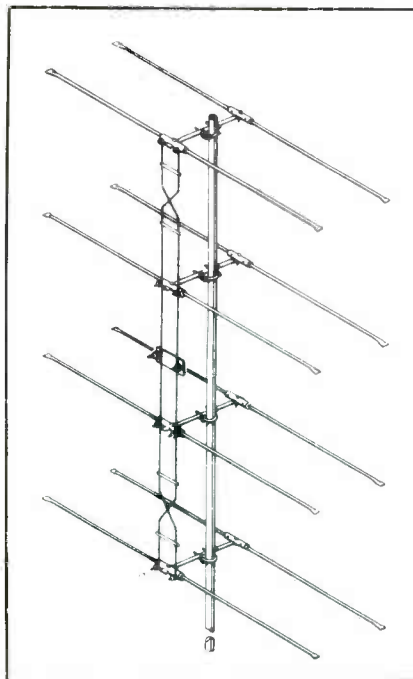

Fig. 12. This TACO 4-stacked array uses a combination of center and end feed.

Another
Sencore
Time-
Saver

NEW IMPROVED SENCORE LC3 Leakage Checker

Check these outstanding New Features
Now — For the first time . . .

Checks 130 different tube types — more than any other "grid circuit" type checker. Includes UHF and latest type tubes.

Checks picture tubes without removing tube from cabinet or chassis.

New Roll Chart prevents obsolescence — just dial the tube type and save time. Chart is easily replaced at no extra cost.

Dynamic Filament checks including heater to cathode leakage & shorts — no need for a second filament tester.

Two spare preheating sockets to cut down testing time.

Capacitor checks simplified.

The LC3 provides all these new improved features in addition to those employed in earlier leakage or "grid circuit" testers. A must for any TV service technician.

\$28.95

DEALER NET
Really Whips Tough Dogs

SERVICE

INSTRUMENTS CORP.

171 Official Rd. • Addison, Ill.

In stock at your local parts distributor

Cut out this ad now for further information



"It's a JENSEN NEEDLE"

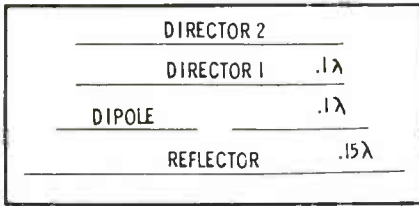

Fig. 13. Drawing shows typical spacing between elements of a 4-element yagi.

which the length of the interconnecting line is approximately one-half wavelength. Thus, the former method would be advantageous for reception of a wide range of frequencies, while the latter would be most satisfactory for narrow-band reception.

Additional gain can be obtained by stacking four arrays, as in Fig. 12. The method of interconnecting these sections is seen to be a combination of the two systems just outlined. Naturally, vertical and horizontal directivity are narrowed, and because of the phasing relationship between the stacks, this type of array is best used for single-channel reception.

Yagi Antennas

Yagi antennas have attained considerable popularity principally because of their high gain. Basically, the yagi consists of a reflector, a half-wave receiving element (dipole), and two or more directors (Fig. 13). Gains up to 10 db or more are possible; however, because of the greater number of elements, the array is highly directional and a slight change in orientation can cause

the received signal to be reduced considerably.

The spacing of the elements of a yagi generally conform to the distances shown in Fig. 13. The spacing between the directors and also between the first director and the dipole is about 0.1 wavelength, and the reflector is positioned about 0.15 wavelength behind the dipole. Reflector length is 5% greater than that of the dipole, while the directors are each 5% shorter than the dipole. Sometimes the director at the front of the array is made shorter than the director behind it, but this varies with the design.

Yagis usually have only one reflector, because adding more would neither increase the gain nor appreciably reduce reception from the rear. However, yagis with three or four directors are quite common, each added director increasing the over-all gain by a few db. At the same time, the horizontal directivity becomes narrower, making it imperative that the array be properly oriented and then securely fastened to prevent any wind movement.

The close proximity of the reflector (0.15 wavelength) and initial director (0.1 wavelength) to the active dipole causes the latter's impedance to fall far below its normal value of 73 ohms. In a 4-element yagi of the type shown in Fig. 13, the input impedance of the dipole could easily be in the neighborhood of 10 ohms. This, of course, makes impedance matching between antenna and lead-in practically impossible. By moving the reflector farther away, say to a distance of 0.2 or 0.25 wavelength, the dipole impedance can be increased, although now the gain of the array is less.

To overcome this low dipole impedance, folded dipoles with auxiliary elements or with elements of unequal size are used. For example, when a double-folded dipole like that in Fig. 14A is employed, the input impedance is increased by a factor of 9 over that of a simple dipole. Assuming the latter value to be 73 ohms, then 9×73 equals 657 ohms. Impedance can be similarly increased by making the folded arm of the dipole larger in diameter than the driven arm, as in

About the Cover

There are few among us whose hearts fail to skip a beat when a glance at the rear-view mirror reveals a motorcycle policeman speeding up behind. A quick look at the speedometer and the pounding in your ears either fades away or mounts to a crescendo. This is one time our cover technician didn't mind being the butt of an April Fool joke. "It's better than getting a speeding ticket!" he says.

Better heed the traffic laws, men. The officer you meet may not be as good-natured as the one our friend ran across!

This is the 2-Set TV COUPLER Rated No. 1

••• by a nationally known independent product quality rating group as the result of tests made on 10 leading two-set couplers for:

- IMPEDANCE MATCH
- SIGNAL TRANSFER
- TWO-SET ISOLATION

MOSLEY 902



List Price \$3.10

Rated FIRST in overall quality for weak signal reception means; the MOSLEY 902 Dual Match 2-Set TV Coupler can be sold and installed in practically any TV area with full confidence that your customers will be completely satisfied!

Available at Radio and Television Parts Distributors — coast-to-coast.

Mosley
Electronics, Inc.
8622 ST. CHARLES ROCK ROAD
ST. LOUIS 14, MISSOURI

(Advertisement)

latest **JACKSON** tube test data

TUBE TYPE	MODEL 648	FIL. D.	CIRCUIT	PLATE TEST	E. TEST	MODEL 115/715/501		X. PLATE	YZ
						FIL.	FIL.		
3BN4	3.0	AC123	357	3BV	4.2	3.0	45	18	20R
4BZ6	4.2	AC1234	567*	16WV	4.2	6.3	26	3UK1VQ	
6Q4	6.3	123	AC46	16VZ	6.3	256	32	7KS	
6350	12.6	A125	AC34	60Z	12.6	7	16	2S	
		A129	AC78	60Z		7	16	4S	
6973	6.3	129	B046	30W	6.3	46	13	7JKS	
TUBE TYPE	MODEL 19	SEC.	A.	B.	C.	D.	E.	F.	G.
3BN4	T	3.0	3	67X	25				
4BZ6	P	4.2	3	X	1567	2	30		
6Q4	T	6.3	4	278X	19	3	30		
6350	T	12.6	4	9	13	2			
	T	12.6	4	9	68	7			
6973	P	6.3	4	68	139	7			

Latest Chart Form 648-19, 115/715/501-10, 19-1

CORNELL- DUBILIER CAPACITORS

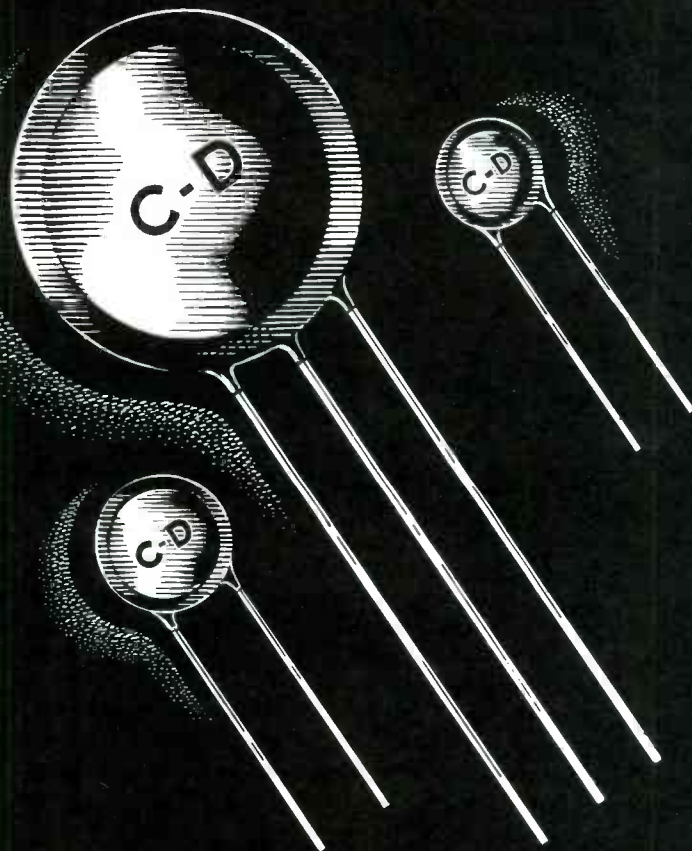

The Ceramics with the "worries" removed

If you want ease of mind, take a second look at C-D Ceramics... the Ceramics with the "MILLION DOLLAR BODY." Even if they were costly—which they're not—they would be the most economical replacements you could use. Because C-D Ceramics remain stable, won't melt, and are virtually immune to shorts and opens.

Besides, C-D Ceramics have a quality that can't be matched—because their manufacture, all under one roof, is rigidly supervised from raw materials to finished product.

Next time you need to replace a bypass or blocking capacitor, use a C-D Ceramic. They're available from your local C-D distributor in all the popular values and voltage ratings. Catalog 200D-3 is yours for the asking. Just write Cornell-Dubilier Electric Corporation, South Plainfield, New Jersey, Dept. PR-48



CORNELL-DUBILIER
CAPACITORS

Old Hands at Dependability

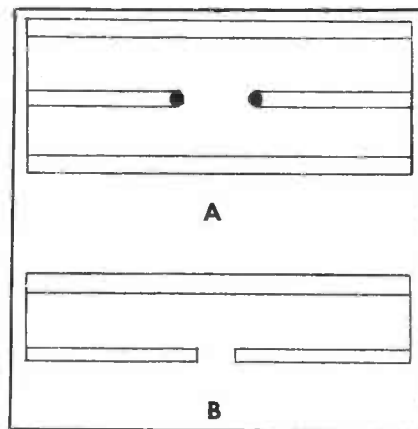

Fig. 14. Impedance is increased by double folding or increasing folded arm size.

Fig. 14B. The lowering effect produced by the closely spaced reflector and directors can be offset to a large extent, permitting a more efficient transfer of signal from the antenna to transmission line.

Another characteristic of the basic yagi is its narrow bandwidth. Any of the yagis thus far discussed, even those possessing an input impedance of 300 ohms, will have a frequency response that peaks quite sharply at the frequency for which it was designed. This limits yagi usefulness to one channel, or two at most, necessitating a number of arrays if signals on widely separated channels are to be received. This is somewhat of a limitation and various methods have been designed to overcome it, at least to the extent of enabling the array to provide useful operation over 3 or 4 channels.

One common method of broad-banding yagis is to vary the lengths of the driven and parasitic elements according to the different channels it is desired to cover. For example, for a yagi to operate suitably over channels 4, 5 and 6, the longest element, the reflector, is cut for channel 4. (That is, its length is 5% greater than that of a channel 4 dipole.) The driven dipole element (folded or otherwise) is then cut for channel 5. The directors are each adjusted until a fairly even response is achieved for channel 6. Much of this design technique is essentially cut and try, and only experience and experimentation can be used—there are no specific formulas available.

Another approach to broad-

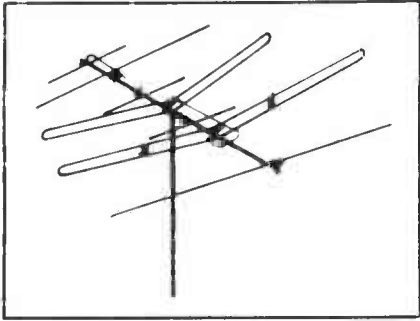
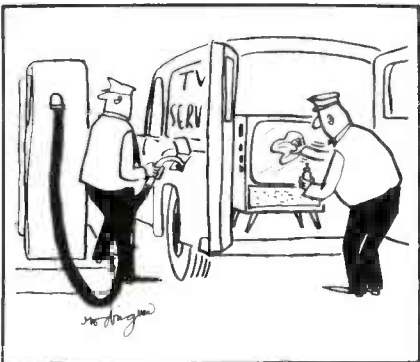

Fig. 15. Broad-band 7-element yagi by Winegard uses two driven folded dipoles.

banding is the use of two driven elements, each tuned to different channels. One such array is shown in Fig. 15 and is seen to consist of one reflector, two active folded dipoles, and four directors. The dipoles are interconnected by means of a quarter-wave line, forming what is known as an end-fire array. By again tuning each of the parasitic and active elements to slightly different frequencies, reception over a range of several channels is possible. Note that the lowest frequency should govern the size of the reflector and, progressing forward, the size of the other elements chosen for best reception on the higher channels.

If more gain than one yagi can supply is needed, the stacking principle can be utilized. Well-designed stacked yagis will have a gain of 3 or 4 db over a single antenna. For a broad-band yagi, the distance between the upper and lower arrays is generally set at one-half wavelength at the center frequency of the band covered. This, while favoring the higher frequencies because the separation distance for them is greater than one-half wavelength, is done purposely in order to help overcome the higher transmission line losses for these frequencies. ▲



RADIART VIBRATORS



Consistently dependable power

Next time an auto-radio vibrator replacement is called for, try Radiart. There's a complete line for all 6-volt and 12-volt applications. And no waiting for the type you want, because your local Radiart Distributor maintains a full stock for your convenience. Ask him for your free copy of the Radiart Vibrator Replacement Guide, or write to Dept. S-1, The Radiart Corporation, Indianapolis 5, Indiana.



RADIART TOBE Vibrators

Old Hands at Dependability

25 WORDS



Tell Why You Like Tobe Service Capacitors

Your 25 words can win the Ford Ranch Wagon

And Here are the TSC* Features to Help You Win • No substandard materials can possibly enter the manufacture of TOBE SERVICE CAPACITORS, because *everything* is quality-checked beforehand • Highest grade dielectric materials prevent voltage breakdown in service • TSC's are designed for high-temperature operation — will not dry out or deteriorate in service • Copperweld leads soldered directly to foil insure you against opens • Moisture-tight seals guard against shorts • Pigtail leads will not pull out or break off • No danger of hot soldering iron opening internal connection or melting sealing compound • TSC's will maintain specified capacity over entire operating temperature range • TSC's receive 100% quality-control inspection prior to shipment • Continuous production-line testing automatically rejects "duds" • Maintenance of large inventories on complete line means faster delivery to your TOBE DISTRIBUTOR and *you*.

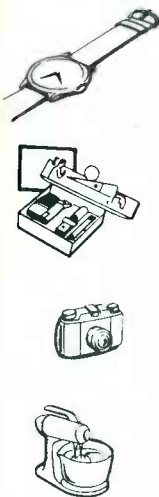

*Tobe Service Capacitors



TOBE
RADIART
CAPACITORS

**HERE'S YOUR
ENTRY BLANK**

Tobe Deutschmann Corporation, Dept. C
2900 Columbia Avenue, Indianapolis 5, Indiana

"I prefer Tobe Service Capacitors in my work because _____

NAME _____

ADDRESS _____

CITY _____ ZONE _____ STATE _____

I enclose a Tobe boxtop

AGC Circuits for '58

(Continued from page 18)

the grid of the video amplifier and applied to the inner control grid (pin 7) of the 4BU8. Since its peak-to-peak amplitude is less than 1 volt, it normally has very little effect on tube conduction. However, the bias on this grid is established at such a value that noise pulses having greater amplitude than the sync pulses will momentarily cut off the tube. This serves to cancel noise pulses in the main AGC input signal and therefore minimizes their effect on receiver gain.

The outer control grid (pin 9) receives a sync-positive, composite video signal very similar to that which drives a conventional AGC keying tube. This signal is DC coupled from the plate of the video amplifier to insure that a variation in video signal strength will register as a change in the DC level of the sync pulse tips. This level regulates the plate current of the 4BU8 and hence the voltage on the AGC line. When video signal amplitude increases, the sync-tip level moves up to a more positive value at the outer control grid and the tube section is permitted to conduct more heavily. This increases the AGC bias voltage and reduces the gain of the RF and first IF amplifiers.

No keying pulse from the horizontal sweep section is required at the plate in order to drive the 4BU8 into conduction. Since the plate is returned to B+ through 3.3 megohms, plate voltage is in the vicinity of 35 volts; consequently, the tube is able to conduct at any time that the inner and outer control grids are both above cutoff. Because of the nature of the input signal at the outer control grid, conduction occurs chiefly (or entirely) during sync pulses. It might be said that this circuit is "keyed" by the sync pulses, their amplitude automatically controlling its gain.

The voltage actually applied to the AGC line is the result of an electronic "tug-of-war" between the plate of the 4BU8 and a -50 volt source. In Fig. 1, note that 1.8-meg, 120K and 1-meg resistors are connected in series between these points. The values were

chosen so that, in the absence of an input signal, the AGC line to the tuner would have a slightly positive voltage and the IF line would be slightly negative. When a signal arrives, the plate voltage drops and causes the intermediate AGC-line voltages to go in a negative direction. The IF voltage is always slightly more negative than that applied to the tuner; in other words, the tuner has a type of delayed AGC.

The B— source is at the grid of the 17DQ6 horizontal output tube. Variations occur in the voltage at this point due to the presence of the horizontal drive signal, but these are leveled out by the AGC filters without affecting the operation of the horizontal sweep circuit.

This same B— point is also used as a source of negative bias voltage for the outer control grid of the 4BU8. Such a voltage is necessary because the circuit is direct-coupled to the video amplifier and cannot utilize grid-leak bias. Voltage is reduced to the desired level by applying it to pin 9 of the 4BU8 through a resistive voltage divider.

Zenith Chassis 17A20

The redesigned 6BU8 circuit used in this year's Zenith 17A Series chassis (Fig. 2) is actually a noise-cancelling keyed AGC or "noise-hasn't-a-chance" circuit. Positive keying pulses, 110 volts peak to peak, are coupled from the grid of the horizontal discharge tube to the plate of the AGC tube via C1. Note that this capacitor has no counterpart in the circuit of Fig. 1.

The high-resistance DC connection between the plate of the AGC tube and the horizontal sweep circuits, used in other Zenith 6BU8 circuits to provide a bucking voltage for the AGC line, is absent from the 17A Series chassis. However, a bias voltage for the outer control grid (pin 6) of the 6BU8 is still obtained from the horizontal sweep section, just as it was in the circuit of Fig. 1. This voltage is not filtered and therefore contains horizontal retrace pulses, but these are harmless because the resistive network in the AGC grid circuit attenuates them to a height of only 2 or 3 volts peak

WIN THIS FORD



RANCH WAGON

Or one of 49 other valuable prizes



Here's all you do . . . In 25 words or less, tell us why you prefer TOBE SERVICE CAPACITORS.

Then, send your entry to us with the top from any TOBE capacitor carton, or the plastic box some TOBE capacitors are packed in.

That's all there is to it. Enter as many times as you wish, providing each entry is accompanied by a TOBE carton top or the plastic box. Use entry blank below. Additional entry blanks can be obtained from your TOBE DISTRIBUTOR.

Contest Closes May 30

Contest is open to all service-men over 21 years of age residing in the continental United States. Employees of the TOBE DEUTSCHMANN CORPORATION and their advertising agency are excluded. All entries become the property of TOBE DEUTSCHMANN CORPORATION. Decisions of the judges are final. In case of ties, duplicate prizes will be awarded. Contest closes May 30, 1958. Winners will be announced June 30th.



HERE'S YOUR ENTRY BLANK



TOBE RADIART
CAPACITORS

Tobe Deutschmann Corporation, Dept. C
2900 Columbia Avenue, Indianapolis 5, Indiana

"I prefer Tobe Service Capacitors in my work because _____

NAME _____

ADDRESS _____

CITY _____ ZONE _____ STATE _____

I enclose a Tobe boxtop

HOW TO SELL MORE **RECOTON** REPLACEMENT NEEDLES

JUST TELL YOUR CUSTOMERS THESE 6 IMPORTANT FACTS...

1. There is no such thing as a permanent needle.
2. There is a RECOTON needle for every purpose and every pocketbook.
3. RECOTON needles are the finest in fidelity, quality and value.
4. RECOTON needles are always priced lowest.
5. RECOTON replacement needles are mounted on large, easy-to-read cards.
6. All replacement data and installation instructions are printed right on the cards.

And remember — RECOTON backs you up with the most complete line in the industry, compelling advertising and intensive merchandising; plus most convenient reference, model numbering and inventory control.

Insist on RECOTON.

A RECOTON PLUS: Self-selling stylus merchandiser. 100 power microscope lets customers check their own styli. Increases sales, profits, turnover!

Recoton CORPORATION
52-35 Barnett Avenue Long Island City 4, N. Y.

In Canada:
Quality Records, Ltd.,
Toronto

to peak at pin 6. An AGC control is provided for adjustment of the DC voltage level at this point.

The main AGC input signal is applied to pin 6 from the top end of the contrast control in the plate circuit of the video amplifier. The noise-cancelling signal is obtained in customary fashion at the grid of the video amplifier and then applied to pin 7 of the 6BU8. A "Fringe Lock" control regulates noise-cancelling action for both AGC and sync.

Basically, the plate circuit of the 6BU8 is similar in operation to that of a conventional keyed AGC system except that some rather startling voltage readings will be observed when no video signal is present. Unlike the usual keying tube, the 6BU8 has a plate connection to B+ (through 1.5 megohms to 110 volts) which maintains a plate potential of +25 to +30 volts in the absence of an input signal. This voltage is fed directly to the AGC line and appears at the grid of the first IF stage. For proper biasing of this tube, it then becomes necessary to place the cathode at approximately the same voltage level as the grid. A voltage divider across B+ is employed for this purpose in the cathode circuit. (See inset in Fig. 2.)

AGC voltage is fed to the tuner through isolating resistor R5. If the RF amplifier tube were not in its socket, the AGC voltage would divide evenly between R5 and R6, and the RF grid voltage would be equal to half the 6BU8 plate voltage. With the tube in place, however, the grid voltage is very close to zero when no input signal is present—no matter how high the voltage at the junction of C2 and R5. The RF amplifier draws grid current and shunts R6 with its low grid-to-cathode resistance; as a result, virtually all the positive voltage is dropped across the high resistance of R5.

Voltages on the AGC line change drastically when an input signal arrives. Filter capacitors C2 and C3, just like the capacitors used in more familiar types of AGC circuits, charge in proportion to signal strength and drive the voltage on the AGC line in a negative direction. On moderately strong signals, the 6BU8

WRIGHT WIRE STRAND PERFORMS LIKE A KING AND IS NON-SNARLING



Wright TV Guy Wire Strand is your guard against irritating snarls. Each concentric coil measures two feet.

You save money in guying antennas. Greater flexibility, heavily galvanized continuous connected coils. Prompt delivery from stocks in Worcester, Chicago, New Orleans, Houston, Dallas and Los Angeles.

Non-Snarling Pre-Measured Wire Strand Sold only through Wholesale Distributors.

G. F. WRIGHT STEEL & WIRE CO.
235 Stafford St. • Worcester, Mass.

plate voltage assumes some value in the range from approximately -10 to +4 volts. The grid voltage of the first IF stage drops to the same value.

The cathode voltage must also decrease at this time in order to keep pace with the sudden drop in grid voltage. It is interesting (and important!) to see how the cathode voltage is regulated. The drop in grid voltage itself causes some reduction in cathode voltage, simply because the plate current flowing through the cathode resistors is reduced. In order to provide an additional decrease in cathode voltage, a negative bucking voltage is applied to the cathode circuit. In the inset of Fig. 2, note the connection through R7 to the outer control grid (pin 9) in the sync section of the 6BU8. Grid-leak bias at this latter point produces a negative voltage which varies from near zero under no-signal conditions to approximately -20 volts with a strong signal present. The portion of this voltage which is fed to the IF circuit contributes to proper cathode biasing of the IF stage. The net effect of all this circuitry is to vary the spread between grid and cathode voltages smoothly according to signal amplitude, just as in more conventional types of AGC-controlled IF stages. A 6BZ6 tube with a semi-remote cutoff characteristic is used in the circuit so that a signal can get through the stage over a wide range of bias voltages.

Tuner AGC voltage remains near zero on weak or moderate signals because the plate voltage of the 6BU8 is still at some positive value. As signal strength increases, C2 and C3 become so heavily charged that the AGC line voltage begins to go negative. The RF amplifier then ceases drawing grid current, and the AGC voltage is divided equally between R5 and R6. Only the portion appearing across R6 is applied to the RF amplifier. In this manner, considerable AGC delay is provided for the tuner.

The "Fringe Lock" control connected to the inner control grid (pin 7) of the AGC tube should be kept near its maximum counterclockwise position except in fringe areas or noisy locations.

VACO HAS "TWINS"

TWIN DRIVERS! TWIN USES!

Two combination tools that make your servicing work easier . . . faster!

No. 1 . . . 5/8" insulated blade screw driver with 1/4" nut driver. Pocket clip handle.

No. 2 . . . genuine Phillips No. 1 point driver with 1/4" nut driver. Pocket clip handle.



Look for them on this handsome VACO Display Card at your favorite Parts Jobber.

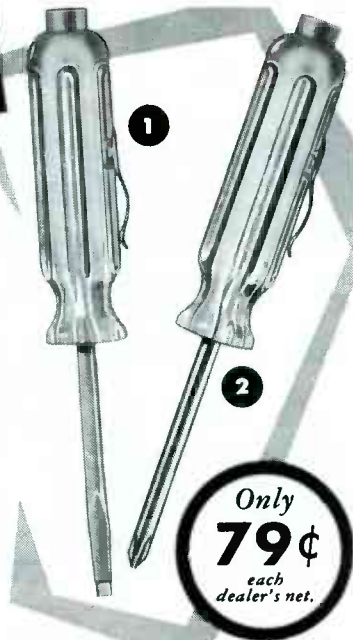

Only **79¢**
each
dealer's net.

VACO PRODUCTS CO. 317 E. Ontario St., Chicago 11, Ill.

In Canada: Atlas Radio Corp., Toronto 19, Ontario

selling TV parts?
for the right replacement

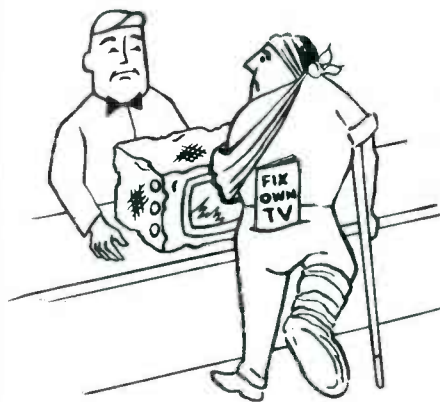

you'll find it
faster in the
MASTER

new 1958 edition—world's largest
electronic catalog only \$3.50 at
your local parts distributor—now
Free! Write for Panel Lamp Chart.

THE RADIO-ELECTRONIC MASTER
60 MADISON AVE., HEMPSTEAD, N. Y.

WILL YOUR REPLACEMENT
Fuse Resistor
BURN OUT AGAIN?

Not if you use—
The NEW SENCORE
"FUSE-SAFE"
CIRCUIT TESTER

Save costly call backs
by testing the circuit
before replacing
fuse, fuse resistor or
circuit breaker.



Individual scale for
each value fuse res-
istor — no inter-
pretation, just read
in red or green area.

★ Measures line current
and up to 1100 watts of
power at 115 volts using
line cord and socket.

★ Two convenient current
ranges — 0 to 2 amps and
0 to 10 amps. Test leads
clip in place of fuse or fuse
resistor.

★ 5 ohm, 10 watt resistor prevents TV circuit
damage and simulates operating conditions.

As Recommended by Leading Manufacturers



Mfg by **SERVICE**
INSTRUMENTS CORP.
171 OFFICIAL RD., ADDISON, ILL.

Cut out this ad now for further information



\$8.95
DEALER NET
MODEL FS-3
AC-DC or both as
needed for Fuse
Resistor Circuits

RCA 'scope

for
troubleshooting
black-and-white
and color TV
receivers!

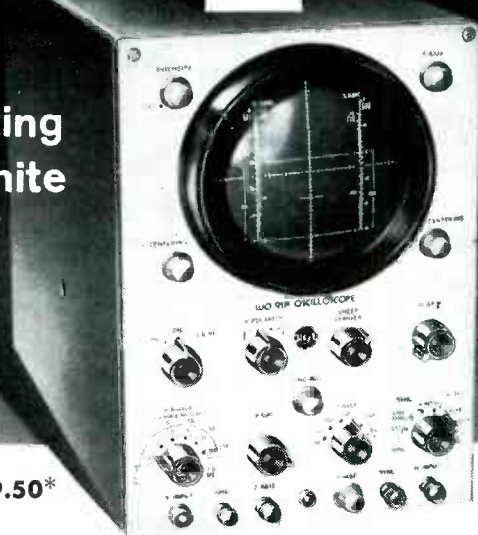

RCA WO-91A 5-inch Oscilloscope only \$239.50*

*User Price (Optional). Supplied with probes, cables, green graph screen, instruction booklet.

Don't sell yourself short on one of the most important shop instruments you can own—get the best from RCA! Here's a 'scope that will help you make money, now and in the years of increased color servicing to come.

You get full 4.5-Mc bandwidth with high sensitivity—18 millivolt—for checking low-level stages of any TV receiver, color or black-and-white. Three short, simple steps and the WO-91A is calibrated, ready for voltage measurements at all settings of the "V" range and band-width control. Unlike 'scopes with the usual 10:1 step attenuators, there is never a need to disturb calibration because the WO-91A's unique 3:1 step attenuator permits selection of the trace height best suited for analysis.

Plus these important WO-91A features: vertical polarity-reversal switch for "upright" or "inverted" trace display • sturdy single-unit low capacitance/direct probe minimizes circuit loading • shielded vertical-input coaxial connector and shielded cable minimizes hum and stray-field pickup • Z-axis input facilities permit direct modulation of the control grid of the cathode-ray tube • "plus" or "minus" internal-sync selector • positive-lock internal sync.

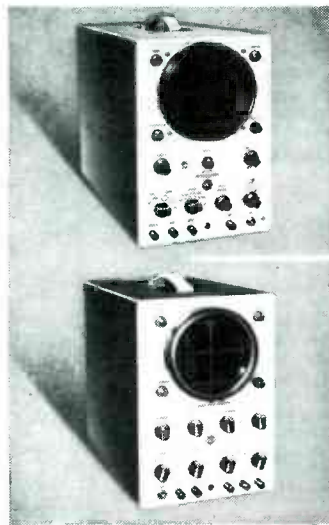

Choose from RCA's famous family of high-quality 'scopes

RCA WO-78B 5-inch Oscilloscope—laboratory-type 'scope with high 3.5-millivolt sensitivity. Designed with all the features necessary for photographing screen patterns—flat-faced CRT, 2.7Kv high voltage on CRT to obtain bright patterns, fine focus. Excellent roll-off characteristics, a feature usually available only in higher-priced 'scopes. **\$475.00***

RCA WO-88A 5-inch DC Oscilloscope—low cost; has all basic features for general service applications. Features 25-millivolt sensitivity, input impedance of 10 megohms to minimize loading of test circuits; built-in voltage-calibrating facilities permit simultaneous waveshape display and peak-to-peak voltage measurements. Supplied with switch-type low-capacitance probe. **\$179.50***

Available from Your Local RCA Distributor's!



RADIO CORPORATION OF AMERICA
Electron Tube Division
Harrison, N. J.

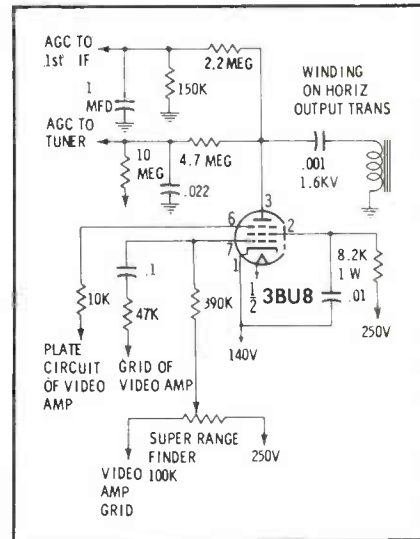

Fig. 3. 3BU8 circuit in Admiral 16J1.

Then it should be advanced clockwise to obtain maximum noise cancellation. The control is first turned until the picture becomes unstable, indicating that the sync pulse tips in the signal are cutting off the 6BU8. It is then necessary to back off the control until a steady picture is restored.

Admiral Chassis 16J1

Several 1958 Admiral chassis feature the AGC circuit shown in Fig. 3. Those readers who are familiar with the keyed AGC circuits previously used by this manufacturer will recognize that the cathode and plate circuits of the AGC tube are the same as those in former designs. Only those modifications necessary to meet the requirements of the 3BU8 or 6BU8 tube have been made—namely, the shifting of the AGC input signal to the outer control grid (pin 6) and the addition of a noise-cancelling circuit.

A "Super Range Finder" control regulates the bias on the inner control grid (pin 7) and thus governs noise cancellation for the AGC and sync circuits simultaneously. The electrical location of this control is the same as that of the "Noise Gate" used on previous Admiral chassis such as the 20Z4.

This description of new AGC circuits will be concluded in a succeeding article. Novel 6BU8 circuits in DuMont and Motorola receivers will be presented, followed by several short items on unusual circuit features in other 1958 TV sets. ▲

Scope for Signal Tracing

(Continued from page 15)

application of the scope at the output of the video detector, the use of such a probe for signal-tracing at this point is almost as undesirable as the use of a direct probe. A resistive isolating probe has a low-pass filter action which is desirable for alignment work but very undesirable for signal-tracing work. To anticipate our discussion a trifle, it will be noted at this point that the proper probe to use in signal-tracing at the output of the video detector is the low-capacitance probe and not a direct probe.

Beginners are also sometimes puzzled by the appearance of a weak, distorted response when the direct probe is applied to the grid of an IF amplifier tube, as shown in Fig. 3. When such a response is noted, it is because the probe detunes the circuit in such a manner that regeneration results and extremely high gain is developed over a limited portion of the IF band. This abnormally high gain causes the tube to overload for signal frequencies falling in the regenerative peak, and as a result of the overload, partial rectification, as well as the anticipated IF amplification, takes place. The scope responds to the rectified components and displays a waveform which is, of course, highly distorted. It is perhaps unnecessary to note that only demodulator probes are suitable for this type of test work.

A direct probe is very suitable for checking the level of hum voltage in power supplies, as illustrated in Fig. 4, since the value of the filter capacitors is very large and the additional 150-mmf shunt capacitance of the direct probe is negligible. Furthermore, the use of the direct probe permits full gain of the probe and scope arrangement to be realized (as compared with the 10-to-1 attenuation obtained through the use of a low-capacitance probe) and also permits a more accurate analysis of the low voltage levels normally constituting ripple.

The experienced technician recognizes that a direct probe and cable operate as a tuned stub when high-frequency voltages are present, and that for IF frequen-

cies (such as video-detector feed-through), the input of the cable will appear capacitive. This resonant effect is illustrated in Fig. 5. Because the coaxial input cable to the scope is terminated at the scope end by a high resistance and a small capacitance, the cable can be regarded for practical purposes as an open stub, becoming series-resonant at some frequencies (harmonically related) and parallel-resonant at other frequencies (also harmonically related). Thus, the input impedance of the direct probe varies with fre-

quency, being capacitive at IF ranges for the usual lengths of input cables. In the RF ranges, however, the cable will develop a very low input impedance which progresses through inductive values and then to a very high input impedance at the high end of the frequency range.

The variation of input impedance is accompanied by abnormal increases and decreases of output voltage to the scope; thus, if RF signals are permitted to enter the cable, the resonant rise of voltage at the output end may, at certain



The TOTE MASTER
TUBE 'N' TOOL

- Over 4000 cubic inches of useable space
- Room for more than 360 tubes plus tools and accessories
- Instantly tailors to fit every need
- Loaded with quality extras

Here is the newest idea in a tailored tote box... a MASTRA Box convertible into any size... to suit any need! TOTE MASTER can carry a complete tube inventory plus tools and equipment.

The handiest box you've ever seen! Sections are interchangeable... you can carry it all... or make any size box you desire. Built-in tube pin straightener, order book and schematic holder, detachable non-distortion mirror... and quality built throughout for long, dependable service.

Attractive too! Covered in brown tweed, waterproof leatherette with heavy nickel-plated raised steel corner protectors and strong draw pull catches. Ask for a demonstration at your Parts Jobber today!

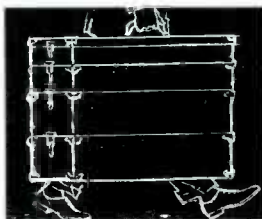

Designed to size... lightweight but durable! Carry all of your tubes and tools to the job...

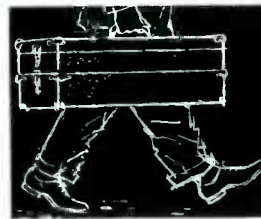

...or tailor the box to your needs. All sections are interchangeable to suit every need.

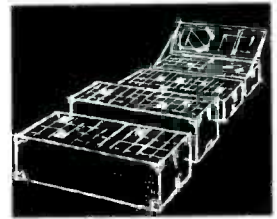

Handiest box you have ever seen! Room for everything and anything.

Ask for a demonstration of this remarkable service box.

See TOTE MASTER and other MASTRA TNT boxes at your jobber.

TOTE BOXES



MASTRA COMPANY 2104 SUPERIOR AVE. CLEVELAND 14, OHIO

PIONEER MANUFACTURERS OF THE TUBE AND TOOL TOTE BOX
CANADIAN DISTRIBUTOR: TENATRONICS LTD., NEW MARKET, ONTARIO

frequencies, overdrive the grid of the input stage and cause it to draw grid current, partially rectifying the RF voltage and producing a distorted pattern on the scope screen. Hence, the direct probe should not be applied in circuits which have RF signals present. (Note that other suitable probe types, which provide isolation between the probe output and the cable input, are available.)

Cable Impedance

Standing waves are always developed on improperly terminated

cables when the wavelength of the operating frequency is such that the physical length of the cable may be termed "long." A cable is long electrically when its input impedance departs substantially from its characteristic impedance. In general, the technician may regard a cable as electrically long when its physical length approaches an eighth wavelength for the frequency of test. The following tabulation brings these considerations home, in terms of frequencies commonly utilized in TV service work.

Freq.	λ , inches	$\frac{1}{8} \lambda$, inches
40 mc	295	37
100 mc	118	15
200 mc	60	7.4

Upon occasion, technicians may have need to check video waveforms and levels in video distribution systems where the input cable may be electrically long, even at 4 mc. In such cases, it is usually necessary to provide a suitable terminating resistor at the scope input terminals, as indicated in Fig. 6. It is of interest to note that some 10-mc scopes used in broadcasting work provide such a terminating resistor internally, with provisions for switching the termination in or out as desired. Since the TV technician seldom requires such a facility in his work, there is little point in incorporating the feature in a service scope since it can easily be improvised, should occasion arise. It is perhaps unnecessary to point out that when a terminating resistor is applied at the scope input terminals, the input resistance of the cable is always equal to the characteristic impedance of the cable and will be a low value, such as 75 ohms.

If an electrically long input cable is unterminated, the input end of the cable will appear as a series-resonant circuit (with very low input impedance) for lengths which are an odd multiple of quarter wavelengths; at even multiples, the input end of the cable appears as a parallel-resonant circuit (with very high input impedance). When the input impedance is high, the output voltage from the cable is low; when the input impedance is low, the output voltage from the cable is high. These are the sources of distortion, circuit loading and scope overdrive when testing with a direct probe in circuits having RF components present.

In some cases, the technician can proceed with confidence, knowing that the internal impedance of the circuit under test and the operating frequency are both low enough that a direct probe cannot produce noticeable distortion; e.g., this situation exists when testing a power supply for ripple. However, in other cases the technician may have some doubt con-

JERROLD MF-2: THE 2-SET COUPLER WITH GUTS!

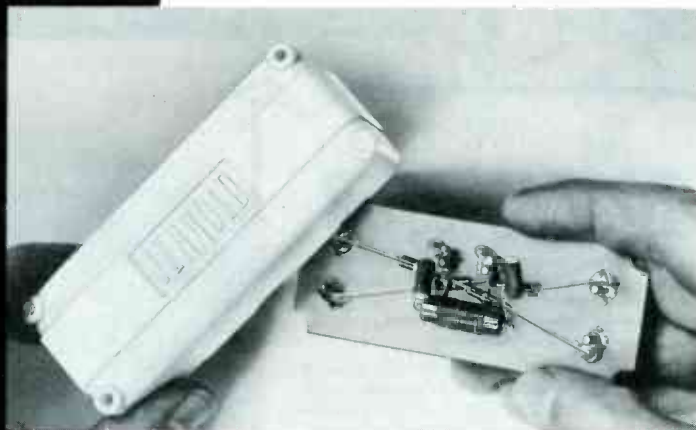

The MF-2 Doesn't Care Where It's Used!

Even though the impedance of most TV sets varies greatly from 300 ohms, the low-loss MF-2 doesn't care. Its special electronic circuit consisting of a resonated auto transformer with stabilizing resistors will produce positive results—prevent interference between sets—will not introduce ghosts!

USE FOR TV and/or FM

The MF-2 has quickly become the leading coupler in the industry. Attractively packaged . . . universal mounting for easy installation. **\$4.50 LIST**

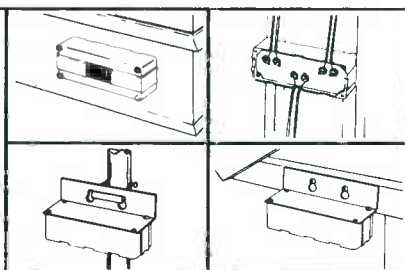

Order the MF-2 From Your Jerrold Distributor Today, or Write:

JERROLD

ELECTRONICS CORPORATION
Dept. PD45, Philadelphia 3, Pa.

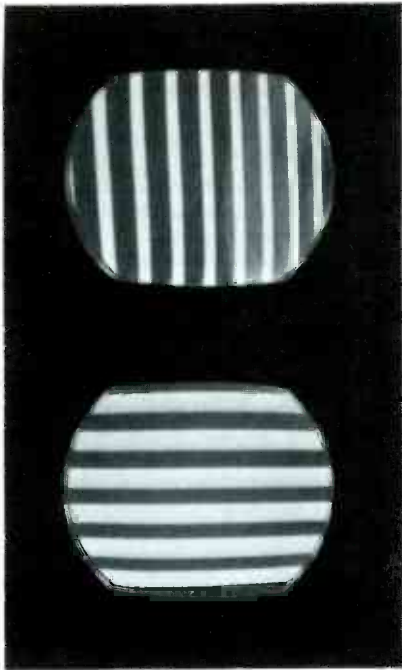

Fig. 7. If, when direct probe is applied, any observable change is noted in the screen pattern, a high-impedance probe should be utilized instead.

cerning whether or not the circuit under test is being appreciably loaded. Suppose, for example, that a direct probe is being used to check the waveform at an intermediate point in the video-frequency amplifier. The signal which is applied to the receiver to provide a basis of test also produces a pattern on the screen of the picture tube, as shown in Fig. 7. To determine whether or not the circuit under test is being loaded, the technician can watch this pattern as he touches the probe to the test point; no noticeable change should be observed in the pattern if loading is negligible. If there is any change in brightness of the pattern, in the clarity of edge definition, or any movement in the pattern, circuit loading is occurring and a high-impedance probe should therefore be used. It will often be found that when the frequencies used in this test are rela-

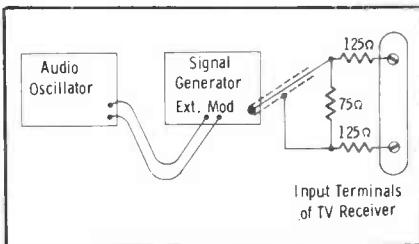

Fig. 8. Test set-up used to obtain the patterns shown in Fig. 7. This type of signal is useful for signal-tracing in the RF, IF and video-frequency circuits.

tively low, there will be little evidence of circuit loading, while severe loading may be evidenced as the frequency is increased. The test setup shown in Fig. 8 is suitable for signal-tracing the RF, IF and video-frequency circuits and provides screen patterns such as shown in Fig. 7.

Improper Applications of the Direct Probe

Application No. 1

Attempt to signal-trace IF amplifier with direct probe (instead of demodulator probe).

Pattern Characteristics: Either no pattern whatsoever will be obtained, or a highly distorted reproduction of the signal will be observed.

Reason: The scope itself cannot respond directly to IF frequencies. In case an overloading signal is applied to the IF amplifier or if the stage is seriously detuned by the probe, regenerative distortion may occur and cause a normal signal to drive the tube into grid current. A demodulator probe should be used.

Application No. 2

Attempt to check flatness of output from RF sweep generator with direct probe (instead of demodulator probe).

Yes, all over the U. S.—Utah stands for Unsurpassed Service.

US—Utah and the Service Man—because Utah stands behind you—the Service Man.

Utah stands behind you—with a speaker name that for over 30 years has signified the finest in quality, design, engineering and production.

Utah stands behind you with a speaker that gives installation performance. You can sell customer satisfaction with a Utah—because Utah gives performance satisfaction.

Utah stands behind you—with a secure source of supply. Leading jobbers all over the U. S. handle Utah—because Utah has the finest and widest line of replacement speakers available to the trade.

Utah your one complete speaker source auto * Rear Deck Kits * Standard Replacement * Television * Public Address * High Fidelity * Outdoor * Inter-Com * Wood & Metal Baffles

Utah is your one, complete satisfactory speaker source. When you order speakers today — THINK—then order Utah.

Get your FREE copy of the latest Utah Catalog S-157 listing over 100 replacement speakers. Available at your distributors or write direct.

Export Dept. Fidevox International, Chicago, Illinois

April, 1958 • PF REPORTER

Pattern Characteristics: At some generator output frequencies, a highly distorted reproduction of the sweep output will be observed; at other frequencies of output, no deflection will be obtained on the scope screen.

Reason: A resonant voltage rise occurs at the output end of the scope cable for RF signals having wavelengths which are odd multiples of a quarter wavelength. This resonant rise drives the input stage of the scope into grid current. At other frequencies, there is no grid-current flow and no response from the scope. A demodulator probe should be used.

Application No. 3

Attempt to signal-trace video-fre-

quency amplifier with direct probe (instead of low-capacitance probe).

Pattern Characteristics: At the higher video frequencies, excessive loading of the video-amplifier circuit is caused by the input capacitance of the direct probe, causing attenuation of the response and phase shift. The phase shift is not observable unless a suitable wave is used for testing, such as a square wave.

Reason: A video-frequency amplifier is designed as a low-pass filter in order to obtain uniform response up to approximately 4 mc, after which the response cuts off sharply. The filter-type network must be correctly terminated in its own characteristic impedance to obtain undistorted response. The 100 to

150-mmF input capacitance of a direct probe shunts the termination of the load-sensitive circuit and causes severe high-frequency attenuation and phase shift. A low-capacitance probe should be used.

Application No. 4

Attempt to check output from video detector with direct probe (instead of low-capacitance probe).

Pattern Characteristics: Satisfactory results can often be obtained when the test signal has a low frequency. However, in some cases the circuit is thrown into oscillation, or a highly distorted reproduction of the signal is obtained.

Reason: The direct probe and shielded input cable to the scope apply considerable shunt capacitance across the video-detector output circuit and greatly attenuate the high-frequency response. The input cable also operates as a resonant stub in some frequency ranges, and may reflect a disturbing impedance back into the last IF stage due to feed-through IF voltage. A low-capacitance probe should be used.

Application No. 5

Attempt to check waveform and peak-to-peak voltage at grid or plate of vertical-blocking oscillator.

Pattern Characteristics: Severe waveform distortion often results when the direct probe is applied, with change from true p-p voltage value and change in operating frequency of the blocking oscillator.

Reason: Although the fundamental component of the waveform has a low frequency (60 cycles), the harmonics of the waveform have much higher frequencies and the circuit capacitances at the point of probe application are small. Hence, the capacitive loading of the direct probe disturbs normal circuit operation. A low-capacitance probe should be used.

Application No. 6

Attempt to adjust Synchroguide transformer for correct waveform, using a direct probe.

Pattern Characteristics: Severe waveform distortion and incorrect indication of p-p voltage with change in operating frequency occurs.

Reason: The relatively high input capacitance of the direct probe and cable detunes the resonant circuit by capacitive shunting. A low-capacitance probe should be used.

Application No. 7

Attempt to check waveform and p-p voltage across horizontal-deflection coils.

Pattern Characteristics: Over-drive of the input stage of the vertical amplifier causes serious distortion and reduction of p-p voltage indication.

Reason: Service scopes are not rated for over 500 or 600 volts input in most cases; higher input voltages cause the first tube in the vertical amplifier to be driven into grid current and beyond plate-current cutoff, which produces serious distortion and clipping. A low-capacitance probe should be used for its attenuating characteristic. ▲



For Every Serviceman ... The Dozen That Does The Most!





12 TOP TOOL KIT

**HERE'S THE ALL
IMPORTANT 12!**

LONG REACH 16" ALIGNMENT TOOL No. 8729	List \$0.90
NYLON .125 HEX IRON CORE TOOL No. 9091	List \$0.75
"SHORTY" 2" ALIGNMENT TOOL No. 8289	List \$0.70
ZENITH-ADMIRAL NYLON HEX TOOL No. 8606	List \$0.55
ZENITH-RCA ALIGNING TOOL No. 9050	List \$0.30
K-TRAN—I.F. TRAN TOOL No. 5097	List \$0.85
WESTINGHOUSE ALIGNMENT TOOL No. 9089	List \$0.90
HEAVY DUTY SOLDERING AID TOOL No. 9088	List \$1.65
DUPLEX ALIGNMENT TOOL No. 8276	List \$0.80
NYLON LONG REACH 12 1/4" ALIGNER No. 8607	List \$1.80
STACKPOLE-TYPE CORE ALIGNER No. 8271	List \$0.90
PLASTIC SLIM 14 1/2" SCREWDRIVER No. 8988	List \$1.50

KIT No. 5040X

WRITE TODAY for free copy of illustrated G-C Catalog. Do it now! Contains thousands of useful service aids.

SPECIALLY PRICED DURING APRIL !

GENERAL CEMENT MFG. CO. Division of Textron Inc.
400 SOUTH WYMAN STREET • ROCKFORD, ILLINOIS

**12 TOOLS FOR ONLY
\$4.95 Dealer Net**
(Regular Dealer Net \$6.48)

PRODUCT report

Outdoor Antennas



Winegard Co., Burlington, Iowa, has marketed a new "Scotchman" line of low-priced TV antennas. Basically, the new design consists

of V-angled, folded dipoles plus directors and reflectors. Four different models with list prices ranging from \$6.95 to \$19.95 provide various degrees of gain. Model 503 (shown; \$14.95) is suitable for suburban and near-fringe areas.

The basic models are shipped in pre-assembled form. A choice of several kits of extra elements can be added by the installer to increase gain and front-to-back ratio of any basic model. Kit A includes two additional reflectors and an "Electro-Lens" array of four directors for better fringe-area performance on all channels. Kit B features three short director elements to increase gain on Channels 7-13. Kit C contains stacking harness. Also available is Kit D that includes a tripod base, mast, lead-in, and other mounting hardware.

For further information, check 44Q on Literature Card.

Axial-Lead Rectifiers



Sarkes Tarzian, Inc., Bloomington, Ind., is manufacturing a new series of silicon rectifiers with axial pigtail

leads for "solder-in" mounting. This Type K series includes four diodes (1N1439 through 1N1442) having peak inverse voltage ratings of 100, 200, 300 and 400 volts, respectively. The ends of the component are sealed with epoxy resin, which is color-coded to indicate polarity. The DC load current rating for all types is 750 ma at temperatures up to 55°C or 500 ma for temperatures to 100°C.

For further information, check 41Q on Literature Card.

Control Parts Stock

International Resistance Co., Philadelphia, Pa., has made available a parts stock kit from which the technician can assemble any of 809 different TV replacement controls. "Dealer Parts Stock #22" includes 44 varieties of Type Q carbon controls with a choice of 11 different styles of detachable shafts, as well as 13 values of wire-wound controls with a selection of 3 shaft types. Also included are parts needed to assemble any of 700 types of concentric dual controls.

Priced at \$113, the kit includes replacement and assembly information plus a 96-compartment stock cabinet.

For further information, check 43Q on Literature Card.

ALL
OUR
BABIES!

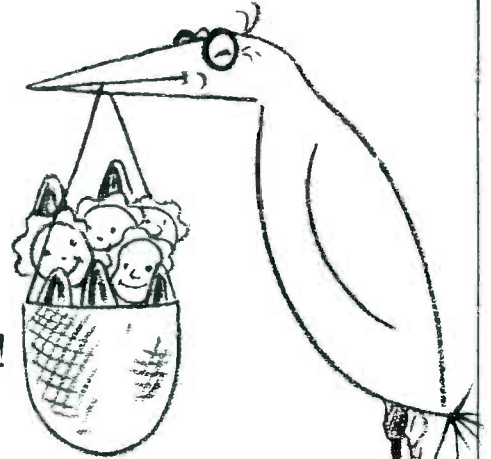

- the first commercial diamond needle
- the first 1 mil twin needles at the same price as the 1 mil-3 mil twin
- the first "needle that remembers"!
- the first record cloth
- the first in advertising — sales — profit



DUOTONE COMPANY, INC.
KEYPORT, NEW JERSEY

In Canada — Charles W. Pointon, Ltd., Toronto

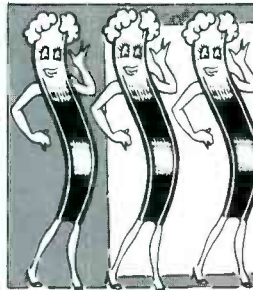

Which one can prove her
QUALITY?

Most brands of twin lead look alike! Also, the price brands make the same claims of quality and performance as the top quality brands.

What Reason . . . What Proof

Can you give your customer that he is getting something better when he pays a little more for twin lead?

WITH
Columbia PERMALINE

Your Customer has the reason

So GOOD that it's
GUARANTEED up to 25 YEARS!

DISTINCTIVE APPEARANCE

HIGH MOLECULAR WT. POLYETHELENE

DEVELOPED AFTER YEARS OF RESEARCH

See Ask him about Permaline — and ask to see the Laboratory Report on weathering studies of Polyethelene.
your Once you "Try" COLUMBIA . . . you'll want to always
Jobber "Buy" Columbia . . . Because only, but only COLUMBIA gives you a complete guarantee for 25 YEARS.

AVAILABLE AT ALL LEADING DISTRIBUTORS

Columbia
WIRE & SUPPLY CO.

2850 IRVING
PK. RD.,
CHICAGO 18

LEADING SET MAKERS SPECIFY TUNG-SOL

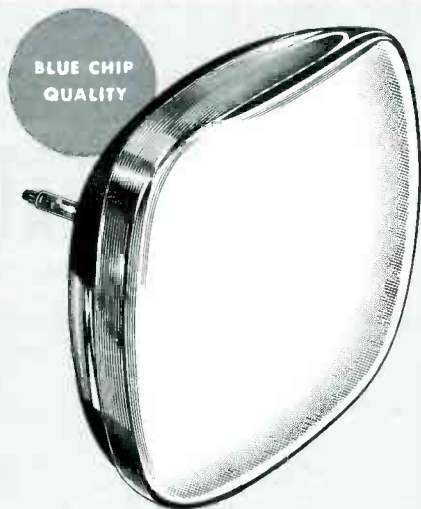

TUNG-SOL®
Magic Mirror Aluminized
PICTURE TUBES

ELECTRON TUBE DIVISION  **TUNG-SOL ELECTRIC INC.**
NEWARK 4, NEW JERSEY

Silicon Rectifier Stacks



New silicon power rectifiers made by Audio Devices, Inc., Rectifier Div., Santa Ana, Calif., have threaded terminals which are adaptable to several mounting methods. The cartridge-style units can be clipped into a fuse holder; or, if one end may be operated at ground potential, it can be screwed into the chassis, which then serves as a heat sink. In addition, threaded bushings are available for connecting two or more rectifiers end-to-end in a series arrangement as pictured. This series stacking provides a much higher voltage rating than the 400 volts (PIV) possible with a single unit. The Type A-750 rectifiers shown have a DC output current rating of 750 ma; other ratings are also obtainable.

For further information, check 46Q on Literature Card.

File Cabinets



Howard W. Sams & Co., Inc., Indianapolis, Ind., is offering a new single-drawer file cabinet free with the purchase of each 60 Sets of Photofact Folders. The 60 Sets may be purchased as part of the new Photofact Library "Easy-Buy" plan or by standing order subscription for all new Sets as issued. The all-steel cabinets feature nylon drawer rollers

and gray finish, and can be bolted together into stacks of four or five units. A matching base for the stack is available at \$2.50, and extra cabinets can be purchased from distributors at \$8.95 each.

For further information, check 45Q on Literature Card.

Three-Way Speaker

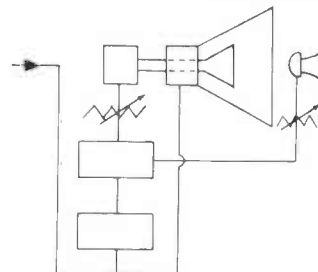

The Model G-600 "Triax" loudspeaker recently introduced by Jensen Mfg. Co., Chicago, Ill., contains three different sections: 15" direct-radiator woofer; thru-bore compression horn-type mid-range reproducer; and compression driver tweeter. As shown in the diagram, all sections are driven by separate signals. Cross-over points between units occur at 900 and 4000 cps, and over-all frequency range is from 30 cps up to audibility limit. Power rating is 35 watts, impedance is 16 ohms, and net price is \$129.50. The G-600 is a new, moderately-priced version of the heavier G-610A "Triaxial" speaker (\$252.75) which has been on the market for several years.

For further information, check 48Q on Literature Card.

Battery Eliminator Kit



A battery eliminator kit (Model B-10) has been introduced by Paco Electronics Co., Inc., Glendale, L. I., N. Y. Standard 6- and 12-volt ranges, with output voltage continuously variable over either range, are provided for auto radio servicing. Continuous-duty current ratings are 10 amps on the 6-volt range and 6 amps on the 12-volt range. A special jack on the front panel is connected to the output of a supplementary filter from which a low-current output (5 amps maximum) is available for servicing transistor circuits. Ripple content of this special output is 0.3% or less. Case dimensions of Model B-10 are 7" × 11½" × 6¾", and net price is \$41.95.

For further information, check 42Q on Literature Card.

Four-Section Tote Box



Mastra Co., Cleveland, Ohio, convinced that the serviceman should not have to carry his entire stock of tubes into the home on every service call, has designed a new "Totemaster" tube caddy made up of four

separate sections fastened together with pull catches. Special tubes such as series-string types can all be kept in one or two sections that can be left in the truck when not needed on a particular call. Attached to one section is a top equipped with carrying handle, mirror, 7- and 9-pin tube straighteners, and a holding strap for books and schematics. Total capacity of the "Totemaster" is over 4,000 cu. in., and price is \$27.98.

For further information, check 47Q on Literature Card.

Power Antenna

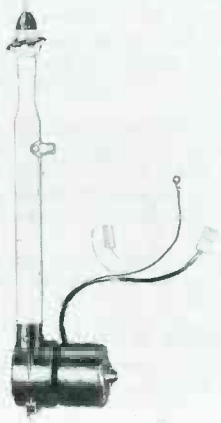

"Tennamatic," an electrically-operated retractable auto radio antenna, has been announced by Tenna Mfg. Co., Cleveland, Ohio. Powered by a 12-volt electric motor in a waterproofed housing, the antenna mast extends or retracts in 10 seconds or less. A special feature is a thrust-limiting clutch that prevents the motor from stalling and burning out in case the mast sticks in its housing.

Two versions of the "Tennamatic" are available—Model TM-1 for front-fender mounting or Model TM-2 for rear mounting. With a TM-3 conversion kit, the TM-1 can be rear-mounted.

For further information, check 49Q on Literature Card.

LEADING INDEPENDENT SERVICE DEALERS CHOOSE TUNG-SOL

LOW IN CALLBACKS



BLUE CHIP
QUALITY

TUNG-SOL® RECEIVING TUBES

ELECTRON TUBE DIVISION  TUNG-SOL ELECTRIC INC.
NEWARK 4, NEW JERSEY

April, 1958

Advertisers	Page No.
Aerovox Corp.	37
Amperex Electronics Corp.	64
Amphenol Electronics Corp.	34
Anchor Products Co.	43
Astron Corp.	35
B & K Mfg. Co.	1, 9
Belden Mfg. Co.	39
Burgess Battery Co.	6
Bussmann Mfg. Co.	25
Centralab, A Div. of Globe-Union, Inc.	49
Clarostat Mfg. Co., Inc.	33
Columbia Wire & Supply Co.	77
Cornell-Dubilier Electric Corp.	66
Delco Radio Div., General Motors Corp.	27
Duotone Co., Inc.	77
EICO	63
E-Z-Hook Test Products	63
Electro Products Laboratories	59
Electro-Voice, Inc.	13
Electronic Publishing Co.	48
General Cement Mfg. Co.	76
Illinois Condenser Co.	62
International Resistance Co. (IRC)	2nd cover
Jackson Electrical Instrument Co.	65
Jensen Industries, Inc.	64
Jerrold Electronics Corp.	74
Kedman Co.	36
Kingston Electronic Corp.	60
Krylon, Inc.	32
Littelfuse, Inc.	4th cover
Mallory & Co., Inc., P. R.	56, 57
Marjo Technical Products Co.	26
Mastra Co.	73
Merit Coil & Transformer Corp.	51
Milwaukee Resistor Co.	58
Mosley Electronics, Inc.	65
Ohmite Mfg. Co.	28
Planet Sales Corp.	53
Pyramid Electric Co.	55
Quam-Nichols Co.	52
RCA Components Division	72
RCA Electron Tube Division	3rd cover
Radiart Corp.	
Cornell-Dubilier Electric Corp.	67
Raytheon Mfg. Co.	19
Recoton Corp.	70
Sams & Co., Inc., Howard W. Service Instruments Corp.	23, 44, 63
Sprague Products Co.	26, 36, 48, 58, 64, 71
Sylvania Electric Products, Inc.	2
Technical Appliance Corp. (TACO)	29
Tenna Mfg. Co.	8
Tobe Deutschmann Corp.	68, 69
Triplett Electrical Instrument Co.	31
Tung-Sol Electric, Inc.	78, 79
United Catalog Pubs.	71
Utah Radio Products Corp.	75
Vaco Products Co.	71
Vis-U-All Products Co.	43
Walsco Electronics Mfg. Co.	61
Ward Products Corp.	21
Webster Electric Co.	45
Wen Products, Inc.	7
Westinghouse Electric Co.	41
Winston Electronics, Inc.	42, 43
Wright Steel & Wire Co., G. F.	79
Xcelite, Inc.	62
Zenith Radio Corp.	10-11

ACCESSORIES

- 1Q. *E-Z-HOOK*—A convenient reference sheet titled "How to Build the Five Most Useful Scope Probes," with schematic, mechanical component layout, etc. See ad page 63.

ANTENNAS

- 2Q. *AMPHENOL*—Sales aids and technical data on new "VI-FI" indoor TV antenna. See ad page 34.
- 3Q. *MARJO*—Specification Sheet #14A on Channel King indoor TV antenna. See ad page 26.
- 4Q. *WALSCO*—New 16-page catalog listing over 60 antennas for UHF, VHF, color and black and white. See ad page 61.

ANTENNA TOWERS

- 5Q. *KTV TOWERS*—A 4-page multicolored brochure showing tower construction features, plus mounting and installation equipment.
- 6Q. *CBS-HYTRON*—Fourth edition of Dealer Business Builder's Catalog—PA-37.

BUYING GUIDES

- 7Q. *UNITED CATALOG PUBS.*—Information on "1958 Radio-Electronic Master," detailing the 150,000 products catalogued in this buying guide. See ad page 71.

CAPACITORS

- 8Q. *ASTRON*—Handy pocket-sized AC4-D, Replacement Catalog and Pricing Guide for servicemen. See ad page 35.
- 9Q. *CENTRALAB*—Bulletin on new "Ultra-Kap." micro-miniature ceramic-disc capacitor for low-voltage uses which require extremely high capacities and low power factors. See ad page 49.
- 10Q. *CORNELL-DUBILIER*—"The Story About Mylar Capacitors;" brochure and catalog data. See ad page 66.
- 11Q. *SPRAGUE*—"ABC's of Ceramic Capacitors," comprehensive brochure on the theory and applications of ceramic capacitors. See ad page 2.
- 12Q. *TOBE DEUTSCHMANN*—Catalog of complete capacitor line. See ads pages 68 and 69.

CHEMICALS

- 13Q. *KRYLON*—Catalog pages describing crystal-clear rust release, dulling spray, spray enamels, varnish sprays, and metal primers. See ad page 32.

CONTROLS

- 14Q. *CLAROSTAT*—"C Line" controls, composition element and wire wound, for lab and prototype work—2, 3, and 4 watts. Form #753394. See ad page 33.
- 15Q. *IRC*—Form SO 35C (DLR-58) Replacement Parts Catalog. See ad 2nd cover.

FUSES

- 16Q. *BUSSMANN*—Complete TV Fuse Guide shows types and ampere ratings of fuses used in various TV sets. See ad page 25.
- 17Q. *LITTELFUSE*—Up-to-date cross reference card showing LC fuses and list prices. See ad 4th cover.

KNOBS

- 18Q. *COLMAN*—"Having Trouble Finding the Right Knob?" Universal-type replacement knob catalog showing the various knob parts which can be assembled to fit numerous applications.

MICROPHONES

- 19Q. *ELECTRO-VOICE*—Catalog #126 on public-address and general-purpose microphones. See ad page 13.

PHONO NEEDLES

- 20Q. *JENSEN*—1958 catalog and assorted literature. See ad page 64.

POWER SUPPLIES

- 21Q. *ELECTRO-PRODUCTS*—New K-612T power supply for low voltage DC servicing. See ad page 59.

RESISTORS

- 22Q. *MILWAUKEE RESISTOR*—Data & price sheets on servicemen's items. See ad page 58.

SERVICE CASE

- 23Q. *MASTRA*—New Convertible Totemaster tube and tool Tote Box. See ad page 73.

SPEAKERS

- 24Q. *ARGOS*—Consumer handout folder on hi-fi extension speakers and wall baffles.
- 25Q. *QUAM-NICHOLS*—Catalog No. 80 covering high fidelity speakers and crossover units. See ad page 52.
- 26Q. *UTAH*—S157 catalog describing new "Blow Out Proof" rear deck speaker system. Fabulous "G" series catalog. See ad page 75.

TEST EQUIPMENT

- 27Q. *B & K*—Bulletin AP12 gives helpful information on new point-to-point signal-injection technique with Model 1075 Television Analyser; B & K Dyna-Quik Models 500B, 650, and Automatic 675 Portable Dynamic Mutual Conductance Tube and Transistor Testers; B & K Model #00 CRT Cathode Rejuvenator Tester. See ads pages 1 and 9.
- 28Q. *EICO*—12-page catalog shows how to save 50% on electronic test instruments and hi-fi equipment in both kit and factory-wired form. See ad page 63.
- 29Q. *JACKSON*—Folder covering the entire Jackson line of "Service Engineered" test equipment. See ad page 65.
- 30Q. *KINGSTON*—"Puts Money in the Pockets of TV Servicemen" a 4-page, two-color brochure, gives details on the operation of the Kingston Absorption Analyzer. See ad page 60.
- 31Q. *SERVICE INSTRUMENTS*—Specification sheet on new LC3 leakage checker. See ads pages 26, 36, 48, 58, 64, 71.
- 32Q. *TRIPLETT*—Circular on Model 696 Transistor Tester. See ad page 31.
- 33Q. *WINSTON*—One-page flyer on full line of equipment. See ads pages 42 and 43.

TOOLS

- 34Q. *KEDMAN*—Catalog sheet describing 4 screwdriver displays and specifications of 14 kinds of screwdrivers in the company's line. See ad page 36.
- 35Q. *VACO*—Catalog on new 5-piece screwdriver set with special free offer. See ad page 71.
- 36Q. *WEN*—Illustrated Catalog Sheet No. 808 describes new 2-speed $\frac{3}{8}$ " power drill. Also folder AL-1 on line of high-grade, low-cost power tools including soldering guns with special purpose tips. See ad page 7.
- 37Q. *XCELITE*—Illustrated catalog on full line plus literature on new products. See ad page 62.

TRANSFORMERS & COILS

- 38Q. *MERIT*—Catalog No. 5811 listing more than 900 coils & transformers. See ad page 51.
- 39Q. *TRIAD*—TR-58 General Catalog, TV-58 Television Replacement Guide, and Service Aid #3.
- 40Q. *CHICAGO STANDARD*—100-page TV Transformer Replacement Guide, cross-referenced for over 7,000 chassis of 98 manufacturers.



SUPPLEMENT TO SAMS FEBRUARY 1958 MASTER INDEX

Covers PHOTOFAC Set Numbers 390 through 396 Released

MARCH and APRIL

This Supplement is your index to new models covered by PHOTOFAC in April 1958. For model coverage prior to this date see the Sams Master Index dated February 1958. Use this Supplement with the Sams Master Index— together they are your complete Index to PHOTOFAC coverage of over 30,000 receiver models.

Table listing receiver models under categories: ADMIRAL, AIRLINE, AMERICAN MOTORS, ARVIN, BELL SOUND SYSTEMS, BLAUPUNKT, BUICK, CADILLAC.

Table listing receiver models under categories: CHALLENGER, CHEVROLET, COLUMBIA RECORDS, CORONADO, CRESCENT, CROSLEY, DAVID BOGEN, EMERSON.

Table listing receiver models under categories: EMERSON—Cont., EMERSON—Cont.

Table listing receiver models under categories: EMERSON—Cont., FIRESTONE, FISHER, GENERAL ELECTRIC.

Table listing receiver models under categories: GENERAL ELECTRIC—Cont., HOFFMAN, HOTPOINT, LINCOLN, MADISON FIELDING, MAGNAVOX, MERCURY, METEOR, MOPAR, MOTOROLA.

THIS IS YOUR LATEST INDEX SUPPLEMENT! FOR COMPLETE PHOTOFAC LISTINGS USE IT WITH THE FEBRUARY 1958 MASTER INDEX!

THROW AWAY ALL OTHER SUPPLEMENTS

NOTE: PCB Denotes Production Change Bulletin. • Denotes Television Receiver. S Denotes Schematic Coverage Only.

MOTOROLA—Cont.

●Y21K73B, BA, M, MA, Y21K75B, BA, CW, CWA, M, MA, Y21K76B, BA, CW, CWA, M, MA, Y21K77B, BA, M, Y21K80, CW, CWA (Ch. TS-544Y) 393-2

●Y21K81B, M (Ch. WTS-544Y) 393-2

●Y21T408G, BGA, MG, MGA, Y21T-42B, BA, M, MA (Ch. TS-544Y) 393-2

●Y21V1V, WA (Ch. TS-544Y) 393-2

●Y21F8B, BA, W, WA (Ch. TS-544) 393-2

●Y21K73B, M, Y21K75B, CW, M, Y21K-76B, CW, M, Y21K77B, M, Y21K80-0, CWA (Ch. TS-544) 393-2

●Y21K81B, M (Ch. WTS-544) 393-2

●Y21T408G, MG, Y21T42B, M (Ch. TS-544) 393-2

●Y21V1V, WA (Ch. TS-544) 393-2

5411A, 5412A, 5413A, 5414A, 5415A, 5416A (Ch. HS-46B) 266-9

Ch. HS-46B 266-9

Ch. TS-544, Y 393-2

Ch. WTS-544, Y 393-2

MUNTZ

●724 Series 352-12

●727 Series 352-12

NEWCOMB

E-500 394-12

H-25 391-7

H-50 391-10

KX-25 393-10

OLDSMOBILE
(See Auto Radio Listing)

OLYMPIC

●"Kabold" 3720W 390-8

●"Meteor" 5781W 392-9

●"Moderna" 5783W 392-9

●TY95L (Ch. DY) 391-2

●14T91, U, 14T92, U (Ch. GT, GTU) 395-2

●14TU9, U, 14TU94, B, BU, M, MU, U (Ch. GU, GUU) 391-2

Ch. DY 391-2

Ch. GT, GTU 395-2

Ch. GU, GUU 395-2

PACKMAKER

PM10, PM10S 394-13

PACKARD
(See Auto Radio Listing)

PACKARD-BELL

RM-200 (TV Remote Control) 393-3

3T3 392-2

●21DC5, 21DC6, 21DC7 (Ch. 98D3) 393-3

●21SC6, 21SC7, 21SC8 (Ch. 8853) 393-3

●21SK3 (Ch. 8853 and AM Tuner 3T3) 392-2

●21ST3 (Ch. 8853) 392-2

●21VT2 (Ch. 8853) 392-2

●24DC4 (Ch. 98D3) 393-3

●24SC2 (Ch. 8853) 392-2

●24VT1 (Ch. 8853) 392-2

Ch. 8853 392-2

Ch. 98D3 374-17-5

PHILCO

F-760 396-6

F-963 396-6

●F4210, E, L, F4212, L (Ch. 8L14) 381-17-5

●F4214STM, STN (Ch. 8L47) 381-17-5

●F4216, L (Ch. 8L71) 381-17-5

●F4620SL, SM (Ch. 8L41) 381-17-5

●F4622, L, F4624 (Ch. 8L43) 381-17-5

●F4626, L (Ch. 8L73) 381-17-5

●F4632 (Ch. 8L43) 381-17-5

●F4626SL, SM (Ch. 8P51, A) 381-17-5

●F6020SL (Ch. 8P51, A) 381-17-5

●F6624T, TL (Ch. 8L72) 381-17-5

●UF4210, E, L, UF4212, L (Ch. 8L14U) 381-17-5

●UF4214STM, STN (Ch. 8L42U) 381-17-5

●UF4216, L (Ch. 8L71U) 381-17-5

●UF4620SL, SM (Ch. 8L14U) 381-17-5

●UF4622, L, UF4624 (Ch. 8L43) 381-17-5

●UF4626, L (Ch. 8L73U) 381-17-5

●UF4632 (Ch. 8L43U) 381-17-5

●UF4206SL, SM (Ch. 8P51U) 381-17-5

●UF6020SL, SM (Ch. 8P51U) 381-17-5

●UF6624T, TL (Ch. 8L72U) 381-17-5

Ch. 8E11, U, 8E13, 370-16-5

Ch. 8H20, U, 8H22, 370-16-5

Ch. 8L41, U, 8L42, U, 8L43, U 381-17-5

Ch. 8L71, U, 8L72, U, 8L73, U 381-17-5

Ch. 8P51, A, U 381-17-5

PONTIAC
(See Auto Radio Listing)

RCA VICTOR (Also See Record Changer Listing)

SHF3, SHFD3 (Ch. RC-1168B) 396-7

SHF6, SHF7 (Ch. RS-164, A) 395-11

8EY31HE, KE (Ch. RS-165 (2nd Prod.)) 383-11

8RF13 (Ch. RC-1168A) 390-9

9CZEE, FE, LE, 9CZFE, J, MZ3 (Ch. RC-1166B) 394-14

9U55H, KE (Ch. RC-1170A) 395-12

9X10FE, JE, ME (Ch. RC-1166A) 394-14

●14PD8053, U, 14PD8054, 14PD-8055, U, 14PD8057, U (Ch. KCS111C, D) 396-3

●14PT8021, U, 14PT8022, U (Ch. KCS111A, B) 396-3

RCA VICTOR—Cont.

●14VT8155, U, 14VT8157, U (Ch. KCS111F, H) 396-3

●17DB185, U, 17DB186, U, 17D-8187, U (Ch. KCS109C, D) 392-3

●17PD8093, U, 17PD8094, U, 17PD-8094, U, 17PD8099, U (Ch. KCS-109C, D) 392-3

●17PT8071, U, 17PT8072, U (Ch. KCS 109A, B) 392-3

●21CD8725, U, 21CD8727, U (Ch. CTC7A, B) 379-15-5

●21CD8775, U, 21CD8776, U, 21CD-8777, U (Ch. CTC7A, B) 379-15-5

●21CD8865, U, 21CD8866, U, 21CD-8867, U (Ch. CTC7C, D) 379-15-5

●21CD8885, U, 21CD8886, U, 21CD-8888, U (Ch. CTC7C, D) 379-15-5

●21CD8906, U, 21CD8907, U (Ch. CTC7C, D) 379-15-5

●21CD8926, U, 21CD8927, U (Ch. CTC7E, F) 379-15-5

●21CD8947, U (Ch. CTC7E, F) 379-15-5

●21CS7815, U, 21CS7817, U (Ch. CTC5, A) (PCB 395-4) 353-11

●21CT7835, U, 21CT7837, U (Ch. CTC5B, C) (PCB 395-4) 353-11

●21CT7855, U, 21CT7857, U (Ch. CTC5D, E) (PCB 395-4) 353-11

●21CT7865, U, 21CT7866, U, 21CT-7867, U (Ch. CTC5D, E) 353-11

●21CT8785, U, 21CT8787, U (Ch. CTC5F, H) (PCB 395-4) 353-11

●21D8281, U, 21D8282, U (Ch. KCS116A, B) 382-15-5

●21D8305, U, 21D8306, U, 21D-8307, U (Ch. KCS116A, B) 382-15-5

●21D8525, U, 21D8526, U, 21D-8527, U, 21D8528, U (Ch. KCS108C, D) 390-2

●21D8545, U, 21D8546, U, 21D-8547, U (Ch. KCS108C, D) 390-2

●21D8565, U, 21D8566, U, 21D-8567, U (Ch. KCS108E, F) 390-2

●21D8588, U (Ch. KCS108C, D) 390-2

●21D8605, U, 21D8607, U, 21D-8608, U (Ch. KCS108C, D) 390-2

●21D8628, U (Ch. KCS116C, D) 382-15-5

●21RD825 (Ch. KCS108H) 392-2

●21RT8202 (Ch. KCS113H) 375-18-5

●21RT8425 (Ch. KCS113K) 375-18-5

●21T7112, U, 21T7113, U (Ch. KCS-98A, C) (PCB 393-5) 347-14

●21T7117, U (Ch. KCS98A, C) 347-14

●21T7152, U, 21T7153, U (Ch. KCS98A, C) (PCB 393-5) 347-14

●21T7352, U, 21T7355, U, 21T7357, U (Ch. KCS98E, F) 393-5 347-14

●21T7157, U (Ch. KCS98A, C) 347-14

●21T7375, G, GU, U, 21T7377, G, GU, U (Ch. KCS98I, K, L, M) (PCB 393-5) 347-14

●21T8202, U, 21T8205, U, 21T8207, U (Ch. KCS 113A, B) 375-18-5

●21T8265, U, 21T8267, U (Ch. KCS113A, B) 375-18-5

●21T8375, U, 21T8376, U, 21T8377, U (Ch. KCS113P, R) 375-18-5

●21T8395, U, 21T8397, U (Ch. KCS113P, R) 375-18-5

●21T8405, U, 21T8407, U (Ch. KCS113P, R) 375-18-5

●21T8425, U, 21T8426, U, 21T8427, U, 21T8428, U (Ch. KCS113E, F) 375-18-5

●21T8445, U, 21T8447, U, 21T8448, U (Ch. KCS113E, F) 375-18-5

●21T8465, U, 21T8466, U, 21T8467, U, 21T8468, U (Ch. KCS113E, F) 375-18-5

●21T8485, U, 21T8486, U, 21T8487, U (Ch. KCS113E, F) 375-18-5

●24DR455, U, 24DR457, U (Ch. KCS108C, D) 390-2

●24DR476, U, 24DR478, U (Ch. Ch. KCS108C, D, E, F, H) 390-2

Ch. CTC5, A, B, C, D, E, F, H 396-3

Ch. CTC7A, B, C, D, E, 379-15-5

Ch. KCS108C, D, E, F, H 390-2

Ch. KCS109A, B, C, D, 392-3

Ch. KCS111A, B, C, D, F, H 396-3

Ch. KCS113A, B, E, F, H, K 375-18-5

Ch. KRS23A 396-3

Ch. RC-114AA, B 394-14

Ch. RC-1168A 390-9

Ch. RC-1168B 396-7

Ch. RC-1170A 395-12

Ch. RS-164, A 395-11

Ch. RS-165 383-11

SENTINEL
Chassis AMP-154AA 396-8

SETCHELL-CARLSON

●58, R (Ch. 158, 158RP) 396-4

●581, 582, 583 (Ch. 158, 158RP) 396-4

●5800, R, 5801, 5802, 5803 (Ch. 158, 158RP) 396-4

Ch. 158, 158RP 396-4

SHERWOOD

S-1000 H 390-10

S-2000 396-9

SILVERTONE

●7114 (Ch. 528.51040) (See Photo-fact Servicer) 393

●7115 (Ch. 528.51050) 393

(See Photofact Servicer) 394

●7116 (Ch. 528.51040) (See Photo-fact Servicer) 393

SONIC

465 390-11

SILVERTONE—Cont.

●7117 (Ch. 528.51050) 393

(See Photofact Servicer) 394

●7120 (Ch. 528.51040) (See Photo-fact Servicer) 393

●7121 (Ch. 528.51050) 393

(See Photofact Servicer) 394

●7122 (Ch. 528.51040) (See Photo-fact Servicer) 393

●7123 (Ch. 528.51050) 393

(See Photofact Servicer) 394

●7124 (Ch. 528.51040) (See Photo-fact Servicer) 393

●7125 (Ch. 528.51050) 393

(See Photofact Servicer) 394

●7128 (Ch. 528.51040) (See Photo-fact Servicer) 393

●7129 (Ch. 528.51050) 393

(See Photofact Servicer) 394

●7130 (Ch. 528.51040) (See Photo-fact Servicer) 393

●7131 (Ch. 528.51050) 393

(See Photofact Servicer) 394

●7132, 7134 (Ch. 528.52040) 393

(See Photofact Servicer) 396

●7136 (Ch. 528.51040) (See Photo-fact Servicer) 393

●7137 (Ch. 528.51050) 393

(See Photofact Servicer) 394

●7172 (Ch. 528.51040) (See Photo-fact Servicer) 393

●7173 (Ch. 528.51050) 393

(See Photofact Servicer) 394

●7190 (Ch. 528.51040) (See Photo-fact Servicer) 393

●7191 (Ch. 528.51050) 393

(See Photofact Servicer) 394

●7192 (Ch. 528.51040) (See Photo-fact Servicer) 393

7777 (Ch. 528.53190) 391-3

8005, 8006, 8007 (Ch. 132.42700) 395-14

8009, 8010, 8011, 8012 (Ch. 132.42800) 391-12

8013, 8014, 8015 (Ch. 132.42900) 396-10

8021, 8022, 8023 (Ch. 528.53040) 392-10

8059, A, 8060, A, 8061, A, 8069, A (Ch. 528.53150) 394-15

8102AQ, CL, YL (Ch. 528.50125) 389-3

8104CH, CO (Ch. 528.50125) 389-3

●8106 (Ch. 528.50125) 389-3

●8110, 8112 (Ch. 528.50144) 389-3

●8114 (Ch. 528.51100, 102, 104) 390-3

●8115 (Ch. 528.51110, 112, 113) 390-3

●8116 (Ch. 528.51100, 102, 104) 390-3

●8117 (Ch. 528.51110, 112, 113) 390-3

●8150, 8152 (Ch. 528.50144) 389-3

●8154 (Ch. 528.51100, 102, 104) 390-3

●8155 (Ch. 528.51110, 112, 113) 390-3

●8156 (Ch. 528.51100, 102, 104) 390-3

●8157 (Ch. 528.51110, 112, 113) 390-3

●8158 (Ch. 528.51100, 102, 104) 390-3

●8160 (Ch. 528.51140, 142, 143) 390-3

●8161 (Ch. 528.51150, 152, 153) 390-3

●8162 (Ch. 528.51140, 142, 143) 390-3

●8163 (Ch. 528.51150, 152, 153) 390-3

●8182 (Ch. 528.51100, 102, 104) 390-3

●8183 (Ch. 528.51110, 112, 113) 390-3

●8184 (Ch. 528.51140, 142, 143) 390-3

●8185 (Ch. 528.51150, 152, 153) 390-3

●8186 (Ch. 528.51140, 142, 143) 390-3

●8187 (Ch. 528.51150, 152, 153) 390-3

●8188 (Ch. 528.51140, 142, 143) 390-3

●8190, 8190A (TV Ch. 528.52100, 101, 102 and Radio Ch. 528.53190) 391-3

●8191, 8191A (TV Ch. 528.52110, 111, 112 and Radio Ch. 528.53190) 391-3

●8192, 8192A (TV Ch. 528.52100, 101, 102 and Radio Ch. 528.53190) 391-3

●8193, 8193A (TV Ch. 528.52110, 111, 112 and Radio Ch. 528.53190) 391-3

Ch. 132.42700 395-14

Ch. 132.42800 391-12

Ch. 132.42900 396-10

Ch. 528.51040 (See Photofact Servicer) 393

Ch. 528.50125 389-3

Ch. 528.50144 389-3

Ch. 528.51050 393

(See Photofact Servicer) 394

Ch. 528.51100, 528.51102, 528.51104 390-3

Ch. 528.51110, 528.51112, 528.51113 391-3

Ch. 528.51140, 528.51142, 528.51143 390-3

Ch. 528.51150, 528.51152, 528.51153 390-3

Ch. 528.52040 393

(See Photofact Servicer) 396

Ch. 528.52100, 528.52101, 528.52102 391-3

Ch. 528.52110, 528.52111, 528.52112 391-3

Ch. 528.53040 392-10

Ch. 528.53150 394-15

Ch. 528.53190 391-3

SPARTAN

●24 Series 383-14-5

●25 Series 384-17-5

Chassis AMP-158AA 390-12

Chassis CR-729AA, BA 395-15

●Chassis U24-01AA, U24-02AA, U24-03AA, U24-04AA, U24-06AA 383-14-5

●Chassis U25-01AA, U25-02AA, U25-03AA, U25-04AA, U25-05AA, U25-06AA, U25-07AA, U25-08AA, U25-09AA, U25-10AA, U25-11AA 384-17-5

●Chassis V24-01AA, V24-02AA, V24-03AA, V24-04AA, V24-05AA, V24-06AA, V24-07AA, V25-01AA, V25-02AA, V25-03AA, V25-04AA, V25-05AA, V25-06AA, V25-07AA, V25-08AA, V25-09AA, V25-10AA, V25-11AA 384-17-5

STEELMAN

4D15, 4D17, 4D18 395-16

STROMBERG-CARLSON

AU-62 391-13

SR-402 395-17

STUDEBAKER
(See Auto Radio Listing)

SYLVANIA

●31C606 Series (Ch. 1-534-1) 391-4

●31T304 Series (Ch. 1-534-1) 391-4

4401 (Ch. 1-608-1) 396-11

Ch. 1-534-1, 2 391-4

Ch. 1-608-1 396-11

TECH-MASTER

16A 396-12

21 391-4

●1930N 390-4

●2430N 390-4

TRAV-LER

TR-250-A, TR-251-A 392-11

●717-MT-500 (Ch. 775-37) 371-13

●721-K-610 (Ch. 718-17, 775-17) 389-3

(PCB 394-5) 371-13

●721-K-611, U, 721-K-612, 721-K-613 (Ch. 736-47, 737-47) 391-3

(PCB 394-5) 371-13

●721-LP-650 (Ch. 718-17, 775-17) 389-3

(PCB 394-5) 371-13

●721-LP-651, U (Ch. 736-47, 737-47) 391-3

(PCB 394-5) 371-13

●721-MT-600 (Ch. 718-17, 775-17) 389-3

(PCB 394-5) 371-13

●721-MT-601, U (Ch. 736-47, 737-47) 391-3

(PCB 394-5) 371-13

●721-T-602 (Ch. 736-47) 391-3

(PCB 394-5) 371-13

●724-K-772 (Ch. 776-17) 371-13

(PCB 394-5) 371-13

●1710, A (Ch. 72917, A, 775-27) 391-3

(PCB 394-5) 371-13

●1715, U (Ch. 72916, 72917, 73016) 391-3

●1720, U (Ch. 72916, 72917, 73016) 391-3

(PCB 394-5) 371-13

●1722, 1723, 1725 (Ch. 740-17) 391-3

(PCB 394-5) 371-13

Ch. 718-17, 775-17 (PCB 394-5) 371-13

Ch. 736-47, 737-47 (PCB 394-5) 371-13

Ch. 740-17, 775-17 (PCB 394-5) 371-13

Ch. 775-17, 27, 37, 776-17 (PCB 394-5) 371-13

Ch. 72916, 72917, 73016 (PCB 394-5) 371-13

TRUETONE (Also See Auto Radio Listing)

D2832B, D2834B 384-16

D576A 386-12

●2D1824A, B, 2D1825A, B, 2D1826A, B, 2D1827A, B 394-3

●2D1840A, 2D1841A, 2D1842A, 2D1843A, 2D1844A, 2D1845A 395-3

●2D2728A, B (PCB 396-5) 375-5

●2D2840A, 2D2841A, 2D2842A, 2D2843A 396-3

V-M (Also See Record Changer and Recorder Listing)

155A 393-11

1276 391-15

1290 392-12

WEBCOR
(See Webster-Chicago)

WEBSTER-CHICAGO

1853 356-17

WESTINGHOUSE

●H-17T241, H-17T242, H-17T243, H-17T244, H-17T245 (Ch. V-2373-1) 392-4

●H-17T241, H-17T242, H-17T243, H-17T244, H-17T245 (Ch. V-2383-1) 392-4

●H-21T219B, H-21T221B, H-21T222B (Ch. V-2372) 388-3

H-580TS, H-581TS, H-583TS (Ch. V-2259-3) 392-13

H-621P6, H-622P6 (Ch. V-2296-1) 396-14

Ch. V-2259-3 392-13

Ch. V-2296-1 396-14

Ch. V-2373-1 392-4

Ch. V-2383-1 392-4

ZENITH (Also See Record Changer Listing)

●A181SP, PU (Ch. 15Z31, U) 376-5

●A2221J, JU, Y, YU, A2223E, EU, H, HU, R, RU, Y, YU 393-4

(Ch. 17A20, U) 393-12

●A2245E, EU, R, RU (Ch. 17A20, U) 393-4

ZENITH—Cont.

●A2250M, MU, R, RU, A2251E, EU, R, RU, (Ch. 17A20, U) 393-4

●A2282E, EU, R, RU, (Ch. 17A20, U) 393-4

●A2329J, JU, A2330E, EU, H, HU, R, RU, (Ch. 19A20, U) 394-4

●A2358E, EU, R, RU, A2359E, EU, H, HU, R, RU, A2362M, MU, R, RU, (Ch. 19A20, U) 394-4

●A2673E, EU, R, RU, (Ch. 17A20, U) 393-4

●A3007E, R (Ch. 17A21Q) 393-4

●A3001E, H, R, (Ch. 17A20Q) 393-4

●A3004, E, R (Ch. 17A21Q) 393-4

●A3006E, H, R (Ch. 17A20Q) 393-4

●A3008E, R (Ch. 17A20Q) 393-4

●A3010E, H, R, A3011, E, Y, A3012H, R, A3013H, A3014H (Ch. 19A20Q) 394-4

●A4007E, R (Ch. 19A20Q) 394-4

●HF140E, R (Ch. 3A03) 396-15

●HF1290H, R, HF1292, E (Ch. 12Z21) 392-11

●Z2675EZ, RZ (Ch. 17Z33) 357-14-5

●Z4006EZ, RZ (Ch. 17Z33Q) 357-14-5

Z4006EZ, RZ (Ch. 17Z33Q) 357-14-5

Ch. 3A03 396-15

Ch. 12Z21 394-16

Ch. 17A20, Q, U, 17A21Q 393-4

Ch. 17Z33, Q 357-14-5

Ch. 19A20, Q, U 394-4

AMERICAN MOTORS

84MA (8990494) 394-6

8990494 394-6

BLAUPUNKT

"Frankfurt" 393-7

"Hamburg" 394-8

"Keln" 392-7

BUICK

981902 (See Photofact Servicer) 393

981903 395-18-5

CADILLAC

7266565 (See Photofact Servicer) 396</

straight from the shoulder talk...

A TV Picture Tube Warranty is only as good as the manufacturer who issues it...

You can rely on the

Picture Tube Warranty

of RCA



The manufacturer's warranty is for your protection. An RCA 12-month warranty card is assurance that your replacement picture tube is a genuine RCA Silverama—and that the reputation and integrity of RCA stand behind it. It's well worth while to insist on an RCA Silverama, the same advanced tube used in many of the new '58 TV sets. Often, it will even produce a picture more brilliant, sharper, clearer than your set gave when new! So, if your picture tube should need replacing, be sure you get what you pay for, the best picture tube made—RCA Silverama. After your service dealer installs it, ask him to complete your copy of the warranty card. One comes with every genuine RCA Silverama Picture Tube.

Super-Aluminized  Daylight Clear

RCA Silverama

PICTURE TUBES

RCA Electron Tube Division, Harrison, N. J.

“Just as good” isn't good enough for your TV!



Let's face it! Nothing lasts forever. When you have to pay out good money for a replacement Picture Tube, you're entitled to the best that modern electronics can produce—that's an RCA SILVERAMA. It stands to reason that RCA, with its great laboratories, facilities, and “know-how”—produces the finest Picture Tubes money can buy. So, don't let “just as good” tempt you. Remember, RCA Silverama Picture Tubes cost no more than other brand-name aluminized tubes ... they are warranted for one full year, too.

Super-Aluminized  Daylight Clear

RCA Silverama

PICTURE TUBES

RCA Electron Tube Division, Harrison, N. J.

...that makes it easy
for you to sell the #1
picture tube... RCA Silverama

Messages like these appear regularly in TV Guide and other publications, telling millions of TV viewers (many of them your customers) the facts about their all-important picture tube.



RADIO CORPORATION OF AMERICA

Electron Tube Division

Harrison, N. J.

day
and
night
protection
with

LITTELFUSE

Inc., Des Plaines, Illinois

