

MAY, 1957
25 CENTS



PHOTOFACT

REPORTER

FOR THE ELECTRONIC SERVICE INDUSTRY

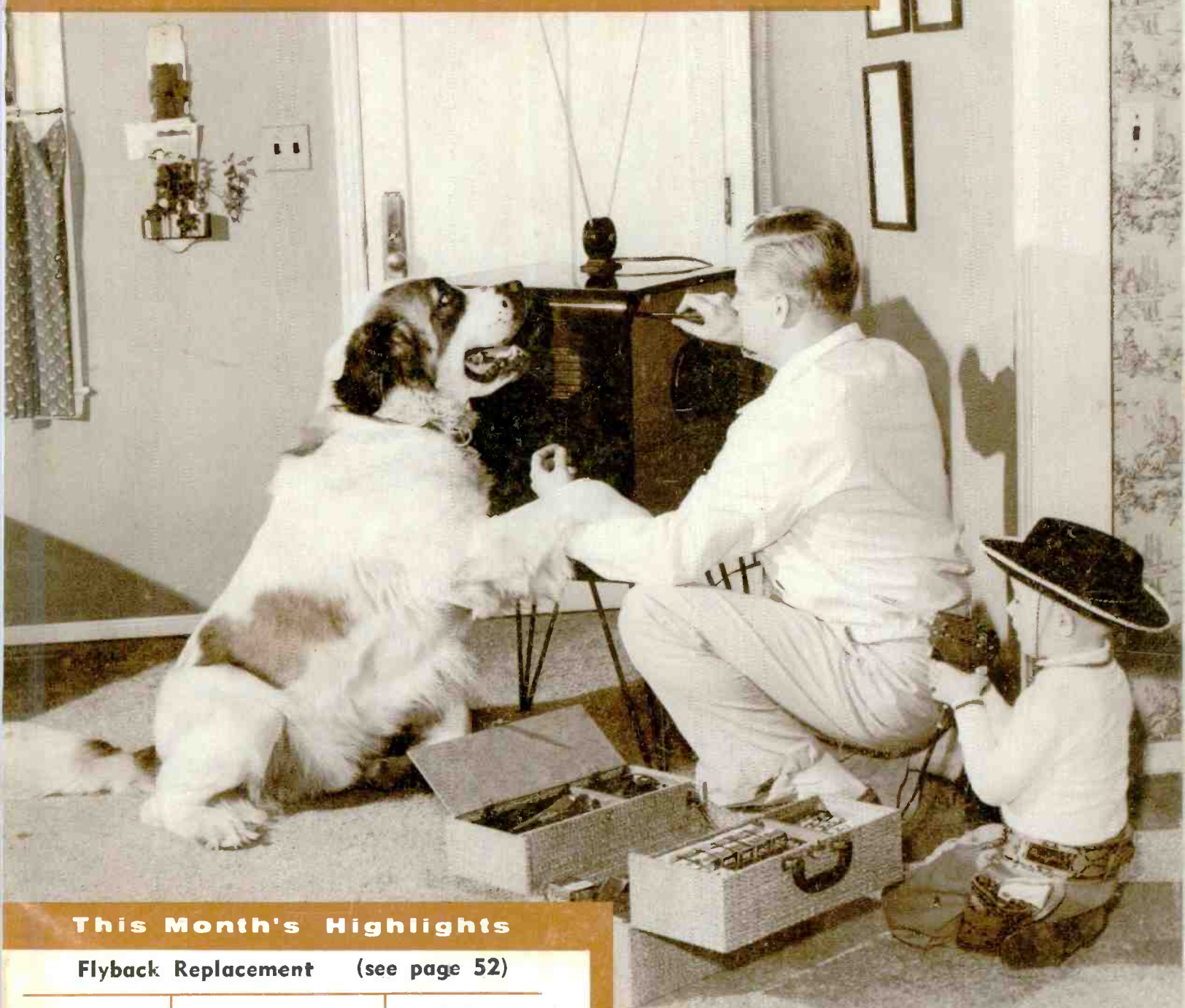

This Month's Highlights

Flyback Replacement (see page 52)

Planning for Auto Radio Service
(see page 25)

Working in the Cage
(see page 15)

Here's Another New Color Receiver
(see page 44)

PLUS SUPPLEMENT No. 102-D TO SAMS MASTER INDEX

460 1 2
CHASE RADIO SUN PRAIRIE, WIS.



FUSE
RESISTOR

IRC 629
FR 5.6

Stock No.
FR5.6

5.6 ohms



FUSE
RESISTOR

Stock No.
FR5.6

5.6 ohms

IRC "Skin-Packed" Fuse Resistors

CONVENIENT TO BUY—Your IRC Distributor has IRC fuse resistors now on perforated display cards. You can buy one, a dozen or more—each on an individual "skin-packed" card section.

- Improved plug-in type for fast, easy replacement in the newer TV receivers. Terminal pin holes facilitate attaching leads where necessary.
- Featuring sturdy terminal pins—both attached inside a rugged ceramic case.
- "Skin-packed" cards protect each fuse resistor from dirt and handling.
- Available in 2 types—FR5.6 at 5.6 ohms and FR7.5 at 7.5 ohms to meet popular TV requirements.
- Type and range clearly identified on both fuse resistor and "skin-packed" card.

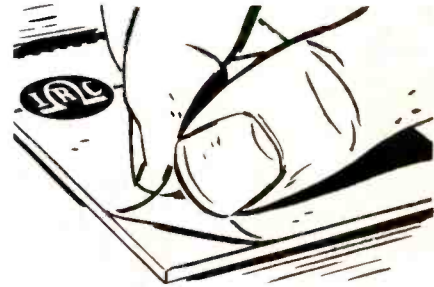

EASY TO STOCK—Heavy card helps prevent breakage or damage... "skin-packing" keeps every fuse resistor factory-fresh. Just peel off plastic skin, and you're all set.

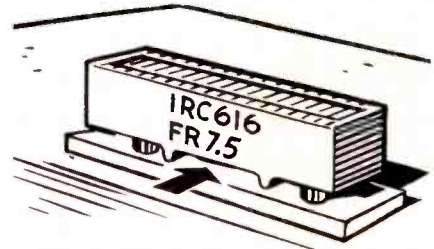

HANDY TO USE—Sturdy terminal pins. Simply plug fuse resistor into receptacle. Projections on bottom of case leave air space so receptacle won't overheat.

ORDER NOW FROM YOUR IRC DISTRIBUTOR

Wherever the Circuit Says



INTERNATIONAL RESISTANCE CO.

Dept. 361, 401 N. Broad St., Phila. 8, Pa.

In Canada: International Resistance Co. Ltd., Toronto, Licensee

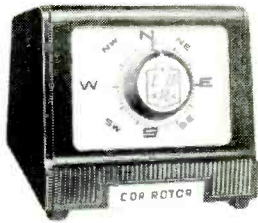

AR-22



TR-2

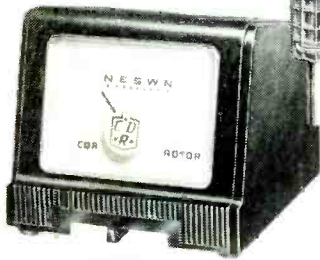

TR-4

CDR ROTORS

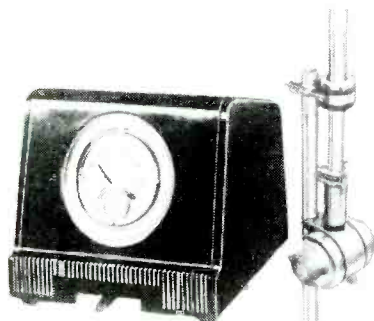

TR 11 and 12

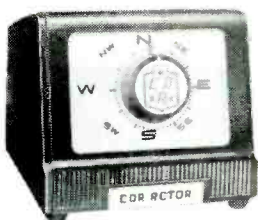

AR 1 and 2

5-star feature...

1 **the best color TV picture**

the growth of color TV means an even greater demand for CDR Rotors for pin-point accuracy of antenna direction.

2 **a better picture on more stations**

CDR Rotors add to the pleasure of TV viewing because they line up the antenna perfectly with the transmitted TV signal giving a BETTER picture . . . and making it possible to bring in MORE stations.

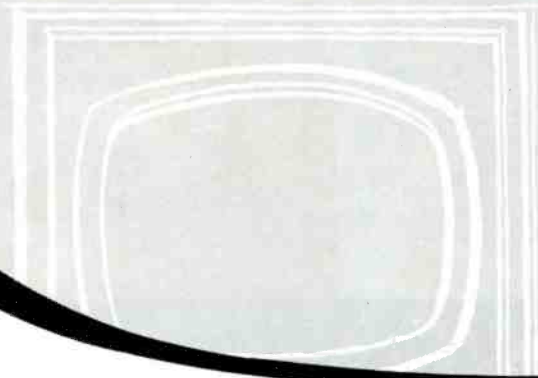

3 **tested and proven dependable**

thousands and thousands of CDR Rotors have proven their dependability over years of unflinching performance in installations everywhere in the nation. Quality and engineering you know you can count on.

4 **pre-sold to your customers**

the greatest coverage and concentration of full minute spot announcements on leading TV stations is working for YOU . . . pre-selling your customers.

5 **the complete line**

a model for every need . . . for every application. CDR Rotors make it possible for you to give your customer exactly what is needed . . . the right CDR Rotor for the right job.



CORNELL-DUBILIER
SOUTH PLAINFIELD, N. J.



THE RADIART CORP.
CLEVELAND 13, OHIO

for the Right
'LYTIC replacement
... use an exact
SPRAGUE replacement



YOU GET EVERYTHING IN A SPRAGUE TVL! *Every TVL for every voltage rating* is made with the more expensive high-purity etched-foil anode construction using ultra-stable film formation techniques. Cathodes are etched to meet high ripple requirements. Sprague TVL's give maximum trouble-free service—NO HUM—as well as long shelf life. And they perform just as well in the cold North as they do in the sub-Tropics. Yet this premium quality costs you no more!

That's why Sprague Twist-Lok® electrolytic capacitors are the first choice of leading radio-TV set makers and independent service technicians alike. Insist on TVL's for more exact ratings . . . quality that meets original equipment specifications . . . and all the latest results of capacitor research.

don't be vague . . . insist on

SPRAGUE®

world's largest independent capacitor manufacturer

SPRAGUE RESEARCH IS CONSTANTLY PRODUCING NEW AND BETTER CAPACITORS FOR YOU

Sprague Products Company • Distributors' Division of the Sprague Electric Company • North Adams, Massachusetts

PUBLISHER
Howard W. Sams

GENERAL MANAGER
Mal Parks, Jr.

EDITOR TECHNICAL EDITOR
Glen E. Sutz Verne M. Ray

ASSOCIATE EDITORS
Leslie D. Deane Thomas A. Lesh
Calvin C. Young, Jr.

CONSULTING EDITORS
William E. Burke C. P. Oliphant
Robert B. Dunham George B. Mann
Paul C. Smith

ART DIRECTOR EDITORIAL ASSISTANT
Glenn R. Smith Gwen Bigham

PHOTOGRAPHY CIRCULATION
Robert W. Reed Pat Tidd

ADVERTISING SALES OFFICES
MIDWESTERN
PF REPORTER,
2201 East 46th Street, Indianapolis 5, Ind.
Clifford 1-4531
EASTERN
Paul S. Weil and Donald C. Weil,
39-01 Main Street, Flushing 54, New York.
Independence 3-9098.
WESTERN
The Maurice A. Kimball Co., Inc.,
2550 Beverly Blvd., Los Angeles 57, Calif.
Dunkirk 8-6178; and 681 Market Street,
San Francisco 5, Calif. EXbrook 2-3365.

Published monthly by Howard W. Sams & Co.,
Inc., at Indianapolis 5, Indiana.
Entered as second class matter October 11,
1954, at the Post Office at Indianapolis, Indiana,
under the Act of March 3, 1879.
Copyright 1957 by Howard W. Sams & Co., Inc.
No part of the PF REPORTER may be reproduced
without written permission. No patent liability is
assumed with respect to the use of information
contained herein.
A limited quantity of back issues are available
at 35c per copy.

next month

ALIGNMENT OF CHROMINANCE BANDPASS CIRCUITS

Theory and instructions on the
procedure and use of equipment for
color alignment work.

A GALLERY OF TRIODE/PENTODES

A complete explanation of the
electrical and physical differences in
the various triode-pentode tube de-
signs, including basing diagrams.

TROUBLESHOOTING AND SIGNAL TRACING IN TRANSISTOR RADIOS

Useful, down-to-earth service in-
formation to help the technician
isolate troubles in transistor radios.

VOL. 7 · No. 5



MAY · 1957

PF REPORTER

FOR THE ELECTRONIC SERVICE INDUSTRY

CONTENTS

Letters to the Editor.....	8
Shop Talk.....	13
How transistor circuits fit together.	Milton S. Kiver
Working in the Cage.....	15
Audio Facts.....	19
Connecting public-address amplifiers to speakers.	Calvin C. Young, Jr.
Dollar & Sense Servicing.....	21
Selenium and germanium crystal diodes in latest TV sets.	John Markus
Semiconductor Diodes.....	23
Selenium and germanium crystal diodes in latest TV sets.	Thomas A. Lesh
Planning for Auto-Radio Service.....	25
Equipment and tools for auto-radio repair.	Thomas A. Lesh
Notes on Test Equipment.....	27
Equipment and tools for auto-radio repair.	Leslie D. Deane
Stock Guide for Popular Replacement Parts.....	29
Quicker Servicing.....	30
Symptoms and present-day cures.	Calvin C. Young, Jr.
Adjacent- and Co-Channel Interference.....	34
Symptoms and present-day cures.	Calvin C. Young, Jr.
Here's Another New Color Receiver.....	44
Data on the 1957 Westinghouse with its 22" rectangular tube.	
Flyback Replacement.....	52
Suggestions for finding a suitable flyback replacement.	Leslie D. Deane
Product Report.....	80
Free Catalog & Literature Service.....	84
Supplement to SAMS Master Index.....	85

SUBJECT INDEX

AUDIO		Damper tube (6W4GT), removing pin 1 on.....	32
Public-address systems		Damper-tube failure, case histories of.....	30
Constant-impedance type.....	69	Flyback transformers, replacement of.....	52
Constant-voltage type.....	67	High-voltage cage, repairs in.....	15
Speaker phasing.....	19	TEST EQUIPMENT	
Wire and conduit size.....	69	Electro Products	
COLOR TV		Model D-612T power supply.....	79
Westinghouse 1957 color receiver..	44	Fretco Model SCTU-1	
COMPONENTS		diode and transistor tester.....	27
Check list of items		Precision Model 220 marker-adder.....	78
to keep in stock.....	29	Semiconductor diodes, testing of..	74
Germanium crystal diode.....	23	Simpson Model 382	
Selenium diode.....	73	in-circuit analyzer.....	27
RADIO		THEORY	
Auto-radio service,		Transistor circuit function.....	13
getting set up for.....	25	TRANSISTORS	
SERVICING		Amplifier stages,	
Adjacent-channel		typical circuits used in.....	13
interference problems.....	40	Class A and B amplifiers.....	65
Auto radios.....	25		
Co-channel interference problems.	34		

USE HANDY CARD AT BACK TO ENTER YOUR SUBSCRIPTION

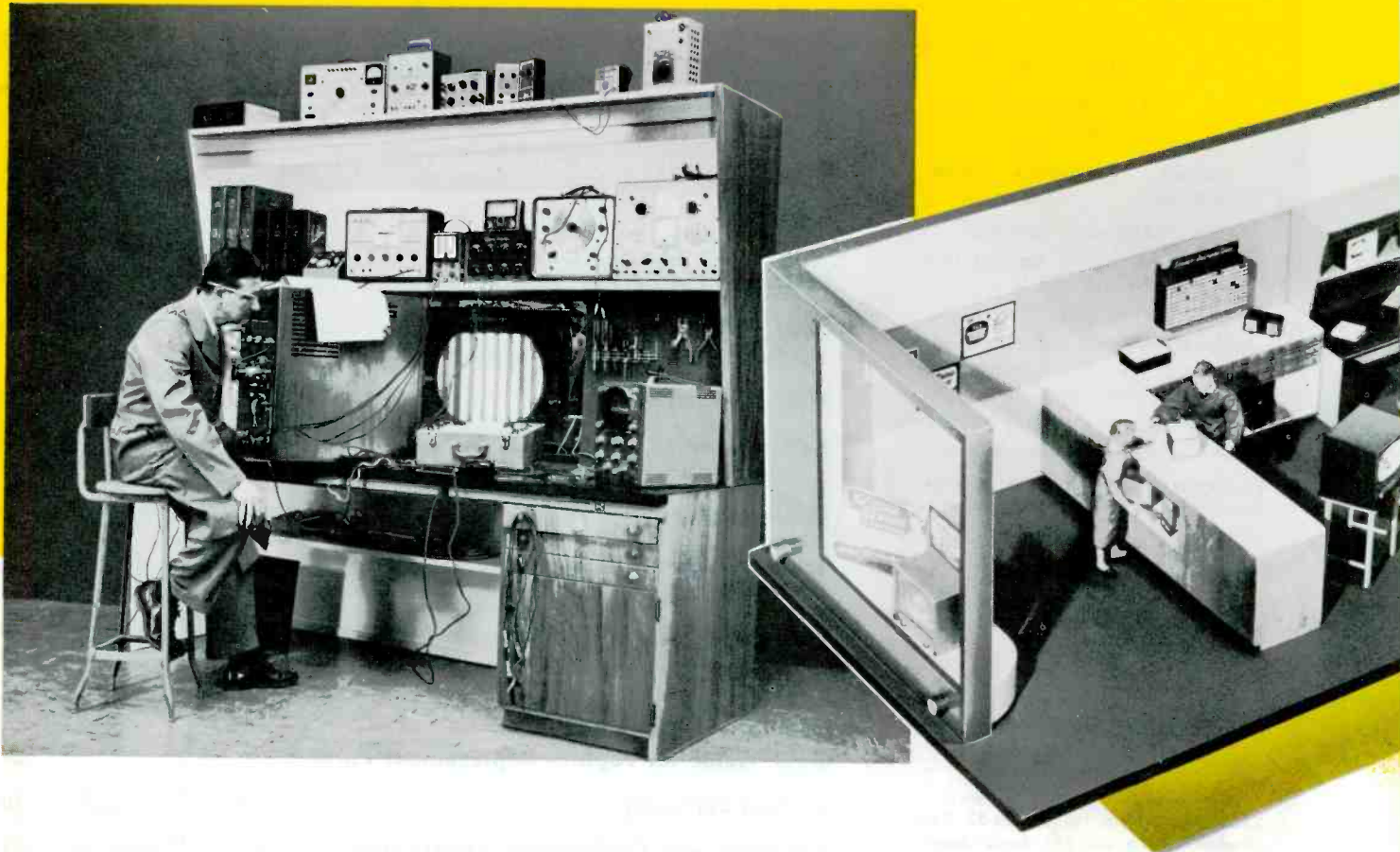

JOIN THE 50,000 PROGRESSIVE READY TO MODERNIZE WITH NEW

Over 50,000 TV-radio service dealers already have asked for the new General Electric shop plans (above) that were specially developed for the independent technician. Dealers in every part of the country know that today's growing market for service, calls for improved facilities... and that proper planning saves space, costs, time, and labor.

You too can modernize for the in-

creased volume that lies ahead... by following the practice of other progressive technicians, and using General Electric's shop layout to equip your shop for top-efficiency service to more customers. Phone your local General Electric tube distributor for complete plans! They include dimension drawings and material lists, so a carpenter or builder can start work at once.

Progress Is Our Most Important Product

GENERAL  **ELECTRIC**

161-1A20

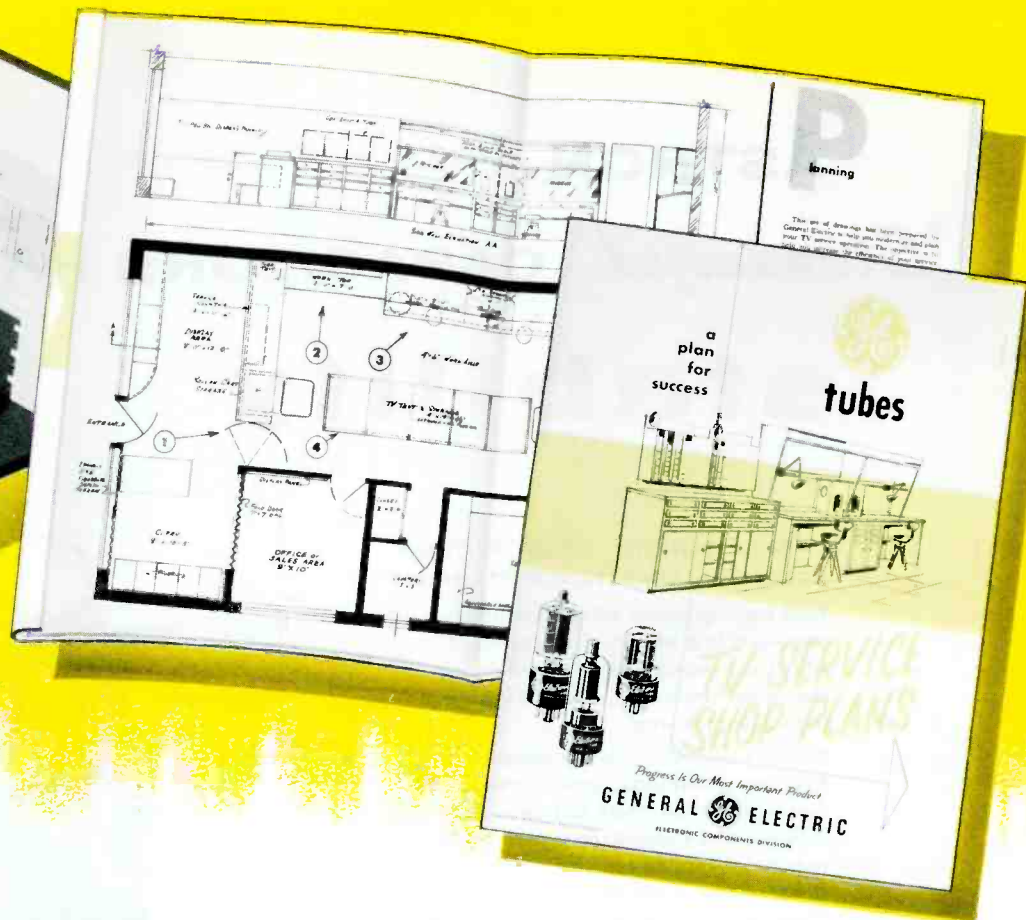
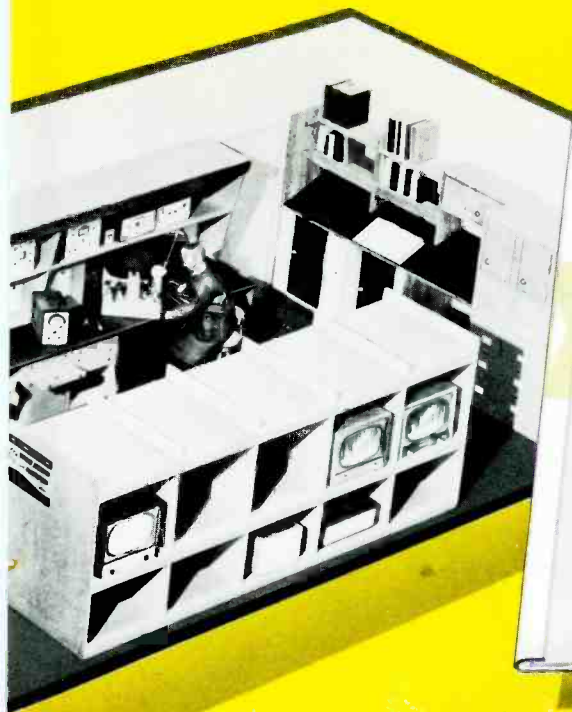

SERVICE DEALERS GENERAL ELECTRIC SHOP PLANS!

AND NOW

**ANOTHER G-E BUSINESS-BUILDING,
TIME-SAVING AID TO THE
INDEPENDENT SERVICE TECHNICIAN...**

Most complete tube guide ever published—the new edition of “Essential Characteristics”! Over 1500 types, with descriptions, ratings, and basing diagrams. Pocket size. See your General Electric tube distributor immediately!

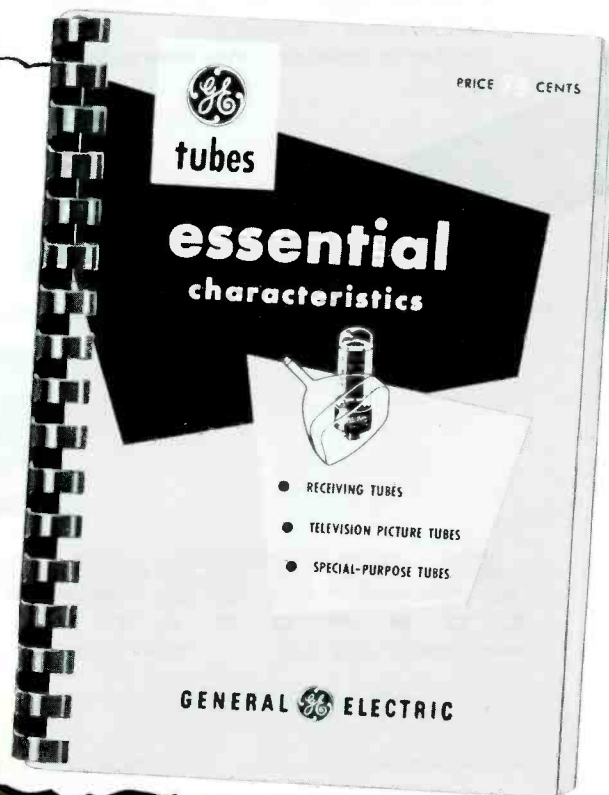

ASTRON

"Staminized" CAPACITORS HAVE **stability**

SAFETY MARGIN* CONSTRUCTION ASSURES CAPACITANCE STABILITY

Real staying-power **after** installation is what you need in a replacement capacitor . . . consistent characteristics maintain top circuit performance . . . and Astron builds them just that way!

Astron's exclusive "Safety Margin" construction withstands ripple currents, vibration, and wide temperature changes. Minimum leakage and impedance is assured by special processing methods. Only the very finest of raw materials pass Astron's "Selected Purchasing System". Special production techniques, strict quality controls, meticulously clean assembly methods and 100% final inspection before shipment assure you top performance from every Astron capacitor.

There is an Astron "Staminized" Capacitor built especially to fill the specific, exacting replacement requirements of any job you tackle.

Remember, **your reputation is our business.** Build it, guard it, protect it . . . buy Astron capacitors, **they have stability.**



SAFETY MARGIN "SM" MINIMITE*



CERAMIC CASED TUBULAR TYPE AP



FREE SERVICING AID

Save time, use handy Astron pocket-sized Replacement Catalog and Pricing Guide (AC-4D) — Write Today!

ASTRON

C O R P O R A T I O N
255 GRANT AVENUE EAST NEWARK, N. J.



*Trade-mark

Export Division: Rocke International Corp., 13 East 40th St., N. Y., N. Y. In Canada: Charles W. Pointon, 6 Alcina Ave., Toronto 10, Ontario

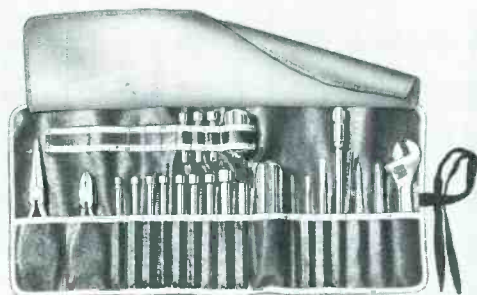

New! No. 99 S.M. Kit — 21 tools

"99" TOOLS
 cover the full range of electronic servicing — 3 popular "99" roll kits — the 26 individual "99" tools shown — plus distributor backup stock kits.

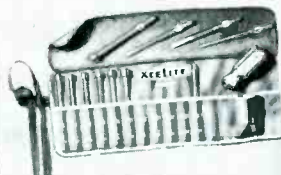

No. 99-JR
 Roll Kit
 — 11 Tools



No. 99-PR
 Roll Kit
 — 13 Tools



*Toolmanship...
 Preferred by All Hands!*

From individual screwdrivers, nut drivers and pliers to the big new No. 99 SM Service Master Kit, there's a bonus of craftsmanship and imagination that makes every XCELITE hand tool "preferred by the experts."

Besides its regular popular line, XCELITE brings you a continual supply of new and original tools — the new No. 99-X10 Snap-in Shaft Extension — reamers with the T-handle leverage feature — pocket clip nut drivers and screwdrivers — adjustable wrenches and "special-purpose" pliers.

See the latest
 — as well as the
 "tried and true"

— at the

**PARTS SHOW
 BOOTH 592!**

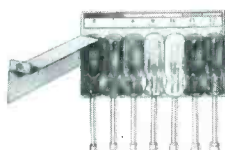
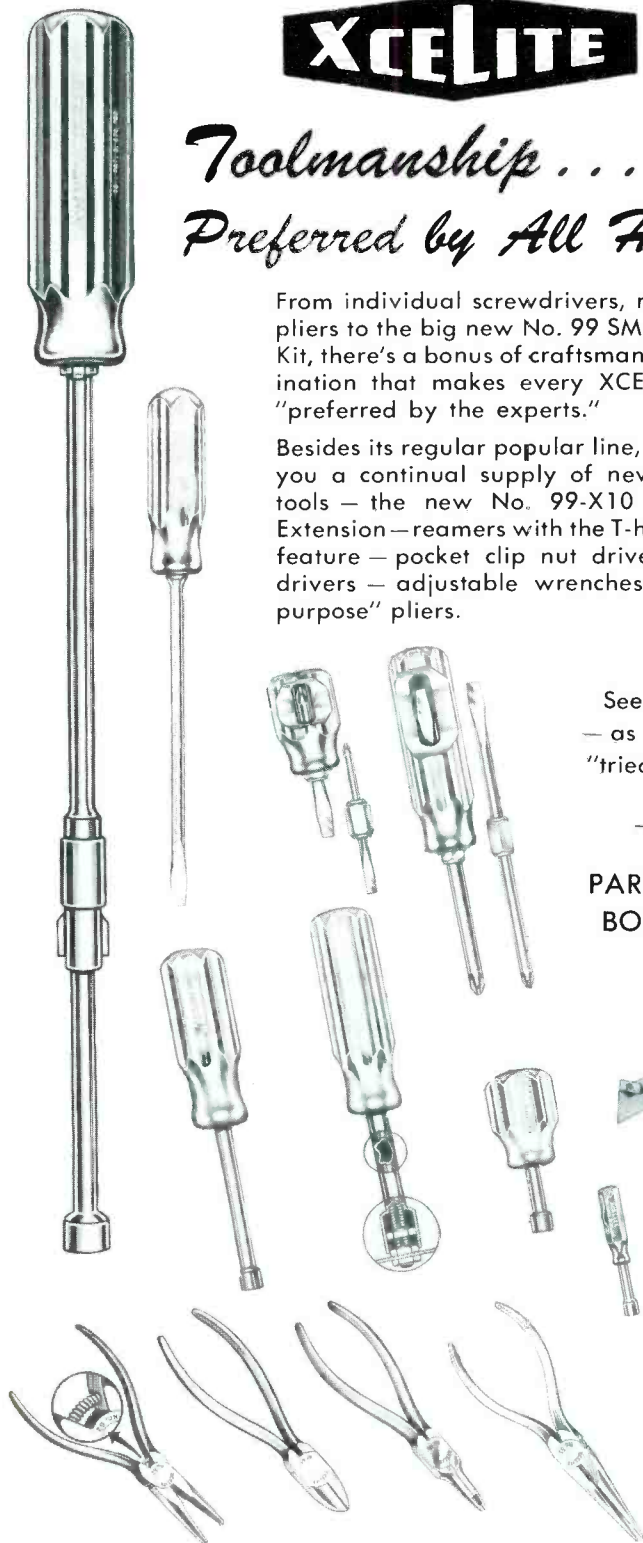

No. 127
 Lockable Wall Kit
 — 7 Color Coded
 Nutdrivers

SERIES "99" TOOLS

- No. 99-1 Handle (Regular)
- No. 99-2 Handle (Junior)
- No. 99-3 Handle (Stubby)
- No. 99-6 3/16" Nut Driver
- No. 99-7 7/32" Nut Driver
- No. 99-8 1/4" Nut Driver
- No. 99-9 9/32" Nut Driver
- No. 99-10 5/16" Nut Driver
- No. 99-11 11/32" Nut Driver
- No. 99-12 3/8" Nut Driver
- No. 99-14 7/16" Nut Driver
- No. 99-16 1/2" Nut Driver
- No. 99-81 3/16" & 9/32" Slotted, Reversible
- No. 99-82 #1 & #2 Phillips, Reversible
- No. 99-83 3/16" & 9/32" Frearson, Reversible
- No. 99-84 3/16" Clutch "G," Reversible
- No. 99-811 3/16" Slotted
- No. 99-812 9/32" Slotted
- No. 99-821 #1 Phillips
- No. 99-822 #2 Phillips
- No. 99-38 Reamer (1/8"-3/8")
- No. 99-39 Reamer (1/4"-1/2")
- No. 99X10 Extension
- No. 99-58 Stubby Nut Drivers
- No. 99-S10 Stubby Nut Drivers
- No. 99-S12 Stubby Nut Drivers

XCELITE, INCORPORATED

ORCHARD PARK, NEW YORK

In Canada — Charles W. Pointon Ltd., 6 Alcina Avenue, Toronto, Ontario

Simpson...the most Complete Line of VOM's

Select the one that fits your needs!

MODEL
260
world's most popular!

Over half a million Model 260's have been sold to date! 20,000 Ohms per volt. You'll find it wherever quick, accurate, electrical checks are needed. It's so handy, so dependable, so sensibly priced! Ask your jobber. Price, including Adjust-A-Vue Handle, only **\$43.95**

Carrying Cases from **\$7.75**

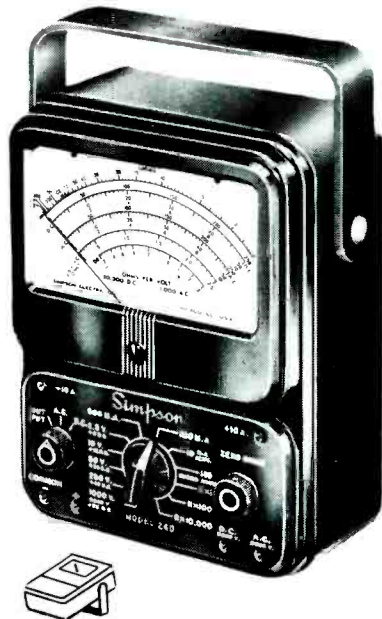

MODEL **262**

Deluxe!

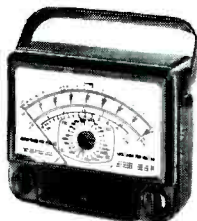

the new VOM with a 7" meter

20,000 Ohms per volt DC and 5,000 Ohms per volt AC sensitivity... 33 ranges... compact 7" case with Adjust-A-Vue Handle

\$59.50

Carrying Case **\$ 9.95**

MODEL **269**

100,000 Ohms per volt!



Most sensitive VOM

available! A Volt-Ohm-Microammeter with a big 7" meter in a compact 7" case... 33 ranges... Adjust-A-Vue Handle

\$88.00

Carrying Case **\$ 9.95**

NEW!

- ▶ **MIDGETESTER** Model 355—New shirt-pocket size Volt-Ohmmeter **\$34.95**
- MODEL 240**—Small VOM; 14 ranges; up to 3000 volts AC or DC **\$28.95**
- MODEL 230**—Small VOM; 12 ranges; up to 1000 volts AC or DC **\$27.95**
- ROTO RANGER** Model 221—25 Separate meters at turn of a switch **\$75.00**
- LABORATORY STANDARD**—For instrument calibration. Price on application.

Simpson ELECTRIC COMPANY

World's Largest Manufacturer of Electronic Test Equipment

5200 West Kinzie St., Chicago 44, Ill. Phone: ESTebrook 9-1121
In Canada: Bach-Simpson, Ltd., London, Ontario

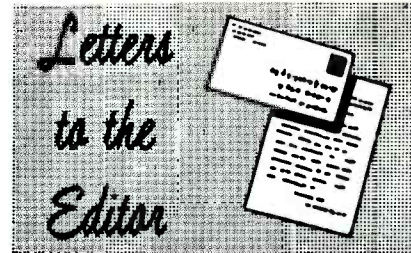

Dear Editor:

In the article "Horizontal AFC and Oscillator Troubles" in the March issue, mention was made of an antihunt circuit and of the fact that "pie-crust" effect is caused by trouble in this circuit. Could you tell me just which part of the AFC circuit performs this antihunt function?

I would also like to know if it is possible to contact your editorial staff for the answers to questions on servicing. I don't mean for help in servicing "dog" sets or in solving immediate problems—just for information that I might keep for future reference.

EDWIN M. MENEKEN

San Francisco, Calif.

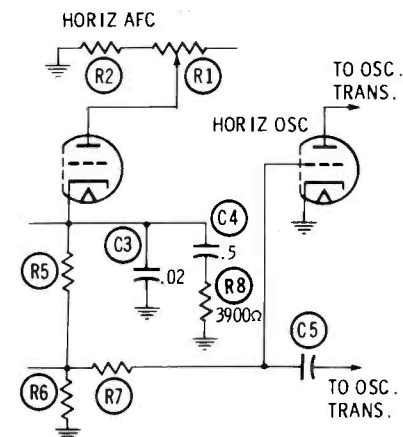

The antihunt function in this circuit is performed by C3, C4, and R8. C3 is low in value and places a limit on how fast the AFC voltage can change, while C4 is large so that control is maintained for a longer period of time. Hence, hunting is minimized.

We would like to point out that questions from readers are **always** welcome. If the answer requires more detail than can be supplied by letter, we will give the subject high priority for future editorial coverage in the magazine.—Editor

Dear Editor:

From here on, I'll carry my tube checker on calls to service series-connected TV sets. Why? Not to check tubes, but to heat up tubes prior to substitution in sweep circuits.

Recently, I was swapping 12W6's in the vertical output of an Airline set when I suddenly came up with no vertical sweep! Since this wasn't a part

of the original complaint, I put in an unpleasant 5 or 10 minutes explaining to Mr. Airline-Owner that the temporary loss of sweep was due to the fact that the aforesaid 12W6 was cold and took a bit longer to heat up than the tubes which were already warm. Anybody have a history of a tube failure due to this circumstance?

NORMAN D. SLATER

Huntsville, Ala.

As far as we know, there is little experience of tube failure as a result of putting a cold tube into an otherwise warmed up series filament string and then turning the set on to check it. In fact, the cold tube has a fairly high resistance (compared to hot tubes of the same voltage rating) and acts as a surge limiter. Thus, it would actually help to prevent tube failure in the string. Reader Slater's basic problem was with his customer. In future cases like this, we recommend that the brightness be turned down until the cold tube has had time to warm up.—Editor

Dear Editor:

I liked particularly the way you treated the article on "Radio for the TV Man" in the March issue. You undoubtedly appreciate that repair shops today are staffed partly by apprentices who, I am sure, could profit by articles treated in a similar manner.

FRED L. FAULKNER

Deerfield, Ill.

That was our reason for publishing it.—Editor

Dear Editor:

The article, "Replacing Twist-Prong Electrolytics," which appeared in the February PF REPORTER, revived an old pet peeve of mine. I contend that the identifying cutouts should be on the inside instead of the outside edges of the terminals. If this were done, there would be less chance for the cutouts to become hidden by wires connected to the terminals.

JOHN J. HANCOCK

Hancock Radio-TV
Sales & Service
Keokuk, Iowa

Reader Hancock has a good point; however, the base already has a small vent hole in its center. Positioning the identifying cutouts on the inside of the terminals would seriously weaken the structure—thus, manufacturers have a strong point in favor of the present style.—Editor

• Please turn to page 61

May, 1957 · PF REPORTER



Now . . . look to ELGIN for research, design and manufacturing leadership

American's FULL VISION—FULL SOUND audio equipment now comes to you from Elgin! Warehouse and service facilities are being maintained in California, of course; but manufacturing and product development have been moved to Elgin to work hand-in-glove with Elgin's well known styling and electronics research experts. You can expect the best . . . in appearance and performance . . . from American Microphones.

Does your equipment require a specially designed microphone? American is now better equipped than ever to help you!

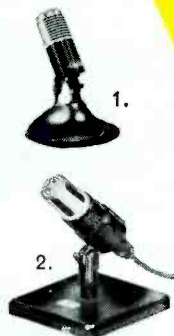

an American Microphone
for every use!

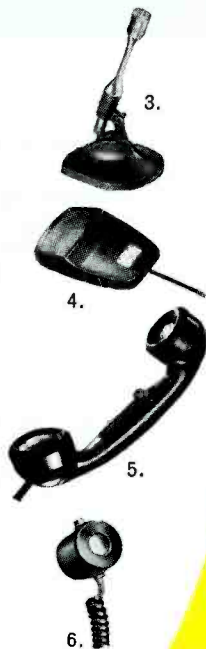

FOR BROADCAST QUALITY

1. DR330 Cardioid Dynamic and Ribbon Microphone meets strictest requirements of tv-radio broadcasting and motion pictures.

2. Presidential Series Dynamic Omni-Directional Microphone is rugged, compact, quickly converts to 6 oz. hand microphone.

FOR RECORDING AND GENERAL P. A. USE

3. D22 Dynamic Omni-Directional Microphone is a beauty queen—and dependable too. Quickly converts to hand use.

FOR TAPE RECORDERS

4. Versatile microphone is designed for hand or desk use, weighs only 2 ounces, yet gives outstanding performance.

FOR SOUND-POWERED TELEPHONES

5. No external power source required for this lightweight, sensitive unit. Rugged and extremely versatile.

FOR RUGGED, DEPENDABLE OUTDOOR MICROPHONES

6. A mobile microphone that resists moisture. Ideal for ship-to-shore and aircraft installation. High output, shock resistance.



ELECTRONICS DIVISION

ELGIN NATIONAL WATCH COMPANY

107 National Street, Elgin, Illinois

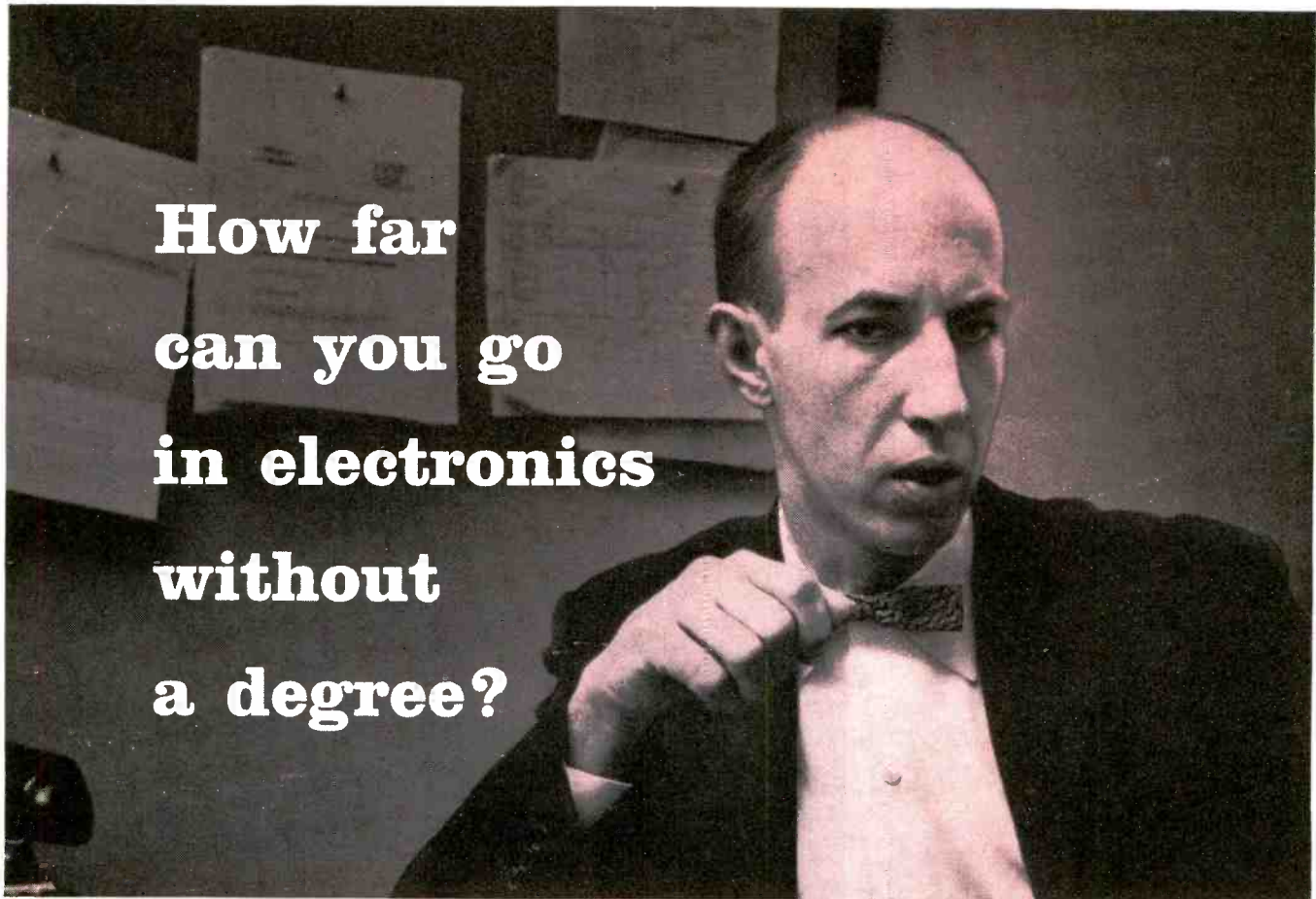

How far can you go in electronics without a degree?

Bill Miles talks frankly about the technicians' biggest problem

2 years ago, degreeless Bill Miles had reached a blind alley in his career. Yet today, with IBM, he's actually supervising engineers in America's biggest electronics project. Here's how this technician broke through the "education barrier."

"Training and local assignments," recalls Bill Miles, "were what caught my eye when I saw an IBM ad in 1955. So I investigated. Now here I am with an advanced electronics education under my belt—and responsibility as a Group Supervisor in Project Sage. I work on the world's largest and most advanced computer. I live in my home town. And my future in the company is what I make it. Yet only 2 years ago, I thought I'd gone as far as a technician ever could!"

Becomes radar technician

Bill's background is typical of thousands of capable, ambitious technicians who never acquired a formal engineering degree. His interest in electronics, aroused in Camden, New Jersey, high school, was nourished by a 3-year stint as Aviation Radar Technician in the Navy's "Black Cat" air-sea rescue squadron.

Takes night courses

Discharged in 1946, Bill married a girl he'd known in high school. During the

next 9 years, Bill was teacher in a radio-TV institute, TV service man, TV company technician, and chief supervisory TV technician. All the while he pursued an engineering education at night. But growing family responsibilities made it more and more difficult.

Finds doors barred

However, feeling he was equipped for greater responsibility, Bill, now 30, investigated several companies but found that, while they liked his abilities, his lack of degree barred the door to any significant future advancement.

Enters IBM school

In May 1955, when he moved his family to Kingston, New York, and started at IBM, Bill wasn't quite sure what to expect. The 9-month training course—valued at many thousands of dollars per man—had been the big magnet for him. He hoped the future would match his expectations.

Meets head of school

"Sixty of us started school at IBM, attending class 8 hours a day. The course consisted of about 20 subjects, mostly dealing with computer circuits and units,

and maintenance techniques. The teaching was adult, superb. After the first 20 weeks, we received a living expense allowance, over and above salary. We kept our own grades, and every 6 weeks when we reviewed them with the instructors, they asked us for ways to improve the course. I expected a casual 'hello' when I met the Division Manager of Education, but he talked to me for an hour about myself and my interests. The real concern IBM has for you as an individual, both before and after they hire you, is undoubtedly one reason why we all began to take a lot of pride in this outfit."

Joins home-town computer site

Bill had joined IBM as a Field Systems Engineer. After graduation, when 10 of his classmates were immediately promoted to specialized assignments, Bill was assigned to a computer site near his home in Mt. Holly, New Jersey, with IBM paying his moving expenses. For the first two months he helped install the SAGE computer, an important link in America's air defense. Ultimately, such computers will ring America's entire air defense perimeter. Looking back, Bill notes, "I'll admit the work was laborious and difficult, but still I have a sense of great accomplishment. Together we all helped create something of value from almost nothing."

World's largest computer

"The computer is probably the largest one in the world, with over a million components. Flattened out, it would probably fill a ball field. The computer analyzes radar data on every object in the sky. Then it checks each object against available traffic information and identifies it as either friendly or hostile. It can make suggestions, but it can't send a Nike missile against what it thinks is a 'baddie.' Only airmen can make that decision."



Bill gets electronic computer education at IBM Kingston

Supervises fifteen

Recently promoted to Group Supervisor, Bill now directs an entire shift of 15 men, reporting to a Group Manager. His job: to maintain the computer in combat readiness. "I have to be familiar with the entire system. I rely on two types of specialists to help me: computer units men who are specialists in certain areas; systems engineers for the over-all computer."

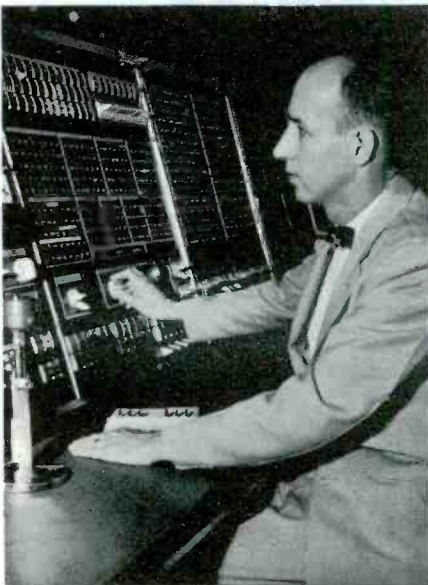

Miles does diagnostic programming on the Operating Console of the Sage Computer



Miles nails down problem with Site Manager R. Schimmel

Buys house, car

Bill has bought a 7-room house in Mt. Holly. When not busy with his son and twin daughters, he likes to bowl. He drives a new automobile. He's enjoying the good life, and expects it to get even better. His employee benefits alone represent a cash value of many hundred dollars a year. He expects the IBM-sponsored General Education Program will prepare him for higher management responsibilities. Later, Bill's manager said, "He's currently assuming the responsibilities of an electrical engineer."

But the question remains: Is Bill really an engineer?

The "professional" engineer

"No, I certainly don't consider myself a 'professional' engineer, qualified to design machines, for instance. But the point is, I'm doing work ordinarily done by engineers . . . work usually denied to men without a degree."

IBM upgrades technicians

Could he do this elsewhere? "Of all the companies I know, IBM appears to be one of the few upgrading the technician to the level of engineering responsibility. Fortunately for me, IBM had the imagination to get men without degrees and encourage them to rise in responsibility and income to the level of their native talents . . . not what their formal education dictates."

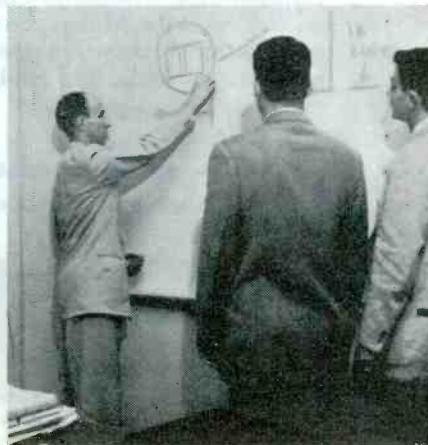

"Student" Bill Miles diagrams computer circuit

Both titles gain

Is this a sign that the educational system is wrong? "Not at all," answers Bill Miles. "A Doctor's, a Master's, a B.S. degree stand for something and always will. But if a technician can perform many jobs that traditionally belong to the engineer, they both stand to gain. The technician, because he gets much of the engineer's salary, satisfaction and recognition; the engineer, because he is free to do work which *only* a man with his formal training can do. When everybody wins, and nobody loses, it's the sign of a good thing."

Since Bill Miles joined IBM, opportuni-



Home-town assignment pleased Miles' wife, son, twin girls

ties in the Project Sage program, destined for long-range national importance, have grown more promising than ever. If IBM considers your experience equivalent to an E.E., M.E. or Physics degree, you'll receive 8 months' training, as a Computer Systems Engineer. If you have 2 years' technical schooling or the equivalent experience, you'll receive 6 months' training, as a Computer Units Field Engineer, with opportunity to assume full engineering responsibility. Assignment in area of your choice. Every channel of advancement in entire company open—and IBM is leader in a field that's sky-rocketing in growth. All the customary benefits and more. WRITE to Nelson O. Heyer, Room No. 9605, IBM, Kingston, New York. You'll receive a prompt reply.

IBM

MILITARY PRODUCTS

- DATA PROCESSING
- MILITARY PRODUCTS
- TIME EQUIPMENT
- ELECTRIC TYPEWRITERS

SHOW ANY PICTURE or PATTERN

at any time — ON ANY TV SET

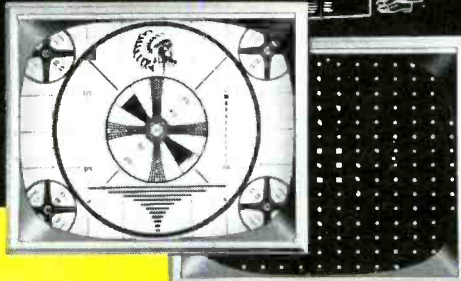
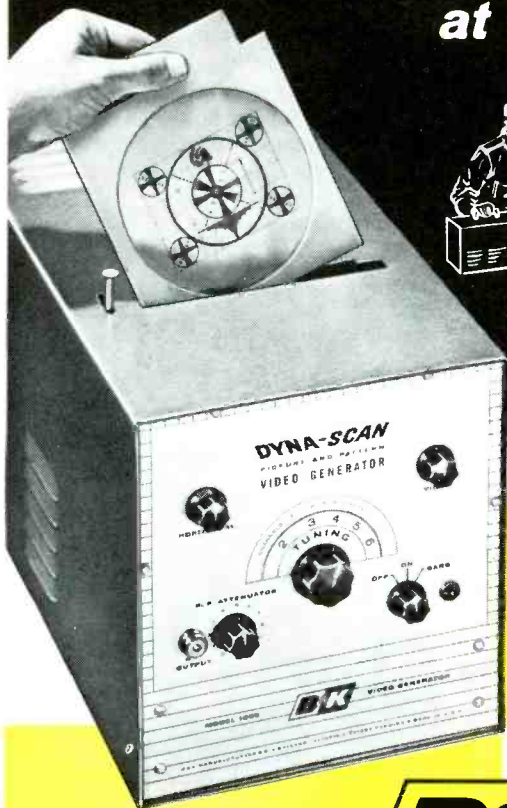

For Both Black & White and Color TV

Provides standard Indian Head Test Pattern for proper TV set alignment, and stable White Dot and White Line Patterns for color convergence adjustments.

For Merchandising & Industrial Uses

Provides closed circuit TV system. Transmits pictures or messages for advertising, educational and commercial visual communication.

MODEL 1000

B&K DYNA-SCAN PICTURE AND PATTERN VIDEO GENERATOR

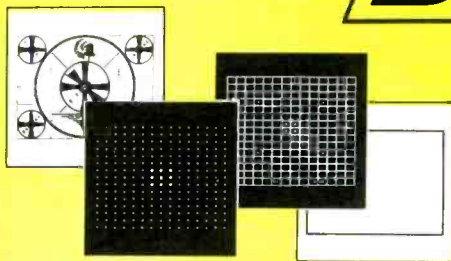

3 TEST PATTERN TRANSPARENCIES AND ONE CLEAR ACETATE SUPPLIED

- 1 Indian Head Test Pattern
- 2 White Dot Pattern
- 3 White Line Crosshatch Pattern

These are broadcast-quality transparencies, and assure accurate, high-definition TV images. You can also transmit your own transparencies of any subject you wish. The clear acetate can be used for special messages. Extra transparencies and acetate available.

Make the most of this *Complete Flying Spot Scanner*. It produces a composite video and sync signal that operates any standard black & white or color TV receiver. Can be used with one or more TV sets or fed into a master antenna system or community antenna system. Maximum resolution capability is well in excess of 450 lines; band width in excess of 5 mc. Projects and reproduces pattern or picture with high definition from any slide transparency. Transmits messages typed or written on clear acetate. Makes convenient stand-by and break-in for community distribution operation. Rugged, compact, portable, and ready to operate.

NET \$199⁹⁵

See your B & K Distributor, or Write for Bulletin No. 1000-R

Available on Easy Time Payment Plan

B & K MANUFACTURING CO.

3726 N. SOUTHPORT AVENUE - CHICAGO 13, ILL.



Model 950 Dyna-Scan Pickup and RF Generator only. Enables you to make your own picture and pattern video generator, at a saving. Supplied with three test pattern transparencies and one clear acetate. Net, \$69.95



Model 500 DYNA-QUIK
Dynamic mutual conductance tube tester. Accurately tests tubes faster. Net, \$109.95



Model 400 CRT
Cathode Rejuvenator Tester. Tests and repairs TV picture tubes. Net, \$54.95

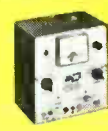

Model 750 CALIBRATOR
Designed to check and adjust test instruments with laboratory accuracy. Net, \$54.95

ShopTalk

MILTON S. KIVER

Author of . . .
*How to Understand and Use TV Test Instruments
 and Analyzing and Tracing TV Circuits*

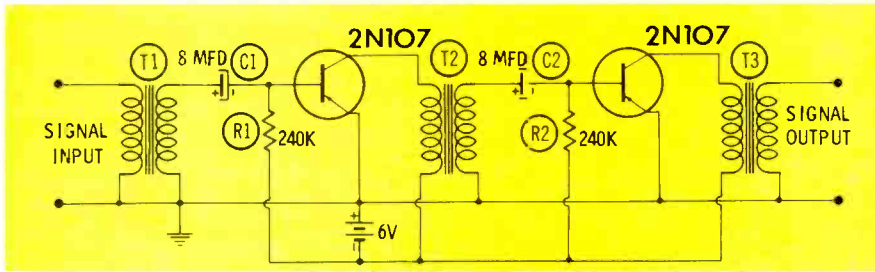

Fig. 1. An amplifier which utilizes T1 and T2 to match output to input impedances.

How Transistor Circuits Fit Together

As you become more familiar with transistor circuits, you will find that 90% of all amplifiers fall into the common- or grounded-emitter category. This is the transistor equivalent of the widely used vacuum-tube counterpart, the grounded-cathode amplifier, and a brief comparison of the common-emitter circuit with the other amplifier configurations reveals quite clearly the reasons for this popularity.

- Input resistance of each of the three types of transistor amplifiers (junction transistors) is:
 - Lowest for the common base (about 70 to 100 ohms).
 - Intermediate for a common emitter circuit (about 850 to 1,000 ohms).
 - Highest for the common collector (200,000 ohms or more).
- Output resistance for each of the three types of transistor amplifiers is:

- Highest for the common base (850,000 ohms or more).
- Intermediate for the common emitter (20,000 ohms).
- Lowest for the common collector (about 250 ohms).

In order to transfer the maximum amount of signal from one stage to the next, it is desirable that the output impedance of the prior stage be matched as closely as possible to the input impedance of the following stage. Glancing over the values given above, it is seen that the least mismatch is achieved with the common emitter. Note that a certain mismatch still exists, but at least this is much lower than that produced by any other combination.

Another factor in favor of the common emitter is its current amplification, an important consideration since transistors are current-operated devices. For the common-base arrangement, the current amplification is less than 1 (generally between .95 and .99). For common-emitter amplifiers,

current gain averages around 50 for currently available junction transistors. For the common-collector amplifier, the current gain is only a little greater than for the common emitter.

Power gain is important, too, and here again the common-emitter circuit excels. Power gain is greater in this amplifier than it is in either the common-base or the common-collector circuits. When all these features are taken together, they place the common-emitter arrangement in the preferred position.

Now let us examine some typical amplifier stages, and discuss each in detail. Fig. 1 contains the circuit diagram of a two-stage transformer-coupled amplifier. Each interstage transformer, through its step-down ratio, matches the 20,000-ohm load requirement of the previous stage to the 1,000-ohm input impedance of the following stage. (In the diagram, the 20,000 ohms appears on the primary side of each transformer and the 1,000 ohms on the secondary side.) Resistors R1 and R2 serve to bring the necessary bias voltage to each base; their values are chosen to produce the desired current in the base-emitter circuit. C1 and C2 are needed to prevent the low resistance of each transformer winding from shunting the base bias to ground.

By way of comparison, a three-stage RC-coupled amplifier is shown in Fig. 2. These three stages provide about the same gain as the two transformer-coupled stages of Fig. 1. This is because better output-to-input impedance matching can be achieved with transformers than with RC coupling.

In Fig. 2, R1, R2 and R3 provide the necessary base-emitter operating currents, while R4, R5 and R6 tie the collectors to the "B" supply and also serve as the respective load resistors.

Transistorized PA Amplifier

An interesting circuit arrangement containing both RC- and transformer-coupled stages is shown in Fig. 3. This is a high-power PA system, designed for compactness and dependability and for operating directly from a 12-volt storage battery. The input

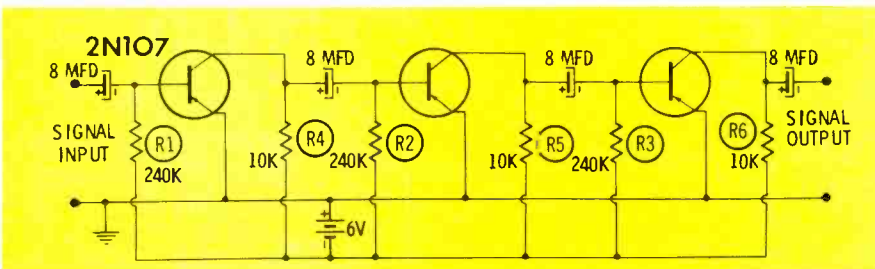

Fig. 2. The power gain of this amplifier is about the same as the unit of Fig. 1.

• Please turn to page 62



How

Helps

Independent Service Dealers with their TV-Radio Service Business

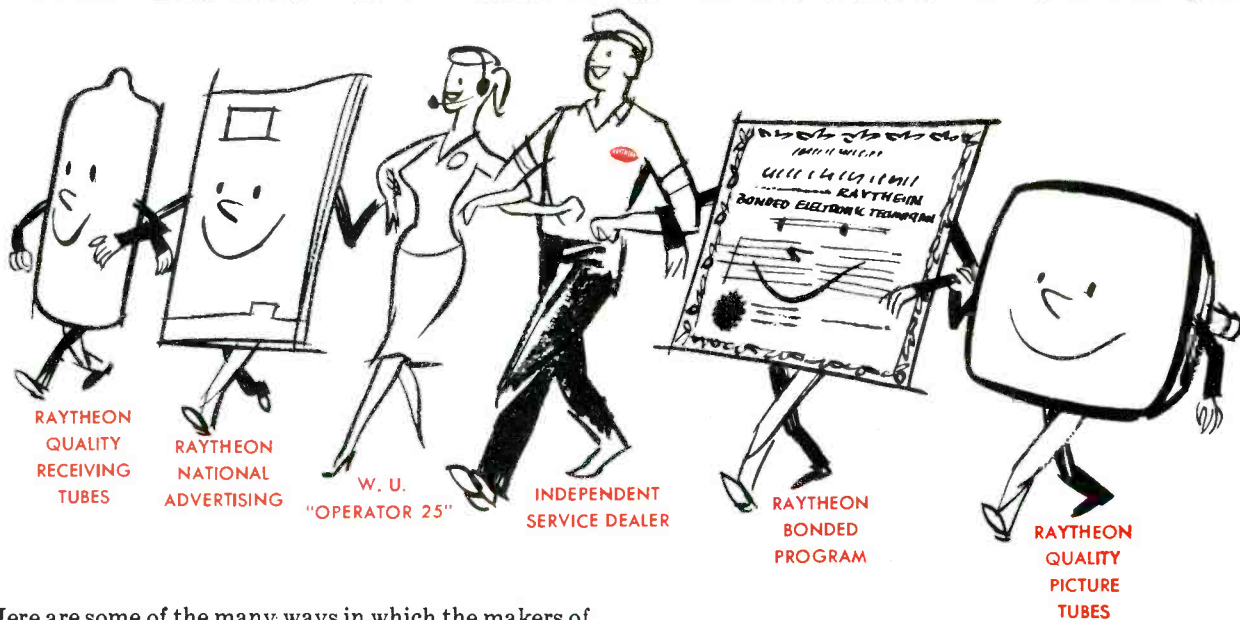

RAYTHEON
QUALITY
RECEIVING
TUBES

RAYTHEON
NATIONAL
ADVERTISING

W. U.
"OPERATOR 25"

INDEPENDENT
SERVICE DEALER

RAYTHEON
BONDED
PROGRAM

RAYTHEON
QUALITY
PICTURE
TUBES

Here are some of the many ways in which the makers of Raytheon TV and Radio Tubes help the Independent Service Dealer with his business.

1 For nearly 12 years Raytheon has offered the Raytheon Bonded Electronic Technician program to Independent Service Dealers. Dealers who qualify have their service and parts guarantee backed by a bond issued through Continental Casualty Company, one of the country's largest insurance companies. It gives them real prestige in the eyes of the customer.

2 Raytheon provides "Western Union Operator 25" service for Bonded Dealers in 23,000 cities and towns. In answer to phoned requests for fast, dependable, bonded TV-Radio service, "Operator 25" sends customers to Bonded Dealers.

3 Raytheon consistently runs national advertising, presenting Independent Service Dealers as the best in the business.

4 Raytheon has a network of independent distributors with well trained personnel who are eager to help independent dealers.

5 Raytheon makes a complete line of TV and Radio Tubes that are tops for replacement work — Raytheon All-Set Tubes — designed to help the versatile service dealer who repairs all makes and models.

For the whole Raytheon story, get in touch with your nearest Raytheon Tube Distributor.

TV-Radio service is your business . . . serving you is ours



RAYTHEON MANUFACTURING COMPANY

Receiving and Cathode Ray Tube Operations

Newton, Mass. • Chicago, Ill. • Atlanta, Ga. • Los Angeles, Calif.

Raytheon makes all these { Receiving and Picture Tubes, Reliable Subminiature and Miniature Tubes, Semiconductor Diodes and Transistors, Nucleonic Tubes, Microwave Tubes.



working in the CAGE

INTRODUCTION

Although the high-voltage cage houses only a small percentage of the circuits in a TV receiver, many technicians find that they spend a disproportionate amount of their time when they have work to do in that section. There are some very good reasons for this. First of all, the technician wastes time if he has no systematic procedure to follow. Secondly, the presence of high peak voltages, together with the effects of heat, dust and humidity, calls for special care when working with test equipment and tools in the high-voltage cage.

Trouble shooting in the cage can be simplified, and several hints are given in this pictorial coverage.

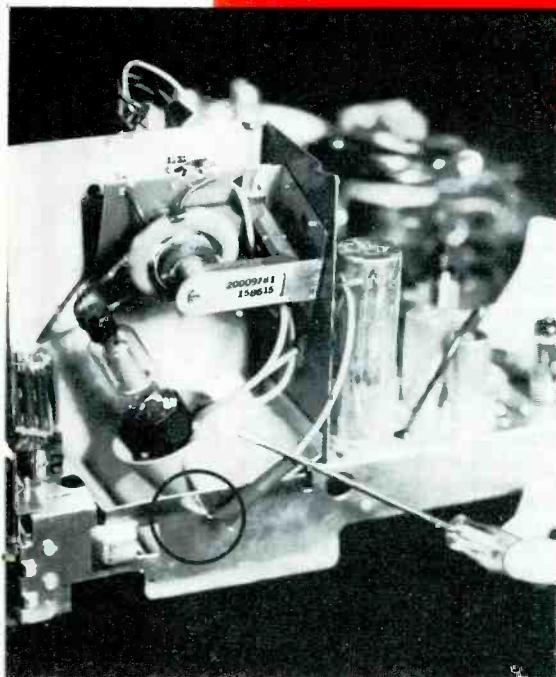

CHECKING THE RECTIFIER CIRCUIT

When the CRT anode connector is placed in close proximity to the chassis, a bluish-white arc, ranging in length from 1/2" to 1" and accompanied by a sharp crackling sound, should be produced. Its presence indicates that the rectifier circuit is functioning. Failure to obtain an arc, however, is not a positive indication that it is not functioning. The next step, then, would be to ascertain if energy is being supplied to the rectifier plate.

CHECKING THE FILTER CIRCUIT

Many receivers employ a deposited-carbon filter resistor between the rectifier output and the CRT anode connector. By removing the rectifier tube from its socket, an ohmmeter can be used to check continuity from one side of the filament winding to the end of the anode lead. A reading greater than 1 megohm should lead you to suspect that the resistor is defective. An open or high-value resistor in this application can cause picture blooming, arcing at the rectifier output, low second-anode voltage, or a complete loss of the raster.

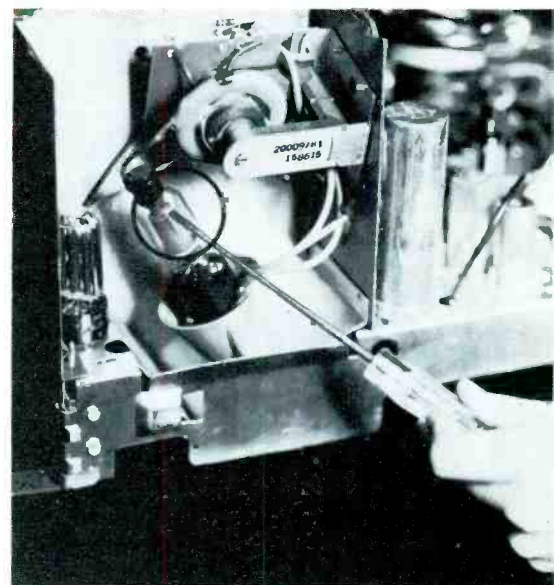
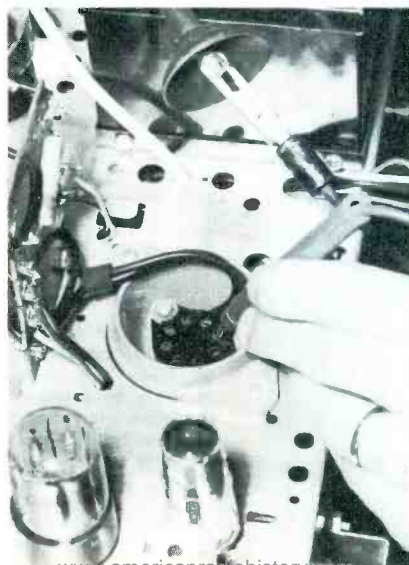

PULSE VOLTAGE AT THE RECTIFIER PLATE

At the HV-rectifier plate cap, the arc should never be drawn to the chassis but into free space with the blade of a screwdriver having a well-insulated handle. At this point, a bluish-red, snake-like arc about 3/4" long should be obtained. A normal arc at this point, but not at the CRT anode, would indicate a defective rectifier tube, filter resistor, or filament circuit. A weak arc, or none at all, usually indicates that little or no energy is being supplied to the flyback circuit; but, before proceeding further, one should try to obtain a normal arc at the plate cap after disconnecting it from the tube. Leakage paths from the filament winding to the transformer core, through the filter capacitor, or to the grounded aquadag coating on the picture tube, have been known to lower or cause a loss of rectifier pulse voltage.

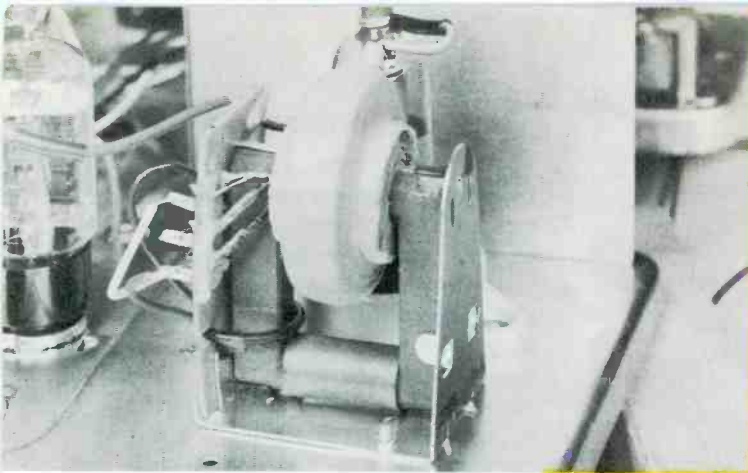

FILAMENT-WINDING LEAKAGE

Occasionally, the HV filament winding will become deteriorated due to excessive heat and humidity, or because of someone's carelessness with a soldering iron. Leakage between the filament lead and the transformer core will lower the anode voltage. Corona discharge may or may not be heard, but its effect should be noted in the picture. Flashing, blooming, or a dull and poorly-focused raster are its symptoms. Placing a small piece of insulating material between the core and the lead will sometimes remedy the trouble. If not, the filament winding must be replaced.

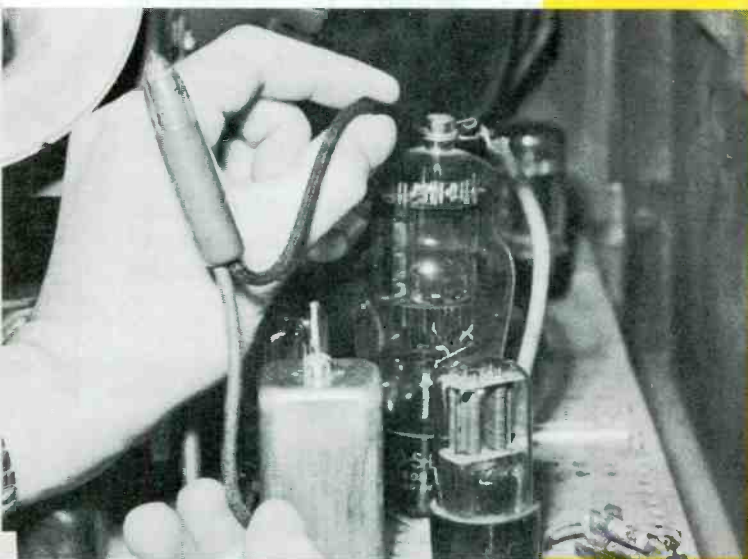

CHECKING THE ENERGY SOURCES

Failure to obtain a normal arc at the HV-rectifier plate may be due to a lack of energy from preceding circuits. A 1/4" arc drawn to the blade of a screwdriver from the output-tube plate indicates that the oscillator and output tubes are functioning. If this is the case, insufficient voltage at the rectifier plate could be an indication that the transformer or yoke is defective.

No arc at the output-tube plate can be caused by one of three things: the oscillator signal is not reaching the output tube, the output circuit is defective, or no B+ voltage is being applied to the output plate. The last is very easy to check—a meter or neon tester will indicate the presence of B+ voltage at the plate and at the fuse terminals. Remember that B+ voltage is supplied to the flyback circuit through the damper tube, and it should be suspected if the test is negative. CAUTION: Never make this test if an arc is present at the output plate.



CHECKING FOR SIGNAL DRIVE

When an arc cannot be obtained at the plate of the output tube, it will be advantageous to know whether or not the oscillator signal is reaching the output-tube grid. By removing the output tube, an AC voltmeter can be used to measure the signal. (In series-string sets, an octal socket adaptor can be used.) Ordinarily, the value of the signal is between 80 and 100 volts peak-to-peak; however, the low impedance of the meter will lower this reading somewhat. Then too, the oscillator plate may be tied back to boost B+, and the signal will be lower than normal because the energy will be derived from B+. A nominal reading of at least 25 volts rms is a fair indication that the oscillator signal voltage is sufficient. Naturally, readings obtained on different scales will vary considerably because of the relatively low sensitivity of AC meters; thus, it is best to use the highest scale possible for the most positive indications.

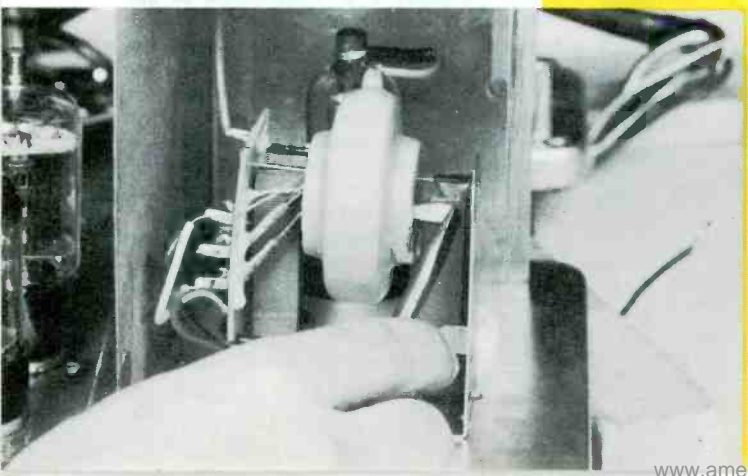

ELIMINATING FLYBACK SINGING

Mechanical resonance in the flyback transformer is often the cause of an annoying high-frequency tone. To alleviate this condition, make sure that the unit is securely mounted. Also tighten any bolts used to secure the mounting bracket to the core. As a last resort, fashion small wooden wedges and drive them between the core and the cylindrical coil form.

CURING BARKHAUSEN RADIATION

An oscillation known as Barkhausen may take place between the plate and screen of the horizontal-output tube due to the fact that the plate voltage changes rapidly from a highly-positive to a slightly-negative value. A thin, dark, vertical line on the left side of the screen indicates that the oscillation is being radiated and picked up by the RF or IF circuits. The symptoms are most noticeable during the reception of weak signals.

Replacement of the output tube, adjustment of the horizontal drive and linearity controls, redressing of the output-tube plate lead, and shielding of all RF and IF tubes are steps that may reduce the effects of Barkhausen. If none of these prove satisfactory, it may become necessary to install low-value wire-wound resistors in the plate and screen leads of the output tube. Curbing radiation that emanates directly from the bulb can be accomplished by placing a magnet around the envelope and orienting for best results.

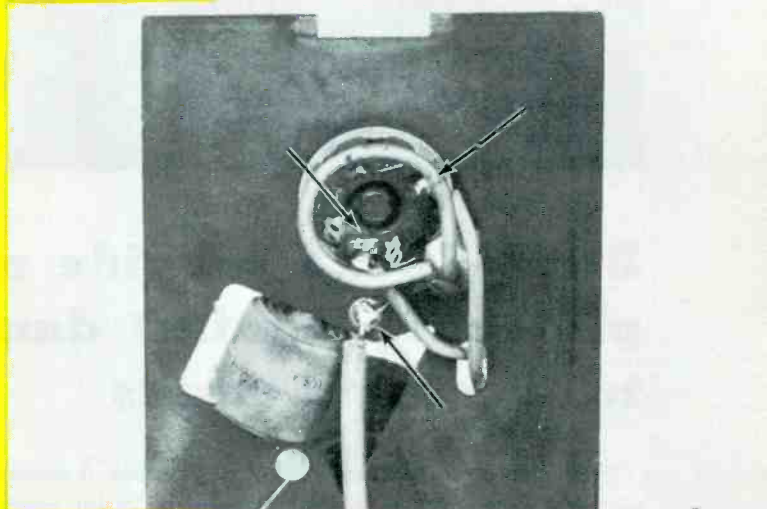
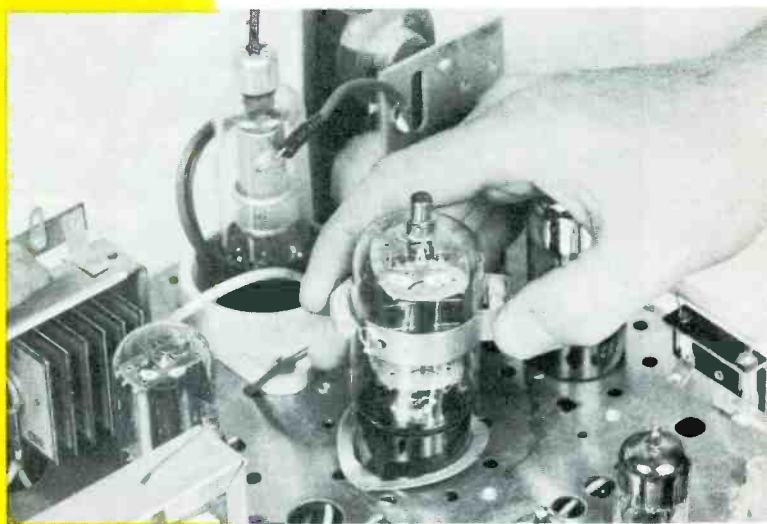
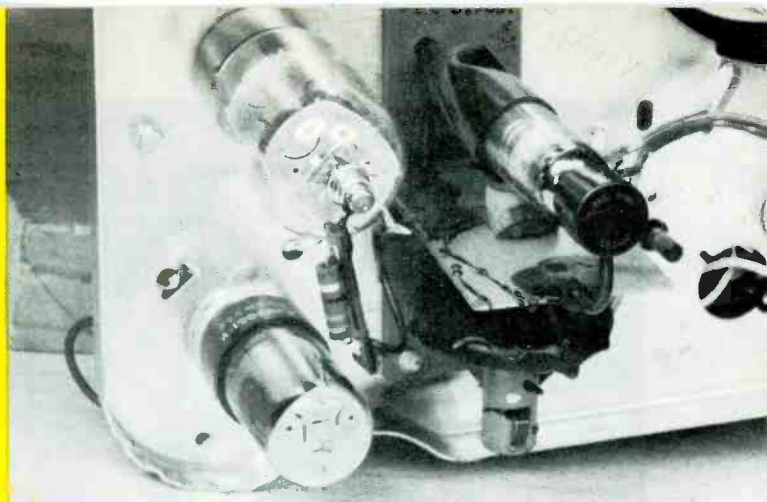

PREVENTING CORONA DISCHARGE

The high potential developed at the output of the rectifier circuit requires that special care be taken to prevent arcing. When making solder connections at or around the rectifier socket, do not leave any sharp edges or points. A further precaution against possible arcing is to thoroughly clean the area with carbon tet (or a similar agent) to remove all dust and moisture. Also check for poor lead dress which might contribute to arcing. After working in the cage, coat exposed sections with an acrylic plastic spray, or the equivalent, to make them moisture-proof. This will reduce the chances for corona discharge.

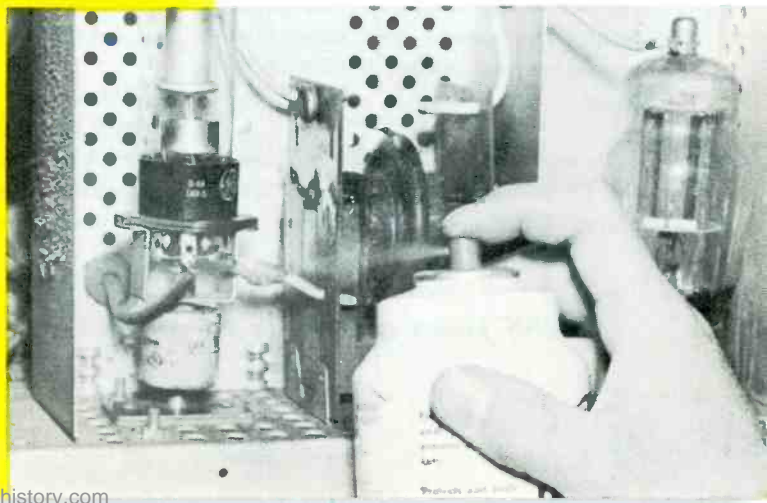

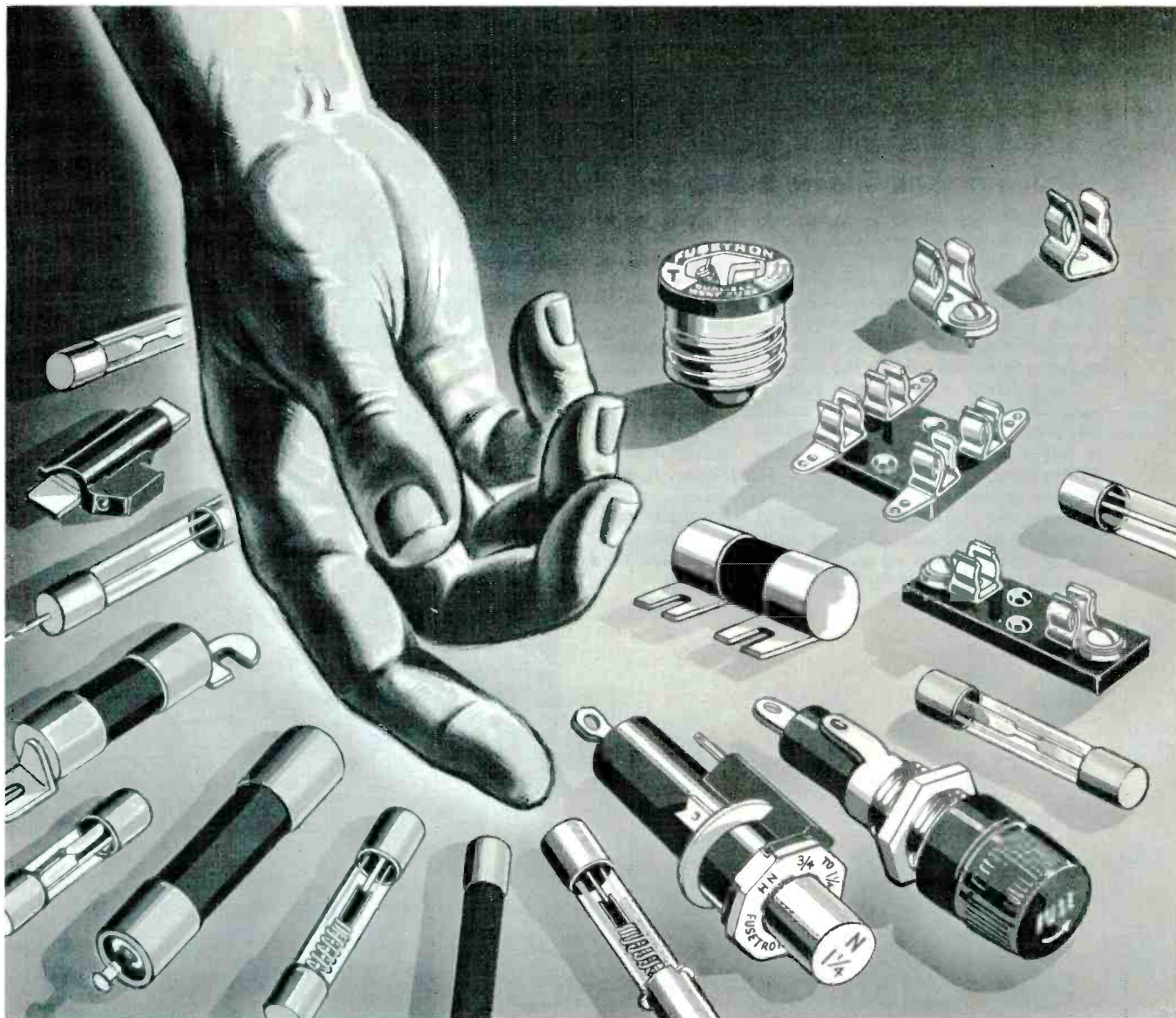

BUSS FUSES provide maximum protection against damage due to electrical faults

Protection against damage due to electrical faults can be no better than the device used to protect the equipment. The safest, most dependable protection you can get is with BUSS fuses.

To make sure BUSS fuses will clear the circuit should an electrical fault occur,—BUSS fuses are electronically

tested. A sensitive testing device automatically rejects any fuse not correctly calibrated, properly constructed and right in all physical dimensions.

This careful testing is also your assurance BUSS fuses won't give a false alarm by blowing needlessly. Shut-downs due to faulty fuses blowing without cause are eliminated.

By safeguarding users' equipment against damage—and by eliminating needless fuse blows—BUSS fuses give you double protection against loss of customer goodwill.

With a complete line of "trouble-free" BUSS fuses available in all sizes and types,—it is just good business to standardize on BUSS fuses.

For more information on BUSS and FUSETRON Small Dimension fuses and fuseholders . . . Write for bulletin SFB. Bussmann Mfg. Co. (Div. of McGraw-Edison Co.) University at Jefferson, St. Louis 7, Mo.

BUSS fuses are made to protect—not to blow, needlessly



Makers of a complete line of fuses for home, farm, commercial, electronic, automotive and industrial use.

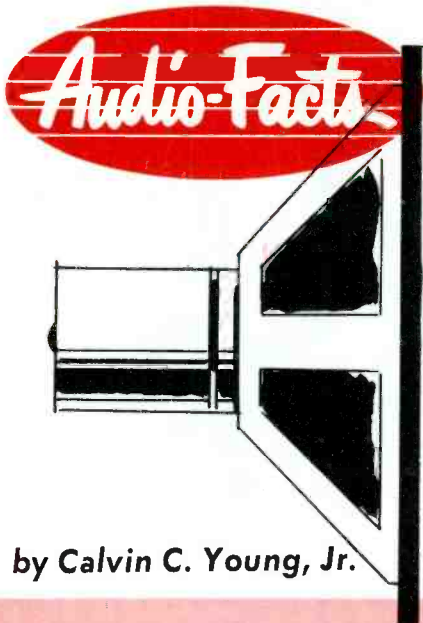

Between the PA Amplifier and Speakers

Facts About Speaker Phasing, Impedance Matching, Distribution Lines and Conduits

by Calvin C. Young, Jr.

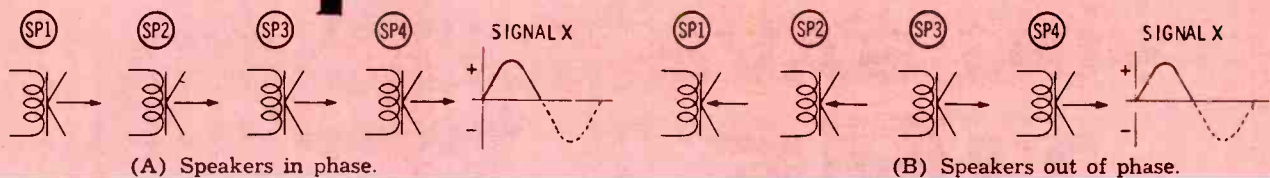

Fig. 1. Direction of cone travel with positive voltage indicates speaker phase.

While it is true that commercial sound systems do have a complex wiring layout between the amplifier and the speaker, it is not true that this system is unduly complicated or hard to understand. The reader will come to realize this as he reads this article.

Speaker Phasing

The efficient operation of multiple speakers in a single location depends on whether or not the sound is reinforced by all of the speakers. Each speaker will reinforce the over-all sound only if all speakers are properly phased. When signal X (Fig. 1A) is going in the positive direction and all of the speaker cones move in the same outward direction, all of the speakers are in phase. However, if some of the cones move outward and others move inward when the signal is going positive, the speakers are not in phase (Fig. 1B). In this case, it is necessary to reverse the connections to either pair of speakers for proper phasing.

There are two methods which are generally employed to obtain correct phasing. The easiest of these is to use color-coded wire, speakers of the same make and matching transformers of the same make. The voice coils in the commercial PA speakers made by any one manufacturer are always

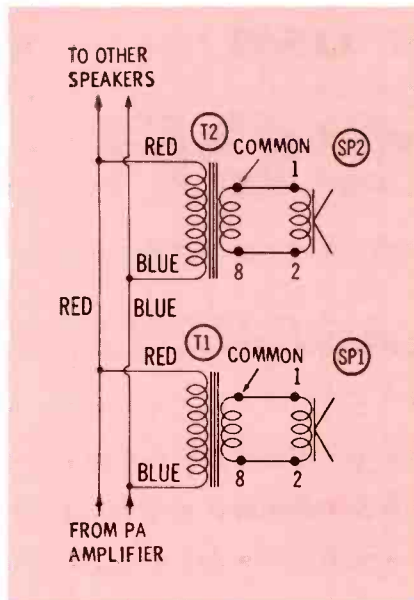

Fig. 2. Automatic phasing is obtained by the use of color-coded wire, identical transformers and identical speakers.

wound in the same direction, and all transformers of one make have leads or terminals coded to produce the same output phase; thus, the use of these identical components, together with color-coded wire, will automatically result in correct phasing. This is illustrated in Fig. 2.

It sometimes becomes necessary to use speakers and transformers made by several companies in order to complete a system accord-

ing to a particular customer's specifications. If different brands of speakers are to be employed, but the matching transformers are all of the same brand, only speaker phasing need be considered. However, if different brands of speakers and output transformers are to be used, then the proper connections to both speakers and transformers must be investigated.

The phasing of individual speakers can be determined by the use of a battery or a VOM as illustrated in Fig. 3. Connect the negative lead from either a 3-volt battery or a VOM (low-ohms range) to one terminal of the speaker. Momentarily touch the positive lead to the other terminal and note the direction in which the cone of the loudspeaker travels. Mark with a dot the terminal of the speaker to which the negative lead of the battery or VOM was connected. Using this same test setup, check the next speaker. If the cone travels in the same direction, place an indicating dot on the negative terminal. If the cone moves in the other direction, put the dot on the positive terminal. This test need only be repeated for one speaker from each different manufacturer. The polarities of other speakers can be

• Please turn to page 67

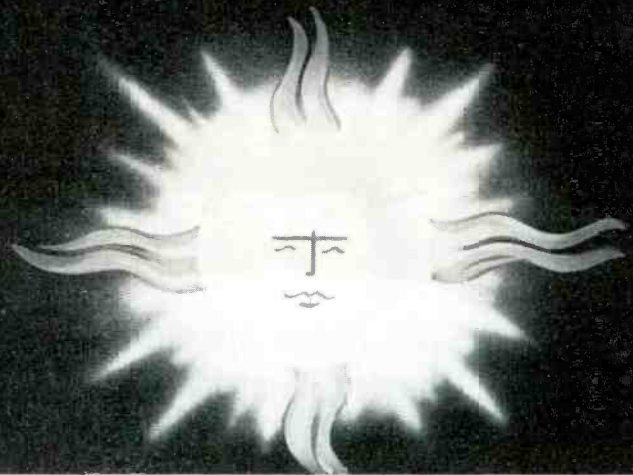

**YOU SAVE
TIME**
when you use
STANCOR
CONSERVATIVELY RATED
EXACT REPLACEMENTS

No re-wiring, no circuits to change, because almost all STANCOR transformers are exact replacements, built for quality from original manufacturers' physical and electrical specifications. At better distributors everywhere. Write for your free catalog.

**CHICAGO STANDARD
TRANSFORMER CORPORATION**
3503 ADDISON STREET • CHICAGO 18, ILLINOIS
Export Sales: Roburn Agencies, Inc., 431 Greenwich St., New York 13, N.Y.



Sidewalk TV. Noting an unused section of wall fronting on the main shopping street, one TV dealer arranged to lease the space and installed therein a 21" TV set. This he turns on each night at dusk for operation through the theater hour. A time switch cuts off the set automatically around midnight. A sign under the screen says, "This TV set furnished for your enjoyment thru the courtesy of Ratcliff's Firestone Store."

With a location on the shady side of the street, such a set could be operating in the daytime as well. A hinged plywood door, with an opening for the picture tube, can be mounted so as to prevent tampering with the controls. A neat furniture-type lock built into the door will look best, but even a hasp and padlock can serve. With an appropriate sign, such a set could well offset the disadvantage of having a service shop located on a side street, providing the set is kept working at top-notch performance. A possible sign here could be, "Does your TV set work this well? If not, call us for prompt, professional service." Give your shop name, address and phone number underneath.

To avoid the expense of having a special power line and electric meter installed, make sure your lease includes authorization to connect one TV set to the power line in the building for continuous operation. Since power cost is less than one cent an hour, you might even want to leave the set running continuously 24 hours a day, particularly if there are early morning programs in your locality.

\$ & ¢

Color. If you like tough problems, ask Santa Claus to bring you a color TV servicing job having an intermittent that shows up only on color programs, so erratically that you can't tell whether the station or the set is at fault. With so few color programs during the working day, hourly charges can really skyrocket.

Our own RCA color set is acting this way now. After an indefinite number of minutes of a color program, the color gradually reverts to black and white. One suspect is our Siamese cat, who hides his pipe-cleaner toys behind the set where they rest on the antenna twin-lead, and then tangles this lead with the line cord.

Theoretically, it is possible to



BY JOHN MARKUS

Editor-in-Chief, McGraw-Hill Radio Servicing Library

cause color carrier suckout by positioning metal at a critical point on the lead (like the sliding tinfoil trick used with lead-ins of early TV antennas), but so far we haven't been able to duplicate the effect manually with any combination of pipe-cleaners and line cords.

\$ & ¢

Looking Ahead. If you've ever cussed the compactness of portable TV, you can look forward to even more cussing in the future; around two million portables were sold last year—accounting for roughly 30% of all TV output—and predictions are that close to four out of ten sets sold this year will be portables. Fortunately, the trend is toward the 17" size, which gives a bit more working room, even when the new stubby 110° tube is being used.

Only 120,000 color sets were sold in 1956, with most of them being serviced under contract. RCA predicts they'll sell 250,000 sets in 1957, but first-quarter sales don't bear this out. For most shops, then, the over 44 million black-and-white sets and approximately 150 million home and auto radios now in use will dominate service work.

\$ & ¢

Diagnosis. Just as in television and radio, tracing of symptoms to a cause in medicine requires an exceptionally good memory, particularly for the less common causes. In recognition of this, one French doctor has placed on punched cards all of the symptoms and characteristics of corneal disease. When examining and interviewing a patient, he records the results by punching appropriate keys from the 200 on his machine's keyboard. The machine

then sorts the cards and rejects those that do not match the patient's symptoms. This generally leaves around half a dozen that are possibilities for guiding the physician and refreshing his memory when he makes the final diagnosis.

When demonstrated at the World Cybernetics Congress in Belgium, the robot doctor was welcomed by experts in the field because of its infallible memory. Ultimate goal of inventor Francois Paycha is to have a medical publisher prepare sets of cards, one for each disease, so that even family doctors can use cybernetic diagnosis.

With the increasing complexity of color TV, it is within the realm of possibility that a similar punched card technique could speed servicing of these sets and greatly reduce the training time required by color TV technicians.

\$ & ¢

Mailings. Each piece of promotional mail you send out should have a definite objective. For a final check before sending your next one to the printer, pretend you are the typical prospect. Read your promotion quickly, just as you would do if opening your own mail at home while the potatoes are starting to boil over on the stove. Would you know exactly what the mailing piece wants you to do? Would you do it?

To pass this test, promotion copy must be attention-getting, concise and clearly written. It must ask for action. For maximum value, in the event no service work is needed that day, it must also convey the idea that it is worth keeping for future use. How about offering a free cabinet-polishing job with the first service call?



SPEAKERS

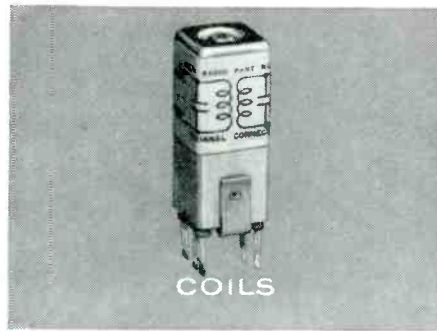

COILS



TRANSFORMERS

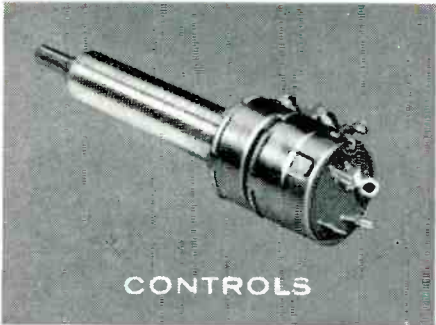

CONTROLS



TRANSISTORS



VIBRATORS

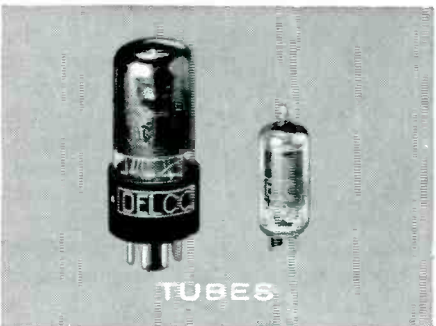

TUBES

**From
DELCO
RADIO:**



IRON CORES

a complete line of replacement parts

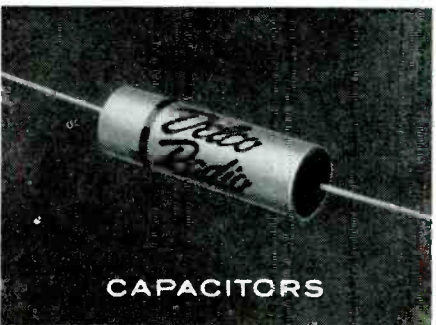

CAPACITORS



RESISTORS

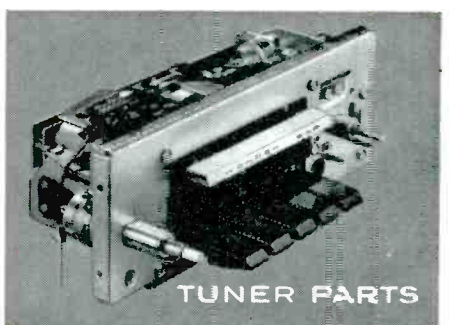

TUNER PARTS

for your Delco Radio service work!

It's one-stop service from the world leader in auto radio! Your Delco Electronic Parts Distributor gives you fast delivery on all items, *plus* a truly profitable Delco Radio independent dealer program that includes:

1. A technical training program conducted by factory engineers.
2. An attractive warranty policy.
3. Plenty of attractive dealer identification.

Delco Radio also offers a wide selection of Special Application Parts for your convenience and profit. Get the facts today.

DELCO

W O N D E R B A R

RADIO

DIVISION OF GENERAL MOTORS, KOKOMO, INDIANA



A GENERAL MOTORS PRODUCT — A UNITED MOTORS LINE
Distributed by Electronics Distributors Everywhere

SEMICONDUCTOR DIODES

A Study of Selenium and Germanium Crystal Diodes Used in the Latest TV Sets

by Thomas A. Lesh

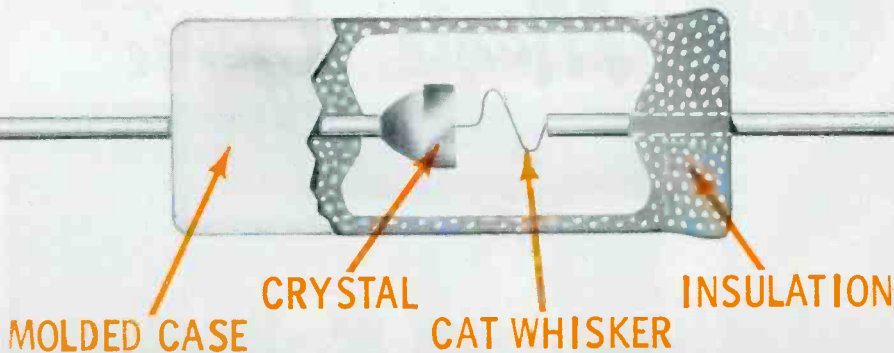

Fig. 1. Internal structure of a point-contact germanium crystal diode.

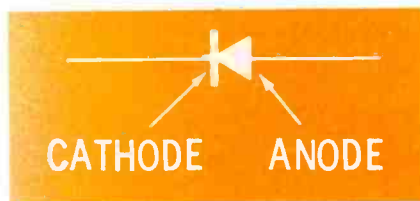

Fig. 2. Conventional circuit symbol for a semiconductor diode.

Although transistors have not yet come into commercial use in TV receivers, their cousins—the germanium crystal diodes—are already widely employed in television circuits, where they are most frequently used to take the place of vacuum-tube diodes in video detector and UHF mixer applications. They are also found in other circuits, such as FM sound detectors. Related components, the selenium diodes, are being utilized in horizontal AFC circuits. Not only are these semiconductor diodes economical to use and small in size, but they have other advantages, too. They require no heater current, and in some cases, their electrical properties are more desirable than those of diode tubes.

Inside the Crystal Diode

Like a transistor, a crystal diode may be of either a point-contact or a junction type. However, transistors are now almost entirely of the junction variety, while point-contact construction

has been thus far preferred in diodes for TV use.

The drawing in Fig. 1 shows the internal structure of a typical point-contact germanium diode. Its two principal parts are a small section of germanium crystal and an S-shaped conductor which is commonly referred to as a cat

whisker. These two units are so assembled that the sharp-pointed end of the cat whisker makes contact with the crystal.

Germanium crystals are not found in nature but are made by a laboratory process. Raw material—usually germanium dioxide powder—is reduced (deoxidized) in a hydrogen furnace, and the product goes through several stages of purification. Only minute impurities are allowable in the germanium used for diodes, and the specific amount and kind of impurities determine the electrical characteristics of the diode crystals.

The germanium metal obtained after purification is made up of many small crystals which are oriented in different directions, and current does not flow with the desired degree of ease through this material. Therefore, one more step is necessary in the manufacture of diodes. The metal is melted, and a small crystal called a seed is dipped into it. The molten germanium solidifies into a single-crystal structure patterned after that of the seed. A diamond saw is used to cut the big crystal into many minute particles for use in diodes.

The cat whisker is made of a metal like tungsten, platinum or gold, and the end of the wire which touches the crystal is

• Please turn to page 71

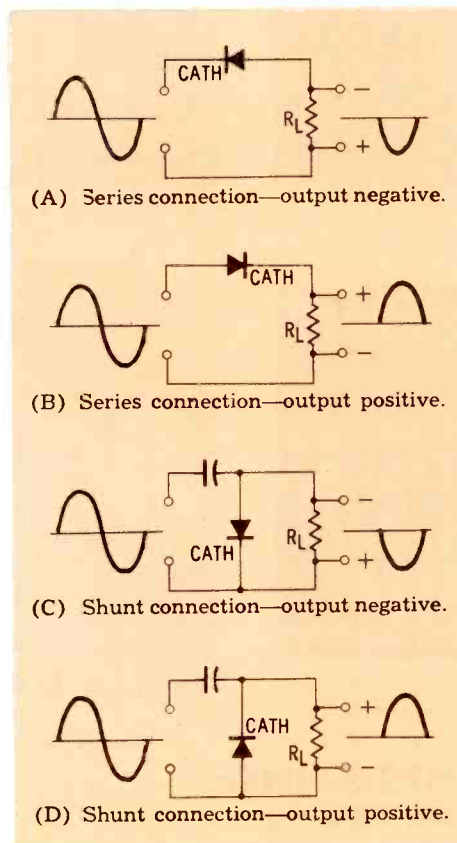

Fig. 3. Semiconductors as rectifiers.

MR. SERVICE-DEALER:

YOU CAN MAKE \$6⁴⁰ EXTRA on 7 OUT of 10 TV SERVICE CALLS in INDOOR ANTENNA AREAS

with the  *Magic Genie*[®]

Here's How:

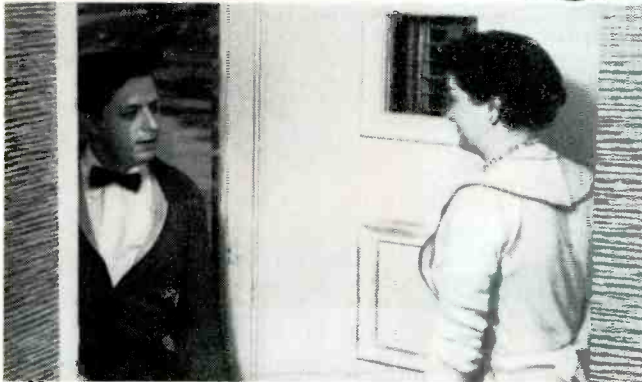

1 TAKE the JFD Magic Genie with you in your tube caddy on your next service call. It's conveniently small and compact.



2 USE the Magic Genie to check the picture after you have serviced the set.



3 YOUR customer is sure to ask about it. This is your invitation to tell the fabulous Magic Genie story.



4 SHOW your customer how much more beautiful the Magic Genie looks than the old ugly indoor antenna sitting on top of her TV set.

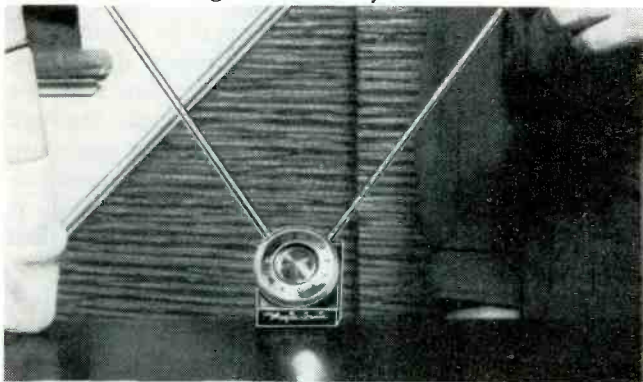

5 DEMONSTRATE the way dipoles rotate and adjust in any direction for powerful black and white and color reception.



6 CLINCH the sale by pointing out the Magic Genie unconditional money-back guarantee backed by JFD's 28 years of electronic know-how.



ELECTRONICS, INC.

PIONEERS IN ELECTRONICS SINCE 1929

Call your JFD distributor for your Magic Genies and start earning that extra money now. It's so easy.

NATIONALLY ADVERTISED AT \$17.95 promotionally priced at **\$14.95**

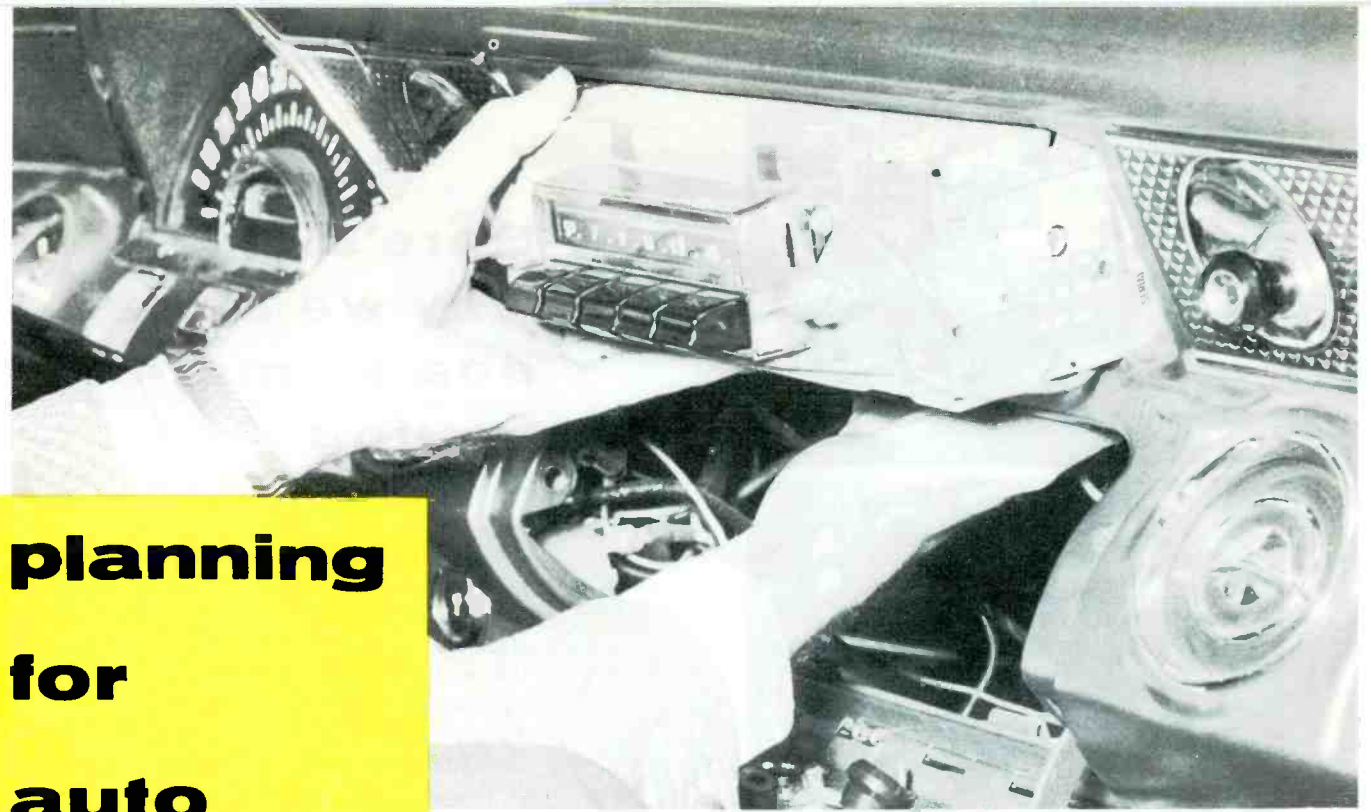

planning for auto radio service

equipment and tools for auto-radio repair

by Thomas A. Lesh

Automobile radio servicing can be a lucrative specialty for the shop that is set up to handle it efficiently. You might do well to expand your activities in this field—particularly if you already have the two basic assets which are most useful to the auto radio technician:

1. Parking space adjacent to the shop, enabling you to attract customers by offering convenient drive-in service.
 2. A limber neck and back. This is not as tongue-in-cheek as it may sound; perching uneasily on your shoulder blades while reaching up underneath a dashboard to remove or reinstall a radio can be quite tiring. It's the kind of work that even a chronic do-it-yourselfer might willingly pay for because it proved to be too much for him.
- Got these advantages? Then you're well on your way toward being able to handle a large proportion of the auto radio work

which you may be called upon to do. Only a modest stock of specialized bench equipment, parts, and tools are needed in addition to the ordinary radio-shop inventory to enable you to handle most car-radio work efficiently.

One mandatory piece of equipment is a low-voltage DC power supply. For this purpose, most shops prefer to use a battery eliminator which steps down and rectifies the AC line voltage. A stor-

age battery with trickle charger can also be used, but the battery eliminator is more convenient and flexible in operation. Modern power packs usually have a toggle switch for selection of DC output voltages in either the 6-volt or 12-volt range; and, in addition, they incorporate a vernier control or tap switch for fine adjustment of the voltage. This latter feature is ideal for checking the starting

• Please turn to page 75

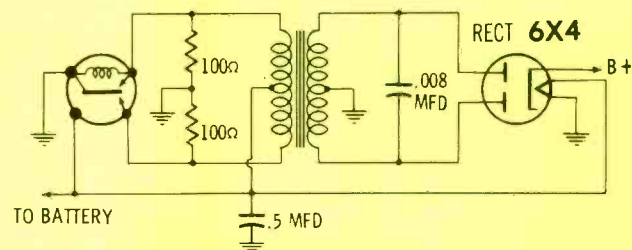

(A) Type commonly used in many makes.

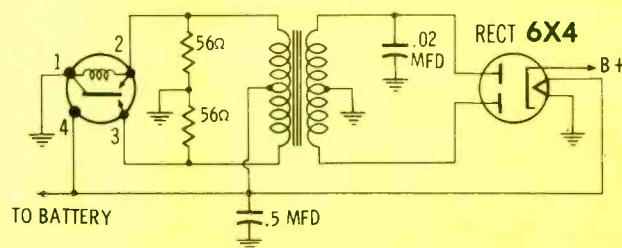

(B) Type found mainly in Motorola and Philco radios.

Fig. 1. Vibrator power supply circuits.

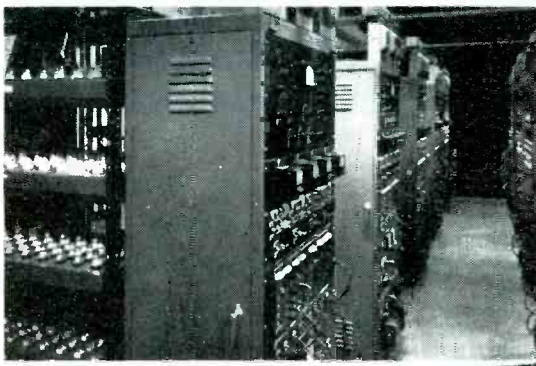
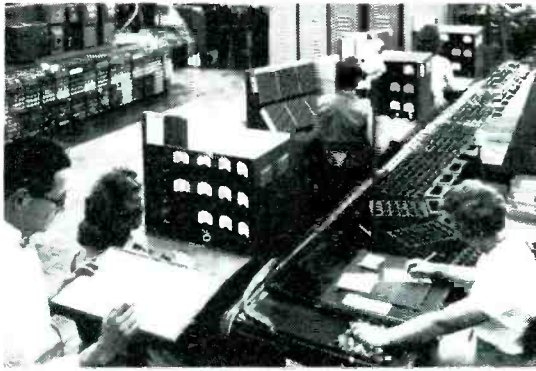

Here's why we added dealer meter testing

For years, you service-dealers have been checking your tubes in dealer meters. This was in addition to many exhaustive tests — materials control, production, quality, design, and life — that we tube manufacturers have been running ourselves. And you found it good insurance, or you wouldn't have continued to do this extra work.

As another step in our program to serve you independent service-dealers, and to correlate our tests with yours, we decided to do this job for you. Instead of making our last check a simple conventional short test, we put CBS tubes through the latest type of dealer meter.

If you are one of the thousands of dealers who have been buying CBS tubes, you know the result. You have been getting, in addition to a high average quality, practically no inoperables.

And you have discovered that double-checking CBS tubes confirms it. When you do test them in front of your customer, the tubes and you always look "good" to him. And the impression lasts because the tubes last. Most important of all, you have been experiencing fewer call-backs . . . and, if you took time to figure it out, more profit.

Make us prove our point. Try CBS tubes . . . test them, put them to work, find out for yourself: It is a fact that there are no better tubes made than CBS tubes.

*Reliable products
through Advanced-Engineering*



CBS-HYTRON

Danvers, Massachusetts

A Division of
Columbia Broadcasting System, Inc.

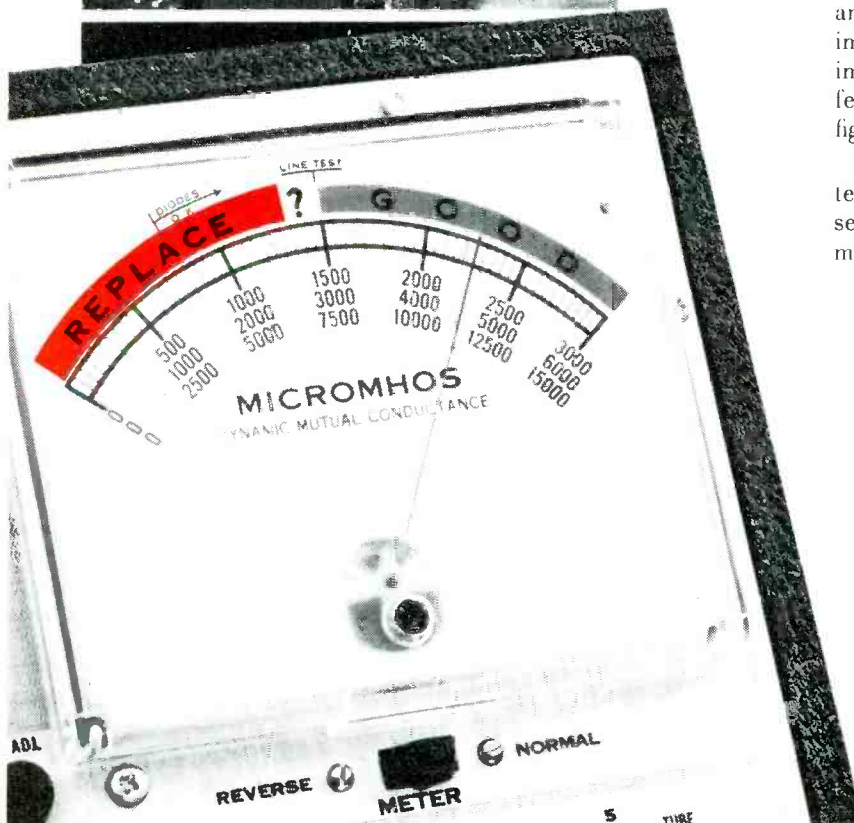

NOTES ON TEST EQUIPMENT

Latest Information on Application,
Maintenance and Adaptability
of Service Instruments

In-Circuit Analyzer Speeds Servicing

The Simpson Electric Company of Chicago, has recently developed a new television test instrument which combines both an in-circuit "Q" analyzer and capacitor checker into one portable unit. Pictured in Fig. 1, the instrument is completely identified as the Model 382 TV horizontal system in-circuit analyzer and capacitor tester.

Specifications and test features are:

1. Power Requirements—105 to 125 volts, 60-cps AC line only, power consumption 20 watts.
2. TV Horizontal System Test—a quick over-all sweep circuit analysis can be accomplished without disturbing circuit wiring, a coaxial test cable is provided.
3. Horizontal Sweep Components Test—checks for a shorted or open deflection yoke winding, width coil, or individual fly-back transformer winding.
4. Capacitance Measurements—indicates value of measured capacitor directly on meter scale, checks capacitors with values from 10 to 100,000 mmf.

When examining this unit in our own labs, I found the test procedures so simple that I knew our readers would be interested in seeing exactly what they are.

My first step was to read over the operating instructions completely. In doing so, I noted that you are not to use test leads other than the shielded cable supplied with the unit. The cable's length, capacitance, and impedance have been taken into consideration in

the instrument's basic design. A change in the test lead may result in false indications.

I decided to use one of the newer portable TV chassis in my first experiment which was to be the over-all horizontal system test. This test is designed to reveal any defect in the entire flyback circuit. Following instructions, I waited for the instrument to warm up and then zeroed the meter. I disconnected the TV chassis from the power line and discharged all capacitors associated with the fly-back circuit. I next removed the plate cap lead from the horizontal output tube and connected the "hot" clip of the test cable to the open lead. With the function switch in the "Shorts" position, I clipped the shielded cable lead to the receiver chassis and observed the indication on the meter face of the instrument. The meter needle came to rest in an area on the lower scale marked "Good." This indicated no shorts existed in the flyback transformer, yoke, or width coil circuits. Had the needle registered in the "Replace" portion of the scale, I would have proceeded to check individual components in the flyback system.

The next test procedure outlined in the operating instructions was a check of the horizontal yoke winding. To perform this operation, I obtained a chassis which I happened to know had a shorted yoke. After the over-all horizontal system test revealed the defective flyback circuit, I connected the analyzer to the yoke as recommended.

First, I disconnected the hot or top side of the horizontal yoke winding and placed the test cable

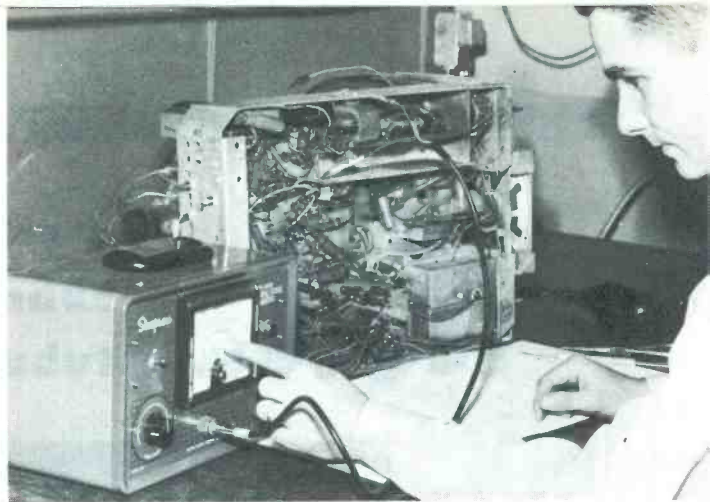

by Leslie
D. Deane

Fig. 1. Testing separate flyback components using the "Q" analyzing circuits of the Simpson Model 382 In-Circuit Analyzer.



Fig. 2. Battery-powered diode-transistor tester Model SCTU-1 by Fretco.

between this lead and chassis ground (Fig. 1). With the function switch in the "Shorts" position, I then obtained a meter reading. The needle pointed to "Replace," indicating the yoke was bad. By leaving the yoke disconnected, I was also able to check the flyback transformer in a like manner. In addition to testing fly-back components for shorts, the "Analyzer" also has provisions for a continuity check. This test makes use of an AC-powered ohmmeter circuit which detects any open condition in the yoke or transformer windings.

Another feature of the Model 382 is its capacitance measuring test. By positioning the function switch on any desired range, then discharging and disconnecting one end of the cap, the technician can measure capacitances up to .1 mfd.

Battery-Powered Diode-Transistor Tester

Pictured in Fig. 2 is the Fretco Model SCTU-1 diode and transistor tester. This light-weight portable instrument is manufactured by Fretco Inc. of Pittsburgh.

• Please turn to page 78

NOW...

a completely new subminiature paper tubular capacitor

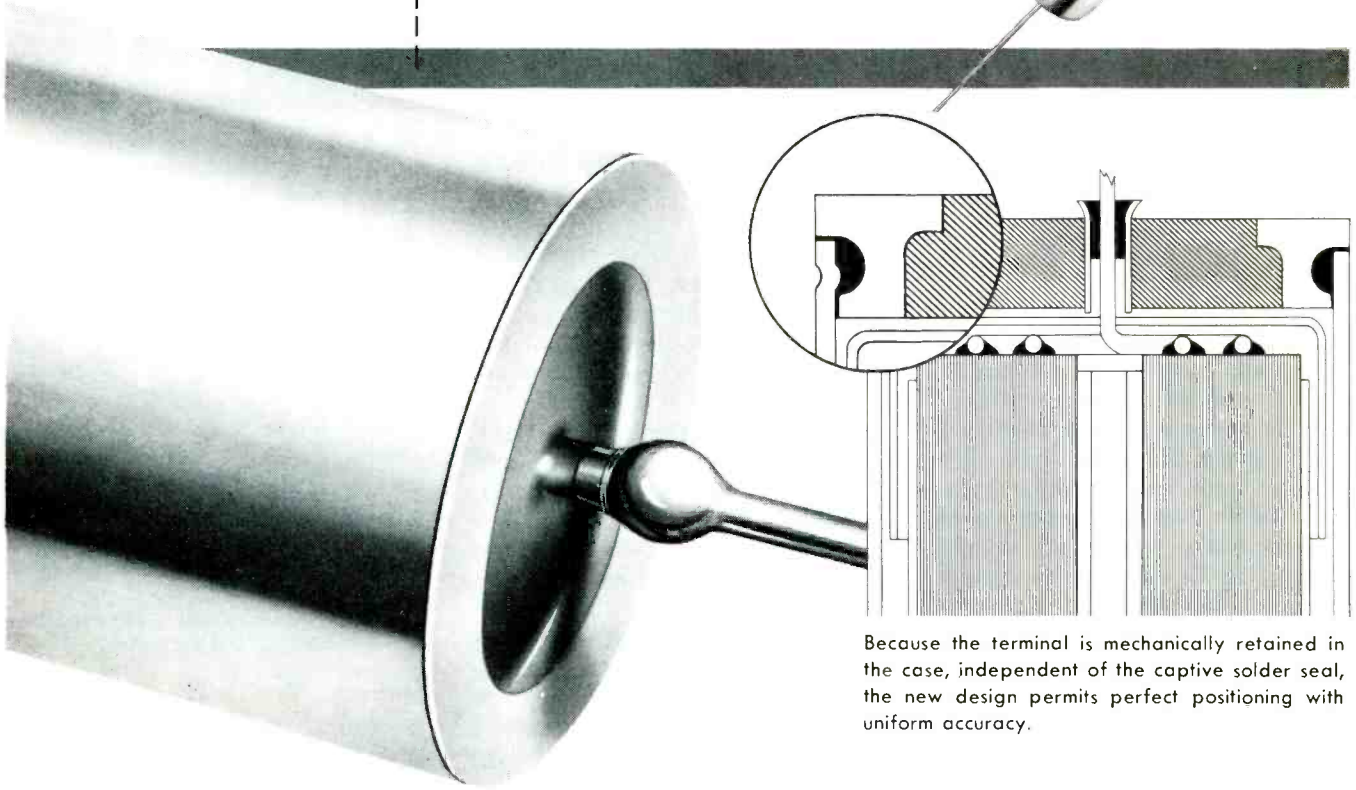
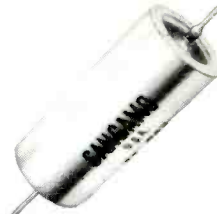

Because the terminal is mechanically retained in the case, independent of the captive solder seal, the new design permits perfect positioning with uniform accuracy.

Hermetically sealed with Sangamo's new "Innerseal" terminal...for higher reliability...for longer service life

Here is today's latest development in miniaturized military type capacitors—a newly designed terminal for Sangamo subminiatures. This Sangamo engineering development offers many advantages over conventional seals.

The "Innerseal" structure seats and locates itself exactly on the case. Terminals cannot be cocked at angle, extend out of case, or be pushed too deeply into case and cause cupped

ends or section damage. It permits optimum performance and reliability through greater flexibility of internal design.

The solder is confined and automatically sealed. Solder or flux cannot run down inside case to cause life failures due to contamination. There are no cracked terminals due to solder time variation.

Write for Bulletin TSC-117.

SANGAMO ELECTRIC COMPANY

Electronic Components Division — Springfield, Illinois

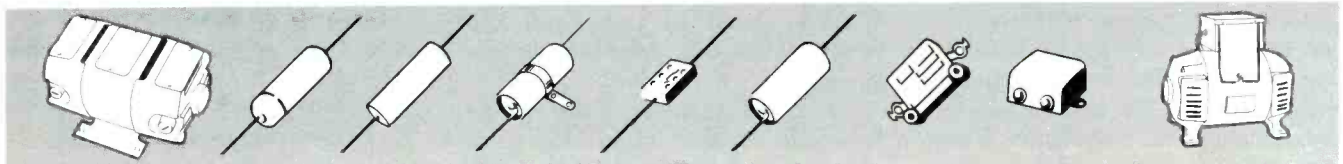



STOCK GUIDE

for

Popular

Replacement

Parts



The number of various components that a service shop should have in stock will be governed to a large degree by the volume and type of service work it does. However, every TV shop, large or small, should have a supply of the components listed in this chart. The quantity of each item to be stocked can be assigned on the basis of the amount of service performed. The chart also lists an assortment of the various miscellaneous items which are most often needed in service work.

CAPACITORS

TUBULAR & CERAMIC DISC (ratings 600V unless specified)	.068 mfd	470 mmf
	.1 mfd	560 mmf
	.15 mfd	680 mmf
.001 mfd	.2 mfd at 400V	ELECTRO-LYTIC
.0015 mfd	.25 mfd at 400V	50/30 mfd
.002 mfd	.5 mfd at 200V	at 150V
.003 mfd	MICA OR CERAMIC	100 mfd
.0047 mfd	100 mmf	at 50V
.01 mfd	150 mmf	10 mfd
.015 mfd	180 mmf	at 25V
.02 mfd	220 mmf	40/40/40/20 mfd
.022 mfd	270 mmf	all sections
.025 mfd	330 mmf	at 450V
.03 mfd	390 mmf	
.047 mfd		

RESISTORS

(all values in 1/2 W, plus A values in 1 W and B values in 2 W)

22	3300, B	82K
47	4700, A, B	100K
56	5600	150K
100, A	6800, B	220K
150	8200, A	270K
220	10K, A	330K
270	15K, B	470K
330	18K, A	560K
470, A	22K, A, B	1 meg, A
560	27K, A	1.5 meg, A
1000, A, B	33K	2.2 meg
1500	47K	3.3 meg
2200, A, B	56K	4.7 meg
2700	68K	10 meg

FUSES

STANDARD	C or N
1/4 A, S/B, PT	N 1/4
3/8 A, S/B	C 3/10
1/2 A, S/B	N 4/10
1.5 A, S/B	C 7/10
3 A	C & N 3/4
5 A, S/B	N 1
1/4 A (1" x 1/4")	N 1-1/4
3/8 A (1" x 1/4")	C 2-1/2

MISC. ITEMS

AC interlock
AC power cord
7- and 9-pin tube sockets
Octal tube socket

AUDIO OUTPUT TRANS.

(all units 3.2-ohm sec.)

3000-ohm prim. 60 ma.
with 5% hum-buck tap
5000-ohm prim. 50 ma.
7500-ohm prim. 50 ma.
10K-ohm prim. C. T. 30 ma.

FUSIBLE RESISTORS

5.6 ohms, 4-watt
7.5 ohms, 4-watt

POWER RECTIFIERS

100 ma—130V (selenium)
400 ma—130V (selenium)
500 ma—130V (silicon)

VERT. OSC. TRANS.

1 to 4.2 turns-ratio

ASSORTED HARDWARE

#6 self-tapping screws, 1/4", 3/8"
#8 self-tapping screws, 1/4", 3/8"
#4 mach. screws, nuts, washers
#6 mach. screws, nuts, washers
#8 mach. screws, nuts, washers

VERT. OUTPUT TRANS.

8 to 1 turns-ratio
10 to 1 turns-ratio
11.4 to 1 turns-ratio
15 to 1 turns-ratio

Damper Tube Failure

The damper tube is one of the hardest-worked tubes in a TV receiver because it is exposed to both high DC and pulse voltages. Even though damper tubes have been especially engineered for this type of service, there is a tendency for the filament to sag slightly with age. This reduces the cathode-to-filament spacing and thus lowers the potential at which arc-over will occur (Fig. 1). Arc-over can cause: (1) an open filament, (2) flashing in the picture, or (3) a blown fuse.

In order to minimize filament sagging, tube manufacturers generally recommend that the filament pins line up vertically when a damper tube is mounted horizontally. This gives the filament more support.



QUICKER SERVICING

by Calvin C. Young, Jr.

was to remove the $\frac{1}{4}$ -amp fuse, after which he accidentally let it drop into the changer compartment. This, of course, ended his pursuit of the trouble.

When the technician arrived, he was informed about the dropped fuse and made a hurried search for it. Finding that the changer would have to be removed in order to locate the original fuse, the

When the customer called again about a week later and complained of the same trouble, the technician left at once to make the recall. He expected to see a snowy raster when the set warmed up, and when no raster at all appeared, he was somewhat surprised. The back of the set was removed, and a check was made of the high-voltage and sweep section. When no arc was found on the plate of the horizontal output tube, the fuse was examined and found to be blown. Since he hadn't seen the original fuse, the technician didn't know whether the failure was coincidental or not—so a new fuse was installed. Power was applied and the fuse went out again, but this time the technician inspected it very closely. About $\frac{1}{2}$ " of the fuse element was missing and each end of the remaining portion was fused into a little round ball. Stopping to think for a minute, the technician decided that the fuse could have failed as it did only as the result of a direct short. He reasoned that an overload would have simply melted about $\frac{1}{4}$ " of the fuse element. He also reasoned that the most likely source of a short was the damper tube (a 6AX4 with one side of the heater grounded). He removed the damper tube and, with the base pointing upward, tapped the tube. A number of flakes from the filament collected in the top of the glass envelope (Fig. 2). A new 6AX4 was installed, and the receiver operated normally. The technician strongly believed that he had solved the fuse-blowing problem, a conviction which was later confirmed by the customer when the latter brought a radio in for repairs.

This case history should emphasize that close analysis of the

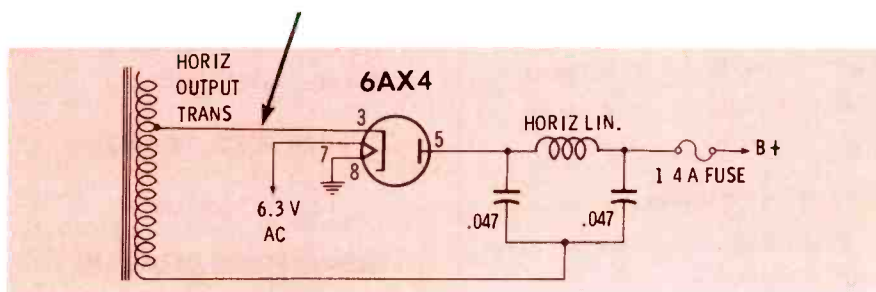
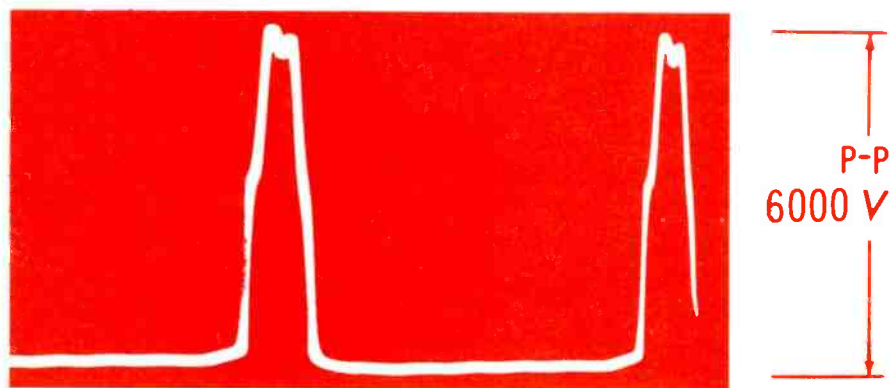

Fig. 1. Schematic of damper circuit showing voltage waveform at the cathode.

Case History of Damper Failure

A certain technician recently made a call to service a receiver having the following symptoms as reported by the customer: the set had a raster but no picture, and sound only on channel 6.

Between the time the customer phoned for service and the time the technician arrived, the customer decided to try and fix the set himself. The first thing he did

technician obtained a new fuse from his service kit and installed it. The cause of the customer's original complaint was immediately apparent when power was applied—a bad RF amplifier was preventing the reception of every station except the strongest one, and only the sound was getting through on it. Replacement of a defective RF amplifier tube cured the trouble, so the technician collected his fee and left.



Fig. 2. Flakes in damper tube produced by arcing between cathode and filament.

symptoms and the defective parts on each service call can save time for you and money for your customer. It also impresses the customer with your professional thoroughness.

Speaking of Callbacks

A technician friend of mine recently told me about a certain GE television receiver that suffered three damper-tube failures in less than three months, all because of open filaments. The original 6AX4 replacement lasted only a week, when the customer called and complained of the "same trouble." This time a 6AU4 was installed because of its more rugged construction and higher ratings. When this tube failed after only a few weeks of service, the technician quite logically pulled the chassis and took it to the shop. Here, another new tube was installed when initial checks failed to reveal any defective components in the damper or output stages; however, the filaments in the new tube didn't light. This made the technician suspicious, and a filament continuity check of the supposedly bad 6AU4 proved that it was good.

A thorough check of the filament wiring to the damper tube revealed the source of the trouble—the ground connection to a press-fit connector wasn't making good contact with the chassis pan. The technician now realized that the previous damper failures hadn't been failures at all but had been symptoms of this poor ground connection. Moral—a quick ohmmeter check of the filaments of any tube which appears to have an open heater would pre-

DON'T REMOVE THAT PICTURE TUBE!



WILL SNAP IT BACK TO NORMAL BRILLIANCE

Save time and effort pulling defective picture tubes. With the 'Nu Life' Kinecure, you can correct INSTANTLY open cathode, shorted control grid to cathode, open control grid, and shorted cathode to filament.

Use the 'Nu Life' Kinecure to save time and money where the customer will not permit the set to leave the house. Follow the wiring diagrams furnished with each unit to snap the picture tube back to normal brilliance — FAST. You can't go wrong with 'Nu Life' Kinecure — can't harm set or tube if erroneously wired. And your customer will thank you for a brighter, better picture than he had before.

Try it. It works like a charm. Your jobber has 'Nu Life' Kinecure now. Or send coupon below for full explanation.

**FREE
WRITE
FOR FULL
DETAILS**

CIRCUIT MANUFACTURING CO., INC.
26 Rittenhouse Place, Ardmore, Pa. C

Gentlemen: Please send me full illustrated details about the 'Nu Life' Kinecure.

YOUR NAME _____

COMPANY NAME _____

ADDRESS _____

CITY _____ ZONE _____ STATE _____

Sonotone's 2-model line simplifies cartridge replacement!

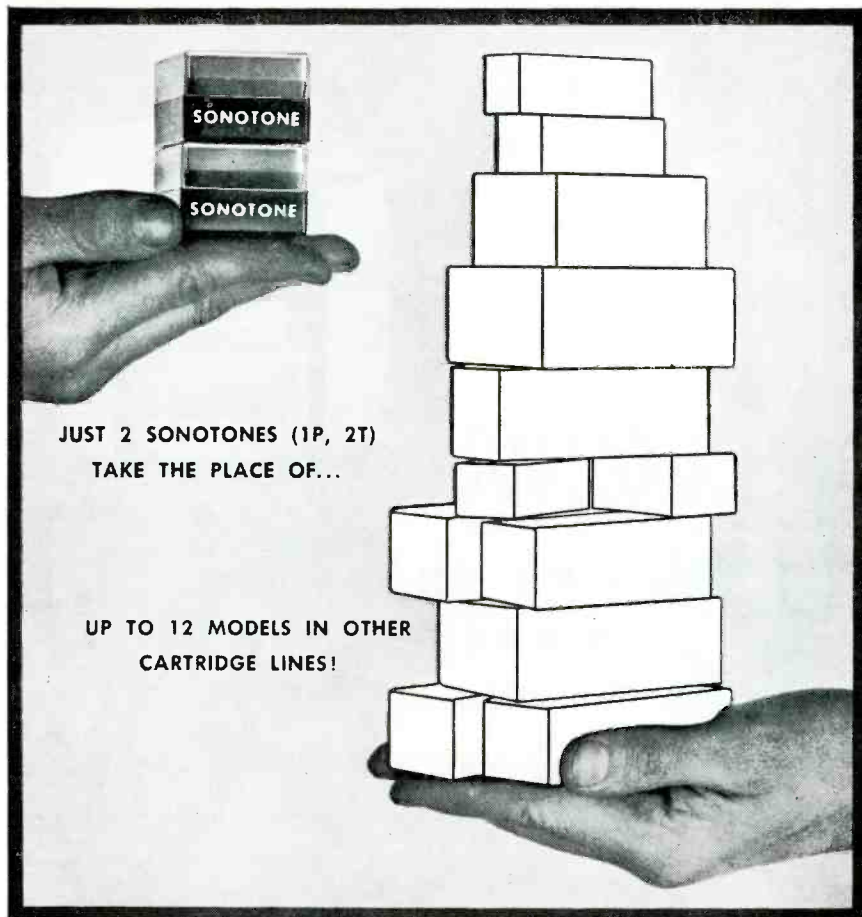

*You finish jobs faster, please customers more,
when you standardize on Sonotone Ceramics*

Why juggle a handful of different cartridges, when it's so much easier and faster to stick to just *two*! Sonotone single-needle 1P and turnover type 2T are all you need for over 90% of quality replacement jobs.

These two Sonotone cartridges fit practically any arm. They're quick to install. And remember, Sonotone cartridges are *more* than replacements. They'll give *better* response than original equipment...enhancing your reputation for quality work.

New standard of the phono industry

In more than half the quality phonographs made today by leading manufacturers, you'll find one of these Sonotone cartridges. All the more reason why you should standardize on Sonotone.

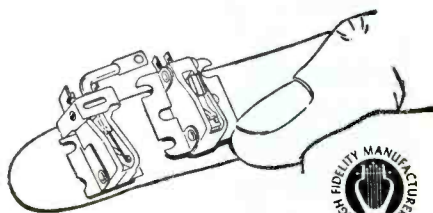

SONOTONE CERAMIC CARTRIDGES

ELMSFORD, N. Y.

In Canada, contact Atlas Radio Corp., Ltd., 50 Wingold Avenue, Toronto

vent this type of trouble from being such a nuisance.

Hint From a Reader

In the February column, we gave a hint on the use of a foam rubber pad on record changers to reduce hum pickup. Robert B. Smith of Lancaster, California reports that he encountered some indexing trouble when trying to incorporate this hint. It seems that on certain changers (many VM and some Admiral models) there is a small lever which rises just beyond the rim of the turntable to touch the bottom record during each change cycle. If this lever fails to make contact, the tone arm will index for 7" records. The foam rubber pad lifts the record beyond the reach of this lever and causes the tone arm to index for 7" records at all times. If a foam rubber pad is placed on a changer of this type, the index lever must be extended by the thickness of the pad to avoid this trouble.

There is a small rubber bumper on the index levers of many changer models. Sliding this bumper slightly upward, or using a bumper that extends high enough to contact the edge of the record, will usually do the trick. ▲

Arcing Damper Tubes in RCA Victor KCS-47A Chassis

When replacing the 6W4GT horizontal damper in an RCA Victor Chassis KCS-47A, make sure the replacement tube does *not* have a pin 1 in the base. Terminal 1 on the socket in this set—and possibly in other types and models of TV sets as well—is used as a ground connection, and therefore an internal ground will be present in the damper tube if it has a pin 1 in its base. Since damper circuits operate at a high potential above ground (in some cases, thousands of volts), extreme arcing may occur within the tube and overload the circuit to the extent that the horizontal output tube can be ruined in a very short time. Some 6W4GT tubes are supplied with pin 1 on the base. When installing such a tube, cut the extra pin off with side cutters rather than risk a recall.

—George D. Philpott



If it's worth an Engineer's time . . .



. . . it's worth an Engineered Cable



**Belden
microphone
cables**

Whatever the installation,
whatever the requirements,
there is an accurately
rated Belden Microphone
Cable built for the job.

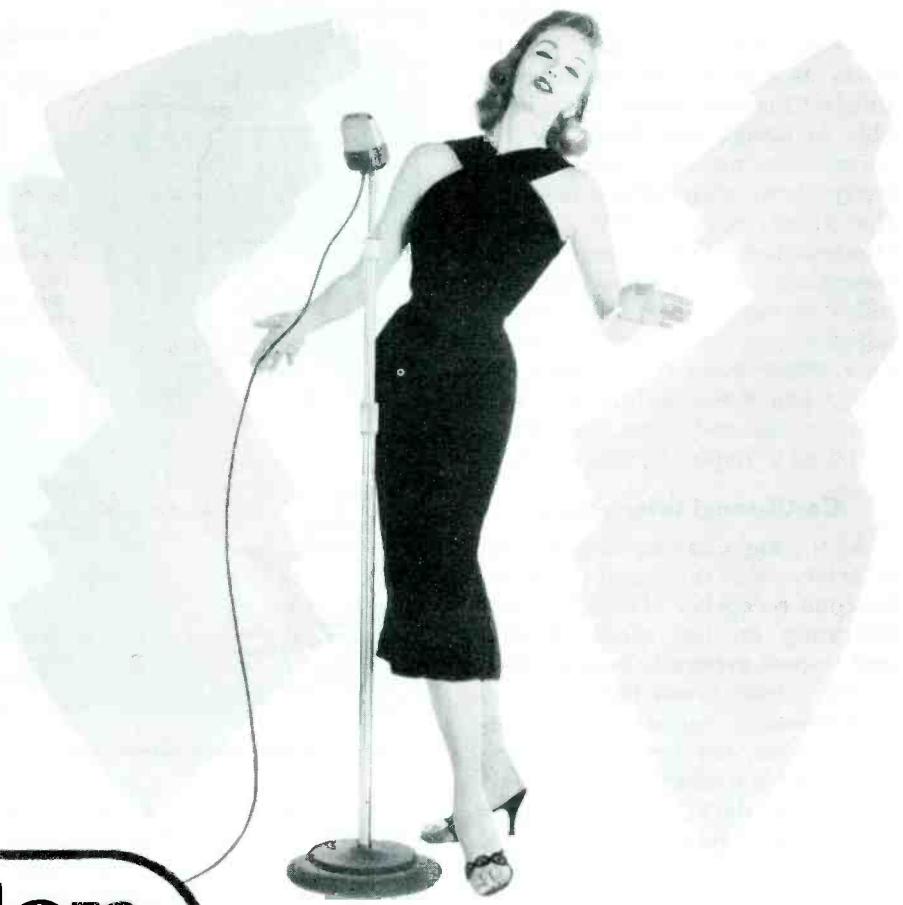

4-8

1001 WIRES FOR EVERY ELECTRONIC NEED

adjacent - and co-channel interference

*SYMPTOMS AND
PRESENT - DAY
CURES*

by Calvin C. Young, Jr.

Over 80% of the more than 400 VHF TV stations now in operation are located in the eastern half of the country. Most of them are transmitting at maximum authorized power levels to extend their coverage over as many square miles as possible. In addition to this, set manufacturers have been able to design and build TV receivers having exceptional sensitivity and gain characteristics. For these reasons, TV stations transmitting on the same or adjacent channels, even within 250 miles of each other, often cause adjacent- or co-channel interference. Since these two types of interference have different symptoms, causes and cures, this article will deal individually with each.

Co-Channel Interference

As the name implies, co-channel interference is the result of simultaneous reception of two stations operating on the same channel and is most generally encountered in the fringe areas between two stations—one signal being received from the front of the antenna and the other from the rear. The wide, dark, horizontal bars (commonly referred to as a venetian-blind effect) which appear in TV pictures are symptomatic of this trouble. The map in Fig. 1 shows the possibilities for this condition on channel 5. (Similar charts could be prepared for other channels, but this one will serve as an example.)

Because of unusual atmospheric conditions, co-channel interfer-

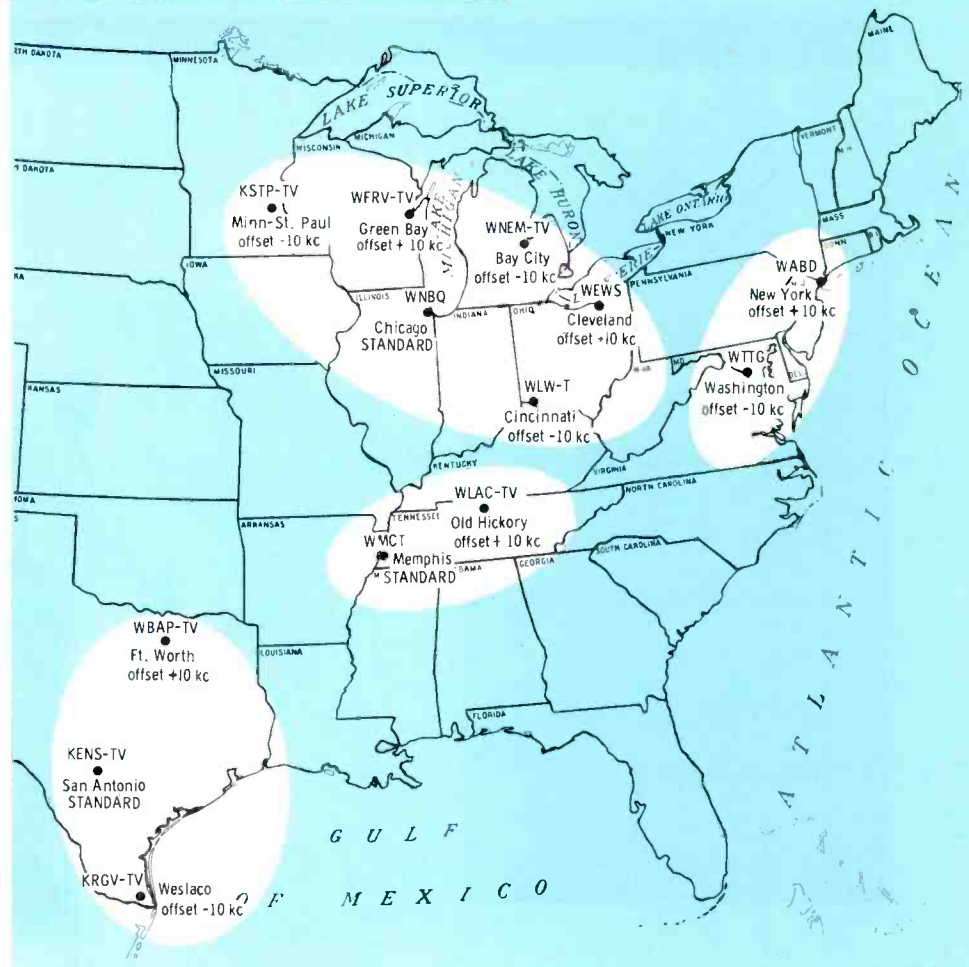

Fig. 1. Areas where interference on channel 5 is most likely to be encountered.

ence will sometimes occur on a local channel due to the reception of a distant signal which is normally out of range. As a rule, however, co-channel interference is most predominant in an area (see Fig. 2) about halfway between two stations.

To help combat the interference problem, the FCC has set up an offset carrier system for stations operating on the same channel in

the same general area. Referring to Fig. 3, the specifications under this system are such that a difference of 10 or 20 kc will exist between carrier frequencies for the same channel in a given area. The resultant interference pattern produced on the screen will be similar to that shown in either (A) or (B) of Fig. 4.

While the offset-carrier system does not actually correct the

V-M S-M-A-S-H-E-S the barrier

to volume S-T-E-R-E-O s-a-l-e-s!

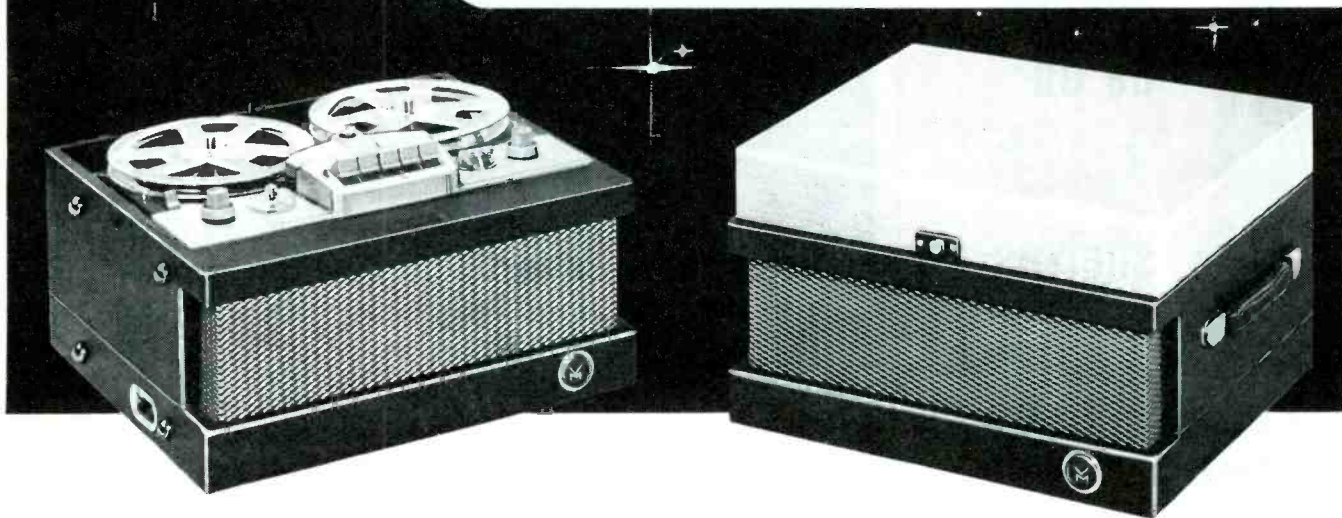

*Here's the Sensational V-M Stereo Duo
to Sell the Mass Market... and Sell It Now!*

V-M tape-o-matic® . . . it's a quality monaural and stereophonic 'tape player'; it's also a complete, professional-quality monaural tape recorder. Sell it for stereo; sell it for recording. Why risk money on stereo-only units when you can sell this dual-purpose unit? Just \$209.95.*

Sell V-M StereoVoice Speaker with Amplifier for stereo with tape-o-matic. It's a smart sound and style "look-alike." Sell it separately, too. StereoVoice includes the new V-M Model 8810 amplifier; frequency response, 30-20,000. Model 166, \$75.* (Model 8810, \$35,* is a real seller in its own right, too. You can install it in V-M Model 27 external speaker or any custom hi-fi system.)

How Sensational can you get? For only \$284.95*, you sell your customers quality stereo, hi-fi portable tape recorder and an external speaker with amplifier. You can't miss with this sensational V-M deal that no competition touches or even comes close to!

Have the mass market on your doorstep. See your V-M Rep. F-A-S-T!

**Slightly higher in the west.*



V-M CORPORATION • BENTON HARBOR, MICHIGAN

WORLD'S LARGEST MANUFACTURER OF PHONOGRAPHS AND RECORD CHANGERS

Service Dealers!

transistors should be on *your* shelves...

AND THE TRANSISTORS SHOULD BE



There are many thousands of portable transistorized radios now in use, plus thousands of experimenters and hams working with transistors.

This means just one thing to you. You are going to get more and more calls for transistors and for transistor receiver service.

Stock and sell Raytheon Transistors and you'll have the jump on competition because Raytheon makes a most complete line of quality Transistors — Transistors that are low in cost, yet high in performance. Raytheon Transistors are priced from 99¢ (Raytheon CK722) and there are more in use than all other makes.

A new *Transistor Interchangeability Chart* just produced by Raytheon, is now available to you. It shows which ordinary transistors can be replaced by Raytheon Transistors to give your customers top-notch performance. Ask your Raytheon Tube Supplier for a copy or write to Department R-1.



Excellence in Electronics
RAYTHEON MFG. CO.
Receiving and Cathode Ray Tube Operations
Newton 58, Massachusetts

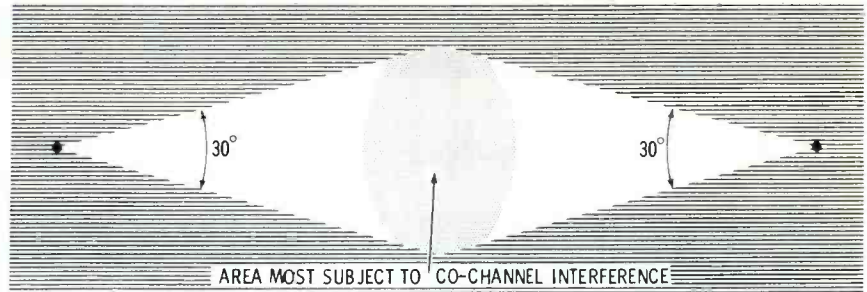

Fig. 2. Co-channel interference between two stations usually takes place in the fringe areas as outlined above.

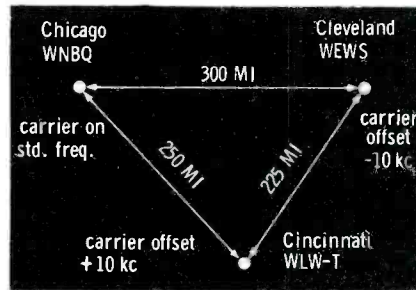
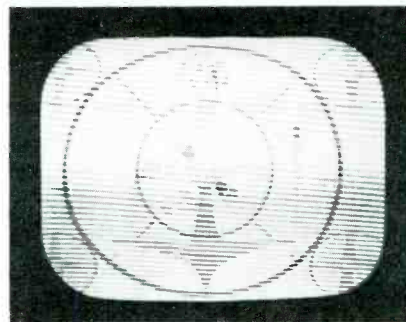
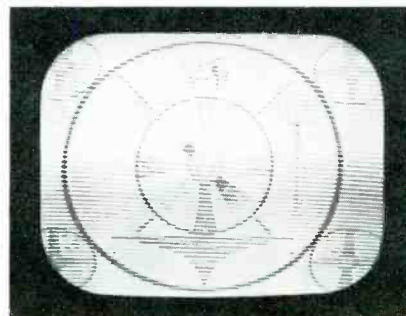

Fig. 3. TV transmitters assigned Channel 5 frequencies in this area and having a radius of about 170 miles are offset from each other by 10 or 20 kc.

trouble, it does permit more feasible steps to be taken at the receiving end than is possible when the two carriers have the same frequency. For example, consider the problem of eliminating an interfering carrier which has the same frequency as the one you are trying to preserve. The only logical measure is to employ a very directive antenna having a



(A) 10-kc beat.



(B) 20-kc beat.

Fig. 4. Interference patterns produced as a result of co-channel interaction.

high front-to-back ratio. Even then, there could be instances where both signals are arriving from essentially the same direction.

The solution is much simpler when the carriers are offset from each other. Carriers which differ in frequency by 10 or 20 kc will heterodyne in the video detector stage, and this difference frequency will be present in the video stages. Since most of the signal energy obtained as a result of any scanning process concentrates at frequency multiples of the scanning rate, a high-Q trap inserted in the video circuits of a TV receiver will very effectively filter out a 10- or 20-kc beat without affecting the important 15,750 and 31,500 cps components in the desired signal.

Theoretically, there are several circuit modifications which might be employed to eliminate the beat frequency. For example, a series resonant circuit might be con-

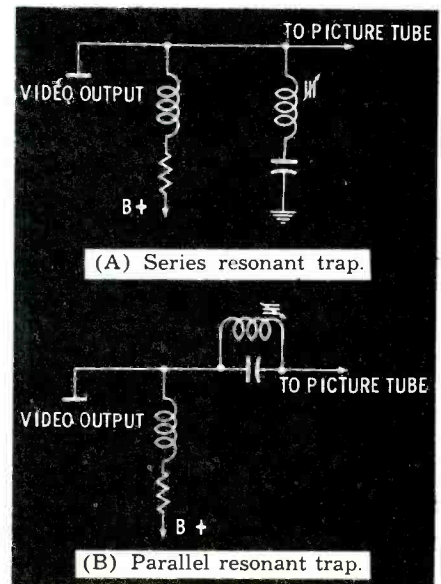
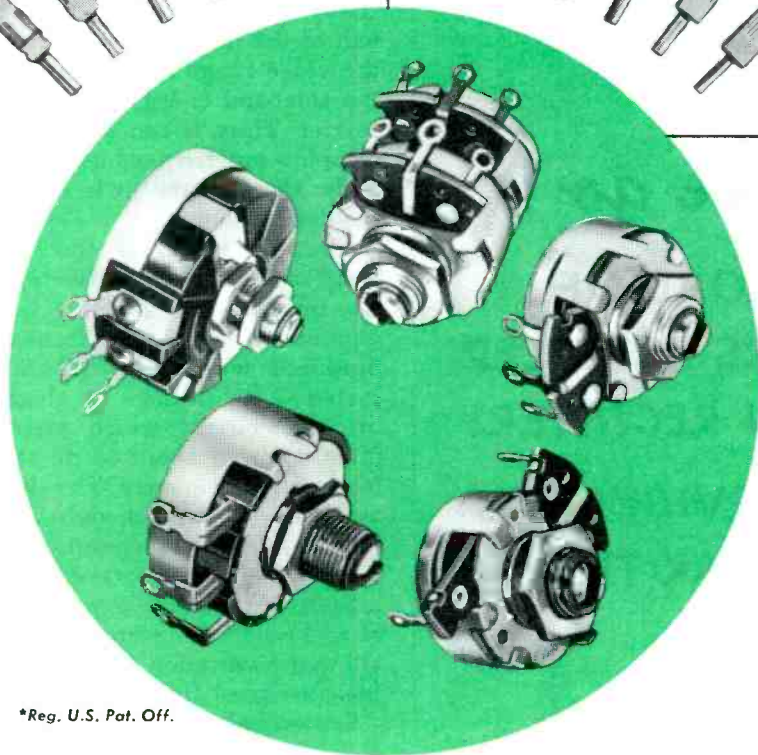

Fig. 5. Theoretical trap circuits that might be installed to minimize the 10- or 20-kc difference frequencies.

TAKE YOUR CHOICE



*Reg. U.S. Pat. Off.

**WITH EVERY CLAROSTAT
PICK-A-SHAFT* CONTROL YOU
GET YOUR CHOICE OF SHAFT
AT NO EXTRA COST!**

Select the control you want— $\frac{1}{2}$ -watt composition-element, regular, tapped or dual; 2-watt wire-wound; 3-watt wire-wound; or 4-watt wire-wound. Then choose from any one of the 13 types of shaft. There's one for every need.

Ask your Clarostat distributor...



for **P**erformance... **D**ependability... **Q**uality...

Controls and Resistors

CLAROSTAT MFG. CO., INC., DOVER, NEW HAMPSHIRE

In Canada: **CANADIAN MARCONI CO., LTD., TORONTO 17, ONT.**

BIG LOAD

for little fellow



.... and away we go!

-----WITH ANOTHER LOAD OF
SELENIUM RECTIFIERS REPLACED
BY THE M-500 SILICON RECTIFIER.

MOST SMART SERVICEMEN
ARE REJUVENATING WEAK T.V. SETS
---ARE YOU----- HUH ?

Sarkes
Tarzian INC. *RECTIFIER DIVISION*

415 N. College Ave., Bloomington, Indiana
IN CANADA: 700 WESTON RD., TORONTO 9, TEL. ROGERS 2-7535
EXPORT: AD AURIEMA, INC., NEW YORK CITY

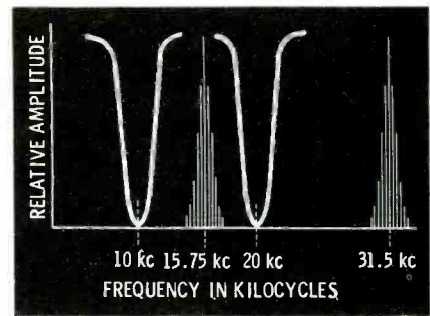

Fig. 6. Energy distribution at the low end of the video range concentrates at frequency multiples of 15.75 kc, making it possible to trap out 10- and 20-kc beat frequencies only.

nected in the video amplifier plate circuit as shown in Fig. 5A, or a parallel resonant circuit could be inserted between the video amplifier and picture tube as in Fig. 5B. Naturally, the circuit must be tunable through the beat frequency of 10 or 20 kc and must have a very high Q so that no important frequency components in the desired signal will be attenuated. As shown in Fig. 6, however, nearly half of the frequency spectrum in the video range is unoccupied by the sideband energy of the video carrier. Thus, it can be seen that trapping out frequencies at 10 or 20 kc should have little effect on the desired signal.

The unit in Fig. 7, the "Line-Out," made by Jerrold Electronics, has proved very effective in the elimination of the beat frequency produced with the offset-carrier system. It utilizes a high-Q, bridge-T circuit which provides attenuation of about 30 db at the interfering frequency. The unit is available in two models: V-20 (shown) for 20-kc operation, and V-10 for 10-kc operation. Both models are tunable over a range of ± 2 kc since TV transmitters are allowed a variation of ± 1 kc from their assigned frequencies.

Occasionally, a co-channel interference problem which is unusually severe or which is caused

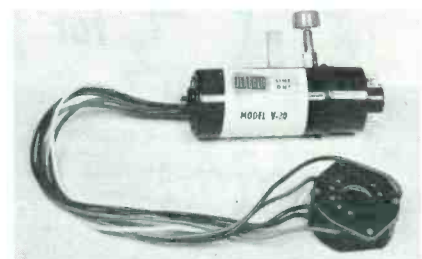
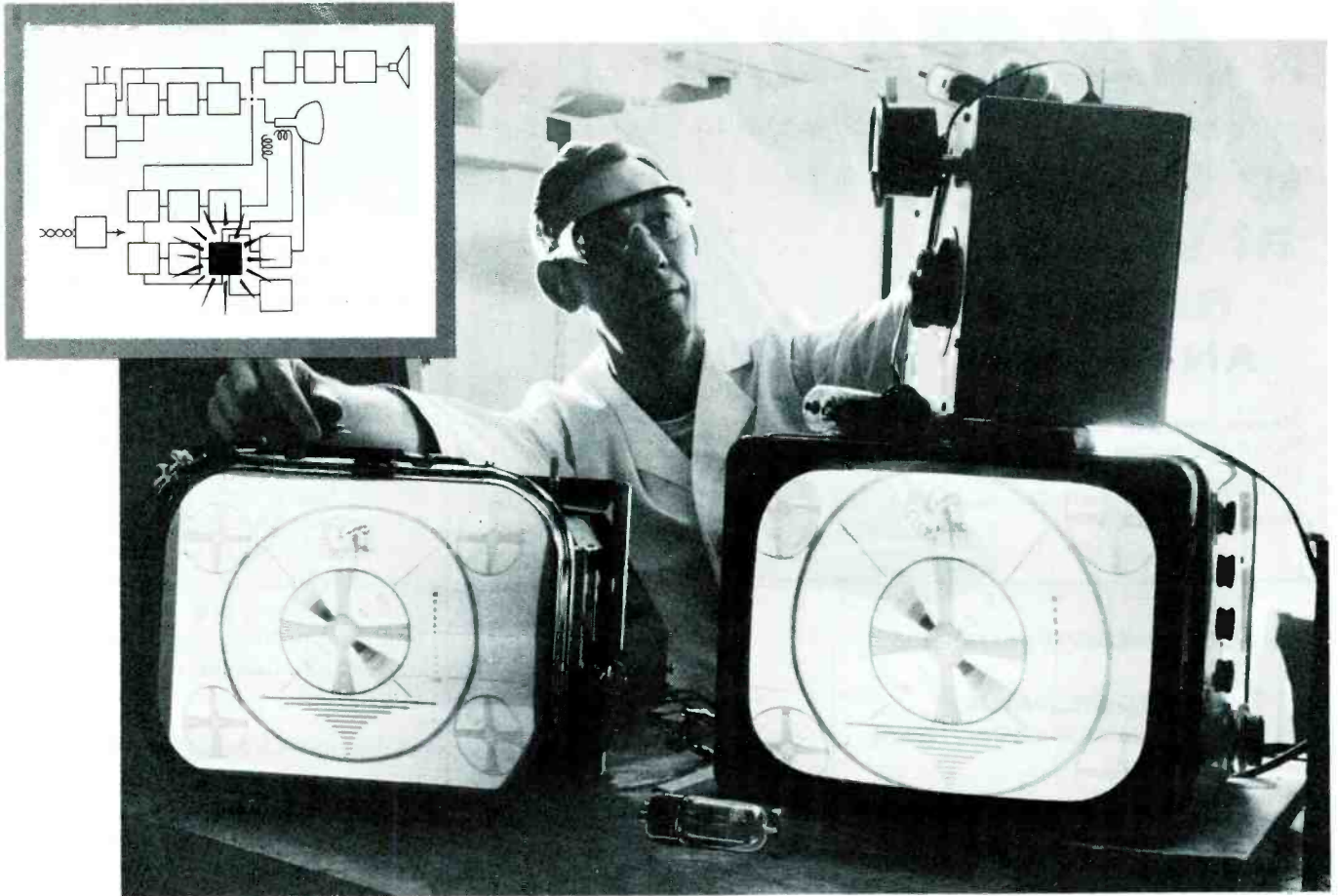

Fig. 7. Jerrold "Line-Out" Model V-20.



ABOVE: A General Electric application engineer demonstrates, on set at right, superior sweep of G-E horizontal amplifier tubes. Every tube is tested at the

factory for zero-bias plate current and plate-to-screen current ratio—your assurance of exceptional sweep performance and top reliability.

General Electric horizontal amplifier tubes are quality-designed for full-sweep, long-life performance!

A WHOLE series of design advancements combines to make General Electric horizontal-sweep amplifiers high-quality, long-lasting tubes.

Enlarged plate areas cut plate and screen emission, two causes of shrinking raster and picture distortion. A specially processed screen grid increases heat dissipation, and new, improved beam plates prevent glass deterioration from electron bombardment of the bulb.

Also, the possibility of electrical leakage is sharply reduced. Maximum spacing between elements . . . mica slots . . . spraying of micas—these measures effectively combat harmful inter-element leakage by lengthening potential leakage paths.

All General Electric horizontal-sweep amplifiers have button-stem construction. This strengthens internal

tube structure, and gives greater heat conduction for reduced electrolysis and air leakage. Advanced cathode-processing techniques assure superior operation at low line voltages, and finned or dimpled plate design lessens danger of "snivets"—dark, irregular, vertical interference on the raster.

Select a General Electric sweep tube every time you need a replacement! All G-E tubes have this same high quality that will win new service customers . . . keep your present customers satisfied. *Electronic Components Division, General Electric Co., Schenectady 5, N. Y.*

Progress Is Our Most Important Product

GENERAL  ELECTRIC

161-1A4

NEW

at Ward... REAR FIN ANTENNA

Newest, smartest, pace-setting rear fin on the market. Heavy chrome plated—3 sections extend to 27". 15-ft. lead with built-in signal booster.



MODEL NO. TFL-1

Also available as dummy mount.
—Model TFD-1

... AND HERE'S MORE!

NEW FENDER PADS

... for 1957 cars

Fender Pads—

For mounting 8-Ball mount antennas on front fenders of 1957 cars. C-61



Fender Pads—

For mounting Tear Drop mounts on front fenders of 1957 cars. C-62

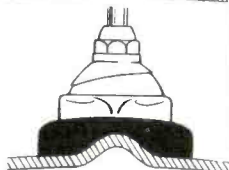

Fast-Selling

Ward

TEAR DROP MOUNT



Model TF-56MO

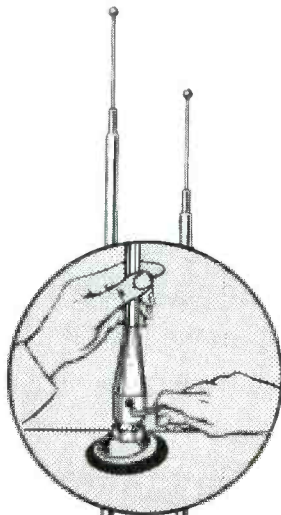

Model TCFR-1

Model TCFR-2

Smart NEW Replacement Masts

No need to disturb the mast. Just slip on and tighten. Easiest, quickest replacement ever developed. Bell-shaped collar on mast fastens to stub of original antenna mast with set screws.

The fastest selling style leader of them all ... the replacement antenna with original equipment styling. Mounts completely outside the car ... easily ... quickly. Heavy chrome plate ... 3 sections extend from 22" to 56".

Just a few of Ward's new quality leaders that have joined the famous Ward family—8-Ball, Majorette, and Silveramic®. Order *TODAY*. For complete information, write: Dept. PF-5.

See us in ROOM 509A—1957 Electronics Parts Distributors Show

Ward PRODUCTS CORPORATION

DIVISION OF THE GABRIEL COMPANY

1148 EUCLID AVE. • CLEVELAND 15, OHIO

IN CANADA, ATLAS RADIO CORPORATION • 50 WINGOLD AVE. • TORONTO, ONTARIO



Fig. 8. Adjacent-channel interference is often encountered between these two stations in the Indianapolis area.

by two stations operating on exactly the same frequency will be encountered. As previously mentioned, the only remedy is to use an extremely directive antenna which has a very high front-to-back ratio. Antennas having these characteristics fall into three basic classifications: (1) yagi types, (2) radar-screen types, and (3) antennas especially designed to aid in the elimination of co-channel interference.

Adjacent-Channel Interference

With the exceptions of channels 4 and 5 or 6 and 7, stations operating on adjacent channels in a given area can also interact and cause interference. The interference results when the upper-channel picture carrier and the lower-channel sound carrier heterodyne in the video detector. Fig. 8 shows the possibilities for adjacent-channel interference in the Indianapolis area. The frequency of the sound carrier from Louisville is 65.75 mc, while the picture carrier from Cloverdale has a frequency of 67.25 mc. Assuming that both signals arrive at the receiver and are not attenuated by special circuits, the 1.5-mc difference frequency will appear in the video circuits whenever the receiver is tuned to either channel.

Under the right conditions, this 1.5-mc beat frequency can cause

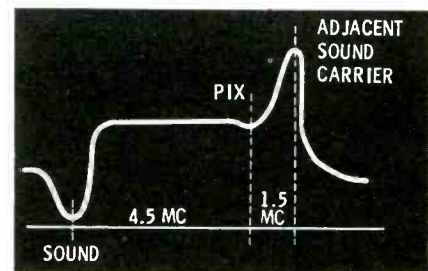

Fig. 9. Over-all response curve distortion which can be caused when the 1.5-mc beat frequency increases the AGC bias.

IN GLAMOROUS NEW YORK CITY—ALL EXPENSES PAID PLUS \$100 CASH

WIN A WEEKEND AT THE WALDORF FOR 2

IN THE PYRAMID TWIST-MOUNT CAPACITOR CONTEST

TOTAL—147 WONDERFUL PRIZES—PLUS A PRIZE TO EVERY ENTRANT . . . SERVICEMEN, ENTER NOW! YOU CAN'T LOSE!

IT'S EASY TO WIN ANY ONE OF THESE WONDERFUL PRIZES:

GRAND PRIZE: Weekend at New York's fabulous Waldorf Astoria Hotel for 2, guest of Pyramid. Air transportation from your home to New York and return. Weekend of entertainment including a visit to the famous Gaslight Club, dinner at the Waldorf's Starlight Roof, and breakfast at the Waldorf. Air transportation CAPITAL Airlines Viscount.

1st PRIZE: One 4-drawer steel file cabinet plus your choice of 50 sets of PHOTOFAC folders. Value: \$120.45.

FIVE 2nd PRIZES: 5 CR-30 PRECISION Cathode Ray Tube Testers. dlr. net \$109 ea.

TEN 3rd PRIZES: 10 CRA-2 PYRAMID Capacitor-Resistor Analyzers. dlr. net \$92.50 ea.

TWO 4th PRIZES: 2 SW-54 NATIONAL Short Wave Receivers. dlr. net \$59.95 ea.

TEN 5th PRIZES: 10 JENSEN professional speaker units consisting of a D-30 lifetime driver unit and RT-20 rectangular horn. dlr. net \$44.40 per set.

FIFTEEN 6th PRIZES: 15 TW CHANNEL MASTER 7 element "traveling wave" TV antennas, Model 350. dlr. net \$33 ea.

EIGHTEEN 7th PRIZES: 18 PYRAMID Pyra-Pak kits consisting of \$69.95 in Pyramid capacitors, metal tool box and tool kit. dlr. net \$29.95.

THIRTY-FIVE 8th PRIZES: 35 PYRAMID gift certificates entitling you to \$10. (dlr. net) of Pyramid capacitors at your distributor.

9th PRIZE: WALCO twin-point diamond phono needle. dlr. net \$30. For G.E. Var. Rel. Cartridge.

FIFTY 10th PRIZES: 50 WALCO needles for G.E. twin-point sapphires. \$3.50 dlr. net.

AND to all entrants a kit of 5 bypass and coupling capacitors featuring the Pyramid type IMP.

It's easy to win any one of 147 big prizes—just follow these simple rules: Identify the unnamed Pyramid T-M capacitor in the TV set schematic appearing on this page. Give the Pyramid stock number, name and model number of TV set. Then mail your entry to Pyramid. Use coupon on this page or obtain additional blanks from your distributor. A different schematic will appear in these servicemen's magazines for 4 months. Prizes will be awarded on a points-earned basis as follows: 5 points for Contest No. 1; 10 points for Contest No. 2; 15 points for Contest No. 3; 20 points for Contest No. 4; and 10 points each contest for neatness. Possible perfect score: 90 points. However it is not necessary to achieve a perfect score to be declared a prize winner.

So act quickly...send in your entries early each month...you can't lose.

JUDGES: M. Harvey Gernsback, editor director, Radio-Electronics
Oliver Read, Dsc, publisher, Radio & Television News
Howard W. Sams, Chmn. Board, Howard W. Sams, Inc.



HELPFUL HINTS

The unidentified capacitor in each entry will be a Pyramid Twist-Mount. All schematics are of TV sets made in the U. S. by a known manufacturer within the past 2 years.

Schematics for reference may be those published by the TV set manufacturers, Howard Sam's Photofacts, or by any other accepted publisher. You may enter as often as you like but be sure to include a box top (showing stock number) of any Pyramid Twist-Mount Capacitor, with your letterhead or business card with each entry.

WHO MAY ENTER

Any Radio-TV serviceman or employee of a Radio-TV service company may enter. Officers, employees, (members of their families) of Pyramid Electric Co. or its advertising agency are not eligible to enter the contest. All entries are limited to residents of the continental U. S. over 21 years of age.

All entries become the property of Pyramid Electric Co., none will be returned and the decisions of the judges are final. In case of ties, duplicate prizes will be awarded. This contest is subject to all federal, state and local laws and regulations.

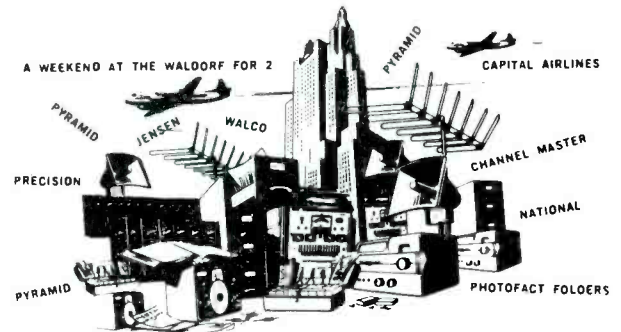

MAIL THIS ENTRY BLANK NOW!

Pyramid Twist-Mount Contest, Dept J
Pyramid Electric Co.
P.O. Box 655, Tyler Park Station, North Bergen, New Jersey

Entry No. (1) (2) (3) (4)—(check one)—Is: Pyramid stock No. _____

Twist-Mount values _____

Set manufacturer's name _____ TV set model No. _____
I enclose a box top (indicating stock number) of any Pyramid Twist-Mount Capacitor together with my business card or letterhead or my employer's).

Contestant's name _____ Position _____

Contestant's address _____

City _____ Zone _____ State _____

Employer's Firm name _____

Employer's address _____

City _____ Zone _____ State _____

My jobber's name and address _____

ENTER AS OFTEN AS YOU LIKE—FOR ADDITIONAL ENTRY BLANKS SEE YOUR JOBBER.

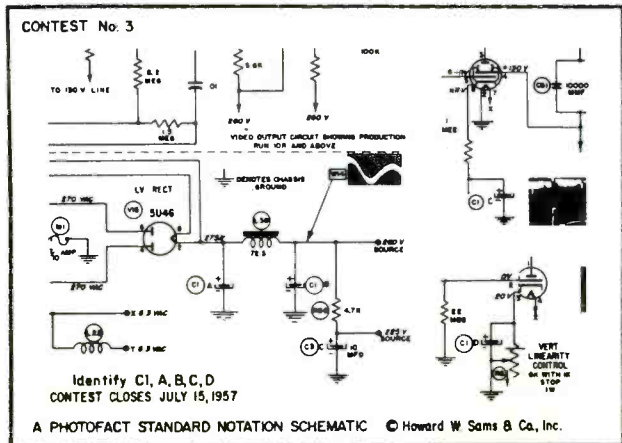



Build today's profits with

MALLORY

Mercury BATTERIES

— the batteries of tomorrow !

The amazing mercury battery, pioneered by Mallory, helped make practical the remarkable new pocket-size transistor radios. Tiny, powerful, long-lasting, Mallory Mercury Batteries are the fast-growing line that will bring you profitable sales today . . . even greater sales tomorrow.

Mallory Mercury Batteries excel in long shelf life . . . in service life and economy in transistor portables. To help spark your sales, you get the backing of year 'round promotion and strong advertising in magazines like The Saturday Evening Post, Time, Newsweek, Business Week and TV Guide.

See your Mallory distributor today, and get full facts on the full line of Mallory Mercury and Zinc-Carbon Batteries.

For vacuum-tube portables, sell Mallory Zinc-Carbon Batteries . . . unsurpassed for performance.



P. R. MALLORY & CO. Inc.
MALLORY

P. R. MALLORY & CO. Inc., INDIANAPOLIS 6, INDIANA

- Capacitors
- Vibrators
- Resistors
- Power Supplies
- Mercury and Zinc-Carbon Batteries
- Controls
- Switches
- Rectifiers
- Filters

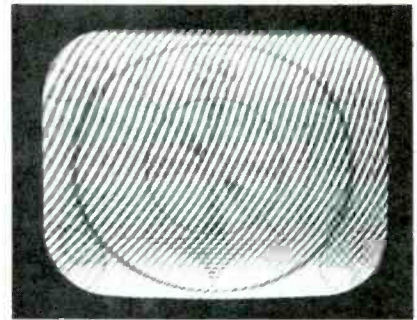

(A) Herringbone pattern.

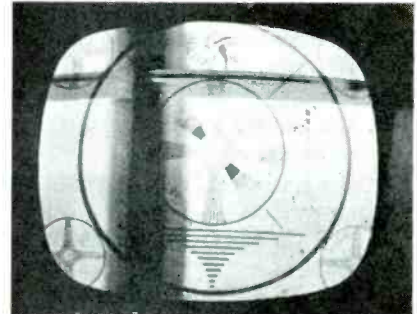

(B) Windshield-wiper effect.

Fig. 10. Interference patterns produced by adjacent-channel interaction.

a marked increase in the AGC voltage and thereby reduce amplification of the desired signal. The adjacent-channel signal, normally not falling within the frequency ranges of the IF stages connected to the AGC line, is hardly affected by the bias change and passes through to the video stages at about the same level. The overall response curve in a severe case might appear as in Fig. 9. The symptom which characterizes this situation is the "herringbone pattern" (Fig. 10A).

The "windshield-wiper effect" in Fig. 10B, although often symptomatic of co-channel interference, can also occur as a result of signal spillover from the next higher channel, particularly when the selectivity of the receiver is not as good as it might be. Since the sync signals of the two transmitters are not in step, the strongest signal will synchronize the receiver's sweep oscillators and appear stationary, while the other will wander across the screen. With more severe cases, trouble will be encountered in trying to synchronize either picture.

In receivers which employ properly adjusted adjacent-channel traps, the interfering signal is attenuated in the video IF stages and no problem exists; so naturally our concern is with the sets

needing such features but not having them. One thing that could be done, of course, is to install traps that would resonate at frequencies 1.5 mc above the IF picture carrier and 1.5 mc below the IF sound carrier (usually 27.25 or 47.25 mc for the sound carrier of the next lower channel and 19.75 or 39.75 mc for the picture carrier of the next higher channel), but this would require that the set be taken to the shop. Furthermore, in any one instance, it is usually only one signal that is causing all the trouble—and there are simpler and less expensive ways of curing it.

As with co-channel interference, one solution is to employ a highly directional antenna, or one that discriminates against the unwanted signal. Another point to consider is that the customer may desire to receive the interfering signal, but under more ideal conditions. If this is the case, a special antenna system incorporating a rotator might be ideal.

On the other hand, the interfering signal may not be usable. If so, it can easily be attenuated with a trap especially designed for that purpose. Units which are tunable over the high or the low VHF channels are commercially available, and their makes and models are:

Jerrold	HQ-91 (Ch. 2-6) HQ-92 (Ch. 7-13)
JFD	WT26 (Ch. 2-6) WT713 (Ch. 7-13)
Meissner	15-7513 (54-108 mc) 15-7514 (108-216 mc)
Miller	6163 (150-250 mc) 6164 (75-150 mc) ▲



"THERE'S NO SUCH THING AS AN INACCESSIBLE NUT WITH ME, SIR!"

YOUR
customers
see
YOUR
story...

in
MALLORY
advertising to
TV set owners

For nearly four years, consistent Mallory advertisements in TV GUIDE—read by over 4 million TV set owners—has been explaining to your customers some facts that they should know. We've been telling the public that TV and radio service is a skilled profession, and that you service engineers are doing a mighty important and responsible job in keeping them supplied with entertainment, news, sports and all the other good things that fill the air today.

For many years, Mallory has taken the lead in working with and for the service professions — by promoting standardization, publishing helpful reference material, providing assistance on technical and customer-relations problems. This advertising campaign is a part of our continuing program of support for you service engineers in the important work you are doing for and for the future.

Tell Us What You Think
about this series: do you like
it . . . shall we
continue it?
Write to us
today!

P. R. MALLORY & CO. Inc.
MALLORY

P. R. MALLORY & CO. Inc., INDIANAPOLIS 6, INDIANA

Capacitors • Controls • Vibrators • Resistors • Switches • Rectifiers
Power Supplies • Filters • Mercury and Zinc-Carbon Batteries



Here's Another New

COLOR Receiver

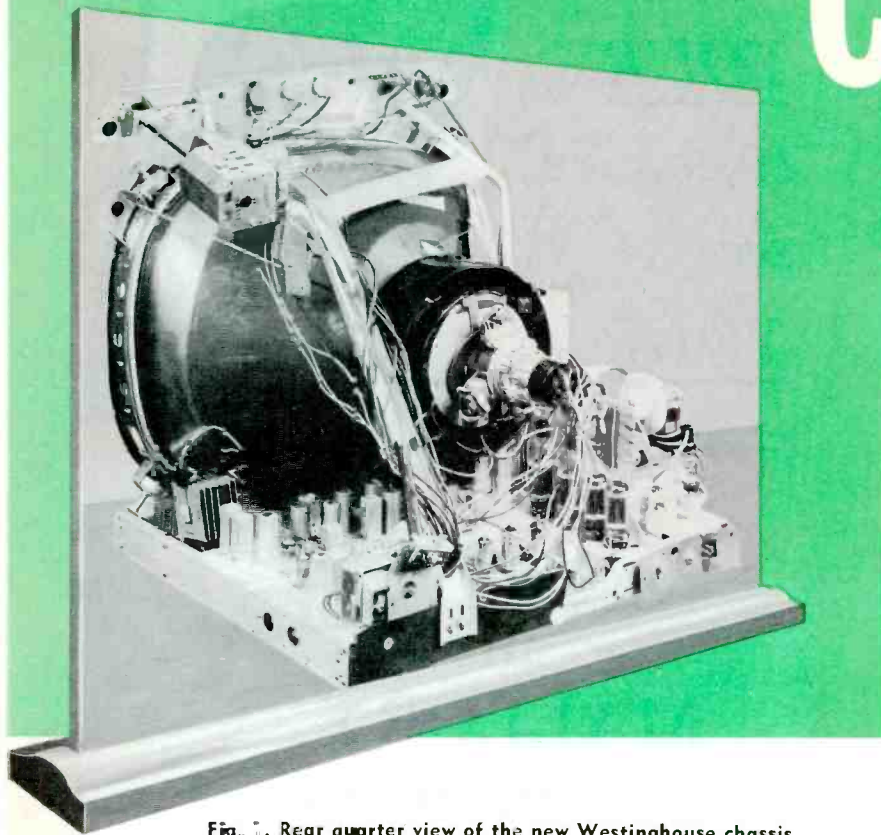

Fig. 1. Rear quarter view of the new Westinghouse chassis.

Data on the 1957 Westinghouse With Its 22" Rectangular Tube

by Calvin C. Young, Jr.

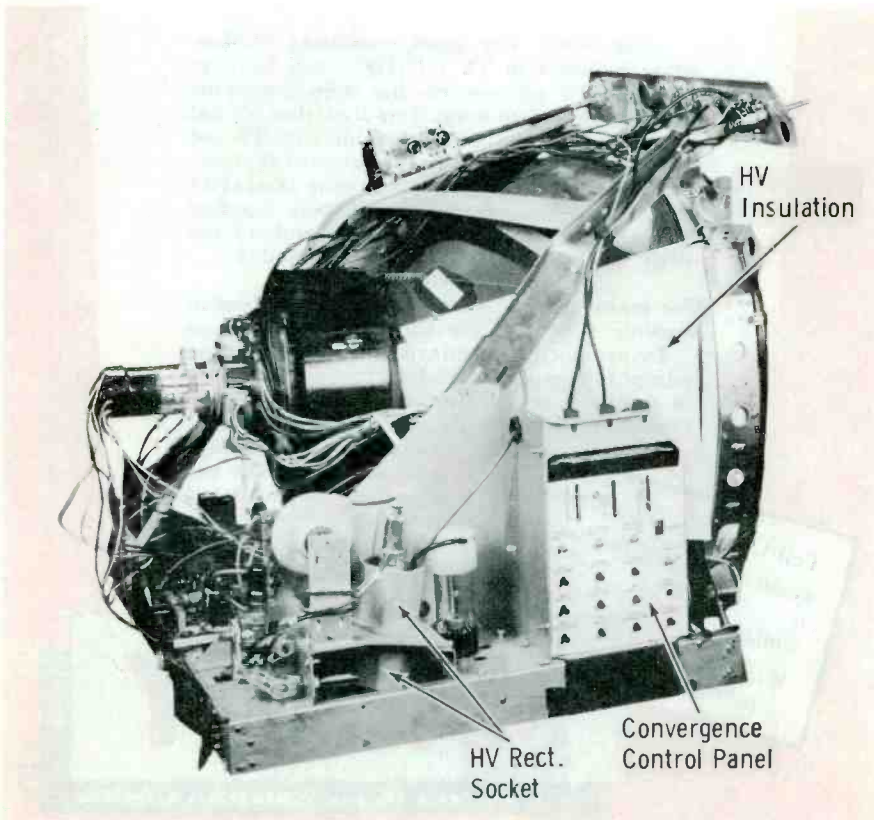

Fig. 2. Side view of the Westinghouse chassis with HV cover removed. Note the insulation used between the anode connector and convergence control panel.

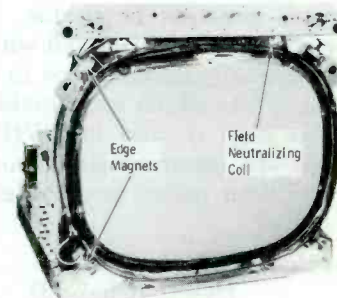

Fig. 3. Locations of the equalizing magnets and field neutralizing coil on the front of the new color set.

A 22" glass rectangular picture tube mounted on the chassis and a series-parallel filament string are two of the dramatic departures in the 1957 color receiver being produced by Westinghouse. Here's a detailed examination of the innovations in this new receiver.

The Picture Tube

Not only is the picture tube rectangular, but it is glass, not metal, and is mounted on the chassis instead of in the cabinet. As you can readily see in Fig. 1, no magnetic shielding is employed over the bell of the picture tube. The grounded aquadag coating serves as the negative plate of a

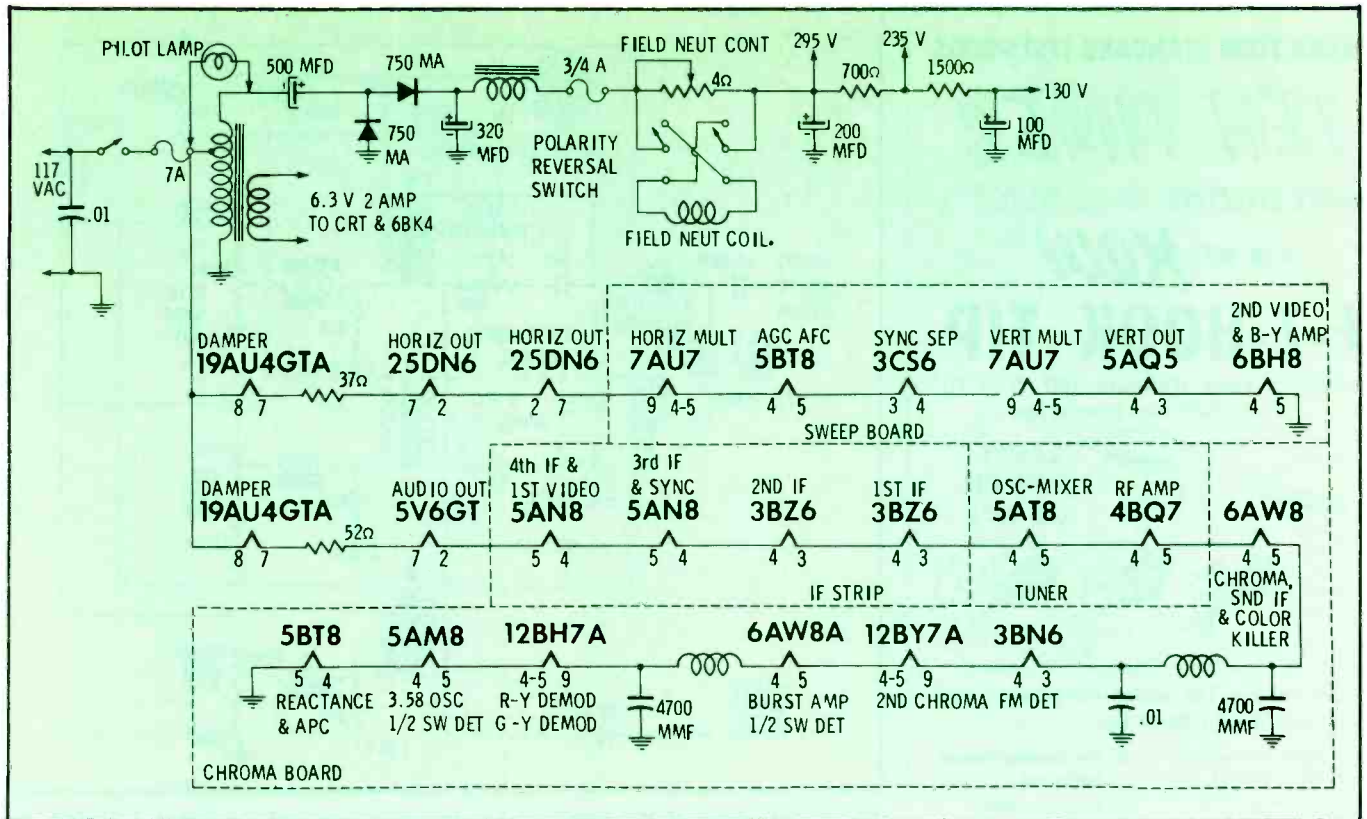

Fig. 4. A partial schematic of the low-voltage and heater supplies.

HV filter capacitor—the other plate is the internal coating to which the anode potential (25KV) is applied. The electron-gun assembly and the arrangement of the three color phosphors are the same as in the 21" metal shadow-mask tubes.

In Fig. 2 you can see the heavy sheet of high-voltage insulating material which prevents arcing or corona from the anode bulb connector to the control panel; this also provides protection for the technician when he is servicing the receiver.

Edge Magnets and Field-Neutralizing Coil

Both field-equalizing magnets and a neutralizing coil (Fig. 3) are provided to compensate for extraneous magnetic fields which would otherwise affect color purity. Additional magnets can be accommodated should they be required for optimum purity. These additional magnets clip to the metal rim strap and may be obtained from Westinghouse distributors. Up to two additional magnets may be placed on each of the four sides (a total of eight additional magnets).

Control of the current through
May, 1957 · PF REPORTER

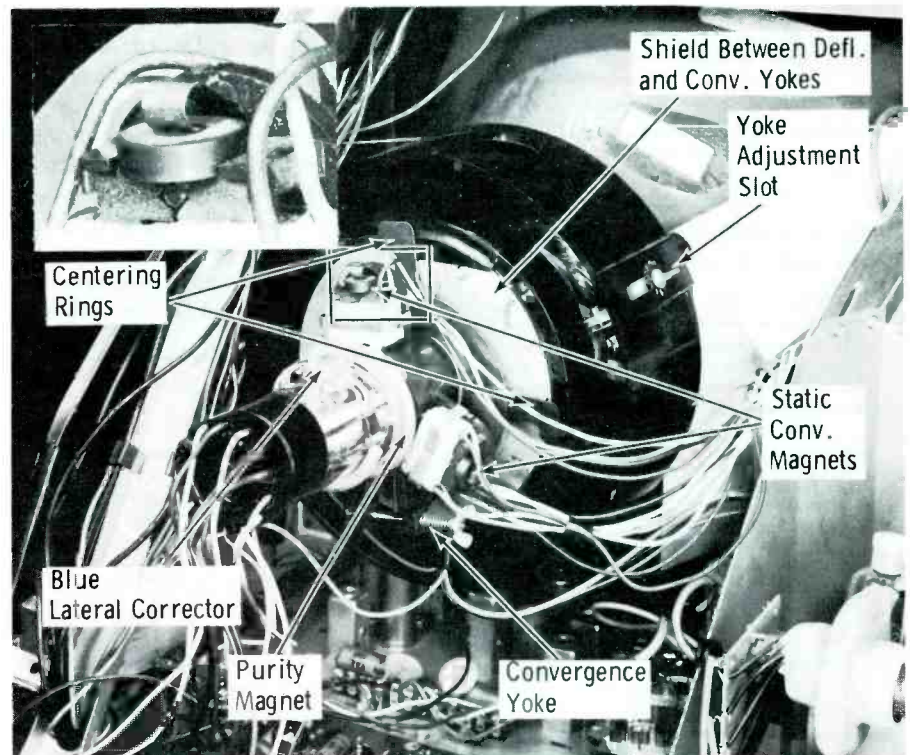

Fig. 5. In addition to the standard auxiliary components, the picture-tube assembly in the Westinghouse set incorporates a magnetic centering device.

the field-neutralizing coil is obtained through the use of a potentiometer and a polarity reversal switch (Fig. 4).

Convergence Assembly

A convergence yoke comprised

of both electromagnets and permanent magnets (Fig. 5) for each electron gun is positioned on the neck of the tube so that each set of coils is aligned with the magnetic pole pieces at the end of its associated electron gun. The

MAKE YOUR STANDARD TEST PRODS

TEN TIMES

MORE EFFECTIVE IN SECONDS

WITH THE **NEW**

E-Z-HOOK TIP

CONVERTS YOUR STANDARD TEST PROD TO A SELF-HOLDING CONNECTOR

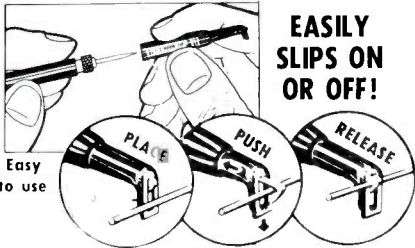

Here are the TEN added advantages you get with the E-Z-Hook Tip:

1. Frees your hands
2. Won't slip off
3. Insures positive connection
4. Makes difficult connections
5. Easy to connect or disconnect
6. Fits irregular shaped conductors
7. Fully insulated
8. Small and compact
9. Hands clear of wiring
10. Easy to use

"Built like a battleship!"

That is how one electronics expert described the E-Z-Hook Tip construction.

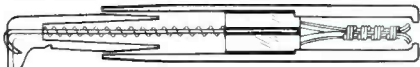

INTERNAL CONSTRUCTION OF E-Z-HOOK TIP (Nylon and Stainless Steel for durability)

The new E-Z-Hook Tip attachment makes your present probe ten times more effective and easily slips on any standard test prod. Illustrated are but a few of the many different connections that can easily be made with the E-Z-Hook Tip.

CONNECTING TO A PRINTED CIRCUIT FEED-THROUGH TERMINAL

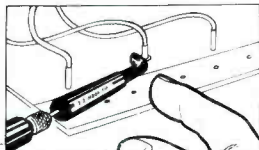

CONNECTING TO A TERMINAL LUG ON A VARIABLE CONTROL P.C. BOARD

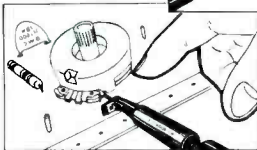

GET THEM AT YOUR PARTS DISTRIBUTOR Today

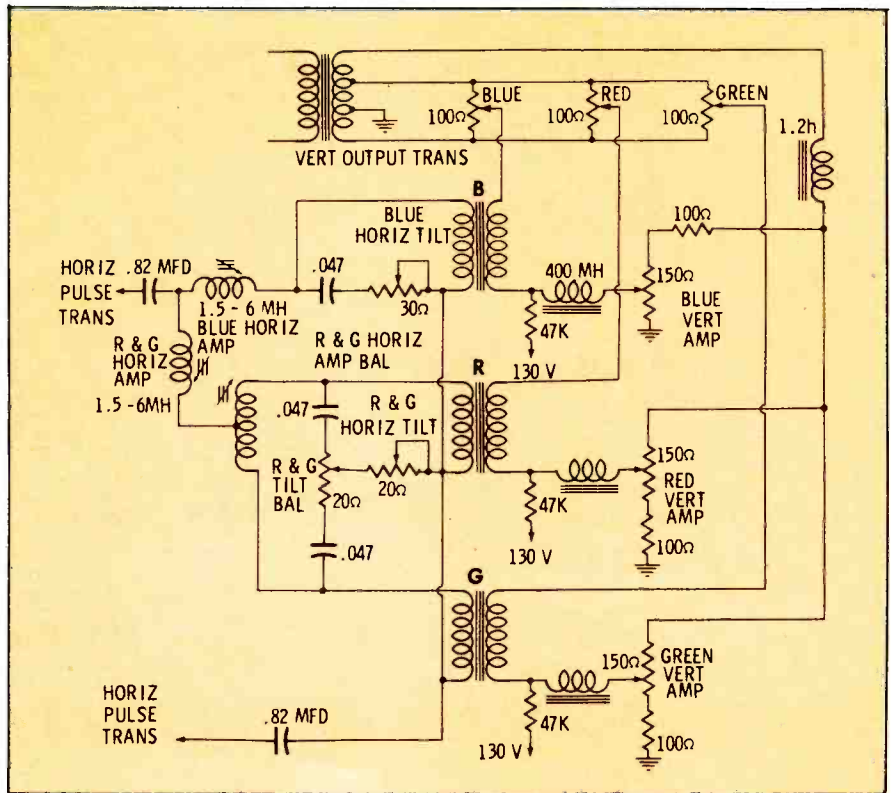

Fig. 6. Schematic of the tubeless convergence circuit with interrelated controls for red and green horizontal dynamic convergence.

static convergence adjustments are made by rotating the disc-shaped permanent magnets (see inset in Fig. 5) one way or the other. The blue lateral corrector magnet is also adjusted during the static convergence procedure. Dynamic convergence is obtained by adjusting the controls associated with the electromagnets of the assembly in the sequence out-

lined in the service manual. Separate vertical tilt and amplitude controls (Fig. 6) are provided for each electron beam. Separate horizontal tilt and amplitude controls are provided for the blue beam only—a slightly modified system is used for the red and green beams. Common amplitude and tilt controls are used in conjunction with balance controls to

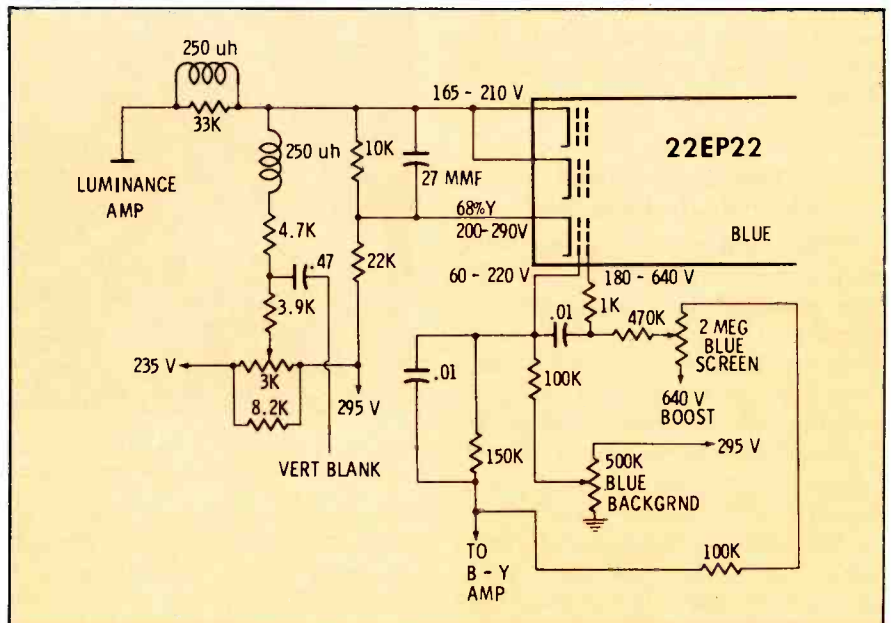
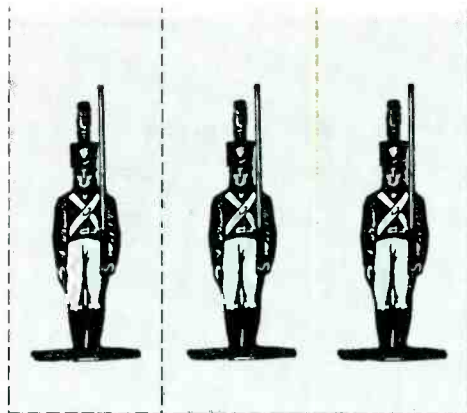

Fig. 7. Simplified circuit for the 22EP22 rectangular color picture-tube. The red and green grid circuits are similar to that shown for blue.

performance matched
test equipment
for black and white
and ALL COLOR TV TESTING



basic !

fundamental !

essential !



**MODEL 631
VOM-VTVM**

two in one tester for 100% service—VOM covers 90% of your usage, battery operated VTVM available for the other 10% when you need it. **\$64.50**

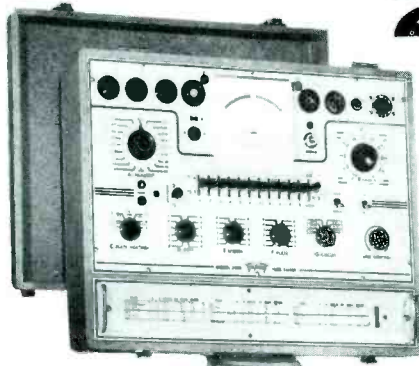

MODEL 3423

four in one—mutual conductance tube tester, transistor tester, germanium diode tester, selenium rectifier tester —checks for accuracy as circuit demands depending on the tolerance of the circuit. The patented circuit for the tube testing employs actual signal (4KC) for grid and DC bias voltage making it independent of line voltage hum. It also has a complete coverage of all tube types—six plate voltages (including 0-10 variable). Micromhos scales read 0-1,800, 0-6,000, 0-18,000 and 0-36,000. Leakage measured directly on meter 0-10 meg-ohms. **\$199.50**



MODEL 3441-A

three in one scope—oscilloscope, peak-to-peak meter, audio oscillator—essential for more than 50% of your Black and White Servicing—all Color Servicing. 10 mv sensitivity. 4.5 mc bandwidth. **\$249.50**

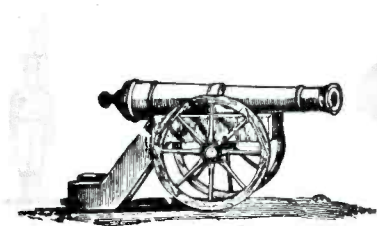









BURTON BROWNE ADVERTISING

TRIPLETT

These three units provide the ideal basis for the complete servicemen's test setup for black and white and color TV. You will want to consider also Model 3438 Dot Generator, Model 3439 Color Bar Generator, Model 3434-A Sweep Generator and other Triplett units.

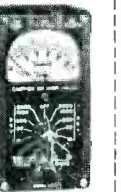
TRIPLETT ELECTRICAL INSTRUMENT COMPANY • BLUFFTON, OHIO

 <p>631 Combination V-O-M—VTVM</p>	 <p>630-NA For Best Testing Around the Lab, Production Line or Bench</p>	 <p>630 The Popular All-Purpose V-O-M</p>	 <p>630-A A Good Lab and Production Line V-O-M</p>	 <p>310 The Smallest Complete V-O-M with Switch</p>	 <p>630-T For Telephone Service</p>	 <p>666-HH Medium Size for Field Testing</p>	 <p>625-NA The First V-O-M with 10,000 Ohms/Volt AC</p>	 <p>666-R Medium Size with 630 Features</p>
--	--	---	--	---	--	--	---	---

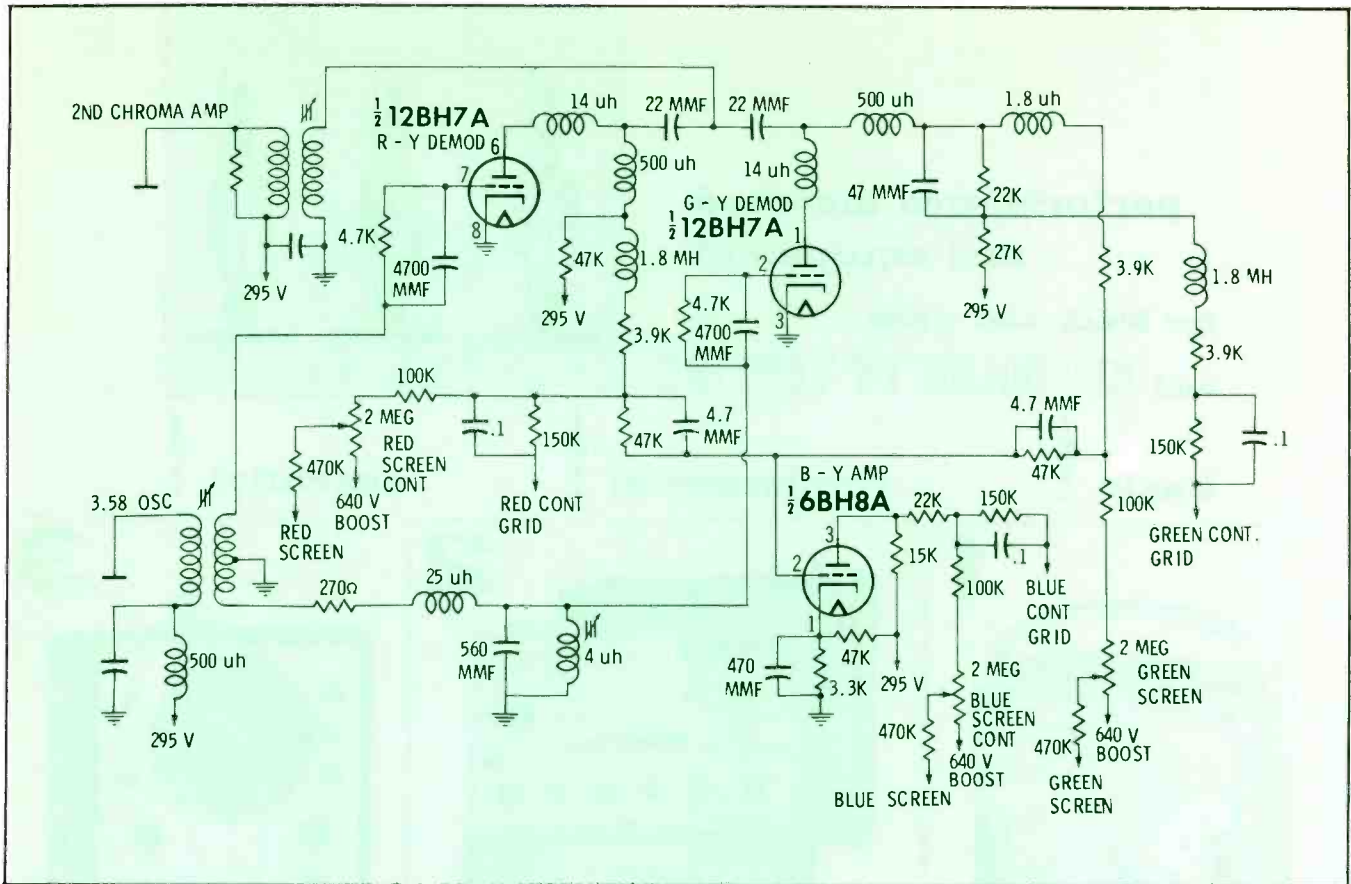

Fig. 8. This drawing schematically shows how the R-Y and G-Y color-difference signals from high-level demodulators are combined and amplified to form B-Y.

IT'S NEW! IT'S A BARGAIN! IT'S "IN THE BAG"!

VACO[®]

5-PIECE ALL HOLLOW SHAFT Nut Driver Kit

No. K 505

Only **\$368** NET

Convenient! Compact!

Here's a practical, quality built nut driver kit . . . economically priced, too! 5 popular sizes . . . 3/16", 1/4", 5/16", 11/32", 3/8" ideal for every service need . . . in one convenient plastic bag with button-down flap to keep drivers in place! Made to VACO professional quality standards throughout backed by our famous unconditional guarantee.

See Your Parts Distributor, Today!

VACO PRODUCTS CO., 317 E. Ontario St., Chicago 11, Ill.
In Canada: **ATLAS RADIO CORP., Toronto 10, Ontario**

Break-Proof Shock-Proof Comfortome Handle

All-Hollow Heavy Duty Shaft

Extra Hard Long Wearing Hex Head

The **NEW** **YEATS "Shorty"** STATION WAGON & PANEL PICK-UP appliance dolly

YEATS Model No. 5
Aluminum alloy
Height 47"
Weight 32 lbs.

Only 47" tall, this new YEATS dolly is designed for TV and appliance men who make deliveries by station wagon or panel truck. No need to detach appliance for loading into the "wagon" or pick-up . . . the YEATS "Shorty" will slide into your vehicle with ease. Has aluminum alloy frame with padded felt front, quick fastening (30 second) strap ratchet, and endless, rubber belt step glide. New YEATS folding platform attachment, at left, saves back-breaking work handling TV chassis or table models. Call your YEATS dealer today!

Folding platform is 13 1/2" x 24 1/2" —attaches instantly. (Platform only) \$9.95.

"Everlast" COVERS & PADS

YEATS semi-fitted covers are made of tough water repellent fabric with adjustable web straps and soft, scratchless white flannel liners. All shapes and sizes—Write.

Furniture Pad

TV Cover

SEND postcard for full information on our complete line TODAY!

YEATS appliance dolly

sales co.
Milwaukee, Wis.

2103 N. 12th St.



Jensen

VIKING SERIES LOUDSPEAKERS

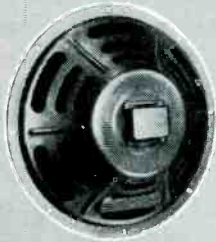

12J10

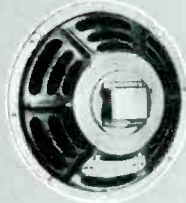

10J10



8J9



7J9



6J6



57J9



69J9



525J6



5J6



4J6



46J6



3J6



35J6



CTM-1

Designed for all today's requirements, the Jensen Viking series speakers are completely streamlined for stocking, selling and performance. Viking is the most complete line for general purpose, radio, TV and replacement applications —there are 13 models including 3 ovals

Because of the ingenuity of the Jensen design, you need only one universally applicable model in each speaker size. Your inventory requirements are lower than for any other speaker line—your stock investment is cut to the bone.

And Jensen Viking speakers are universal. The Jensen Viking design is the *most compact*; the extremely shallow depth makes them the ideal speaker to fit into even the most crowded sets. And with the most compact design Jensen Viking speakers have improved efficiency, heavier magnets, and truly permanent alignment, for excellent service and performance at low cost.

A universal mounting bracket for attachment of speaker to chassis and accommodating transformers up to 1/2 x 1/2 inch in size is available no charge.

Jensen Viking speakers are boxed in individual art cartons distinctly marked with Size, Model Number, V.C. Impedance, and Magnet Weight.

Nom. Size In.	Model No.	Magnet Weight	DIMENSIONS		V. C. Diam. In.	List Price
			H & W In.	Depth In.		
3	3J6 *	.85	3	1 7/16	3/16	\$3.70
3 1/2	35J6 *	.85	3 1/2	1 9/16	3/16	3.60
4	4J6 *	.85	4 1/8	1 3/4	3/16	3.60
4x6	46J6 *	.85	4 1/8 x 6 1/8	1 13/16	3/16	4.70
5	5J6 *	.85	5	1 15/16	3/16	4.05
5 1/4	525J6*	.85	5 1/4	2 1/8	3/16	4.15
5x7	57J9	1.47	5x7 1/4	2 9/16	3/4	5.85
6	6J6 *	.85	6 1/16	2 5/16	3/16	4.35
6x9	69J9	1.47	6 3/8 x 9 1/8	2 15/16	3/4	6.50
7	7J9	1.47	7	2 1 1/16	3/4	6.25
8	8J9	1.47	7 1 1/16	2 15/16	3/4	6.25
10	10J10	1.73	10 1/8	3 3/8	1	9.00
12	12J10	1.73	12 1/8	4 1/2	1	10.00

All Jensen Viking speakers have 3.2 ohm voice coils. Oval design.

*CTM-1 Universal Mounting Bracket for these models furnished free on request.

Jensen

 MANUFACTURING COMPANY
6601 South Laramie Ave., Chicago 38, Illinois

Division of The Muter Co. in Canada, Cooper Wire Products, Ltd., Toronto

Jensen Loudspeakers... World's Quality Standard for More Than a Quarter Century

BURTON BROWNE ADVERTISING

would you sell your REPUTATION for a QUARTER



Sometimes a quarter saved is not a quarter gained! At current dealer prices, the difference between a "price" twin lead and AMPHENOL top quality in an average 50 foot installation is only 25¢. For this quarter difference you are gambling with customer satisfaction, and may lose all the profits because of a call back—you are in danger of having sold your reputation for a quarter!

Every foot of Twin Lead sold by AMPHENOL is guaranteed in the following ways:

1. LONG TROUBLE-FREE LIFE—because only virgin polyethylene and pure copper conductors are used.
2. OPTIMUM PERFORMANCE—100% inspection during extrusion assures that proper conductor spacing, web thickness and full insulation over the wires are maintained at all times.
3. FULL LENGTHS—you're never shorted on AMPHENOL put-ups—full lengths are provided on every hank or reel shipped.

Every time you buy at a "bargain" you lose these guarantees—and customers soon afterward! Don't sell your reputation for a quarter!

Sell the BEST!...sell



AMPHENOL ELECTRONICS CORPORATION
chicago 50, illinois

achieve red and green dynamic convergence.

Picture Tube Setup Adjustments

In addition to the convergence and purity adjustments shown in Fig. 5, centering rings and an adjustable deflection-yoke mounting are also used for the picture tube setup. The centering rings are used to properly center the raster. However, their fields must be neutralized (tabs together) during purity adjustments and reset for picture centering prior to making dynamic convergence adjustments. The metal plate also shown in Fig. 5, while not a part of the setup adjustments, is very important since it provides shielding between the deflection yoke and the convergence assembly and must therefore be in place (taped to the rear cover of the yoke.)

Low-Voltage and Heater Supplies

While series heater strings and line-driven DC supplies are not new, they have not been previously used in color receivers. Such designs not only save money—but also decrease chassis weight and permit the use of a simpler and thinner chassis pan. Fig. 1 shows an insulating material (fish paper) fastened to the rear of the chassis. The metal panel to which the customer controls (contrast, volume, horiz. hold, vert. hold, and brightness) are fastened is insulated from the chassis by nylon standoffs into which the hold-down bolts are secured. This protects the customer from shock hazards; however, the technician must use an isolation transformer having a minimum rating of 500 VA to protect himself and his test equipment.

The tube heaters are connected in two series strings (Fig. 4) from the hot side of the line—the high-voltage regulator and picture tubes being the exception. A small filament transformer is used to provide 6.3 VAC to these tubes. This transformer also provides a small step-up so that the voltage-doubler circuit will receive enough AC input to produce 300 volts DC output. The step-up is approximately 12 volts RMS which is also used to power the pilot light. Either a #47 bulb in series with a 39-ohm, 2-watt resistor or two

PF REPORTER • May, 1957

#47 bulbs in series are used in this application.

Other Features

Further examination of the chassis will reveal the use of a printed wiring board for the sweep, sync, and AGC circuits plus the 2nd video and B-Y amplifier stages. In addition, there is a 3.58-mc crystal that, at first glance, might be mistaken for a 6AL5; a pair of 750-ma selenium rectifiers with clip-on connectors; a massive high-voltage rectifier socket; and parallel horizontal-output and damper tubes.

The picture-tube circuit (Fig. 7) is quite interesting. The luminance (Y) signal is applied, in proper proportions, to the cathodes, and the color-difference signals are applied to their respective control and screen grids. The circuit for the blue gun in Fig. 7 shows that signal coupling from control grid to screen is provided by the network comprised of a .01 mfd capacitor and a 1K-ohm resistor. Only the blue-gun circuit is shown since the red- and green-gun circuits are the same.

This departure from conventional circuitry was necessary to obtain better efficiency during color reproduction. With this hookup, additional drive is afforded at the screen grids by their respective color-difference signals. During monochrome reproduction, the screens will be at the normal DC level required for black-and-white balance. Fig. 8 shows the high-level demodulator circuit employed to obtain the color-difference signals. R-Y and G-Y signals are produced at the demodulator outputs and com-

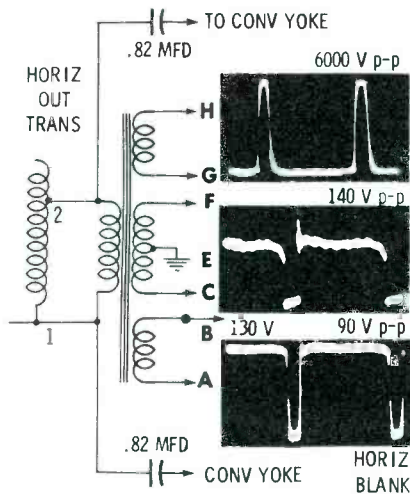

- A - screen of 2nd video amp
- B - to B+
- C - burst amp cathode
- E - ground
- F - color killer
- G - AGC line
- H - AGC keyer plate

Fig. 9. Drawing of the pulse transformer circuit and pulse voltages supplied to various stages.

bined to form a B-Y signal which is further amplified before reaching the picture tube. A voltage-divider network in the plate circuit of the G-Y demodulator is used to reduce the signal to the green grid by about 40% to match the Y or luminance signal fed to the associated cathode. This is necessary because the G-Y amplitude required in the formation of B-Y is much greater than that needed to drive the green gun.

Horizontal Pulse Transformer

A separate winding connected across part of the horizontal sweep transformer is employed to furnish pulse voltages for various circuits. This reduces the complexity of the horizontal output transformer and provides a pulse-signal source remote from the high-voltage cage.

Conclusion

Working with this receiver in our laboratories in preparation of this article served to emphasize the progress which is being made in the field of color TV. The ease with which the newer sets may be adjusted to produce quality color and monochrome pictures definitely indicates that manufacturers are making every effort to produce receivers which can be easily maintained. ▲



Dave Riee's OFFICIAL PRICING DIGEST

containing a NEW detailed guide to flat rate and hourly service charges, based on and showing regional and national averages.

When you want to know what to charge your customers for parts

DON'T WASTE TIME

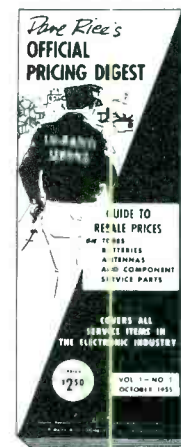

- ... HUNTING for an invoice
 - ... LOOKING for a catalog
 - ... CALLING your distributor
- USE *Dave Riee's*

OFFICIAL PRICING DIGEST

with up-to-date list or resale prices on over 60,000 components. Arranged alphabetically by manufacturer and product, numerically by part number. Compact, convenient size fits in tube caddy, tool box or pocket. \$2.50 per copy from your distributor.

and for every TV-Radio Service Call

Dave Riee's OFFICIAL ORDER BOOK

Triplicate forms serve for order, invoice and office record with spaces for complete information on every job. 75c each, \$6.50 per box of 12.

ELECTRONIC PUBLISHING COMPANY, INC.
180 North Wacker Drive • Chicago 6, Illinois

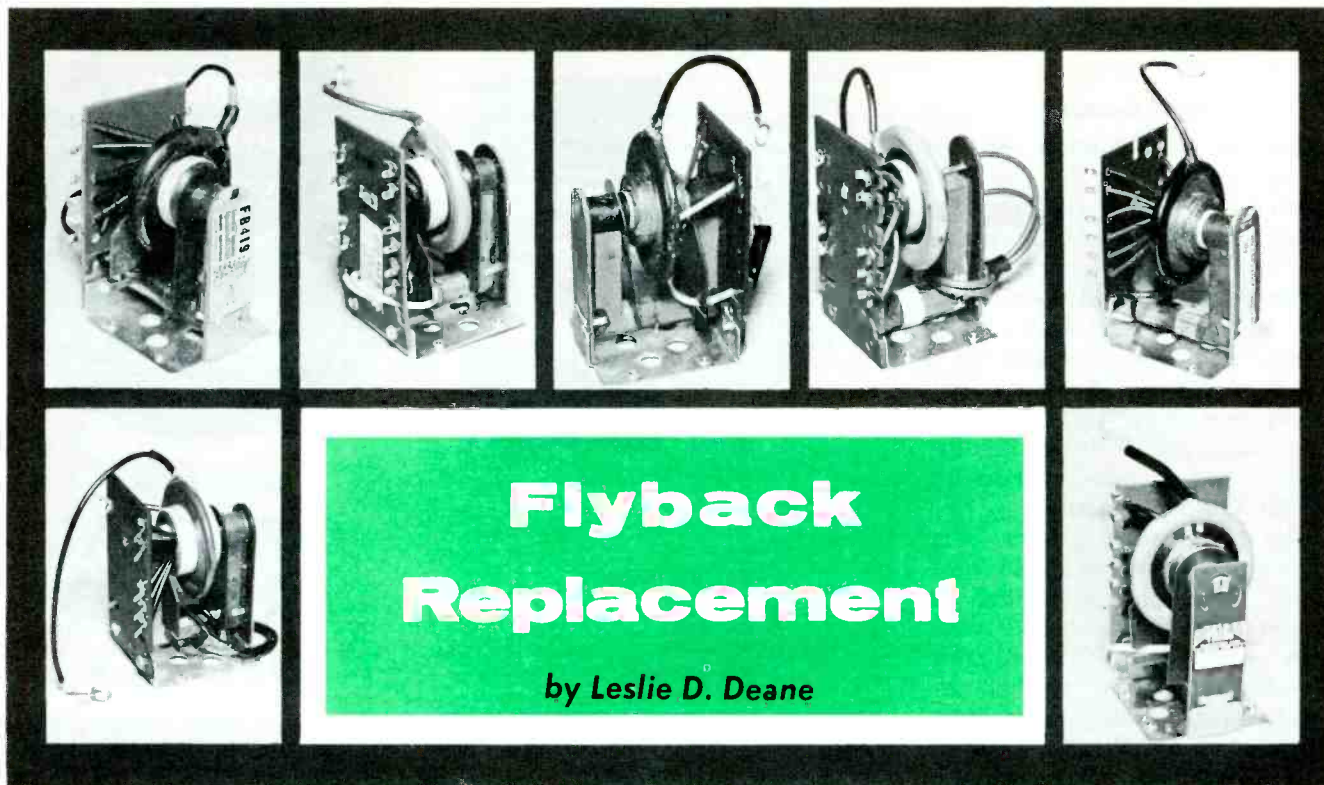

SUGGESTIONS FOR FINDING A SUITABLE HIGH-VOLTAGE TRANSFORMER REPLACEMENT

Isolating a trouble in the horizontal-output and high-voltage section of a TV receiver and finding that it is caused by a defective flyback transformer is a problem in itself. The technician, however, has test equipment and other servicing aids which can be very helpful in this phase of servicing. But that's only half the job. Very often, major problems still have to be solved.

After a technician is reasonably sure that a certain flyback transformer is faulty, his next move is to seek a suitable replacement. The manner in which he approaches this problem may determine whether he repairs the set today or two weeks from today. With this in mind, let's see what he might do to obtain a satisfactory flyback replacement.

Exact Type Replacement

Naturally, the technician's first preference is an exact duplicate of the original transformer, because then electrical or mounting modifications would not be necessary. To obtain such a transformer, he should first check with a local parts distributor who handles one or more transformer replacement lines. Contacting the nearest set manufacturer's outlet for an original part is an alternative, but it may involve the two weeks delay mentioned previously if the replacement must be ordered from an out-of-town source. Should the technician consult a local independent jobber, it is very likely that an exact duplicate made by a replacement parts manufacturer can be obtained without delay.

Using a reliable source of service information covering the receiver in question, the technician

should have at his disposal a part number for the original transformer, a diagram of the flyback circuit and recommendations for possible replacement units. With these facts at hand, selecting a suitable replacement should not present any problems in the majority of cases.

Replacement listings will often include those transformers which are not, in reality, the same as the original but which can be made to operate very satisfactorily with minor changes in terminal connections or with the drilling of a new mounting hole. Although some of the replacements recommended in the service literature will operate with only slight electrical or physical alterations, the technician should always check for an exact replacement listing in the distributor's latest catalog or replacement guide. Many of the independent transformer manufacturers have exact flyback replacements for most of the sets now in the field and are constantly introducing newer units that were not listed in service data published prior to their development.

Similar But Not Exact Replacement

At this point the technician might ask, "What do I do when I'm unable to get an original part from the set manufacturer and exact type replacement units are either not recommended or unavailable?" This can sometimes happen when a set manufacturer discontinues production or produces only a limited number of sets using a particular part. In this situation, the technician has little choice but to try a universal replacement or a transformer which replaces

**MOST COMPACT
LOWEST PRICE**

of any
completely packaged
variable transformer
on the market!



\$13.50

Adjust-A-Volt

PA-1

**VARIABLE
AUTO-TRANSFORMER**

This low cost, deluxe auto-transformer is small and compact, measuring only 3 7/8 x 3 7/8 x 3 1/2. It has a wide range of uses in industrial laboratories, schools, homes, and institutions.

The PA-1 can be used as the variable AC voltage control for mixers, agitators, centrifuges; for small motors; model railroading; hobbies; light dimming; and many similar applications.

SPECIFICATIONS FOR THE PA-1: Input, 120V; load rating max., 165VA; max. output current, 1.25A; output voltage, 0-132V. For PA-1L output voltage, 0-120V.

Designed for long service life, the PA-1 is supplied in an attractive, well ventilated, grey wrinkle finish case with easy to read dial, pilot light, push type switch, fuse, cord, plug and receptacle. The transformer is toroidally wound and features the LoRes brush track for extra long service life.

Write for the catalog describing the PA-1 and complete line of Adjust-A-Volt variable transformers.

**STANDARD
ELECTRICAL PRODUCTS CO.**
2240 E. THIRD ST., DAYTON, OHIO

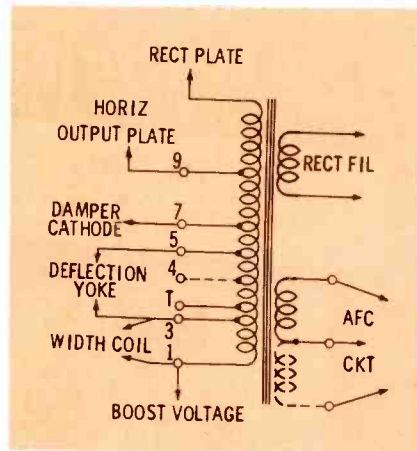

Fig. 1. Typical autotransformer circuit connections and terminal numbering.

similar units in the same set manufacturers' line. Not knowing the inductance of each winding on the original flyback, the technician may have considerable misgivings in this respect.

Older receivers, operating with 53° to 70° picture tubes, usually employed an isolated primary-secondary type flyback or a 70° autotransformer unit. Technicians are now more or less familiar with universal replacements for these circuits, but how about the more recent receivers? Most of the 1955, '56 and '57 TV sets with large screen picture tubes employ 90° autotransformers in their flyback circuits. Although these receivers are not particularly prone to failures, terminals 1 and 3 or terminals 3 and T of the replacement flyback.

If the AFC pulse is obtained from an isolated winding on the original transformer, it may be that connections to taps on the replacement unit will not produce the desired pulse polarity. In this instance, it will be necessary to connect the feedback circuit to either terminal 6, 2, or 8 of the particular replacement used. One tap on the isolated winding should return to RF ground.

If the replacement selected is without an isolated winding, then the secondary winding of one of the width coils recommended in Table I must be used. A tap on the secondary of these coils should be grounded and one of the remaining taps connected to the AFC feedback circuit. The primary winding of the replacement width coil should be connected across terminals 3 and 1 of the new flyback. (See Fig. 2 for width coil diagrams.)

You need a special tool
for a special job . . .

Lenk
**"PRINTED CIRCUIT"
SOLDERING GUN**
for
**Printed Circuits
and Miniaturized
Components**



Printed Circuit photograph
courtesy of Electrolab, Inc.

Write for name of nearest Jobber
The LENK MANUFACTURING CO.
30 Cummington Street Boston 15, Mass.

PF REPORTER • May, 1957

to flyback failure, there will be occasions when the transformer must be replaced. If the technician is unable to obtain a recommended replacement or an original part, he may wish to try a transformer which is more or less universal in application.

Table I lists several autotransformers which, due to their design, make them particularly suitable for use in various 90° flybacks circuits. These units represent seven of the leading replacement transformer manufacturers. Basically, all of these transformers are the same in both electrical and physical specifications. Typical circuit connections and terminal numbers are shown in Fig. 1. Naturally, there will be certain limitations involving the physical mounting space for these replacements. For example, they are actually too large for use in many of the newer portable TV chassis. Remember, adequate space must be maintained between the flyback transformer and all surrounding objects in order to prevent possible arcing and corona discharge.

The units listed in Table I differ only slightly in terminal numbering and AFC-AGC provisions. For instance, the Halldorson FB419 has all of the terminal connections shown in Fig. 1 except No. 8. The Merit HVO-36, on the other hand, includes this additional terminal. The Ram XO94 includes all terminals except Nos. 4 and 8. RCA's 235T1, Stancor's HO-256, Thordarson's FLY-16, and Triad's D-50 all differ from the Fig. 1 illustration in that they have no isolated secondary winding (terminal Nos. 6, 2, and 8). When the original flyback circuit employs an autotransformer with a separate AFC or AGC winding, a primary-secondary type of width coil must be used in conjunction with these latter four replacement units. A diagram of each width coil plus its terminal coding is given in Fig. 2. Circuit connections for this type of width coil will be discussed later in the article.

In addition to the variations mentioned, the Thordarson FLY-16 is also without a terminal-4 connection. Thus, the Ram and Thordarson replacements are the

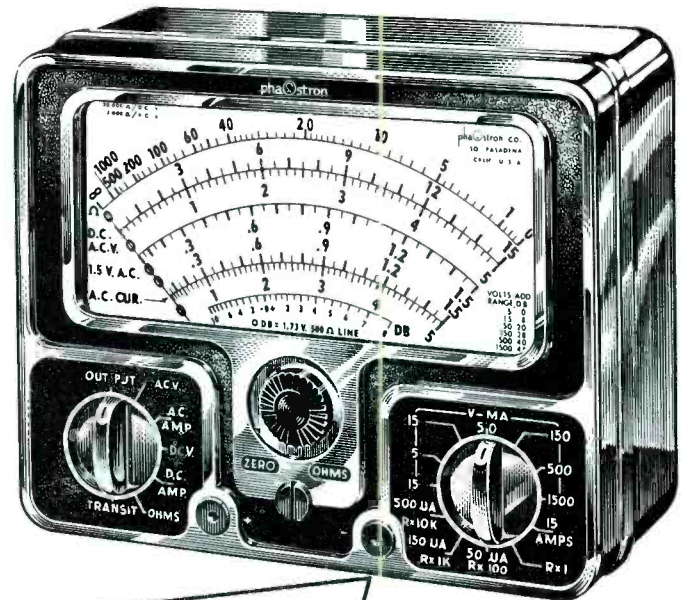

555A VOM

YOU NEED THESE FEATURES:

Meter Movement Protection up to 500 times overload is provided by a rectifier network.

The 555A Measures: AC Current, DC Current, AC Voltage, DC Voltage, Output, Resistance

43 Unduplicated Ranges

Separate Range and Function Switches

Double Magnetic Shielding

3% DC, 4% AC Permanent Accuracy

Easy to Read, Four Color Scales 4 7/8" long

Metal Case with Die Cast Bezel 6 1/8" x 4 5/8" x 2 1/8"

Sensitivity: 20,000 Ohms/Volt DC, 2000 Ohms/Volt AC

Complete with Probes and Batteries at your Parts Distributor **\$49⁵⁰**

PHAOSTRON INSTRUMENT AND ELECTRONIC COMPANY

151 Pasadena Avenue, South Pasadena, California

**New items
to save time,
make money**

**...literally hundreds of them,
in Centralab's
new Catalog 30**

Tells you what's new at your Centralab distributor. Keeps you up to date on the latest developments that make servicing of radio, TV, and electronic equipment faster and more profitable.

Shows hundreds of new, exciting items it pays you to know about — new values in Packaged Electronic Circuits — new volume controls — new ceramic capacitors — new switches — new transistor amplifiers.

Everything is arranged so that it's easy to find just what you're looking for.

Ask your Centralab distributor for your free copy. Or write us today.

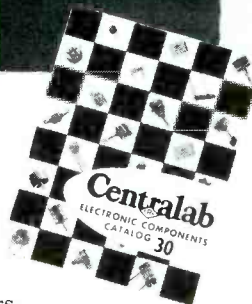

Centralab A DIVISION OF GLOBE-UNION INC.
942E EAST KEEFE AVENUE • MILWAUKEE 1, WISCONSIN
G-958

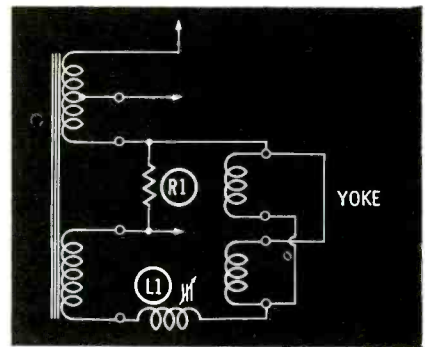

Fig. 3. The yoke connections to the transformer will depend on the combined inductance of the paralleled windings.

only units without this terminal on the main winding; however, this terminal is of little value from a replacement standpoint and can therefore be ignored.

Applications

The technician's next question might be, "In what type of circuit will these transformers work?" Although there are certain limitations, they can usually be made to operate satisfactorily in any conventional 90° autotransformer circuit.

"What then, does this conventional circuit consist of?" In the first place, the original flyback must be an auto type and not a primary-secondary transformer. Also, the voltage required for the picture-tube anode should be approximately 14 to 18 kv, the horizontal winding of the 90° yoke should have an inductance of 10 to 22 millihenries, and the damper plate should return to a 200- to 300-volt DC source.

The boost B+ voltage will normally be supplied from one of the lower taps on the transformer. If the current drain on this supply is excessive, it will tend to lower the efficiency of the replacement and result in insufficient sweep and high voltage. AFC and AGC feedback may or may not be used in the original circuit. The same is true for width and linearity coils.

The next logical question in our discussion is, "To what terminals of the replacement transformer should the various components be connected?" Although the flyback transformer serves several different purposes, its prime function is to act as a coupling device between the horizontal-output tube and the horizontal-deflection coils. When impedances are matched, a

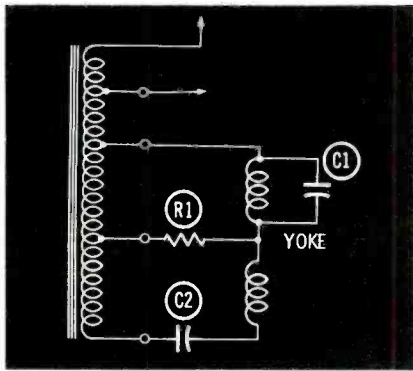

Fig. 4. Installation of a universal type transformer in this circuit requires that R1 be placed in series with C1 across the high side of the yoke.

maximum transfer of sweep energy will take place; thus yoke inductance must be matched by the inductance of that part of the flyback across which it connects.

The horizontal windings in the most popular 90° yokes have inductance values of approximately 20 millihenries. Many sets, however, use a 90° yoke which has an inductance of about 12 millihenries. The DC resistance of a 17- to 22-millihenry yoke will usually range from 30 to 40 ohms, while a 10- to 13-millihenry unit may average 15 to 25 ohms. With conventional series-connected yoke windings, the technician should obtain satisfactory matching by connecting the 17- to 22-millihenry coils across terminals 7 and 1 of the replacement flyback. For the 10- to 13-millihenry yoke, connect the coils across terminals 5 and 3. Terminal "T" can also be used in place of terminal 3 to obtain a more satisfactory match.

If the original yoke had been connected as pictured in Fig. 3, remove resistor R1 from the circuit and connect the paralleled coils of the yoke across the proper terminals of the replacement transformer. These will be either terminals 7 and 1 or 5 and 3 depending upon the total inductance value of the yoke windings in parallel. Width coil L1 should remain in series with the yoke return.

When the original circuit appears similar to that shown in Fig. 4, resistor R1 should be disconnected from the transformer and placed in series with damping capacitor C1 across the top winding of the yoke. In addition, leave capacitor C2 in the yoke return

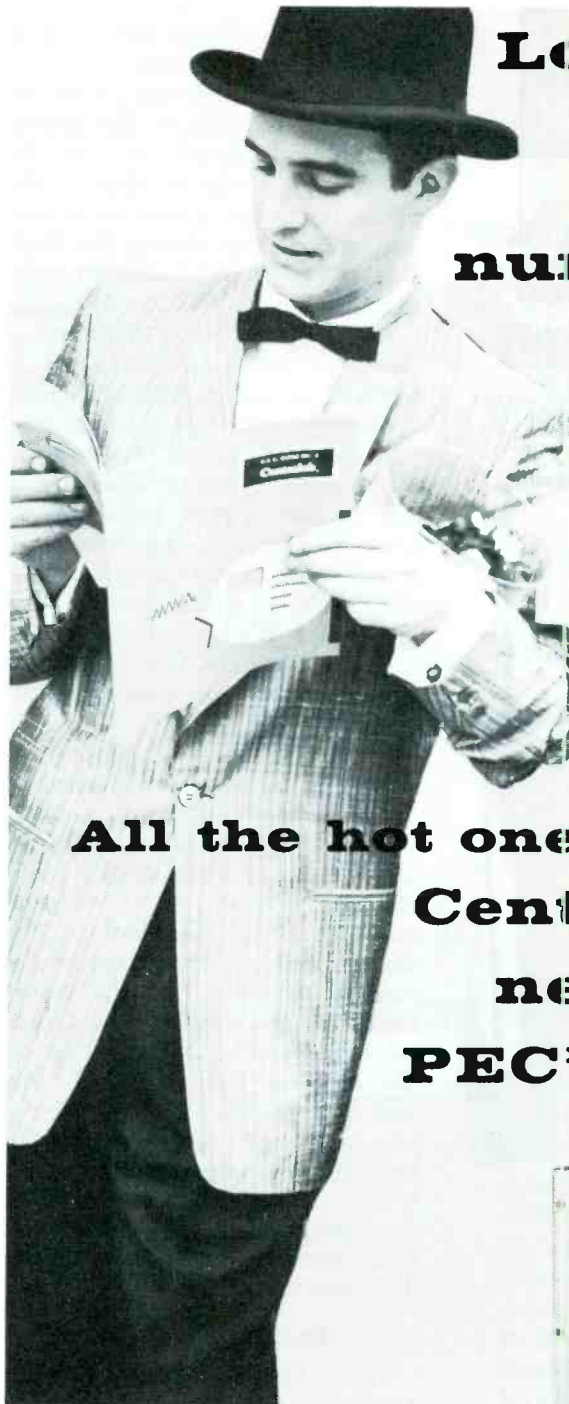

**Looking
for
new
numbers?**

**All the hot ones are in
Centralab's
new, free
PEC* Guide**

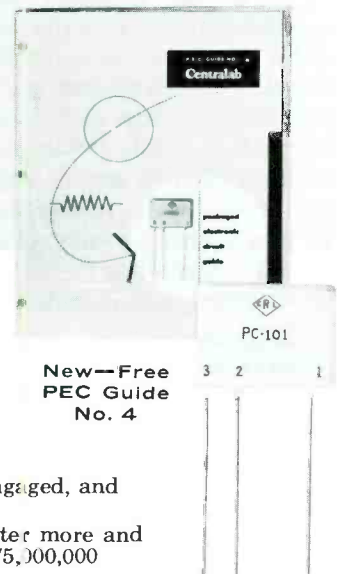

Twenty-five fresh new beauties to choose from. Currently keeping company with the entertainment industry's most popular chassis.

Brand-new edition of the Discriminating Serviceman's Guide — loaded with vital statistics, on both the old favorites and the new models. Gives practical techniques for testing — how to tell good ones from bad.

Get the lowdown on what models have been engaged, and where, by 130 radio and TV manufacturers.

These are facts it pays to have — you encounter more and more of these slim, trim PEC's every day. Over 75,000,000 now in circulation.

These beauties are waiting to be picked up at your Centralab distributor. Write us for your copy of PEC Guide No. 4.

Centralab A DIVISION OF GLOBE-UNION INC.
942E EAST KEEFE AVENUE • MILWAUKEE 1, WISCONSIN

* Trademark

MR. TV SERVICE TECHNICIAN

are you keeping up-to-date
with HOWARD W. SAMS
"TELEVISION TUBE
LOCATION CHARTS"

2nd SUPPLEMENT now available!

The second release of the SAMS "Television Tube Location Guide" is now being shipped to subscribers. Are you getting yours? If not, subscribe now—get your binder, the first and second supplements—and stay up-to-date with the latest chart releases issued every 90 days!

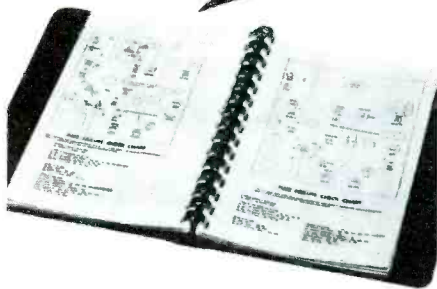

Subscribe now to the invaluable new Sams Television Tube Location Guide service, and get current coverage at 3 month intervals. A sturdy, deluxe binder is supplied to you as part of the service, and the releases come to you already punched and ready for easy filing. Here's what your subscription includes:

Current Charts Every Three Months
Complete Cumulative Indexing Service
Deluxe Binder for Easy Filing

COMPLETE SUBSCRIPTION
INCLUDING BINDER, ONLY... **\$3.95**

Subscribe today at your Sams Distributor and start getting your current Sams Television Tube Location Charts NOW!

HOWARD W. SAMS & CO., INC.
2201 East 46th Street
Indianapolis 5, Indiana

SUBSCRIBE TODAY!

circuit and connect the yoke across recommended terminals of the replacement flyback.

After matching the yoke as closely as possible to the proper flyback inductance, it may be necessary to add or change the value of damping and neutralizing components across the high side of the yoke to prevent ringing. Placing a 1K- to 47K-ohm resistor and a 50- to 100-mmf capacitor in series across this winding will usually minimize ringing. Capacitors used in this application should have a voltage rating of approximately 2 kv. When using one of the flyback replacements given in Table I, the technician should connect the hot or top side of the yoke to either terminal 7 or terminal 5. It's a good idea to try both positions and then select the one providing optimum performance.

Other familiar connections include the plate of the horizontal output tube, the plate of the high-voltage rectifier tube, and the filament connections to the high-voltage rectifier. These connections are, of course, obvious. The damper cathode circuit should return to terminal 7 of the transformer. If one side of the damper-tube filament is tied to a tap on the original flyback, place this lead on terminal 4 or T of the replacement unit. Terminal 1 should be used as the boost-supply point. If boost voltage is excessive, move the damper cathode connection from terminal 7 to a lower tap on the transformer.

Feedback Voltages

Many flyback circuits provide feedback pulses for AGC and AFC operation. Let's first con-

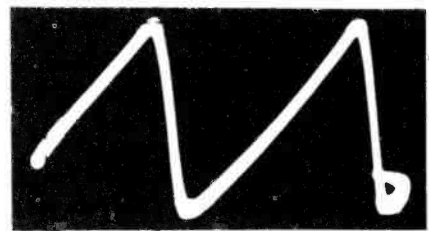

A

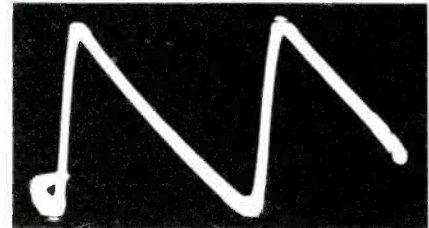

B

Fig. 5. AFC sawtooth signals derived from horizontal flyback pulse.

sider a flyback circuit which supplies an AFC feedback pulse. Some AFC circuits require a sawtooth signal which might be termed positive-going (Fig. 5A). Others require a negative-going signal (Fig. 5B). In either case, the amplitude of this signal will usually range from 10 to 20 volts peak-to-peak. In the design of the original flyback circuit, pulses from which the AFC sawtooth signal can be derived may be obtained from a tap on the transformer, an isolated winding on the transformer, or from the secondary winding of a width coil.

When the AFC pulse is obtained from a tap on the original transformer, either terminal 4, T, or 3 of the replacement can be used, depending on the signal amplitude requirements. Should the pulse originate from the secondary winding of a width coil, most likely the original coil will work satisfactorily with its primary connected across either ter-

Table I—Typical 90° Autotransformers

Suitable for Universal Applications

Manufacturer	Part No.	Provisions for AFC and/or AGC Feedback
Haldorson	FB419	Isolated Winding on Transformer
Merit	HVO-36	Isolated Winding on Transformer
RCA	235T1	214R1 Width Coil
Ram	XO94	Isolated Winding on Transformer
Stancor	HO-256	WC-16 Width Coil
Thordarson	FLY-16	WC-20 Width Coil
Triad	D-50	WC-11 Width Coil

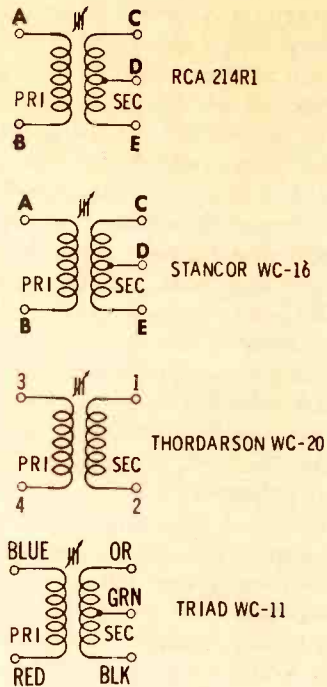

Fig. 2. Width-coil circuits which can be used to provide AFC and AGC signals when the transformer has no secondary.

If, after making the initial AFC feedback connections, the picture is out of phase or the horizontal blanking bar appears in the middle of the screen, reverse connections at the width coil secondary. The amplitude of the feedback pulse can be varied by changing the values of capacitors in the feedback network.

In many receivers, an AGC feedback pulse from the flyback circuit is used to control the action of an AGC keying tube. This tube is keyed into conduction by the positive-going pulse produced during sweep retrace. An example of the AGC-keying pulse can be seen in Fig. 6. Its amplitude may range from 300 to 600 volts peak-to-peak. The proper AGC connection in the replacement circuit can be determined by following the same procedures outlined in the discussion on AFC feedback. Most often the AGC pulse will be derived from the yoke-return circuit or from one of the taps on the flyback transformer. Should it become necessary to increase or decrease the amplitude of the pulse, the value of the feedback coupling capacitor may be changed or the signal may be obtained from a different tap on the transformer.

"If a width coil is employed in the original circuit for width con-



"EMERGENCY CALL GUS!—LADY SAYS THEIR HI-FI'S GONE HAYWIRE AND HER HUSBAND IS THREATENING TO FIX IT HIMSELF!"

The lady's right Gus — her husband can't compete with a trained technician and his stock of

Webster cartridges. And the whole family will be happier with the results — the renewed life found in their records.

There's more money in it for you too because there's never an unhappy customer.

BUY WISELY...BUY WEBSTER!



Model B202—3-speed; push-in mounting; clip-mounted needles.

ELECTRONICS DIVISION
WEBSTER  **ELECTRIC**
 RACINE · WIS

trol only, can it be used with any one of the replacement flybacks?" The answer to this question will depend largely upon the inductance range of the original coil. If its minimum inductance is greater than 2 millihenries, chances are the coil can be used and should be connected across terminals 1 and 3. Generally speaking, width coils having a suitable inductance range will have a DC resistance value of 10 to 20 ohms. A unit too low in value will draw excessive current and overheat.

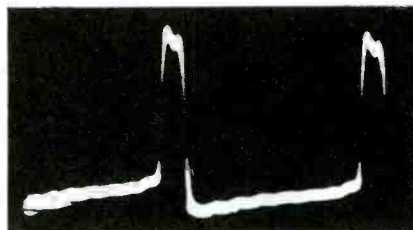

Fig. 6. AGC keying pulse obtained from the flyback circuit.

If insufficient sweep is encountered after considering all of the replacement techniques previously mentioned, there are a few other steps the technician might take. The first is to set the hori-

zontal width, linearity, and drive adjustments for maximum linear sweep. Next, check the B⁺ supply of the receiver. Remember also to check all of the tubes associated with the flyback circuit and to replace those which are not up to par. If a single-winding width coil is connected across the replacement transformer, remove it entirely and note whether or not additional sweep is obtained.

Placing a 50- to 100-mmf capacitor across the entire horizontal yoke winding may also increase sweep width. Remember to use a capacitor with a voltage rating of approximately 4 kv.

Picture blooming and low brightness may be an indication of insufficient high voltage. If these symptoms are in evidence, the technician should measure the high voltage with a suitable meter and probe. Keep in mind that this voltage will change with the setting of the brightness control. Many of the 90° picture tubes will operate satisfactorily with voltages as low as 12 to 14 kv; however, if the technician wishes to increase high voltage, he might try the following suggestions.

Change the value of the high-voltage rectifier filament resistor. Adding a resistor to this circuit or increasing the value of the original one actually reduces the load on the flyback, thereby allowing an increase in the pulse voltage applied to the rectifier plate. In some cases it may be necessary to use a longer rectifier filament lead and add an additional turn around the transformer core. This may not, however, increase high voltage until the proper value of filament resistor is placed in the circuit.

In summarizing this discussion on the replacement of modern 90° flybacks, one might get the impression that such a job requires much more than ordinary servicing ability. Actually this is not the case—for by merely applying the practical recommendations set forth in this article, the technician can and will realize satisfactory and lasting replacements. Let it be emphasized, however, that he should exhaust every effort to obtain an exact replacement before following the universal approach. ▲

How to increase your income

- ▶ **Two-way radio**
- ▶ **Microwave relay**
- ▶ **Home electronics**
- ▶ **Industrial electronics**
- ▶ **Radar**

Find out how you can increase your monthly income by installing and maintaining the types of electronic devices listed above.

Anyone now in the radio-television servicing field can qualify. A Commercial FCC license will open the door to new profit areas . . . and the work is interesting.

Don't limit yourself to receiver servicing. Prepare yourself to handle the more profitable jobs in electronics. Fill out the coupon below and mail it TODAY. The information is free!

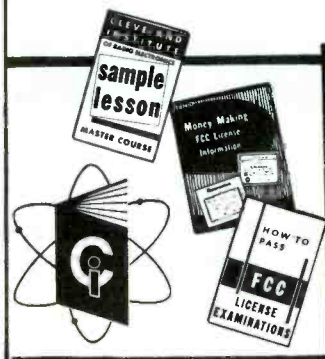

CLEVELAND INSTITUTE OF RADIO ELECTRONICS
Desk PR-5, 4900 Euclid Bldg., Cleveland 3, Ohio
Please rush the Free booklets to

Name _____

Address _____

City _____

Member National Home Study Council

Letters to the Editor

(Continued from page 9)

Dear Editor:

After reading about a trouble with picture jitter in this column in the December issue, I find that I have a similar trouble with a Muntz TV-16A2. The bottom of the picture jitters, and at the top it is crowded and tears. I have installed a new vertical output transformer and checked the circuit thoroughly.

I also have a Motorola Model 19F1 with picture flashing. It flashes with no signal present, but with a signal it is okay. I need help on both of these.

BERT I. NANCE

Carson Tee Vee
Torrance, Calif.

The Muntz receiver (Photofact set 108-Folder 8) is somewhat unique in that one-half of a multivibrator circuit also serves as the vertical output stage. It seems logical to assume that the trouble is in the multivibrator and such circuits have given many good men a hectic time. To eliminate the possibility of erratic operation of tube V7, the sync limiter-DC restorer, use a scope to monitor the sync signal at its plate. Any change in the waveform accompanied by the appearance of jitter in the picture would indicate trouble in this stage or ahead of it. If this signal looks okay, substitute for all of the capacitors in the oscillator circuit, specifically C45, C46, C47, C48, C49 and section C of C1, since capacitors are more prone to give trouble in this circuit than other components. From your description of the trouble in the Motorola receiver (Photofact Set 111-Folder 9), it sounds very much as though the horizontal oscillator is running wild when sync signals are not present. The natural free-running frequency of the oscillator may be too far from 15,750 cps, a condition which could be caused by value changes in C99, C100, R94, R2B, or shorted turns in transformer T9.—Editor

Dear Editor:

I think you wasted space with the article "Replacing Twist-Prong Electrolytics" in the February issue. Why not take a soft pencil and mark on the chassis the positions of the sections; then clip all prongs close with a pair of dikes? You're wasting time trying to straighten the twisted prongs, and nine times out of ten you'll still crack the can. I don't unsolder the wires from the clipped lugs until I start soldering the leads back on the new unit. This way, you don't have a bunch of wires flopping around loose, and the wires to each terminal are kept together.

H. WARREN SMITH

Austin, Texas

May, 1957 • PF REPORTER

New Macmillan BOOKS ON RADIO AND TV

Matthew Mandl's

**HANDBOOK of BASIC CIRCUITS
TV, FM, AM** \$7.50

Now one book answers all electronic circuit questions. Schematics and descriptions of 136 circuits for TV, FM, AM, Hi-Fi and PA systems are arranged alphabetically for quick reference. Each is treated as a separate unit telling purpose, characteristics, use and function, clearly and briefly. It's an extra tool to help you make money by saving you time.

Edward Noll's

**CLOSED CIRCUIT and INDUSTRIAL
TELEVISION** \$4.95

Get in on the ground floor of a fast growing field. Learn how to set-up, operate, maintain and construct every part of a closed-circuit system in terms written for technicians. Every step explained for quick understanding. You can actually make a closed-circuit TV system for use in your own home, simply and inexpensively. Learn how from a master.

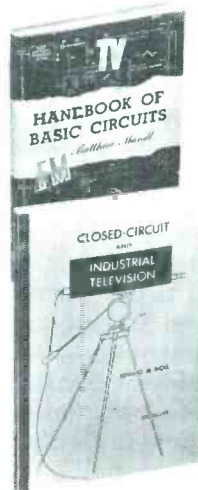

FREE EXAMINATION

Study Mandl's HANDBOOK OF BASIC CIRCUITS (\$7.50) and Noll's CLOSED-CIRCUIT and INDUSTRIAL TELEVISION (\$4.95) for 10 days FREE. If not satisfied return them. Otherwise we will bill you the price of each plus a small delivery charge. Fill in and mail the coupon now!

THE MACMILLAN COMPANY, Dept. RE6 (PF 3)
60 Fifth Ave., New York 11, N. Y.

Please send me on 10-day approval book(s) checked:
HANDBOOK OF BASIC CIRCUITS TV, FM, AM \$7.50
CLOSED-CIRCUIT and INDUSTRIAL TELEVISION \$4.95

Check or M.O. enclosed Bill me later
(return privilege guaranteed)

Name

Address

City & State

Distributed in Canada by Brett-Macmillan Ltd.
25 Hollinger Rd., Toronto 16

**MORE INCOME
IN 1957
FOR INDEPENDENT
TV TECHNICIANS!**

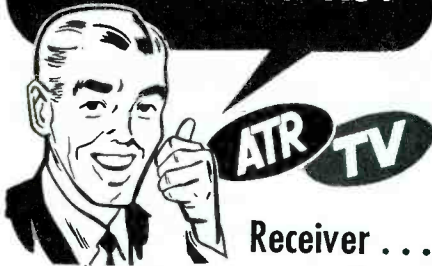

**ATR TV
Receiver . . .
precision-engineered
"for those who want the
finest" . . . is a non-
competitive line.**

**GENEROUS COMMISSIONS
THRU EXCLUSIVE
PROFITABLE TV
TECHNICIAN FRANCHISES
NOW AVAILABLE**

You can recommend ATR with the pride and assurance of your own know-how and the reputation and craftsmanship of AMERICAN TELEVISION & RADIO

- ✓ . . . as original sets
- ✓ . . . as replacement sets
- ✓ . . . as the No. 1 set in two-set homes
- ✓ . . . and for special chassis installations (without cabinet)

**UNEQUALLED
IN
PERFORMANCE**

**UNMATCHED
IN QUALITY
CONSTRUCTION**

**UNSURPASSED
IN
BEAUTY**



**FOR FULL INFORMATION —
WRITE TODAY FOR COLORFUL
BROCHURE SHOWING THE
NEW LINE OF ATR TV SETS**

ALSO MANUFACTURERS OF DC-AC INVERTERS,
"A" BATTERY ELIMINATORS, AUTO RADIO VIBRATORS



Shop Talk

(Continued from page 13)

stage, containing transistor X1, is a common-emitter amplifier. A departure from what has been given before is the manner in which the bias current is brought to the base of this transistor. A divider, consisting of R1 and R2, is connected from the collector to ground and the base is connected to the junction of R1 and R2. Note that since R1 is attached to the collector, it supplies to the base whatever signal variations appear across load resistor R3, in addition to the DC current obtained by virtue of the "B" potential present at the collector. Since the signal is shifted 180° in passing from base to collector, we have basically a degenerative feedback arrangement. This is useful in stabilizing the stage, particularly against temperature variations.

By way of contrast, the second stage, X2, uses the same base biasing method, but a 1-mfd bypass capacitor to ground from the junction of feedback resistors R4 and R5 prevents any signal variations reaching the base from the collector; hence, no degeneration occurs. However, DC current flows through these resistors for proper biasing of the stage.

R6 is a volume control and it is purposely connected so that rotation of the center arm will not affect the bias current flowing in the base circuit of X2. Any change in bias current would mean a change in operating conditions and would lead to distortion.

R7 is a voltage-dropping resistor, reducing the potential at the collector of X1 to the desired value. It also serves, in conjunction with C1, to prevent undesired signal feedback between the first stage and a subsequent stage. Failure to take this precaution could lead to motor-boating.

High-value coupling capacitors, such as C2 and C4, between stages are needed because they are followed by relatively low-value resistors in the inputs of succeeding stages. To prevent any substantial portion of the signal from appearing across these capacitors, they must be made large enough so that their respective reactances will be low in comparison to the input resistances. In vac-

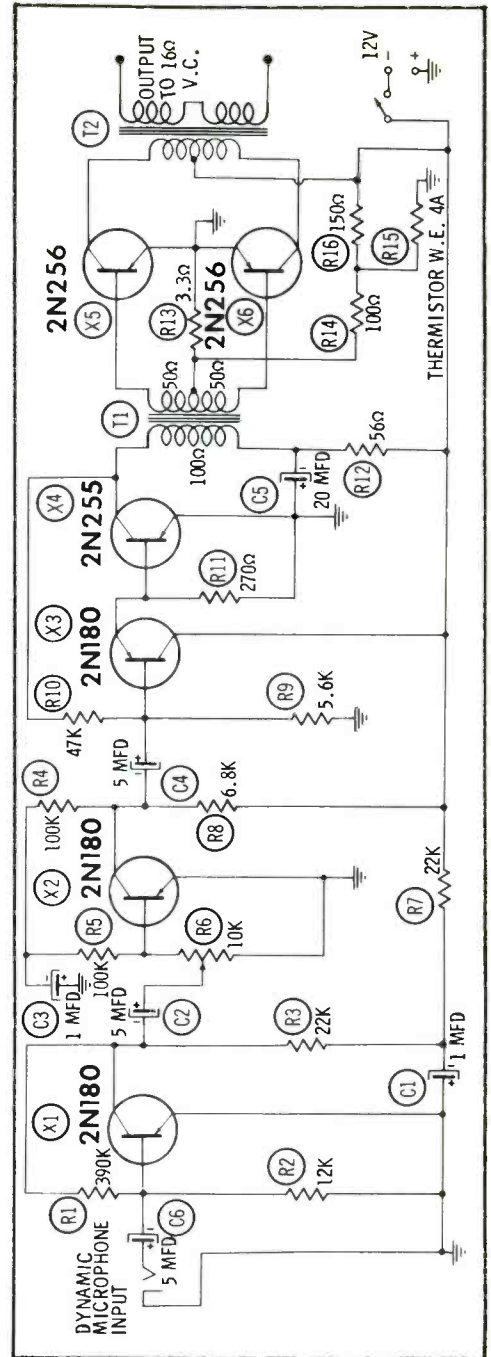

Fig. 3. Schematic of a CBS high-power PA transistor amplifier which operates from a 12-volt storage battery.

uum-tube circuits, lower-valued capacitors are permissible because the grid resistors following them are much higher in value.

The next two stages, containing transistors X3 and X4, form a combination common-collector, common-emitter amplifier. Note that the base of X4 is connected directly to the emitter of X3, with enough current being diverted by R11 to provide the base of X4 with the current needed to establish its operating point. Since the 2N180 transistor is a p-n-p type, electrons will flow down through R11,

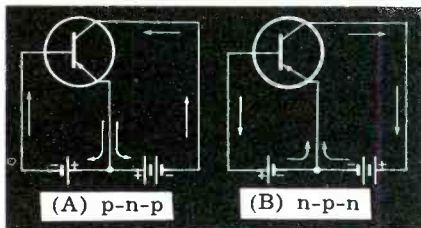

Fig. 4. Arrows indicate the directions of electron flow in the external circuits of junction transistors.

making the top end negative with respect to ground and establishing the proper polarity between the base and emitter of X4.

As mentioned in last month's article, one of the things a technician must learn is the direction of current flow through transistors. If we consider a p-n-p transistor, the external batteries must be connected as shown in Fig. 4A (which neglects load and bias resistors for the sake of simplicity). Since electrons travel (externally) from the negative to the positive terminals of the power source, electron flow in the input and output circuits is as shown by the arrows. On the other hand, if n-p-n transistors are employed, the direction of electron flow would be as shown in Fig. 4B. If you keep these diagrams in the back of your mind, they will help you determine the polarities across circuit resistors.

Another interesting feature of the X3 and X4 circuit in Fig. 3 is the manner in which the base of X3 is biased. The top end of R10 is connected to the collector of X4. Had this resistor been connected to the output circuit of X3, here

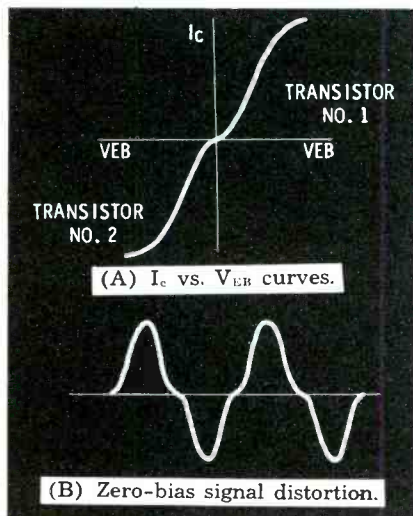

Fig. 5. Transistor characteristics when connected for push-pull operation.

NOW FOR BOTH 12" AND 8" SPEAKERS

The NEW *Tiny Mite*
Model TM-812

**A TINY GEM WITH MIGHTY PERFORMANCE
AT AN UNBELIEVABLY LOW PRICE**

It is hard to describe "sound." The picture above gives a pretty good idea of what a TINY-MITE looks like, but what it sounds like... that's not so easy.

If we used words like "beautiful," "sonorous," "rich-bodied," you'd conjure up some sort of mental auditory response. But at best it wouldn't be accurate. You have to actually listen with your own ears to know what "sound" really sounds like. You'd have to look twice to believe that the magnificent sound produced by the TINY-MITE was emanating from an enclosure only 21" h. x 15½" w. x 12" d.

It's no trick to achieve good results with a large enclosure, but realizing the great need for limited space enclosures, we set ourselves the goal of producing the finest small enclosure possible... *This is it!*

JUST LOOK AT THESE FEATURES:

1. The *only* cornerless-corner enclosure for both 12" and 8" extended range speakers, employing highly efficient University horn-loaded phase-inversion principle.
2. Versatile design permits use in room and ceiling corners or along flat wall. *All* exteriors, including the back, are beautifully finished, permitting unlimited decorating possibilities.
3. Construction equals the finest cabinetry. Full ¾" wood used throughout, thoroughly braced.

4. Supplied with mounting board cut out for 12" speaker; adapter for 8" speaker with ample space for tweeter opening is available.
5. No more struggling to install speakers. Baffle board is easily removed at front of cabinet.

The TINY-MITE makes any speaker sound its best. Matching the superb quality of the TINY-MITE, University offers the largest selection of 8" and 12" 2- and 3-way Diffaxials... to meet any budget requirement. Visit your favorite Hi-Fi center and listen for yourself.

Mahogany ...	\$39.75
Blond	42.25
Unfinished ..	34.00

UNIVERSITY LOUDSPEAKERS, Inc., 80 South Kensico Ave., White Plains, N.Y.

LISTEN *University sounds better*

"G" PRESENTING THE *New* GRIP SPINTITE® WRENCHES

PATENTS PENDING

FINEST QUALITY
STEEL SHANK
AND SLEEVE
•
BRIGHT PLATED
FINISH
•
STRONG
PLASTIC HANDLE

WITH THE EASY "FINGER-CONTROL"
GRIP AND RELEASE ACTION
FOR THOSE
HARD-TO-GET-AT PLACES —

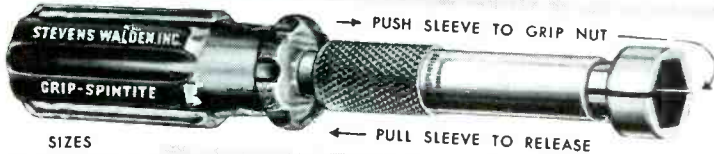

SIZES
3/16" TO 1 1/16"

BY THE MAKERS OF
THE ORIGINAL
SPINTITE
WRENCHES
OVER 150 STYLES
AND SIZES

ONE HAND OPERATION—

- GRIPS nuts or bolts of any material
- HOLDS firmly in any position
- TIGHTENS nut or bolt securely
- RELEASES at the pull of the fingers

Write for
catalogue

STEVEN'S WALDEN Inc.

500 SHREWSBURY STREET — WORCESTER, MASSACHUSETTS
MAKERS OF WORLD-FAMOUS HAND TOOLS FOR OVER 50 YEARS

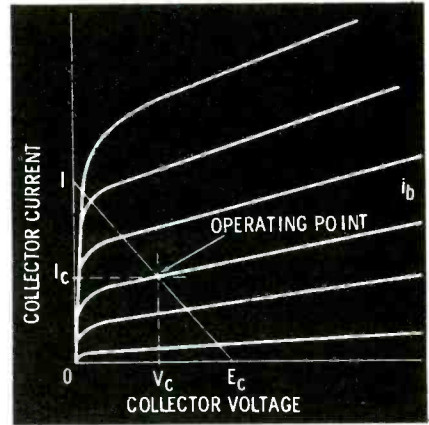

Fig. 6. Typical operating characteristics for a common-emitter transistor.

the emitter, oscillations would have occurred because there is no signal polarity reversal in going through a common-collector amplifier (which X3 is). However, the signal polarity does reverse in passing through X4 (common-emitter arrangement), and bias current for X3 is obtained from the output of X4.

Note, again, that this method of providing bias entails a degenerative action which serves to stabilize the stage (or stages) involved, although it does so at the expense of gain. If degeneration were not desired, the far end of R10 could be attached to B-.

Decoupling of X4 from the other stages via the B- line is achieved by R12 and C5. This is the only function of R12 since its value is only 56 ohms.

The output stage X5 and X6 of this PA system is a push-pull class-B amplifier. Both transistors

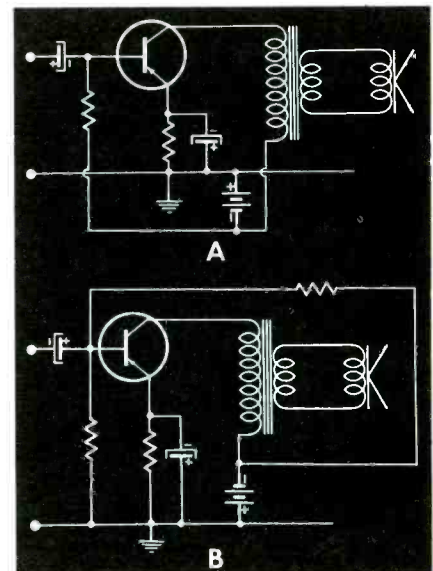
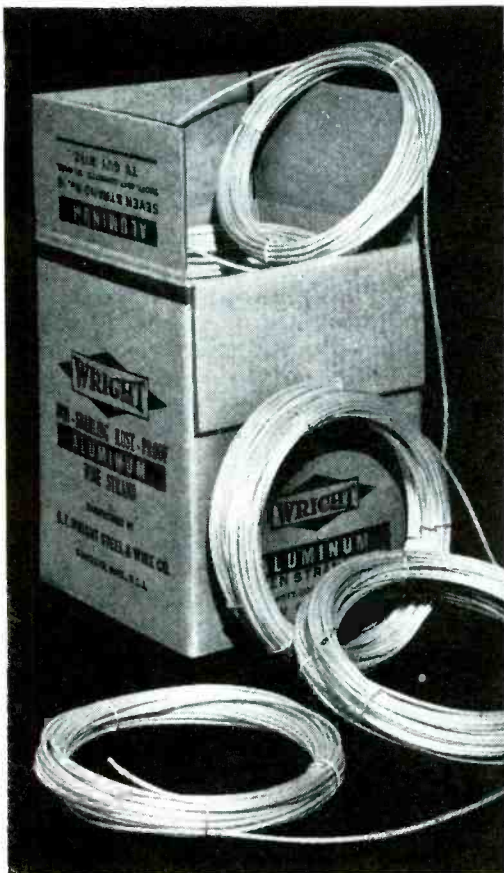

Fig. 7. Class-A power amplifiers with different base-emitter biasing methods.



ALUMINUM WIRE STRAND

Aluminum Wire Strand—strong (500 lbs. breaking strength) 7 strand #18 wire—clean handling because of special pre-cleaning process—corrosion resistant—non-snarling—pre-measured—every concentric coil measures 2 feet—connected coil 1000 feet of 50 ft. coils to a carton—an addition to present line of galvanized TV wire—Prompt deliveries from stocks in Worcester, Chicago, New Orleans, Houston, Dallas and Los Angeles.

Sold only through wholesale Electronics and Hardware Distributors.

**G. F. WRIGHT
STEEL & WIRE CO.**
235 Stafford St.
Worcester, Mass.

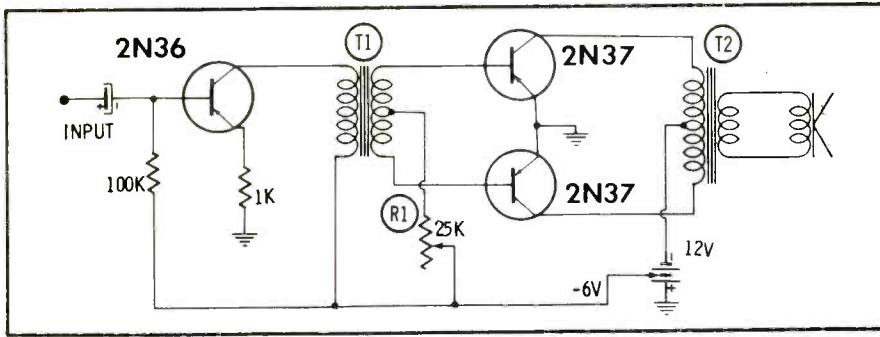

Fig. 8. A push-pull output circuit designed for class-A operation. Classification depends on the value of resistance between the T1 center tap and the 6-volt line. A high resistance would greatly reduce the base current, bringing the 2N37's nearer to class-B operation.

are operated in the common-emitter configuration. The input signal is fed to each base in opposite phase, and the collector of each transistor is connected to opposite ends of the primary winding of an output transformer. The bias voltage between each emitter and its base is provided by the voltage drop existing across R13. This is an exceedingly low-value resistor, much lower than R14 and R15, and the voltage across it is minute, actually only about .01 volt. Its purpose is not so much to provide base-emitter bias as to minimize a condition known as crossover distortion. When transistors are connected back-to-back, as they are in a push-pull arrangement, and the bias is zero, there is a region near current cutoff where their respective characteristic curves tend to become nonlinear as shown in Fig. 5A. Note the jog in both curves near the origin. This jog will distort an input signal in the manner shown in Fig. 5B. To prevent this, a small amount of bias is introduced between the base and emitter of

each transistor, and this is the purpose of R13 in Fig. 3.

Class A and Class B

It might be desirable at this point to consider in some detail the differences between class-A and class-B operation. In class-A operation, current is flowing throughout the entire cycle of input signal. That means that the base-emitter circuit is never cut off and that some emitter current is always flowing. In a common-emitter circuit, this condition is achieved by adjusting the base-emitter bias until the desired base current is attained. Graphically, the operating point is chosen as indicated in Fig. 6. The maximum collector voltage (E_c) and the maximum collector current (I_c) that the transistor can safely withstand are noted and then a suitable voltage and current within these limits are chosen. E_c should be somewhat less than the rated maximum collector voltage and I_c should not exceed the maximum collector current rating. The line between I_c and E_c represents the load line for the circuit and is used in determining the value of the load resistor needed for the collector circuit.

For maximum swing along this line, a mid-point value is chosen, here indicated by V_c and I_c . To attain this operating point, we set the base current (I_b) equal to the value indicated by the intersection of I_c and V_c . The incoming signal then varies I_b above and below the operating point and I_c varies accordingly. Note that there is a definite value of I_c for every value of I_b over the entire signal cycle.

For class-B operation, we want to bring I_b down to zero. At this point, the collector current is practically at zero and the collector voltage is at full battery value. Actually, there is a minute collector current flowing, called

I_{co} ; however, for our purpose at the moment this may be disregarded. To obtain zero base current, we reduce the driving bias between base and emitter to zero. Contrast this with a vacuum tube where cutoff is achieved by heavily biasing the grid with respect to the cathode.

(Advertisement)

MODEL 648		PLATE TEST		MODEL 715/115/561	
TUBE TYPE	FL.	CIRCUIT D.	E.	FL.	X. PLATE YZ
5CZ5	5.0	129	B346	32W.	5.0 46 15 7JKS
6CZ5	6.3	129	B346	32W.	6.3 46 15 7JKS
12AD7	12.6	A123	A45	65XZ	12.6 7 35 2LS
12CT8	12.6	A127	A89	65XZ	12.6 7 35 4NS
		A127	AC689*	50WZ	12.6 - 21 4JNQ
		A123	A45	58V	21 2LR

MODEL 49		CATH. SHORTS	
TUBE TYPE	SEC.	A.	D.
5CZ5	P	5.0	4
6CZ5	P	6.3	4
12AD7	T	6.3	9
12CT8	P	12.6	4
	T	12.6	4

Latest Chart Form 648-17, 715/115/561-9, 49-3

note:
Estimated 13/4 million portable TV sets to be sold in '57'!
Here's Your MARKET...

for the
MOSLEY Flush Mount TV Socket

LOW LOSS
NEAT
EFFICIENT

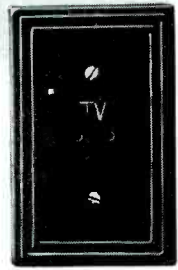

MODEL F-1PK

● The tremendous demand for portable TV sets opens another BIG market for good set-to-antenna plug-in outlets. MOSLEY Flush Sockets meet this need—supplying attractive, convenient, customer-approved wall outlets for every installation requirement.

Without MOSLEY TV Outlets, portable TV—in most areas—ceases to be portable! Let MOSLEY TV Outlets spark YOUR Portable TV Sales!

For a complete line of up-to-date TV Accessories and Electronic Components send for our "57" catalog.

Mosley Electronics, Inc.
 8622 ST. CHARLES ROCK ROAD
 ST. LOUIS 14, MISSOURI

Mr. Serviceman
You'll Like This
**CONTACT
CLEANER**
OR

"WISSH"

Electronic Contact
CLEANER AND LUBRICANT

IT WON'T COST YOU A RED CENT!

"WISSH"
3 FREE DISPENSERS

"WISSH" is especially formulated for cleaning and lubricating electrical contact points, TV tuners, band switches and carbon controls. It prevents oxidation and gives long-lasting protection to radio and TV equipment. Just a few drops will give you excellent results.

also available
in Aerosol
Cans

99¢
DEALER NET



Here's your chance to try this new contact cleaner and lubricant at our expense. You get 3 FREE dispensers when you buy the quart size at only \$2.90. If you're not convinced that "WISSH" is better than your present brand, return the unused portion for a full refund or credit... and keep the 3 dispensers for your trouble! We unconditionally guarantee, there is no better contact cleaner at double this price! Order your "WISSH" from us now!

STOCKED IN CANADA BY:

- **LEN FINKLER & CO.**
330 ADELAIDES ST. WEST,
TORONTO 2B, ONTARIO.
Phone EMPIRE 8-5222
Serving Ontario • Manitoba • Alberta •
Saskatchewan
 - **E. S. GOULD SALES CO.**
3500 ATWATER AVE., SUITE 108,
MONTREAL, QUEBEC.
Phone WE 7115
Serving Quebec and Maritime Provinces
- † PRICES SLIGHTLY HIGHER IN CANADA



All for only
\$2.90*
Dealer Net

*\$3.15 WEST OF MISS.

WORKMAN TV INC. TEANECK, N. J.
Manufacturers of
Electronic SPECIALTIES

NOW-YOU CAN MASTER TV THIS EASY WAY with this latest book in the G/L TECHNICIANS' BOOK CLUB



The author, international TV authority E. Aisberg, calls his book TV—IT'S A CINCH!—and he named it well. The breezy conversational style and the hundreds of amusing but informative sketches help you grasp the elements of TV quickly, easily and ENJOYABLY! You'll learn more from this big unusual 224-page book than from most conventional school-book type texts. Read how you can get this \$4.60 book for only \$3.35 through the G/L TECHNICIANS' BOOK CLUB.

HOW THE BOOK CLUB WORKS

Through mass printing and distribution, the G/L TECHNICIANS' BOOK CLUB enables you to get TV—IT'S A CINCH and other fine books on servicing at a saving of 27% on a money-saving one-at-a-time plan. Examine the books in your own home at our risk. Keep only the books you like—pay only for those you keep. Reap the savings of mass publishing.

HOW TO ENROLL

Just fill out the coupon below and indicate the book you want. SEND NO MONEY NOW! Look the book over. If you like it, keep it and send remittance. If you don't send it back. Every three or four months a new book is published which you receive under the same FREE inspection plan. You agree to take a minimum of only four books over the full term of your membership. You may cancel at any time after that. These beautifully bound cloth-cover books by top writers cost \$4.60 retail—club members get them at a 27% discount—\$3.35 each. Join now to take advantage of this exceptional saving!

THESE BOOKS ALREADY PUBLISHED

- The Oscilloscope—By George Zwick
- Probes—By Martin Clifford and Bruno Zucconi
- The VTVM—By Rhys Samuel
- RAPID TV REPAIR—By G. Warren Heath
- Sweep and Marker Generators for Television and Radio—By Robert G. Middleton
- Servicing Record Changers—By Harry Mileaf

TO BE PUBLISHED SOON

- HOW TO SERVICE COLOR TV RECEIVERS—Robert G. Middleton
- TV AND RADIO TUBE TROUBLES—Sol Heller
- WORKING WITH THE 'SCOPE—A. Haas
- TRANSISTORS
- SERVICING TAPE RECORDERS

NO-RISK COUPON

Gernsback Library Inc. P-57
154 West 14th St.
New York 11, N.Y.

- Begin my enrollment with the book checked below. Send me book for FREE 10-day trial.
- | | |
|--|---|
| <input type="checkbox"/> TV—It's a Cinch | <input type="checkbox"/> The V.T.V.M. |
| <input type="checkbox"/> Sweep and Marker Generators | <input type="checkbox"/> Probes |
| <input type="checkbox"/> Servicing Record Changers | <input type="checkbox"/> Rapid TV Repair |
| | <input type="checkbox"/> The Oscilloscope |
- Send me more information on the G/L TECHNICIANS' BOOK CLUB

Name _____
(Please print)

Street _____

City _____ State _____

One further point in Fig. 3 is of interest. A thermistor* is employed in the bias-resistor chain of the class-B output stage. Transistors are highly sensitive to temperature changes and the insertion of a thermistor in the bias network tends to vary the base-emitter voltage to keep the crossover current at the desired value and minimize crossover distortion.

Class-A power amplifiers are also widely used, and these can be either single-ended, as in Fig. 7, or push-pull, as in Fig. 8. Observe that the circuit arrangement of a single-ended power amplifier does not differ noticeably from corresponding voltage amplifiers. This is particularly true of transistor amplifiers because in essence every transistor amplifier is a power amplifier (irrespective of its function). For the final stages of a system, we would use larger transistors to obtain more power. In the initial stages, the driving power is smaller and so we use smaller transistors (those with lower operating currents).

The two class-A power amplifiers shown in Fig. 7 are similar, differing only in the method used to bias the base-emitter circuit. The circuit in (A) uses one less resistor and the current drain on the battery is lower, but its stability with temperature change is not as good as the circuit in (B). The amount of power which can be obtained from either arrangement depends on the amplitude of the driving signal and the allowable transistor dissipation.

The circuitry for transistors in push-pull is scarcely more complex than it is for the single-ended arrangement. In Fig. 8, a balanced input transformer provides equal but oppositely-phased signals, while a similarly center-tapped transformer is employed for the output. The emitters of the two 2N37 units are grounded, and the operating point is established by varying the resistance of R1. In the present instance, a total collector current of 8 ma is recommended by the transistor manufacturer. ▲

* A thermistor is a thermally-sensitive resistor which has a high negative temperature coefficient; i.e., its resistance decreases as temperature rises and increases as temperature falls.

Audio Facts

(Continued from page 19)

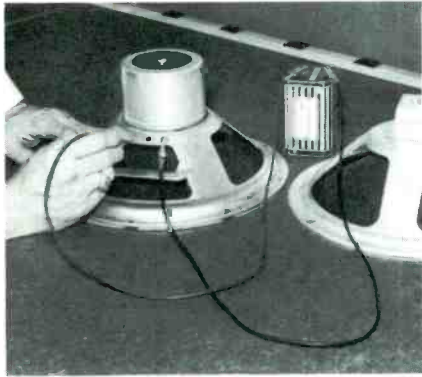

(A) With battery.

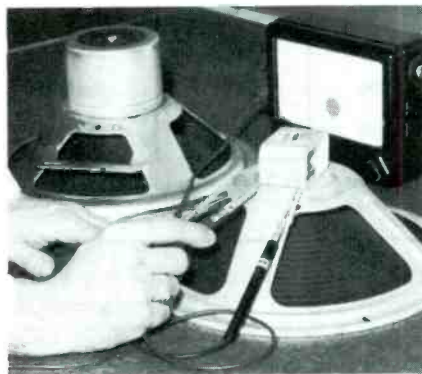

(B) With VOM.

Fig. 3. Determining speaker phase.

marked using the test speakers as a guide.

If transformers made by different manufacturers are to be used in a multiple speaker system, the phasing of the different transformers must be determined. This may be done with a previously checked speaker and a 45- or 67½-volt "B" battery. As shown in Fig. 4, connect the speaker to the transformer secondary, making sure that the marked side of the speaker (side to which the negative terminal of the battery was connected in the speaker phasing check) goes to the transformer terminal marked "C" or "common." Then connect the negative side of the battery to the low side of the primary winding. Touch the positive battery lead to the other end of the primary and note the initial direction of cone travel at the instant contact is made.

Repeat this test using the same speaker and battery for at least one transformer made by each different manufacturer. If the loudspeaker cone travels in a different direction with any brand of transformer, make a note to re-

verse the connections of any speaker used with that brand of transformer.

Having determined the phasing characteristic of each type of transformer and loudspeaker, it is possible to connect the entire speaker system so that all of the speakers will operate in phase with each other.

The efficient transfer of audio power from a power amplifier to several speakers can be obtained only if the load presented by the speakers closely matches the output impedance of the amplifier. There are two methods of impedance matching in widespread use—constant voltage and constant impedance.

Constant-Voltage System

First, you can't look at the output transformer in the PA power amplifiers for the two systems and see any physical difference; however, there is an electrical difference between them. The constant voltage system functions on the same principle as does the 117-volt AC line; i.e., the output transformer is a low-impedance, constant-voltage power source very much like the substation of a power company. In the constant-voltage system, the voltage on the secondary of the output transformer is relatively constant, regardless of load, as long as the rated power capacity isn't exceeded. This permits each individual speaker to be operated at different power levels in much the same way that different loads can

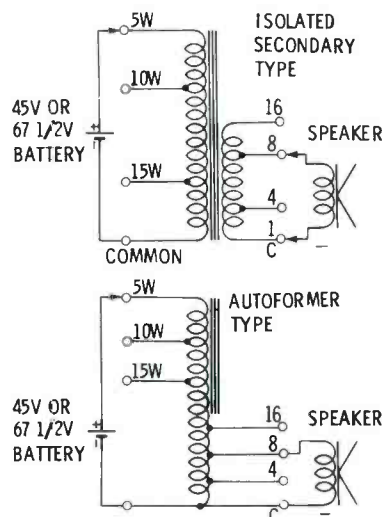

Fig. 4. Setup for checking transformers for proper output phase.

Europe's
largest selling
electronic tubes
... and at standard prices!

TELEFUNKEN

electronic pioneer
since 1903



**NOT A REPLACEMENT
BUT AN IMPROVEMENT!**

**NO
RETURNS**
**NO
MICROPHONICS**
**NO
DISTORTION**
**NO
COMPROMISE
WITH
QUALITY**

Write for your Telefunken Tube Manual and
for the name of your nearest jobber.

Exclusively imported by

AMERICAN ELITE, INC.

Dept. Y, 7 Park Avenue, New York 16, N. Y.

Exclusive importers also of Hi-Fi Home Systems,
Microphones and Hi-Fi FM Car Radios.

the specs are the proof . . .
the BEST BUYS are **EICO**
for COLOR & Monochrome TV servicing



• Features DC Amplifiers!

Flat from DC-4.5 mc, usable to 10 mc. VERT. AMPL.: sens. 25 rms mv/in; input Z 3 megs; direct-coupled & push-pull thruout; K-follower coupling bet. stages; 4-step freq-compensated attenuator up to 1000:1. SWEEP: perfectly linear 10 cps-100 kc (ext. cap. for range to 1 cps); pre-set TV V & H positions (30 & 7875 cps); auto. sync. ampl. & lim. PLUS: direct or cap. coupling; bal. or unbal. inputs; edge-lit engraved lucite graph screen; dimmer; filter; bezel fits std photo equip. High intensity trace CRT. 0.06 usec rise time. Push-pull hor. ampl., flat to 400 kc, sens. 0.6 rms mv/in. Built-in volt. calib. Z-axis mod. Sawtooth & 60 cps outputs. Astig. control. Retrace blanking. Phasing control.



Entirely electronic sweep circuit (no mechanical devices) with accurately-biased inductor for excellent linearity. Extremely flat RF output; new AGC circuit automatically adjusts osc. for max. output on each band with min. ampl. variations. Exceptional accuracy: edge-lit hairlines elim. parallax. Swept Osc. Range 3-216 mc in 5 fund. bands. Variable Marker Range 2-75 mc in 3 fund. bands; 60-225 mc on harmonic band. 4.5 mc Xtal Marker Osc., xtal supplied. Ext. Marker provision. Sweep Width 0-3 mc lowest max. deviation to 0-30 mc highest max. dev. 2-way blanking. Narrow range phasing. Attenuators: Marker Size, RF Fine, RF Coarse (4-step decade). Cables: output, 'scope horiz., 'scope vertical.



COMPLETE with steel cover and handle. SPEED, ease, unexcelled accuracy and thoroughness. Tests all receiving tubes (and picture tubes with adapter). Composite indication of Gm, Gp & peak emission. Simultaneous set of any 1 of 4 combinations of 3 plate voltages, 3 screen voltages, 3 ranges of continuously variable grid voltage (with 5% accurate pot). New series-leakage voltages: for 600, 450, 300 ma types. Sensitive 200 ua meter. 5 ranges meter sensitivity (1% shunts & 5% pot). 10 SIX-position lever switches: free-point connection of each tube pin. 10 pushbuttons: rapid insert of any tube element in leakage test circuit & speedy sel. of individual sections of multi-section tubes in merit tests. Direct-reading of inter-element leakage in ohms. New gear-driven rollchart. Checks n-p-n & p-n-p transistors: separate meter readings of collector leakage current & Beta using internal dc power supply. CRA Adapter \$4.50

See the 50 EICO models IN STOCK at your neighborhood distributor. Write for FREE Catalog PF-5 Prices 5% higher on West Coast

EICO BROOKLYN 11, N. Y.

TABLE I—LENGTH OF SPEAKER RUNS

Impedance at Source (ohms)	70V Line and 140V Line	Cable Length From PA Amplifier to Farthest Speaker. (feet)		
		No. 18 AWG	No. 16 AWG	No. 14 AWG
4		50	75	125
8		100	150	250
16		200	300	450
250		1100	2000	3000
500	70V, 10 watts	2000	3000	4000
333	70V, 15 watts	1600	2000	3000
167	70V, 30 watts	750	1200	2000
100	70V, 50 watts	450	750	1200
50	70V, 100 watts	230	360	560
400	140V, 50 watts	1800	2800	4000
200	140V, 100 watts	950	1600	2000

Note: 4, 8, and 16 ohm speaker runs are calculated for 15% line loss. Remaining runs are calculated for 10% line loss.

be placed on 117-volt power lines. The power level of each speaker is determined by the tap (Fig. 5) which is selected on the primary of the matching transformer between the speaker and the line. Constant voltage systems may employ either isolation or autoformer types of line transformers. The primaries of the matching or line transformers used in the 70.7-volt constant-voltage system are gen-

erally tapped in 3-db power steps according to RETMA standards. These power steps are: .625, 1.25, 2.5, 5, 10, and 20 watts.

In using the 70.7-volt system of distribution, the power levels to the various speakers should be adjusted so that the total power at the speakers equals the power output capacity of the amplifier. In this way, the volume control setting at the amplifier governs

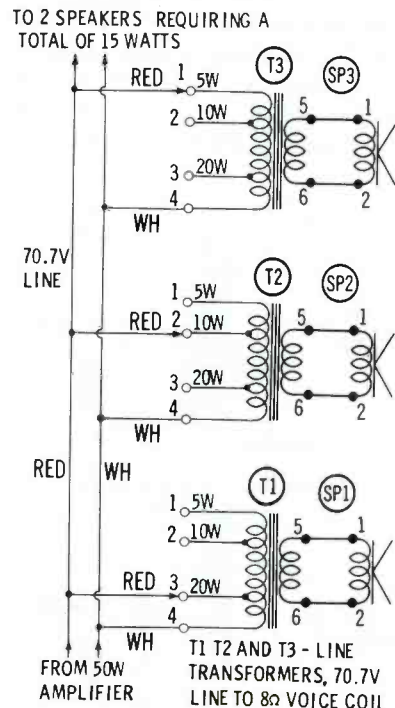

Fig. 5. Typical constant-voltage distribution system to speakers.

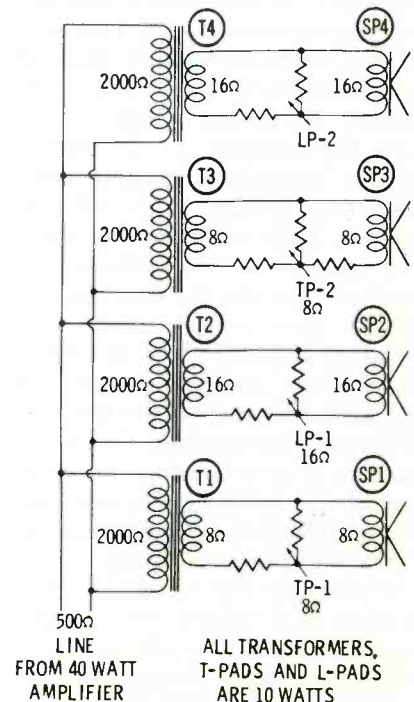
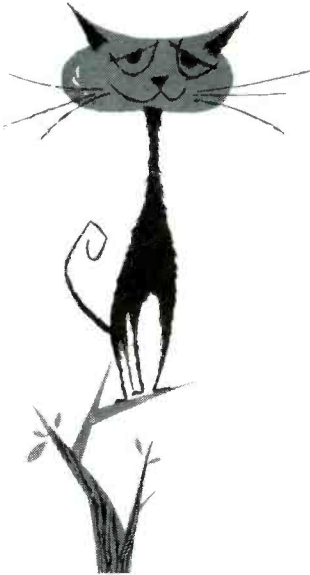

Fig. 6. Typical constant-impedance distribution system using L- and T-pads.



UP A TREE?

Don't be a crazy cat—
come down and get a Merit
exact replacement. Our engineering
and production keep your parts
jobber supplied with parts,
superior to the original,
that drop into place without
mechanical or electrical
change in set chassis.



MERIT

MERIT COIL AND TRANSFORMER CORP.

4427 N. CLARK ST., CHICAGO 40, ILLINOIS

the output levels at all speakers; i.e., at the maximum setting of this control, each speaker will receive its full calculated power and at center setting, one-half of its calculated power.

Constant-Impedance System

In the constant-impedance system, the impedance of each matching-transformer primary must be the same and the parallel combination of all of the primary impedances must equal the output impedance of the PA amplifier (generally 250 or 500 ohms).

Using the constant-impedance method of distribution, each line transformer receives the same amount of power. Should lower power levels be required at some speakers, T-pads or L-pads of proper impedance values and wattage ratings must be used at these speakers. The impedance of each pad must equal the impedance of the speaker, and the wattage rating must equal the power available at this point. If 10 watts is being supplied to each matching transformer, the T- or L-pad must have at least a 10-watt rating.

A speaker distribution and matching system of the constant-impedance type is shown in Fig. 6 complete with T- and L-pads to adjust the power levels at each speaker location. Isolation-type transformers are shown here, but autotransformers could be used.

At first glance, it might seem that the constant-impedance system would be abandoned in favor of the simpler constant-voltage system, but there is one distinct advantage to the former; namely, the volume level at each speaker can be individually varied from very loud to soft or even turned off. This is especially valuable if the speakers are located in different rooms or are widely separated in outdoor installations.

Wire and Conduit Size

We are all accustomed to thinking of a wire as a short circuit with zero resistance. For short runs, such as in TV and radio chassis, or even to an outside antenna, this is essentially true; however, the wires which connect the various speakers to the PA amplifier in a multiple speaker

YOUR BEST BUY

in a UHF Converter

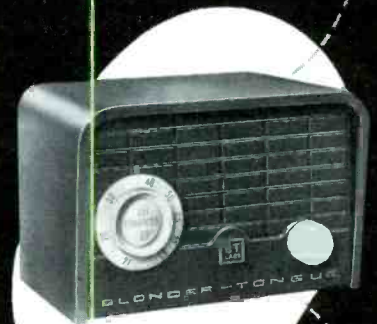

UL approved

B-T LABS Model '99'

OFFERS TOP PERFORMANCE AT LOW COST

only **\$19⁹⁵** LIST

- Tuned Input—tracks with oscillator
- Precise Impedance Match
- One-Knob Tuning
- Dri-t-Free Performance

Check with your supplier today. Also ask about the *Deluxe Ultraverter* ... or write Dept. P-5

BLONDER-TONGUE LABORATORIES, INC.
9-25 Alling St., Newark 2, N.J.

EBY
HELPS YOU SIMPLIFY SERVICING

THE MOST COMPLETE LINE OF

COLOR TELEVISION HARNESSSES AND EXTENSIONS

EBY now makes available, harnesses and extensions to facilitate servicing of all makes Color TV Receivers. A complete service kit is also available . . .

56-12H	CRT Extension	5.35 List
56-6H	Deflection Extension	2.70 List
49-9H	Deflection Extension	2.02 List
AC-4	Hi Voltage Extension	1.44 List
K-312	Color Service Kit	11.00 List

WRITE FOR INFORMATION

EBY SALES CO. of N. Y.
130 LAFAYETTE ST.
NEW YORK 13, N. Y.

Authoritative SAMS AUDIO BOOKS



HI-FI HANDBOOK

This new book by William F. Boyce provides comprehensive information for audiophiles and technicians interested in Hi-Fi design, selection and installation. Chapters cover: Fidelity, Sound Theory and Distortion; Loudspeakers; Baffles and Enclosures; Amplifiers, Preamplifiers and

Controls; Program Source Equipment; Systems Design, Selection and Installation. Really covers the subject, with invaluable hints on equipment selection, operation of program sources, speaker location and system installation. 240 pages; 5½ x 8½"; fully illustrated... **\$3.00**



THE RECORDING AND REPRODUCTION OF SOUND

Oliver Read's popular best-seller; favorably reviewed by leading authorities on audio. Widely used by sound engineers, audiophiles, public address technicians, broadcasting stations, recording studios and audio students. Authoritative chapters cover: behavior of sound

waves; basic recording methods; the decibel; phono reproducers; cutting styli; microphones; loudspeakers and enclosures; amplifiers; AM and FM tuners; home music systems; public address systems—plus hundreds of other subjects. Illus.; 810 pages; 6x9"; hard cover **\$7.95**



TAPE RECORDERS: HOW THEY WORK

Gives you an expert understanding of tape recording. Explains magnetic recording theory; describes characteristics of tape; tells how a recorder operates; discusses motorboard mechanism, drive motors, volume indicators, bias oscillators, equalization circuits, amplifiers and magnetic heads. Tells you how to get best frequency response, how to avoid overload, how to obtain best bias settings; includes procedures for testing recorders and tape. 176 pages; illus.; 5½ x 8½"..... **\$2.75**



ATTENUATORS, EQUALIZERS AND FILTERS

Thoroughly describes design, application and theory of operation of every type of Attenuator, Equalizer and Wave Filter. Covers equalization and attenuation used in audio recording and reproducing systems, both professional and home-type. Includes chapter on

Hi-Fi crossover networks. Provides time-saving charts which permit the easy determination of component values required in designing equalizers and filters. Indispensable to technicians in radio, television and cinema work, and to audiophiles. 176 pages; 5½ x 8½"; hard cover; illustrated... **\$4.00**

PUBLISHED BY

HOWARD W. SAMS & CO., INC.

Order from any Radio & TV Parts Distributor, or mail to Howard W. Sams & Co., Inc., Dept. 3-E7, 2201 E. 46th St., Indianapolis 5, Ind.

Send books checked below. \$_____enclosed

- Hi-Fi Handbook (\$3.00) Tape Recorders (\$2.75)
 Recording & Reproduction of Sound (\$7.95)
 Attenuators, Equalizers & Filters (\$4.00)

Name _____

Address _____

City _____ Zone _____ State _____

TABLE II—CONDUIT FOR SPEAKER CABLES

Size of Wire in Cable	Approximate Size of Conduit (inches)									
	Number of Pairs in Cable									
	2	3	4	5	6	7	8	9	10	20
No. 18 AWG	½	½	½	¾	¾	1	1	1	1¼	1½
No. 16 AWG	½	½	¾	¾	1	1	1	1	1¼	1½
No. 14 AWG	½	¾	1	1	1¼	1¼	1¼	1¼	1½	2

Note 1: If several 90° bends are to be made in one run, use next larger conduit size.
Note 2: Conduit runs between junction boxes should be limited to 50' or less.
Note 3: This chart applies to speaker and intercom cables only.

system are very often quite long—several thousand feet in some cases. For this reason, the resistance of wires in speaker distribution lines cannot be ignored if efficiency is to be maintained.

It is a generally accepted fact that the resistance of connecting wires should not exceed 10% to 15% of the output impedance. This is the reason why line transformers must be employed. It is easy to see that an 8- or 16-ohm speaker connected directly to the proper secondary tap of the output transformer in a PA amplifier could not be placed far away from the amplifier without the use of extremely large wire. It is possible that speakers with voice coils of higher impedance could be made, but this would greatly increase their complexity and cost—line or matching transformers are simpler and less expensive.

Table I gives the length of speaker runs which are possible using No. 14, No. 16 and No. 18AWG 2-wire cable for the impedances and voltages normally encountered in commercial audio work. You will notice that when the constant voltage system is specified, the wire-size requirements increase as the power increases. This follows, since an increase in power means an increase of current flow when the voltage remains constant. The wire sizes shown should be suitable for all power amplifiers in general use.

When speaker cables (distribution lines) will be exposed to weather or other hazards, they should be enclosed in suitable conduits. Table II gives the size in inches for conduit necessary to

handle cable with two to twenty pairs of No. 14, No. 16 or No. 18AWG wire.

Since the cables must be pulled or "fished" through the conduit after the conduit is installed, and since the length of "fish-wire" generally available is limited to about 50 feet, the conduit should have junction boxes at intervals of less than 50 feet. In addition, the conduit should be increased in size if 90° bends are used. It isn't a bad idea to have a junction box between every 90° bend, especially when the cable is a large one.

When conduit is run outdoors, all joints and junction boxes must be made weatherproof. Otherwise, moisture will enter the conduit and possibly cause short circuits. Special waterproof and windproof connectors and junction boxes are available for this application and should be used if possible. In case they are not used, however, a heavy coating of plastic roof cement over each coupling and each junction box will provide adequate protection. If the latter method is employed, the protective coating must be replaced each time a junction box is opened.

Summary

The network between the power amplifier and the speakers is a very important link in any commercial sound system. Correct speaker phasing, impedance matching, and wire size are mandatory if the system is to operate with optimum efficiency. Proper conduit runs are required not only to protect the distribution lines, but also to give the installation a professional touch. ▲

Semiconductor

(Continued from page 23)

formed into a fine point. After assembly, the crystal and cat whisker are encased in wax or some other substance to make the contact moistureproof. The body of the component is molded from an insulator such as plastic, ceramic or glass.

There are also junction diodes on the market. In these, the surfaces of two dissimilar materials are bonded together to form an area-type contact which takes the place of the point contact between the cat whisker and the crystal.

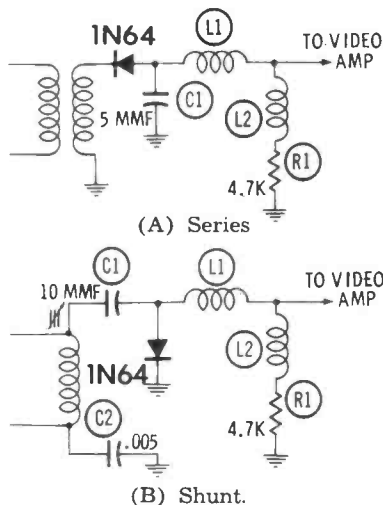

Fig. 4. Typical video detector circuits.

Junction diodes—used mostly in non-TV applications such as computers—may be made from either germanium or silicon.

Identification of Diodes

The symbol which designates a crystal diode in a circuit drawing is shown in Fig. 2. The straight bar represents the crystal which acts as the cathode of the diode, and the arrow stands for the cat whisker, which is the anode. Since this arrow actually points from anode to cathode, it is somewhat misleading to think of the diode symbol in terms of electron flow. When encountering this symbol in a diagram, the reader may find it easier to determine polarity with the aid of some little memory jogger such as A (rrow) = A (node).

A band is usually printed around the cathode end of the diode body to identify polarity. In some cases, the circuit symbol is shown in the proper polarity on the body. The type number is

usually shown also. In the standard RETMA numbering system used for most germanium and silicon diodes, the prefix 1N identifies the unit as being a diode, and the different types are indicated by numbers following this prefix.

Some popular detector diodes are the 1N60, 1N64, 1N295 and 1N367; these are used in transistor radios as well as TV receivers. Among the specialized crystal diodes used as UHF mixers are the 1N72 and 1N82A.

Operating Characteristics

The purpose of the semiconductor diode, like that of the vacuum-tube diode, is to allow electrons to flow readily in one direction and to oppose electron flow in the other direction. In a point-contact crystal diode, this rectifying action depends upon several properties such as the degree and type of impurity in the crystal and the size of the contact area between the crystal and the cat whisker.

It should be explained that a crystal diode does not act as a simple valve because the amount of electron flow is not the same at all times when the anode is positive with respect to the cathode. The diode has some resistance to electron flow in the forward (cathode-to-anode) direction. This resistance becomes less as the potential between anode and cathode is increased. Therefore, more forward current is passed when the potential difference is high than when it is low.

Electron flow through the diode does not cease completely when the anode is made negative with respect to the cathode. That is to say, the reverse resistance of the diode has a finite (but high) value, and some current will therefore be passed in the reverse direction. The amount of reverse current is in the order of microamperes and is slight in comparison with forward current which is generally measured in milliamperes.

Whenever the potential is increased in the inverse direction (cathode more positive than anode), the reverse resistance is lower and there is an increased amount of reverse current. Crystal diode circuits must be designed

for the first time . . .
a five-volt phono cartridge
with response to 10,000 cps
for improvement-replacement
applications!

the new

SHURE

W9

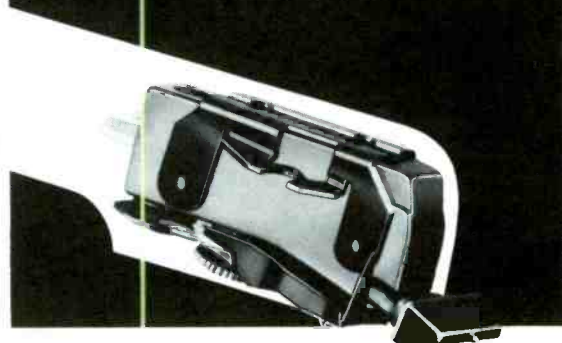

This three-speed, dual-needle, dual-voltage crystal cartridge creates a whole new market for you! With the Shure W9, you can dramatically improve the sound of low-cost, low gain phonographs. The W9 replaces sixty-nine frequently used, high output cartridges of twelve manufacturers.

You can replace the needle of the W9 in a matter of seconds, without tools and without removing the cartridge from the tone arm.

SPECIFICATIONS

Output: 5.0V for 78 rpm, 3.5V for microgroove*

Needle Force: 9 grams

Response: 40-10,000 cps

Net Weight: 7 grams

List Price: \$9.50 with two synthesized sapphire needles

*Model W9 has capacitor furnished as an accessory. With capacitor, output is 1.7V for microgroove, 2.5V for 78 rpm.

SHURE

The Mark of Quality

SHURE BROTHERS, INC.

Microphones ~ Electronic Components

204 HARVEY AVENUE • EVANSTON, ILLINOIS

"In Electronics since 1925"

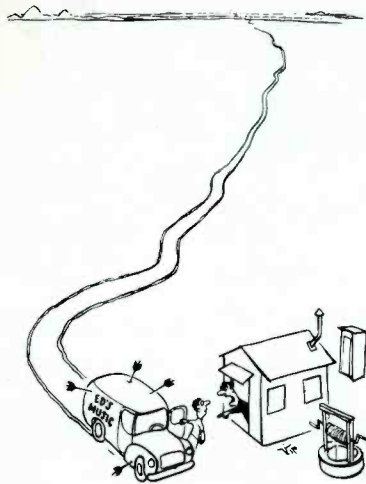

"Listen! If you don't have
JENSEN NEEDLES,
just forget I called!"

NOW! MORE METAL
PICTURE-TUBE SETS
THAN EVER BEFORE
CAN BE CONVERTED TO
ALUMINIZED or ALL-GLASS TUBES



NEW

C-6
Kit

AIRLINE
CORONADO
TRUETONE
FIRESTONE
WELLS-GARDNER
LIST PRICE \$6.25

NEW

C-7
Kit

ARVIN
SILVERTONE
LIST PRICE \$6.95

NEW

C-8
Kit

27" RCA-VICTOR
LIST PRICE \$5.95

NEW

C-9
Kit

CROSLEY
LIST PRICE \$5.75

COLMAN TOOL & MACHINE CO.
P. O. Box 7026, Amarillo, Texas

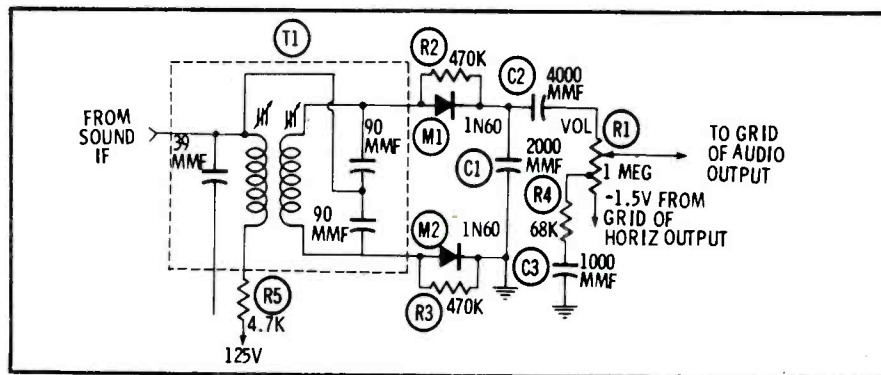

Fig. 5. Discriminator circuit in Muntz Model 621C which uses non-matched 1N60 crystal diodes with shunt resistors.

so that the maximum reverse-current rating of the diode will not be exceeded, and the reverse current will thereby be kept within permissible limits.

Crystal Rectifier Circuits

Reduced to its simplest terms, a crystal diode circuit is a half-wave rectifier similar to one of those which appear in Fig. 3. The basic circuits shown in this figure can be modified and combined for various practical uses. The diode is connected in series with the load in Figs. 3A and 3B and in shunt with the load in Figs. 3C and 3D. Two circuits of each kind are shown to illustrate that the polarity of the output signal depends upon the way the crystal is connected in the circuit.

The output of each rectifier is similar to one half of a sine wave when the input is a complete sine wave, but DC could be obtained if the output were filtered. Since these are rectifier circuits, the cathode of the diode corresponds to the positive output terminal. It is assumed that the load resistor in each circuit has a value that is several times greater than the forward resistance of the diode and considerably less than the reverse resistance.

When the crystal is connected as shown in Fig. 3A, the cathode of the diode is positive with respect to the anode during the positive half of the input sine wave. Because of the high reverse resistance of the diode, minimum current will flow in the circuit and essentially no signal voltage will appear across R_L . During the negative portion of the cycle, the cathode of the diode is made negative. Forward current then flows readily through the diode, and a

negative output voltage is developed across the load resistor R_L . In Fig. 3B, the polarity of the diode is such that heavy forward current will flow during the positive half cycle of the applied voltage. As a result, the positive half of the signal will be developed across R_L .

The diode in Fig. 3C is biased in the forward direction during the positive half cycle of the input signal. The diode conducts heavily and places a virtual short across the load resistor, with the result that no appreciable output voltage is developed. During the negative portion of the input signal, the diode is biased in the reverse direction. The reverse resistance of the diode is much higher than that of R_L , and a negative output voltage is obtained. Fig. 3D shows that changing the polarity of the diode also causes a change in output polarity.

Circuit Applications

Video Detector

Fig. 4 shows two kinds of crystal-diode video detectors which have been employed in TV sets—the popular series arrangement in Fig. 4A, and the less common shunt arrangement in Fig. 4B. Note the similarity to Figs. 3A and 3C respectively. Both of the detector circuits are designed so that negative sync pulses will be present at the input of the following stage. Use of this output signal polarity is common practice in the majority of TV receivers.

Although signals in the IF range must be filtered out, an extremely wide range of video frequencies (from approximately 30 cps to 4 mc) must be kept intact in the video detector output. To pre-

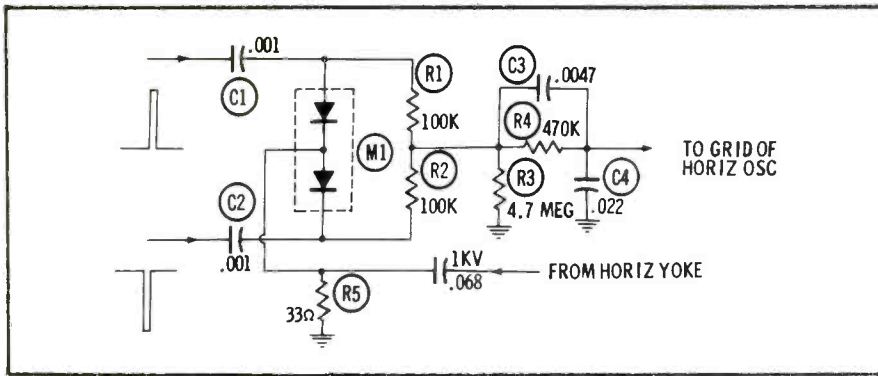

Fig. 6. Horizontal AFC circuit using selenium diodes instead of tubes in Admiral Chassis 14YP3B.

serve the higher video frequencies, the RC time constant of the output circuit has to be fairly short. The load resistor R1 must be held to a low value for this purpose, since considerable stray capacitance is in shunt with the circuit at high video frequencies. An important advantage of the crystal diode over a vacuum tube is that the former places less shunt capacitance in the circuit and permits the use of a higher-value load resistor without an increase in total RC time.

Nevertheless, the value of load resistance is still so low that the forward resistance of the diode becomes a significant portion of the total resistance of the circuit. Some of the output voltage is dropped across this internal resistance, with the result that the video detector is less efficient than an ordinary narrow-bandwidth detector. This problem is not peculiar to crystal circuits, but affects all kinds of video detectors.

A crystal for use in a video detector should have the lowest practical value of internal forward resistance in order that the detector will be as efficient as possible, and in order to minimize distortion of the video signal that might be caused by the nonlinear nature of the forward resistance.

FM Sound Detector

Germanium diodes take the place of a tube in the discriminator or ratio detector circuits of a few recent models of TV receivers. For example, the Muntz Model 621C includes the circuit of Fig. 5. Notice that it is similar to a discriminator using a tube except that two 470K resistors are in parallel with the diodes. These are included because of the finite back

resistance of the crystal units. If the resistances of the two diodes in the reverse direction were unequal, the circuit would be thrown out of balance. The possible remedies are either to select a pair of diodes with matched values of reverse resistance or else to include the shunting resistors for the purpose of establishing a more stable value for this characteristic.

Crystal-type ratio detectors are also being designed. One of these, using 1N367 diodes, can be found in the RCA Victor Chassis KCS 100B portable receiver; another, with 1N60 diodes, is used in the Trav-Ler Chassis 520A5.

Selenium Diodes

Increasing numbers of semiconductor diodes have been used in the horizontal AFC stages of TV receivers during the past year or two, and most of these have made use of selenium. Much of the foregoing description of crystal diode circuitry and operation applies as well to selenium diodes, but the latter have certain distinctive features. Instead of being point-contact devices, such as crystal diodes are, they are area-type rectifiers. Their greater contact area results in larger internal capacitance which limits them, at least at present, to low-frequency operation.

Various configurations are used in selenium-diode AFC circuits; one arrangement, found in an Admiral portable TV chassis, appears in Fig. 6. Component M1 is a matched pair of diodes encapsulated in a single housing. This particular unit has the anode of one diode tied to the cathode of the other, but common-cathode types have also been produced. Interna-

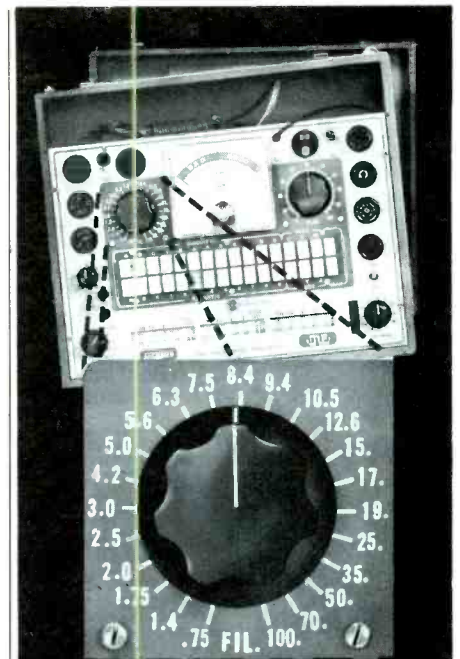

**23 Separate
Heater Voltages
on the Dynamic®
JACKSON 648A
Assure Accurate
Tests for all
Series-String Tubes
...The Correct Voltage
for Every Known or
Presently Planned Type.**

YOU CAN MODERNIZE YOUR PRESENT 648

New 64E FV Kit provides same heater voltages as the new 648A Tester. Only four wires to solder. Installs in minutes. Available from your distributor now.

JACKSON
ELECTRICAL INSTRUMENT CO.

"Service Engineered"
Test Equipment

16-18 S. Patterson Boulevard • Dayton 2, Ohio
In Canada: The Canadian Marconi Company

Another Sencore Time-Saver

SENCORE TUBE and CAPACITOR LEAKAGE CHECKER



A MUST FOR SERVICING GRID CIRCUITS

A highly accurate tester for detecting leakage between tube elements.

MODEL LC-2

A reliable instrument for indicating capacitor leakage with 50 volts applied. Quickly indicates • Grid to cathode leakage • Grid emission • Heater to cathode leakage • Gassy tubes.

"Two Testers in One"

POPULAR SENCORE PRODUCTS

- Transistor Tester
- Leakage Checker
- Filament Tester
- Voltage Regulator
- Bias Supply

Only \$2495

DEALER NET KIT — \$19.95

Checks 70 Critical Tube Types AT LEADING DISTRIBUTORS EVERYWHERE

Mfg by **SENCORE SERVICE INSTRUMENTS CORP.**

171 OFFICIAL RD., ADDISON, ILL.

tional Resistance Co. makes exact replacements for these dual diodes.

In the event exact replacements for encapsulated dual diodes are not available, one of these components can be replaced by two single diodes of a type such as the 1T1 (International Rectifier Corp.) or the 1215 (Federal Telephone & Radio Co.). Proper polarity can be determined by reference to a schematic of the receiver. Replacement AFC diodes of a silicon or germanium junction type may also become increasingly available.

Testing Semiconductor Diodes

A very simple and conclusive method of testing a semiconductor diode is to replace it temporarily with one that is known to be in good condition. If a diode must be unsoldered from its circuit for testing purposes, care should be taken to prevent the unit from becoming damaged by overheating.

A rough test of the condition of a diode can be made with an ohmmeter. If the component is good, the resistance measured across it in one direction should be only a fraction of the resistance measured in the other direction. It is impractical to use an ohmmeter to check either resistance alone against that given in technical data for a diode, since the latter figure is correct for only one specified value of applied voltage and the ohmmeter battery voltage is different in many cases.

Some information can be gleaned by comparing resistance readings obtained from different diodes, but the readings will be meaningless unless they are all taken with the same ohmmeter and on corresponding meter scales.

General-purpose diodes can be tested accurately for the forward and reverse current characteristics given in technical data if suitable test circuits are set up. Pieces of test equipment required are a source of variable DC voltage, a voltmeter, and an ammeter having milliamperere and microampere scales. The voltages specified in the data should be applied across the crystal in the required direction, and the resulting cur-

rent should be measured and compared with the listed value.

Diodes used for specific purposes (for example, video detectors and UHF mixers) are best tested in elaborate circuits which simulate actual operating conditions. Building such a test circuit would be worthwhile if a large number of diodes were to be checked, but not for only an occasional check. Much the same kind of test is accomplished when a crystal is put into an actual circuit to see whether it will function properly.

Summary

A semiconductor diode is actually similar to one half of a transistor. There is still much that is not known about the contact rectification action that takes place at the surface of semiconductors, although a considerable amount of research is taking place in this direction. Despite this, however, the factual material presented here should leave the reader with a good practical understanding of semiconductor diodes and their applications. ▲

ask the "Man-on-the-Roof" why he prefers *South River*.



COMBINATION PEAK & FLAT ROOF MOUNT

MODEL PFM-30
(Fits Masts up to 1 1/2")

MODEL PFM-30 LM
(Fits Masts up to 2")

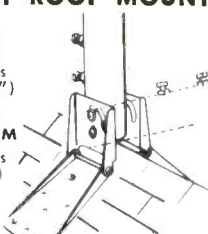

Features the patented South River "Walk-Up" — "Drop-Lock" mast socket for easy installation on either Peak, Flat or Pitched roofs. Heavy gauge pipe mast socket has two heavy duty screws and locknuts to secure mast. Factory assembled and supplied in a heavily plated rust resistant finish. U.S. PAT. #2734708

WRITE FOR NEW 1957 CATALOG

SOUTH RIVER METAL PRODUCTS CO., INC.
South River, New Jersey

pioneer & outstanding producer of finest line of antenna mounts

the cartridge that scores **100%**

passes all tests with **FLYING COLORS**



Recoton - Goldring

New MODEL "555 SDM" MU-METAL SHIELDED MAGNETIC TURNOVER CARTRIDGE

Acclaimed the best performer by a national independent research organization!
Acclaimed the best by audiophiles everywhere!

Sturdy construction, excellent performance, popular price, make it the best bet for bigger profits, bigger sales!
Write for descriptive literature today.

RECOTON CORPORATION
52-35 Barnett Ave. Long Island City 4, N. Y.
In Canada: Quality Records, Ltd., Toronto

Auto Radio Service

(Continued from page 25)

voltage of a vibrator (an index to its condition) or for observing the effect of high or low input voltages upon the operation of the radio. Battery eliminators normally can put out at least 10 amps continuously on the 6-volt range and 6 amps on the 12-volt range. Some handle even greater loads.

Both a voltmeter and an ammeter are usually built into the unit for monitoring the exact DC voltage output and current drain. The rectifier output circuit often includes a circuit breaker with an automatic reset feature, to furnish convenient protection for the radio being repaired.

When hybrid auto radios were introduced, the fear was expressed that these would be harmed if powered from a battery eliminator. It is logical to suspect that ripple and transient pulse voltages in the output of power packs might exceed the rather low maximum voltage ratings of the transistors and tubes used in hybrid sets. However, a recent check of several auto radio shops revealed that hybrid radios are being serviced successfully with standard type battery eliminators.

To minimize the possibility of damage to the hybrid radios, it would be wise to check the condition of the filters in any rectifier type of power pack used with them. The latest models of battery eliminators are equipped with improved filtering in the output.

An auto radio should be connected to the power source through heavy-duty leads having a high-current capacity. Alligator clips may be attached to both ends of the leads; or, for greater convenience, some of the leads can be equipped at one end with a special tip for attachment to the fuse receptacle of the radio.

If an auto-radio fuse blows for reasons other than a simple short circuit or vibrator failure, you should find out whether the cause was age or weakness of the fuse itself or some defect producing an increase in the current drain of the receiver. You can check for the latter condition while the set is still mounted in the car. For safer and speedier checks, equip an ammeter with test leads having

special end connectors to fit the fuse receptacle and the external "hot" lead of the radio.

An ordinary whip antenna with a coaxial lead can be fastened to the service bench and plugged into the antenna jack of a receiver whenever needed. A test speaker with clip leads or pin connectors will relieve you of the chore of pulling separately-mounted speakers out of cars.

Components

Many of the failures in auto radios involve certain hard-work-

ing components, and it pays to stock an assortment of these even if you have only an occasional auto job. Chief among these components are vibrators, buffer capacitors, fuses, and certain tubes.

Vibrators and Buffers

The vibrator and buffer work as a team with the vibrator transformer. The buffer capacitor and the secondary winding of the vibrator transformer acts as a tuned circuit to damp out the high voltage pulses developed each time the vibrator contacts are opened.



The Capacitor Package that means Quality

1 year service guarantee

When you see this package in the familiar red and black box, you know it contains "trouble-free" Planet capacitors—mechanically and electrically tested throughout manufacture.

This rigid system of quality control makes our unconditional one-year guarantee possible. But making Planet capacitors correctly from the start means reasonable prices too!

PLANET SALES CORPORATION

225 BELLEVILLE AVENUE
BLOOMFIELD, N. J.

Write for Catalog listing specifications on stock items.

If the buffer is of the wrong value, the pulses are not properly suppressed and may be reflected back into the primary circuit to cause eventual damage to the vibrator.

A standard piece of advice in the servicing industry is to replace the buffer as a matter of routine whenever you replace a bad vibrator—it's a form of call-back insurance. Relatively few different types of vibrators and buffers need to be carried in stock to accomplish most repairs. Usually, 6-volt radios have a standard 4-prong vibrator which can be re-

TABLE I—Vibrator Cross-Reference Chart

	ATR	Delco	James	Mallory	Radiart	Vokar
4-prong 6-volt						
2 7/8" high....	340		J2SP	1601/859	5301	464
3 1/8" high....		8542			5300	
4-prong 12-volt....	1340			G1601/G859	6301	4124
3-prong 12-volt....	1343	8550	12J7	G1602/G874	6330	3129

placed with any of the units in the first line of Table I. The 3 1/8" units in the second line of the table are like the 2 7/8" types electrically and can be used if there

is sufficient clearance. The 12-volt counterparts of the standard 6-volt vibrators are also listed. The buffer capacitor used with all these 4-prong vibrators is connected across the entire secondary of the transformer (as in Fig. 1A) and is rated at 1,600 volts as a rule. The most frequently encountered values are .008, .007, .006 and .004 mfd; less often used values are .0033, .0068, and .0082 mfd.

Many Motorola and Philco sets have buffer capacitors connected to ground from one side of the transformer secondary, as in Fig. 1B. These units have lower voltage ratings (usually 1,000 volts) and higher capacitances (.015, .02, .022, or .03 mfd) than the type in Fig. 1A. Vibrators used in the second type of circuit are very similar physically and electrically to the standard 4-prong types, but they are different enough that the exact replacements may have special part numbers. These vibrators can often be replaced with the standard variety, but it would be wise to check the waveform across the buffer with an oscilloscope to be sure that the pulse voltages are not excessive.

Some 12-volt radios, notably those in General Motors cars, employ a 3-prong vibrator, replacements for which are listed in the bottom line of Table I. This vibrator is used in a circuit much like that of Fig. 1A.

Fuses

Type numbers for the various

TABLE II

Common Auto Radio Fuses

Type No.
1AG 5
3AG 7 1/2
3AG 10
3AG 15
7AG 7 1/2
SFE 9
SFE 14
SFE 20

HI-FI KITS FOR THE HIGHWAY!





G-C SPEAKER KITS . . .
High Fidelity Sound for Every Automobile

G-C SONATA HI FIDELITY DUAL SPEAKER KITS

Breathtakingly realistic sound for rear deck installation. Includes two matched speakers—Tweeter & Woofer—with crossover network for balancing the high and low frequencies. Universal harness connector for custom-style hookup; 3-way switch; instructions; all hardware. Choice of grille colors.

List

No. 9502 (Classic Chrome) **\$19.95**
 9503 (Springtime Gray) **19.95**

GENERAL CEMENT MFG. CO.

DIVISION OF TEXTRON INC.
 400 South Wyman Street • Rockford, Illinois

ALL G-C KITS PACKED IN SELF-MERCHANDISING DISPLAY BOX



G-C REAR DECK HI-FI DUO-SPEAKER KITS

Actually two speakers in one, this new G-C model gives the finest radio sound without taking extra space. Large permanent magnet. Ready to install complete, wired, switch, plate, knob and hardware.

List

No. 9506 (Chrome) **\$15.95**
 9505 (Gray) **15.95**

ALSO A COMPLETE LINE OF G-C REAR DECK AUTO SPEAKER KITS AND ACCESSORIES FOR ANY REQUIREMENT.



FREE . . . Send today for G-C Catalog and complete information.

fuses often called for in auto radio work are given in Table II where the figures following the letters indicate the amperage rating of each fuse. The 14-amp type is common in 6-volt radios, 7½- or 9-amp types in all-tube, 12-volt radios, and 5- or 7½-amp types in hybrid transistor sets.

Tubes

Until the introduction of hybrid auto radios, the miniature receiving tubes used in the automobile field were fairly well standardized. Many types are common to both auto and home radios. Table III lists the tubes ordinarily used in various functions in all-tube car radios. An entirely different complement of tubes, intended for hybrid radios, was listed in "Stock Guide" in the March PF REPORTER.

Tools

The "right tool for the job" is really indispensable when you are working behind the dashboard of a car. If your shop is reasonably well equipped for general radio-TV work, you should already have most of the tools required in the auto-radio field. Check your tool kit against this list of items needed to remove and reinstall radios on various 1955 cars:

- Ordinary screwdriver.
- Regular and stubby Phillips screwdrivers.
- Box-end (or open-end) wrenches

TABLE III

Popular Auto Radio Tubes

RF/IF	6-/12BA6 6-/12BD6 6-/12AU6
CONVERTER	6-/12BE6
DETECTOR & 1st AUDIO	6-/12AV6 6-/12AT6 6-/12CR6 12BF6
PHASE INVERTER	6C4 12AV6
AUDIO OUTPUT	6-/12AQ5 6-/12V6 12AB5
RECTIFIER	6-/12X4 6X5GT 0Z4
RELAY TUBE	12AU7

in sizes from ⅜" to ¾".
Nut drivers in sizes from ¼" to ⅜".

Deep socket wrenches in sizes from ⅞" to 1⅞".

#6 and #8 Allen wrenches.

Electric drill and reamer for antenna installations.

The stubby Phillips screwdriver is handy in tight quarters, as when you are removing screws inside a glove compartment. Ordinary wrenches are okay for removing most chassis mounting bolts, but deep-socket wrenches are often

the only suitable means for removing the large nuts behind tuning knobs. These are often set in a recessed spot in the dashboard, inaccessible to open-end wrenches; and the protruding tuning shafts get in the way when you try to use a shallow socket wrench. Pliers? Horrors!

As you have probably suspected, auto radio servicing is not a lazy man's game. But come to think of it, neither is any other kind of radio or television servicing that we have heard of. ▲



"Blue Beaver"® Electrolytics

Cornell-Dubilier's "Blue Beavers" are the serviceman's very own. They're sold only through authorized C-D Distributors. Full profit and complete customer satisfaction comes only with "Blue Beaver" Electrolytics. They are a truly *exclusive* capacitor—exclusive in quality and long life performance—and made only by C-D, *exclusively* for the service trade. Ask your nearby C-D Distributor for catalog or write direct to Cornell-Dubilier Electric Corporation, South Plainfield, N. J.



Cornell-Dubilier capacitors

South Plainfield, N. J.; New Bedford, Worcester & Cambridge, Mass.; Providence & Hope Valley, R. I.; Indianapolis, Ind., Sanford, Fuquay Springs & Varina, N. C.; Venice, Calif., & subsidiary, The Radiart Corporation, Cleveland, Ohio.

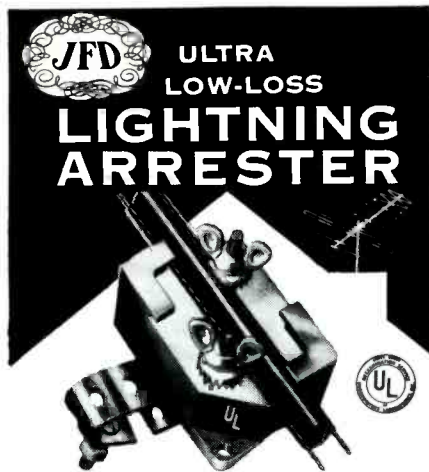

Ultra low-loss performance on VHF-UHF frequencies.

Patented strain-relief retaining lips prevent tearing or ripping of wire.

Universal design takes all transmission lines.

NO. AT110 LIST \$1.50
(wall mounting)

AT110S LIST 1.75
(stainless steel strap)

"World's largest manufacturer of TV Lightning Arresters"



MANUFACTURING CO., Inc.
BROOKLYN 4, NEW YORK



Pat. No. 2757316

TV TUBE RESTORER

Model K-101

\$550

List Price

LOCATES AND CORRECTS FOR

- Control Grid-Cathode Short
- Heater-Cathode Short
- Open Cathode
- Open Control Grid
- Low Emission
- Combinations of above

Perma-Power COMPANY

3100 N. ELSTON AVE. • CHICAGO 18, ILLINOIS

There's Always Something NEW Being Developed by Perma-Power

Notes on Test Equipment

(Continued from page 27)

Test features are:

1. Static PNP-NPN Transistor Test—base-emitter and base-collector leakage current with open base element. Base current amplification factor (Beta) with 40- μ a DC signal applied to base element. (Meter reading $\times 25 = \text{Beta}$.)
2. Static Diode Test—forward and reverse resistances given in terms of maximum and minimum current flow, two test leads are provided for the diode measurement.

On examination of this instrument, I found the transistor test of considerable interest. It actually involves two separate operations. Selecting one of the p-n-p type of transistors from a typical transistor radio, I placed the unit in the subminiature socket on the front panel of the tester. Next, I set the selector switch labeled "Test-NPN-PNP" in the "test" position and flipped the battery power switch on. The instrument was now ready for the first test which determines whether the transistor is good or bad. Snapping the toggle switch labeled "Test-Gain" to the "test" position, the meter pointer barely moved from its zero position. In this test, the internal battery voltage is applied across collector-emitter elements while the base is left floating. Leakage current between base-emitter or base-collector junctions is then measured directly on the panel meter. The meter movement has a 3-ma full scale deflection. Readings higher than .5 ma for this first test indicates the transistor is defective and should be replaced.

In the second test, I placed the selector on "PNP," flipped the toggle switch to the "gain" position, and observed the meter reading. According to the instrument's instructions, the meter reading must be multiplied by 25 to get the base current application factor of the transistor.

Adder Accessory Aids Alignment

The relatively small bench instrument pictured in Fig. 3 is the new Model 220 Marker Adder manufactured by Precision Apparatus Co., Inc. of Glendale, L.I. This unit is designed to help the



Fig. 3. Precision 220 Marker-Adder.

service technician in aligning monochrome and color TV receivers as well as FM radios. It does not generate alignment signals but serves to superimpose a given marker pulse on the scope response pattern without passing the marker signal through the receiver.

Specification features are:

1. Power Requirements—117 volts, 50-60 cps AC supply, power consumption 30 watts.
2. Frequency Response—adequate for all TV-FM alignment frequencies (IF through VHF), excellent response to 60-cps square waves for true scope pattern reproduction.
3. Sweep and Marker Inputs—input impedance of 90 ohms each, decoupling network between inputs for isolating marker signal from receiver, separate coaxial input cables provided.
4. Receiver Response Input—680-ohm minimum impedance, circuit design maintains response polarity, coaxial input cable provided.
5. Output to Oscilloscope—marker and receiver response amplitudes continuously variable; selector switch provides narrow, medium and wide marker widths, coaxial output cable provided.

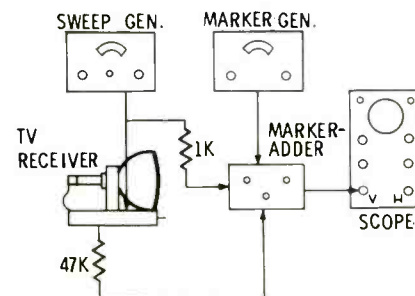

Fig. 4. Typical instrument setup for IF alignment using marker adder.

I had the chance to use one of these instruments while performing some experimental alignment work in our labs recently. Since one phase of my work called for the IF alignment of a typical monochrome TV receiver, I followed the procedures outlined in the instruction manual of the Model 220 and arranged the alignment apparatus as illustrated in Fig. 4.

I first connected the output of the sweep generator directly to the IF amplifier section of the receiver and to the adder through a 1,000-ohm isolation resistor. Attaching the marker and oscilloscope cables properly, I then placed a 47,000-ohm isolation resistor in series with the cable which extends between the detector load of the receiver and the "Rcvr. Response Input" connector of the Model 220.

After all of the equipment including the receiver had warmed up, I placed both generators on the proper frequency, set up the scope, and adjusted sweep and marker amplitudes. A satisfactory response curve was then visible on the screen of the scope. The most important advantage I found when using this instrument is that the marker signal can not distort or modify the receiver's true response. By not injecting the marker signal into the receiver, I also noticed that I could use large marker pips without overloading stages within the receiver.

The Model 220 is a non-selective device; therefore, it is possible to pickup spurious markers produced by harmonic voltages of the marker generator. These spurious signals, however, can usually be distinguished from the desired marker by the fact that they are smaller in amplitude and they move at a faster rate across the pattern as the generator frequency is changed.

Due to its compact design, the instrument requires little bench space and is easily connected to generators and oscilloscopes of conventional design.

DC Power for the Service Bench

The piece of equipment shown in Fig. 5 is the Model D-612T DC power supply. Developed by the Electro Products Laboratories of

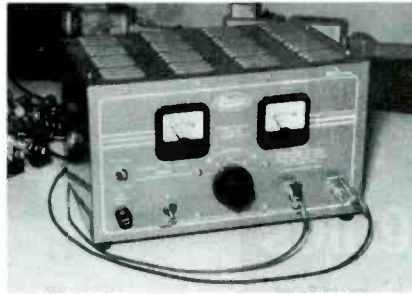

Fig. 5. Model D-612T power supply made by Electro Products Laboratories.

Chicago, the unit is especially designed for servicing transistor auto radios and is also suited for operating and testing tube type auto radios, battery chargers, telephone equipment, model trains, and various other devices requiring DC voltages up to 16 volts.

Specification features are:

1. Operating Power—110 to 120 volts, 50/60 cps AC, power consumption of 250 watts with a 10-amp 12-volt DC load, line fuse on front panel.
2. DC Output—adjustable voltage from 0 to 16 volts, AC ripple less than 2% at 6 amps, intermittent overload up to 100% of continuous rating which is 10 amps at 12 volts.
3. Panel Meters—ammeter 0-10 amps DC, voltmeter 0-20 volts DC.

Although I have had little opportunity to employ this piece of equipment on auto radios, I recently made use of it in connection with a service analysis on portable transistor radios. The instrument has enough control over AC ripple that it can be used as a satisfactory substitute for batteries in these miniature transistor units.

Of course, completely transistorized radios draw only a small fraction of the total current capabilities of the supply. Using a typical transistor radio, drawing only 6 ma, I measured the ripple voltage content and found it to be slightly less than .1%. One can see that this is much lower than that specified for a 6-amp load.

Most of the portable receivers I powered with the instrument operated from a single 9-volt battery. There are others which may need as high as 22½ volts; but with such a low current requirement, I discovered that the Model D-612T would also produce this higher potential. ▲



Hot-and-humid or cold-and-damp... Aerovox "DURAMIC" Capacitors give you "trouble-free" operation even under the most adverse weather conditions. You avoid costly call-backs when you specify-and-buy "DURAMIC" capacitors because the severe-service characteristics are built into each capacitor.

AEROVOX "DURAMICS"

...utilize a dense steatite case to provide exceptional protection against humidity. All terminal lead wires are firmly imbedded into the end seals so that they will not pull out or work loose even under the most severe operating conditions.

AEROVOX "DURAMICS"

...have that exclusive Aerovox end-fill which will not soften or flow nor separate from the case at any rated temperature.

AEROVOX "DURAMICS"

...have excellent power-factor, insulation resistance and temperature characteristics. Operating temperatures from -55°C. to +85°C. Available in 10 standard voltage ratings from 200 to 15,000 VDC.

Your local Aerovox Distributor always carries a stock of Aerovox "DURAMIC" Capacitors in a wide range of capacitance values and voltage ratings. While you're there ask for your free copy of the latest Aerovox Catalog with complete listings of all Aerovox components.



AEROVOX CORPORATION

Distributor Sales Division NEW BEDFORD, MASS.

In Canada: AEROVOX CANADA, LTD., Hamilton, Ont.
Export Ad. Auriema, 89 Broad St., New York, N. Y. - Cable Auriema, N. Y.

FIDELITONE

phonograph needles



*Always
the best seller*

**NOW
IN SPARKLING
TRANSPARENT
BOXES**

PERMO, INC.

Chicago 26, Illinois

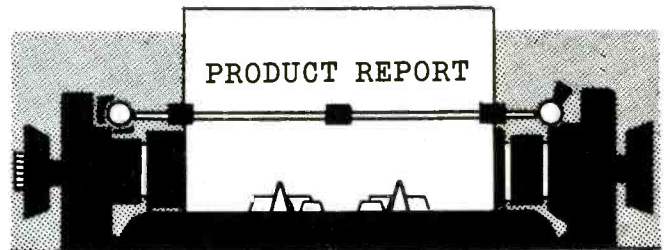

Stubby Screwdrivers



A companion to the CK-20 screwdriver kit is the SK-20 stubby screwdriver kit made by Xcelite, Inc., Orchard Park, N. Y. Two double-ended screwdriver blades with $\frac{3}{16}$ " and $\frac{1}{4}$ " regular and No. 1 and No. 2 Phillips points are supplied. In the middle of each blade is a $\frac{7}{16}$ " hexagonal sleeve which fits into a hex bushing imbedded in the stubby-size handle. Diameter of the handle is $1\frac{1}{4}$ " and length is 2". List price of the kit is \$3.70.

Custom TV Chassis

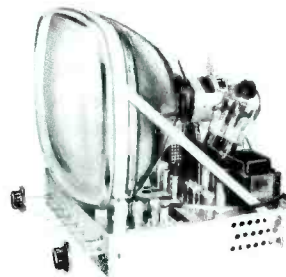

A 25-tube TV chassis for custom "built-in" installations is available from American Television and Radio Co., 300 E. Fourth St., St. Paul, Minn. Features include push-pull audio output, 18-kv CRT anode potential, keyed AGC, and 5 sync stages. A similar chassis is included in a line of full-door consoles made by ATR.

The company has announced a new policy of marketing its TV sets only through franchised independent servicemen. Chassis (less picture tubes and speakers) are supplied to these "Certified Independent" technicians directly from the factory at \$189.50 each, and the consoles are available at \$297.00. ATR invites applications for new franchises.

Bias Substitution Box

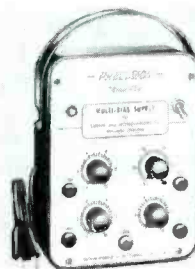

A Multi-Bias Supply (Model 230) made by Precision Apparatus Co., Inc. of Glendale, L. I., simultaneously provides four substitute bias voltages for use in servicing AVC, AGC, automatic chroma control, and similar circuits. The outputs are individually adjustable; three of the bias voltages are variable from 0 to -15 volts, and the fourth covers the entire range from 0 to -150 volts. The source voltage is regulated, and all bias voltages are filtered. Price is \$27.50 net.

Replacement Flyback



Rogers Electronic Corp., 49 Bleecker St., New York, announces the availability of a new flyback transformer (Model EFR 137) which is an exact replacement for Bendix part numbers NH265051-1, -2, and TSOH05.

The transformer is mounted on a board which includes the high-voltage rectifier socket and associated components, less the rectifier tube, and is packaged in a hermetically sealed plastic container to extend shelf life.

Dwarf Selenium Rectifier



Tiny 5-ma selenium rectifiers made by Siemens of West Germany and the equipment for their eventual manufacture in this country are being imported by Radio Receptor Co.,

Inc., 240 Wythe Ave., Brooklyn, N.Y. These rectifiers are suitable for such low-current circuits as bias supplies, arc-suppression circuits, and transistor power supplies. The four different types of dwarf rectifiers available are designed for 25- to 125-volt rms inputs when used with a resistive load, and for half these ratings when a capacitive load is used. List prices range from 51 to 60 cents each.

Record Brush

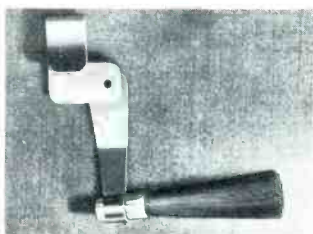

Static-resistant record brushes made of sable hair are obtainable from Duotone Corp., Keyport, N.J. This type of brush is mounted on the tone arm of a phonograph in such a way that it cleans dust out of the record groove just ahead of the needle.

Each brush, packed in a dust-proof bag, has a list price of \$1.

Wire Stripper

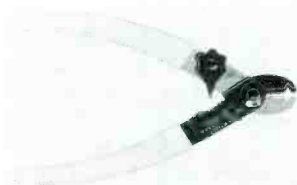

Walsco Electronics Mfg. Co., 3225 Exposition Place, Los Angeles, Calif, has designed a new tool, "Strip-Er-Clip," with a safeguard that prevents accidental nicking or cutting of

wires from which insulation is being stripped. A mechanical adjustment, which holds the jaws of the tool just far enough apart to let the wire pass through, can be set to accommodate any of seven wire sizes from 14 to 26 gauge. A cutting edge for wire clipping is also provided. Net price is \$1.39.

Your **DISTRIBUTOR**
ERIE
has "PAC"

Replacement Modules

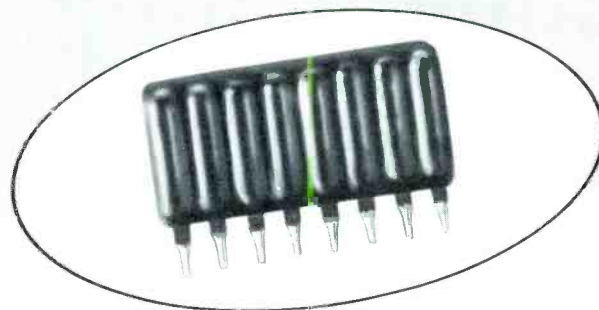

for Servicing . . . 1957 Auto Radios

PAC is a group of interconnected capacitors and resistors, combined in a single-insertion unit. Several popular 1957 model automobile and truck radios employ this new concept in component packaging. When servicing these auto radios, a complete PAC (Pre Assembled Circuit) module can be quickly and easily replaced.

Your ERIE Distributor has PAC Replacement Modules in stock. See him for complete information and prices.

ERIE ELECTRONICS DISTRIBUTOR DIVISION
ERIE RESISTOR CORPORATION
Main Offices: ERIE, PA.
Factories: ERIE, PA. • LONDON, ENGLAND • TRENTON, ONTARIO

FOR A brighter TV picture

Rely on the tube that has always been specified by leading independent set makers.

Blue Chip Quality
TUNG-SOL[®]
 Magic Mirror Aluminized
PICTURE TUBES

TUNG-SOL ELECTRIC INC., Newark 4, N. J. Sales Offices: Atlanta, Ga.; Columbus, Ohio; Culver City, Calif.; Dallas, Tex.; Denver, Colo.; Detroit, Mich.; Irvington, N. J.; Melrose Park, Ill.; Newark, N. J.; Seattle, Wash.

Hex-Wrench Holder

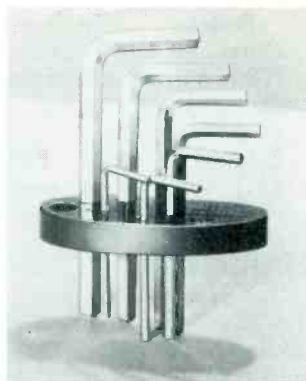

Hunter Tool Co., Box 564, Whittier, Calif., is manufacturing a "Handy Holder" for hex wrenches—a plastic disc with hexagonal holes into which the wrenches are inserted. The wrenches fit snugly into the holes and are held securely in place, always in plain view for easy selection of the right wrench.

Two different wrench assortments are mounted in "Handy Holders." One contains seven sizes from $\frac{5}{64}$ " to $\frac{1}{4}$ "; the other has ten sizes covering the range from $.050$ " through $\frac{5}{16}$ ".

Auto Speaker Kit

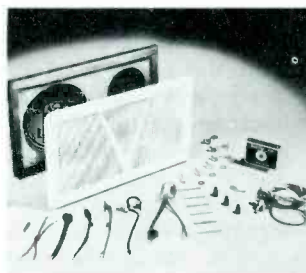

A new speaker kit for rear-deck installation in automobiles, made by General Cement Mfg. Co. (Division of Textron Inc.), 400 S. Wyman St., Rockford, Ill., contains separate woofer and tweeter units, plus a crossover network. The "G-C Sonata Hi-Fi

Speaker Kit" also includes a grille, three-way switch, connecting harness and all mounting hardware needed to make an installation.

In the 9502 kit, the grille is polished chrome, and in the 9503 kit it is gray. Each is priced at \$19.95 list.

Transistor Radio Earsets

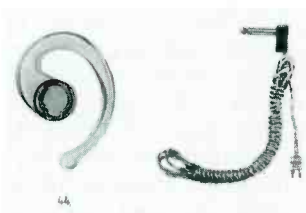

A new line of earsets for transistor radios is available from Rye Sound Corp., 21 Rye Road, Rye, N.Y. Composed of a magnetic receiver, plastic earloop, cord, and molded jack, the sets are made in a

variety of special types to fit nearly all different makes of transistor radios on the market.

The earsets are packaged in clear plastic boxes and are labeled to indicate the brand of radio which they will fit. Suggested list price is \$6.95.

RC Substitution Box



The "X-Checker," designed and produced by Ram Electronics, Irvington-on-Hudson, N.Y., provides a continuously variable resistance or capacitance—or a series combination of both—for substitution in electronic circuits. The resistor is a 2-watt unit with a range of 0 to 2500 ohms, and the capacitance range

range of 0 to 2500 ohms, and the capacitance range

is from 20 to 450 mmf. Values are read directly from scale calibrations; accuracy is within 10%. Since the RC combination forms a tuned circuit, the substitution box is useful in testing for conditions such as improper trap-circuit action or faulty peaking of high video frequencies.

New Replacement Yokes

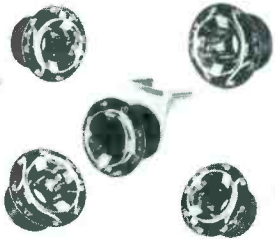

Five exact replacement yokes for the most recent General Electric chassis are being made by Merit Coil & Transformer Corp. of Chicago and are now available from parts jobbers. The new components replace original yokes in more than 150

G-E models and chassis without the necessity for any mechanical or electrical changes.

New Merit part numbers and their G-E equivalents are as follows: MDF-83 for RLD-013; MDF-84 for RLD-025; MDF-85 for RLD-041 and -045; MDF-86 for RLD-042; and MDF-87 for RLD-052 and -067.

Plug-In Filament Resistors



"Thermistol," a new product of Workman TV, Inc., 309 Queen Anne Rd., Teaneck, N.J., is a negative-temperature-coefficient resistor designed to prevent current surges in filament circuits when electronic equipment is first turned on. For series-string radio and

TV sets there are two "Thermistol" models (TH1 and TH2). Resembling tube socket adapters, they are plugged into 7-pin miniature and standard octal sockets, respectively. Dealer net is \$2.37. A third model (TH3, \$5.97 net) plugs into a wall outlet and is used with transformer-powered equipment.

Transistor Radio Kit



Vokar Corp., Dexter, Mich., offers a new kit of parts from which the technician or amateur can assemble a six-transistor subminiature radio. Unlike a previous kit which contained only IF transformers and oscillator coil, the new TC-6 kit also includes a speaker, input and output transform-

ers, a tuning capacitor, ferrite antenna, off-on switch and volume control, resistors and capacitors. User net price is \$24. Transistors, in addition to the above parts, are furnished with an alternate TC-6T kit that costs \$36.

FOR A brighter



profit picture

Rely on the tube that has always been a favorite with leading independent service dealers.

Blue Chip Quality
TUNG-SOL®
RECEIVING TUBES

TUNG-SOL makes All-Glass Sealed Beam Lamps, Miniature Lamps, Signal Flashers, Picture Tubes, Radio, TV and Special Purpose Electron Tubes and Semiconductor Products.



PF REPORTER

INDEX TO ADVERTISERS

May, 1957

Advertisers	Page No.
Aerovox Corp.	79
American Elite, Inc.	67
American Television & Radio Co.	62
Amphenol Electronics Corp.	50
Astron Corp.	6
B & K Mfg. Co.	12
Belden Mfg. Co.	33
Blonder-Tongue Labs	69
Bussmann Mfg. Co.	18
CBS-Hytron	26
Centralab, Div. of Globe-Union, Inc.	56, 57
Chicago Standard Transformer Co.	20
Circuit Mfg. Co., Inc.	31
Cleveland Institute of Radio Electronics	60
Clarostat Mfg. Co., Inc.	37
Colman Tool & Machine Co.	72
Cornell-Dubilier Electric Corp.	77
Delco Radio Div., General Motors Corp.	22
Eby Sales Co.	69
Electronic Instr. Co., Inc. (EICO)	68
Electronic Publishing Co.	51
Elgin Nat'l Watch Co. (Electronics Div.)	9
Erie Resistor Corp.	81
E-Z Hook Test Products	46
General Cement Mfg. Co.	76
General Electric Co.	4-5, 39
Gernsback Library, Inc.	66
International Business Machines Corp.	10-11
International Resistance Co.	2nd cover
Jackson Electrical Instr. Co.	65, 73
Jensen Industries, Inc.	72
Jensen Mfg. Co.	49
JFD Mfg. Co.	24, 78
Lenk Mfg. Co.	54
Littelfuse, Inc.	4th cover
MacMillan Co.	61
Mallory & Co., Inc., P. R.	42, 43
Merit Coil & Trans. Corp.	69
Mosley Electronics, Inc.	65
Multicore Sales Corp.	61
Permo, Inc.	80
Perma-Power Co.	78
Phaostron Co.	55
Planet Sales Corp.	75
Pyramid Electric Co.	41
Radio Corp. of America	3rd cover
Radiart Corp.—Cornell-Dubilier Electric Corp.	1
Raytheon Mfg. Co.	14, 36
Recoton Corp.	74
Sams & Co., Inc., Howard W.	53, 58, 70
Sangamo Electric Co.	28
Sarkes Tarzian, Inc.	38
Service Instruments Corp.	74
Shure Bros., Inc.	71
Simpson Electric Co.	8
Sonotone Corp.	32
South River Metal Products Co.	74
Sprague Products Co.	2
Standard Electrical Products Co.	54
Stevens-Walden, Inc.	64
Triplet Electrical Instr. Co.	47
Tung-Sol Electric, Inc.	82, 83
University Loudspeakers, Inc.	63
Vaco Products Co.	48
V-M Corp.	35
Ward Products Corp.	40
Webster Electric Co.	59
Workman TV, Inc.	66
Wright Steel & Wire Co., G. F.	64
Xcelite, Inc.	7
Yeats Appl. Dolly Sales	48

CATALOG and LITERATURE SERVICE

MAY 1957

- 1E. AMERICAN ELITE**
Tube interchangeability chart—European and American numbers. See ad page 67.
- 2.E AMPHENOL**
Vest pocket guide to twin lead. See ad page 50.
- 3E. B & K**
Bulletin 500 describes "Dyna-Quick" dynamic mutual conductance quick-check tube tester. Bulletin 1000 on new "Dyna-Scan" picture and pattern video-generator. Also Bulletin 750 on new lab-type test equipment calibrator Model 750 that checks instrument accuracy and Bulletin 400 on CRT cathode rejuvenator tester. See ad page 12.
- 4E. BELDEN**
1957 Radio electronic wire & cable catalog. See ad page 33.
- 5E. BUSSMANN**
New and very comprehensive book on fuses and fuse mountings used by the electronics industries. See ad page 18.
- 6E. CHICAGO STANDARD**
New 1957 STANCOR TV transformer Replacement Guide & Library. See ad page 20.
- 7E. CIRCUIT**
Explanation sheet tells when and how to install "Nu Life Kinecure" to overcome 33 CR tube defects (includes wiring diagrams). See ad page 31.
- 8E. CLAROSTAT**
Catalog No. 57—Form No. 754975—control, resistor and switch products. See ad page 37.
- 9E. CORNELL-DUBILIER**
Guide to ceramic replacement capacitors, XTR200D3-C. See ad page 77.
- 10E. EICO**
12-page catalog shows how to save 50% on electronic test instruments and hi-fi equipment in both kit and factory-wired form. See ad page 68.
- 11E. ELGIN**
New data sheets on broadcast and general purpose microphones. See ad page 9.
- 12E. ERIE**
New D-57 Distributor Catalog describes Erie's complete line of distributor products. See ad p.81.
- 13E. E-Z HOOK**
A convenient reference sheet titled "How to Build the Five Most Useful Scope Probes" gives the schematic, mechanical component layout, and a brief description of five scope probes most useful in servicing. See ad p.46.
- 14E. GERNSBACK**
Descriptive literature on Gernsback library books. See ad page 66.
- 15E. HICKOK**
Condensed catalog listing describing the latest radio-TV-electronic test equipment.
- 16E. IRC**
New replacement parts Catalog DLR-57 (form S-035-1). See ad 2nd cover.
- 17E. JENSEN INDUSTRIES**
Special dealer merchandising materials for sapphire and diamond needles. See ad page 72.
- 18E. JFD**
"Magic Genie" kit containing assortment of sales promotional displays and helps showing how to make extra profits. Includes name of local JFD "Magic Genie" distributor. See ads pages 24, 78.
- 19E. MERIT**
#541 "Let George Do It." See ad page 69.
- 20E. MULTICORE**
Multicore Fact Sheet. See ad p.61.
- 21E. PHAOSTRON**
Illustrated catalog lists complete line of custom panel meters. Includes comparison chart of Phaostron instruments vs. other brands and complete information on dimensions and features. See ad page 55.
- 22E. RADIART**
"Vipower" Catalog. See ad page 1.
- 23E. RCA**
Form APL-24 gives details on "Custom Convertible" speaker systems and suggests choice of units for individual applications. See ad 3rd cover.
- 24E. RECOTON**
Simplified reference guide features complete line of "phoneedles," cartridges, cutting styli, tape, accessories, etc. See ad page 74.
- 25E. SHURE**
Manual No. 57 contains latest replacement information on phono cartridges and magnetic recording heads. See ad page 71.
- 26E. SIMPSON**
Bulletin No. 2058 describes test equipment for servicing radio, TV and industrial equipment. See ad page 8.
- 27E. SOUTH RIVER**
New 1957 catalog on antenna mountings, accessories, aluminum ground wire, aluminum guy wire and magnesium ladders. See ad page 74.
- 28E. SPRAGUE**
Revised distributor service parts catalog No. C-611A. See ad page 2.
- 29E. STANDARD ELECTRICAL**
22-page catalog describing complete line of "Adjust-A-Volt" variable transformers. Also catalog page on PA-1 "Adjust-A-Volt." See ad page 60.
- 30E. TRIPLET**
"MIGHTY NINE" line of volt-ohm-milliammeters. See ad page 47.
- 31E. VACO**
Catalog on Vaco screwdrivers, nut drivers, pliers, solderless terminals and other TV service tools. See ad page 48.
- 32E. XCELITE**
Folder on new No. 99 Service Master Kit with 21 tools for handling 99% of service calls. See ad page 7.

MAY 1957

SUPPLEMENT to SAMS MASTER INDEX No. 102

File this Supplement with your 36-page SAMS MASTER INDEX. Together, they give you complete PHOTOFAC coverage.

This Supplement is your handy index to new models covered in the latest PHOTOFAC Sets 346 through 358. It's your guide to the world's finest service data coverage of the current output of the new TV and Radio receivers, as well as models not previously covered in PHOTOFAC. It keeps you right up to date.

ALWAYS USE YOUR LATEST ISSUE OF THIS SUPPLEMENT WITH THE SAMS MASTER INDEX . . . TOGETHER, THEY ARE YOUR COMPLETE INDEX TO OVER 30,000 MODELS.

For models and chassis not listed in this Supplement, refer to SAMS MASTER INDEX No. 102. If you haven't a copy, send for it today. It's FREE . . . just write to HOWARD W. SAMS & CO., INC., 2201 East 46th Street, Indianapolis 5, Indiana.



IMPORTANT: THIS SUPPLEMENT REPLACES APRIL SUPPLEMENT No. 102-C

Discard prior supplement, since this issue includes all previous listings plus latest models

FILE WITH YOUR SAMS MASTER INDEX No. 102, DATED FEBRUARY, 1957

Model No.	Set No.	Folder No.	Model No.	Set No.	Folder No.	Model No.	Set No.	Folder No.	Model No.	Set No.	Folder No.
ADMIRAL											
Chassis 4E2		354-2									
Chassis 4G2, 4G2A		344-2									
Chassis 4H2		354-2									
Chassis 5N3, 5N3A		357-2									
Chassis 5W3		352-2									
Chassis 6R2, 6R2A		356-1									
Chassis 14UY3B, C		351-1									
Chassis 14Y3C, BK, C		350-1									
Models HC2276, HC2277 (See Ch. 5N3A)											
Models HC4406, HC4407 (See Ch. 6R2A)											
Models HP2235, HP2238 (See Ch. 4G2)											
Models T101, T102, T103, T104, T105AL, T106AL, T107AL (See Ch. 14Y3B)											
Models T140, T141, T142, T143, T144AL, T145AL (See Ch. 14Y3C)											
Models T1010, T1011AL, T1012AL, T1013AL (See Ch. 14Y3B)											
Model T1410 (See Ch. 14Y3C)											
Models TS101, TS102, TS103, TS104, TS105AL, TS106AL, TS107AL (See Ch. 14Y3B)											
Models TS140, TS141, TS142, TS143, TS144AL, TS145AL (See Ch. 14Y3C)											
Models TS1010, TS1011, TS102AL, TS1013AL (See Ch. 14Y3B)											
Model 4D18D (See Ch. 4G2)											
Model 4D28D (See Ch. 4G2)											
Model 4E21 (See Ch. 4E2)											
Models 4F22, 4F24, 4F26, 4F28 (See Ch. 4E2)											
Model 4G22D (See Ch. 4G2)											
Models 4H22, 4H24, 4H26, 4H28 (See Ch. 4H2)											
Models 5B42, 5B43 (See Ch. 5W3)											
Model 5B48 (See Ch. 5W3)											
Models 5H44, 5H47, 5H49 (See Ch. 5W3)											
Models 5M36D, 5M37D (See Ch. 5N3)											
Models 5M56D, 5M57D (See Ch. 5N3)											
Models 5M66D, 5M67D (See Ch. 6R2)											
Models 5W32, 5W33, 5W34 (See Ch. 5W3)											
Models 5W38, 5W39 (See Ch. 5W3)											
AIRLINE											
FJB-6525A (Similar to Chassis)		325-4									
FJB-6526A (Similar to Chassis)		325-4									
FJB-6527A (Similar to Chassis)		325-4									
FJB-6528A (Similar to Chassis)		298-4									
FJB-6599A (Similar to Chassis)		298-4									
GEN-1090A		350-2									
GEN-1103A		349-2									
GEN-1655A, GEN-1656A, GEN-1657A, GEN-1658A, GEN-1660A, GEN-1661A		358-1									
GRX-4020A, GRX-4120A		347-1									
GTC-1085A, GTC-1086A		356-2									
WG-5030A, WG-5032A, B, C, WG-5035A, B, C		351-2									
WG-5130A, WG-5132A, B, WG-5135A, B		351-2									
ALLSTATE											
6263-1 (Ch. 528.6263-1) (See Model 6263)		269-3									
6295-7 (Ch. 528.6295-7) (See Model 6295-6—Set 229-2)											
6295-8 (Ch. 528.6295-8) (See Model 6295-6—Set 229-2)											
Ch. 528.6263-1 (See Model 6263-1)											
Ch. 528.6295-7 (See Model 6295-7)											
Ch. 528.6295-8 (See Model 6295-8)											
AMBASSADOR											
177T61E, M, 177T62, 177T63 (Ch. A2005)		352-3									
Ch. A2005 (See Model 177T61E)											
AMERICAN TELEVISION											
American Television 1956 (F-56)		353-20-5									
American Television 1956 (Late)		353-20-5									
ANDREA											
21B-VP21 (Ch. VP21) (See Model C-VP21—Set 326-4)											
ARVIN											
2563 (Ch. 1.40300)		356-3									
2564 (Ch. 1.40400)		356-3									
3561 (Ch. 1.40600)		358-2									
5561 (Ch. 1.40800)		351-3									
9562 (Ch. 1.40900)		348-1									
Ch. 1.40300 (See Model 2563)											
Ch. 1.40400 (See Model 2564)											
Ch. 1.40600 (See Model 3561)											
Ch. 1.40800 (See Model 5561)											
Ch. 1.40900 (See Model 9562)											
AUTOMATIC											
TT600		349-3									
BENDIX											
KM17CD (Ch. T17-1) (See Photofact Servicer Set 320)											
KS21C (Ch. T17) (See Photofact Servicer Set 320)											
KS17C (Ch. T17-1) (See Photofact Servicer Set 320)											
STM17C (Ch. T17-1) (See Photofact Servicer Set 320)											
TM17CD (Ch. T17-1) (See Photofact Servicer Set 320)											
TS17C (Ch. T17-1) (See Photofact Servicer Set 320)											
TS21C (Ch. T17) (See Photofact Servicer Set 320)											
Ch. T17 (See Model KS21C)											
Ch. T17-1 (See Model KM17CD)											
BROCINER											
Mark 30A		347-2									
Mark 30C		346-3									
BUICK											
981707		347-3									
981708		346-4									
CAVALIER											
603		353-2									
CBS-COLUMBIA											
U23C39, B (Ch. 921-93) (See PCB 179—Set 346-1 and Model 23C49L—Set 292-3)											
U23C49L (Ch. 921-93) (See PCB 179—Set 346-1 and Model 23C49L—Set 292-3)											
U23T19, B (Ch. 921-93) (See PCB 179—Set 346-1 and Model 23C49L—Set 292-3)											
23C39, B (Ch. 921-94) (See PCB 179—Set 346-1 and Model 23C49L—Set 292-3)											
23T19, B (Ch. 921-94) (See PCB 179—Set 346-1 and Model 23C49L—Set 292-3)											
Ch. 921-93 (See Model U23C39)											
CHEVROLET											
987577		352-17-5									
3725156		352-17-5									
COLUMBIA RECORDS											
420		354-3									
522, 524, 527		352-4									
526		356-4									
528		355-1									
530		358-3									
CORONADO											
RA12-8121-A		346-5									
RA48-8342A		355-2									
RA48-8352A		356-5									
TV1-9399A, TV1-9400A		353-3									
CRESCENT											
A-740		355-3									
A-600		355-3									
F-637, F-639		355-3									
F-737, F-739		355-3									
M-633		355-3									
M-732, M-734		355-3									
CROSLY											
AC-10B, AC-10M (Ch. 487)		351-4									
AC-11C, AC-11M (Ch. 488)		351-4									
AH-10B (Ch. 487)		351-4									
AH-11B (Ch. 488)		351-4									
AT-10B, AT-10M (Ch. 487)		351-4									
AT-11B, AT-11M (Ch. 488)		351-4									
BC-12BZ, M, MZ, BC-13B, M, BC-14M, BC-15M (Ch. 489, 490)		352-5									
BT-12BZ, M, MZ, BT-13B, M (Ch. 489, 490)		352-5									
H-21T0BU (Ch. 431) (See PCB 182—Set 353-1 and Model G-21T0BH—Set 263-6)											
H-21T0MU (Ch. 431) (See PCB 182—Set 353-1 and Model G-21T0BH—Set 263-6)											
H-21T0WU (Ch. 431) (See PCB 182—Set 353-1 and Model G-21T0BH—Set 263-6)											
Ch. 487 (See Model AC-10B)											
Ch. 488 (See Model AC-11B)											
Ch. 489, 490 (See Model BC-12BZ)											
DEWALT											
K-544		347-4									
DUMONT											
RA-372, RA-373		358-4									
RA-380, RA-381		346-22-5									
RA-392, RA-393		356-19-5									
1110, 1120, 1130, 1140, 1150		354-4									
ELECTRO-VOICE											
A15CL		353-4									
A30		354-5									
PCZ		351-5									
EMERSON											
834-A (Ch. 120308-A) (See PCB 182—Set 353-1 and Model 834-B—Set 310-3)											
839-B (Ch. 120270-B) (See PCB 182—Set 353-1 and Model 834-B—Set 310-3)											
841-A (Ch. 120291-A) (See PCB 182—Set 353-1 and Model 834-B—Set 310-3)											
844 (Ch. 120309)		353-5									
847 (Ch. 120328)		353-5									
855 (Ch. 120314)		354-6									
1232 (Ch. 120311-H)		354-7									
1233 (Ch. 120332-R)		354-7									
Ch. 120311-A (See Model 841-A)											
Ch. 120308-A (See Model 834-A)											
Ch. 120309 (See Model 844)											
Ch. 120314 (See Model 855)											
Ch. 120328 (See Model 847)											
Ch. 120331-H (See Model 1232)											
Ch. 120332-R (See Model 1233)											
FIRESTONE											
4-A-141, 4-A-142 (Code 382-6-398) (See PCB 184—Set 357-1 and Model 4-A-141 [Code 382-5-377])											
4-A-149 (Code 297-5-524)		358-5									
4-A-152 (Code 364-6-360)		350-4									
4-A-154 (Code 382-6-374/2)		348-2									
4-A-160 (Code 297-6-581)		346-6									
4-A-161 (Code 389-6-556A) (Similar to Chassis)		354-14									
4-B-64 (Code 120-1-M90) (Similar to Chassis)		67-4									
4-B-65 (Code 120-1-D251) (Similar to Chassis)		174-4									
4-C-34 (Code 382-7-40900)		356-7									
FORD											
75MF (FEG-18806-H)		353-6									
78MF (FEG-18806-G)		352-6									
79MF (FEJ-18806-C)		354-8									
FEG-18806-G (See Model 78MF)											
FEG-18806-H (See Model 75MF)											
FEJ-18806-C (See Model 79MF)											
GRANCO											
770		350-5									
HALLICRAFTERS											
TW200, TW201, TW202, TW203 Mark 1, 1A)		349-4									
HALLICRAFTERS—Cont.											
10TS900B, M, T, 10TS901B, M, T (Ch. A2011, B2011)		348-18-5									
17TS740B, M (Ch. A2007)		348-18-5									
17TS760B, B, M (Ch. A2007, E2007)		348-18-5									
17TS780B, M (Ch. A2007)		348-18-5									
21KT854B, M (Ch. C0005) (See Model 17T7700E—Set 339-7)											
21KT855B, M (Ch. D005) (See Model 17T7700E—Set 339-7)											
Ch. A2007 (See Model 17TS740B)											
Ch. A2011, B2011 (See Model 10TS900B)											
Ch. E2007 (See Model 17TS760B)											
HARMAN-KARDON											
FM-100		353-7									
T-10		350-6									
T-120		354-9									
TA-10		351-6									
HOFFMAN											
83191, U (Ch. 420, U)		352-17-5									
M3181, U (Ch. 420, U)		352-17-5									
SP3181, U (Ch. 420, U)		352-17-5									
11191, U (Ch. 329, U)		358-14-5									
1201, U (Ch. 330, U)		358-14-5									
1211, U (Ch. 329, U)		358-14-5									
2021 (Ch. 706)		350-18-5									
3241, U (Ch. 329, U)		358-14-5									
3251, U (Ch. 330, U)		358-14-5									
4041 (Ch. 706)		350-18-5									
4051 (Ch. 706)		350-18-5									
4061 (Ch. 706)		350-18-5									
Ch. 329, U (See Model 201)											
Ch. 330, U (See Model 3191)											
Ch. 420, U (See Model 3191)											
Ch. 706 (See Model 2021)											
HOTPOINT											
145201, UHF, 145202, UHF, 145203, UHF ("O" Line)		356-8									
175301, 175302 ("MMA" Line)		347-6									
215401 ("U" Line)		348-3									
215411, 215452 ("U" Line)		348-3									
215501, 215502 ("U" Line)		348-3									
215551, 215552 ("U" Line)		348-3									
245801, 245802 ("U" Line)		348-3									
INTERNATIONAL TRUCK (Auto Radio)											
994833-R91 (Similar to chassis)		336-11									
966834-R91 (Similar to chassis)		336-11									
KNIGHT											
9352445		356-9									
9352655		358-6									
9352822		357-4									
9352690		352-7									

MOTOROLA—Cont.

Table listing Motorola models and their specifications, including A21T338G, A21T338M, A21T338B, etc.

OLYMPIC—Cont.

Table listing Olympic models and their specifications, including 4CF75, 4CF76, 4K8F4, etc.

RCA VICTOR—Cont.

Table listing RCA Victor models and their specifications, including 21T7157, 21T7352, 21T7355, etc.

SILVERTONE—Cont.

Table listing Silvertone models and their specifications, including 7245CA, 7246, 7246C, etc.

W-M

Table listing W-M models and their specifications, including 156, 556-A, 625, etc.

WELLS-GARDNER

Table listing Wells-Gardner models and their specifications, including 37A10-551, 37A10-562, etc.

WESTINGHOUSE

Table listing Westinghouse models and their specifications, including H-14T170, H-14T172, etc.

SONORA

Table listing Sonora models and their specifications, including 502, 518, 523, etc.

SPARTAN

Table listing Spartan models and their specifications, including 21 Series AMP-151A, 21 Series AMP-151B, etc.

STEELMAN

Table listing Steelman models and their specifications, including 3A14-1, 3D12, 3D14U, etc.

STUDEBAKER

Table listing Studebaker models and their specifications, including AC2786.

SYLVANIA

Table listing Sylvania models and their specifications, including 21C405, 21C501, etc.

SENTINEL

Table listing Sentinel models and their specifications, including Chassis C8729AA, BA.

SETCHEL-CARLSON

Table listing Setchel-Carlson models and their specifications, including P-62, 71, etc.

SILVERTONE

Table listing Silvertone models and their specifications, including PC-7100, PC-7112, etc.

MINZ

Table listing Minz models and their specifications, including 721C8D, 721C8A, etc.

PACKARD-BELL

Table listing Packard-Bell models and their specifications, including 21DC3, 21DC4, etc.

PHILCO

Table listing Philco models and their specifications, including E-1345, E-672, etc.

PHONOLA

Table listing Phonola models and their specifications, including 155, 255, 355, etc.

PONTIAC

Table listing Pontiac models and their specifications, including 98B569.

NASH

Table listing Nash models and their specifications, including 1CA70, 1CB72, etc.

OLDSMOBILE

Table listing Oldsmobile models and their specifications, including 983336.

OLYMPIC

Table listing Olympic models and their specifications, including 1CA70, 1CB72, etc.

TRUETONE

Table listing Truetone models and their specifications, including D2786A, D3600A, etc.

TRAVLER

Table listing Travler models and their specifications, including 55C46, 56C46, etc.

NOTE: PCB Denotes Production Change Bulletin. Q Denotes Television Receiver. S Denotes Schematic Coverage Only.

Set No.	Folder No.	Set No.	Folder No.	Set No.	Folder No.	Set No.	Folder No.	Set No.	Folder No.		
WESTINGHOUSE—Cont.				WESTINGHOUSE—Cont.				WESTINGHOUSE—Cont.			
●H-21TU101 (Ch. V-2354-204)	350-17	H-587P7, H-588P7, H-589P7 (Ch. V-2278-1)	351-20	Ch. V-2347-27 (See Model H-24KR126A)	351-14-5	●Z2359EZ, RZ, Z, Z2360RZ (Ch. 22230)	358-14-5	●Z2282EZ, RZ (Ch. 17232)	355-18-5	ZENITH—Cont.	
●H-21TU101A (Ch. V-2356-205)	358-13	H-598P4, H-599P4 (Ch. V-2271-1)	346-19	Ch. V-2347-29 (See Model H-24KR126F)	351-14-5	●Z2675EZ, RZ (Ch. 17233)	357-14-5	●Z3000EZ, RZ (Ch. 17232Q)	355-18-5	●Z3001EZ, RZ (Ch. 17234Q)	355-18-5
●H-21TU104, H-21TU105, H-21TU106 (Ch. V-2354-204)	350-17	H-602P7 (Ch. V-2295-1)	357-13	Ch. V-2354-204 (See Model H-21-TU101)	351-14-5	●Z3004EZ, RZ (Ch. 17232Q)	355-18-5	●Z3008EZ, RZ (Ch. 17234Q)	355-18-5	●Z3010EZ, HZ, RZ, YZ (Ch. 19232Q)	357-14-5
●H-21TU107, H-21TU108 (Ch. V-2354-204)	350-17	H-610P5, H-611P5, H-612P5 (Ch. V-2278-2)	354-20	Ch. V-2255-204 (See Model H-24-TU117)	351-14-5	●Z3012HZ, RZ, Z3011-HZ, RZ (Ch. 22230Q)	358-14-5	●Z4000EZ, RZ (Ch. 17233Q)	357-14-5	●Z4006EZ, RZ (Ch. 17233Q)	357-14-5
●H-21TU107A, H-21TU108A (Ch. V-2356-205)	358-13	●H-783T7 (Ch. V-2240-1, -3) (See Photofact Servicer Set 314)	354-20	Ch. V-2356-205 (See Model H-21KU112A)	351-14-5	Ch. 3Y04 (See Model HFY10L)	357-14-5	Ch. 3Y05 (See Model HFY15E)	357-14-5	Ch. 5Z04 (See Model Z524W)	357-14-5
●H-21TU107B, H-21TU108B (Ch. V-2356-204)	358-13	Ch. V-2105 (See Model H-113)	354-20	Ch. V-2356-405 (See Model H-21KU185)	351-14-5	Ch. 5Z05 (See Model Z508B)	357-14-5	Ch. 5Z07 (See Model Z519P)	357-14-5	Ch. 5Z08 (See Model Z550G)	357-14-5
●H-21TU180A (Ch. V-2356-605)	358-13	Ch. V-2259-2 (See Model H-499T5B)	354-20	Ch. V-2356-204 (See Model H-21KU112B)	351-14-5	Ch. 5Z21 (See Model HFZ18R)	357-14-5	Ch. 7Y03Z (See Model Z733G)	357-14-5	Ch. 7ZT41 (See Model Royal 800)	357-14-5
●H-21TU185A (Ch. V-2356-605)	358-13	Ch. V-2261-2 (See Model H-547T5A)	354-20	Ch. V-2356-605 (See Model H-21KU186)	351-14-5	Ch. 15Z31 (See Model Z1817GZ)	357-14-5	Ch. 17Z31 (See Model Z2223CZ)	357-14-5	Ch. 17Z32 (See Model Z2243EZ)	357-14-5
●H-22T155, H-22T156, H-22T157A (Ch. V-2293-11, -31)	357-12	Ch. V-2271-1 (See Model H-557P4)	357-13	Ch. V-2356-204 (See Model H-21KRUI90)	351-14-5	Ch. 17Z33 (See Model Z2675EZ)	357-14-5	Ch. 17Z33Q (See Model Z4000EZ)	357-14-5	Ch. 17Z34Q (See Model Z3001EZ)	357-14-5
●H-22T155, H-22T156 (Ch. V-2293-11, -31)	357-12	Ch. V-2278-1 (See Model H-587P7)	357-13	Ch. V-2357-205 (See Model H-24KRUI27B)	351-14-5	Ch. 19Z32 (See Model Z2229RZ)	357-14-5	Ch. 19Z32Q (See Model Z3010EZ)	357-14-5	Ch. 22Z30 (See Model Z2359EZ)	357-14-5
●H-22T155, H-22T156 (Ch. V-2293-11, -31)	357-12	Ch. V-2278-2 (See Model H-610P5)	354-20	Ch. V-2357-205 (See Model H-24KRUI27B)	351-14-5	Ch. 22Z30Q (See Model Z3012HZ)	357-14-5	Ch. 22Z30Q (See Model Z3012HZ)	357-14-5		
●H-22T155, H-22T156 (Ch. V-2293-11, -31)	357-12	Ch. V-2293-11 (See Model H-22T157A)	354-20	Ch. V-2357-205 (See Model H-24KRUI27B)	351-14-5						
●H-24K122 (Ch. V-2345-26)	350-17	Ch. V-2293-31 (See Model H-22T155)	354-20	Ch. V-2357-205 (See Model H-24KRUI27B)	351-14-5						
●H-24K125 (Ch. V-2345-26)	350-17	Ch. V-2294 (See Model H22TU155)	354-20	Ch. V-2357-205 (See Model H-24KRUI27B)	351-14-5						
●H-24K126, H-24K127, H-24K128 (Ch. V-2345-26)	350-17	Ch. V-2295-1 (See Model H-602P7)	354-20	Ch. V-2357-205 (See Model H-24KRUI27B)	351-14-5						
●H-24K126B, E, H-24K127B, H-24K128B (Ch. V-2347-27)	358-13	Ch. V-2311-45 (See Model H-14T170)	358-13	Ch. V-2357-205 (See Model H-24KRUI27B)	351-14-5						
●H-24K126A (Ch. V-2347-27)	358-13	Ch. V-2321-40 (See Model H-14T170)	358-13	Ch. V-2357-205 (See Model H-24KRUI27B)	351-14-5						
●H-24KR126F, H-24KR127F (Ch. V-2347-29)	358-13	Ch. V-2344-25, -26 (See Model H-21T101)	358-13	Ch. V-2357-205 (See Model H-24KRUI27B)	351-14-5						
●H-24KRUI27B, H-24KRUI28B (Ch. V-2357)	358-13	Ch. V-2345-26 (See Model H-24T-117)	358-13	Ch. V-2357-205 (See Model H-24KRUI27B)	351-14-5						
●H-24KRUI22 (Ch. V-2355-204)	350-17	Ch. V-2346 (See Model H-21K114B)	350-17	Ch. V-2357-205 (See Model H-24KRUI27B)	351-14-5						
●H-24KRUI25 (Ch. V-2355-204)	350-17	Ch. V-2346-21 (See Model H-21K111A)	350-17	Ch. V-2357-205 (See Model H-24KRUI27B)	351-14-5						
●H-24KRUI26 (Ch. V-2355-204)	350-17	Ch. V-2346-25 (See Model H-21T101B)	350-17	Ch. V-2357-205 (See Model H-24KRUI27B)	351-14-5						
●H-24KRUI26A, B (Ch. V-2357-205)	358-13	Ch. V-2346-26 (See Model H-21K112B)	350-17	Ch. V-2357-205 (See Model H-24KRUI27B)	351-14-5						
●H-24KRUI27, H-24KRUI28 (Ch. V-2355-204)	350-17	Ch. V-2346-27 (See Model H-21KR113A)	350-17	Ch. V-2357-205 (See Model H-24KRUI27B)	351-14-5						
●H-24KRUI27, H-24KRUI28 (Ch. V-2355-204)	350-17	Ch. V-2346-29 (See Model H-21KR113F)	350-17	Ch. V-2357-205 (See Model H-24KRUI27B)	351-14-5						
●H-24T117, H-24T118, H-24T119, H-24T120, H-24T121 (Ch. V-2345-26)	350-17	Ch. V-2346-41 (See Model H-21K119A)	350-17	Ch. V-2357-205 (See Model H-24KRUI27B)	351-14-5						
●H-24T117, H-24T118, H-24T119, H-24T120, H-24T121 (Ch. V-2355-204)	350-17	Ch. V-2346-45 (See Model H-21T180D)	350-17	Ch. V-2357-205 (See Model H-24KRUI27B)	351-14-5						
●H-113, H-114, H-116 (Ch. V-2105) (See Model H-117—Set 11-34)	350-17	Ch. V-2346-47 (See Model H-21KR189)	350-17	Ch. V-2357-205 (See Model H-24KRUI27B)	351-14-5						
●H-499T5B, H-500T5B, H-501T5B, H-502T5B (Ch. V-2259-2)	355-16	Ch. V-2346-61 (See Model H-21K1185)	350-17	Ch. V-2357-205 (See Model H-24KRUI27B)	351-14-5						
●H-547T5A, H-548T5A, H-549T5A, H-550T5A (Ch. V-2261-2) (See Model H-547T5—Set 325-15)	355-16	Ch. V-2346-65 (See Model H-21T180A)	350-17	Ch. V-2357-205 (See Model H-24KRUI27B)	351-14-5						
●H-551T5B (Ch. V-2259-2)	355-16	Ch. V-2346-67 (See Model H-21KR188)	350-17	Ch. V-2357-205 (See Model H-24KRUI27B)	351-14-5						
●H-557P4, H-558P4, H-559P4 (Ch. V-2271-1)	346-19	Ch. V-2346-68 (See Model H-21K1194)	350-17	Ch. V-2357-205 (See Model H-24KRUI27B)	351-14-5						
		Ch. V-2347 (See Model H-24K126B)	350-17								

NOTE: PCB Denotes Production Change Bulletin. ● Denotes Television Receiver. S Denotes Schematic Coverage Only.

KEEP UP-TO-DATE for GREATER PROFITS

Here's an easy way to keep up-to-date on current model coverage of TV, Radio, Record Changer, Recorder, Amplifier, and Tuner Models. Fingertip information in PHOTOFAC T helps you solve servicing problems faster and easier—helps you earn more daily!

Fill out the coupon below—take it to your PHOTOFAC T distributor and start receiving every profit-making set of Folders as released!



PHOTOFAC T STANDING ORDER SUBSCRIPTION PLAN

HOWARD W. SAM S & CO., INC., 2201 E. 46th St., Indianapolis 5, Ind.

Enter my order to receive all new SAM S PHOTOFAC T Sets automatically as published each month.

Service Dealer's Name _____

(please print)

Address _____

City _____ Zone _____ State _____

Signed _____

I understand this order will start in _____

(month)

(year)

with PHOTOFAC T Set No. _____

Distributor Name: _____

Address _____

City _____

State _____

Salesman's Name: _____

(please print)

Note to: Howard W. Sams & Co., Inc.

Increase our PHOTOFAC T standing order by _____ copies.

Order No. _____ Date _____

Signed by _____

FOR THE TV-RADIO SERVICE TECHNICIAN

NOW! have the complete

PHOTOFACT

Service Data Library

for as little as . . .

\$10

DOWN

**UP TO 24 MONTHS TO PAY—
NO INTEREST—NO CARRYING CHARGES**

NOW—for as little as \$10 down, you can have at your fingertips the *complete* PHOTOFACT Service Data Library and a sturdy four-drawer steel cabinet for easy-reference filing. It's the *only* Service Data Library covering over 28,000 TV, Radio, Record Changer, Recorder and Amplifier models . . . the *only* library that gives you *all* the information you need to repair *more* jobs per day . . . Faster—Better—Easier—and pays for itself as it earns for you!

**MAKE YOUR MOVE
TO BIGGER PROFITS**

TODAY!

With our Easy Pay Plan, you'll find that PHOTOFACT actually pays for itself as your earnings grow. It's the best investment you can make in the future of your service business—so make your move to BIGGER PROFITS—see your PHOTOFACT Distributor TODAY!

HOWARD W. SAMS & CO., INC.

2201 East 46th Street
Indianapolis 5, Indiana

the world's
**BEST TV-RADIO
SERVICE DATA**

HE DOES



HE DOESN'T

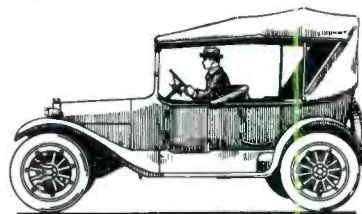

STOCK AND SELL RCA BATTERIES!

The modern, up-to-date dealer stocks and sells RCA Batteries. He knows that customer acceptance of RCA quality assures him of profit-making battery sales throughout the year.

There's an RCA Battery for virtually every need . . . in the home, in the factory, or on the road.

Order your stock of RCA Batteries *today* for profit-making sales all year long!



RADIO CORPORATION of AMERICA

COMPONENTS DIVISION

CAMDEN, N.J.

CONSUMER • INDUSTRIAL • GENERAL • RCA IS YOUR BEST BATTERY BUY!

another
LITTELFUSE First

MOUNTINGS DESIGNED AND DEVELOPED
FOR THE

NEW

SARKES-TARZIAN

Silicon Rectifiers

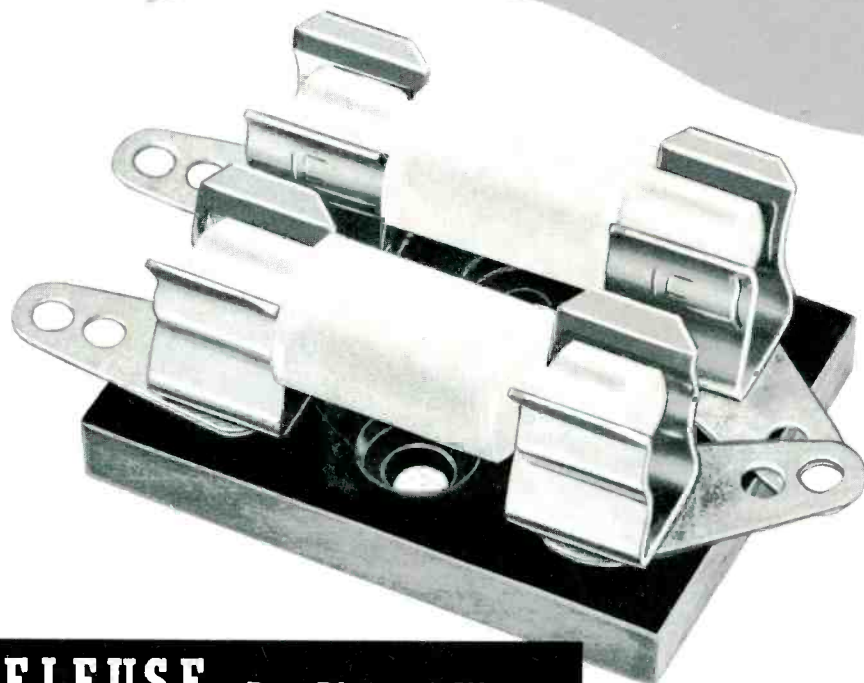

LITTELFUSE, *Des Plaines, Illinois*