

*E. L. Marnen*



~~~~~  
*Western Electric*  
**OSCILLATOR**  
~~~~~

NUMBER 4

JULY 1946

New Line of  
FM Transmitters

Telephone on Wheels

Cavity Magnetrons -  
Magic Radar Tubes

# Western Electric OSCILLATOR

NUMBER 4

JULY 1946

DEVOTED TO DEVELOPMENTS IN COMMUNICATIONS AND ELECTRONICS

Published periodically from November, 1935 to May, 1942 under the name *Pick-Ups* by the

## Western Electric Company

195 Broadway : New York 7, N. Y.

C. G. STOLL . . . . . President  
F. R. LACK . . . V. Pres. and Mgr., Radio Div.  
N. R. FRAME . . . . . Secretary  
G. B. PROUD . . . . . Treasurer

WILL WHITMORE, Editor  
VANCE HILLIARD, Assistant Editor

The *Oscillator* does not accept responsibility for quoted statements appearing in the magazine. Such statements reflect only the opinions of the person quoted.

Copyright, 1946  
by Western Electric Company, Incorporated  
Printed in U.S.A.

### THE COVER

In this color reproduction is presented the 10 KW, one of the stars of Western Electric's new line of FM transmitters, described on pages 18-24. Unexcelled performance — plus such design features as full-length glass panels in the front doors and an unobstructed view of all tubes — makes this new line a stand-out.

### THIS ISSUE

	Page
Telephone on Wheels . . . . .	3
Cavity Magnetrons . . . . .	7
Stereophonic Sound Reinforcement . . . . .	11
A Clover-Leaf Goes Up . . . . .	12
Something New in Wire Program Distribution . . . . .	15
Special Section on FM Transmitters . . . . .	18
Program Peak Limiter in FM Broadcasting . . . . .	25
Navy Radar Puts On Civvies . . . . .	28
Direct Crystal Control at 50 MC . . . . .	30
Radio Rides the Rails . . . . .	32
A Loudspeaker Is Born . . . . .	35
A Simplified Radio Frequency Bridge . . . . .	36
Book Reviews . . . . .	42
They Witnessed the Big Explosion . . . . .	43

## Radio and Transportation

Radio is rapidly becoming one of the chief workhorses of our modern world, reaching into ever-widening branches of our daily activities.

Besides the 80-odd million listeners who depend on Broadcasting's 1,011 AM and the increasing number of FM stations for vital information, news and entertainment, Radio is spreading into communications fields that will equally affect our lives and bring more speed, comfort and safety to all forms of transportation.

In this issue of the *Oscillator*, we take a look at two recent examples of these new developments. We see mobile telephone service springing up in city after city. We see it spreading to the highways across the Nation, presaging the time when a motorist in any large city or on any main highway may pick up the telephone in his automobile and in a few minutes be connected with any one of the Nation's 29,000,000 regular wire telephone subscribers. The technological aspects and practical applications of the problem have already been successfully worked out.

We see also the telephone coming to the aid of the railroads—increasing speed, safety and convenience in this form of transportation. This will help round out Radio's vital services to transportation on land, in the air and at sea.

Finally, we see Radio being prepared on a vast scale as a valuable adjunct to the wire communications services. Specifically, work is now being undertaken by the American Telephone and Telegraph Company on a radio relay from New York to Boston, and as soon as these tests are completed we may be able to give you a good assessment of just how far radio relay can go in helping wire communications with its back-breaking job — just how efficient and economical it is both for carrying telephone messages and for taking Television's audio and video on their way. That story will be a major assignment in one of the *Oscillator's* future issues.

In the entertainment field, Radio has already reached maturity. Now in the communications field also, Radio is coming of age as one of the world's most useful communications tools — a communications tool that oils Civilization's wheels and keeps them turning — more efficiently, more economically and more safely.

### Telephone on Wheels

Here is the story of mobile telephone — the experiment in St. Louis and the technological aspects of mobile radiotelephony everywhere. In this article beginning on

page 3, you can figuratively pick up the telephone in your automobile and get a good idea of what happens and how it came about.

### Unveiling a New FM Line

Of particular interest to broadcast engineers will be the center section of this issue covering pages 18 to 24. Here are unveiled some brand new beauties of a line of 1 to 50 kw FM transmitters. Developed by Bell Telephone Laboratories with a cabinet designed by the noted industrial designer, Henry Dreyfus, and incorporating every improvement, these fine operating units will gladden the eyes of engineers everywhere.

### Radar's Magic Wand

The heart of radar is a small tube, known as the cavity magnetron, capable of generating pulses of radio energy with frequencies as high as 10,000 megacycles. The article beginning on page 7 tells of the development and production of these vital elements, so aptly called the "magic tubes of World War II."

### Stereophonic Sound

A sound system that has depth or perspective is the subject of the article entitled "Stereophonic Sound Reinforcement" beginning on page 11. Using commercially available equipment, a stereophonic sound reinforcement system was set up for a large open air production of the light opera, "Naughty Marietta," and the results were so superior to any that could be obtained from single channel systems that a new criterion of quality was established.

### A Loudspeaker Is Born

As the result of a request by the Navy for the design of a loudspeaker capable of unusual realism and fidelity, the speaker, known as the 728 Type Loudspeaker, was developed. A commercial version has now been designed by Bell Telephone Laboratories and made by Western Electric, which is ideal for installations requiring a single unit system. The new 728 is finding many uses in many fields, and will be seen in high quality installations on trains, planes and passenger ships, in hotels, restaurants and public buildings. The story of this loudspeaker begins on page 35 of this issue.



## TELEPHONE ON WHEELS

THE doctor driving down Main Street picks up the telephone in his automobile and is informed of an emergency call; the delivery man receives a change of orders over the phone in his delivery van; the power company truck while returning from an assignment is dispatched to the scene of a line break by telephone instructions from the home office. These events — not so long ago a part of the wide-eyed stories of the world of the future — are already being removed from the realm of the imaginary, for such easy mobile communication is now an actuality and is now being experimentally tested under conditions that will best bring out its unique usefulness in modern life.

The city selected for this first comprehensive test of Bell System general mobile radio service is St. Louis, Missouri, and the first license to operate radiotelephone service for vehicles on a commercial basis was granted by the Federal Communica-

*By Robert Bright, Jr.,  
and Stanton Vanderbilt*

tions Commission to the Southwestern Bell Telephone Company.

Participants in the trial will include such concerns as parcel delivery and express companies, newspaper publishers, power companies, contractors, bus, trucking and



moving van concerns as well as oil burner, refrigeration and other servicing organizations which operate vehicles within the area and to whom keeping in touch with their drivers is important.

Three classes of service are being offered: (1) a general two-way telephone service between any vehicle and any wire telephone or other mobile unit; (2) a two-way dispatching service between a customer's office and his own mobile units only; and (3) a one-way signaling service to mobile units to notify the driver that he should comply with prearranged instructions.

The rates for a three-minute general service message range from 30 to 40 cents depending on the location of the wire telephone. The charge for a one-minute two-way dispatching call is 15 cents. If the calling or called land telephone is outside the St. Louis mobile service area, then toll rates would apply.

The mobile telephone service will operate like this:

Calls to and from vehicles will be handled by mobile service operators. The conversations will travel part way by telephone wire and part way by radio. For example, a man at his desk in St. Louis who wants to talk to the occupant of a certain car or truck will lift his telephone receiver and dial or ask for the mobile service operator, to whom he will give the telephone number of the vehicle he wants, such as WJ2-3873. The numbering will not conflict with any existing central office code.

The mobile operator checks channel WJ to determine whether it is in use. If the channel is idle the mobile service operator inserts a dial cord and dials 2-3873. The mobile station bell rings and the subscriber answers and talks to the wire line subscriber. The mobile service cord circuit supervisory lamp is extinguished. The operator starts timing the ticket covering the call. At the termination of the call, the supervisory lamp at the switchboard lights. The mobile service operator releases the channel and enters the ending time of the call on the ticket. The channel is now ready for the next call.

A call from the mobile station to a wire line subscriber is just as easily completed. The mobile subscriber removes the handset from the control unit and "monitors," i.e., listens to check that the channel is not in use. If the channel is idle, the mobile subscriber presses the "push to talk" button on the handset. The line lamp at the mobile service switchboard position lights. The mobile service operator answers, and asks for called number. The mobile service operator completes the call in the same manner as for a wire line sub-

scriber. As before, the cord supervisory lamp gives a continuous indication of the progress of the call.

As can be seen, the originating or the receiving of a mobile radiotelephone call is no more complex than performing the same operation from a regular wire line telephone. Transmission standards equal to wire line service can be maintained and no complex or tricky operating procedures are necessary.

#### Service Planned for 58 Cities

At the present time, in the Bell System, 37 cities have had FCC construction permits granted for urban mobile service, 7 cities have applications pending and 14 cities have applications in preparation, giving a total of 58 cities currently having plans for urban service.

The cities in which the construction of urban stations have been authorized to date include Boston, Springfield (Mass.), New York, Newark, Philadelphia, Baltimore, Washington, Pittsburgh, Miami, Atlanta, Minneapolis, Milwaukee, Chicago, Detroit, Toledo, Cleveland, Dayton, Columbus, Cincinnati, Louisville, Indianapolis, Memphis, Kansas City, Birmingham, New Orleans, Fort Worth, Dallas, Houston, Oklahoma City, Denver, Salt Lake City, Portland (Ore.), Los Angeles, San Francisco, St. Louis and Seattle.

Applications for authorization to construct urban stations in Worcester, Norfolk, Akron, Des Moines, Omaha, Providence and San Antonio are now pending before the Commission. Surveys to determine the desirability of extending the service to other cities are also under way.

Bell System plans for mobile telephone service to cover certain intercity highways

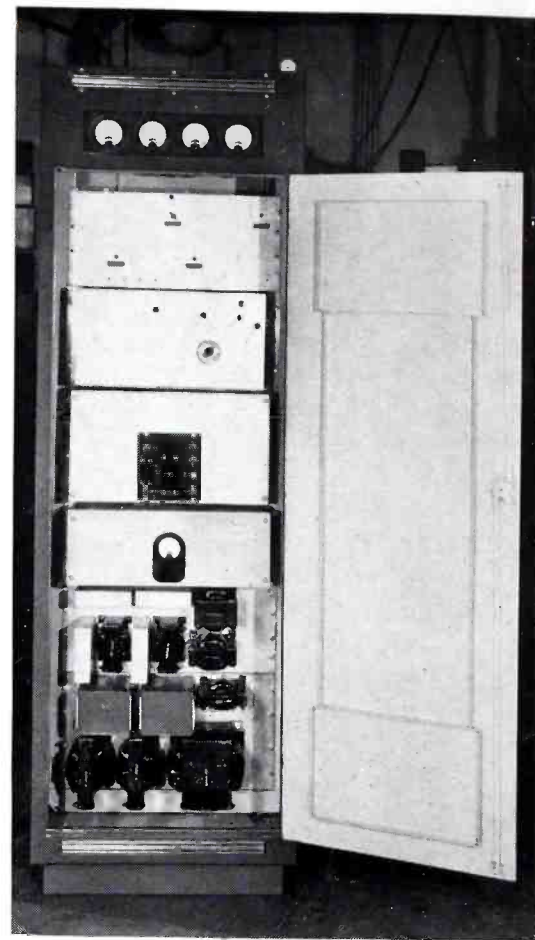

The Land Station Transmitters have an output of 250 watts and can be remotely monitored and controlled. This is the 540A for 152-162 mc band.

were announced last December. Applications for authorization to construct transmitter-receivers along the highways between New York and Boston, New York and Buffalo, Los Angeles and San Diego, Cincinnati and Cleveland and between Chicago and St. Louis have either been granted or are pending.

When established, the highway stations will permit communication between vehicles traveling along the routes and any



The 41A Control Unit is mounted under the instrument panel of the radiotelephone equipped vehicle.

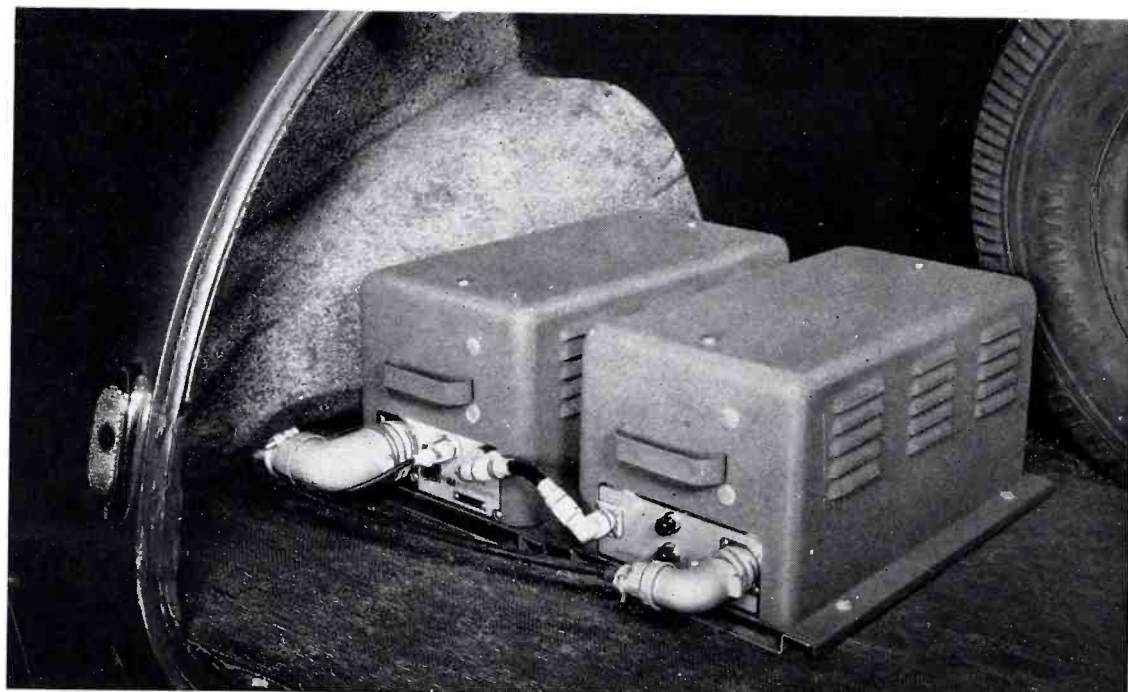

In passenger vehicles the transmitter and receiver of the 238 Type Radiotelephone Equipment are placed in the luggage compartment. In trucks and buses a special cabinet is mounted inside or beneath the body.

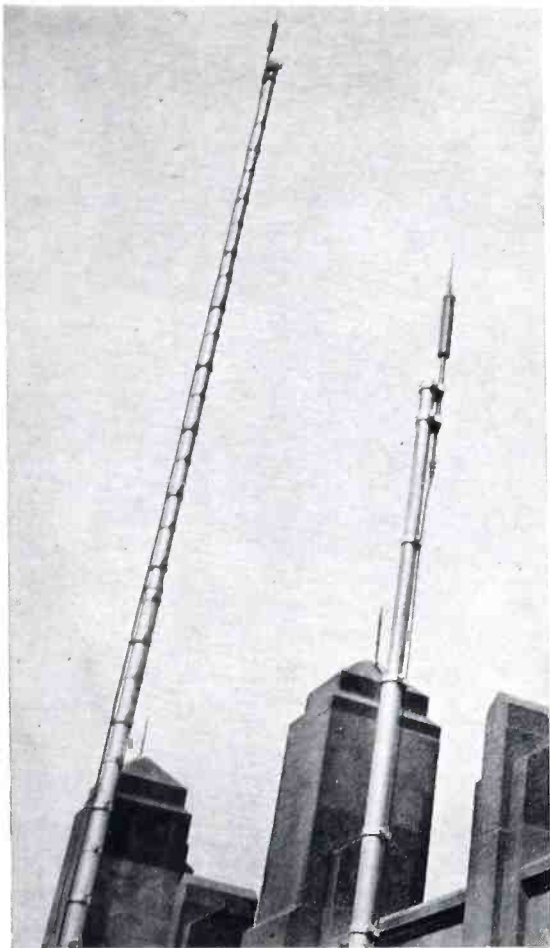

Antennas used in the St. Louis trials. Receiving mast is in the foreground, transmitting mast is in background, mounted atop the Telephone Building.

wire telephone. A number of companies, including truck and bus lines, long distance movers, utilities and other organizations have indicated interest in highway radiotelephone service and a desire to participate in experimental trials.

### Characteristics of Equipment

Equipment for mobile telephone service has already been designed by Bell Telephone Laboratories and manufactured by Western Electric.

Coded as the 238 and 239 Type Radiotelephone Equipments, they were developed to meet the rigid specifications of the Bell System as well as the requirements of the Federal Communications Commission.

The equipment is of two general types — the 238, that operating in the 152-162 megacycle band and its counterpart, the 239, operating in the 30-44 megacycle band. The following description refers to the 238 Type, but is applicable in most cases to the 239 also.

The equipment consists of a radio receiver and transmitter, antenna, selective signaling device and telephone instrument. All controls and the instrument may be conveniently mounted under the instru-

ment panel of the vehicle in a single unobtrusive unit.

Controls are few in number: One ON-OFF power switch and a simple "push to talk" switch in the handle of the handset. No tuning or adjustments are made by the vehicle operator. All such adjustments are made by the telephone company at the time of installation.

*Transmitter.* The transmitter has an output of 20 watts, sufficient power to give reliable service in the area served. The high voltages are supplied by a dynamotor, which receives its power from the battery in the vehicle. No additional battery is required although in general it will be desirable to provide a battery of larger capacity than the one normally supplied with the vehicle to care for the power requirements of the radiotelephone equipment. A larger generator is also necessary in most cases to maintain the charge on the larger battery.

Quartz plate control of the transmitter frequency is provided, with a thermostatically controlled, constant temperature oven enclosing the quartz plate. Temperature control insures operation of the transmitter on the proper frequency. The radio fre-

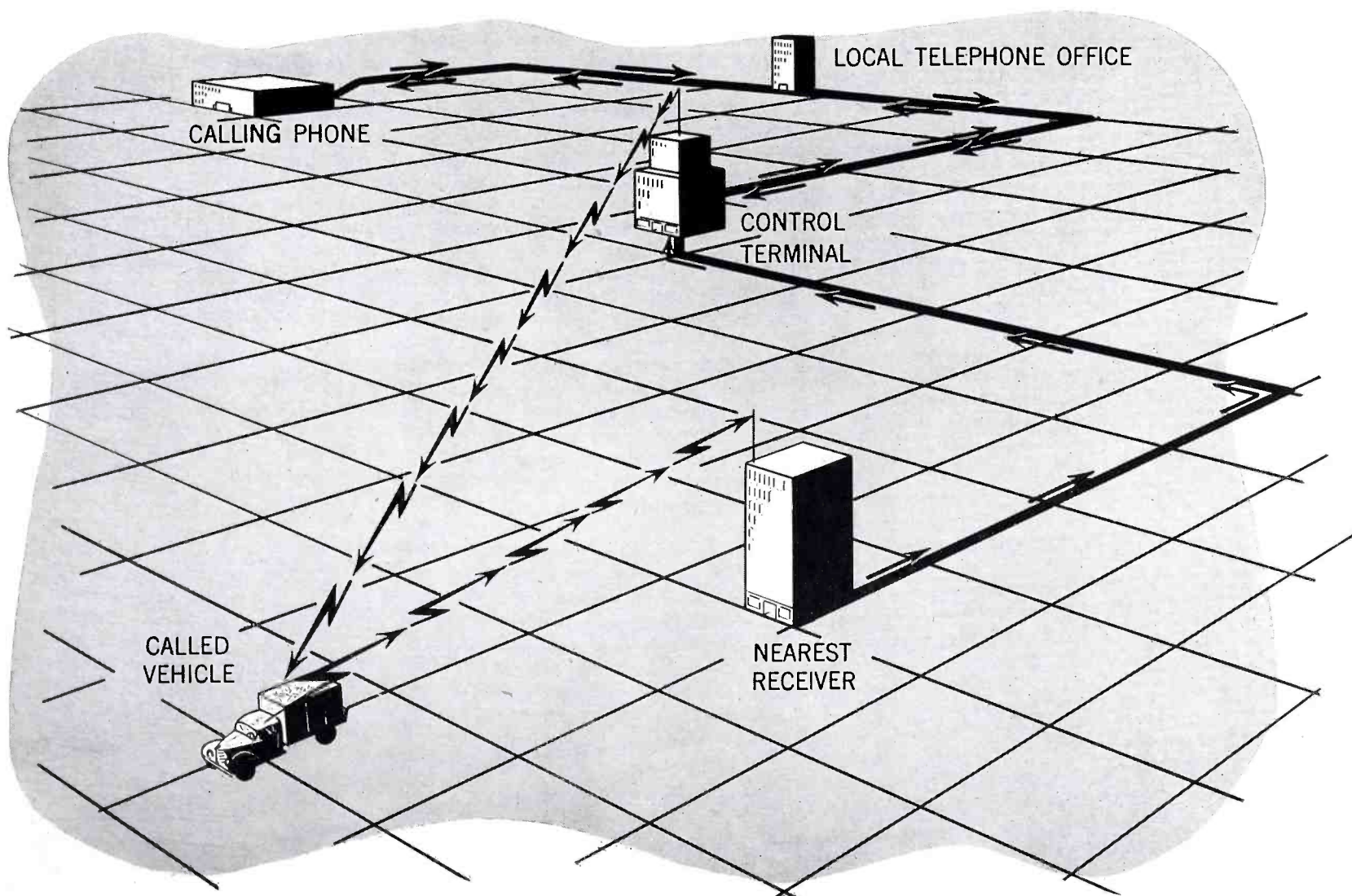

Call from a land telephone to a vehicle travels by telephone wire through local telephone office and control terminal to transmitter. Here it is put on the

air and picked up only by called vehicle. Returning message goes from vehicle to nearest receiver; by wire back to control terminal, then to calling phone.

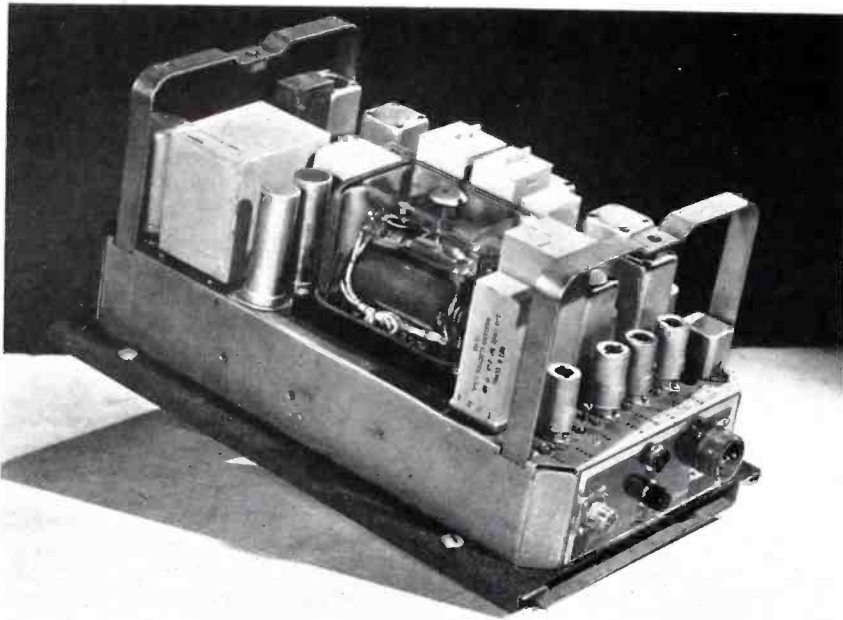

Removing the cover of the 38 Type Receiver reveals its clean, compact arrangement. Inherent high sensitivity and selectivity are two important features.

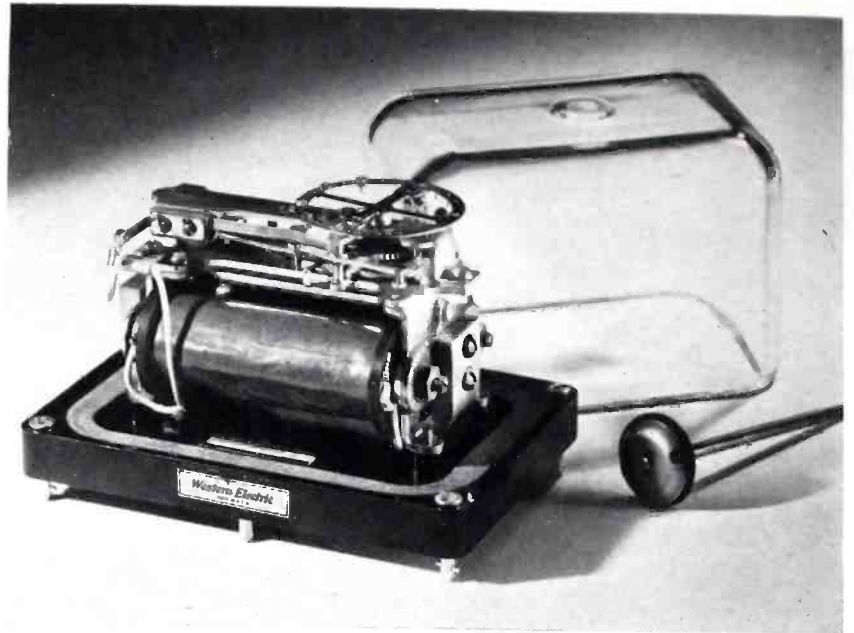

The D-175279 Selector makes certain that each vehicle is signaled only for its own incoming calls. It is shown above and in the receiver in left photo.

quency carrier is modulated by a phase modulation circuit, resulting in excellent voice-quality transmission with an extremely low noise level. Minimum deviation plus frequency tolerance of the carrier under speech modulation is normally a swing of plus or minus 15 kilocycles. Unusual features of the modulation circuit are that no adjustments are necessary, and that only one vacuum tube is used.

Spurious radiation, that is, radiation of signals on other than the assigned frequency, is well below what is normally expected with mobile transmitters, an unusual double-tuned circuit in the first doubler stage providing one of the reasons for the absence of undesirable radiation.

All test and measuring points are brought out to a convenient jack on the front of the panel, adding to the ease with which adjustments are made by the installation or maintenance man. A meter test set is used with a plug to fit the test jack, and the value of the currents in the various sections of the transmitter circuit is measured by simply rotating the test set switch

to its various positions.

*Receiver.* The Western Electric 38 Type Radio Receiver, used in the 238 Type Radiotelephone Equipment, is of a sensitive triple detection superheterodyne type. It is fixed tuned, with quartz plate control for both conversion oscillators. Triple detection is a modification of the usual superheterodyne, having two converters and two intermediate frequencies. The great advantage of triple detection is effective image suppression with no loss in selectivity. Images in superheterodyne receivers are spurious responses to signals separated from the frequency to which the receiver is tuned by twice the intermediate frequency. Further image rejection, along with added sensitivity, is gained by having a tuned radio frequency amplifier ahead of the first converter stage. A non-synchronous vibrator is used in the power supply circuit. The advantage gained by using this type of vibrator is that no concern need be given as to whether the positive or negative side of the vehicle battery is grounded.

A switch is provided for ease in chang-

ing from a 6-volt battery supply to a 12-volt battery. The switch opens or closes the circuit to one half of a tapped primary winding on the power transformer. While a tapped transformer is slightly more expensive than using a resistor to drop the voltage, the method used has the advantage of lower power requirements from the vehicle battery when used on a 12-volt source. The vacuum tube filament circuits are easily switched for operation from a 6-volt filament supply to a 12-volt supply.

The intermediate frequency stages of the 38 Type Receiver are designed to have bandpass characteristics that provide an unusual degree of selectivity.

#### Negative Feedback Improves Reception

The audio frequency response of the receiver is flat in the voice frequency range with the resultant faithful reproduction of the talker's voice. With less than a micro-volt input to the receiver the signal-to-noise ratio is about +25 db. During the period when the voice circuit is in use, neg-

(Continued on page 38)

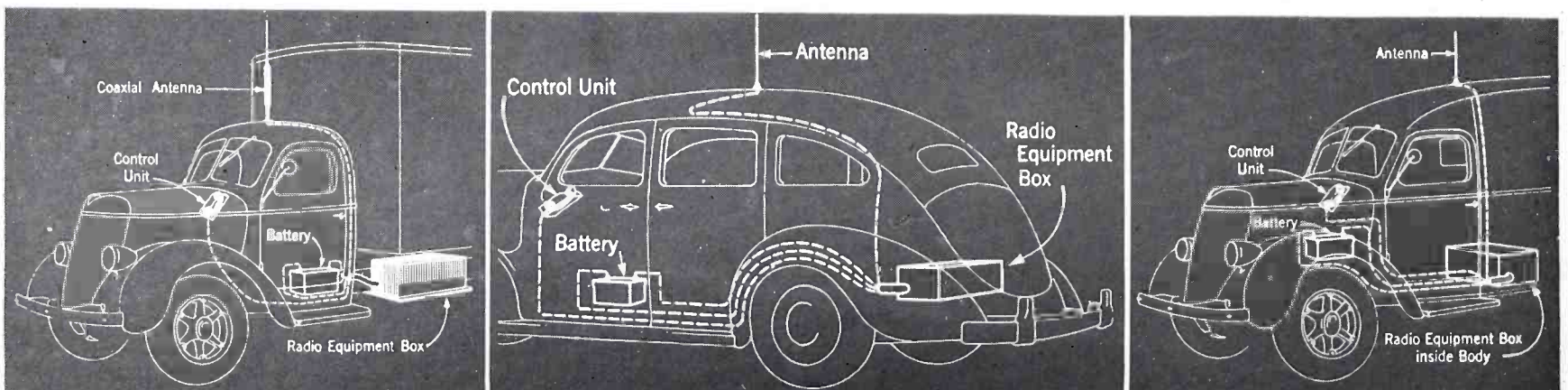

These diagrams show the arrangement of units of the radio equipment in various types of vehicles. In the van at left, transmitter and receiver are in the box

beneath the body and the coaxial antenna rises above the body of the truck. The panel delivery at the right has the radio equipment box inside the body.

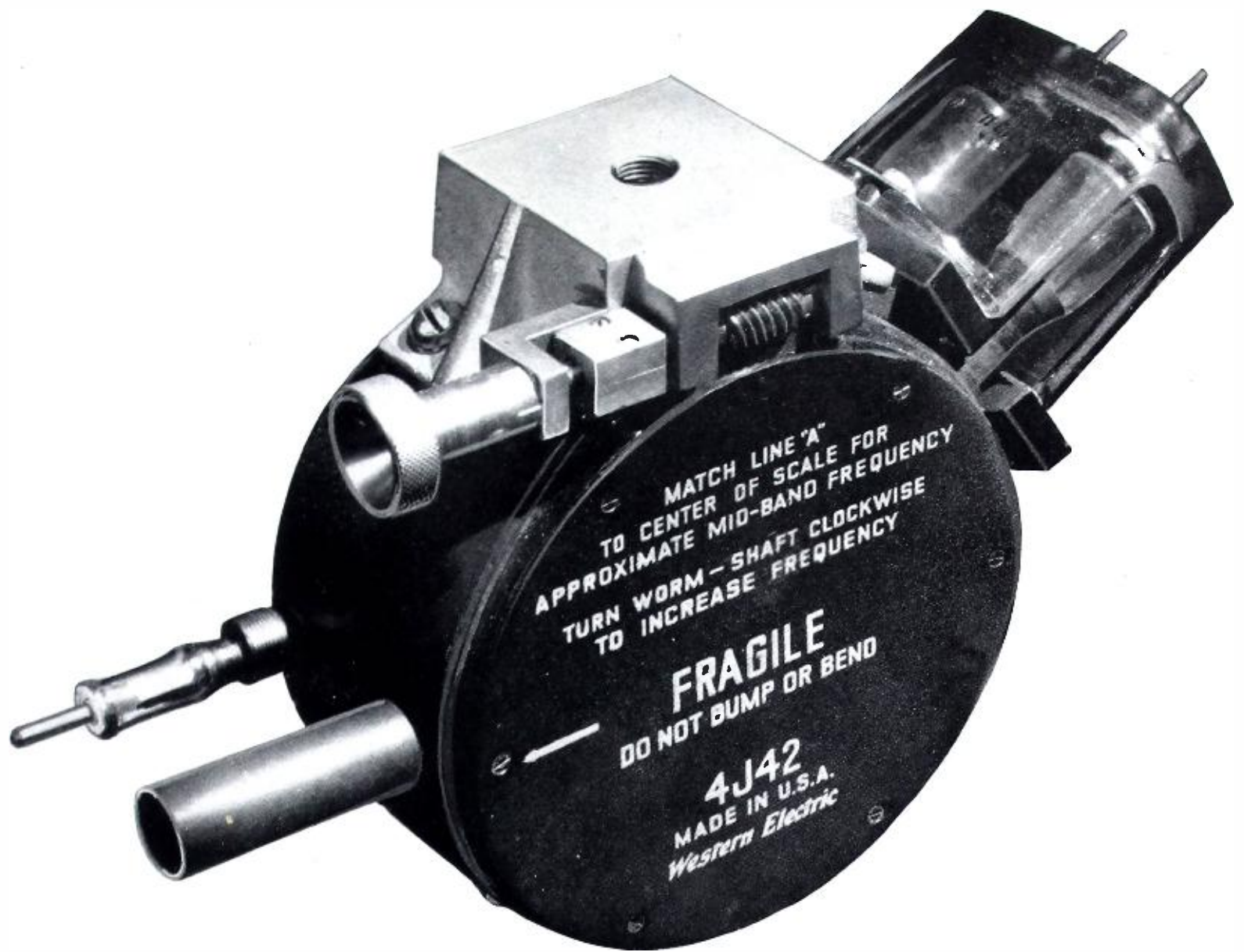

## CAVITY MAGNETRONS ... Magic Tubes of World War II

HISTORIANS of the future will spend countless hours in debating what was the critical turning point in the course of World War II. But military scientists will tell you that one of the decisive points in the war was the day the first cavity magnetron was introduced into the circuits of early forms of radar. Like the magic wand of the medieval court magician, the cavity magnetron literally lifted radar out of the incubator of experimentation and made it the most potent electronic weapon of the war. Mute evidence for this conclusion can only be found now in the memory of a progression of victories on land, in the air, and on the sea, stretching from the rugged beaches at Anzio across Europe, and in the Pacific from the Savo Islands to the very heart of Japan.

Although many people were familiar with the basic magnetron and the principles of the resonant cavity, and even others had worked with the combination

*By J. Clifford Johnson*

of the two, it was not until 1940 that British scientists at the University of Birmingham, England, seeking a means to thwart a ruthless and powerful enemy, successfully made and pulsed a cavity magnetron and started microwave radar on its way. In the fall of that year, as the Nazi blitz approached its full fury, a model of the tube was secretly brought to the United States and demonstrated before Army and Navy officials. Under a veil of secrecy, the tube was delivered to Bell Telephone Laboratories. Here, in less than five weeks the Laboratories' scientists completely tested the tube and produced five operating duplicates — an outstanding feat in electronic history. Shortly thereafter cavity magnetron production began in the United States and by the end of the war Bell Telephone Laboratories had developed over 50

varieties of the tube, and the Western Electric Company had manufactured nearly 300,000 tubes from these designs.

The cavity magnetron in one broad sweep radically changed electronic frontiers, brought into being a new art which required new techniques and new thoughts.

First, realize that the comparatively low frequencies that were considered the practical limit by engineers a few short years ago were completely abandoned. Broadcasting stations, for example, transmitted over a band of frequencies the center of which was one megacycle. Ultra high frequency was spoken of as 60 to 100 megacycles. By the end of the war, however, many radars employed cavity magnetrons capable of generating pulses of radio energy with a frequency in the order of 10,000 megacycles. Wavelengths for broadcasting stations operating on one megacycle are in the order of 300 meters. The wavelengths of some of the latest mag-

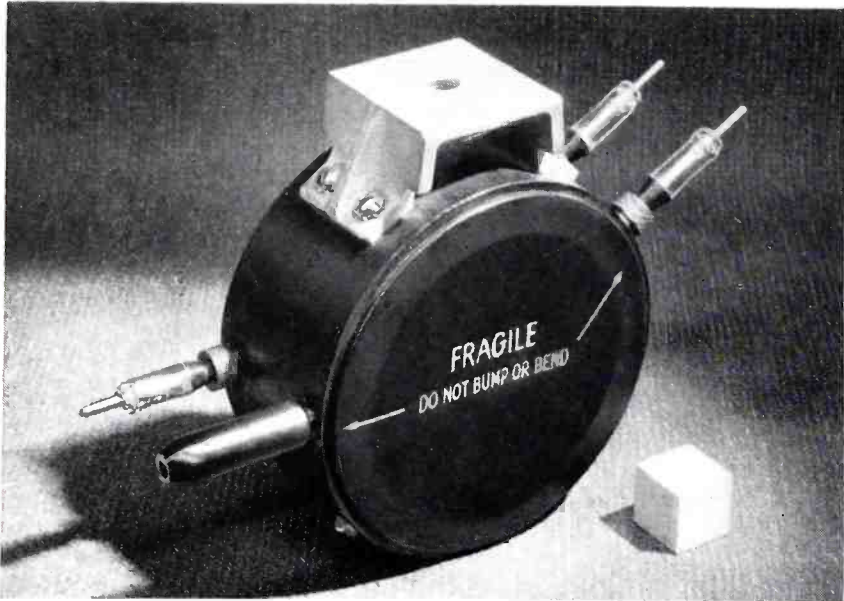

The 700A to D Type Cavity Magnetron was the earliest of the L-band group. It was used aboard U.S.S. Boise in famous night engagement off the Savo Islands.

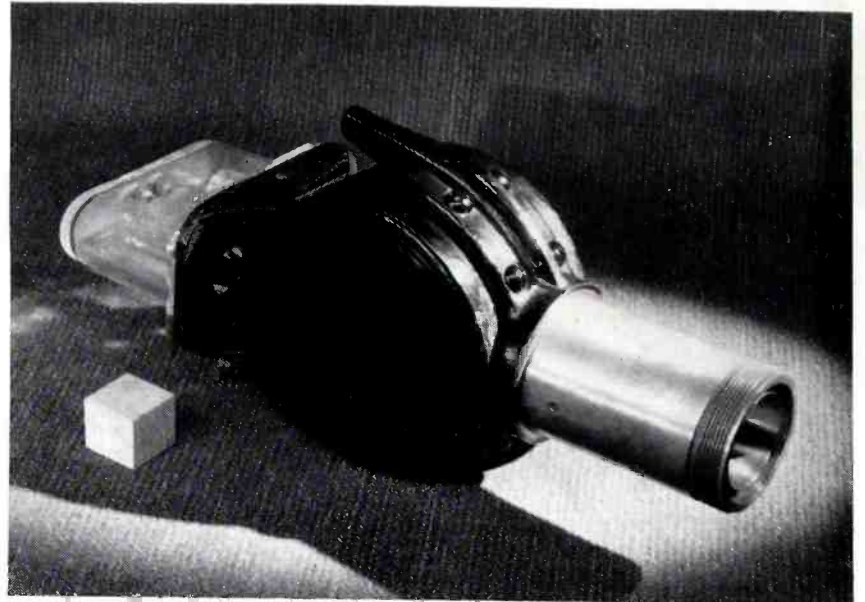

The 728AY to GY Type of cavity magnetron operates in the L-band and has an output power of 400 kw. It was later replaced by the 4J51 tunable magnetron.

netrons are three centimeters and less. Output power for some radio stations range up to as much as 50 kilowatts, while some cavity magnetrons develop instantaneous (peak) powers of up to 1,500 kilowatts. All of which means that the scientist, in order to achieve this advance in the art, has had to exercise more and more control over the electron itself as his radio waves approached the wavelength of light.

#### L, S, X and K Bands

Cavity magnetrons produced during the war cover four main wavelength bands in the ether spectrum: L-band from 25 to 50 centimeters, S-band from 8 to 11 centimeters, X-band of three centimeters and K-band with a group of even shorter wavelengths. Since there are many varieties of cavity magnetrons of both fixed and tunable frequency designs, the scope of this article will be limited to a description of one of the earliest and most famous of the

fixed frequency type known as the 700 series with a range from 660 to 720 megacycles and a corresponding wavelength in the order of 40 cms. This type of magnetron is particularly noted for distinguished service as part of a radar equipment aboard the light cruiser *U. S. S. Boise*, the one-ship task force that broke up a Jap flotilla in a memorable night engagement in the South Pacific.

Before explaining the theory involved in the operation of the cavity magnetron, it may be advantageous to describe briefly the functioning of radar equipment and magnetrons as used aboard the *U. S. S. Boise*. The radars involved were the Mark III and Mark IV — detecting and ranging equipments for the detection and location of surface craft and aircraft. The Mark III provided bearing and range data for the solution of fire-control problems while the Mark IV supplied elevation data in addition to the bearing and range.

In operation, a short pulse generated by the cavity magnetron in the radar transmitter is emitted from a directive antenna, mounted on the ship's gun director. This pulse may then be returned to the antenna by reflection from some remote target. Each pulse is a few millionths of a second in length and pulses recur at the nominal rate of 1640 per second or about once every 600 microseconds. The distance to the target is measured by the round trip time required for the signal to reach the target and return to the antenna. Inasmuch as radio waves travel at a constant speed of 328 yards per microsecond and since the energy must travel the same distance twice, going out and returning, the maximum range of an equipment is determined by the pulse length and the interval between pulses, and in the equipment using the 700 Type cavity magnetron it is approximately 100,000 yards.

The radar transmitter together with the

Spot welding the supporting cup and coated cathode assembly. The especially-prepared thermionic surface is the electron source for the cavity magnetron.

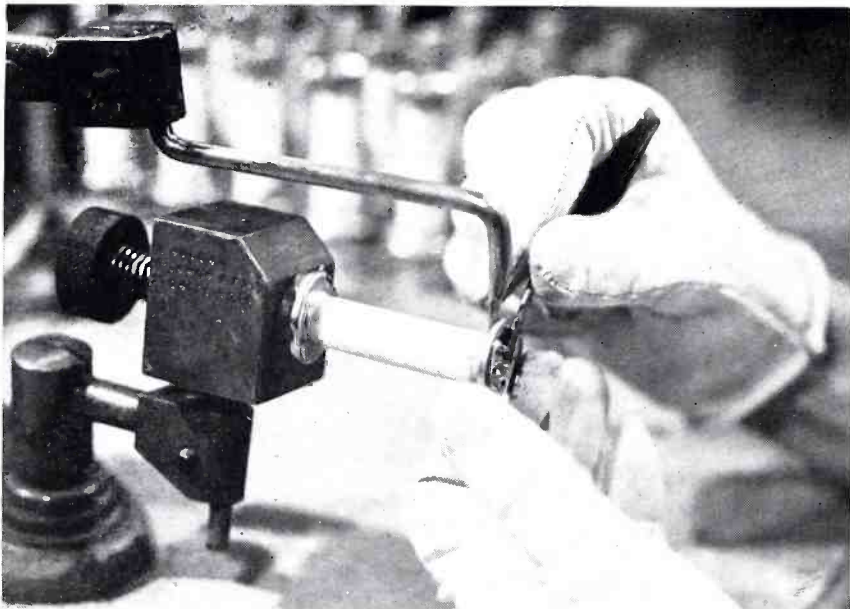

The anode of the cavity magnetron tube, showing the internal cavities, is made from oxygen-free high-conductivity copper. Note the output loop in top cavity.

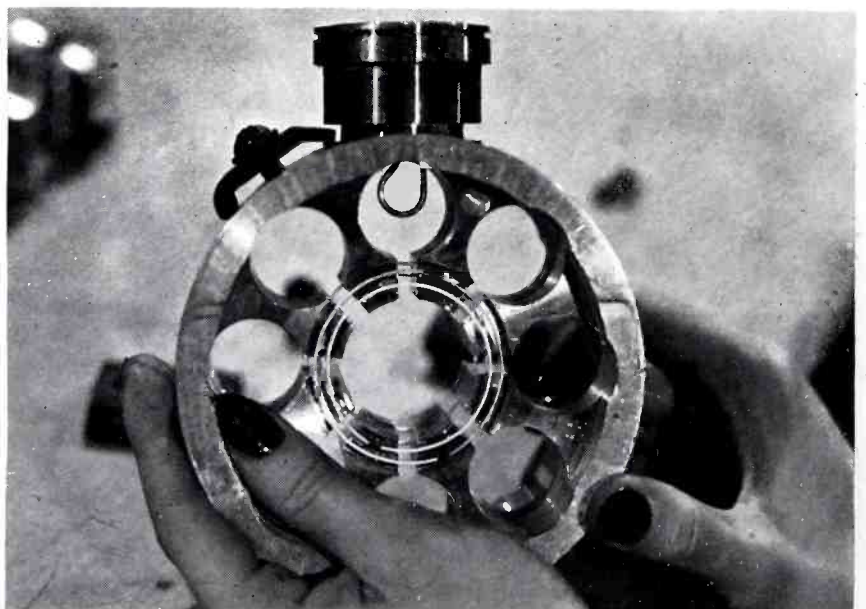



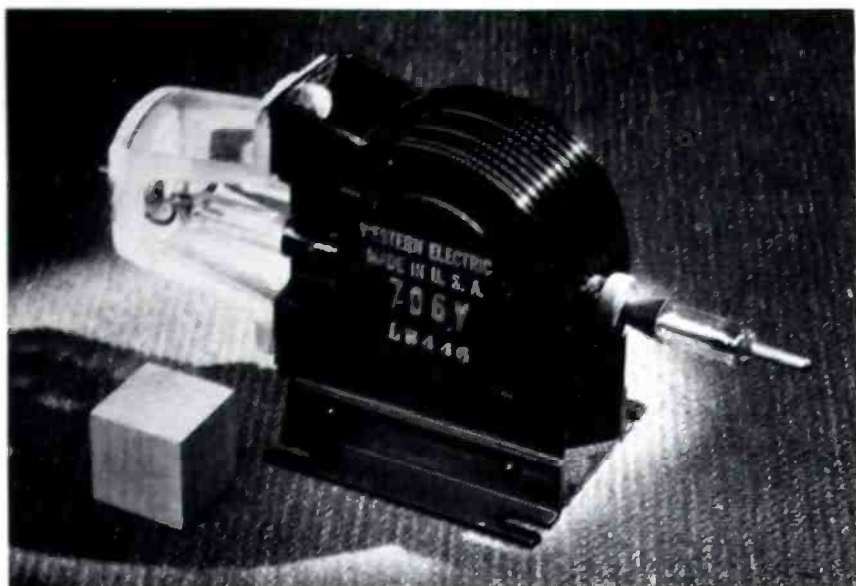

The 706AY to GY Type Cavity Magnetron operates in the S-band. Its predecessor was the British magnetron secretly brought to the United States in 1940.

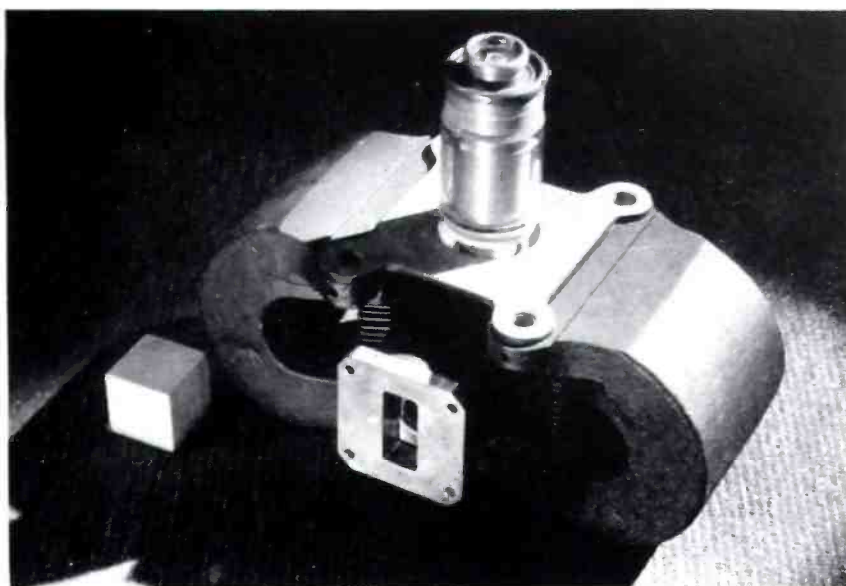

The X-band 4J52 Cavity Magnetron is a medium power, packaged type. One of the latest designs in X-band, it has wave guide output and coaxial cathode mount.

modulation generator, radio receiver, control panel and high voltage rectifier are mounted in a single frame which is installed below deck near the base of the ship's director tube. Besides the cavity magnetron, the transmitter includes pulse amplifier or keying tubes, a recharging diode, and two rectifiers. The keyer tubes are normally biased to cutoff and conduct on pulses supplied from a modulation generator. A simplified schematic of such a transmitter circuit is shown in Figure 2 on page 10.

The 700 Type Cavity Magnetron, a photograph of which is on page 8, is a two element electron tube. Its electron source is a cylindrical, unipotential-heater cathode with an oxide coating which is supported in the center of a massive, copper anode. Each anode, as shown in Figure 1, contains a number of resonant cavities shaped in cross-section like keyholes with stems or slots feeding into the central

cathode chamber, all of which comprise the tube's high frequency circuit. The tube is equipped with a base of non-magnetic material which supports the tube so that it is symmetrically located between the poles of an electromagnet. The electrical characteristics of such a tube are as follows: maximum peak radio frequency output, 100 kilowatts; normal peak anode rating, 12 kilovolts at 10 amperes; maximum duty cycle, 1/400; maximum pulse duration, two microseconds; nominal average input power, 120 watts.

#### Complex Construction

Some idea of the complex construction of the cavity magnetron may be gleaned from some of the manufacturing photographs and the following wide assortment of materials required in its manufacture. A nickel cylinder with an active oxide coating for the cathode, oxygen free high conductivity copper for the anode, pure

tungsten wire with an alumina insulating coating, ceramic spacers, chromium, rubber-asbestos for gaskets, silver for conducting surfaces, brass, glass and phenol-fibre sheets for gas-tight closure purposes.

To operate the 700 Type Magnetron, a low voltage is impressed across the cathode in order to bring it to a proper operating temperature. Then, when approximately 12,000 volts of pulsating direct current is applied between the anode and the cathode, the latter's especially prepared thermionic surface emits a flow of electrons. If these were no magnetic field to contend with, these electrons would proceed on a uniform, direct course from the cathode to the anode surrounding it as shown in Figure 3(a). However, as a magnetic field is applied through the axis of the tube — which field is at right angles to the direction of the natural electron movement — it exerts force on the electron causing it to bend in flight as shown in Figure

Installing the two heater leads in the massive copper anode of a cavity magnetron. Later, these leads will be welded to the cathode's supporting cup.

A 728 Type Cavity Magnetron receives its final electrical test before being packaged and shipped. The test set simulates actual radar operating conditions.

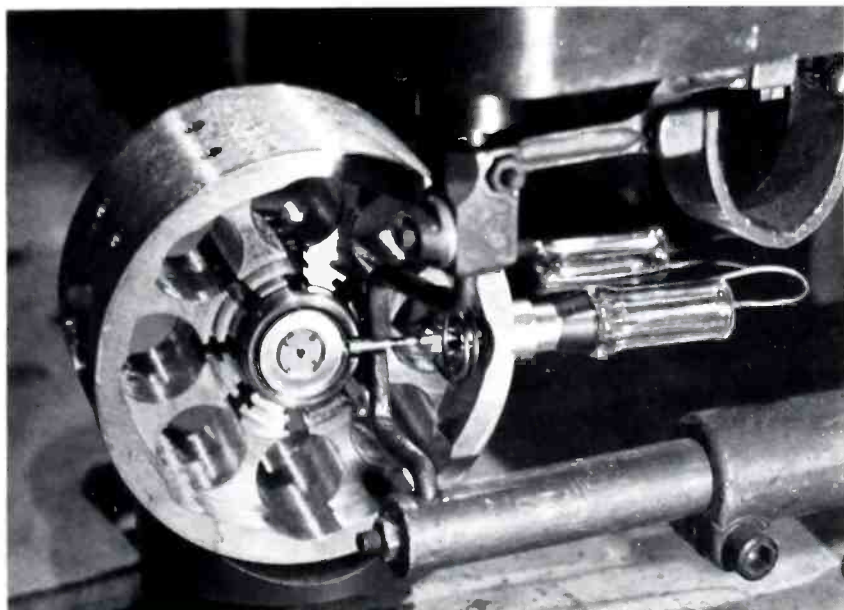

3(b). These two illustrations serve only to show the effect of a magnetic field on the flow of electrons from the cathode to the anode. In the non-oscillating magnetron, when the strength of the field is increased to what is known as the critical value, the path of the electron misses the anode and follows a circular course back to the cathode as shown in Figure 3(c). At this critical value of the field strength the plate current abruptly drops to zero as the electrons are deflected away from the anode as indicated by the curve in Figure 3(d). This condition, however, does not hold true for the multi-cavity type magnetron as indicated by the path of some electrons in Figure 1 because of the introduction of certain other factors some of which will be explained below.

In the multi-cavity magnetron, the internal cavities act as resonators and function as a tank circuit. The walls of the slots serve as the capacitance while the inductance of this oscillating circuit is centered in the circular portion of the cavity walls. It should also be noted from Figure 1 that one wall of the slot is always positive when the other is negative, and also that the potential between the walls of any one slot is the reverse for the two adjacent slots. However, when the tube is in operation there is a continuous change in the potential between the walls of each slot.

Thus, when an electron emitted by the cathode starts on its course to the anode, it is first affected by the applied magnetic field and begins to bend. Some electrons are driven back and bombard the cathode, while others proceed on a curved path of cycloidal form. If, on this journey, the electron approaches a region of negative potential, it will be slowed down or repelled, while other electrons following in its wake, because of the rotational velocity, will approach a region of positive potential

*(Continued on page 40)*

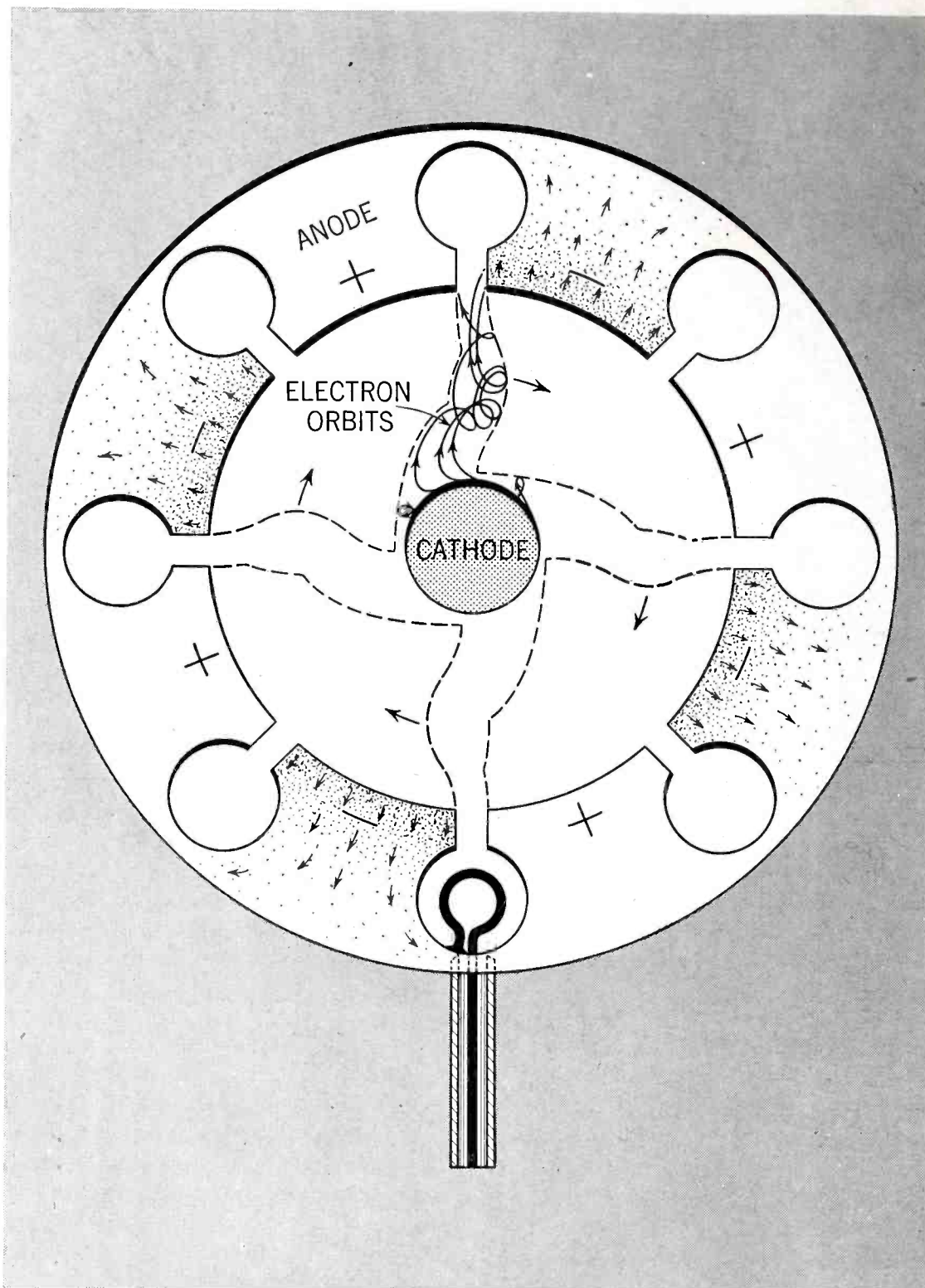

Figure 1 — Calculated configuration of space charge clouds with the spiraling lines representing electron paths superimposed on diagrammatic cross-section of a cavity magnetron. Output loop position is at bottom.

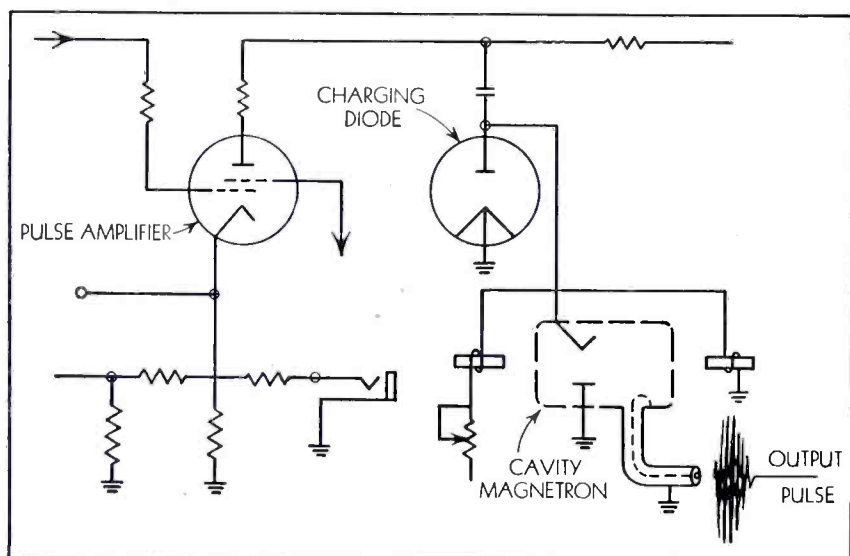

Figure 2 — A simplified schematic of the radar transmitter circuit in which 700 Type Cavity Magnetron is used — showing pulse amplifier and charging diode.

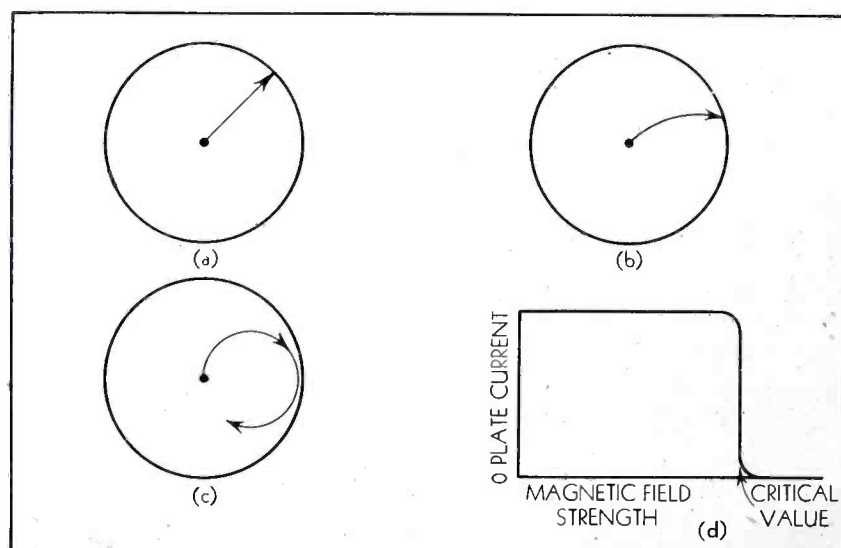

Figure 3 — Effect of magnetic field on electron flow shown in (a) and (b); (c) and (d) show critical value and the plate current relation in basic magnetron.



Gala open air performance of "Naughty Marietta" is given new realism with Stereophonic Sound. Note the microphones (circled) and loudspeakers (in rectangles).

# Stereophonic Sound Reinforcement

## ... Brings New Sound Quality to Operettas Under the Stars

*By A. W. Colledge*

STEREOPHONIC or audio perspective systems are not new. The Bell Telephone Laboratories first demonstrated such a system in 1933 at Constitution Hall in Washington, D. C., where there was reproduced by wire transmission a musical pick-up of the Philadelphia Orchestra playing in the Academy of Music in Philadelphia.<sup>1</sup> In 1936 a stereophonic sound reinforcement system was demonstrated by Bell Telephone Laboratories and the Electrical Research Products Division of Western Electric at the Hollywood Bowl in Los Angeles. The application of stereophonic to sound motion pictures was discussed in 1937,<sup>2</sup> and in 1941 Bell Telephone Laboratories demonstrated a stereophonic sound film system at Rochester, New York.<sup>3</sup>

Recently, a commercial installation of a stereophonic sound reinforcement system was made by Modern Sound Systems of Pittsburgh, a Western Electric sound system dealer. The system was installed in the

Pitt Auditorium in Pittsburgh to provide sound reinforcement for a series of open air operettas. The results obtained from this system, using commercially available equipment, are so superior to any that can be obtained from single channel systems that a new criterion of quality has been established for such type of reproduction, and a pattern has been set for future installations.

Before going into the details of this installation, a brief resume of the principles

of stereophonic reproduction is warranted. A normal person hears sound with two ears, and possesses the ability to judge both the direction and the distance of the sound source. The loss of hearing in one ear practically destroys the ability to determine the direction of the sound source, although it does not affect the judgment of the distance. A single channel sound system is like a person hearing with only one ear; it cannot give direction to sound.

If, in a single channel system, sound is reproduced from an unseen source, this lack of acoustic perspective is not particularly noticeable since the senses of sight and hearing do not conflict. Orchestral reproductions, however, lack the naturalness of the real thing even if the system has adequate frequency response characteristics, since the sound is coming from a point source instead of being spread over an area the size of the orchestra. The use of several

*(Continued on page 40)*

<sup>1</sup> "Auditory Perspective Basic Requirements," by J. Fletcher, *Electrical Engineering*, 53, January 1934.  
<sup>2</sup> "Auditory Perspective — Physical Factors," by J. C. Steinberg, W. B. Snow, *Electrical Engineering*, January 1934.  
<sup>3</sup> "Pickup for Sound Motion Picture" by J. P. Maxfield, A. W. Colledge, R. T. Friebus, *Journal Society of Motion Picture Engineers*, Volume XXX, 1938.  
<sup>4</sup> "Stereophonic Sound-Film System — General Theory," by J. Fletcher, *Journal Society of Motion Picture Engineers*, Volume XXXVII, October 1941.

# A CLOVER-LEAF GOES UP...



# ... Steps in Erecting a 54A Antenna

**W**ESTERN ELECTRIC's new 54A Antenna for FM broadcasting, no longer in the scaled-down model stage, is now a full size structure ready for service to the broadcaster. The first production prototype antenna was erected at Bell Telephone Laboratories, Whippany, New Jersey, in May for checking the assembly of parts to insure trouble-free installations. The photographs below and on the following page show the antenna in progressive stages of assembly from the erection of the base tower section to the mounting of the aircraft warning beacon. Every component of the antenna and its associated accessories was carefully examined and assembled in the prototype to make certain that the design is ready for the customer. The transmission line end-seal, de-icing heating elements and the beacon light and its flasher were all tried out in this first assembly.

The 54A was first announced to the Federal Communications Commission and to a group of consulting engineers at a meeting in Washington in March 1946, and its features were described in the April 1946 issue of the *Oscillator*. The performance characteristics contained in the April issue were obtained from tests of precise scaled-down models because of the higher order of accuracy possible with small mod-

*By Arnold K. Bohren*

Bell Telephone Laboratories

els tested at many times the operating frequency of the full size antenna. The full size installation was made to check the performance and to prove-in the design.

A well-known tower installation concern was employed for the first erection so that the comments and suggestions of a trained crew could be obtained. The crew foreman expressed praise for all phases of the design after completing his first 54A job, which proceeded without a hitch.

## Radiating Units Easily Installed

The clover-leaf radiating units are assembled to the tower at half wavelength spacings with a slight correction for velocity along the inner conductor. Charts are provided for all frequencies to permit assembly from established dimensions rather than depend on field calculations.

The gin pole used in this particular installation was a 20-foot section of 3-inch center conductor from a second antenna. If a gin pole is not readily available at a customer's installation, the center conductor sections may be installed after the tower sections have been erected in order to use the 20-foot section of conductor furnished

with the antenna as a pole. If the local riggers prefer to install the conductor as the tower sections are erected, a piece of pipe may be employed as a pole. Each tower section weighs only 270 pounds, therefore hoisting a section into place requires very little effort with a pulley or block and tackle. No special tools were required to complete the installation; in fact, the only tools used were several sizes of wrenches, a pulley, a hacksaw and a pail for carrying nuts and bolts.

The transmission line from the transmitter is terminated at an end-seal (see Figure 8) mounted on the bottom plate of the "B" tower section. Since the end-seal will vary with the size of transmission line it is an accessory item to the antenna and must be ordered separately. Flanges are provided on some types of transmission line, and in this case the line flange is connected to the end-seal with assembly bolts. For types of line not equipped with flanges a loose flange is provided with each end-seal for brazing to the line. By using a flange on the line, brazing at the end-seal is unnecessary, thus making installation and replacement extremely simple.

The size of the de-icing heating elements required to keep the radiating units free of sleet had previously been determined by

1. The supporting frame shown is not part of the 54A Antenna but shows the simple type of structure which may be utilized. The square section 6 feet high was desired to facilitate testing and is not required in a regular broadcast installation — only the angular braces and a webbing to withstand the reaction at the base of the antenna are required. The supporting frame has assembled in it the 54A base section named "B Section". The center conductor support may be seen in the base of the "B" section. This part, in addition to giving lateral support to the center conductor, also serves to suppress to some degree even harmonics of the operating frequency . . . 2. The first "A" section (additional

section) is being hoisted into place. Note that the gin pole being used is a 20-foot length of 3-inch conductor, a part of the 54A Antenna. The splice plates loosely assembled to the top of the "B" section serve as locators or guides for the "A" section about to be lowered into position. In the foreground is a length of center conductor with a coupling assembled in the near end to serve as a pilot for the next section of conductor to be installed . . . 3. The first "A" section is in place and bolts in splice plates are being tightened. Gin pole is being used by man on top to assist in lining up "A" section. Splice plates at top were assembled on ground to serve as locator for next "A" section to be erected.

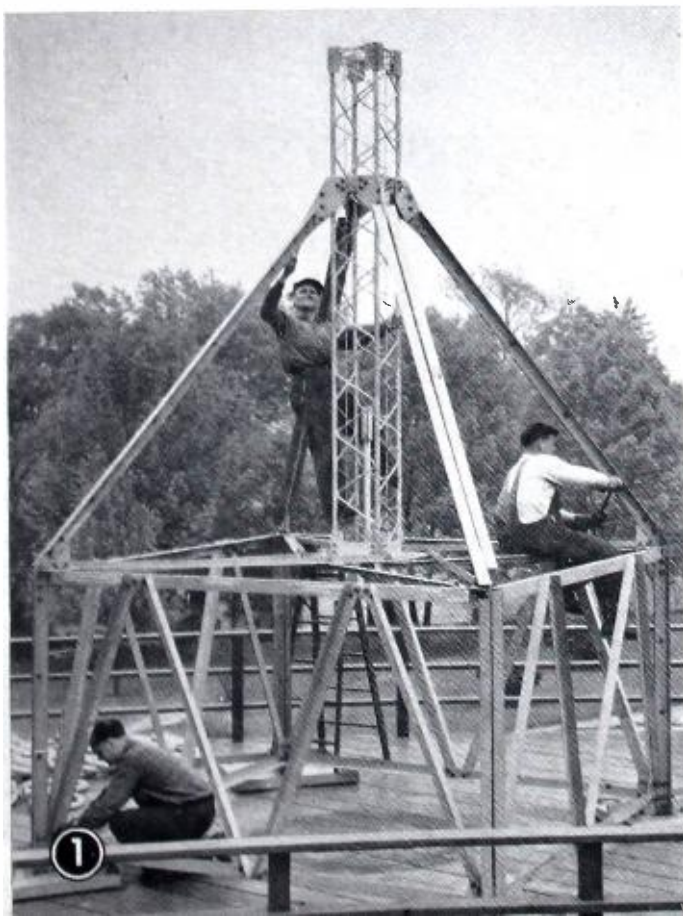

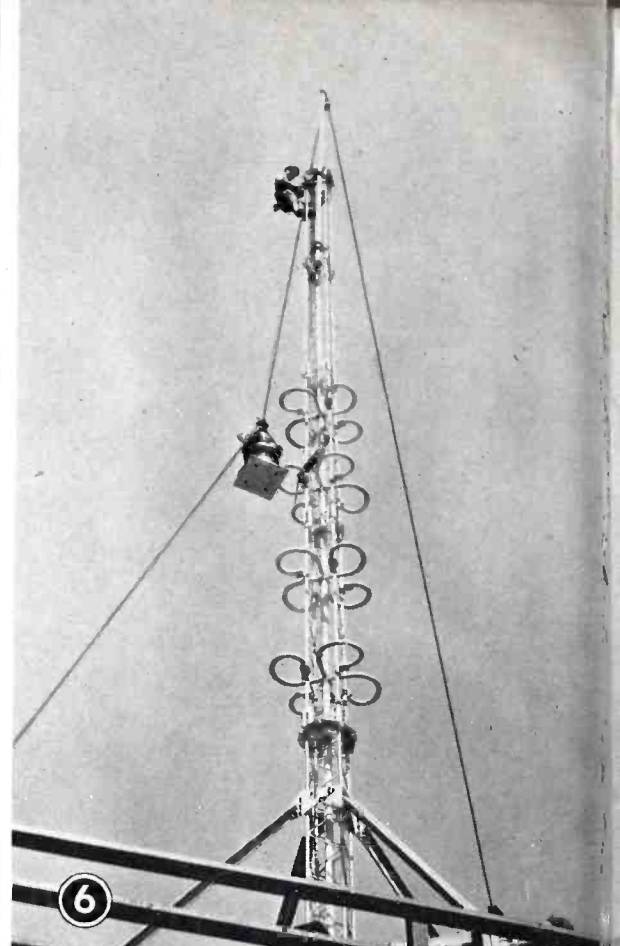
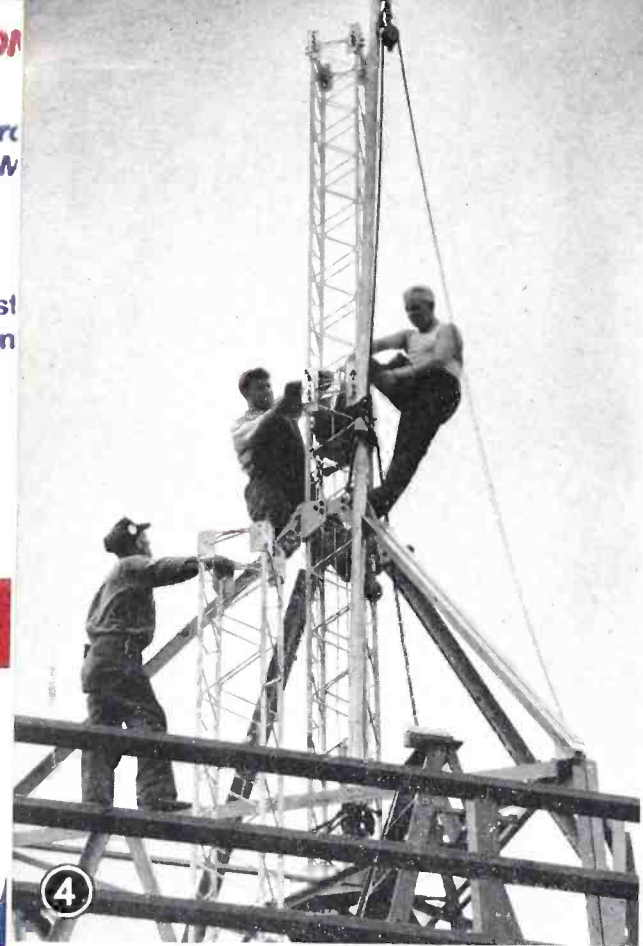

4. The second "A" section is in upright position about to be raised . . . 5. The second "A" section is erected and the splice bolts are being tightened at the same time the first clover-leaf is being assembled. Note that the gin pole is lashed to the first "A" section. The 20-foot length of 3-inch conductor has been assembled in the center of the tower. Steps are provided in one face of the tower

but all of the faces were found easy to climb. Observe that the clover-leaf radiating units provide convenience seats for the riggers . . . 6. Four of the "A" tower sections and a like number of radiating units are assembled. The beacon is taking a ride. Drillings are provided in the top plate for the standard 300 mm aircraft beacon but it is also possible to mount other types by drilling the plate to suit.

refrigerator tests which simulated actual icing conditions encountered throughout the country as recorded by the U. S. Weather Bureau. In a test assembly, made with a full size radiating unit mounted to a tower section, the heating elements were easily placed within the radiating loops. In an actual installation the heating elements

are inserted in the clover-leaf units before assembly to the tower and the leads terminated at condulets in the conduit runs within the structure. Two conduits are used for running power to the de-icing elements and one conduit is used for supplying power to the beacon light. The conduit, condulets and wire are all standard parts

available from Graybar stocks.

Erection proceedings other than that described may be followed in installing a 54A Antenna. For example, the center conductor, clover-leaf units and tower section may be assembled on the ground, and this assembly handled as a unit. The method employed will depend on the local riggers.

7. The final touch is being applied to the eighth clover-leaf. Only the suppressor cables through the radiating units and conduits remain to be installed . . . 8. The two adjustable impedance transformers (7-inch cylinders) are shown on

the 3-inch center conductor in the "B" tower section. The transmission line end-seal is assembled on the base plate. These transformers match the impedance of the array to that of the transmission line . . . 9. The Clover-leaf is up!

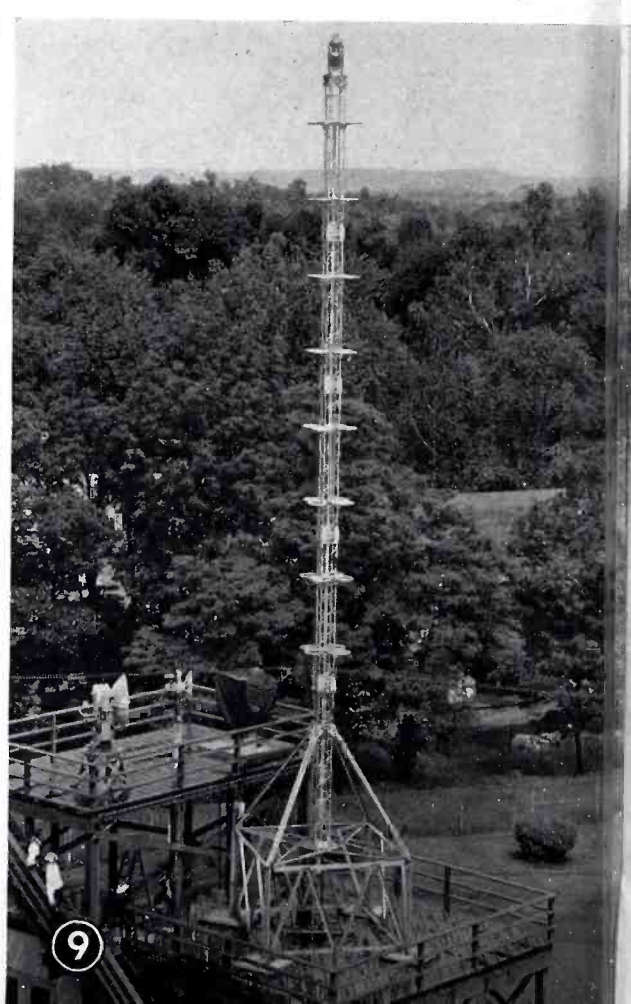
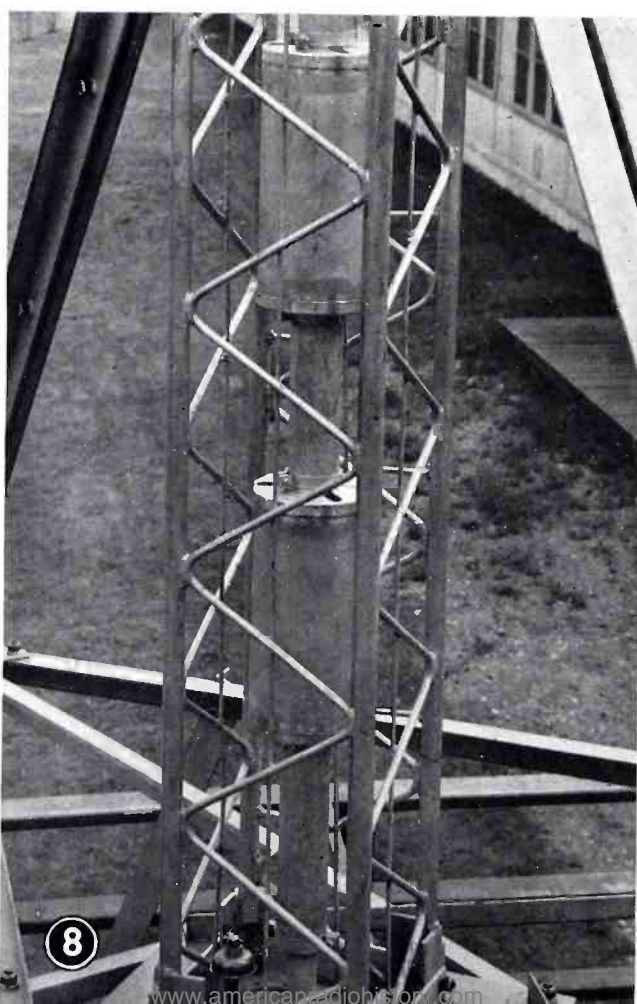
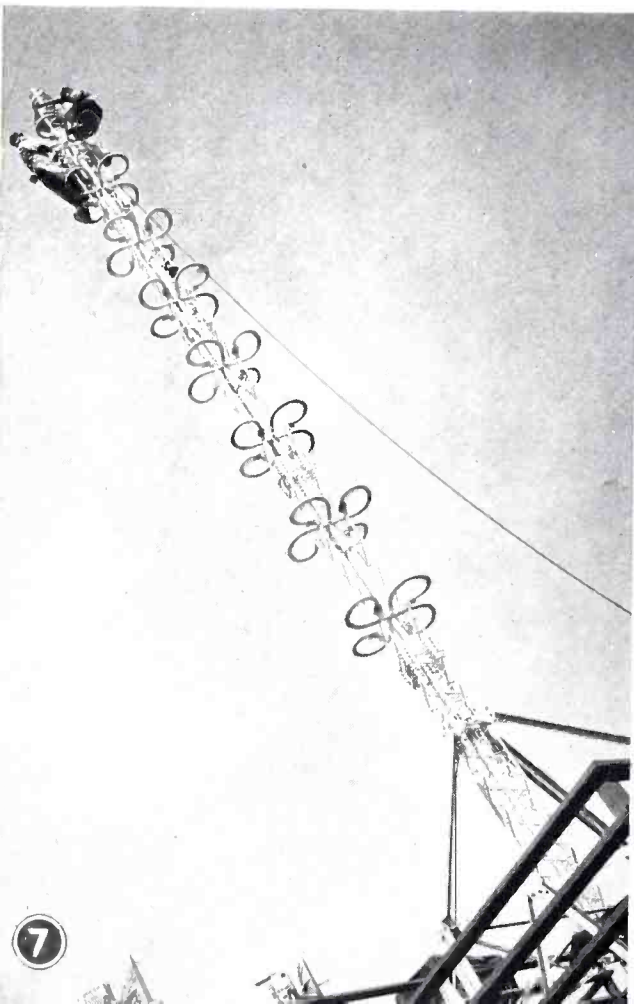

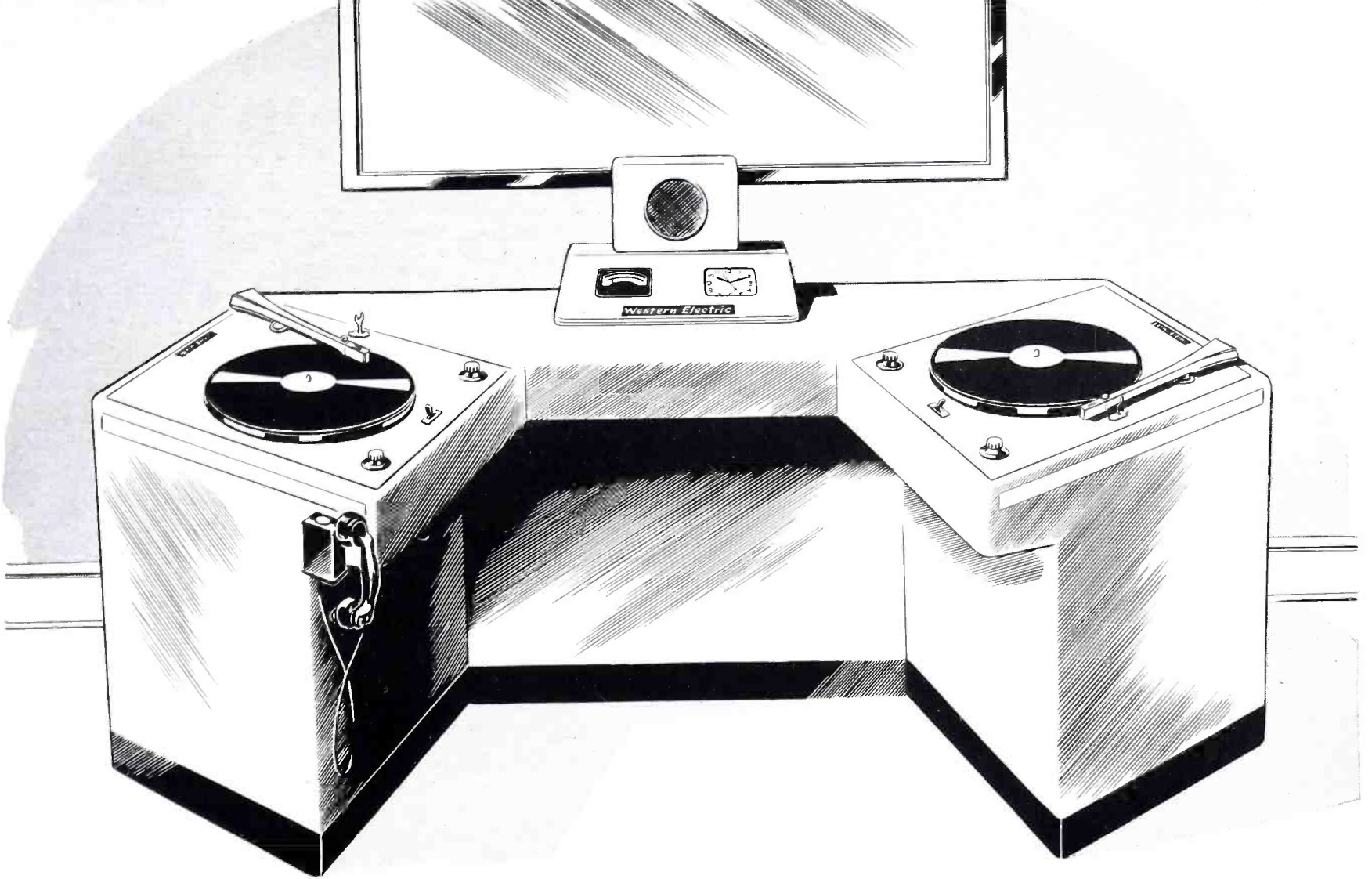

New program console — heart of wire program distribution systems — showing the Originating Unit at left, the Supplementary Unit at right, and connecting unit.

## Something New in Wire Program Distribution

WITH its return to peacetime manufacturing operations, the Western Electric Company has resumed its former role in the development and production of equipment for wire program distribution systems.

These systems are designed specifically to originate programs of recorded material, transmit them locally over telephone lines and reproduce them on the subscribers' premises. They are an outgrowth of experiments begun almost 15 years ago by a group of Western Electric engineers. Utilizing turntables, amplifiers and loudspeakers developed originally for sound motion pictures, these engineers in 1932 designed and built an experimental program center in the Fisk Building in New York. The new idea appealed so strongly that a number of New York's finest hotels and restaurants installed subscribers' equipment in their public rooms. A two year period of operational testing and improvement followed. High quality vertical cut recordings were used as the source of program material. Amplifiers and loudspeakers were improved and standardized. Distribu-

tion and switching facilities were developed.

Having proved that wired program distribution was technically feasible and economically sound, Western Electric turned the project over to independent operating companies and thereafter confined its activities to design and production of equipment and engineering service.

These operating companies have made elaborate investigations into the types of music best suited for use in dining rooms, cocktail lounges, industrial plants, waiting rooms and the many other types of subscriber locations. Consisting mainly of background music, wire program recordings are usually instrumental numbers especially selected for the various types of subscribers. Large libraries of these special recordings have been built up and are leased to responsible individuals or companies which operate their own wire program distribution systems.

### Need for New Equipment

Although the basic principles of wire program distribution remain essentially un-

changed, the rapid growth of the franchise system and the broadening fields of subscriber applications have created new demands for equipment.

These demands have resulted in completely packaged, shop-wired program center units, standardized subscriber amplifiers and a complete line of accessories such as loudspeakers, volume controls and switches.

The heart of the program center equipment is the program console which consists of two reproducing turntable assemblies and a connecting unit. One assembly, the Originating Unit, when ordered separately, is equipped with a two-speed turntable, reproducer, equalizing transformer, preamplifier, main amplifier, repeating coils, volume indicator, clock and necessary controls. The second assembly, called the Supplementary Unit, is similar to the first except that the main amplifier, repeating coils, volume indicator and clock are omitted. When these units are ordered assembled as a complete console, the volume indicator and clock are mounted on the top of the connecting unit and the volume con-

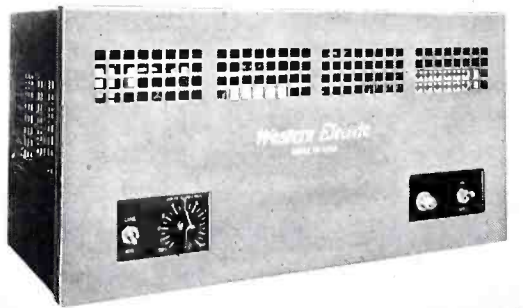
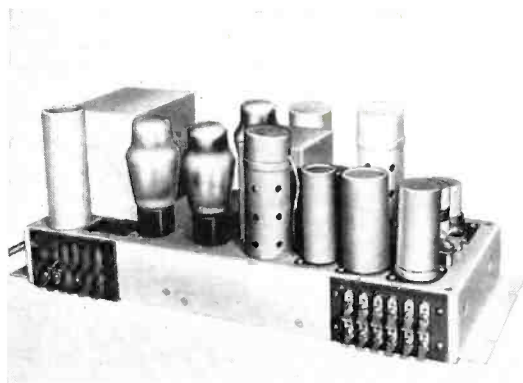

Views of the 20-watt ac amplifier for subscribers used in small and medium installations. At top is rear view of amplifier chassis. Middle view is of front of amplifier shown in cabinet without cover. At bottom is amplifier in its special cabinet unit.

trols are tied together electrically to provide a two position mixer. A monitor amplifier and speaker unit consisting of a floor type cabinet equipped with a suitable volume control, amplifier and speaker and a cueing amplifier and speaker are also available.

For convenience in operation, either of two types of connecting units may be employed. One, illustrated on page 15, has its sides cut at an angle to provide a semi-circular arrangement with platters and controls within easy reach. The other is rectangular in shape and permits the assembly of a straight line console similar to a modern office desk. If it is desired, the reproducer assemblies may be fastened together and the connecting unit omitted, as shown at the right in the drawing below.

The Originating Unit may be ordered equipped for network operation or for combined network and private line use. In network operation all subscribers on one network receive the same program, while in private line use the subscriber is offered a choice of different programs or may even request specific recordings.

#### Standardized Accessories

For large systems or for private line operation a number of standardized accessories, panels and bays are available. All panels are complete, shop-wired units designed for mounting on standard relay racks. All bays are enclosed type relay racks with shop-made cable forms connected to terminal strips at the bottom of the bays. Included in these equipments are the following items:

Subscribers' Line Coil Panel — equipped with repeating coils for terminating subscriber and network lines at the program center end.

Program Switching Panel — equipped with gang switches to facilitate transfer of subscriber lines from one program bus to another.

Line Equalizer Panel — equipped with equalizers and repeating coils to provide facilities for terminating and equalizing incoming program lines.

Main Amplifier Bay — arranged to mount several main amplifiers and an Emergency Amplifier Switching Panel.

Distribution Bay — arranged to mount Subscribers' Line Coil and Program Switching Panels as required. Also provides facilities for checking each program level on volume indicator before changeover.

Radio Test Bay — arranged to mount a Radio Tuner, Audio Test Oscillator, Amplifier, Power Level Indicator, Jack Strips, Line Equalizer Panels and a writing shelf. In addition to the foregoing Program Center Equipment, the following items will be available for subscribers' locations:

Subscribers' Amplifiers — a six-watt ac-dc amplifier and a 20-watt ac amplifier — three views of which are shown at left — used for small and medium installations.

Accessories — A well rounded line of high quality loudspeakers, microphones, remote volume controls, matching and volume regulating transformers and amplifier housings is being developed which should completely fill the needs of all subscriber installations.

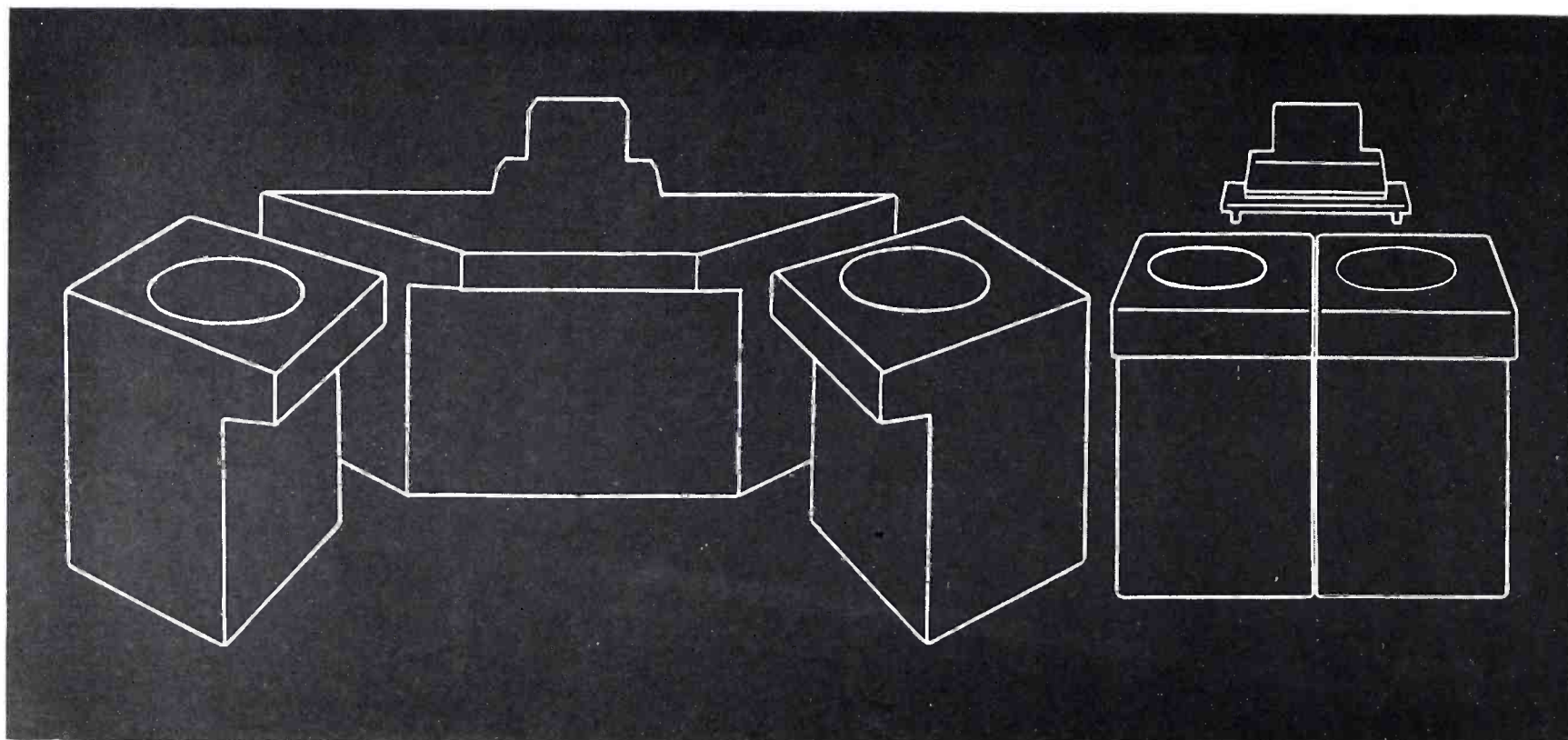

Units of console may be arranged to suit individual requirements. Here the Originating Unit and the Supplementary Unit are shown with and without connecting unit.



# When Wire Program Distribution Began...

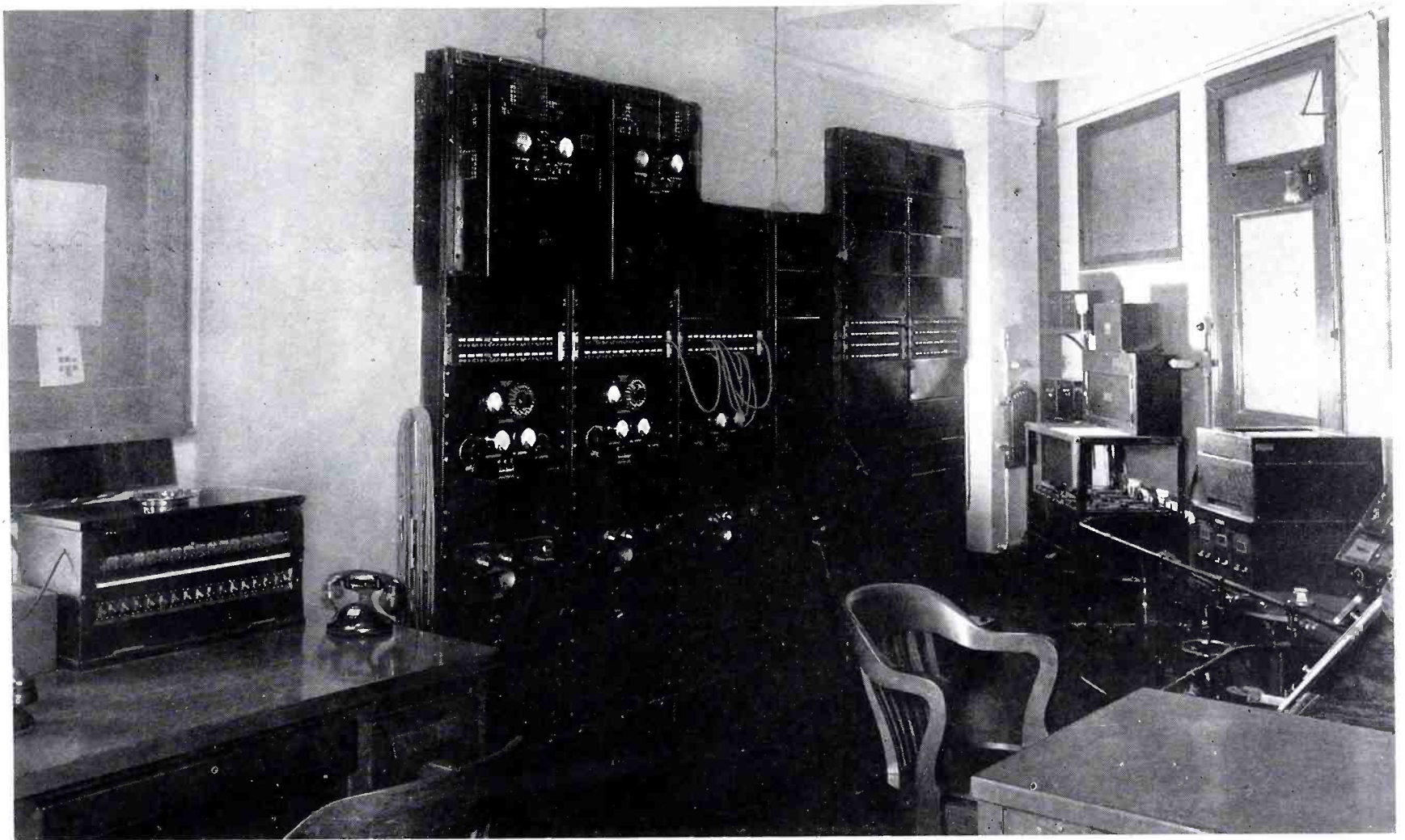
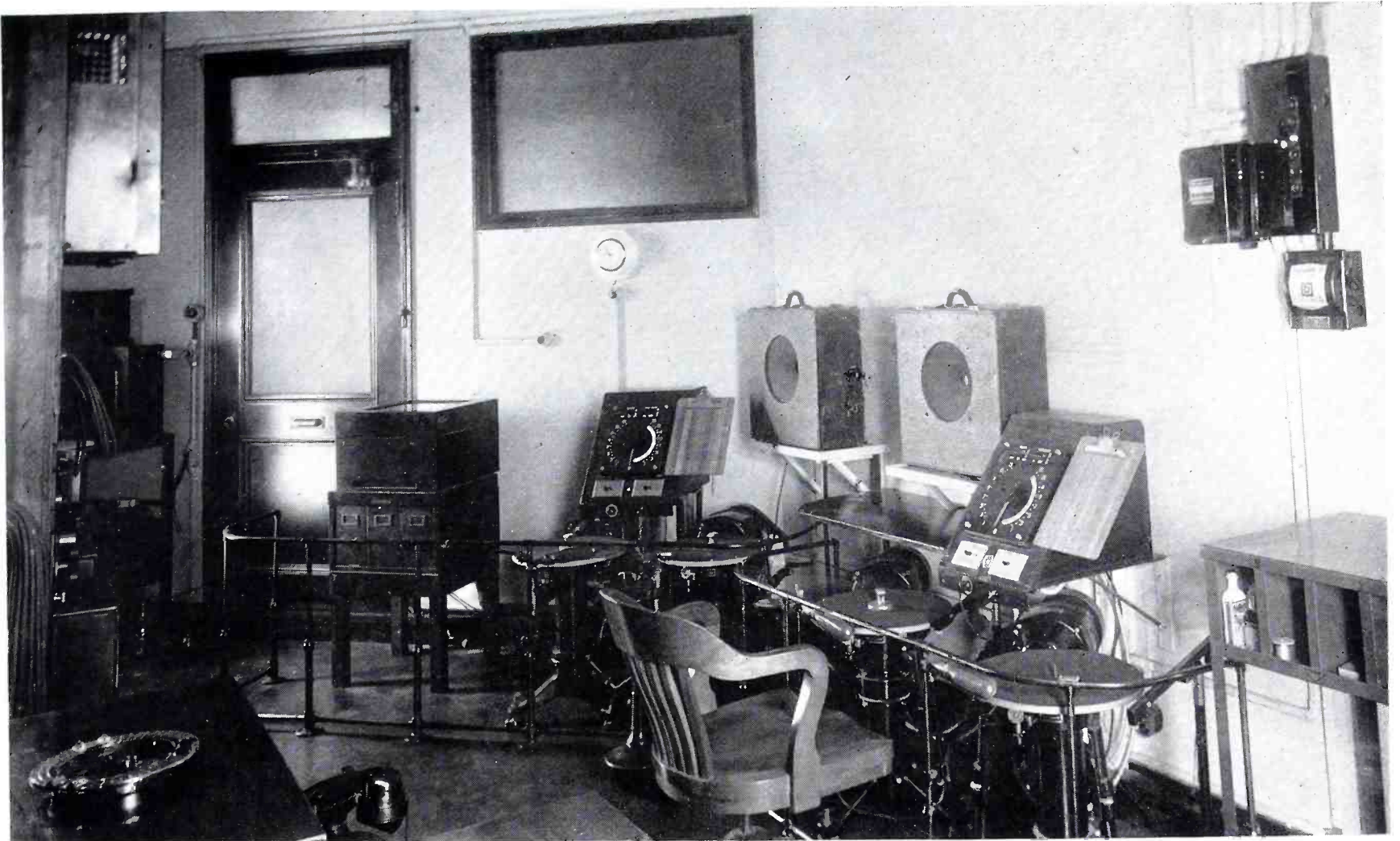

This was the control center for the first wire program distribution system, designed and installed by Western Electric on an experimental basis in 1932. The turntables and amplifiers were designed originally for sound motion pictures and were borrowed from this earlier Western Electric development when a

group of engineers saw the need for high quality programs distributed by wire. The photograph at the top shows the turntable equipment. Facing this across the room were the amplifiers, shown in the bottom photo. Test programs from this center were transmitted to several New York City hotels and restaurants.

# Announcing...

## NEW FM TRANSMITTERS

IN this issue, the *Oscillator* raises the curtain on Western Electric's new line of Frequency Modulation Broadcast Transmitters.

When Bell Telephone Laboratories engineers completed their war assignments and tackled postwar FM, no retreat was in order from the high standards of quality they had established in apparatus for the battlefield. Wartime electronic equipment had to "take it", and as this new series of broadcast transmitters makes its appearance, circuit improvements are more than matched by advances in design for ruggedness and reliability and for modern businesslike appearance.

The transmitters shown on these pages were developed by the same engineers who contributed so outstandingly to Western's gigantic war program and led the way in extending the radar spectrum from a hundred megacycles to the tens of thousands of megacycles. Not only is the new FM band right in a portion of the spectrum that they have thoroughly and scientifically explored, but like the radars they designed for land, sea and air, their new products now taking shape are *built for business*.

### New Construction and Styling

The cabinets for these new transmitters are completely new in design and styling and give at a glance the impression of important internal machinery. The full length hinged glass panels which constitute the front doors on all units — a new feature in broadcasting equipment — necessitate special care in the design, and a high order of craftsmanship in the construction, of the interiors, but it is a matter of experience that designs which are neat and orderly so that they may be viewed through a glass panel are also easy to maintain. The ability to see all vacuum tubes, rather than a few, without having to open doors and hence remove and reapply power, will be appreciated by operators and will greatly reduce the time for determining the location of trouble. The over-all appearance will be a source of pride to operating personnel and an incentive to give the equipment the kind of maintenance that insures trouble-free service.

The new construction carries important manufacturing features which are of ultimate value to the broadcaster. All units are standard width and employ the same front

and rear door assemblies and side and top panels. With the full-length glass door it is not necessary to penalize the equipment layout to make a few tubes visible through small windows. Nor is it necessary to have special front doors for each unit to make certain elements visible when the circuit will not permit locating them behind small openings in standard doors. Thus many parts can be manufactured in large quantities, which makes it possible to employ good tooling and obtain greater uniformity.

Where two or more units are arranged in a line to make up the higher power transmitters, a common base and a common meter panel are provided to tie all units together. This gives a pleasing appearance and the effect is of one transmitter assembly rather than a line-up of discrete units. All inter-unit wiring may be run in the base, thereby requiring no holes in the floor. In locations where it is desirable to build the front panels into a wall, the rear door assemblies and side and top panels may be omitted, except in areas where dust may be a serious problem.

The attractive two-tone gray and blue finish of the cabinets, the large meters, roomy design, visibility of all vacuum tubes and numerous other features of these transmitters reflect the results of country-wide surveys to determine the preferences of broadcasting people.

### One to Fifty

A substantial 1000-watter, coded the 503B-2, is the cornerstone for the line.

Capable of driving either the Three or the Ten directly, the 503B-2 is already a veteran, for its predecessor in the lower frequency band has served some 15 stations since 1940. All of these were converted to the new band early this year, and six new sets were recently placed in service. Some are already scheduled for increases to higher power.

New high-frequency vacuum tubes are vital contributors to the performance of the higher powered stages up to 50 kilowatts, driven by the 503B-2. These new tubes are more powerful, easier to drive, and incorporate latest advances in the fast-moving electron tube art.

Always considered tops for FM quality and dependable frequency control, *Synchronized Frequency Modulation* remains a feature of Western Electric equipment. Those who are familiar with the development of Synchronized FM\* by Bell Telephone Laboratories will remember the exceptionally wide range of distortion-free signal it affords as a result of the complete independence of the carrier frequency control system from the modulation system. With the broad-band circuits employed in the power amplifiers to render them substantially distortionless over a band of hundreds of kilocycles, small wonder that in measuring the characteristics of the 503B-2 and its higher powered companions the best monitoring device available is hard pressed to give the answers.

\* "The Frequency Watchman," by R. H. Lindsay, *Western Electric Oscillator*, December 1945.

### PERFORMANCE OF WESTERN ELECTRIC FM TRANSMITTERS

Audio Frequency Response .....	± 0.25 db from 30 to 15000 cycles
Harmonic Distortion . . . for ± 75 kc swing .....	Less than 0.5% from 30 to 15000 cycles
for ± 100 kc swing .....	Less than 0.75% from 30 to 15000 cycles
Intermodulation . . . for ± 75 kc swing .....	Less than 0.5% for 80% 50 cycles and 20% 1000 cycles; less than 1.0% for 80% 50 cycles and 20% 7000 cycles
FM Noise Level .....	65 db below ± 75 kc swing
AM Noise Level .....	50 db below 100% amplitude modulation
Carrier Frequency Stability .....	Less than 2000 cycles deviation (no crystal heater)

### POWER CONSUMPTION

1 Kilowatt Transmitter.....	4.2 kw at 208/230V 50 or 60 cycles 1 phase
3 Kilowatt Transmitter.....	9.8 kw at 208/230V 50 or 60 cycles 3 phase
10 Kilowatt Transmitter.....	25 kw at 208/230V 50 or 60 cycles 3 phase
25 Kilowatt Transmitter.....	65 kw at 460V 50 or 60 cycles 3 phase
50 Kilowatt Transmitter.....	115 kw at 460V 50 or 60 cycles 3 phase

# 1 KW

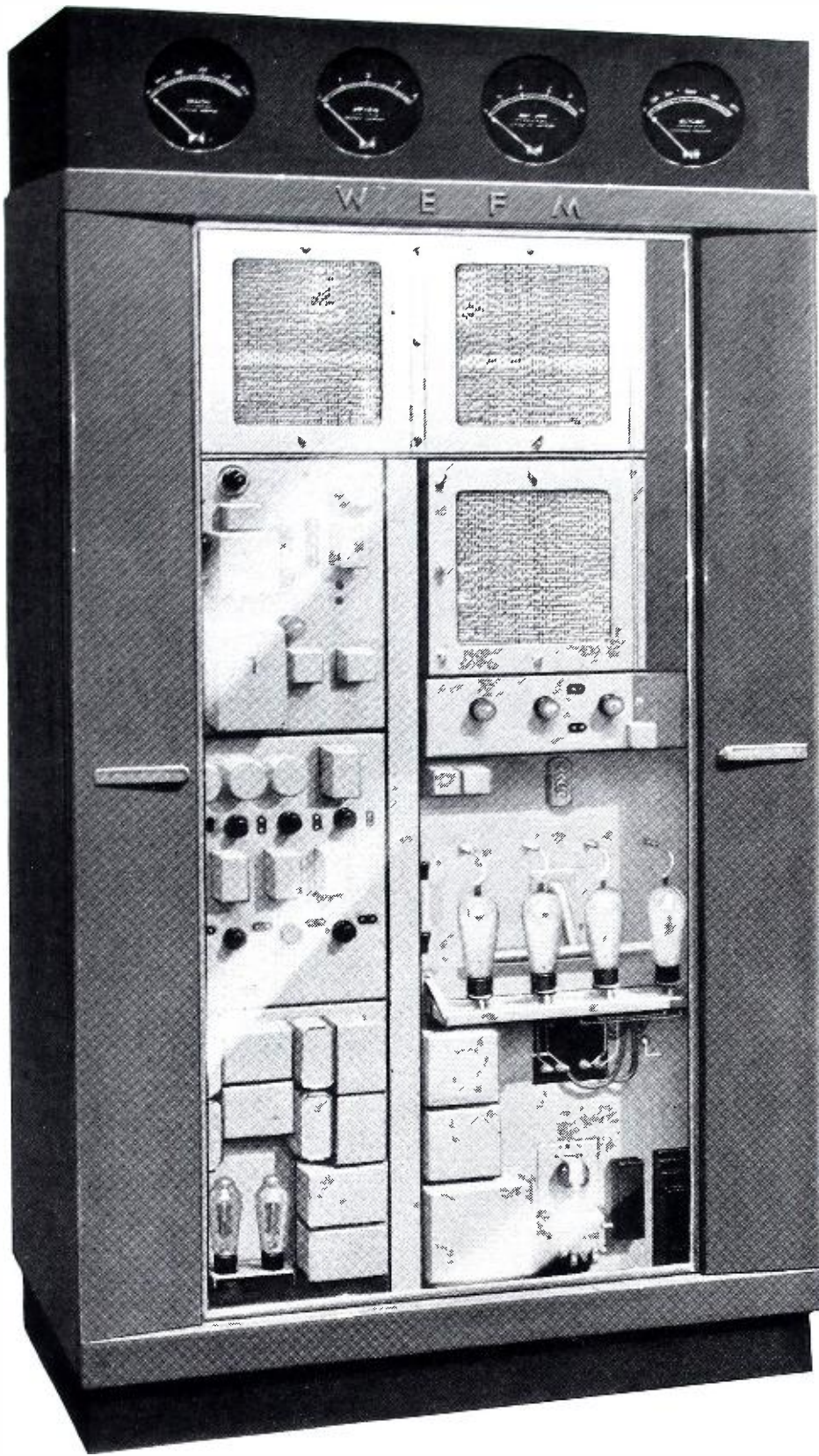

The 503B-2, a complete 1000-watt transmitter in itself as well as the driver for higher powers, uses the same two 357's that saw long service in the old FM band. Even at 108 these clean-cut triodes are far from reaching their frequency limit.

The glass front door, affording view of all tubes, is a feature of the new styling. Flanked by long metal panels on each side which are likewise hinged to open outward, the glass door and the orderly interior seen behind it bring appearance and ease of maintenance to a new high. The side panels open with a light pull on the handles to uncover the controls, which are thus protected during operation so that adjustments are not accidentally disturbed. Behind one of the side panels is the catch releasing the main door for access when required.

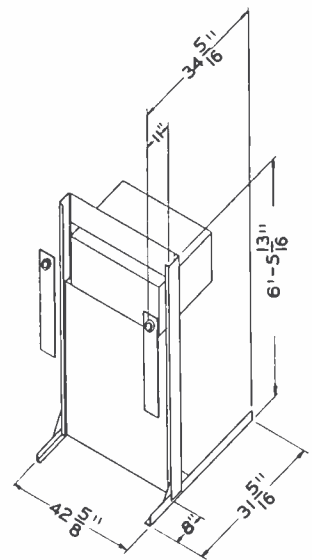

View Showing Outline Dimensions of Inner Frame for Shipping and Installation Purposes.

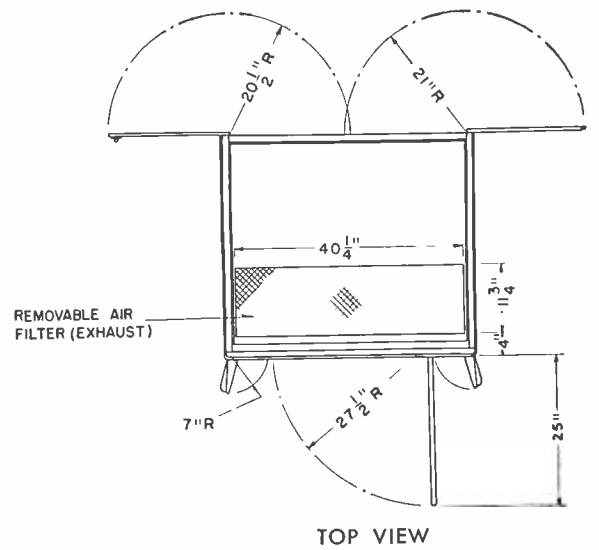
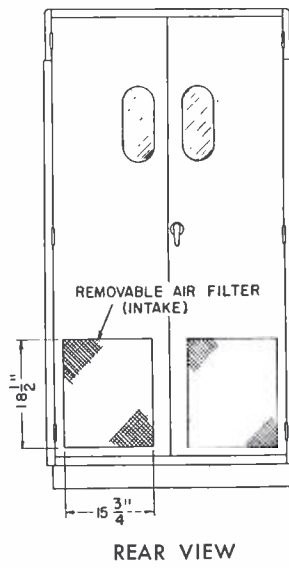
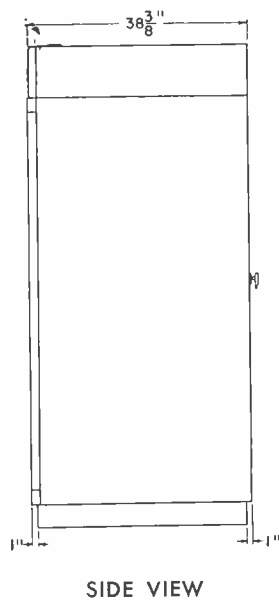
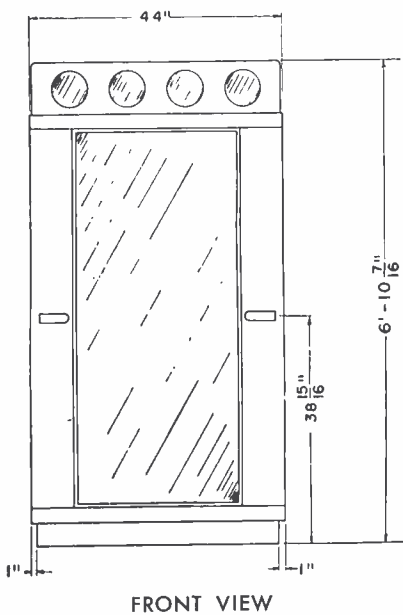

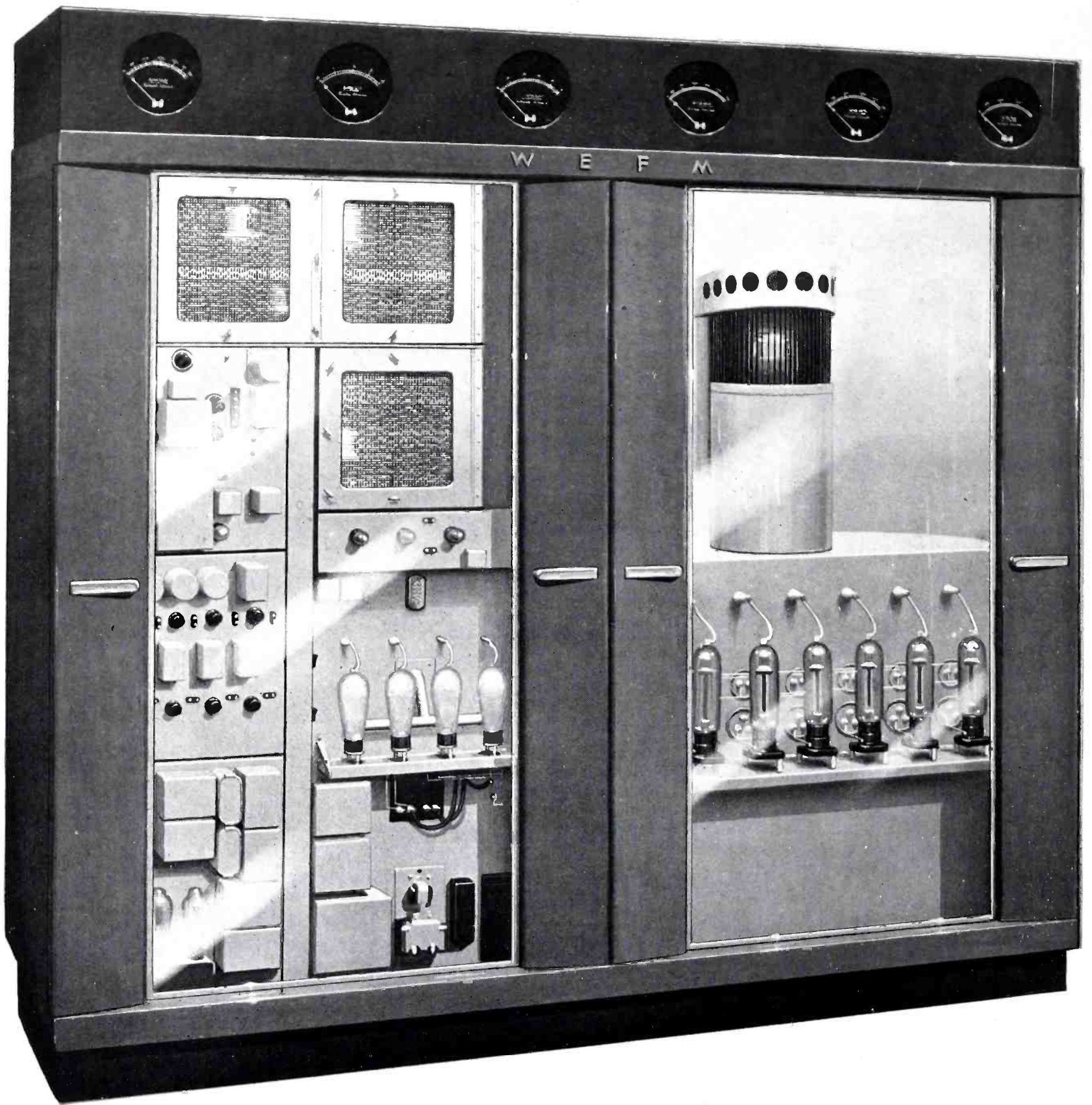

## 3 KW

In the 504B-2, as in all transmitters of this up-to-the-minute line, no blank panels conceal the vital and interesting parts. Radio transmitting circuits and tubes, neatly arranged, have the animation of intricate machinery. The practical value of a full view of tubes and components during operation needs no

emphasis to operating personnel.

The 3-kilowatt unit contains its own rectifier tubes and power components. Simplicity itself is the completely shielded assembly of the air-cooled triode in its broad-band circuit.

Each cabinet is made up of a standard front assembly containing the glass front

door and two control doors, a rear door assembly containing two rear doors with glass panels, two side panels and a top panel. The cabinets are shipped knocked down and assembled at the time of installation. The units are tied together with a common meter panel and a common base to give a unified appearance.

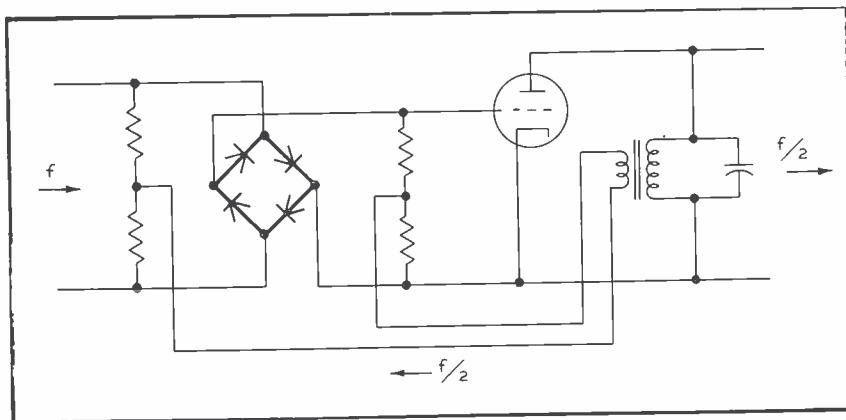
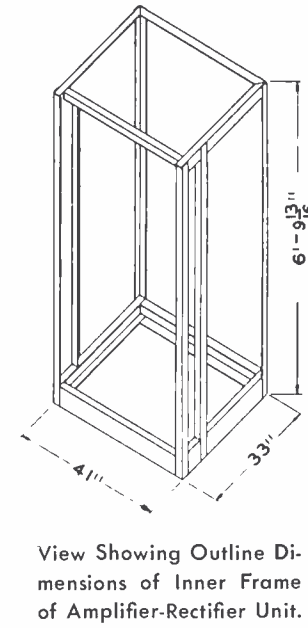
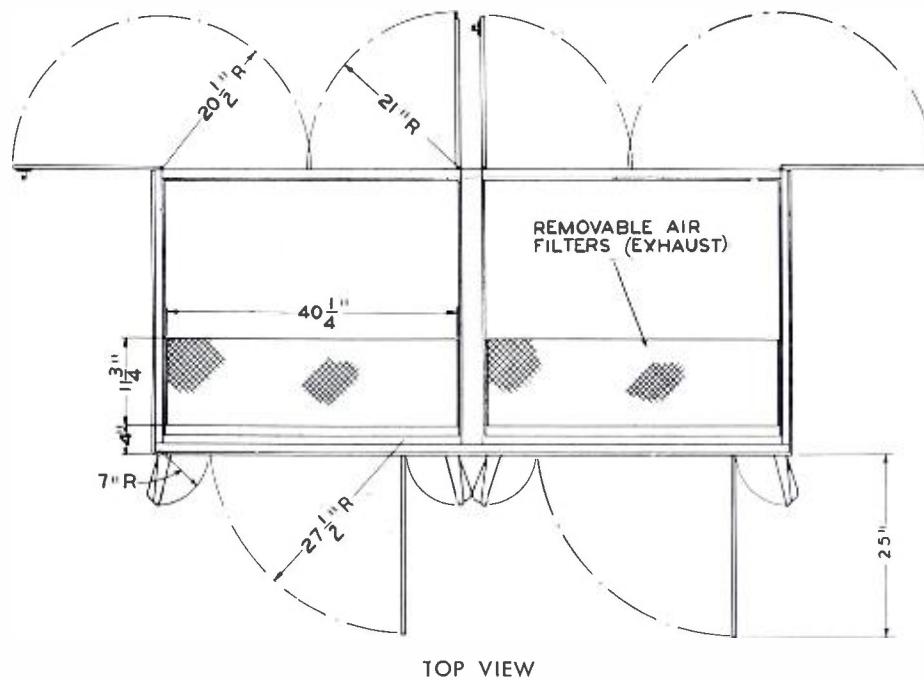
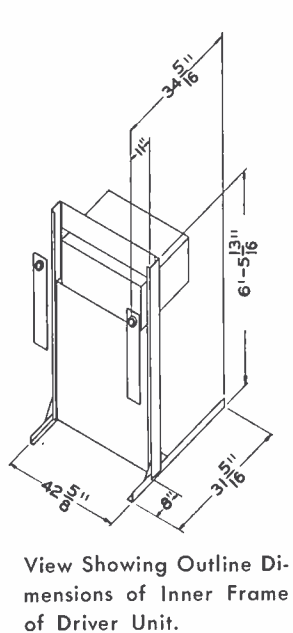
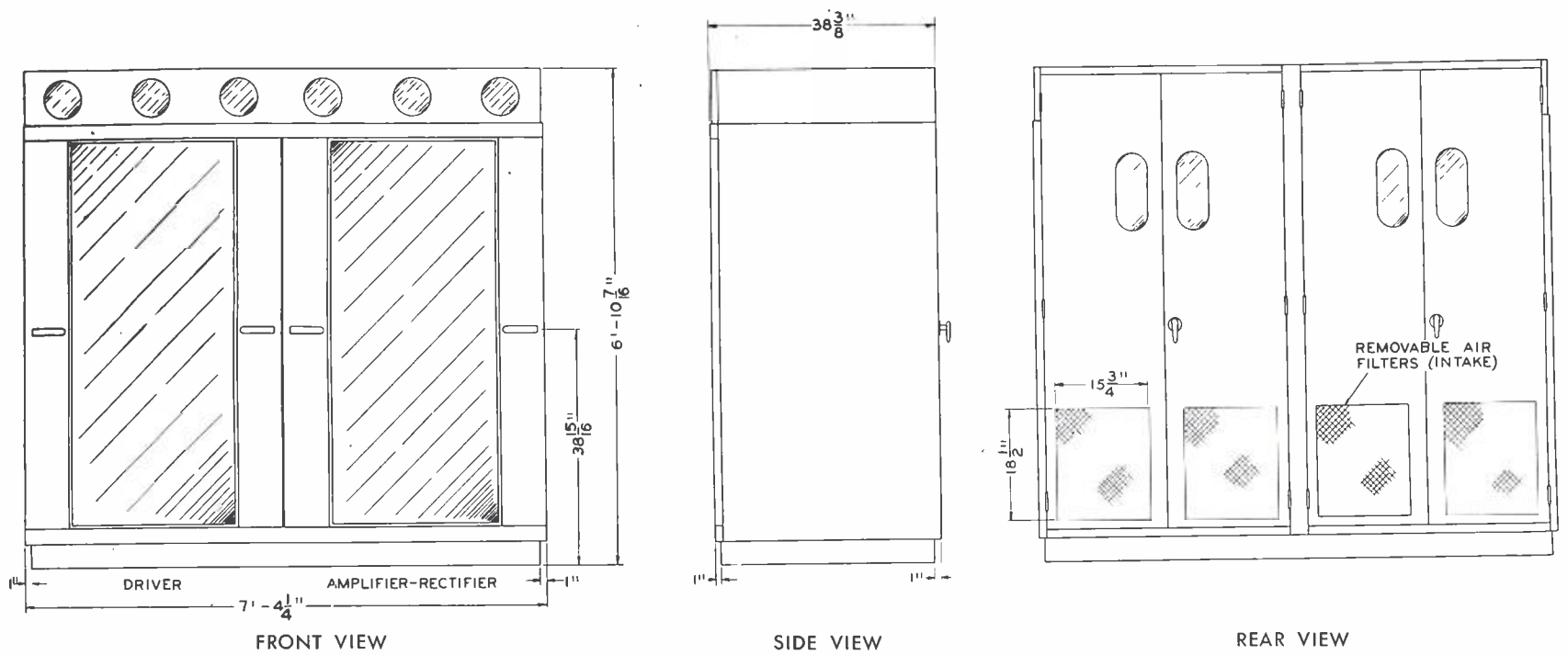

**COUNTING THE CYCLES** — Stable as a rock, the frequency divider used in Synchronized FM cannot give the wrong answers, for no frequency but  $f/2$  can beat with  $f$  in the balanced modulator to reproduce itself. Oscillation is impossible. Germanium varistors, a wartime development, have a wide margin in signal capacity and high conversion efficiency. The divider brings the frequency down to  $1/16384$  of the carrier frequency for comparison with a crystal oscillator.

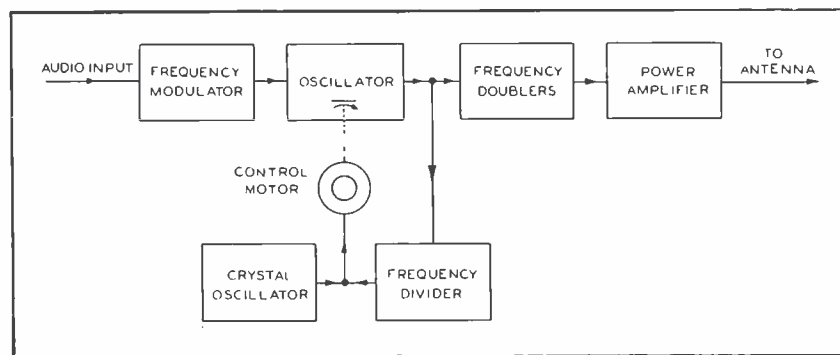

**LINEARITY PLUS** — In Synchronized Frequency Modulation, originated by Western Electric, the carrier or mean frequency of the frequency modulated oscillator is held "on the button" by a condenser under the control of a precision monitoring system. The monitoring system employs frequency dividers to remove the frequency modulation so that the mean frequency can be compared with that of a crystal oscillator. Any difference, however slight, actuates the control motor to restore the frequency to its correct value. Thus the frequency modulator, having no connection with control of mean frequency, is operated under optimum conditions and gives distortionless modulation over a wide range.

# 10 KW

The 506B-2 makes its debut with a new air-cooled thoriated-filament triode having power to spare and driven with ease by the One. The Grounded Plate Circuit originated by Western Electric and time-tested in the old FM band, is a natural at 100 megacycles where the tuning coaxials are only short pipes.

The 10 kilowatt rectifier unit at the right gives the operator full view of the mercury vapor tubes at all times. The rear doors too have glass panels for observation of large power items.

On the front cover of this issue of *The Oscillator* is a full color reproduction of this transmitter.

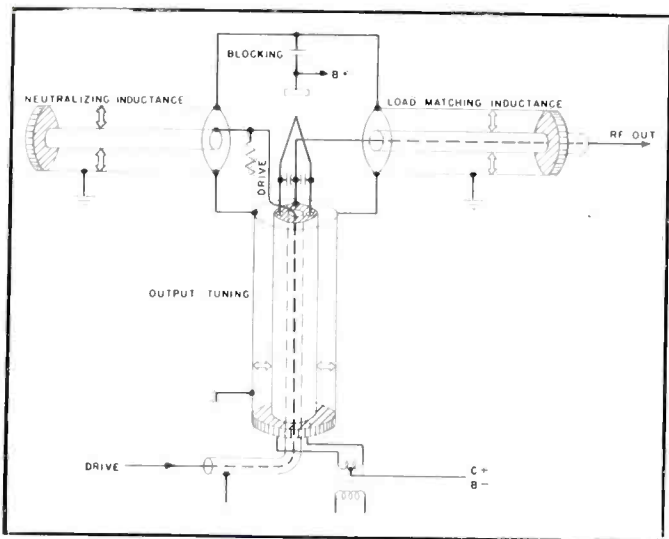

**TUNED WITH COAXIALS** — The Grounded Plate Amplifier was originated by Western Electric and used with great success in the 40-50 megacycle FM band to eliminate the effect of large capacity to ground of the anode and its cooling fins. In this circuit the output is taken from the cathode, and the grid drive gets a free ride up to the high cathode potential by running it as a center conductor in the output tuning line. All variable elements are short-circuited lines, giving a completely shielded amplifier, simple to tune, driven with ease by the 1 kw.

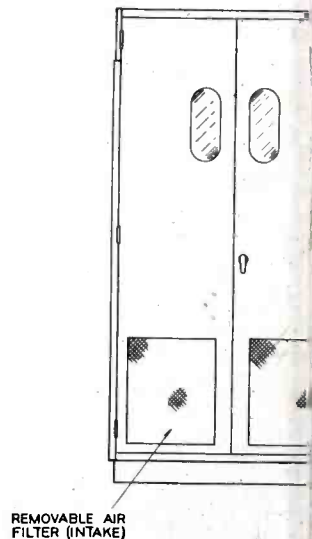
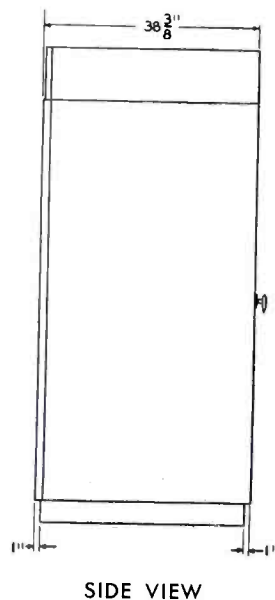
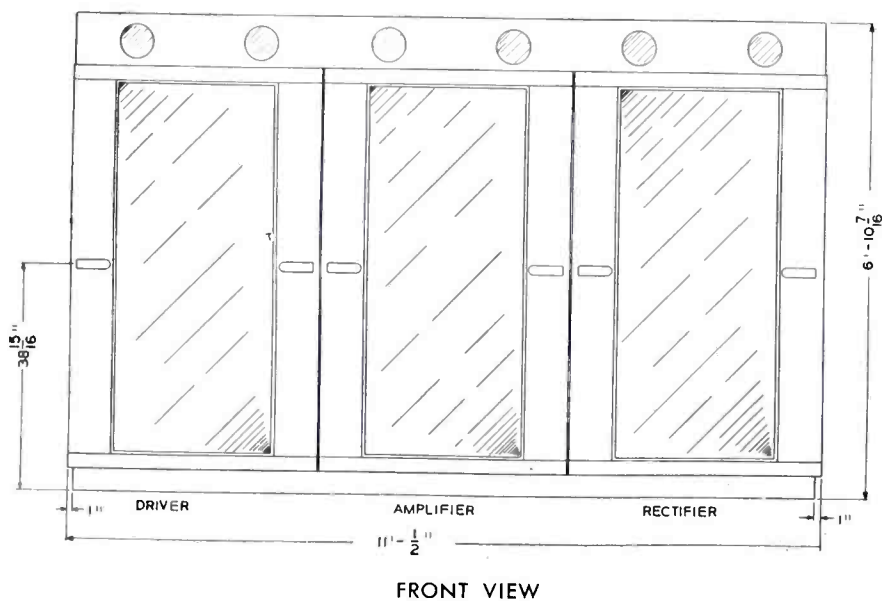
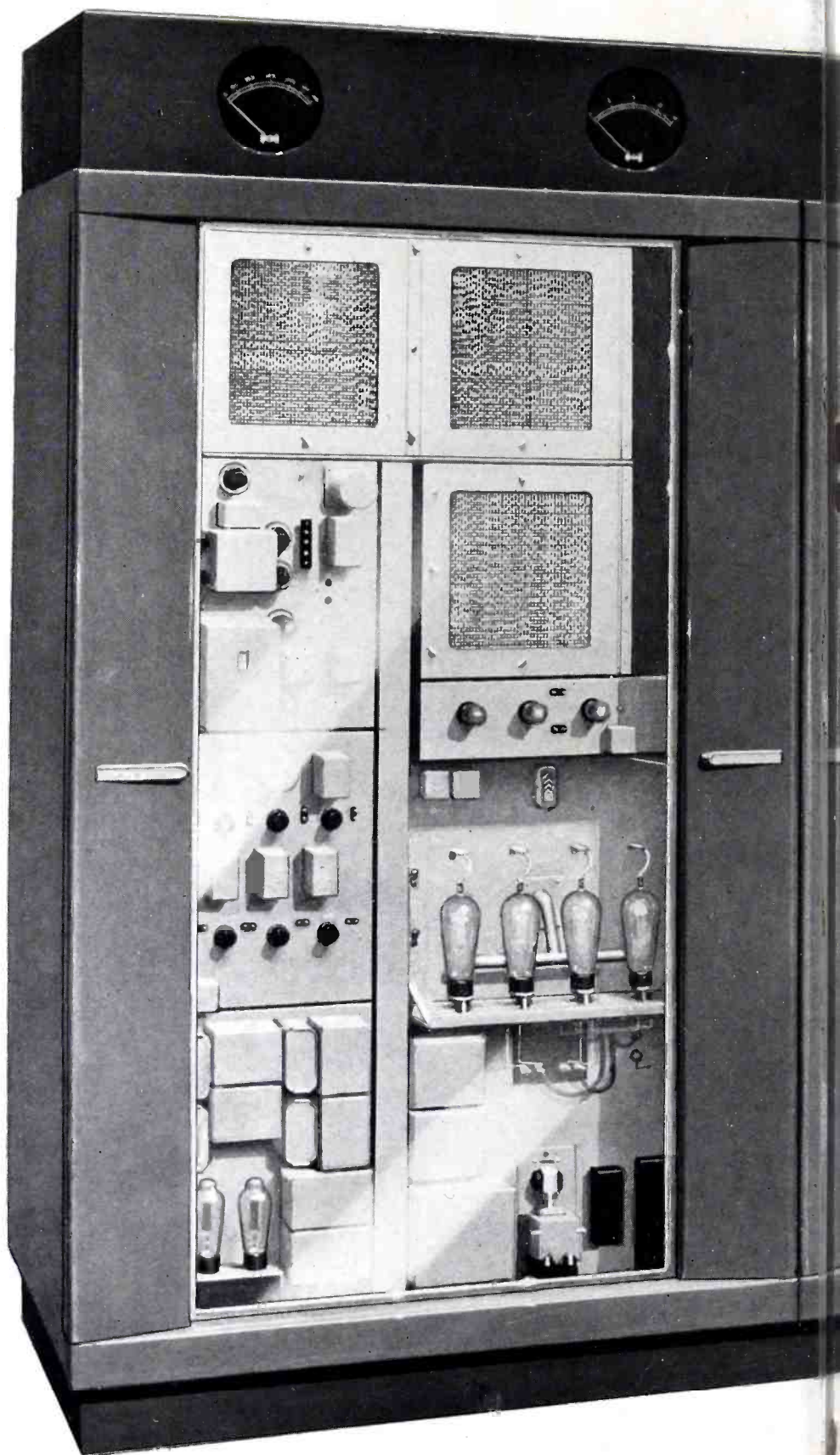

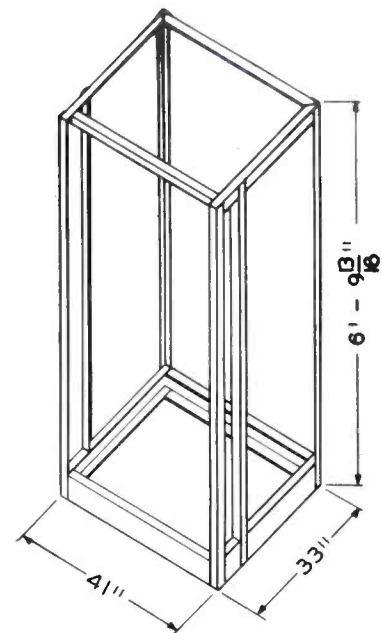
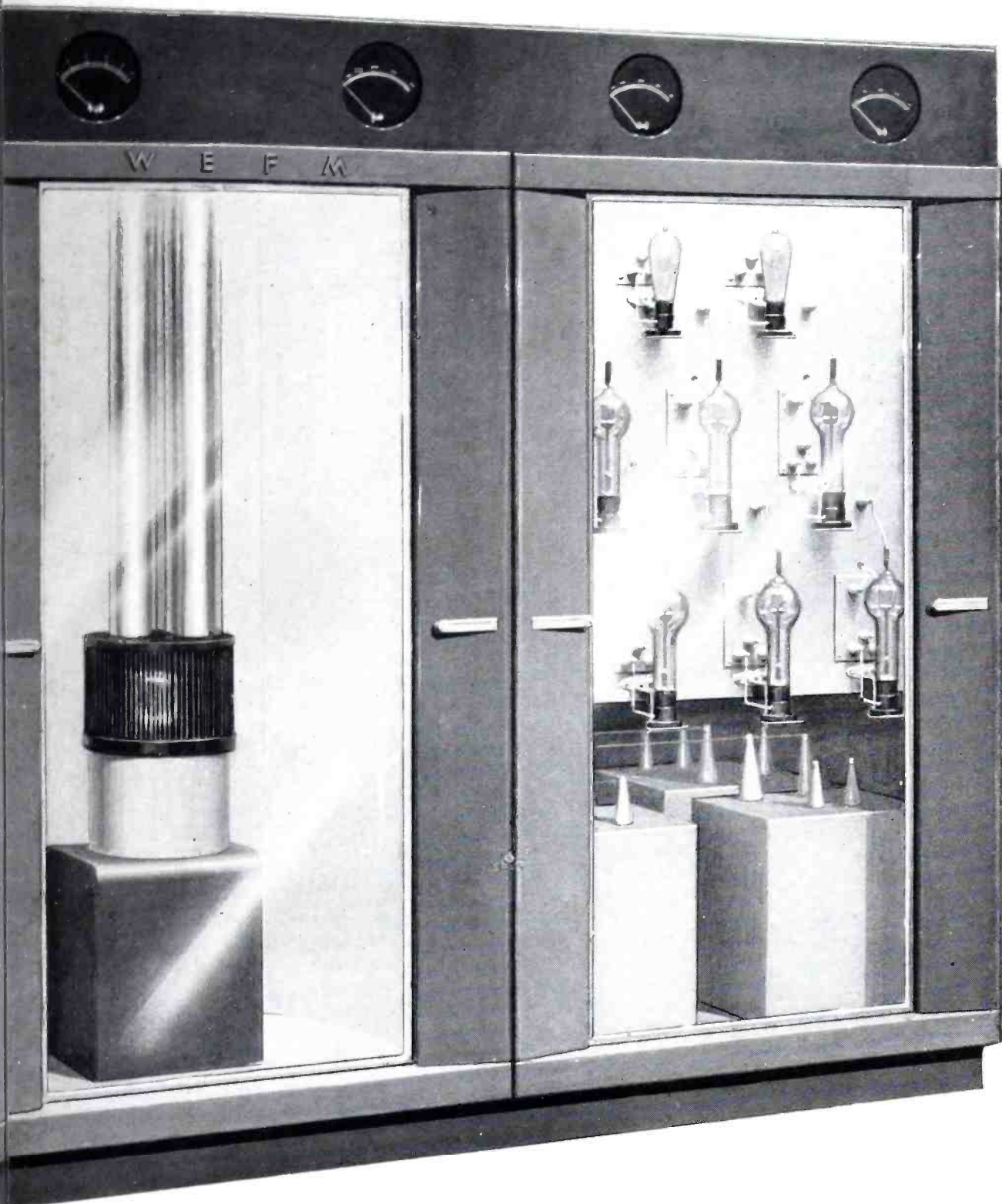

View Showing Outline Dimensions of Inner Frames of Amplifier and Rectifier Units.

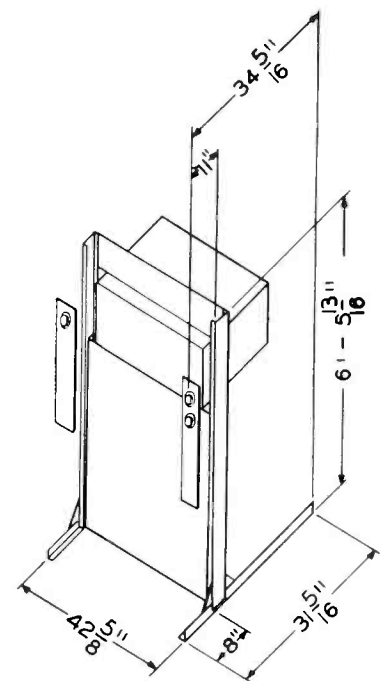

View Showing Outline Dimensions of Inner Frame of Driver Unit.

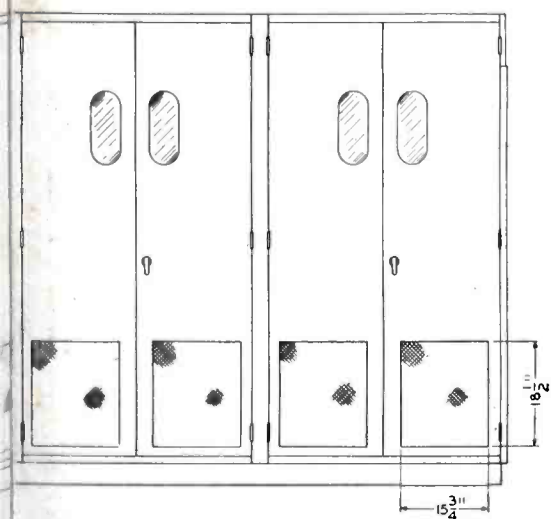

REAR VIEW

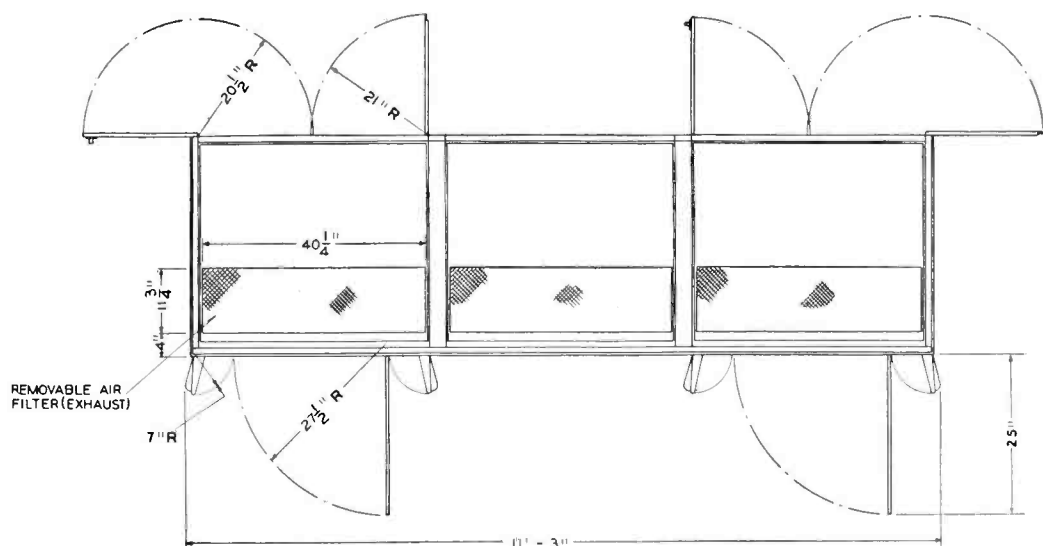

TOP VIEW

# 25 KW

# 50 KW

In these higher powered transmitters the "final" is a single thoriated-filament triode with the anode at RF ground, ideal for simplified water cooling and high circuit efficiency. The large power components are at the rear of the power amplifier.

Side and top panels and rear door assemblies can be omitted, if desired, in stations where the front panels are built into a wall.

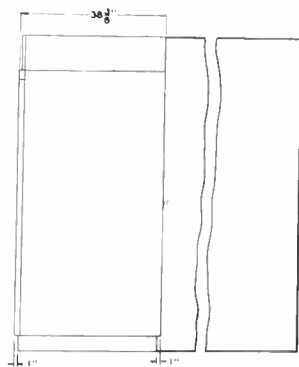

SIDE VIEW — 25 KW

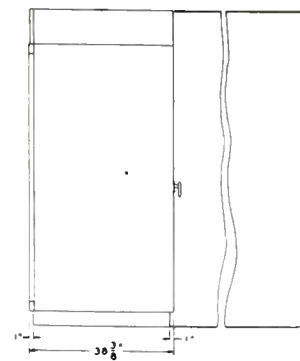

SIDE VIEW — 50 KW

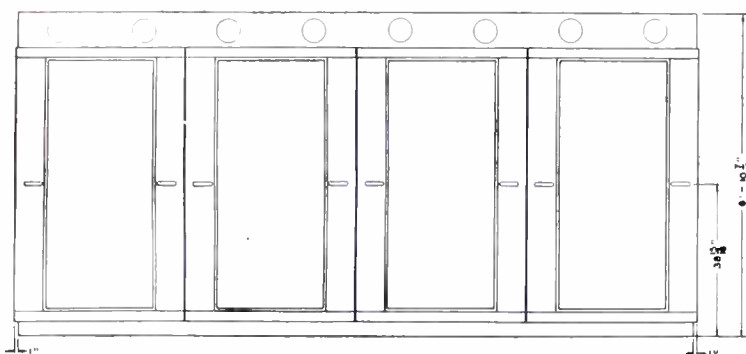

FRONT VIEW — 25 KW

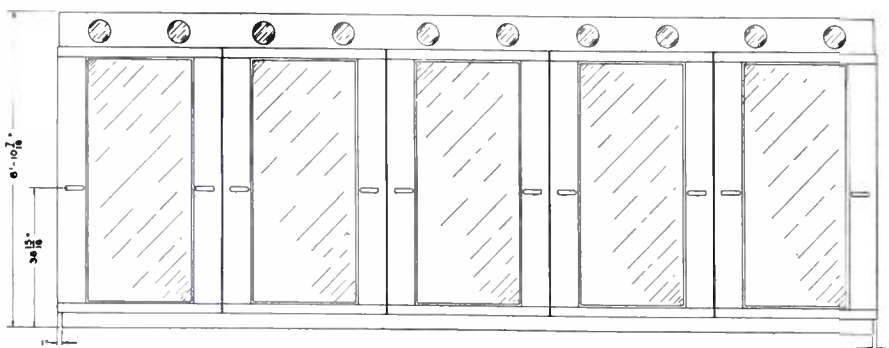

FRONT VIEW — 50 KW

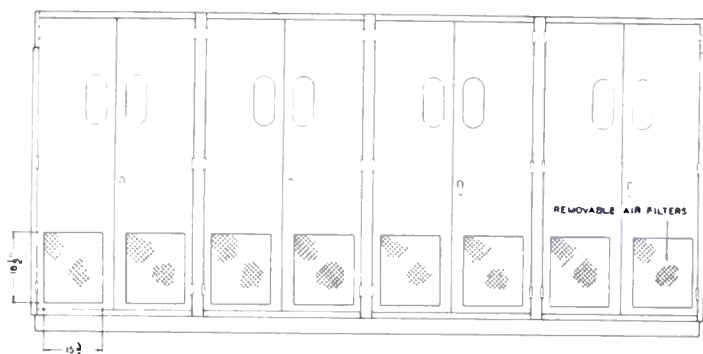

REAR VIEW — 25 KW

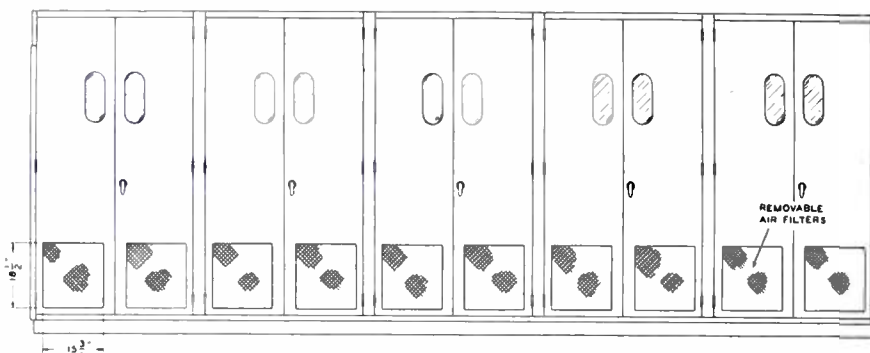

REAR VIEW — 50 KW

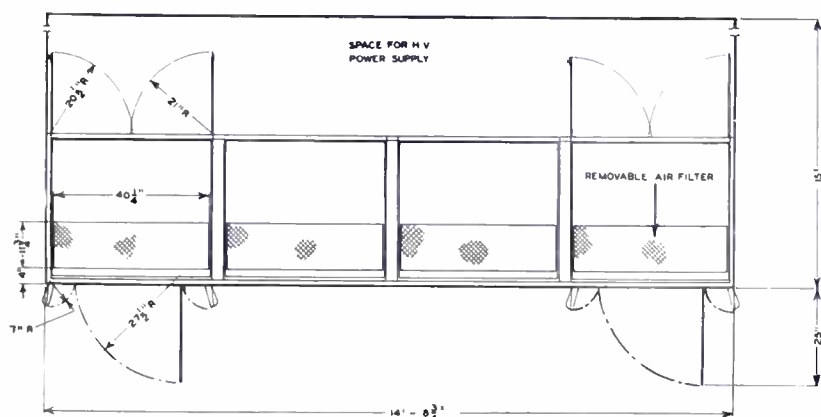

TOP VIEW — 25 KW

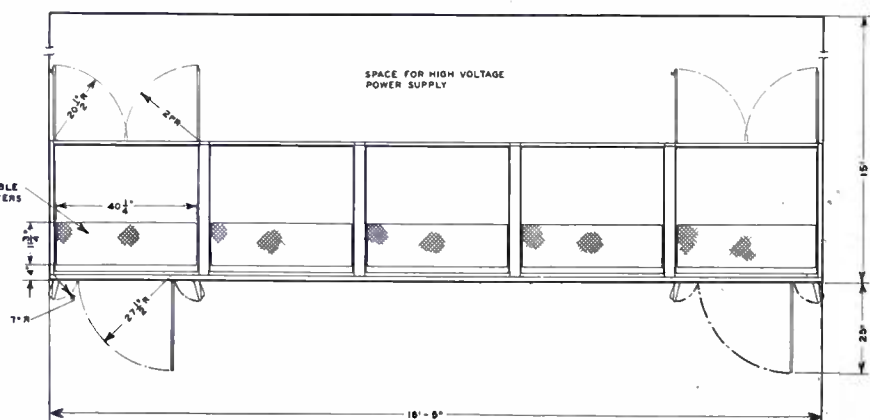

TOP VIEW — 50 KW



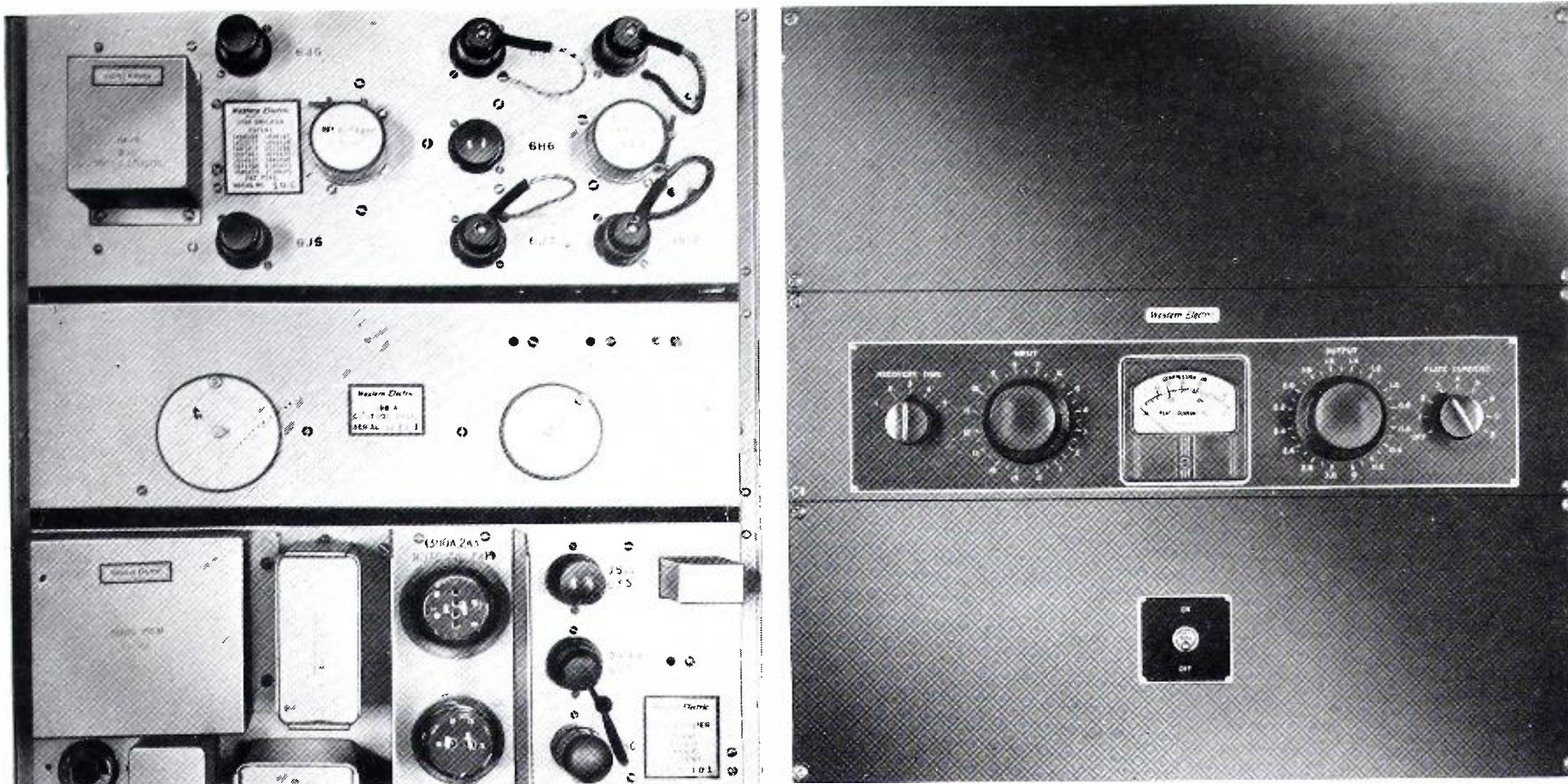

The 1126 Type Program-Operated Level-Governing Amplifier — rear view at left, front view at right — which avoids overmodulation without introducing distortion.

# Use of a Program Peak Limiter in FM Broadcasting

By *W. L. Black*

Bell Telephone Laboratories

IN any practical amplification system which is intended to have the maximum naturalness and dynamic range, the limitations of noise for low level, and overmodulation for high level, portions of a program are sufficient to seriously degrade the overall performance. The requirements for manually controlling programs of wide dynamic range to minimize these limitations are beyond average human capabilities.

It is generally possible to keep the low level portions above noise as these are rarely sudden in occurrence. Furthermore, no particularly harmful effects occur if the manual monitoring is not sufficiently rapid to prevent the program level instantaneously dropping below threshold noise. High level portions however cannot be accurately or instantaneously anticipated and consequently the limitation of overmodulation becomes serious and imposes a terrific burden upon the monitor operator.

In order to avoid overmodulation numerous devices have been used which may be classified briefly in the following categories:\*

1. Compressor in which the output is held within a fixed dynamic range

\* "Devices for Controlling Amplitude Characteristics of Telephonic Signals" by A. C. Norwine, *Bell System Technical Journal*, October 1938.

over a relatively wide portion of the input range.

2. Peak Chopper which merely cuts off the peaks of individual audio frequency waves when the instantaneous peak exceeds a predetermined value.
3. Peak Limiter which quickly reduces gain and slowly restores it when the instantaneous peak exceeds a predetermined value.

The compressor and peak chopper obviously cannot be used in any high quality system, as the first excessively reduces the dynamic range and the second is a serious source of high harmonic distortion. A properly designed limiter which is for all practical purposes an instantaneously acting volume control operated by program peaks will cause no distortion, and when used only to avoid overmodulation and not as a compressor will not obviously detract from the naturalness or realism of the program material. Such a device must, of course, not only accomplish the desired objective of avoiding overmodulation but must do so without introducing distortion or other spurious components.

The Western Electric 1126 Type Program-Operated Level-Governing Amplifier<sup>1</sup> has been designed to fulfill these requirements. The speed of operation is sufficiently rapid to reduce the gain to the proper value to avoid overmodulation in the first half cycle of an average program peak signal and succeeding portions of the peak are undistorted. Harmonic distortion has been held to less than 1 per cent over the operating range, including limiting, and spurious components have been minimized so as to be unobservable under the critical listening conditions.

The need for a program operated limiter in frequency modulated transmitters has been misunderstood and a difference of opinion regarding the desirability of a limiter has arisen. This discussion is intended to resolve existing misconceptions.

Assume a frequency modulated radio transmitter is adjusted for 100 per cent modulation (75 kilocycle carrier swing by definition) using a single frequency audio input. Then if the audio frequency input voltage is reduced by one half or 6 db, the modulation is reduced to 50 per cent or to 37½ kilocycle swing. A further 6 db voltage decrease reduces modulation to 25 per

<sup>1</sup> "Program-Operated Level-Governing Amplifier" by W. L. Black and N. C. Norman, *Proceedings IRE*, Vol. 29, pp. 573-578, November 1941.

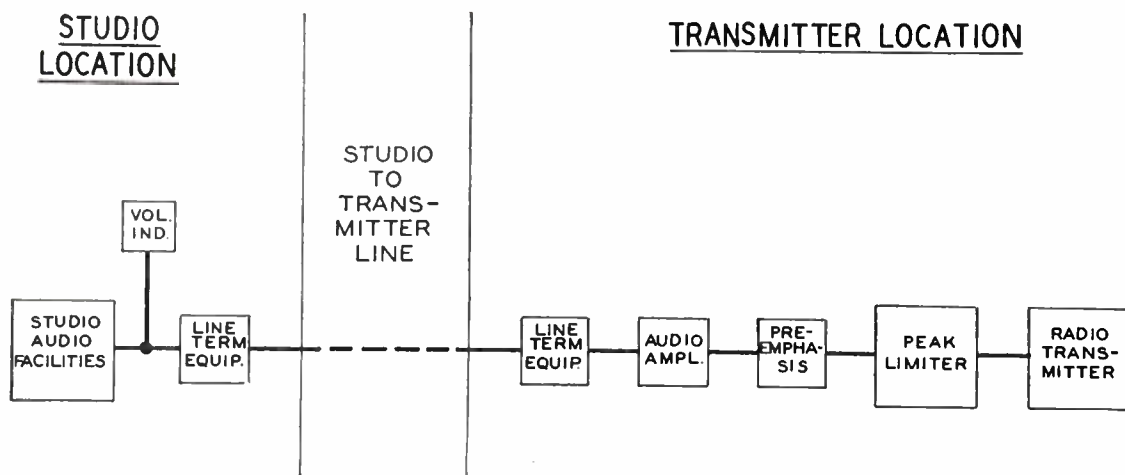

Figure 1 — Peak Limiter — shown in relation to transmitter — is located after the preemphasis network.

cent or  $18\frac{3}{4}$  kilocycle swing. Or if the input voltage is doubled (increased 6 db), the modulation becomes 200 per cent or a 150 kilocycle swing. A further 6 db voltage increase results in 400 per cent modulation or 300 kilocycle carrier swing.

Under single frequency test conditions, input variations of 12 db, if modulation capabilities are being checked, are obviously absurd. However, consider the program transmission problem. Laboratory listening tests, using the standard volume indicator<sup>2</sup> in a system capable of transmitting frequencies only to 11000 cycles and including a sharply overloading amplifier, have indicated that for tolerable distortion the margin of system transmission capability required indicated by the volume indicator ranges, for the most critical listener, all the way from 3 db for dance music to approximately 14 db for male speech. This is due to the differences between volume indicator readings which give the r.m.s. voltage integrated over a finite interval and the peak voltages actually present in complex program material. Thus, it may be seen that the transmitter operator is faced with a difficult decision. If the level as shown by the volume indicator is chosen to coincide with the 100 per cent modulation level for a single frequency, the peaks, some of which are as much as 12 to 14 db above volume indicator level, correspondingly overmodulate the transmitter instantaneously several hundred per cent. If, however, the peaks are allowed for, and the level as shown by the volume indicator is correspondingly reduced some 10 db or more, then overmodulation is experienced infrequently, if at all, on instantaneous peaks, but the average modulation is then extremely low, having a maximum value in the order of 30 per cent.

#### Early Peak Limiter

In the past, in amplitude modulation

<sup>2</sup> "A New Standard Volume Indicator and Reference Level" by H. A. Chinn, D. K. Gannett and R. M. Morris, *Proceedings IRE*, Vol. 28, pp. 1-17, January 1940; *Bell System Technical Journal*, Vol. XIX, pp. 94-137, January 1940.

broadcasting systems this dilemma has been resolved by a compromise determined by two considerations. First, the station operator's desire is to maintain as high an average percentage of modulation as possible. This objective is spurred on further by regulatory rules requiring the operation of such transmitters at not less than 85 per cent modulation on peaks of frequent recurrence in so far as possible. The second consideration, where relatively high average modulation level is achieved, is the use of a peak limiter. The first commercial device of this type, the Western Electric 110A Program Amplifier, was described in 1938<sup>3</sup>. However, even this compromise was not entirely adequate in some instances. In particular, at least one instance is known where the frequency of occurrence of overmodulation was such that interference was experienced in adjacent transmission channels. This was identified, when the disturbing transmitter was transmitting the music of dance orchestras, by the rhythm which was characterized by brass instruments such as trombones having relatively high ratio of instantaneous peak power to integrated average power. This difficulty led to the development of an improved peak limiter, the Western Electric 1126 Type Program-Operated Level-Governing Amplifier<sup>1</sup>. This device has had continued satisfactory field service both in installations where the avoidance of overmodulation has been stressed and in systems where the maximum obtainable increased modulation level consistent with no disturbing overmodulation has been the principal criterion.

In a frequency modulated system the frequency band transmitted is wider, the listener's observation tends to be more critical and finally an equalizer to preemphasize the higher frequencies is incorporated in the transmitter system. Discounting for a moment the use of a preemphasis network, let us consider the practical effects of overmodulation in an FM broadcasting

<sup>3</sup> "Volume Limiting Amplifier" by O. M. Hovgaard, *Bell Laboratories Record*, Vol. XVI, No. 5, January 1938.

system. In such a system the carrier frequency swing which can be accommodated by the receiver, using intolerable aural distortion in the output as a criterion, is ordinarily the practical limitation in determining the satisfactory percentage of modulation which can be achieved. The entire frequency modulation broadcasting system is organized on the basis that a 75 kilocycle carrier swing is 100 per cent modulation.

#### Receivers Tested

It is, therefore, fair to assume that receivers will not ordinarily be made capable of handling much greater swing than this amount. Indeed, several years ago observations made in conjunction with transmission from the then experimental frequency modulation station W2XOR indicated that, of three different commercial receivers, two were able to accommodate peak carrier swings up to 80 kilocycles and the third only up to 50 kilocycles, although all were ostensibly designed for the standard swing of 75 kilocycles. In such receivers, the effect of swing beyond the circuit capabilities is essentially similar to exceeding the overload point of a sharply overloaded amplifier as previously described. Indeed, using the receivers mentioned, this effect existed to an exaggerated extent probably due to the abrupt and considerable departure from linearity which occurred when the carrier swing for which the circuit was designed was exceeded. Therefore, the indications are, particularly with the tendency to more critical listening, that overmodulation must be as nearly minimized as possible, if not completely avoided. While it continues to be true that it is desirable to maintain a high average modulation, the burden on the system due to overmodulation is much more acute than in amplitude modulation systems. This is important from a practical point of view since a monitor under the control of the transmitter operator may be so designed that it will accept a wider over-swing than the listener's receiver. In such a case, there would be no indication, excepting complaints from listeners, that poor quality due to disturbing overmodulation was occurring.

Let us now return to the preemphasis incorporated in the frequency modulation system for noise reduction. The presence of this preemphasis further tends to complicate the frequency modulation control problem in three ways.

1. The disparity between peak modulation levels and volume indicator readings (remembering that the indicator is normally connected at the output of the studio equipment and ahead of the preemphasis) is further increased by increasing the

higher frequency energy peaks of transient complex waves.

2. The modulation level obtained for a given volume reading even on sustained tones is increased whenever the program material contains substantial energy at frequencies above 1000 cycles.
3. The spread of relative values of peak voltages obtained from different program materials of apparent equal loudness but of different character is increased; or conversely, the spread of apparent loudness for different types of program material when their peak voltages are maintained equal is increased.

The first factor applies principally to speech where peak voltage increases, due to preemphasis, ranging from 0 to 3 db, depending upon the individual voice, have been observed. The second factor applies principally to certain solo instruments such as strings and brasses and especially to the trumpet and trombone when muted. The latter are commonly used in dance orchestras, and under such conditions peak voltage increases as high as 12 db due to preemphasis have been observed.

The third factor applies to programs generally where musical numbers of various types may be interspersed with announcements, dialogue, sound effects and applause. If the operating aim is to maintain normal loudness relations among the various program parts, the operator must keep modulation very low most of the time to allow for the high frequencies occurring in the few passages whose peak voltage will be substantially increased by preemphasis. If, on the other hand, the operating objective is to obtain the maximum allowable modulation for all parts, the operator must "ride gain" constantly and use widely different volume indicator references for different types of program material while the apparent loudness will vary radically with the energy versus frequency distribution of the material. It is to be noted, moreover, that this requires additional controlling of gain over and above the type normally done at the program originating point, thus requiring more or less constant attention at the transmitter.

#### Function of a Peak Limiter

In practice the final control of peak modulation is obviously most desirably the function of a peak limiter such as the 1126 Type Amplifier to which reference has been made.<sup>1</sup> In this connection, several additional factors warrant observation. If the peak limiter is located in the system before the preemphasis network and is adjusted to limit the maximum carrier swing for single low frequencies to ap-

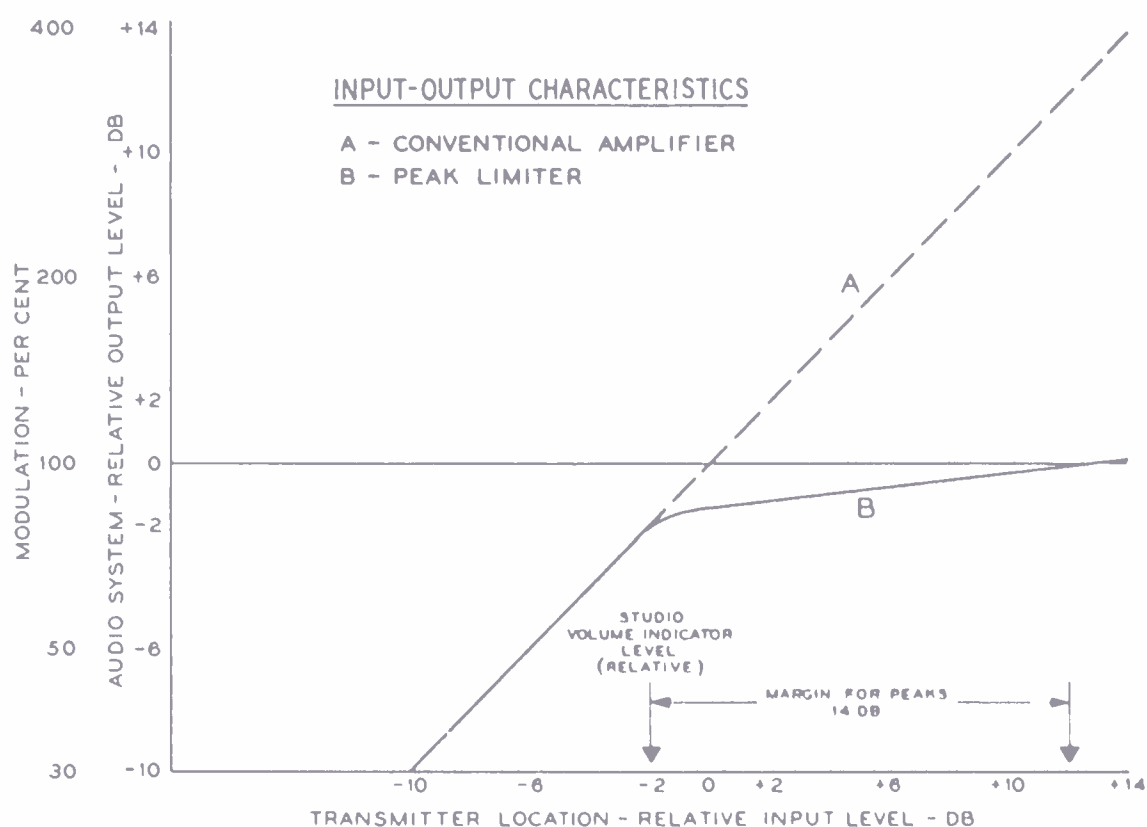

Figure 2 - Characteristic curve designated B is representative of performance of 1126 Type Amplifier

proximately 75 kilocycles, it is found that the preemphasis following tends to nullify the peak limiter's usefulness on certain types of programs by increasing the peak voltage at higher frequencies beyond the maximum established by the limiter for single low frequencies. If, on the other hand, the limiter is adjusted to operate so that approximately 75 kilocycle swing is obtained with a single high frequency input, then a large portion of the transmission is at an extremely low average modulation level. It is thus obvious that the limiter must be located after the preemphasis network as shown in Figure 1. This, however, introduces a new operating problem: namely, the difficulty of keeping the amount of limiting under control with varying types of program material. This, however, may be overcome satisfactorily by a compromise between the extremes of the third factor encountered by the use of preemphasis, as already described. It should further be noted that limiting seems much more objectionable when preemphasis is used. Whereas in a flat system the compression is confined to loud passages, with preemphasis its occurrence bears no obvious relation to program loudness. The effect is particularly disturbing on brass bands where the cymbal crash normally accompanying a crescendo controls the limiting and the resulting compression causes the loudness to drop just when the ear expects it to increase. Of course, the obvious solution is to so align the system that compression is minimized.

In the alignment of the system, account must be taken of the characteristic of the peak limiter beyond the point on its input-

output characteristic where limiting starts. Refer to Figure 1 in which the curve designated B is representative of the performance of the 1126 Type Amplifier. It will be noted that when the volume indicator input level is -2 db (relative) there is a 14 db margin for peaks from that point to the corresponding output level where 100 per cent modulation occurs. It should be further noted that if a conventional amplifier following the input output characteristic designated A is used, it would be necessary to reduce the volume indicator input level to -14 db (relative) to insure that 14 db peaks did not exceed 100 per cent modulation.

In conclusion and summary:

1. Cracking or breaking on modulation peaks in frequency modulation systems is attributable to operation with peak carrier swings greater than some receivers will accommodate and is difficult to avoid when no peak limiter is used or when preemphasis is used after the peak limiter in the system.
2. "Fading away" of received volume on instrumental passages, when the limiter is used after the preemphasis, is inevitable, unless maximum limiting is kept very low. This requires maintenance of levels far below the limiting thresholds on passages whose energy is mainly below 1000 cycles. While the preemphasis theoretically affords a substantial gain in over-all signal to noise ratio, in practice this gain tends to be nullified by the necessity for general reduction

(Continued on page 11)

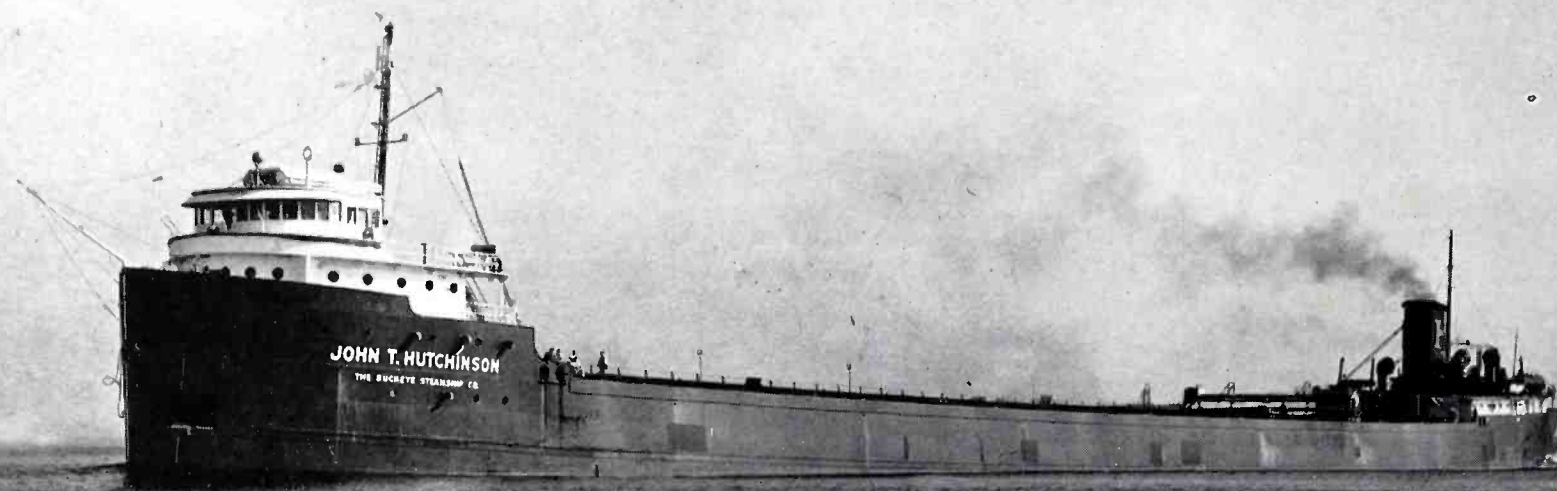

# Navy Radar Puts On Civvies

*By Charles E. Maass*

EVER since man has traveled the waters on the earth's surface he has been faced with problems of navigation. His early navigation instruments may have been crude in a modern sense, yet they enabled Columbus to discover the new world. However, when Columbus sailed west it was the eyes of man alone that enabled him to sight land.

As navigation was developed and the earth's water areas were charted, the navigator still found it necessary to depend upon lookouts to sight obstacles. When out of sight of land he was dependent upon the sun and stars, his sextant, chronometer and tables to locate his position. When the sun and stars were obscured by overcast or stormy weather, he had to proceed by dead reckoning, but in fog he had to depend on slow speed and ship whistles to prevent collision, especially in shipping lanes or near shore.

The radio compass was a big step forward in navigation when it took its place on board ships in the early 1920's. However, this device could only tell the ship's captain or navigator where he was in respect to a ship or shore station that was actually sending out radio energy at the time he wished to take a bearing. It could not tell him of his proximity to other ships that carried no radio transmitter or whose transmitters were not operating at the time he desired to take a bearing. Nor could it warn him of icebergs or floating wreckage.

During the war radar was developed to an exact science, and the radar-equipped ship now has electronic eyes that enable it to identify through night and fog objects from within 100 yards of the ship to 40 miles away. Radar is thus able to prevent collision and can be used to show the outlines of channels and shore lines at great distances. It is capable of performing this

modern miracle by sending out and timing the reflections of radio waves on frequencies of the order of nine billion cycles per second. This can be compared with the normal radio broadcast frequencies of around one million cycles per second. The energy is sent out by a revolving antenna which focuses the radar beam exactly as a searchlight focuses light. The beam is narrowed to only two degrees in the horizontal plane, to obtain good definition of objects, and 15 degrees in the vertical plane so that rolling of the ship will not cause the beam to miss objects. The radar energy is transmitted in pulses lasting but one-half of a millionth of a second, and 1,000 of these pulses are transmitted and received each second.

Recently the Western Electric Company in association with Bell Telephone Laboratories installed the first peacetime experimental radar equipment licensed for civil-

ian maritime use on one of the largest cargo carriers of the Great Lakes, the S.S. *John T. Hutchinson*. This experimental radar equipment was specially assembled under the sponsorship of the Lakes Carriers' Association to determine the specific requirements suitable for peacetime navigation in crowded waterways.

Notorious for unreliable weather, the Lakes are often blanketed by storms or fogs for from 20 to 60 hours at a time, causing long delays and serious navigation difficulties. It is thus easy to see that radar has an important part to play in Great Lakes shipping.

A few statistics on the "*John T.*" may suggest the type of ship which navigates these stormy waters. The "*John T.*" was built in 1943. She is 605 feet long with a 60 foot beam, 35 feet deep and has a gross tonnage of 8,758. She has a carrying capacity of more than 12,000 tons, and when the Lakes are high will take 600,000 bushels of grain.

#### Array of Modern Instruments

An example of the complexities of navigation and operation of a large vessel can be gathered by gazing at the instruments in the pilot house of the "*John T.*" These include: ship-to-shore radiotelephone, radio direction finder, engine room telegraph, polaris, steering wheel and "iron mike" automatic steering device, clinometer for determining inclination of the vessel, standard magnetic compass, gyro compass repeater, and RPM indicator for the propeller, rudder angle indicator, ship public address system, searchlight control, ship intercommunicating system and a talking tube from the bridge back to the engine room. To this has now been added the eyes that will see through darkness and fog, RADAR.

What the installation of radar in ships of the Great Lakes will mean in the future



R. C. Newhouse of Bell Telephone Laboratories looks into indicator scope of the new radar installation.



Antenna of first experimental commercial radar licensed on the Great Lakes being christened by Mrs. H. A. Andersen of Buffalo, as Captain Harold Jacobson, skipper of the S. S. *John T. Hutchinson*, looks on.

may be indicated by the study of a few statistics showing the tremendous importance of Great Lakes transportation to the country. Lake carrier statistics, for the year 1941, a typical year, which did not include greatly swollen war activity, indicated that

the total net tonnage carried on the Lakes that year amounted to about 170,000,000 tons, which included about 80,117,000 tons of iron ore; 50,300,000 tons of soft and hard coal; 17,634,000 tons of stone  
(Continued on page 42)

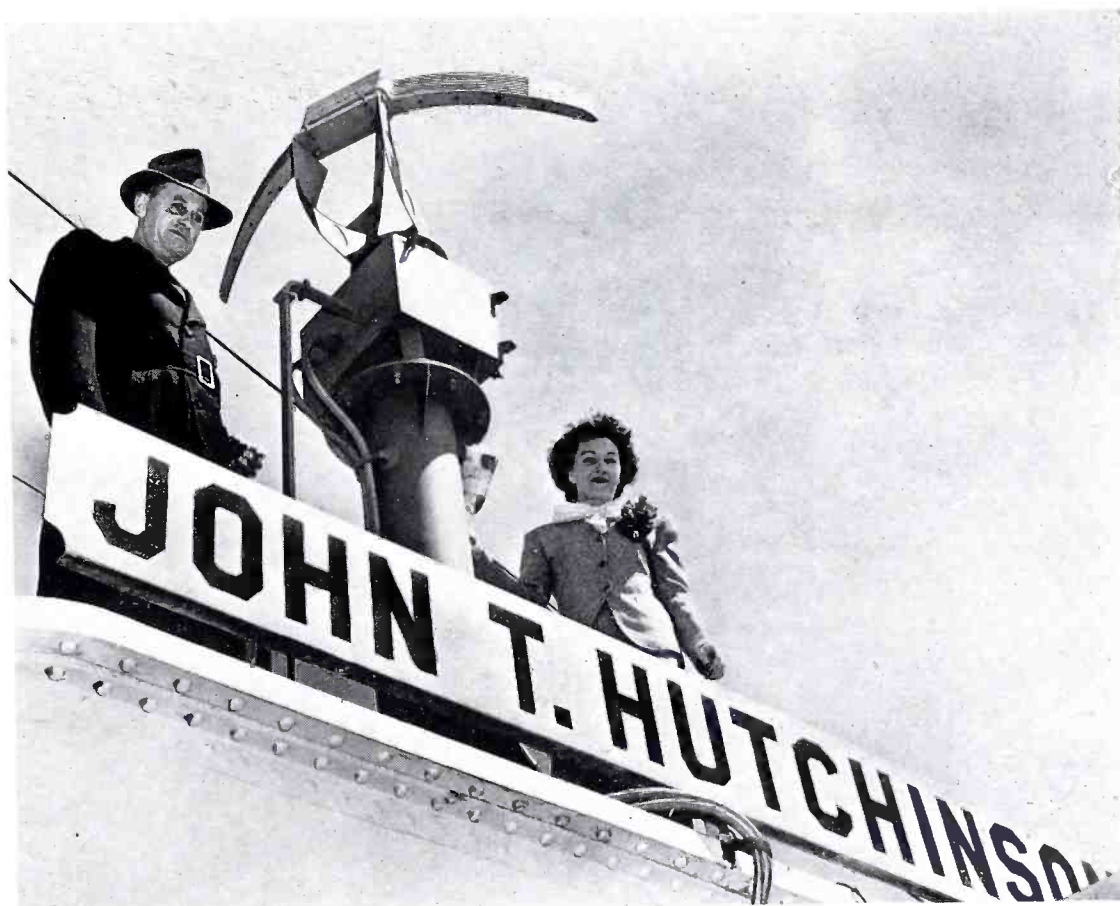

View of antenna of the first experimental commercial radar licensed on the Great Lakes. Installation of radars such as this will in the future save Great Lakes shipping from costly delays due to fog and storm.

# Direct Crystal Control at 50 MC!

By George M. Thurston

Bell Telephone Laboratories

A NEW crystal, recently developed at Bell Telephone Laboratories, has made it possible to simplify and at the same time increase the efficiency of Western Electric very high frequency equipment.

In the past, VHF transmission has depended upon low frequency crystals with harmonic generators to produce the carrier or beat frequencies required. But the use of a low frequency crystal with multiplier stages requires complicated equipment and also introduces a series of extraneous noises and unwanted harmonics that are difficult to suppress or eliminate.

This new development, the D-153053 Crystal Unit, also called CR-9, was designed to use a crystal plate vibrating at a mode of thickness shear higher than the fundamental mode for the express purpose of eliminating the need to start the primary frequency control at the low frequencies. The quartz plate used in the overtone mode D-153053 Crystal Unit is a mechanical vibrator that has a single frequency response at the third or fifth mode of the shear. These quartz plates are made at frequencies of from 15-50 megacycles and part of the circuit can be used to multiply electronically these frequencies up to 150 mc. The advantages in using these plates in place of the conventional fundamental plates are:

1. Saving of several tubes and many resistors, condensers and other circuit elements per equipment.
2. An increase of the number of channels that are usable without obtaining any interaction between the

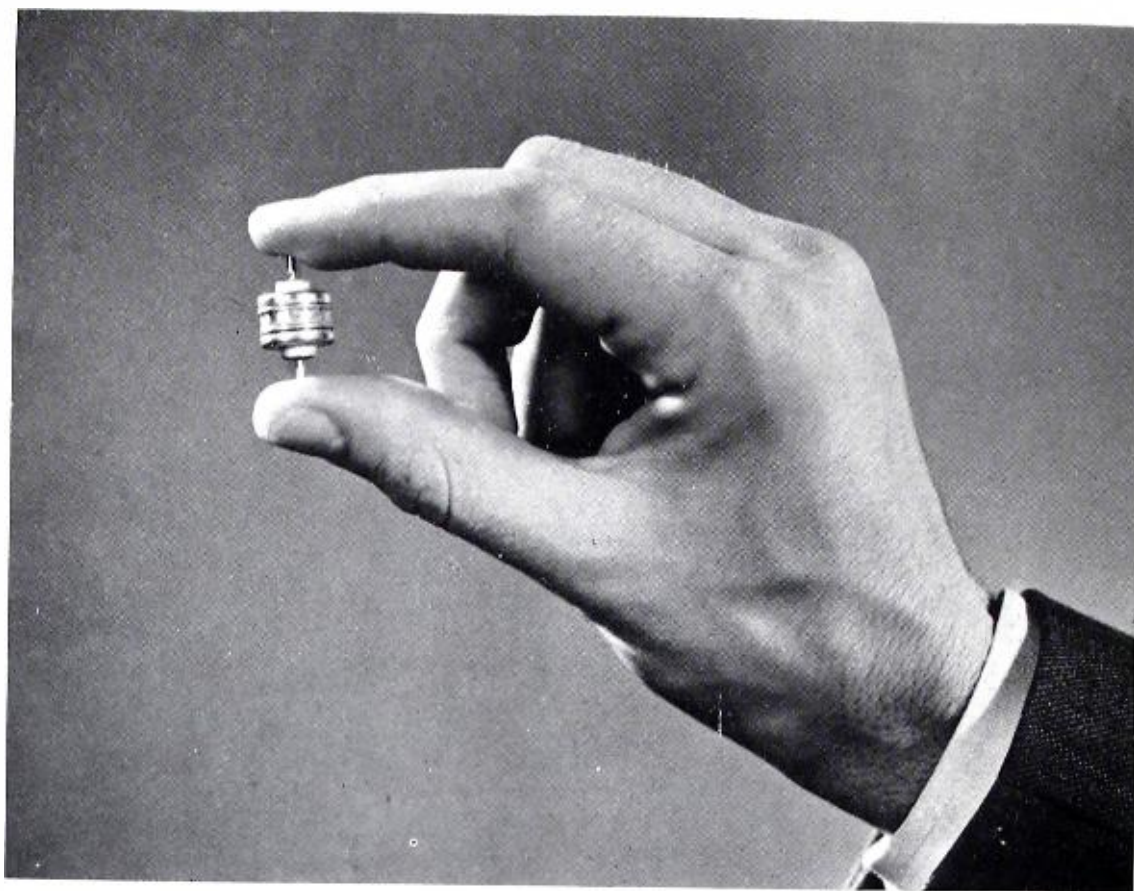

The D-153053 Crystal Unit, also known as the CR-9, which gives direct crystal control from 15 to 50 mc.

3. A reduction in both the magnitude and the number of undesirable responses which are usually present due to the harmonics of the fundamental crystal units.
4. A greater latitude in the choice of the intermediate frequency. With normal fundamental crystal operation the range of fundamental crystals and the amplifying factors have to be suitably chosen to prevent some crystal electrical harmonics from falling in the intermediate frequency band. This problem is entirely elimi-

nated when higher crystal frequencies are used.

Whenever crystal controls are used for frequencies higher than ordinarily obtained by use of fundamental mode crystal units, the overtone mode crystal unit will be used. The over-all effect in using this unit will be to reduce the size and weight of the equipment, to increase the number of channels available for communication, and to eliminate the design problems involved in suppressing unwanted harmonics. The absence of harmonics is due primarily to the fact that the quartz is vibrating mechanically at only the frequency

Exploded view of the D-153053 Crystal Unit. Units are sealed from effects of moisture and dirt by Kovar-to-glass seal and neoprene gaskets, .001 in. thick. Quartz plate is excited by electrodes, separated by an air gap. The electrodes are ceramic and are silver plated.

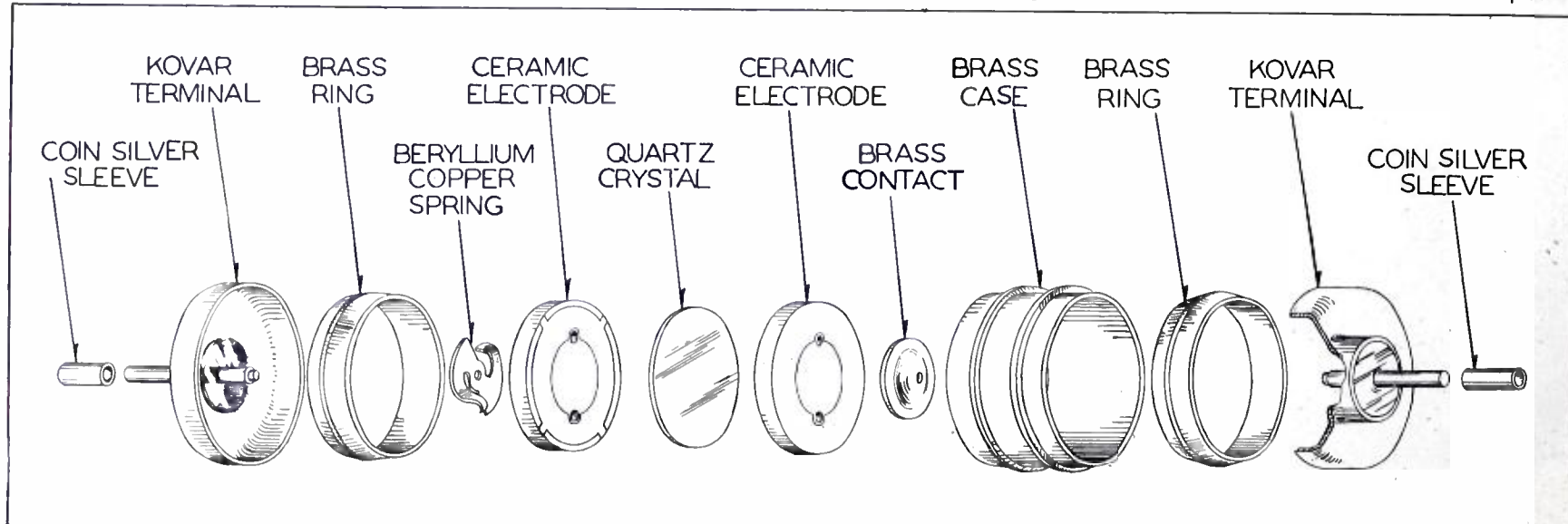

desired for operation. All other extraneous modes are suppressed by the manner of mounting the plates, by the manner of shaping the plate and the electrodes which excite the mechanical vibration.

### AT Quartz Plate Used

Stability with temperature is obtained by cutting the plate at the proper angular orientation with respect to the piezoelectric axes. An AT quartz plate is used and is cut at such an angle that its temperature characteristic will never cause the frequency to deviate by an amount greater than that shown by Figure 1. The envelope of frequency deviation includes the temperature characteristics of the AT quartz plate vibrating at the third or fifth mode and it also includes the maximum and minimum frequencies to which the quartz plates are adjusted. The temperature frequency characteristics of such a plate are accurately defined by the angle at which the plate is cut. In production, X-ray measurements may be substituted for temperature frequency measurements.

The design of this unit was separated into the development of a quartz plate, the development of an electrode, the development of a sealed holder with Kovar-to-glass sealed pins, and the development of oscillator circuits that could be used to excite the overtone frequency.

The D-153053 Crystal Unit developed from the solution of these problems is shown on page 30 in the exploded view. The units are sealed from the effects of moisture and dirt by means of Kovar-to-glass seal. The holder itself is sealed by means of pressure rings and neoprene gaskets which are approximately .001 inch thick.

The electrodes are made of ceramic and

are silver plated. They must be optically flat and are made in this manner by lapping them with equipment ordinarily found in crystal cutting shops. The quartz plate is excited by electrodes that are separated by an air gap. The ceramic electrodes are plated with silver in order to provide the proper electrical excitation of the crystals. The air gap is obtained by plating along the periphery of each electrode face a sufficient amount of silver to provide a space between the electrode face and the crystal. The thickness of this raised portion of the silver on the face of the electrode maintains an air gap only a few hundred thousandths of an inch thick. As may be seen from the exploded view, contact to the outer pins of the holder is made through a spring and a brass disc which serves to clamp the electrodes upon the quartz plate. The quartz plate is circular—about 1 1/2 inch in diameter—and varies in thickness from 0.006 inch to 0.015 inch.

Electrically the crystal unit itself provides a configuration of static capacitances as shown in Figure 2. Inherently the crystal unit has minimum capacitance between pins and from each pin to ground. To use such a configuration of capacitances and at the same time utilize the quartz crystal as a series resonance electrical element, a circuit such as shown in Figure 2 may be used. In this circuit the quartz plate operates very close to its series resonance point, and the holder capacities are absorbed by other elements in the circuit.

To adjust such a circuit, the procedure is as follows:

1. Insert at Q a capacitance equivalent to the crystal capacitance. This may be simulated quite accurately by placing a dummy CR-9 holder hav-

ing a static capacitance equal to an operative crystal unit.

2. Adjust  $C_1$  to minimum capacitance with  $C_2$  at mid-scale. Oscillations as evidenced by grid current should appear at this adjustment.
3. Increase  $C_1$  to the point where zero or no change in grid current is obtained.
4. Replace the dummy crystal holder by the test crystal unit, adjust condenser  $C_2$  for maximum grid current at the frequency stamped on the unit.

If in step 2 oscillations do not occur, the coil ratio  $L_1/L_2$  should be changed slightly. In extreme cases  $C_1$  may be omitted.

A typical tuning curve obtained in an oscillator such as shown in Figure 2 appears on Figure 3. The change in grid current  $I_g$ , the change in frequency  $F$ , and the change in voltage  $E$  across  $L_1/L_2$ , is given for various settings of the tuning condenser  $C_2$ . If the tuning range of the oscillator is sufficiently large, it is possible to obtain two maximum grid current readings. Each maximum represents a different mode of vibration and care should be taken to operate the crystal unit at the correct overtone. This is easily determined by taking the precaution to check the frequency by the use of an absorption type wave meter.

A variation of the D-153053 crystal is the D-153141. This is a similar unit except that it is intended to operate as a temperature controlled unit at  $70^\circ\text{C} \pm 10^\circ\text{C}$  and to have a frequency accuracy of  $\pm .005$  per cent.

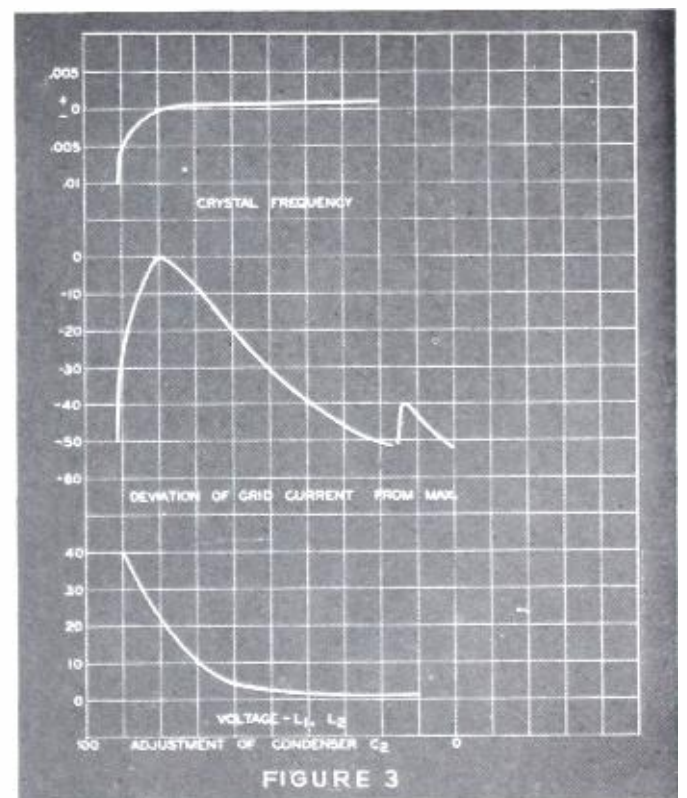
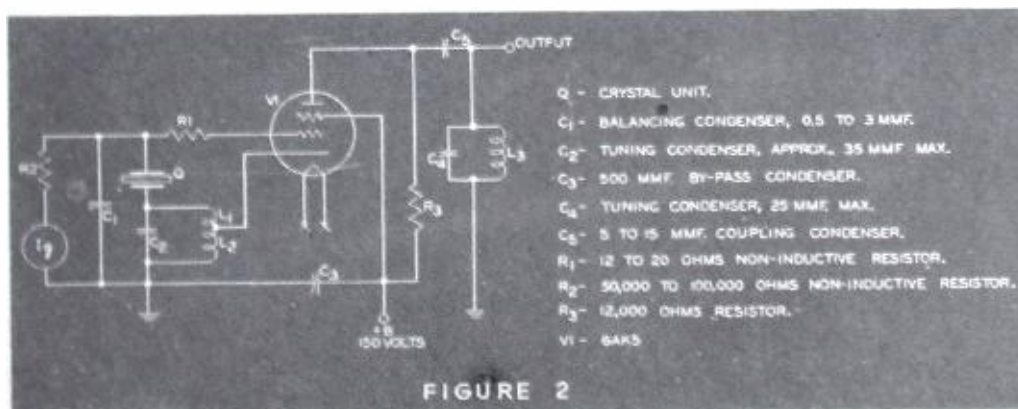
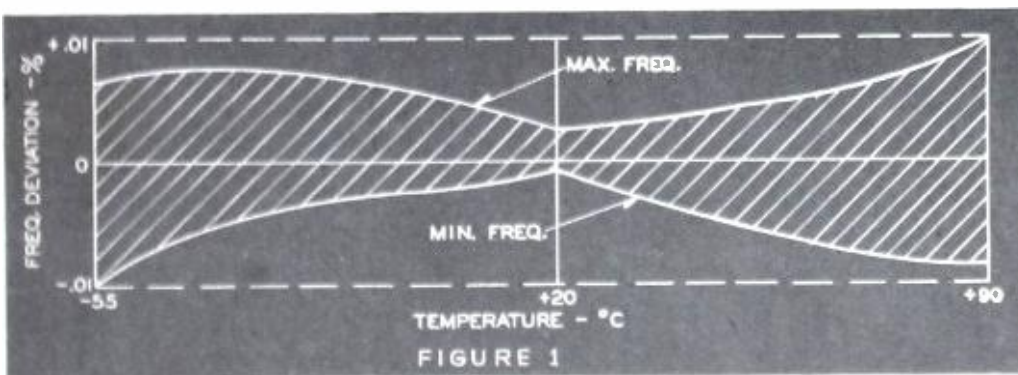

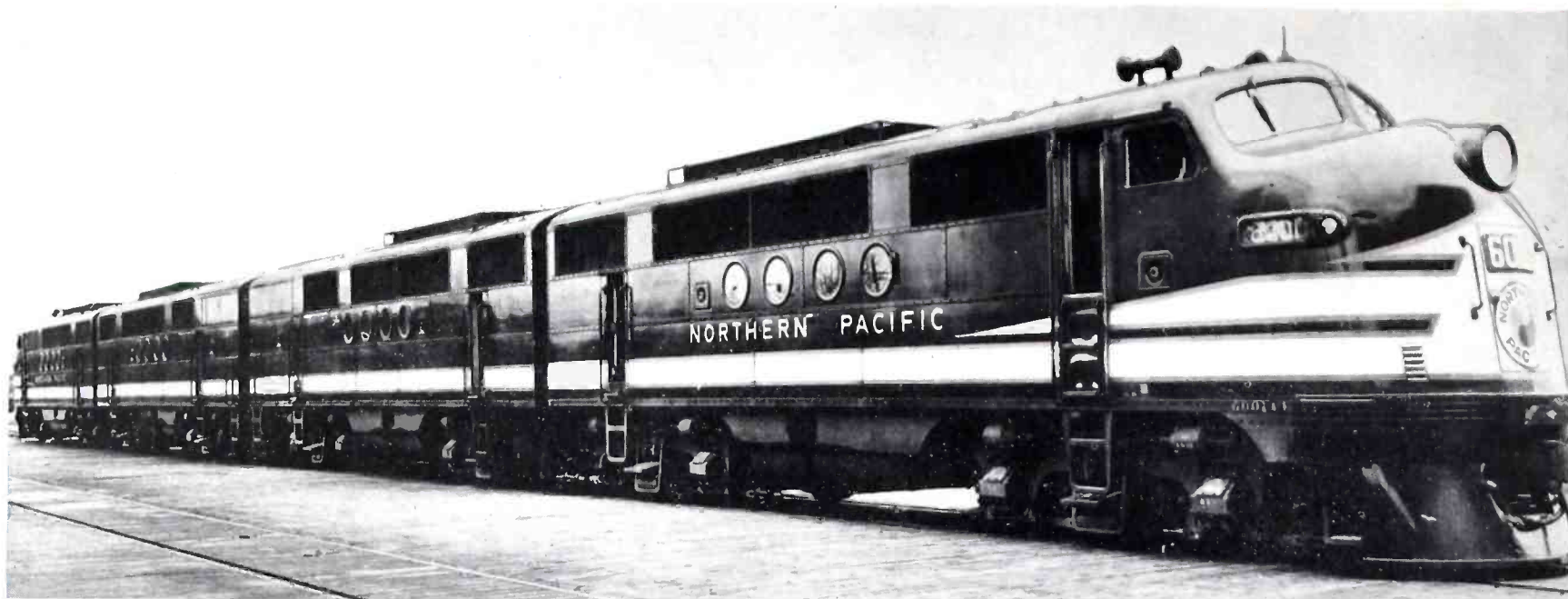

# RADIO RIDES THE RAILS

**Railroad radio developed by Bell Telephone Laboratories and made by Western Electric gets its first tests**

ONE of the really tough sections of the country for railroading is served by the Tacoma Division of the Northern Pacific line, west of the Rockies in the States of Washington and Oregon. Here, to test what VHF radio communications can do for railroading, officials and engineers of the Northern Pacific, Bell Telephone Laboratories and Western Electric installed Bell Laboratories-designed and Western Electric-made railroad radio equipment on two crack freight trains in round-trip runs between Auburn and Yakima, Washington, a distance of 140 miles, and between Seattle, Washington and Portland, Oregon, a distance of 180 miles.

This first experiment was especially significant in two respects. First, the terrain is exceptionally difficult. The train winds through 800-foot gorges and up steep 2.2 per cent grades in particularly mountainous country, and there are a great many curves. Thus, the radio could be tested under the most difficult conditions; and secondly, almost every element that should be considered or might arise in railroading—from cutting in a "helper" engine on upgrades to switching to sidings to make way for fast passenger and freight—was well represented along these routes.

In the first run, radio equipment consisting of very high frequency transmitter and receiver, tuned to the 159-162 mc band allotted to railroad radio by the Federal Communications Commission, a handset, a control unit and a loudspeaker, was installed in each of two 5,400 hp diesel electric locomotives for the run from Auburn

to Yakima as well as in the private business car Number 1904 belonging to F. L. Steinbright, Superintendent of Telegraph of the Northern Pacific Railway Company, which was coupled to the rear end of the 101-car train.

It is believed that this was the first time radio had been used in two diesel electric engines on the same train.

The experiment started on a morning in April 1946. The train (designated "J Manifest" which means a lumber train restricted to a speed not to exceed 35 miles per hour) swung slowly into motion behind diesel electric engine Number 6001 on this single track route. The train was about a mile long, and carried a load of 3,360 tons of lumber.

## Play-by-Play Report

Before discussing the results of this experiment in detail, it may be of interest here to give the following excerpts from Mr. Steinbright's notes on this typical trip, jotted in succinct railroad man's language. It will then be possible to analyze the ways in which this radio saved time and increased safety of operation. The notes are transcribed literally except that where the language is obscure, explanations have been added and the use of the railroad radio indicated. Here is the transcript:

At 9:18 A.M. — pulled out of Auburn.

9:28 A.M. — conductor to front end (over radio) "Hang onto 6 instead of 3 at Kanaskat." (This meant that the engine should remain coupled to six cars when making a pick-up at Kanaskat and thus save time in switching

operations later on when the six cars were all to be "set out", or dropped, from the train at one place.)

9:51 A.M. — Reception from Auburn (from the fixed radio installed at the Auburn station): Reliable and solid communication for 10 miles.

9:57 A.M. — Radio reports: head end going in hole (entering siding) at Covington.

10:09 A.M. — Rear end reported clear of crossing.

10:20 A.M. — Rear end reported brakeman on. "Give her high-ball."

10:43 A.M. — Conductor told the engineer over radio that brakeman was going to look train over at Kanaskat. (This meant go slowly so brakeman could get on as rear end came by).

10:48 A.M. — Head end radios Auburn that there is a leak in hose connection in "B" unit of the head Diesel.

10:58 A.M. — Asst. Master Mechanic Hermanson talked to Nelson at Auburn (20 miles) by radio, tells him of leak in "B" unit of Diesel 6001.

12:06 P.M. — Front end contacted helper 6006 by radio. 8 miles apart. (This was in the vicinity of Lester. This is probably the worst terrain for radio of any encountered).

12:38 P.M. — Head end reported by radio going to make a set-out. While stopped the train was cut and helper coupled into center of train instead of whole train being pulled up to where helper is usually cut in.

12:41 P.M. — Head end radios helper



to report when train is in clear.

12:42 P.M. — Helper radios "in clear."

1:00 P.M. — Engines 6001 and 6006 checked air, etc., preparing to go.

1:03 P.M. — Engine and helper used radio communication to synchronize starting by going to successive throttle positions at the proper time.

1:31 P.M. — Conductor radios engineer that he had 55 cars on front and if he would pull up close to the switch they would just fit in. (Just leave room for the helper to be cut out).

2:24 P.M. — Helper radios: "uncoupled."

2:26 P.M. — Helper radios "head-end in clear."

2:30 P.M. — Helper indicates by radio clear of train and radios back-up signal for front end.

3:23 P.M. — Moving.

3:32 P.M. — Rear end radios all on.

3:47 P.M. — Started into the hole at Nelson for No. 5.

3:56 P.M. — Rear end radios in the clear. Tight fit with 100 cars.

3:59 P.M. — Head end radios high-ball switch. (Work train took care of it.)

7:30 P.M. — Arrived Yakima, Washington.

This log indicates three important areas in which radio communications saved time and effort over difficult terrain. They may be summed up briefly as follows:

First, reliable communication was furnished between the engine and the rear-end, that is, between the locomotive engineer in the front and the conductor at the rear. This resulted in saving of time in transmitting orders or changing orders, in starting and stopping, in picking up swingmen (switching men or flag men who get off to make switches) and in pulling into sidings to allow trains to pass. In such cases, for example, the conductor must tell the engineer when his rear is completely

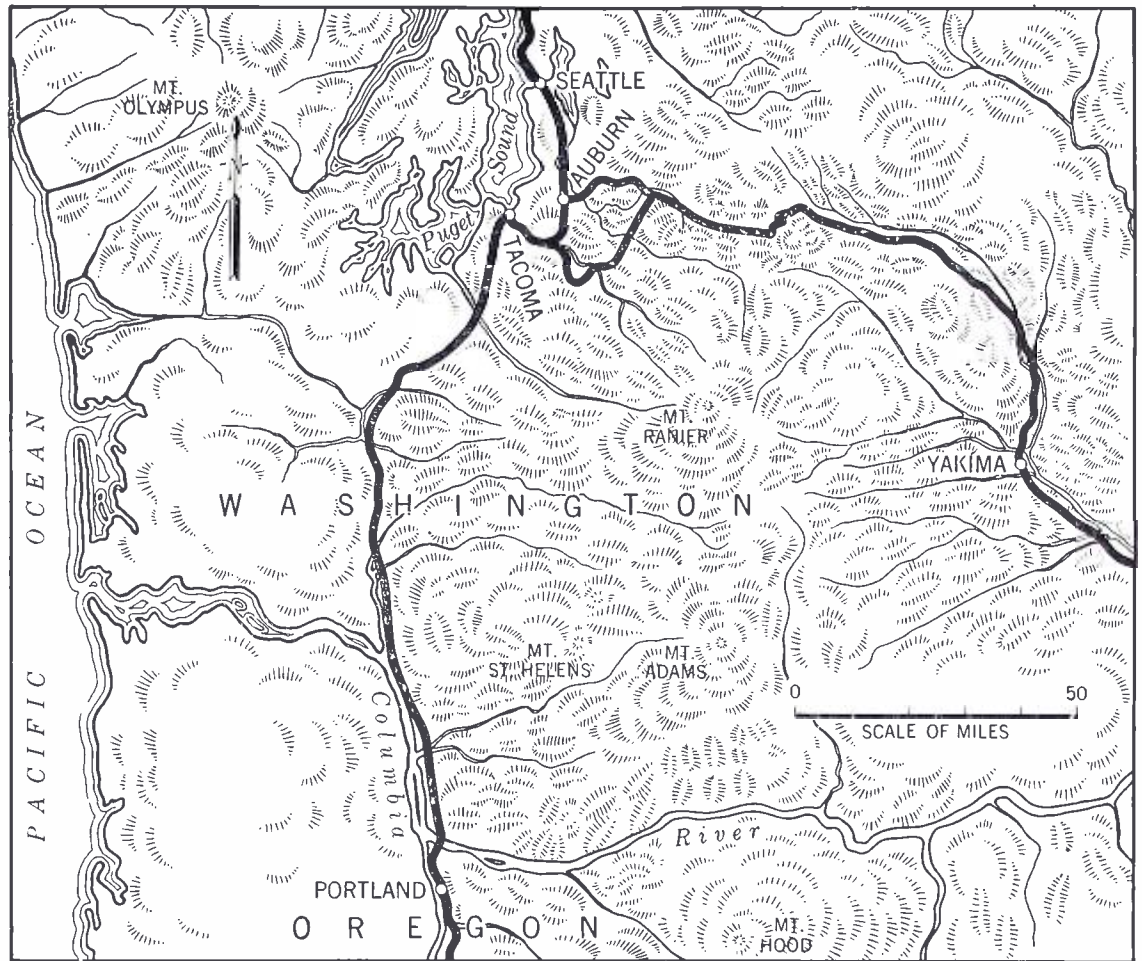

Map indicates rugged, mountainous terrain of routes followed by Northern Pacific trains during experiments in communication by railroad radio from Auburn to Yakima, Wash., and from Seattle to Portland, Ore.

on the siding, so that the switch can be thrown to allow the other train to roll by.

Secondly, reliable communication was established between the engine and its helper engine, which saved a great deal of time in cutting in the helper into the middle or any part of the train to help on upgrades. This also was an aid in starting and stopping, since the helper can synchronize his throttle with that of the head engine, thus speeding up starting and minimizing the danger of a "break-in-two", and can release his throttle on stopping, to allow the lead engine to apply the brakes without resistance from the helper.

Finally, excellent communication could be maintained between the station and the train up to 12 miles and readable (understandable) communications at intervals up to almost 25 miles. This made it possible to transmit, relay or change orders, or to give advance announcement of arrival.

The operation of the set occasioned few problems and was considered extremely successful. It was estimated that time saved might average as much as 15 per cent of the time of the whole run.

In the second tests on the run from Seattle to Portland, a steam locomotive was used, and communication was between the steam locomotive and rear-end and the station at Auburn, Washington. Although the results were similar to those on the Auburn to Yakima run, several features are worth noting.

At Auburn, the short wave equipment maintained communications on both runs for a distance of 12 miles either side of the station. It was further found that although noise on steam engines was greater, the engineer was able to maintain "readable" communications throughout the test runs. The time saved in cutting in helper on grades, picking up or setting out cars, swinging into sidings, starting and stopping, relaying and receiving orders, and dropping or picking up swingmen was about the same as in the earlier runs and amounted to a very substantial saving, besides increasing the safety of operations.

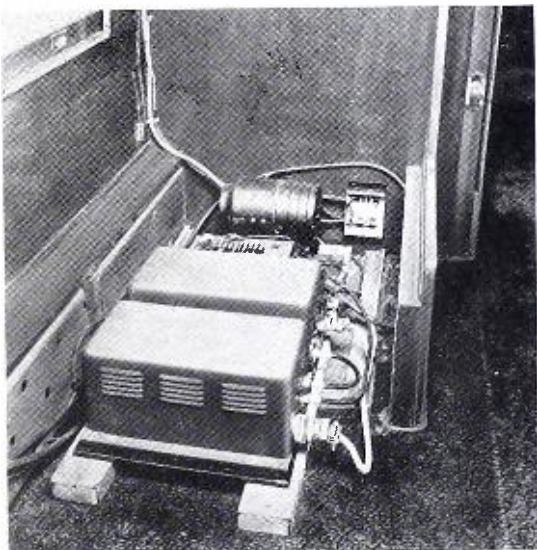

Radiotelephone equipment for end-to-end test was placed under a seat in the business car of F. L. Steinbright, Northern Pacific Supt. of Telegraph.



Radiotelephone handset and loudspeaker in business car, which was coupled to rear of 101-car freight and used in end-to-end test during an actual run.

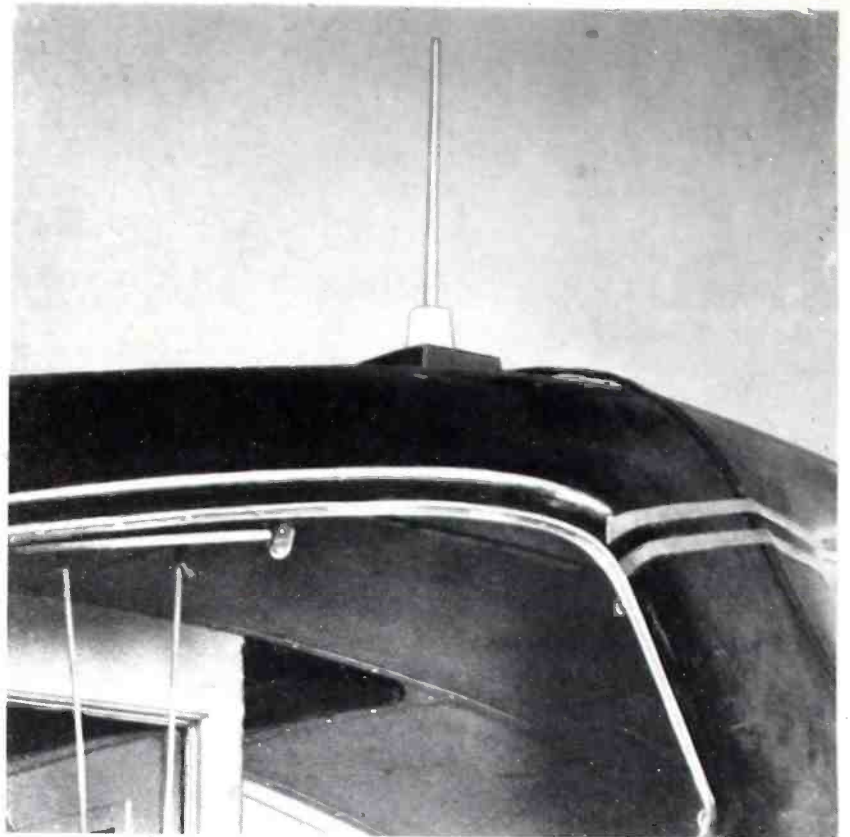
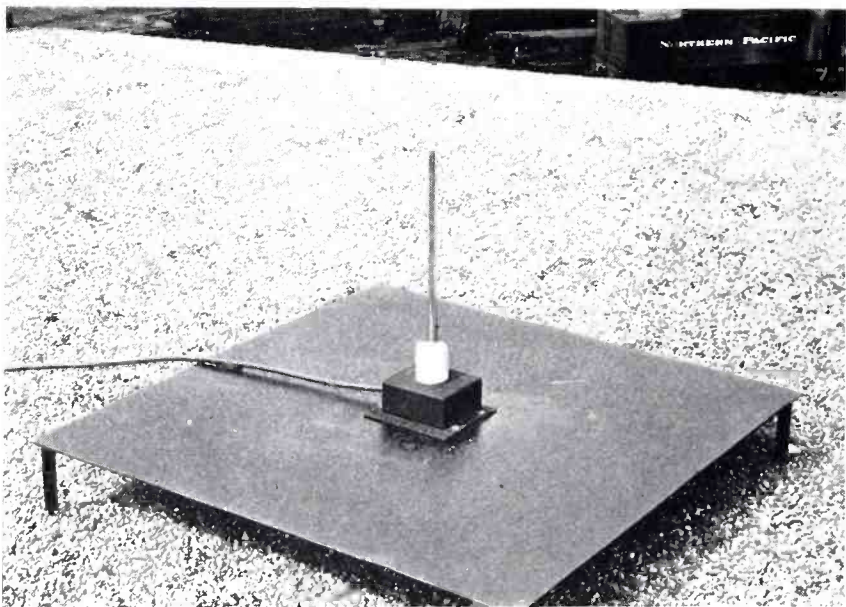
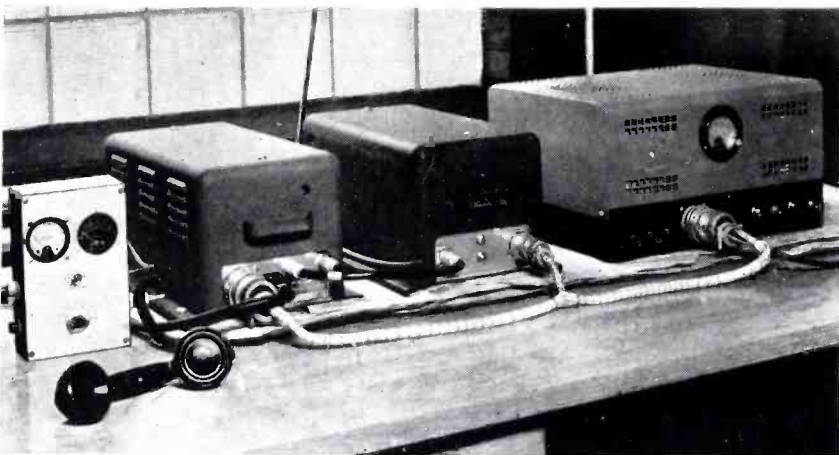
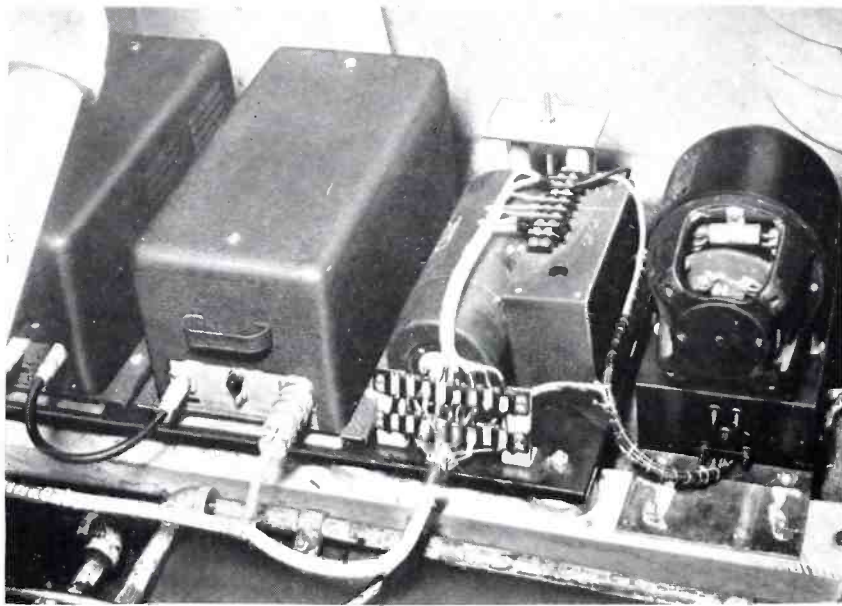

Above: The 14-inch antenna mounted on the cab of the Northern Pacific's huge 5400 horsepower locomotive (shown at the top of page 32) for the railroad radio tests. On a run from Auburn to Yakima, Wash., a distance of 140 miles, the radio equipment effected a saving of about 15 per cent in over-all time.

Above, left: Radiotelephone handset and loudspeaker in the locomotive cab.

Left: Mobile transmitter, receiver and associated power supply equipment were located in the nose of the locomotive cab. The equipment was designed by Bell Telephone Laboratories and made for the tests by the Western Electric Company.

Left: Installed in the engine house at Auburn, Wash., this equipment was used as the fixed station during the comprehensive series of tests. For the wayside station test, clear transmission was maintained with the train up to 12 miles.

Below, left: Antenna on engine house roof, used with fixed station at Auburn.

Below: Standing beside car used for end-to-end test on a 101-car freight are some of the men who arranged the tests. L. to R., they are: R. T. McFarland and G. B. Fisher, Western Electric; F. L. Steinbright, Northern Pacific; J. G. Nordahl, Bell Laboratories; F. M. Harris, Western Electric; Clarence Martin, Graybar Electric; W. C. Hunter, Bell Laboratories; and R. B. Johnson, Northern Pacific.

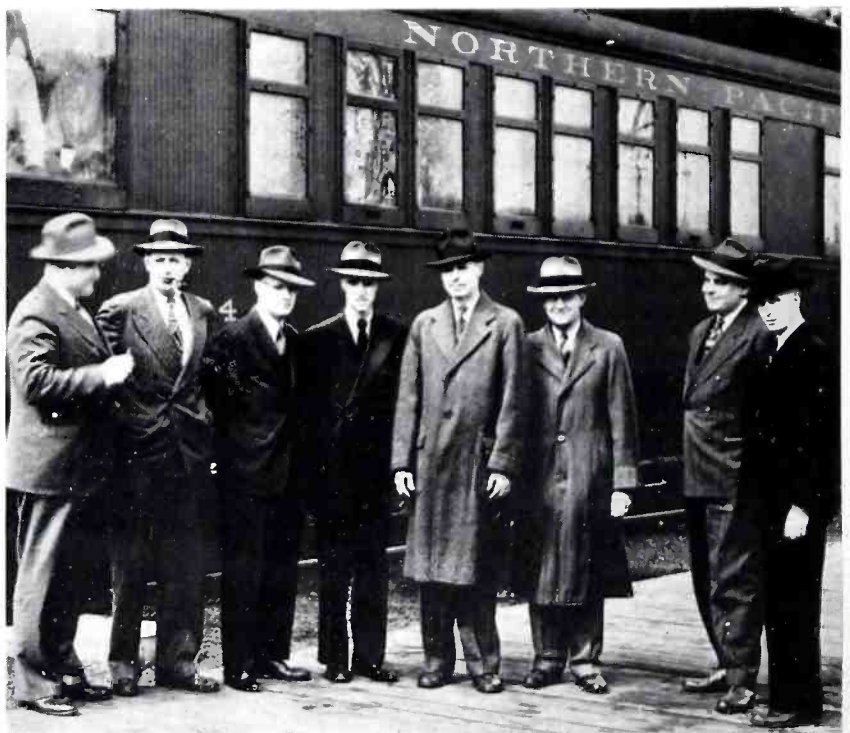

# A LOUDSPEAKER IS BORN!

**D**URING the war, the Navy approached the Western Electric Company with a rather formidable problem which called for the design of a new loudspeaker capable of unusual realism in reproducing sound. Bell Telephone Laboratories and Western Electric engineers tackled the job — and licked it!

Although technical details of that Navy speaker cannot yet be revealed, a commercial version of that unit, coded the Western Electric 728B Loudspeaker, has been developed, embodying every one of its characteristics important to the reproduction of the utmost realism in sound. The 728B is now available for installations requiring a single unit speaker system, where only the finest in speech and music reproduction must be realized without the aid of supplementary high frequency speakers. The normal frequency range of 60 to 10,000 cycles is ideal for faithful reproduction of vertical and lateral transcriptions, standard records, or live programs where the loudspeaker is used in a public address system. In systems employing FM radio receivers, the 728B can be expected to surpass results obtained with any other single unit speaker system now commercially available.

## Efficient Below 60 Cycles

The remarkable low frequency efficiency of the 728B below its rated 60 cycle limit was recently demonstrated at Bell Telephone Laboratories when the speaker was used in conjunction with the "Connsonata", a new electronic organ. The manufacturers of the Connsonata required that the 32-cycle note on the organ be reproduced in addition to the normal frequency range. This was accomplished by designing a suitable exponential horn housing two 728B Loudspeakers, and while, as might be expected, the reproduced signal was down somewhat at this frequency, good 32-cycle reproduction was obtained. As a result of the interest created by this rather unusual demonstration, Connsonata has ordered a quantity of these speakers for further tests with the new organ.

Demonstrations of the speaker with vertical-cut transcriptions, FM radio, microphone pick-up and sound-on-film equipment similarly prove that stand-out performance of this new unit, which brings to the world of reproduced sound the vital, life-like quality so lacking in single-unit speaker systems until now.

The new 728B is finding many uses in many fields. Soon they will be seen in high-quality installations on trains, planes and



The remarkable 728B Loudspeaker, designed for installations which require a single unit system, where the finest speech and music reproduction must be realized without supplementary high frequency speakers.

passenger ships where selected recordings on magnetic tape or hit radio programs will be provided for the enjoyment of passengers in dining cars, lounges, salons — yes, and even in private staterooms and cabins. Hotels, restaurants and public buildings are replacing present speaker equipment with the new 728B to provide a higher standard of service to their patrons in musical reproduction, paging and sound reinforcement systems. Broadcast studios, particularly in frequency modulation stations, appreciate its "naturalness" of reproduction so necessary in monitoring high quality program lines. Progressive motion picture theatres will bring to their audiences new enjoyment, new realism, by installing Western Electric 728B's.

Many other outstanding qualities in addition to its uniform frequency response make this the ideal unit for all full range loudspeaker requirements where the additional cost of supplementary high frequency horns and crossover networks is not desirable. With a very conservative continuous power handling capacity of 30 watts

and a coverage angle in typical rooms and auditoriums of as much as 50 degrees, the 728B is adaptable to practically all installations where a single speaker is required. Or, used in multiple in direct radiator type baffles or suitable exponential horns, with or without supplementary high frequency horns, it is especially suitable for large rooms, theatres and auditoriums where greater power and wider coverage are necessary.

Dimensionally, the 728B eliminates many problems in mounting and baffling. Its diameter of approximately 12 inches is an accepted standard with radio and sound equipment manufacturers. But — its depth is only approximately 4 inches! Furthermore, the recommended minimum baffle dimension for maximum performance over the entire frequency range is a total enclosure of only 2½ cubic feet! Where space is at a premium, such as in radio cabinets, portable speaker cases, ceilings or walls of railroad cars and planes, theatres where space behind the screen is limited

*(Continued on page 42)*

# A Simplified Radio Frequency Bridge

By J. M. Tiffany

TUBES in the radio frequency stages of radio transmitters must work into an optimum value of load resistance in order that they will exhibit the characteristics for which they are intended. These values of impedances vary in magnitude from relatively low for a linear AM amplifier, to a high value for amplifiers intended primarily for efficiency. The impedances are determined mainly by the resistive component and the ratio of capacitance to inductance.

Normally the load circuits are tuned to anti-resonate at the operating frequency of the particular amplifier stage so that reactances are tuned out, and the resulting load is resistive. In practice, the factors determining the impedances are associated not only with the lumped capacitance and inductance of the tuned plate load circuit, but include other values, such as the grid input circuit of the following amplifier stage, or in the case of the final amplifier, the reactance and resistance of the transmission line, branching circuit, and antenna.

Other influences on the resulting impedance are harmonic suppression circuits, choke coils, etc. These complex values make it difficult to predict the exact magnitude of the components so that it is desirable to make one or more of them adjustable for optimum operating conditions. For simple amplifier stages where plate efficiency alone is the main characteristic desired, tuning for minimum plate current and maximum output power is usually sufficient, but where the amplifier stage is to be amplitude modulated and should look into a specified impedance for properly loading the tube, a radio frequency bridge is very helpful in obtaining a correct adjustment.

## Simple and Inexpensive

A laboratory type impedance bridge is a rather imposing instrument and requires some care in its use and a knowledge of the theory of its operation. In addition, this type of bridge is not always available to the transmitter operator when he has the greatest need of it. Mr. W. H. Doherty of the Bell Telephone Laboratories has suggested a very inexpensive and simple reference type bridge suitable for use on many of the tuned circuits found in radio transmitters of the modern types. The Broadcast Engineering Force of Western Electric has found this type of bridge to be very useful and has made up a number of them for making adjustments of the plate load circuits of the Doherty high efficiency ampli-

fier\* used in all of the Western Electric AM broadcast transmitters having power outputs in excess of 250 watts.

Figure 1, and the accompanying photographs, show the form the bridge takes as used by the Broadcast Engineering Force. It consists of two fixed non-inductive resistors having a nominal value of perhaps 1000 ohms each, shown as "A" and "B" in Figure 1, especially selected to be within 1 per cent of the same absolute value; a rectifier type, 0-1, A.C. milliammeter shunted by a 1000-ohm variable resistor for adjusting the meter sensitivity; terminals for connecting to the circuit to be adjusted, and to the reference resistor; and a coaxial connector for connecting to a source of radio frequency current at the operating frequency. In place of the variable resistor for adjusting the meter sensitivity, it may be more convenient to use a fixed resistor of about 50 ohms, connected across the meter in series with a single-pole, single-throw switch. Both methods are good, and the selection of either is a matter of personal preference. The value of the reference resistor is selected to be the same as the impedance of the circuit to be adjusted. If

\*"A New High-Efficiency Power Amplifier for Modulated Waves" by W. H. Doherty, *Proceedings IRE*, Vol. 24, p. 1163, Sept. 1936.

the circuit is to be adjusted to 2000 ohms, for instance, a 2000-ohm composition type resistor is connected at terminals "REF" on the bridge. It should be noted that this is a reference type bridge and is not continuously adjustable for measuring all values of impedance in the same sense as are more elaborate impedance bridges. This is the key to the simplicity of the instrument, and all that is needed to use it for adjusting other values of impedances is a reasonably accurate calibrated resistor for each application. Radio frequency current from a low power stage of the transmitter is induced in the coupling coil and is impressed across the bridge via the coaxial cable. The coil is approximately 1 inch in diameter and 5 inches long, wound with about 60 turns of insulated wire. The exact size of the coil is not critical and is determined by the nature of the circuit to which it is coupled. A bakelite tube is slipped over the coil to protect it from contact with high voltages.

The resistors for the "A" and "B" arms, and for insertion at REF must be non-inductive, wire-wound, with a dissipation rating of at least 10 watts. Attempts to use composition type resistors will result in disappointing results due to serious drifting in resistance.



Reference type radio frequency bridge suitable for use on many of the tuned circuits found in radio transmitters of the modern types where a resistance requirement must be met. Bridge is simple and efficient.

This bridge has useful application for the adjustment of any of the tuned circuits found in a radio transmitter where a resistance requirement must be met, such as the adjustment of input resistance of an antenna phasing unit, or any circuit operated at resonance which must present a pure resistance at the carrier frequency. Where the circuit to be adjusted has a resistance greatly different from the value of resistance in arms A and B of the bridge, the null reading will not be sharp. Therefore it is suggested that if a very small or a very large value of resistance is to be checked by means of this bridge, arms A and B might be changed to more nearly approach the resistance of the circuit to be checked. For example, in adjusting a transmission line to, say, 72 ohms, the arms A and B could be changed to 100 ohms each to make the null sharper. On the other hand, a circuit under test having a resistance of 25,000 ohms, could be more easily checked by substituting perhaps 20,000 ohms in the arms A and B. For most purposes a ratio of as much as ten to one of the arms A and B to the circuit under test is satisfactory.

#### Adjusting High Efficiency Amplifier

Here is an example of its use for adjusting the plate load circuits of the high efficiency amplifier, shown in greatly simplified form in Figure 2. The amplifier uses two tubes, or sets of tubes, V1 and V2, with associated tuned plate circuits C2L2 and C3L3 for properly loading each tube. These tuned circuits are coupled together through an impedance inverting network of which L4 is the principal element, and which makes it possible for one tube to operate at high efficiency at carrier level, and for the other tube to come into play to provide the additional power during modulation only, thus maintaining a high efficiency of the final stage. In order to do this, the plate load circuits are adjusted to predetermined values, in the ratio of four-to-one to each other. In the Western Electric 443A-1 1 KW Transmitter, these are 4000 and 1000 ohms respectively. Table 1 on page 42 lists the recommended values for other type transmitters.

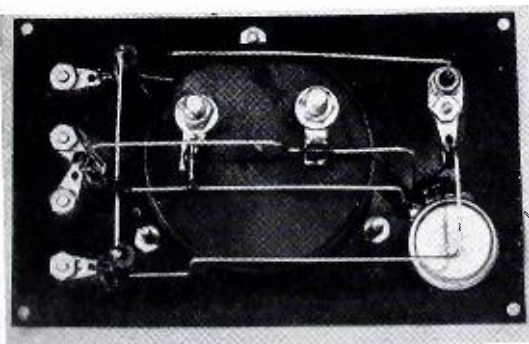

View of the wiring of the radio frequency bridge.

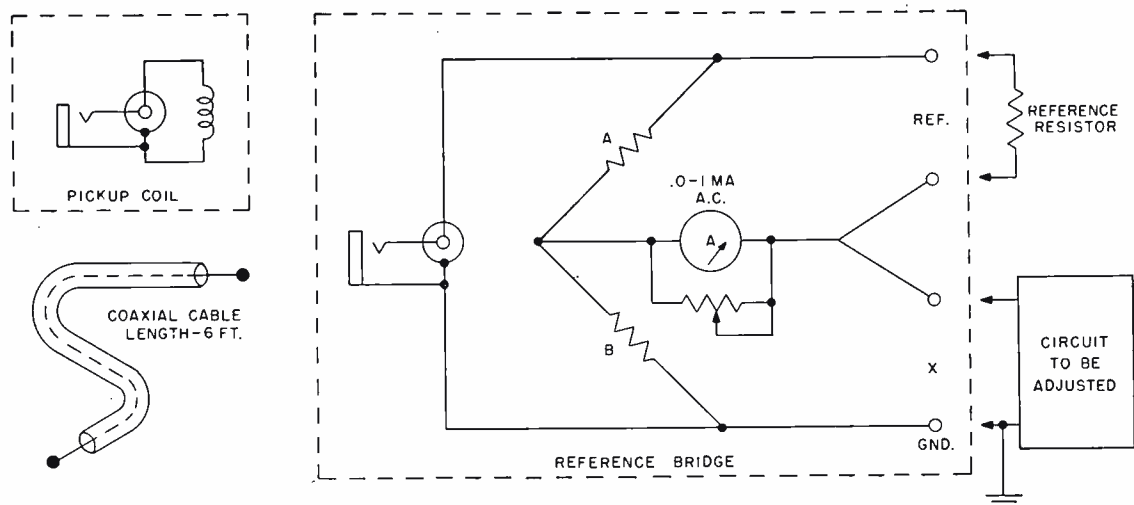

Figure 1—Schematic showing simplified bridge with arms "A" and "B" representing fixed non-inductive resistors.

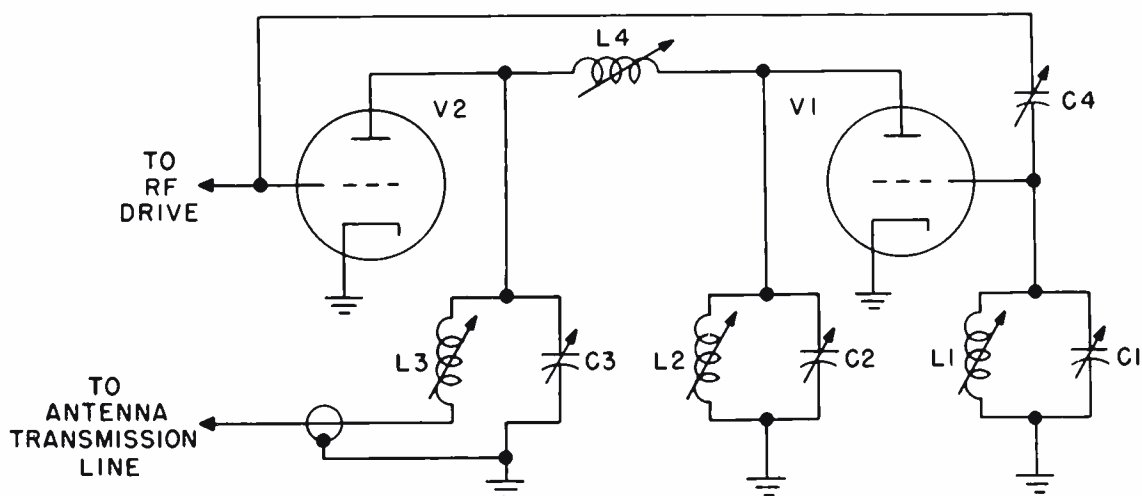

Figure 2 — Schematic drawing showing the Doherty high efficiency amplifier in a highly simplified form.

Starting with the adjustments of L3C3, which are to be adjusted to 1000 ohms, connect a 1000-ohm resistor at REF on the bridge, remove all filament, grid and plate power from the amplifier being adjusted, and couple the bridge pickup coil to a low power stage to obtain a convenient reading on the bridge meter. The sensitivity of the meter should be reduced by means of the shunt variable resistor to provide more sensitivity when a null is approached. Temporarily ground the plate of V1, and connect the X terminals of the bridge to plate of V2 and ground, observing the ground at X. The resistance of the circuit is represented by the transmission line feeding the antenna system, and having previously been tuned, presents a fixed value of resistance. The only adjustments possible are changing the ratio of L3 to C3 if the circuit is to look like 1000 ohms at resonance. Tuning C3 will cause the meter to dip at resonance, but a null will not be indicated until the correct ratio has been arrived at. Increasing L3 and decreasing C3 will cause the circuit to have a higher value of resistance at resonance, and decreasing L3 while increasing C3 will cause it to have a lower value of resistance at resonance. When the null is indicated, the circuit is not only tuned to resonance at the operating fre-

quency, but it also has a resistance of the desired 1000 ohms.

Remove the temporary ground from the plate of V1 and connect the X terminals of the bridge to plate of V1 and ground. Proceeding as above, but with a 4000 ohm resistor at REF on the bridge, the plate load impedance for V1 is adjusted by varying both L2 and C2 until a null is indicated on the bridge meter. In both cases, the conditions for a null reading are: excitation voltage of the desired operating frequency, adjustment for the correct L/C ratio, and care in tuning to resonance each time a measurement is made. Null occurs then when  $\frac{A}{B} = \frac{REF}{X}$  the bridge may have had on the tuning of the circuits can easily be corrected by slight retuning when power is applied to the amplifier.

In circuits where dc is present, due to rectified radio frequency current, or other reasons, a condenser of about .01 mfd can be connected in series with the X terminal, without affecting the accuracy of the meter at broadcast frequencies.

Field experience indicates that there is a rather large tolerance in the values of the load resistances of the high efficiency am-

(Continued on page 42)



The only part of the mobile radio equipment visible to the vehicle operator is the 41A Control Unit. This is mounted conveniently beneath the instrument panel.

## Telephone On Wheels

(Continued from page 6)

ative feedback is introduced, further providing for a high degree of distortionless reception.

The selective signaling device incorporated in the receiver requires slightly more output power than is available when the feedback circuit is operative. Consequently, when the handset is not in use, i.e., when it is in its cradle, the feedback circuit is disconnected, providing additional power to operate the selector.

A frequency modulation type of squelch is used to make the audio circuit operative whenever a usable signal is received. An outstanding feature of the squelch circuit is that selected noise is amplified to bias the audio circuit to cut-off, reducing the possibility of anything but the desired radio frequency carrier opening the squelch and making the audio circuit operative. Such an arrangement greatly reduces the possibility of false operation of the selective signalling equipment by noise.

*Selective Signaling.* Unique with the Western Electric equipment is the D-175279 Selector, incorporated as an integral part of the receiver. This selector and its associated filters and relays provide full selective signalling with 2030 combinations available. Each radio channel will serve a number of mobile stations. The "fully loaded" circuit condition will be determined by such factors as calls per station, holding time per call, and the grade of service for which the system or particular channel is designed. Each mobile station will be assigned a five digit number, prefixed by a channel designation of two letters. Because the number 1 will be used as the selector "return to normal" pulse, the station number will never include the digit one. The selector is designed so that the total of the five digits must always add up to 23. An example of a mobile station number would be WJ3-4727, WJ being the channel designation, and 34727 the mobile radiotelephone station number.

The mobile telephone traffic operator will dial the digits for the called station.

In doing so, she causes the control terminal equipment to modulate the land transmitter with a series of pulses of 600 and 1500 cycles. These pulses, received and amplified at the mobile stations, cause all selector sets assigned to the same channel to be actuated. Stop pins in the code wheel of the selector in the receiver called will cause only that selector to be positioned to ring a bell and light a call lamp in the vehicle. All other selectors will fail to reach the final or signaling position.

*Control Unit.* The only part of the mobile radio equipment visible to the vehicle operator is the 41A Control Unit. This is normally mounted under the instrument panel of the vehicle, convenient to the driver. On the left of the control unit panel is a lamp to indicate an incoming call. The lamp lights along with the ringing of a bell when the subscriber is called. However, the bell stops ringing after a short interval but the lamp remains lighted until the subscriber acknowledges the call by removing the handset from its cradle. By having the lamp signal lock in, the sub-

scriber is notified that he has been called while he was not within hearing range of the audible signal.

Centered on the front panel of the 41A unit is the main power ON-OFF switch. With the switch in the ON position, the receiver is in operating condition, ready to receive a call and the transmitter is in a standby condition. The transmitter is ready to operate when the handset is removed from the cradle, and operates when the "push to talk" button in the handset handle is depressed.

To the right of the switch is a lamp to indicate power ON. The lighted lamp will serve as a reminder to the driver to switch off the power when the vehicle is put in the garage for the night.

The total weight of the control unit is under 8 pounds, including the handset. It is about 6" high, 4" wide and 13" deep. A retractile handset cord is used to prevent any fouling or tangling that might occur with a regular handset cord.

### Bell Signals Incoming Calls

The bell is mounted inside the control unit; also internal to the control unit are contacts which operate the various control circuits when the handset is removed. Provision is made for optional wiring to connect an auxiliary horn or loud ringing bell into the circuit, so that an incoming call signal can be heard at a distance from the car, as might be wanted by a lineman on a pole with the car nearby.

*Land Station Equipment.* The transmitting equipments at the land station are coded 540A and 541A for the two different frequency bands. The 540A will be used with the 238 Type receivers. This has an output power of 250 watts. It is capable of being remotely monitored and controlled to facilitate maintenance by the telephone plant people. Ordinarily one 250 watt transmitter per channel will be required.

Land receivers, coded 40A and 41A and used with the 540A and 541A Type transmitters, are located at strategic locations, to best receive signals from the mobile transmitters. The number of receivers necessary in a particular area is dependent on coverage expected and on the topography of the countryside. The receivers are arranged to operate a relay when a usable signal is received. When the relay is operated the switchboard lamp at the mobile service operator's position is lighted to indicate an incoming call.

Also associated with an urban system is a test transmitting equipment coded 542A Radio Transmitting Equipment. It is used for routine testing of the land receivers, is low powered and is on the same frequency as the mobile transmitters.

Control terminal equipment of the G Type provides connection of the radiotelephone equipment with the wire line plant. The selective signaling oscillator is part of the G terminal; facilities are also provided at the terminal for continuous monitoring of the channel. Alarms and signals are provided for "off frequency" indication and other trouble indications that might cause service interruptions. Jack strips are provided for testing and patching, and a Vogad (voice operated gain adjusting device) is incorporated in the transmitting circuit to keep the transmitter modulation at a predetermined value.

Many articles and stories have already been published on the variety of uses to which mobile service might apply. However, the usefulness of mobile service does not end with the connection to the general telephone system. Calls can be made from vehicle to vehicle.

The 238 Type equipment may also be used in private systems provided by the telephone companies to customers such as trucking companies, taxicab companies and others who have sufficient need to justify the full use of a channel. The telephone companies have made proposals for such private systems in a number of cases where the proposed use warrants a channel being assigned by the FCC.

### Early Development

Mobile Radio is not new. The Western Electric Company pioneered in mobile radio, and as early as 1930 equipped the Detroit, Michigan, Police department with a system for operation on the original low frequency police band.

In the Forestry Service over \$100,000,000 worth of property has been saved by the prompt use of mobile radio. Municipal Fire Departments have come to depend on it, and, in the Public Utility field the mobile radio car is sent to repair service interruptions due to accident or the elements.

The superior operation offered by FM communication in the emergency services prior to the war and the successful operation of FM communications equipment in the armed services during the war created such an increased demand for channels in the emergency service bands that the Federal Communications Commission predicts that by July, 1947, over 11,000 two-way mobile installations will be in use in buses, trucks, ambulances and taxicabs for urban and highway service and by that same date 3,300 installations will be in operation by the railroads. This does not include fixed and mobile applications for new stations and additions to existing systems, applications for which are being received by the FCC at two to three times the prewar rate.



*"Wrong number, Operator. I seem to be talking  
with some automobile in St. Louis."*

Permission The New Yorker  
© The F-R Publishing Corp.

## Stereophonic Sound

(Continued from page 11)

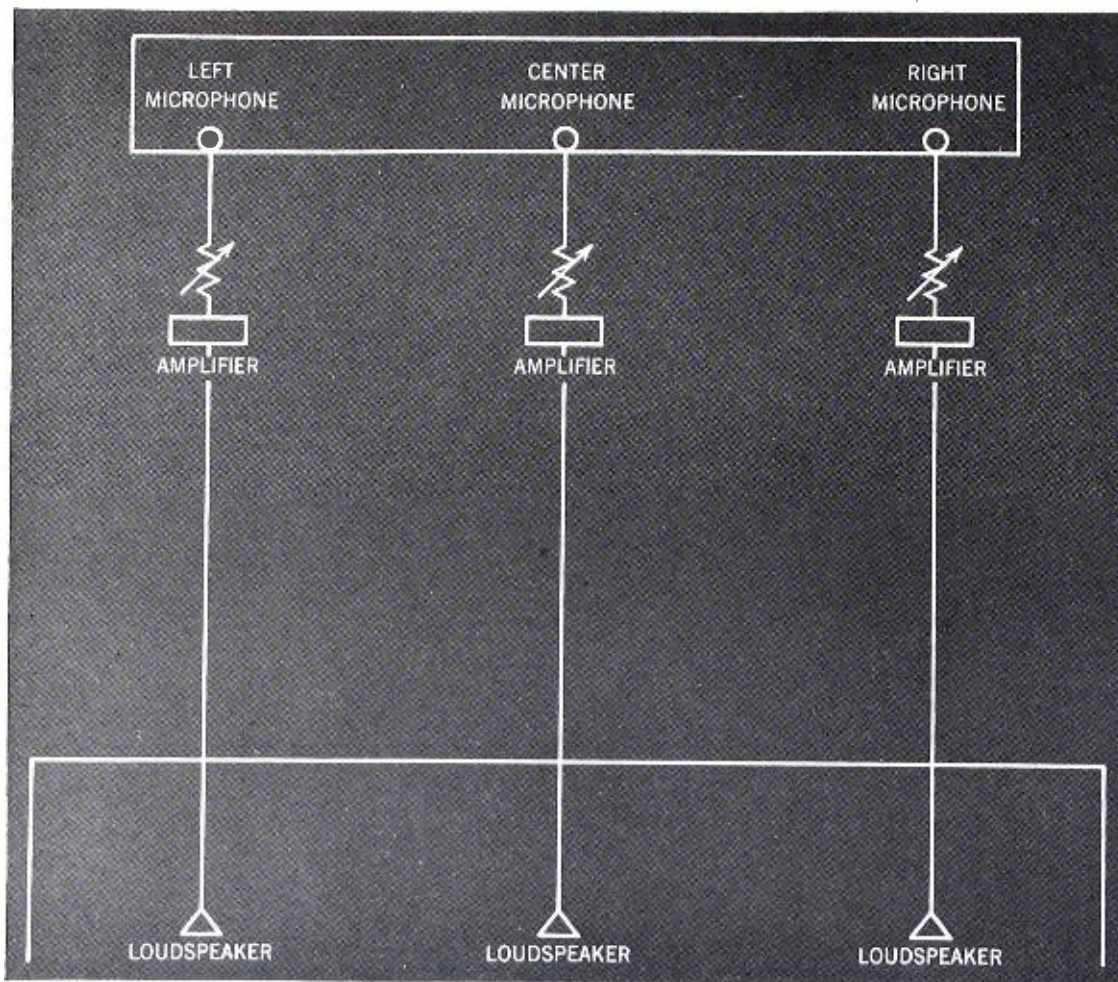

Figure 1 — Diagram of a three channel stereophonic sound system which adds greatly to the naturalness of reinforced sound. As the sound source moves about the stage, the reinforced sound appears to follow.

## Cavity Magnetrons

(Continued from page 10)

where they will be speeded up and catch up with the electrons in front. Thus, the electrons collect in bunches and form, in effect, a pinwheel, as indicated in Figure 1 on page 10, the spokes of which are concentrations of electrons which rotate around the central cavity at an enormous rate of speed. As these electron spokes revolve past the mouth of a cavity, they will induce a surge of current around the walls of the cavity. The tube is so designed that the phase relationships between the electron spokes and the cavities are such that there is a maximum transfer of energy to the cavities.

Since the cavities are inter-connected by lines of force and resonate at the same frequency, it is only necessary to insert a single loop of copper wire into one of the cavities in order to carry off the high powered pulses developed by the magnetron. This output loop is shown in Figure 1.

All the earlier forms of multi-cavity magnetrons, such as the 700 series, were fixed frequency devices, but more recently an external means of tuning over a moderate range was devised and applied to practical design.

The Western Electric 4J42 magnetrons,

which replaced the 700 series and covered the same frequency range, incorporated this tuning feature. In the photograph of the 4J42 magnetron on page 7, the tuning knob can be seen at the top of the tube.

Considerable speculation is already underway as to the possible future uses of the cavity magnetron — some are sound and others verge on the border of fantasy. To date, however, some practical tests have been made, one of which is mentioned elsewhere in this issue regarding the use of radar equipment for guiding a Great Lakes steamer through dense fog. Another is the plan of a New Zealand whaling station to use radar to locate and chase whales at night during the short three month whaling season. Other practical uses are in the planning stage in laboratories here and abroad or will be brought forth by future needs.

One thing is certain, however, like de Forest's "audion" which, some three decades ago, opened up an entirely new field for the scientists to ponder, so the cavity magnetron, with its ability to produce thousands of watts of pulsed microwave energy, has carried us to a new stage in the art with many unknown horizons. Along the road to these horizons much will be uncovered by continued research that will benefit mankind.

speakers helps, but does not eliminate, this condition.

When a single channel sound system is used for reinforcement, as in public address work, naturalness is obtained only when the sound source is relatively small, such as one person or a very small orchestra, and the loudspeaker is located in the line of sight of the observer and the sound source. When action takes place over a large stage, it is impossible to secure naturalness since the sense of direction obtained visually and that obtained acoustically are almost constantly at variance. Suppose, instead of a single channel system, three identical channels as shown in Figure 1 are used.

If a sound source were to move from stage left to stage right in a direction parallel to the footlights, the reproduction as heard from the speakers would also appear to have the same sidewise position as the source. This is because the sidewise position of the sound image is almost completely dependent upon the ratio of the intensity of the direct sound falling on each of the microphones. If the sound source moves from upstage (front) to downstage (rear), the reproduced sound will appear to follow to an extent dependent upon the acoustic characteristics of the stage. This is because the apparent position of the sound downstage from the microphones is determined principally by the ratio of the intensity of reverberant sound to the intensity of the direct sound at the microphone nearest the source. One of the factors determining this ratio is the acoustic absorption of the stage or its time of reverberation, and this ratio will increase with an increase in the "liveness" of the enclosure.\*

If the apparent position of the source were carefully plotted as the source moved across the stage, it would be observed that the path was not a straight line, but a curved line between the microphones. A sound source placed half way between two microphones would appear to have the same sidewise position as the source but to be farther downstage. This is true since — although the direct sound intensity fall-

$$* \frac{E_R}{E_D} = \frac{4 D^2 \Omega [1 - \exp(CS \ln(1-a)) t / 4 V] (1-a)}{a S}$$

where  $E_R$  = energy density at microphone due to reflected sound

$E_D$  = energy density at microphone due to direct sound

$D$  = distance of microphone from sound source

$\Omega$  = solid response angle of microphone

$C$  = velocity of sound

$S$  = area of absorbing material

$a$  = absorption coefficient

$V$  = volume of enclosure

$t$  = time



ing on both microphones is the same — the ratio of the reverberant to the direct energy on each microphone is greater than when the source is closer to one of the microphones. On a two channel system, this effect is quite pronounced.

It is obvious that to obtain a true acoustic reproduction, a large number of channels would be required, located in both horizontal and vertical planes, to give the sound a three dimensional effect. Since in most cases the audience is located some distance from the stage, the three channel system described above gives excellent acoustic perspective.

The physical location of the center loudspeaker is often a difficult problem, and a modified three channel system shown schematically in Figure 2 has been found to give comparable results, except for a slight decrease in the apparent stage depth. In this system, the bridging circuits from the center to the side channels must allow speech current only in the directions shown by the arrows. The final balance of the three channels can be made acoustically from the sound source on stage.

The photograph at the beginning of this article shows the stage setting for the production "Naughty Marietta" at the Pitt Stadium. The stage is placed parallel to, and on one side of, the long axis of the elliptical bowl. Four sections of seats — plus box and terrace seats—holding a total of 8,000 persons are covered. The stage width between the proscenium columns is 75 feet, but there is action with sound as far as the entrance doors on either side of the proscenium, a width of about 90 feet. The active depth of the stage is about 35 feet.

The modified three channel system described above is used. Two Western Electric 639 Cardioid Microphones are located in each position circled in the photograph both to have an emergency microphone at each position and to give a more uniform pick-up level across the stage. On this stage, tests indicated no difference in the apparent sidewise location, whether single or double microphones were in use at each location. Western Electric 117 Type Primary Amplifier and 118 Type Power Amplifier were used. Spare channels with switching facilities are provided. The loudspeakers were the two way type using Western Electric 31A Horn with 713 Type Receivers for the high frequency unit and PLM-18 Type Speakers for the low frequency units. The speakers were located directly above the doors on top of the set as shown in the photograph. Tests indicated that a slightly more desirable position for the speakers would have been several feet lower and at the edge of the proscenium, but this would not have blended into

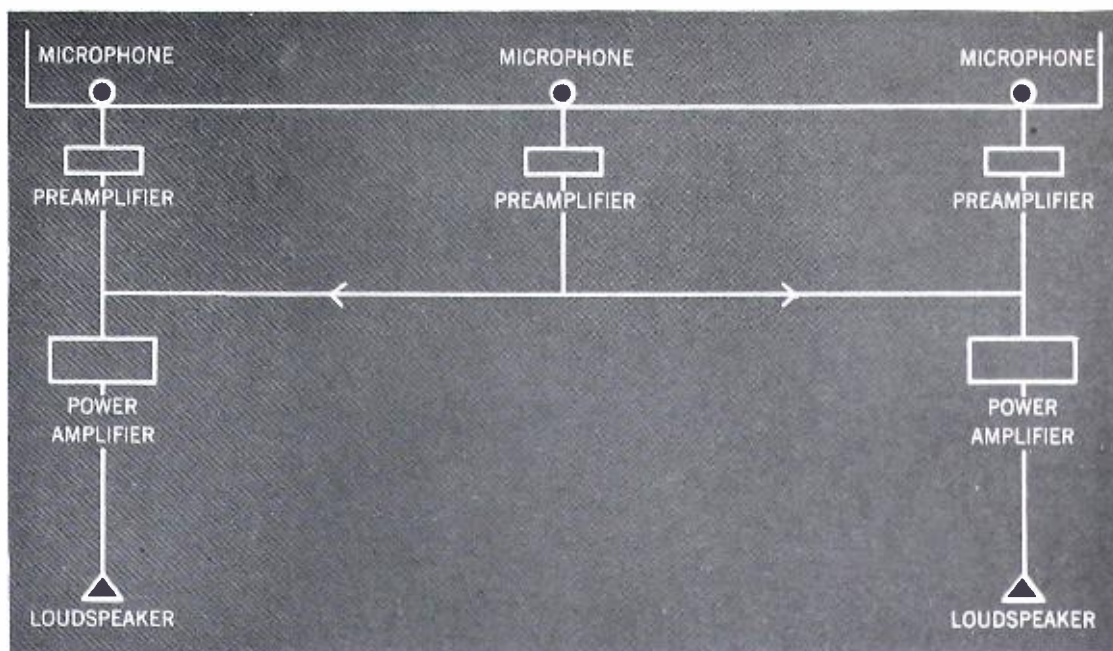

Figure 2 — This modified three channel system uses only two loudspeakers, eliminates the problem of mounting a speaker above center stage. Speech currents must move only in directions shown by the arrows.

the architectural effect, which was already completed. The area covered by the loudspeakers was greater than that giving good line of sight.

Although the bowl is of concrete construction, no serious difficulties were encountered due to sound reverberations even without an audience. With the audience present, the acoustics were excellent. The stage sets were made as sound reflective as possible to offset the lack of complete side walls and ceiling. Adequate gain above feedback "sing" was available at all times. At no time did the stage action come closer than six feet to the microphones. Offstage and downstage lines were heard with ease and with excellent localization. Undoubtedly, the best compliment that can be paid the system is that the audience was entirely oblivious of its existence.

## Limiting Amplifiers

(Continued from page 27)

in modulation levels if various types of program material, including some with substantial high frequency energy, are to be transmitted at uniform loudness. This is true whether a peak limiter is incorporated in the system or not.

3. The problem of maintaining high average modulation without observable distortion on peaks is more acute in present FM systems because of the wider frequency and volume ranges transmitted and the generally higher performance standards expected. The use of preemphasis, however, appears to contribute materially toward the complication of this basic problem.
4. As for a limiting amplifier, it ap-

pears that its use to permit a substantial increase in average modulation as is done in amplitude systems is not warranted, as such use involves a sacrifice of realism in reproduction which cannot be tolerated in any really high quality system, much less in one using preemphasis. However, as a "safety valve" to minimize the possibility of overmodulation, its value is beyond question.

Consequently, it is recommended that a peak limiter having a stable point at which limiting occurs, adequate frequency response, low harmonic distortion and low output noise level and incorporating a visual indicator of compression be used, provided it is installed in the system beyond the preemphasis network (see Figure 1). The system should be so aligned that the indicated compression is of very infrequent occurrence. Further, at least initially, observations should be made with representative radio receivers and, if any audible signs of overload due to over-swing are observed, additional operating margin should be allowed by reducing the level at the radio transmitter input.

This discussion has been predicated upon distortion which largely occurs in the radio frequency portion of a receiver which may not have been observable in the past because of limitations imposed by audio frequency amplifiers and restricted range loudspeakers. With the use of higher quality amplifiers and loudspeakers which are essential for full realization of the inherent high quality of frequency modulation broadcasting it becomes of paramount importance to avoid distortion caused by over-swing of frequency modulated carriers beyond the capabilities of the receiver.

## Book Reviews

**PRINCIPLES OF RADIO.** By Keith Henney. 534 pp. 5th Edition. New York: John Wiley and Sons, Inc. \$3.50.

In its new and revised edition, this standard work by Keith Henney will prove of interest to the radio engineer as a remarkably clear text on the fundamentals of radio. Its range is wide, and it covers the subject from the most elementary electronic principles to study of ultra high frequency phenomena. Much new material has been added, principally on wave guides, velocity modulation tubes, frequency modulation, and new data may be found on the use of Kirchhoff's laws, on power factor, filter circuits, differentiating and integrating circuits, pulses, transients, square waves, voltage and current regulator tubes, filter design for power supply, tuning indicators, horn radiators, quarter- and half-wave transmission lines, magnetrons, voltmeters and cathode ray oscillographs.

**SOUL OF AMBER.** By Alfred M. Still. 274 pp.

**SOUL OF LODESTONE.** By Alfred M. Still. 233 pp. New York: Murray Hill Books. \$2.50 each.

These companion volumes by Alfred M. Still treat of "the background of electrical science" and "the background of magnetical science" in a highly original manner.

*Soul of Amber* outlines the story of electricity from ancient times through the middle ages to the maturity of electrical science from three aspects. First, it tells of the progress of discovery in the science of electricity. Secondly, it tells something of the lives and personalities of the men who contributed to that progress. And finally, it describes something of the long and changing history of scientific thinking itself.

*Soul of Lodestone* tells the story of magnetism using the same three points of reference. Both books are characterized by a wealth of references and copious quotations.

**ELECTRIC CIRCUITS AND MACHINES.** By Eugene Lister. 358 pp. New York: McGraw-Hill Book Co. \$3.50.

In this introduction to practical electricity, electric circuits and machinery have been made easily understandable to the reader. The emphasis has been placed on the physical action that occurs rather than on a detailed analysis of theory. The work is divided into 17 sections from Fundamental Units, Direct Current Circuits, Primary and Secondary Batteries and Magnetism to Electrical Instruments and Measurements and Electronic Tubes.

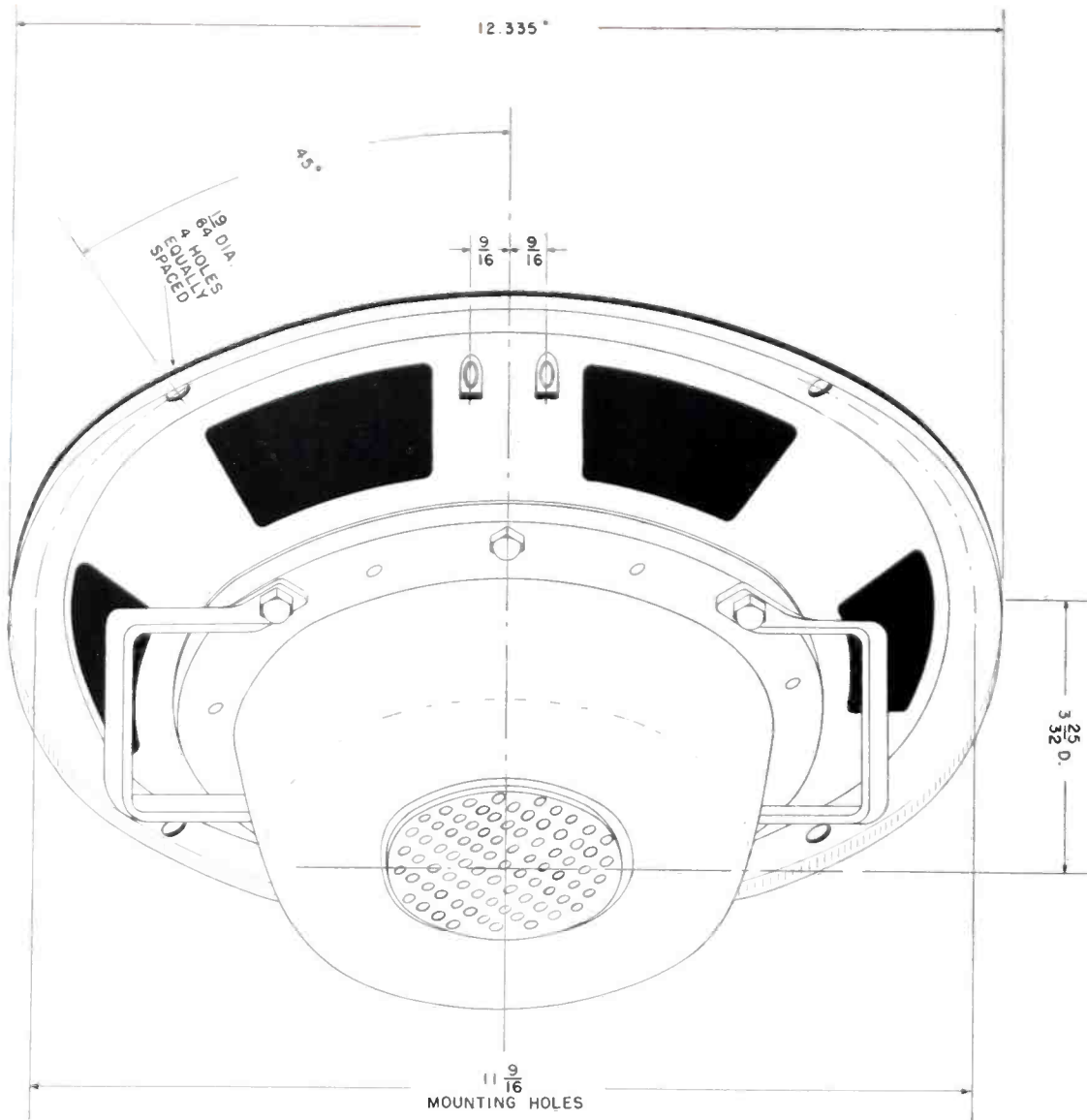

Dimension drawing of the new 728B Loudspeaker. Where space is at a premium — in radio cabinets, portable speaker cases, railroad cars and planes — its depth of less than 4 inches is a decided advantage.

### A Loudspeaker Is Born

(Continued from page 35)

and other "hard-to-fit" spots, the 728B is the answer to a designer's prayer. To quote one manufacturer at a recent demonstration "It is more speaker — in a smaller package — for less money — than any other speaker yet designed."

Farnsworth, long famous as the maker of the Capehart, "the world's finest instrument for musical reproduction" has chosen the Western Electric 728B for the most expensive models in the Capehart 1946 line of phonograph-radio combinations — a glowing tribute to the performance of this remarkable new speaker.

### Marine Radar

(Continued from page 29)

and 11,400,000 tons of grains. Soo Canal traffic alone was almost five times the traffic of the Panama Canal.

It thus seems logical that millions of dollars worth of delays will be eliminated and safety greatly promoted when radar takes over its duties as the "eyes" of this vital fleet.

### Radio Frequency Bridge

(Continued from page 37)

plier tubes before performance is seriously affected, but for best results, values specified in Table 1, and in the instruction book should be maintained. The bridge described here is a convenient way of making the initial adjustments and for making periodic routine checks over a period of time to keep the equipment operating at peak efficiency.

Of course, it is important that the usual precautions should be taken when working on the transmitter where any of the circuits have power applied to them, in order to avoid coming in contact with dangerous voltages.

TABLE 1.

Transmitter	Load Impedance Plate of V1	Combined Load Impedance Plates of V2 and V1
442A-1	8000 ohms (V4A)	2000 ohms (V5A)
443A-1	4000 ohms (V4A)	1000 ohms (V5A)
405A-1	10800 ohms (V1C)	2700 ohms (V2C)
405A-2	10800 ohms (V1C)	2700 ohms (V2C)
405B-2	10800 ohms (V1C)	2700 ohms (V2C)
406A-3	9200 ohms (V1C)	2300 ohms (V2C)
407A-1	2800 ohms (V1C)	600 ohms (V2D)
407A-3	2800 ohms (V1C)	600 ohms (V2D)
407A-4	2800 ohms (V1C)	600 ohms (V2D)



JOHN WADDELL



WILL WHITMORE



HOWARD MANGAN



A. R. GONSTEAD

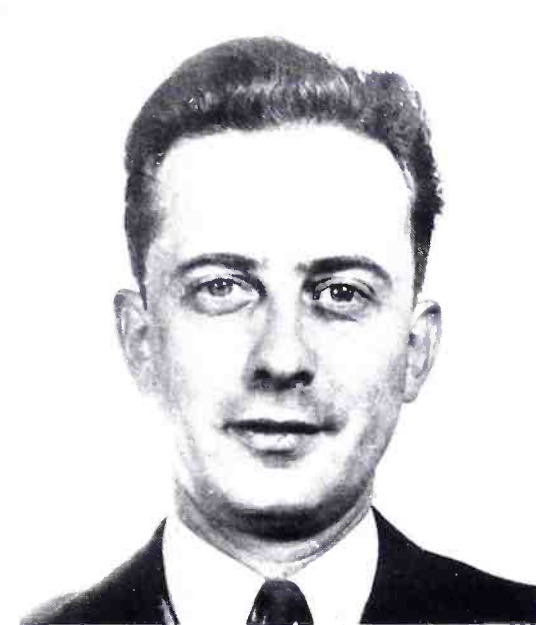

L. H. LIENEMAN



J. K. GOSSLAND

# They Witnessed the Big Explosion

When the atom bomb unleashed its earth-shaking power at Bikini Atoll, five men from Western Electric and one from Bell Telephone Laboratories were carrying out important assignments for the Army and Navy — Will Whitmore, advertising manager of the Company and editor of the *Oscillator*; Howard Mangan, Western Electric field engineer and airborne radar specialist; John Waddell, photographic engineer from Bell Telephone Laboratories; A. R. Gonstead; L. H. Lieneman and J. K. Gossland, Western Electric radar specialists.

Mr. Whitmore was one of a small civilian group responsible for electronic activities under the direction of Captain Christian L. Engleman of the United States Navy. Mr. Mangan served as a technical observer with the Army Air Forces especially for newly developed airborne radar equipment used in spotting targets and in



the synchronizing of the tests. He trained the group which accompanied him to Bikini Atoll.

Mr. Waddell was a technical advisor to the Army Air Forces and supervised the operation of 60 of the famous high-speed Fastax cameras which he helped develop at Bell Laboratories. Mr. Gonstead, Mr. Lieneman and Mr. Gossland were all on special assignment in a civilian capacity under the direction of the Navy.

These men from the Bell System's research and manufacture centers were part of the great group of scientific and technical men from major institutions of the nation — whose skills are proving useful in assessing the power of the great bomb and in interpreting and evaluating its effects for the scientific world. On their skills to a large degree depend the value and usefulness of these tests from a scientific and technological viewpoint.

# Thinking of going into FM BROADCASTING?

Here are the A-B-C's of what you need for a top quality station

**A:** YOU NEED A TRANSMITTER...

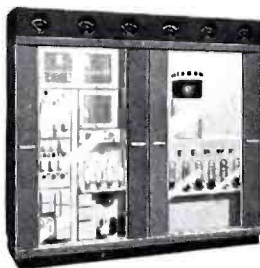

that is easy to keep on frequency. In Western Electric Synchronized FM, the "Frequency Watchman" keeps your transmitter precisely on frequency, constantly, automatically.

**B:** YOU NEED AUDIO FACILITIES...



... that combine highest quality transmission with maximum operating flexibility and convenience. The Western Electric 25B console — which will handle your AM and FM programs simultaneously — is the most recent addition to Western's complete line of studio equipment.

**C:** YOU NEED MICROPHONES.....



... that can handle every type of pick-up. Western Electric offers you the new 640 Double-A for high quality single mike pick-ups or the famous 3-way and 6-way Cardioids and the time tested Salt Shaker.

**D:** YOU NEED AN ANTENNA.....

... that can really cover your service area. That's the high gain Western Electric CLOVER-LEAF antenna which radiates horizontally polarized waves in a circular azimuth pattern.

**Yes** ... you can count on Western Electric for your *complete* FM broadcasting equipment. And you can count on the equipment itself for high quality, trouble-free performance.

It's designed by Bell Telephone Laboratories — world's largest organization devoted exclusively to research and development in all phases of electrical

communications. It's made by Western Electric, manufacturing unit of the Bell System and a producer of the best in broadcast equipment for over 25 years.

Consult your nearest Graybar Broadcast Equipment Representative or write to Graybar Electric Company, 420 Lexington Avenue, New York 17, N.Y.

# Western Electric

**QUALITY COUNTS**

