

The
Indiana
Historical
Radio Society



BULLETIN

Volume 46

July 2017

Number 2



The AWA Journal

Quarterly Bulletin of the Antique Wireless Association



THE OLD TIMER'S BULLETIN

Official Bulletin of the Antique Wireless Association, Inc.

Published for the Antique Wireless Association and ARRL from Washington, D.C.

VOL. 38

AUGUST 1995

NO.



100 Years of Radio



**The
Antique Wireless
Association Review**

The BULLETIN

A PUBLICATION OF THE INDIANA HISTORICAL RADIO SOCIETY.
CELEBRATING FORTY-SIX YEARS OF DOCUMENTING EARLY RADIO

The Indiana Historical Radio Society Bulletin

July 2017

On the cover of this issue of the Bulletin:

The cover is a tribute to the Antique Wireless Association, and the organization's dedication to preserving historically significant wireless and radio through quality publications. Shown on the cover is a display of AWA's Journal, Review, Gateway, and museum. The quarterly publication, The AWA Journal, was titled The Old Timer's Bulletin in the earlier years of publication. Keep that in mind if you look for past issues of the Journal.

It is not an accident the August 1999 Old Timer's Bulletin was selected as part of our July cover of the IHRS Bulletin. It is my bragging rights for my one and only contribution to the quarterly AWA publication. The Marconi Wireless Station, Glace Bay, Nova Scotia, is copied from the face plate of a 1918 book titled Electricity, by W. H. McCormick. The drawing was done by Irene Sutcliffe.

Fred Prohl



In this issue:

If you are not a member of the Antique Wireless Association, perhaps the facing page article will prompt you to join.

Page 6 is a reminder of the next IHRS Vintage Radio Meet, Cool Creek, Carmel. This Summer Meet is unique in that Cool Creek is a popular destination for runners, bikers, and picnicking families. Many enjoy talking about vintage radio.

Ed Dupart talks about his restoration of a Detrola 295-1 portable radio, page 7. The Detrola was his contest entry at the 2017 Spring Meet in Kokomo.

On page 15 Fred Prohl describes the restoration of a small Steinite cathedral, model 24-27.

In his article "Servicing AM/FM Radio", Ed Dupart covers the basics of troubleshooting FM circuits, page 19.

Fred Prohl, Editor

The Antique Wireless Association "Review"

by Fred Prohl

Recently I received my copy of "The Antique Wireless Association Review". This 295 page book is volume 30 – 2017 of radio history, published by the Antique Wireless Association (AWA).

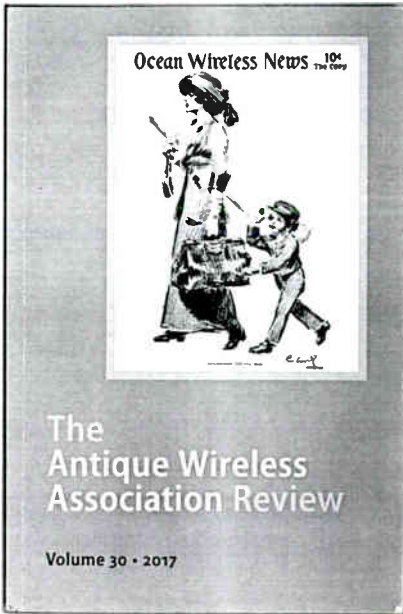

Formed in 1952, the AWA established itself as the premier organization for researching and documenting wireless and radio history. Evidence of this is shown in the publication of the quarterly The AWA Journal; an online periodic The AWA Gateway; and the periodic The AWA Review. The "Journal" is currently in the 57th year of publication, the "Gateway" is a recent online effort, and the "Review" is the 30th book in

AWA's 65 years.

Articles in the "Review" have become an important reference for many AWA members who have a special interest in vintage radio; such as Atwater Kent, Early Radio Development, by Ralph Williams. The Atwater Kent story is found in volumes 1, 2, 3, 10, and 12. Indiana collectors will be interested in Dan Howard's Arvin Metal Cabinet Radios found in volume 28, or The Regency TR-1 Fifty Years Later, by Paul Farmer, volume 17. Topics in this issue of the "Review" include:

- Paradigm Lost: Mikola Tesla's True Wireless, *David Wunsch*
- Zeh Bouck, Radio Adventurer, part 1, *Robert Rydzewski*
- A Soviet Era Broadcast Receiver System of the 1950's For Remote Locations, *Robert Lozier*
- Westinghouse Radio and Television Production, *Mike Molnar*
- The Wireless News, *Bart Lee*
- Henry K. Huppert and His Vacuum Tubes, *Eric Wenaas*
- The Naval Radio School At Harvard: A New Era In Military Training, *David and Julia Bart*
- The Cradle of College Radio: WJL and the Prescient Professors, *Mike Adams*

The AWA Review—continued

Over the years the AWA has been very supportive of the Indiana Historical Radio Society. In 1971 and several years to follow, officers of the AWA attended IHRS meetings in Lafayette, Auburn, and Kokomo to assist the development and promotion of the new organization in Indiana. That relationship continues as the AWA provides "This is the Indiana Historical Radio Society" space in each issue of the "Journal".

AWA operates the Antique Wireless Museum in Bloomfield, New York. The museum is dedicated to preserving and sharing the history of technology used to communicate and entertain from the first telegram to today's wireless text messaging.

Membership in the Antique Wireless Association is \$35.00 per year. Dues are sent to AWA Membership, P.O. Box 421, Bloomfield, NY 14469-0421.

56th AWA WORLD CONVENTION

AUGUST 15-19, 2017

At the Rochester Institute of Technology Inn and Conference Center
5257 West Henrietta Road, West Henrietta, NY 14586

This year there are dual convention themes:

Military Communications and Transistors

Renew your Indiana Historical Radio Society membership now!

If the date on your mailing envelope for this issue of the Indiana Historical Radio Society Bulletin is 12/16 or earlier, it is time to renew your membership. Make your check payable to the *Indiana Historical Radio Society* in the amount of \$15.00 per year and send to: **Don Yost, IHRS, 3814 E 400 N, Windfall, IN 46076**. Include your current mailing address, if not on your check, and your email address, if you have one.

- 2017 Regional Vintage Radio -

Indiana Historical Radio Society (IHRS)

August 12— Summer Meet, Cool Creek Park, Carmel

October 14— Fall Foliage Meet Greenfield Riley Park

indianahistoricalradio.org

Mid-South Antique Radio Club (MSARC)

Meet information contact: layvinrad@twc.com

Antique Radio Club of Illinois (ARCI)

www.antique-radios.org

August 4— August 6 RADIOFEST

Medinah Shriners, 550 Shriners Drive, Addison, IL

Michigan Antique Radio Club (MARC)

www.michiganantiqueradio.org

Cincinnati Antique Radio Society (CARS)

Info. at oltubes@roadrunner.com or Bob Sands 513-858-1755

Dayton Antique Radio Club (SPARK)

Contact - Ed App 937-865-0982

Central Ohio Antique Radio Association (COARA)

Info. at <http://coara.org> for event schedule.

Pittsburg Antique Radio Society (PARS)

information at pittantiqueradios.org

AWA-Antique Wireless Association

August 15— August 21 2017 Annual Convention

RIT Inn & Conference Center, Henrietta, NY

www.antiquewireless.org

Saturday, August 12 - the Indiana Historical Radio Society will meet at Cool Creek Park, 2000 East 151st Street, Carmel, Indiana for a 2017 Summer Meet

There is space for indoor and outdoor Swap N Sell setup. Tables are available indoors. General admission is free. Swap N Sell set-up in the building and parking lot is \$10 for IHRS members, \$15 for non-members.

Cool Creek Park, Carmel, is located east of US31 and north of 151st Street. From US31 go east on 151st Street to a round-about. The Cool Creek Park entrance is the street north out of the round-about.

Complimentary doughnuts and Danish, coffee and soda will be provided.

Schedule of activity:

- 7:00 AM—Swap n Sell of Vintage Radio setup.
- 8:00 AM the IHRS Summer meet begins. Popular Vote Contest set-up.
- 10:00 AM Vote for your favorite radio in each of the contest categories.
- 10:15 AM contest results and announcements.

**The 2017 Summer Meet
Popular Vote
Contest categories:**

category 1 – 1930's Table Radio
category 2 – Open to all radio and radio related equipment

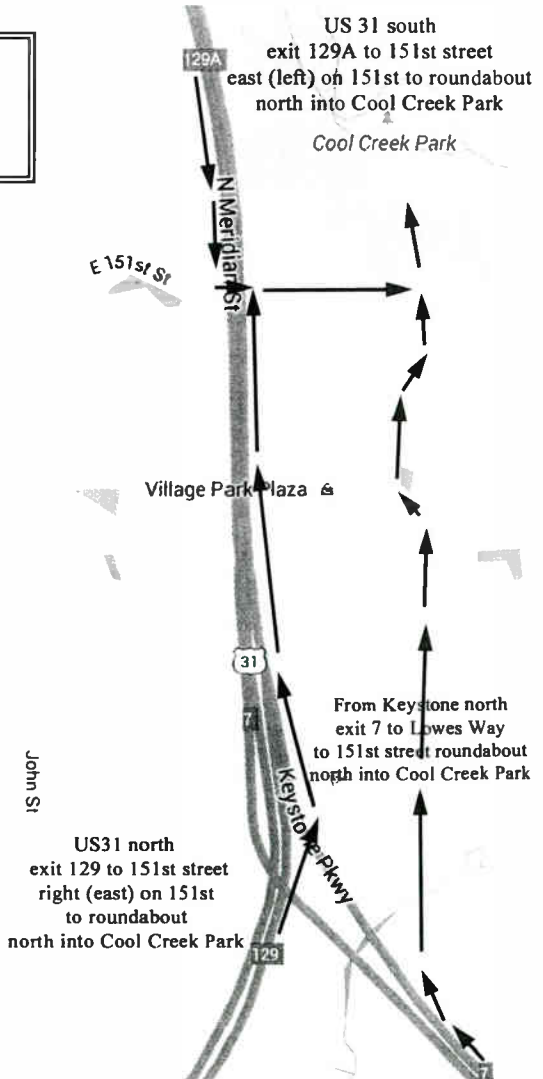

Detrola 295-1 By Edward Dupart

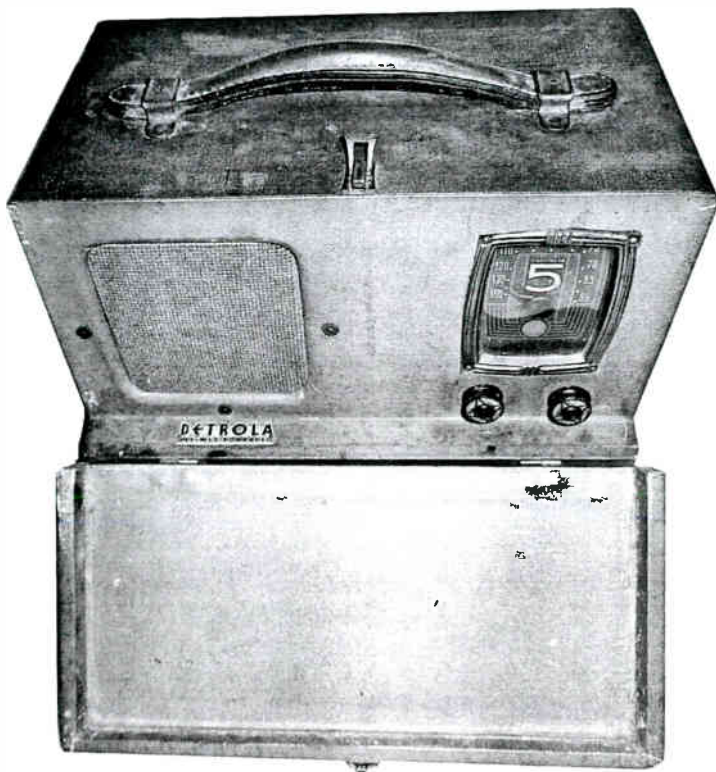

A friend of mine who knows I like Detrola radios gave me this 1940 Detrola 295-1 and he knows I have a soft spot for battery radios. The case was in excellent shape, but had a brown dingy look to it and I didn't know for sure if that was the original color or cigarette stained. The case is the typical cloth covered wood cabinet popular with portable radios of that time period. I finally got around to restoring it for an upcoming radio show that is having a contest for AC/DC battery radios.

Upon opening it up I found it to be very clean with zero corrosion. I took it apart and took a paintbrush to it and vacuumed it. It has an aluminum chassis and looked very nice and shiny. All the tubes were original and checked good. Looking at the bottom of the chassis told me it had never been serviced before and the curtain burner cord was like new, so this radio had been stored in a dry area for years. I'm guessing, but I think the people bought the radio or it was given to them and they decided they didn't like and put it in a cor-

ner and that's where it stayed. The brown I determined was from cigarettes so they were heavy smokers. Other than that this radio was in amazingly good shape.

bow grease, the cabinet came clean and what a difference! I removed the bezel and that usually tells what the original finish looked liked and sure enough, the finish



My next step was to replace all the capacitors and they were the blue Solar types that just about always go bad, so I replaced every single last one of them. Even the electrolytics were made by Solar. After that I cleaned and lubricated the tuning capacitor and the volume control. I plugged it in and it worked and with a little tweaking of the IF alignment it was working great. So, electrically it is done.

See page 13 of this Bulletin for a picture of the Detrola as a contest entry.

Cleaning the cabinet was a job in itself and 409 wouldn't cut the cigarette stain by itself so I used a soapy steel wool pad with the 409 and that worked. With a lot of el-



Before cleaning

"I used a soapy steel wool pad with the 409 and that worked. With a lot of elbow grease"

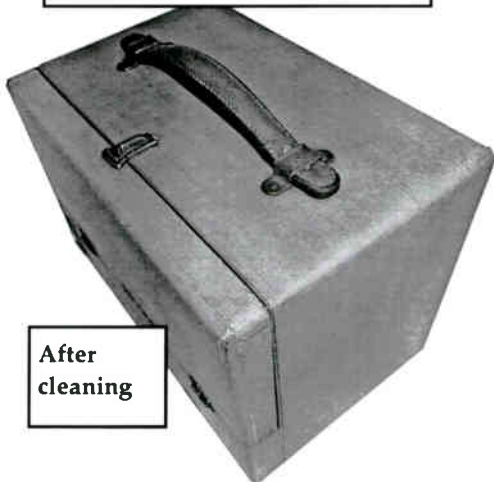

After cleaning

under the bezel matches the cleaned up cabinet. If someone has a better way to clean up cloth covered cabinets let me/us know.

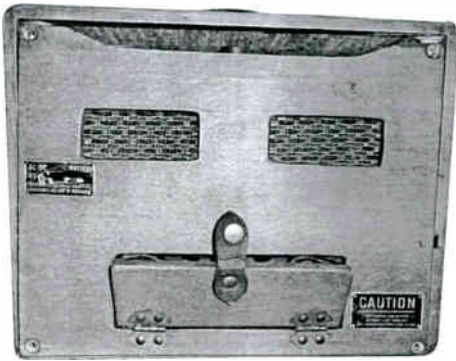

I put it all back together and it oscillated on the low end of the dial but worked fine out of the cabinet. What was happening was the IF lead to the IF tube was providing feedback through the loop antenna that is wound around the cloth covered wood cabinet. If I held the IF lead and touched ground at the same time the oscillation would stop. So that meant

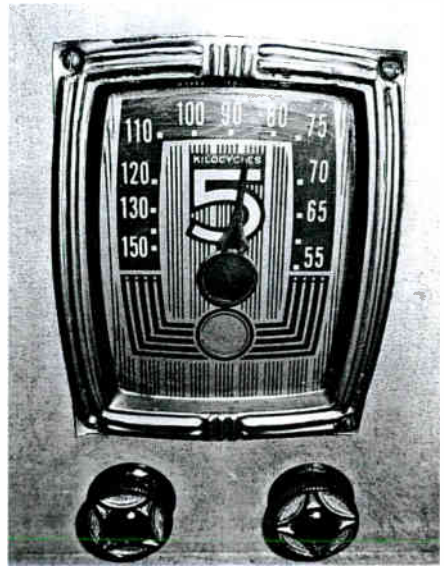

the IF lead to the IF tube needed to be shielded, so I took some #26 solid, insulated wire and wrapped it around the IF lead and grounded it and that took care of the problem. Now, it is a good functioning radio.

By Edward Dupart, April 30, 2017

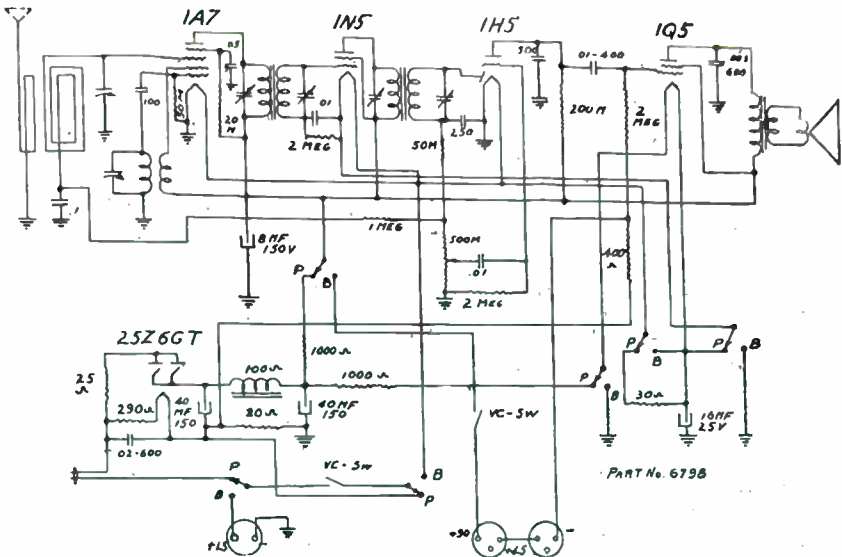

2017 IHRS Spring Meet – Kokomo

Ed Dupart leads a discussion on "Checking Out A New Old Radio".

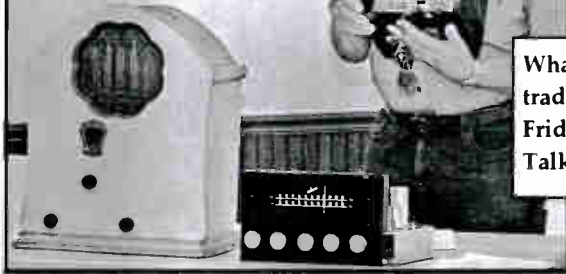

What is now becoming a tradition – the Spring Meet Friday evening "Tech Talk" with Ed Dupart.

Many thanks to the Yost's for providing the barbeque and makings for the IHRS Spring Meet!



Indiana Historical Radio Society "Plank Holders" Ed Taylor and Don Johnston. Ed and Don were part of the original 13 who organized the IHRS in 1971.

Old Equipment Contest, Kokomo, May, 2017

Contest pictures taken by Ed Dupart

WWII Military Electronics:



William Smith was awarded 1st place for his YE-2B Homing System



Tom Williams won 2nd place with his Signal Corp BC348



Tom Adelsperger entered a Crosley REP (left) and a Hallicrafters Sky Traveler, S-29 (right)

Old Equipment Contest, Kokomo, May, 2017

Contest pictures taken by Ed Dupart

Open to all Radio:



This 1938, model 240H Stromberg Carlson, submitted by Michael Feldt, was awarded second place in the open category.



Bob Sands won first place and "Best Of Show" with his show of a 1938 Coronado radio with documentation and original shipping box.



Three Way Radios:

Robert Pote received first place in the "Three Way Radio" contest category. He describes his process of recovering the Zenith, 6G501 in the binder.



To the right is Ed Dupart's Detrola model 295-1. See Ed's accompanying article on page 7 in this Bulletin.

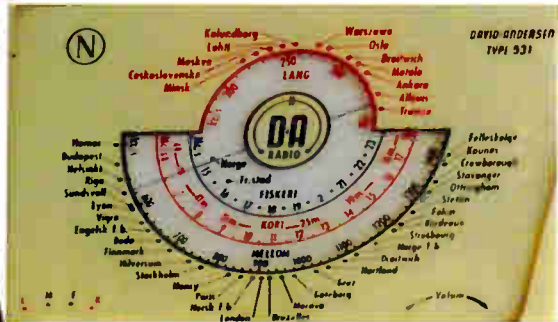
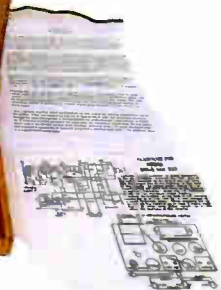

This unusual David-Anderson Three Way Radio was entered by Bill Morris.

Old Equipment Contest, Kokomo, May, 2017

Contest pictures taken by Ed Dupart



In the Three Way Radio category Fred Prohl entered this Arvin portable.

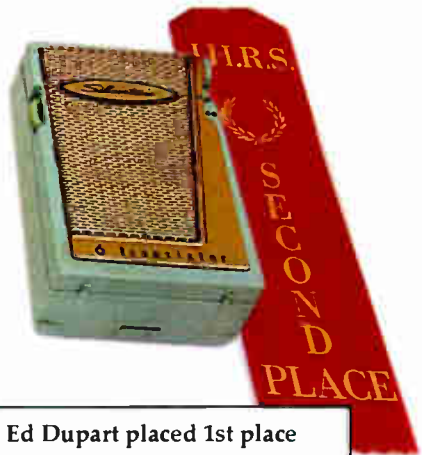
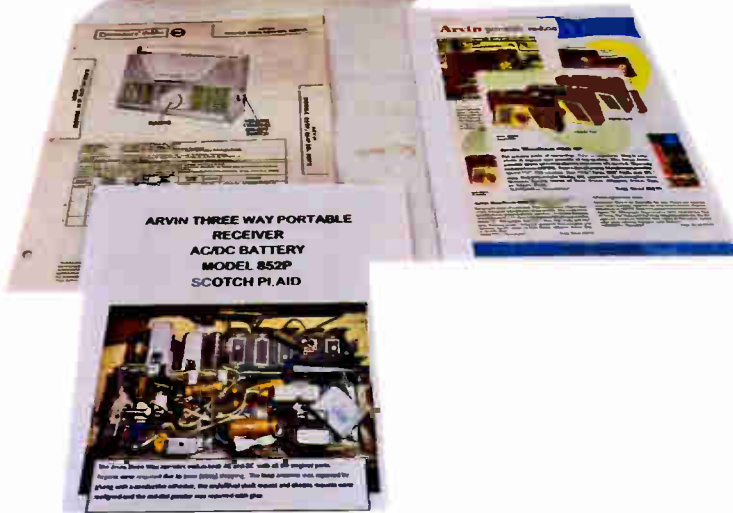

In the Indiana Made category, Ed Dupart placed 1st place with his Regency Jade Transistor radio. 2nd place was awarded to Steve Ewbank for his Silvertone (Arvin) pocket transistor radio.

The Steinite Cathedral, a CRC model 24-27 by Fred Prohl



A couple decades ago, while at an IHRS Meet in Elkart, I purchased this small (roughly 12x9x7 inches) Steinite cathedral. It was in bad shape, painted brown, with a 2"X2" dent in the cabinet, close to the top of the round, left side. The dent was not a hole, but daylight passed through. I've never been able to claim much success with cabinet repair so it was late in the day, the radio not yet sold, the price was sufficiently reduced to convince me I should buy the Steinite and give the repair a try. Besides, it was a Fort Wayne, Indiana radio. Right?

Twenty years passed, the Steinite has been safely stored in a garage attic, and an email from another small Steinite cathedral

owner inquiring about the Steinite was posted on the IHRS website—(indianahistoricalradio.org lists a number of Indiana manufactured radios with pictures). The writer of the email was looking for any information on the radio as well as a schematic. This was sufficient for me to pull the radio from storage and see what I could do with it. We could not find a four tube Steinite in Riders—but did find 4 four tube schematics under CRC, Chicago Radio Company, in Riders. Momentarily overlooked was a small CRC label on the radio's chassis, indicating the radio's manufacturer.

Here is a bit of Steinite history as reported by Alan Douglas in volume 3 of Radio Manufactures of the 1920's: In 1929, the Steinite Company, Atchison, Kansas, opened factories in Auburn and Fort Wayne, Indiana. In addition to the Indiana plants, the company maintained production facilities at Atchison and Chicago.

The removal of the paint was fairly easy with applications of an alcohol/mineral spirits mix and a rough cloth. The dent repair began by applying a damp cloth

The Steinite Cathedral—continued

against the rise of the dent inside the cabinet. The cloth was held in place with a weight , applying pressure against dent. It required several applications of the damp cloth and weight before a noticeable change. Eventually the plywood settled back into the curved shape of the cabinet plywood. Since the damage created splitting as well, several applications of a wood filler were required—sanding between applications. Staining the cabinet body was not a problem. Several applications of stain along with a fine steel wool rub were required to help cover the repair. The Steinite face was a different story. After removing the paint the face was a pale tan—and would not take a stain. After attempting to get a decent color to the face unsuccessfully I asked experienced “finishers of radio cabinets” what was happening? Evidently the face is made of a pressed wood material—giving it a non-porous surface. My solution was to layer stains of two different color tones, giving the cabinet face a wood grain look. The entire cabinet was finished with a spray satin polyurethane.

The tube lineup for this radio is 35, 24, 47 with an 80 rectifier. Following the replacement of filter capacitors, nicely stuffed in the

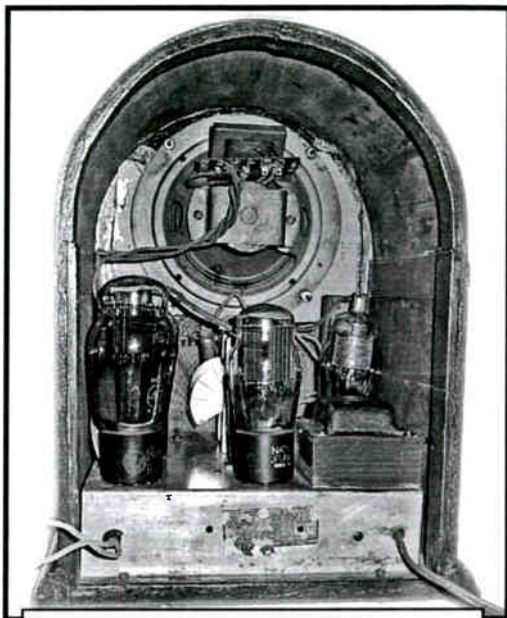

Inside the Steinite model 24-27

After a short period of operation one of the new electrolytic capacitors (nicely stored in the chassis mounted can), failed. The second set of filter caps are now mounted under the chassis.

chassis mounted electrolytic can, the Steinite worked, not well, but it worked. The previous owner had replaced most of the circuit capacitors with what appeared to be pulls from another circuit. I replaced all these capacitors. The most significant improvement on audio volume was the removal of a .02microfarad capacitor that connected the plate of the 47 tube to ground (across the audio transformer primary), effectively coupling the audio to ground. None of the 4 schematics show any ca-

pacitor in this configuration. The audio improved considerably with this capacitor removed, but reception is still poor. Living in the lowlands on the south side of Indianapolis, I consider receiving WLW 700 out of Cincinnati during the day time a successful reception. With the four tube Steinite I may be picking up a whisper of WLW, but only a whisper.

Anyway, with the knowledge there will be more work to do on the Steinite, I've "buttoned it up" with the intent to get back to it another day.

I was tempted to title this article "A Not Quite What It Seems radio"

- When I bought the Steinite I remember thinking "Ah!, a Fort Wayne, Indiana Made radio! Probably not, more than likely it was assembled in Chicago. It wouldn't surprise me to discover the same radio labeled with a different name.
- A close examination of the Steinite's face shows an imbalance in the speaker grill work. Did some one in the recent past do a very good job of creating a new face for the Steinite? (The mating of the face to the cabinet is well done.) Or, was it the first

day on the job for a new employee of CRC, and this was his practice cut?

- While the tube lineup of my Steinite matches the schematic for a CRC model 24-27, there are a number of differences in the actual wiring, particularly the front end.
- There is no guarantee that cheap, new, electrolytic capacitors will have a long life. While listening to the completed radio the audio slowly became garbled with an increase in power supply hum. The new replacement filter capacitors are now easily reached on the underside of the receiver's chassis.

Fred Prohl July, 2017

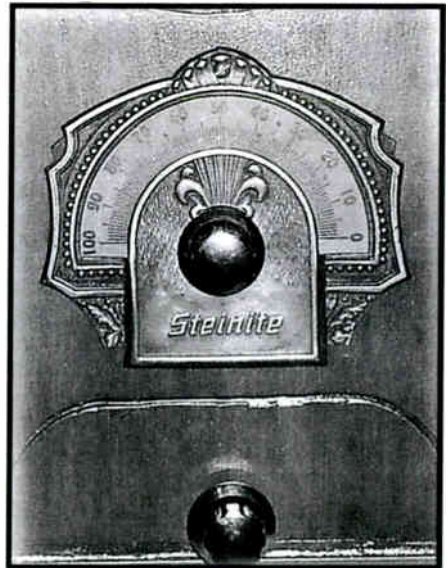

Servicing AM/FM Radios, by Ed Dupart

The popularity of AM/FM radios has increased lately so I was asked to do an article on repairing AM/FM radios. Most articles/discussions have focused on AM and short-wave radios and the AM/FM radios have been pretty much left out. I'm going to stay away from math and one really doesn't need vector analysis to fix an old tube AM/FM. Most readers simply want to know how to fix this stupid thing that doesn't work. Some basic assumptions will be made, one; all the paper capacitors and electrolytic capacitors have been changed or checked, two; all the tubes are good. I will be doing this analysis stage by stage.

Some early AM/FM radios actually had two separate radios with a common audio amplifier that could be on one chassis or two chassis's. This was true of both tube and transistor units but this was not the norm. Generally the FM portion had its own tuner with an optional RF amplifier, 2-4 IF stages with two being the most common and one IF stage shared with the AM section. This cut down on cost. The FM section used either a ratio detector or a Foster-Seeley detector/demodulator that required a limiter stage that re-

duced or eliminated unwanted AM interference. The output from the detector went into a common audio amplifier that would switch between AM and FM. The AM portion had its own separate tuner with an optional RF amplifier that fed into 1-2 stages of IF amplification, with one stage being the most common and shared with the FM section, again to save costs. The AM detector usually consisted of one diode, tube or crystal and that fed into a common audio amplifier. There were a few radios that used a common converter tube, 12BE6/6BE6 comes to mind, for both AM and FM, but I consider that the exception.

A word of caution when working on the FM section: the wiring is short and direct, the tuning coils are wound with heavy wire. Squishing or expanding the tuning coil will change its resonance and will give you headaches in trying to get it back in alignment. Unless you are a pro, don't mess with the tuning coils. Don't move the wiring around unless you really have to and if you do, put it back in its original position. In AM radios the wires can be moved around, coils can be messed with somewhat and the radio will probably still work. Things just aren't that critical

working with AM frequencies but it's a different ball game when working with frequencies well above 50 MHz.

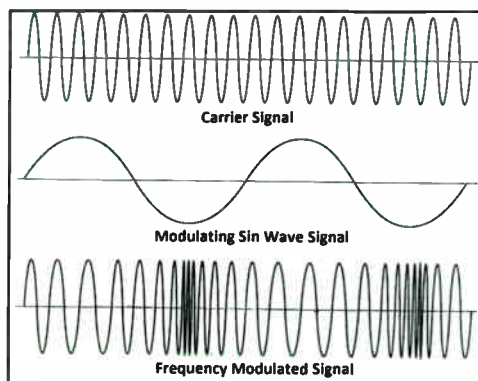

The first stage is the RF stage and is optional. Its function is to improve sensitivity, image rejection, reduce local oscillator radiation and increase selectivity. Sensitivity is the ability to pick up weaker stations. If the RF stage is tunable then it helps reduce image rejection, which is the possibility of picking up the same station twice, but in different spots on the dial. The local oscillator can act as a transmitter and interfere with nearby radios and the RF stage tends to reduce this problem. Selectivity is the ability to reject the interference of stations adjacent to the one you are tuned to. A strong station can bleed into an adjacent weaker station and the RF stage helps to eliminate this problem. Cheap radios may not have an RF stage and some may not be tun-

able. From a technician point of view I like RF stages.

What kinds of problems does a faulty RF stage cause? Usually a loss of sensitivity, not picking up stations or only a strong one or two and the first thing to check are the voltages on the RF tube. A lack of a voltage indicates the possibility of a bad resistor or a shorted screen grid bypass capacitor or other B+ bypass capacitor. If all the voltages and capacitors check out there is the possibility that the alignment may be off if it is a tunable RF stage. If there is a station coming in around 106-107 MHz then adjust the RF trimmer on the tuning capacitor for maximum volume. To determine which section of the tuning capacitor is for the RF stage, trace the wires from the tuning capacitor and one will go to the RF section, one to the mixer section and one to the oscillator section. Mica and ceramic capacitors are very reliable, but I have had them go bad and they can cause weird problems in RF circuits. In the case of RF amplifiers I have had ceramic coupling capacitors open up and so no RF would get to the mixer circuit resulting in weak reception or no reception.

In a FM tuner where there are separate tubes for the mixer and oscillator, the mixer usually doesn't create many problems, but the

usual problem is a weak or no signal. Check for low or missing voltages and like the RF stage, check the resistors and bypass capacitors. For a tuner that has the mixer and oscillator combined in one tube the above problems could still hold true and use the same checks.

The oscillator stage can have some unique problems and is the trickiest stage in the FM section of the radio. If you are experiencing weird problems and you believe it is in the oscillator, try different tubes. I have had new tubes not work at high frequencies and I have had tubes check good that don't work at high frequencies. So make sure tubes are not an issue. One of the problems I have encountered is losing the high end of the band while stations at the low end of the band come in just fine. This is usually due to low voltages on the plate of the oscillator or the tube itself, which is a common problem with the Zenith Transoceanic using the 1L6 converter tube. When the 1L6 starts to get weak the high short wave band goes first then the low short wave band then the upper part of the AM is gone. If the voltages and the tube are good, then make sure the tuning capacitor is clean and there are no plates touching. If the tuning capacitor checks out then it's time to check all the resistors, ceramic and mica ca-

pacitors. Hopefully, one of these suggestions will take care of it.

If the oscillator is not working at all, the FM section will appear to be dead. To check a FM oscillator to see if it is dead, place another functioning FM radio next to the one you are working on. Tune the working radio to a weak station and then tune the non-functioning radio across the dial. If the oscillator section is working it will beat against the weak station and produce a squeal or even block the station out all together. If no interference is detected, then there's a good chance the oscillator is not working. Do all the checks for the weird functioning oscillator listed above.

The next section to look at is the IF section and in most AM/FM's of the 50's-60's they have two IF amplifiers for the FM section and one IF for the AM section and one of the IF stages being common both to the AM section and the FM section. Other than an occasional screen grid resistor or B+ supply resistor opening up or a shorted bypass capacitor, the IF section has rarely given me any real problems, unless it is a Zenith.

Zenith long noted for its quality did have an IF transformer issue in the 50's to 60's. The transformers would cause a cracking, snapping, popping noise due to the mica capacitors that are internal to the transformer breaking down. Usu-

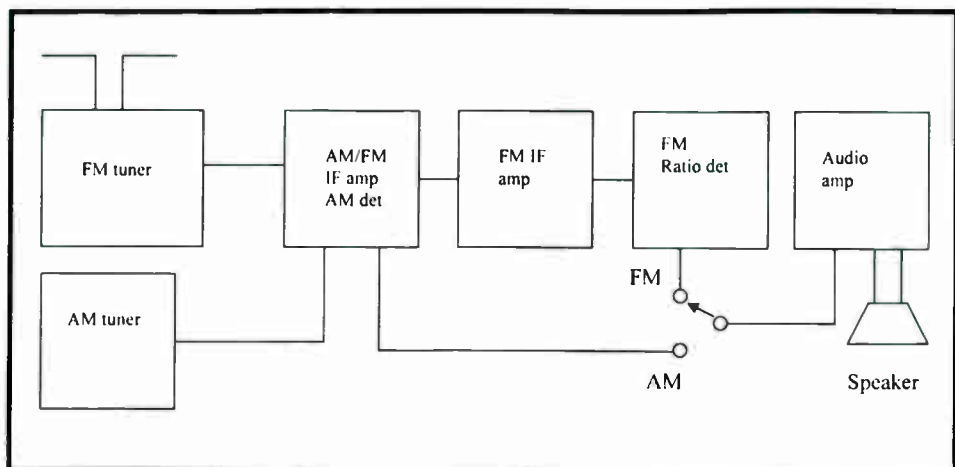

ally people remove the bad mica capacitors and replace them with a ceramic or mica capacitor and then re-align the IF stages. If the radio is not receiving anything, basically dead but you know the audio is working then I definitely won't overlook the IF stage that is common to both the AM and FM bands. An RF generator is an excellent choice for checking the IF stages. The vast majority of radios use 10.7 MHz for the FM band and 455KHz for the AM band. Set the generator at the desired frequency and connect it to the input of the IF stage and if the IF stages are working, just getting near the input will produce an output. If the AM/FM IF stage is dead, check the resistors and bypass capacitors, usually the resistor will open up and the bypass capacitors shorts out. Occasionally, I'll run across an open plate winding on the AM IF transformer, which would render the

entire stage dead. If you are lucky, you might be able to open up the IF transformer and repair the break in the winding and many times it is at the terminal. I generally solder a solid wire to the terminal and solder the broken winding wire to the solid wire. I use the solid wire to extend the length of the terminal. The reason the winding wire usually breaks at the terminal is that the winding wire wasn't long enough to begin with and over time the stress breaks the wire. Again, this is one of the more reliable stages in the radio.

A stage that resembles an IF stage is called a limiter stage and its job is to clip the peaks of the incoming signal and removes all AM modulation, which means this stage eliminates or reduces greatly lightning noise, electric motor interference, bad ignition systems on vehicles and other AM interference. This stage is used with the

Foster-Seeley detector developed by Dudley E. Foster and Stuart William Seeley in 1936, but not with the ratio detector stage. The limiter uses low screen and plate voltages and may have a grid leak composed of a capacitor and resistor that will establish a negative bias on the control grid or it can have a large cathode resistor that will establish a large negative voltage on the control grid. This enables the limiter to go into cutoff and saturation easily which will clip the peaks of the incoming signal. So if you encounter what you think are low voltages in the limiter stage, regard this as normal. Treat this stage like an IF stage when servicing.

The last two stages I will cover are the ratio detector and the Foster-Seeley detector. They convert the changing FM signal into audio. At first glance the circuits look the same, but the Foster-Seeley circuit uses a choke and the ratio detector uses a third winding in the ratio detector transformer and there is an electrolytic capacitor across two resistors. The diodes in the Foster-Seeley circuit appear to be in parallel and in the ratio detector they appear to be in series. The Foster-Seeley detector depends on the limiter to remove unwanted AM interference whereas the ratio detector utilizes an electrolytic to remove unwanted AM interference. The obvious advantage of the

ratio detector is that eliminates the need for a limiter stage and reduces the cost in building the radio, hence its popularity in tube radios. This stage gives very little trouble and about the only things I have had to do to them is change the electrolytic and an occasional bad detector transformer and a tube or two. There is very little current flowing in these detector/demodulator circuits, so there is very little stress on the components.

The audio circuits are usually straightforward so the only real difference is in the switching between AM and FM. The most common problem with the switch is that it is noisy when switching bands and cleaning normally takes care of that problem.

I just covered the very basics and what I would like to see is some of you experienced techs out there contributing your solutions to some problems covered in AM/FM radios that I didn't mention or may not have run across before. So let's hear from you!

Edward Dupart May 14, 2017

Editors note: Ed is considering a followup article on the early FM band and post war FM radio.

Comments and questions regarding Ed's articles can be directed fo inhistradio@gmail.com



2017 Officers

Alex Whitaker President
2927 South East Street
Indianapolis, Indiana 46225
317-787-2854 ehscott@sbcglobal.net

Michael Feldt, Vice President
12035 Somerset Way, East
Carmel, Indiana 46033
(317) 844-0635 email: feldtm@msn.com

Don Yost, Treasurer
3814 E 400 N
Windfall, Indiana 46076
(765) 945-7014
email: dearsir@netscape.com

Editor Fred Prohl
615 Wren Drive
Franklin, IN 46131
(317) 736-1228 email inihistradio@gmail.com

Dr. Ed Taylor, Historian
245 North Oakland Avenue
Indianapolis, Indiana 46201-3360
(317) 638-1641

Responsibilities

Activities, business,
administration, & publicity

Sites and dates of meets

Dues, financial, and address
change. Please notify
immediately of change of address.

News articles, radio ads, photos
for Bulletin publication
Maintain indianahistoricalradio.org

Donations & scrapbook material

Bulletin Deadlines: News, Articles & Radio Ads, 2/15, 5/15, 8/15, 11/15
IHRS Web site address: www.indianahistoricalradio.org

The INDIANA HISTORICAL RADIO SOCIETY is a non-profit organization founded in 1971. Annual membership dues of \$15.00 includes the quarterly IHRS "BULLETIN." Radio-Ads are free to all members. Please include an S.A.S.E. when requesting information. Send applications for membership and renewals to Don Yost, our treasurer as noted above.

The BULLETIN
A publication of the Indiana Historical Radio Society
Forty-six years of documenting early radio.



On display at the 2017 IHRS Spring Meet, Kokomo
On the left is Bob Sands 1948 "Crosby Junior Juke"
(Jukebox, manufactured by the Lindstrom Corp.)
On the right is John Hauger's display of antique phonographs and related memorabilia.