

Call Letter

of the Northwest Vintage Radio Society Portland, Oregon

Vol. 21

April, 1995

No. 4

The Homebrew & Kit Issue

HomeBrew Zapper -page 7

Homebrew History -page 10

Homebrew Fun -page 15

Homebrew & Kit Contest -page 3



More than two decades in print

Northwest Vintage Radio Society

The Northwest Vintage Radio Society is a non-profit historical society incorporated in the State of Oregon. Since 1974 the Society has been dedicated to the preservation and enjoyment of "vintage radio" and wireless equipment.

Membership in the Society is open to all who are actively interested in historic preservation. The dues are \$15.00 for domestic membership, due on January 1st of each year (prorated quarterly).

The Call Letter has been a monthly publication since 1974. It was originated with the founder Bob Bilbie and our first president Harley Perkins. Through several editors and with the assistance of numerous members the Call Letter has continued to be a publication that both informs members of the society's business and that has supported the hobby of collecting, preserving, and restoring vintage radios.

Society meetings are held monthly (except July and August) at the Northwest Vintage Radio Museum, 7675 SW Capitol Highway (at 32nd street) in Portland Oregon. They convene at or about 10 AM for the purpose of displaying radios, conducting Society business, and information exchange. Guests are welcome at all Society meetings and functions (except board meetings)

Other Society functions include guest speakers, auctions, radio shows and radio sales which are advertised in the Call Letter and are held in and around SW Portland.

Society Officers:

President	Greg Bonn	(503) 642-5097
Vice President	Speed Feldschau	(503) 390-3928
Treasurer	Ed Charman	(503) 654-7387
Secretary	Ken Seymour	(503) 642-9115
Board member at large	Ed Pittaway	(503) 645-2883
Call Letter Editor	Dick Karman	(503) 281-6585
Museum Curator	Frank Rasada	(503) 246-3400

The Society's address is:

The Northwest Vintage Radio Society
Post Office Box 82379
Portland, Oregon 97282-0379

April 1995

Table of Contents

Meeting Minutes	2
March Contest Report	3
April HOMEBREW contest	3
May Show and Sale	4
Atmospherica	6
In the Shack	7
HOMEBREW Story	10
Acquisition	11
SWAP SHOP	12
EMR Research Report	15
Calendar	16

The CALL LETTER

Editor, Dick Karman, (503) 281-6585

Word Processing, Binding, and Distribution,
Gordon Phillips (503) 234-3517

Is your newsletter getting
to you in one piece?
If you have difficulty with
delivery, please contact
Gordon Phillips.

The Call Letter is the official publication of the Northwest Vintage Radio Society. Circulation is limited to the membership and guests of the Society. The Society is not responsible for the material contributed for publication, nor the quality, timeliness or accuracy of the items offered for sale in the SWAP SHOP. By common agreement of the board of directors, the buyer assumes all responsibility for the satisfaction of any transaction.

Meeting Minutes

By Secretary Pro Tem Gordon Phillips

Minutes of the March 11th, 1995 meeting of the NW Vintage Radio Society.

The meeting was called to order at 10:00 AM by Society President Greg Bonn with 31 members in attendance.

The minutes of the February meeting were reviewed with a motion made by Glen Bricker and seconded by Ed Pittaway to approve the minutes as they were published in the March Call Letter.

The Treasurer's report was given by Ed Charman. A motion was made by George Kirkwood and seconded by John Bucholtz to approve the report as it was given.

Good & Welfare

There was some discussion about how Don Iverson was doing. One of the members stated that he attended the February 18th Ham Fair in Rickreall. He seemed to be doing fine.

Old Business

Dick Dielschneider reported on the progress of the upcoming Vintage Radio Show and Sale. He reported that there were 22 tables still available for sales displays. He has already had the flyers printed and would like to have as many distributed as possible. If you want a table or need some flyers for distribution. Call Dick at (503) 246-1062.

Mike Parker commented on the Table that Greg Bonn furnished to put the VCR and Television on. Questions were asked about showing radio related programs on the society VCR & TV. It was suggested that tapes be shown before or after the regular meeting.

Dick Dielschneider asked about putting a receptacle on the table by the entrance door with a sign asking for volunteer donations to help offset the costs of the sale.

Speed Feldschau and others related to the problems they had getting home from the Salem Sounds Of Nostalgia meet.

New Business

Frank Rasada discussed on how to operate the coffee machine. It was suggested that coffee be purchased in packets measured for each pot, rather than buying a large can. Frank said that he and Mary would look into buying the packets and testing the coffee machine.

Speed Feldschau talked about his upcoming July 8th swap meet. He asked if they wanted to tailgate their wares or have tables to set them on. Tables seemed the preference but tailgating was OK if you wanted. For those that use the tables, they will be required to dis-assemble and put them away. Speed said power would be available if wanted.

Greg Bonn announced the April contest of "Homebrew and Early kit radios. This category will include all home-made radios as well as manufactured kit radios prior to 1935. The set may be built by members or part of a collection.

March Contest Wrap-up

The March meeting contest was "Founder Name" radios. There were a good variety of well conditioned radios. The first prize ribbon went to **Ray Nelson** for his 1935 Stewart Warner Model R-180-A. Second prize went to **Art Redman** and his Cockaday brand radio. Third prize was given to **Mike Parker** for his Freshman Masterpiece. A Certificate of Participation was given to all the members that participated.

The April Homebrew & Kit Contest

The April 8th contest will feature "Homebrew and Early-kit radios. This category will include all home-made radios as well as manufactured kit radios prior to 1935. The set may be built by members or part of a collection.

The June 10th Meeting.

On this date a representative of Mohawk Finishing Products, Inc. will make a video tape presentation of their products and application. The "Midget" radio contest has been cancelled. Please watch for more information in future issues of the Call Letter.

Vintage Radio Show and Sale

Saturday, May 13th, 1995
and
Saturday, November 11th, 1995

9:00 AM to 1:00 PM
at the Multnomah Arts Center
in the heart of Multnomah Village
7688 SW Capitol Hwy., Portland OR
parking is located at the rear of the building

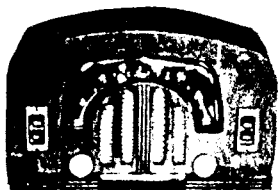

- * Antique Radios**
- * Radio Parts**
- * Transistor Radios**
- * Radio Advertising**

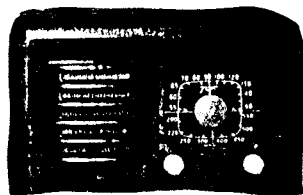

Over 4,000 square feet!

Collectors, hobbyists, and dealers will be present.
Table space is available by reservation. For directions and table
reservations, contact Dick Dielschneider (503) 246-1062.

From downtown Portland, take I-5 southbound to the Multnomah Blvd. exit.
Turn right on 31st Ave from Multnomah Blvd.

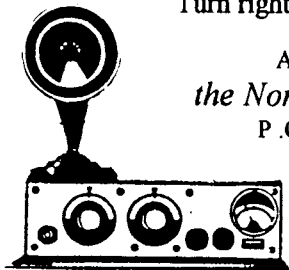

A community event sponsored by
the Northwest Vintage Radio Society
P .O. Box 82379 Portland OR 97282

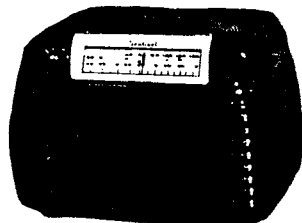

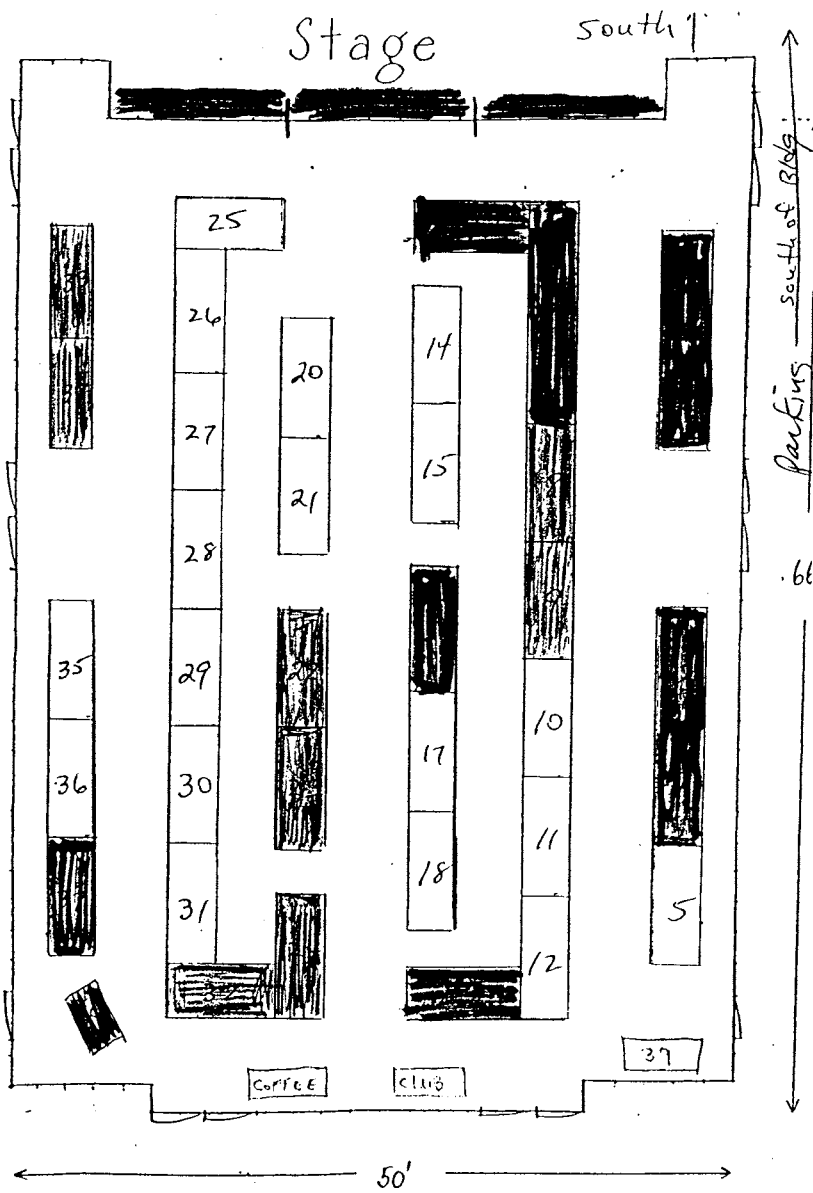

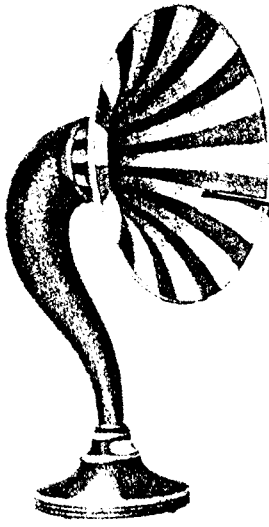

ATMOSPHERICA

By J

Dissertation on Caps

*A CAPACITOR is a capricious thing;
For instance, in a filter
If it leaks a little bit
The whole sets out of kilter.*

*Then again, in trimmers
If screwed to a small degree,
You'll get a Seattle station
Where Chicago ought to be.*

*If a by-pass fails to function
And lets R.F. sneak around
About all you can hope to hear
Is that awful squealing sound.*

*Then there is the tuning kind
Which rotate to and fro
When they rub their plates together
The electrons cease to flow.*

*The coupling kind are also found
With an intermittent quirk
The way the signal comes and goes
Will drive one half berserk!*

*Here's to sound Capacitors
(Or condensers, as you will)
Squat or tall, big or small,
May their aches and pains be nil.*

History: Twenty years ago everyone remembered the scratchy reception of the 30's and 40's. It was blamed on atmospheric conditions, defined as the cause of breaks in serious reception. Atmospheric conditions soon were referred to as "atmospherics." Founding member Tom James thought that our newsletter should have some breaks in serious reception and started to write poetry, titled first **Atmospherics**, and later as **Atmospherica**. Tom and his wife, Dorothy, are gone, but the *Call Letter* continues to publish Tom's works as a *break in serious reception*.

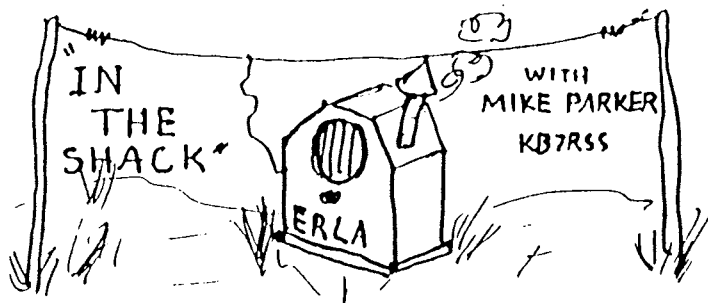

This article is a continuation of last months topic. Restoring and replacing audio transformers in 1920's Radios.

Here is some new information I have received concerning the practice of fusing or "Zapping" open audio windings, with high voltage current.

A friend of mine, H.K. Fredrickson, VA3HKF, of Kember, Ontario, Canada was advertising in A.R.C. for two "NATIONAL" brand audio transformers. They were original equipment on his scarce OPERADIO portable radio of 1923. I had two of the nickel plated beauties for sale cheap. They both had open windings.

He bought them from me anyway and later wrote that he had restored a broken winding in one of them with his "Zapper" recently. I wrote and asked about it and he sent me a description and the schematic he used to build the device.

Here is a description of the "Zapper" and the schematic. Credit is due to Robert Lozier, who designed the circuit.

An Automatic Circuit for Welding Internal Wire Fractures in Audio Transformers

There seems to be two distinct types of failures in the old audio transformers. Corrosion forms at the solder connection between the end of a winding and the heavier wire used to bring the connection outside the transformer. There appears little that can be done to repair these failures if the junction is buried in the transformer. The other type of failure occurs when one small spot of corrosion appears within a winding or a wire fractures due to temperature changes. In this case, it is

often possible to create an arc at the break in the winding. If things go well, a molten copper bridge will form at the break and the winding will be repaired.

It is easy enough to apply a sufficient voltage to make this bridge; but it usually results in too much power being dissipated at the break and after a few milliseconds the copper or carbon begins to burn away, causing the break to open again before power can be removed.

It, therefore, becomes necessary to provide an electronic circuit that can turn off the power instantly after the bridge is formed. Fortunately, this can be done very easily with a simple SCR circuit. When current begins to flow in the winding being repaired, this provides a trigger current to the SCR which causes the SCR to conduct and dump the remaining energy in the capacitor. The neon lamp tells you if the winding is drawing current. The DPDT switch permits you to make a test and then instantly check the winding with an ohmmeter to see what progress has been made. The 400 to 600 volts DC can come from any source.

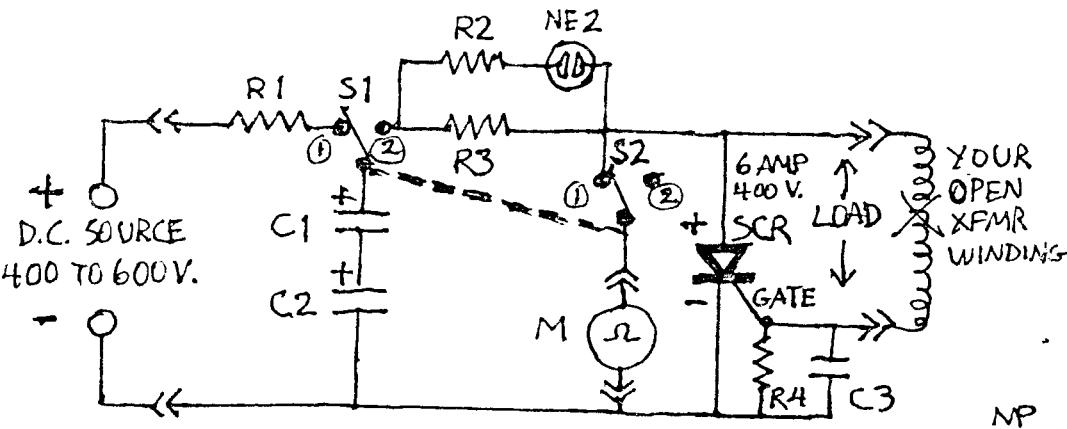

Automatic Coil "Zapper" designed by Bob Lozier

List of components used in the schematic:

- C1, C2--47 mfd./450 Volt Electrolytic capacitors
- C3,-- .1 mfd/450 Volt Electrolytic capacitor
- M-- Testing meter (Volt-Ohmmeter)
- NE 2--Neon lamp for current check
- R1--Resistor, 1000 ohm, 1 watt
- R2--Resistor, 27,000 ohm
- R3--Resistor, 270 ohm
- R4--Resistor, 100 ohm
- SCR--Silicon Controlled Rectifier, 400 Volt, 6 Amp
- S1--Double Pole Double throw (DPDT) Switch, 450 Volt rated. Pole No. 1
- S2--Pole No. 2 of above switch.
Position No. 1 is "Charge" mode.
Position No. 2 is "Discharge" mode.

Dotted line indicates DPDT switch is ganged.

As stated before, working with these high voltage circuits must be done with EXTREME CAUTION! Know where the high voltage is at all times and if in doubt, use ONE HAND to make any live contact with the energized device and sit on your other hand or at least, keep it away from ground.....We want to see you at the next NWVRS meeting!

At this time, I want to welcome any questions about any topic I have covered so far "in the shack" or even any topic "out of the shack". Let's have some Q&A! Just write a note to the CALL LETTER editor or telephone me with your question at (503) 235-7187. We will print your name and question and hopefully, the answer.

See you next time "In the shack"73's Mike Parker

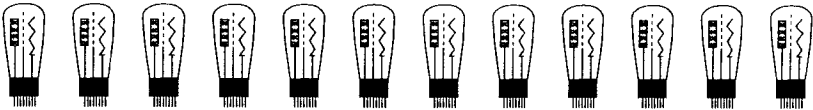

A Home Brew Beer and Sausage Rig

By Pete Petersen (WY7Z)

Let me take you back to 1860 and the first recorded attempt to transmit speech by electricity. In that year Phillip Reis, a German schoolteacher, constructed a voice transmitter by hollowing out a beer-barrel bung and stretching a sausage skin over the small end. He fastened a thin strip of platinum foil to the skin. A second foil strip, placed a small distance above the first, had a contact point that was adjusted to lightly touch the first foil strip.

As Herr Reis spoke into the large end of the bung, his voice vibrated the sausage skin, causing the contacts to make and break with the same frequency as his voice (more or less). That accomplished, he faced the problem of what to use as a receiver. His solution was simple and ingenious.

To build a receiver, Herr Reis used a violin. He took the violin and stuck a steel knitting needle in the violin's bridge and placed a coil of wire around the needle to make it an electromagnet. The transmitter, the receiver, and a battery were connected in series. The battery current, modulated by the transmitter, intermittently energized the receiver electromagnet. This caused the violin strings to vibrate audibly - presumably, at frequencies corresponding to those of the original sound.

Did it work? Just barely. A solid tone, as from another violin, occasionally could be reproduced fairly well. When trying to reproduce speech, only a rare syllable could be recognized and very indistinctly at that. Succeeding equipment was slightly more successful but the method of reproducing sound by making and breaking contacts never proved practical.

Perhaps it's stretching things a bit to say that our modern microphones are descended from German beer and sausage (noble as this lineage might seem) but modern equipment would not exist without these early experiments.

Acquisitions

Acquisitions is a place to tell others what new or old items have been added to collections in the Northwest. If you'd like to share your finds with others, please get your list to Gordon Phillips (see inside front cover).

Glen Bricker

1939 Zenith Model 8-S-463 Console
1942 Zenith Model 10-S-668 Console
1928 A.K. Model #40 Table Radio
10 tube Zenith Shutter Dial Chassis, dial cover & speaker
1200 assorted tubes. most N.I.B.
120 radio knobs
3 tube testers
12 N.I.B. Power Transformers
16 tube Midwest Cathedral
Boxes and boxes of misc.

Gordon Phillips

Philmore "Little Miracle" One-Tube Battery Kit Model No. 7501 (Un-assembled)

Mike Parker

RCA Radiola 103 Speaker
Steinite model 27 2 dial table radio

It has come to our attention that some of our readers have read the acquisition page and then called upon the listed member hoping to obtain one or more of the items listed "new" to their collection. This has soured a number of our contributors from listing their "finds" on this page. This is not the intent of this page and should be noted, not the intent of those listing their new acquisitions. We trust that this practice will not continue.

SWAP SHOP

Wanted: Cutting needles for Webcor type older type records. Glen Bricker 1030 N.11th St. Cottage Grove Or. 97424 (503) 942-3717

For Sale: Model 414 B&K TV Analyst with probes and manual; Model 455 B&K Cathode; Rejuvenator with manual and charts; Model Y33 Sencore Flyback Tester with manual; Model CG 141 Color Generator with manual; **Glen Bricker** 1030 N. 11th Cotage Grove, Or. 97424 (503) 942-3717

Wanted: Philco parts. Speed Feldschau (503) 390-3928

For Sale: Atwater Kent parts Zenith Transoceanic parts and whole sets. Speed Feldschau (503) 390-3928

Wanted: Tubes 25B5 7 pin audio output. 25N6 and 6J8 both octals. Transcription Records. Lester Lewis (503) 648-9730.

Wanted: Old and interesting Crystal Radio diagrams, detectors and related parts. Galen Feight (503) 231-9708

For Sale: RCA RE-45 Electrola Parts Cabinet, RCA Radiols 41 Parts Cabinet, Edison 7R rcvr unit. All 3 Free. @SS = **Wanted:** Old and interesting Crystal Radio diagrams, detectors and related parts. Galen Feight (503) 231- 9708

Wanted: Powell Radio, Chassis for a Gilfillan or similar set, 12' wide, 8.75' deep (see the drawing); Hallicrafter SX-96 or SX-100. Jerry Talbot (503) 649- 6717.

For Sale: A-K 60 "c" Chassis
B/O Jerry Talbot (503)
649-6717

Wanted: Antenna insulators
and lightning arresters.
Auto-related radios. Dan
Howard (503) 761-7799

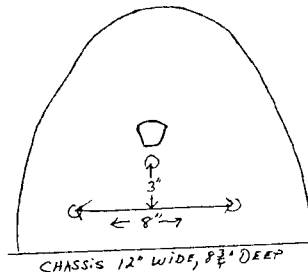

For Sale: Over 200,000
tubes, panels, speakers,
chassis, electronic surplus and supplies. R5-D3 Surplus. **Bob Lee**,
6111 SE 82nd Ave. Portland, Or. (503) 774-6560.

Wanted: For PSARA Museum RIDERS 18, 21-23 Ken Korhonen (206)
932-9363

Wanted: BOYS radios (2 transistor radios C. 1960-1963), pre-1950 TV
sets and literature, Crosley 59 chassis, Sky Cheif radios, Sylvania
1202 radio **Ken Korhonen** (206) 932-9363

- Wanted:** HALLICRAFTERS S-53A, SX-42, SX-43 Steve Posey (206) 361-1967
- Wanted:** CRYSTAL sets commercially made. Bob Farnam (206) 863-9631
- Wanted:** Farnsworth 16 E Phonograph Turntable. For Capehart deluxe phonograph Richard Tussey 3938 NE 6th Ave. Portland (503) 288-6187
- For Sale:** 1937 RCA 813K 5 band 13 tube console w/eye. Jim Collins (206) 867- 0929
- For Sale:** PEIRCE Wire Recorder w/mike & cassette. \$68.00. Walt Kiefner (206) 526-1452
- Wanted:** INFORMATION German SW RX (DEBEG) 100khz - 30Mhz. McIntosh MR-55 Signal Strength Meter or set for parts. Ernie Beetz (206) 285-2711
- Wanted:** KNOBS for Grebe HS-4 Cathedral of info. of their design. Ray Hackbrath (206) 841-3620
- Wanted:** Meissner Tube receiver, any tube compliment like the Traffic Master Scout or #7502 or smaller. Call Bruce Russell collect (604) 299- 1116.
- Wanted:** RED RCA Metal Tube Gil Arroyo (206) 244-2344
- Wanted:** ADVICE on rewinding power transformers for Atwater Kent. Brian Miller (509) 255-6326
- Wanted:** RIDERS 21 and 22 Mark S. Davidson (206) 927-4838
- Wanted:** Riders Volume 1 Steve Metzenberg (206) 941-0699
- Wanted:** RADIOLA AR Jerry Brannon (206) 854-4234
- For Sale:** RADIOLA 80 Console, plays well \$200.00 or \$100.00 without tubes. Jerry Brannon (206) 854-4234
- Wanted:** (1) Military radio items espec. WW2---(2) Obsolete Comm. equip- Aircraft, Boat, Forest Service.---(3) Regenerative SW Receivers, Old or Recent.---(4) Beginners Kit Radios Old or Recent, Non-Superhet.--- (5) Manuals for any above. Will pay to pack/ship or will pick up Aug. 1995 Hugh Miller KA7LXY 3625 N 104 Ave # 35 Omaha NE 68134 (402) 422-3561
- For Sale:** RCA RE-45 Electrola Parts Cabinet, RCA Radiola 41 Parts Cabinet, Edison 7R rcvr unit. All 3 Free. Garod 11FMP2 SW/AM/FM/PH Cons. W/Rola spkr. \$25.00. Edwin Buhite (503) 288-8719
- Wanted:** Crosley Book condenser. Gordon Phillips (503) 234-3517.

Wanted: Collectors and those interested in collecting radio antenna insulators and lightning arresters. Join a group of enthusiasts from across the country who are forming an organization. call Dan Howard (503) 761-7799.

Wanted: HICKOK model 600-A tube tester (will consider substitute) John Bookout (503) 644-0235.

For Sale: Wilson Gay model #53 Recordio Console record player and recorder. Make offer Lee Jensen (503) 289-9048.

Wanted: Heath DX-100 Transmitter, 811 and 813 tubes. Ken Seymour (503) 248-7439 (days)

Wanted: Antenna insulators and lightning arresters. Auto-related radios. Dan Howard (503) 761-7799.

For Sale: Several plastic AC/DC radios, pocket transistors sets, Newcomb B-100 "school" radio (AC in cloth-covered cabinet), clock radios, 2- meter ham transceiver, 6-meter AM transceiver (Hallicrafter SR-46), 2 Eico tube testers, Knight signal tracer, etc, from 2 estates. Send large SASE for complete list. Bud Larson, 1325 Ridge Way, Medford, OR 97504 (503) 773-5214.

LEEDS

Riders (Index 11 12 13);
Manuals Abridged 1 to 5 plus 8
12 13 14; Philco 1939 year book;
Books Supreme Publications
M.N. Beitman Radio Diagrams-
4 books 1926-1938, 1940, 1941,
1942; Sams (1, 2, 3, 4, 5, 6) 8, 9,
11, 12, 13, 14, 15, 16, 17, 18, 19,
20, 21, 22, 23, 24, 25, 26, 27, 28,
29, (2)30, 31, 32, 37, 76, 121, 227,
237, 263, 275, (2)512; Zenith
Technical information for
Zenith record changers
(Cobra). Don Lacey (503) 654-
1556.

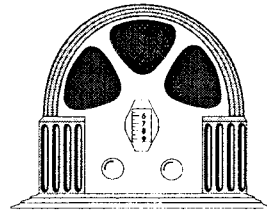

Zenith 16 inch TV with turntable. A console. Ed Charman (503) 654-7387.

EMR Research Funded

By Pete Petersen (WY7Z)

The government's Advanced Financing Department recently announced a grant of \$4.1 million to an international consortium of leading university and research laboratories for the development of ways to reduce electromagnetic radiation (EMR). Although not substantiated conclusively by research, EMR is thought by some to contribute to health problems, including cancer.

The consortium will be headed by Dr. Aprile Stolto-Giorno, a specialist in EMR reduction and a great scientist in the tradition of her countrymen Guglielmo Marconi and Alessandro Volta. Research will focus on a little known phenomenon called the smoke conduction factor.

Empirical evidence suggests that a small amount of smoke is unavoidably included in all electronic component parts as a result of their traces conduct smoke from one component part to another through the sub-atomic sized spaces between molecules. It has been hypothesized that the movement of smoke supplements, to some extent, the movement of electrons in the operation of electronic circuits.

This hypothesis is supported by the observation that an electronic device will fail to work properly after it's smoke has escaped. Sometimes, if only a small amount of smoke escapes the device will continue to work but often with degraded performance. If a large puff of smoke escapes the device will usually fail completely.

Dr. Stolto-Giorno and her research staff will attempt to increase the use of smoke within electronic components and their connectors while reducing the use of electrons to negligible amounts. It is expected that similar reductions of EMR will result. This being part of a preliminary report issued April first, 1995.

We'll chalk this up to our "*tongue-in-cheek*" department.

Calendar

Compiled by Dan Howard

April	6-9	April Car Swap Meet - Expo Center
	8	NW Vintage Radio Meeting
	16	PSARA Meeting & Auction, Seattle
May	13	NW Vintage Radio Swap Meet 9AM
	14	PSARA Meeting, Seattle
	20-21	Yakima Ham Fest Middle School, Selah Wash.
June	3-4	SEAPAC Ham Convention - Seaside, OR
	10	NW Vintage Radio Meeting
	18	PSARA Meeting, Seattle
July	8	Speed's Swap Meet, Keizer, Oregon
	15-16	Antique Show - Portland Expo Center
	16	PSARA Meeting, Seattle
	22	Ham Fest Junior Hi. School North Bend, Oregon
	23	NW Vintage Radio Show, Forest Grove Concours D'Elegance
August	20	PSARA Annual Swap Meet, Seattle
September	9	NW Vintage Radio Meeting
	16-17	Portland Ham Fair, Portland Meadows 1001 NE Schmeer Rd. Portland, Oregon
	16-17	Antique Show - Tacoma Dome
	17	PSARA Meeting, Seattle
October	14	NW Vintage Radio Meeting
	15	PSARA Meeting, Seattle
	21	Ham Swap Meet, Polk County Fair Grounds. Rickreall, Or.
	21-22	NW Vintage Radio Display, Expo Center NW Car Collector's show
	28-29	Antique Show - Expo Center
November	11	NWVRS Annual Fall Swap Meet
	19	PSARA Meeting, Seattle
December		NW Vintage Radio Christmas Party
	10	PSARA Meeting, Seattle
	16-17	Antique Show - Oregon Convention Center

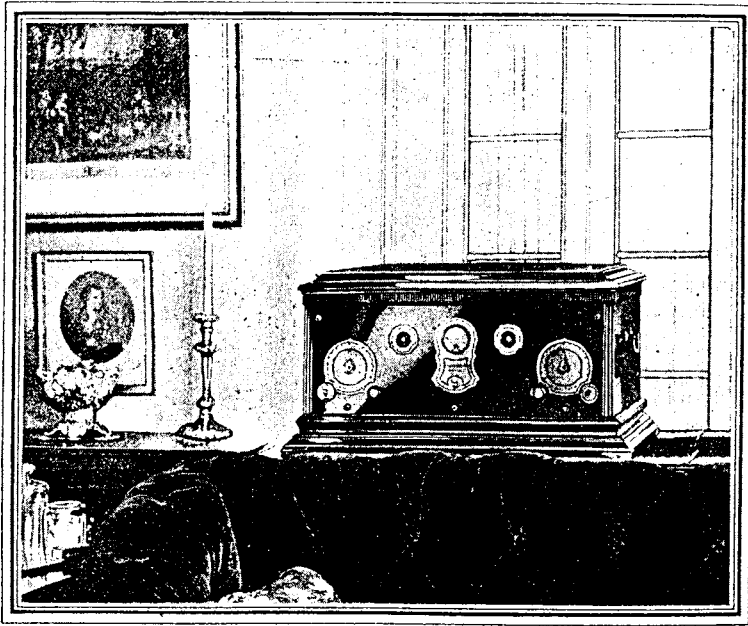

Stromberg-Carlson
Receivers

Stability in performance
Stability in value