

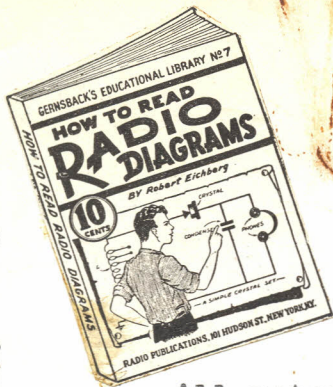

NORTHWEST
VINTAGE RADIO
SOCIETY



"THE CALL LETTER"
of the
NORTHWEST VINTAGE RADIO SOCIETY
VOL. 2 NO. 12
NOVEMBER, 25th, 1976 - Written and
Edited by Bob Bilbie
Mailing labels by Doug Eggert &
mailing handled by Bobbie Kibler.
Printed by Lightning Quick Print,
Foster Rd., Portland, Oregon

All material submitted for publication should
be mailed to Bob Bilbie, 295 S. Knott St., Canby
Ore., 97013, by the 25th of the month in order
to be included in the latest issue. Thank you.

PRINTED FREE OF CHARGE EACH MONTH FOR THE ENJOYMENT OF OUR MEMBERS.....

Honest fellas, I'm not crowing about it, perhaps I wanted it more than any-
one else, but the Editor got an unusual Atwater Kent Breadboard, not a
numbered model, built possibly earlier than the numbered models, it is most
unusual and not listed in McMahan's "Vintage Radio". Research is in progress
to find out more about it and you will see it at the next meeting which
will be on Dec. 11th, IOAM, Saturday, Buena Vista Clubhouse, 16th & Jackson,
Oregon City, Ore.



IMPORTANCE OF NEXT MEETING

This is the time of year we elect a new
slate of officers to head up our organ-
ization for the coming year and we need
all of you present that are qualified to
vote to get this job done. Please revise
your plans if possible to be there, as
your cooperation is vitally needed!

BASKING IN SUNSHINE

Received a cute little "one tube
receiver" from member Joe Tomkins
who is enjoying a brief but deserved
stay in Honolulu, Hawaii. We hope he
has the luck to find him one of these
gems, too. Hear tell he may come up with
a Dole-O-Dyne, 5 pineapple TRF batt. set,
Oh poi, what a receiver that would be!
See you when you get back and have a
good time, Joey.....

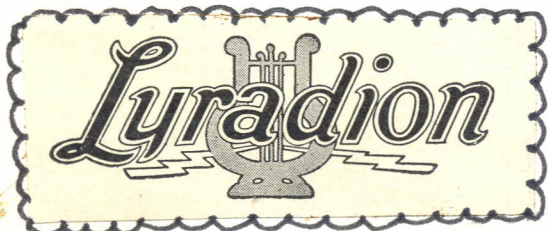

SEEK INFO ON SODION TUBE D-21

Anyone out there among our members who
might have any information on SODION
tubes the editor would really like to
hear from you. With a very large library
on radio at my own disposal I still can
not find anything on these tubes. Can you
help??

Oregon's Museum of Science and Industry (OMSI) has asked us to provide a display
of vintage radios for a show starting in December. We hope you can attend and
Pres. Bob Campbell has made the necessary arrangements to get a display setup.
(SHOW WILL RUN FROM DEC. 1 TO DEC. 5th) (over, Please) GO AND ENJOY THE SHOW!

LYRADION MANUFACTURING CO., MISHAWAKA, IND.

FROM LITERARY DIGEST - 1922

MARKS'MEMO by

MARK MOORE, Sec., NWVRS

Once again we have several new members to welcome into the club:
Byrd, W.
2234 SE IIth,
Potland, OR , 972I4Ph236-0234

Sahnow, Gordon Sr. (Sr. Cit.)
I76 N.3rd St.,
Hillsboro, OR, 97123
648-2441

Chandler, Wallace, (A),
927 S. Washington,
Lansing, MI, 489I0

Stokes, Bruce,
3205 SE Schiller
Portland, OR, 97202
774-2064

Lofquist, Capt. Erik,
67I7 37th Ave., NW,,
Seattle, WN, 98II7
782-6343

Walker, Mark, (A)
16819 Military Rd. South
Seattle, WN 98188
242-2065

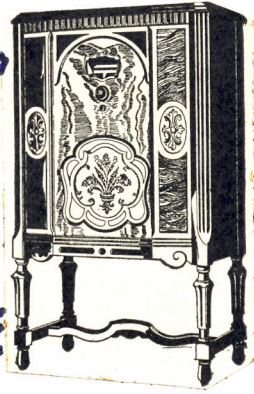
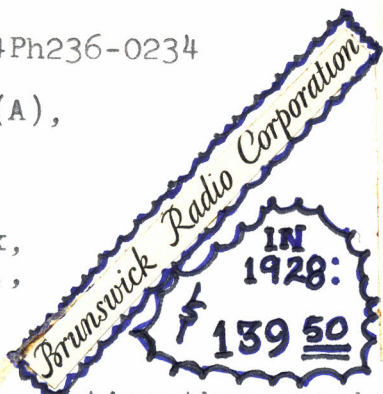

We look forward to meeting those we have not met and are very pleased to have become acquainted with those we have met.

Our next meeting on Dec. the 11th, will be an important meeting since we will be electing a new slate of people to head up our organization for the coming year. Those in the running are as follows:

- President - Bob Bilbie and Bob Campbell
- Vice President - Tom James and Tom Sebens
- Secretary - Don Iverson , Don Knotts , Mark Moore
- Treasurer - Jim Mason and Alan Shaddock



Also on the agenda will be an amendment to the clubs' Constitution which would allow for a separation of duties for the office of Secretary. Having been in this office this year I am strongly in favor of this amendment. Not only would it allow another person to have a voice in the leadership of our club, but it will reduce the work load for both. This year has brought a tremendous increase in correspondence so the office would be divided as follows; a recording sec., to handle the minutes at the meetings as well as the board meetings. He would also be free to head up committees and have the time for special projects. Secondly the corresponding secretary would then be responsible for receiving and answering correspondence the club regularly receives.

Article V, Section 3 would be ammended as follows:

Sect 3A - Recording Secretary - The recording secretary shall be responsible for recording the minutes of every business meeting and of every board meeting. He will assist the Vice President in planning and arranging technical or entertainment activities associated with club meetings.

Sect 3B - Corresponding Secretary - The Corresponding Secretary shall be responsible for receiving and answering all correspondence sent to or from the club. He will be present at any committee meeting set up to handle publicity for the club. Under his jurisdiction will be the annual list of membership.

We urge all regular members (those that have paid \$I0 dues) and those persons aged 70 or over who have paid \$4 dues to be present at the next meeting in order to elect a new slate of officers for the coming year. I personally would like to see more projects and activities started in the new year. This allows more people in on the joys of active participation and will help salvage a lot of radios destined for oblivion. If I am reelected to the office of secretary it will be my choice to continue on as corresponding secretary.

In order to reduce confusion for the officers involved we would like to request all those able to pay their dues for the new year to do so at the next meeting. Dues are pro-rated and those that joined later in the year need to contact Tres. Jim Mason to find out what their dues will be for the year coming up. You can call Jim at 644-2343, and he will provide you with the necessary info. If

"MARKS' MEMO, continued,

any of you need information on any point that requires clearing up please call me in the evenings at 658-2260.

One more important item is that anyone not wanting his name and address to be put in the new mailing list available in Feb., it will be YOUR RESPONSIBILITY TO CONTACT ME BEFORE JAN. 15th, 1977 and let me know! We also must know of any changes in your mailing address so please advise.

I have enjoyed serving the NWVRS in 1976.....

Your Secretary,
Mark Moore

No election year would be complete without a few campaign speeches so let us begin with one sent in by Pres. Bob Campbell., Ed..

Hi,

Thought at this time in the year we should begin to think of the coming year. Here are a few of my ideas.

Our Swap Meets should be standardized into a Fall or Winter month with probably two weekends to vary the actual dates.

We should get a committee of members from various areas to compile an active list of members, and radios that would be readily available for any display that may be needed at short notice.

In 1977 we should all try to provide articles, information and classified ads to assist our editor. Our editor can then print the "CALL LETTER" with a wide variety of items of interest to all the Society members (Amen, Ed.)

Let us work together to build this Society for the betterment of our hobby. Remember everyone's two bits worth adds up, and thank you for a very active and fun year!
Bob Campbell

**NORTHWEST
VINTAGE RADIO
SOCIETY**



By Bob Bilbie:

As you all know by now I have taken an active part in our Society since its inception two years ago, by doing your little scandal sheet faithfully each month and enjoying every minute of it! I love both the Society and old radio no end and would do all in my power to further those ends. I would try to establish working guide lines to help the development of our club. I am strongly in favor of monthly Board

Meetings in order to set a pace of operations beneficial to our Society. Another hope in the future is that in any endeavor by anyone outside the club in using OUR RADIOS as a display is that THE NORTHWEST VINTAGE SOCIETY is given FULL CREDIT for any such display, and not have to play second fiddle, because OURS IS A VERY WORTHY CAUSE, the preservation of an American heritage, antique radio. Win or lose I will remain your editor if you still want me. Thank you.

By Alan Shadduck, nominee for treasurer:

As a Charter Member, I have often wondered what it would be like to be an officer in the Northwest Vintage Radio Society and now, given this opportunity, I would like to serve as Treasurer of this club.

If you vote for me, I will help the Society in every way and perform ably the duties of the office. I hold a degree in electronics and work for TekTronics as a computer repairman. Perhaps a lot of you don't know me because I am shy and reserved, but what I lack in this

department, I more than make up for in my devotion to the Society and antique radio...
Thank you

GEM TUBE
A Guaranteed Radio Tube Within Reach of All

A tube for a dollar of \$3 value. A trial order will convince you as it has thousands of others. (Blue or Silver with Bakelite Base). Send your orders at once.	Types \$ 401A \$ 400 499A Each
---	--------------------------------

Orders sent C.O.D. parcel post with UV or UX Bases

Dealers, Write for Discounts

GEM TUBE CO.
(Dept. N.) 200 B'way, N. Y. City
220 So. State St., Chicago, Ill.
Lafayette Bldg., Detroit, Mich.

By Don Iverson - nominee for Secretary

My name is Don Iverson and I am running for the office of Secretary of our club. My opposition has sat idly by and allowed old radios to practically disappear and the price to skyrocket. What our club needs is someone who will do something about the availability and cost of old radios.

I, therefore guarantee, I say GUARANTEE, if elected, a Battery or Electric set of your choosing in every home! I further guarantee to bring the cost of radio down to what it was 10 years ago. I also promise to make the public give up all those old WDII's, I99's, 201A's etc. tubes that they have been hoarding for so long

I will not under ANY circumstances allow your dues to rise (unless we need the money)

And I further state BLAH, BLAH, BLAH.....

Seriously I believe it is everyone's duty to do their share to keep the Society going. I know for a fact that I can not do as good a job as some of the other members, but I also know I would do the best I can.

I don't believe, as has been stated, that without top-notch officers that our Society would fold.

It is activities and new ideas which create a need for a club. And a person does not have to be an officer to bring up new ideas or take part in activities.

Sincerely,
Don Iverson

And from Tom James - nominee for V.P.:

When you vote for your illustrious Veep,
Keep the BEST at the top of the heap,
Vote X for Tom James
and no other names.....
For you won't catch that Rascal asleep!

YOU NEED ALL 8
Rider 8
MANUALS
JOHN F. RIDER, PUBLISHER
404-4th Ave., New York City

NORTHWEST
VINTAGE RADIO
SOCIETY

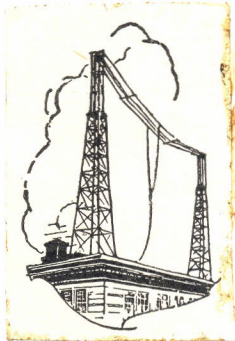

One of the greatest disadvantages that users have experienced with crystal detectors is the loss of the sensitive points in the crystal. If there is a spot through which good signals can be rectified, the chances are very large that it will be almost impossible to find again, once the catwhisker is displaced. The crystal detector shown in the accompanying illustration is so calibrated that once a spot is found, its position can be logged, and therefore can again be located. This is an English invention.

Those are all the speeches we received so I will say that regardless of who is elected a very good job will be done as it has in the past. Good luck to all in the race! (Ed.)

This has not been as interesting as some of our previous issues but it is a sort of Milestone Issue in effect for at last our group of members are taking pride in our Society by getting up and saying how they feel! Next month, after we are done with our election, we will return to the "nuts & bolts" type of newsletter. So hang in there members and thank you all for taking active participation in our coming election

On the next page you will find what you have all been waiting patiently for.....

Next page, please.....

"ATMOSHERICS"*

by TOM JAMES

TOM'S ANSWER TO JIM'S HORN SPEAKER

Carving out a speaker
From old BOSSYS' horn,
Is like making auto tires,
From old boots you've worn.

Methinks Jim Masons' speaker,
Brings in too much BULL--
He should try the other end
And get that stations "pull".

Make panels from old rawhide-
Round leg bones for knobs,
Your receiver then resembles,
A "vintage" one of Bob's.

So heres to innovation---
Lets toot a clearer M0000.
Let's turn out cow-horn speakers
In stead of making glue!

"IT'S HERE!"

Christmas time is here again,
With hoop and hulla-balloo,
Of stores all hawking wares
To trap both me and you

Maybe we can rise above
The commercial hue & cry,
And concentrate on a Birthday past
Instead of BUY & BUY!

Let's stress the goodwill theme
, And mark the Peace of Man---
As we stumble thru the year
Doing the best we can.

A toast to happy holidays
Around the vintage board;
And may our vintage portions
Overflow the drinking gourd!

1930 REMLER
"Cameo"
From Radio Mag.
Dec., 1930



NORTHWEST
VINTAGE RADIO
SOCIETY



Self-portrait by t/j!



RADIO
CRAFT
1938

HOW MANY ARE STILL LEFT??
From RADIO - 1930

Number of Radios in Use

The estimate by the United States Department of Commerce as to the number of radios in use in the United States is 13,478,600 sets. These are estimated to be distributed as follows:

Ala.	87,700	Neb.	203,000
Ariz.	46,600	Nev.	23,000
Ark.	90,500	N. H.	47,000
Cal.	1,470,000	N. J.	453,000
Col.	172,000	N. Mex.	28,000
Conn.	219,000	N. Y.	1,752,000
Del.	29,000	N. C.	92,000
D. C.	105,000	N. D.	61,000
Fla.	124,000	Ohio	845,000
Ga.	111,000	Okla.	182,000
Idaho	42,000	Ore.	219,000
Ill.	1,060,000	Pa.	977,000
Ind.	348,000	R. I.	111,000
Iowa	310,000	S. C.	44,000
Kan.	195,000	S. D.	77,000
Ky.	92,000	Tenn.	104,000
La.	121,000	Texas	364,000
Maine	80,000	Vt.	45,000
Md.	115,000	Va.	114,000
Mass.	656,000	Wash.	351,000
Mich.	627,000	W. Va.	86,000
Minn.	239,000	Wis.	322,000
Miss.	48,000	Wyo.	32,000
Mo.	433,000		
Mont.	54,000	Total	13,478,600

Quickly demonstrate your sets in apartments, houses, hotels, offices, hospitals, etc.

APPROVED RADIO NEWS ANDRAGIBLE 1926

POPULAR RADIO

RADIO BROADCAST

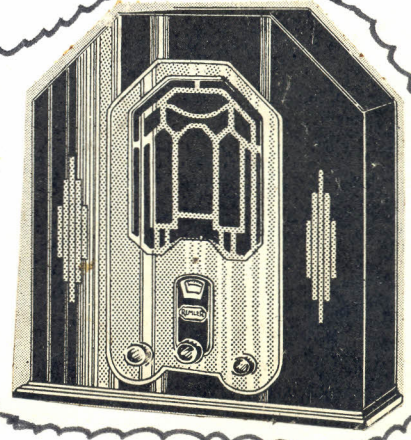



NORTHWEST
VINTAGE RADIO
SOCIETY

Another campaign speech that arrived from; TOM SEBENS-nominee for Vice President My name is Tom Sebens and I am a Charter Member of the NWVRS.

We are in this club to learn about old radio, not to discuss how little we know.If elected,I will work to get the majority(those who want to learn)to take advantage of the knowledge of the minority.(those who know but only discuss it among themselves)

Sincerely,
Tom Sebens

And from Treas.Jim Mason,perhaps the most sporting campaign speech of all!

I would be willing to serve the NWVRS another year as Treasurer if the membership so desires, however I feel that it would be beneficial for as many members as possible to share in the duties of the Society.I unselfishly feel that candidate Alan Shaddock should be given consideration for this post.

Sincerely,
Jim Mason



OZARKA

122 Austin Avenue E
Chicago, Illinois

The last page of this months issue has a unique puzzle which was devised by our famous Gonshorowski Bros(known throughout the world for their famous cough drops and their equally famous picture on said box of same,Ed.)We feel that this deserves special mention in our newsletter,for it is indeed an intricate advent-into the realm of the mystik!After spending about a week trying to figure the answer out , I too , will have to wait for the complete answer(the radios came fairly easy , but wait til you try to figure out the message with the letters left over)Congrats , Bros.Smith and may you bless us often with such shenanigans!!We DIG IT!

Ala Stromberg Carlson

As your letter is being hammered out a lovely lady in the corner is serenading her heart out to me.Of all the radios I have come to know and love this old girl perhaps is the most satisfying of all,in the way she so proudly goes about her business of entertaining.Here,certainly, is the instant culmination of mans efforts to outdo himself,a super chassis,a body far exceeding the merits of Raquel Welch(I think)and a poise equal to and perhaps better than Princess Grace of Monaco.If there is a radio heaven I'm sure this one is there in her full and resplendant glory! Viva,Stomberg-Carlson!

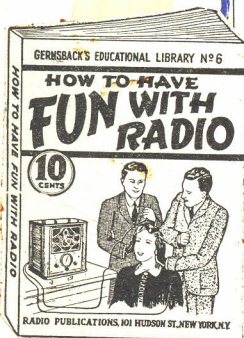

- Only \$18.95

for this new Universal "Push Button" Tube Checker

See it at your **JOBBER**

- Direct Push Button Test
- New Easy Reading Scale
- Tests all Standard Tubes
- New Precision Design
- Looks like a Million

Outstanding in performance, precision and design. Universal for all tubes with the convenience of direct "push button" readings.

Write for literature.

MILLION RADIO and TELEVISION LAB.
559 NO. UNION ST. CHICAGO, ILL.

Is'nt it great how certain radios turn certain people on?Do you have a very special radio that works this way on you?If so,why don't you write to us about it and let us in on the secret,be a battery set or an electric.We promise to print it!

OVER, PLEASE.....

WHAT ARE 1931 TUBES?

It's easy to identify 1931 tubes among the general run of tubes. Meters and performance rather than labels and claims soon separate the sheep from the goats. Briefly, and for your guidance, the 1931 radio tube features are:

Positive Characteristics because of the doubling of the diameter of some support wires and better bracing, together with tightened tolerances.

Improved Tone Quality resulting from greater rigidity and therefore minimum microphonic effects, together with suppression of distortion arising from undesirable regeneration.

Quiet Background brought about by DeForest research into causes of hum and crackle, resulting in one-fiftieth the noise level heretofore considered standard practice, together with lower gas content made possible by unique DeForest exhaust units now in use.

Longer Service Life brought about by important improvements in filaments, cathode insulators and

emitters, insuring full thousand hours of peak efficiency.

Greater Volume through the increase of the mutual conductance in power tubes, yet maintaining full interchangeability with usual tubes of lower output.

Quick Heating averaging about 10 seconds, due to patented DeForest notched cathode insulator, without sacrificing life, reliability or quiet operation.

Higher R.F. Amplification with screen-grid tubes, or 60 instead of usual 30 per stage, while decreased grid-plate capacity permits of maximum stability or minimum regeneration for the highest gain with least distortion.

The foregoing 1931 radio tube features are not to be found in tubes produced six months ago, much less those a year or two old, taken from large inventories. DeForest research and engineering, rapidly translated into everyday terms by a production geared to the demand, brings these features to you in fresh.

DeFOREST
RADIO CO.

de Forest
AUDIONS
RADIO TUBES

PASSAIC
N. JERSEY

Weston
PIONEERS SINCE 1888
INSTRUMENTS
WESTON ELECTRICAL
INSTRUMENT CORPORATION
600 Frelinghuysen Ave. Newark, N. J.

Q. How would you put a load on a complete power pack condenser bank, so as to make a rough check as to its condition, the pack being part of a fully assembled set?

A. Remove all the tubes from the set except the rectifier and turn the set on. This will put an excessive load on the condenser bank, usually sufficient to show up leaks or defects. The plate current and should be watched on the rectifier plates as excessive current will denote leaks or other defects.

Q. If you had some shorted turns in the primary of a power transformer which raised the voltage on all secondaries on account of change in ratio, how would you make an emergency repair?

A. Use a suitable wattage resistor in the primary circuit to cut down the voltage at the input, until the voltage delivered by the secondaries was of correct value.



Here is a schematic for a Clarion Junior that may come in handy in the future

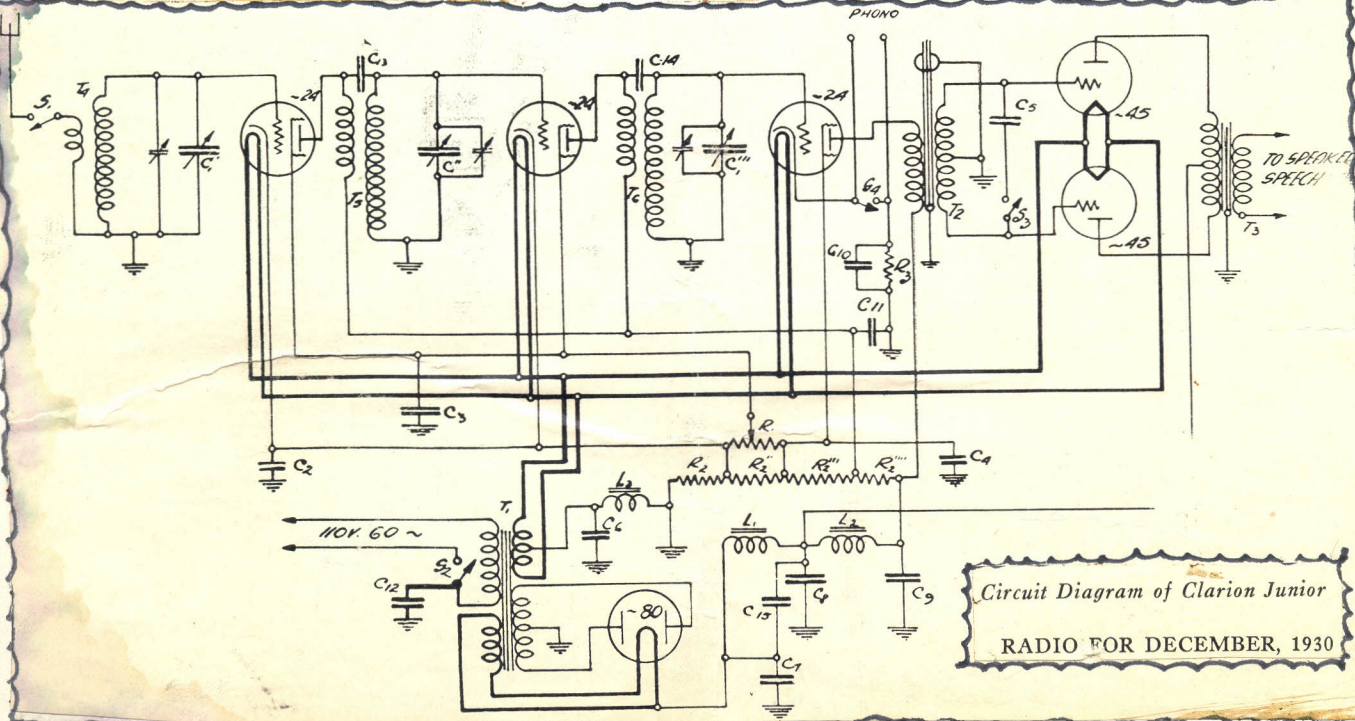

Circuit Diagram of Clarion Junior
RADIO FOR DECEMBER, 1930

SO THERE YOU
HAVE IT FOR
THIS MONTH,
UNTIL WE SEE
YOU ALL AT
THE NEXT
MEETING, WE
REMAIN YOUR
FAITHFUL SE-
VANT AND
LOYAL
DEVOTEE!
THE
NWVRS
BYE!