

# NATIONAL RADIO NEWS



## IN THIS ISSUE

Telephone Systems for Adjusting TV Antennas  
How to Make Continuity Tests  
Alumni Association News

Oct.-Nov.  
1948

VOL. 13  
No. 5



---

---

# You Are Heading Toward Success

*"To find a career to which you are adapted by nature, and then to work hard at it, is about as near a formula for success and happiness as the world provides."*

So spoke Mark Sullivan, famous author and commentator.

You have every reason to expect real success in your Radio career . . .

. . . you like Radio.

. . . you have a natural inclination toward things mechanical.

. . . you are willing to work hard at Radio to learn all you can about the subject.

. . . you are willing, yes, anxious to make some sacrifices to get ahead.

There you have it! There is your formula for success. Let nothing steer you from your path. Keep at it. Be so strong in your determination that no obstacle, however great it may seem, can veer you from your purpose. You are the master of your destiny.

Think success. Believe success. Be a success.

J. E. SMITH, *President*

# Telephone Systems For Adjusting Television Antennas

By GEORGE ROHRICH

NRI Laboratory Instructor



George J. Rohrich

SOMETIMES we wonder how important is an antenna installation? This question is raised because many times a short piece of wire may seem to be all that is necessary. This happens frequently enough so that we get into the unfortunate habit of believing the makeshift antenna works everywhere. This is not the case. In fact the well-engineered antenna fails in some locations.

Surely, on the AM (amplitude modulated) broadcast band, with a sensitive receiver near a system of powerful transmitters, a short piece of wire or a built-in loop antenna often gives excellent reception. The customer might be quite happy with the results he gets from one or two or several stations. If he has a combination AM and FM (frequency modulated) receiver he may experience a serious disappointment with his makeshift aerial while trying to get equal or better reception so persistently claimed for the FM band. If he possesses a television (TV) receiver his disappointment may be even greater because results in his particular location are not like those of his neighbor, although he appears to have duplicated the installation in every detail, including an impressive looking commercial antenna, supposedly engineered to give optimum results with nothing better claimed to equal its performance.

Now what is the answer? The customer is baffled. The serviceman was successful for many previous jobs. He has hit a snag now. He erected the folded dipole with reflector, this last antenna system, in exactly the same manner as he did the other for his customer's neighbor. But results here are different. Why? Can you supply the answer?

active press agents and engineers, that its promises are ahead of its practice. Each week brings new transmitters, new programs, and new types of receiving equipment, accompanied by new experiences, so that what seemed a mystery one week is a proved fact the next.

Now we were discussing a problem arising from a typical experience of a recent television customer who is not getting expected results. Undoubtedly, you will have to solve a similar problem sometime. All of us are bound to hit a snag now and then. You have solved other problems and you can solve this one too.

You are called in on the job. A set of direct questions reveals the suspected cause of difficulty. Did the other serviceman have a helper? Did he try locating the antenna elsewhere? Did he try rotating the antenna while in its present location? Your customer says NO to each of these questions. This lets you narrow the probable cause of trouble down to one of two conditions. First, the antenna may not be located where signal pickup is at its maximum. Second, the antenna may not be oriented (turned) to pick up the best signal.

## To Site The Antenna Is Important

The difference of a few feet in the location of an antenna *sometimes* is enough to bring success or failure. Portable equipment, either receiving or transmitting, soon gives evidence to the truth of this statement. Think of those cases you have undoubtedly noticed while riding in an automobile. Here the AM signal fades, disappears and reappears in succession.

Television has come so fast, sped by the most

Mobile FM transmitters, used by police and by

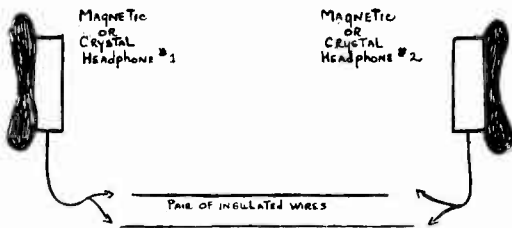

Figure 1. Quickly assembled telephone system. The pair of wires can be any length for talking between two places separated as much as 500 feet. Talk into either headphone. Someone listening at the other unit will hear you. A battery is not needed here.

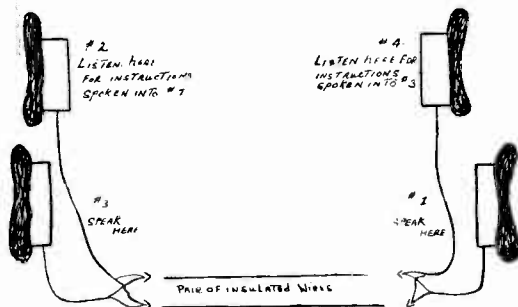

Figure 2. Four headphones connected in parallel. Such an arrangement makes a convenient "sound-powered telephone system."

some taxi owners, and also found on public utilities service trucks for gas and electric companies quite often cannot be heard by their dispatch operators. The dispatch operator knows the answer for his poor reception and phones his instructions—"Move your location, I can't hear you—OK now, that's perfect"—the last curt "OK now" follows in a very brief matter of time, the previously parked vehicle having moved and stopped a few feet from its former position.

FM and TV transmitters use frequencies which are higher than those used by the familiar broadcast stations. Consider that these higher frequencies act very much like the light sent out from a strong searchlight. This will help you visualize why the site (the location) of the receiving antenna is important with regard to its transmitter antenna. Unlike the dispatch operator, you can't move the transmitter antenna but you can move the receiver antenna where results are improved if not made perfect.

Usually, good results can be expected under line-of-sight conditions. Therefore, try to select a site where such conditions do exist. However, if you can't see the transmitter antenna from the location where the receiver antenna is mounted, then

it is absolutely essential to check results by actual trial in order to get away from "shadow areas" and find optimum locations where strong signals (or ghost-free signals) are received. The viewer may receive the signal directly, or indirectly by reflection, or not at all.

### This Is Not A One Man Job

Two persons are needed for checking. One person is at the receiver. He observes what actually happens while the antenna is being shifted.

The other person shifts the antenna upon receiving instructions. Both must be able to talk back and forth readily while giving and receiving instructions.

### A Telephone System Is Required

Few installations of the antenna on a roof are near enough to their receivers so two persons can talk back and forth without aid of a telephone while taking steps to site and orient the antenna. One man, holding a pole upon which is mounted the portable antenna, changes his position. The portable antenna is connected to its receiver with a two-wire transmission line that is loose and long enough to reach any location on the roof. In addition, position for its height can be determined. Here one should remember that a variation of a few feet in height of the antenna may put it in line with the desired high frequency FM or TV signal. Such exploration proves that best results can be determined with the help of a telephone.

To the inexperienced, the question arises how elaborate must be the telephone system? How much equipment is needed? How should it be connected? There will be differences of opinion to these questions. These opinions will depend largely on conditions existing at the location. Availability of materials is another factor. Make your own choice to suit any situation from the simpler or more elaborate arrangements which follow.

### A Simple Telephone Will Do

Probably the simplest telephone can be made with two magnetic or crystal headphones. Just connect the two wires of the one unit to the corresponding two wires of the other headphone. The arrangement is shown in Fig. 1. The pair of insulated wires serves to extend the distance by which the headphones can be separated. This is practical for talking between two points located up to 500 feet apart. A battery is not needed. Neither will a battery make this system more sensitive.

The insulated copper wires may be selected from a variety intended for many common electrical

uses, such as lampcord, bell wire, microphone cable, twisted-pair telephone wire, etc. Flexible wire is easier to handle than most varieties of solid wire because it does not kink or tangle. The most popular size is No. 18 although anything from No. 14 through No. 22 can be handled well. The larger size No. 14 has greater mechanical strength but its extra weight might be objectionable during temporary installation from roof to receiver. On the other hand the smaller size No. 22 is light and easily handled but breaks frequently after receiving rough treatment during several handlings on the job and in storage.

In Fig. 1 each headphone unit serves two purposes. It serves as a microphone while speaking into it. It serves as a reproducer while listening. Therefore, it is necessary to tell your listener when you are through talking, so he can talk to you. This is done best by ending your conversation with the command—"OVER"—just as is done in radio telephony on planes and in police work.

Because Fig. 1 has its drawback, you can improve the system, by making it into a two-way system. This can be done by adding an extra phone in parallel at each end of the line as shown in Fig. 2. This parallel arrangement is better than a series circuit of these same parts.

The chief drawback for the arrangement in Fig. 2 is its lack of sensitivity because part of the voltage generated in any microphone unit is distributed in each of the three remaining units. To retain the sensitivity obtained in Fig. 1, along with the convenience of Fig. 2, add the third insulated wire, with connections made as shown in Fig. 3.

#### Carbon Mike Gives Slightly Louder Signals

Substitution of a carbon mike (microphone) for either the magnetic or crystal type, approximately doubles the generated talking voltage. However, twice the voltage does not reproduce the voice twice as loud in the reproducer unit. This is discussed in your regular lessons. The increase is hardly perceptible for practical purposes in a short line but you may like to use one anyway, if the carbon type happens to be on hand. Over lines longer than 50 feet, it can be made more sensitive than carbon or crystal mikes.

A 1.5-volt flashlight cell is needed with a pair of carbon mikes. All parts are connected in series. The series arrangement is used in most commercial equipment which can be purchased from many radio dealers and mail order houses. Fig. 4 shows the series arrangement. However, in the series circuit, it makes no difference how the individual parts are arranged with relation to each other for polarity or position. Therefore, you can vary the arrangement to suit your own purpose.

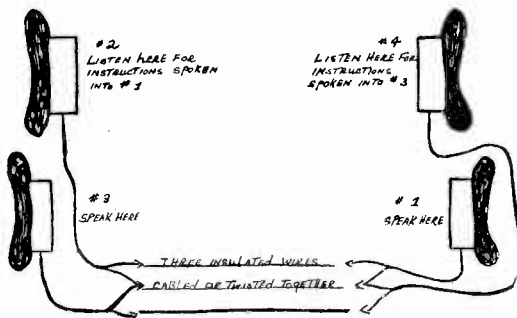

Figure 3. Sound-powered telephone uses three insulated wires for connecting four magnetic or crystal headphones.

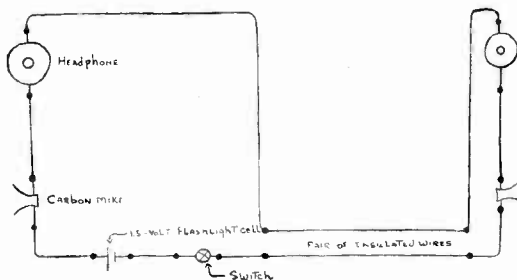

Figure 4. Two headphones, with two carbon microphones and a dry cell, are connected in series for a simple telephone system. Opening the switch prevents exhausting the dry cell during idle periods.

A few words of caution are necessary about the carbon mike and dry cell. The cell will become exhausted if left permanently into the circuit. Therefore, a switch is necessary. The push-button variety of switch has the advantage of keeping the circuit open until ready to talk.

Furthermore, don't use too many dry cells in series with the circuit. Too many cells will destroy the carbon mikes by burning and welding their granules into an inoperative solid mass. This burning is usually accompanied by an initial frying or hissing sound, heard in either headphone. Therefore, be alert when using more than one cell and decrease the number of cells being used until you don't hear the hissing sound. Otherwise, by adding a cell or two, you will find added sensitivity in talking voltage is maintained over lines longer than 50 feet. This is true for the carbon mike but not for the magnetic or crystal variety.

One cell is enough but don't use more than two cells for lines up to 50 feet in length. Two cells are enough but don't exceed using four cells for lines which are 100 to 500 feet long.

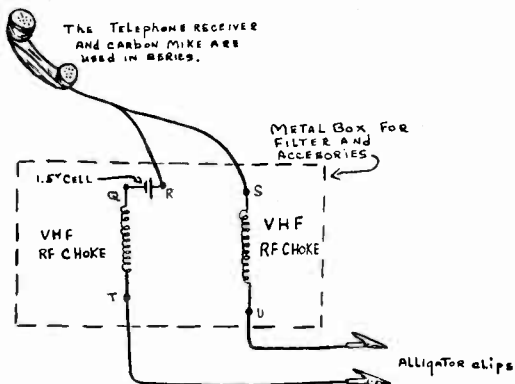

Figure 5. A filter is needed. The addition of these chokes is necessary before making connections described in Fig. 6. Q, R and S are three soldering lugs mounted on an insulated support for conveniently making connections while supporting the chokes. T and U are similar soldering lugs mounted on another support.

If the granules in a carbon mike have become slightly charred through overload so they stick together, some sensitivity can be restored by jarring the microphone lightly. Of course, avoid excessive jarring. To do so, can also damage it.

#### Phone System For Adjusting A Television Antenna Which Uses The TV Transmission Line

As you know, Television and FM antennas often use a two-wire transmission line leading to their receivers. It is possible to adapt this line temporarily for use as a telephone line for clipping on a filter at each end.

Quite often the telephone can be added with no circuit alterations in the line. Use with an open ended dipole is an example. But some circuit alterations are needed at times, especially if a folded dipole antenna is used. Such alterations take time, effort, and outdoor soldering equipment to restore the temporarily altered circuit. Therefore choice of using any system is a matter of being practical and knowing which one saves the most time and effort.

Outdoor antenna installations put up on hotels, schools, apartments, public buildings and office structures often use concealed transmission lines, built into enclosed and inaccessible runways. Here there is no question about saving time because the method of telephoning over the transmission line is the only practical solution.

The method of arranging a single purpose portable filter circuit is shown in Fig. 5. One R.F. choke coil is put in series with each side of the line. These stop the high-frequency radio signal

from entering the phone. These chokes would be the only items needed when the phones shunt the line in Fig. 6.

Alterations are needed before a phone is connected to a transmission line with the folded dipole antenna shown in Fig. 7. These changes are described in Fig. 8.

Fig. 9 is self explanatory when you recall how the chokes function in Fig. 5. You also remember that  $C_2$  is only needed for connecting it to a cut transmission line shown in Fig. 8.  $C_1$  is hardly necessary but helps  $C_2$  in some localities where very strong radio signals get by the RF chokes.

Fig. 9 uses switch  $S_1$  for disconnecting the dry cell. Being of the double-throw variety,  $S_1$  also re-establishes the electrical phone circuit so the phone will function from another talking voltage generated by a magnetic, crystal or carbon mike (with battery) connected at the other end of the line. Furthermore, with two identical units like Fig. 9, one being connected temporarily at each end of the line, the two cells can be connected in series-aiding, provided polarity is observed. Otherwise you get a series-bucking arrangement of the cells with no signal. To re-establish a series-aiding circuit, simply exchange the position of one pair of alligator clips where they are connected to either end of the line.

An examination must be made at the receiver end of the transmission line before clipping on the phone because here it is also necessary to know if a series or shunt connection is required. If the transmission line terminates with condenser coupling to its receiver as shown in Fig. 10 then no alterations are needed. Simply connect the alligator clips of Fig. 9 to the antenna terminals in Fig. 10 and open  $S_2$ . You are again using the chokes alone as shown in Fig. 5.

If the receiver uses a coil input as shown in Fig. 11, alterations are needed for temporarily connecting the phone in series. Here you essentially duplicate conditions made for Fig. 8 at the other end. However, you don't have to know actually what type of connection is at the other end if you can depend on your helper having made his connections to suit the conditions found there. In each case the telephone signal finds its proper path over the transmission line to terminate without interference in the other headphone. This is done without interference to the radio or television signal which is picked up by the antenna and passed on to the receiver.

Several models of a molded combination of receiver with carbon mike are currently available from "Surplus" radio dealers and some mail order houses which they purchased as surplus Signal Corps stock and now are selling at prices far below those paid originally by the U. S. Government. Their general appearance resembles the

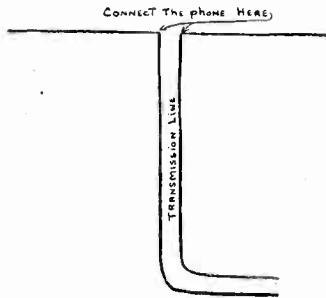

Figure 6. No alterations are needed on a standard dipole antenna for clipping on a phone which has filter chokes arranged in each phone lead.

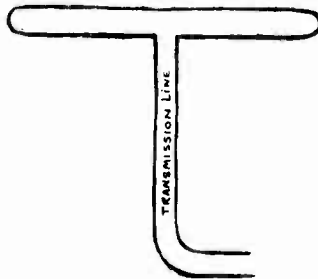

Figure 7. A phone system cannot be added to this transmission line with its folded dipole antenna until circuit changes are made temporarily for adding the phone in series.

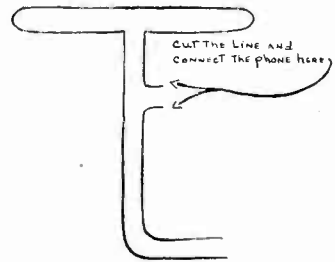

Figure 8. Transmission line temporarily cut to add phone in series. Opened line must be shunted with small RF by-pass condenser. This is fulfilled by  $C_2$  in Fig. 9 when  $S_2$  is closed.

Signal Corps Type TS-13-C unit shown in Fig. 12. Their internal circuit connections were identical for two models we used. These were the Type TS-13-B and Type TS-13-C. We were advised that other models have similar internal connections but the color code for wiring is sometimes slightly altered.

If you are fortunate in owning (or purchasing from remaining but dwindling stock) a pair of this surplus equipment, then it will be rather simple to disconnect and discard the original four-wire cable with its plugs.

Each terminal (to which the discarded four-wire cable was connected) is marked as shown in Fig. 13. Add the jumper between the BLACK and

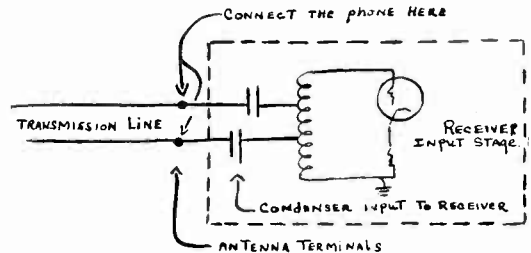

Figure 10. If the receiver uses condenser input it is a simple matter to clip on the phone because no circuit alterations are needed.

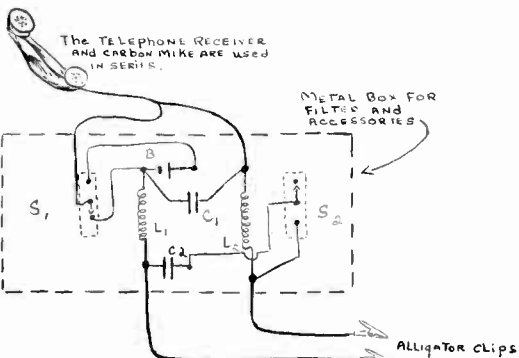

Figure 9. This filter allows for either shunt or series addition of the phone to a transmission line.  $L_1$  is a VHF choke.  $L_2$  is same as  $L_1$ .  $C_1$  is a .001 mfd mica condenser.  $C_2$  is same as  $C_1$ .  $S_1$  is a single-pole double-throw switch.  $S_2$  is same as  $S_1$  although connected for ON-OFF use of  $C_2$ . B is the 1.5-volt flashlight cell shown in Fig. 5, but  $S_1$  is now added to disconnect it when necessary.

GREEN terminals as shown in Fig. 14. Then connect the two wires of a new flexible cable so one wire fastens to the RED terminal followed by its second wire being fastened to the WHITE terminal. You have now connected the mike and receiver in series with the flexible new cable. Here at NRI we used a length of two-wire rubber covered lampcord for the new flexible cable.

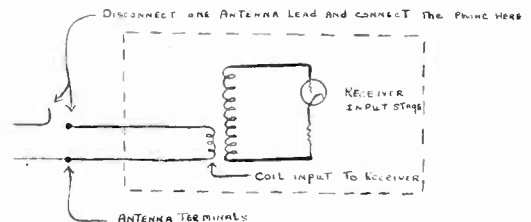

Figure 11. If the receiver uses coil input, then the transmission line must be opened to connect the phone in series. The opened line must be shunted with a small condenser. The condenser lets the radio signal pass although the transmission line is otherwise open for adding the phone in series. Compare with Fig. 8.

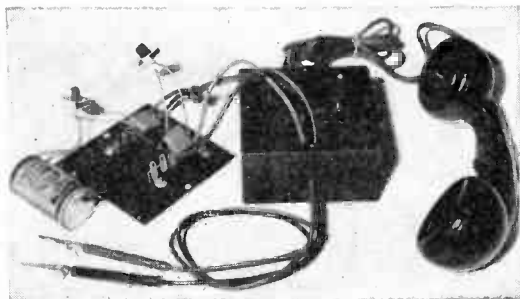
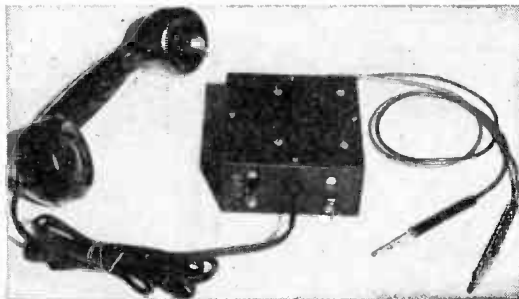

Figure 12. Photo of outside appearance of All-Purpose Phone System appears at left. Inside arrangement of parts is shown at right.

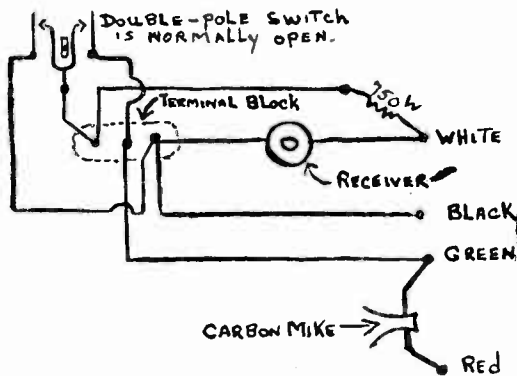

Figure 13. Internal connections to Signal Corps Type TS-13-B phone unit. Receiver can be connected in series with the carbon mike by adding the jumper and 2-wire line shown in Figure 14.

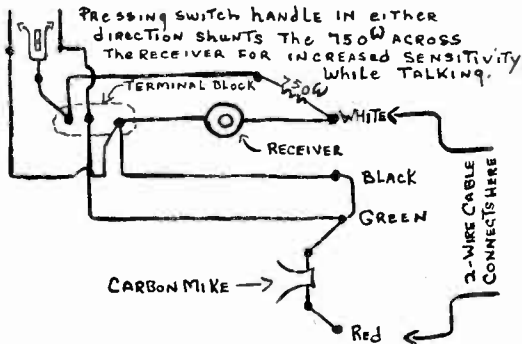

Figure 14. A jumper has been added between the BLACK and GREEN terminals. This connects the receiver in series with the carbon mike.

It is obvious that tests are conducted while the desired television station is on the air and the receiver is turned on. Thus, with any one of the telephone systems, the two men working together, although they are out of sight and ear-shot of each other, can explore and know when and where the antenna is working at its best.

— n r i —

## TELEVISION BOX SCORE

Stations Operating	33
Construction Permits Granted	91
Applications Pending	295

(AS OF AUG. 30, 1948)



# Promptness Makes More and Better Friends

By

DR. JAMES F. BENDER, DIRECTOR

THE NATIONAL INSTITUTE FOR HUMAN RELATIONS

*copyrighted, all rights reserved*

THEY began to call him "the late Mr. Jones" while he was still in his twenties. You see, he was seldom on time for an appointment. The poor fellow lived breathlessly, rushing around, missing the boat, and with more apologies on his tongue than a goose has feathers.

Strangers might have guessed, "There goes a busy fellow." But in truth, he was about as busy as an eight-day clock lacking a main spring. All his huffing and puffing didn't add up to promptness. For time had made him a slave—kept him sweating on a treadmill.

And that was the reason why Jones' human relations missed fire: *He never got in the habit of being prompt.* He never learned how to turn the tables—to make time a slave.

This business of being prompt—whether at home or on the job—is the corner-stone of good human relations. Go down a list of men and women you like best, and arrange them according to their promptness. Nine times out of ten, the leading lady (or man) is the one who never keeps you waiting.

And so, if you would build better human relations, get in the habit of being prompt. Like a miser, budget your hours and minutes, particularly those that involve friends, relatives, and co-workers. And as the habit grows, your credit

rating, your popularity, and your workmanship—all climb heavenward.

Have you ever noticed that people who are prompt have an air of strength and composure about them? They're not easily thrown off base. They know there is time enough. Down deep within them they have developed a sense of keeping in step with time. They have discovered a rhythm in life.

When you discover this rhythm, people shower you with increased responsibilities, and these have rewards in tow. And the secret of being prompt is not hard to find. All we have to do is say to ourselves "From now on, I'm going to be prompt." Keeping that promise faithfully for two or three weeks, in all our family and outside relationships, ordinarily wears a groove into which our schedules fit nicely. The groove may need a bit of lubrication from time to time, and this is easily supplied with a renewal of the promise. It really isn't difficult at all.

More than two centuries ago a father wrote to his son at college these priceless words of advice—jewels of wisdom for those who wish to improve their human relations—"Know the value of promptness: and snatch, seize and enjoy every moment of time. No idleness, no laziness, no procrastination: never put off till tomorrow what you can do today."

# Turns to Radio Repair After Mine Accident

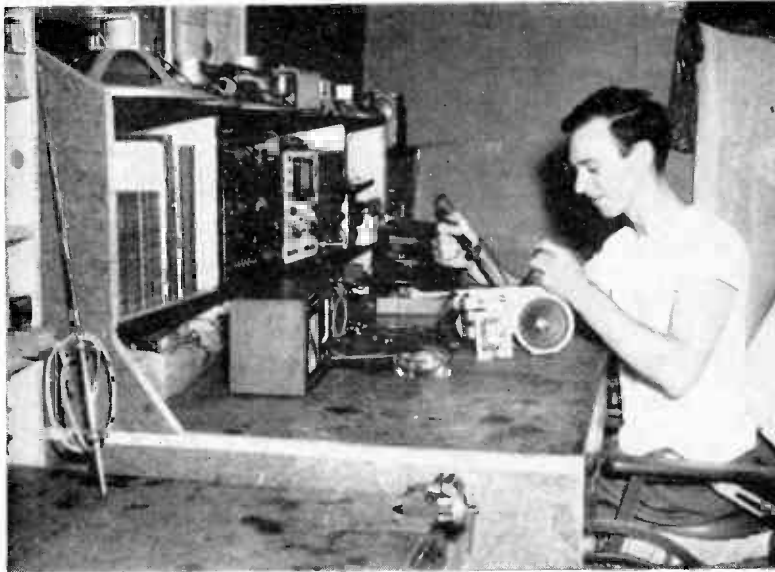

*This article appears through the courtesy of the "Herald Advertiser," Huntington, W. Va. It was written by Joanne Pinckard, of that newspaper.*

**P**ERFORMING technical radio jobs that the average layman can't do is all part of the day's work to Lewis Edwards, who not long ago was a layman himself when it came to the mechanical side of a radio.

A resident of Varney, W. Va., Edwards, 29, is in the radio repair business, and has been only since last year. Until 1944 he was a miner but was injured that year in a mine accident which left him paralyzed from the waist down.

Following almost a year's hospitalization, Edwards lived solely on mine compensation received for his injury until, in 1946, his case was brought to the attention of the local office of the West Virginia Division of Vocational Rehabilitation.

This Division offered to give Edwards a correspondence course in radio repairing from the

National Radio Institute and Edwards, not discouraged but anxious to learn a new field, agreed to take the training. The course lasted approximately a year, during and after which time the Division bought Edwards all necessary equipment.

Edwards set up shop in his own home in Varney, where he lives with his wife and their three children, Lewis Denver, eight, Barbara, six, and Virginia Lee, five. He uses a wheel chair to get around and sleeps right in the workshop. His bed has a handy contraption made of pulleys by which he can hoist himself up.

Edwards' work consists of general radio repairs, but as a side line he likes to tinker with loudspeaker systems. He has already built and sold two loudspeaker sets.

Doctors tell him that there is a possibility he may again walk some day, but until then he maintains he's happy and content working in his small shop.

# HOW TO MAKE CONTINUITY TESTS

By WILLIAM F. DUNN

NRI Consultant



William F. Dunn

*When we say there is continuity between two points we mean there is a path between the points through which DC can flow. The path may be a high resistance path or a direct connection between the two points. "Continuity Tests" involve the checking of the circuit to see that this path does exist, and also the checking of other circuits where a DC path should not exist to be sure that a circuit does not exist.*

**C**ONTINUITY testing in a receiver involves checking circuits for continuity where we know it should exist and also checking other circuits for continuity where we know the circuit should be open.

For example, we know that there should be continuity between the plate of the output tube and the cathode of the rectifier tube. By using an ohmmeter we can check this circuit for continuity, and if we do not obtain a reading we immediately know that there is a defect in this circuit. The next step is to then check the individual parts in the circuit for continuity—one of them will prove to be open.

We also know that the plate of the output tube should not show a low resistance reading to ground. If we checked the resistance between the plate of the output tube and ground and we obtain a low reading we immediately know that there is a short either in the plate circuit of the output tube itself or in the power supply.

Tests of this type are extremely simple and they are very useful to the beginner, because they can be performed with a minimum amount of test equipment. A multimeter similar to the NRI Professional Volt-Ohm-Mil-Ammeter can be used for carrying out all of these tests.

Whenever we encounter a receiver that fails to operate, we can frequently decide on the best procedure to use in locating the trouble by an examination of the set. For example, in an a.c.-d.c. receiver, if none of the tubes light (the tubes are all connected in series), the first step should be to check the continuity of the heaters of the various tubes in the series circuit. In all probability we will locate a tube that is defective.

If the set should be an a.c. operated receiver that uses a power transformer, and none of the tubes light, it is generally an indication either that the power cord is defective, the on-off switch is defective or the power transformer itself is defective. By taking a few simple readings with an ohmmeter we can quickly determine which of the parts is causing the trouble.

If when we plug the set in and turn it on we find that the tubes light and there is no sound whatsoever coming from the speaker it indicates that there is probably some defect in the power supply. If the power supply were operating there would more than likely be some slight hum in the speaker, except of course if the speaker itself were defective.

In any case, the most common cause of trouble in a power supply is defective filter condensers. We know that we should not obtain a low resistance reading when we check across a filter condenser with an ohmmeter. Our first step should be to check across the filter condensers in the set with an ohmmeter and if we do obtain a low reading it indicates that there is a short somewhere in the power supply. We should then proceed further and disconnect the leads from the filter condensers and check them one at a time. If one of the condensers is defective it will soon be located.

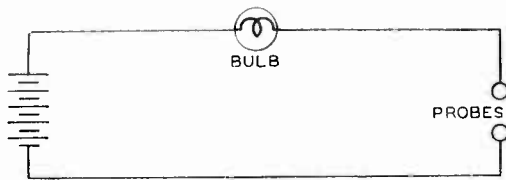

Fig. 1

Frequently you will encounter a receiver in which you can hear a slight hum in the speaker but otherwise the set is dead. This slight hum indicates that the power supply is probably operating and that the defect is somewhere else in the receiver. It may be that there is a defective screen by-pass condenser that has removed the screen voltage from one of the tubes or that there is a plate by-pass condenser somewhere in the set that is defective. By checking the continuity from the cathode of the rectifier to the plates of the various tubes in the receiver and also checking the continuity from the cathode of the rectifier to the screens of the various tubes in the receiver we will find out whether or not any of these circuits are open. Next, check between the plates of the various tubes and ground and also between the screens of the various tubes and ground. This will quickly show us if any shorts are present.

There are a great number of continuity tests that can be made on a receiver, and every repairman should be thoroughly familiar with these tests. Regardless of what type of equipment a serviceman may have available there will be times when the final location of the defective part will involve the actual checking of one or more parts with an ohmmeter.

In the early days of radio, servicemen realized that some means of checking continuity would be useful. The first continuity testers consisted of a battery and a bulb hooked up as shown in Fig. 1.

This system had the disadvantage that the bulb would not light when there was a high resistance in the circuit as well as when the circuit was open. Nor would it show how much resistance there was in the circuit even when the bulb did light. It was soon realized that a more suitable method of checking continuity was needed.

Servicemen next began to use a meter, a battery and a resistor all connected in series as shown in Fig. 2. The value of the resistance was chosen so that the meter would read full scale when the probes were shorted together. Then by reading the current flowing in the circuit as indicated on the meter, the resistance between the probes could be calculated.

The next step was a simple one, simply that of

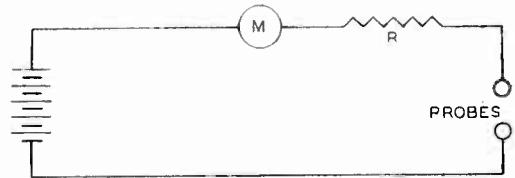

Fig. 2

adding a scale on the meter that had already been calibrated to read in ohms.

Fig. 3 shows a typical a.c.-d.c. receiver. While it's true that all of the defects that could exist in this receiver cannot be located by continuity measurements, a great deal of them can be located. Fortunately the most common defects in this type of receiver can be located by means of an ohmmeter, and as a result most beginners can service these receivers even though they have very little test equipment available.

Probably the most common defect in this type of receiver is the failure of the tubes to light. A glance at the diagram quickly shows us that the heaters of all of the tubes are connected in series. A break anywhere in this series circuit means that none of the tubes will light.

If, in a set of this type, the tubes do not light, the trouble can be quickly located by a few simple continuity tests. First, remove the 35W4 from its socket and then use an ohmmeter to check for continuity between one prong of the power plug and the #4 terminal of the 35W4 socket. There should be continuity between one of the prongs of the power plug and this terminal of the tube socket. After this test has been made, check the continuity between the other prong of the power plug and the chassis.

If both circuits prove to be complete we know that the power cord is good and also that the on-off switch is closing when the switch is turned on. This means that the failure of the tubes to light is due either to a defective tube, failure of one of the tubes to make good contact in its socket or the wiring between two of the tubes is defective.

The next step should be to fasten one probe from the ohmmeter directly to the chassis and then touch the #3 pin of 12AT6 with the other probe of the ohmmeter. If the #3 pin is connected to ground and the ground connection is good you should obtain a zero reading on the ohmmeter.

Next, move to the #4 pin of the 12AT6. If the 12AT6 is good and the tube is making good contact in the socket, you'll obtain a low reading between the #4 pin and ground. Next move on to the #3 pin of 12BE6 and so on through the remainder of the heater circuit. Somewhere in

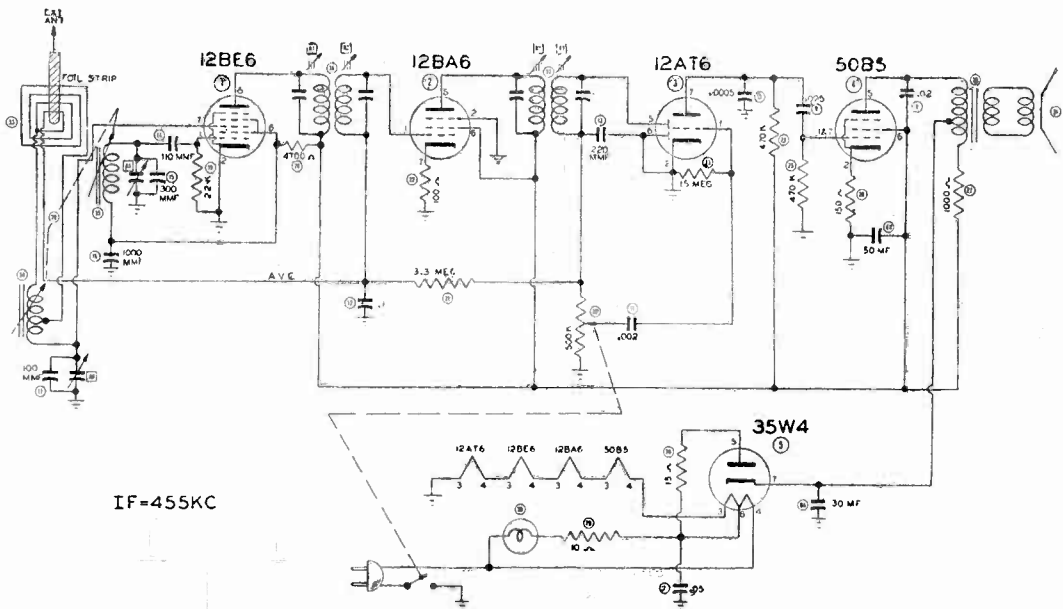

Fig. 3

this circuit you will find an "open" due, in all probability, to a burned out tube.

In addition to a defect in the heater circuit there are many more defects that can be located with an ohmmeter. Shorted filter or by-pass condensers can be quickly located. Also, open resistors or open i.f. or output transformers can be tested.

A very common defect in a receiver of this type is a shorted filter condenser. Filter condensers can be checked by checking the resistance between the cathode of the rectifier tube and ground.

If we check the resistance between the #7 pin of the 35W4 and ground and obtain a low reading, we immediately know that there is a short in the B supply. It's quite likely that this short is due to a defective filter condenser.

Suppose we obtained a reading of about 200 ohms between the cathode of the 35W4 and ground. Looking at the diagram, we see that the #7 pin of this tube is connected directly to the 30-mfd. input filter condenser. From this point we go through a portion of the output transformer that is used as a choke and then through a 1,000-ohm resistor to the 50-mfd. output filter condenser.

If there was a direct short in the 50-mfd. output condenser, the lowest reading we could obtain would be a reading of 1,000 ohms due to the fact

that there would be a 1,000 ohm resistor connected between the cathode of the 35W4 and the defective filter condenser. Since we obtained a reading lower than 1,000 ohms we can rule out the possibility of the output condenser being defective, and try replacing the input condenser.

Let's take another situation,—suppose we check the resistance between the cathode of the rectifier tube and ground and obtain a reading of about 5,000 ohms. This reading indicates either that there is a short somewhere in the set due to a defective condenser or else some condenser in the receiver has a very low leakage. However, a casual look at the schematic diagram will not tell what part is defective. We must investigate further.

This can be done by checking the resistance between the plate and ground and the screen and ground of each tube in the receiver. Somewhere in these measurements you will probably locate a clue that will lead us to the defective part.

Suppose, for example, that in this case the trouble was due to a defect in the 1,000 MMF. condenser used as the screen by-pass on the 12BE6 stage. As soon as we checked the resistance between the screen of this tube and ground, we would obtain a zero reading. When we look at the diagram, we'll see that the screen of this tube is isolated from the B supply by a 4700-ohm resistor and this would explain a reading of around 5000-ohms.

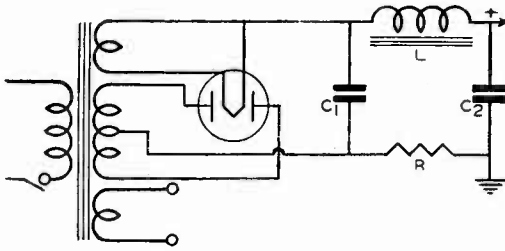

Fig. 4

In addition to shorts, it's possible to locate an open circuit by means of a continuity test. We know for example that there should be continuity between the cathode of the rectifier tube and the plate of each tube in the receiver. By checking the continuity from the cathode of the 35W4 to the plate of each of the tubes in the set, we would quickly locate an open circuit.

When we check to the plate of the 12BE6 and the 12BA6 we would expect to find a fairly low reading. We would not expect a zero reading because we know that there must be some resistance in primary of the i.f. transformers. A typical i.f. transformer usually has a resistance of about 20 ohms. However, since there's a 1,000-ohm resistor in the circuit a reading of about 1,000 ohms would be obtained.

We could carry this test further by checking the resistance between the cathode of the 35W4 and the screen of the 50B5. Then, we could check the resistance from the screen of the 50B5 to the plate of the 12BE6 and the plate of the 12BA6. In this case the only resistance in the circuit would be the resistance due to the primary winding of the i.f. transformers. Here we could expect to obtain a reading of about 20 ohms.

If we obtained a high reading in either case it would indicate an open or a partial open in the i.f. transformer. A zero reading would indicate that the primary winding was shorted either due to a defect in the trimmer or due to the fact that the leads to the primary of the i.f. transformer had shorted together.

Frequently in a receiver of this type the output transformer will open. A check between the cathode of the rectifier tube and the plate of the output tube should show continuity. A reading of somewhere around 400 or 500 ohms would be normal. If we obtain a high resistance reading we know that the output transformer is defective.

Whenever a receiver of this type using a tapped output transformer is encountered the continuity should also be checked between the cathode of the rectifier tube and the screen of the output tube when the output transformer is being tested.

It's possible that only one part of the winding is open and therefore both tests must be made before the output transformer can be assumed to be good.

Sometimes the defect will exist in the cathode circuit. It sometimes happens that the cathode resistor, particularly in the output stage, either opens or changes value. A check between the cathode of the various tubes in the receiver and ground will quickly reveal whether or not this trouble exists. The diagram shows that two of the tubes are grounded directly and therefore when we check between the cathodes of these tubes and ground we should obtain a zero reading. The other tubes have resistors in the cathode circuit, the sizes are given on the diagram and

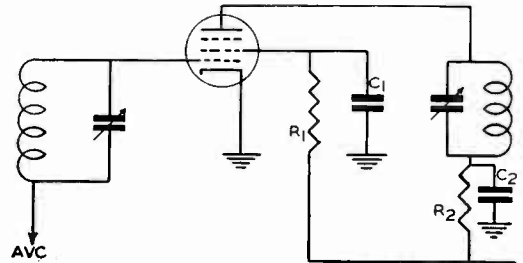

Fig. 5

from this information we know what reading we should expect.

Most of the tests outlined for an a.c.-d.c. receiver can be applied to an a.c. receiver using a full-wave power supply. Fig. 4 shows a diagram of a typical power supply.

The first step in checking this power supply should be to check the continuity of the various windings on the power transformer with an ohmmeter. An open in any winding indicates a transformer defect.

Next, check the resistance between the filament of the rectifier tube and ground. A low reading indicates a defect either in C1 or C2 or else a short somewhere else in the receiver.

You can quickly determine if the filter condensers are at fault by disconnecting them one at a time. For example, if you discover that when you disconnect condenser C1, the low reading disappears, this condenser is defective and should be replaced.

Sometimes the choke in a power supply will break down and the winding will short to the core. Since the choke is mounted directly on the receiver chassis, this results in a short across the power supply.

The surest way to check a choke is to disconnect both leads and check the resistance between one of the leads and the core. You should use a very high range on the ohmmeter and a reading of 10 megohms or more should be obtained.

After you've made this test on the choke, check it for continuity by checking the resistance between the two leads of the choke. Normally a filter choke used in a power supply will have a resistance of somewhere around 400 or 500 ohms. A reading of about 800 ohms wouldn't indicate a defect in the choke, it would simply indicate that the resistance is somewhat higher than normal. However, a high reading or no reading at all would definitely indicate that the winding is defective.

The only remaining component in the power supply to be checked is the resistor marked R on the diagram. The value of this resistor will usually be listed on the schematic diagram. Usually it's inserted in the power supply for the purpose of obtaining a bias voltage. Its value should be checked quite carefully.

Once the power supply has been checked we should, as in the case of the a.c.-d.c. receiver, check the continuity from the plate of each tube to ground and also from the screen of each tube to ground.

Fig. 5 shows a typical stage used as an i.f. amplifier in a receiver. Suppose when we checked the resistance between the plate of this tube and ground we obtained a reading less than the value of the resistor  $R_2$ . Immediately we know that there must be a defect somewhere between the plate of this tube and the resistor  $R_2$ . The chances are that the condenser  $C_2$  is defective.

If the reading between the plate of the tube and ground is higher than the resistance of  $R_2$  it's still possible that the condenser  $C_2$  is defective. All we have to do is take a reading on both sides of  $R_2$ . If the reading on the plate side of this resistor is lower than the reading on the other side of the resistor, the short is on the plate side of the resistor and it may be due to excessive leakage in the condenser  $C_2$ .

In exactly the same manner, condenser  $C_1$  should be checked. However, in the screen circuit, since  $R_1$  will usually be a fairly high resistance, if there is any indication of leakage in  $C_1$  even though the leakage resistance may be quite high, the condenser should be replaced. If there should be any doubt as to whether or not there is leakage in the condenser, it should be disconnected and a reading taken directly across it with an ohmmeter.

Frequently trouble is encountered in a receiver due to an open grid circuit. Fig. 6 shows how a.v.c. voltage is applied to the grid of the mixer

stage and the grid of the i.f. stage in a typical superheterodyne. If this circuit should become open at any point the grid of one or more of the tubes will be open-circuited and this will result in considerable hum especially when a station is tuned in.

A quick check of the i.f. transformer and the coil in the grid circuit of the mixer tube can be made by checking the continuity between the grids of the two tubes. You should obtain a reading equal to the resistance of  $R_1$ . An open circuit indicates that one of the coils or  $R_1$  is open—the defective part can be located by checking each of the coils individually.

Once we've found that there is continuity between the two grids, check the continuity between the grid of the i.f. stage and ground. An open reading indicates that  $R_2$  is defective or that the volume control  $R_4$  is defective.

When taking a reading of this type, you must use an ohmmeter capable of reading very high resistances. The value of  $R_2$  is frequently several megohms and the volume control is generally a .5-megohm unit. As a result, there will be a fairly high resistance between the grid of the i.f. stage and ground under normal conditions. If there should be any doubt as to whether or not there is a defect in the circuit, the correct thing to do is to check first the i.f. transformer, then  $R_2$  and finally the volume control itself.

Probably one of the most important things in making continuity measurements is to use the correct range of your ohmmeter. If the correct range is used, the readings that you obtain have a definite meaning that can be useful in determining the cause of the trouble in the set.

Referring back to the typical a.c.-d.c. receiver shown in Fig. 3, if we were to check the resistance between the cathode of the rectifier tube and

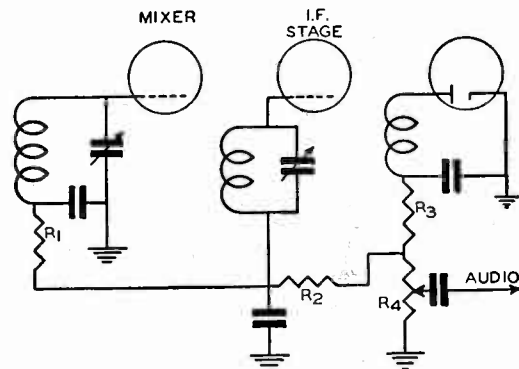
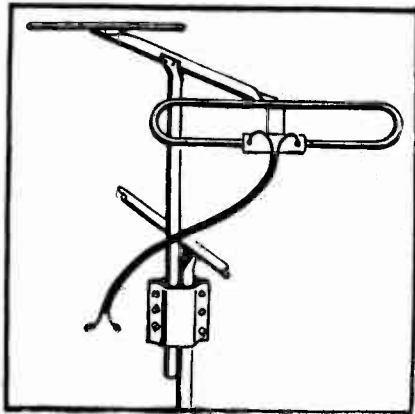

Fig. 6

ground using a very low range on the ohmmeter, it's possible that we might have a partial short in the 50-mfd. output filter condenser and this short would not show up in a test. We would obtain a reading of around 1,000 ohms even though this condenser had practically a direct short across it. 1,000 ohms might be such a high resistance that it would give very little deflection on the ohmmeter on the low range and therefore we would assume that there were no shorts in the power supply. On the other hand, if we used a higher range on the ohmmeter, we would immediately see that there's only 1,000 ohms resistance between the cathode of the rectifier tube and ground and from that information we could immediately suspect that the output filter condenser is defective.

It's just a great an error to use a high resistance range on the ohmmeter when you expect to obtain a low resistance reading. If we were checking the continuity of the primary of the input i.f. transformer used in the a.c.-d.c. receiver and used a high resistance range of the ohmmeter, there could be a partial open in the primary winding and the resistance of the primary could be several thousand ohms. However, if we were using a very high range on the ohmmeter this reading might not show up. The ohmmeter might simply indicate a relatively small resistance reading. From this we would assume that the primary winding of the i.f. transformer is good and fail to locate the trouble.

Whenever you take a continuity measurement the first step should be to determine approximately what the resistance should be. This can usually be determined from the schematic diagram. Then set the ohmmeter to the correct range and check the resistance.



The illustration at the left shows the new Taco type 445 high-frequency antenna adapter for use in tuning in TV Channels 7 to 13, now opening up. It is supplied with an aluminum tubular mast extension which mounts to the mast of the existing low-frequency antenna assembly, by means of a coupling clamp.

## Our Cover Photo

The WBZ-TV mobile truck, which is a "television control room on wheels," is pictured on this magazine's front cover ready for a remote pickup of a sporting or special event.

Technician Truman Craine is shown focusing an image orthicon camera with 17-inch lens, while technician Robert Henderson (right) is beaming micro-wave "dish," used in relaying the picture images back to main transmitter.

Technician Fred Moriarty is peering through escape hatch which leads from roof platform of truck to interior.

— n r i —

## High-Frequency Television Antenna Adapter

The type 445 high-frequency television antenna adapter for Channels 7 to 13, comprising a half-wave folded dipole with reflector as well as a quarter-wave connecting link with the existing antenna, is announced by Technical Appliance Corp., Sherburne, N. Y. The matching network is so designed that instead of the usual loss that occurs when loading one antenna with another, a gain is actually the result over the low band.

It should be noted that Taco antennas operate in both high and low bands, because the low-band antenna is a half wave length long on Channels 2 to 6, but will be three half waves long on Channels 7 to 13. The low-band antenna has an exceptionally low standing wave ratio in the high-

frequency band. However, it presents two main lobes against one single lobe for a half-wave antenna. This may necessitate re-orienting the antenna for reception of high channel stations if the antenna is now oriented for low-channel stations. This may present the problem of secondary images or "ghosts," which in extreme cases makes one antenna unsatisfactory. The Type 445 High-Frequency Antenna Adapter may be oriented independently of the low-frequency antenna, therefore providing satisfactory reception by minimizing "ghost" troubles.



# NRI LINE OF TEST INSTRUMENTS IS PROVING VERY POPULAR

WE are pleased with the response we are receiving from our students and graduates who have purchased one or more of the NRI Test Instruments. In many cases students and graduates have purchased all five of the instruments now available. Here are some brief comments:

"The Signal Tracer is really a wonderful test instrument. It saves lots of time in locating defects in a receiver."...

"My NRI Professional Signal Generator is Tops."...

"Am delighted with my NRI Tube Tester. It is not only a fine looking instrument but seems to do a fine job of testing."...

"I wish to express my thanks for such a fine instrument as the NRI Professional Resistor-Condenser Tester. I would be lost without it. This instrument has cut my work down to just about half. There is no guess work."...

"Am well pleased with my Signal Tracer. I have about cleaned my shop of the hard jobs that I had set aside. I would not think of being without this wonderful instrument."...

"I have had my NRI Professional Signal Tracer for about two months now. For alignment purposes it cannot be beat."...

"I have used both the NRI Signal Tracer and NRI Professional Resistor-Condenser Tester with much satisfaction. I can say I am proud to own such good instruments."...

"Received my Signal Generator. I think it is a beauty."...

## Quality Instruments at Reasonable Prices

There are good reasons why we are able to sell these high-grade quality instruments at our reasonable prices. There is no middle man profit. We contract for these instruments in large lots. They are manufactured exclusively for us according to our own engineering specifications and quality parts. They come direct to us from the factory and are shipped from our NRI Store Room direct to our students and graduates. Only students and graduates of the National Radio Institute may purchase these instruments.

## Immediate Deliveries Now

All of these instruments are now in stock. Immediate deliveries can now be made. If you plan to get one or more of these instruments for Christmas don't wait too long.

## Circulars Sent Upon Request

Without obligation in the least you may have a circular pertaining to any of these instruments. These circulars give full details regarding price and specifications. Simply place a check mark in the box in the coupon below indicating the instrument or instruments in which you are interested. Information will be sent to you by return mail. On the other hand if you are ready to place your order now then use the proper coupon order blank which you will find on each of the following five pages.

## Sold only in the United States and Canada

All instruments are sent by railway express. They are shipped express charges collect. It is requested that those who live outside of the United States or Canada do not send orders for these instruments because we have no facilities for making deliveries to foreign countries. Personal checks are acceptable but should be certified to avoid delay of ten to fifteen days in shipment waiting for checks to clear.

We believe the information given in the following five pages regarding testing instruments will be of great interest to our readers.

## IF INTERESTED IN RECEIVING CIRCULARS, USE THIS COUPON

NATIONAL RADIO INSTITUTE  
16th and You Streets, N. W.  
Washington 9, D. C.

98

Send me circulars pertaining to the instruments I have checked.

- NRI Professional Radio Tube Tester
- NRI Professional Signal Tracer
- NRI Professional Volt-Ohm-Mil-Ammeter
- NRI Professional Resistor-Condenser Tester
- NRI Professional Signal Generator

Name ..... Student No.....

Address .....

City ..... Zone ..... State .....

# The NRI Professional Radio Tube Tester

THE NRI Professional Radio Tube Tester is an ideal Tube Tester which we offer to you at a price you may feel assured is reasonable for a high grade, quality instrument of its kind.

In designing a portable Tube Tester which NRI felt would best serve its students and graduates we were primarily concerned with: 1, completeness of the test; 2, ease of operation; 3, long life (freedom from obsolescence); 4, appearance, and 5, cost.

The NRI Professional Radio Tube Tester is an emission tester, using the circuit type recommended by the Radio Manufacturers' Association, Tube Division.

It is a fact that after testing each tube for shorts or leakage between elements the value of a tube as far as its future use is involved is the ability of its cathode to emit electrons. Hence the NRI Tube Tester, like all emission testers, tests for shorts, leakage and then emission. Like all emission testers the circuit is so set that the meter tells you at once whether the tube is GOOD, BAD OR ? (questionable).

A Tube Tester is a basic need. If a serviceman can check tubes for shorts, leakage and emission quickly, he has eliminated tubes as a possible source of trouble, thus allowing him to concentrate on circuit defects. We decided on an emission type Tester because it can be made to test tubes rapidly and conclusively.

In the past, obsolescence (getting out of date due to the introduction of new tube types which could not be tested) was a very important factor to consider in purchasing a Tube Tester. In the NRI Tube Tester every effort has been made to avoid obsolescence.

This Tester is professional in appearance and impressive in action.

## Specifications

1. **Employs Standardized R.M.A. Emission Test Circuit**—Ten separate tube element switches make tube prong connections flexible—take care of future electrode connections.
2. **Ten Tube Test Sockets**—Tests 4, 5, 6, 7, and 7L prong tubes; plus octal, loctal, bantam, miniature; 5, 6, and 7 prong sub-miniature; and the new nine-prong miniature tubes.
3. **Tests Electric Eyes, Pilot Lamps, and Gaseous Rectifiers.**
4. **Nineteen Filament Voltage Taps**—0.75, 1.2, 1.4, 1.5, 2, 2.5, 3.3, 5, 6.3, 7.5, 12.6, 25, 32, 50, 70, 85, 95, 100, and 110 volts.
5. **Red Dot Triplett Meter**—Three inch square case. Entire Tube Tester covered by the standard R.M.A. guarantee.
6. **Short and Leakage Test**—Between all elements while tube is "hot," duplicating actual operating conditions.
7. **Value Test**—Reads directly BAD, ?, or GOOD. Meter is calibrated for comparison tests.



8. **Manual Line Voltage Adjustment.**
9. **Separate Tests for Multi-function Tubes**—individual tests for each diode in full-wave rectifier tubes. Separate checks on each section of multiple tubes.
10. **Special Tests**—open element test, filament tap and continuity test.
11. **Sturdy Maroon Crackle Finish Carrying Case**—balanced for easy carrying. Measures 10 x 10 x 6 1/2 inches.
12. **Actual Weight**—11 1/2 pounds. Shipping Weight, 15 pounds.
13. **Power Requirements**—50-60 cycle, 110-120 volts A.C. required. (Cannot be operated on D.C. or 25 cycle A.C.)
14. **Shipped Complete With Instruction Manual**—includes instructions for making your own chart listings on new tubes.

**\$42.50 Cash With Order**

The price is \$42.50 cash with the order. In every case the instrument is sent express charges collect. Please use order blank below.

## USE THIS BLANK TO ORDER YOUR TUBE TESTER

NATIONAL RADIO INSTITUTE  
16th and You Streets, N. W.  
Washington 9, D. C.

99

I enclose \$42.50 (certified check, money order, or bank draft) for which send me, express collect, one NRI Professional Radio Tube Tester.

Name ..... Student No. ....  
Address .....  
City ..... Zone.... State.....  
Express Office .....

# The NRI Professional Volt-Ohm-Mil-Ammeter

NRI is proud to offer this fine instrument to its students and graduates. The NRI Professional Volt-Ohm-Mil-Ammeter, Model 45, has been carefully engineered to give you maximum service and quality at a price you may feel assured is reasonable for a high grade, professional instrument of this kind. Simplicity of operation is an important feature. Easy-to-follow instructions are included with each instrument.

## 20,000 Ohms Per Volt

Enables you to make all necessary A.C. and D.C. voltage measurements. NRI design engineers have given careful consideration to selection of the voltmeter ranges incorporated in this instrument. A sensitivity of 20,000 ohms-per-volt was selected for the D.C. Voltmeter ranges, since this is ideal for D.C. voltage measurements in A.V.C. and other high resistance circuits found in A.M., F.M., and Television Receivers. We have selected a sensitivity of 5,000 ohms-per-volt for the A.C. Voltmeter ranges to give accurate readings for audio frequencies with minimum disturbance to the circuit under test.

## Plus These Features

- Wide Range of Resistance Measurements
- Valuable in F.M. Alignment
- Three Milliampere Ranges
- A 12 Ampere D.C. Current Range
- Output Meter Useful in Alignment
- Detachable Cover Included—Completely Portable

The NRI Professional Volt-Ohm-Mil-Ammeter, Model 45, is shipped complete with a removable, hinged cover; black leather carrying strap; 50 inch rubber-covered test leads; detachable alligator clips; and instructions for operating the instrument.

## Specifications

<b>VOLTS D.C.</b> (At 20,000 ohms per volt)	<b>VOLTS A.C.</b> (At 5,000 ohms per volt)	<b>OUTPUT</b>
0-3	0-3	0-3
0-12	0-12	0-12
0-30	0-30	0-30
0-300	0-300	0-300
0-1200	0-1200	0-1200
<b>AMPERES</b>	<b>MILLIAMPERES</b> D.C.	<b>MICRO-AMPERES</b>
0-12	0-12 0-12 0-120	0-60
<b>OHMS</b>		
0-1,000 (4 ohms center scale)		
0-10,000 (40 ohms center scale)		
<b>MEGOHMS</b>		
0-1 Meg. (4,000 ohms center scale)		
0-100 Meg. (400,000 ohms center scale)		

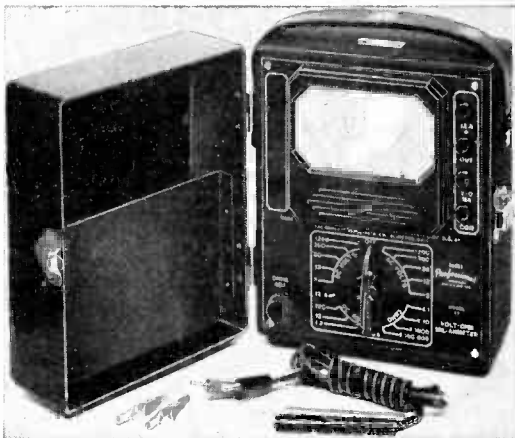

**BATTERIES:** One size "D" and One 30 v. Mini-Max Furnished.

Attractive Maroon Crackle Finish—Nickel Plated Hardware Case—7 $\frac{1}{8}$ " high, 6 $\frac{5}{8}$ " wide, 5 $\frac{1}{4}$ " deep.

Actual weight 5 lbs. Shipping weight 11 lbs.

Operating Instructions Included

**\$39.95 in Full With Order**

An excellent instrument—one you will be proud to own. The price is \$39.95, cash with order. In every case the instrument is sent express charges collect. Please use order blank below.

## USE THIS BLANK TO ORDER YOUR VOLT-OHM-MIL-AMMETER

NATIONAL RADIO INSTITUTE 100  
16th and You Streets, N. W.  
Washington 9, D. C.

I enclose \$39.95 (certified check, money order, or bank draft) for which send me, express collect, one Model 45 NRI Professional Volt-Ohm-Mil-Ammeter.

Name ..... Student No. ....

Address .....

City ..... Zone.... State.....

Express Office .....

# The NRI Professional Signal Generator

WE pooled the knowledge and skill of NRI's staff and the manufacturer's engineers to produce the NRI Professional Signal Generator. We wanted outstanding quality and performance.

It's priced low. The beginner in Radio Servicing can afford it. It's engineered to satisfy the serviceman who has been fixing AM, FM and Television sets. You'll know it's a honey once you've used it.

We gave foremost consideration to the following major specifications: (1) It has wide frequency coverage. Frequencies are available from 170 Kc. to 60 Mcs. on fundamentals, and 2nd harmonics may easily be used to cover frequencies as high as 120 Mcs. (2) It has high quality materials, to assure accurate calibration and stability. (3) It is professional in appearance. (4) All important essentials are included. Yet, it is simple in operation. It fills the needs of the beginner and experienced serviceman alike.

A new miniature tube in an electron coupled oscillator circuit has been used, as well as cathode follower output and other advanced engineering features. Little wonder we're proud to offer our Students and Graduates such an unusual buy!

## Specifications

**Power Requirements:** 50-60 cycle, 110-120 volts A.C. required. (Cannot be operated on D.C. or 25 cycle A.C.)

**3 Tubes Included:** 1—6BE6; 1—6SN7; and 1—5Y3.

**Frequency Coverage: 170 Kc. to 60 Mc.**

Band A: 170 Kc. to 550 Kc.

Band B: 550 Kc. to 1600 Kc.

Band C: 1.6 Mc. to 5 Mc.

Band D: 5 Mc. to 15 Mc.

Band E: 15 Mc. to 30 Mc.

Band F: 30 Mc. to 60 Mc.

F<sub>1</sub>: 60 Mc. to 120 Mc. (2nd harmonic of Band F)

**Planetary drive tuning condenser** — eliminates back-lash, ratio 6:1.

**Permeability-tuned R.F. Coils**—on first five bands. Air core coil used on F Band. Highly stable ceramic trimmers used on all bands. All coils not in use are automatically shorted.

**Three Types of Signals Available:** Unmodulated R.F., Modulated R.F., and 400 Cycle A.F.

**Coarse and Fine Attenuation.**

**Flexible Coaxial Output Cable**—with Amphenol connector.

Page Twenty



Actual Weight, 14 lbs. Shipping Weight, 17 lbs.

**Sturdy Maroon Crackle Finish Case:** Size 12" x 8 1/4" x 10 1/4", handsomely etched aluminum panel.

**Shipped Complete with Instruction Manual.**

**\$39.85 in Full With Order**

We are pleased to be able to offer this fine instrument to our students and graduates for \$39.85 with order. This price is very reasonable for this quality instrument. In every case the instrument is shipped express collect. Please use order blank below.

## USE THIS BLANK TO ORDER YOUR SIGNAL TRACER

NATIONAL RADIO INSTITUTE  
16th and You Streets, N. W.  
Washington 9, D. C.

101

I enclose \$39.85 (certified check, money order, or bank draft) for which send me, express collect, one Model 88 NRI Professional Signal Generator.

Name ..... Student No. ....

Address .....

City ..... Zone ... State .....

Express Office .....

# The NRI Professional Signal Tracer

## WHAT THIS INSTRUMENT WILL DO

1. Traces signal from antenna to loudspeaker.
2. Quickly localizes trouble in dead receivers.
3. Locates source of hum, noise or distortion.
4. Speeds tracing down intermittent trouble.
5. A tuned-type Signal Tracer enables accurate alignment without Signal Generator.
6. Also traces signals in F.M. Receivers.
7. Measures gain per stage.
8. Isolates oscillation in R.F. or I.F. stages.
9. Two stages of R.F. amplification select only that signal to which instrument is tuned.
10. Practically foolproof—you can't misuse it.

### Specifications

**Power Requirements**—50-60 cycle, 110-120 volts A.C. required. (Cannot be operated on D.C. or 25 cycle A.C.)

**6 Vacuum Tubes Included:** 2-6SK7; 1-6SQ7; 1-6K6-G; 1-6E5; and 1-5Y3-G.

**Frequency Coverage**—170 Kc. to 11.3 Mc.

- Band A: 170 kc. to 490 kc.
- Band B: 490 kc. to 1470 kc.
- Band C: 1.47 mc. to 3.9 mc.
- Band D: 3.8 mc. to 11.3 mc.

**Permeability-tuned R.F. Transformers** — insure better tracking, more gain.

**Planetary drive tuning condenser** — eliminates back-lash, ratio 6:1.

**5" Electro-Dynamic Loudspeaker**—insures plenty of audio output.

**Calibrated R.F. and A.F. Attenuators**—necessary in stage gain measurement.

**Actual Weight, 15 pounds. Shipping Weight, 20 pounds.**

**Sturdy Maroon Crackle Finish Case**—Size 12" X 8 $\frac{3}{4}$ " X 10 $\frac{1}{4}$ ", handsomely etched aluminum panel.

**Input Capacity of R.F. Probe**—2 uuf.

**Shipped Complete with Detailed Instruction Manual.**

### Canadians Note

Canadians should read specifications, first line, regarding power supply. Shipments to Canada require purchaser to pay customs duty and sales tax amounting to about 33% of purchase price.

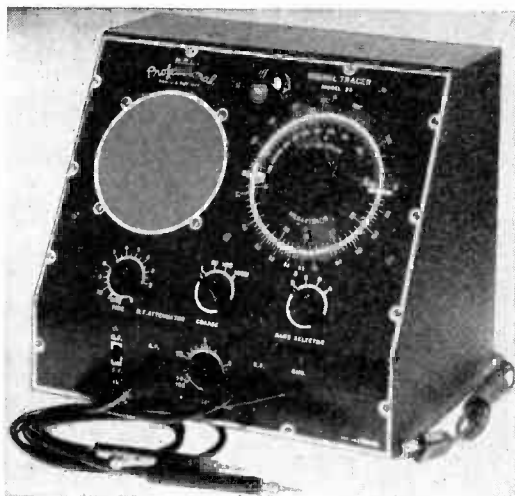

\$52.50 in Full With Order

We are pleased to be able to offer this fine instrument to our students and graduates for \$52.50 with order. This price is very reasonable for this quality instrument. In every case the instrument is shipped express collect. Please use order blank below.

## USE THIS BLANK TO ORDER YOUR SIGNAL TRACER

NATIONAL RADIO INSTITUTE  
16th and You Streets, N. W.  
Washington 9, D. C.

102

I enclose \$52.50 (certified check, money order, or bank draft) for which send me, express collect, one Model 33 NRI Professional Signal Tracer.

Name ..... Student No. ....

Address .....

City ..... Zone ..... State .....

Express Office .....

# The NRI Professional Resistor-Condenser Tester

## CONSIDER THESE FEATURES

1. Measures power factor of electrolytic condensers.
2. Measures capacity of all types of condensers.
3. Checks condensers for breakdown.
4. Measures resistor values in ohms and megohms.
5. Valuable in giving estimates on repair jobs.
6. A fundamental tester—does not become obsolete.
7. Enclosed in a sturdy self-shielding steel case.
8. Attractive maroon colored crackle finish.
9. Black panel with high-lighted, easy-to-read lettering.
10. Manufactured for NRI by a quality instrument maker, Industrial Instruments, Inc.
11. Easy to operate.
12. Step by step instructions supplied.
13. Price only \$34.25 in full with order.

## Specifications

1. Capacity ranges: .0001 mfd. to 200 mfd. in six ranges.
2. Resistance ranges: 10 ohms to 20 megohms, in six ranges.
3. By following simple instructions, capacity as low as 10 micro-microfarads and resistance as low as 1 ohm may be measured. This extremely low resistance range makes it easy to identify r.f. coil windings.
4. An ingenious bridge type circuit gives a linear calibrated main scale, with uniform sensitivity, unique in capacity testers.
5. D.C. voltage up to 600 volts available for condenser leakage and breakdown tests.
6. Uses four tubes: type 1-V and 6Y6G rectifiers; type 6SL7 dual triode in bridge circuit amplifier; and a type 6J5 tuning eye. Tubes furnished with instrument.
7. Extra heavy rubber covered test leads. Also two special test plugs for use in measuring very small capacity and very high resistance.
8. A.C. operated, 110-120 volts, 50 to 60 cycles per second. (Canadian Students and Graduates: Some localities in Canada do not have 110-120 volts, 50 to 60 cycles per second A.C. electricity, which is standard in the United States. This instrument cannot be operated on any other type power supply.)
9. Maroon colored, crackle finish cabinet. Deep etched black panel with attractive "high-lighted" lettering.
10. Measures 10 x 8 x 7½ inches.
11. Actual weight, 11 pounds. Shipping weight, 13 lbs.
12. Complete instruction Manual for operating shipped with instrument.



## Canadians Note

Canadians should read specifications, number 8 regarding power supply.

**\$34.25 in Full With Order**

This is another NRI service. We offer our students and graduates this high quality instrument at the moderate price of \$34.25, with order. In every case the instrument is shipped express collect. Please use order blank below.

## USE THIS BLANK TO ORDER YOUR R-C TESTER

NATIONAL RADIO INSTITUTE  
16th and You Streets, N. W.  
Washington 9, D. C.

103

I enclose \$34.25 (certified check, money order, or bank draft) for which send me, express collect, one Model 112 NRI Professional Resistor-Condenser Tester.

Name ..... Student No.....

Address .....

City ..... Zone..... State .....

Express Office .....

# Prescription For Long Transmitter Life

## Some Basic Rules and Procedures for the Care and Treatment of 250 Watt and 1 KW Broadcast Transmitters

*Reprinted from "OSCILLATOR," a Western Electric Company publication, with genuine thanks to that company for granting NRI permission to reproduce this article here. It will be of particular interest to those identified with transmitter work.*

THIS story is aimed at you, the engineering operator of a 250 watt or 1 kw broadcast transmitter. You are a man of real importance, because the smooth functioning of a broadcasting business depends to a great extent on how well you and that transmitter entrusted to your care get along with each other. This means the faithful application of a few simple rules of maintenance that are indispensable to the technical well-being of a broadcast installation.

Proper maintenance is not something "extra" that you as the transmitter engineer can throw in for good measure. It is required to prevent deterioration of equipment which may lead sooner or later to unnecessary and costly repairs or replacements, lost air time, and last, but not most important to you, the more than likely cooling of the management's affection for the engineering staff. A well-designed modern transmitter has built into it considerable "plus value" in the form of extra stamina and ability to survive definite amounts of harsh treatment. But it is fundamentally a complex, delicate piece of machinery, and over the long run, *any* transmitter, if neglected or abused, will surely bring trouble for you and the station management.

### Good Maintenance Demands Good Tools

The first requirement for proper maintenance is possession of the tools necessary to do the job. Following is a list of the test equipment spares and tools that should be on hand to allow efficient maintenance of the smaller broadcast transmitters. It does not include all the equipment that might be useful. It does include those tools that on the average can be expected to pay for themselves by saving repairs, replacements, lost air time, managerial and engineering agony, and gradual deterioration of the station's technical quality. Following the list of tools and equipment the uses to which they should be put will be discussed, together with the simple, basic re-

quirements of maintenance for any low power broadcast transmitter. In buying any of these tools, it pays to get equipment of the best quality. Here is the list:

### A. Test Equipment

1. A volt-ohm-milliammeter, 20,000 ohms per volt. (Yes, there *are* stations without one.)
2. A standard three-inch—or larger—oscilloscope.
3. An audio oscillator with good waveform.
4. A dummy antenna, that is, a non-reactive load of a value equal to the transmission line input impedance, capable of dissipating the modulated output of the transmitter, at least for short periods.
5. A mutual-conductance type tube-checker. This is optional but will greatly facilitate maintenance.
6. A multi-range VU meter for checking audio-levels.

### B. Supplies

1. A complete set of spare tubes, one for each socket, is recommended—rather than the minimum set allowed by F.C.C. rules.
2. An assortment of  $\frac{1}{2}$  watt, 1 watt and 2 watt carbon resistors, 50 ohms to 1 megohm.
3. An assortment of small mica and paper condensers, .0001 to .01 mfd.
4. A bottle of red fingernail polish. (This will be explained later.)
5. Spools of  $\frac{1}{8}$ " and  $\frac{1}{16}$ " rosin core solder.
6. Insulating tape.
7. Flexible hook-up wire with high-voltage insulation.
8. A quantity of bus-bar wire.
9. In addition, all spares and supplies not included in the above, which are recommended by the transmitter manufacturer.

### C. Tools

1. A tank type vacuum cleaner with flexible "sucker" attachment.

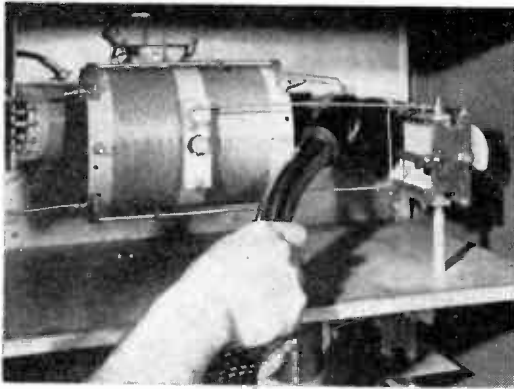

Figure 1. A tank type vacuum cleaner and the soft brush attachment used for furniture is an efficient way to remove dust and dirt from a transmitter.

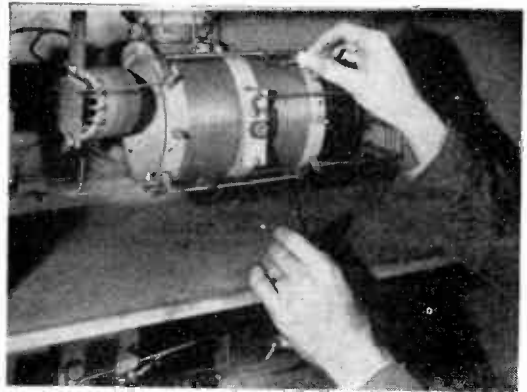

Figure 2. Fingernail polish, applied to taps on open coils, panel dials, etc. is insurance against accidentally losing the proper control settings.

2. A set of small ratchet wrenches,  $\frac{3}{16}$ " to  $\frac{5}{8}$ ".
3. Set of hex wrenches,  $\frac{1}{4}$ " to  $\frac{5}{8}$ ".
4. A pair of long nosed pliers.
5. A pair of good 6" diagonal cutters.
6. At least 3 screwdrivers—6" x  $\frac{1}{8}$ ", 6" x  $\frac{1}{4}$ ", and 6" or 8" x  $\frac{5}{16}$ ".
7. A 100-watt soldering iron—the best quality you can get.
8. A set of "Allen" wrenches.
9. A trouble light with 20-foot extension cord and insulated guard.
10. A 20-foot extension cord with multiple outlet.
11. A pen light.
12. A standard flashlight.
13. A fingernail filing board.
14. A small file or burnishing tool of the type designed for cleaning relay points.
15. Puller for indicator lamps.
16. Adjustment tools for jacks, plugs, relays.
17. Small dental-type mirror for inspecting relays.
18. In addition, the tools not included in the above, which are recommended in the Instruction Book issued by the manufacturer of your transmitter.

As already stated, the above list of tools and equipment is the *minimum* for the pay-off level in dollars and cents. Additional tools can be added to make the operator more efficient, to make his job easier and more convenient and to make sure of keeping the transmitting equipment at the very peak of its operating condition.

#### Dirt—Transmitter Enemy No. 1

The vacuum cleaner is placed first on the list of tools for a reason. Control of dirt is by far the most important single factor in keeping a transmitter in trouble-free operation. Different makes

and models of transmitters differ in their arrangements for minimizing the entry of dirt into the equipment, and different locations have widely varying amounts of material in the air. However, on the average, the operator should *once a week* remove the dirt from every part of the transmitter interior with the vacuum cleaner, being sure that all of the dirt is sucked into the cleaner bag, and not just blown away to some other location. At the same time, if the transmitter uses a filter on the input to the air cooling system, this filter should be washed thoroughly, in accordance with the instructions accompanying the transmitter, then immediately replaced, for it is very easy to forget to replace filters after washing.

In rural locations where the air is unusually clean, or in installations which have very close control of the air for the whole transmitter building, transmitter cleaning can be done less often. On the other hand, in certain of our cities—no names need be mentioned—the operator of a broadcast transmitter has a continuous cleaning headache because of "smog," that oily, smoky, man-made dirt storm. With a serious smog to contend with, complete air conditioning for the transmitter building will often prove to be economical, not only in preventing transmitter deterioration but in promoting operator efficiency and comfort.

After regular cleaning, the next most valuable maintenance habit is a parts inspection, *made about twice a week*, immediately after the transmitter is shut down. All parts such as transformers and chokes, by-pass condensers, small resistors not intended to dissipate appreciable power, etc., should be felt for abnormal temperatures. This will involve a good knowledge of the *normal* operating temperatures of the various



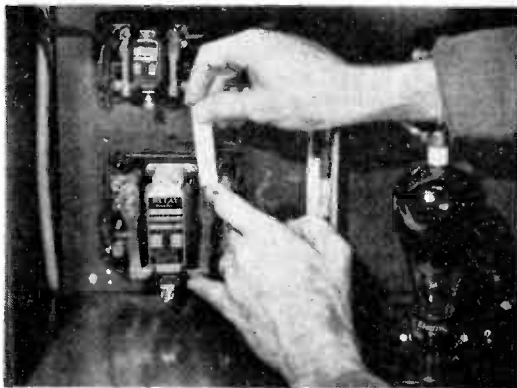

Figure 3. A fingernail board can be used to remove oxidation from relay contacts. For telephone-type relays, use the special burnishing tool recommended.

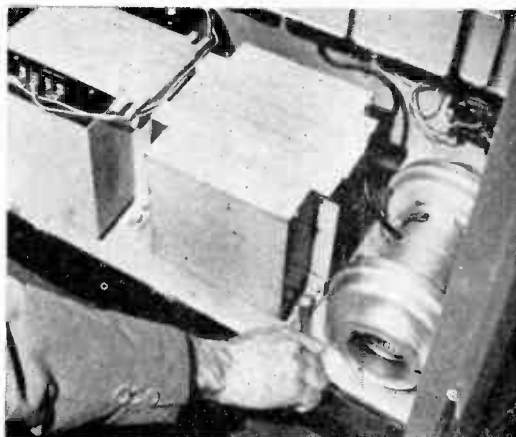

Figure 4. Bolted joints carrying current must be kept tight to avoid vicious circle of resistance, heat, oxidation—more resistance.

parts in the particular transmitter, as obviously certain parts in any transmitter, such as heavy chokes carrying large amounts of current, and resistors dissipating more than a few watts, are *designed* to run at various levels above room temperature. If a mica or paper by-pass condenser or 1 watt resistor is too hot to touch after the transmitter is shut down, a failure of some kind has occurred or is on the way. An immediate investigation is in order. *Don't short-cut safety rules and precautions during this inspection.*

During the temperature inspection, all relays and contactors can be examined for pitting of contacts, and excessive deterioration found should be removed with the fingernail board, or in the case of telephone-type relays, with the special thin file or burnishing tool designed for this purpose, to the extent recommended by the manufacturer. Wholesale filing of relay points to remove slight discoloration or irregularities, if the relay is operating properly, is *not* recommended.

You should study the manufacturer's maintenance instructions for blowers, circuit-breakers, and other auxiliary apparatus, as well as for the various types of relays.

A special case of abnormal temperature is that arising when a bolted junction carrying large current becomes loose, and dirt gets in the joint. The high resistance develops heat, causing oxidation across the joint, which increases the resistance, and this vicious circle will go on until the transmitter is inoperative or seriously out of adjustment. To avoid loss of service from such an oxidized joint, *tighten all the bolts on transformers, condensers, terminal strips, etc., and in*

*the frame, periodically.* If a high-resistance joint with considerable oxidation has developed, clean it out thoroughly before retightening. This can be one of the more mysterious causes of transmitter failure, since normal testing procedures can show every part of the transmitter in perfect condition, without indicating a high resistance in some part of the ground circuit, for instance.

If your transmitter has a multimeter on the panel which can be switched across various circuits to read tube currents and voltages, etc., have a schedule of normal readings handy at the operating point, for rapid checking. (See figure 6.)

It may be insulting to many engineers to suggest that they ought to learn what the normal test point voltages in their transmitter are, but here again experience has shown that there *are* individuals who make no use of this most valuable guide to normal operation of the transmitter.

#### "Lost—The Proper Control Settings"

And now we come to that fingernail polish. Every transmitter has a sizable number of control settings, including panel dials, switches, resistor sliders, taps on open coils, etc., which are determined and set when the transmitter is tuned. Nothing can cause more unnecessary lost service, mysterious and headache-producing "bugs," and post-mortem sense of foolishness, than an inconspicuous control setting which has been accidentally moved from its proper position. The fact that it has been moved is almost sure to escape attention, indeed cannot be determined in many cases without a retuning, and resetting of a major section—or all—of the transmitter.



Figure 5. An important maintenance "tool" is familiarity with test point voltages established for normal operation, as read on built-in panel multi-meter.

There are two principal ways to avoid thus losing your control settings and *both* should be employed, as they supplement each other. The first consists of putting a small dot of the polish at each setting after the transmitter is completely and properly tuned up. The advantages are apparent. Not only can you make a rapid visual check of all control settings when trouble develops; you have a quick and simple, but valuable aid to maintenance. A regular inspection of all the marked control settings requires only a few minutes each time and gives an excellent check on the proper operating condition of the transmitter.

The fingernail polish method of holding on to control settings is an effective and quick visual maintenance aid, but it must be supplemented by a second and more comprehensive maintenance tool—a complete tuning chart for the transmitter. Such a tuning chart should be carefully and completely prepared on a single sheet of paper and posted next to the transmitter after the tune-up is completed, showing not only all control settings, but in addition all meter readings covering normal operation of the transmitter in the tuned condition.

In figure 6 is reproduced a section of the tuning chart which is completely filled in and supplied with every Western Electric 442A or 443A, 500 watt or 1 kw AM transmitter. Similar charts are supplied with every other model of Western Electric transmitter. Every variable quantity or control setting of any significance, covering well over a hundred items for the 1 kw transmitter, is included on the chart, giving a most comprehensive and detailed picture of what "normal operation" means for that particular transmitter, and that particular antenna, operating on the assigned frequency and power.

#### Keep the Tuning Chart on Tap!

Intelligent use of such a chart will uncover nearly any conceivable type of failure, at least to the extent of showing what section of the transmitter is affected and how the abnormal condition has upset operation. In addition, the tuning chart is a powerful maintenance tool, often enabling the engineer to forecast and forestall trouble, while it is an early stage of development. For instance, tubes beginning to lose emission are readily spotted. And yet there have been stations discovered with the tuning chart filed away in some unknown drawer, completely lost to the engineering staff. If not posted next to the transmitter, it should have a fixed place where it is always kept, near the transmitter, for constant and ready use by the operating personnel.

The tuning chart should be a stabilizing influence on the dial grabber, that trigger-happy operator who can cover the distance, from anywhere in the transmitter building to the transmitter panel in one and a half seconds. The most important rule, when trouble develops, is *not* to jump to the transmitter and attempt a split-second retuning job—it can't be done that way. The "emergency" will become more serious, the transmitter hopelessly fouled up, if you try to retune without (1) a thorough knowledge of the transmitter and its normal action and (2) a careful analysis of any particular situation, to determine just what is wrong and what should be done about it. For this analysis, you should make it a rule to *take time for a tuning chart check*, at least of the principal meter readings and control settings, before touching the transmitter. Unless the automatic cut-off fails and something is burning up, of course; then you knock off the power in a hurry!

#### A Dummy Antenna Is Smart Business

For isolating a misadjustment, a dummy antenna is one of the most useful repair tools. If a transmitter's signal drops below normal, and the final stage is not operating in a normal fashion, it will generally be impossible to tell whether the antenna or the transmitter is out of adjustment without time-consuming measurements with an accurate r-f bridge, particularly with antenna

arrays. A mis-adjusted antenna can of itself upset the action of the final stages of *any* transmitter. An attempt to correct such an *antenna* fault by corrective adjustments on the *transmitter* can result in an endless snarl and the transmitter may be damaged.

On the other hand, if a simple and ready means of connection has been provided, in a matter of minutes the dummy antenna can be connected and the transmitter fired up. If the output stages now behave normally, the trouble has been identified as antenna misadjustment or failure, and a great deal of going around in circles avoided. Conversely, if the output stages are misadjusted, a quick re-alignment can be made with the dummy antenna in place. Various types of dummy antennas are available, the characteristic of all acceptable types being that they present a nonreactive—pure resistive-load of the proper value to the transmitter output, and are capable of taking the full modulated r-f power output of the transmitter without going up in smoke.

### Don't Let Your Blower Loaf

There are a number of operating habits that come under the heading of "maintenance," since they help keep the transmitter in good condition. One questionable practice common in some low power stations is the cutting off of the blower temporarily while announcements are made from the transmitter control room. No possible good can come from thus allowing the power tubes to overheat, even for relatively short periods. Some form of isolation for the microphone, for reducing any noise that may be created by the blower, is more economical in the long run than turning off the blower for announcement periods.

When a transmitter has been cut off, the blower should be allowed to run for another few minutes to clear all the hot air out of the cabinet. Cutting the power and the blower at the same instant produces a temporary rise in temperature in the power tubes which is similar to that occurring when an automobile motor is switched off and the cooling system stops operating. Repeated temperature rises of this kind may cause deterioration or damage to the tubes or other components.

A ten to fifteen minute filament warm up, when the transmitter is turned on, has proved itself as a tube-stretcher. This also gives you a chance to inspect all the tubes in the transmitter before

## 442A RADIO TRANSMITTER EQUIPMENT 443A

02 12-39	SERIAL NO. _____	
_____ KC	CHIEF ENG. _____	ADJUSTMENTS FOR _____ WATTS PO.
_____	TRANSMITTER SUPPLY _____ VOLTS	CYCLES. POWER REDUCTION FROM _____
<b>INTERNAL ADJUSTMENTS (Cont'd.)</b>		
L15A (2ND PLATE SAMPLING) ACTIVE TAPS, NO. _____	AND NO. _____	D-90418
L15A (1ST OUTPUT MESH) _____	TURNS.	D-90419
L16A (INTER-PLATE) _____	TURNS. UNUSUAL TURNS OPEN SWICHTED.	SS1A1
L16A (VIA PLATE SAMPLING) ACTIVE TAPS NO. _____	AND NO. _____	AUTEN
L16A (2ND OUTPUT MESH) _____	TURNS.	SEMI
L20A (2ND OUTPUT MESH) _____	TURNS.	
L25A (A.V. FILTER) ACTIVE TAPS NO. _____	AND NO. _____	D-9700F
L25A (VIA GRID SAMPLING) ACTIVE TAPS NO. _____	AND NO. _____	D-9728
L25A (VIA GRID SAMPLING) ACTIVE TURNS _____	AND _____	
C8A (VIA FIXED PLATE) _____	HPD.	SS1A
C15A, C16A (VIA FIXED PLATE) _____	HPD.	THRE
C31A (VIA FIXED PLATE) _____	HPD IN CIRCUIT.	AUTEN
C32A (VIA FIXED GRID) _____	HPD.	CI,
C32A (1ST OUTPUT MESH) _____	HPD. IN CIRCUIT.	C6,
C13A (2ND OUTPUT MESH) _____	HPD. IN CIRCUIT.	LL
C72A _____	HPD VIA GRID SAMPLING.	MISC11
C73A _____	HPD	
C74A _____	HPD VIA GRID SAMPLING.	AV7F
C75A _____	HPD	
C78A _____	HPD VIA PLATE SAMPLING.	THA
C79A _____	HPD	
C81A _____	HPD VIA PLATE SAMPLING.	1B1
C82A _____	HPD	
C83A, IN OUT.		
C90A, IN OUT.		
<b>RESISTANCE ADJUSTMENTS</b>		
R54A SLIDER _____	INCHES FROM LEFT TERM.	AMP. CONTROL OUT
R61A SLIDER _____	INCHES FROM LEFT TERM.	

Figure 6. Control settings established in final tuning are shown in detail on tuning chart. Above, portion of chart furnished with W.E. 442A and 443A.

the plate voltage is applied, so that you don't attempt to go on the air with an open filament or heater somewhere in the equipment.

### Knowledge Is Your Strongest Maintenance Tool

The most important "maintenance" procedure of all is implied in much that has been said above, but it needs to be emphasized as strongly as possible. It is for every member of the engineering staff to acquire a complete knowledge of your transmitter, of its theory of operation, of the normal function of each section and part, of what happens when different controls are misadjusted. Study the instruction book prepared by the manufacturer, if possible before your transmitter goes on the air, and keep it in an accessible place for use by the engineering staff. The manufacturer has spent a large sum of money and considerable time in getting down on paper all the things you need to know for top-efficiency operation of the transmitter.

— n r i —

The art of concentration spells the difference between rapid progress in lesson studies and relative slowness. When you are studying, put everything but the lesson material out of your mind—concentrate. Too few of us have learned this valuable secret but it is the stock in trade of all successful men, whether they be bankers, lawyers, candlestick makers or radionien.

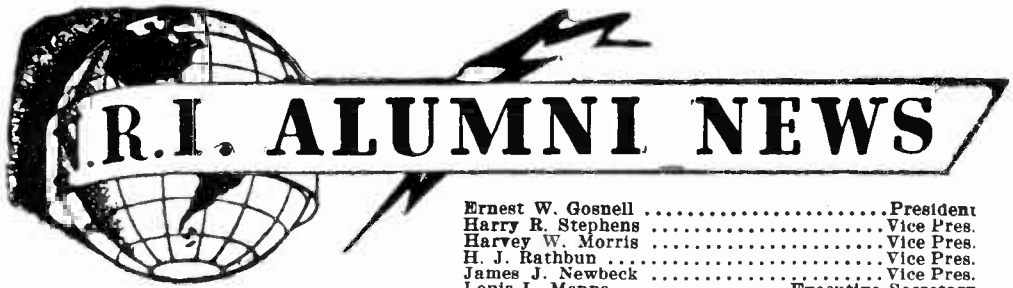

Ernest W. Gosnell .....	President
Harry R. Stephens .....	Vice Pres.
Harvey W. Morris .....	Vice Pres.
H. J. Rathbun .....	Vice Pres.
James J. Newbeck .....	Vice Pres.
Louis L. Menne .....	Executive Secretary

## Harry G. Andresen of Chicago and Louis J. Kunert of New York are Nominated for President

THE balloting for nominees for President and Vice-Presidents of the NRI Alumni Association came to a close on August 25. A count of the votes shows Harry G. Andresen of Chicago and Louis J. Kunert of New York to have the highest total of votes. They therefore will be the candidates for President.

Both Andresen and Kunert are well known to our members. Andresen for many years was Chairman of Chicago Chapter as well as Vice-President of our National Organization. He has contributed much to the welfare of Chicago Chapter and has always been a loyal member through thick and thin. He would make a good president.

Kunert is one of the shining lights in New York Chapter where he has served as Secretary for many years. In 1944 he was elected President of our national organization.

Previous to that time he served several terms as Vice-President. It is a real compliment to Kunert to be nominated for the Presidency even though he previously held the office.

According to our Constitution, the President may not succeed himself, but he may be a candidate after a lapse of one year. Therefore, Mr. Kunert is a fully qualified candidate to run for the office against Mr. Andresen.

For Vice-Presidents we have eight nominees, four of whom will be elected. To begin we have Charles H. Mills of Detroit. Mr. Mills has been very active in Detroit Chapter for many years. James Newbeck of New York Chapter has been re-nominated. Newbeck is just completing his first term as Vice-President. Likewise, H. J. Rathbun of Baltimore Chapter has been re-nominated. He too is completing his first year as Vice-President. Harvey Morris of Philadelphia

also has been re-nominated and is another of our loyal workers who was elected to a National Office for the first time this year. Harry Stephens and F. Earl Oliver of Detroit again are nominees. Stephens has been President and has been elected a Vice-President for the past several years. Oliver likewise has been President and Vice-President. He is always a strong candidate in our annual elections.

It is very interesting to have as nominees two men who have no chapter affiliations. They are Oliver B. Hill of Burbank, California and J. J. Jenkins of Washington, D. C. Mr. Hill was a Vice-President in 1945. Mr. Jenkins has been a candidate for one office or another on numerous occasions and it is a real compliment to him to be nominated for the Vice-Presidency in this year's election.

We at Headquarters wish to thank those of our Alumni members who submitted ballots. We hope that even more will vote for President and Vice-Presidents now that the nominees have been selected. The ballots will close October 25. The successful candidates will be announced in the December-January issue of NR News which goes to the printer on November 1.

You will find your ballot on page 29. Remember that only members of the NRI Alumni Association are qualified to vote in this election. All Alumni members are urged to vote. If you do not wish to destroy your magazine by clipping the ballot, you may submit your choice of candidates in a letter or postcard. You must, however, follow the style of the ballot.

Mail your ballot to Chas. Alexander, Bookkeeper, NRI Alumni Association, 16th and U Streets, N. W., Washington, D. C. Please do it now.

## Chapter Chatter

Right off the bat we are going to start with some good news regarding the Chairman of Philadelphia-Camden Chapter, Harvey W. Morris. Harvey is quite a Television expert and is now working for a Philco Television contractor in Byrn Mawr, Pennsylvania, in charge of the shop. Again he finds that his new employer is an NRI man. . . . Six new members but the Secretary has not yet sent the names to Headquarters. . . . With Television taking the country by storm, most of the discussions at this Chapter have been on the subject of Television with Chairman Morris taking the lead. . . . At one meeting, however, they had a demonstration of the oscilloscope and meter in aligning radios. At still another meeting, the Chairman brought a Philco projection model Television chassis and picture tube and gave the members a demonstration of projection Television.

Charles Fehn, who never misses a meeting, and who has been Vice President and also President of our National Organization, has been late at several of our meetings but he never misses entirely. His mother has been ill. Best wishes of all of our members for her speedy recovery. . . . Big news is that some twenty members of Baltimore Chapter are going to visit Philadelphia-Camden Chapter on the twenty-seventh of September. Alumni President Gosnell and Vice President Rathbun will be in the group. Executive Secretary Menne will also come from Washington to join us. This should be a big night. . . .

Speaking of Baltimore, Secretary Lutz reports regularly after each meeting. Things always run smoothly there because all the officers take a serious interest in their work. They have a program committee consisting of Members Clark as Chairman, Rathbun and Whitt. They think things out in advance and that is why Baltimore always has something worth while to offer its members. . . . Rathbun gave an excellent talk on Second Detectors with diagrams and charts on the blackboard. . . . Whitt also made a good talk. His subject was Servicing by Signal Tracing. New member is James F. Thomas. . . . a hearty welcome to him. Chairman Marsh has been ill lately and Thomas Clark has filled the Chair in a very acceptable manner. . . . At one meeting, we discussed record players, also loop antennas on a.c.-d.c. sets. . . .

Not much from Chicago on which to base a report. Harry Andresen has a pet idea. . . . He would like a Chapter on both the north and south sides of Chicago. Thinks it would improve attendance if fellows did not have to travel so far to attend meetings. . . . The thought is good but it has some bugs in it. We'll be glad to hear from Chicago members regarding this suggestion.

(Page 30, please)

## Election Ballot

All NRI Alumni members are urged to fill in this ballot carefully, following instructions given on page 28. Mail your ballot to National Headquarters immediately.

### FOR PRESIDENT (Vote for one man)

- Harry G. Andresen, Chicago, Illinois
- Louis J. Kunert, New York, N. Y.

### FOR VICE PRESIDENT (Vote for four men)

- Oliver B. Hill, Burbank, Calif.
- J. J. Jenkins, Washington, D. C.
- Chas. H. Mills, Detroit, Mich.
- Harvey Morris, Philadelphia, Pa.
- James Newbeck, New York, N. Y.
- F. Earl Oliver, Detroit, Mich.
- H. J. Rathbun, Baltimore, Md.
- Harry R. Stephens, Detroit, Mich.

### SIGN HERE:

Your Name .....

Your Address .....

City ..... State .....

Polls close October 25, 1948. Mail Your Completed Ballot to:

C. ALEXANDER, BOOKKEEPER  
NATIONAL RADIO INSTITUTE  
16th and U Streets, N.W.  
WASHINGTON 9, D. C.

Detroit, as is customary, suspended meetings during July and August. They opened again in September with the same enthusiasm which has always been present on opening night. Look for full report next issue.

New York goes along in its even way. Every now and then they have a social meeting at which they serve refreshments. . . . There is a real club spirit in New York Chapter. Everyone is more than willing to do his share for the good of the organization. . . . Ralph Georg gave a very good talk on FM. He began by talking about the transmitter which was so interesting the fellows kept him right on the subject. It was necessary to carry the talk over until the next meeting to be concluded. . . . Chairman Wappler is as aggressive as ever. Secretary Kumert always on the job. . . . The Executive Committee meeting regularly to plan programs and other things for the good of the members. . . . Zimmer and Remer doing fine work. . . . As we go to press, a meeting of this committee is scheduled with Executive Secretary Menne to be present. After the meeting, we will adjourn to our regular meeting of the Chapter. Everything in swell shape here.

Meeting places and dates for all Chapters follow. All NRI students and graduates are welcome as guests at any of these meetings.

### Local Chapter Meetings

**NEW YORK**—Meet at 8:15 P.M. on 1st and 3rd Thursday of each month at St. Mark's Community Center, 12 St. Mark's Place—between 2nd & 3rd Ave., New York City.

**PHILADELPHIA**—Meet at 8:15 P.M. on 2nd and 4th Monday of each month at 4510 Frankford Ave. (third floor).

**BALTIMORE**—Meet at 8:15 P.M. on 2nd and 4th Tuesday of each month at 745 West Baltimore St.

**DETROIT**—Meet at 8:15 P.M. on 2nd and 4th Friday of each month at Electronics Institute, 21 Henry St., corner Woodward (fourth floor).

**CHICAGO**—Meet at 8:15 P.M. on 2nd Wednesday of each month at 2759 So. Pulaski Road.

### Television Coverage Expanding Rapidly

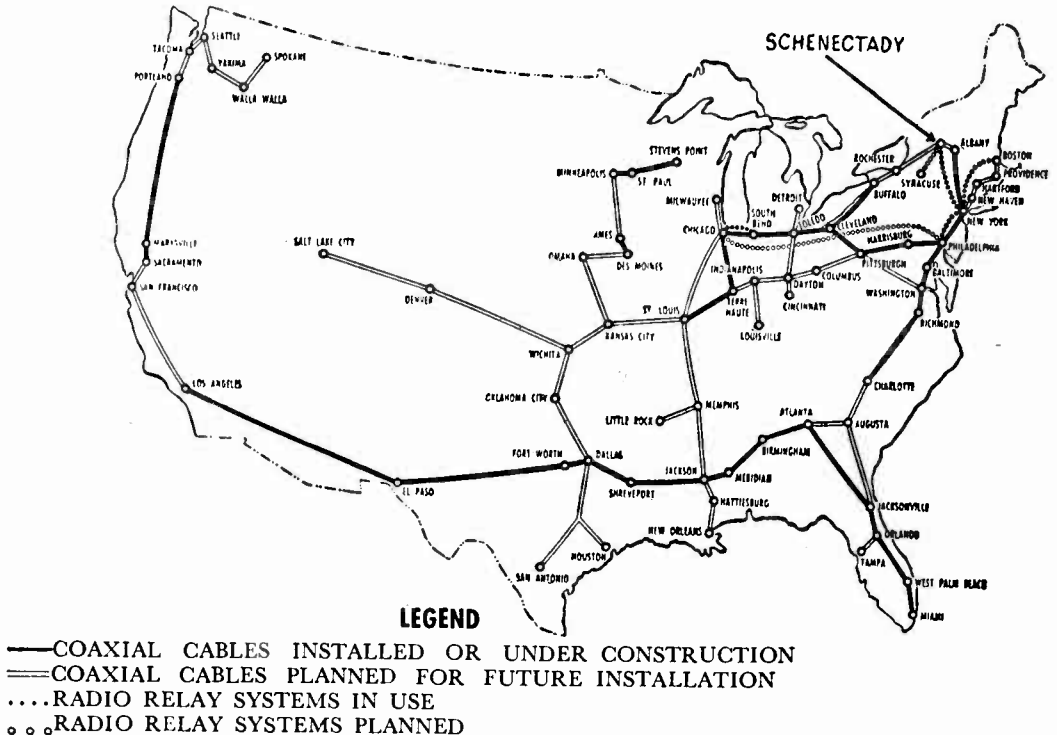



## Here And There Among Alumni Members

Alumnus Crite Mason, Jr., of Memphis, Tenn., is accepting a position as instructor in Radio Theory and Servicing at the Griggs Business College. Mason owns his

just received a photo of Rockwell at his test bench. Really a neat setup!

— n r i —

Graduate Isaac T. Hudgens, of Magnolia, Ark., has branched out into wholesale servicing for dealers, as well as appliance sales. Says that 90% of the servicemen he knows are NRI men.

— n r i —

Otis L. Wright of Albuquerque, New Mexico, has been advanced to the Civil Service rating of P-5 Electrical Engineer. Congratulations!

— n r i —

John Keller, St. Martinsburg, Penna., has been with the CAA for several years as an Air-craft Communicator. Making over \$4000 a year now!

— n r i —

Graduate A. B. Carraway now owns the Gulf Radio Lab in Port St. Joe, Florida. He has a very nice service business and says he's really busy.

— n r i —

Our last letter from Roy Brownson, of Venice, Calif., says he is now with the Electrical Research Products Division of Western Electric. He is an Equipment Specialist, and making over \$500 per month. We think this is excellent.

— n r i —

Graduate John W. Pritting has been transferred from Adak, Alaska to the island of Guam. He is engaged in ionospheric research for the U.S. Bureau of Standards.

— n r i —

Nice letter from J. C. Akins, of Brady, Texas. He has a spare time service business on his farm, bringing in \$10 a week average.

— n r i —

Jim McWilliams, of Birmingham, Alabama, has retired as Captain of Engine Co. 24 of the Birmingham Fire Dept. and is devoting all his time to Radio servicing and electrical work. Says he is making more money now than he ever made before.

— n r i —

Clifton W. Hartley has had a spare-time service business in Arcadia, Indiana for the past eight years. He is thinking of making a full-time job out of this business, as it is becoming too large for a part-time proposition.

— n r i —

Herbert F. Lucke of Palmyra, Mo., was a visitor at NRI. Now has eighteen people in his employe in his merchandising business. Mr. and Mrs. Lucke, with two of their three children were enjoying a well earned vacation, traveling by auto.

— n r i —

Very nice letter from Carl F. Knudsen of Copenhagen, Denmark. He is tremendously interested in Wire Recorders, and is doing some experimenting on a device of his own. Sends greetings to all Alumni members. Says he always turns to Alumni News first. Hear! hear!

own service business in Memphis.

— n r i —

Metro M. Sorockha, New York Chapter member boasts a new "ham" ticket. His call is W2YPF.

— n r i —

Good news from Guy Emery of Sacramento, Calif.! Guy's eyes have been giving him trouble, but he is now able to use them for short periods.

— n r i —

We're glad to hear from Charles L. Foster, of Cambridge, Ohio, who works for American Telephone and Telegraph Co. Foster has just passed the FCC exam for a first class radio-telephone license.

— n r i —

A visitor at NRI—Joseph P. Smith, Jr. of Detroit, Mich. He has a spare-time radio service business, which from present indications will be full time eventually.

— n r i —

Graduate Walden P. McKim, an engineer at W.J.L.D. Bessemer, Ala., is doing fine. In addition to a first 'phone ticket, he has acquired his second class telegraph and amateur call W4KVB. He is busy installing F.M. equipment for their new F.M. station, WD4XE.

— n r i —

We thank Graduate Leon Latham, of Streator, Ill., for the two fine photos we received from him. Although Streater is 100 miles from Chicago, Latham has attended local chapter meetings there, and is proving a real booster.

— n r i —

Evidently Clarence Zink, of Elmhurst, Ill. is a camera fan as well as a Radio-Trician. In his last letter, he enclosed two time-exposures of his fine radio test bench. He owns four of the five NRI test instruments. Says business is good.

— n r i —

C. E. Hoskin is now Service Manager for the Home Appliance Co. in Seattle, Wash. Making \$72 a week and doing very well. Hoskin expects Television in Seattle soon and is busy getting prepared for it.

— n r i —

R. L. Rockwell, of Mt. Vernon, Ohio, is really going places in Radio service work. His spare-time radio business now includes electrical appliance sales. He grossed better than \$10,000 last year in the front room of his home. We've also

# NATIONAL RADIO NEWS

FROM N.R.I. TRAINING HEADQUARTERS

Vol. 13                      October-November, 1948                      No. 5

Published every other month in the interest of the students  
and Alumni Association of the

NATIONAL RADIO INSTITUTE  
Washington 9, D. C.

The Official Organ of the N. R. I. Alumni Association.  
Editorial and Business Office, 16th & You Sts., N. W.,  
Washington 9, D. C.

L. L. MENNE, EDITOR  
J. B. STRAUGHN, TECHNICAL EDITOR

NATIONAL RADIO NEWS accepts no paid advertising. Articles referring to products of manufacturers, wholesalers, etc., are included for readers' information only, and we assume no responsibility for these companies or their products.

## Index

Article	Page
Editorial .....	2
Telephone Systems for Adjusting Television Antennas .....	3
Television Box Score .....	8
Promptness Makes More and Better Friends .....	9
How to Make Continuity Tests .....	11
Our Cover Photograph .....	16
The NRI Line of Radio Test Instruments .....	17
Prescription for Long Transmitter Life .....	23
NRI Alumni Nomination Results .....	28
Alumni Association Local Chapter News .....	29
Here and There Among Alumni Members .....	31

Printed in U.S.A.

P O S T M A S T E R : If addressee has removed, notify  
sender on FORM 3547 postage for which is guaranteed.

**NATIONAL RADIO NEWS**  
16th & U Sts., N.W., Washington 9, D. C.

Published every other month by  
National Radio Institute

For:

Mr. Robert A. Felkey  
326 Schenectady St.  
Schenectady, N.Y.

1215 YC 8 GI

\* 3/8/48

U. S. POSTAGE  
1c PAID  
Washington, D. C.  
Permit No. 7052