

# NATIONAL RADIO NEWS

STRATOVISION  
See Page 13



Aug.-Sept.  
1947

**IN THIS ISSUE**  
Jerry McCarthy—Professional Recording  
Ballast Tubes in Radio Servicing  
Alumni Association News

VOL. 12  
No. 10



---

---

## THE AGE OF OPPORTUNITY

Your father or your mother will remember the excitement which swept the country when "moving pictures" were first introduced. Today, scarcely forty years later, you are enjoying the marvels of natural-color talking pictures. Within a single lifetime this great progress has taken place, bringing opportunity, success and fame to countless thousands.

About the same time that movies became popular, the Wright brothers were making their first flights at Kitty Hawk, North Carolina. The aviation industry was born—and look at it today!

It was just twenty-seven years ago that station KDKA thrilled the nation with the first broadcast of presidential election returns; today Radio is ranked among the billion-dollar-a-year industries, with Radio servicemen taking in one hundred million dollars last year for their labor alone in repairing Radio sets. Radio is still expanding—still creating new opportunities for trained men!

And today, under our very eyes, another huge new industry has been born. Television transmitters are already feeding picture signals into the ether on regular schedules, and television receivers are reproducing these pictures with a quality equal to that of home movies. No one can predict how large this marvelous new industry will grow, creating countless more good jobs for men having the necessary fundamental Radio training.

Today, also, the electronic control field offers unlimited opportunity. The man who knows how to build and install robot electric eye devices, electric ears, electric noses, electric feelers, and electric tasters need never worry about his future—and this industry, like television, is still in its baby days.

Radio, television, electronics—growing fields which know no limit—offering much today and promising more tomorrow—and best of all, one fundamental course of training can prepare a man for any one. Truly we are living in an age of opportunity!

J. E. SMITH, *President.*

# Jerry McCarthy Busts Things Wide Open In The Field Of Professional Recordings

*By L. L. Menne, Editor*

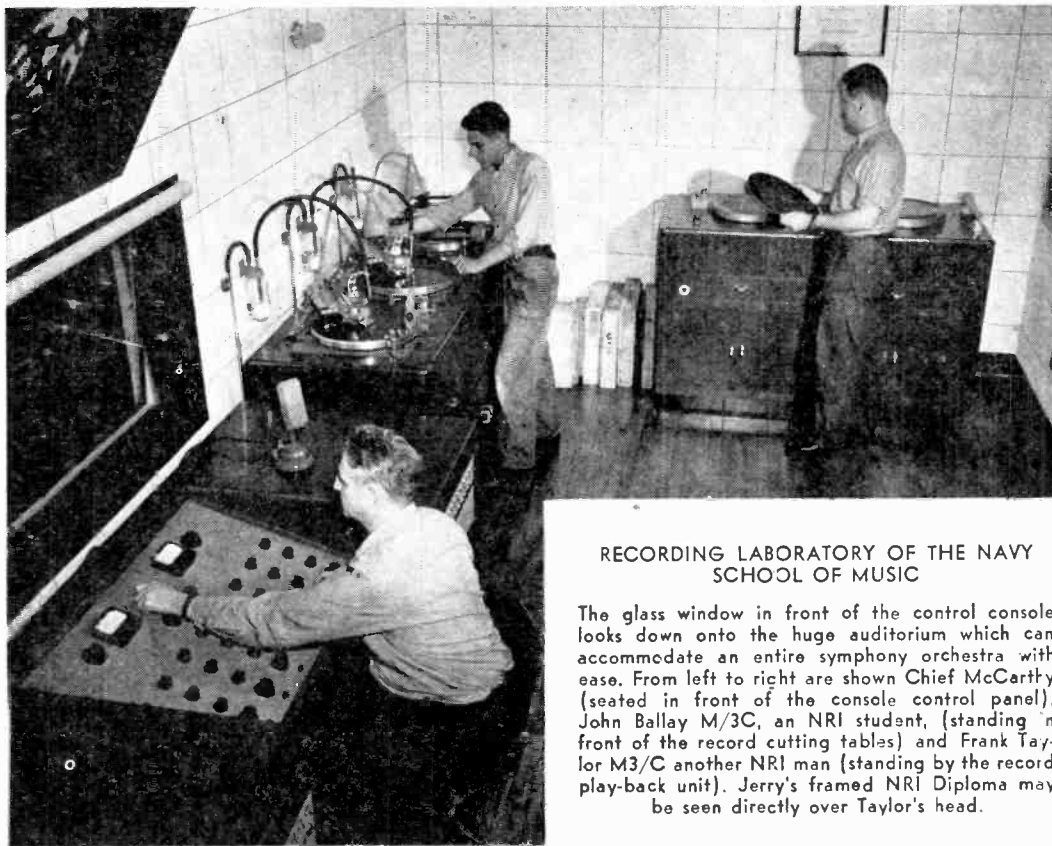

RECORDING LABORATORY OF THE NAVY  
SCHOOL OF MUSIC

The glass window in front of the control console looks down onto the huge auditorium which can accommodate an entire symphony orchestra with ease. From left to right are shown Chief McCarthy (seated in front of the console control panel), John Ballay M/3C, an NRI student, (standing in front of the record cutting tables) and Frank Taylor M3/C another NRI man (standing by the record play-back unit). Jerry's framed NRI Diploma may be seen directly over Taylor's head.

It was a sweltering day in June, 1933, that Jerry J. McCarthy enrolled as a student with NRI. Jerry, like the usual beginner in Radio, had his ups and downs. He waded into his lessons and gradually mastered the fundamentals of receiver action. Later he took his first faltering steps at fixing radios. Jerry made full use of our Consultation Service and in a reasonable time was able to handle most any service job without advice. Today, Jerry is an "old timer" in radio and is one of the best service men in the Wash-

ington area. Jerry is a real credit to NRI.

Jerry's studies were complicated by the fact that he was then a Chief Musician in Uncle Sam's Navy. He was featured soloist with the Navy Band for years, and as such performed for many notables. Jerry played for the King and Queen of England when they were in this country, at the White House for ceremonies and dances, at the Mardi Gras in New Orleans, at the Canadian National Exposition in Toronto and the Ottawa Ex-

hibition at Ottawa, Canada, to mention a few.

The late William H. Woodin, Secretary of the Treasury during the first Administration of President Roosevelt, was an active music patron. He played the banjo himself and often Chief McCarthy was called upon to entertain at the Woodin home. Little persuasion was needed before the Secretary would haul out his banjo and thump away with McCarthy much to the delight of his guests.

In what spare moments he had, Jerry kept right after his studies and in due course of time graduated and joined the NRI Alumni Association.

In 1941, at the outbreak of the war, the Chief was assigned to the School of Music as an instructor. Experience he had gained teaching Midshipmen from the Naval Academy at Annapolis, who were studying music for their own enjoyment, set him in good stead for the position as saxophone instructor at the school.

Lieut. Thurmond, Officer-in-Charge of the school, appreciated the value of recordings in music education. He knew of McCarthy's background as a radio technician and asked him to check into the possibility of installing a recording laboratory within the school. McCarthy reported the project feasible and the Navy, aware of the value of training aids, endorsed the program early in 1943.

The Office of Strategic Services offered the talents of Orrison W. Hungerford, a Western Electric engineer, and one of the leading figures in his field. He worked closely with Chief McCarthy, holding conferences, designing parts, examining blueprints and sketches and supervising the crew of musician-technicians who worked far into the night on many occasions.

A third floor was added to the building to house the laboratory. The lab was divided into the actual cutting and control room, a work shop and two recording studios. These studios were equipped with acoustical tile, thick rugs, and drapes which make them attractive and also ideal for correct recording.

An unique feature of the lab (which was an idea of the Chief's) is a unit at the turn-tables which "vacuums" off the chips made by the cutting head. Pneumatic hoses draw the chips into glass jars partially filled with water, thus eliminating the possibility of clogging the system.

A master amplifier rack is at the back of the lab, opposite the control panel. It is the terminal point for 31,000 feet of cable extending through the walls of the building. These cables lead to and from five different rooms from which the unit bands or orchestras can record. While one program is being cut from a broadcast, records can also be recorded from music being played in one

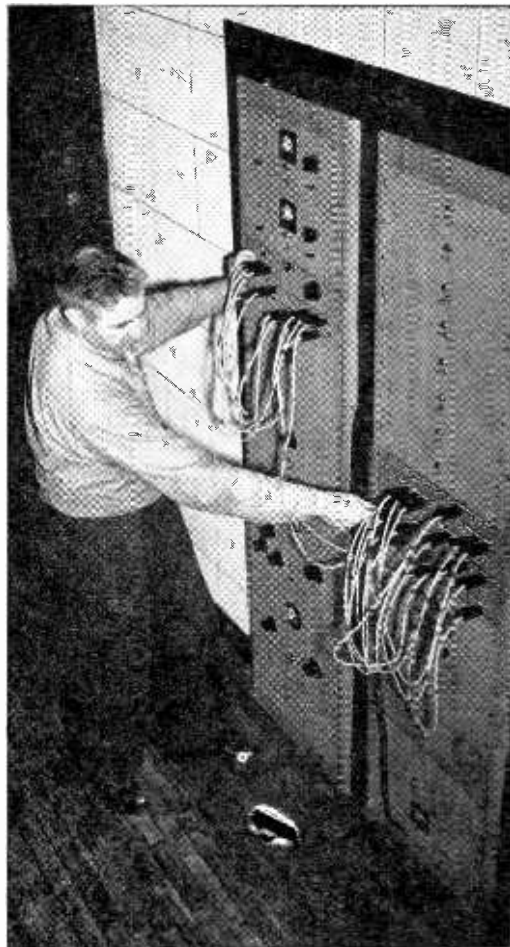

Jerry McCarthy at the amplifier rack, switching in another studio to record a practicing Navy musician.

of the studios or rooms throughout the building.

The recording lab is utilized for individual musician and band progress checks (comparison of recordings made at regular intervals a few months apart), playbacks at rehearsals, dubbing of records previously cut, recording school programs off the air, and the cutting of graduation concerts.

McCarthy believes the top contributions of the laboratory have been the service rendered to the Armed Forces Radio Service by cutting "V" Discs and other AFRS programs; and a series of religious programs which were recorded for the Navy Chaplain Corps for use aboard ships which have no bands.

Throughout the world—on land and sea—men of the U. S. Navy have listened to recordings produced in the Recording Laboratory of the Navy School of Music under the supervision of NRI Graduate Jerry McCarthy.

Band music, bugle calls, speeches, dance music, "V" Discs—"Chief" McCarthy and his staff of technicians have recorded them all—and have prepared these recordings so they could be sent to Naval units everywhere.

However, all things come to an end and early this year Jerry retired from the Navy at the ripe old age of 39. Retired is hardly the right word for it because Jerry is the proud father of four lively daughters, Mary Ann, Kathleen, Marella (Marcy) and Annette (Bitsy). There can be no doubt that his charming wife, Ann, is happy he is in civies but she says he is still on the go from morning to night.

Jerry and brother Justin who is also a retired Navy Bandsman and NRI graduate have realized their long planned dream. They are now sole proprietors of McCarthy Bros. Electronic Company, Washington's foremost Recording Studio, specializing in Recording,

Inter-Communication and PA systems, Radio Repair and Sales.

Starting from scratch at the first of this year, Jerry and his brother Jay have completely remodeled their two story building which they own, have bought a pick-up and delivery truck, all necessary test equipment and several thousand dollars worth of P.A. and recording equipment, to say nothing of their tube and parts stock which is unusually complete.

While both Jerry and Jay are exceptionally hard workers, they know that two men can't pick up and deliver set repairs, work at the bench, install PA rentals, cut recordings at parties, funerals, weddings and religious ceremonies and drum up new business.

As helpers they have L. W. Wells, an NRI student who goes out and brings in the P.A. business; Amos L. Lewis, another NRI student who is rapidly becoming an expert repairman at the bench; and Bill F. Smithson, truck navigator extraordinary.

The first floor of their completely redecorated building contains the



From left to right, the employees of the McCarthy Bros. Electronic Co. Jerry McCarthy, A. L. Lewis, Jay McCarthy, Bill Smithson (in truck) and L. W. Wells. (Note the two neon signs on their building).



Above, Jay McCarthy, Wells and Jerry McCarthy show the set up they use in making a recording. When making "on the spot" recordings, this equipment is moved to the job. The microscope (partially visible behind Wells' head) is used to examine the cut on the recording.



At left, Lewis, Jerry and Jay McCarthy at their well equipped service bench.

office and radio repair shop. In the back, is a large kitchen where a coffee pot is in almost continuous use. On the second floor, a large recording studio takes up the front room. The remaining rooms continue to do service as bed rooms for the helpers, who live right with their work.

The Institute is justly proud of these NRI men.

Page Six

and we predict that they have a real future before them.

The story of Jerry McCarthy is briefly told here. It should be an inspiration to every man who feels, to be successful, he must come up the hard way. "Hard way," you say! What is the hard way. It isn't the hard way at all. It is determination, grit, ambition. It is the only way.

# Pointers on Replacing Volume Controls

By Leo M. Conner  
NRI Consultant

**T**HE replacement of volume and tone controls is a mechanical service job. It is one that you will do many times in your career as a serviceman. The job is simple, but there are certain points which must be kept in mind.

## Why Controls Go Bad

Volume controls and tone controls contain a movable part that slides over a resistance element. The element will eventually become worn due to friction. Poor contacts also develop between the rotating arm and the connecting terminal in certain type controls. Should some defect occur that would cause excess current flow through the resistance element, it would burn out just the same as any resistor.

## How To Recognize Volume Control Defects

A good control should be noiseless in action, control the volume, and should be smooth in action (give a steady increase or decrease in volume without sudden changes).

Any control which does not do these things is most likely defective. If you apply certain simple operating tests, you can prove that the control is defective without making electrical tests.

Usually a control that is worn will cause a very noticeable amount of noise. If the set is noisy when the volume control is turned, pulled or pushed, or becomes more noisy as the control is rotated, then the control is certainly defective and should be replaced.

If the volume control has no effect on the volume as it is rotated, there is most likely a break or open near one terminal.

If the volume jumps suddenly as the control is rotated, then there is quite likely an internal defect or a worn resistance element. Usually noise will be present with this type of defect.

## How To Test Controls

Should you wish to test a control electrically, you may do so with an ohmmeter.

Contact between the moving arm and the resistance strip may be tested by connecting the ohmmeter probes to the moving arm terminal and

one of the terminals which connects to the end of the resistance strip. The set leads should be unsoldered from the volume control terminals first, in order to remove any shunt paths that may be present. The resistance, as indicated by the ohmmeter, should vary smoothly without jerks or erratic movement of the needle as the volume control is rotated. The resistance of some controls will vary slowly over part of the rotation and then change rapidly over the rest of the control movement. This is due to the "taper" of the control and does not necessarily mean that the control is defective. If, however, the volume control's resistance varies back and forth as it is rotated, there is poor contact between the rotor and the resistance strip and the control should be replaced.

## How to Obtain the Correct Replacement Control

In order to obtain a replacement control, give your supplier the make and model number of the receiver. If the receiver is a standard make, an

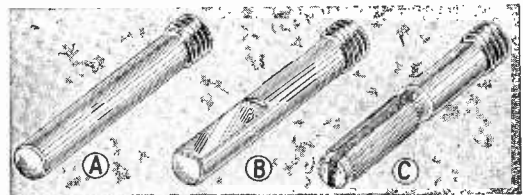

Fig. 1. Typical volume control shafts: A, round; B, half-round; C, slotted.

exact duplicate replacement or a general purpose replacement will be available for it, and will be listed in the volume control replacement guide books that are available at distributors.

Sometimes, particularly if the receiver is of unknown make, you must give the resistance value and the circuit connections of the control. (Your regular lessons on Radio Fundamentals describe the many ways of connecting volume controls, together with details regarding the resistance values.)

Naturally, if you are not using an exact duplicate control, the shaft on the replacement control should be similar to that of the original. Fig. 1 shows several shaft types. If the original control

had a switch, be sure to order a switch with the replacement.

If you have a shop and do considerable repair work you will probably want to carry a number of replacement controls in stock. There are kits available which contain several controls which have the values most frequently used. You should have a volume control replacement guide book, published by the manufacturer of the controls you stock, in order to know the correct control to use for a particular receiver.

### Installing Exact Duplicate Controls

Do not disconnect a defective control until you have a correct replacement.

The first step in replacing a defective volume control should be the drawing of a sketch showing all of the connections to the old control. An exact duplicate control will, of course, be exactly like the old one and should have the same connections. If you make a rough sketch, such as in Fig. 2, showing the connections, you will have no trouble in making the replacement.

One important point often overlooked by servicemen is the grounding of the moving arm on some controls used in older receivers. The receiver diagram will show if the center terminal should be grounded. Some controls had this connection made automatically when the control was mounted on the chassis. However, many controls are designed to be used on several different receivers and some sets have the contact arm insulated from the mounting stud. Be sure to test the control to see if the center arm is connected to the mounting stud.

Use your ohmmeter to check between the terminal lugs and the shaft of the old control. Many controls have an internal connection between the shaft and a terminal that should be grounded, thus automatically grounding the control when it is mounted. An exact duplicate control will have this feature, but a general replacement will not. Therefore, if you find continuity between any terminal and the shaft of the old control, you will have to provide a ground connection between the proper terminal on the new control and the set chassis. Add this connection to your sketch.

Another time saving hint is to leave all leads connected to the old control and, after dismantling it from the chassis, mount the new control in place. Then clip off part of the old lug with a pair of cutters and sweat the piece of lug with the lead attached directly to the terminal on the new control.

Occasionally you will find two or more wires fastened to a single lug and twisted so that they

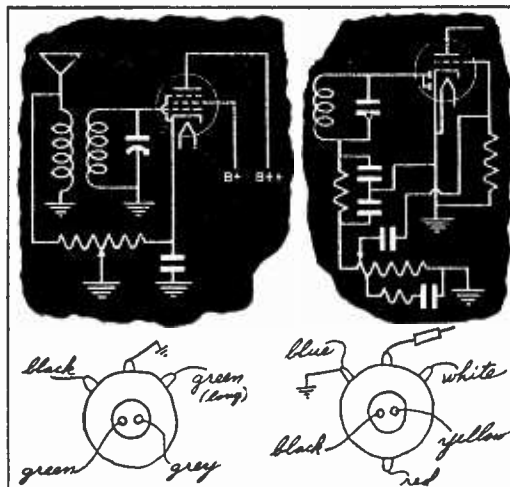

Fig. 2. Two representative circuits and the rough sketches such as you should make when replacing a control.

are hard to get off. Clipping the lug as suggested above is a real time saver in this case.

Be sure to tighten the volume control holding nut as much as possible. If the nut is not tightened fully, the customer may turn the entire control when he turns the knob and break the leads off the control. There may be a projecting metal or bakelite tab that fits into a hole in the chassis wall when the control is properly located. If so, be sure this tab is in its hole before tightening the holding nut.

### Installing General Replacement Controls

A general replacement control is a unit that is electrically similar to the original (has the same resistance), but different in physical size or shape. If it is larger than the original, be sure you have room to mount it before trying to install it. In addition, since the replacement control is designed to fit a number of different receivers, it will have an extra-long control shaft, often much longer than is necessary.

Most general purpose controls do not have switches on them, but a switch can be added simply by removing a back-plate of the control and installing a new plate that has the switch mounted on it.

After you have the recommended general replacement control and a switch, if needed, your next step is to draw a picture of the arrangement of the leads. Then, remove all leads from the defec-



# Superheterodyne Alignment Without A Signal Generator

By Don B. Looney

NRI Consultant

WHEN alignment of a superheterodyne receiver is necessary, one of three conditions will be encountered:

1. Stations come in at the right point on the dial.
2. Stations do not come in at the right dial setting.
3. Someone has tightened (or loosened) all of the alignment screws, and as a result the set is dead.

In cases 1 and 2, alignment can be made (in an emergency) without recourse to conventional test equipment. In case 3, an experienced service man stands a chance of completing rough alignment only in a few cases. In most instances, the threads on the trimmer screws will be worn out before any kind of alignment is achieved. In this third case a signal generator, or a tuned type signal tracer, are really necessary.

Receiver band coverage and dial tracking depend on the i.f. alignment. To obtain sensitivity, the i.f. amplifier must be peaked—that is, all i.f. circuits are adjusted to the same frequency. The fact that the i.f. transformers may be peaked 10 kilocycles above or below the correct frequency will not seriously affect the receiver. Neither will the dial settings be seriously affected when picking up various stations. In other words, the stations will come in at about their proper settings, and we say that the receiver tracks its dial.

Now let us take up the alignment of each case in order:

*Case 1:* Since stations come in at the correct dial setting or approximately so, we know that the tuned circuits are not far out of alignment and that the i.f. adjustments are such that the average i.f. value is correct—that is, if the i.f. adjustment has shifted, some have moved in one direction and some in the other so that the average remains approximately correct.

To touch up the alignment in this case, accurately

tune in a station at the high frequency end of the dial. Then adjust all the i.f. trimmers (in any order) for maximum volume. Next, adjust the oscillator and pre-selector trimmers for greatest signal strength.

Tune in a station at the low frequency end of the dial and adjust the oscillator low frequency padder while rocking\* the tuning dial for maximum volume. If there is no padder, you may skip this step.

If the receiver is equipped with short wave bands, switch to the various bands (one at a time), tune in a station and peak the oscillator and pre-selector trimmers of that band.

If the oscillator and pre-selector trimmers are mounted in a row (for the various bands), then you should be very careful to identify the particular trimmer before trying to adjust it. Make sure that you are adjusting the trimmer for the particular band which you are aligning. If you do not do this, you may unknowingly change the alignment of one of the other bands so much that it will be difficult to bring it back into proper alignment.

*Case 2:* The fact that stations do not come in at the proper dial settings means that the dial pointer has shifted, that the oscillator is out of adjustment, or that the i.f. amplifier is aligned at the wrong frequency. The last possibility may be dismissed, if the i.f. trimmers have not been tampered with, for it is highly improbable that the i.f. adjustments have all shifted in the same direction.

First, check on the dial pointer by tuning the receiver to its lowest frequency. The dial pointer should be over the lowest calibration mark on the dial. If it is not, you should then adjust the pointer to this position.

Let us now assume that the stations still come in at the wrong dial setting. Tune in a station

\*Covered in regular NRI lessons,  
(page 12, please)

# THE NRI SERVICE MANUAL IS STILL AVAILABLE

The first three thousand have sold quickly  
An additional supply is now in stock

OUR original order to John F. Rider, Radio's authoritative publisher of diagrams, called for three thousand NRI Service Manuals. This Manual has proved very popular. When we saw that we would soon need an additional supply, we placed a repeat order for three thousand more of these Manuals. We are well into this lot and they are moving fast. If you are interested in this Manual we suggest you order promptly. Deliveries can now be made at once.

This Manual was prepared especially for NRI students and graduates. For years there was a demand for a diagram manual of popular Radio circuits, for quick, ready reference. The NRI Service Manual is the answer.

#### May Not Be Available Later

The Manual is of real assistance to those who are sufficiently advanced in their studies to be able to do part-time Radio Servicing work.

New students too, even though not ready to do actual Radio Servicing, may want to purchase this Manual now. It may not be available later.

This is another NRI service planned for NRI students and graduates. This Manual is a big help to both the beginner and the long experienced Radio serviceman, because it contains, in one volume, more than 1400 popular circuit diagrams, covering 7287 models, old and new, up to 1946.

The Manual contains 1566 pages of diagrams and service information, plus 31 pages devoted to index and 34 pages to alignment procedures.

Over sixty leading makes of receivers are covered including Air King, Allied, Andrea, Atwater-Kent, Crosley, Detrola, Emerson, Fada, Farnsworth, G-E, Magnavox, Majestic, Montgomery Ward, Philco, RCA, Sears-Roebuck, Sparten, Spiegel, Stewart-Warner, Warwick, Wells-Gardner, Westinghouse and Zenith, to name a few.

#### Filled With Valuable Service Information

The NRI Service Manual is compact and filled with valuable service information. It gives com-

plete separate presentation of aligning methods, with each method keyed. Each diagram tells by a key what method to use.

It covers AM, FM, Television, Audio Amplifiers, Record Changers, Inter-Communicator Circuit Diagrams, and data.

It gives complete circuit diagrams, all with parts values, many with pictorial part layouts. Gives special adjustment procedures.

It includes push-button and automatic tuning adjustments. Intermediate frequencies are given on each diagram. All tube numbers are identified. Manufacturers' parts numbers are given in many cases. Most diagrams include operating voltages.

#### Easy To Use. Easy Reading Index

It is easy to use. Lies flat. Arranged alphabetically by make and model number with easy reading index.

Cloth bound (simulated leather). Sturdy construction. The easy removable page mechanism enables you to remove or replace any diagram at will. The cover is attractive maroon color with gold lettering.

This is a big, solid volume, weighing eight pounds. It is standard manual size 9 x 11½ x 4 inches.

This NRI Service Manual was prepared especially for NRI by John F. Rider, who is well known as the diagram manual authority. It contains those diagrams most frequently requested from NRI by Students and Graduates.

#### Costs About One Cent Per Diagram

The price is \$14.50 with order—about one cent per diagram.

No C.O.D. shipments—no charge accounts. If you wish to purchase this Manual please use coupon order blank on the next page. Send money order, postal note or bank draft. Personal check should be certified to avoid delay of ten to fifteen days in shipment. Sent POSTAGE PREPAID.

**A Big  
Manual.  
Actual  
size is  
9"x11 1/2"  
x4"**

**More than 1400 most used  
Radio circuit diagrams  
covering 7287 models  
— in one big  
NRI Manual**

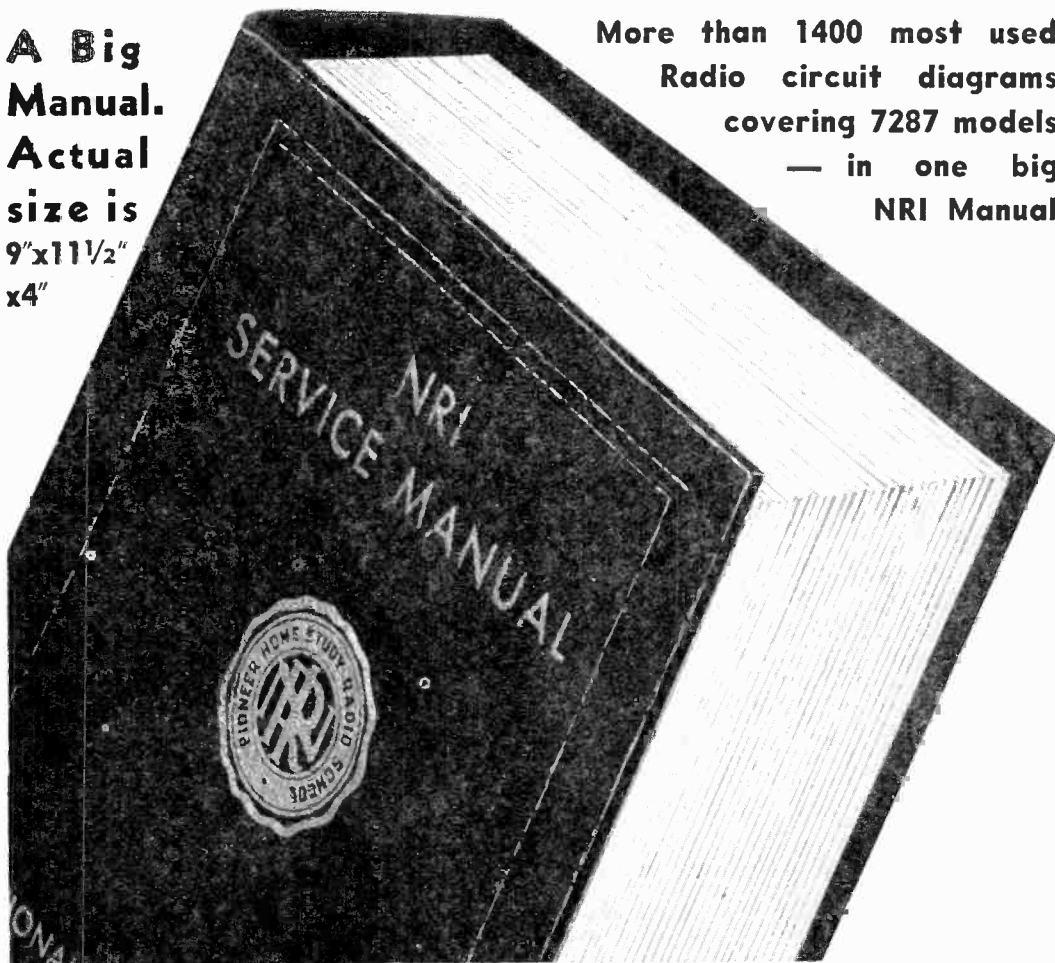

**NOT SOLD OUTSIDE  
THE UNITED STATES**

*Covers only Radio receivers manufactured in the United States. Therefore, this Manual is not suitable for students in Canada and foreign countries.*

**NOTICE TO GI  
STUDENTS**

*The Veterans Administration will not authorize payment for "extras" such as this Manual.*

**CLIP THIS ORDER BLANK**

**NATIONAL RADIO INSTITUTE**  
Supply Division  
16th and You Streets, N-W  
Washington 9, D. C.

85

I enclose \$14.50 (certified check, money order, postal note or bank draft) for which send me, postage prepaid, the NRI Service Manual.

Name ..... Student No. ....

Address .....

City ..... Zone ..... State .....

## Superheterodyne Alignment

(continued from page 9)

of known frequency at the high end of the dial. Now, tune the receiver toward the correct dial setting (that is, toward the correct calibration mark for the station you are picking up)—continue tuning toward this correct dial setting until the station can barely be heard and adjust the oscillator and pre-selector trimmers for maximum output. You can then repeat this procedure until you are picking the station up at the correct dial setting with maximum volume.

Next, tune in a station at the low frequency end of the dial and adjust the oscillator low frequency padder while rocking the receiver dial for maximum volume. Do not worry about the actual dial setting.

In some sets, there will be no low frequency padder. There may be an adjustable iron core on the various coils instead. In still other sets—particularly the small, modern sets of the a.c.-d.c. type, there will be no low frequency padder or coil adjustment. Instead, the oscillator condenser plates will have been cut so that the set will track properly. If this is the case, you can skip the low frequency adjustment.

Now, retune the receiver to the high frequency end of the dial and adjust the oscillator high frequency trimmer *only* so that the station comes in at the correct dial setting.

Now, tune in any convenient station—tune it in very accurately. Adjust the i.f. trimmers for maximum output. You may adjust the trimmers in any order. This completes the alignment.

**Case 3:** Here we have a receiver which is completely dead or one station may be received all over the dial. In the latter instance this indicates that the i.f. amplifier trimmers have been loosened sufficiently to tune the amplifier into the broadcast band. This may also cause oscillation—the oscillation would probably occur at the low frequency end of the receiver dial.

When the receiver is dead, you will generally find that all trimmers have been tightened. If all the trimmers are loose just tighten them and then back off all adjustments  $\frac{1}{2}$  turn from tight. If all the trimmers are tight, then back off the adjustments  $\frac{1}{2}$  turn.

If only the alignment is at fault, this will probably bring the i.f. amplifier to life and you may even be able to pick up a number of stations. You should now tune the set to a weak station—preferably in the middle of the broadcast band or at the high frequency end.

**Now, adjust the i.f. transformers for maximum**

signal, being careful to check to see if the station comes in at about the proper dial setting.

In most receivers, the correct i.f. frequency is obtained with the i.f. trimmer condensers about one half turn out. Since this is the case, you can get some indication of whether you are adjusting to the correct i.f. frequency or not by noting how far out you turned the i.f. trimmers.

You may then tune to a station at the high frequency end of the dial and adjust the oscillator and pre-selector trimmers for maximum volume at the correct dial setting. Use the procedures which have been outlined previously.

Now, tune to the low frequency end of the dial and adjust the padder if there is one. Use the rocking procedure that has been mentioned.

When you are first aligning the i.f. transformers in this third case, it has been mentioned that you should tune to a weak station. If there are no weak stations which can be picked up, you may try attenuating the signal somewhat. It is often difficult to attenuate the signal if the set has a loop antenna—in this case, you may shift the loop (if the loop is adjustable) for minimum pickup. If the loop is not adjustable, you may try shifting the position of the set.

Normally, the volume level is kept low for all alignment. With low volume level the ear can detect changes much more easily than if the volume level is high.

In general, the above outlined procedures will work satisfactorily. Of course, it has been assumed that the set is in proper operating condition—that is, that the local oscillator is working and that there is nothing wrong with the various amplifying stages. It is also assumed that all tubes are good and that proper operating voltages are being supplied.

The procedures which have been discussed can be used without any test equipment. Of course, if you have a multi-tester available, it is better to use this as an output indicator rather than rely upon the ear. You may use the multi-tester as an a.c. voltmeter and connect it across the speaker voice coil.

If the tester is a vacuum tube voltmeter, the best way to use it is to connect it to read the set's a.v.c. voltage. The set is then aligned for maximum a.v.c. voltage.

Of course, if you have a signal generator available, use this as your signal source and use conventional alignment techniques as are discussed in the NRI Course. If you have a tuned-type signal tracer available, such as the Model 33 NRI Professional Signal Tracer, you may use the alignment techniques which are discussed in the instruction manual for the instrument.

# Stratovision To Boost Television's Coverage

Plane-Borne Antenna Gives Radio Waves 422-Mile Area at Height of 30,000 Feet

*Reprinted through courtesy of  
"Westinghouse News"*

**S**TRATOVISION, a word compounded of "stratosphere" and "television," describes a revolutionary high-altitude communication development by Westinghouse for overcoming television's biggest hurdle—the fact that the world is round.

All propagation tests for the new development have been completed, according to Baltimore engineers, and plans are now under way to make demonstration-program tests, both for television and FM (frequency modulation broadcasting.)

Because the ultra-high - frequency radio waves needed to carry television and FM broadcasts travel in a straight line, like a flashlight beam, the range of such broadcasts has been limited by the line of sight from the transmitting tower to the horizon. Even television transmitters mounted on skyscrapers have a range of only approximately 50 miles.

Up to now it had seemed certain that only through a slow, expensive procedure of building hundreds of such ground transmitters could television be brought within the range

of even city dwellers. There was little hope that it would ever be economical to reach the millions of rural people living beyond the 50-mile limits of urban centers.

## Engineer Finds Solution

Then, a little over a year ago, Charles E. Nobles, a 27-year-old radar engineer at the Baltimore Plant, found the solution to this problem in the wartime developments of radar.

Since radio waves from television and FM programs travel farther the higher their starting point, he reasoned: Why not use an airplane to lift the broadcasting antenna into the stratosphere? Mr. Nobles and a group of the Company's electronics engineers and research men went to work. This is what their experiments showed:



**ANTENNAS AWAY!** Engineer A. A. Nims lowers antennas into place during Stratovision flight tests. The two 15-inch loop antennas are mounted on a ten-foot shaft of aluminum tubing, hinged to the plane's under side. The shaft is lowered into place, loops down, after the take-off. Equipment will be entirely automatic.

From a height of 30,000 feet (about six miles), short-waves sent out from a plane-borne antenna would blanket an area of the earth's surface four hundred twenty-two miles across about equal to the combined area of the states

of New York, Pennsylvania and New Jersey.

Reception of such Stratovision broadcasts would be practically free from interference and distortion, caused normally by reflected ground waves and by the numerous amplifications or boosting stages which would be required by any previous proposed system to carry television and FM broadcasts over a comparable area.

To provide with usable radio signal throughout this 422-mile wide receiving area would require only one-fiftieth of the power needed by a 50-kilowatt transmitter on the ground capable of reaching only 50 miles in any direction.

#### Power Requirements Less

The smaller power requirement for the plane-borne transmitter results from the technical reason that the path difference between the direct wave and the ground-reflected wave is increased.

As a result, small-powered transmitters can be made in sizes and weights small enough to be carried in an airplane. Power to operate them can be generated with electronic tubes which were developed during the war.

The radio equipment problems involved in making Stratovision work turned out to be very similar to those which Westinghouse had helped solve in connection with wartime radar production. Almost every feature has been proved by the Company's experience of the last few years.

As for the aviation technique involved, the need was fundamentally to reverse previous aviation objectives and design a plane that would go no place slowly. This job was undertaken by the Glenn L. Martin Company.

The plane proposed by the Martin people is an all-metal, low-wing monoplane almost as large as the famed B-29 Super-fortress but weighing only about a third as much, and powered by two 1,450-horsepower engines.

#### Plane Would Circle

The Stratovision plane would be able to circle lazily over its station, cruising at less than 150 miles an hour. It would be big enough to carry four television transmitters, five FM transmitters, monitoring equipment, and sufficient relaying apparatus to handle these nine separate programs, plus radio communication equipment for use of the plane's crew.

Such a plane would be a flying transmitting station and antenna. The programs would be on ground, fed into a small ground-to-plane link transmitter, received by the plane and rebroadcast.

Page Fourteen



HOOPS, MY DEAR!—Betty Ann Nolan, of the Baltimore Plant, takes a curious look at the 15-inch antennae, mounted on 10-foot shaft of aluminum tubing.

FLYING STATION—The cutaway drawing on this magazine's cover shows an artist's conception of the interior of one of the monoplanes planned for use in Stratovision.

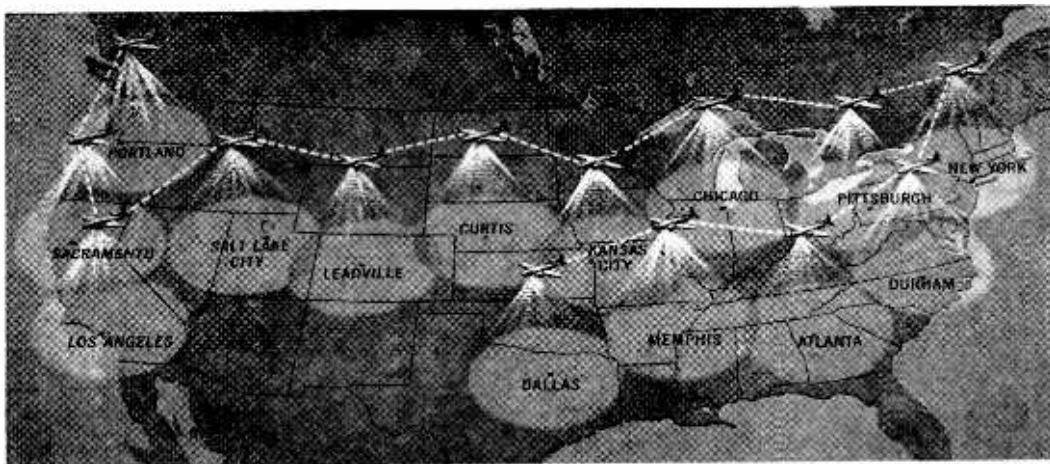

**STRATOVISION NETWORK**—Eight planes would provide a coast-to-coast network for broadcasting of television and FM programs by Westinghouse Stratovision. By adding eight planes, broadcasts would reach 78 per cent of people.

To form a coast-to-coast network for relaying programs originated in New York or Hollywood or at any point between would require only eight such planes stationed about 400 miles apart. They would fly over New York, Pittsburgh, Chicago, Kansas City, Central Nebraska, Central Colorado, Salt Lake City and Los Angeles.

By adding six more planes—over Durham, Atlanta, Memphis, Dallas, Sacramento and Portland—it would be possible to provide Stratovision coverage for 51 per cent of the nation's area and 78 per cent of its population.

#### 4 Planes at Each Location

To maintain uninterrupted service, such a nationwide Stratovision system would require four planes for each of the 14 locations. With a plane taking off at each station every four hours and remaining in the stratosphere for eight hours,

two planes would be in the air at all times. The other two would be on the ground, ready for emergency relief.

As a designer and builder of television and FM receivers and transmitting equipment, Westinghouse is commercially interested in Stratovision as a means of hastening the availability of television and FM programs, with consequent increased sales of products in the broadcasting field.

As for the role Westinghouse may eventually be assigned in such a national service as Stratovision, no one is in a position to say. But Chairman A. W. Robertson some time ago made this public expression of confidence in the future of Stratovision.

"Show the possibility, and somehow the way will be found to make it work."

— n r i —

## Replacing Volume Controls

(continued from page 8)

tive control and take it out.

The next step is to cut the shaft of the replacement control to the right length. Measure the length of the old shaft with a ruler or caliper from the point where the body of the control touches the chassis wall. Mark the shaft of the

new control to the same length with a pencil or crayon. Then put the shaft (not the control itself) in a vise and cut it off at the marked length with a hacksaw. Smooth the cut edge of the shaft with a file.

Next, add the ON-OFF switch to the control if one is used. Remove the plain back-plate of the control by lifting a clamping lug (or two) that holds it down. The new back-plate with the ON-  
(page 25, please)

# Ballast Tubes In Radio Servicing



Willard R. Moody

By Willard R. Moody,

NRI Consultant

A BALLAST tube is a special resistance element which tends to change its resistance when the circuit current changes. This change in resistance is in such a direction as to maintain the current in the circuit at a nearly constant value. Although such tubes are often termed voltage regulators, they really act as current regulators. The product of current and resistance is  $E = IR$  and as a result the voltage drop is regulated. This product,  $IR$ , is maintained constant (for voltage regulation) by varying  $R$  as required. If  $I$  decreases,  $R$  increases and if  $I$  increases,  $R$  decreases. This action is automatic in a voltage regulator.

The constant voltage drop across the ballast resistance assures a constant load voltage. This is illustrated by Fig. 1. We can say that  $E_L = E_S - E_R$ . If  $E_S$  varies and  $E_R$  also varies, the net load voltage variation is practically zero and  $E_L$  remains unchanged. This is the desired condition that may be obtained with real ballast tubes.

Ballast tubes which really regulate current are of special construction. An ordinary "ballast" tube in an a.c.-d.c. set may be simply a resistance element which limits the flow of current but doesn't change in resistance value to maintain a constant value of current flow. It is important to differentiate between the two.

The chief limitation of a ballast tube is its slowness of action (a lag of a few seconds) and its reduced effectiveness when the load resistance is not steady in value.

In Fig. 2, the characteristics of a typical ballast tube are illustrated. Fundamentally, the ballast tube consists of iron wire sealed in a glass envelope containing hydrogen or helium. Its regulatory action is based on (1) the high tempera-

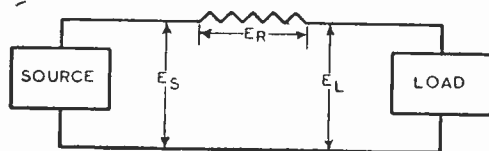

Fig. 1. The load voltage equals the source voltage minus the drop in the voltage regulator, as you can see by careful consideration of the drawing.

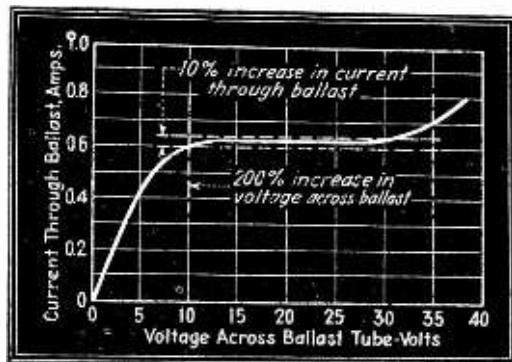

Fig. 2. Characteristics of a typical ballast tube.

ture coefficient of resistance for relatively small changes in the current flowing through it, and (2) the cooling effect of the gas used which stabilizes this action and provides a means for shaping and extending the regulatory characteristic.

When current of lower value than the range for which the ballast is designed is passed through it, there will be some heating of the wire but the resistance change will be gradual, as indicated by the steep slope at the beginning of the three



regulator curves in Fig. 3. The curves for voltage-current characteristics of carbon and tungsten lamps compared with those of resistance type regulators are shown in Fig. 4.

At some particular value of current, determined by the design of the ballast, a critical point is reached beyond which any further increase in current will cause a very rapid change in the resistance of the wire. At another higher and less critical value the resistance change once more becomes more gradual. It is between these two values known as the "threshold" and "end" values that the operating range of the ballast is placed. Within this range is another range over which the resistance increase is so rapid as to completely offset any tendency toward current increase. It is over this portion of its operating range that the ballast provides maximum regulation.

By varying the form, size and length of the iron wire employed, and its distribution on the spacer forms, ballasts can be made to widely different specifications. A typical application is illustrated by Fig. 5. The use of a ballast resistance in the primary circuit of the Majestic 70 is shown in Fig. 6. The ballast in the primary circuit maintains the transformer primary voltage at a reasonably constant value. "Ballast" resistances which are used in a.c.-d.c. receivers for voltage dropping purposes are not true voltage regulators, but are merely resistance elements in tube form. They are convenient and eliminate the use of a special resistance type line cord which would otherwise be required. A series wire-wound resistor is sometimes used in filament circuits but the majority of sets use line cord or "ballast" resistances.

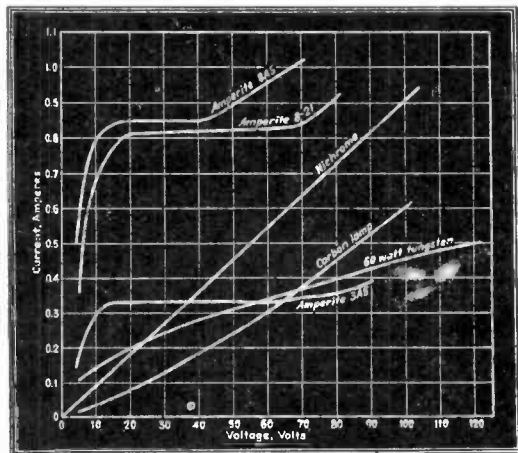

Fig. 3. Constant Current Characteristics of three typical resistive regulators compared with other types of resistors.

The usual receiver circuit employs a single ballast tube. A typical set of this kind is the General Electric GD-60 shown in Fig. 7. The ballast tube is simply a resistance element which is connected in series with the tube filaments. The circuit in Fig. 7 is a typical, simple type. Sometimes we find that special ballast tubes and circuits are used, and Fig. 8 shows a circuit of this kind. Later, we will analyze these circuits with reference to the filament and ballast tube sections.

### Types of Ballast Tubes

Various types of ballast tubes are used in receivers and as replacements in servicing. All-

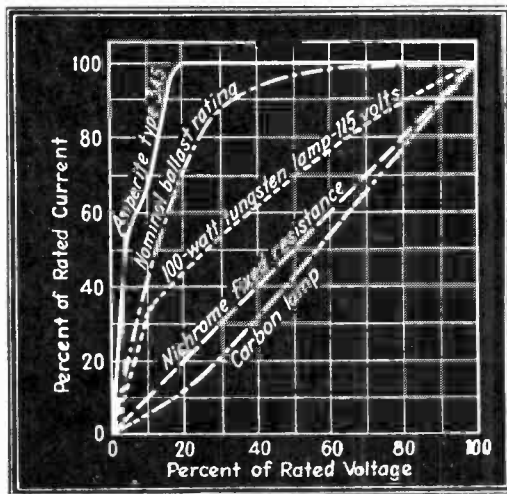

Fig. 4. Voltage-current characteristics of carbon and tungsten lamps compared with those of resistance regulators. Neither type of lamp offers much advantage over a straight dropping resistance whereas the regulator tubes provide regulation over a wide voltage range.

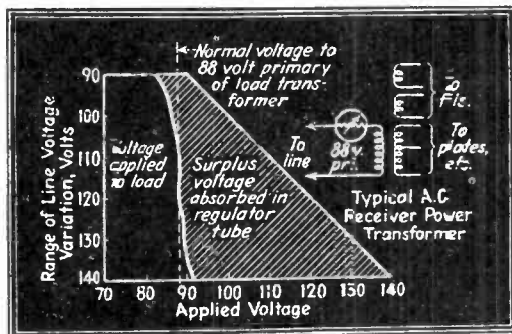

Fig. 5. Voltage distribution in an a.c. receiver utilizing a resistive regulator to insure reasonably constant supply voltage despite wide variations in line voltage.



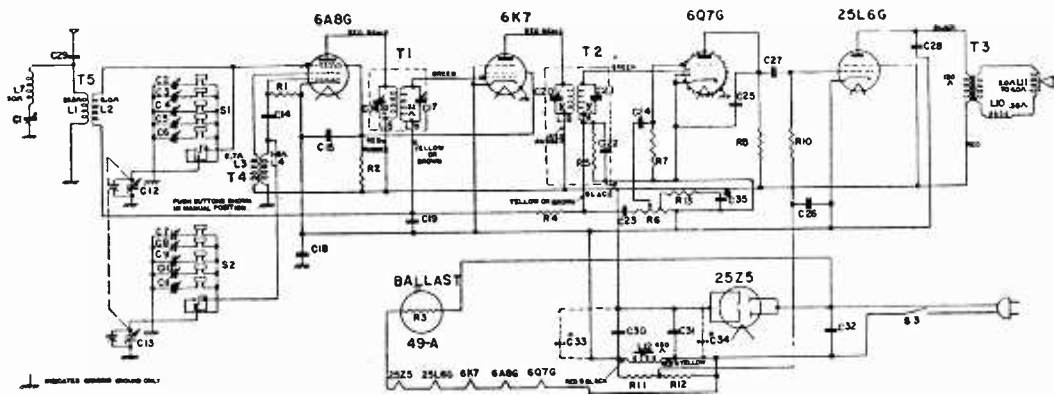

Fig. 7. General Electric 6D-60.

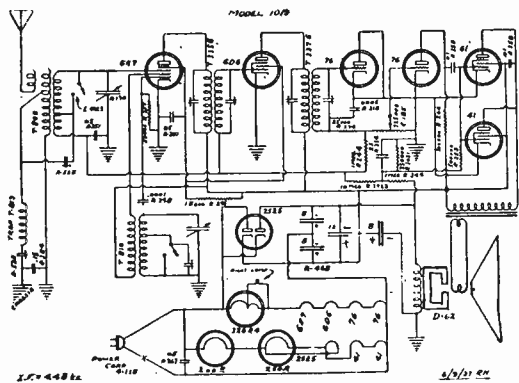

Fig. 8. International 1019.

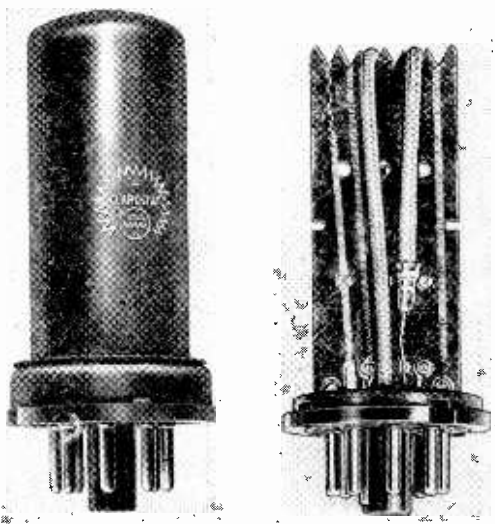

Fig. 9. Tube Type Wire Wound Resistors.

Type No.	Rating Watts	For Use With Sets Consuming	No. of Tubes Used
O	50	Up to 60 Watts	4
A	100	60 to 100 Watts	5, 6, 7
B	150	100 to 150 Watts	8, 9, 10
C	200	150 to 200 Watts	11, 12
D	250	200 to 250 Watts	2 Type 50

Dimensions are 1 1/4" dia. x 1 1/4" long. Prongs 3/8" long.

List Price .....\$1  
Standard Packing—10 (ten) per carton

The basing arrangements of the tubes in Fig. 10 and Fig. 11 are simple. Two prong connections in a series circuit are employed. The connections for tubes of the octal type and other having four prongs are complex by comparison.

The pin terminal connections for various Clarostat types are shown in Fig. 12. The ballast resistors are non-inflammable, with the resistance element wound on a mica form securely embedded

in the metal tube and connected to the base prongs.

In connection with listing ballast tube type numbers, the following nomenclature applies. Prefixes in the type number indicate the type of pilot lamp used with this ballast tube. Thus:

- "K" denotes a 6.3 volt, 150 ma., No. 40 pilot lamp.
- "L" denotes a 6.3 volt, 250 ma., No. 46 pilot lamp.
- "M" denotes a 6.3 volt, 200 ma., No. 51 pilot lamp.

The numeral in the type number indicates the total voltage drop across the plug-in resistance unit.

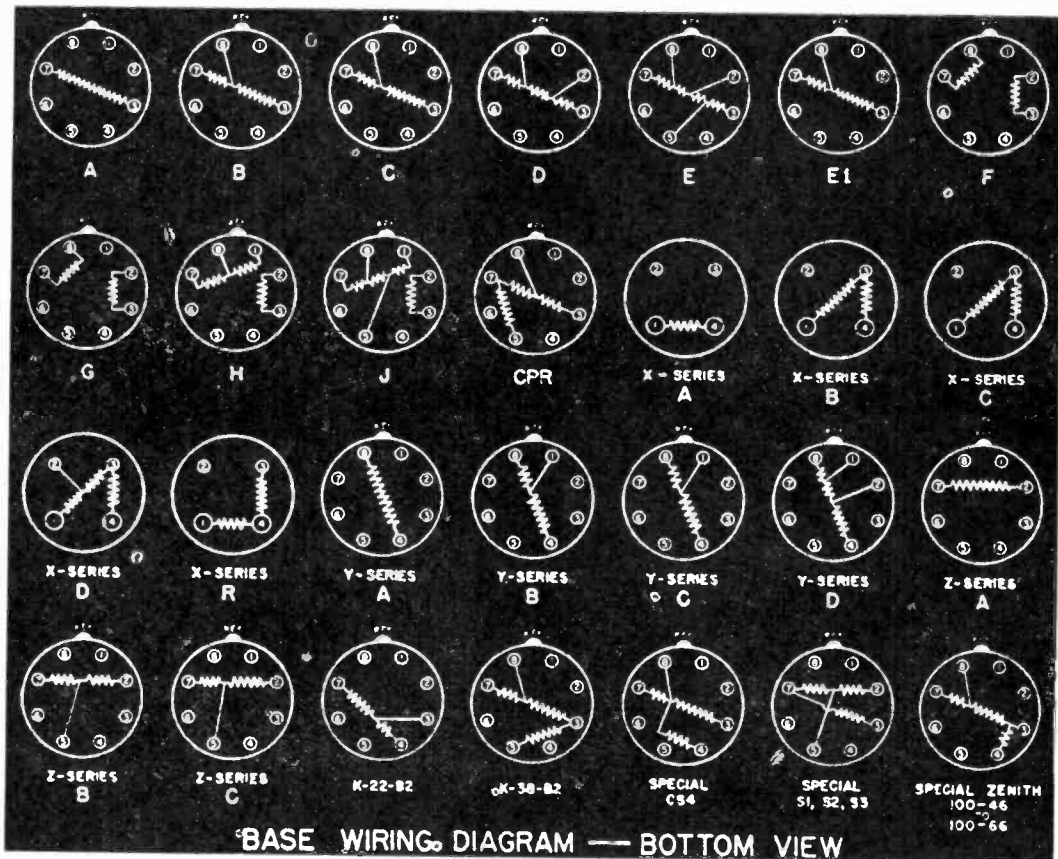

Fig. 12.

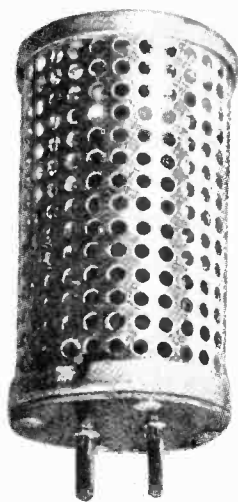

Fig. 11. (Above)  
Automatic Line Volt-  
age Regulator.

Fig. 10. (Left) Re-  
placement Line  
Ballasts.

Suffixes in the type number of a ballast tube designate as follows:

- "A"—No pilot lamp taps.
- "B"—1 pilot lamp tap for 1 lamp.
- "C"—1 pilot lamp tap for 2 lamps.
- "D"—2 pilot lamp taps for 2 lamps.
- "E"—3 pilot lamp taps for 3 lamps.
- "E<sub>1</sub>"—1 pilot lamp tap for 3 lamps.
- "F"—1 pilot lamp tap for 1 lamp.
- "G"—1 pilot lamp tap for 2 pilot lamps.  
(Tapped sections isolated from main reducing body.)
- "H"—2 pilot lamp taps for 2 pilot lamps.  
(Tapped sections isolated from main reducing body.)

The letter "J" following any of the suffixes denotes a shorted connection between two prongs of the tube: i.e., in a type K-49-BJ, the short is located between the No. 3 and 4 prongs.

Care must be exercised when replacing any tube

## R. M. A. DESIGNATIONS

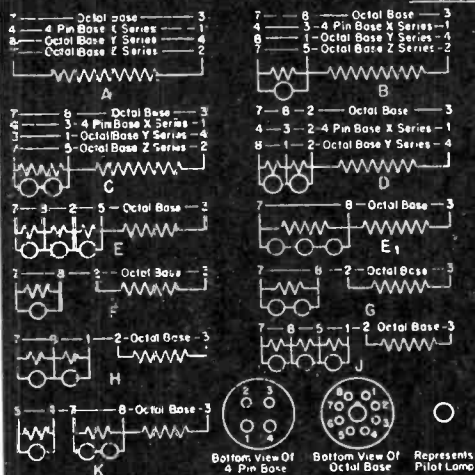

### EXAMPLE:

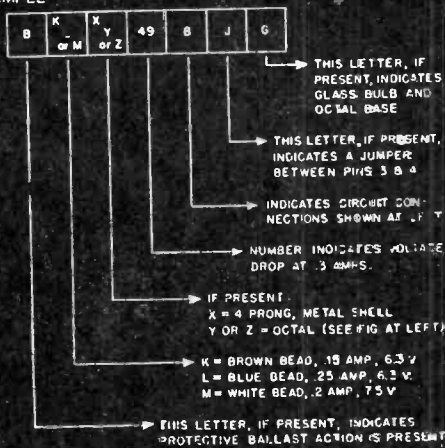

### SYSTEM A

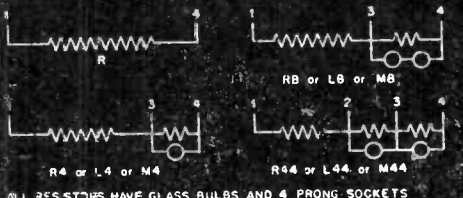

ALL RESISTORS HAVE GLASS BULBS AND 4 PRONG SOCKETS

### SYSTEM B

### EXAMPLE

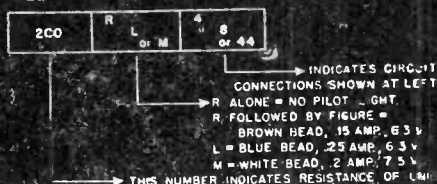

Fig. 13.

## SYLVANIA DESIGNATIONS

### CHARACTERISTICS

TYPE	USE	MA. LOAD CURRENT	AVERAGE VOLTAGE DROP *	BULB	BASE
1A1/5E1	Battery	500	1.0	ST-12	4-A
1B1	Battery	360	1.0	ST-12	4-A
1C1	Battery	745	1.0	ST-12	4-A
1D1	Battery	340	1.0	ST-12	4-A
1E1	Battery	480	1.0	ST-12	4-A
1F1	Battery	720	1.0	ST-12	4-A
3E1	Battery	425	1.0	ST-12	4-A
1J1	Battery	620	1.0	ST-12	4-A
1K1	Battery	550	1.0	ST-12	4-A
1R1G	Battery	540	1.0	ST-12	4-T
1T1G	Battery	560	1.0	ST-12	4-T
1K1	Battery	780	1.0	ST-12	4-A
1Y1	Battery	540	1.0	ST-12	4-A
1Z1	Battery	900	1.0	ST-12	4-A
2	DC or AC-DC	300	9.0	S-14	4-A
3	DC or AC-DC	300	128.0	ST-16	4-A
4	DC or AC-DC	400	115.0	ST-16	4-A
5	DC or AC-DC	460	115.0	ST-16	4-A
6	Battery	685	1.0	ST-12	4-A
7	DC or AC-DC	300	175.0	ST-16	4-A
8	DC or AC-DC	300	132.0	ST-16	4-A
9	DC or AC-DC	300	50.0	ST-16	4-A
46A	DC or AC-DC	400	46.1	ST-12	5-7
46B1	DC or AC-DC	300	46.1	ST-12	5-7

\* The voltage drop shown is for average operation and may vary according to the supply voltage.

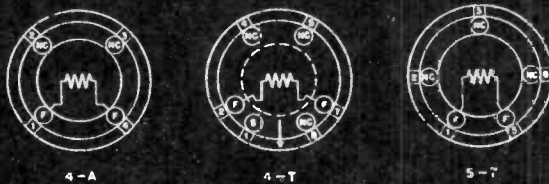

### BASE VIEWS

#### NOTE:

GROUP 1A1/5E1 TO 1Z1 IS EMPLOYED IN BATTERY RECEIVERS - GROUP 2 TO 46B1 IS EMPLOYED IN AC-DC RECEIVERS.

Fig. 14.



Referring to Fig. 8, a 320R4 ballast tube is shown connected in series with the 6A7, 6D6, 76, 76 filaments. If this tube burns out and a suitable replacement ballast is unavailable, the 320R4 may be replaced with an equivalent resistor combination. Fundamentally, we know the current through this section of the circuit is 0.3 ampere since the 6A7 has a heater rated at this value. The four 6 volt filaments in series have a total drop of  $6 \times 4 = 24$  volts. The pilot lamp is a 6 volt type so that the *total drop* is  $24 + 6 = 30$  volts. As the drop across the section of the ballast tube connected between the pilot light and line is the line voltage minus the total drop,  $115 - 30 = 85$  volts.

To find the value of this resistance,  $R = E/I = 85/0.3 = 283$  ohms. Actually, the use of a 280 or 285 ohm resistor would be permissible. The power rating of the resistor can be calculated easily. First, we multiply  $0.3 \times 0.3 = 0.09$ . (We have "squared" 0.3.) Next, we multiply  $283 \times 0.09 = 25.47$  watts. We can "round this off" to 25. Now we use a safety factor of 2 and  $25 \times 2 = 50$  watts, the recommended power rating of the resistor.

The pilot lamp across a section of 320R4 may be a standard 6 volt, 0.15 amp. type. The resistance is  $R = E/I = 6/0.15 = 40$  ohms. As the current is 0.3 amp.,  $0.3 - 0.15 = 0.15$  shunt current. As this current is passed through 40 ohms, a 40 ohm shunt is used. The power is  $.15 \times .15 \times 40 = 9$  watts. A resistor rated at 20 watts may be used.

In a similar way, the value of the resistor used in place of the 200 R ballast tube can be found. First, we add up the voltage drops,

$$\begin{array}{r} 41 = 6 \text{ volts} \\ 41 = 6 \text{ volts} \\ 2525 = 25 \text{ volts} \\ \hline 37 \text{ volts} \end{array}$$

We subtract 37 from the line voltage, 115 volts:

$$\begin{array}{r} 115 \\ - 37 \\ \hline 78 \text{ volts.} \end{array}$$

This is the drop across the 200 R. The filament of the 41 requires 0.4 ampere. This current flows in 200 R. Then,  $78/0.4 = 195$  ohms. The power is  $0.4 \times 0.4 \times 195 = 31.2$  watts and  $15 \times 2 = 30$  watts rating.

As the 2525 has a 0.3 amp. filament, the shunt resistor 250R must pass  $0.4 - 0.3 = 0.1$  ampere. The resistance of 250 R =  $25/0.1 = 250$  ohms. The power is  $P = I^2R = 0.1 \times 0.1 \times 250 = 2.5$  and  $2.5 \times 2 = 5$  watts rating for 250 R.

(page 25, please)

Fig. 16. (Shown at right).

THEIR RESISTOR TUBE No.	REPLACE WITH REGULAR CLAROSTAT No.	REPLACE WITH CLAROSTAT UNIVERSAL No.
<b>WALGREEN CO.</b>		
L-42-C	L-42-C	23*55-A
L-49-C	L-49-C	23*55-A
2905	L-49-C	23*55-A
2906	L-42-C	23*55-A
<b>WAEWICK RADIO CO.</b>		
185-R8	KX-55-C	UK-23*55-A
L-49-B	L-49-B	23*55-A
L-55-B	L-55-B	23*55-A
<b>WATERSON RADIO CO.</b>		
L-49-C	L-49-C	23*55-A
M-49-B	M-49-B	23*55-A
L-55-B	L-55-B	23*55-A
<b>WEESTER (Chicago) (Ampical)</b>		
R-3003	R-3003	.....
K-54-A	K-55-A	23*55-A
<b>WESTINGHOUSE ELECT. Supply Co. &amp; International)</b>		
K-42-C	K-42-C	23*55-A
K-49-C	K-49-C	23*55-A
K-55-C	K-55-C	23*55-A
L-55-B	L-55-B	23*55-A
K-67-A	K-67-A	60*92-A
K-84-A	K-84-A	60*92-A
Z-R-212	KY-42-D	.....
<b>WILCOX-GAY RADIO</b>		
L-42-B	L-42-B	23*55-A
L-42-C	L-42-C	23*55-A
L-49-B	L-49-B	23*55-A
65-2037	L-42-C	23*55-A
65-2003	L-49-B	23*55-A
<b>ZENITH RADIO CORP.</b>		
120.37	L-49-CJ **	23*55-A
120.38	L-42-CJ **	23*55-A
100.45	L-49-CJ **	23*55-A
100.46	†100.46	.....
100.47	†100.47	.....
100.48	-100.48	.....
100.49	-100.49	.....
100.55	-100.55	.....
100.56	-100.56	.....
100.57	-100.57	.....
100.58	-100.58	.....
100.59	†100.59	.....
100.60	†100.60	.....
100.61	†100.61	.....
100.62	†100.62	.....
100.63	†100.63	.....
100.64	†100.64	.....
100.65	†100.65	.....
100.66	†100.66	.....
<b>ZEPHYR RADIO CO.</b>		
-40-C	L-42-C	23*55-A
-49-B	L-49-B	23*55-A
-49-C	L-49-C	23*55-A
-55-B	L-55-B	23*55-A
<-38-B2	K-38-B2	.....
<b>TRAVLER RADIO CO.</b>		
140R8	KX-42-C	UX-23*55-A
160KB	K-49-B	23*55-A
180KB	K-55-B	23*55-A
185R8	10X-55-C	UX-23*55-A
250KB	K-74-B	60*92-A
270KB	K-80-B	60*92-A
K-55-B	K-55-B	23*55-A
K-74-B	K-74-B	60*92-A

# 'Pop' Miller

## Now With Station KOAT

Dear Mr. Smith:

"I landed in Albuquerque in 1930, with practically nothing but a sick wife and three small children. Like thousands of others, I had come here on account of my wife's health, and of course expected to find employment.

As the late, but not lamented, depression arrived here just about the time I did. I could find no employment except common labor, and not enough of that. I had previously been a minister, and part time school teacher down in Arkansas, and of course had no technical training to fit me for any trade. Making a living here at my previous professions was completely out of the question. It was during those very hard years of the early thirties that I decided I had been wrongly educated—that no man was really educated unless he was more or less a master of some good trade that was in wide demand.

In those years I had a lot of time in which to think these things through. (In fact "time" was about all I *did* have.) In trying to decide just what trade to learn, I noted that almost every trade was represented in goodly numbers among the ever growing army of the unemployed. Every trade I could think of except radio!

I made careful inquiry, and not one unemployed radio man did I find! That decided the issue for me. Though I knew at that time as little about radio from a technical standpoint as a native Fiji Islander, I *determined* to learn it some way as soon as I could find an opportunity.

The opportunity came in 1937 when I had a WPA job teaching literary classes in a CCC camp. Yes, I don't mind telling the truth about it, I was working on the WPA, and glad to have

Page Twenty-four

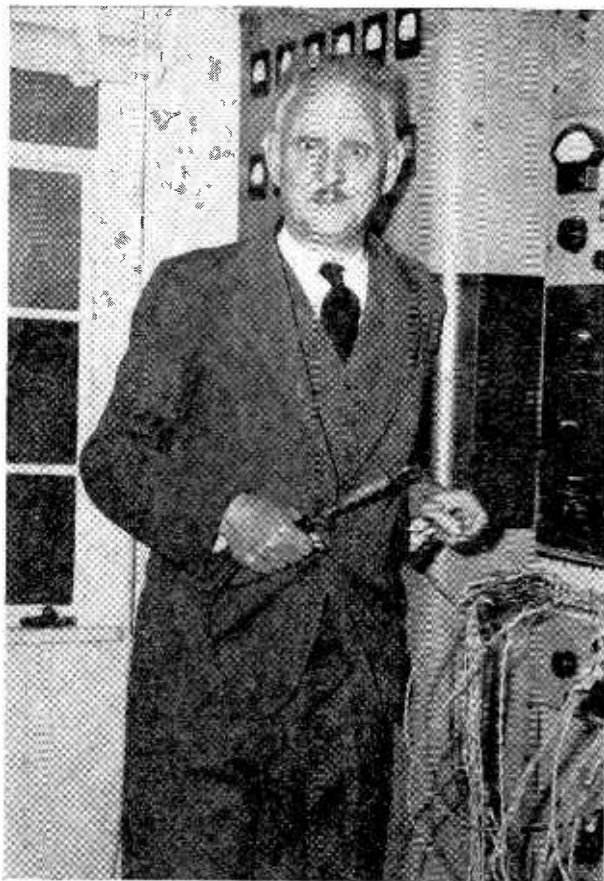

NRI Graduate O. B. Miller

even that good! I wrote to five or six correspondence schools, got their literature, studied it, and decided that NRI offered me the most for the money, so sent in my first payment, and included seven dollars a month in my budget to keep up the course.

I did not even know what people meant when they spoke of AC or DC current until I learned it in Lesson #1 of the course. Among all my friends and acquaintances, not one knew the first thing about radio so I couldn't get any help from any of them. I kept up my studies, and stayed on my job until after I was about halfway through the advanced course. I was transferred to a camp on the outskirts of town here, and one of the first new friends I made was Jackson C. Ream who had just arrived here to set up his radio repair business following his graduation from NRI. (Graduate Ream was a lot of help to me in finishing up my course and getting started in my spare time servicing business, and I



would not think of forgetting to give him the credit he deserves here. He is still a successful radio serviceman, and of course one of my best pals.)

In 1940 I went into radio full time. I bought a small lot, and built a modest home thereon, and settled down to radio as a career.

In 1941, a friend who was an electronics Prof. in the University here told me about a National Defense course which was open to anyone who knew a few fundamentals of radio. It was a course in Radio Communications and he was the instructor. I took it, and about the time it was over the semi-annual FCC licensing exams were held in Albuquerque. I took the exam, and came off with a Second Class Radio Telephone License.

After coming back to Albuquerque, I resumed my former business, and made a living at it, but that "Second Class" ticket kept haunting me. I wanted a *First Class*. I got acquainted with the boys over at KGGM, and helped out a bit there, and got myself some practical experience with a good Xmitter, and did quite a bit of reviewing such parts of the course as pertained to that field as well as studying various other works on the subject.

Last Sept. I took the exam again, and had no trouble whatever in getting my First Class Ticket. KGGM did not have any opening for a full-time operator, but I did "fight the extra board" there and carry on my service business at home, until in December of last year when station KOAT went on the air.

I went on as one of the regular operators. In this station I work my regular shift as operator, and produce and put on a twenty-five minute program five mornings each week. (That as an extra curricular activity.)

I still do a bit of servicing at home in my workshop, and am doing quite all right. I know there is a lot more to radio than I have learned so far, and I aim to keep right on increasing my knowledge in the field.

Sincerely yours,

O. B. "Pop" MILLER,  
Albuquerque, N. M.

---

## Ballast Tubes

(continued from page 23)

Simple decimals and arithmetic are very useful and should be familiar to every radio serviceman. However, calculations will not be required often in radio servicing. When they are necessary, it's important to be prepared to make them

speedily. Then, the time spent in brushing up on ordinary arithmetic will have proved itself worthwhile.

---

n r i

## Replacing Volume Controls

(continued from page 15)

OFF switch will then slip into place easily. Rotate the shaft of the control to approximately the mid-position. Then put the switch on, hold it in place with your hand, and turn the volume control shaft all the way counter clockwise. This should make the switch snap OFF. It should snap on again when you turn the control to the right (clockwise). This shows that the switch is in the proper position, so you can attach the back permanently. (Since controls differ in their clamp arrangements, the switch you use must be intended for the brand of control you are installing.)

Finally, slip the shaft through the chassis hole and start the holding nut. Connect the leads according to your sketch, then tighten the holding nut.

*Summary.* The replacement of a defective control may be broken down into the following simple steps:

1. Obtain the replacement.
2. Draw a picture sketch of the original connection.
3. Remove the connecting leads and the defective control.
4. For a general replacement control, check for a grounded terminal on the original; cut the shaft to the right length; add a switch if one is used.
5. Install the new control with the holding nut remaining loose.
6. Solder the connecting leads to the proper terminals on the replacement control.
7. Tighten the control holding nut.

---

n r i

## Electronic Technicians Still Needed In Winston-Salem, N. C.

The Western Electric Company is establishing permanent manufacturing facilities for communications electronic equipment in Winston-Salem, North Carolina. They have an employment program which calls for a number of skilled electronic technicians with a broad theoretical background in electronic theory and practice.

Qualified men should write a letter fully outlining their qualifications to: Mr. H. S. Cody, Jr., EMPLOYMENT MANAGER, Western Electric Co., Inc., Chatham Road, Winston-Salem, N. C.

Page Twenty-five



# N.R.I. ALUMNI NEWS

Frank Zimmer .....	President
Ernest W. Gosnell .....	Vice-Pres
Harry R. Stephens .....	Vice-Pres.
Chas. J. Fehn .....	Vice-Pres.
Harry Andresen .....	Vice-Pres.
Earl Merryman .....	Secretary
Louis L. Menne .....	Executive Secretary

## NOMINATIONS FOR 1948

IN accordance with our Constitution and By-laws, revised and adopted March 15 of this year, it is time to call for nominees for the election of officers to serve the NRI Alumni Association during the year 1948.

The Constitution provides for the election of a President and four Vice-Presidents. Because of the steady increase in our membership, now totaling more than 7,000, it was deemed advisable to place the affairs of the NRI Alumni Association in the hands of a Board of Trustees. The Board of Trustees was elected to office last March. The Board of Trustees, consisting of J. E. Smith, J. Morrison Smith, E. L. Degener, J. A. Dowie of the National Radio Institute and L. L. Menne of the National Radio Institute Alumni Association, is empowered to appoint, from among the executives of the National Radio Institute, an Executive Secretary to administer the affairs of the National Radio Institute Alumni Association. The Executive Secretary absorbs the duties of the former office of Secretary. This appointee is L. L. Menne, who has held the office of Executive Secretary of the Alumni Association for the past eleven years.

The Board of Trustees is also empowered to fill any vacancy in any office, by reason of death, resignation, retirement, disqualification or otherwise, without necessarily going through the cumbersome process of holding a special election. The new arrangement is highly desirable and is working very smoothly.

In line with our Constitution, you are asked to place in nomination the men you wish to have serve as President and Vice-Presidents. This means a total of five officers to be elected.

The following is taken from article VI of the Constitution:

*1. The election of the President and the Vice-Presidents shall be by ballot.*

*2. The President shall be eligible for reelection only after expiration of at least one year following his existing term of office, and when not a candidate for President, may be a candidate for any other office. Other officers may be candidates to succeed themselves, or for any other, but not more than one, elective office in the Association.*

*3. The election of officers shall be held in October of each year, on the day designated by the Executive Secretary, but not later than the twenty-fifth of the said month.*

*4. The Executive Secretary shall advise Members by letter, or through the columns of the NATIONAL RADIO NEWS, on or before August first of each year, that names of all nominees shall be filed in his office not later than August twenty-fifth following.*

*5. Each Member shall be entitled to submit, in writing, one nomination for each office, and the two nominees receiving the highest number of votes shall be the nominees for the office for which nominated.*

*6. The Executive Secretary, before placing any names on the ballot, shall communicate with each nominee, to ascertain his acceptance of the office, if elected. If such tentative acceptance is withheld, the eligible nominee having the next highest number of votes shall be nominee for that office.*

*7. The Executive Secretary, on or before October first of each year, shall furnish Members a ballot listing the names of the nominees for each office.*

*8. No Member shall be entitled to vote if he is in arrears in the payment of dues.*

*9. Ballots, properly executed and valid according to the instructions plainly printed thereon, shall be returned to the Executive Secretary on or before midnight of October twenty-fifth of each year.*

*10. The Executive Secretary shall designate three Tellers from the staff of the Institute, who shall count the ballots and certify the results, together with the return of the ballots, to the Executive Secretary.*

*11. In the event of a tie vote for any office, the*

**Executive Secretary shall cast the deciding ballot.**

*12. The nominee receiving the greater number of votes for the office for which nominated shall be declared by the Executive Secretary to be elected to that office, and notice of such election shall be forwarded in sufficient time, prior to January one, to permit such elected officer to enter upon the duties of said office on that date.*

The ballot will be found on pages 27 and 28. The polls for nominations will close August 25. This is in order to allow time to count the votes and announce the nominees in the next issue of NATIONAL RADIO NEWS which goes to the printer on September 1. We will then ballot on the nominees to choose our officers in time to take office on January 1, 1948.

The term of office of Frank Zimmer, that dynamic leader of New York Chapter, will therefore expire on December 31, 1947. Mr. Zimmer has been a grand President who is tremendously interested in Alumni affairs. He will continue to give his full support to all of our activities.

There is no rule which makes it necessary to elect our President from among our Vice-Presidents. Any member of our Alumni Association in good standing may be a candidate. However, it has been the custom to elevate one of our Vice-Presidents to the Presidency. If this should hold true this coming year, the two outstanding candidates undoubtedly will be Ernest W. Gosnell of Baltimore and Harry Andresen of Chicago. Harry R. Stephens and Charles J. Fehn, the other Vice-Presidents who are serving currently, have previously held the office of President. This does not disqualify them from serving again, but both agree with the great majority of our members that it is a more desirable condition to have these offices go to other hard working and deserving members. This leads us to repeat that the two logical contenders this year may be Mr. Gosnell and Mr. Andresen.

For the offices of Vice-Presidents, four to be elected, the field is wide open.

To mention just a few, H. J. Rathbun of Baltimore; James J. Newbeck or Wm. Peterson of New York; Harvey Morris, Philadelphia; Jacob J. Knaack, Cleveland; Elmer E. Hartzell, Allentown, Penna.; William Weisman, Fort Atkinson, Wis.; Harold Bailey, Peoria, Ill.; E. H. W. Smith, Winnipeg, Man., Canada; and G. C. Gunning, Smith's Falls, Ont., Canada, are all well qualified men for the offices of Vice-Presidents.

In order that our members may have a list of candidates to choose from, we are submitting some names of members located in various parts of the country. These are submitted merely to be of assistance to you. See pages 28 and 29.

## Nominations

All Alumni Association Members are requested to fill in this Ballot and return it promptly to National Headquarters. This is your opportunity to select the men you want to head your association. Turn this page—the other side is arranged for your selections.

After the ballots are returned to National Headquarters, they will be checked carefully and *the two men having the highest number of votes* for each office will be nominated as candidates for the 1948 election. The election will be conducted in the next issue of NATIONAL RADIO NEWS.

The President cannot be a candidate to succeed himself, but you may nominate him for Vice-President if you wish. You may, however, nominate all Vice-Presidents who are now serving, to succeed themselves, or select entirely new ones. It's up to you—select any men you wish as long as they are MEMBERS IN GOOD STANDING OF THE NRI ALUMNI ASSOCIATION. Be sure to give the city and state of your selections to prevent any misunderstanding.

The offices of Secretary and Executive Secretary have been combined. The Executive Secretary is appointed by the Board of Trustees and is no longer an elective office. Vote only for a President and four Vice-Presidents.

Detach this slip carefully from your NATIONAL RADIO NEWS so as not to damage the book. Tear off the slip at the dotted line, fill it out carefully. Sign it, and return it immediately to L. L. Menne, Executive Secretary, NRI Alumni Association, 16th and U Sts., N.W., Washington 9, D. C.

*The 1948 nomination is a very important one. Choose carefully the men you desire to handle the reins of the Alumni Association for the coming year. Let's all do our part to help the staff handling the elections, by submitting ballots on or before August 25, 1947.*

## Nomination Ballot

L. L. MENNE, *Executive Secretary*,  
 NRI Alumni Association,  
 16th and You Sts., N. W.,  
 Washington 9, D. C.

I am submitting this Nomination Ballot for my choice of candidates for the coming election. The men below are those whom I would like to see elected officers for the year 1948.

### MY CHOICE FOR PRESIDENT IS

.....  
 City ..... State .....

### MY CHOICE FOR FOUR VICE PRESIDENTS IS

1. ....

City ..... State .....

2. ....

City ..... State .....

3. ....

City ..... State .....

4. ....

City ..... State .....

Your Signature .....

Address .....

City ..... State .....

Student Number .....

Page Twenty-eight

## Nominations For 1948

Gorden E. DeRamus, Selma, Ala.  
 Don Smolley, Cottondale, Ala.  
 H. E. Nichols, Bisbee, Ariz.  
 Edgar E. Joiner, El Dorado, Ark.  
 R. A. Waller, Keo, Ark.  
 Oliver B. Hill, Burbank, Calif.  
 John Jerry, San Francisco, Calif.  
 Herbert Garvin, Los Angeles, Calif.  
 P. A. Abelt, Denver, Colo.  
 A. H. Wilson, Salida, Colo.  
 W. R. Haberin, Bridgeport, Conn.  
 David McKendrick, Devon, Conn.  
 Joseph Snyder, Danbury, Conn.  
 Jesse O. Starr, Darien, Conn.  
 Wm. F. Speakman, Wilmington, Del.  
 Lambert P. Ayres, 3rd, Millsboro, Del.  
 J. J. Jenkins, Washington, D. C.  
 Robert E. Many, Washington, D. C.  
 Clyde D. Kiebach, Washington, D. C.  
 Wm. G. Spathelf, Washington, D. C.  
 Glen G. Garrett, Bonifay, Fla.  
 Austin L. Hatch, Ft. Lauderdale, Fla.  
 Stephen J. Petruff, Miami, Fla.  
 W. P. Collins, Pensacola, Fla.  
 Chas. W. Hardigree, Macon, Ga.  
 R. R. Wallace, Ben Hill, Ga.  
 Joseph Bingham, Twin Falls, Idaho.  
 Arvil H. King, Montpelier, Idaho.  
 Arthur E. Miller, LaGrange, Ill.  
 Earl R. Bennett, Evanston, Ill.  
 Fred J. Haskell, Waukegan, Ill.  
 Harry Andresen, Chicago, Ill.  
 Harold Bailey, Peoria, Ill.  
 Lowell Long, Geneva, Ind.  
 Chase E. Brown, Indianapolis, Ind.  
 Russell Tomlinson, Marion, Ind.  
 Harry DeBolt, Cherokee, Iowa.  
 E. C. Hirschler, Clarinda, Iowa.  
 Elmer Dyer, Salina, Kans.  
 Wm. B. Martin, Kansas City, Kans.  
 K. M. King, Wichita, Kans.  
 Wm. S. Nichols, Cynthiana, Ky.  
 E. V. Hess, Louisville, Ky.  
 L. H. Ober, Alexandria, La.  
 Lawrence Merz, New Orleans, La.  
 Austin Vachone, Bath, Maine.  
 Harold Davis, Auburn, Maine.  
 Ralph E. Locke, Calais, Maine.  
 H. J. Rathbun, Baltimore, Md.  
 J. B. Gough, Baltimore, Md.  
 Samuel Robinson, Hagerstown, Md.  
 G. O. Spicer, Hyattsville, Md.  
 Laurence E. Grant, Belmont, Mass.  
 Louis Crestin, Boston, Mass.  
 A. Singleton, Chicopee, Mass.  
 Omer Lapointe, Salem, Mass.  
 Robert Swanbum, Duluth, Minn.  
 Arthur J. Haugen, Harmony, Minn.  
 A. R. Stewart, Staples, Minn.  
 F. Earl Oliver, Detroit, Mich.  
 J. Stanish, Detroit, Mich.  
 Harry R. Stephens, Detroit, Mich.

Al Fisher, Clarksburg, Miss.

Robert Harrison, West Point, Miss.

C. S. Burkhart, Kansas City, Mo.

A. Campbell, St. Louis, Mo.

C. W. Wichmann, Inverness, Mont.

Carl M. Darner, Sweet Grass, Mont.

V. S. Capes, Fairmont, Nebr.

Albert C. Christensen, Sidney, Nebr.

C. D. Parker, Lovelock, Nev.

Clarence Caraway, Las Vegas, Nev.

Clarence N. George, Dover, N. H.

E. Everett Darby, Woodsville, N. H.

J. A. Stegmaier, Arlington, N. J.

Delbert Delanoy, Weehawken, N. J.

Claude W. Longstreet, Westfield, N. J.

Ewell Wilkinson, Carlsbad, N. Mex.

George Baum, Hagerman, N. Mex.

John E. Kreitner, Buffalo, N. Y.

Alfred R. Guiles, Corinth, N. Y.

James J. Newbeck, New York, N. Y.

L. J. Kunert, Jamaica, L. I., N. Y.

Charles W. Dussing, Syracuse, N. Y.

Wm. Peterson, Jamaica, L. I., N. Y.

Irvin Gardner, Saratoga, N. C.

Max J. Silvers, Raleigh, N. C.

Arvid Bye, Spring Brook, N. Dak.

Jacob J. Knaak, Cleveland, Ohio.

H. F. Leeper, Canton, Ohio.

Chas. H. Shipman, E. Cleveland, Ohio.

Byron Kiser, Fremont, Ohio.

P. E. Traylor, Maysville, Okla.

Emil Domas, Dale, Oreg.

H. M. Pruner, Newport, Oreg.

Harvey Morris, Philadelphia, Pa.

Elmer E. Hartzell, Allentown, Pa.

Chas. J. Fehn, Philadelphia, Pa.

William Dyson, Pawtucket, R. I.

James F. Barton, Greer, S. C.

Joel J. Lawson, Aberdeen, S. Dak.

Chester Warren, Lead, S. Dak.

Argil Barnes, Jonesboro, Tenn.

J. E. Collins, Paris, Tenn.

Dan Droemer, Ft. Ringgold, Texas.

Richard Mallard, Dallas, Texas.

Paul Boelten, Salt Lake City, Utah.

J. W. Gladden, Alexandria, Va.

A. P. Caldwell, Buchanan, Va.

T. E. Ellis, Richmond, Va.

Walter Leland, Orleans, Vt.

J. E. Thibodeau, Tacoma, Wash.

Alfred Stanley, Spokane, Wash.

G. Blomberg, Aberdeen, Wash.

G. McCollum, Weston, W. Va.

Wm. Wiesmann, Fort Atkinson, Wis.

J. C. Duncan, Duncan, Wyo.

Robert Kirkham, Calgary, Alta., Canada.

M. Martin, New Westminster, B. C., Canada.

E. D. W. Smith, Winnipeg, Man., Canada.

Ernest Earle, St. John, N. B., Canada.

Russell Burhoe, Woodstock, N. B., Canada.

Donald Swan, Springhill, N. S., Canada.

G. C. Gunning, Smith's Falls, Ont., Canada.

E. Bergeron, Sherbrooke, P. Q., Canada.

Thos. Crook, Saskatoon, Sask., Canada.

## Baltimore Chapter

Chairman Rathbun spoke on Audio Troubles and Motorboating using the blackboard for diagram drawing as he advanced. Very interesting. We then proceeded with our Radio trouble shooting and repairs. Members bring in balky sets and we take the bugs out for the benefit of all present.

This meeting was covered by our good and true charter member, Mr. John B. Gough, who acted as Secretary for the undersigned during a period of illness.

At another meeting we discussed Harmonics and Sub-Harmonics. This discussion was as entertaining as interesting. These meetings are proving very beneficial judging from the comments from our members.

Mr. Rathbun also opened another meeting with a short talk on Filter Condensers. This was followed by our regular schedule talk, this time delivered by Mr. Thomas Clark, who spoke on "Servicing by Signal Substitution." Mr. Clark brought his Signal Generator to the meeting to aid in his talk. He began at the Audio Output and continued through the Second Detector, I.F.'s and R.F. sections.

Member Audrey Hooper is sick in Fort Howard Hospital, Fort Howard, Md. He is a veteran. We are keeping in contact with him.

New members are Mr. Norman McClelland, Baltimore; Mr. Leonard C. Hornick, Glenburnie, Md.; and Mr. Harry B. Neff, Baltimore. We greet these new members and trust they find much of interest and good fellowship in our Chapter.

There is always a welcome sign out on the second and fourth Tuesday of each month at 8:15 P. M. The address is 745 West Baltimore St. Come and look us over.

P. E. Marsh, Secretary,  
Box 2556, Arlington Station  
Baltimore 15, Md.

— n r i —

## Detroit Chapter

Through the courtesy of our own Floyd Buehler, who is an instructor at Electronics Institute, two motion pictures were shown. Incidentally, our new meeting quarters are now ready. They certainly are appealing to our members.

At one of our meetings, after the regular program, we enjoyed a prize fight being televised from Detroit. This too, was a courtesy on the part of Mr. Buehler, who had assembled the Television receiver over which the boxing contest was received.



Annual Dinner-Party of Detroit Chapter held at the Copacabana Club in Detroit to wind up the season. Regular meetings will be resumed September 12.

## Detroit Chapter

(continued from page 29)

A tentative program for the 1947-1948 season is being worked out. Next meeting is September 12. Beginning then our meetings will be held on the second and fourth Friday of each month.

We closed our season with our annual dinner party (See above photo). This was held in the Copacabana Club in Detroit and was a grand success. The attendance, including many of our wives and sweethearts, was very good. The music was supplied by a fine orchestra and was simply too good for words. A trio of musicians, in addition to the orchestra, played many of the popular numbers while the entire group sang. Harold Chase, as Master of Ceremonies, proved to be a great showman. Chairman Earl Oliver and our guest, Lou Meine, did the speaking. Robert Mains entertained as a magician and he had every one in stitches with his clever tricks. A number of very fine prizes for the ladies and men were drawn. The dancing was tops and the food simply delicious—all thanks to those who planned so long and worked so hard to make this annual event bigger and better than ever—which it certainly was by every vote.

NRI Students and Graduates are welcome to meet with us, beginning September 12, at Electronics Institute, 21 Henry St., corner Woodward (fourth floor). Drop in on us.

Harry R. Stephens, Secretary,  
5910 Grayton Rd.,  
Detroit 24, Mich.

Page Thirty

## New York Chapter

Following is a resume of our recent activities at meetings.

Eugene L. Williams gave a fine talk on a Television receiver he had built. Our members liked this talk very much.

James Newbeck gave a wonderful talk and demonstration on General Alignment Procedure. For this talk we used an unusual arrangement. We had Newbeck up on a platform and used two spotlights. One of the lights was put on the demonstration board and the other on the blackboard. All other lights were put out. It looked real good. All the members moved up close—that is, as close as 61 men can get. We had Chairman Wappler's oscilloscope and signal generator. Just before the demonstration started we passed out a sheet giving the general alignment procedure for A.C. sets. Then Newbeck went to work—and how. It was one of our best talks and demonstrations and that, my fellow member, is mighty good. This was a new idea and it worked beautifully. It takes new ideas to keep things pepped up.

We are sorry to report that the wife of our grand old member, George Woodward, passed away. This couple recently celebrated their fiftieth wedding anniversary.

Alex Remer continues his quiz program and Pete Peterson always conducts his questions and answers feature. These are always part of our regular programs. The members count on and look

(page 32, please)



## Here And There Among Alumni Members

meter cw. My call is W7LBN. Shortly following this, I received my second class 'phone ticket. I have just completed two years of Radio, including VHF, in college." Sounds like you are making real progress, Don.

*Graduate R. C. Gregg, owner of the Delaware Radio Shop in Indianapolis, Ind., sent us a very well prepared Radio Log Book. He is furnishing this excellent item of advertising to some 20,000 homes on his prospective customer list. Sounds like a real business-getting idea.*

A flying cop for New York City and member of New York Local Alumni Chapter, Michael Fabia, paid us a pleasant visit recently. We enjoyed meeting you, Mike.

*Arthur Berger, NRI Graduate from Philadelphia, writes that he has been very successful in servicing. He is studying for his 1st Class Radiotelephone license now.*

NRI Graduate John A. Sulick, from Bay Village, Ohio, now has his first class Radiotelephone ticket. He'd like to learn of an opening in the broadcasting field.

*From Petty Officer Bill Marshall in the Pacific, "While finishing my NRI Course, I was promoted to Seaman 1st Class. On June 1, 1947, I was again promoted to an Electronic Technicians' Mate. I am highly pleased to be in such an interesting branch of the Navy." Bill is now an Alumnus of NRI.*

Harold O. Trummel, formerly with WSOY, Decatur, Ill., is now holding down the Chief Engineer's position with newly established WHOW, 1520 kc, Clinton, Ill. Congratulations!

*Mr. and Mrs. Roland D. La Marche visited the Institute while vacationing in Washington. The La Marches are from New Bedford, Mass.*

Richard Salley, former G.I., has accepted a position as a tester on the broadcast transmitter assembly line of the Western Electric Co., Winston-Salem, N. C. We feel sure he will make good at this new work.

*Alumnus Avery A. Leuty, of Salem, Ill. requests more articles on service hints on present day re-*

*ceivers. Also on "stage gain." What are your ideas fellows?*

George L. Buckmann, Jr. is now employed as a Radio Operator by Station WMGA, located in Moultrie, Ga.

*Alumnus Harold Myers, of Worthville, N. C. has just finished the NRI Course under the G.I. Bill. He says that his shop, which will be spare-time at first, is to be completed soon. Also has his stock of parts for sales and service nearly completed. Everything is debt free—paid for by spare-time earnings while still a student. Another NRI man is well on the way to success!*

Now Chief Engineer of Station KSFA, Nacogdoches, Texas, Graduate T. L. Kidd writes that giving birth to a new Broadcast Station is quite an operation. Just 46 days after he took over KSFA, they were on the air. We call this getting results in a hurry. Congratulations, Graduate Kidd, on your new position.

*We were especially pleased to receive two fine photographs of the interior of Graduate Harold Sedgwick's Radio Service Shop. He is doing an excellent business in Taunton, Mass. Has all new, modern test equipment to give good service on F.M. as well as A.M. We'd like more of our Alumni members to send photographs with their letters.*

Horse kicks Radio—Tracy Cash, of Raphine, Va., writes that after servicing Radios for seven years, he received this unusual repair job. It seems the Radio was playing satisfactorily until a horse backed up to the window and kicked the window out, silencing the Radio, too.

*From Toronto, Ont., Canada, Alumnus W. B. Doubleday writes an interesting letter, "I am in Radio Inspections with the Dominion Government of Canada. Since taking your course, (graduated 1932), I have put in five years in commercial operating on ships and Coast Station duties. Have met several others who started Radio with the NRI Course. My amateur call is VE3BOW."*

John W. Pritting, who is stationed at a Naval Radio Propagation Field Station in Adak, Alaska, sent an unusual photograph of himself operating special equipment. He is expecting to get a "ham" station on the air soon. John has been doing lots of spare-time radio service, also.

*A new member of the NRI Alumni Association, Alexander Brack of New York City is happy to have graduated and be one of us. He plans to attend meetings of the local New York Chapter soon.*

## New York Chapter

(continued from page 30)

forward to them.

Again Jimmy Newbeck took over, at another meeting, and spoke on "Tuning Indicators." This was demonstrated on our Demonstrator. Newbeck, ever ready, jumped in at the last minute to do this one because our scheduled speaker was unable to be with us. Sixty-six attended this meeting.

We meet on the first and third Thursday of each month at St. Mark's Community Center, 12 St. Mark's Place—between 2nd and 3rd Avenues, New York City. Meetings begin at 8:15 P. M. All NRI men—whether students or graduates are invited. Drop in on us next meeting.

Louis J. Kunert, Secretary  
145-20 Ferndale Ave.,  
Jamaica 4, N. Y.

— n r i —

## Chicago Chapter

We still meet at 2759 Pulasky Road. Chairman Steve Bognar presides.

Vice President Harry Andresen made an earnest appeal that our members patronize the Radio concerns in Chicago which have always cooperated with our Chapter. Outstanding among these is Radolek Company, whose representative, Mr. Coleman, has donated many valuable door prizes which are drawn for at our meetings.

Our secretary suggested to the members that they bring to the meeting the case history of a set they repaired; its symptoms and actions before it was repaired, the method used to find the defect, and the reasons for its failure to play. A greatly enlarged schematic should be made of the defective stage so all the members can visualize and follow the speaker as he relates his experience with this particular job. The members are also to express their opinion and technical knowledge afterwards so as to create a general discussion and analysis of the set in question. This is to be a regular feature at all of our meetings.

The big attraction at our meetings is the actual Radio servicing we do on sets brought in by our members.

Refreshments are usually served at each meeting.

If you wish to receive notices of our meetings, please send your name and address to the undersigned. Graduate or just beginning—it makes no difference. You are welcome at our meetings.

L. Brodhage, Secretary,  
4820 N. Kedzie Ave.,  
Chicago 25, Ill.

# NATIONAL RADIO NEWS

FROM N.R.I. TRAINING HEADQUARTERS

Vol. 12

August-September, 1947

No. 10

Published every other month in the interest of the students  
and Alumni Association of the

NATIONAL RADIO INSTITUTE  
Washington 9, D. C.

The Official Organ of the N. R. I. Alumni Association.  
Editorial and Business Office, 16th & You Sts., N. W.,  
Washington 9, D. C.

L. I. MENNE, EDITOR

J. B. STRAUGHN, TECHNICAL EDITOR

NATIONAL RADIO NEWS accepts no paid advertising. Articles referring to products of manufacturers, wholesalers, etc., are included for readers' information only, and we assume no responsibility for these companies or their products.

## Index

Article	Page
Editorial .....	2
Jerry McCarthy Busts Things Wide Open in the Field of Professional Recording .....	3
Pointers on Replacing Volume Controls .....	7
Superheterodyne Alignment Without a Signal Generator .....	9
The NRI Service Manual is Still Available ..	10
Stratovision to Boost Television's Coverage ..	13
Ballast Tubes in Radio Servicing .....	16
NRI Alumni Association Nominations For 1948 .....	26
Alumni Chapter News .....	29
Here and There Among Alumni Members ..	31