

NATIONAL RADIO NEWS



IN THIS ISSUE

Improvements in Al-Wave Receiver Antennas

The Tools of Communication

Alumni Association News

FEB.-MAR.
1938

VOL. 8
No. 1



DON'T QUIT IN THE CHASM!

You probably know some fellows who are great starters, but poor finishers. As long as everything runs smoothly they do nicely, but let some obstacle cross their path and then what happens? They take the easy way out—they quit cold.

The world is crowded with such fellows. They never get anywhere. They are all traveling a well greased one-way road which leads straight to failure. They know their plight. They know they are doomed. They actually feel sorry for themselves, but they won't do anything about it. They think the fellow who gets ahead by study and prepara-

tion is lucky. They refuse to recognize the fact that every successful business and career is built upon determination, upon hard work, and most important of all, upon study.

I know a man, today the owner of a prosperous business, who not so many years ago was just about ready to go under. One misfortune after another hit him; at times it seemed impossible that his business could last another day. But he wouldn't quit. Before him, where he could read it every minute, was this motto:

"When today's difficulties overshadow yesterday's triumphs and obscure the bright visions of tomorrow—

"When plans upset and whole years of effort seem to crystallize into a single hour of concentrated bitterness—

"When little annoyances eat into the mind and corrode the power to view things calmly—

"When the jolts of misfortune threaten to jar loose the judgment from its moorings—

"Remember that in every business—in every career—there are valleys to cross, as well as hills to scale; that every mountain range of hope is broken by chasms of discouragement, through which run torrent streams of despair.

"To quit in the chasm is to fail. See always in your mind's eye the sunny summits of success.

"Don't quit in the chasm! Keep on."

He had faith in those sunny summits of success waiting on the opposite side of the chasm, and that faith pulled him through.

You, too, can profit from this little motto. Read it again—now—and when everything seems to go wrong—when things seem blackest—go to it for the courage and inspiration which will make you keep right on fighting.

I don't know who wrote this motto. It might have been Marconi, or Edison, or Steinmetz; it might have been the owner of a small shop somewhere, but I do know one thing—no failure could write it. Whoever wrote those inspiring words knew what it takes to be successful.

E. R. HAAS, *Vice-President and Director.*

Recent Improvements in All-Wave Receiver Antennas

By W. FRANKLIN COOK
N. R. I. Consultant

BY definition an antenna for receiving purposes is any device used for the intentional interception of electromagnetic waves. From this definition *any* system that picks up energy radiated by broadcasting stations can be called an antenna, and is so considered by many people. It is this fact that prevents a very large number of radio owners from experiencing *good* reception! They believe that as long as *something* is received, the antenna is operating properly. The Radiotrician must be a salesman in many cases, explaining the fact that it is possible to obtain much better reception by the proper installation of a well designed antenna.

Replacement of any antenna that is several years old by new equipment will result in higher efficiency in picking up signal energy. This is due to the fact that the corrosion existing at joints in the old system, together with leakage of energy across dirty and cracked insulators, results in a large loss of signal voltage. The installation of the original system in most cases was not carefully thought out, with the result that the Radiotrician will find many instances of antennas running through trees, close to or over power lines, too close to metal roofs and drains, and in the cities, frequently tangled up in a mass of other antennas on some apartment house.

In clearing up the antenna troubles by installing a new system, several facts must be considered. The theory of the various antenna arrangements must be understood enough to permit the choice of the most desirable system for each installation, the best position must be discovered, and of course the antenna must be installed properly.

The antenna to be used in any installation should be chosen with care. Not only must the largest possible signal strength be obtained; at the same time a minimum of noise should be picked up. First, let us take up signal efficiency.

When a signal strikes an antenna a current flow will be set up. Due to the distributed inductance and capacity, the voltage and current will be distributed in a definite pattern, depending upon the frequency. Where the wire has the same electrical length as that of the particular wave received, the voltage and current distribution will be as pictured in Fig. 1A. Note that for one wavelength, the voltage is maximum at the ends while the current is zero at the center.

From the foregoing it can be seen that we can "tune" our antenna by adjusting the length so that it corresponds to approximately the wavelength desired. As the longer wavelengths would require excessive wire lengths, it is desirable to cut the antenna in half, making a half-wave antenna with a current and voltage distribution as shown in the left half of Fig. 1A. Note that the harmonic currents are pictured in Fig. 1B. This shows that even harmonics, such as the second, would have current nodes (no current) in the center, while the fundamental and odd harmonics give current loops (maximum current) at this point.

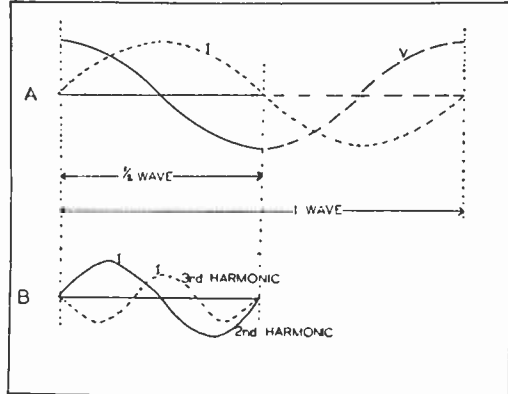

Figure 1

It is customary to feed the radio receiver with maximum current, which means we must connect to a point of maximum current in the antenna; the center in the case of the resonant frequency and the odd harmonics. Since the current distribution varies for different frequencies in the same antenna system, it can be seen that other frequencies will give less than maximum results for any single connection point. The length must therefore be chosen so that a current loop will be at the point of connection for the most desired frequency.

The fact that the current varies over different parts of the antenna suggests that the impedance would be found different at different points. Measurement would prove this: By starting at the center of the half-wave portion and proceed-

ing toward either end, as we cut the wire at various points, we would find that the impedance varied from a low value to a high value as the ends are approached. This impedance is called the radiation resistance and is quite important from the standpoint of impedance matching. For maximum power transfer, the impedance should be matched as in the case of any source and load relationship.

As mentioned above, a point of maximum current is generally employed for connection purposes, this point being the center of the antenna. On cutting a half-wave antenna in the center, we would find this to be the point of lowest radiation resistance, having a value of approximately 75 ohms. This cutting in two of a half-wave antenna gives us the well known half-wave doublet. All half-wave doublet antennas used for all-wave work have this characteristic resistance of 75 ohms at their resonant frequency, when cut in the center. Now, knowing the impedance value, and having our antenna of the proper length for the desired frequency, we must transfer the energy from the antenna to the receiver. As the receiver cannot be moved to the antenna, we must employ some means of transferring the antenna current to the receiver and properly matching the impedances. A two-wire line, called a transmission line, is used for this purpose.

In order to study lines of various types, the physical construction should be reviewed. (See Fig. 2.) In Fig. 2A is shown a parallel pair of wires spaced by insulators. In Fig. 2B, a transposed pair is pictured. The twisted pair of Fig. 2C and the shielded line of Fig. 2D are the remaining common types. Briefly, the first two are very efficient, the transposed type being the best of all. Both types, however, represent considerable cost and are more difficult to erect in the average case. The shielded line has a lower efficiency as there is a loss of energy through the leakage between line and shield.

The twisted pair of Fig. 2C is used in practically all modern all-wave kits. Although this type is

not quite as efficient as the first two, it is far easier to install, design and construct and is also less expensive.

If a twisted pair or any other transmission line had infinite length, and the impedance at the terminals were to be measured, a definite value would be obtained. This impedance is due to the distributed inductance and capacity and is known as the surge impedance. Such a line has another very important characteristic. If the line is cut to any definite length and a resistance equal in value to the surge impedance is connected across two terminals, the impedance measured at the other two terminals will still be equal to the surge impedance.

By regulation of the size of wire, the spacing, etc., the distributed factors are changed, which changes the surge impedance; it is thus possible to construct a line to match the 75-ohm antenna impedance, resulting in maximum signal energy at the receiving end. It is now only necessary to match the transmission line to the input of the receiver, a simple job for a transformer.

It can now be seen that an antenna can be designed to give maximum results by adjusting the length and properly connecting the line. However, the ordinary type of antenna using a single wire lead-in instead of using transmission lines would still be used almost entirely if it were not for noise pickup. The transmission line serves not only as a means of efficient signal transfer, it also is the major item making possible the modern noise reducing all-wave antenna.

Noises of the man-made type originate within the home, travel over power and telephone lines and in many cases set up a strong field about the receiving location. Automobiles contribute their share on the short-wave bands due to radiation of ignition disturbances. This means that to have good reception the signal must be strong with respect to the noise (a high signal to noise ratio), the noises must be eliminated or filtered

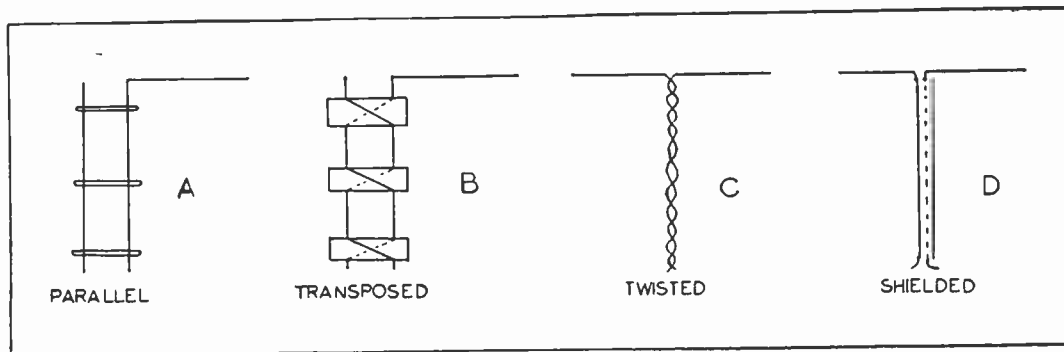

Figure 2

out at the source or else the antenna system must be noise rejecting. The signal-to-noise ratio is generally improved by increasing the efficiency of the antenna. While great strides are being taken in eliminating noise at the source, there is still enough interference to make noise rejecting antenna systems desirable.

How can we make the antenna favor signals over noise, especially when the lead-in must come through the noise area to reach the set? First, as much noise pickup as possible can be eliminated at the antenna itself, by taking advantage of the fact that the transmission line can be very long, permitting the antenna to be erected in a noise-free area. If this is impossible, the directional properties of the antenna may be employed. As the antenna receives best from the side, it must be erected at right angles to any power lines or other visible interference producing devices.

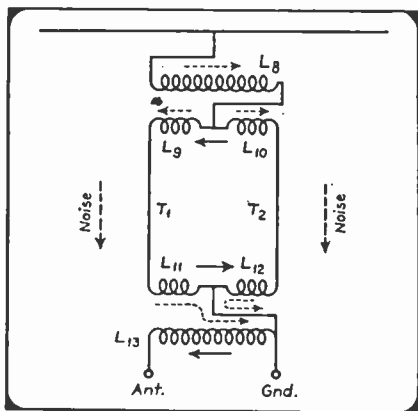

Figure 3

The transmission line offers no problem as we can take advantage of the fact that it consists of two wires and is not a part of the signal collecting system. If a voltage is induced into one wire, an equal voltage will be induced into the other. By connecting the two wires to opposite ends of a coil in the receiver, the induced voltages will oppose and cancel. On the other hand, the signal from the antenna is fed in at the ends of the coil in such a manner that there is no opposition. By using a capacity shield to ground at the receiver, even the noise induced through capacity coupling is removed.

MODERN ALL-WAVE SYSTEMS

Now, having studied the theory of an efficient noise reducing antenna, let us see what the manufacturers are doing to make use of this theory. First, practically all large radio manufacturers have several types of all-wave antennas avail-

able to meet various price ranges and certain physical requirements. Most of them include an antenna kit with their better grade receivers and urge its installation for best results. In spite of various models, fundamentally all modern systems consist of the doublet or half-wave antenna and a transmission line, the physical variations being the major technical difference between many models.

Space limitations are of importance especially in cities. As the antenna should be of sufficient length to be resonant to a desired frequency, we find in many cases that the half-wave portion is still too long for the space available. A loading coil may be inserted to electrically make a shorter antenna equal to a half wave. A loading coil consists of sufficient wire, widely spaced on a coil form, to furnish the desired increase in length, if it were stretched out. While the cur-

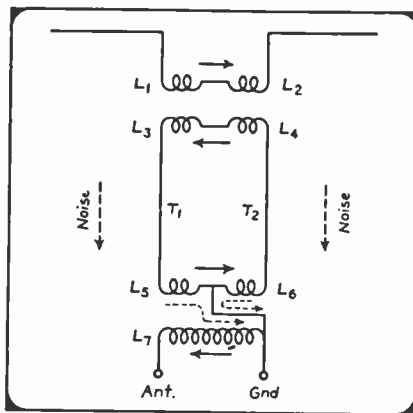

Figure 4

rent distribution is not exactly the desired shape, it is close enough for practical purposes. In some cases, a matching transformer is needed at the antenna end; therefore in some systems the loading coil may be a part of the transformer. In this case the turns may be closely wound for an increase in coupling or a part may be wound for the transformer, the remainder being spaced.

The use of coupling transformers to match the line permits a number of variations in modern systems. In several systems, notably some of the Philco antennas, a coupling point is chosen that is not in the center of the antenna. This results in the 60-foot Philco antenna being divided into segments of 17 feet and 43 feet. The antenna contains a coupling coil, both inductively and capacitively coupled to the pick-up coils on the transmission line, one being on each wire. The off-center coupling furnishes a higher impedance at the antenna, which the manufacturers claim re-

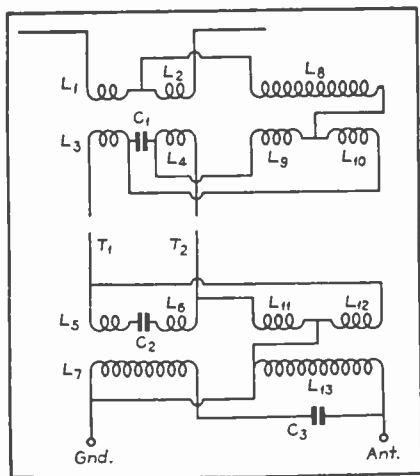

Figure 5

sults in a more uniform response over a wide range of frequencies. At the highest frequencies, the special coupling transformer no longer acts inductive, the capacity between the windings being the means of signal energy transfer.

A single antenna can only be highly efficient at one frequency, which means that many wave bands of interest, especially in the short-wave region, would not be handled well. Many attempts have been made to overcome this. One method consists of making use of the coupling transformers at both ends of the transmission lines; by adding sufficient inductance or capacity to cause them to be broadly resonant at one of the frequencies the antenna does not favor. This generally gives good results in the short-wave bands, the ability of the receiver making up for poor broadcast band pickup.

The Technical Appliance Corporation (TACO) has worked out a system of double transformers that aid both broadcast and short-wave reception, giving a good signal to noise ratio. In order to show clearly the action of such a system, we can divide it into the two parts, the broadcast and short wave sections. Figure 3 shows the broadcast portion. In this section, the signals picked up by the antenna pass through the high inductance coil L8 into the center tap between L9 and L10, through the transmission line to the ground as shown by dotted arrows. As the voltage through L11 and L12 are out of phase, this produces no signal in the receiver coil L13. However, in flowing through L8, a voltage is induced in L9 and L10, as indicated by the solid arrow. This is a circulatory current, flowing through L11 and L12 in the same direction, inducing a signal into L13.

In the short-wave portion a doublet form is used, energy flowing through L1 and L2 of Fig. 4, inducing a circulatory current in L3 and L4, causing L5 and L6 to induce a voltage into L7. In both portions, noise voltages are in opposite directions at the receiver transformer, inducing no voltage into the receiver and flowing to ground.

In order to combine the two portions so they would work without switches at both ends, a connection was worked out using the fact that inductive reactance increases with frequency while capacitive reactance decreases with frequency. The complete system is shown in Fig. 5. The short-wave signals are passed into L3 and L4, the high inductance of L8 preventing them from passing to the broadcast coil. Condenser C1 acts as an effective short at the short waves, thus completing the circuit for the coils L3 and L4. At the other end, short wave signals pass through L5, C2 and L6, inducing a voltage in L7. On the broadcast band, the broadcast circuit is followed, condensers C1 and C2 having enough reactance to prevent the coils L3-L4 and L5-L6 from shorting the broadcast coils. Condenser C3 performs a similar function for L7.

The desirability of covering various bands has also been met by having more than one aerial. Of course, space generally prevents having these antennas widely separated; they must be combined in some manner so that a single installation will put both in operation. The RCA double doublet is representative of early attempts in this direction. Here we have two doublets having 29-foot and 16-foot sections. The two 29-foot sections are strung in a line, making a single antenna of 58 feet. The two 16-foot sections are strung downward from the center in the form of an inverted "V," forming a 32-foot doublet. The same transmission line is used for both, a maximum transfer being obtained from the antenna nearest resonance, as off resonance, the impedance match and hence the energy transfer is poor with all types of doublets.

During recent months, RCA has gone further,

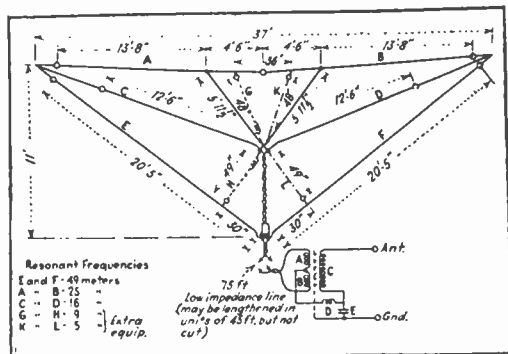

Figure 6

bringing out the type called a Spiderweb. This system consists of a number of doublets as shown in Fig. 6, each designed to favor one of the popular foreign short-wave bands. Note that loading coils are used to keep the size of the antenna within reasonable limits. The transmission line is noise reducing in the short-wave bands but is not in the broadcast band. In this band the entire antenna system, including the lead-in, is employed to pick up signals. This is possible due to the design of the special receiver coupling transformer illustrated. The longer wavelengths pass through coils A, B and D, being fed to the input across condenser E. In the short-wave bands, signals are fed down both legs of the lead-in out of phase through the coils A and B, which are wound so that signals will add, being passed by induction to coil C. Noises picked up by the line are eliminated by action of the Faraday or capacity shield to ground.

Another recent TACO system has been designed to take advantage of the fact that an antenna receives best from the sides by combining two antennas, spaced 90 degrees apart, as shown in Fig. 7. This system has been primarily designed for amateurs; however, it probably will be introduced for all-wave work later if it meets any wide success.

In theory, when two directional antennas are combined properly, they can be made to aid the directional effect in one particular direction while receiving a minimum from other directions. The favored direction is determined by properly phasing the coupling coils, which when variable may be made to favor any particular direction. This system of course works on this principle. This results in stronger signals from the desired direction and a reduction of interference from other directions.

The systems discussed so far have been of the all-wave noise reducing types. There remains the noise reducing type that is not all-wave in primary design, although good results are obtainable over a very wide range of frequencies. The new RCA Magic Wave system is an example of this type. Any antenna may be used, the ordinary "L" type being commonly employed. A coupling transformer is employed on the roof to couple to the noise reducing transmission line. This system requires an efficient ground at the roof, a vent pipe or special ground wire run to the roof being commonly used. The antenna sends a signal down its lead, through the coupling transformer to the ground. From the coupling transformer, the noise cancelling transmission line carries the signal to the receiver. The antenna has no noise reducing ability and must be installed out of the noise zone.

Now for some general rules of installation, regardless of antenna type. First, follow the instructions of the manufacturer packed with the antenna kit. Many failures can be traced to

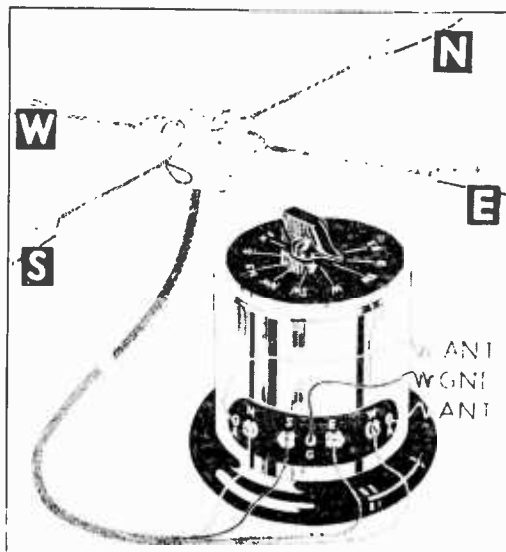

Figure 7

failure to observe this rule. The antenna should be as high as possible, away from noise sources, if possible. It should be clear of other antennas and securely fastened. The transmission line must be carefully fastened to prevent excessive strain, shorts and open circuits. The receiver transformer must be mounted as close as possible to the antenna and ground posts, many systems being designed to mount right on the binding posts. A good ground is important for noise reduction and several different grounds should be tried in stubborn cases.

In rural districts, where noise is not much of a problem, the old standard antenna is still employed, consisting of a flat top and a single wire lead-in. Such systems, properly installed, are excellent even for short-wave work. It must be remembered, however, that the antenna includes the lead-in, the coil in the receiver, and the ground wire. This means exceptional care must be taken to properly install the lead-in away from grounded metallic objects and it must not be run parallel to the ground wire for any great distance to prevent loss of energy.

If the length of the flat top, lead-in, ground wire, and wire in the antenna coil is equal to one quarter a desired frequency, a current maximum will appear at the ground and the radio will give excellent results. The ground "reflects" the quarter wave of the antenna, causing it to act as a half-wave system with the maximum current point near the radio, resulting in the same type of maximum efficiency as that experienced with a half-wave doublet.



Action! Camera! Cut!

President J. E. Smith cuts the cake at a luncheon given in his honor at Engineers Club, Dayton, Ohio. At right, Mr. H. W. Hammick, President of local civic club. Mr. Smith was the principal speaker. Photograph by courtesy of Dayton Daily News.

— n r i —

New Gadget Counts Radio Listeners!

It is now possible to measure accurately the number of listeners tuned in to a particular station at any given time, provided that the Radiovoter, a 4-inch square instrument designed by Dr. N. M. Hopkins, is connected to each Radio. Whenever the broadcasting station desires a count, it transmits a tone signal of a special frequency. The Radiototers in all receivers tuned to this station will respond by drawing additional power from the line, and accurate instruments at the power company measure this sudden increase in power and interpret it in terms of the number of Radiototers in action. Provisions are also made to permit the listeners to vote "yes" or "no" whenever asked to by the station, simply by pressing a button attached to the set. Tests of the Radiovoter are now being made in about one thousand homes in Montclair, New Jersey.

Page Eight

Fish Story

(Courtesy of "Radio Retailing")

To deep-sea diver Art Mercer goes the palm for developing a new and practical use for sound, putting it over with a novel publicity stunt. Dissatisfied with old, one-way telephone systems for under-water communication (divers formerly could hear but not talk back, phones slipped off their ears), Mercer went to Benjamin Werrick of the U. S. Sound Company with his problem. Werrick had engineer Frank J. Nunez build a combination microphone-speaker into the top of Mercer's helmet, connect it to a similar unit and an amplifier intended for use on dry-land.

Newspaper syndicates gasped, sent reporters and photographers when diver Mercer descended to the bottom of Calvin Coolidge lake, near Norfolk, guided the lures of prominent anglers into the mouths of trout, caught one with his gloved hands. They responded with more publicity when Mercer later descended in forty feet of water, reported to officials on the surface damage done by termites to the piles of Central Wharf. Bathed in the light of newspaper lineage, sound specialist Werrick profited, sold more sound.

To technicians, the following details will be interesting: The mike-speaker in Mercer's helmet was specially treated to resist moisture from condensation of air due to temperature differential, perspiration. The tube lineup consisted of a 30, another 30 and a 19 operating in Class-B to minimize static plate current. All stages were transformer coupled, operated by 135 volts of B-battery. A twisted wire pair capable of sustaining 2,000 lb. served as connecting cable and also as the diver's lifeline. Waterproofing included a sealed steel case for the amplifier, special connector at the helmet.

The surface unit operator pressed a button to talk.

— n r i —

Videotron Tubes

National Union Radio Corporation announces that concurrent with the enlargement of research and production facilities concerned with developing and manufacturing Cathode Ray tubes, that they have established the trade name of "Videotron," as descriptive of these tubes.

National Union Videotrons with viewing screens of 1", 2" and 3" are now being manufactured. It is believed by National Union that the name "Videotron" is accurately descriptive for the type of tube to which it has been applied, since such tubes are used exclusively for video or sight work.

The Laboratory Page

By GEORGE J. ROHRICH



George J. Rohrich, Engineer
in Charge N. R. I. Laboratory

The purpose of this department is to furnish supplemental experiments to students who have completed their Home Laboratory Course, but who wish additional laboratory experience. You are not required to perform these experiments, but you will gain increased knowledge by doing so.

Most of the material required will be that received as part of the Laboratory Course. Any other material necessary can be purchased very reasonably and will constitute an investment rather than an expense, as it will serve as replacements in service work or be useful in your shop later.

EXPERIMENT NO. 62

Objects: 1. To show that voltmeters are not changed in voltage calibration when resistors of any value are connected in parallel with the voltmeter terminals. 2. To show that voltage sources have internal resistance. 3. To show that voltage sources are tested best when placed under definite load. 4. To study the best selection of cells for special uses.

Apparatus Required: 0-10 voltmeter (item No. 1); two 30 ohm variable resistors (items No. 14); test prods (item No. 8); Procure three or more new 1.5 volt dry cells, each cell of different size or weight, selected from those you can obtain conveniently in your locality. This selection may be made from cells used for flashlights and radio "A batteries." For example, it is suggested you use a No. 1 cell, a No. 2 cell, a No. 4 cell and a No. 6 cell or a No. 4FI cell. The approximate size of a No. 1 cell is 1 7/8 by 1 inch; of a No. 2 cell is 2-5/16 by 1-5/16 inches; of a No. 4 cell is 1-5/16 by 5/8 inch; of the No. 6 cell is 2 3/8 by 6 inches. Also procure an equal number of similar cells which are known to be partly exhausted.

Apparatus Assembly: 1. Attach the red and black test prods to the meter terminals as in Fig. 94. Also use a short piece of wire to connect one end of one 30-ohm resistor to one terminal of the meter. Temporarily leave the other terminals on the resistor disconnected until directed to make changes in the experimental procedures. 2. Attach one end of the other 30-ohm resistor to the negative terminal of a new No. 6 cell as shown in the top sketch of Fig. 95. Arrange the remaining new cells where their voltages

may be conveniently measured with the test voltmeter of Fig. 94.

Experimental Procedures: 1. Hold the red and black test prods on the positive and negative terminals respectively of the No. 6 cell shown in the bottom sketch of Fig. 95. 2. Maintain the connection of the previous procedure and at the same time allow the movable contact off the 30-ohm resistor of Fig. 94 to come in contact with the other (negative) terminal on the meter, so this resistor will be in parallel with the meter as shown in Fig. 96. Make and break this temporary connection several times in order to observe if the meter deflection is affected by the resistor being included across the meter.

3. Change the position of the movable contact on the 30-ohm resistor so the meter will have any one of various values shunted across the meter, ranging between 30 ohms and a minimum of two ohms. Repeat Procedure No. 2 during these tests.

4, 5 and 6. Repeat Procedures Nos. 1, 2 and 3 while the tests are conducted with the No. 2 flashlight cell.

7, 8 and 9. Repeat Procedures Nos. 1, 2 and 3 while the tests are conducted with the No. 1 flashlight cell.

10, 11 and 12. Repeat Procedures Nos. 1, 2 and 3 while the tests are conducted with the red test prod held on the positive terminal of the arrangement as shown by the top sketch in Fig. 95. During this time hold the black test prod on various positions of the 30-ohm re-

(Page 10, please)

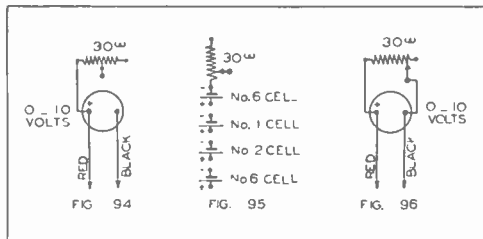

The Laboratory Page (Continued from page 9)

sistor shown in this Fig. 95.

13, 14 and 15. Repeat No. 1 on each one of the used cells, followed by tests Nos. 2 and 3.

Observations: 1. Test No. 1 will produce a deflection of approximately $\frac{3}{4}$ milliamperes on the meter which corresponds to a voltage of 1.5 volts. As explained in previous experiments this deflection may vary, due to the fact that it is a difficult matter to make meters which retain exact calibration. Whatever this deflection may be, we should accept it as representing the amount produced by 1.5 volts.

2. Connecting the 30-ohm resistor in parallel with the meter does not noticeably change the previous deflection, thus proving the first object of this experiment. Should a noticeable decrease in deflection occur then this indicates that the cell has developed an increase in internal resistance, which means that the cell is partly exhausted.

3. The third observation further proves the facts stated in the second observation. The resistor can be readily reduced to a value of two ohms, during which time there will be approximately $\frac{3}{4}$ of an ampere (750 milliamperes) taken from the cell. This fairly high current can be delivered by a new No. 6 cell with little drop in voltage. The limit of two ohms given in this case is set by the current-carrying ability of the size of wire used in the resistor. Using less than 2 ohms with a No. 6 cell overheats this resistor. This should be avoided as there is a possibility of burning out the wire used in this resistor.

4. Observations of the deflections obtained in procedures Nos. 4, 7, 10 and 13 will show that the deflections are the same as in No. 1, thus showing that the voltage of all cells is the same when simple voltage tests are made on all cells regardless of their size or state of exhaustion. Test No. 10 also shows that the inclusion of resistance does not produce a noticeable change in voltage.

5. Observations of the deflections in procedures Nos. 5 and 8 will show slight decreases from that obtained in test No. 2. This shows that the smaller cells begin to drop their voltage when called upon to deliver more than a few milliamperes of current.

6. Observations No. 6 and No. 9 give further and more conclusive proof of the facts observed in No. 5. By carefully carrying out test No. 9 followed by test No. 12 we can find conditions where the two deflections are equal, which proves the second object of this experiment, that the decrease in voltage is caused by resistance which is internal within the cell. Test No. 14 or No. 15 followed by No. 12 gives further proof of this and also shows that the internal resistance increases as the cells become exhausted.

13. This test No. 13 may lead us to believe a cell is in good condition. However, tests No. 14 and 15 will show that exhausted cells will not maintain their voltage, thus proving the third object of this experiment, that voltage sources, like cells, transformers and generators are tested best when placed under actual load. This also shows how we may best test cells and batteries during the time when the real load is disconnected after trouble is encountered—by con-

necting a resistor across a meter as shown in Fig. 96. This resistor takes the place of the regular load. By choosing a variable resistor as we have done here we can vary the load and get added tests on the ability of individual cells and batteries to maintain their voltage at rated and also above the rated loads. If the voltage drops gradually or fairly rapidly then this will clearly indicate that the cell is unfit for further use.

Explanation: The type 4F11 dry cell weighs only 22 ounces and yet its electrical characteristics and life are equal or perhaps a trifle better than a standard No. 6 dry cell. All dry cells are rated to deliver 1.5 volts when new, regardless of their size.

A standard No. 6 dry cell weights approximately thirty ounces. The maximum current which can be obtained under a short circuit in a new cell ranges between 30 and 35 amperes. (The internal resistance of each cell when new is approximately .05 ohms.) However, for maximum life one should limit the current so that the current drain does not exceed 1 ampere. Of course, by connecting two sets of these batteries in parallel the current drain can be doubled. The cell will deliver one ampere for a period of eighteen hours, or one-half ampere for forty hours, or one-quarter ampere for ninety hours.

The weight of a No. 2 standard flashlight cell is 3.5 ounces. The maximum current which may be obtained under short circuits in the new cell ranges between 7 and 10 amperes. (The internal resistance of each cell when new is approximately .2 ohms, or 4 times greater than in a No. 6 cell.) However, for maximum useful life the current should not exceed 250 milliamperes. Much better service can be obtained if the current does not exceed 100 milliamperes.

The standard No. 2 flashlight cell will deliver 250 milliamperes (or one-quarter ampere) for a period of one hour, or 100 milliamperes for five hours, or 40 milliamperes for 25 hours, or 20 milliamperes for 75 hours, or 5 milliamperes for 450 hours.

A $4\frac{1}{2}$ volt C battery consists of three flashlight type cells connected in series. A 45 volt B battery consists of thirty of the flashlight type cells. The life of each battery is the same as for a single cell. As most B and C batteries consist of the No. 2 flashlight type cells, the above ratings for their life will apply. The maximum current which can be taken from a battery of two cells or even from 30 or more cells connected in series is the same as from a single cell. This is because the internal resistances add together and offset the corresponding increases in voltage. For example, 7 amperes are obtained when short-circuiting a single cell or a $4\frac{1}{2}$ volt or 45 volt battery, provided the No. 2 type cells are used.

The weight of a No. 1 standard flashlight cell is 1 ounce. The maximum current which may be obtained under a short circuit ranges between 2 and 3 amperes. (The internal resistance of each cell when new is about one-half ohm, or ten times greater than in a No. 6 cell.) This type cell is used chiefly in C batteries, and in B batteries where the total current required does not exceed 10 milliamperes. It will deliver 10 milliamperes for 60 hours, or 5 milliamperes for 200 hours.

More Winners in Business-Getting Idea Contest

Winners of the ten third prizes in the recent NATIONAL RADIO NEWS Radio service business-getting idea contest are given on this page, together with some of the prize-winning letters essentially as received. A complete set of socket wrenches for Radio service work has been sent to each of these prize winners. (First and second prize winners, with winning entries, were given in the last issue of NATIONAL RADIO NEWS.)

Logan, Utah.

"Enclosed is my business-getting idea, an advertisement which I run from time to time in the local paper. Although it has already produced good results, I expect to follow it up with additional insertions two or three times a month."

Graduate M. P. Gudmundson.

(Ad appears at upper left in illustration.)

Jamestown, R. I.

"Enclosed you will find the idea which has boosted my Radio business about 60% in the last two months. Of course this idea could not be used very well in the larger cities, but in small towns such as I live in, the idea is very practical.

"This business card is responsible for my boost in repair work. Quite a few people called my attention to the slogan on the card; they thought it very good. These cards cost me \$1.75 per thousand.

"This is the way I advertised my business. In all public places that had a telephone, I tacked my card above the phone so people could not help read the card while phoning.

"In restaurants which had booths, I tacked my card on the side wall of each booth over the center of the table, so people sitting on either side of the table could read it without straining their eyes.

"In counter wagons and all other stores which had no phone or booths, I left my cards on the counter for the public to pick up and carry home.

"I also mailed cards to the summer residents, getting their names and addresses from the phone book.

"This method of advertising did not cost me over \$3.00 in all and I can truthfully say I have earned that amount many times over since I had the cards printed."

Student Joseph McGonigal.

(Card appears at upper right in illustration.)

Apopka, Fla.

"The following is my entry in your business-getting ideas contest: I have actually tried a number of methods for getting more business, such as advertising, placing blotters, distributing handbills, etc., but have found the following method to be the most effective as well as the most inexpensive. Only one month after its use my business actually doubled, and business is increasing all the time.

"When I take a Radio back after repairing it I make it a point to guarantee my work. Now, having created a good impression, I ask the customer to recommend me to friends whenever they have Radio trouble, and give him a couple of cards for that purpose. That insures me of an increase of business. Now I take another of my cards and with a thumb tack allix it on the inside of the Radio cabinet in such a position that it may be seen as soon as the Radio cabinet is turned around. When the Radio goes bad, the owner always looks to see if all the tubes are lighted, then seeing my card, remembers my previous work and sends for me. This insures a return of all old customers.

"Now here are the actual figures as to increase in business, with no other form of advertising than that stated above.

"During the first week of June, 1937, I repaired 14 radios and did 2 installation jobs, while during the first week in July, 1937, I repaired 31 radios and did 1 installation job! No one could expect a better increase in work or more satisfactory results from any one form of advertising, no matter how expensive!

"The best form of advertising to be had is a satisfied customer's recommendation to his friends!"

Student Herbert C. Eddy.

(Card appears at lower right in illustration.)

Washington, D. C.

"My business-getting card was designed to have three purposes:

1. Appeal to the prospect. It gives to the bearer 75c worth of service for nothing, without obligation.
2. Get prompt action from prospect. The dated feature, with a one-week time limit, does this.
3. Impress the prospect. Membership in the Columbia Heights Business Men's Association implies reliability.

"A certain area is selected on which to concentrate. Previous to giving out this card, two other efforts are made to obtain business. The first is usually a message playing up honesty, fair charges, quality work, the fact that our store is as near as their telephone, and the fact that they can get a thorough inspection for the 75c

<p align="center">—SURE—</p> <p align="center">I'M LOOKING FOR TROUBLE... IF IT'S IN YOUR RADIO I'LL FIND IT!</p> <p align="center">M. P. GUDMUNDSON</p> <p align="center">Only Certified Radio-Tician in Cache Valley</p> <p align="center">253 South 3rd East Phone 182</p>	<p align="center"></p> <p align="center">GUARANTEED RADIO SERVICE TUBES AND ACCESSORIES</p> <p align="center">FOR BLESSED RELIEF TOMORROW SEE ME TODAY</p> <p align="center">JOSEPH E. MCGONIGAL 410 AMSTOWN ST.</p>
<p align="center">FREE! No Cost or Obligation</p> <p align="center">This card entitles the bearer thereof, one of our regular 75 cent Radio Set Inspection and estimate check-up-free of charge.</p> <p align="center">TIME LIMIT - GOOD FOR 1 WEEK ONLY</p> <p align="center">FROM TO</p> <p align="center">COLUMBIA HEIGHTS RADIO SERVICE 3710 Fourteenth St., N. W. Rear</p> <p align="center">Day Phone (at 10) Night (at 8) P. M. (at 10) M. (Numbers include single Beers, Meats, etc.)</p>	<p align="center">GUARANTEED RADIO SERVICE</p> <p align="center"> </p> <p align="center">HERBERT EDDY</p> <p align="center">MEMBER NATIONAL RADIO INSTITUTE</p> <p align="center">P. O. BOX 112 APOPKA, FLA.</p>

service charge. About six weeks later, a card describing the operations we execute on our 75c inspection trip is given out. Finally, the special free offer card is passed out, after rubber-stamping the date in the space provided.

"The average results have been approximately 8%, by far the greatest of all returns so far on my advertising. Many parties call on the last day and 'wish to take advantage of our offer before it expires.' Often when making an inspection in connection with this card (which is always collected as if it were a premium), another card of the same type but with "UNLIMITED" written in place of a date, is issued. This is done to obtain rooming house business after the house is once entered. I use this card systematically once a year, and only in areas which can economically be served."

Student Henry Strickland.

(Card appears at lower left in illustration.)

Haverhill, Mass.

"I'm only a student, not yet graduated, and my Radio work is done only in spare time, but I'm thinking very seriously of devoting full time to it.

"Two years ago I received my first Radio to service, and I did a thorough job. I had home-made testers, assembled through N. R. I. instructions. Now I have a complete service laboratory with a stock of tubes and parts valued at \$1,100.00. My N. R. I. Course was also paid for with Radio servicing earnings, and the beauty of the whole thing is that I don't owe the world a penny! It was strenuous at times but now I can see that road, which Mr. J. E. Smith has mentioned so much, open before me and I'm getting there with but very few obstacles to clear.

"I'm sending a duplicate of the service guarantee slip which I give each customer when I return his set. I keep a duplicate slip. Every Monday of each week I go over these duplicate slips in my files and when ninety days have elapsed, I make a personal call to inspect that receiver, and I make it a point to call every ninety days thereafter. This, I find, keeps me in close contact with these people; after I have kept this up for a while, these customers begin referring me to their friends or relatives who have Radio trouble."

Student Richard Gosselin, Jr.

(Mr. Gosselin uses the Radio Repair and Service Guarantee slip prepared for servicemen by National Union (not shown), with his name and address rubber-stamped on each slip.)

Long Island City, N. Y.

"A friend of mine was telling me that his club was going to have a party. He had a dissatisfied look when he said the orchestra would cost the club \$85.

"Then I thought of an idea. I asked my friend to send a committee from the club over to my house. I did not tell what I had up my sleeve. I wanted to surprise them.

"I had a phono pick-up connected to my Radio, and many of the latest dance hits. I thought I might be able to rent it out to the club.

"When the committee arrived I said: 'Fellows, I'm going to let you listen to some swell dance music.' I started to play a selection. 'Boy! That's swell!' was the reply. I explained how well this could be used at their dance. Believe me, I did not have to do much

talking, for they agreed almost immediately. **HERE WERE MY TERMS:**

"1. I was to rent the pick-up and records to them for \$10. I was to connect it to their own Radio and to operate it.

"2. If it proved entirely satisfactory, I was to install one permanently in their club, and they would give me letters of recommendation to other clubs.

"Well, I think I'm going to be pretty busy from now on. Many people at the dances have asked me about their own Radios, and have become customers."

Graduate Leo Mele.

Brooklyn, N. Y.

"Six months ago I started servicing Radio receivers, and started with Mr. Smith's advice in my mind, to be on the level and square with your customers.

"My first jobs were small ones and the charges were small. I could have charged more and secured it, but I am not sorry, for those first calls brought me more business than I can handle right now.

"The best advertisement for any Radio man is a satisfied customer, particularly if he doesn't know much about Radio. Some servicemen will overcharge this type of customer, not realizing that he can be their best advertising agent."

Student William F. Richardone.

The remaining three winners are:

Graduate Edward Schminke, Irvington, N. J., Student M. G. Parisi, Woodhaven, N. Y., Student E. R. Rances, Philippine Islands. We regret that space does not permit publication of their equally meritorious entries.

— n r i —

New Resistance Analyzer and Indicator

Variable in a range from 0 to 1.0 megohm with a direct-reading calibrated dial, a new IRC Resistance Analyzer and Indicator is announced by the International Resistance Company, 401 N. Broad St., Philadelphia, Pa.

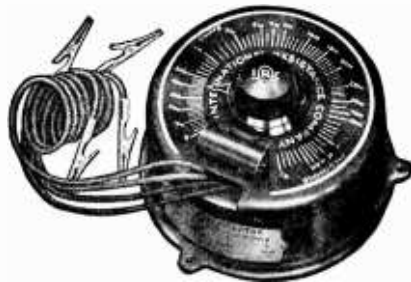

The Analyzer is controlled by a single knob. Electrically, it consists of two sections, the first comprising a heavy duty, wire wound rheostat type element from 0 to 30,000 ohms. The second section is a specially designed Metallized type resistance element having a range of from 30,000 ohms to 1 megohm.

Tips on How-to-Study

When You Feel Sleepy: The room may be too hot; turn off the heat, open the windows and put on a coat if necessary, for it is easier to study in a cool room.

Sponge your face and neck, and particularly your eyes, with cold water. Take a brisk five- or ten-minute walk.

Only when you know that the sleepy feeling is due to an extreme lack of sleep should you yield to it; in this case go to bed and get a good rest so you can start fresh the next day and make up for lost time.

When You Hate to Start Studying: Set a definite starting time for study each day and make up your mind to open a text-book and start studying at this time.

Leave the sharpening of pencils, trimming of finger nails, and the other little ways of wasting time, until after the study period.

Remember that the longer you put off doing a task, the less you feel like starting it. Whenever possible, stop your studies at an interesting point, so you have something to which you can look forward the next day. You might even try setting your alarm clock to ring at the time when you plan to start studying.

When You Can't Concentrate: You are your own task-master and will have to discipline yourself for mental laziness. Regular exercising of the mind builds up its vigor and power, just as physical exercise builds up strength.

If your mind begins to wander from study while you are alone in a quiet room, try moving to a noisy room, or try turning on the radio. Be sure, however, to select a location or tune in a program which is free from loud conversation.

The human mind oftentimes accepts sound or the mere presence of people as a challenge and concentrates on study and this challenge, instead of on a host of other things. Study yourself and experiment until you find a particular scheme which helps you to concentrate.

Once you acquire the ability to concentrate, you will understand and remember the thoughts expressed in each sentence instead of simply reading groups of words over and over.

When You Have Difficulty in Understanding a Subject: Try outlining the text-book or parts of it. Jot down in a notebook a few words which are descriptive of each paragraph, copying all titles as well in their proper order, then study this outline for a while. Rewriting an explanation in your own words is another way of understanding and mastering it.

P. A. Amplifier Service Hint

By PAUL H. THOMSEN,
N. R. I. Consultant

While doing consulting work for the operators of P.A. amplifiers, I found that poor response at the higher audio frequencies was in several of the systems due to the capacity shunting effects of the shielded line used between the preamplifier and the main amplifier. After correcting for this shunting effect by installing the simple equalizer shown in the diagram, flat frequency response was obtained over the entire audio frequency range.

The conventional coupling condenser (.1 to .5 mfd.) in the preamplifier output is left un-

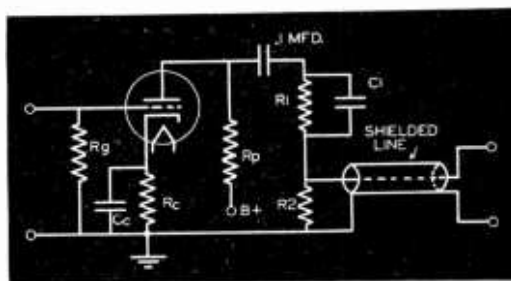

changed, but an additional capacitance C1, shunted by a resistor R1, is inserted. The capacitance of C1 is made equal to the capacitance of the shielded line (this being measured with a condenser bridge). Under this condition, the voltage division between the two capacities (C1 and the line capacity) will be the same at all frequencies. The loss in gain resulting from equalization will be between 6 and 10 db.

If the preamplifier feeds directly into the grid of the first tube in the main amplifier, then the values of R1 and R2 should be equal and approximately 50,000 to 250,000 ohms each. If the grid of the first tube in the main amplifier is connected to a volume control of the potentiometer type, then the value of R1 should be equal to the resistance of the potentiometer, and R2 should be omitted.

— n r i —

Supreme Offers New Instrument Broadside

A profusely illustrated two color eight page general catalog of the newest in service test instruments is offered free by the Supreme Instruments Corporation of Greenwood, Mississippi.

Page Fifteen

The Tools of

By HORATIO
Research Engineer, G.

THE phenomenal advances in science which have been made in the last four decades are due in no small degree to the perfection of better tools with which to undertake scientific research. This is particularly true in the art of electrical communication as exemplified by the telephone and the Radio. There are in this country several organizations whose chief purpose is the manufacture, development, and constant improvement of apparatus which is used in the operating field and in the research laboratories of industrial organizations and educational institutions the world over.

With such high-grade tools which, in themselves, are sometimes very elaborate, the Radio engineer can design and produce better receiving sets, construct and maintain higher quality broadcasting stations, and so give the Radio public of many millions of listeners more enjoyment and profit from their Radio and a better appreciation of the finest achievements of the musical arts. With better tools, your favorite movie theatre can give you better acoustic programs, and, in the days to come, the television engineer will be able to provide larger and clearer reproduction of far-off events at your own fireside. Let us relax in our



Here you see some of the most accurate clocks in the world. They are entirely electrical in design, depending for their action upon the 50,000-cycle-per-second vibrations of tiny quartz crystals rather than upon the movements of massive pendulums. They can be read to the nearest thousandth of a second, and are used to check the primary standard of frequency at the General Radio factory.

favorite arm-chair for a few moments while we make a brief tour of one of these organizations devoted to the production of research, testing, and control equipment.

One of the fundamental problems in modern Radio is the precise measurement and control of the frequency with which alternating currents repeatedly reverse their direction of flow back-

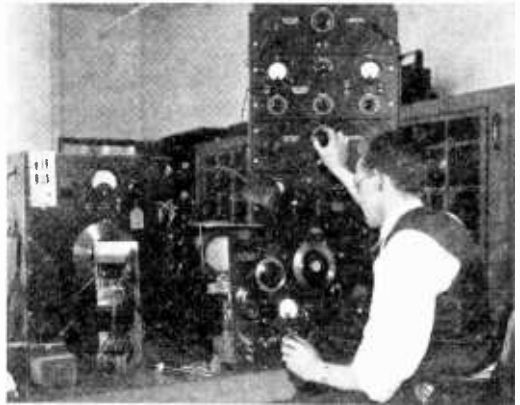

A General Radio engineer is here adjusting (with his left hand) a control on a miniature broadcasting station or laboratory type standard signal generator while comparing it with the accurately-calibrated apparatus in the background.

wards and forwards in a circuit. Were we not able to do this, hopeless chaos would result in the ether waves with some 600 broadcasting stations on the air in the United States alone, to say nothing of thousands of commercial stations, police and aviation Radio, and a horde of active amateurs.

In our everyday living, we are accustomed to regard the second as a rather short interval, but in Radio phenomena, a second may be a very long time. The Radio engineer must frequently split a second into a million or even a hundred million parts and, at the same time, check his subdivision with extreme accuracy. How, we ask, can such a feat be accomplished?

On the fourth floor, in a well-lighted room

Communication

W. LAMSON

General Radio Company

stand a row of shiny black panels, 6 feet in height, and covered with an elaborate array of clock dials, meters, control knobs, flashing pilot lights, and other gadgets. Behind them are many shelves, each of which carries an assortment of vacuum tubes, coils, resistors, condensers, and other paraphernalia familiar to the Radio worker. A continuous musical whistle pervades the air at a frequency of 1,000 cycles per second, which, as



Standard signal generators and many other types of precision instruments are being calibrated and adjusted in this corner of the General Radio standardizing laboratory.

you know, is approximately two octaves above middle C on the piano. Occasionally, we hear the click of hidden automatic relays, as pilot lamps flash on and off. Day and night, month after month, without a pause, this primary standard of frequency continues to operate unattended.

This imposing equipment is, in reality, a series of very special electrical clocks which count the seconds, hour after hour, and, at the same time, subdivide each second in a myriad ways into very minute parts. They are among the most accurate clocks in the world, and their pendulums are not massive weights swinging to and fro once a second in a vacuum, but rather are small slabs of transparent quartz, such as you read about in the October issue of your National Radio News. These quartz "pendulums" vibrate not once, but 50,000 times, per second and, in order to control them accurately, they must be kept in sealed,

heat-regulated boxes, so that their temperature never varies as much as 0.01 degree no matter how cold or warm the outside room may become.

Such insignificant yet all-important slabs of quartz control the frequency of the oscillations of vacuum-tube oscillators at a precise value of 50,000 cycles per second. Then, by means of circuit arrangements known as multi-vibrators or relaxation oscillators, a large number of other frequencies of both higher and lower values may be obtained, all definitely related to the fundamental frequency of the quartz. These many frequencies may be piped over various wire channels to the different laboratories throughout the plant and there used for calibrating frequency-measuring equipment over the entire range used in the communication arts.

You are all familiar with the close relationship between frequency and time which permits us to measure frequency in terms of time. The quartz crystals control 1000-cycle currents which, in turn, drive electrical clocks identical in principle to the familiar Telechron so that the rate at which these clocks run gives an exact measure of the frequency of the crystals and of all other frequencies obtained from this equipment. Ac-

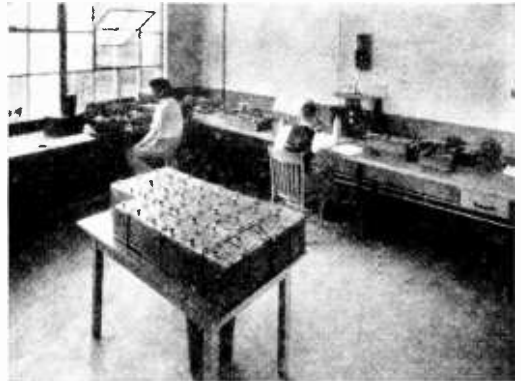

They call this the Bridge Room at the General Radio plant. Here ultra-accurate Wheatstone bridges of various forms are used for precise measurements of standard resistance, capacitance and inductance units. On the table are variable inductances ready for calibrating.

(Page 18, please)

Page Seventeen

curacy demands that these clocks be timed in comparison with man's most precise clock, the rotation of the earth. This is accomplished by checking them against the hourly time signals sent out via Radio from the Naval Observatory at Washington. A special mechanism permits these clocks to be read each hour not to the nearest second as you might check your favorite watch, but with an accuracy of 0.001 second or better.

When this is done, it is found that these crystal-controlled clocks keep constant time to about one part in 30,000,000! It is hard for most of us to realize just what one part in 30,000,000 really means. It is equivalent, roughly, to one second in a whole year or, if you will, to 6 inches in 3,000 miles, the distance from Boston to San Francisco or, again, to one ounce of coal taken from a long freight train of 50 loaded cars (1,000 tons). With such a tool, the Radio engineer today can maintain a rigid control of the ether waves. In other laboratories around the plant, we will find less elaborate equipment built on the same principles for use where less accurate control is required.



A stroboscope in action. The engineer is adjusting its controls to vary the rate at which the neon or mercury vapor lamp flashes; when the rate of flashing is correct, the disc on the electric motor shaft will appear to be perfectly stationary even though it actually may be whirling around 12,000 times per minute!

The average owner of a modern Radio receiver has no idea of the amount of work involved in the design of his set. Twirling the tuning control, he brings in station after station from all corners of the globe. He varies the volume gradually and smoothly from a whisper to a roar, getting natural reproduction at each sound level; he also has a certain control over the tone—the proportion of high and low notes in the sound coming from the loudspeaker. He enjoys many other technical features like automatic volume expansion, automatic volume control, automatic fre-

quency control and bass compensation, and simply takes all these things for granted. If he is able, with ease, to obtain from his Radio programs which sound natural and pleasing to his ears, and those of his family and friends, he is happy and boasts of his Radio to all who will listen. But if the programs are distorted, or unnaturally weak and fading in character, or if they are intermingled with sundry growls, hums, and buzzings he does one of two things. He may do nothing and curse the whole fraternity of Radio, especially the maker of his particular set, but, if he is wise, he will send for a competent service man to remedy the trouble and give him the enjoyment which he has a right to expect of a modern Radio.

Mechanical Ears Test Radio Sets

In order to design this almost perfect Radio receiver the manufacturer, however, could not depend upon the none-too-reliable judgment of his own ears to insure excellence. He had to perform elaborate tests upon it, employing for the purpose a miniature broadcasting station known as a signal generator, while using an output meter to see how much energy the set was delivering to the loudspeaker, and a cathode ray oscillograph, a vacuum tube voltmeter and other tools for checking distortion and adjusting the various stages in the receiver. Furthermore, the design engineer uses vacuum tube bridges and other special instruments to check the performance of the vacuum tubes and the individual parts in the receiver, and a harmonic analyzer to pick apart and study the sounds coming from the loudspeaker. All these are precision instruments which, being quite elaborate, are necessarily rather expensive.

The modern receiver is a complicated mechanism and the Radio serviceman, who must check its performance when trouble develops, cannot afford to tinker with it blindly but must make essentially the same sort of *quantitative* measurements upon it but with less elaborate apparatus. True, there is a growing trend among the more ambitious and expert servicemen toward more accurate instruments and more elaborate testing. However, if you have mastered the fundamental principles of Radio in your work at the National Radio Institute and understand thoroughly the uses and limitations of instruments, you can do much good work with a proper assortment of inexpensive equipment designed especially for this type of work.

In one corner of the standardizing laboratory we may find a lot of these miniature broadcasting stations, or standard-signal generators, as they are called, which have just come from the production shops and which must each be given a rigid test and calibration to make sure that it can produce a volt of properly modulated Radio fre-

(Page 21, please)

The Tools of Communication (Continued from page 18)

quency signal of any desired frequency and then reduce this signal, in any required degree, down to as little as one-millionth of its original value, when it will be comparable with an extremely feeble signal from a far-distant Radio transmitter. On a bench nearby may be a battery of new beat-frequency oscillators which, among other things, might be used to modulate the standard-signal generators over the whole audio range from the lowest rumble to the highest squeal.

In another part of the laboratory we may find elaborate bridges which will tell us all the facts about any one of the myriad of different types of vacuum tubes. On another bench, we spy a lot of output meters, together with power-level indicators and all sorts of volume controls, calibrated in the familiar decibels, which are the tools of the engineer in the monitoring booth of the broadcast station, the motion-picture studio, and the movie theatre.

Mounted on rack panels, we will find distortion meters, frequency-monitoring equipment, and various other devices which make modern high fidelity broadcasting possible, all undergoing a rigid examination before being shipped to the consumer.

A call bell shrills and the dummy elevator brings up a load of boxes, each having a little screened ball projecting from its top. These balls are crystal microphones and the boxes are sound-level meters, designed to measure accurately the sound which exists in a room or out-of-doors. Combined with another instrument known as a wave analyzer, a complex sound—such as most sounds are—can be broken up into its many component parts, and each part measured with precision.

Stopping Motion

We may run across a lot of stroboscopes, which are special forms of flashing neon or mercury-vapor lights and which can perform the magic feat of making a spindle whirling at perhaps 12,000 revolutions per minute appear to move very slowly or, perhaps, to stand absolutely still! Here is a tool which finds its way into all manner of industry and engineering where it is desired to observe the motion of highspeed machinery and to study how gears, cams, and levers behave at high speeds. Moreover, the stroboscope can be used to measure the speed of machinery without in any way touching or disturbing it. The duration of these light flashes is so short—about five micro-seconds—that newsprint tearing through the presses at a mile a minute may be read with ease because it moves only a few thousandths of an inch during each flash of the light.

As we journey about, we will see a wide variety of other equipment—standards of resistance, inductance, and capacitance which are indispensable tools in any man's electrical laboratory; all sorts of bridges for measuring these fundamental characteristics of an electrical circuit; instruments which can compare the color of two pieces of paper or cloth more accurately than the human eye; setups for measuring the electrical properties of bakelite, oils, and other insulating materials; tuning-fork oscillators operating at a high note of 1500 cycles per second; and massive, highly accurate forks vibrating only 50 times per second.—indeed our pencil is worn flat ere we have noted down all the devices that we have seen.

Research Creates New Tools

Our visit would not be complete should we fail to step into some of the individual laboratories where engineers are constantly at work in the design and developments of new and better in-



One of the twelve research laboratories at the General Radio Co. plant in Cambridge, Mass. Here precision measuring instruments, the tools of communication, are created.

struments. A well-equipped shop is kept busy making "toys" for these research and design engineers, toys which are frequently born in the form of "hay-wire" bread-board layouts and which sometimes undergo many changes ere the information gleaned from them is sent to the drafting room, and thence to the production shops. But from the slide rules and the bread-boards come the finished instruments and from these tools come the progress and achievements of one of man's blessings, the science of communication.

Novel Radio Items

—BY L. J. MARKUS—

Television Tube Has Velvet Screen!

A patent on a cathode ray television tube screen made from woven rayon velvet impregnated with chemicals has recently been granted to Philo T. Farnsworth, noted television inventor and member of the N. R. I. Advisory Board. The velvet cloth is burned away, leaving a screen made up of small chemical particles and air spaces. Television pictures reproduced on this screen are said to be much brighter than home movies.

— n r i —

Radio Lands Army Plane!

With his plane several miles from an airport and headed away from it, an army pilot flipped a switch, folded his hand and watched. Almost human radio controls turned his ship around and brought it down to a perfect landing at the airport. To engineers of the U. S. Army Air Corps goes credit for this remarkable application of short-wave radio.

— n r i —

Police Radio Stations Are Fortified!

The first two fortified radio stations in the U. S. have just been completed for the Indiana State Police network. Police radio operators maintain a 24-hour watch inside these solid brick, bullet-proof short-wave stations.

SOS Silences Station WMCA!

For 45 minutes station WMCA went off the air one afternoon to prevent interference with radio compass bearings being made by navy officials to locate a British freighter afloat at sea.

— n r i —

A Use for Static!

One amateur radio operator has built and demonstrated a tiny motor which runs on static electricity picked up by an ordinary antenna.

— n r i —

Towers Sell For 60c A Foot!

Radio amateurs who yearn for modern steel antenna towers can now buy them in any desired height up to 105 feet at a cost of only about 60c a foot. The towers come already assembled in 20-foot sections, with a tapered 5-foot tip.

— n r i —

Mikes Refuse to Pick Up Noise!

Difficulties with intercommunicators in noisy locations have in several instances been remedied by the use of double loudspeaker elements arranged back to back with their voice coils connected in parallel but opposite in phase. When these loudspeakers are used as microphones, general noise which strikes both diaphragms in phase will cancel out and not be amplified. Sound waves striking one diaphragm will be reproduced as usual.



ELECTRIC EYES HERD WILD GAME! Animals are discouraged from wandering out of a German game preserve by an ingenious photocell-alarm system. When an animal intercepts a beam of light in the arch of a gate, glaring floodlights flash on and an auto horn blares, scaring the animal back. Plank-controlled switches embedded in the highway allow autos to pass without setting off the alarm.

"MACHINE-GUN" MIKE IS HIGHLY DIRECTIONAL! By placing a group of aluminum alloy tubes, each of different length, in front of an ordinary dynamic microphone unit, engineers have secured a mike which looks like a machine gun and is so highly directional that it must actually be aimed at a desired sound. Possible uses include picking up of songs of birds for recording purposes.

ELECTRIFIED FENCES DISCOUR-AGE CATS! When nocturnal raids by cats threatened to wipe out valuable pheasants on one farm, the owner installed a single wire at the top of the existing fence and connected it to a commercial electric fence-charging unit. The harmless, skin-tickling electric shocks proved enough to discourage even the boldest of feline marauders. Voltage used is about 600 volts.

COVER PHOTO: Writing an N. R. I. Text-Book

By S. M. ARMSTRONG, N. R. I. Service Director

On the front cover of this issue you will see the four men who play a most important part in making your N. R. I. Course practical, complete and easy to learn. Let me introduce them to you and describe exactly how they go about writing a new N. R. I. text-book for you.

First, meet Mr. Kaufman, their "boss" and your Director of Education, seated at the desk with pencil in hand. He is particularly well qualified for his position, having taught electricity and physics at the Massachusetts Institute of Technology, then engaged in the Radio manufacturing business for many years before coming to N. R. I. Today he hob-nobs with the big shots in the Radio industry, yet still spends long evenings studying deep theories of Radio and keeping in step with new television and electronic control developments, so he will know what the future holds in store for Radio experts.

The three instructors who work under Mr. Kaufman are all practical experts, each in his own field. Mr. Straughn, at the extreme right in the photo, is one of the best Radio servicing experts in this country; even now he spends many an evening doing spare time service work "to keep his fingers nimble," to keep right in touch with new Radio developments and new service techniques, and to keep his mind attuned to the practical side of his work.

Mr. Thomsen, second from the left, is a whiz at Radio communication problems—operating 1000-watt short-wave station W3LA or "chewing the rag" with the engineers and operators at some of the local Radio stations when he is not busy doing spare time consulting work for Washington engineering firms.

Mr. Markus, at the extreme left, is an engineering college graduate with years of journalistic experience on the editorial staffs of well-known magazines, and consequently knows how to put technical information into easy-to-understand phrases. You will find articles by him in many technical magazines.

These four men, along with the other instructors and consultants who work under Mr. Kaufman at N. R. I., study and answer your consultation service letters, making notes of the things which give you trouble. When a text-book comes up for revision or rewriting, they carefully consider these student reactions.

All new lessons originate with Mr. Kaufman, who "starts the ball rolling" by preparing an outline of what is to go into the lesson. The

other instructors go over this outline carefully to see that no important points have been overlooked, after which they gather around Mr. Kaufman's desk to decide how various topics shall be handled.

Then comes the actual writing of the lesson. A few of the N. R. I. books, particularly on certain communication subjects, are assigned to outside experts. Communication lessons are written by Mr. Thomsen, servicing lessons by Mr. Straughn, and practically all other lessons are written by Mr. Kaufman. These men do not write just to show how much they know, but rather to teach what you should know about a particular subject.

The completed manuscript for a lesson is carefully checked by Mr. Kaufman, who oftentimes suggests rewriting of certain sections when he believes they can be made clearer. The approved manuscript then goes to Mr. Markus, who reads it very carefully, conferring with the others whenever he feels that radical changes are necessary, and checking to make sure that the new lesson will fit in with the rest of the Course. Only then does he commence his work of editing and rewriting in a language which you and other students will easily understand. The grammar must be perfect, sentences and paragraphs must follow in logical order, and the entire book must read "as smooth as silk" before he passes it back to Mr. Kaufman for a second check-up.

Now the lesson, still in typed manuscript form, goes to the other instructors, and if a fundamental book, to Mr. Dowie. These men try to put themselves in your place now when they read the lesson, and make notations on each part which appears at all difficult to understand. Mr. Kaufman considers all suggested changes carefully, making those which meet with universal approval. There is a final check of the entire book again by Mr. Markus, and then the questions and answers are prepared.

Illustrations and diagrams are made by N. R. I. draftsmen, necessary photographs are taken, printing cuts are made, the lesson is set up in type by a printer, and cuts and type are assembled in page form to give a pleasing appearance while keeping each illustration near the associated text matter. Final page proofs are carefully checked by Mr. Markus, and soon another N. R. I. text-book is on the presses.

Yes, indeed, it takes plenty of time and money to produce an N. R. I. text-book in this way, but we spare no expense to make your training complete.

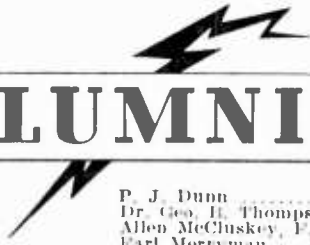

N.R.I. ALUMNI NEWS

P. J. Dunn President
Dr. Geo. B. Thompson, Earl Bennett .. Vice Pres.
Allen McCluskey, F. E. Oliver Vice Pres.
Earl Merryman Secretary
Louis L. Menne Executive-Secretary

EXTRA! ELECTION RESULTS!

Pete Dunn is re-elected. Bennett and Oliver are also returned to office. Two New Vice Presidents.

President—Peter J. Dunn

Vice Presidents—Dr. Geo. B. Thompson, Earl Bennett,
Allen McCluskey, F. E. Oliver

Secretary—Earl Merryman

Executive Secretary—Louis L. Menne

In one of the most spirited contests in the history of N.R.I. Alumni Association, Peter Dunn, better known as Pete, was re-elected National President for the year of 1938. This is the fourth consecutive year Pete has been elected to this high office. Under his leadership during the past three years the N.R.I. Alumni Association has made real progress, has grown in numbers and has won greater recognition in the radio industry.

Pete wanted the job and the job wanted him. Serving without compensation of any kind, except the satisfaction of helping his fellow men, President Dunn felt that one more year would permit him to round out his policies in this work which he enjoys immensely. President Dunn is a successful business man, a good speaker, quiet in manner but dynamic in action. We congratulate you President Dunn—we know the job is in capable hands.

Ed Witherstone drew surprising support. He was formerly Chairman of the Toronto Chapter and his Canadian friends backed him heavily. He also drew many votes from members throughout the United States. The name of Ed. Witherstone undoubtedly will again be prominently mentioned in some forthcoming election. For a fellow little known to the membership at large he ran a remarkable race.

As provided in the Constitution of the Alumni Association four Vice-Presidents were elected. A surprisingly strong candidate was Dr. George B. Thompson of Los Angeles. He topped all candidates for Vice President in total number of votes. Allen McCluskey of Birmingham, Alabama also was elected to the office of Vice President. He is no stranger to the Alumni Association. Last year he was a candidate for Secretary. Earl Bennett of Evanston, Illinois was re-elected to the office of Vice President. His greatest strength came from the Middle West. Another candidate to be re-elected is F. E. Oliver of Detroit, Michigan. The latter two have long been active in the affairs of the N.R.I. Alumni Association and have served it creditably.

Earl Merryman was re-elected Secretary. He seems to have a lock on the office—and why not. Earl is ideally fitted for the job, lives close to Headquarters and fills the bill in tip-top shape.

L. L. Menne was returned to the office of Executive Secretary.

So, here we have our new line-up of officers for 1938. Let's give them our wholehearted cooperation. Let's help them in making the N.R.I. Alumni Association a real influence for the advancement, protection, and guidance of Radio servicemen everywhere.



The Service Forum

Conducted by
J. B. Straughn, N. R. I. Service Consultant

Send in your service notes. We will re-word them for publication. To qualify your note for the News you must have observed the same trouble on two or more identical receivers.

PHILCO MODELS 37-650, 660 and 670 INTERMITTENT

If this clears up when the plate of the 6K5G tube is shorted to ground suspect a defective 6K7G R.F. or I.F. tube. Try new ones although it is usually possible to locate the offender by standing the chassis on end and tapping the tube envelope. This will aggravate the condition causing the fading which is a screen grid to suppressor short inside the tube.

—————n r i—————

PHILCO MODEL 37-116 POOR AFC ACTION
If the AFC works backwards rejecting instead of pulling in the station this indicates that the discriminator voltages are in some manner reversed. Simply reverse the leads to the cathode of the 6HG discriminator tube. An improper connection is easy to make if you install a new discriminator transformer. If a new transformer is to be installed mount it so the bare wire leads face the rear of the chassis. Then the bottom lead should go to the bottom socket contact and the top one to the top socket contact.

—————n r i—————

GALVIN MOTOROLA MODEL 79 WEAK AND HUMS
Check the 6-46 microfarad condenser block located between the two steel strips on which the output transformer is mounted. A Mallory type SR-607 unit will serve as a replacement if found defective.

PAUL HUMPHREY, Ohio.

—————n r i—————

CROSLEY MODEL 635 VERY WEAK
Check the screen to cathode by-pass condenser of the 6A7 tube for leakage. If necessary use a .02 microfarad 600 volt replacement.

PAUL HUMPHREY, Ohio.

—————n r i—————

GENERAL ELECTRIC MODEL K52 MOTOR BOATING
Check the 404 microfarad filter condensers for opens by substituting others.

PAUL HUMPHREY, Ohio.

SPARTON MODELS 600, 610, 620, 737, 930 AND 931

When the set is dead, check the 110 watt fixed resistor connected from one end of the volume control to the cathode of the tubes in the R.F. section. This resistor furnishes minimum bias on the tubes when the volume control is in full on position. I have found that a value of 200 to 300 ohms at 1 watt works well. This resistor is located below the terminal strip on the power converter chassis.

HILBERT E. GLADE, Milwaukee, Wis.

—————n r i—————

PHILCO MODEL 630 DISTORTION
Touching control grid and chassis (75 tube) clears up trouble, indicating excessive bias. However bias across bias resistor is normal (about 1.5 volts). Trouble due to fact that bias is too high for plate voltage which is below normal due to leaky .1 mfd. decoupling condenser in plate circuit. Normally you should measure about 150 plate volts on the 75 using the high range of 1000 ohm per volt voltmeter.

—————n r i—————

GENERAL ELECTRIC HUM NOT DUE TO BAD CONDENSERS MODELS E91 AND E95

The heater of the 6F5 is connected to the volume control by means of a heavy wire which is grounded to a lug on the chassis. A resistance of ¼ ohm or so may develop at this lug and the 60 cycle voltage drop across this resistance is applied through the VC to the control grid of the 6C5. Cut the wire at the lug and resolder both ends to the lug.

—————n r i—————

CROSLEY MODEL 167 DEAD
If the heater of one 58 tube is too bright and the other does not light the latter is shorted and the first receives excessive voltage as their filaments are in series. The short is usually between a filament wire and the chassis. Remove the lead between the pilot lamp socket and the 58 heater. Insulate this lead with spaghetti.

(Page 27, please)

Here and There Among Alumni Members

Fellow member E. H. Symons, 2045 Osler Street, Regina, Sask., Canada, has been active in canvassing N. R. I. men in his locality with a view of organizing a local chapter of the Alumni Association in Regina. The first meeting was attended by a small group of students and graduates who are enthusiastic over the plan. Any N. R. I. men in the vicinity of Regina who are interested are requested to get in touch with Mr. Symons promptly.

— n r i —

P. N. Kanten of Seattle, Wash., and President Smith of N. R. I. had a personal visit recently at which time they exchanged pleasant memories of the 15th anniversary celebration of N. R. I. in 1929, which Kanten attended. At that time N. R. I. Alumni Association was organized, Kanten being a charter member.

— n r i —

Station WSB, *The Atlanta Journal*, Atlanta, Ga., has on its staff our good friend, Graduate Frank A. Parkins. He has every reason to be happy in his work with this outstanding station.

— n r i —

Word comes to headquarters that C. W. Bourne, who was formerly in the Radio service business at Hill Top, Ark., was killed in an accident at St. Louis, Mo. The only means of identification was his N. R. I. registration card. Anyone knowing of relatives of Bourne, please communicate with the Executive Secretary.

— n r i —

Ernest Wall of Winnipeg, Man., Canada, stepped into a good connection with T. Eaton Co. as soon as he completed the Course. It's his first Radio job.

— n r i —

Graduate John E. Fetzer of Station WKZO, Kalamazoo, Michigan, is again recognized for his outstanding ability. At the formation of the Michigan Broadcasters Association, Fetzer was elected Vice-President and Director.

— n r i —

T. S. Norton of Hamilton, Ohio, writes that he is now with the Police Radio Station, at that point operating a two-way communication system installed by General Electric Co.

— n r i —

A couple of swell photographs came from J. M. Danyluk, of Andreic, Alberta, Canada, showing the fine store Graduate Danyluk has. He started with \$50.00 capital, made steady growth until he was able to buy the shop, lot and all, on the main street in his town.

— n r i —

Clifford Davis is employed as a Radio operator for the Wyoming Air Service. He is located at Cheyenne and entirely pleased with the world.

— n r i —

A recent visitor at headquarters was Ezra Harris of Bloomington, Indiana.

O. E. Hartford of Hyde Park, Mass., writes, "Just another instance of the far-reaching benefits of our Alumni membership. I wrote to a factory for a pre-selector coil, but heard nothing. After three weeks I became impatient and wrote to C. H. Mills, Secretary of the Detroit Chapter. Back promptly came a card from Mr. Mills. He had phoned the factory. The coil came the next day and I was saved further apologies to my customer."



— n r i —

Elie Lalumiere writes, "I want to tell you how practical and helpful I find all the information one obtains by becoming a member of this great organization. The name of N. R. I. acts like a charm when dealing with companies."

— n r i —

Claude L. Allday has been given a Civil Service appointment of Aircraft Radio Technician at San Antonio, Texas. He is an accepted authority on aircraft Radio equipment and laboratory apparatus. Incidentally, Mr. Allday is leading a movement to organize a local chapter of the Alumni Association in San Antonio.

— n r i —

A H. Wagner of New York Chapter visited headquarters recently. He does a nice spare time Radio business, but on this mission he was driving a special built \$17,000.00 truck from New York to Warrenton, Va., carrying what? Blue blooded horses, of all things.

— n r i —

August H. Ketelhut who served Chicago Chapter as Chairman during 1937, has established himself in the Radio servicing business in Benton Harbor, Mich. He will also do P. A. work. Prospects for a successful business are extremely bright.

— n r i —

Charles H. Richman has an interesting job with RCA Manufacturing Co. at Camden, N. J. He is in the special Test Section, aligning the I. F. section of the Radio Compass Receiver, being manufactured for the U. S. Army. It is a three band receiver covering from 150 kc to 1500 kc having 15 metal tubes operating on 14 volts D. C.

— n r i —

Alfred Parker of Ottawa, Ont., Canada, sent us some snapshots of his very attractive store front. Parker was formerly a grocery clerk. Now he makes three times as much in his own business.

The Service Forum (Continued from Page 25)

CROSLLEY MODEL 167

**WEAK AND
DISTORTED**
Try a new filter condenser block as leakage frequently develops between the filter condensers and the cathode by-pass condenser for the 2A5. Suspect this if the plate current of the 2A5 is abnormal even with the grid coupling condenser disconnected. The disconnection of this condenser checks it for possible leakage.

— n r i —

CROSLLEY MODEL 173

WEAK
Check the speaker field as it may be open. Also check the 8 mfd. 25 volt by-pass condenser from the 78 first A.F. cathode to the condenser gang frame. The cathode lead is of course positive.

— n r i —

CHEVROLET 1937 MODELS

FADING
Probably due to a defective volume control or a faulty resistor in the A.V.C. circuit. Substitution is the best check.

JOHN HATIS, New York.

— n r i —

CROSLLEY MODEL 154

RATTLE
This is mechanical in nature and can be overcome by removing the nuts and washers from between the speaker and baffle. The speaker should then be bolted tightly against the baffle.

— n r i —

CROSLLEY MODEL 167

OSCILLATION
Due to loss in capacity of electrolytic filter condensers. Check by substitution and if condensers are thus proved to be the trouble install a new block.

— n r i —

CROSLLEY MODEL 167

INTERMITTENT

Replace the .1 mfd. condenser used to by-pass the 3,500 ohm resistor in the cathode circuit of the 58 detector-oscillator tube. Use a 600 volt replacement condenser.

— n r i —

SILVERTONE BATTERY RECEIVERS

**EXCESSIVE
FILAMENT VOLTAGE**
It has been discovered that a fairly high percentage of ballast tubes, although with unbroken filament, still do not provide proper ballast action to the filaments of the regular receiving tubes. This results in a higher than normal filament voltage on the receiving tubes. (The filament voltage may rise as high as 2.7 volts.) This condition is likely to occur when the ballast tube has been on the stock shelf, or otherwise inactive for a period of several months. When the ballast tube has been out of service for a length of time, measurement of filament voltages in the receiver with a high resistance voltmeter may show voltages as high as 2.5 volts or higher. In these instances, the voltage to the regular receiving tubes will return to normal if the ballast tube is removed and an external source of 1½ volts is applied directly to the ballast tube filaments for 20 seconds.

The BALLAST tube must be given this separate treatment OUT of the radio receiver. Continuous use in the receiver alone will not restore proper ballast action. This procedure is necessary to handle satisfactorily customer complaints of short tube life, short battery life and also to reduce all expenses associated with the adjustment of battery receivers using ballast tubes.

— n r i —

CROSLLEY MODEL 163

WEAK
Check the plate voltage of the 77 second detector. Using a 1,000 ohm per volt meter you will normally measure about 5 volts on the detector plate. Lack of plate voltage indicates an open in the detector plate circuit. The plate coupling resistor has a value of 3,000,000 ohms while the filter resistor in series with it is rated at 300,000 ohms. Replace both.

— n r i —

CROSLLEY MODEL 148

**WEAK AND
OSCILLATES**
Generally due to leakage and loss in capacity of the 6-8 mfd. filter condenser. Try a new unit as the old one may appear to be O.K. A Mallory duplicate replacement proves quite satisfactory.

— n r i —

CHEVROLET 1937 MODELS

**EXCESSIVE CURRENT
DRAIN**
If the ammeter shows excessive current drain check the power transformer for leakage. The ohmmeter will show 5,000 ohms or more if leakage is present.

JOHN HATIS, New York.

— n r i —

CHEVROLET No. 985255

INTERMITTENT
Replace the audio coupling condenser marked 26 in the schematic and the oscillator grid coupling condenser marked 16. While the audio coupling condenser has a value of .15 mfd. a .1 mfd. 600 volt replacement may be used. Condenser No. 16 should have a value of 250 micro-microfarads. The 6X5G rectifier tube in this model sometimes develops a cathode to heater short. If the receiver seems to be unaccountably weak check the value of the 20,000 ohm 6R7G plate resistor. Motor noise may be due to a poor ground connection on the speech music cable.

JOHN HATIS, New York.

— n r i —

CHEVROLET MODEL 985253

DISTORTION
When this set sounds mushy or muffled, check the 100,000 ohm resistor in the plate circuit of the 6Q7G tube. This resistor has probably changed in value. Replace with a 1-watt 100,000 ohm resistor. The original was either a half or a quarter watt.

GEORGE GILES, Claude, Texas.



New York Chapter

Nominations for Officers for the year of 1938 are as follows:

Chairman—Joseph Barrette
George Hitchcock

Vice-Chairman—Alfred Stock
Fred Lawes

Secretary—Louis J. Kunert

Treasurer—H. Struble

The Secretary and Treasurer have no opposition. This is an expression of appreciation by the members of New York Chapter of the efficient services of Mr. Kunert and Mr. Struble. It is highly desirable that both these gentlemen serve at least another year. Results of the election for Chairman and Vice-Chairman will be announced in the next issue of the News.

After the business of nominating officers was out of the way a round table discussion was held pertaining to Radio servicing problems. These sessions are tremendously interesting and profitable to all who attend.

Meetings are held regularly on the first and third Thursday of each month at 8:30 P. M. Meeting place is Damanzeks Manor, 12 St. Marks Place, New York City. All students and graduates of N. R. I. who live in the Metropolitan area are welcome and urgently invited to attend meetings. The round table sessions are led by qualified Radio men, members of this chapter, who are glad to help those who are less experienced.

A new meeting place is being given consideration. It is desired to change to a more central location. Until further notice however, meetings will be held at 12 St. Marks Place, New York City. Remember the date, the time and the place.

————— *n r i* —————

Detroit Chapter

Go to 11305 Woodward Avenue, Detroit, on the second or fourth Friday of any month, at 8:30 P. M. and here's what you will find. A meeting of the Detroit Chapter of N. R. I., yes, but not a business meeting in the strict sense of the word.

Page Twenty-eight

Instead, you will find an enthusiastic group of fellows at a work bench doing actual Radio servicing.

These fellows meet in a Radio shop. They have quarters set aside for their own use. Here they have built a full size work bench which they have equipped with necessary instruments. They do real practical work from which all present can benefit.

L. L. Menne, the Executive Secretary of N. R. I. Alumni Association recently visited the Detroit Chapter. He was impressed with the business-like way in which the affairs of this Chapter are conducted. The Chairman called the meeting to order promptly on schedule, the roll was called, a few business details were quickly disposed of and the meeting was under way. No lost motion with this group—they get down to action at once.

Mr. Menne, of course, was allotted sufficient time to present a message from Headquarters. After this there was an informal discussion in which every one present was invited to participate. As a result of this discussion, a real constructive program has been mapped out for 1938.

After the meeting was closed, the entire group stayed for refreshments. The work was done and it was time for a little play. It won't take any one very long to get acquainted with these fellows. They do everything right.

The Executive Secretary is very grateful to Chairman F. E. Oliver, Secretary Mills, and all of those present, too numerous to mention, for the royal way in which he was received. Yes sir, if you live in the Detroit area and want to meet a real bunch of fellows take in these meetings. You are missing something if you don't. Remember, the meeting place is 11305 Woodward Avenue on the second and fourth Friday of each month at 8:30 P. M.

————— *n r i* —————

Baltimore Chapter

Officers for this year were nominated at our January 18th meeting. These nominations will be voted upon at the following meeting which will be Tuesday, February 1.

All meetings will be held at Fishpaw's Hall, Baltimore and Gilmor Sts. We meet the first and third Tuesday of each month at 8 P. M. We returned to Fishpaw's Hall because the boys think the meetings are more homey where we are free from rigid hotel restrictions as formerly.

We have some fine things lined up for 1938 and invite all the boys to our meetings to help us put them over in a big way.

Philadelphia-Camden Chapter

Big plans are made for 1938. A special business meeting was called for the purpose of mapping out a constructive program. Present at this meeting was a number of former officers of the Chapter, including Charles J. Fehn and Clarence Stokes, both of whom previously served the Chapter as Chairman. A special invitation was extended to L. L. Memme, Executive Secretary of N. R. I. Alumni Association who outlined some of the work being done by other Chapters which he visited recently.

As the result of an interesting discussion during which all present who had any recommendations were given an opportunity to express themselves, it was decided to start 1938 with a big grand rally to which all members, past and present, as well as students and graduates of N. R. I. in the Philadelphia-Camden area, will be invited. As a special feature, Mr. Joseph Kaufman, Director of Education of N. R. I., will deliver a talk on Automatic Frequency Controls. Final details of this big meeting are not complete as this issue goes to press. However, anyone in the Philadelphia-Camden area who is not now a member of this Chapter is invited to telephone Mr. Clarence Stokes at Nebraska 7163, or write to him at 3405 Kensington Avenue, Philadelphia. You are assured a cordial invitation to attend this and other meetings of the Chapter as a guest.

— n r i —

New Wire-Wound Resistors "Buried in Bakelite"

Center tap IRC wire-wound resistors with moulded insulation and incorporating many unique features have been announced by the International Resistance Company, Philadelphia, Pa. The resistors, known as Type MW-2J, are completely enclosed with moulded bakelite.



A metal strip across the top, which is extended at the ends to serve as a mounting bracket, assists in exceptionally rapid heat dissipation. This strip may be removed easily if terminal mounting is desired.

The units will carry up to 5 watts if mounted on a metal chassis with the mounting brackets and 2½ watts if mounted in the open air. Ranges now available through leading IRC jobbers include 10, 20, 50, 75, 100 and 200 ohms.

Line-Noise Eliminators

Offering a choice of condenser, inductance and ground connection arrangements in the form of six convenient plug-in devices, Aerovox engineers have worked out solutions for practically every kind of line noise. Five of the units plug in between appliance or the Radio set, as the case may be. The sixth unit, in a sturdy rectangular case and provided with attachment plug, receptacle and ground binding post, is intended for exceptionally severe disturbances.



An attractive display card and silent salesman for line-noise eliminators is now being supplied to distributors and dealers.

Printed in vivid yellow and black, the easel card shows the various electrical appliances guilty of Radio interference, and the several types of Aerovox noise eliminators and the noise analyzer. Actual noise eliminator units may be fastened to the card, directly in front of their corresponding actual-sized illustrations, by means of elastic bands. As the units are sold, the illustrations come into view, so that the card is always telling its complete story. This display is suitable for the window, on the counter, or hung on the wall.

Literature on the Aerovox line noise filters and noise analyzer may be had by addressing Aerovox Corporation, 70 Washington St., Brooklyn, New York.

Chicago Chapter



Off to a good start for 1938 Chicago Chapter elected its officers in time for them to take charge immediately beginning with the New Year. It is a rule of this Chapter, as covered by its by-laws, that no principal officer can succeed himself, although he may be a candidate after a lapse of a year.

It is interesting to note that practically the same slate of officers who served the Chapter so well two years ago were returned to leadership for the present year. Here is the lineup.

E. R. BENNETT, Chairman
SAM JURICEK, Secretary
LEO LEWANDOWSKI, Sergeant-at-arms
C. B. MOREHEAD, Librarian

One of the proposals which met with favor was that an Executive Committee be appointed to aid the chairman in planning programs for the year. This committee consists of Edward Sorg and C. B. Morehead. A Membership Committee also was appointed consisting of J. A. Cordero and Edward Sorg. Other committees will be appointed as the need arises but for the present the Executive and Membership Committees will work together with the chairman to put into effect the plans for a very busy year.

Edward Sorg was nominated as a candidate for chairman but withdrew in favor of E. R. Bennett, who has, in and out of office, given much of his time and capabilities to the success of Chicago Chapter. Recognizing the ability of Mr. Sorg, however, the membership prevailed upon him to serve on two important committees.

Programs for 1938 will consist largely of speakers from various manufacturing firms, engineering laboratories and other firms connected with the Radio industry with some meetings devoted to a round table discussion of questions submitted by the membership.

A. H. Ketellut, the retiring chairman, has moved to Benton Harbor, Michigan, where he has established a Radio business. He has the best wishes of all of the boys but, of course, they expect him to make the trip to Chicago frequently to attend meetings, just as he did, to complete his term of office.

L. L. Menne, Executive Secretary of N.R.I. Alumni Association, recently visited the Chicago Chapter. He was elated with the fine spirit of comradeship as shown by the members and he expressed himself as being extremely confident that under the guidance of Chairman Bennett the Chicago Chapter will grow and prosper during the present year.

— n r i —

And Good Wishes to You

J. E. Smith, E. R. Haas, J. A. Dowie, the N.R.I. Staff, and Alumni Officers are profoundly grateful to the many students and graduates who sent greetings during the holidays.

— n r i —

Directory of Chapters

Baltimore—I. A. Willett, Secretary, 2411 Arunah Ave., Baltimore, Md.
Philadelphia-Camden—Clarence Stokes, Treasurer, 3347 N. Front St., Philadelphia, Pa.
New York—L. J. Kunert, Secretary, 66-11 74th St., Middle Village, L. I., N. Y.
Buffalo—T. J. Telaak, Chairman, 657 Broadway, Buffalo, N. Y.
Toronto—Ed. Witherstone, Secretary, 363 Nairn Ave., Toronto, Ont., Canada.
Chicago—Sam Juricek, Secretary, 4223 N. Oakley Ave., Chicago, Ill.
Pittsburgh—Albert Maas, Secretary, 9 S. Howard Ave., Bellevue, Pa.
Detroit—C. H. Mills, Secretary, 5458 15th St., Detroit, Mich.

Page Thirty

Directory of Officers

(To Serve Until January, 1939)

President—P. J. Dunn, Baltimore, Md.
Vice-Presidents—
Earl Bennett, Evanston, Ill.
F. E. Oliver, Detroit, Mich.
Dr. Geo. B. Thompson, Los Angeles, Calif.
Allen McCluskey, Birmingham, Ala.
Secretary—Earl Merryman, Washington, D. C.
Executive Secretary — L. L. Menne, National Headquarters, Washington, D. C.

— n r i —

"To cultivate fraternal relations among the Alumni of the National Radio Institute, to promote the welfare of each alumnus by interchange of helpful information, to foster the spirit of unity and loyalty to our Alma Mater."



We Started Something

I get so much kick out of the News that I just have to tell somebody. Give us some more of the adventures of Jay and Ozzie of "Electronics, Inc." They were good. I had been wondering when you would start something like that. I enjoy every page of the News.

GEORGE GILES,
Claude, Texas

—————n r i—————

Another Boost for Electronics, Inc.

The article in the October-November issue of N. R. NEWS, "Electronics, Inc." by L. J. Markus, aroused my interest in photo-electric cell immensely. Although being science fiction, I found it more interesting than anything else in N. R. NEWS since I've been receiving it.

HAROLD R. KUNTZ,
Christiansted, St. Croix, V. I.

—————n r i—————

Liked Article on Quartz, Too

Fiction or non-fiction, the story, Electronics, Inc., was very interesting to me. Also the article on Quartz was of interest. It is hard to find anything in our News that is not interesting.

BASCOM D. HARMAN,
New York City

—————n r i—————

Thank You, Mr. Ganong

I think that the N. R. NEWS certainly is a swell magazine—just crammed full of worthwhile "dope." The Novel Radio Items are swell and I hope you keep them coming. Also the Laboratory section and Service department are very interesting and valuable to me.

REID H. GANONG,
Fredericton, N. B., Canada

What About This?

The Service formulas are a great help, but I would like to see them on both back and front of same leaf, so if a man wanted to put them in a service manual, he would not destroy something equally as valuable.

WM. A. BEASLEY,
Red Boiling Springs, Tenn.

—————n r i—————

Educational and Helpful

The two items in NATIONAL RADIO NEWS on "To Ships at Sea" and "Automatic Tuning Is Here to Stay" were very educational and helpful.

W. DOURY,
Detroit Lakes, Minn.

—————n r i—————

New Short Wave Stations

The new short wave station at Delhi (10 K.W.) is completed. The other new short wave stations at Madras, Calcutta and Bombay will be on the air by the end of 1938. This will be of interest to the DX fans.

K. S. V. RAJAN,
Tumker P. O., South India

—————n r i—————

Laboratory Page Finds Favor

The experiments are indeed very helpful. They are all very interesting and instructive.

LLOYD G. LYNCH,
Kisbey, Sask., Canada

—————n r i—————

Wants Descriptive Stories

I like those stories about branches of Radio as The Illinois State Police Radio System.

GUNNAR SOLSNES,
Seattle, Wash.

More Jobs for Communication Men

With Mayor F. H. LaGuardia and Fire Chief and Commissioner John J. McElligott officiating, New York City's new two-way Radio system for fireboats was formally put in operation recently. The Radio installation now makes possible communication between the City of New York and each of its nine fireboats. The equipment was designed, built, and installed by the General Electric Company.

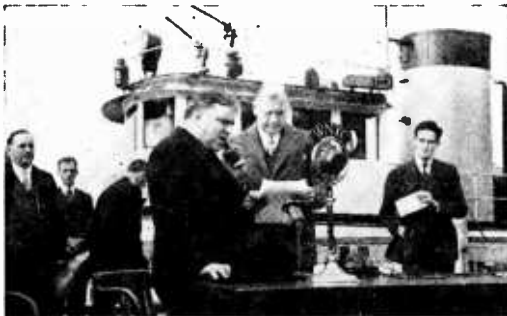

Mayor F. H. LaGuardia speaking to the fireboats at the dedication of New York City's new fireboat Radio equipment. Fire Chief and Commissioner John J. McElligott is shown with the mayor.

The system permits constant communication between the boats and headquarters while the boats are tied up or are in action away from their docks. Heretofore it has been impossible for a boat at the scene of a fire to keep in direct contact with headquarters. Frequently it is necessary for a fireboat to remain away from its dock for 24 hours or more. With the new Radio equipment, speedboats may be ordered to remove injured persons to a waiting ambulance, saving valuable time in the prevention of loss of life.

The new system provides duplex communication identical to an ordinary telephone conversation, with no switching operations from transmitter to receiver required. It is also possible to connect the two-way Radio system and the ordinary telephone system, thus providing direct communication from any telephone connection with any or all of the boats.

— n r i —

Additions to the N. R. I. Ham List

Following are call letters of amateur stations reported since the last issue of the News:
 William Dunne—W3ASE—Washington, D. C.
 Marcel E. Vincent—W8KYM—Ogdensburg, N. Y.
 J. R. Troxel—W2KQG—New York City
 Clarence Stoltz—W9YVL—LaCrosse, Wis.
 Gervasio Carvalho—PY2KE—Santos, Brazil
 Alfred Freitag—W3HDZ—Baltimore, Md.

Page Thirty-two

NATIONAL RADIO NEWS

FROM N. R. I. TRAINING HEADQUARTERS

Vol. 8

February-March, 1938

No. 1

Published every other month in the interest of the students and Alumni Association of the

NATIONAL RADIO INSTITUTE
 Washington, D. C.

The Official Organ of the N. R. I. Alumni Association

Editorial and Business Office, 16th & You Sts., N. W.,
 Washington, D. C.

L. L. MENNE, EDITOR
 S. M. ARMSTRONG, MANAGING EDITOR

NATIONAL RADIO NEWS accepts no paid advertising. Articles referring to products of manufacturers, wholesalers, etc., are included for readers' information only, and we assume no responsibility for these companies or their products.

Index

Article	Page
All-Wave Receiver Antennas	3
The Laboratory Page	9
Winners in Business-Idea Contest	11
Data Sheet—Grunow Models 410 and 411.	13
P.A. Amplifier Service Hint	15
The Tools of Communication	16
Data Sheet—Stromberg-Carlson 225	19
Novel Radio Items	22
Cover Photo—Writing a Text-Book	23
Alumni Election Results	24
The Service Forum	25
Here and There Among Alumni Members..	26
The Mailbag	31