



# Journal

**JULY/AUGUST 1970 35 Cents**



***Electronics Devices Move Police***

***Into Era of Dick Tracy Detection***

# Announcing... THE OFFICIAL SCHOOL RING OF NATIONAL RADIO INSTITUTE

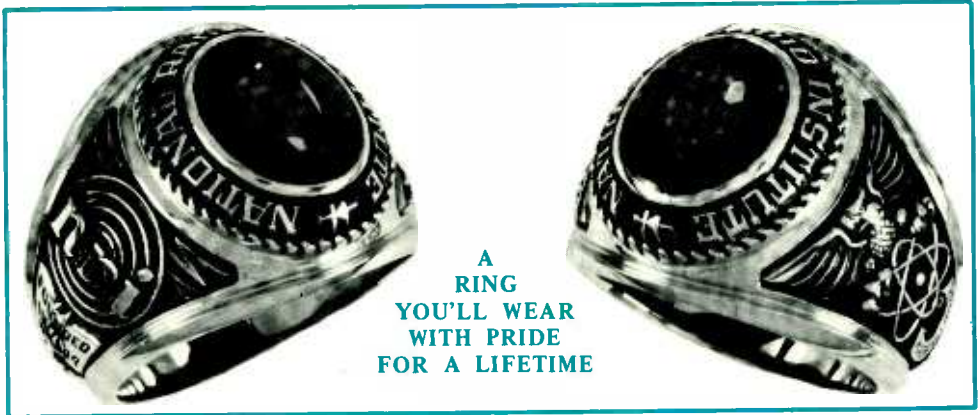

You will be proud to wear this distinguished ring in any company. It identifies you as a man of ambition and achievement who is dedicated to success through education. The ring speaks well of both you and your school.

Your official NRI school ring is a masterpiece of jewelry created to NRI specifications by the L. G. Balfour Company, makers of the most distinguished school rings in America. A full 9 pennyweight of brilliant, durable 10 kt. gold gives the ring the heft and feel you would expect of a university style ring. The smooth, round-top stone is a sparkling ruby-red, the color which identifies your school.

The famous NRI symbol boldly dominates one side of the ring. The opposite side features an American eagle and a symbol representing both the space age and electronics – concepts to which your school is dedicated.

Order your ring now and wear it with pride for a lifetime.

## HOW TO ORDER YOUR OFFICIAL NRI SCHOOL RING

To order your ring, use the order blank on page 25. BE SURE TO GIVE US YOUR CORRECT RING SIZE. You may pay for your ring three ways: (1) Send \$49.95 with your order. (Add 4% sales tax only if you live in Washington, D. C.); (2) If you have an open account with Conar Instruments Division of NRI, simply ask to have the ring added to your account, or (3) Send a \$5.00 down payment and ask to open a Conar credit account. Be sure to fill in the credit application on the back of the order blank on page 25.

### BE SURE TO TELL US YOUR RING SIZE

The best way to find out your correct ring size is to ask your local jeweler to measure your finger. Otherwise, use the ring chart below. Wrap a strip of paper or adhesive tape around the largest part of your finger. Mark where it overlaps and cut off the excess paper or tape. Measure it on the chart below. If it falls between sizes, choose the next size.

RING SIZES FOR MEASURING FINGER



**OFFICIAL  
NRI SCHOOL RING  
\$49.95**

STOCK # IDS  
SHIPPED  
PARCEL POST INSURED



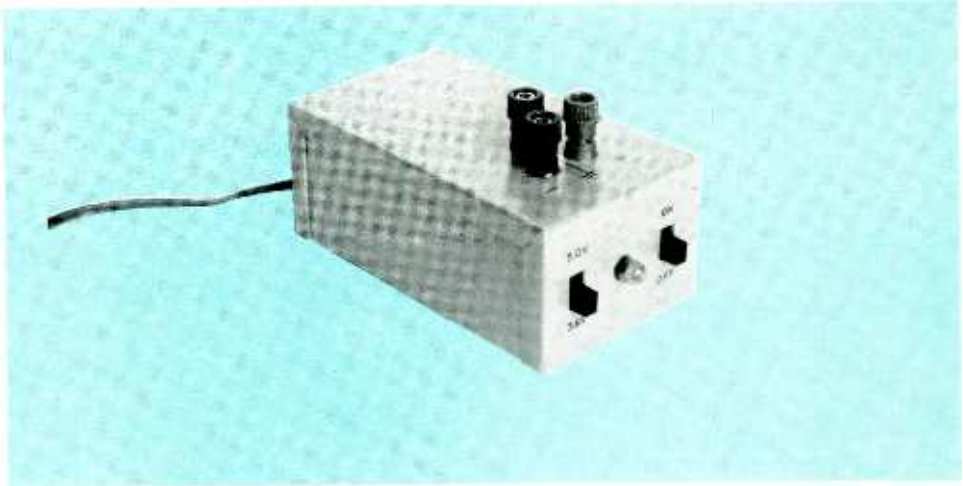

# 'Goof-Proof' Power Supply Aids In IC Experimentation

By Robert L. Carlson

*The power supply described in this article was intended primarily as a "bench supply" for IC experimentation. However, because of its extreme simplicity, low cost and excellent regulation characteristics, it could easily be built into finished IC projects, etc.*

*Here are some of the features of this little power supply.*

- 1. Dual voltage 3.6V and 5.0V for RTL, DTL and TTL circuits*
- 2. 0% regulation*
- 3. Short-circuit proof*
- 4. Maximum current 1.0 ampere*

*The two voltage levels of 3.6V and 5.0V were selected as being the most useful for most digital integrated circuits.*

*Zero percent regulation means simply that the no-load to full-load voltage variation is zero – there is*

*NO change at all! This amount of regulation is usually available only in very expensive commercial power supplies. A neat application of both negative and positive feedback in the dc amplifier (which is what a power supply regulator really is) gives us this most desirable characteristic, and with only very few parts.*

*The only penalty we must pay for this nice regulation is that we cannot vary the output voltage continuously — each output voltage requires a different amount of positive feedback. In addition, we must use some sort of variable load to properly set the feedback for each voltage. A simple load suitable for this purpose will also be described in this article.*

*The power supply is “goof-proof” in that the short-circuit current is automatically limited by the circuit to about 1.1 amperes. At this level, the only thing that happens is that the power transformer may heat up a bit if the*

*short-circuit exists across the output terminals for several minutes. The transformer, after all, is only rated at 1.0 ampere.*

*The transistors and other parts are loafing under the short-circuit condition. The output voltage drops, of course, to zero with such treatment, but cheerfully bounces back to 3.6V or 5.0V when you clear the short. Holding a deliberate short for too long a time may possibly heat up the series pass transistor. Then, when the short is removed, the output voltage may possibly “soar” up to 3.8V or 5.3V. After the power transistor cools off, down will come the voltage.*

## **Simplicity, low cost, good regulation give strength to finished projects, too**

The circuit of this little power supply is shown in Fig. 1. The unit built by the author is shown in the photographs. This particular model of the power supply is housed in a 5-1/4" X 3" X 2-1/4" aluminum slide case, although almost any type of construction could be used. The transformer is mounted on the bottom of the case and all other parts are mounted on the other half of the case. All of the filter and regulator parts except the voltage selector switch and the power transistor, are on a 3" X 2-1/2" circuit board. The “plus” and “minus” output jacks support the circuit board.

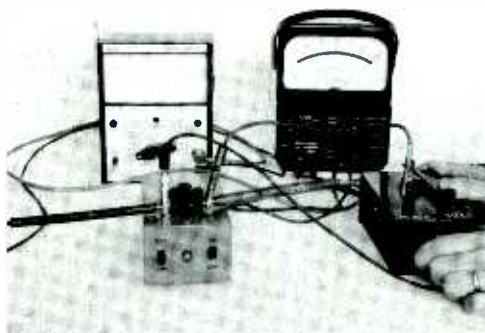

Using the “black box” variable load to check regulation on the 3.6V range.

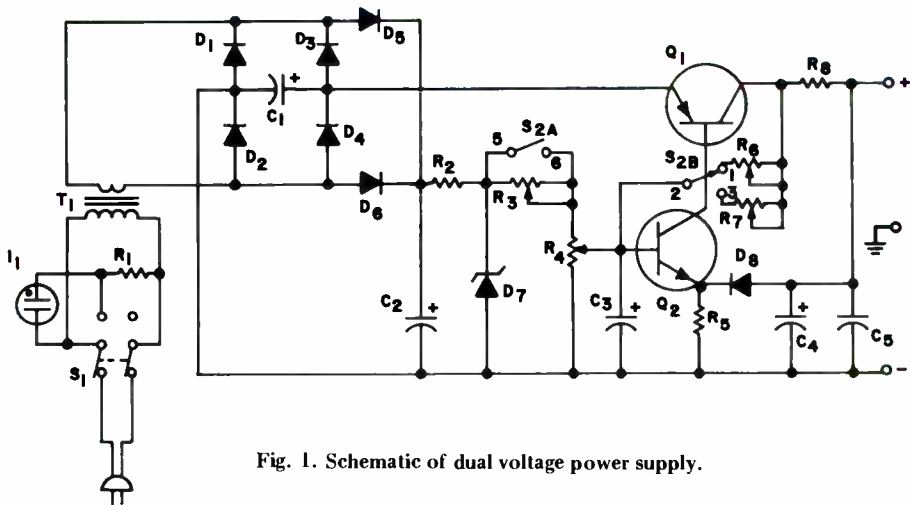

Fig. 1. Schematic of dual voltage power supply.

C <sub>1</sub> , C <sub>2</sub>	1000 mfd, 15V	R <sub>1</sub>	82K, 1/2W, 10%
C <sub>3</sub>	100 mfd, 10V	R <sub>3</sub> , R <sub>4</sub> , R <sub>6</sub> , R <sub>7</sub>	1K trimmer pot. (CTS X201)
C <sub>4</sub>	5 mfd, 10V	R <sub>5</sub>	68Ω, 1/2W, 10%
C <sub>5</sub>	.1 mfd, 50V	R <sub>8</sub>	1Ω, 1W, 10%
D <sub>1</sub> - D <sub>6</sub>	50 piv, 1 amp silicon rect.	T <sub>1</sub>	6.3 vac, 1 ampere filament transformer
D <sub>7</sub> - D <sub>8</sub>	2N5134 - see text	S <sub>1</sub> - S <sub>2</sub>	DPDT slide switch
I <sub>1</sub>	NE2 neon	R <sub>2</sub>	470Ω, 1/2W, 10%
Q <sub>1</sub>	40050 - see text		
Q <sub>2</sub>	2N5134		

## CONSTRUCTION

Parts selection is not at all critical, and in fact four different PNP germanium power transistors were used at Q<sub>1</sub>: a 40050, a 2N555, a 2N178 and one of unknown heritage and origin pulled from a "bargin" bin. All worked very nicely. Q<sub>2</sub> can be any inexpensive NPN silicon type having a moderate (at least 20) beta. The 2N5134 was selected for its attractive price.

Zener diode D<sub>7</sub> can be any 1/2 watt type in the 5V to 7V range. Again, for the sake of low cost, the author used the reverse-biased collector-base junction of a 2N5134 which works quite well. Fig. 2

shows the connections. About six 2N5134s tried in this circuit exhibited quite nice and sharp junction breakdown over the range of 5.3V to 7.4V. Any of

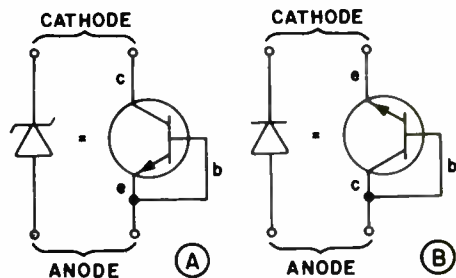

Fig. 2. How to connect an NPN silicon transistor (A) as a zener diode, and (B) as a standard diode.

these voltages is adequate for the reference voltage of the power supply.

Diode  $D_8$  is the emitter-base junction of still another 2N5134, the anode being the base and the cathode the emitter. You can tie the base and collector together if you want, although it isn't necessary. This connection is also shown in Fig. 2.

All other parts are also standard, readily available parts. A DPDT slide switch was used for  $S_1$  instead of the usual SPST switch for the sake of providing some "free" terminals for  $I_1$  and  $R_1$ , thereby saving the cost of a terminal strip. Switching both sides of the ac line also gives you some place to connect both of the leads of the ac line cord, again saving another terminal strip. I believe you will find that the DPDT switch costs only a penny or two more than the less versatile SPST, so why not "standardize" on DPDTs?

### ADJUSTMENT

Now that we know all about the parts involved, let's see how we get our 0% regulation at 3.6V and 5.0V. To properly make the adjustments you will need a variable, high wattage, low resistance load. Rather than invest in an expensive wire-wound potentiometer, you can easily build the simple variable load shown in Fig. 3.

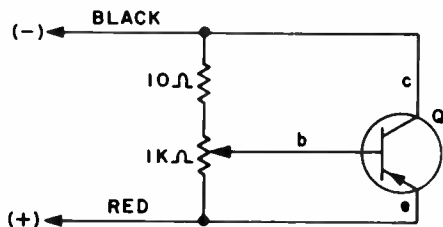

Fig. 3. How to connect a PNP power transistor as a variable load.

As you can see, there are only three parts, yet the electronic load is adjustable from 30 ma at 30 volts to over 4 amperes at 30 volts. That last condition is for *very* short periods of time only! The power transistor is any old PNP germanium from one of the bargain assortments. The 1K-ohm pot should be a 2-watt type if you plan to use the load at the 30-volt level. Otherwise, and for adjusting this power supply, it can be a simple carbon control. The 10-ohm resistor is needed simply to keep you from shorting the base and collector when you get carried away playing with the power supply.

The lashup of the variable load needn't be anything elaborate, since it will only be used for short tests; a haywire arrangement is fine – no heat sink or anything fancy like that, just hang the parts around the control and connect a red (+) and black (-) lead as indicated. The author's variable load is built into the "black box" which you can see in the photograph.

With everything wired up and ready to go, adjust  $R_6$  and  $R_7$  for maximum resistance and set  $S_2$  to the position that shorts out  $R_3$ . This is the 5.0-volt position for  $S_2$ . Connect the variable load to the power supply output terminals (with a 0 to 1.5 ampere dc meter if you wish), plus to plus and minus to minus. Set the 1K-ohm control of the variable load so the base of Q is shorted to the emitter.

Now turn on the power and connect a voltmeter across the output terminals of the supply. Adjust  $R_4$  for exactly 5.0 volts. Now increase the load by adjusting the 1K-ohm control of the variable load. At some point the output voltage will fall off noticeably. When the voltage drops below 4.7 volts, adjust  $R_7$  to bring the voltage back to 5.0 volts.

Now reduce the load to minimum and readjust  $R_4$  for 5.0 volts. Crank up the

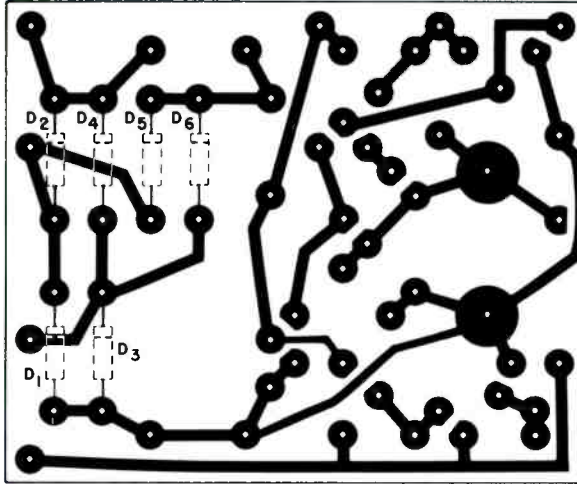

Actual size foil pattern you can use to make a circuit board  
(D<sub>1</sub> - D<sub>6</sub> mount on foil side).

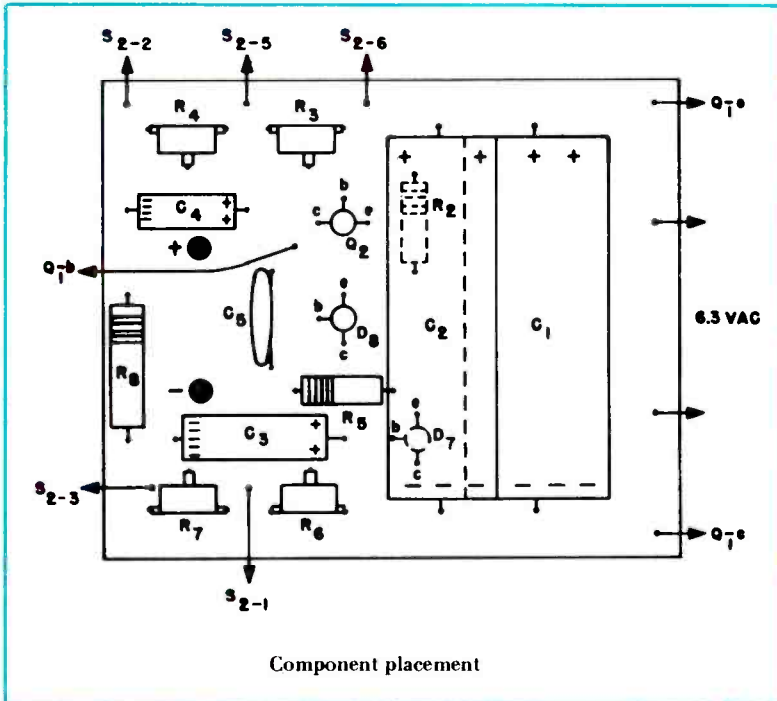

Component placement



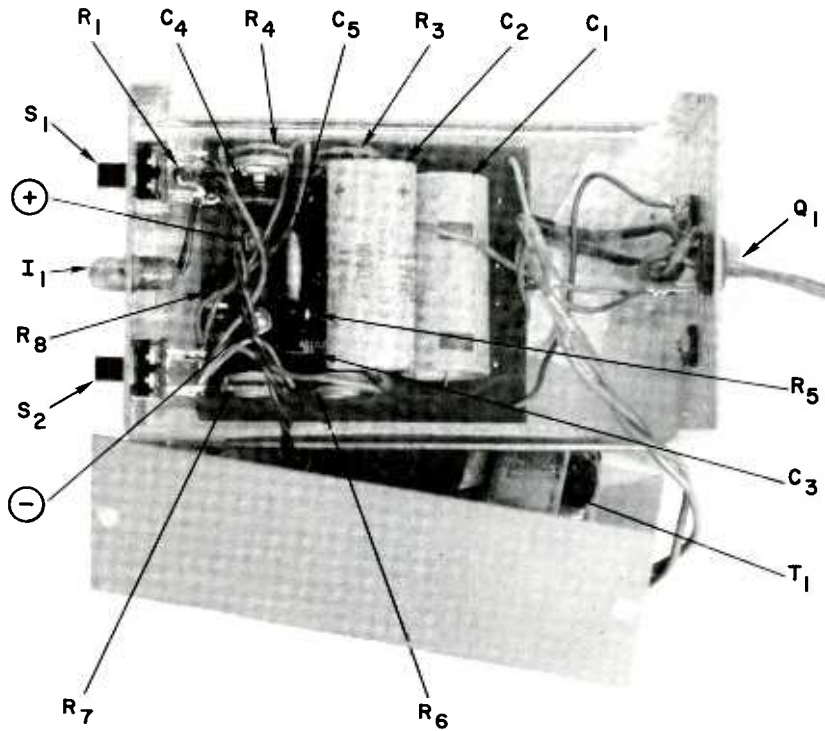

load again and this time you may find that the output voltage actually rises as the load increases! If so, readjust  $R_4$ ,  $R_7$  and the load until the voltage remains steady at 5.0 volts under load. Don't try to get more than 1.0 ampere of current, as the ac output of  $T_1$  will drop at this level and cause the reference supply voltage of  $D_7$  to drop.

When all is well with the 5.0-volt position, repeat the process with  $S_2$  in the 3.6-volt position. This time adjust  $R_3$  and  $R_6$  for exactly 3.6 volts.

### CONCLUSIONS

No voltmeter or ammeter is included in the supply since none is really necessary. The supply is current-limiting, and within

the range of limiting current load, the output voltage is constant, so who needs meters?

As mentioned at the beginning of the article, the *basic* power supply is quite easily modified to be used as a "built-in" supply for IC projects which have appeared in various magazines. To pare it down to "bare bones", you can do away with  $D_5$ ,  $D_6$ ,  $C_2$ ,  $S_2$ ,  $R_3$  and  $R_6$  if you will be happy with one voltage at perhaps 500 ma. If you do this,  $R_2$  should be reconnected to the (+) terminal of  $C_1$ . Although regulation will fall off at about 500 ma or 600 ma, the supply still retains its short-circuit protection and will limit current to about 1.1 amperes.  $R_4$  can be set to 3.6 volts, 5.0 volts or any value up to that determined by  $D_7$ . In fact, you could use a real Zener at  $D_7$  of the type

needed to produce the required output voltage and do away with  $R_4$  altogether.

You could also go the other way. Put in a huskier transformer at  $T_1$ , jack up the voltage a bit (Watch out for the electrolytics, though. You'll need higher

voltage ones.) and make a 9-volt or 12-volt supply if you need that much voltage. The cost of the whole supply is so low you could almost afford to build one for each output voltage you might need!

## How It Works

The power supply uses both negative and positive feedback to give the regulation characteristics. Reference voltage  $D_7$  is divided down by  $R_4$  (and  $R_3$ ) to the required output voltage,  $V_{ref}$ , and is applied to the base of  $Q_2$ . The output voltage is tied to the emitter of  $Q_2$  by  $D_8$ .  $D_8$  compensates for the  $V_{be}$  drop of  $Q_2$  and, since it is also a base-emitter junction, will track with  $Q_2$  with changes in temperature.

The collector current of  $Q_2$  (which is essentially the same as the emitter current of  $Q_2$ ) is the base current of  $Q_1$ .  $Q_2$  emitter current flows through  $R_5$ . If the output voltage rises,  $D_8$  becomes more forward-biased and diverts emitter current from  $Q_2$ , lowering the conduction of  $Q_1$ , to lower the output voltage.

A decrease in output voltage will reduce the conduction of  $D_8$  through  $R_5$ , allowing more current to pass through  $Q_2$ . This increases the conduction of  $Q_1$ , causing the output of  $Q_1$  to increase. Both of these actions require a *change* in the output voltage to take place before any correction can take effect. This is undesirable, so we crank in a little positive feedback to speed things up a little. This is accomplished by  $R_6$  or  $R_7$ .

Any increase in load current will produce a voltage drop across  $R_8$  which will make the end of  $R_8$ , connected to the collector of  $Q_1$ , more positive. This positive voltage is applied directly to the base

of  $Q_2$  through  $R_6$  or  $R_7$ , causing  $Q_2$  to conduct more, which in turn causes  $Q_1$  to conduct more, raising the output voltage. This circuit, then, *anticipates* a decrease in output voltage when the load current increases and compensates for the decrease before the voltage can drop.

$R_5$  and the beta of  $Q_1$  provide the short-circuit protection. With the output shorted, the base of  $Q_1$  is connected to its collector through  $Q_2$ ,  $R_5$  and  $R_8$ . We can neglect  $R_8$ , and the drop across  $Q_2$  will be quite small. The base current of  $Q_1$  will be approximately equal to the emitter current of  $Q_2$  which is:

$$(V_{ref} - V_{be})/R_5 = I_{b1}$$

The collector current of  $Q_1$ , which is the output current, will be equal to beta times the base current, or:

$$\beta (V_{ref} - V_{be})/R_5 = I_{c1} = I_{SC}$$

At the 5.0-volt setting this would be:

$$\beta(5.0 - 0.6)/68 = \beta(4.4)/68 = .065\beta$$

If  $Q_1$  has a beta of 20, then the maximum short-circuit current would be  $.065 \times 20 = 1.3$  amperes. Transformer rating and filter capacitor limitations bring this down in reality to about 1.1 amperes for the circuit shown. 

# Start With The Right Equipment For Yourself AND Your Shop

AUTO RADIO SERVICING *By Harold J. Turner, Jr.*

The idea of specializing in one small area of one's chosen field is a sign of our times. We are all familiar with the scarcity of the family doctor . . . the old gent who would treat anything from measles to ingrown toenails to tuberculosis. Nowadays many, if not most, doctors devote their skills to a specific area of medicine. And so it is in other fields of endeavor: for example, you can now take the family car to one shop for a new muffler, another for new tires, still another for a major brake repair.

There are many advantages and disadvantages in this system, but the fact of the matter is that the American public believes in and has confidence in those who specialize in one thing or another. These specialists are never looked down upon for knowing little outside their specialty; rather, they are admired because of their competence in their particular area of work.

For some reason or another, the consumer electronics servicing industry is one area where this idea of specialization has not often been employed. Why not? Most good technicians feel that they are fully qualified to service any type of equipment that might ever be brought to them. But, since a specialist needs only those tools and spare parts applicable to his particular field, you can easily see that



this would result in a more efficient operation. Of course, this means more profit for your labor. Would *you* like to specialize in one small area of electronic servicing? This is the first of a series of articles that will appear in the NRI Journal from time to time: each will be devoted to one such specialty.

If you want to specialize in auto radio servicing, or any other area of electronics, for that matter, you must be proficient in the general field of electronics. Your NRI training will provide you with this basic qualification. Of course, no matter which area of electronics is your specialty, you should always keep yourself up-to-date by regularly reading at least two or three of the best trade magazines, such as Electronics World, Radio Electronics, and Electronic Servicing (formerly PF Reporter).

Most of the servicing work you will do in the area of automotive radios will be very similar to servicing other types of equipment. Of course, the circuits used in this type of equipment are similar to the circuits used in most other electronic equipment, so the procedures you will use and the test equipment and tools you will need will also be much the same as needed for servicing other types of gear. What, then, sets you aside as an auto radio specialist? Let's see: what special equipment do you need to operate an ordinary table radio or a TV set in your shop? None . . . you just plug it into the standard ac outlet.

Now . . . try the same trick with a car radio that you have just removed from a customer's Chevy. Before even a perfectly

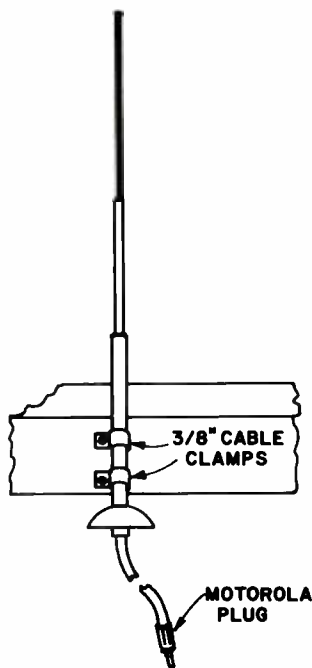

**An easy way of mounting a standard auto antenna on a wooden bench.**

good auto radio will operate in your shop, you must make three essential connections: first, the auto set requires a source of dc power (12 or 6 volts, depending on model). You can obtain this voltage from a low-ripple battery eliminator. Next, connect an antenna to the antenna input jack. Ideally, this antenna will be very similar to the type actually used by the radio when it is installed in the car. Finally, many car radios do not have built-in speakers . . . the speakers are located elsewhere in the passenger compartment where they can radiate most efficiently. So, you must provide a speaker for test purposes. All this equipment is needed simply to make the radio feel "at home" in your service shop . . . you must give the radio the same environment it has during normal operation. After you have taken care of this, you can proceed to service the radio just as any other piece of equipment.

Let's take a closer look at these three essential items. First, the battery eliminator. Now, there's no law that says you can't use a couple of six-volt automobile batteries, connected in series for a twelve-volt supply, or used singly or in parallel as a six-volt supply. But these batteries are bulky, messy, and they must be constantly under charge. The most practical thing to do is to use a standard battery eliminator. Here are some points to check when you buy this important piece of gear. Of course, the eliminator must be able to furnish the basic voltages of 6 and 12 volts; the average modern car radio uses only two amps or so, but some of the older units that you're apt to run into sooner or later will need as much as ten amps! Naturally, the output voltage will tend to fall as current drain is increased, so some means of adjusting the

output voltage is essential. It is not important that the output voltage be variable from zero to maximum, as long as the voltage can be controlled so that it stays at 6 or 12 volts under any reasonable load.

For reasons that are very obvious, current and voltage meters on the front panel of the battery eliminator are essential to obtaining the maximum performance from the instrument. The current meter, in addition, can give important clues about the trouble with the set under test. For example, if the current indication is zero, there must be an open circuit in the radio's power supply circuit.

Finally, make sure you select a battery eliminator with a very low ripple level. This requires expensive chokes and filter capacitors in the unit, so an eliminator with low ripple output will, in general, be more expensive than one with an unfiltered output. This additional investment is indeed worthwhile, as some auto

radios will not work well at all if the ripple is too high in amplitude. Not all battery eliminator manufacturers specify the ripple output of their products, so be careful . . . in general, a unit with a maximum ripple amplitude of 250 millivolts (.25 volt) will be quite satisfactory. There are several excellent battery eliminators on the market; one which I know will fulfill all the specified requirements is the ATR model 610, which is available through CONAR.

Next, you will need a standard auto-type whip antenna with a coaxial cable output. The output should be terminated in a "Motorola" plug, which will fit almost all auto radios made. You can mount the antenna at a convenient place on your bench; the simplest way of doing this is with a pair of clamps, as shown on the previous page. Extend the antenna to the same height as is usually done in an actual auto installation: 4 or 5 feet. If possible, keep the antenna away from sources of interference, such as fluorescent lights.

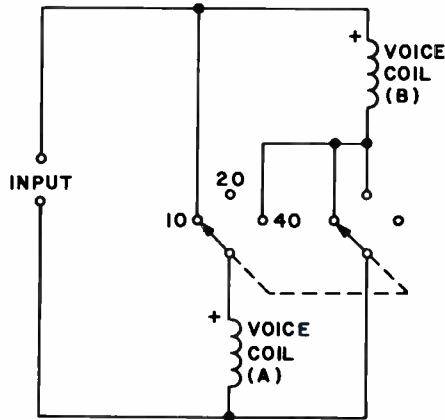

How to connect a dual voice con speaker for switch selection of 10, 20, or 40 ohms. Note the polarity indications.

What about the speaker? That sounds easy, but there's one complication: not all car radios are designed to drive standard 8-ohm speakers. Many, especially late models, must have 40-ohm loads. But don't worry . . . you needn't keep two separate speakers on your bench . . . there are universal speakers available with dual voice coils. In these versatile units, the independent 20-ohm voice coils can be parallel-connected for 8-to-10-ohm operation, or hooked in series for radios that need a 40-ohm load.

You can even use one coil all by itself if you ever need a 20-ohm load (I've never seen an auto radio that uses a 20-ohm speaker, but you never know . . . it could happen). If you wish, you can permanently wire the speaker to a switch to select the desired impedance. For details on this, check the schematic on the previous page. Be sure to observe polarity on the speaker connections . . . if the two coils are connected out-of-phase, they will work against each other, and almost no sound will be heard. Polarity is always marked on this type of speaker.

Of course, you will also need the standard instruments that are used in other areas of electronics servicing: vtvm, signal generator, and signal tracer (preferably a *tuned* signal tracer, such as the CONAR Model 230). An oscilloscope will sometimes be useful, but not nearly as often as in, for example, TV repair work.

For the most part, you will need no special hand tools that aren't needed in other areas of electronics. However, you will not get very far in this business without a 5/8" hollow shaft nutdriver (Xcelite HS-20 or equivalent), as this is

the size needed to remove control mounting studs from auto radios.

Once you make yourself known as an auto radio specialist, you will probably be called upon to work on or install other types of automotive electronic equipment: antennas, rear seat speakers, tape cartridge players, perhaps even transistor ignition systems and two-way Citizens Band radio equipment. (Of course, you must have an FCC First or Second Class Radiotelephone Operator's License to work on any radio transmitter.)

The next time you stop in at your wholesaler's, notice the wide variety of auto accessories he has in stock . . . or check one of the large mail order parts catalogues. You are sure to find many more examples than I have listed here. Since you are repairing and installing this type of equipment, it is a natural thing to move into the sales business, again with the same specialty in mind. There is really no end in sight, as the market for these products is growing tremendously.

This article is intended merely to make you aware of the opportunities in auto servicing. Before you actually begin any work of this type, brush up on the electronics you will need by reviewing your NRI lessons on auto radios. Also a visit to your wholesaler or a quick glance through a mail-order catalog will show many good books on this subject. I can especially recommend "Auto Radio Servicing Made Easy", by Wayne Lemons, published by Howard W. Sams & Co. Books such as this one are an inexpensive way of picking up bits of valuable information that may have been overlooked before. 

# ELECTRONICS DEVICES MAY MOVE POLICE INTO AN ERA OF DICK TRACY DETECTION

*Courtesy McGraw-Hill News*

- *Computerized criminal records.*
- *Electronic tracking beacons that spot stolen cars.*
- *Space rocket equipment used to trap bookmakers.*

Sound like Buck Rogers teaming up with Dick Tracy in a new comic strip adventure?

It isn't, according to Electronics magazine. Developments like these represent a very real link-up of technology and law enforcement to combat soaring crime rates. Electronics examined this new aspect of crime fighting in a special report in a recent issue.

Lois Vermillion, editorial staffer for the magazine's Washington bureau, prepared the article after months of extensive research. She visited Justice Department and District of Columbia police headquarters, attended a seminar on law enforcement and technology, and talked to police officials and electronics engineers throughout the U.S.

"Until the late 1960's, electronics technology and law enforcement were relatively far apart," notes Miss Vermillion. "They were kept apart by money shortages in most police departments and resistance among many old-line law enforcement personnel."

Matching grants from the Justice Department to local police agencies helped solve the money problem. Resistance was lessened by the successful use of new equipment.

Computers are aiding police on a large scale in Washington, D.C. Under an operation called WALES (Washington Area Law Enforcement System) data on wanted criminals and stolen items can be obtained instantly from the FBI's National Crime Information Center.

(SEARCH will begin a two-month demonstration beginning this month. For the demonstration, the central index will use a Burroughs 5500 at Michigan State headquarters. Ten states, each given \$100,000 in LEAA funds, will participate, with five others observing.)

(Evaluation of the system and possible redesigning will begin in

September and the first design should be out by the end of the year, says SEARCH project coordinator Paul K. Wormeli of the California Crime Technological Research Foundation. April 1971 is the target date for SEARCH to become an operational national system, and during calendar 1971, he says, the pressure will be on the states to tie into the SEARCH network.

**READY FOR TESTS.** This is Search, an information-handling system which will be tried out this summer.

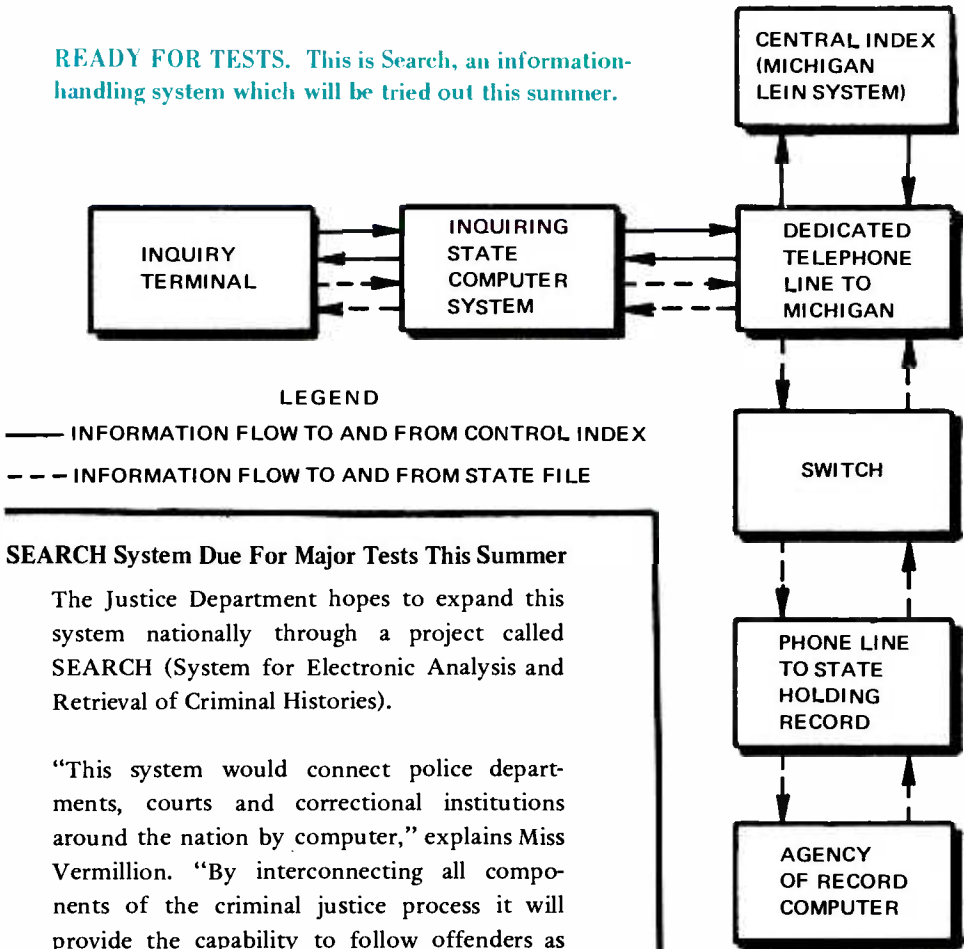

**SEARCH System Due For Major Tests This Summer**

The Justice Department hopes to expand this system nationally through a project called SEARCH (System for Electronic Analysis and Retrieval of Criminal Histories).

“This system would connect police departments, courts and correctional institutions around the nation by computer,” explains Miss Vermillion. “By interconnecting all components of the criminal justice process it will provide the capability to follow offenders as they pass through the system. A central data bank would channel information on each offender.”

*Reprinted Courtesy ELECTRONICS*



Other crime control equipment now under development or in use includes:

Tracking beacons built into cars and triggered by an unauthorized user. This is aimed at preventing car thefts.

Facsimile transmission of fingerprints, in much the same manner as news photos are transmitted by wire and radio.

Voiceprints – pictures of the spoken word received on a sound spectograph. This evidence-

gathering technique is based on the premise that a person's voice is as unique as his fingerprints.

Even the nation's space agency is getting into the crime-fighting act. NASA's Technology Transfer Team is working on a device to help catch bookmakers. "One of the most important pieces of evidence uncovered during a gambling raid could be a writing pad used to record bets from which the original page might have been destroyed. Police need a device sensitive enough to measure indentations on succeeding pages. NASA's solution

## A PLACE IN SPACE FOR COPS?

*A synchronous satellite for police communications seems a far-out solution to the problem of police spectrum congestion – except to Roger Reinke of the International Association of Chiefs of Police. "There's just no more room," says Reinke, to accommodate the spectrum requirements of such new systems as mobile teleprinters and vehicle location systems. Another IACP argument for consideration of a dedicated police satellite system is the rapidly growing requirement for data transfer among Federal, state, and local agencies.*

*Law Enforcement Assistance Administration officials acknowledge that some thought has been given to the concept, although they are at pains to point out that a police satellite system is not now under active consideration. Nevertheless, and LEAA source notes that a piggyback launch of a police-only satellite -- like the amateur radio system orbited on the last Tiros shot – could cut the estimated \$6-8 million system cost sufficiently to make a law enforcement net cost effective in a period of three to five years. (Courtesy Electronics)*

involves a special surface roughness gauge originally developed to examine certain valve fittings in the Saturn rocket.”

Despite the application of such sophisticated equipment, a basic problem of communications still exists between law enforcement officials and electronics engineers.

“Like other non-engineering customers, police sometimes have trouble defining the exact nature of their problems to industry,” observes the Washington correspondent. “They must state in

precise terms what they want to achieve.”

Some electronics firms have tried to convert military equipment towards fighting urban crime. But this doesn’t always work.

Despite the drawbacks, many electronics firms, faced with shrinking military and space budgets, are viewing law enforcement as a lucrative marketing alternative. And police officials, caught up in spiraling crime problems, are looking towards the electronics industry for some of the solutions. ✱



### *San Antonio Alumni Fete Mr. and Mrs. Tom Nolan*

Received too late to run in the previous edition of the NRI Journal was this photo taken during the recent official visit of Alumni Association Executive Secretary Tom Nolan to the San Antonio, Texas NRIAA Chapter. During the visit Mr. Nolan and his wife (far right in the photo) were entertained by chapter members with a covered-dish supper at the home of Bob Bonge, Chapter Chairman. Tom isn’t in the picture because he took it.

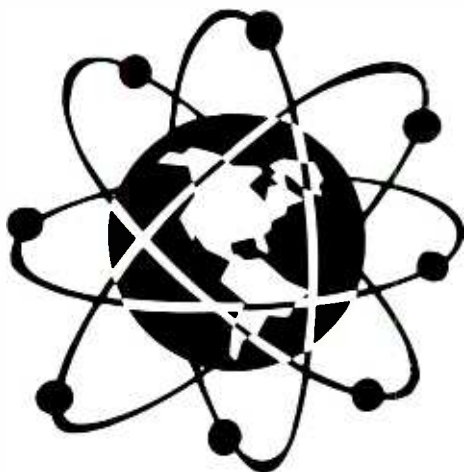

*By Ted Beach, K4MKX*

Well, this looks like the time for corrections. After Loren, WA7KLL, was listed in the last Journal and my secretary sent out the frequency allocation chart as promised, I got a note from Loren. It seems he questioned five of the Extra/Extra-Advanced domains listed as being effective November 22, 1969. You know what? He was right, by golly.

It seems that this chart (which also appears in various forms in some of our Amateur License Course lessons) was prepared based on the timetable published by the FCC. Anyway, back in November of last year the FCC decided that since the great rush to get Extra Class licenses had actually been more like a slow plodding, they would open up some of those sacred CW segments to the common people. The rules change became effective November 22, 1969, but the only way anyone would know of it was if they read the Federal Register (unlikely) or QST (quite likely). At any

rate we surely missed it in QST (which we usually read religiously) and didn't get the word until Loren wrote. Naturally, just after we got his letter we got the transmittal sheet from the Government Printing Office for Volume VI (Part 97) of the FCC Rules and Regulations, telling us of this change effective back in November!

The charts and various lessons have been corrected, and for those of you who have the bogus charts (sent out in good faith!), here are the five corrections:

<u>FREQUENCY BAND</u> (kilocycles)	<u>Effective</u> <u>Nov. 22, 1969:</u>
3525-3550	EAGC
7025-7050	EAGC
14025-14050	EAGC
21025-21050 (megacycles)	EAGC
50.10-50.25	EAGCT

Sorry about that!

While we're on the subject of corrections it seems that there should be an amendment to one of our two-letter state abbreviations made also. Nebraska is now abbreviated NE instead of NB, and NB will be used for New Brunswick, Canada. While we're at it, we may just as well give you the rest of the accepted two-letter abbreviations for US possessions and Canadian Provinces:

Canal Zone	CZ
Guam	GU
Hawaii	HI
Puerto Rico	PR
Virgin Islands	VI

(CANADA)

Alberta	AB
British Columbia	BC
Manitoba	MB
New Brunswick	NB
Newfoundland	NF
Northwest Territories	NT
Nova Scotia	NS
Ontario	ON
Prince Edward Island	PE
Quebec	PQ
Saskatchewan	SK
Yukon Territory	YT
Labrador	LB

My secretary has misplaced a recent letter from Paul, K1PNB, regarding the CW net. I *think* I can recall what was in it, however. Paul has a new job with different working hours and has heard (by mail and on the air) from very few people. What gives? Also, Paul wanted me to crank up the Ranger and "have at it".

Well, the truth of the matter is I strung out an antenna, built an antenna tuner and SWR indicator and proceeded to

blow up the Ranger the first time I hit the key. Just my luck. What happened was that we tried to get just a wee bit too much out of the ole 6146 and wiped out the power transformer.

When I got the rig (a year ago?) I decided to soup it up a little by replacing the 5R4 and 5Y3 rectifiers with silicon rectifiers. Worked fine. Less heat and power consumption (no filaments), more voltage (650 instead of 550 keydown) and more power. We also removed all audio tubes (I'm a cw man, remember?) so felt fairly confident that the power transformer could handle the extra drain when we loaded the final to 105 watts (*very* ICAS).

Everything worked just as we figured it would. 105 watts input with no sweat. The only things we hadn't reckoned with were:

- (1) someone (not us) had replaced line fuses in the plug with aluminum foil.
- (2) the filter capacitor was old and tired.
- (3) keyup voltage tends to soar with rapid keying.

These three things added up to curtains for the power transformer and filter choke the very first time we rapped out a snappy CQ at 18 WPM and the filter capacitor shorted.

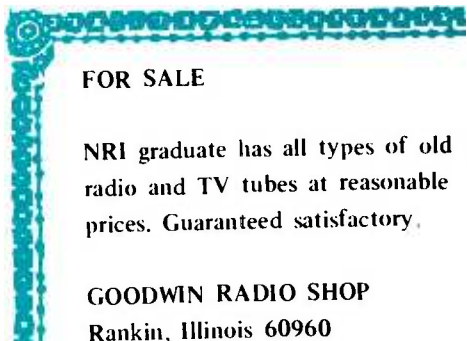

**FOR SALE**

NRI graduate has all types of old radio and TV tubes at reasonable prices. Guaranteed satisfactory.

**GOODWIN RADIO SHOP**  
Rankin, Illinois 60960

You've never seen such smoke! Now we are QRT and looking for a new power transformer and choke and some more 1KV silicon rectifiers.

replace the filter capacitor with a new one having a higher voltage rating and make sure the transformer fuses are in place!

Actually, there is nothing wrong with the modification or the "pushing" of the 6146. If any of you try this, however,

Enough of our problems. Here are our latest and newest amateurs who are taking our course for Amateur Licenses:

Bill	WN1MUZ	N	Fairfield, ME
David	WN2NLG	N	Hayts Corners, NY
Bob	WB5AJT	C*	Ozona, TX
W.E.	WN5ASJ	N	Malvern, AR
Phil	WN5BFZ	N	Dallas, TX
J.L.	WA5MBY	C	Dallas, TX
Vincent	WA6EEF	G	San Leandro, CA
Horace	WB6HSG	A	Newbury Park, CA
Forrest	WB8DCY	**	Grove City, OH
Edgar	WN8GMM	N	Galion, OH
John	WN8GOB	***N	New Carlisle, OH
Richard	WA8WMC	G	Ludington, MI
Barry	WN/AQC	N	Kansas City, MO
Larry	WN/BDP	N	Sauk Centre, MN

\* Just upgraded from Novice. Congratulations!

\*\* Did not give class of license.

\*\*\* My handwriting's so bad I'm not sure call is correct!

Congratulations to all of you. With luck, you will get your acknowledgment before the next issue of the Journal.

Vincent, WA6EEF, gives NRI the credit for his passing the General exam so easily and says he is almost ready to take the Advanced Class test. It's not too tough, Vince, we can vouch for that.

playing with the CONAR 400 and 500 rig and has worked lots of DX on 40. He even eavesdropped on a W8/VK QSO on 40 one time. How about that?

WB6HSG, Horace, got his General on November 26, 1969 and his Advanced Class December 24, 1969. No grass growing under his feet! Since Horace says his code speed is 24 WPM, it looks like two years more will net him his Extra.

Another CONAR enthusiast is Barry, WN/AQC. He too uses the 400 and 500. He has worked 17 states in two months on 40 meters and hopes to get on 15 real soon.

Richard, WA8WMC, says he enjoys

The other NRI students and graduates we have heard from are:

Godfrey	W1EXG	A	Jamestown, RI
James	WN1MSL	N	Brockton, MA
Gilbert	W3YYO	A	Philadelphia, PA
Maitland	WA4DJF	A	Pulaski, TN
Charles	WA4EXY	G	Northport, AL
Charlie	WA4SPC	G	Norfolk, VA
Earl	WA4ZIZ	C	Madison, GA
David	K8BRX	C	Traverse City, MI
Dave	WN8FDA	N	London, OH
Emil	K8PPO	C	East Tawas, MI
Oren	W8YBO	G	East Palestine, OH
Constance	K8YGC	T	Saline, MI
Mark	WA9KGV	C	Glenwood, IL
Richard	WNØAUK	N	Canistota, SD
Claire	WØJCP	G	Lincoln, NE
Harold	PJ3ADA	-	Aruba, Neth. Ant.
Jim	KP4CSV/W3	A	Levittown, PR/Meade Hts., MD

The photo is the portable station of Godfrey, W1EXG. As you may be able to see, it has a CONAR 400 and 500 rig, all in a nicely made box (formica covered!) with handle. Also included are surplus Navy cw filter, WRL antenna tuner, relay t-r switch, bug, log book, crystals, phones, paper and pencils, and wow! He also has 150' of fine wire, rolled up, which is his portable antenna. This, thrown over the nearest tree limb or out a window, puts Godfrey's rig on the air. One of his recent 40 meter QSOs was with Mickey, WN4NRI. How about that?

Godfrey also has a Yaseu FTdx 400 transceiver and FL2000 linear for a cool kilowatt on all hf bands, 80 through 10, and a Lafayette HA-460 for 6. Very nice, OM, and if any of you guys or gals has interesting photos of your shack (preferably with you in the cockpit) we will sure try to print them in the column. Be sure the photo you send is one you can spare as we will *not* return it.

Gilbert, W3YYO, is a Math Course student and says he wants to get a real good math background before going on for his Commercial FCC licenses. We can assure you, Gil, that this is an *excellent*

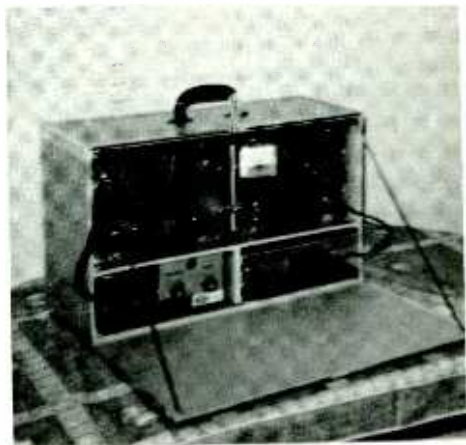

**For Godfrey, W1EXG, his souped-up CONAR rig is on the air as soon as he throws its fine-wire antenna out the window or over a tree limb.**

idea. Electronics *is* mathematics when you come down to the basics, so we think you are quite wise in your selection of studies. Good luck.

Maitland, WA4DJF, also sent us a photocopy of his Advanced Class License. Maybe if we get enough of these we can go into business.

Dave, K8BRX, writes that he is a QRP man, using a D&B - QRP84 and an HRO receiver. Indeed, Dave works for D&B Electronics, the makers of the QRP84. How about sending us some information on this, Dave? I'm sure our readers would like to know more about the company and their products, as would we.

WN8FDA, Dave, is our second second-time Novice. He was also KN8UUP in 1959. Dave has written Paul about the 40 meter net and hopes to get in on the fun. He uses a CONAR 400 on 40 and 15 along with a NC - 101A receiver.

A nice note from Technician Constance, K8YGC, let us know she liked what we had to say about the CB'ers. She is also a CB'er and does not like the ham operations on 11 meters (do *you* remember when we had 11?). Thanks, Connie, and that sure is a good-looking Collie on your notepaper!

WNØAUK writes that he is available on 80 at 3.72 MHz most every night for anyone who would like a South Dakota QSO and QSL. Richard uses the 7CC transmitter from the NRI Communications Course and an EICO 753 for receiving. When he gets his General Class license in June, he will probably discard the 7CC rig and transceive with the EICO.

Can't say we blame him.

A note from Larry, WB9ADJ, lets us know he is aghast that we said that WA9PJD was the club station at Purdue U. Actually, Larry is at the Fort Wayne regional campus of Purdue and *is* solo operator of WA9PJD. W9YD is the club station at Purdue (Lafayette) and they have *lots* of active operators. Anyway, now we know who is where, doing what. Or do we?

Graduate Kent Jackson, WA7IMT, informs us he now has his Advanced Class license. Nice going, Kent.

Jerome, WA9MNB, has upgraded from Technician to Advanced class - a real big jump. I'll bet that 13 WPM really looked tough after the 5 WPM of Tech. Congratulations, Jerome.

Carol, now WA1LGU, got her General Class license just recently, and hopes to go for Advanced by the end of the summer. As if the family and rag chewing weren't enough, Carol has just joined the ranks of us editors as top man of the Valley Amateur Radio Club newsletter, "Oscillator". We're sure you will do a good job, Carol, and best of luck on the Advanced exam.

As a final note, VE3BZP writes to thank NRI for all he has learned in electronics. Bill feels that his recent acquisition of an advanced ticket is due to his NRI course.

So that makes it QRU for now - see you in a couple of months. Have a *nice* summer, fellows!

VY 73

Ted Beach - K4MKX



...HELP WANTED...

...HELP WANTED...

...HELP WANTED...

**SERVICE KINGS, INC.**  
needs  
**RADIO-TV SERVICING TECHNICIANS**

Contact: J.C. Pumphrey  
Service Kings, Inc.  
4210 Howard Ave.  
Kensington, Md.  
301-942-3600

POSITIONS AVAILABLE DEALING WITH HEAVY  
DUTY INDUSTRIAL EQUIPMENT, 2-WAY RADIOS,  
CLOSED CIRCUIT TV AND PAGING SYSTEMS.  
REQUIRES AT LEAST 2ND CLASS FCC LICENSE.

CONTACT: MR. GLENN WHITE  
DISTRICT SERVICE MANAGER  
19-A BRADSTON STREET  
BOSTON, MA 02118  
617-445-4545

WANTED .....

*Experienced or well-trained two-way radio technicians. Ideal positions open for responsible men. FCC second class license required.*

CONTACT .....

*Manager, Communications Department  
Lafayette Radio Electronics  
2025 Arden Way  
Sacramento, Calif. 95825*

**SEARS**

has many career opportunities  
for experienced TV technicians  
or recent graduates of electronics  
schools. Top benefits,  
locations throughout the U.S.

CONTACT:

The Service Manager  
of your nearest  
**SEARS SERVICE CENTER**  
or the  
Personnel Manager  
of your nearest  
**SEARS** retail store.

**MONTGOMERY WARD**

has openings for  
TV technicians or grads  
of electronics schools.  
Openings available in Wash.,  
Md., and Va. areas.

CALL OR WRITE:

Pat F. Cosentini  
Service Manager  
7100 Old Landover Rd.  
Landover, Md. 20785  
301-322-3344

!!!!!!!!!!!!WANTED!!!!!!!!!!!!Field Service Technicians!!!!!!!!!!!!

Positions now available in the Graphic Communications Field. Technicians  
needed to install and maintain such equipment as Electronic handwriters  
and Facsimile units. Top starting salary and excellent benefits.

Contact: Telautograph Corp., 1921 North Harlem Ave., Suite 108, Chicago, IL 60636  
(312-622-7111)



UNIVERSITY POSITION OPEN FOR MAINTENANCE ENGINEER ON  
CC – ITV FACILITY. ALL NEW EQUIPMENT, QUALITY BROAD-  
CAST GEAR INCLUDING 10 CAMERAS AND THREE QUAD VTR's;  
EXTENSIVE CAMPUS-WIDE RF, VIDEO DISTRIBUTION SYSTEM IN  
THE WORKS.

LOCATED 1-1/2 HOURS NORTH NYC IN THE CATSKILLS.

PAID RETIREMENT PLAN, 20 DAYS VACATION, MANY OTHER  
FRINGE BENEFITS. QUITE GOOD STARTING SALARY.

WRITE OR PHONE  
KENNETH B. KNECHT  
SUPERVISOR, TELEVISION ENGINEERING  
STATE UNIVERSITY COLLEGE  
NEW PALTZ, NEW YORK 12561

TELEPHONE 914-257-2523

**WANT TO MAKE UP FOR LOST TIME?**

*RCA has training programs for the inexperienced in basic TV service as well  
as for the experienced technician in the latest solid-state circuitry. If you've  
got some catching up to do, write:*

**T. G. MacNamara, Employment Manager  
RCA Service Company, Cherry Hill, N.J. 08034**

**HELP WANTED: ZENITH DISTRIBUTOR IN ARIZONA HAS OPENINGS  
THROUGHOUT THE STATE FOR TELEVISION BENCH MEN, OUTSIDE  
MEN, AND TRAINEES WITH OUR DEALER ORGANIZATION.**

**If interested, please contact:  
MR. R. J. ENGARD  
P.O. BOX 10704  
PHOENIX, ARIZONA 85036**

# NRI HONORS PROGRAM AWARDS

*For outstanding grades throughout their NRI course of study, the following March and April graduates received Certificates of Distinction with their Electronics Diplomas.*

## WITH HIGHEST HONORS

Peter Barnosky, Beaver, Pa.  
Surrie L. Battle, Long Branch, N. J.  
Duane J. Blakstad, Cocoa, Fla.  
Thomas Ferguson, Annandale, Va.  
Hal C. Lakin, Novato, Calif.  
Robert W. Rucker, Atlanta, Ga.  
Matthew G. Van Broklyn, Kingston, N. Y.  
Frank D. Wolff, Topsham, Maine

## WITH HIGH HONORS

Loren R. Armstrong, Palmer, Arkansas  
Joseph Bisauta, Concord, Calif.  
H. E. Cameron, Rosenberg, Texas  
Craig R. Clark, Erie, Pa.  
Juan B. Cotto, Trujillo Alto, Puerto Rico  
Larry Clinton Cox, Boothwyn, Pa.  
Roger G. Dickey, Sunny Valley, Oregon  
Edward C. Doherty, Independence, Kansas  
James L. Dunlap, Dillsburg, Pa.  
Leo N. Dunston, Moncton, N.B., Canada  
William W. Fleet, Leesburg, Va.  
James M. Gammon, Alexandria, Va.  
Lorraine Gowrylish, Parsippany, N.J.  
John P. Hamel, FPO San Francisco  
J. Handley, Miles City, Montana  
Earl R. Heaton, Hurst, Texas  
John Hendry, Kitchener, Ont., Canada  
William J. Hilt, Janesville, Wisconsin  
John B. Hubeny, Windsor Locks, Conn.  
Ralph C. Johnson, Hattiesburg, Miss.  
Thomas W. Josten, Yonkers, N. Y.  
Stan Katcher, Lakewood, Ohio  
Edward L. Keaton, Lynchburg, Va.  
Bruce V. Kerrick, FPO San Francisco  
Dewey F. King, Athens, Ohio  
Andrew S. Lampp, Waukegan, Illinois  
Duane M. Lietha, Marquette, Mich.  
James E. Lindquist, Indianapolis, Indiana  
Lee Mabry, Palmdale, Calif.  
Wayne McCall, Marion, N. C.  
Robert McKinney, Helena, Ohio  
H. David Molony, Deer Park, Wash.  
Theodore Obrebski, Bronx, N. Y.  
Michael E. Opauski, Forestville, Md.

Roy T. Robinson, Conyers, Ga.  
Robert W. Rose, Arvada, Colorado  
Rev. Michael J. Ruck, Bethpage, N. Y.  
James E. Sampson, FPO San Francisco  
Robert E. Schweikert, Akron, Ohio  
James A. Sears, Columbus, Indiana  
Alfred W. Selloy, El Paso, Texas  
William R. Shomber, Kansas City, Kansas  
Richard E. Slaughter, Cincinnati, Ohio  
Clair M. Smith, North Apollo, Pa.  
Ivor Tang, Mackenzie Demerara River, Guyana, S.A.  
Reynold Tanguay, Cap De La Madeleine, Quebec  
William C. Thomason, Daleville, Alabama  
Elwood S. Thompson, Blytheville, Arkansas  
Jimmie C. Walker, Hartselle, Alabama  
Donald L. Wier, Lititz, Pa.  
Richard W. Wiley, Triangle, Va.  
John Woodberry, Buffalo, N. Y.  
Conn M. Woods, Guelph, Ont., Canada  
Carl J. Wright, Colorado Springs, Colorado

## WITH HONORS

Federico M. Ablog, Jr., New London, Conn.  
Robert J. Adams, FPO San Francisco  
Ed Austin, Menlo Park, Calif.  
Thomas J. Barbish, Jr., Joppa, Md.  
Bobby J. Barnes, Orlando, Fla.  
Robert J. Beaver, Eugene, Oregon  
Andrew D. Bell, Charlottesville, Va.  
Bill D. Berglund, Offutt AFB, Nebraska  
John C. Blount, Georgetown, S. C.  
Nelson S. Bolling, Dayton, Ohio  
Jean Claude Borno, New York, N. Y.  
Eugene J. Bradley, San Antonio, Texas  
Jacque E. Braun, Bethel Park, Pa.  
Jerry D. Brown, Nashville, Tenn.  
Robert Dean Bucklew, Ft. Walton Beach, Fla.  
Charles H. Bunting, Pottstown, Pa.  
Roy L. Byers, Florissant, Mo.  
Anton Callery, Finleyville, Pa.  
Paul Canale, Otis AFB, Mass.  
David C. Cantwell, Jr., Owensboro, Ky.  
Danny J. Carlson, Cleveland, Ohio  
James B. Chandler, Big Spring, Texas  
Richard C. Chang, Vancouver, B.C., Canada  
Charles S. Clark, Paris, Tenn.

Richard A. Colapinto, Manassas, Va.  
 Gordon Colwell, Minto, N.B., Canada  
 Thomas H. Combs, Sr., Headrick, Oklahoma  
 Manuel G. Coronado, San Jose, Calif.  
 Robert A. Cotton, Alexandria, Va.  
 James A. Cox, Yazoo City, Miss.  
 Joe L. Cummings, Tulsa, Oklahoma  
 George Cunningham, Tumwater, Wash.  
 Ronald W. Dana, Detroit, Mich.  
 Carlos H. Daugherty, Jessups, Md.  
 L. M. Davis, Jr., Newton, Kansas  
 Jimmy C. Duty, Tekonsha, Mich.  
 Curtis L. Eggleston, Milwaukee, Wis.  
 John H. Ferrell, Chesapeake, Va.  
 Gordon W. Fischer, Ft. Thomas, Ky.  
 George D. Fowle, Cape May, N.J.  
 Stanley M. Finney, Lowther, Ont., Canada  
 Phillip J. Frey, Highland, Ill.  
 Donald A. Galio, Clearfield, Pa.  
 William B. Geoghegan, Woodbridge, Va.  
 Beat A. Gimmel, Bachtelweg, Switzerland  
 Buenaventura G. Gonzalo, San Francisco, Calif.  
 Clarence J. Gordon, San Jose, Calif.  
 Ralph L. Graham, Newark, Delaware  
 Willie L. Haggins, Cleveland, Ohio

Walter M. Haley, Jr., North Andover, Mass.  
 Wayne E. Hall, Lamar, Colorado  
 George F. Hays, APO New York  
 Francis E. Helm, Modesto, Calif.  
 Ralph D. Hiatt, Alexandria, Indiana  
 Billy Hill, Eupora, Miss.  
 H. W. Hillman, Anniston, Alabama  
 David W. Holley, Tempe, Arizona  
 James A. Howes, Kincheloe AFB, Michigan  
 Ralph J. Hunt, West Sand Lake, N.Y.  
 Richard P. Joseph, Warren, Michigan  
 Paul M. Kauffman, Washington, D.C.  
 John Kavanagh, Philadelphia, Pa.  
 Frank Kingsley, Sawyerville, P.Q., Canada  
 Tim Klaus, Edwards, Ill.  
 Donald Kolacz, Buffalo, N. Y.  
 G. K. Landes, Missoula, Montana  
 Wiley J. Landry, Lafayette, La.  
 Kwi-Ung Lee, FPO San Francisco  
 Patrick Letendre, Danbury, Conn.  
 Michael J. Lloyd, Forrestville, Md.  
 John C. MacKenzie, Ellsworth AFB, S.D.  
 Edward B. Marak, Panama, Ill.  
 Jimmy Parker McKinney, Winchester, Tenn.  
 William J. McMahon, Keansburg, N.J.

# CONAR ORDER BLANK

J13

DIVISION OF NATIONAL RADIO INSTITUTE, 3939 WISCONSIN AVE., WASHINGTON, D.C. 20016

PLEASE PRINT

NAME

ADDRESS

CITY

STATE

ZIP

NRI STUDENT NUMBER

- CASH  
 C.O.D. (20% Deposit required)  
 ADD TO MY CONAR ACCOUNT  
 NEW EASY PAYMENT PLAN (10% Deposit)

Quantity	Model	Name of Item	Price Each	Total

If you live in Washington, D.C., add sales tax.  
 All prices are net, F.O.B. Washington, D.C.

TOTAL \_\_\_\_\_

## ON NEW TIME PAYMENT ORDERS

please be sure to complete the Easy Payment Plan credit information form on the reverse side of this page and include 10% deposit with your order. ▶

Fred R. Messer, Moretown, Vermont  
 George Miller, Old Bridge, N.J.  
 George Milligan, Slidell, La.  
 Avery W. Morris, Brunswick, Maine  
 George W. Moser, Papillion, Nebraska  
 Paul E. Myers, Clearbrook, Va.  
 Eduardo S. Najjar, Silver Spring, Md.  
 Alex Nano, E. Boston, Mass.  
 Pascal W. Newton, Saltville, Va.  
 Camber M. Oderkirk, Edmundston, N.B., Canada  
 William E. Odom, Jr., Asheville, N.C.  
 Arthur L. Oliver, Jr., Yonkers, N. Y.  
 Clarence P. Ottosen, Denver, Colorado  
 Leonard E. Paulson, International Falls, Minn.  
 Bob L. Pierce, Jefferson City, Mo.  
 Paul Perrello, Buffalo, N.Y.  
 William E. Peters, Statesboro, Ga.  
 Richard Quappe, Patchogue, N.Y.  
 G. Raymon Ralph, Los Angeles, Calif.  
 Ronald S. Range, Kingsport, Tenn.  
 Clyde W. Rhodes, Las Vegas, Nevada  
 Denis A. Roy, Nashua, New Hampshire  
 Richard S. Rutherford, Green Springs, Ohio  
 Joseph A. Sbaraglia, Jr., Philadelphia, Pa.  
 D. E. Scheitzach, LaCrosse, Wisconsin

Sheldon L. Schmidt, San Diego, Calif.  
 Timothy B. Schnapp, Toledo, Ohio  
 Julius J. Schrader, Columbia, Mo.  
 George M. Servesko, Sheffield, Pa.  
 James D. Shaw, Fort Riley, Kansas  
 Anthony Siciliano, Newark, N.J.  
 Carl A. Smith, Framingham, Mass.  
 Robert S. Smith, Toledo, Ohio  
 R. L. Sullivan, Stockton, Calif.  
 O. V. Thomas, Garland, Texas  
 John J. Toohey III, Cornwells Heights, Pa.  
 Antonio Torres, Port Monmouth, N.J.  
 Palmer A. Trommler, Sumner, Wash.  
 Truman J. Twidwell, Stockton, Calif.  
 James D. Vanderport, Superior, Wisconsin  
 Adolph Velatini, Kankakee, Ill.  
 Willis H. Walker, Virginia Beach, Va.  
 William D. Warner, Stamford, Conn.  
 Raymond B. Wilburn, Brownsville, Texas  
 Ralph Winkle, Cincinnati, Ohio  
 Charles F. Wirth, Brentwood, N.Y.  
 William F. Witman, Austell, Ga.  
 Ronnie Wolfenbarger, Thorn Hill, Tenn.  
 Fitzhugh M. Woody, Scottsville, Va.  
 Tom Wright, Fairfield, Calif.

## CONAR EASY PAYMENT PLAN

J13

### CREDIT APPLICATION

Note: Easy payment plan credit applications cannot be accepted from persons under 21 years of age. If you are under 21, have this form filled in by a person of legal age and regularly employed.

Enclosed is a deposit of \$..... on the merchandise I have listed on the reverse side. I hereby apply for credit under the Conar Easy Payment Plan. The statements below are true and are made for the purpose of receiving credit.

Date ..... Written Signature .....

#### CREDIT APPLICATION

Print Full Name ..... Age .....

Home Address .....

City & State ..... How long at this address? .....

Previous Address .....

City & State ..... How long at this address? .....

Present Employer ..... Position ..... Monthly Income .....

Business Address ..... How Long Employed? .....

If in business for self, what business? ..... How Long? .....

Bank Account with ..... Savings  Checking

CREDIT REFERENCE (Give 2 Merchants, Firms or Finance Companies with whom you have or have had accounts.)

Credit Acct. with ..... Highest Credit .....

(Name)

(Address)

Credit Acct. with ..... Highest Credit .....

(Name)

(Address)



## Alumni News

Sam Stinebaugh	.....	President
Br. Bernard Frey	.....	Vice-Pres.
William Sames	.....	Vice-Pres.
Graham Boyd	.....	Vice-Pres.
Samuel Antman	.....	Vice-Pres.
T. F. Nolan, Jr.	.....	Exec. Sec.

### **DETROIT CHAPTER USES CONAR TV FOR DEMONSTRATIONS ON COLOR**

*Dave Harding* brought in his CONAR Color TV set and *Raymond Berus* brought in his B & K Sweep/Marker Generator at the last meeting of the Detroit Chapter. The two gentlemen demonstrated how the color TV could be properly set up using the B & K generator.

Attendance at the meeting was very good, and should remain so with the promise of more color TV and solid-state servicing information to be presented at future meetings.

### **FLINT (SAGINAW VALLEY) CHAPTER ACQUIRES A REFERENCE LIBRARY**

Flint (Saginaw Valley) Chapter now has a service reference file of manufacturers'

addresses so that members may write for TV and radio parts. Also, *Steve Avetta* has subscribed to the new TV Tech Aid which furnishes information on all 1969 and 1970 color TV sets. This will allow chapter members to get the latest information each month at their meetings. (Member *Robert Poli* suggested that the new service tips should be made available to the NRI Journal.)

*Gilbert Hams* gave a talk at the chapter's standing-room only meeting on the installation of a high-voltage transformer. An important point to remember, he said, is to use silicone grease between the chassis and the transformer. The grease helps to transfer the heat from the high-voltage transformer frame to the chassis.

Special service tips were given by *Andy Jobbagy* concerning the cleaning of volume controls.

## TV TROUBLES AND TRANSISTORS TOPICS FOR NEW YORK CHAPTER

*William Foggie* demonstrated how to check distortion of vertical sweep, using his analyzer and the chapter's scope, at the March meeting of the New York City Chapter. *Lionel Williams*, using schematic diagrams, showed how to trace trouble in an Admiral portable TV.

The chapter *almost* had a Merchant Marine guest, *Mohammed Sieden*, at the March meeting. He had dinner with Chairman *Sam Antman* that evening, but was called back to his ship before the meeting.

In April *Lionel Williams* talked on transistors, a subject highly popular with the members. For his lecture, he used a meter and a scope to test the circuits he had

made up on breadboards. He also showed a square wave on the scope. The square wave signal came from a generator he had made as part of his NRI Color TV course.

## NORTH JERSEY CHAPTER LEARNS ABOUT TRIGGERED-SWEEP SCOPE

A very impressive demonstration and lecture on the triggered-sweep scope was given to the North Jersey Chapter by guest speaker *Alex Reid*, electronics technician with IT&T. He used the scope on a real tough-dog, reworked TV set which had no picture, raster, or sound. He replaced a tube, capacitor and resistor in the horizontal section, and adjusted the magnetic deflection of the set, and everything was like new again.

*William Mincey* of Jersey City, an NRI student, was a visitor at the March meeting.



A full house attended the April meeting of the North Jersey Chapter held at the Players Club in Kearney, N. J.

Executive Secretary *Tom Nolan* was guest speaker at the April meeting, held at the Players Club in Kearney, N.J. His program covered comparison of tube and solid-state color TV, including alignment procedures.

Tom demonstrated a special unit he built for alignment of color receivers. The unit includes a tuner, picture i-f, sound, and color bandpass sections. Waveforms generated by the sweep and marker generators fed into the mockup were shown on the scope. After the demonstration, the audience was invited up to the speaker's table to try their hands at making the adjustments and obtaining the various waveforms.

Tom also used a slide projector and tape unit to demonstrate the initial adjustments and replacement of color picture

tubes. It was a full house with 38 attending. Door prizes were won by *Mathew Rechner* of Hackensack and *Wesley Landstrom* of Paterson.

#### **PITTSBURGH GAINS NEW MEMBER, HEARS TWO TALKS ON COLOR TV**

*Carl Palm* of Jeannette, Pa., joined the Pittsburgh Chapter at the April meeting. (He also won the door prize!) Two speakers, *Jack Benoit* of Benoit's TV Service and *James Wheeler* of Wheeler's TV, spoke on color alignment and color test jigs respectively. Both did such a good job that they were asked to repeat the talks a little later on in the year.

At the May meeting, Executive Secretary Tom Nolan demonstrated his color TV mockup for teaching alignment of color receivers. The lecture was well received and the good turnout gratifying.



**Pittsburgh Chapter members also turned out in full force in May to see a demonstration of color TV alignment.**

The chapter has scheduled a talk in August sponsored by the Admiral Corp. and a seminar in the fall conducted by the Zenith Corp., and is looking forward to a good year.

### **SAN ANTONIO CHAPTER INCREASES MEMBERSHIP**

The April meeting of the San Antonio Chapter saw three new members admitted, *Arturo Martinez*, *Frank M. Lopez*, and *William Albach*.

An outstanding program on television tuner operation and repair was given by *Jose Camarillo*, owner and operator of Alamo Tuner Service. He simplified every question and its answer in the discussion which followed in such a way that it was readily understandable.



National Chairman *Sam Stinebaugh*, who is also Secretary of the San Antonio Chapter, is flanked in this photo by *Bob Bonge*, left, Chapter Chairman, and *Sam Dentler*, Treasurer.

The chapter is looking forward to his next visit, and to the possibility that he may become a member.

*Lt. Col. E. B. Geisendorff*, Vice-Chairman, brought in two delicious cakes baked by his wife for the refreshment period.

Planned for the May meeting, but unreported as yet, was a talk by *George Hartley*, who is the Philco Company's area technical adviser.

*Sam Stinebaugh*, Secretary/National Chairman announced a current membership of 35. Good going there.

### **SAN FRANCISCO CHAPTER HEARS RADIO OFFICER BYRON**

Merchant Marine Radio Officer *Arthur Byron* was speaker at the April meeting of the San Francisco Chapter. He used an rf oscillator, oscilloscope, microphone, loudspeaker, and audio amplifier to explain his interesting points on some NRI course experiments.

Mr. Byron demonstrated how a scope can be used for testing TV sweep circuit components. He also showed other uses of the scope as a servicing tool to cut down on repair time. At the next meeting, *Ross Alexander* gave servicing tips based on a similar background.



**NEED HELP? NEED A JOB?**

Use the free Job Ops columns in each issue of the NRI Journal



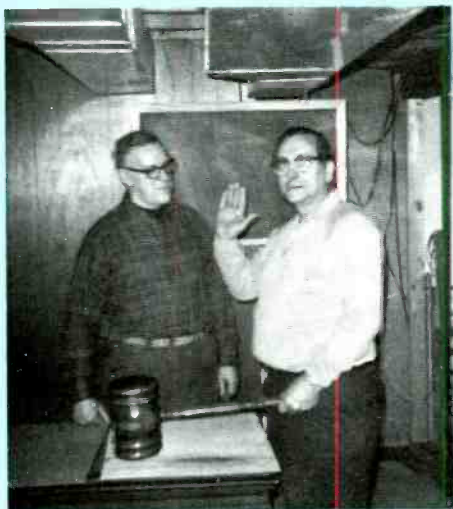

Brother Bernard Frey, left, and Chairman Al Dorman at the Springfield (Mass.) Chapter meeting.

### SPRINGFIELD (MASS.) CHAPTER HAS COLOR DEMONSTRATION

The Zenith Color TV owned by the Springfield chapter is used in many programs to demonstrate troubleshooting procedures and methods of adjustment. The chapter has formed a committee to check the possibility of securing the services of a Zenith factory engineer to aid in its training program.

At the April meeting, Chairman *Al Dorman* used a B & K Analyst to demonstrate problems in the high-voltage section of the color receiver. He stressed the necessity of measuring the current in the high voltage transformer circuit, especially when installing a new transformer or changing the horizontal output tube.

*John Parks* described his problem of picture pulling, and members traced the problem to the picture tube itself rather than the chassis. Another picture tube problem was demonstrated on an Admiral portable which had a black bar three inches wide moving from top to bottom, apparently caused by heater-to-cathode leakage in the gun of the picture tube.

While working on the Zenith receiver during the May meeting, it was discovered that the red gun filament would no longer light up. After a little gentle tapping on the neck of the picture tube, it began to glow, and members were happy because purity and convergence adjustments could then be completed. Now, however, the chapter will have to start saving for a new picture tube!

Newly admitted members of the chapter are *Ronald Murdock*, *Carl Dionisi* and *Federico Ablog*. ✖

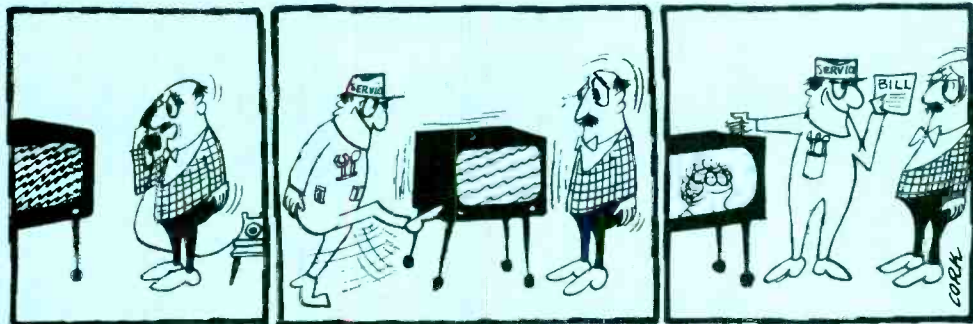

# DIRECTORY OF CHAPTERS

**CHAMBERSBURG (CUMBERLAND VALLEY) CHAPTER** meets 8 p.m. 2nd Tuesday of each month at Bob Erford's Radio-TV Service Shop, Chambersburg, Pa. Chairman: Gerald Strite, RR1, Chambersburg, Pa.

**DETROIT CHAPTER** meets 8 p.m., 2nd Friday of each month at St. Andrews Hall, 431 E. Congress St., Detroit. Chairman: James Kelley, 1140 Livernois, Detroit, Mich. VI 1-4972.

**FLINT (SAGINAW VALLEY) CHAPTER** meets 7:30 p.m., 2nd Wednesday of each month at Andrew Jobbagy's shop, G-5507 S. Saginaw Rd., Flint, Mich. Chairman: Andrew Jobbagy, 694-6773.

**LOS ANGELES CHAPTER** meets 8 p.m., third Friday of each month at Graham D. Boyd's TV Shop, 1223 N. Vermont Ave., Los Angeles, Calif., NO-2-3759.

**NEW ORLEANS CHAPTER** meets 8 p.m., 2nd Tuesday of each month at Galjour's TV, 809 N. Broad St., New Orleans, La. Chairman: Herman Blackford, 5301 Tchoupitoulas St., New Orleans, La.

**NEW YORK CITY CHAPTER** meets 8:30 p.m. 1st and 3rd Thursday of each month at 264 E. 10th St., New York City. Chairman: Samuel Antman, 1669 45th St., Brooklyn, N.Y.

**NORTH JERSEY CHAPTER** meets 8 p.m., last Friday of each month at Midland Hardware, 155 Midland Ave., Kearney, N.J. Chairman: William Colton, 191 Prospect Ave., North Arlington, N.J.

**PITTSBURGH CHAPTER** meets 8 p.m., 1st Thursday of each month in the basement of the U.P. Church of Verona, Pa., corner of South Ave. & 2nd St. Chairman: Tom Schnader, RFD 3, Irwin, Pa.

**SAN ANTONIO (ALAMO) CHAPTER** meets 7 p.m., 4th Friday of each month at Alamo Heights Christian Church Scout House, 350 Primrose St., 6500 block of N. New Braunfels St. (3 blocks north of Austin Hwy.), San Antonio. Chairman: R. E. Bonge, 222 Amador Lane, San Antonio, Texas.

**SAN FRANCISCO CHAPTER** meets 8 p.m., 2nd Wednesday of each month at the home of J. Arthur Ragsdale, 1526 27th Ave., San Francisco. Chairman: Isaiah Randolph, 60 Santa Fe Ave., San Francisco, Calif.

**SOUTHEASTERN MASSACHUSETTS CHAPTER** meets 8 p.m., last Wednesday of each month at the home of John Alves, 57 Allen Blvd., Swansea, Mass. Chairman: Oliva J. Laprise, 55 Tecumseh St., Fall River, Mass.

**SPRINGFIELD (MASS.) CHAPTER** meets 7 p.m., 2nd Saturday of each month at the shop of Norman Charest, 74 Redfern Dr., Springfield. Chairman: Al Dorman, 6 Forest Lane, Simsbury, Conn. 06070.

**PHILADELPHIA-CAMDEN CHAPTER** meets 8 p.m., 4th Monday of each month at K of C Hall, Tulip and Tyson Sts., Philadelphia. Chairman: Herbert Emrich, 2826 Garden Lane, Cornwell Heights, Pa.

# IF YOU OWN A . . . . CONAR 600

## COLOR TV RECEIVER

NOW YOU CAN USE IT AS A

## COLOR TV TEST JIG

WITH THE NEW CONAR  
WIRING HARNESS ADAPTOR KIT



- SAVE TIME, EFFORT, MONEY.
- LEAVE THE TV CABINET IN THE CUSTOMER'S HOME; TAKE ONLY THE CHASSIS TO THE SHOP.
- NO NEED TO READJUST CONVERGENCE AND PURITY CONTROLS ON THE SET AFTER YOU REPAIR THE CHASSIS.

Many professional color TV servicemen invest \$150 to \$200 for a color TV test jig. They consider it a wise investment because the test jig quickly saves them enough time, effort, and money to pay for itself.

**Now, for a fraction of the cost of a commercially available color TV test jig, you can adapt your Conar model 600 color TV receiver for use as a test jig! The new Conar Wiring Harness Adaptor Kit makes it possible.**

Think of what this can mean to you. No more furniture moving. Leave the customer's TV cabinet in his home and take ONLY the chassis to your shop. And since the cabinet hasn't been moved, you don't have to readjust the convergence and purity controls for the picture tube. This could save as much as half of the time you would otherwise spend working on the customer's set.

The Adaptor Kit is easy to use. Simply connect the three extension cables between the customer's chassis and your Conar 600, and insert the convergence plug into the chassis. Your Conar 600 is now a color TV test jig which will show on its screen the pictures produced by the customer's chassis. You will be able to see how your work on the chassis affects the picture.

The Adaptor Kit connections will not affect the convergence or purity adjustments on the Conar

600 either, so whenever you choose, simply disconnect the wiring harness and use your receiver to watch your favorite TV programs.

The Adaptor Kit includes a yoke adaptor which allows you to service more than 280 different chassis. Additional yoke adaptors will permit you to service many additional chassis. These adaptors are available from Conar for \$4.95 each plus \$1.50 for a matching convergence plug, if needed. A list of all these adaptors and the chassis they fit is supplied with each Adaptor Kit.

Using your Conar 600 as a test jig will make your color TV servicing easier and faster. In servicing, when you save time you save money. Start saving money now. Order your Conar color TV test jig Adaptor Kit today.

CONAR WIRING HARNESS

## ADAPTOR KIT

STOCK #600AD

# \$29.95

ADD \$1.00 FOR POSTAGE & HANDLING

USE CONVENIENT ORDER BLANK ON PAGE 25



## 6V-12V battery eliminator

Best selling battery eliminator on the market today. Specially designed for operating auto radios—either 6 or 12 volts—transistor or vibrator type.

The ATR Model 610 delivers 6 volts at 10 amps or 12 volts at 6 amps. Has separate meters for volts-amps, eight position voltage control, 6-12 volt switch with safety lock and toggle on-off switch. Full-wave dry disc rectifier gives noiseless, interference free operation.

Housed in steel cabinet, gray hammertone finish. Rubber feet protect bench. Size: 6½" x 9⅛" x 8½". 110-120 volts, 50-60 cycle AC.

FULLY ASSEMBLED  
READY TO USE

**\$55<sup>00</sup>**

Stock #610WT  
22 lbs. express collect

**USE CONVENIENT ORDER BLANK ON PAGE 25**

MR WALTER MEISNER  
BOX 65  
ARIEL WA 98603

C54-AB27-C

NRI JOURNAL  
3939 Wisconsin Avenue  
Washington, D. C. 20016

Second-Class  
Postage Paid  
at Washington, D.C.