

---

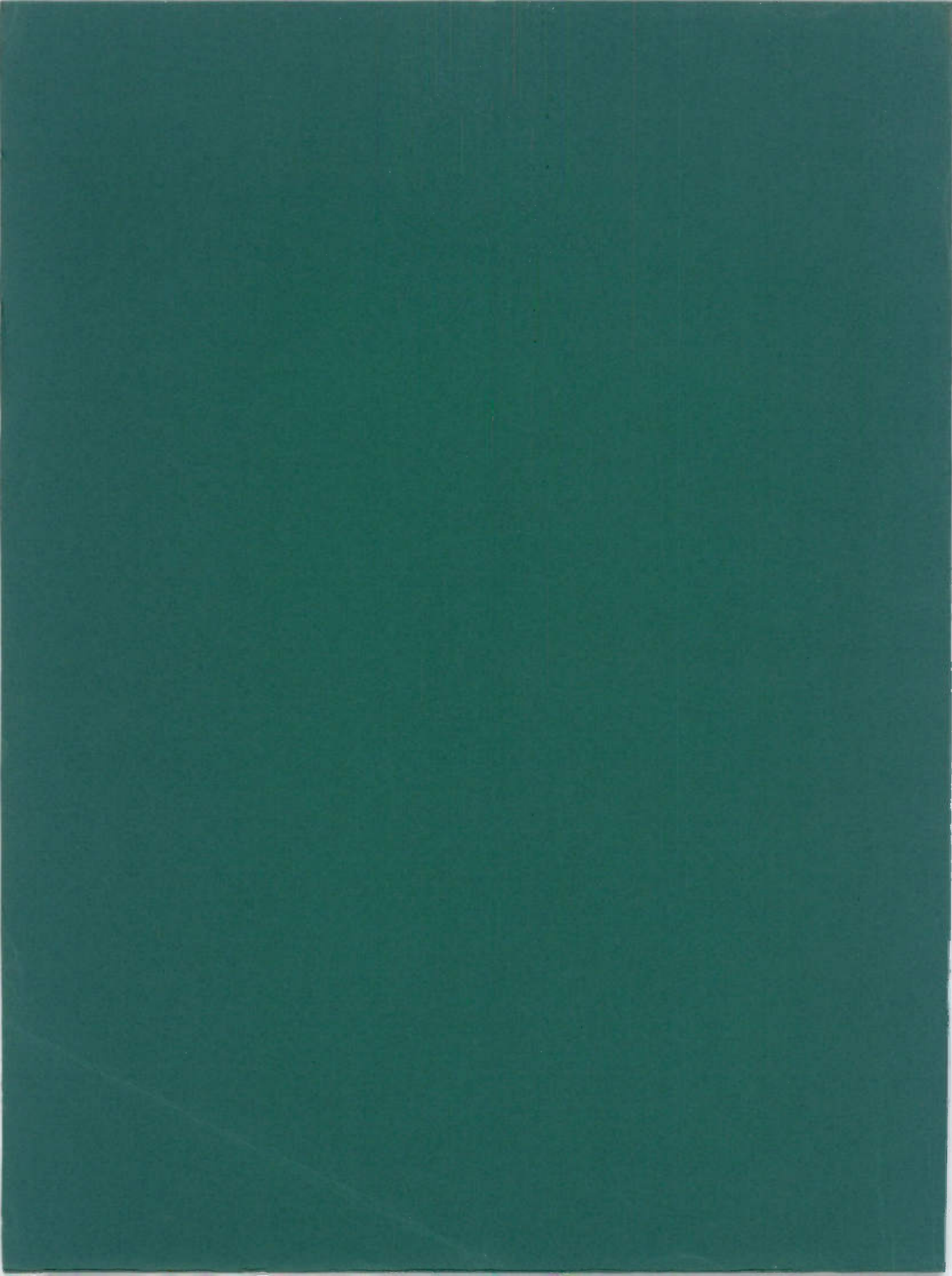
# PROCEEDINGS

39TH ANNUAL BROADCAST  
ENGINEERING CONFERENCE

---



NATIONAL ASSOCIATION OF BROADCASTERS  
LAS VEGAS, NEVADA  
1985





---

# PROCEEDINGS

39TH ANNUAL BROADCAST  
ENGINEERING CONFERENCE

---



NATIONAL ASSOCIATION OF BROADCASTERS  
LAS VEGAS, NEVADA  
1985



These proceedings contain technical papers presented at the NAB Engineering Conference April 13-17, 1985, in Las Vegas, Nevada.

Published by the NAB Office of Science and Technology

©Copyright, 1985, National Association of Broadcasters

ISBN 0-89324-004-4

Reproduction or publication of the content, in whole or in part, without expressed permission is prohibited. No liability is assumed with respect to the use of the information contained herein.

References to the papers contained in the 1985 *Proceedings* may be made without specific permission but attributed to the 39th Annual NAB Broadcast Engineering Conference.

Additional copies of the 1985 *Proceedings* are available through NAB Services, 1771 N Street, N.W., Washington, D.C. 20036. For price information, please call (800) 368-5644.



1771 N STREET, N.W.  
WASHINGTON, D.C. 20036

NATIONAL ASSOCIATION OF BROADCASTERS

THOMAS B. KELLER  
SENIOR VICE PRESIDENT  
SCIENCE AND TECHNOLOGY

Dear Reader:

These Proceedings contain many of the papers presented at the 39th Annual Broadcast Engineering Conference held in conjunction with the NAB Convention in Las Vegas, Nevada, April 13-17, 1985.

The Proceedings contain papers on important technical issues of concern to all broadcasters (broadcast auxiliary, non-ionizing radiation, maintenance), timely new papers on recent technical developments (high definition television, AM technical improvements) and further developments in existing broadcast technology (multichannel television sound, radio subcarriers, satellite systems). Special emphasis was placed this year on broadcast facility maintenance and the state of the art in electronic television graphics.

Take the time to read and learn from the papers within this volume, papers which have been prepared with great care by their authors. To a large extent the technical development of the future of our industry relies upon your interest and ability to understand and utilize the concepts and applications described here. In many respects they are blueprints of our future; a how-to manual of success and a valuable reference source to complement the new NAB Engineering Handbook. Further, in the increasingly diverse and competitive broadcast marketplace, engineering becomes even more important to the maintenance of high quality signal transmission and the ability of a station to compete effectively. The size of these Proceedings reflect that concern and our efforts to provide broadcast engineers with important up-to-date technical information.

We at NAB are proud to publish these Proceedings. Your comments on any of the papers or on any respect of the '85 Engineering Conference are always welcome.

Best personal regards,

Thomas B. Keller







## 1985 NAB BROADCAST ENGINEERING CONFERENCE PROCEEDINGS

### CONTENTS

#### AM TECHNICAL IMPROVEMENT

<b>Charting a Course for AM Improvement</b> Michael C. Rau.....	1
<b>AM Antenna Broadbanding -- Does Your Station Need It?</b> Kenneth J. Brown.....	10
<b>Fundamentals of AM Receiver Design</b> Jon P. GrosJean.....	21
<b>Synchronous Detectors Improve AM Receiver Performance</b> Alfred E. Resnick.....	26
<b>AM Preemphasis and Deemphasis: A Systematic Approach</b> Robert Orban and Greg Ogonowski.....	38

#### RADIO BROADCAST ENGINEERING

<b>New Design Improves Cavity Backed, Cross Dipole Performance for FM Broadcast</b> A.R. Mahnad.....	59
<b>The Effect of a Quarter Wavelength Stub on Medium Wave Antennas</b> Jerry Westberg.....	69
<b>Process Cooling System for High-Rise Building Transmitter Plants</b> Warren Shulz.....	76
<b>Transmitter Cooling Systems: Design, Operation and Maintenance</b> Jeffrey H. Steinkamp.....	90
<b>Standby Power Systems for Broadcast Radio Facilities</b> Jerry Whitaker.....	101
<b>Lightning Protection for Broadcasters</b> Roy B. Carpenter, Jr.....	113

## TELEVISION ELECTRONIC GRAPHICS CENTERS

<b>Selecting and Optimizing Components for a Broadcast Graphics Creation Center</b> Joseph J. Kresnicka.....	123
<b>NBC Election '84 -- Results by Design</b> Thomas C. Alfieri.....	128
<b>Assembling a Component Video Graphics Creation Center</b> Karl Renwanz.....	133
<b>A Microprocessor Based System Solution to Increase Access to Character Generators</b> Maurice R. Baker.....	139
<b>Videopticals: The Evolution of A Post Production Facility</b> Jason T. Danielson.....	149

## MULTICHANNEL TELEVISION SOUND -- TRANSMITTER CONVERSION

<b>RF Systems Considerations for Multichannel TV Sound Transmission</b> Verne S. Mattison.....	157
<b>Field Conversion of TV Transmitting Facilities for Stereo Operation</b> R.W. "Sam" Zborowski.....	165
<b>System Design for Stereo TV Operation</b> James H. Swick.....	175
<b>Preparing a VHF TV Transmitter for Multichannel Sound</b> Randall Hoffner.....	182
<b>Wideband UHF Aural Notch Diplexer for Multichannel Television Sound</b> Mark A. Aitken and Richard E. Fiore, Sr....	190
<b>RF Performance of MTS Constant Impedance Notch Diplexers</b> Jerome Pozgay.....	198
<b>Testing Television Transmission Systems for Multichannel Sound Compatibility</b> Geoffrey N. Mendenhall.....	207

## TELEVISION MAINTENANCE WORKSHOP

<b>Common Pitfalls in Combining Transmitter Cooling and HVAC Systems</b> Michael V. Chiarulli.....	223
--	-----



<b>Guidelines for Transmitter Plant Installation and Maintenance</b> Homer R. Stanley and James B. Pickard.....	234
<b>Microcomputer Control Enhances NiCad Battery Fast Charging</b> D.C. Hamill.....	241

### AM-FM ALLOCATIONS

<b>How International Agreements Affect U.S. Broadcasting</b> Wallace E. Johnson.....	251
<b>Optimizing the AM Band by Extending Hours and Increasing Power</b> Ralph A. Haller.....	256

### RADIO SUBCARRIERS

<b>The "Grail" System - SCA Technology Meets with Success</b> Howard M. Ginsberg.....	261
<b>A Study of the Feasibility of Using Commercial AM Broadcast Stations for Transmitting Electric Utility Load Management Signals</b> Frank M. Hyde.....	265
<b>A Compatible Data Transmission System for AM Stereo Stations</b> Charles R. Patton, III.....	279
<b>Computer Simulation of FSK Data Transmission Impairments on AM and FM Subcarriers</b> Harry R. Anderson.....	284

### TELEVISION ENGINEERING

<b>The Electronic Newsroom -- An In-House Approach</b> Tim Black and Warren Happel.....	297
<b>The CCD Camera -- A New Way to Look at Television</b> Thomas M. Gurley and Carl J. Haslett.....	305
<b>Novel Procamp ("PixProc") Corrects Video Level and Contrast</b> Blair Benson, Karl Kinast and Robert Murch.....	317
<b>A Case for the Use of Multichannel Broadband Antenna Systems</b> M. B. Anders.....	325
<b>Digital TV Tape Recording</b> F. M. Remley.....	335

## MULTICHANNEL TELEVISION SOUND TECHNIQUE

<b>A Systems Approach to Audio Console Design for Stereo and Multichannel Television</b> Douglas F. Dickey.....	343
<b>Stereo Sound Conversion for the TCR-100 Video Cartridge Recorder</b> C.R. Thompson, J. Tom and T. V. Smith.....	353
<b>Network Distribution of Digital Audio for TV Multichannel Sound</b> Chieu Nguyen.....	360
<b>Stereo Synthesizers Enhance Monophonic Sound for MTS</b> John Bubbers.....	379

## BROADCAST AUXILIARY

<b>Efficient Digital Audio Coding and Transmission Systems</b> Craig C. Todd.....	385
<b>High Dynamic Range Receivers</b> Ernest M. Hickin.....	395
<b>Using LORAN-C for Automatic ENG Antenna Pointing</b> Vincent E. Rocco.....	405

## RADIO NEW TECHNOLOGY

<b>Using a Small Computer to Evaluate RF Coverage of Co-Located FM Stations</b> Michael D. Callaghan.....	415
<b>Newsroom Computers for Radio Broadcasting</b> Kenneth R. MacBride.....	427
<b>Combining New Transmission and Companding Systems for Improved FM Reception</b> Emil L. Torick.....	448

## RADIO PRODUCTION

<b>High Performance Telephone Interfacing Using Digital Signal Processing Technology</b> Steve Church.....	457
<b>An Overview of Stereo Microphone Technique for Radio Broadcasting</b> Skip Pizzi.....	467

## TELEVISION SATELLITE SYSTEMS

- The CONUS Dual Video SNG System** Raymond A. Conover..... 477
- Design Considerations for -- News Express: The Florida News Network's Mobile Ku Band Satellite Service** Bramwell Flynn... 486
- Fly Away SNG Utilizes Portable Ku Band Antennas and Digital Compression Techniques** Dave Garrod and Eric Schechter..... 504

## ADVANCED TELEVISION SYSTEMS

- Report of the Activities of the Advanced Television Systems Committee Enhanced 525-Line Television System Technology Group** Daniel R. Wells..... 519
- Experimental Camera and Recording System for Reduced Bandwidth HDTV Studio Production** W.E. Glenn, J.W. Marcinka and Karen G. Glenn..... 523
- Resolution Requirements for HDTV Based Upon Performance of 35 mm Motion Picture Films for Theatrical Viewing** Arthur Kaiser, Henry W. Mahler and Renville H. McMann..... 528

## AUDIO MEASUREMENTS AND PROCESSING

- Stereo Phase Error Correction and Automatic Phase Correction Using An Audio Cross-Correlation Technique** David A. Howe..... 543
- Audio Program Analysis** David G. Harry..... 560

## AM STEREO

- Audio Processing for AM Stereophonic Transmissions** Ron Jones..... 571
- Second Generation Techniques for AM Stereo Exciter Design** Edward Anthony..... 578
- A Modern Independent Side-band AM Stereo Exciter (Abstract Only)** Leonard R. Kahn..... 591



## UHF TRANSMISSION SYSTEMS

<b>UHF-TV Klystron Multistage Depressed Collector Klystron Program - A Progress Report</b> Earl McCune.....	593
<b>The Development of a 100 Kilowatt High Efficiency UHF-TV Klystron</b> Howard Foster.....	602
<b>An Integrated Exciter/Pulser System for Ultra High Frequency Klystron Operation</b> N. Ostroff, A. Whiteside, L. F. Howard.....	610
<b>The Klystrode: A New High Efficiency UHF-TV Power Amplifier</b> George M. Badger.....	627
<b>High Efficiency UHF Klystron Transmitter Technology</b> Glenn V. Wild and John P. Shipley.....	636

## NON-IONIZING RADIATION

<b>Non-Ionizing Radiation -- Measurement Methods and Artifacts</b> Edward Aslan.....	645
<b>In-Service Measurement of Non-Ionizing Radiation</b> Neil M. Smith.....	656

\*\*\*\*\*



---

## CHARTING A COURSE FOR AM IMPROVEMENT

by

Michael C. Rau  
Staff Engineer  
National Association of Broadcasters  
Washington, DC

In October, 1983, NAB's Engineering Advisory Committee perceived a need to address AM's technical problems on an industry-wide basis. If AM is to be improved, these engineers believed, it seemed to be a proper responsibility for NAB and its technical staff to examine the pertinent issues and develop appropriate solutions and strategies. Accordingly, NAB's AM Improvement Committee was created to collect, study and analyze current technical problems facing AM transmission and reception and to develop, to the extent possible, consensus on ways to improve the technical quality of AM broadcasting. The Committee had eight meetings in 1984 to consider the vast array of technical issues. Industry experts across the board were solicited for their views. We received a great many letters from interested general managers, chief engineers, and other representatives or participants in the broadcast industry. All submissions to the AM Improvement Committee were considered. Although AM Stereo is without a doubt an AM improvement, its controversial nature precluded arriving at a useful consensus of views. AM stereo was therefore not within the scope of the Committee's work.

There is probably little need to review with the reader AM's assorted technical problems. Among the ones we identified include AM skywave and the nature of electromagnetic noise; "narrowband" AM receivers; excessive boosting of high audio frequencies; "spreading" of communities beyond the intended interference-free service area of local AM stations; a paucity of centralized technical information; spurious emissions and/or distortion caused by transmitter transient distortion; and widespread interference from electrical devices. Many of these problems are not easily solved; some in fact, may be beyond solution. But, in response to these identified subjects, the Committee, after careful thought and extensive consideration, formulated eight specific suggestions. In brief, these suggestions are 1) to begin an industry wide AM promotion campaign; 2) to establish a central source for AM technical information; 3) to urge AM broadcasters to limit boost of audio frequencies above 12 kHz prior to transmission; 4) to improve AM transmitting antenna fidelity through broadbanding; 5) to research promising new antenna designs; 6) to research transmitter transient distortion ("TTD"); 7) to work closely with receiver and integrated circuit manufacturers; and finally, 8) to work to mitigate existing and potential interference from radio-frequency electrical devices. Rather than delve extensively into the reasoning that led to these suggestions, this article instead will focus on what is or will be done to implement the AM improvement report in order to realize an actual benefit from the AM Improvement Committee's work. Merely publishing a report will not of itself improve AM. A reader interested in the discussion and background

of these issues is invited to obtain a copy of the NAB AM Technical Improvement Report by calling NAB Science and Technology at (202) 429-5339.

I. Commence an Industry-Wide AM Promotion Campaign. For many reasons, this appears to be one of the most difficult AM improvement suggestions to implement on a nationwide basis. There is no question that the broadcast industry could mount an AM listening campaign in general, very similar to the "Radio is Red Hot" campaign successfully administered by the Radio Advertising Bureau. However, there are a number of obstacles to the success of such a "quality oriented" promotion campaign. If the campaign is designed to sensitize people who are already listening to AM radio that AM can sound "good", the message implicit in such a campaign is that AM can, indeed, sound great -- but only on new generation radio receivers. So the listener, in order to experience quality AM radio, must be enticed into a situation where he or she could experience how good AM can sound. Here is the proverbial rub. For, unless the radio station undertakes to promote and present quality AM radio receivers itself, virtually the only place a consumer can listen to quality radio is in a store that sells them. In other words, a campaign targeted to increase the quality consciousness of AM radio must, at least in the beginning, be formulated as an effort to bring consumers into retail radio receiver outlets. Normally, the encouragement of quality radio sales is a good thing, and of itself presents no problem. Unless quality radio receivers sell, the manufacturers' incentive to build such radios will ultimately be lost. The problem occurs when it is to be decided exactly which radios are designated to be quality. Who or what will decide which of many specifications of radio receivers are used and what their minimally acceptable standards will be? How will a radio station be assured that nearby retailers will carry such radios and that those radios can be demonstrated in the retail shop (many retail outlets do not provide for the reception of AM inside). This is a very sticky problem. It is possible to establish a "standards setting" committee that would establish guidelines for the evaluation of AM radio receivers and whose results could be used to furnish input into a quality radio campaign. But these committees consume considerable time, financial, and personnel resources. And there is no assurance that such a committee, once formed, would be successful in its endeavors. Generally speaking, the more controversial a committee, the less likely that useful guidelines will be realized.

In sum, promotional issues have not been fully resolved by the AM Improvement Committee. It is still not clear the extent to which NAB can create a promotion campaign designed to raise the quality consciousness of the general public with respect to AM radio. Since the promotional issue has yet to be resolved, the committee welcomes any ideas stations may have for a nationally sponsored campaign. Before leaving this issue, however, it should be noted that several localities, such as New Orleans, have mounted AM promotion campaigns which promote not only the quality aspects of AM radio in general, but also the benefits of AM stereo and selected radio receivers. It may well be that promotional campaigns focusing on AM improvement are best initiated on a local level.

II. Establish a Technical Reference Center at NAB. As of this writing, NAB has assembled about half of the technical reference center and has hired a student intern to complete the remaining work. The technical reference center is expected to be ready by the NAB Convention. NAB intends to offer this service to NAB members at no charge. The chief engineer in need of



information on a particular aspect of RF AM engineering will be furnished with a comprehensive bibliography of materials. He or she need only call NAB's Science and Technology Department for a copy of the desired article or paper. Later in the year, NAB intends to assemble a collection of especially useful articles to publish a "primer" on basic AM radio frequency maintenance.

III. Limit the Boost of Transmitted Audio Frequencies Above 12 kHz. The AM improvement report urged AM broadcasters to limit the boost of transmission of audio frequencies above 12 kHz. The report recognized that many industry engineers believe "it is not necessary to excessively boost these frequencies to realize good quality AM reception. A ceiling on transmitted frequencies above 12 kHz could produce significant interference reducing benefits to the listenability of AM stations." The report also noted that many current AM audio processors contain filtering which in effect implements this recommendation. In brief, without getting into the pros and cons of establishing a standardized preemphasis curve for AM, a consensus in the Committee could not be reached on the preemphasis issue. It was agreed, however, that there are significant interference costs of excessively boosted audio frequencies above 12 kHz to AM receivers listening on adjacent channels. And there is little, if any, benefit to the fidelity of co-channel AM reception. While the worthwhileness of a "standard" preemphasis curve could not be agreed upon, the committee did not rule out working toward the establishment of a deemphasis standard for use within AM receivers.

IV. Improve AM Broadcast Antenna Performance Through Broadbanding. A spot study of direction antennas on 1300 kHz revealed that many antennas could be improved through broadbanding. Although techniques for broadbanding have been known for some time, the skills for doing so are highly technical in nature, usually requiring services of an expensive engineering consultant. In order to help station personnel do the jobs themselves, we anticipate that the technical reference center will have a great deal of material about antenna broadbanding and would make such material available to NAB members upon request. The primer, too, would have material on broadbanding. The benefits from widespread broadbanding are significant and help to greatly improve the quality of broadcast transmission and reception.

V. Undertake Research of Supplementary Antenna Designs. These antenna designs offer the potential to significantly attenuate skywave in chosen, specified directions. Perhaps more than any other AM Improvement Report study area, this suggestion, not surprisingly, engendered the most interest. The reason, obviously, is that these designs promise to enhance ground wave coverage by as much as 15 dB in the areas where that coverage is now limited because of distant station protection requirements. Currently, a computer model has been developed which attempts to analyze theoretically the characteristics of such an antenna. A 27 MHz model antenna is also being developed. When enough work has been done, the Committee will release a report of its findings and suggestions on implementation. We are reluctant to "promise too much" at this point because much of the research is still to come.

VI. Undertake Research of Transmitter Transient Distortion ("TTD"). The Committee believes that TTD potentially is causing interference with no apparent compensating benefit. However, the nature and causes of TTD, and

some of its effects, remain unknown; research into transmitter designs must be undertaken in order to find "cures" for TTD in existing transmitters. Some research has been started and more will occur further into the year. A paper on this subject will be presented at the NAB Convention by Bob Weirather of Harris Corporation.

VII. Encourage the Development of a High-Quality, Useful and Inexpensive Integrated Circuit for Use in AM Radios. This suggestion is premised on the belief that the IC chip is the most determinative factor in the design of today's AM radio receiver. This premise, however, is arguable: many IC's being produced today are capable of far greater quality than the radio which is built around them. The reasons for this have to do with the increased expense of incorporating additional components in the radio receiver chassis in order to take greater advantage of the IC's quality features. The idea behind this AM Improvement Committee suggestion is to try and influence the development of the next generation of IC's in a manner favorable to broadcasters and in a manner that could lower the IC's unit costs to make them more attractive for use in future generations of AM radio receivers. "Quality" IC's will only find widespread use if their cost/performance ratio is especially low.

VIII. Work to Mitigate Existing and Potential Interference from Radio Frequency Electrical Devices. As everyone knows, interference arising from electrical devices such as automobile ignition systems, vacuum cleaner motors and certain electrical fixtures is a pervasive impediment to quality AM reception, notwithstanding potential noise-blanking receiver improvements. The committee noted the impending introduction of radio frequency lighting device technology. These RF lighting devices promise to significantly cut energy costs by replacing the ubiquitous incandescent lightbulb with RF devices. Unfortunately, however, many RF lighting devices emit energy at AM broadcast frequencies, both over the air and through the power line. The FCC has begun a Notice of Inquiry (Gen. Docket 83-806) to explore 1) the issues surrounding radio frequency lighting devices, 2) whether or not they are to be regulated, and 3) what interference protections will be provided to AM radio listening. But at this point, we do not know whether the prospects of widespread use of RF lightbulbs would significantly impair the AM radio listening environment in light of existing electrical interference problems (no pun intended). Accordingly, NAB has begun a research program to compare electrical interference to AM reception from existing electrical devices with likely electrical interference from new radio frequency lighting devices. Such a study would illuminate these issues for NAB, enabling a nationally enlightened decision on how best to proceed. If RF lightbulbs would not significantly increase existing interference, it would seem that opposing implementation of such technology would not benefit AM broadcasters. Instead we should find ways to minimize existing electrical interference. On the other hand, if our study shows that RF lightbulbs would cause significantly more interference than existing electrical devices, NAB should act to insure that the FCC adopts regulations carefully designed to protect AM radio listening. The results of our study will be presented at the Convention in April. Figure 1 is a spectrum analyzer photo of sample emissions from an RF lighting device. It shows periodic interference "spikes" roughly 10 dB high throughout the AM band.

Conclusion. The foregoing is a summary of "where things stand" on AM improvement matters at the time of this writing. NAB is pursuing each of these options as our time and resources permit. There is no guarantee that our efforts will be successful; but, the Committee believes, as I do, that the task of researching AM problems and offering AM solutions is a task that ought to be performed by the industry's largest trade association. A failure to address the industry's real problems would be an abdication of NAB's responsibility to its over 3000 AM radio members.

Comments and suggestions are welcome. Please write the AM Improvement Committee, care of National Association of Broadcasters, 1771 "N" Street, N.W., Washington, D.C. 20036.

## **Appendices**

### **A. List of References: Technical Papers and Reports**

Bingeman, G., A Bandwidth Flattener for AM Transmission Systems, unpublished paper, February, 1977, available at NAB.

Bryan, G.L., Getting Better AM Sound: It's a Mike-thru-Antenna Job, BM/E, October, 1974, at 32.

Davis, H. et al., AM Receiver Performance for 10 kHz and 9 kHz Signal Spacings. FCC/OST TM 62-1. Washington, D.C.: U.S. Federal Communications Commission, March, 1982.

Grosjean, Jon F. "Some Considerations in the Design of AM Broadcast Receivers". January, 1980.

Norberg, Eric G., "An AM Stereo Commentary". Broadcasting March 5, 1984, p. 30.

Payne, Christopher P., AM Pre-emphasis and Transmission Bandwidth in Proceedings of the 1981 Broadcast Engineering Conference, Washington, D.C.: National Association of Broadcasters, 1981.

Riley, J.F., and Klein, H., The Only True route to High-Grade AM Audio, BM/E, October, 1975, at 28; Part 2, November, 1975, at 5b.

Wright, W. E., Selectivity and Sensitivity of Standard Band AM Broadcast Receivers. Technical Report BIRB-4, Telecommunication Regulation Service (now the Canadian Radio Technical Commission, Ottawa, Canada), April, 1973.

### **B. Correspondence, Memos and Letters**

Brown, Ken, Allocations Engineer, ABC. Memo to Subcommittee (summarizing AM antenna system problems), April 17, 1984.

DeWitt, John H., Letter to Tom Keller (Quality of reception improves with use of low pass transmitter filter.) March 4, 1984.

Frizzell, Ron, General Manager, WLAM/WKZS Radio, Lewiston, ME. Letter to Michael Rau, NAB (expressing frustration at the apparent quality of new Delco AM Stereo radios; urging NAB to conduct tests to evaluate the public's view of "quality" radios), April 11, 1984.

Harris, Bill, Chief Engineer, KNUS Radio, Denver, Colorado.

Letter to Subcommittee (opposing 5 kHz nighttime filters and believing that a standard AM pre-emphasis curve will be "at best" a trade-off), January 4, 1984.

Hoke, James H., VP and Director of Engineering, Harte-Hanks Radio, Winston-Salem, N.C. Letter to Subcommittee (opposing nighttime 5 kHz filters and standardized pre-emphasis, but suggesting "an upper limit" on transmitted high frequency boost), January 23, 1984.

Hubert, David L., Chief Engineer, KIRO, Seattle, Washington. Letter to Bill Wisniewski (opposing standardized pre-emphasis and 5 kHz nighttime filters), January 16, 1984.

Jeffers, Don, WCFL Radio, Chicago. Letter to Bill Wisniewski (supporting a standardized "curve frequency" and opposing a nighttime 5 kHz filter), January 6, 1984.

Klein, Harrison J., Director of Radio Engineering, Group W. Memo to Subcommittee (summarizing the Orban/Gregg paper urging standardized pre-emphasis), February 7, 1984.

\_\_\_\_\_. Letter to Bill Wisniewski (status of Subcommittee activities for NAB convention), April 18, 1984.

\_\_\_\_\_. Memo to Subcommittee (thoughts on Subcommittee activities to date; urging radio station promotion of good receivers), March 19, 1984.

Mann, Thomas L., NBC Radio. Memo to Subcommittee (reporting on survey of AM antenna bandwidths at 1300 kHz), March 27, 1984.

McBride, Bryce, Chief Engineer, KWBE/KMAZ Radio, Beatrice, Nebraska. Letter to Bill Wisniewski (urging taller antennas for Class IV radio stations to enhance AM groundwave and reduce AM skywave), February 15, 1984.

Morgan, Charles T., Pre-emphasis/De-emphasis. Memo to Subcommittee, March, 1984 (urging receiver manufacturers to "shape their band pass to a recommended minimum de-emphasis curve....").

Ogonowski, Greg J., Gregg Laboratories (an audio-processing equipment company), Tuslin, California. Letter to Subcommittee (opposing 5 kHz night filter, supporting standardized pre-emphasis, and urging receivers with 10 kHz notch filters), January 19, 1984.

Parrish, Howard Jr., General Manager, WQZK/WOAB Radio, Ozark, Alabama. Letter to subcommittee (calling attention to the "ever-increasing" problem of "power line noise and other types of electrical interference....", January 30, 1984.

Rau, Michael C., Staff Engineer, NAB, Memo to File (nature of National Radio Systems Committee), February 14, 1984.

\_\_\_\_\_. draft Memo to Subcommittee (a Review of Past Efforts and Research), January 10, 1984.

\_\_\_\_\_. Minutes of NAB AM Improvement Subcommittee, March 28, 1984; February 14, 1984; and January 10, 1984. Additionally, several cassette tapes of our meetings are available.

Resnick, Al, WLS Radio Engineering, Chicago, Ill. Memo to Ken Brown, ABC, with references and technical papers on Transient Intermodulation Distortion, April 5, 1984.

Serafin, John, ABC Engineering, New York. Memo to Subcommittee (ABC position paper on AM and draft report; Al Resnick studies on synchronous detectors at WLS and AM receiver selectivity characteristics; various technical attachments), March 26, 1984.

Werrbach, Donn R., Broadcast Engineer, Honolulu, Hawaii. Letter to Bill Wisniewski (opposing AM standard pre-emphasis; opposes nighttime filters; sees some interference resulting from unstable transmitters at high modulation levels (together with transmitter intermodulation distortion); suggest 8 ways to improve AM), February 7, 1984.

Wood, J. Robert, General Manager, CHUM Radio, Toronto, Canada (some AM interference is attributable to "small amounts" of overmodulation; urges careful monitoring and use of a "soft clip"), February 7, 1984.

White, James P., VP and General Manager, WSPD Radio, Toledo, Ohio, Letter to Subcommittee (opposing 5 kHz filters; supporting the Orban/Gregg standard pre-emphasis curve; supporting Kann's receiver variable sideband filter circuit), December 2, 1983.

Conversations and Discussions

The Subcommittee would like to thank the following individuals for their advice and counsel:

Leonard Kahn  
Chris Payne  
Frank Hilbert  
Bob Streeter  
Bob Orban  
Ralph Justus  
Jon Grosjean  
Karl Lahm  
Ralph Green

Martin Meaney  
Ed Williams  
Tom Keller  
Dick Biby  
Jules Cohen  
Oliver Richards  
Eb Tingley  
Ron Kackley  
John Serafin

Special Thanks to Al Resnick, WLS

---

## AM Antenna Broadbanding -- Does Your Station Need It?

Kenneth J. Brown

American Broadcasting Company

New York, New York

### INTRODUCTION

In 1949, W. H. Doherty published a landmark article on AM transmitters loading into narrowband antenna systems (1). Since then, it has been known that a transmitting antenna must present an impedance to the transmitter which does not vary much over the modulated bandwidth in order for the transmitter to be able to put a high fidelity signal on the air. But until the last few years, this fact has largely been ignored.

Perhaps this is because FM didn't make a major market impact until relatively recently, so the competition for an AM station came mostly from other AM stations, which usually didn't sound any better. Perhaps it is also because most of the bigger nondirectional stations hadn't refurbished their transmitter plants for years and simply didn't expect any better. Most directional stations were satisfied just to have their patterns in adjustment -- most of the time -- and didn't dare challenge the status quo. Maybe the biggest reason is that AM radio receivers have been so bad for so long that almost anything a station puts out doesn't sound too bad, because it has been almost impossible for a station to transmit a signal as badly as the radios receive it. Of course, the radio makers would have you believe it's all the stations' fault. I particularly remember one article (2) which swore broadcasters wanted better radio receivers made just to save money on facilities upgrading, but I've never heard of a station down 6 dB at 2.5 kHz, where most radios are (3)!

Whatever the reasons, those days are gone. FM is now major competition, and there are a few radios in the hands of the public on which AM sound can compete with FM sound -- if the AM station



is up to it. But most AM stations, even if they recognize the potential problem, don't seem to have any real way to tell if the antenna is what is strangling the station sound; how serious it is; or what to do about it.

This paper is addressed to that station. Nothing fancy, just a few simple ways to test your antennas for bandwidth troubles; and a general idea of what to look for, what to do about it, and when to leave well enough alone. I will not introduce any new techniques, just try to bring some concepts together so it all (hopefully) makes sense for the average station engineer, whose manager screams about the cost of tubes, let alone test equipment.

### THE "FINAL FILTER"

The antenna system of a radio station acts not only as the radiator of the signal but also as a "final filter" on the transmitter output. Since the bandwidth of any practical antenna is limited, the matching networks are designed to optimize the coupling of transmitter power to the antenna at carrier frequency. This is supposed to cause higher harmonics to be mismatched, so transfer of power is inhibited. In the early years of radio, many transmitters did not contain enough filtering within themselves to meet the harmonic radiation limits and extra filtering from the antenna circuits was necessary. More recent transmitters usually do not have this problem, so additional protection supplied by the antenna circuits is "gravy."

However, too narrow an RF bandpass in the antenna system will not only reduce higher harmonics of the carrier but will also roll off the audio sidebands. An antenna system having an impedance that varies greatly across the audio passband ( $\pm 15$  kHz from carrier frequency) presents a very poor load to the transmitter, as measured at the plate of the final amplifier. Since the match usually is good at and near carrier frequency and deteriorates farther away, where the sidebands of the higher audio frequencies are, the increasing VSWR reduces the transfer of power of the higher audio frequencies into the antenna. Thus, good quality audio going into the transmitter never leaves the antenna. Also, differing antenna impedances at frequencies above and below carrier will cause the sidebands to be asymmetrical, which means the received signal will be distorted in the radio's envelope detector (quadrature distortion). Even worse, the particular tower-network combination may behave strangely enough to actually reinforce carrier harmonics under some conditions (4).

The problems caused by the antenna system must be fixed at the antenna system. Merely adding preemphasis will often just overload the transmitter, which is already struggling with the bad load, causing distortion (5), overmodulation, splatter, and sometimes even carrier trips (6). It also wastes modulation capability (loudness) because transmitter modulation is spent on sound that never gets out of the antenna. Combined with asymmetrical sidebands and heavy processing attempting to make up for audio quality lost in the antenna, it is quite possible to get

an overmodulation citation from the FCC monitoring truck even when the modulation monitor at the transmitter shows all is well (7).

These problems exist in both nondirectional and directional antennas, but since directional antennas are much more complex, I will look at nondirectional antennas first.

#### NONDIRECTIONAL ANTENNAS

There are really only two basic ways to match a transmitter to a nondirectional, single-tower antenna. One is to use a slant wire or folded unipole, shunt-fed antenna, where the geometry is designed to match the transmitter as well as possible at carrier. Whatever happens at the sidebands is whatever happens. Although these antennas are sometimes touted as inherently broadband, I personally measured a folded unipole in which not only were the sidebands terrible, due to a sharp reactance slope and a high residual reactance at carrier, but the resistance didn't transform to 50 ohms, so a base network was needed anyway. Just having a folded unipole doesn't mean you're safe.

The second method of matching is, of course, a matching network installed at the tower base, between the transmission line and the antenna. These can be designed to optimize the match, so the transmitter sees nearly 50 nonreactive ohms at carrier and sidebands, but most aren't.

Probably the most common type of base network is what has been called the "Howdy Doody" network (don't ask me how it got that name). This consists simply of a long coil connected between the transmission line and the tower with a capacitor tapped to ground. It is often sold in a box with a choice of two capacitors (pick the one that works) as a ready-made line terminating unit, ready to be installed at the tower with a base meter, tuned up by the consultant, and forgotten. And if it gives you a good match anywhere but at carrier, it's not luck, it's a bloody miracle.

With the shunt leg consisting of just a capacitor, with no trimmer coil, there are no more than two and sometimes only one way to adjust the thing to match impedances at carrier, because there is no control over the phase shift of the network. You have to take whatever phase shift you get for the network to match impedances at carrier, which is usually very far from the -90 degrees where a lag-T network tends to be flattest. So, not only is the impedance slope of the tower not flat (it never is), but the impedance slope of the network may do almost anything. It's hard to mismatch a tower that is roughly 145 to 170 electrical degrees tall, but most towers are shorter, in the 60 to 110 degree range, where mismatch at sidebands is guaranteed with this type of network. In fact, I calculated some combinations to be even worse than simple directional array common points.

The easiest way to get at least partway into the ballpark is to insert a trimmer coil into the shunt leg in series with the capacitor. This allows the shunt leg to be adjusted, so the whole

network can be recalculated for a more advantageous phase shift.

What phase shift? Remember that reactances are frequency sensitive. You want the network which will tend to match the impedances of the tower, at different frequencies within the audio passband each side of carrier, to the  $50+j0$  the transmitter and transmission line want to see (8). Note that this is harder at low carrier frequencies than higher up the band because the audio passband is a larger portion of the carrier frequency. You can find the basic equations for several kinds of networks in a 1978 BM/E article by George Ing (9), and the measured antenna impedances for your tower are in your last FCC Form 302 Application for License. Most likely, you will still not be able to get a good match, but you may be able to improve it somewhat.

A better answer is adding another network (or rebuilding the base network) to gain more latitude in rotating the impedances on the plates of the final tube to a symmetrical condition as suggested in many articles (10). By rotating the impedances in a network, you can at least get the final plate load to be symmetrical on both sides of carrier -- resistances equal and reactances equal and opposite -- which is the minimum distortion configuration. You may want a second network at the transmitter end of the transmission line if your matching problem is complicated by impedance rotation in the transmission line due to high line loss. You know you have that problem if the impedance at carrier frequency is markedly different at the transmitter output than it is at the transmission line output.

The best answer (except in some high line loss cases) is to install a wideband base network in the first place. A lag-T is not the only possible network configuration, and while it is a simple workhorse, it is often not the best network. A 1978 article by Lawrence L. Morton in Broadcast Engineering (11) describes the design technique, but it will likely entail replacing the entire base network. The trick is to get the slopes of the network resistance and reactance to oppose the slopes of the tower resistance and reactance, so the result is close to  $50+j0$  across the audio passband. Doing this eliminates any necessity to rotate impedances at the final PA as well as the extra trouble of measuring the high impedances there, since it simply presents the transmitter output with essentially the resistive load it was designed for.

An important caution: when tearing up any part of your antenna system, if you are not certain you have the particular skills and equipment to finish the job before you start, you shouldn't try alone. It is all too easy to louse things up so well you are either worse off than when you started or even off the air until the consultant arrives. Some consultants love station engineers who play with their antennas -- particularly directionals -- it keeps them in business!

## DIRECTIONAL ANTENNAS

Directional antennas are much more complicated. High "Q" circuits, high circulating currents, sharp nulls in the pattern where the carrier is attenuated much more than the sidebands, negative towers and suchlike all add to the complications. Sometimes the bandwidth can be improved by a simple redesign of the input sections of the phasing system, sometimes a complete phasor redesign is necessary for significant improvement. In some cases no complete solution is possible without completely redesigning the pattern -- which is usually not possible. Most stations, however -- one study estimates 66% of directionals and almost all nondirectionals -- can be improved by some attention to the design of the antenna phasing and coupling networks (12).

A pattern is formed by interaction of the signals produced by the various towers. Since each tower "sees" all the others in the array, the driving point impedance at the base of each tower depends on not just itself (self impedance), but also on how it is impacted by the presence of the other towers (mutual impedances), and on the interactions of the radiated fields from the other towers involved in forming the pattern. But so many physical factors can cause the mutual impedances to be so far different in practice from what theory predicts, that trying to design a broadband phasing system without measuring the mutuals is likely to be fruitless. I have seen several cases where such a simple thing as a slope to the ground at the antenna location made the mutuals so far different from theoretical that the phasor had to be completely redesigned to get the pattern adjusted.

A good consulting engineer or phasor designer can do a broadband design, but if he doesn't start by measuring the mutuals to determine the actual driving points with your towers, get a second opinion.

Also consider that the pattern tends to shift with frequency. Not only do the tower and network impedances vary (13), but the electrical tower spacings are different at sideband frequencies than at carrier frequency. Since tower spacing is one of the parameters controlling the formation of the pattern, the patterns formed at various sideband frequencies may not coincide with the authorized pattern formed at carrier. This can result in wildly varying modulation depths, or "null talk," through the null regions. A very careful phasor design can help make the patterns at modulating frequencies coincide (14), but it must be explicitly considered, and it isn't always possible. Synchronous detectors in radios would help a lot, being much less sensitive to the missing carrier in a sharp null than envelope detectors.

There are some cases in which the entire phasor need not be redesigned to get an acceptable match. I recall one station whose pattern was simple and nulls were shallow enough that the null talk wasn't objectionable, but the common point network and power divider were so highly resonant that most of the modulation was erased. The station had a rackfull of audio processing equipment,

yet still sounded muffled. A simple field redesign of the common point and power divider networks brought the impedances around to where a new broadband phasor wouldn't buy a whole lot more, and opened up the sound of the station dramatically.

There are some arrays which cannot be made broadband regardless of the phasor because of the way the pattern is formed (15). These are not always arrays with many towers and/or tight nulls. These are usually high gain arrays where the signal is very suppressed over wide arcs, which are unusually sensitive to small parameter changes. Some have been designated as critical arrays, but many have not.

The easiest way to determine if you may have a problem array is by the RSS/RMS ratio, and you can determine this yourself. If you have a relatively new pattern, it probably was designed as a standard pattern, and the necessary numbers should appear somewhere on the pattern drawing in the FCC Form 301 Application for Construction Permit. If you have an older station, the authorized theoretical and measured patterns were probably converted to a standard pattern during the FCC proceeding of a few years ago, and the numbers appear on the pattern conversion sheets released by the FCC. A copy of the sheets (one per pattern) for your station can surely be obtained cheaply from your consulting engineer if you don't have a copy.

Simply divide the RSS by the theoretical RMS (NOT the standard RMS or measured RMS). If the resulting ratio is less than 1.5:1, your array should be easily broadbandable. If the number is more like 2 or 2.5 to 1, the problem is more complex and the results may not be as good. If the number is much over 2.5 (I have seen as high as 3.7 and there may be worse), you have my sympathy. With antennas as difficult as those, even if you might possibly get something to flatten the common point (16), you can still expect bad null talk.

#### THE TESTS

The critical question for the station engineer is, of course, how to know if the primary cause of bad sound is the antenna system. There are two simple tests for this.

Possibly the clearest test is to run the audio proof into both the antenna system -- each pattern -- and into a good, nonreactive dummy load. If the audio response into the antenna falls off at higher frequencies (5000-7500 Hz), but the response into the dummy does not, the antenna is limiting the station sound. In severe cases, it may not even be possible to make 100% modulation at 7500 Hz in the antenna, while it is easily done in the dummy. Excessive modulator current (or modulator overload) at higher frequencies in the antenna, but not in the dummy, is another good indication (problems at low frequencies, 100 Hz and below, are more likely transmitter than antenna). Also look for excessive distortion operating into the antenna as compared to the

dummy load.

A somewhat reactive dummy (like the typical resistor bank built into lower power transmitters) is also usable, since it is the difference between the two responses that is important. There are even a few rare cases where the antenna is slightly flatter than an expensive, nonreactive dummy.

Don't have a dummy load? There is a way to take a field meter into a strong signal area in the major lobe and check the sidebands with tone against the modulation monitor. This is discussed in several of the references covering impedance rotation techniques (17).

Another way to tell if antenna work should be considered for a directional antenna is to review the common point impedance plot(s) contained in the latest RF proof of performance. While impedance runs are also done for nondirectional antennas, these measurements are made at the tower base or antenna feed point. The matching networks are between the transmitter and the Non-DA measurement point, where they will not affect these measurements. If you have access to an RF bridge and generator, you can run your own impedance plot. This should be done at the common point for a DA, and at both the transmitter output point and transmission line output for a Non-DA. Make measurements at least every 5 kHz over a range of at least +/- 15 kHz from carrier.

Convert the data to magnitude of impedance (the square root of the quantity resistance squared plus reactance squared), and plot it versus frequency. The impedance magnitude values of a good antenna will stay within 90% to 110% of the impedance at carrier over a bandwidth of at least -10 kHz to +10 kHz from carrier. An acceptable antenna will have impedance magnitudes staying within 80% to 120% of carrier. Resistance and reactance cannot be treated separately since reactance worsens the effect of resistance being off, and vice-versa.

A better guide is to Smith Chart the data (18). A good antenna will stay within the 1.1 VSWR circle; an acceptable one should stay within 1.2 VSWR over +/- 10 kHz. Note that the numbers I gave for the extremes on the impedance plot correspond to the extremes of the VSWR circle on the Smith chart; the Smith chart takes the interaction of resistance and reactance into account.

The worst common point I have ever heard of was one which, from 50 ohms resistive at carrier, fell to 10 to 12 ohms only 2.5 to 3 kHz each side of carrier. This station simply couldn't get much over 90% modulation, and sounded terrible. For good audio, the impedance needs to be as flat as possible over a 10 to 12 kHz range each side of carrier.

With a directional antenna, once you know you have a problem with either common point or null talk, there is a way to determine which tower or towers may be causing more of the trouble. Ed Edison discussed the technique in his paper presented at NAB in

1982 (19).

#### WHICH WAY TO GO?

What you do about your antenna is up to you and your boss. If you sound good enough on a wideband radio and listener fatigue is not a problem, and if your competition is mostly AM and doesn't sound any better, you might not have to do anything for a while.

If you aren't happy with the sound and the station is nondirectional, a wideband matching network may cost more than an impedance rotation network, but it may also do a better job. You can evaluate networks before building anything by solving through the network equations, correcting the reactances of the components for the carrier and sideband frequencies. Also remember to treat each part separately -- don't lump a capacitor and its trimmer coil together.

If you have a directional and your problem is null talk, and your community is spreading into the nulls, a phasing system rebuild might help make that signal more listenable, depending on the pattern. If you don't have null talk, a relatively minor common point fix may help. If you have a high RSS pattern, you might get some relief from a combination of pattern redesign and phasor replacement, depending on how badly your format needs help.

A good consulting engineer should be able to advise you regarding the possibilities, the costs, and any particular problems relating to your situation, but the station management will have to make the decisions based on an evaluation of your market and your competition. Most antenna systems, unless designed specifically with broadbanding in mind, are capable of at least some improvement, and broadbanding will usually result in a noticeable improvement in the air sound.

## REFERENCES

- (1) W. H. Doherty, "Operation of AM Broadcast Transmitters into Sharply Tuned Antenna Systems," Proceedings of the I.R.E., July 1949, pp. 729-734.
- (2) Bob Gerson, "Stand Up for Your Radio & TV Rights," Consumer Electronics Show Daily, date unknown, pp. 20-34.
- (3) Bob Orban and Greg Oganowski, "Two Evaluate AM Stereo Tuners," Radio World, July 15, 1984, p. 4.
- (4) Grant Bingeman, "Suppressing RF Harmonics and IM Products," BM/E, November 1979, pp. 68-76.
- (5) Grant Bingeman and C. V. Clarke, "AM Antenna System Bandwidth Versus Harmonic Distortion," IEEE Transactions on Broadcasting, June 1977, pp. 50-55.
- (6) Donn Werrbach, "CE Observes Xmtr Instability," Radio World, January 1, 1985, pp. 9-10.
- Grant Bingeman, "Reflectometer Operation in Limited Bandwidth AM Systems," Harris Broadcast Products, February 1977.
- (7) Grant Bingeman, "AM RF System Distortion," Harris Broadcast Products, 1977.
- (8) Bingeman & Clarke, op. cit.
- (9) George W. Ing, "Network Solving with Programmable Calculator," BM/E, January 1978, pp. 80-82.
- See also: Howard W. Davidson, "The Antenna Match," BM/E, July 1984, pp. 65-70.
- Grant Bingeman, "How Mutual Inductance Affects Coil Performance," BM/E, October 1980, pp. 88-92.
- Grant Bingeman, "Myths of the 90 Degree Network," BM/E, July 1980, pp. 61-62.
- (10) William J. McCarren, "Antenna Q. vs. Audio Response," Proceedings, NAB Engineering Conference, 1976, p. 38 ff.
- Bingeman & Clarke, op. cit.
- Peter Burk, "The Antenna: AM's 'Final Filter,'" Broadcast Engineering, October 1977, pp. 57-73.
- Grant Bingeman, "A Systems Approach to Transmitter Output Networks," BM/E, February 1979, pp. 85-90.
- Grant Bingeman, "Solving AM Bandwidth Problems," BM/E, June 1978, pp. 65-79, and correction: BM/E, August 1978, p. 12.



-- Dane Jubera, "Essential to AM Quality: A Broadband Antenna System," BM/E, September 1981, pp. 63-71.

(11) Lawrence L. Morton, "Increasing the High Frequency Response of AM Stations," Broadcast Engineering, September 1978, pp. 44-52.

See also: Grant Bingeman, "A Bandwidth Flattener for AM Transmission Systems," Harris Broadcast Products, February 1977.

(12) Thomas L. Mann, "NBC Memorandum to NAB AM Improvement Subcommittee," March 27, 1984.

(13) Grant Bingeman, "Optimizing Impedance and Pattern Bandwidths of a Phased Array," BM/E, February 1980, pp. 84-94.

(14) Edward Edison, P.E., "Another Look at AM Directional Antennas and Phasors," Proceedings, NAB Engineering Conference, 1982, pp. 209-222.

-- Frank S. Colligan, "Antenna Monitor Telemetered Data Memory as an Adjustment and Maintenance Tool for A.M. Directional Stations," IEEE Transactions on Broadcasting, December 1984, pp. 120-121.

(15) Grant Bingeman, "Phaser BW Can Be Unimportant," Radio World, February 1, 1985, p. 7.

(16) Grant Bingeman, "Broadband Your Antenna With an External Network," BM/E, April 1984, pp. 263-272.

(17) Burk, op. cit.

-- Bingeman, "Solving AM Bandwidth Problems," pp. 68-70.

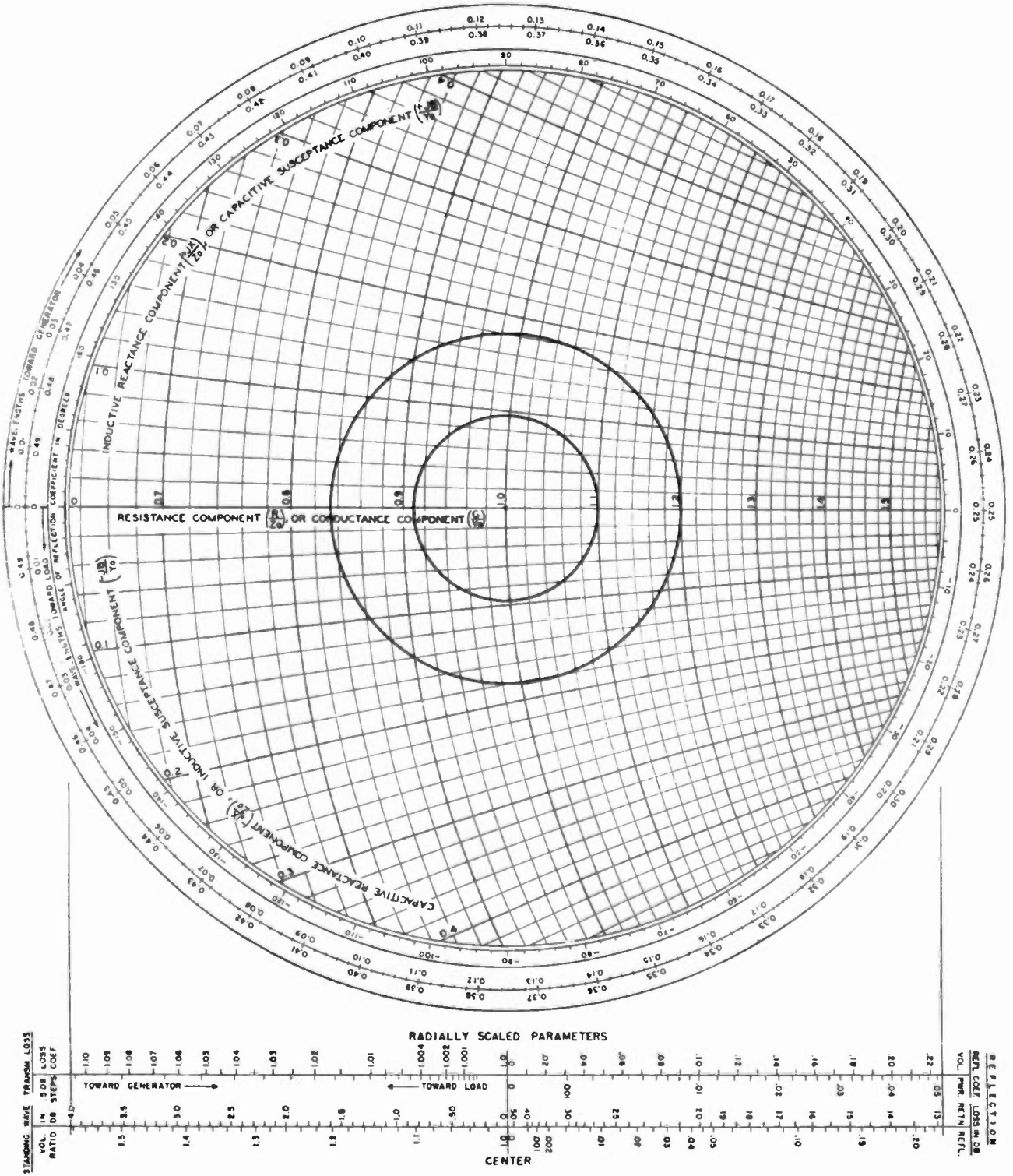
(18) Phillip H. Smith, Electronic Applications of the Smith Chart, Krieger Pub., 1983

(19) Edison, op. cit.

Special thanks to John Hidle and Bill Ball.

TITLE: \_\_\_\_\_ PREPARED BY: \_\_\_\_\_ DATE: \_\_\_\_\_

IMPEDANCE OR ADMITTANCE COORDINATES



---

## Fundamentals of AM Receiver Design

Jon P. GrosJean

Consultant

Woodstock, Connecticut

As with any other consumer product, the design approach for an AM tuner or receiver is largely influenced by how much the final product should cost and what it will be competing against. However, unlike in an FM tuner where it is difficult not to produce a high fidelity signal with a good signal-to-noise ratio, improvements in an AM tuner beyond a certain level are sometimes very difficult or expensive to achieve. Nevertheless, it is often possible to make improvements in an AM receiver design simply by making slight circuit changes and by paying attention to those portions of the circuit which can degrade audio frequency response. Unfortunately, as the fidelity of an AM receiver improves, so does its susceptibility to interference, and a compromise may have to be made between the frequency response and acceptable interference level.

### Integrated Circuits

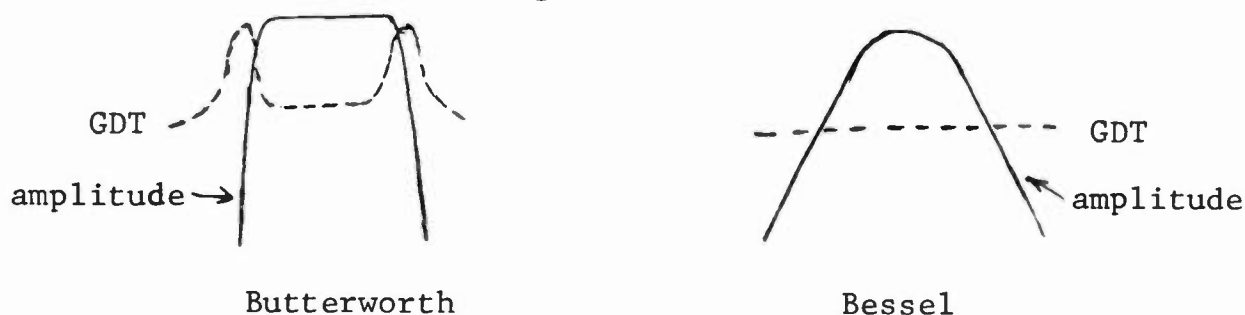
In recent years, the integrated circuit manufacturers have reduced the trade-offs presented to an AM radio designer. Previously, with discrete transistor or even tube designs, there was a trade-off between circuit cost, sensitivity, large signal overload, maximum signal-to-noise ratio and distortion. Current ICs are capable of signal-to-noise ratios of over 50 dB and distortions of less than 1% at 80% modulation whether they are used in a portable radio or high fidelity receiver. The sensitivity is somewhat poorer than that possible with discrete devices because the noise figures of the ICs are higher, but when the choice between large signal overload and sensitivity is made, the IC performance is about as good as discrete designs. For example, if the discrete transistor input stage is matched to the antenna, whether ferrite or whip, for optimum sensitivity, it will overload on relatively weak signals. A typical level might be 10 mV/meter. Consequently, in order to

enable the receiver to work at 1 Volt/Meter levels, the input to the device must be reduced and so the sensitivity to weak signals is degraded. The IC will have several internal circuits to prevent overloading and so can be matched to the antenna for best sensitivity. The net result will most likely be that both receivers have the same sensitivity. Of course, more circuitry could be added to the discrete design to improve its overload, but then it would cost much more than the IC design. It must be remembered that the average AM radio IC costs between 50¢ and \$ 1.25 and may even include most of the FM portion of the radio. Therefore, the most important part of an AM receiver design is, in most cases, not in the active circuitry but is in the RF and IF filter design and any other filtering or processing that may be done on the audio signal.

### Filter Basics

The effectiveness of any type of filter is determined by the arrangement and number of its poles and zeros. A single L-C resonant circuit has one pole pair, but when considering the region around the frequency to which it is tuned, only one pole has much effect. A crystal or ceramic resonator has one pole and one zero. The audio fidelity, selectivity, and now stereo separation of an AM receiver are essentially determined by its IF filter and the number of poles and zeros in it. (Some other factors degrading the audio frequency response will be discussed under RF circuits.) This is true whether the tuner is a conventional superhetrodyne, up-converter, dual conversion or direct conversion. (In direct conversion, the audio filter is the IF filter.) Unfortunately, there are also constraints on what can be done in the receiver regardless of the number of elements in its filter. The first limitation is that the audio frequency being transmitted is greater than the channel separation. Because of this, it is impossible to build a receiver with a 15 KHz audio response and any adjacent channel selectivity since the audio frequency response is essentially equal to  $\frac{1}{2}$  of its overall 3 dB bandwidth. If the channel spacing is ignored temporarily, one might think that any desired performance could be achieved simply by adding enough poles and zeros to the IF filter. If distortion, audio frequency response and stereo separation were not important, this might be true, but good performance in these areas requires good group delay and enough bandwidth. With the exception of surface wave filters which presently cannot be made having the required characteristics for AM Broadcast receivers, good group delay and good selectivity are not compatible. Figure 1 shows two types of filter responses.

Figure 1



The two peaks in the group delay time (GDT) in the Butterworth filter cause distortion and loss of stereo separation. Broadcasters may have noticed the same effect when a very sharp cut-off filter is part of the audio chain in a transmitter. The peaks in group delay cause ringing in square wave signals. A good compromise between the Butterworth and Bessel filters is commonly called a transitional filter and most of the better quality ceramic filters used in AM receivers are this type. Additionally, these ceramic filters usually have zeros in their response so they look like figure 2. These filters have the advantage that the zeros can be placed at or near an adjacent or alternate channel, but they must still be used with coils because they have only about 27 dB of attenuation outside the nulls.

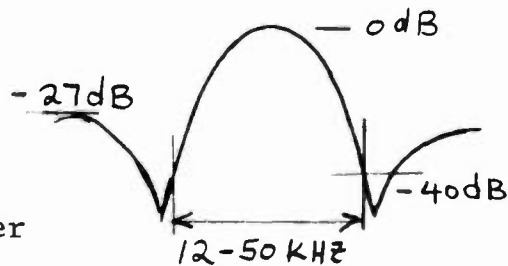


Figure 2

The second limitation in the IF filter design is in the required Q of the resonant elements. As more are added, the required Q for the filter design increases. For an example, suppose a 40 dB bandwidth of 20 KHz (required for night time listening) is desired. The table below for a transitional filter shows what happens:

number of sections	maximum 3 dB BW	resonator Q
3	3.2 KHz	211
4	5.0 KHz	180
5	6.7 KHz	238
6	8.0 KHz	322
7	9.1 KHz	411
8	10.5 KHz	483

From this, it is easy to see that regardless of what is desired, the maximum audio response which can be achieved in a radio suitable for night time listening is something less than 5 KHz. In actual practice, 4 KHz seems to be the practical upper limit with 3 KHz being achieved in good designs and 2 KHz or less in the not-so-good ones. Obviously, it is possible to use a wider IF filter for daytime reception, but the same rules apply to both types. 15 KHz of audio response requires a 3 dB bandwidth of 30 KHz but then a 10 KHz notch filter is required to keep the 10 KHz beat from adjacent carriers down, and background noise, interference and the effects of signal processing increase so much that they often are too objectionable. A good compromise for daytime use seems to be an IF bandwidth of 20 KHz and a 10 KHz notch filter. This results in an audio frequency response of 7 to 8 KHz. It also produces a dramatic improvement in an AM tuner except in cases where stations process the audio signals heavily to make the old radios sound better. In these situations, the listener is almost forced into switching back to the nighttime mode or turning down the treble control if the radio has one. There is no way for the radio designer to make provisions for this situation because no standard similar to that for FM de-emphasis exists. The growth of AM stereo might provide an incentive for the AM broadcasters to come up with an AM pre-emphasis standard which could be incorporated in AM receivers which have wide

bandwidth modes for improved frequency response. Another thing which could also be done would be to limit the transmitted frequency response to less than 10 KHz since very few listeners are able to use a receiver with a 15 KHz audio response even if they have it.

### Input Circuits

Most AM receivers today use two types of antennas: A ferrite rod or a whip as in car radios. The ferrite antenna is used in portable sets and most component receivers and has an advantage of somewhat improved interference rejection. It presents a problem to the designer of an improved AM receiver, however. The ferrite rod has a coil wound on it and forms the RF tuned circuit of the receiver. The induced voltage is proportional to the Q of the resulting tuned circuit. The image rejection of the receiver is also proportional to the Q, but at the low end of the AM band, the RF circuit Q will begin to affect the receiver's audio frequency response adversely. The following calculations will illustrate this:

$$A = \sqrt{1 + \left(2Q \frac{\Delta f}{f_0}\right)^2}$$

A = attenuation at a frequency  $\Delta f$  away from  $f_0$   
 $f_0$  = center frequency  
 Q = loaded Q of the resonant circuit

A typical loaded Q for a ferrite antenna might be 100. At  $f_0 = 600\text{KHz}$  and  $\Delta f = 3.0\text{ KHz}$ ,  $A = 1.414$   $20 \log A = 3\text{ dB}$   
 Thus, the receiver's audio response has been limited to 3 KHz by only the RF circuit. The IF filtering can only make this worse. The image rejection at 1510 KHz for this example will be:  $f_0 = 600\text{ KHz}$ ,  $\Delta f = 910\text{ KHz}$ ,  $A = 303$ ,  $20 \log A = 49.6\text{ dB}$ . This is just acceptable, but if the Q is lowered to improve the audio response, the receiver sensitivity and image rejection will become unacceptable.

Currently, the best solution to this problem appears to be to use a wire or large loop antenna connected directly into an RF stage. Almost all electronically tuned car radios use this approach, but further precautions are necessary to avoid having the same problem occur in the RF tuned circuits between the RF stage and mixer. One solution is to use a double-tuned RF circuit with variable coupling so that the coupling increases as the frequency decreases. Figure 3 shows one approach:

By careful selection of R,  $C_1$ , and  $C_2$ , the circuit can be made to have almost a constant bandwidth across the AM band. It should be remembered that the AM band covers a 3 to 1 frequency range. This means that the tuned circuits may have a 3 to 1 change in impedance across the band. Furthermore, the tracking between the oscillator and RF stage becomes more critical if the audio frequency response around 700 KHz and 1200 KHz is to be maintained.

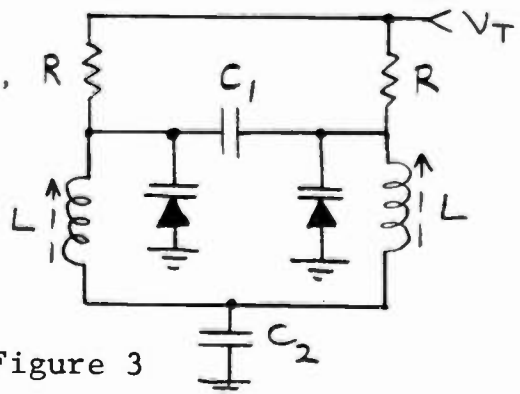


Figure 3

## AM Stereo

Fortunately, adding AM stereo demodulation to an AM tuner often requires only the addition of a stereo demodulator IC. More attention must be paid to oscillator phase noise and freedom from microphonic effects, and some of the synthesizer systems must be redesigned to reduce oscillator phase variations. It is sometimes difficult to sufficiently filter the phase detector signal from the synthesizer IC to the AM local oscillator so that the phase variations are small, the system is stable, and the time required to seek or scan between stations is not too long. Additionally, since the signal passing through the filter circuits of the radio contains phase information, the group delay characteristics are important if channel separation is to be maintained. (This is true in the transmitter also.) Nevertheless, a receiver properly designed for high quality monophonic AM reception can usually have a stereo demodulator added and will produce good quality stereo as well. The introduction of an AM stereo demodulator IC by Motorola has done more than anything else to make AM stereo receivers practical.

## New Developments and Problems

As was mentioned earlier, interference from adjacent channels will always be a problem if the audio modulating frequency exceeds the channel spacing. There is no way to eliminate this in a wide-band set, and use of a 10 KHz notch filter almost dictates a maximum audio frequency of something less than 8 KHz. Consequently, there isn't any good reason for an AM broadcaster to push for 15 KHz audio response in a receiver when a practical one can't receive it.

An even greater problem arising is the increase in man-made interference in the AM band. This has become so severe that many AM receivers are unusable in some areas. AM noise blankers are being used and better ones are being developed, but they will not solve the problem entirely. Synchronous demodulators offer some improvement because they do not peak-detect noise pulses unless they overload. The FCC has recently been more active, especially with computer makers, but the suppliers of devices using SCRs and TRIACs like light dimmers and some motor controllers seem to have escaped. Radiated emissions below 30 MHz are not covered, and TV deflection systems sometimes make AM radios unusable in a home in a rural area. Now, a new problem is possibly arising; Transmission of high speed data over phone lines. One system recently described sends data at 162 KBPS over unshielded phone lines. There are also carrier current systems which send relatively high speed data over power lines at carrier frequencies near the AM band. Since total harmonic distortion is relatively unknown in the digital world, these signals often are rich in harmonics. The overall result is that AM radios are becoming useful only in automobiles. On the other hand, the amount of circuitry which has been added to try unsuccessfully to make FM reception in cars work without picket fencing, intermodulation, and multi-path effects exceeds the AM tuner cost by about 10 times. AM has less fading, much better coverage, and no coverage loss in stereo. With improvements in noise suppression and better audio response, it should be possible to build an AM car radio which would impress even the most sceptical FM listener.



---

## Synchronous Detectors Improve

### AM Receiver Performance

Alfred E. Resnick P.E.

WLS Radio

Chicago, Illinois

Amplitude Modulation is the oldest form of transmission of sound by radio. Since its beginning, its signals have been generated and detected with many techniques and differing degrees of success.

Amplitude Modulated signals are a special case of a class of signals generally referred to as linear modulated signals. These signals include double sideband and single sideband signals with varying amounts of carrier insertion, each being derived from modulation of a continuous carrier wave. For these signals, the principle of superposition applies.

Techniques used to demodulate amplitude modulated (AM) signals have been generally of two types: demodulation by rectification which is common today and demodulation by a square-law device, which is rarely found today.

Under certain conditions these techniques yield results which are inferior to those possible with synchronous detection. The techniques for synchronous detection will be examined as well as the results which can be expected from synchronous detectors.

#### The Amplitude Modulated Signal

As generated in the laboratory, or in a transmitter, the AM signal consists of a carrier and upper and lower sidebands. Ideally the sidebands are exactly equal in amplitude and exactly opposite in phase with respect to the carrier. The signal is symmetrical in the frequency domain about the carrier; it is also symmetrical in the time domain about the zero voltage axis.



Mathematically, an AM signal can be represented as a function of time as:

$$AM(t) = (1 + M \cos pt) \cos \omega t \quad (1)$$

Where:

$$\begin{aligned} M &= \text{the modulation index} \\ \cos pt &= \text{the modulating frequency} \\ \cos \omega t &= \text{the carrier frequency} \end{aligned}$$

When  $M=1$ , 100% modulation occurs. Through trigonometric identities equation (1) can be expressed differently. Expanding equation (1):

$$AM(t) = \cos \omega t + M \cos pt \cos \omega t \quad (2)$$

$$\text{From: } \cos x \cos y = 1/2 (\cos (x + y) + \cos (x - y) )$$

The second term in (2) can be written:

$$AM(t) = \cos \omega t + 1/2 M \cos (\omega + p)t + 1/2 M \cos (\omega - p)t \quad (3)$$

From equation (3) the AM signal is seen to be the sum of three components. The first term is the carrier term. The second term is the upper sideband and the third term is the lower sideband. The superposition principle states that the response at any point in a linear circuit having more than one independent source can be obtained as the sum of the responses caused by each independent source acting alone. The AM signal in equation (3) could be generated by 3 independent sources. Each source would produce an output which could be summed together with the others and produce an AM signal. This is more difficult to do in the laboratory because in equation (3) the parameter  $t$  appears in each term. This implies a phase reference, so if one were to construct three separate oscillators, each to supply a term for equation (3), it is necessary that each oscillator be referenced to a common source. Notwithstanding the difficulty of laboratory construction, the important points to observe are that an AM signal is the linear sum of components, and that the principle of superposition applies. Implied from this is that the response is proportional to the source, or that multiplication of all sources by a constant,  $K$ , increases all the responses by the same factor,  $K$ .

Superposition simplifies analysis but does have limitations. It is applicable only to linear responses. For example, power is not a linear response and the superposition principle does not apply.

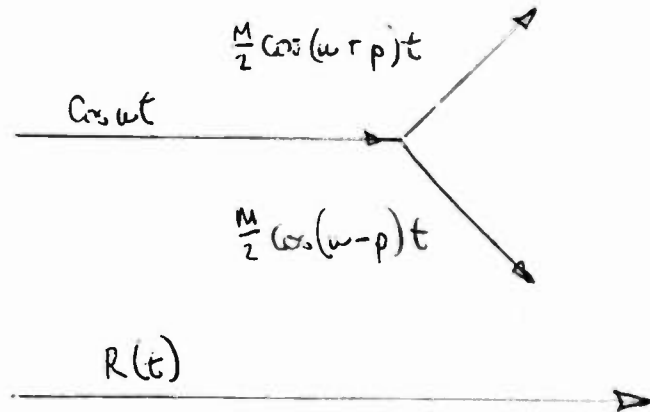
### Demodulation

Traditionally, AM signals have been demodulated by envelope detection. The simplest form of envelope detection is rectification followed by low-pass filtering. When a carrier signal is half wave rectified, components at DC, the carrier frequency, and even multiples of the carrier frequency are present.

If this carrier signal is modulated when rectified and then low-pass filtered the DC component multiplied by the modulating components will be recovered. The analysis of an envelope detector is cumbersome and awkward when performed

with Fourier components. The appendix shows a derivation after Kreyszig to solve for the Fourier components of a half-wave rectified sine wave.

The phasor representation of the components in equation (3) appears below with the carrier term as reference:



The resultant vector lies along the axis of the carrier. An envelope detector produces an output which is proportional to the resultant vector of its input signal.

In the theory, the envelope detector is a distortion-free device when fed signals which meet the parameters of equation (1).

In 1967 the EBU performed measurements of envelope detector performance in a receiver as the control portion of an experiment. These data are presented below:

Test	Point of Reception	Distance (miles)	$k_2$ (%2nd)	$k_3$ (%3rd)
LABORATORY MEASUREMENTS				
1	AM Demodulator without Selectivity -		0.5	0.2
2	Demodulation in the Recording Receiver -		0.6	0.3
FIELD MEASUREMENTS				
3	Control Location	3.7	1.6	0.9
4	Munich	20.5	3.1	1.3
5	Baden-Baden	163	6.6	2.2
6	Cologne	285	4.8	1.7
7	Hanover	296	3.4	1.6
8	Hamburg	376	4.8	1.4

The table above shows the median values of harmonic components as a percentage of the recovered fundamental frequency for 50% modulation with 1000 Hz.

The selectivity characteristics of the receiver precluded the study of higher order components.

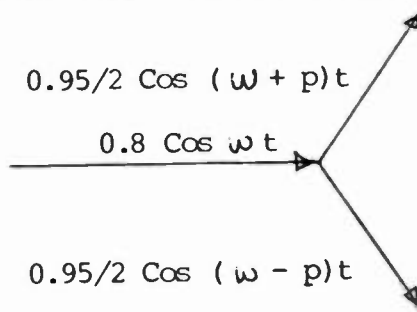
The transmitting antenna for these tests was approximately 0.56 wavelength high. The transmitter power was 20 kW.

These results show envelope detector performance in the laboratory does not indicate the performance which can be expected at a listener's location. Some would cite the ionosphere as the portion of the propagation path causing difficulty and argue that for the vast majority of AM broadcast stations in the US, only the groundwave service areas should be considered. The EBU results show that the control location is experiencing a median THD value of 1.8% with a detector in the receiver which measured less than 0.7% THD when connected to the transmitter. This location was less than four miles from a 20kW transmitter. Because of the location, skywave effects are highly unlikely. How disappointing to take a 0.1% MacArio envelope detector home and realize no better performance than a percent and a half distortion at 50% modulation - and only with stations no greater than four miles distant.

Many phenomena are responsible for changes in signals as they propagate at medium frequencies. Reradiation from high-rise buildings and steel tower power line supports have been known to exhibit reflection coefficients in the order of 0.2. High-rise buildings seldom occur singly. As an example consider a distant source illuminating a reradiating object.

The resultant will be the vector sum of the transmitted and reradiated fields. An envelope detector will respond to magnitude of the resultant. These phenomena can exhibit high Q behavior. Received signals change quickly as a function of position.

If the carrier amplitude were to be reduced to 80% of its relative value, but the sidebands remained unchanged, an ideal envelope detector would produce over 11% THD when the transmitter was modulated 95%. This phenomenon is real and exists in a large percentage of groundwave coverage areas of AM broadcast stations.



A 24 point Fourier analysis of the signal recovered from an envelope detector under these conditions produces the following coefficients:

<u>Frequency</u>	<u>Component (%)</u>
Fundamental	100.
2nd Harmonic	7.00
3rd Harmonic	6.08
4th Harmonic	4.64
5th Harmonic	3.16
6th Harmonic	2.04

The same 24 point Fourier analysis of the recovered signal produces the following components:

<u>Frequency</u>	<u>Component (%)</u>
Fundamental	100.
2nd Harmonic	0.137
3rd Harmonic	0.074
4th Harmonic	0.0105
5th Harmonic	0.0337
6th Harmonic	0.0527

Through the 6th Harmonic, THD = 0.167%, which is an indication of the accuracy of the method. These values would be returned by a synchronous detector if analyzed by this method as well.

### Synchronous Detection

Although a product detector is usually employed as the demodulator, the synchronous detector requires that a reference carrier with certain properties be applied to the product detector.

These properties are:

1. The reference carrier must be free of modulation - both amplitude and angle.
2. The reference carrier should have little or no angular difference with the carrier which is being demodulated.

To examine the products which are produced by the synchronous detector, equation (1) is multiplied by  $\text{Cos } \omega t$ .

$$AM(t) \text{ COS } \omega t = \text{Cos } \omega t \left[ (1 + \text{Cos } pt) (\text{Cos } \omega t) \right] \quad (4)$$

$$= \text{Cos}^2 \omega t + \text{Cos } pt \text{ Cos}^2 \omega t \quad (5)$$

$$= 1/2 \left[ (\text{Cos}^2 \omega t + 1) + \text{Cos } pt \text{ Cos}^2 \omega t + \text{Cos } pt \right] \quad (6)$$

$$= 1/2 \left[ 1 + (1 + \text{Cos } pt) \text{Cos}^2 \omega t + \text{Cos } pt \right] \quad (7)$$

The synchronous detector produces a modulated carrier at the second harmonic,  $2\omega t$ , a DC term proportional to the amplitude of the carrier of the signal being demodulated and the modulation signal  $\text{Cos } pt$ .

If the signal with reduced carrier amplitude which was applied earlier to the ideal envelope detector is applied to the synchronous detector, the following results are obtained:

$$AM(t) = (A + M \cos pt) \cos \omega t$$

$$AM(t) = A \cos \omega t + M \cos pt \cos \omega t$$

$$\begin{aligned} AM(t) \cos \omega t &= A \cos^2 \omega t + M \cos pt \cos^2 \omega t \\ &= A \cos^2 \omega t + M \cos pt \left( \frac{1}{2} (\cos 2\omega t + 1) \right) \\ &= \frac{A}{2} (\cos 2\omega t + 1) + \frac{1}{2} (M \cos pt (\cos 2\omega t + 1)) \\ &= \frac{A}{2} + \frac{A}{2} \cos 2\omega t + \frac{M}{2} \cos pt \cos 2\omega t + \frac{M}{2} \cos pt \\ &= \frac{1}{2} \left[ A + (A + M \cos pt) \cos 2\omega t + M \cos pt \right] \end{aligned}$$

Where:  $M = 0.95$   
 $A = 0.8$

Note that the output contains a modulated carrier at the second harmonic, a DC term proportional to the amplitude of the carrier of the signal being demodulated, and the modulation signal,  $\cos pt$ . Note that there are no terms that are harmonics of the modulation signal. The synchronous detector was able to recover the modulation signal without distortion. It can be shown that for any combination of carrier amplitudes, sideband amplitudes and sideband phases, the modulation signal can be recovered without distortion. Signals propagating at medium frequencies suffer these phenomena.

The WLS transmitter is approximately 27 miles from the studios. Monitor receivers are located at the studio location, and at the WLS-FM transmitter on the Sears Tower in Chicago. Each location is well within the groundwave coverage area of WLS. Each location shows pronounced skywave effects. Synchronous detectors have been constructed following the techniques described by Hershberger (1982) and the skywave effects have been minimized.

#### Receiver Passband Deficiencies

Certain changes, such as those caused by asymmetrical passband response modify the AM signal.

Examination of the published specifications for a high-quality ceramic filter show the following data:

<u>Frequency</u> (kHz)	<u>Filter Attenuation</u> (dB)
452	-2.41
455	-0.31
458	-4.41

If the signal applied is modulated 90%, the signal recovered after passing through the filter will be:

$$IF(t) = 0.965 \cos \omega t + 0.341 \cos (\omega - p)t + 0.271 \cos (\omega + p)t \quad (8)$$

Where:

$$\omega = 2\pi (455 \times 10^3)$$

$$p = 2\pi (3 \times 10^3)$$

This assures equal time delay through the filter - an optimistic assumption. No published data are available showing the group delay of this filter. The THD produced by an envelope detector with the signal  $IF(t)$  applied is 0.2%, primarily second harmonic. This same signal is recovered distortion-free with a synchronous detector.

Cheng and Giles (1984) comment on group delay characteristics of present day filters producing distortion levels as high as 4% at a 2 kHz angle modulating frequency.

IF filtering is somewhat misunderstood. Many designs attempt to realize an ideally flat passband and infinitely steep skirts. Filters of this nature exhibit underdamped behavior when excited by frequencies near their cutoff. Although beyond the scope of this study, the AM receiver designer must be exceptionally prudent and completely aware of IF filter behavior. Ringing at the natural frequency of the filter will be clearly visible with an oscilloscope and plainly audible especially when music program material is passed through the filter. Ruston and Bordogna (1966) provide a good study of filters as well as Orban and Cuccia (1952).

### Interference Performance

When an interfering signal is added to the signal to be demodulated

$$AM(t) = (A_c + M \cos pt) \cos \omega t \quad (9)$$

$$AM(t) = A_c \cos \omega t + M \cos pt \cos \omega t \quad (10)$$

Adding the interfering signal will produce an amplitude distortion and a phase deviation

$$R(t) = AM(t) + A_i \cos \omega_i t \quad (11)$$

Where:

- $R(t)$  = The resultant magnitude
- $A_c$  = The magnitude of the desired carrier
- $\omega$  = The angular frequency of the desired carrier
- $A_i$  = The magnitude of the interfering signal
- $\omega_i$  = The angular frequency of the interfering signal
- $M$  = The desired signal modulation index
- $p$  = The angular frequency of the modulation signal

$$R(t) = A_c + M \cos pt \cos \omega_c t + A_i (\cos \omega_c t \cos \omega_i t - \sin \omega_c t \sin \omega_i t) \quad (12)$$

$$R(t) = \left[ A_c + M \cos pt + A_i \cos \omega_i t \right] \cos \omega_c t - A_i \sin \omega_i t \sin \omega_c t \quad (13)$$

When the amplitude of the interference is small, the second term in equation (13) above can be neglected and the output of the envelope detector can be closely approximated by:

$$E(t) = M \cos pt + A_c \cos \omega_c t \text{ for } A_i \ll A_c$$

When the amplitude of the interfering carrier approaches or exceeds that of the desired carrier, the simplifying assumption above does not apply - Rewriting the equation (12) yields the expression:

$$R(t) = A_c \left[ \cos (\omega + \omega_i) t \cos \omega_i t + \sin (\omega + \omega_i) t \sin \omega_i t \right] + A_i \cos (\omega + \omega_i) t + M \cos pt (\cos (\omega + \omega_i) t + \cos \omega_i t + \sin (\omega + \omega_i) t \sin \omega_c t) \quad (14)$$

Collecting terms:

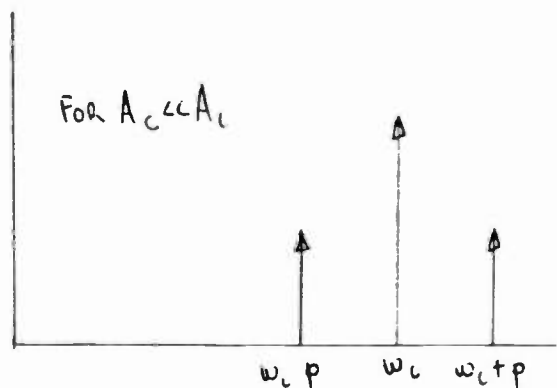
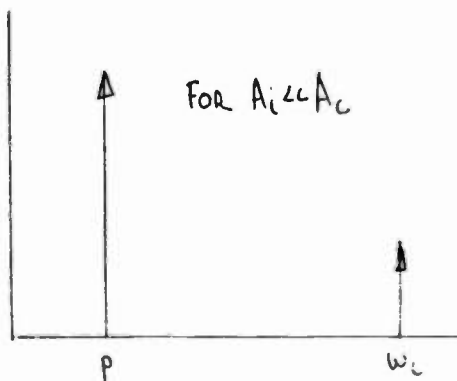
$$R(t) = \left[ A_i + A_c \cos \omega_i t + M \cos pt \cos \omega_i t \right] \cos (\omega + \omega_i) t + \left[ A_i \sin \omega_i t + M \cos pt \sin \omega_i t \right] \sin (\omega + \omega_i) t \quad (16)$$

As the interfering amplitude becomes much greater than the wanted carrier, the sine term in the equation above becomes negligible. The output of an envelope detector when neglecting the DC term is approximately:

$$E(t) = A_c \cos \omega_i t + M \cos pt \cos \omega_i t \quad (17)$$

From this point, several observations can be made. In envelope detectors, the largest carrier amplitude component becomes the effective carrier. When the interfering carrier is small, the desired carrier is the demodulation carrier. When the interfering carrier gets larger, the effective carrier can be the interfering carrier. When this occurs, the frequency of the modulation signal is lost. This degradation of the desired signal is a threshold effect and is a consequence of the non-linearity of the envelope detector.

Detector output spectra:



In the presence of interference, the ideal synchronous detector is able to recover the modulation signal frequency when the ideal envelope detector cannot.

For an excellent treatment of synchronous detector performance with upper and lower sidebands of unequal amplitudes as well as variable carrier amplitudes, the reader is referred to Uyttendaele (1975). Although the study was done for a television demodulator, the theory remains unchanged for AM broadcast demodulation as well.

### Noise Performance

Noise is present in various degrees in all electrical systems. Noise is one of the fundamental physical limitations of transmission of information by electrical means. In any case, noise must be minimized if high performance systems are desired.

Analysis of signal to noise ratios is usually best performed on a power basis. Envelope demodulation differs from synchronous demodulation in the presence of noise because the synchronous demodulator suppresses the quadrature noise component.

The received signal,  $R(t)$ , at the input to the demodulator is assumed to be  $AM(t)$  plus band limited noise.

$$R(t) = A_c [1 + M \cos pt] \cos \omega t + n_c(t) \cos \omega t - n_s(t) \sin \omega t \quad (18)$$

let:  $am(t) = M \cos pt$

Re-writing  $R(t)$  as a magnitude and an angle:

$$R(t) = r(t) \cos [\omega t + \theta(t)] \quad (19)$$

$$r(t) = \sqrt{[A_c (1 + am(t)) + n_c(t)]^2 + [n_s(t)]^2} \quad (20)$$

$$\theta(t) = \tan^{-1} \frac{n_s(t)}{A_c [1 + am(t)] + n_c(t)} \quad (21)$$

in an envelope detector, the expression for  $\theta(t)$  is of no interest.

When the signal to noise ratio is large, the solution is simple as the  $n_s(t)$  term can be neglected and the result approaches:

$$r(t) = A_c (1 + am(t)) + n_c(t) \quad (22)$$

which is the result obtained from a synchronous detector with any signal to noise ratio. As the signal to noise ratio applied to an envelope detector becomes smaller, the analysis is somewhat more involved. Re-writing the noise



terms in terms of envelope and phase, the input to an ideal envelope detector can be written:

$$R(t) = A_c [1 + am(t)] \cos \omega t + r_n(t) \cos (\omega t + \phi_n(t)) \quad (23)$$

When the signal to noise ratio is much less than 1, the envelope detector output is primarily Rayleigh distributed noise and no component is proportional to the signal. As was the case with interference, when the interfering carrier was much larger than the desired carrier, the interfering carrier was seen to be acting as the reference for demodulation, so also in this case the noise is the reference for demodulation. This multiplication of the signal by a function of noise has a much worse effect than does additive noise. The complete loss of signal at low input signal to noise ratios is known as threshold effect and is a result of the non-linear action of the envelope detector. The synchronous detector produces only additive noise under these conditions.

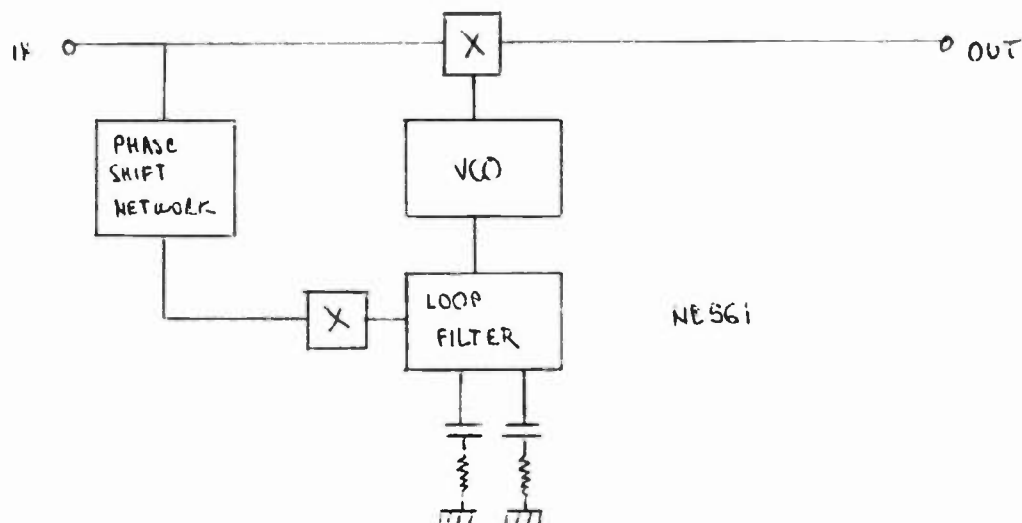
A very good treatment of signal to noise ratios before and after detection can be found in Ziemer and Tranter (1976).

### Synchronous Detection Techniques

The first synchronous detection techniques were examined by Bell Laboratories and others in the 1930's. By comparison, the apparatus used was large and cumbersome. Today's solid state technology has allowed simplification by making devices such as the varicap diode available to designers. An entire synchronous demodulator is contained on a single 14 pin integrated circuit.

A decade or so ago, the Signetics integrated circuit NE561 was used to construct a synchronous demodulator. Its performance was sonically superior to its companion envelope detector implemented with a semiconductor diode and post detection low pass filter.

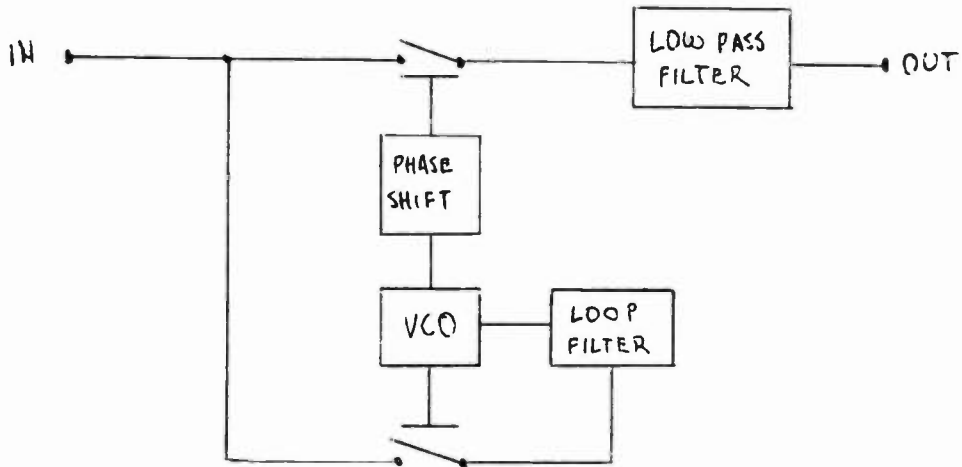
The demodulator was constructed as shown below:



The circuit was developed directly from the application notes. The external phase shift network was implemented with resistors and capacitors.

Modifications were made to increase the loop filter time constants. This demodulator is in service for monitoring a Class IV local channel station in the East. Its performance under cochannel interference conditions is very good.

Those wishing to perform some construction today should consider the techniques used by Hershberger (1982).



The author uses CD4053 switches as the active elements in the in-phase and quadrature demodulator as well as the VCO. Other techniques to obtain single sideband selectivity are presented as well. This is an excellent starting point for the study of synchronous detection techniques.

Several manufacturers offer monolithic integrated circuits suitable for synchronous detection applications. These circuits are the 1496 family, and bear numbers such as LM1496, MC1496, TCA-240D. Sansui Corporation is presently marketing a synchronous detector radio which uses the 1496 as the demodulating element. These devices are capable of exceptionally good performance.

The most promising development is the SONY CX857 integrated circuit. Introduced several months ago, it is a synchronous detector when certain signaling is applied.

No matter how simplistic, a synchronous detector will provide superior performance to most present implementations of envelope detectors. It is hoped the reader will experiment with this detection method.

## Conclusions:

The synchronous detector has been shown to provide performance superior to an ideal envelope detector in every comparison when real world signals are presented to its input. The use of synchronous detection techniques are particularly beneficial in moving vehicles. The use of the synchronous detection technique is indicated wherever possible for AM signal demodulation.

## Bibliography

- Cheng, F. and Giles, M., IC Based AM Stereo Decoder Eases Receiver Design Problems, EDN, February 23, 1984
- Cuccia, L.F., Harmonics, Sidebands and Transients in Communication Engineering, 1952, McGraw Hill Book Company.
- Eden, H. and vonRautenfeld, F., EBU Review #118, Part A, Technical, December 1969.
- Grey, P.E. and Searle, C.E., Electronic Principles; Physics, Models and Circuits, 1969, John Wiley and Sons.
- Hershberger, D., Build a Synchronous Detector for AM Radio, Popular Electronics, Vol. 20, No. 4, April 1982.
- Kreyszig, E., Advanced Engineering Mathematics, 1972, John Wiley and Sons.
- Orban, R., Comments of Orban Associates in Response to FCC Request for Comments in the Matter of Waiver of Section 73.128 (b) (2), November 1983.
- Orban, R. and Ogonowski, G., Processing AM Sound to Compete With FM, EM/E Magazine, October 1983
- Ruston, H. and Bordogna, J., Electric Networks: Functions, Filters, Analysis, 1966, McGraw Hill Book Company
- Uyttendaele, A.G., Envelope and Synchronous Demodulation V.S.B. TV Signals, Proceedings of the 29th Annual Broadcast Engineering Conference, 1975, NAB.
- Ziener, R.E. and Tranter, W.H., Principles of Communications, 1976, Houghton Mifflin Company.

---

**AM PRE-EMPHASIS AND DE-EMPHASIS:  
A SYSTEMATIC APPROACH**

by

and

Robert Orban  
Orban Associates, Inc.  
San Francisco, CA 94107

Greg Ogonowski  
Gregg Laboratories  
Tustin, CA 92680

**ABSTRACT**

This paper presents a systematic approach to deriving pre-emphasis and de-emphasis curves for AM transmission and reception to increase consumer satisfaction with AM. First, the response of an "average" radio is obtained by measurement and statistical averaging. Next, a family of pre-emphasis curves is derived to equalize these curves, thus extending the effective high frequency bandwidth of the radio. Finally, a de-emphasis curve which achieves wider subjectively-perceived bandwidth but which is compatible with the pre-emphasis curves is presented. The authors believe that the curves thus derived are the most effective compromise between the "wideband" and "narrowband" camps. These curves permit the bandwidth of the receiver to be substantially widened without introduction of unpleasant stridency or other undesirable effects. Simultaneously, they are highly effective in improving the perceived high frequency response of existing narrowband radios. Together, the pre-emphasis and de-emphasis provide "quasi-high-fi" audio which can sound very similar to FM to the consumer listening in the car [1].

IN THE UNITED STATES and Canada, AM music programming is dying. Its demise is being hastened by consumer belief that AM can be nothing more than a low-quality, monophonic medium, while FM is always high-fidelity and stereo. (Research has shown that "stereo" and "high fidelity" are often interchangeable in the mind of

the naive consumer: he or she doesn't necessarily realize that "stereo" requires two channels!)

The consumer's negative perception of AM is reinforced by narrowband receivers which provide dull, muffled sound. It is often further aggravated by inappropriate audio processing at the transmitter.

To the casual observer, AM broadcasters and receiver manufacturers seem to be at war. The broadcasters accuse the manufacturers of producing cheap, muddysounding radios. The receiver manufacturers accuse the broadcasters of preemphasizing their signals to the point where splatter and interference demand highly selective radios to avoid consumer complaints.

This paper attempts to constructively mediate the issue. It shows that the seemingly incomprehensible and contraproductive practices within the broadcast industry can be explained by the industry's economics and politics, and by a lack of standardization of receiver frequency response. It then presents a proposal for pre-emphasis and de-emphasis which compromises between the "wideband" and "narrowband" camps. The authors believe that this proposal offers the "greatest good to the greatest number".

**Why Audio Processing:** A colleague of ours is fond of saying: "It's not high fidelity, it's radio!" Although the statement is facetious, it contains a grain of truth. Radio, particularly AM radio, is an entertainment and information medium. Ideally, the purpose of audio processing is to project the message efficiently through the medium. In the case of AM, the medium has limited signal-to-noise ratio, has limited allocated RF bandwidth, is often subject to interference, and is mostly listened to on highly rolled-off receivers. The broadcaster thus compresses, limits, and preemphasizes to get his message to the maximum number of listeners. For the sake of reaching more of the mass audience, this might result in his processing hard enough to cause some discriminating listeners to tune out. Each broadcaster must individually judge what the appropriate quality should be.

Fortunately, broadcasters obtain immediate marketplace feedback from the Arbitron (ARB) audience surveys which are performed in all major and most medium markets. If the processing (or programming) doesn't please listeners, they tune out and the broadcaster's ARB ratings suffer. Audio processing is widely believed by broadcasters to have an important influence on ratings. Since many broadcasters sell time on the basis of the ARB "book", this provides an immediate economic incentive for them to make the appropriate audio processing decisions.

Then why do so many AM radio stations sound bad? The authors believe that there are two principal reasons. First, it is very difficult to design compression and limiting systems which can operate aggressively to increase average sideband power

without simultaneously introducing unnatural and fatiguing artifacts into the audio. Such artifacts might include pumping, noise breathing, distortion, and unnatural frequency balances. While we believe that the latest generation of processing equipment, when properly adjusted, has finally reduced processor-induced artifacts below the average consumer's threshold of perception, many stations are still using processing equipment which does generate objectionable artifacts.

The second reason is related to receiver design. Typical receivers have become so narrowband that broadcasters have had to choose between a "broad spot on the dial" (easy tuning of manually-tuned radios ["MTR's"]) but little pre-emphasis) and a "narrow spot on the dial" (brighter sound but more difficult tuning). In addition, even the various narrowband receivers sound different from each other because IF skirt shapes differ substantially despite an audio frequency response which is quite consistently -3dB @2kHz. It must be strongly emphasized that a single number like this, although it specifies the nominal "bandwidth", says almost nothing about the subjective sound of the radio because it does not specify the shape of the skirts.

Because of this inconsistency from receiver to receiver, it is hard for an AM broadcaster to achieve an acceptable compromise in his processing adjustments -- he's essentially groping in the dark. Thus a given broadcaster might use only a few receivers to "tune" his sound. The program director's car radio is often used as the final reference, even if it is quite unrepresentative of the "average" receiver. Meanwhile, the broadcaster sees his ARB ratings declining consistently, and he is hard-pressed to find a strategy to stop the losses. One thing is certain: It is going to take more than stereo alone to revive AM.

The two authors represent competing companies, both manufacturing electronics for audio processing at the transmitter. Yet it is clearly in our common interest, as well as in the interest of the broadcasting and receiver manufacturing industries, to cooperate in the development of standards. The current situation is chaotic -- almost as if FM broadcasters and receiver manufacturers were to use any value of pre-emphasis they wished instead of the standard 75us. In this paper, the authors offer a way out: practically-proven pre-emphasis and de-emphasis characteristics which can produce subjectively improved AM reproduction for the consumer.

One popular proposal for dealing with the dilemma is reducing pre-emphasis and widening receiver bandwidths (using flattop IF's). The authors have considered and rejected this proposal for the following reasons:

- 1) Radical reduction of pre-emphasis would be unacceptable to most radio stations because it would make their sound non-competitive on typical existing narrowband mono radios.
- 2) Conversely, new wideband radios would sound strident and screechy when reproducing preemphasized signals.

- 3) Wideband radios would have to have sharp transitions between IF passband and stopband to achieve marginally acceptable selectivity. Such an IF characteristic causes unpleasant coloration and ringing and sounds highly unnatural -- very dissimilar to FM. In addition, steep-slope filters cannot be successfully equalized with any amount of practical pre-emphasis.
- 4) Wideband radios would cause static, impulse noise, and buzz from high-voltage power lines and Triac dimmers to sound unacceptably edgy and irritating.

In contrast, our proposed de-emphasis is similar to the characteristic presently found in the better-sounding radios which have succeeded in the marketplace -- just less extreme. When such receivers are combined with AM stereo, appropriate pre-emphasis, and creative programming, the authors believe that music programming on AM can be revived and consumer satisfaction achieved.

These arguments are supported in more detail below.

### Several Problems Addressed In Detail

**Problem 1: Frequency Allocations And Occupied Bandwidth:** FCC Rules and Regulations and the pattern of AM allocations within the U.S. theoretically permit occupied bandwidth to extend to  $\pm 15\text{kHz}$ , achieving 15kHz audio bandwidth. (Sidebands must be down at least 25dB beyond 15kHz.) In Region 2, however, channels are spaced at 10kHz intervals. Strong 10kHz carrier beats occur whenever two carriers 10kHz apart fall within the passband of the receiver IF. This problem is particularly severe at night.

Carrier power is 3dB above the power in the sum of the sidebands even when the carrier is 100% modulated with sinewave. However, even if extremely aggressive audio processing is used, average sideband power is typically 3-4dB below 100% sinewave modulation sideband power or 6-7dB below carrier. Furthermore, under program conditions the spectrum of the sidebands is spread out. This causes the "monkey-chatter" (i.e., the audible interference produced by the frequency-shifted detection of adjacent-channel sidebands) to be better masked psychoacoustically by the desired channel modulation. In contrast, the 10kHz carrier beat is not only 6-7dB above the monkey chatter, but it is spectrally pure and is thus not easily masked.

In theory, monkey chatter from a station 10kHz on either side of the desired signal (a "first adjacency") can extend 5kHz beyond the desired carrier, causing marked interference. In the U.S. and Canada, however, channels are allocated to reduce the probability of such interference. This is untrue in most other parts of the world, precluding the possibility of a true high fidelity AM service there.

De-emphasis can help the situation by reducing the level of the carrier beat. Whether monkey-chatter is reduced depends upon many factors, including whether the interfering signal is a first- or second adjacency, and how the sideband energy is distributed spectrally.

**Problem 2: Receiver Bandwidths And IF Shape:** Despite the theoretical availability of 15kHz audio bandwidth, almost all present-day receivers are limited to a -3dB bandwidth of approximately 2kHz. Fig. 1 shows the mean and standard deviation of the audio response of some fifteen common AM radios as of 1980, as electrically measured at the loudspeaker or line output. (Loudspeaker acoustic responses were not included.) The standard deviation is relatively small up to 6kHz, making synthesis of a corrective pre-emphasis curve statistically valid up to this frequency. (It is possible that the increasing use of sharp ceramic filters in receivers built since 1980 would change the curve shape and/or increase the standard deviation if these measurements were repeated in 1985.) Mean response is approximated within 1dB by a third-order Bessel (maximally-flat delay) lowpass filter with a -3dB frequency of 2kHz.

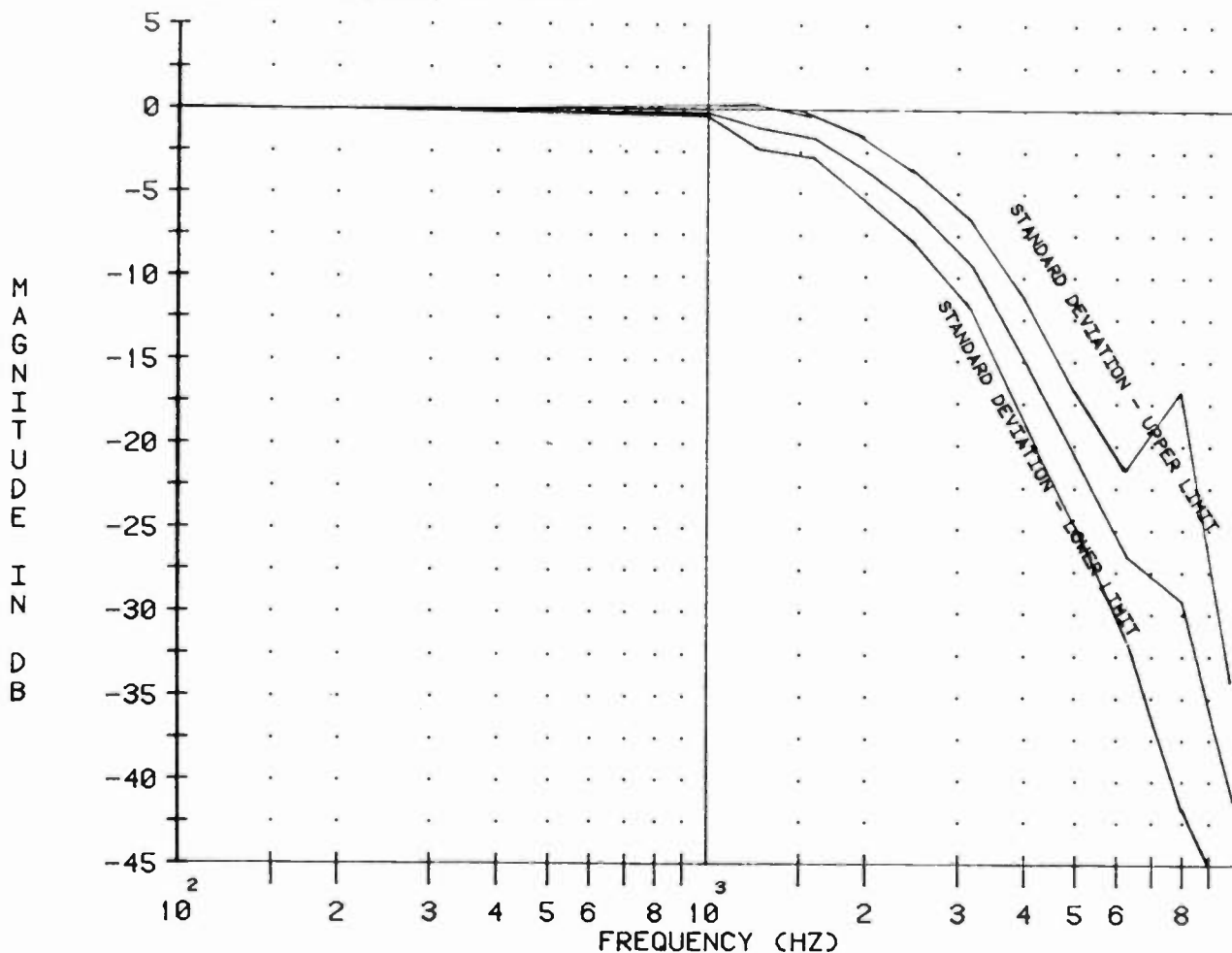


Fig. 1: Mean Measured Response Of Typical AM Radios (circa 1980)



Such a radio sounds dull and lifeless when reproducing music broadcast without pre-emphasis. Reportedly, this highly rolled-off response was a reaction by receiver manufacturers to consumer complaints about interference at night under skywave conditions, about problems encountered when attempting to receive distant stations, and about sensitivity to static and other forms of impulse noise. In our opinion, the bandlimiting necessary to make such degraded distant AM signals even marginally listenable is likely to cause the present-day consumer -- accustomed to high-quality audio -- to tune out anyway unless the program material is of extraordinary interest to the listener (like a hometown sports event).

In the auto industry, it is said that the various operating divisions had rejected wideband radios as proposed by the auto companies' own captive electronic manufacturers, based on the reasoning that consumers expected quiet cars, and that static and interference under difficult conditions are not "quiet". By making the rolloff that extreme, the manufacturers thus sacrificed the interests of millions of urban listeners in order to avoid complaints from those who were attempting to receive stations under difficult conditions. The urban listeners didn't complain that their AM reception was woolly and muffled -- they simply switched to FM! According to Arbitron, the percentage of the total radio audience listening to AM has been declining by approximately 3% per year in the U.S. since the late 1970's. Needless to say, AM broadcasters are deeply concerned about this trend!

In an attempt to make the frequency response of the radios sound better-balanced, many AM stations began to employ high-frequency boost (pre-emphasis). With FM listenership increasing yearly, this was (and is) simply a matter of self-defense.

Since no standards exist for pre-emphasis and de-emphasis, some receiver manufacturers reduced bandwidth even further upon observing that pre-emphasis tended to increase monkey-chatter. In addition, the ready availability of economical ceramic filters finally let many RF-oriented receiver designers have, at low cost, what the textbooks said was desirable: a favorable "shape factor" in IF's.

In communications, the smaller the shape factor (the ratio between the -6dB and -60dB frequencies) the better. Unfortunately, many find that such abrupt filters sound terrible when reproducing music. It has been theorized that a million years of evolution have taught the ear that "natural" high frequency rolloffs (such as those introduced by atmospheric absorption) are gentle and preserve time relationships between spectral components. In contrast, highly selective filters store energy around the edge of the passband, creating severe ringing and non-linear time delay. The ear hears this as an sharp, edgy, unnatural, and fatiguing coloration which is not at all "FM-like" even if the flat-top bandwidth of the IF is wide by current standards. (Other authors have also commented on the unpleasantness of the sound of highly selective lowpass filters with cutoff frequencies in the 2-10kHz region [2,3].)

Fig. 2 shows the step response of a 5kHz Chebychev filter with 0.1dB of ripple in the passband, which represents a model of this type of behavior in the audio domain.

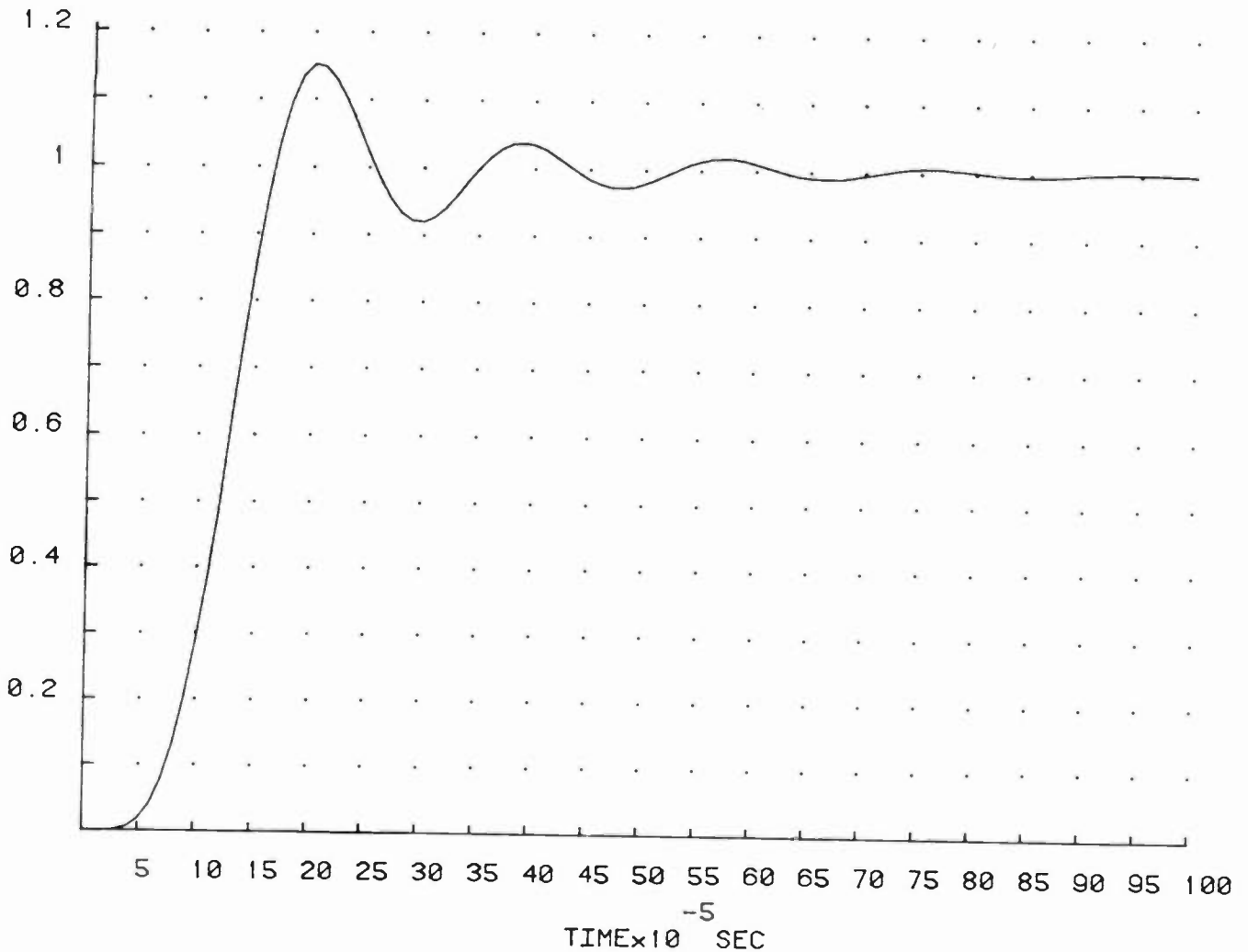


Fig. 2: Step Response Of Sharp Cutoff 5kHz Lowpass Filter  
(Equivalent To IF Filter With Steep Skirts And Abrupt Transition From Passband)

The ringing due to 5kHz stored energy is clearly visible, and is even more clearly audible when music is passed through the filter.

This filter response is not dissimilar to some that have been proposed for use in new AM stereo radios in order to achieve wider bandwidths than the 2kHz typical of current radios. In addition to the ringing and coloration, static and impulse noise will sound far more offensive through such an IF filter because such impulsive interference will make the filter ring, extending the length of the impulse and exaggerating its audibility. In addition, IF ringing can cause the detector to see instantaneous envelope overmodulation. Even though information is not lost (the

envelope "folds around" the zero axis instead of being clipped), the distorted envelope will be faithfully (and distortedly) reproduced by a conventional envelope detector, degrading quality. (A synchronous detector, however, will introduce no such distortion.) When all factors are considered, a  $\pm 4$ -6kHz flattop IF, while "widening the bandwidth", is clearly not the way to compete with FM.

**Problem 3: Inappropriate Audio Processing:** Today, it is usually the program director, not the engineer, who controls the "sound" of a radio station. Despite engineers' complaining, this is not unreasonable. The program director is ultimately responsible for the entire "show". As in the case of a stage or motion picture production, the technical staff is there to assist the director in obtaining the desired artistic effect. After all, it is the program director, not the engineer, who gets fired if ratings are not satisfactory!

To meet the severe competition, most program directors evidently believe that aggressive audio processing is necessary. "Louder!" and "Brighter!" are the rallying cries. (Unfortunately, "Cleaner!" usually comes in a poor third.)

In AM, the authors recognize the need for maximum loudness consistent with good sound, since loudness and coverage are directly proportional. However, pressure for loudness and brightness has often led to processing which is strident, harsh, distorted, and pumpy -- a true audio chamber of horrors! None of these artifacts are necessary, and they have been dramatically reduced or altogether eliminated in the new generation of processors. However, the audiences' impression that AM is somehow "busy" and overly commercial can only be reinforced by the older processing style. The authors believe that this negative image can only be overcome by creating a new FM-like audio quality on AM. Stereo alone is not the answer.

One reason why AM processing can sound harsh and strident (but without "air" and a truly extended high frequency response) is that first-order (6dB/octave) or second-order (12dB/octave) pre-emphasis curves are often used to try to compensate for a third-order (18dB/octave) rolloff in the radio. When this is done, the lower midrange (1-3kHz) is excessively boosted, while the high frequencies are not boosted enough. Some have described this sound as "honky". As will be seen below, our proposed pre-emphasis curve is a third-order curve which does not cause this problem.

Fig. 6 shows the overall transmitter/receiver frequency response when the "average" receiver of Fig. 1 is used with 150us (6dB/octave; up 3dB at 1.06kHz) pre-emphasis. An undesirable lower-midrange boost is clearly seen.

## Other Considerations

**Compatibility:** The cornerstone of our reasoning is simple: whatever pre-emphasis is used must be compatible with current AM receivers. Any new pre-emphasis (or elimination thereof) which causes current mono radios to significantly lose either loudness or brightness will be rejected by program directors, thus failing in the marketplace. Idealistic proposals for radical reduction of pre-emphasis with a simultaneous increase in receiver bandwidths are unrealistic. The millions of currently-used mono radios will not vanish in a puff of smoke. Current auto sales patterns indicate that consumers are keeping their cars longer. It seems probable that most current AM auto radios will be around another 5-10 years.

**The Automobile -- The Key Listening Environment:** It is improbable that any amount of improvement to the AM transmission/reception system will significantly affect home listening habits. Not only does FM stereo have intrinsically wider bandwidth (theoretically 19kHz for FM vs. 15kHz for AM, and practically 15kHz vs. 12kHz when the need for guardbands is taken into account), but it also offers vastly superior rejection of many common types of noise that plague AM, such as static, impulse noise, Triac dimmer buzz, and the like. The most important factor, however, is consumer conditioning. Consumers are in the habit of listening to FM stereo at home because they believe that the programming is better, the sound is better, and because it is the sophisticated thing to do. If AM became better than FM tomorrow, it would still take years to reverse this conditioning!

The automobile is different. FM stereo simply doesn't work consistently well during mobile reception. Bursts of severe multipath distortion, "picket-fencing", and signal dropouts often degrade the signal to well below "entertainment-quality". AM is essentially immune to these effects, and AM stereo promises to offer better and more consistent reception in the automobile environment than does FM stereo. Further, the automobile listening environment seems to minimize the subjective effect of slightly decreased bandwidth (compared to FM), and renders considerable audio processing desirable so that radio listening can be enjoyed despite the very high (by home standards) acoustic noise level in the car.

Even the consumer press is beginning to realize this. Writing in the April 1983 Stereo Review, Christopher Greenleaf observes:

"...Objections to stereo AM on the grounds that AM as such is not capable of good sound have been gradually quashed. Local broadcasters have sent out high-quality signals heard at (consumer electronics) shows, good AM tuners have been made, and the need for long-distance reception in exurban areas has become apparent. Even in big cities, where downtown FM reception becomes a bad joke for most of us, AM is

largely unhampered by tall buildings and such. If the less enlightened broadcasters learn what a good signal can be like, and if a single format for AM stereo becomes standard, then we'll see car radio reception gain an entirely new dimension."

## A SOLUTION: SUBJECTIVELY-MATCHED PRE-EMPHASIS AND DE-EMPHASIS CURVES

**Genesis Of A Pre-emphasis Curve:** Fig. 1 showed the response of an "average" AM radio. The authors propose that the transmission pre-emphasis follow the inverse of this curve up to some frequency and then become flat again. While there is little question that the curve should be up 3dB at 2kHz and rise at 18dB/octave thereafter, it is not immediately clear how to choose the frequency at which the pre-emphasis stops and the shape of the "nose" of the curve around this stopping frequency. These matters must be settled by subjective listening tests, experimentation, and a great deal of experience. A discussion follows.

If the shape of the pre-emphasis curve around 2kHz is correctly chosen, then the transmitter/receiver system can be modelled as a lowpass filter of wider bandwidth than the original receiver. Any common third-order lowpass filter characteristic can be chosen: Chebychev, Butterworth, and Bessel are the three that are best-known.

The choice of a subjectively optimum lowpass filter characteristic is heavily dependent on the frequency response of the receiver used for listening tests. A "quasi-Chebychev" response can be chosen to create a slight "presence peak" at 5kHz. This choice results in brightest sound and greatest loudness on conventional narrowband radios typical of the Fig. 1 curve. The Bessel response provides a substantially smoother sound on radios which are wider-band than Fig. 1, particularly if flat-top IF's are used. However, loudness and presence are lost on conventional narrowband radios.

Peless and Murakami [4] proposed a family of "Transitional Butterworth-Thompson" lowpass filters whose characteristics vary smoothly between a Butterworth (maximally-flat magnitude) and Bessel (maximally-flat delay; also known as "Thompson") characteristic according to an interpolating constant  $m$ , where  $0 < m < 1$ . If  $m=0$  the filter is Butterworth; if  $m=1$  the filter is Bessel. These filters are useful in compromising between the needs of the conventional narrowband and flattop wideband radios.

The three pre-emphasis curves discussed above are illustrated in Fig. 3. It can be seen that they begin to shelve-off in the region between 4 and 5 kHz. If the boost continued beyond these frequencies, the extreme high frequency boost would make manually-tuned radios (MTR's) difficult to tune, might cause audio processors to

misbehave, and would cause loudness loss. Fig. 4 shows that when these curves are applied to the "average" radio, the effective 3dB-down bandwidth of the radio is extended approximately one octave without midrange coloration.

In order to control occupied bandwidth to meet FCC rules, these curves must be used in conjunction with a steep lowpass filter following the processing. A fifth- or higher-order elliptical function filter with a ripple bandwidth of 12.0kHz is appropriate. The ear is very sensitive to small changes in bandwidth around this cutoff frequency, and the authors do not recommend reducing the cutoff frequency of the filter below 12kHz if "quasi-hi-fi" sound quality is to be obtained through the system. (Even a bandwidth change as small as 11kHz to 12kHz is easily perceptible.)

Processors using equalizers which can generate these curves are in use in almost one thousand radio stations worldwide as of February 1985, with substantially over five hundred in the U.S.A. (The "quasi-Chebyshev" curve is most widely employed.) With the use of a 12kHz filter and appropriate high frequency limiting, FCC occupied bandwidth requirements are met by a comfortable margin provided that the transmitter is properly designed and adjusted.

In addition to plug-in modules which enable the broadcaster to choose one of the three curves described above (i.e., "quasi-Chebyshev", Transitional Butterworth-Thompson, and Bessel), the processors also provide a "High Frequency Equalizer" control to permit the broadcaster to vary the frequency at which the pre-emphasis begins to shelve-off. This control was provided to meet the marketplace demands of broadcasters for adjustable pre-emphasis, and is adjusted to make tradeoffs between tuning ease and brightness. The control would probably be unnecessary if receiver frequency response were standardized as proposed below in this paper.

Fig. 5 shows a typical family of "quasi-Chebyshev" curves. Note that the curve shapes within the family are such that the effective bandwidth of the transmitter/receiver system is varied without introducing coloration (i.e., peaking or dipping of the frequency response) in the area below the effective cutoff frequency. Judging from informal discussions and interactions with many customers, the authors believe that most stations adjust the equalizer to produce between 12 and 20dB of ultimate high frequency boost. (A more formal survey would be required to obtain rigorous statistics.)

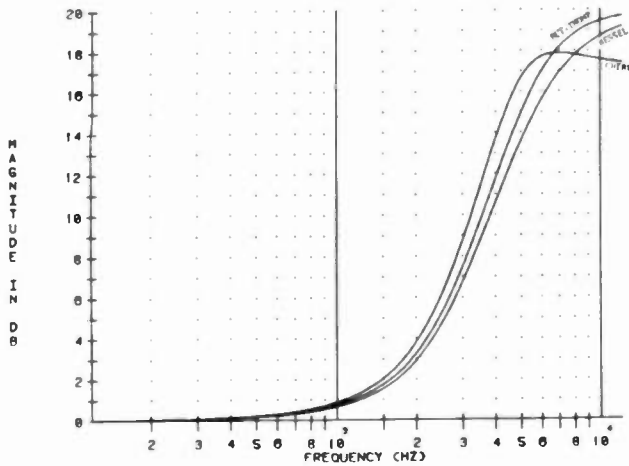


Fig. 3: Recommended Transmission Pre-emphasis Curve Family

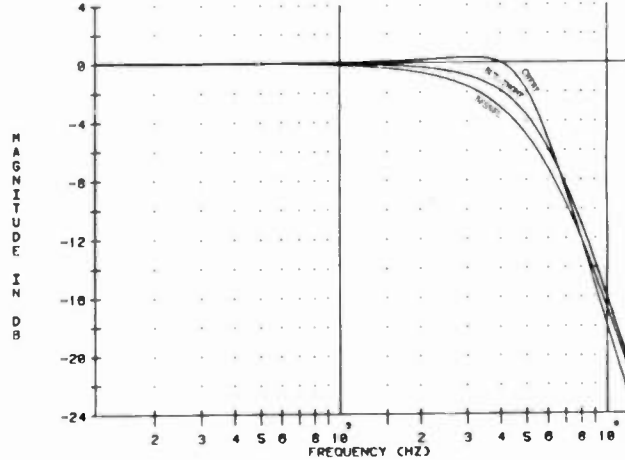


Fig. 4: Recommended Pre-emphasis Curves Through "Average" Radio

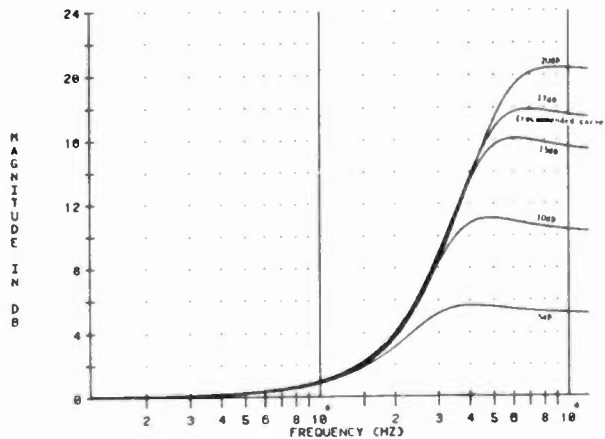


Fig. 5: "Quasi-Chebyshev" Pre-emphasis Curve Family

**Processing For The Recommended Curves:** Receivers which are slightly mistuned or whose IF bandpass is asymmetrical can produce objectionable distortion if excessive high frequency energy is received. Such energy can also occupy excessive bandwidth. To control such potential problems, the pre-emphasis network should be followed by a high frequency limiter. This means that the transmission frequency response is identical to Fig. 3 only when the program material contains a relatively small amount of high frequency energy. When a large amount of high frequency energy is present, the processing dynamically reduces the high frequency response as necessary. With pink noise (equal energy per octave) applied to the processing, the curve is typically up 10dB instead of 18dB as shown in Fig. 3. To achieve minimum perceived high frequency loss, the authors recommend dividing the preemphasized frequencies into several bands with relatively steep slopes, and

processing each band separately.

**Alternate Proposals:** Several papers have proposed the use of a 75us single-time-constant pre-emphasis in AM [5,6]. Fig. 6 contrasts the radio's frequency response unequalized, as equalized by 75us, and as equalized by the "quasi-Chebyshev" pre-emphasis. It can be seen that the 75us pre-emphasis is well-matched to the radio in the sense that it causes no midrange peaking. However, it simply changes the radio rolloff from 18dB/octave to 12dB/octave. While this gives a mild subjective improvement, the result is in no sense "hi-fi"-sounding. About the only advantages that the authors can ascribe to this curve (in comparison to our proposal) are a tendency to reduce adjacent-channel monkey-chatter in difficult reception situations, and easier audio processing. It would probably be "in the running" if we could design new AM receivers on a clean slate without having to worry about compatibility with existing radios. However, given the compatibility problem, the authors must reject 75us as a half-way measure.

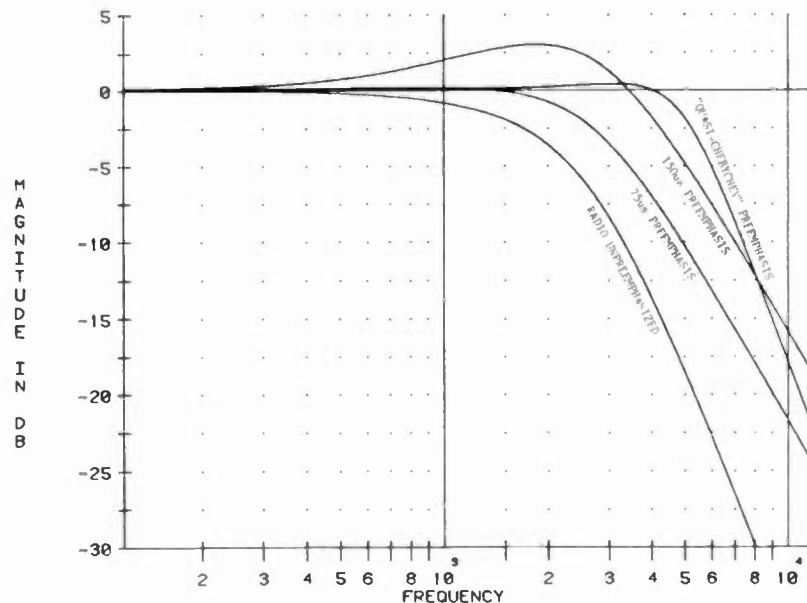


Fig. 6: 75us And 150us EQ vs. "Quasi-Chebyshev" Pre-emphasis Through Average Radio

**Subjectively-Matched De-emphasis:** At first thought, it might be supposed that a filter exactly reciprocal to one of the Fig. 3 curves should be used at the receiver to restore flat response. The authors have experimented with such a filter and have noted the following problems:

- 1) When commercially-desirable amounts of multiband audio processing are used, there is typically a slight depression of midrange energy on current pop records due to the dynamic frequency response of the processing, which effectively changes the pre-emphasis curve as a function of program spectral content.



- 2) The shelf above 5kHz tends to exaggerate any distortion caused by aggressive audio processing.
- 3) The reciprocal of the pre-emphasis curve stops rolling off exactly where the most receiver selectivity is required, exaggerating monkey-chatter problems.
- 4) Realizing the curve in a practical receiver would require a somewhat complex audio filter combined with synchronous detection, since realization of the high frequency shelf in the IF would probably be uneconomical.

The authors therefore decided to perform listening tests with a parametric lowpass filter in an attempt to obtain a receiver frequency response which would sound "FM-like" to the average consumer, but which would respect the practical limitations of the AM channel and the economics of manufacturing. Both second- and third-order all-pole networks were considered. The "quasi-Chebyshev" curve, since it is most effective in equalizing a typical common narrowband radio, was used as the reference pre-emphasis curve in the tests. The de-emphasis curve in Fig. 7 was eventually accepted as the best compromise, yielding a "quasi-hi-fi" sound on both small speakers and large studio monitors. The authors believe that the average consumer would be unable to distinguish this sound from FM, and that even sophisticated audiophiles would find it easily listenable, well-defined, and usually preferable to FM in an automobile listening environment (due to lack of "picket-fencing" and other FM reception problems). This de-emphasis also works well with the alternate (Transitional Butterworth-Thompson and Bessel) pre-emphasis curves.

Fig. 8 shows the overall response of the three pre-emphasis curves each cascaded with the recommended de-emphasis curve. These responses are not flat, exhibiting a peak in the upper midrange and gently rolling off thereafter. The peak, whose size depends on the shape of the pre-emphasis curve, compensates psychoacoustically for the rolloff above 8kHz. It also tends to equalize the dynamic frequency response changes typically introduced by multiband audio processing. The high frequency rolloff reduces the effects of monkey chatter and whatever high-frequency distortion might be induced by aggressive audio processing. Because of its substantial rolloff in the upper midrange (where the ear is most sensitive), the curve also substantially decreases the objectionability of static and other impulse noise -- particularly by comparison to a flat-top wideband IF with steep skirts. Yet the HF rolloff of the recommended de-emphasis is so gentle that the subjectively-perceived bandwidth still extends to 12kHz.

As the step response curve in Fig. 9 shows, impulse noise will not cause the recommended de-emphasis to ring. The lack of overshoot in Fig. 9 also indicates that the recommended de-emphasis is better matched to an envelope detector than is a steep-slope flattop filter because the recommended de-emphasis cannot induce envelope overmodulation in the IF.

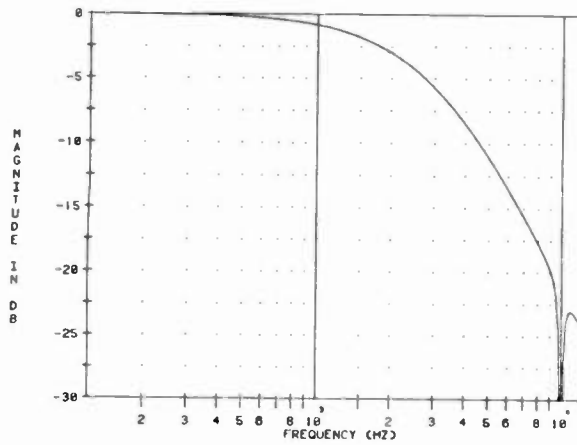


Fig. 7  
Recommended De-emphasis Curve

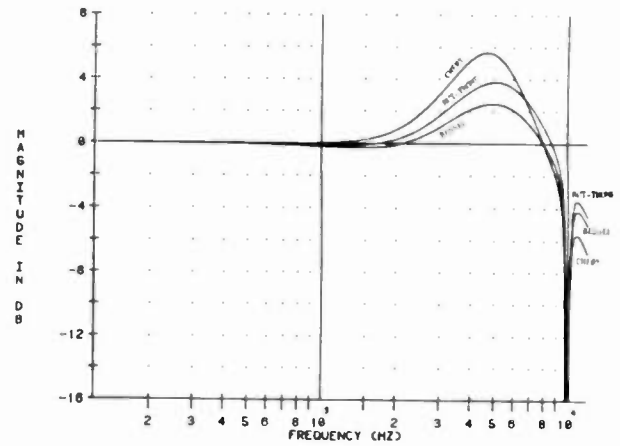


Fig. 8  
Pre-emphasis Curves Cascaded  
With Recommended De-emphasis Curve

A further advantage of such de-emphasis (combined with substantial pre-emphasis) is that de-emphasis within the IF removes enough sideband energy from the signal to reduce the percentage of envelope modulation as seen by the detector. The detector is therefore easier to design and manufacture because linearity requirements at high modulation are relaxed.

**10kHz Notch Filter:** As discussed above, the energy of the 10kHz carrier beat is typically 6-7dB above the integrated energy of all monkey chatter. For this reason, the 10kHz beat is totally dominant psychoacoustically, and its presence is often the single most obvious give-away that one is listening to AM. The FCC requires the carrier frequency to be within  $\pm 20$ Hz of nominal. Thus the carrier beat frequency is predictable  $\pm 40$ Hz and can be removed with an extremely sharp notch filter. (A filter with a "Q" of 15 or higher has no apparent audible effect on program material.)

Note the sharp notch at 10.0kHz shown in Fig. 7. While the notch could probably be omitted in low price-point radios, the authors feel strongly that it should be included in any receiver intended to provide audio quality subjectively competitive with FM.

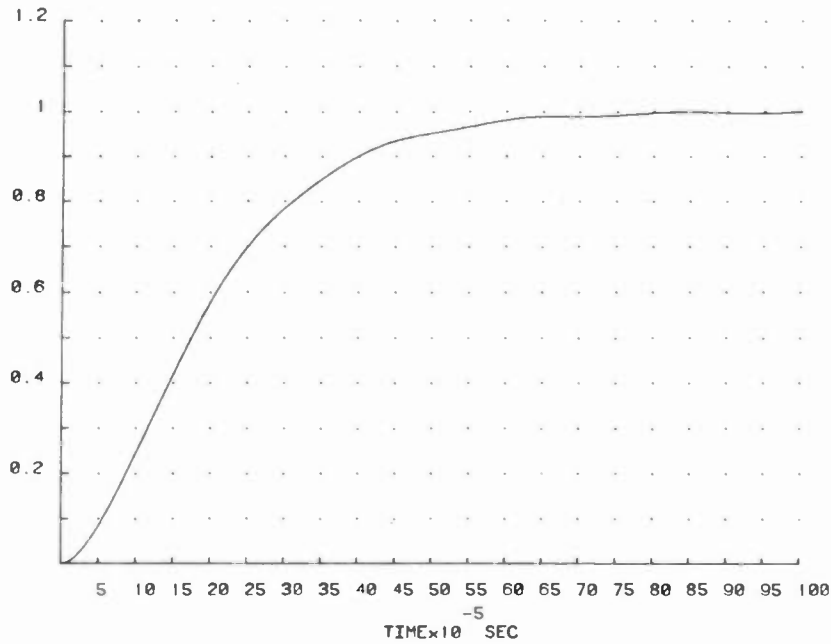


Fig. 9: Step Response Of  
Recommended De-emphasis Curve

**AM Stereo:** While the recommended curve can probably be used with any AM stereo system, receiver design strategy should be different for linear systems than for non-linear systems.

Linear systems using either quadrature modulation or independent sideband modulation (without correction for envelope detector compatibility) will exhibit no problems with pre-emphasis and de-emphasis. Provided that synchronous detection is used for stereo decoding, the recommended rolloff can be incorporated either in the IF or after the detector with essentially no change in system distortion characteristics. There must be enough IF selectivity to avoid potential cross-modulation due to unavoidable non-linearities in real-world IF amplifiers and synchronous detectors. The IF bandwidth can be made arbitrarily small with no degradation other than frequency response rolloff.

In the case of the quadrature system, envelope detector reception in mono will exhibit some even-order distortion. (The independent-sideband system without correction for envelope detector distortion is subjectively incompatible with envelope detector reception because the distortion produced by the envelope detector consists of high-order terms and is therefore audibly offensive.)

In the case of the quadrature system, de-emphasis after the envelope detector would tend to emphasize any difference-frequency IM, and the de-emphasis should therefore be realized in the IF. Fortunately, this is where it is realized in current

mono radios, and field experience to date suggests that the envelope-detector distortion is quite innocuous, mainly adding brightness.

The situation with the non-linear systems [Kahn-Hazeltine (ISB), Magnavox (PMX), Motorola (C-QUAM)] is more complex. Here, IF filtering and audio filtering are not interchangeable because of non-linear detection. Ideally, the non-linear detection is the inverse of the stereo encoding, yielding a linear transfer curve from transmitter input to receiver output. Simultaneously, compatibility with envelope detectors is assured.

This assumes an infinite bandwidth between transmitter and detector. Limiting this bandwidth can introduce problems. Take the example of 9kHz and 10kHz applied simultaneously to a nonlinear system. In addition to tones  $\pm 9\text{kHz}$  and  $\pm 10\text{kHz}$  from the carrier, the RF spectrum will also contain sum and difference tones  $\pm 19\text{kHz}$  and  $\pm 1\text{kHz}$  from the carrier. If such a signal were to be passed through an IF realizing the recommended de-emphasis, the 9kHz and 10kHz tones would be attenuated more than 20dB, while the 1kHz difference-frequency tone would be essentially unattenuated. When presented to the stereo decoder, the phase and amplitude relationship between the 1kHz, 9kHz, and 10kHz tones would not be the same as they were at the transmitter. The 1kHz difference tone would thus not be cancelled by the receiver, and would be heard instead as IM distortion. This observation suggests that the pre-emphasis, de-emphasis and audio processing should be done in a very specific way to alleviate potential problems.

To preserve loudness equivalent to monophonic transmission, audio processing for AM stereo should be performed in "sum-and-difference" mode. The processor senses and controls the L+R (stereo sum) signal, thus achieving maximum envelope modulation. To meet the overload requirements of the Motorola C-QUAM system, it is necessary to incorporate additional peak limiting such that the negative modulation caused by either the left or right channels individually is limited to -75%, where -100% represents envelope carrier cutoff. Because non-linear effects of various sorts are increased in the linear quadrature and Kahn/Hazeltine ISB systems by single-channel modulation greater than 75%, it may be wise to apply such limits to these systems as well.

In the case of the non-linear systems, large amounts of energy above 5kHz should not be transmitted in the L-R (difference) channel to avoid distortion in the receiver and to minimize the possibility of creating excessive occupied bandwidth. In practice, the program material causing problems is typically vocal sibilance and other infrequently-occurring sounds. The authors previously advocated placing a 5kHz lowpass filter in the L-R channel to eliminate potential distortion. However, this filter eliminates separation above 5kHz at all times, even when the program material is benign. The authors have since discovered that a single-channel

modulation limiter, because it operates on the preemphasized signal, detects high-level high frequency L-R information and attenuates it far enough to eliminate objectionable distortion or occupied-bandwidth problems.

In addition, the IF bandwidth of the receiver should be flat and approximately phase-linear throughout as wide a frequency range as possible consistent with adequate selectivity. This way, correct reconstruction of the audio can occur in the stereo decoder and difference frequencies will be properly cancelled. Any IF rolloff beyond the flat, phase-linear region can be shaped to realize the part of the recommended de-emphasis located between the end of the flat IF region and 12kHz.

Finally, the audio section after the stereo decoder should contain filters which realize the part of the recommended de-emphasis which is contained within the "flat" part of the IF, and which realize the 10kHz notch as well.

While different non-linear AM stereo systems have different sensitivities to the problem of distortion induced by limited bandwidth before the decoder, the above strategy should result in cleanest sound with any of them. This strategy's only significant limitation is that it is probably impossible to use it to economically create a variable-bandwidth receiver for the mass-market. However, a reasonable compromise might be made by use of variable audio rolloff instead of variable IF rolloff.

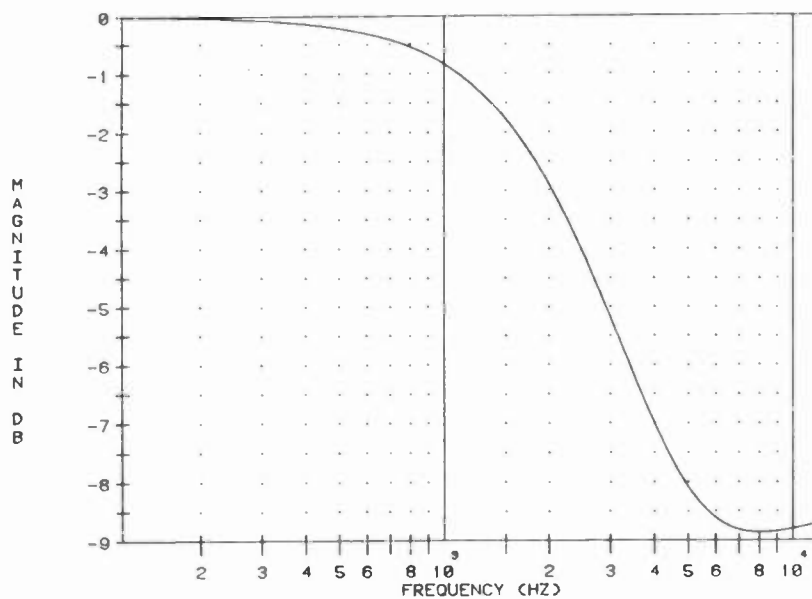


Fig. 10:  
Possible Audio Filter  
To Complete Recommended De-emphasis

## Conclusion

Subjectively-matched pre-emphasis and de-emphasis curves for AM and AM stereo transmission and reception have been described. These curves take into account the commercial realities of AM broadcasting while achieving audio quality at the receiver which is "quasi-hi-fi" and which is essentially indistinguishable from FM to the average consumer. The pre-emphasis curves do not overtax well-designed audio processors, are fully compatible with the millions of conventional mono AM radios in the hands of consumers, and have already received the enthusiastic acceptance of hundreds of broadcasters as this is written. Laboratory modification of a popular electronically-tuned radio to create the recommended de-emphasis produced the expected favorable results, including compatibility with existing broadcast pre-emphasis practices.

This compatibility is crucial. Our proposed de-emphasis curve is "upwardly-compatible": Receivers employing the proposed de-emphasis sound even better than the "average" receiver when receiving pre-emphasized broadcasts, and can also serve as a reference standard for the broadcaster. Because the new curve is compatible with existing pre-emphasis practices, the broadcaster is not forced to choose between old and new radios when adjusting his processing, and can therefore maximize his audience share.

The authors believe that it is particularly important for the major manufacturers of automobile radios to lead the industry by adopting the recommended de-emphasis as their "wideband" standard. If radio frequency response under good reception conditions becomes predictable, the broadcasters will have much less incentive to vary their pre-emphasis practices, and we all will come one step closer to consistently high-quality AM sound.

Use of these pre-emphasis and de-emphasis characteristics will permit the manufacture of economical AM stereo auto radios which perform notably better than FM stereo in the automobile environment. While the authors would not expect a significant change in home FM listening habits, the improved sound in the automobile environment should return a substantial portion of the large drive-time audience to AM, reviving the sagging economic viability of AM music broadcasting.

Combined with creative programming and effective consumer education, the experience of hearing high fidelity AM stereo in the car may just change consumer listening habits in fixed environments as well.

The authors hope that, just as we have cooperated in the development of this proposal with the hope that all in the industry will benefit, others will realize that a standard can only lead to improved economic health for all. Since these curves are not protected by patent rights and are readily duplicated, nothing about them can be construed as anti-competitive. Instead, they can be combined with AM stereo to achieve an AM service which is competitive with FM stereo in the ears and minds of the mass audience.

## REFERENCES

- [1] An expanded version of the present paper, including mathematical descriptions of the curves employed and a discussion of receiver design is found in: R. Orban & G. Ogonowski:"AM Broadcast And Receiver Standards: Towards Opening A Dialogue", Proc. Audio Conf. (IPC7) of 1985 SAE International Conf., Detroit, MI (1985)
- [2] G. Slot, Audio Quality: Requirements For High-Quality Sound Equipment. New York, Drake Publishers Ltd., 1971, pp. 51-53
- [3] R. Lagadec & T.G. Stockham, "Dispersive Models For A-to-D And D-to-A Conversion Systems", Audio Eng. Soc. Preprint #2097, 75th Convention (March 1984), p. 12
- [4] Y. Peless & T. Murakami, "Analysis And Synthesis Of Transitional Butterworth-Thompson Filters And Bandpass Amplifiers", RCA Rev., Vol. 18 (March 1957), pp. 60-94
- [5] G. Petke, "Processing Programme Signals For LF And MF Broadcasting", E.B.U. Rev. - Technical Part, No. 178 (December 1979), pp. 267-279
- [6] C.P. Payne, "AM Pre-emphasis And Transmission Bandwidth", Proc. 1981 Broadcast Eng. Conf., National Assoc. of Broadcasters, Washington, D.C. (1981)





---

## A NEW DESIGN IMPROVES CAVITY BACKED X-DIPOLE

### PERFORMANCE FOR FM BROADCAST

A. R. MAHNAD

CETEC ANTENNAS

SACRAMENTO, CALIFORNIA

#### ABSTRACT

In this paper a new cavity back antenna is introduced. The antenna features four flat spiral shape mono-poles arranged coplanar with the cavity aperture. A circumferential slot in a coaxial feed system excites these monopoles. The combination of feed mechanism and the shape of monopoles and a specially designed coupling system results in an exceptionally low VSWR over a wide band of frequency for each dipole and consequently an excellent axial ratio performance for the antenna over such a broadband of frequencies. Performance data of this antenna is then compared with the pertinent data available on similar antennas to emphasize the improvement. Finally it is noted that the persistent low VSWR and low axial ratio over 20% bandwidth of this antenna makes it an excellent candidate for multiplexed FM and/or TV Broadcast Antenna Systems.

#### INTRODUCTION

Cavity back cross dipole antennas have been around for quite a long time.<sup>(1,2,3)</sup> This type of antenna in its simplest form consists of an open ended cavity, excited by a set of dipoles positioned normal to each other and excited by equal voltages with 90° phase difference.

Over the years, different design features have improved the performance of these types of antennas. Introduction of flat dipoles<sup>(3)</sup>, different feeds and baluns<sup>(2)</sup>, and finally "sleeving the dipole"<sup>(1)</sup>, each has improved the over all performance of the cross dipole to some extent.

In what follows we summarize the performance of these configurations as measured by actual models and compare the data with the computer generated results of their mathematical models. A design improvement is then introduced and its input impedance and axial ratio compared with those of the other designs.

But before we proceed, a few words are necessary to clarify the importance of true CP operation of circularly polarized antenna elements.

### AXIAL RATIO AND CP OPERATION

The term axial ratio, which is almost always used in conjunction with any CP antenna, is indeed an indication of how close to a true CP an antenna is operating. A zero dB axial ratio corresponds to an ideal CP operation, where a rotating plane wave does not go through any change in its magnitude as it rotates in the plane that is transverse to its direction of propagation. Furthermore higher values of axial ratio correspond to elliptical or linear polarizations.

Axial ratio of a CP antenna effects the over all antenna performance in many ways. One of which is the over all gain in the two orthogonal linear polarizations, ie vertical and horizontal.

TV and FM receptions are normally linearly polarized, consequently it is important to optimize the transmission gain in these two polarizations. A poor axial ratio will directly effect the gain in these planes through uneven split of power. This effect will deteriorate the over all performance of an array of such antennas in following ways:

- 1) For an array of identical elements that are identically oriented and excited, the gain in one polarization would be different from the gain of the other.
- 2) In some arrangements, some of the elements are rotated and their phase is then compensated by cable length. This is usually done to improve.
  - a) The over all bandwidth
  - b) The over all axial ratio

However, no matter how this rotation is performed, the over all gain would suffer from this arrangement.

In these cases nonuniformity of the aperture of the array will result in unwanted null fill or broaden the beamwidth of the array, both of which will result in reduction of gain.

It is there for of utmost importance to maintain a low axial ratio over the required bandwidth to minimize the gain deterioration.

### CIRCULAR POLARIZATION AND CAVITY BACKED DIPOLE ANTENNA

A rather common technique for producing circularly polarized beam has been to place two linear dipoles at right angles in front of a reflecting screen or inside of a circular cylindrical open ended cavity and to feed them with equal

voltage magnitudes and in phase quadrature. The advantages of cavity over the flat reflecting screen are: greater control over the radiation pattern, similarity of E & H-plane patterns and greater directivity. In short the dipoles generate the circularly polarized field and cavity controls the field patterns. (4)

Obviously the essential requirement of maintaining circular polarization over a band of frequencies is that the voltages applied to each dipole be equal. (5) This is guaranteed only when the dipole impedances, which are adequately matched, remain the same over that band of frequencies. However, dipoles are resonant elements and their impedance change with frequency. This change of impedance, if great enough, can drastically deteriorate the CP operation of the antenna. To demonstrate this phenomena one can develop a simple circuit model for cross dipoles fed in quadrature phase as shown in fig (1). From the input side, each dipole is viewed as a complex impedance load. Since the impedance of one of the dipoles undergoes an additional rotation in the feed line (of substantially  $\lambda/4$ ), the two impedances at the combining junction are not equal. This results in an unequal split of the incident power divider, if the dipoles are not perfectly matched to the line. Using simple network theories one can compute the combined impedance as seen by the incoming wave from generator.

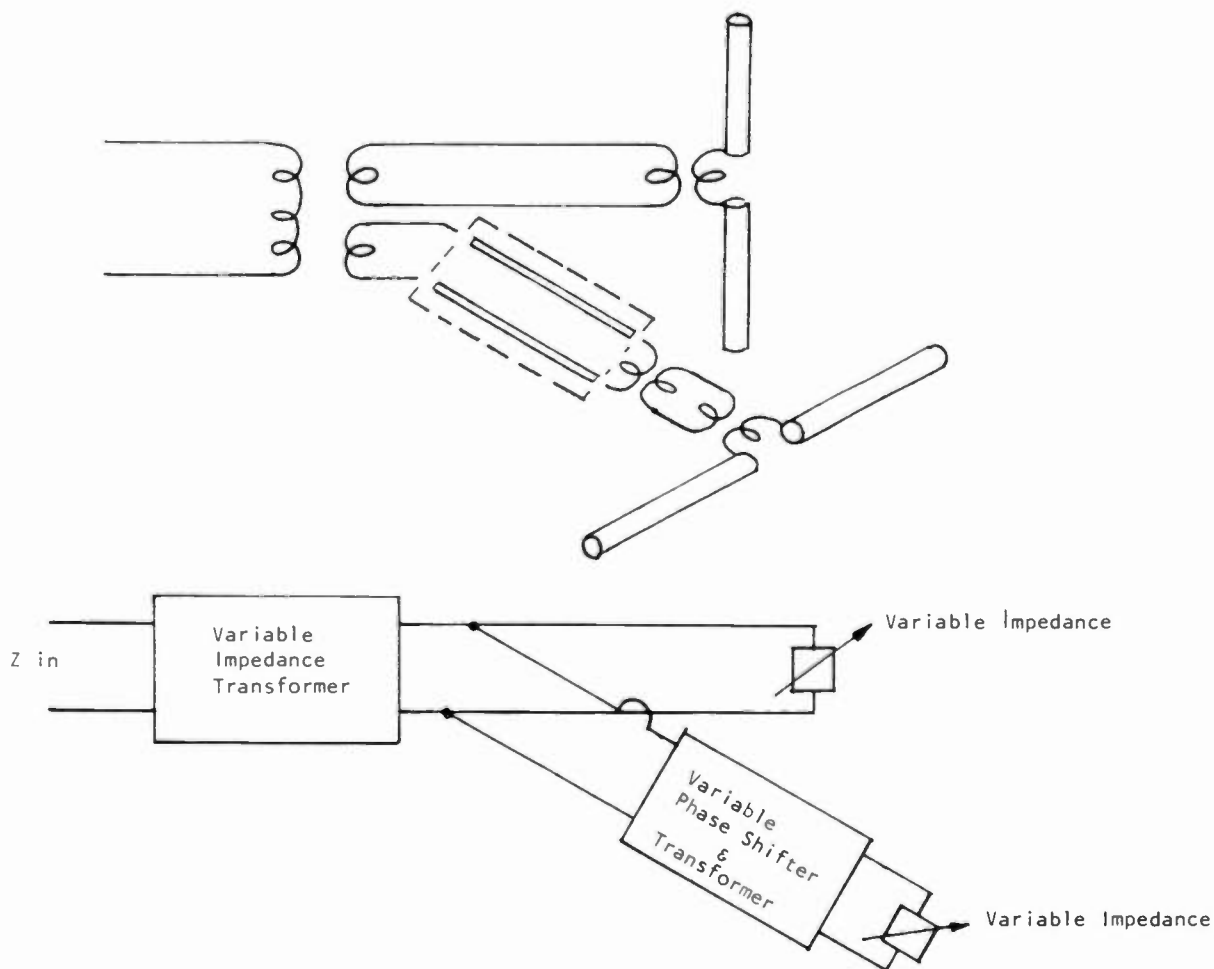
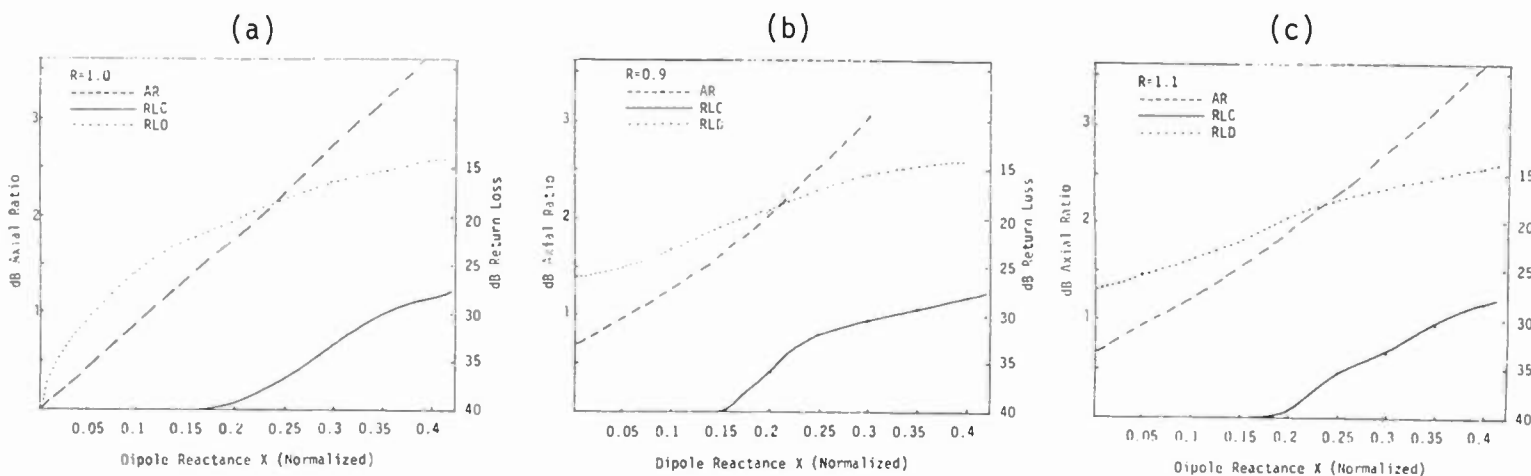


FIG (1) Cross dipole and its equivalent model.

From the outside however, the field generated in each polarization is proportional to the current on each dipole which, in turn, is inversely proportional to the dipole impedance. Knowing the phase and amplitude of these currents then, one can compute the axial ratio of the field produced by such cross dipole. Based on this theoretical model a mathematical formulation was derived and a simple computer program was developed to generate the input impedance of the cavity, the axial ratio, and return loss of each dipole in terms of real and imaginary parts of the dipole impedance, fig (1).

Fig (2) shows graphs of three sample calculations. Fig (2a) indicates the results for the case where dipole is finely matched to a normalized impedance for a single frequency, while fig (2b) and (2c) indicates the same for relatively mismatched cases. Note that in all three cases the over all impedance remains quite acceptable even though the individual dipoles show a rather low return losses. The axial ratio, on the other hand, increases linearly and drastically and becomes quite unacceptable when the reactance of the dipole changes. This demonstrates that for proper performance of a cavity back cross dipole, over a range of frequencies, the impedance of the dipole should be maintained relatively constant within that frequency range. And that, the combined VSWR does not always ensure the proper operation of the cross dipole.

Unfortunately, dipoles are not broadband elements, especially when mounted inside a cavity. Resonance fields of the cavity, and proximity of cavity walls tends to reduce the operating bandwidth of the dipole. A 10% bandwidth can be obtained by using flat dipole, this however is not adequate for some of the broader bandwidth requirements such as community FM antennas where close to 20% bandwidth is required to provide equal and fair performance for all participating stations. It may be noted here that the deterioration of axial ratio of elements of an array would drastically reduce the gain and null fill characteristics of the antennas and consequently result in unequal coverage for stations sharing the community antennas. To make a comprehensive study of alternatives, several cavity back cross dipoles were designed and their performance were measured in every respect. A summary of the measured and computed data is presented next.



Fig(2) Axial Ratio vs Reactance for Basic Cross Dipole

AR: Axial Ratio  
 RLC: Return Loss (Cross Dipole)  
 RLD: Return Loss (Dipole)

## CAVITY BACKED SLEEVED FLAT DIPOLE

It has been known for a long time that improvement of bandwidth can be accomplished by including sleeves under the dipole<sup>(1)</sup>. Fig (3a) gives a typical VSWR for sleeved dipole mounted inside a cavity. Even though it indicates an improvement, it is not drastic. Fig (4a) shows the theoretical and measured VSWR and axial ratio of flat sleeved dipole inside the cavity. The ratio can either be maintained within 1.5 to 2 dB over the entire band (20%) or can be reduced at lower values for a narrower bandwidth 15% (not shown).

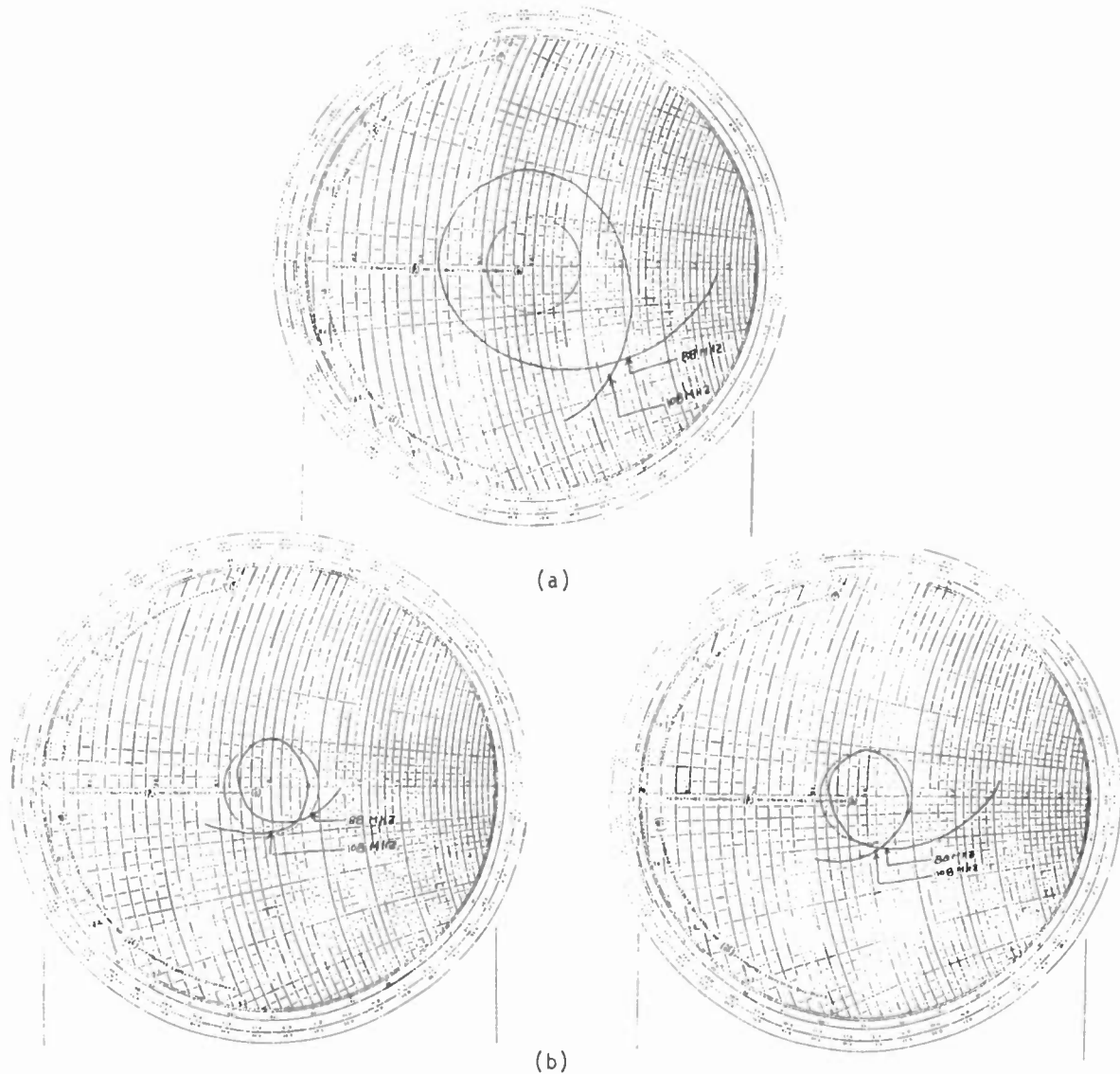


FIG (3) Impedance performance of:  
(a) Regular sleeved - flat dipole  
(b) Semi-spiral sleeved - flat dipole

Further broadening of the bandwidth required a new idea. Experimental data indicated that the tip of dipoles should somehow be kept away from the edge of the cavity. A most elaborate design of the balun feed showed that the further

broadbanding of dipole cannot be accomplished by changing the width of the dipole, so the idea of changing the shape of the dipole to a more geometrically broadband configuration seemed to be a plausible solution. A new R and D project extension lead to the development of semi-spiral shape flat crossed dipole cavity back antenna (fig 5).

Broadband nature of spiral antennas and minimizing the effect of the wall on bandwidth of the dipole resulted in a performance superior to any other design reported to date. Fig (3b) indicates the impedance performance of a single semi-spiral shape flat sleeved dipole inside cavity. Fig (4b) indicates the superior axial ratio over the entire 20 percent bandwidth for two typically tuned antennas. These figures all indicate that measurement and theory are within reasonable agreement.

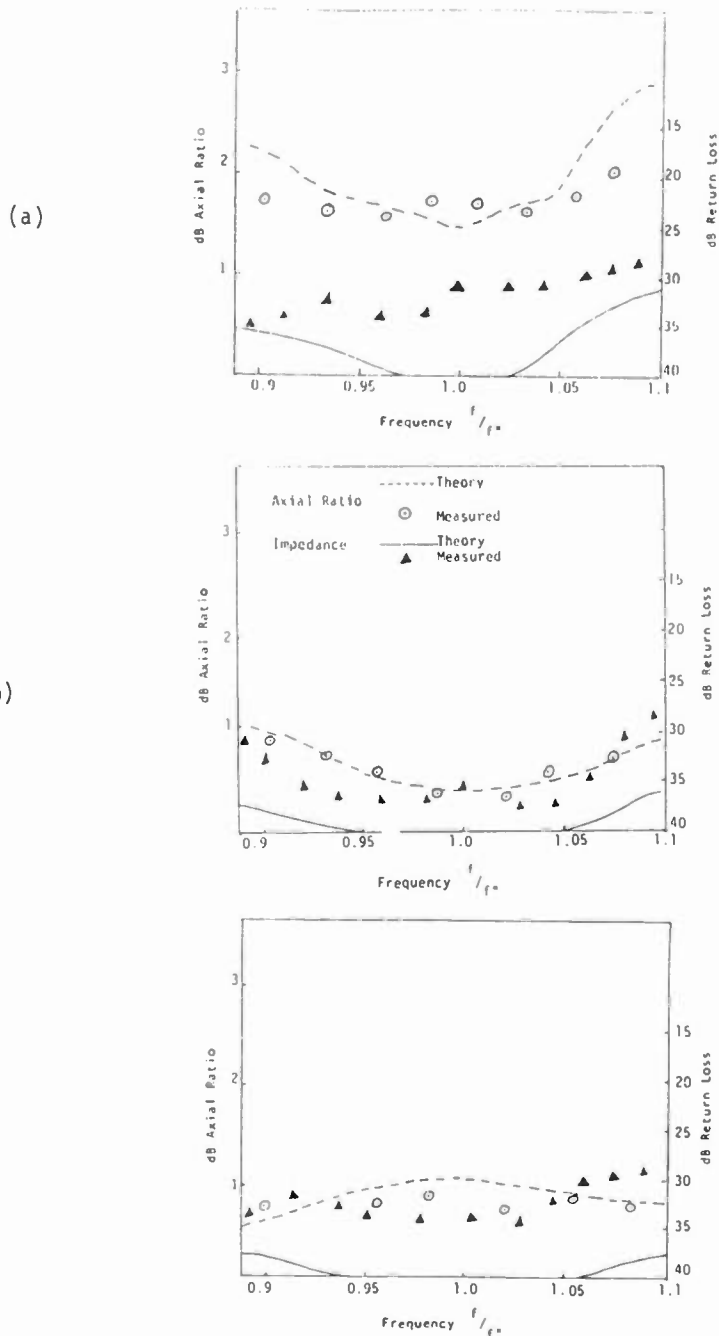


FIG (4) Axial Ratio and Input Impedance of cavity antennas  
 (a) cavity with flat-sleeved cross dipoles  
 (b) cavity with semi-spiral - flat sleeved dipole

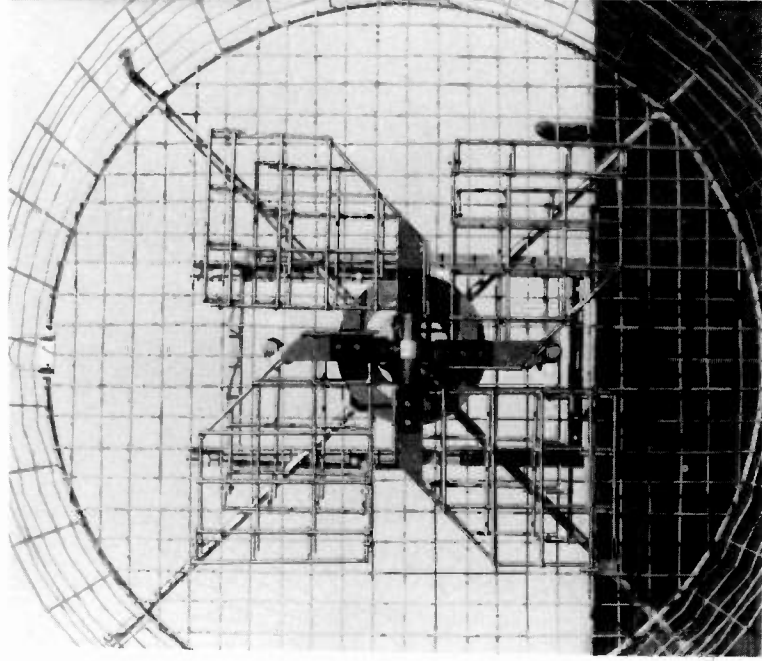
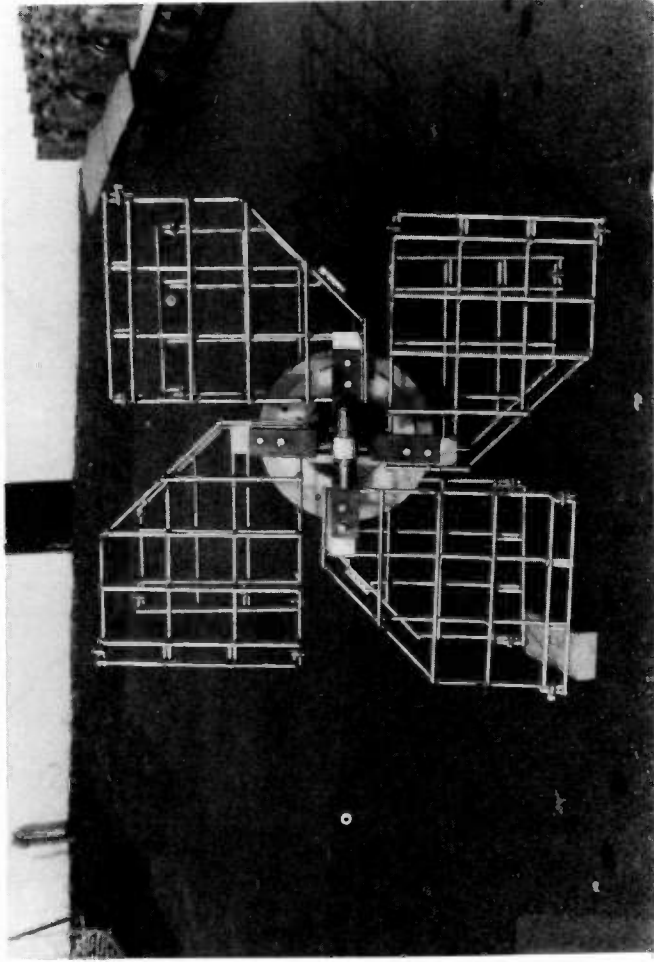


FIG (5) New Cavity Back Antenna

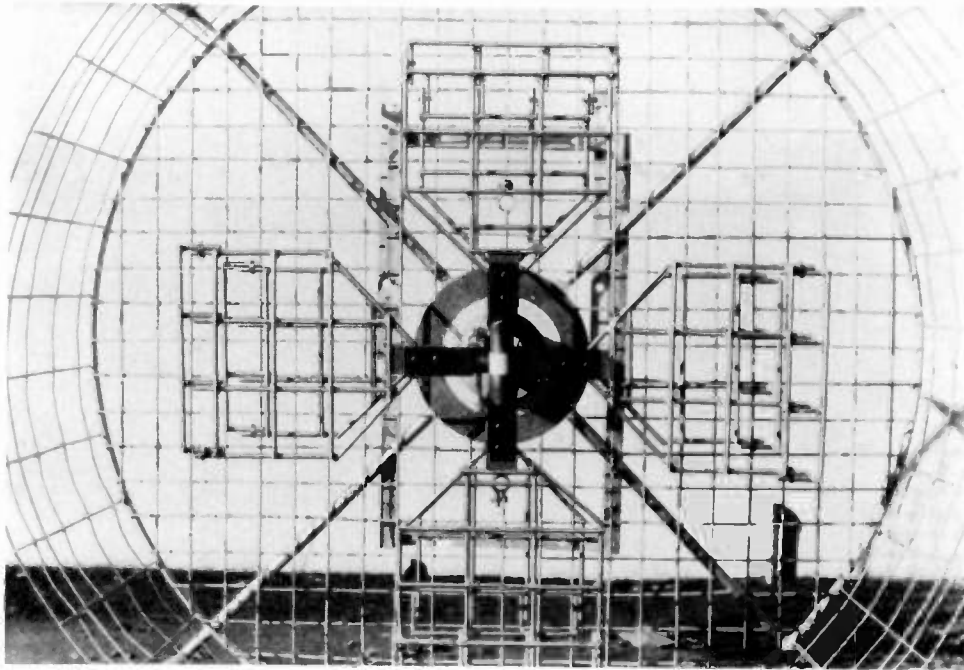
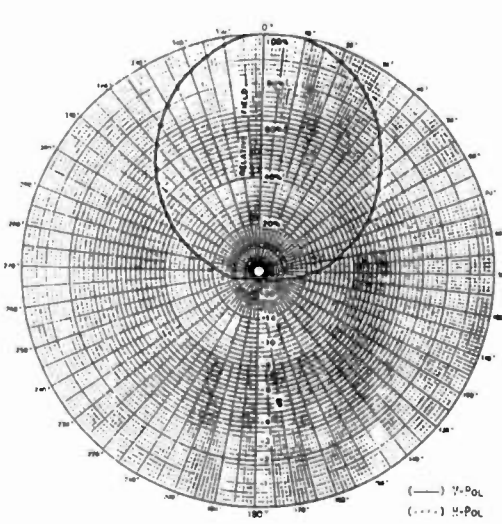
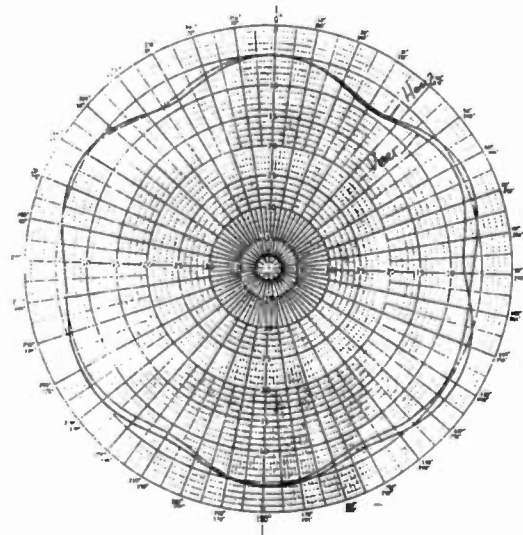


FIG (5b) Flat Cross-dipole inside Cavity



a) measured patterns of a single cavity



b) measured patterns of 3 cavities around triangular tower

FIG(6)



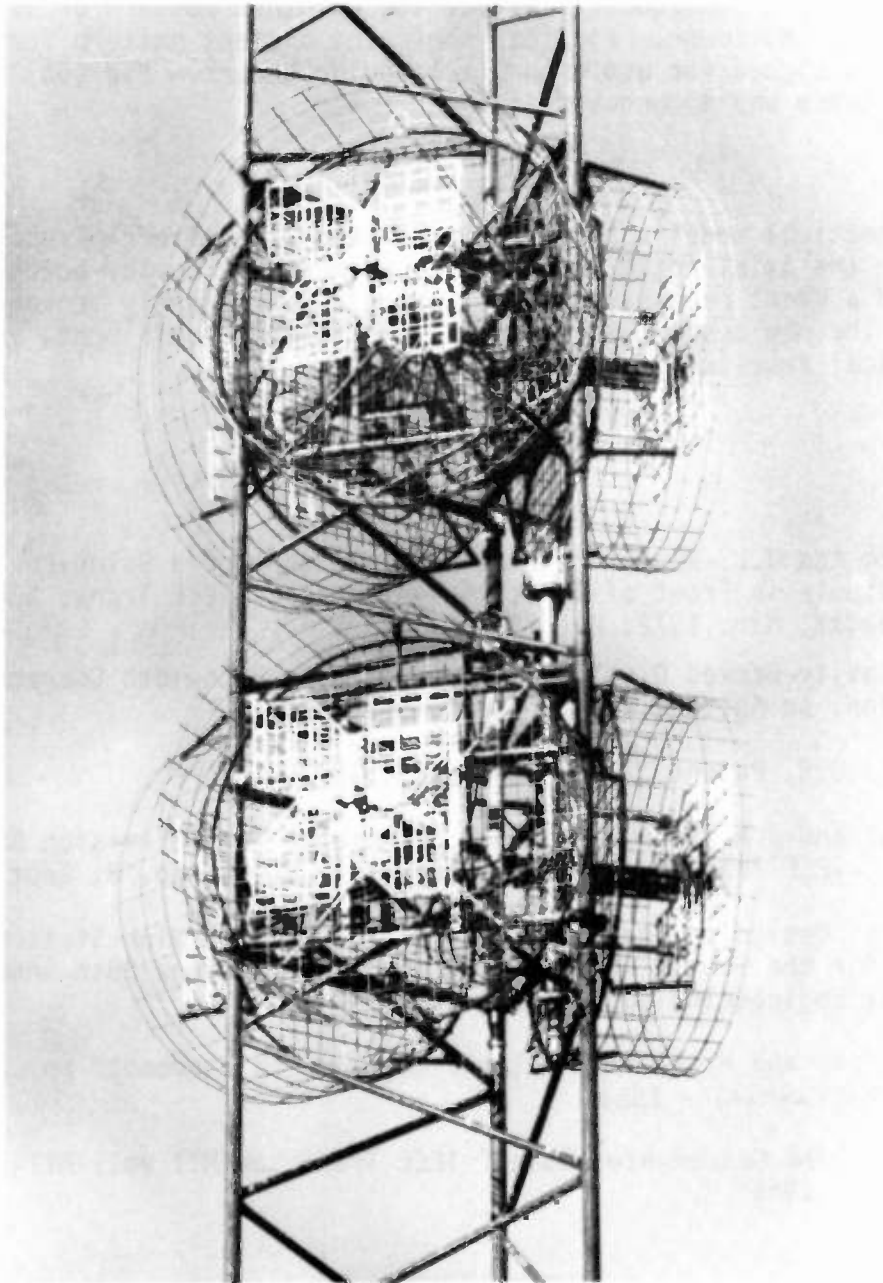


FIG (7) The New Cavity Back Antenna in an Array

As far as the other characteristics of the antenna such as pattern control and directivity are concerned, the measurements indicate consistent results with those of regular flat dipole type(3). Great care should be taken in positioning the sleeves, since they effectively change the phase reference of the aperture and consequently effect the combined pattern of several such cavities around the tower. Fig (6a) shows the element pattern for a 3-way around model designed for use around triangular towers. Fig (6b) is a typical pattern for three way around a triangular tower.

### CONCLUSIONS

A mathematical model was developed to study the effect of each dipole bandwidth on the axial ratio and input impedance of a cavity back cross dipole. It indicated a great necessity for designing a sufficiently broadband dipole (element). The new design was shown to satisfy the requirement, and measured and theoretical results agree reasonably well.

### REFERENCES

1. H.E. King and J.L. Wong, "An Experimental Study of a Balun-Fed Open-Sleeve Dipole in Front of a Metallic Reflector", IEEE Trans. Antennas and Propagat, Mar. 1972, PP. 210-202  
———"A Cavity-Backed Dipole Antenna with Wide-Bandwidth Characteristics". IEEE Trans. on Antenna and Propagat, Sep. 1973
2. J.J. Epis U.S. Patent 3740754, June 19, 1973
3. R.E. Fisk and J.A. Donovan, "A New CP Antenna for Television Broadcast Service", IEEE Trans. on Broadcasting, Vol. BC-22, No. 3, Sept. 76
4. R.E. Fisk "Design and Application of a Multiplexed Nine Station FM Antenna for the Senior Road Tower Group", proceedings 38th Annual Broadcast Engineering Conference, 1984
5. R.C. Johnson and H. Jasik, "Antenna Engineering Handbook" pp. 28-10, 28-11, McGraw-Hill - 1984
6. G. Oltman "The Compensated Balun" IEEE Trans. on MTT vol. MTT-14, No. 3, Mar. 1966

---

## THE EFFECT OF A QUARTER WAVELENGTH STUB ON MEDIUM WAVE ANTENNAS

Jerry M. Westberg

Harris Corporation, Broadcast Transmission Division

Quincy, Illinois

When mounting an FM antenna on a medium wave tower, the coax, which feeds the antenna, must cross the base insulator of the tower. One popular method of crossing the base insulator with coax, is to have the coax insulated from the tower one quarter wavelength up the tower.

There is a common assumption that the performance of an antenna will not be affected by the bonding of coax one quarter wavelength up on a medium wave antenna (hereafter referred to as a quarter wavelength stub). It can be shown by measured and theoretical data that this assumption is not true. The base impedance of a 204° tower was measured before and after the installation of a quarter wavelength stub. The base impedance was then measured off-frequency to determine an equivalent Q for the two antennas. The equation used to compute equivalent Q is as follows:

$$Q_e = \frac{F}{2 \Delta F} \left( \sqrt{VSWR} - \frac{1}{\sqrt{VSWR}} \right)$$

F = Frequency

$\Delta F$  = Frequency change from F

VSWR = VSWR caused by change in frequency

The base impedance of the tower changed from 58-J138 Ohms to 98-J281 Ohms. The equivalent Q of the antenna increased from 9.2 to 15.3.

The antenna was then modeled using a "method of moments" technique. For the analysis, an antenna and coax radius of .48 and .02 degrees, respectively, were used. The center-to-center separation of the antenna and coax is 1.14 degrees. The results were comparable to the measured data. The predicted impedances before and after the installation of a quarter wavelength stub are 54-J204 and 80-J379, respectively. The equivalent Q for each case was computed to be 13.9 and 18.4.

### VARY TOWER HEIGHT

Six other antennas of different height were modeled. The same radii and separation was used. Base impedances and equivalent  $Q_s$  were calculated for each antenna with and without a quarter wavelength stub. The results are found in table 1 below. These data are pictured on figures 1-3.

TABLE 1

TOWER HEIGHT (DEGREES)	IMPEDANCE OF TOWER (OHMS)	$Q_e$	IMPEDANCE OF TOWER WITH 1/4 STUB (OHMS)	$Q_e$
102	104 + J144	4.7	473 - J424	4.7
122	308 + J297	3.9	548 - J589	6.8
143	836 + J19	4.1	328 - J631	9.1
163	398 - J493	5.3	198 - J569	11.6
184	126 - J343	8.9	123 - J484	14.6
194	79 - J269	11.2	98 - J434	16.4
204	54 - J204	13.9	80 - J379	18.4

Tower radius  $.48^\circ$

Stub radius  $.02^\circ$

Separation  $1.14^\circ$

### VARY BONDING POINT

The equivalent  $Q$  of every antenna (except for  $102^\circ$ ) was increased with the addition of a quarter wavelength stub. The distance from the ground to the point where the coax is bonded to the tower was adjusted and the results were recorded. The results are found in tables 2-5 below.

TABLE 2. 204 DEGREE TOWER

BONDING DISTANCE FROM GROUND (DEGREES)	IMPEDANCE OF TOWER WITH STUB (OHMS)	$Q_e$
112	27 - J213	23.4
102	44 - J278	20.3
92	80 - J379	18.4
82	183 - J573	17.0
71	809 - J1011	15.5
66	2067 - J131	14.6
61	1011 + J1078	15.2

TABLE 3. 184 DEGREE TOWER

BONDING DISTANCE FROM GROUND (DEGREES)	IMPEDANCE OF TOWER WITH STUB (OHMS)	$Q_e$
92	123 - J484	14.6
82	381 - J801	12.6
71	2075 - J290	11.4
66	1072 + J1036	10.9
61	384 + J828	12.2

TABLE 4. 143 DEGREE TOWER

BONDING DISTANCE FROM GROUND (DEGREES)	IMPEDANCE OF TOWER WITH STUB (OHMS)	$Q_e$
92	328 - J631	9.1
82	1248 - J594	7.5
76	1428 - J295	7.0
71	791 + J768	7.3
66	391 + J658	7.4

TABLE 5. 102 DEGREE TOWER

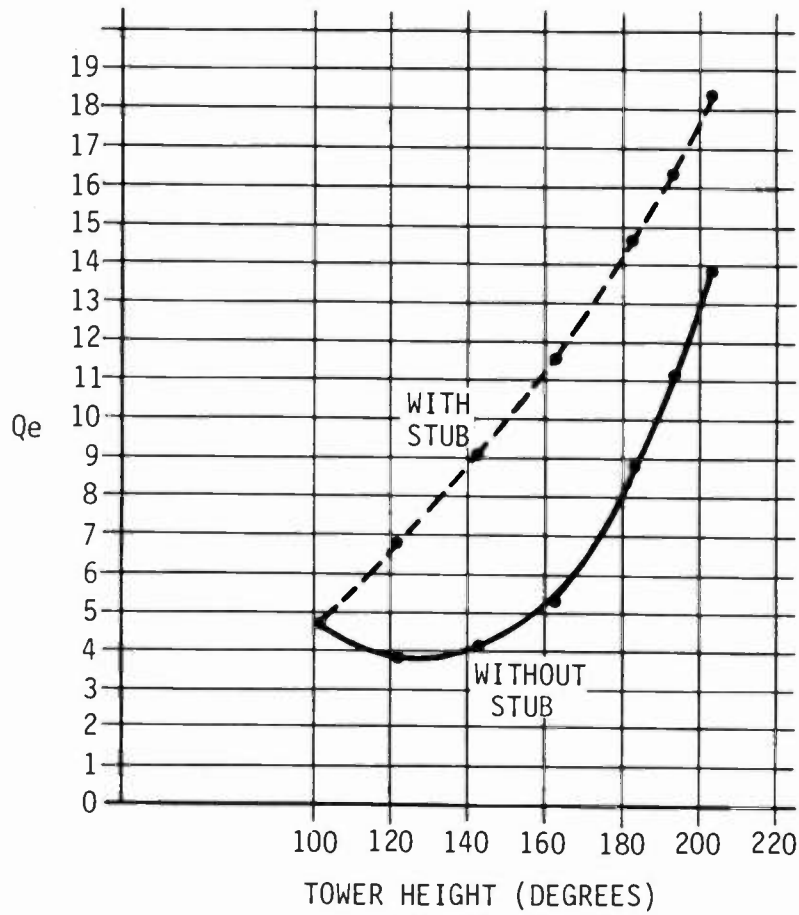
BONDING DISTANCE FROM GROUND (DEGREES)	IMPEDANCE OF TOWER WITH STUB (OHMS)	$Q_e$
92	473 - J424	4.7
87	630 - J344	4.0
82	588 + J226	4.3

### CONCLUSION

The impedance of a medium wave antenna is affected by the presence of a quarter wavelength stub. The magnitude of change in impedance depends on the tower height.

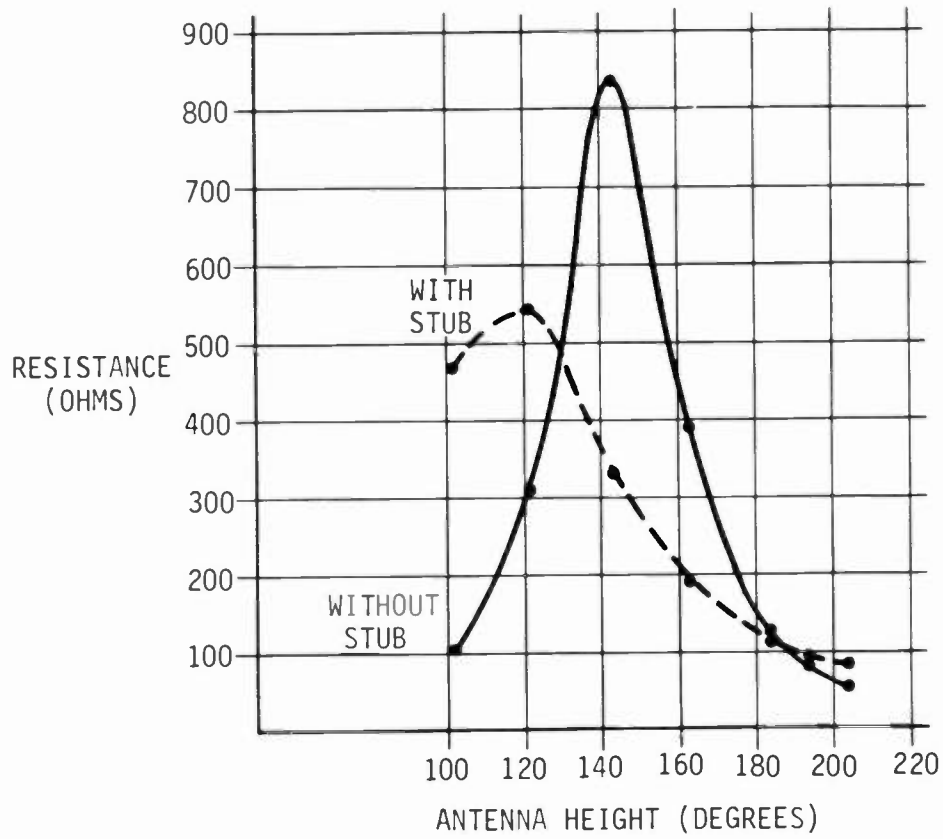
The bandwidth of an antenna is influenced by the presence of a quarter wavelength stub. For tower heights above 102 degrees the data suggest that the stub adversely affects the bandwidth of the antenna. By extrapolating the data shown in figure 1, the presence of a quarter wavelength stub will increase the bandwidth of a medium wave antenna of heights less than 102°.

The bandwidth of the antenna with a quarter wavelength stub may be improved by adjusting the height above ground where the stub is bonded to the tower. For maximum bandwidth the bonding point of the stub varied from 66° for a 204° tower to 87° for a 102° tower. It should also be noted that the maximum bandwidth point of attachment appears to occur when the tower base impedance is close to resonance. This provides a good benchmark for field adjustment. The bonding point of the stub to the tower may be lowered until the base impedance of the tower is resonant.



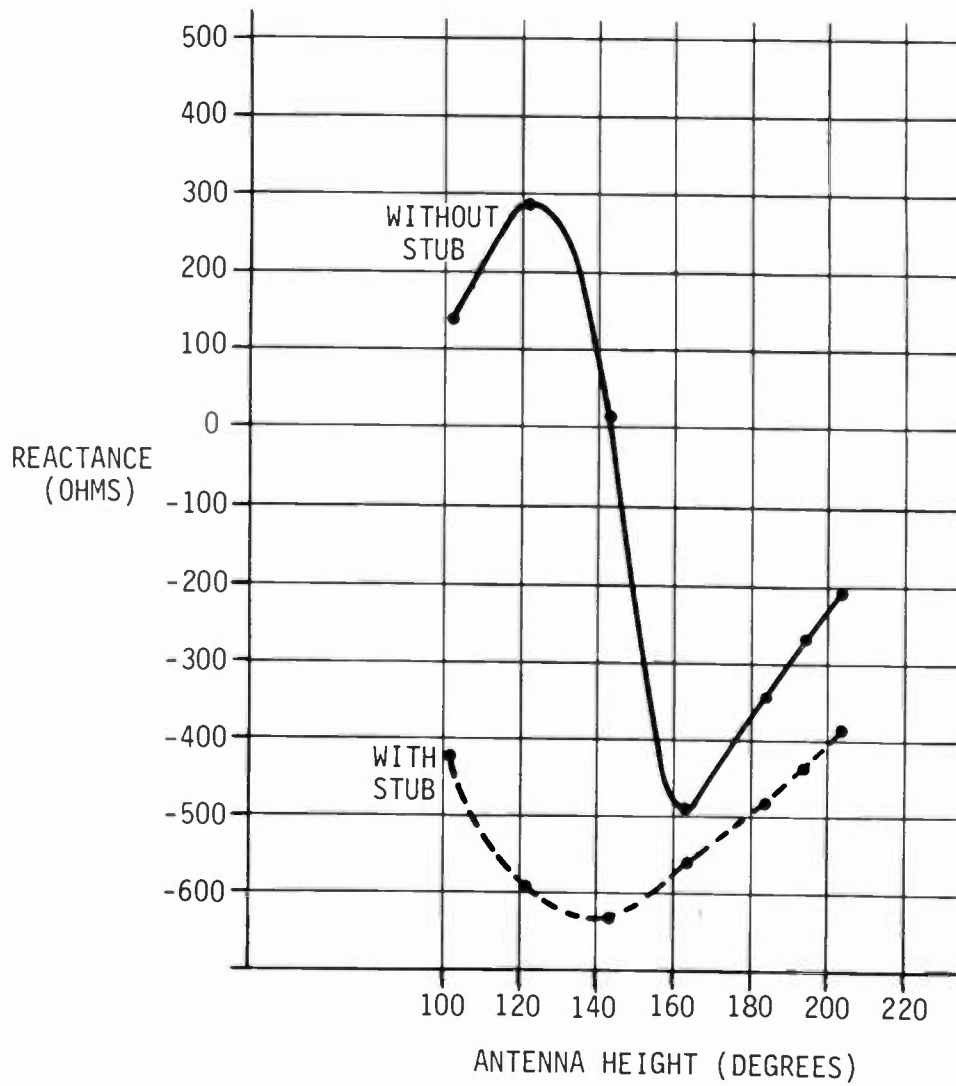
Tower radius .48 degrees  
 Stub radius .02 degrees  
 Separation 1.14 degrees

Figure 1. Equivalent Q vs Tower Height With and Without a Quarter Wavelength Stub



Tower radius .48 degrees  
 Stub radius .02 degrees  
 Separation 1.14 degrees

Figure 2. Resistance vs Tower Height  
 With and Without a Quarter Wavelength Stub



Tower radius .48 degrees  
 Stub radius .02 degrees  
 Separation 1.14 degrees

Figure 3. Reactance vs Tower Height  
 With and Without a Quarter Wavelength Stub



## REFERENCES

Dah-Cheng Kuo and Bradley J. Strait, Improved Programs for Analysis of Radiation and Scattering by Configurations of Arbitrarily Bent Thin Wires (Department of Electrical and Computer Engineering, Syracuse University, Syracuse, New York 13210)(AFCRL-72-0051).

Warren L. Stutzman and Gary A. Thiele, Antenna Theory and Design (John Wiley & Sons, Inc., 1981) pp. 205-212.

---

## PROCESS COOLING SYSTEM FOR HIGH-RISE TRANSMITTER PLANTS

Warren G. Shulz

WFYR Division, RKO General Inc.

130 E. Randolph Street, Chicago, Illinois 60601

*ABSTRACT* - This paper reviews procedures to calculate the heat load of transmitter equipment, sizing of cooling hardware, external considerations, and closed room cooling method. An installation example is presented for a transmitter room located on an upper floor of a 110-story office building.

Comparison is made between comfort, computer room, and process cooling systems. In the practical example, a method is shown using an on site dry cooler that permits a winter economy cooling option.

Methods to deal with building static pressure, heat load, and installation problems are discussed. Results show transmitter equipment can be cooled, and at the same time be provided with a clean environment for reduced maintenance, extended component life, and economic operation.

### INTRODUCTION

Cooling of transmitter and support electronic equipment is necessary to maintain an acceptable environment for year around performance. This performance can be broken down into short-term daily operation, and long-term component life for reduced maintenance. Typically, 20 to 80 percent of the AC input power to a transmitter room is dissipated as waste heat in the transmitter equipment room. The balance of the input power is delivered to the radio frequency (RF) load made up of the transmission line losses, combiner/filter losses, and radiated RF power by the antenna. As the power rating for the transmitter plant increases, cooling of the equipment room becomes increasingly difficult, and more costly.

Many transmitter installations are scheduled for 24-hour programming. As a result of these around-the-clock operations the cooling apparatus becomes an integral component of the transmission system. Full consideration must be directed to dual, or alternate backup systems in order to maintain interruption free program schedules. External climate conditions play a vital role in the overall system plan.



- C. Two high-temperature (1700 F.) sprinkler heads, operated under the building's life safety system, are provided for fire protection.
- D. Floor loading specifications are suitable to permit locating 5-tons of broadcasting and related equipment to be installed.
- E. An air grill to the outdoor provides an opening 52 inches wide by 106 inches high. The total surface area of this grill is 38 sq. ft.

All walls, floor, and ceiling surfaces are adjacent to interior spaces. Two window glass sections, adjacent to the grill, provide 62 sq. ft. of surface area. The concrete floor is a source of heat from tenant operations located on the floor directly below the WFYR transmitter room. The floor above the WFYR transmitter room is a public observation deck and presents no source of heat. Figure 1 details the WFYR transmitter room floor layout.

### EXTERNAL FORCES

Any design, to be effective, must resolve external forces acting upon the system. These actions, external to the transmitter room, play a critical role in the achievement of system performance. Some external forces include: heat infiltration, adjacent tenant activities, and building static pressure.

High-rise buildings exhibit an interior air pressure displacement called 'stack effect'. This condition is best described as an upper floor air flow to the outdoors. The stack effect becomes more acute when the indoor-to-outdoor difference becomes more than 300 F. The mechanical engineer associated with the project estimated at worst case the static pressure could reach 3.5 inches WC. The static pressure (stack effect) is at its highest during the winter months and near a neutral condition during summer periods. The building's design takes this effect into account by providing elevator lobby areas with passage doors. In addition, sky lobbies are utilized to breakup long elevator shaft runs, and all wire shafts are sealed between floors. The adverse results caused by this upward air movement include: interference with elevator door operation, heat loss, dirt infiltration, and loss of fire control.<sup>3</sup>

During summer periods drafts up and down the face of the building can short circuit the heat exchanger. To reduce this effect, a high discharge velocity from the heat exchanger is needed. The intake and discharge points should be separated from each other as much as possible. Another condition to consider is the effects of adjacent tenant heat discharge actions. In this case the tenant on the floor below is dissipating about 225 kw-hr from air grills sharing the same building face.

The UHF-TV operation, on the floor below, does not utilize mechanical cooling of the transmitter equipment room. While the bulk of the heat is removed by water cooling the transmitter power stages only outdoor air is utilized for cooling the balance of the heat generated by the associated transmitter equipment. Under worst case summer condition, it is anticipated the ceiling temperature of this UHF-TV operation will reach 1050 F. This additional heat, conducted through the concrete floor, must be included in the load calculation for summer cooling.

## REFRIGERATION BASICS

To begin a brief discussion of mechanical refrigeration basics some units of measure need to be defined: <sup>4,5</sup>

- British thermal unit (Btu) - - - This is the measure of heat required, in Btu, to raise one pound of water one degree Fahrenheit (F.) where one degree F. is 1/180th of the difference between the melting point of ice and the boiling point of water.
- Sensible heat- - - - - When a substance is heated and the temperature rises the increase in the substance temperature is called sensible heat. All electrical equipment produces sensible heat.
- Latent heat- - - - - When energy is added and no temperature change takes place in the substance, but a change in state occurs the heat added is called latent heat. A substance can have two latent heat values: one from a solid to a liquid, and the other a liquid to a vapor. For example ice to water requires 144 Btu/lb; water to steam (at sea level) requires 970 Btu/lb. People produce both sensible and latent heat.

The vaporization (boiling point) of a liquid can be changed by altering the pressure. The behavior of latent heat is the basis of mechanical refrigeration. When a substance passes from a liquid to a vapor, its heat absorption is very high. It is this concept that is applied to perform the refrigeration task. The evaporator coil provides a place where liquid refrigerant is allowed to expand to a vapor (pressure drop) from its prior liquid state. During this vaporization process, heat is absorbed by the refrigerant. After the expansion has occurred, the vapor is drawn into a compressor pump where the low-pressure vapor undergoes an increase in pressure, causing its temperature to rise. A condenser is used to remove the heat from the vapor. The temperature reduction with the increase in pressure causes the refrigerant to liquify for another pass through the evaporator (cooling) coil. This process continues so long as the compressor is in operation.

An expansion point (such as a needle valve) is required at the point where the liquid refrigerant flows into the evaporator coil. This expansion point can be a simple capillary tube or the more elaborate thermostatic controlled expansion valve. The thermostatic expansion valve is the preferred type of control having the ability to keep the evaporator coil filled with refrigerant for various heat load conditions. The temperature controlled valve places the refrigerant flow into a feedback loop for best match to the heat load. Capillary tube systems are fixed flow and most often they are seen in consumer-type comfort cooling systems.

Two commonly found items in refrigeration equipment are dryers and sight-glass viewers. The efficient operation of the cooling system, using fluorocarbon refrigerants, depend on keeping foreign particles, and moisture out of the system. A moisture content of less than 0.002% of the total system capacity is a typical requirement.

The dryer contains a moisture absorbing element to insure the system remains free of moisture during its service life. At the initial installation the system is connected to a vacuum pump. A high vacuum is established and any moisture in the system boils off under the reduced pressure condition. Then the system is charged with the refrigerant.

The sight-glass viewer is a useful tool to view the refrigerant flow in the liquid line just prior to the expansion valve. Bubbles appearing in the liquid line flow may indicate a lack of refrigerant. Many sight-glass viewers include a moisture sensitive color indicator. This relative indicator is calibrated to change color when the system's moisture content exceeds a safe limit.

Refrigerant mediums are selected for a low boiling point, non-reactive action with humans, and the ability to operate on a positive pressure cycle. Fluorocarbon based refrigerants were developed in the early 1930's as an answer for a safe, efficient medium to replace toxic substances commonly used at that time.<sup>6</sup> One of the major producers of fluorocarbon refrigerants is E. I. DuPont de Nemours. DuPont assigned the trade name FREON<sup>R</sup> (flourine + refrigerant + on) to those organic compounds. FREON-22, a commonly found refrigerant, and just one of many compounds, has a boiling point of  $-41^{\circ}$  F. at sea level; it will change into a liquid when placed under 160 PSI at  $86^{\circ}$  F. In normal operation, when using FREON-22, the refrigeration cycle will always have a positive pressure with respect to the atmosphere. This positive pressure keeps contaminants out of the system.

Refrigeration systems are rated by the heat removal capacity expressed in Btu/hr. Sometimes this is expressed in Tons. The ton notation comes from a period when ice was used for cooling. Recall that one pound of ice will absorb 144 Btu/lb, then one ton would absorb 288,000 Btu per day or 12,000 Btu/hr. Therefore, each ton of specified cooling is equal to 12,000 Btu/hr of absorption.

The ratings of machine cooling capacity are complicated by the fact air is the heat transfer medium. Air contains water vapor as superheated steam at a very low pressure. As the air is drawn over the evaporator coil cooled below the dew point (causing water to condense on its surface) then latent heat is being removed from the air/vapor. If water does not condense only sensible heat is being extracted. The condensation of the water vapor represents the refrigeration system's ability to dehumidify the air. This moisture removal ability is represented by the latent heat rating of the cooling machine. The refrigeration system will have three ratings: sensible, latent, and total (latent + sensible) heat removal capacity. Comfort cooling systems will have about 1/3 of the total capacity applied to latent (moisture removal) cooling. For a condition of  $78^{\circ}$  F. and a relative humidity of 25% the dew point is  $40^{\circ}$  F.; for a relative humidity of 70% the dew point is  $67^{\circ}$  F.

Two important methods used in computer room construction limit the moisture content. First the conditioned space is vapor sealed from moisture infiltration, and second a very limited amount of external air is circulated from outdoors. Meeting these two requirements reduces the latent heat load, and permits accurate humidity control. The following comparison between the three types of cooling arrangements will clarify the different design goals.<sup>7</sup>

## COMPARISON BETWEEN THREE TYPES OF COOLING SYSTEMS

All three types of cooling systems use the same basic components to achieve slightly different design goals. These differences can be identified as follows:

The comfort cooling system has a high latent heat removal capacity that can represent one-third of its total rated capacity. By design the system's air flow and input air mixture require a high degree of moisture removal. The computer room or process cooling system deals with a high sensible heat load. The sensible heat removal capacity represents 95% of the system's total capacity. Little to no outside air is mixed into the computer room or process cooling conditioned space. Elimination of the outdoor air mixture allows exact humidity control.

The discharge air from the evaporator coil of the comfort cooling system is nearly fully saturated vapor. In a computer room cooling system, about 20% of the intake air is permitted to bypass the evaporator coil. The bypass air mixes with the evaporator coil discharge air to maintain a relative humidity of 80% or less. This lower moisture requirement is needed when the discharge air is directly ducted into electronic equipment. This situation can occur when the computer room cooling unit is installed with the air discharge directed into a raised floor plenum. The lower moisture content avoids possible moisture condensation on electronic circuit components.

For comfort cooling applications the typical occupancy rate is one person per 150 sq. ft. or more for a theater, restaurant, or meeting room. Ventilation air, brought from outdoors, can make up 20 percent of the total air flow. This added air is necessary for smoke removal and odor control. The typical computer room has an occupancy factor from zero to one person per 500 sq. ft. Little outdoor air is introduced into the computer room. The reduction of outdoor air into the conditioned space is necessary if accurate humidity control is to be maintained.

For a typical office type comfort cooling application, air volume in circulation may be 100 cfm per 100 sq. ft. For a computer room the air volume in circulation can be 6 times higher. In our example transmitter room the air volume in circulation is 24 times higher or 2,400 cfm per 100 sq. ft.!

The comfort cooling system, when properly applied, does not require a continuous duty cycle. Heat loads vary with occupancy, heat infiltration, and conditions of the mix ventilation air brought into the conditioned space. In a climate where winter conditions permit, the comfort cooling equipment operates only during summer periods and when the outdoor air cannot be used to maintain a desired temperature range. Computer room or process cooling equipment can be a 24-hour, year around operation. In the case of the example presented the process cooling system is an integral component of the transmission system. The differences in construction are significant. A partial list of upgrades typically found in a computer room or process cooling system unit are: fully monitored safety controls, heavy duty electrical components, deep pleated filters, excellent fan balance, and a stainless steel condensate pan.

The only difference between a computer room and process cooling system is the deletion of any moisture control ability for the process cooling system. Process cooling is sensible heat removal without regards for the moisture content of the conditioned space. Humidity control is vital for a computer room operation.

Magnetic tape medium and paper change dimensions with the moisture content of the surrounding air. A good computer room cooling system will maintain the conditioned space moisture content within a few percentage points of the set point. For this degree of humidity control the computer room cooling system is equipped with a humidifier, electric re-heat coil, and associated controls. The process cooler, by the definition of the task defined in this example, lacks the humidity controls found in the computer room system. In this case the process cooler is needed to remove sensible heat from the conditioned space.

### HEAT LOAD CALCULATIONS

For the transmitter room example, Table-1 lists equipment power dissipation. The total sensible equipment heat load is 15.5 kw/hr. This can be converted to Btu/hr by using the conversion factor of one kw/hr equals 3,412 Btu/hr. We can then restate the heat load as 53,000 Btu/hr sensible.

Table - 1 Equipment Heat Load (Sensible)

Transmitter dissipation (AC input 22 kva; output 10.5kw RF)	11.5 kw
75 kva, 3-phase, AC voltage regulator	1.0
Equipment racks (600-watts each X 3 )	1.8
Electrical panels, 480-208v, 50 kva transformer, rm. lights	0.9
RF transmission line & antenna filters	0.3
<hr/>	
Total Electrical Heat	15.5 kw

Two significant areas of additional summer time heat sources are the windows, and tenant operations on the floor below. Heat transmission from these surfaces can be determined from tables prepared listing conduction heat gains through building materials.<sup>4,5</sup>

For the concrete floor (nominal 6-inches thick) the conduction heat gain is 0.6 Btu/hr/sq ft/ deg F. By applying equation 1 we can calculate the heat transfer from the tenant operation below.<sup>4</sup>

$$q = A U (t_2 - t_1) \quad (1)$$

Where: q = Heat flow, Btu/hr

A = Area, sq. ft.

U = Heat transfer coefficient, Btu/hr/ sq ft

(t<sub>2</sub> - t<sub>1</sub>) = Temperature difference in degrees F across barrier

Substituting the values for the concrete floor:

$$288 (0.6) (105 - 78) = 4,665 \text{ Btu/hr} \quad (2)$$

For the glass exposure of 62 sq. ft. the transfer coefficient, for single plate glass, is 1.13 Btu/hr/sq ft/ deg F. We will assume a 95° F. outdoor temperature and a conditioned space temperature of 78° F.



Substituting these values into eq. 1 we obtain:

$$62 (1.13) (95 - 78) = 1,200 \text{ Btu/hr (3)}$$

Table-2 summarizes the summer condition sensible heat load for the transmitter room. The change between summer to winter external conditions account for about a decrease of 18% when the glass surface heat loss in winter is accounted for. Using equation 1 we can determine the heat loss from the glass surface during a winter period when the outdoor temperature is 10° F. Substituting these values into equation 1 we obtain:

$$62 (1.13) (10 - 78) = 4,764 \text{ Btu/hr (4)}$$

From equation 4 we see a 9% heat loss from the conduction of the glass surface.

#### Table-2 Summary Of Heat Sources - Summer Operation

Electrical heat from transmitter equipment	53,000 Btu/hr
Floor conduction (UHF-TV operation on the floor below)	4,700
Window conduction	<u>1,200</u>
	58,900 Btu/hr

Based on the estimated summer heat load a heat removal requirement of at least 60,000 Btu/hr sensible is needed. If we desire a 2/3 on cycle the cooling hardware should be sized to about 50% greater capacity than the known load. This would indicate we should install a machine capable of 120,000 Btu/hr capacity. For economical winter operation a method to cool the conditioned space without mechanical refrigeration would be desirable. In this mode the compressor and associated mechanical apparatus would not be needed to keep the room within limits during winter periods. Finally, a dual or alternate system is required to keep downtime to a minimum.

#### EQUIPMENT SELECTION

A detailed review of three manufacturers product was made. For each proposed system a full set of installation plans were prepared by the mechanical engineering firm retained for the project. Each manufacturer's rep was given an opportunity to tour the transmitter site. After reviewing all three plans only one met all the desired goals. The selected vendor, EDPAC Corp., Horsham, PA, markets a computer room air conditioning system that met the design requirements. The equipment selected would permit a fully closed room environment year around. During winter operation the equipment would provide economy cooling without refrigeration compressor operation, or the necessity of attempting to bring outdoor air into the conditioned space. This particular feature offered energy savings, and reduced mechanical wear on the refrigeration compressors.

The selected equipment has a sensible capacity of 103,500 Btu/hr at 80° F. dry bulb. In particular, the process cooler is adaptive shifting between economy cooling, and single or dual compressor mechanical refrigeration as the situation warrants. The EDPAC system uses a microprocessor based controller for general operations and fault diagnostics.

The air flow through the cooling equipment was field verified at 7,000 cfm. The cooling package was designed for installation using a raised floor plenum. As a result of this construction the air flow is downward.

For this specific application the supplier of the system designed a custom heat exchanger to make maximum use of the outdoor air grill provided. The heat exchanger, commonly called a dry cooler, is simply a two by six foot, multiple row finned coil with a 5 HP driven blower ducted to outdoor air. The heat exchanger has a capacity of 150,000 Btu/hr with an entering air of 95° F. DB. Air flow is rated at 6,500 cfm. A deep pleated air filter protects the finned coil from contamination by outdoor air. (It is more effective to change the filters than chemically clean the coil.) Antifreeze solution is circulated through the dry cooler and process cooler by a 2 HP pump. Electrically controlled valves route the antifreeze solution between the room coil (for economy cooling) or the coaxial tube refrigerant condenser used for mechanical cooling. The operation of the valves is under control of the microprocessor unit. Temperature condition of the antifreeze solution, room temperature, and trends are analyzed, and the most effective mode of operation is selected.

The downward air flow of the equipment required a 2-foot high stand. The stand was designed as a discharge plenum. Three 20 X 28 inch grills were placed in the sheet metal walls of the stand. The total discharge surface area is about 11 sq. ft. The air intake is located nine feet above the floor or 2/3's of the rooms total height. This has proven to work well since all the temperature sensitive equipment is located in the lower half of the room's elevation. The transmitter cabinet has a direct air flow heat discharge from which 75% of the room's heat appears. This air discharge (at about 130° F.) is directed towards the ceiling where it mixes with the existing room air. This warm air mixture is pulled towards the air intake of the cooling system. At the entry point this intake air is passed through a 12 sq. ft. deep pleated disposable air filter. The air flow then passes through economy cooling coil, blowers, evaporator coil, compressor equipment, and out the discharge grills. The transmitter blower pulls its intake area from the floor level, which is the coolest air mixture in the room. With the warmest room air returning to the top of the process cooler the refrigeration efficiency rises slightly. The air velocity at the discharge grill is about 650 fpm or 7.2 mph. This velocity is much higher than a person would tolerate for comfort cooling, but is not a problem for an unattended transmitter site.

Economy cooling, for this system, uses the antifreeze solution circulated between the dry cooler and the 12 row room coil. The manufacturer indicates in his literature about 50% of the time the outdoor temperature is below 55° F. for the Chicago area. This would indicate a possible economy cooling operation of 4,800 hours per year. If we assign a 50% duty cycle for compressor operation an apparent savings of 156 kw-hr per day could be realized if full economy cooling were to occur over a 24-hour period. Spreading this savings over a 10-year period would result in a sizable energy savings. In addition, mechanical wear will be reduced as a result of the economy cooling operation.<sup>7</sup>

A major installation problem was the inability to position a fully assembled unit into position. A major limitation was passing of all the equipment through a three by seven foot door adjacent to a four foot wide hallway. Both the dry cooler and process cooler had to be constructed with full break apart construction. The units were shipped fully assembled and tested by their respective manufacturers.

The local installing contractor then disassembled the equipment, moved all the equipment into a staging area, and re-assembled the equipment in the transmitter room. Without this effort it would have been impossible to make the installation. The labor cost to accomplish the disassembly and reassembly of the components was a significant portion of the installation labor cost. In this particular case we were fortunate to have the installing contractor be responsible for the warranty period and long term maintenance of the cooling equipment. A special effort was made to make all components of the installation accessible for any needed maintenance.

As a backup feature an emergency exhaust fan with a 1% low-leakage rate motorized damper was included into the installation. This fan provides a backup arrangement should the entire cooling system fail. The fan is independent of the process cooler and is activated by a local thermostat. Due to a lack of floor space it was not possible to install a dual system. However, this system has dual compressors with each having sufficient capacity to carry the load should one fail.

### CONCLUSION

This report presented a method to cool a high-rise transmitter installation with some very specific problems. Failures caused by air-borne dirt can be expected to decrease as a result of the closed room approach used. Once the room is clean it will stay that way. To the satisfaction of the building owner the stack effect leakage from the transmitter room has been controlled by sealing the room from the outdoors. This 'sealed' condition keeps summer humid air from entering the conditioned space and aids in keeping the heat load sensible.

### ACKNOWLEDGEMENTS

The author wishes to thank the following people and related employers for all their efforts in making this project possible. In particular, Ron Turner CE/WCLR-Bonneville, and J. Bortowski formerly with WLAK-Viacom are thanked for their early efforts in identification and selection of the equipment. WCLR and WLAK jointly installed an identical system at the same site and at the same time as the WFYR system went into place. A special thank you to:

Bob and R. J. Full - Moto Ventilation (Installing Contractor)  
Ken Lee - Ken Lee Associates (Mechanical Engineer Consultant)  
Art Siegel - RKO Radio

### REFERENCES

- 1) Laurence Gray and Richard Graham, RADIO TRANSMITTERS, (McGraw-Hill, New York, 1961), Chapter 10 - Cooling.
- 2) John D. Lenk, MANUAL FOR INTEGRATED CIRCUIT USERS, (Prentice-Hall, Reston, Virginia, 1973) p. 52 - 54
- 3) William McGuinness, MECHANICAL AND ELECTRICAL EQUIPMENT FOR BUILDINGS, (John Wiley & Sons Inc., New York, 1980) p 247-248.
- 4) TRANE AIR CONDITIONING MANUAL, (McGill Graphic Arts, St. Paul Mn, 1970), Chapters 1 through 5 (recommended reading)

- 5) Andrew Althouse, Carl Turnquist, and Alfred Bracciano, MODERN REFRIGERATION AND AIR CONDITIONING, (Goodheart-Wilcox, Homewood, IL, 1968), chapters 1, 3, 9, 19, 21, 22, and 24.
- 6) Margaret Ingles, WILLIS H. CARRIER, FATHER OF AIR CONDITIONING, (Country Life Press, Garden City, 1951) p 86
- 7) THE 7 MOST COMMON MISTAKES MADE IN DESIGNING COMPUTER ROOM ENVIRONMENTS, EDPAC Corp., P.O. Box 970, Horsham, PA 19044, 215-784-5917
- 8) ENGINEERING DATA MANUAL, EDPAC Corp.
- 9) Edwin Anderson, and Roland Palmquist, REFRIGERATION: HOME AND COMMERCIAL, (Audel/Howard Sams, Indianapolis, 1981), general reference
- 10) Steve Elonka and Quaid Minich, STANDARD REFRIGERATION AND AIR CONDITIONING QUESTION AND ANSWERS, (McGraw-Hill, New York, 1973), general reference
- 11) Rex Miller, REFRIGERATION AND AIR CONDITIONING TECHNOLOGY, (Bennett Publishing, Peoria, IL, 1983), general reference

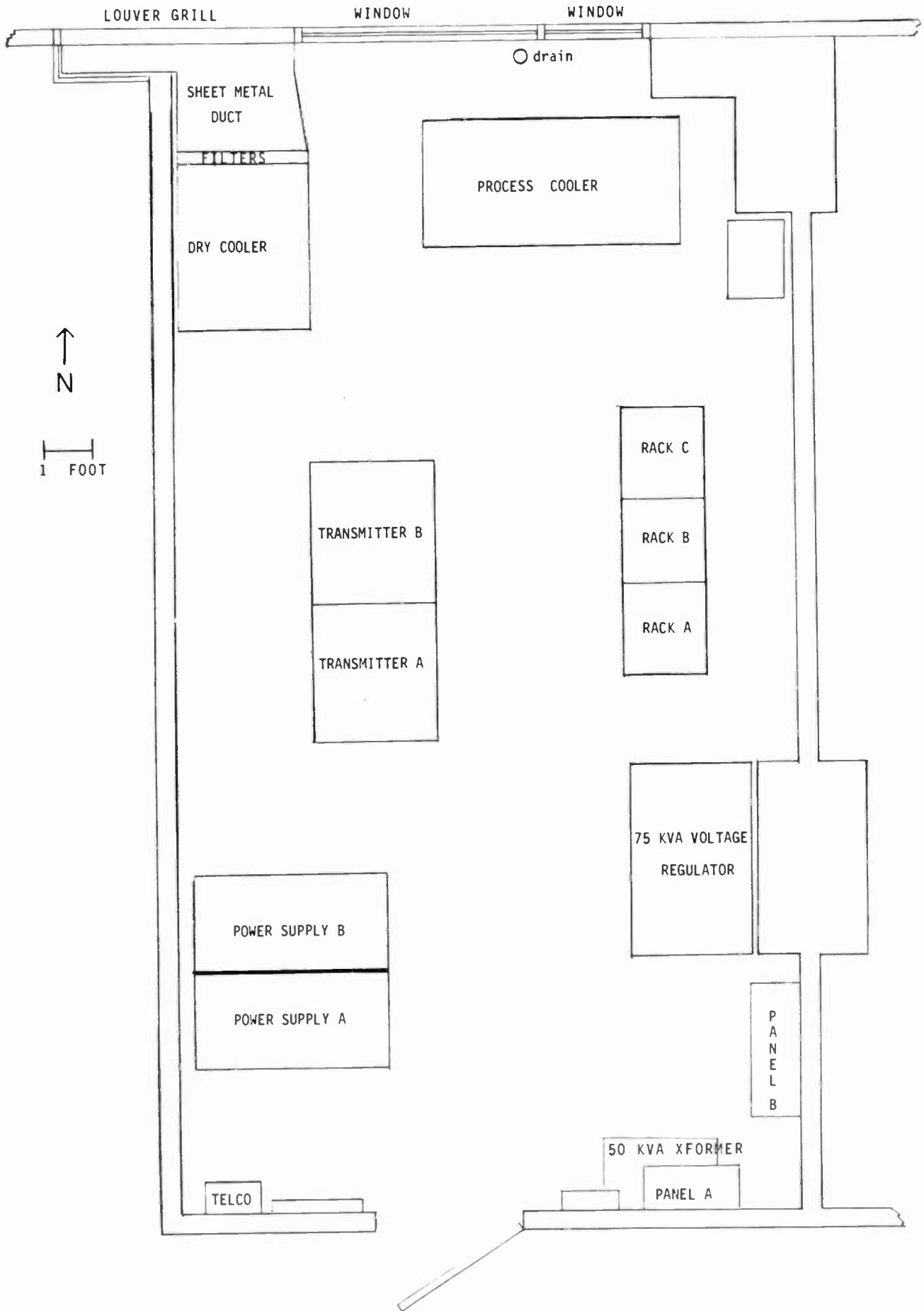


FIGURE - 1 WFYR TRANSMITTER ROOM FLOOR PLAN - SEARS TOWER



PHOTO - 1 This picture shows a side view of the dry cooler heat exchanger before the blower and covers were installed. The dry cooler was being moved into position for ducting connections to the outdoor air louver. The heat exchanger coil is 2 ft. wide by 6 ft. high.



PHOTO - 2 This picture shows the front view of the package cooling unit with service covers removed. The air flow is downward; a base with grills direct the air flow along the floor. The ctangular box on the top houses the economy cooling coil, and frame for the air intake filters. The unit is 5 ft. wide by 8.5 ft. high.

---

## TRANSMITTER COOLING SYSTEMS:

### DESIGN, OPERATION AND MAINTENANCE

Jeffrey H. Steinkamp, P.E.

Broadcast Electronics, Inc.

Quincy, Illinois

#### I. INTRODUCTION

The design, operation and maintenance of broadcast transmitter cooling systems must be properly addressed by the design engineer, system engineer, and station engineer to insure acceptable electrical and mechanical performance. The transmitter design engineer must apply expert thermal management to the heart of his product, the RF power tube. This internal cooling system must provide proper airflow around the tube filament stem, ceramic seals and cooling fins if good performance and long tube life are desired. The system engineer is responsible for providing an acceptable environment to the transmitter. This external cooling system is accomplished by the delicate balance of supply and exhaust air to the transmitter room. Finally, the station engineer must take the resultant efforts of the design and system engineers and properly operate and maintain this equipment within the specified limitations on a daily basis.

Using theoretical calculations to determine the amount of airflow required for power tube cooling presents a problem for the design engineer. The major obstacles to using mathematical solutions are the indeterminate fluid flow characteristics and heat transfer coefficients of the tube. Due to the complex nature of the flow path typically found in electronic equipment, pressure drop calculations do not yield easily to the customary fluid flow equations. Likewise, the heat transfer coefficients of tube surfaces and cooling fins are continually changing with flow velocity. Thus, the designer must resort to empirical testing to determine tube cooling requirements. This paper will present a systematic engineering approach to solving the problem of providing proper cooling for RF power tubes.

The system engineer does not usually have to resort to empirical testing of the external cooling system. The equipment used in supplying fresh air to the transmitter and then exhausting the heated air is used quite commonly in HVAC (Heating, Ventilating and Air Conditioning) systems. Information concerning the



airflow and pressure drop characteristics of standard ductwork components is readily available and complete. The system engineer must review this data and then assemble these components in the proper order and function to provide the correct environment for the transmitter. This paper will explore the approach used by the system engineer in an example installation.

The station engineer has the task of operating and maintaining this equipment within the given design limitations to minimize unnecessary "off-air" time. This paper will address proper operation and specific maintenance advice for a typical arrangement of equipment.

## II. DESIGN

The design of transmitter cooling systems consist of two major parts, internal cooling and external cooling. Internal cooling is concerned with the thermal requirements of components inside the transmitter (i.e. RF power tube, rectifiers, resistors, heatsinks, etc.). External cooling deals with the environmental needs outside the transmitter, namely the temperature control of the transmitter room.

### 2.1 INTERNAL COOLING

RF POWER TUBE THERMAL LIMITATIONS - The power tube has certain electrical and mechanical limitations. The proper voltages and currents applied to the tube are of utmost importance to the electrical engineer in order to achieve correct transmitter performance. Likewise, the mechanical engineer must be concerned with the packaging and cooling requirements of the tube to provide adequate temperature control during operation. For the engineer to better understand the thermal limitations of the tube it is best to consult the manufacturer's specification/application sheet. This data sheet will specify the maximum temperature allowed on the external surfaces of the tube to prevent destruction of the ceramic to metal seal and thermal warpage of the grids. Special air directors may be required for localized spot cooling of particularly hotter portions of the tube. Also contained in this technical literature will be data for airflow and static pressure requirements for rated plate dissipation. Since these curves represent just one particular type of tube socket configuration, they must be used with caution.

RF POWER TUBE TEMPERATURE MEASURING - The external surface temperatures of an operating power tube can be safely and successfully measured by the following methods.

Temperature Sensitive Paints - One of the easiest and reliable ways to measure tube surface temperature is by the use of temperature sensitive paints. These paints are available in a range of 125° to 250°C in steps of less than 10°C. Small, thin dots of paint are applied to the tube surface and if the specified temperature is exceeded, the paint will melt and change appearance from dull to glossy. For best results use a group of paint dots with each dot having a different sensitivity. These groups (3 minimum) should be equally spaced around the tube to compensate for possible temperature gradients.

Thermocouples - The most common electrical method of temperature measurement uses the thermocouple. When two dissimilar metals are joined together a DC voltage develops which is proportional to the

temperature of this junction. If this thermally generated voltage is carefully measured as a function of temperature then such a junction can be utilized for temperature measurements.

The thermocouple can be mechanically attached to the tube filament stem for direct temperature readings via a data acquisition system. Caution must be used when making direct contact with any operating RF power tube because of the potential electrical hazard and/or RF radiation.

AIRFLOW MEASUREMENT - Airflow can be measured in many different fashions. Some of the more common methods include calibrated nozzles, orifice plates, pitot tubes, hot wire anemometers, and flow meters. In searching for an accurate, portable, and cost effective transmitter airflow measuring device, the author has developed a system consisting of a standard blower and a variable frequency AC generator. By using an AMCA (Air Movement and Control Association) tested blower with a 3450RPM @ 60Hz AC induction motor and driven by a variable frequency generator, the engineer can adjust the motor speed from 0 to 3450RPM by controlling the input frequency from 0 to 60Hz respectively.

To utilize this variable speed blower in airflow measurement, the engineer must first determine the performance characteristics of this system. Constant speed blower performance is usually shown graphically by comparing airflow in cubic feet per minute (CFM) versus the static pressure (SP) against which the blower is trying to move air. These constant speed performances can be modified by the following fan laws:

$$CFM(XXHz) = \left[ \frac{RPM(XXHz)}{RPM(60Hz)} \right] \times CFM(60Hz) \quad (EQ.1)$$

$$SP(XXHz) = \left[ \frac{RPM(XXHz)}{RPM(60Hz)} \right]^2 \times SP(60Hz) \quad (EQ. 2)$$

These mathematical formulas allow the engineer to generate a complete set of performance curves for a known blower at any airflow, static pressure or speed configuration. With this graphical data, the variable speed blower and a manometer, the engineer now has essential tools for measuring airflow.

SYSTEM RESISTANCE MEASUREMENTS - System resistance is the term used to define the impedance to airflow presented by a restrictive system. The system could be a combination of sheet metal ductwork, filters, finned heatsinks, RFI honeycomb, tubes, tube sockets, etc. The motion of air through electronic equipment can only be accomplished by the creation of a pressure drop across the piece of equipment, in the same manner that current can only be caused to flow through a resistance by the application of a voltage across it. System resistance is usually expressed graphically by the system resistance curve (SRC) with coordinates of CFM versus SP. The importance of knowing the SRC of a particular obstructive configuration allows the engineer to better understand the flow characteristics of that system during the blower selection process.

By operating the blower into the restrictive system at different frequencies, recording the static pressures with a manometer, and using the varia-

ble frequency blower curves to determine the airflow, the SRC can be generated. Besides this graphical representation, the SRC can be shown by the general equation of:

$$SP = K(CFM)^n \quad (EQ. 3)$$

Where K = a constant determined by the characteristics of the system  
and n = a constant depending upon the type of flow.

Note that any change in the position or quantity of the restrictive elements within the test system will cause a change in the system resistance and should be retested for the correct SRC.

TEMPERATURE/AIRFLOW TEST - Now that the engineer understands the power tube thermal limitations and has the equipment to measure airflow and temperature, it is time to proceed with the actual tube temperature versus airflow test (See Figure 1).

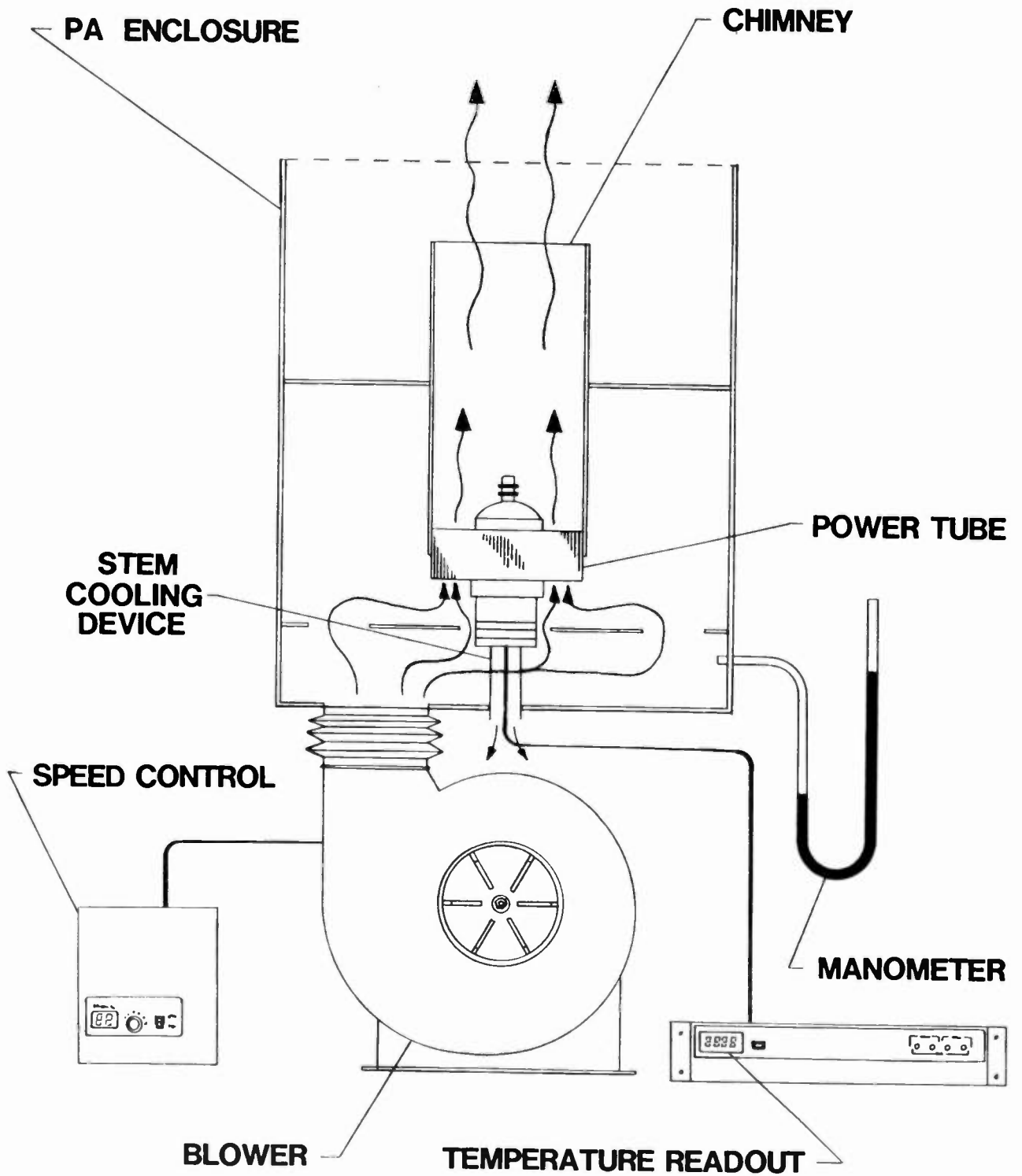
The engineer first energizes the transmitter at a fixed tube power dissipation determined by the difference between the RF power output and the DC power input. Then starting with the maximum airflow, a reading of static pressure and tube temperature should be recorded. By decreasing the speed of the blower less airflow will result and an increase in tube temperature will occur. The SP reading taken at each data point can be used to calculate the airflow in CFM by using either the system resistance curve or the system resistance equation (EQ. 3).

At a certain flow rate some part of the tube will reach the maximum allowable surface temperature and the test should be terminated to avoid damage to the power tube. At this point the minimum allowable flow rate should be noted and as shown in the next section this flow rate will need to be adjusted for different operating altitude and temperature conditions.

BLOWER SELECTION - The selection of a blower depends upon many factors, some of which include: Size, weight, noise, mounting requirements, power consumption, cost and the ability to supply a certain amount of airflow against a specified pressure. This paper will limit its discussion to the airflow and pressure requirements.

In the previous section it was determined that a certain amount of airflow was sufficient to maintain the tube surface temperature at an acceptable level. This airflow is only adequate at the given environmental test conditions of altitude and temperature. To provide proper cooling at maximum transmitter ambient conditions, typically 7500' and 50°C (122°F), an altitude/temperature correction factor must be applied.

Since the cooling capacity of air is a function of its mass, not volume, any change in air density will affect this cooling ability. Increases in altitude and temperature decrease air density and thus reduce the cooling capacity of air. Therefore, if a tube is to be operated at increased altitudes or temperatures, a correction factor which is proportional to these density changes must be applied. Application of this correction factor to the volumetric flow rate will assure the greater volume of air which is required when cooling with lower density air. These correction factors are available in either graphical or tabular form.



**FIG. 1 TRANSMITTER TEMPERATURE/AIRFLOW TEST ARRANGEMENT**

With the adjusted flow rate data in hand, it is a simple matter to select a blower. First, combine standard blower curves with the system resistance curve and select the blower whose curve intersects the SRC at or above the required CFM. At this equilibrium point of operation the pressure available from the blower to force air through the system is equal to the pressure required by the system for that flow rate. If the transmitter must operate at various line frequencies (50/60 Hz) then the selected blower must supply the required air at the lowest line frequency.

## 2.2 EXTERNAL COOLING

External cooling of the transmitter consists of two parts, the supply and exhaust air systems (See Figure 2). The supply air system provides fresh unheated air to the transmitter and the exhaust air system removes the heated air from the transmitter room to the outside world. Although identical transmitters may be used by two different stations it can be a safe bet that the system engineer will have to design two different unique systems. Numerous variables such as room size, transmitter position, outside temperature fluctuations, altitude, prevailing wind direction, and budget constraints will dictate different designs.

SUPPLY AIR SYSTEM - The major component of the supply air system is the supply fan and motor assembly. The function of the supply fan is to provide a controlled amount of clean airflow to the transmitter room. The system engineer must size this air mover for adequate airflow at a given static pressure. The amount of airflow in CFM should be 1.5 to 2 times the amount that actually flows through the transmitter. Transmitter airflow data is obtained from the manufacturer and will specify main blower and flushing fan requirements. The selected fan must deliver the required flow rate when used in series with the intake louvers, damper and filter. Each of these devices will cause a resistance to airflow and a corresponding pressure increase. The louvers are designed to weatherproof the wall opening from rain and snow. The damper is used to control the amount of airflow at different conditions. The filter, of course, is needed to keep the intake air as clean as possible. Filter selection by the system engineer is of utmost importance. With the large selection of filter types available, from simple disposables to electrostatic precipitators, a careful analysis of functional requirements is essential. It is strongly recommended that a local engineering consulting firm be retained for filter selection. A consultant that is familiar with the dust and contaminate conditions of your transmitter site will be invaluable to the proper function of your system.

An often needed accessory to the supply air system is an air conditioning (A/C) unit. This air cooler may be as simple as the window mounting type or as complicated as a large multi-tonnage refrigeration unit. When the transmitter room temperature exceeds an acceptable limit, the A/C unit activates and mixes cooled air with the incoming outside air. The A/C device may also be used in a closed loop system where the heated air from the transmitter is not exhausted outside but recirculated through the A/C unit. In this case, the system engineer would size the A/C equipment by determining the total amount of heat produced by the transmitter. This data in BTU's (British Thermal Units) is again available from the manufacturer and would include all of the heat ejected by the transmitter whether it be by conduction, convection or radiation. Also added to this thermal load are other sources of heat such as interior lighting, solar effect, test equipment, station personnel, dummy loads and heat exchanger.

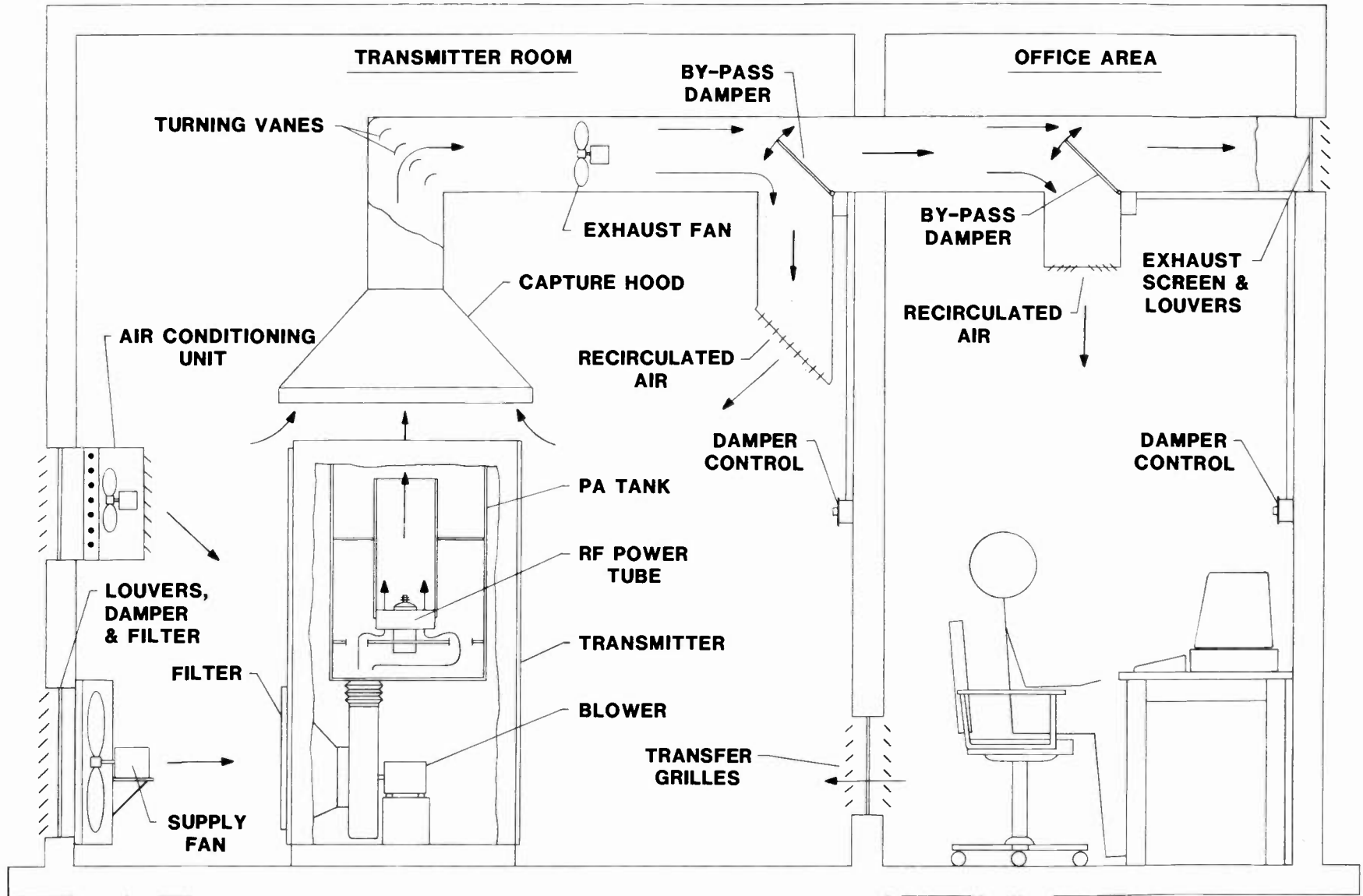


FIG. 2 TYPICAL TRANSMITTER COOLING SYSTEM

With this collected information the system engineer can now select the properly sized air conditioning unit.

EXHAUST AIR SYSTEM - The major components of the exhaust air system are the capture hood, exhaust fan, by-pass dampers and sheetmetal ductwork. Let's investigate the function and design of each of these devices.

Capture Hood - The capture hood is a sheetmetal canopy placed above the transmitter to gather in the heated exhaust air. A properly designed and positioned hood will effectively remove not only the direct air blast from the PA tank but also the radiant heat from the side panels of the transmitter.

Exhaust Fan - The function of the exhaust fan is to remove the heated air from the transmitter to the outside world via the capture hood and associated ductwork. The location of this device is usually as close to the capture hood as possible to keep the ductwork under positive pressure. Positive pressure ductwork prevents dust from infiltrating the system. The fan and motor must be able to withstand elevated temperatures (up to 200°F) so special bearings, windings, and lubricants may be required. The exhaust fan must have the same flow rate as the supply fan in order to maintain a balanced flow in and out of the transmitter room. This flow rate must be provided against the static pressures created by the complete duct system. Typical values for pressure drops through air ducts, elbows, transitions, and diffusers are available to the system engineer from the individual manufacturers.

By-Pass Dampers - The by-pass damper is actually a control gate used to direct airflow in the exhaust air system. Many broadcasting stations now recirculate the heated exhaust air to other rooms of the transmitter building during winter months to reduce energy cost. The movement of this air is regulated by the by-pass dampers. This control may be automatic or manual and the damper may be electrically, mechanically or pneumatically positioned.

Sheetmetal Ductwork - The ductwork used in transmitter cooling systems is the same as used in typical HVAC applications. This sheetmetal, either round, square, or rectangular, is a passageway for airflow from the capture hood to the exhaust louvers. The system engineer must package this duct system into the transmitter building with care and consideration. Always employ competent, skilled craftsmen to fabricate and install this duct system during the construction phase of the project.

### III. OPERATION

The operation of the transmitter cooling system is the responsibility of the station engineer. His understanding of the function of each component will allow him to properly and efficiently operate this sometimes complicated system. Let's use the typical cooling system found in Figure 2 and observe this equipment under various operating conditions. Three different outside temperature conditions will be reviewed with the overall goal of maintaining a transmitter room temperature between 60° and 80°F.

CONDITION "A" (OUTSIDE TEMPERATURE RANGE 50°-75°F) - In this condition the intake damper will be fully opened, the supply and exhaust fans will be on, and the A/C unit will be off. Both by-pass dampers will be in the down positions so that all of the heated air will be removed from the building.

CONDITION "B" (OUTSIDE TEMPERATURE LESS THAN 50°F) - At this range of operation the intake damper begins to close as temperatures decrease and thus restricts airflow into the building. Both the supply and exhaust fans are operating. To compensate for the restricted intake airflow, the transmitter room by-pass damper will begin to rise and allow recirculated air to flow back into the room. The office area damper will also divert some of the heated air into that space. Some of the exhaust air will still leave the building until very low outside temperatures will cause the by-pass dampers to utilize all of the heated air. At this point, the intake damper will fully close and the supply fan will be turned off. The operation is now a closed loop system that uses no outside air. The transfer grilles allow a balance of pressure between the two rooms and provides a flow path for the return air.

CONDITION "C" (OUTSIDE TEMPERATURE GREATER THAN 75°F) - In this "hot" condition the intake damper will be fully opened and both the supply and exhaust fans are operating. The A/C unit will be on and is now mixing cooled air with the intake air before it is drawn into the transmitter. Both of the by-pass dampers will be positioned to allow all of the exhaust air to exit the building. Cooling of the office area must be accomplished by other means and equipment.

The control and functional interaction between the fans, dampers and A/C unit can be as simple as manually operated or automatically activated by a microprocessor. In any case, the station engineer must keep this system in "tune" and properly maintained for reliable performance.

#### IV. MAINTENANCE

Maintenance of the transmitter cooling system by the station engineer is a very important responsibility. An aggressive overall maintenance program is the foundation for a dependable, first class quality transmission system. The benefits of proper maintenance are knowing that the equipment will function when needed and in the manner in which it is required. Preventive maintenance consists of those precautionary measures applied to equipment to forestall future failures rather than to eliminate failures after they have occurred. These procedures are performed on a regularly scheduled periodic basis, and the results recorded in a maintenance log. Maintenance of a cooling system falls predominantly into the category of good housekeeping by cleaning and occasional lubrication of moving parts. Below is a checklist of maintenance procedures that should be applied to various key components of the cooling system:

FANS & BLOWERS - Clean dirt and dust from fan blades and blower impellers as required to prevent reduced airflow performance and unbalanced conditions that may cause bearing damage to this equipment. If belt driven, check the system for belt tightness, wear and alignment. Lubricate all fan and blower motors in accordance with the manufacturer's instructions and use a high quality lubricant. Motors are cooled by air passing through and around them. If airflow is restricted because of accumulated dust, internal failure may result from overheating. Mounting bolts should be checked for tightness.



FILTERS - Air filters should be checked once every week and replaced or cleaned as required. Make certain that disposable type filters are positioned correctly according to airflow direction and never reverse a dirty filter. Use only the filter type and quantity suggested by the equipment manufacturer. The practice of stacking filters does not improve air cleanliness but will restrict airflow and may cause overheating problems.

DAMPERS - Check dampers for accumulated dust and dirt that would restrict airflow or impair movement of the louvers. Lubricate all mechanical linkages and solenoids as recommended by the manufacturer.

POWER TUBE - Visually inspect the power tube for blocked air passages through the fin area. Use a shop vacuum cleaner or high pressure air hose to remove the obstructions. During routine maintenance it is very important to look for tube and socket discoloration, either of which can indicate overheating.

CONTROL SYSTEM - The control system of a transmitter cooling operation can be the most "touchy" component that the station engineer must deal with. A typical system may consist of thermostats, logic boxes, flow sensors, and servo mechanisms. Consultation with the system engineer is essential for proper performance of this system. Adjustments to thermostat settings and flow control should be in accordance with the system engineers instructions and guidance.

#### V. CONCLUSIONS

Proper design, operation and maintenance of a transmitter cooling system is critical to a successful broadcasting organization. The transmitter designer must empirically test the internal cooling system with a competent and logical engineering approach. The system engineer must provide an external cooling system that will produce a proper environment to the transmitter, regardless of outside temperature changes. The station engineer must understand the operation and maintenance requirements of his own unique system in order to have a cost effective and quality transmission signal. And finally, the major purpose of this paper is to sensitize the broadcast station management to the importance of a properly designed, operated and maintained transmitter cooling system.

#### For Further Information On Transmitter Cooling Systems

Chiarulli, M., "Common Pitfalls in Designing Transmitter Cooling and Ventilation Systems", ABC Television, New York, NY

Shulz, W., "Process Cooling System For High-Rise Building Transmitter Installations", WFYR Radio, Chicago, IL

Stanley, H., "Guidelines for Transmitter Plant Installation and Maintenance", Harris Corp., Quincy, IL

Steinkamp, J., "Air Flow Measurements Using A Variable Frequency AC Generator", Broadcast Electronics, Inc., Quincy, IL

Whitaker, J., "Maintenance: Staying on the Air", Broadcast Engineering, November 1984



Standby Power Systems For  
Radio Broadcast Facilities

By Jerry Whitaker

Broadcast Engineering magazine

Overland Park, KS

When utility company power problems are discussed, most people immediately think of blackouts. The lights go out and everything stops. With the station off the air and in the dark, there is nothing to do but sit and wait until the utility company finds the problem and repairs it. This generally takes only a few minutes. There are times, however, when it can take hours. In some remote locations -- like hilltop transmitter sites -- it can even take days.

Blackouts are without a doubt the most troublesome utility company problem that a station will have to deal with. Statistics show that power failures are -- generally speaking -- a rare occurrence in most areas of the country. They are also short in duration. Studies have shown that 50% of all blackouts last 6 seconds or less, and another 35% are less than 11 minutes long. These failure rates are not usually cause for concern to commercial users, except where broadcasting is concerned.

A station that is off the air for 11 minutes--or even 5 minutes--will suffer a drastic audience loss than can take hours (or perhaps days) to rebuild. Coupled with this threat is the possibility of extended power service loss due to severe storm conditions. Many broadcast transmitting sites are located in remote, rural areas, or on mountaintops. Neither of these locations are well known for their power reliability. It is not uncommon in mountainous areas for utility company service to be out for days after a major storm. Few broadcasters are willing to take such risks with their air signal, and choose to install standby power systems at appropriate points in the transmission chain.

The cost of standby power for a broadcast facility (particularly high power stations) can be substantial, and an examination of the possible alternatives should be conducted before any decision on equipment is made. Management should clearly define the direct and indirect costs and weigh them appropriately.

This cost-versus-risk analysis should include the following:

- \* standby power system equipment purchase and installation price;
- \* exposure of the transmission system to utility company power failure;
- \* alternative transmission methods available to the station;
- \* direct and indirect costs of lost air time due to blackout conditions.

The amount of money a broadcaster is willing to spend on standby power protection is generally a function of how much money is available in the engineering budget and how much the station has to lose. An expenditure of \$10,000 for transient protection for a major-market station, where spot rates can run into the hundreds or thousands of dollars, is easily justifiable. At small or medium market stations, however, justification is not so easy to come by.

#### Standby system configurations

The classic standby power system using an engine-generator is shown in Figure 1. An automatic transfer switch monitors the ac voltage coming from the utility company line for any power failure conditions. Upon detection of an outage for a pre-determined period of time (generally 1 to 10 seconds), the standby generator is started and once up to speed, the load is transferred from the utility to the local generator.

Upon return of the utility feed, the load is switched back and the generator is stopped. This basic type of system is widely used in the broadcast industry and provides economical protection against prolonged power outages (5 minutes or more).

In some areas, usually metropolitan centers, two utility company power drops can be brought into a facility as a means of providing a source of standby power. As shown in Figure 2, two separate utility company service drops--from separate power distribution systems--are brought into the plant and an automatic transfer switch changes the load to the backup line in the event of a main line failure.

The dual feeder system provides an advantage over the auxiliary diesel arrangement shown in Figure 1 because the power transfer from main to standby can be made in less than a second. Time delays are involved in the diesel generator system which limit its usefulness to power failures lasting more than several minutes.

The dual feeder system of protection is based on the assumption that each of the service drops brought into the facility is routed via different paths. This being the case, the likelihood of a failure on both power lines simultaneously is very remote. The dual feed system will not, however, protect against area-wide power failures, which can occur from time to time.

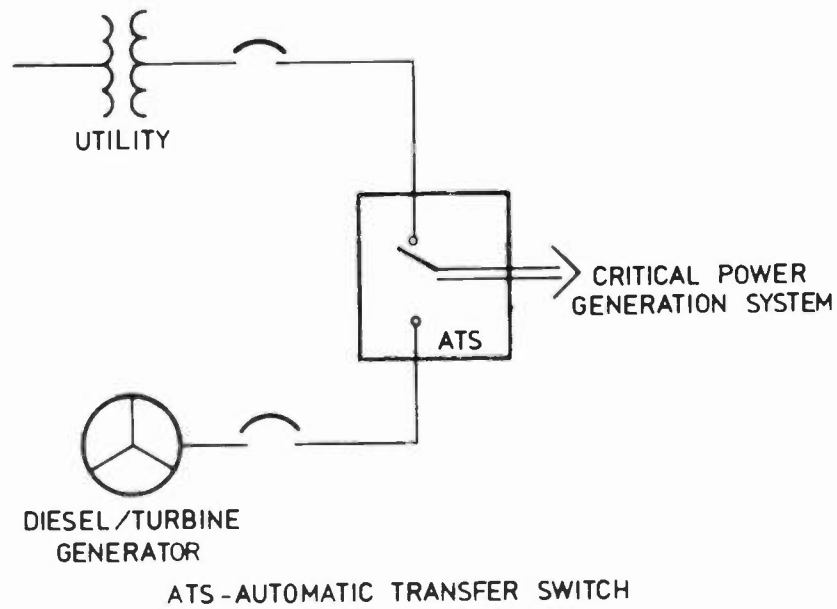
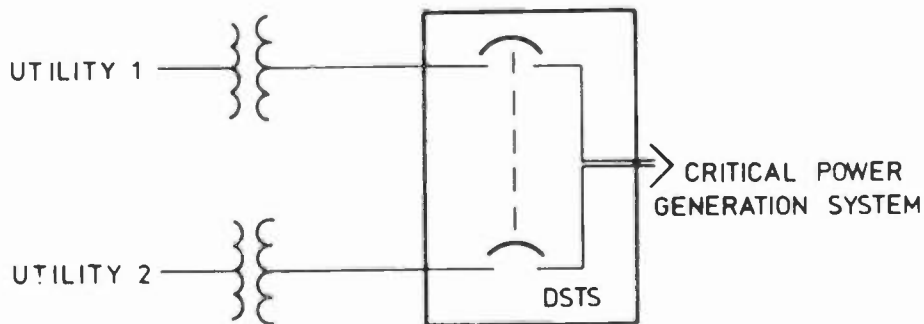


Figure 1. The classic standby power system using an engine-generator unit. This system protects a facility from prolonged utility company power failures.



DSTS DUAL SUPPLY TRANSFER SWITCH

Figure 2. The dual feeder system of ac power loss protection. An automatic monitoring system switches the load from the main utility line to the standby line in the event of a power disruption.

The dual feeder system is primarily limited to urban areas. Rural or mountainous regions are not generally equipped for dual redundant utility company operation. Even in urban areas, the cost of bringing a second power line into a broadcast facility can be high, particularly if special lines must be installed for the feed.

Figure 3 illustrates the use of a backup diesel generator for both emergency power and peak power shaving applications. Commercial power customers can often realize substantial savings on utility company bills by reducing their energy demand during certain hours of the day.

Figure 3 shows the use of an automatic overlap transfer switch to change the load from the utility company system to the local diesel generator. The change-over is accomplished by a special transfer system that does not disturb the operation of load equipment. This application of a standby generator can provide financial return to the station regardless of whether the generator is ever needed to carry the load through a commercial power failure.

#### Advanced system protection

A more sophisticated power control system is shown in Figure 4, where a dual feeder supply is coupled with a motor-generator unit (MGU) to provide clean, undisturbed ac power to the load. The MGU will smooth-over the transition from the main utility feed to the standby, often making a commercial power failure unnoticed by station personnel. An MGU will typically give up to 1/2 second of power-fail ride-through, more than enough to accomplish a transfer from one utility feed to the other.

As the name implies, a motor-generator unit consists of a motor powered by the ac utility supply that is mechanically tied to a generator, which feeds the load. The addition of a flywheel on the motor-to-generator shaft will provide protection against brief power dips.

An MGU also offers the user output voltage and frequency regulation, ideal sine wave output, elimination of common-mode and transverse-mode noise, elimination of utility company power factor correction problems and true 120 degree phase shift for 3 phase models. The efficiency of a typical MGU ranges from 65% to 89%, depending on the size of the unit and the load.

The standby power system shown in figure 4 is further refined in the application illustrated in Figure 5, where a diesel generator has been added to the system. With the automatic overlap transfer switch shown at the generator output, this arrangement can also be used for peak demand power shaving.

#### Choosing a generator

The generator rating for a standby power system should be chosen carefully, keeping in mind any anticipated future growth of the broadcast plant. It is good practice to install a standby power system rated for at least 25% greater output than the peak facility load. This headroom gives a margin of safety for the standby equipment and allows future expansion of the facility without worry about overloading of the system.

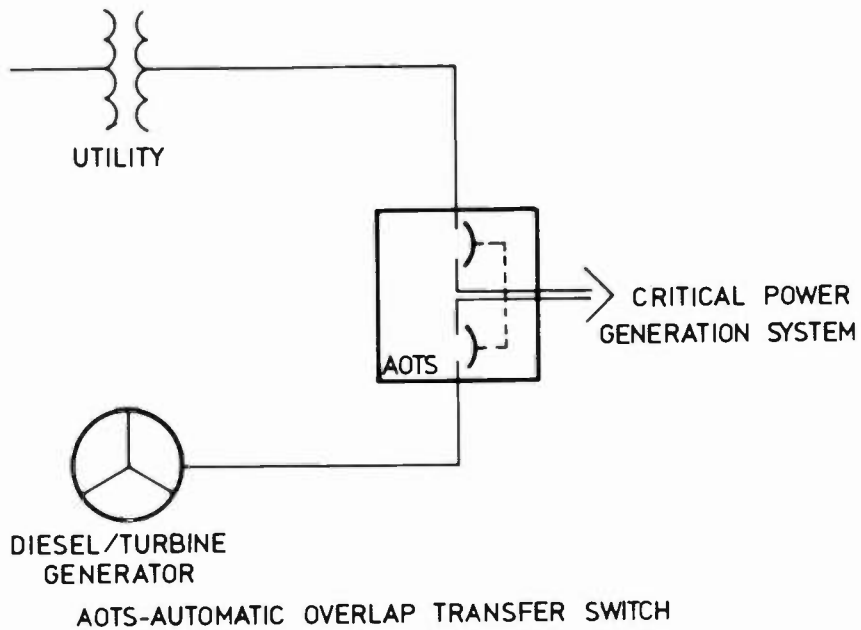


Figure 3. The use of a diesel generator for emergency power and peak power shaving applications. The automatic overlap transfer switch changes the load from the utility feed to the generator instantly so that no disruption of normal operation is encountered.

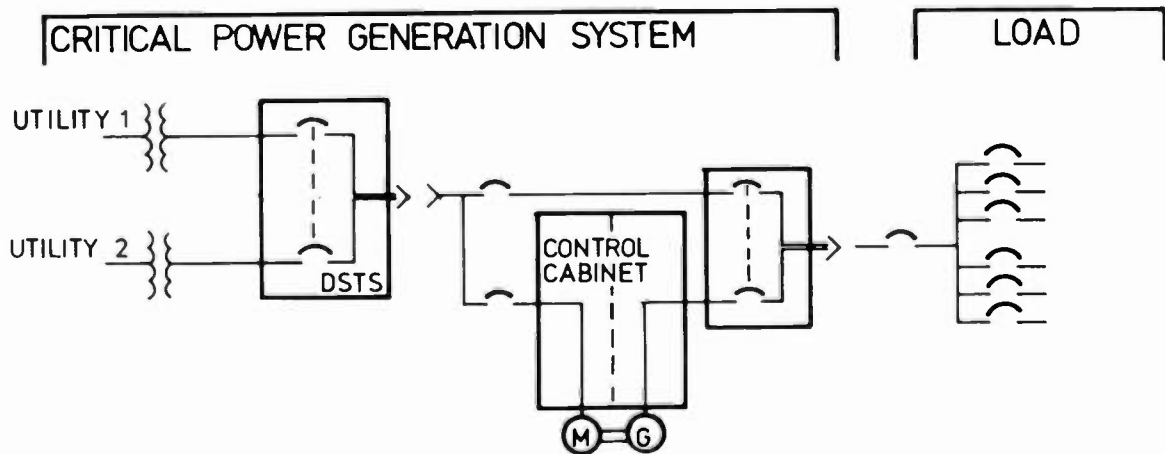


Figure 4. The dual feeder standby power system using a motor-generator unit to provide power-fail ride-through and transient disturbance protection. Switching circuits allow the MGU to be bypassed, if desired.

The type of generator chosen should also be given careful consideration. Generators rated for more than 100kW power output are almost always diesel-powered. Smaller generators are available that use diesel, gasoline, natural gas or propane as a fuel source. The type of power plant chosen is usually determined primarily by the environment in which the system will be operated.

For example, a standby generator that is located in an urban area office complex may be best suited to the use of an engine powered by natural gas, because of the problems inherent in storing large amounts of fuel. State or local building codes may place expensive restrictions on fuel storage tanks and make the use of a gasoline-or diesel-powered engine impractical.

The use of propane is usually restricted to rural areas. The availability of propane during periods of bad weather (which is when most power failures occur) must also be considered.

### Uninterruptable Power Systems (UPS)

A method guaranteed to eliminate the power failure threat is the rectifier-inverter combination, used in many Uninterruptable Power Systems. As shown in Figure 6, ac from the utility is rectified to a given voltage, such as 120 volts dc, across which floats a bank of batteries connected in series to yield slightly less than 120 volts.

This dc power drives a closed-loop inverter, which provides voltage and frequency regulation. If the utility voltage should drop or disappear, current is drawn from the batteries. When the ac power is restored, the batteries are recharged.

Many UPS systems incorporate a standby diesel generator that is started as soon as the utility company feed is interrupted. With this arrangement, the batteries are called upon to supply the operating current for only 10 seconds or so, until the generator gets up to speed.

The output of the inverter may be a sine wave or pseudo sine wave (really a stepped square wave). Sine wave units are usually more complicated and expensive than stepped square wave inverters. The sine wave systems, however, offer guaranteed compatibility with load equipment. Stepped square wave inverters may require some amount of testing before installation.

Figure 7 shows the output waveshape of a commercially available 1kW stepped square wave inverter, viewed at the secondary windings of a step-down transformer. The waveform is a three level step approximation to a sine wave. The ratio of peak-to-RMS voltages of the wave is nearly that of a sine wave.

Tests were conducted by the author on the feasibility of using such an inverter to power broadcast equipment in a standby capacity. Measurements concentrated on what effects, if any, the three level step wave would have on the performance of an FM exciter, standard aural STL and digital transmitter remote control system. It was believed that such applications would constitute an "acceptance test" for system compatibility.



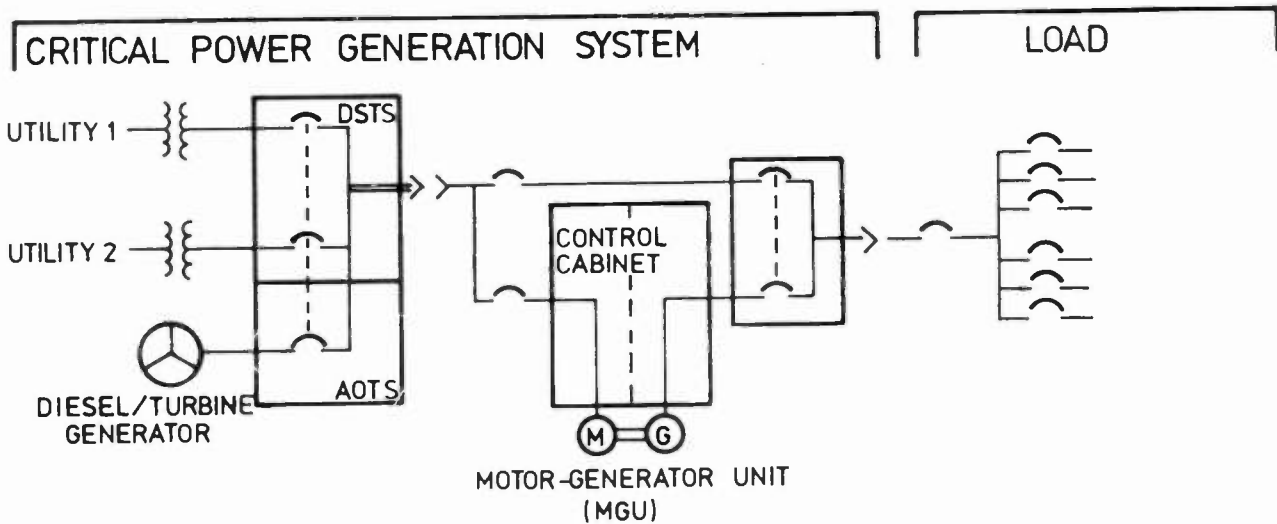


Figure 5. A premium power supply backup and conditioning system using dual utility company feeds, a diesel generator and a motor-generator unit. An arrangement such as this would be used for critical loads that require a steady supply of clean ac.

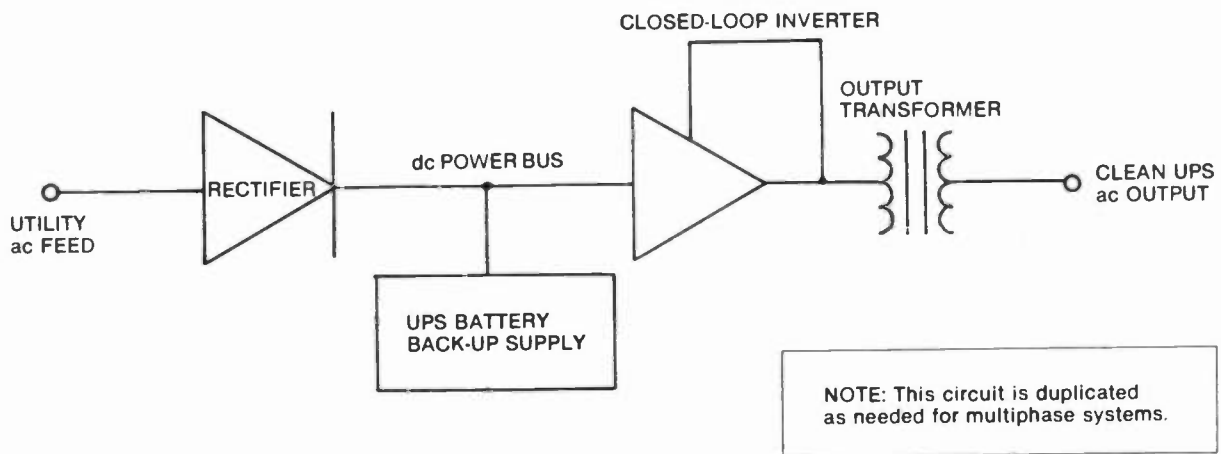


Figure 6. A block diagram of a typical Uninterruptible Power System using ac rectification to float the battery supply. A closed-loop inverter draws on this supply and delivers clean ac power to the protected load.

Despite the input waveform, the rectified noise component was quite small when loaded with even a small value capacitor. Figure 8 shows the stepped square wave signal of Figure 7 passed through a full wave bridge rectifier. The 120Hz spikes are approximately equal in amplitude to the AC waveform on the secondary of the transformer. They are, however, easily filtered out by adding as little as 0.01 $\mu$ F capacitance across the rectifier output.

Figure 9 shows the rectified output waveform with a 1 $\mu$ F filter capacitor across the diode bridge. Noise is reduced to a level comparable to that of a power supply fed with a sine wave.

In actual field tests, no difference in equipment performance could be detected with the FM exciter, STL receiver or digital remote control system when powered by a sine wave or the three-level step wave.

It is important to point out that these tests apply to a three-level step wave, not a square wave. Square wave inverters should not be used to power broadcast equipment.

UPS systems are available in the rectifier-inverter configuration (shown in Figure 6) or in a less expensive switching version, shown in Figure 10.

In the normal mode, the utility company ac line is connected directly to the UPS output terminals. If the utility supply should drop below a present level -- or disappear completely -- the inverter will start and feed the load from the battery supply.

This transfer is generally accomplished in less than one ac cycle. No disturbance of the load is experienced in most cases.

When the utility feed is restored, the UPS system will switch back to the primary power source and turn off the inverter. An internal charging circuit then recharges the system's battery bank.

When shopping for a UPS system, several important points should be considered:

- \* The amount of power reserve capacity for future growth of the broadcast facility.
- \* The inverter current surge capability, if the system will be driving inductive loads (such as motors).
- \* Output voltage and frequency stability over time and with varying loads.
- \* The required battery supply voltage and current. Battery costs vary greatly, depending upon the type of units needed.
- \* The type of UPS system (rectifier-inverter or switching) required by the particular application. Some sensitive loads may not tolerate even brief interruptions of the ac power source.
- \* Inverter efficiency at typical load levels. Some inverters have good efficiency ratings when loaded at 90% of capacity, but poor efficiency when loaded at 40%.
- \* Size and environmental requirements of the UPS system. High power UPS equipment requires a large amount of space for the inverter/control equipment and batteries. Battery banks often require special ventilation and ambient temperature control.

Figure 7. The output wave form of a three level step inverter, measured at the secondary of a step-down transformer.

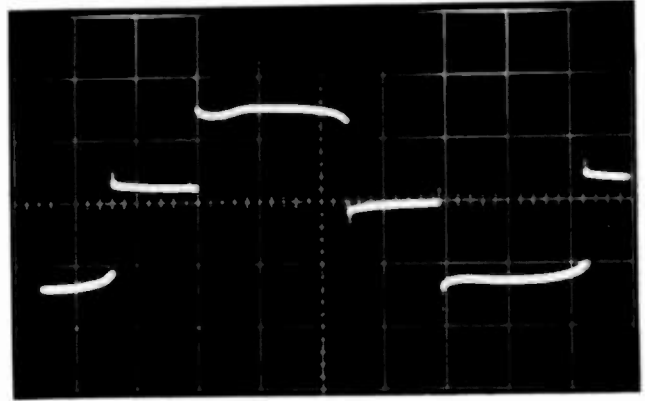


Figure 8. The rectified output of the waveform shown above (same scope sensitivity). The 120Hz spikes shown can be filtered out by a small amount of capacitive loading.

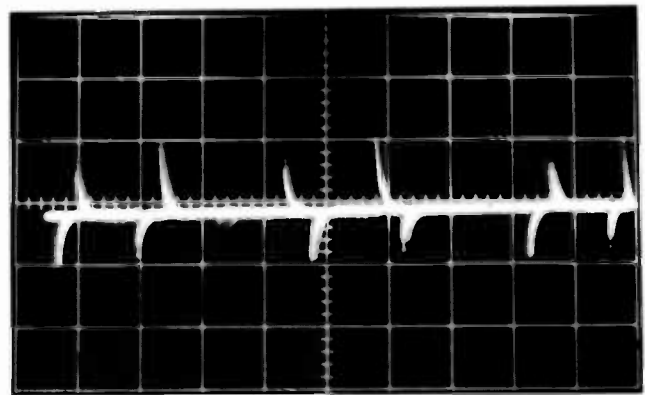
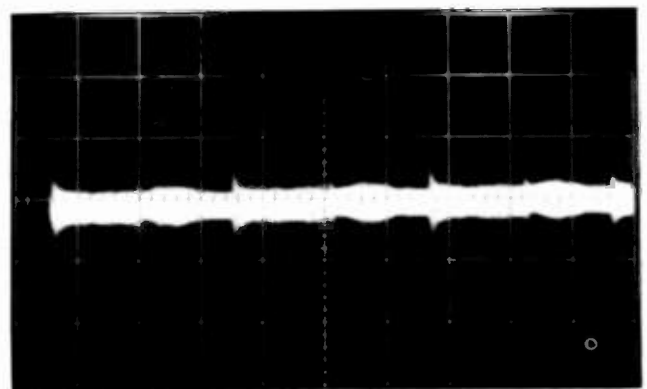


Figure 9. The rectified output of the waveform shown in Figure 7 (increased scope sensitivity) with 1 $\mu$ F capacitive filtering. The noise level is comparable with that of a sine wave ac input.



## Critical system bus protection

A station seeking standby power capabilities should consider the possibility of protecting key pieces of equipment at a facility from power failures with small, dedicated, uninterruptable power systems. Small UPS units are available with built-in battery supplies for microcomputer systems and other hardware used by broadcasters.

If cost prohibits the installation of a system-wide standby power supply (using generator or solid-state UPS technology), consider establishing a critical load bus that is connected to a UPS system or automatic transfer generator unit.

This separate power supply would be used to provide ac to critical loads, thus keeping the protected systems up and running. The concept is illustrated in Figure 11. Unnecessary loads are dropped in the event of a power failure.

A standby system built on the critical load principle can be a cost-effective answer to the power failure threat.

The first step in implementing a critical load bus is to accurately determine the power requirements for the most important on-air equipment. The typical power consumption figures can be found in most equipment instruction manuals.

If the data is not listed in the equipment manual or available from the manufacturer, it can be measured using a portable wattmeter.

A sample power requirement list for a station with a remote transmitter follows:

EQUIPMENT POWER CONSUMPTION	
CONTROL ROOM	1709W
-----	
Audio Console	350
Cart machines (a total of 6)	315
CD players (a total of 2)	60
Air monitor receiver	160
Air monitor amplifier	200
Aircheck cassette deck	24
75 watt floodlights (a total of 8)	600
NEWSROOM	1135W
-----	
Audio console	200
Three play cart machine	144
Record-play cart machine	70
Cassette deck	14
Reel-to-reel deck	150
Police scanner	11
Clock/timers (a total of 2)	18
Weather receiver	3
Teletype printers/modems (a total of 3)	225
75 watt floodlights (a total of 4)	300

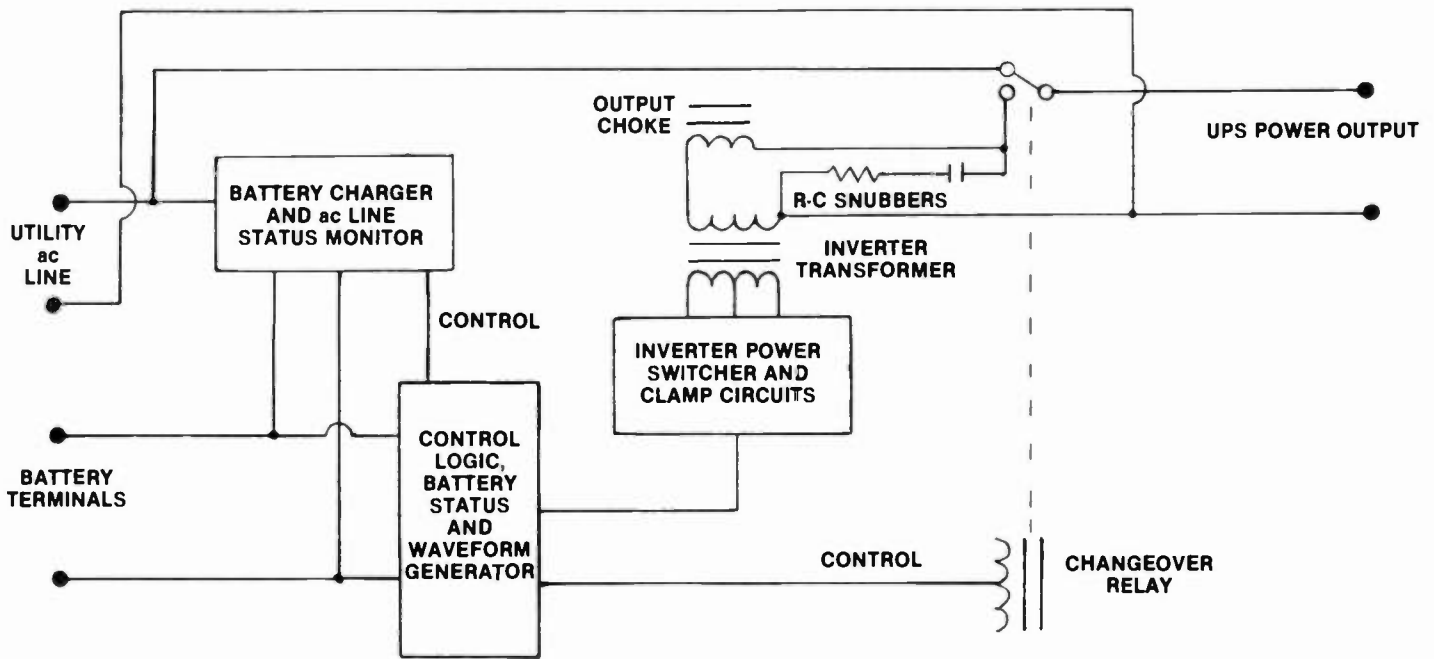


Figure 10. Block diagram of a load switching inverter/UPS system.

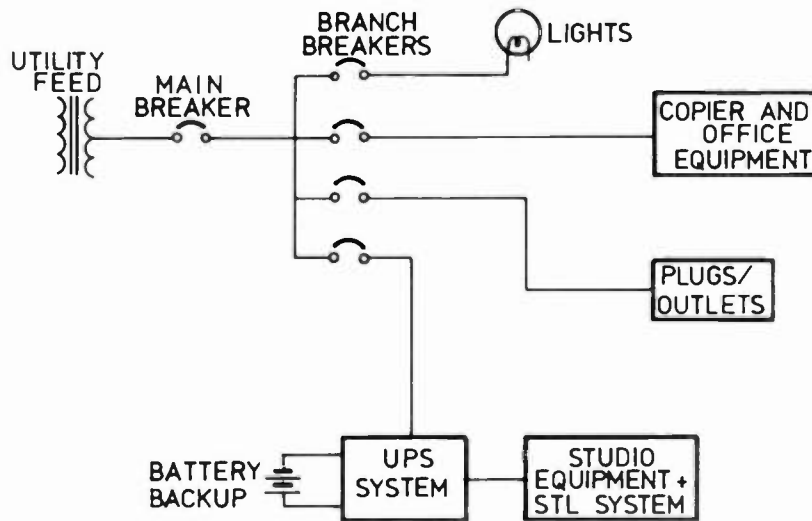


Figure 11. An application of the critical load power bus concept. In the event of a power failure, all equipment necessary for continued operation is powered by the UPS equipment. Non-critical loads would be dropped until commercial ac returned.

TRANSMISSION SYSTEM	232W
-----	
EBS encoder/decoder	20
Audio processor/stereo generator	30
Modulation monitor	70
STL transmitter	82
Remote control system	30
TOTAL POWER CONSUMPTION	3076W
-----	

With a total power consumption of 3076W for all critical equipment at the station, a UPS unit rated for 4kw could be used. This would give the station a reserve capacity of 30%. A UPS system should be chosen that offers a surge capacity of at least 2 to 1 to prevent overload of the inverter if the UPS system is dumped onto a "cold" load.

#### In conclusion

The degree of ac power protection afforded a radio facility is generally a compromise between the abnormalities that will account for better than 90% of the expected problems, and the amount of money available to spend on that protection. Each installation is unique and requires an assessment of the importance of keeping the system up and running at all times, the threat posed by the utility company feed and the budget available for standby power devices and systems.

---

## Lightning Protection for Broadcasters

Roy B. Carpenter, Jr.

Lightning Eliminators and Consultants, Inc.

Santa Fe Springs, California

### The Problem

Broadcasters are usually exposed to lightning activity at both the studio and the transmitter facility. It is, of course, obvious that the transmitter facility is usually far more vulnerable than the studio. Much of what is said about the transmitter facility is true of the studio, but to a lesser degree. The transmitter facilities will therefore be used as the baseline system for this paper.

It is also true that television, FM and AM transmitters are different, but have many commonalities. The common features are usually those subject to lightning activity. Therefore, what is covered with respect to one is true for most others.

A broadcast, TV or FM, station usually has three points of vulnerability, some only two. These are illustrated by Figure 1 and include:

1. The antenna/tower system - vulnerable to direct strikes;
2. The power service entrance - vulnerable to line voltage surges (and other anomalies); and
3. The remote communications system - phone lines, coax lines or the STL, all subject to induced transients of some form.

Each of these represents a potential source of disastrous anomalies from lightning activity; but all of them can be protected completely. For the past 14 years, Lightning Eliminators has been servicing the broadcast industry. During this period, they have developed a complete line of protective equipment that has been proven to be completely effective in protecting against any lightning related phenomena. This paper deals with each of the potential problems

individually, and presents what has been proven to be an effective solution.

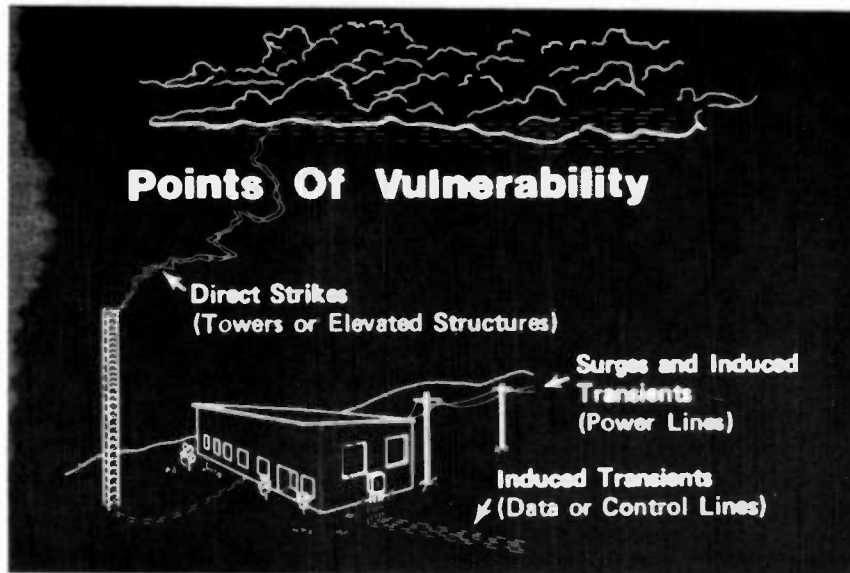


Figure 1

### The Lightning Mechanism

The direct lightning strike is the result of a strong electrostatic field being partially shorted out by your tower(s). Figure 2 illustrates the pre-strike situation and Figure 3 illustrates the stroke mechanism. The storm cell charges up everything beneath it to an equal, but opposite potential. Tall structures tend to create upward moving "streamers" that connect with the downward coming "leader", the meeting of the two results in a conductive channel, referred to as a "flash". The current surges within that channel are what causes the damage (stroke current).

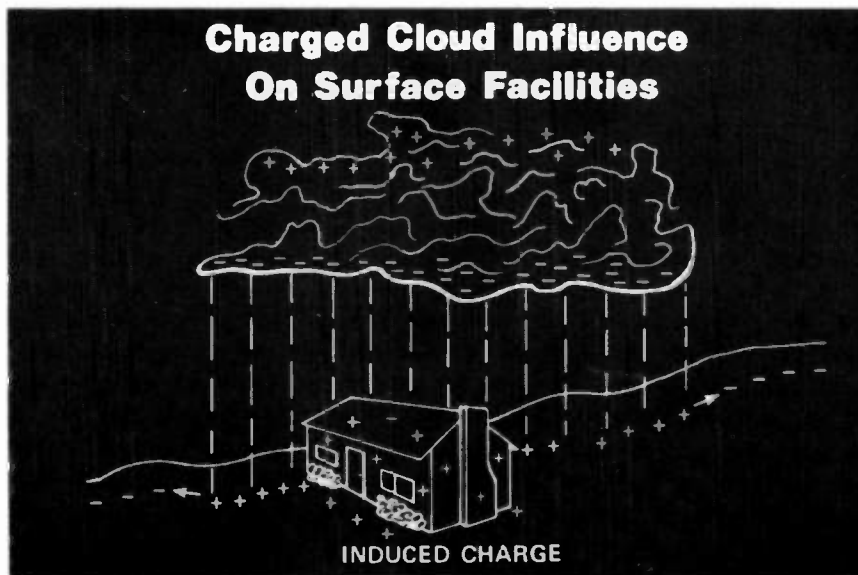


Figure 2



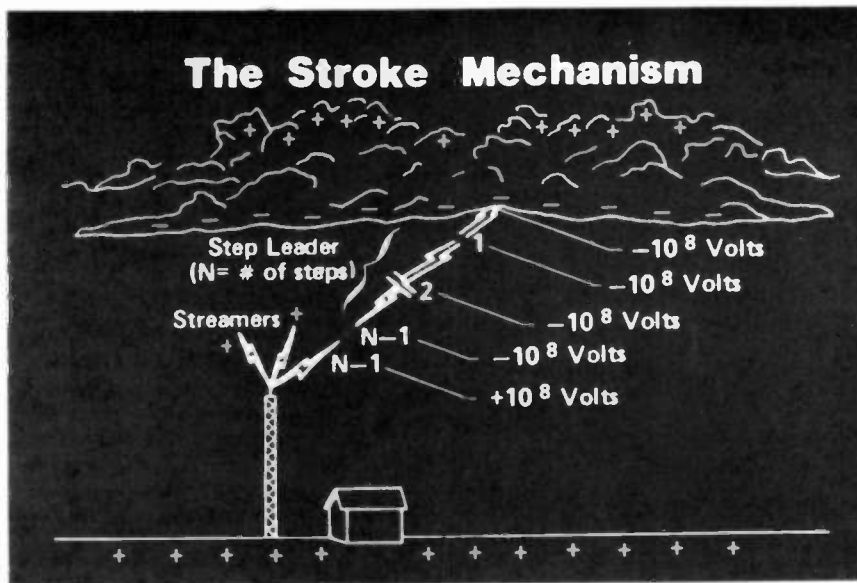


Figure 3

The stroke is caused by the difference in potential between the two bodies (the cloud and earth). The stroke is to neutralize that charge; not dump energy to "mother earth" as commonly believed. The resulting charge motion through the earth's crust is the cause of many lightning related problems, specifically earth current transients. The collapsing electrostatic field beneath the cloud is the cause of atmospherically induced transients.

### Dealing with the Direct Strike

Lightning can be dealt with in one of two ways:

1. Remedial - Assume the strike must occur and attempt to divert it via a "safe" path.
2. Preventative - Prevent the stroke (to the transmitter site) by maintaining pre-strike conditions.

The lightning rod and more recent innovations have all attempted to deal with the strike before it creates damage by providing a diversionary path. All have demonstrated an inability to be completely effective for various reasons; failures have resulted in significant damage.

Fourteen years ago, the Dissipation Array system (DAS) was introduced as a system that prevents the strike to the protected area; and, the protector. In contrast to the lightning rod, the DAS leaks the charge off slowly, by point discharge. Where the lightning rod must handle a deluge of energy in a short time, the DAS dissipates a little energy, constantly throughout the life of the storm (the average stroke is equal to only 1/3 ampere for one minute).

A DAS is composed of three functional subsystems:

1. The Ionizer or Dissipator is usually mounted on your tower or protected structure. It creates the ions and related current flow that discharges the facility. The mechanism is termed "point discharge". It may take any one of many shapes.
2. The Ground Current Collector (GCC) is the inverse of a grounding system. The GCC collects the charge induced into the facility and its surroundings by the storm, providing a preferred path via the service connections; and Ionizer, out of the facility area.
3. The Service Connections carry the charge from the GCC to the Ionizer by some form of safe conductive path.

The resulting protection comes about as a result of a large part of the charge being drained from the site of concern; leaving it at a lower potential with respect to the storm than its surroundings.

After 14 years of history and nearly 550 array installations, the statics have shown that DAS installations are over 90% successful the first time, and another 9% were over 90 percent effective the first time. Two forms are illustrated by Figures 4 and 5.

Note: Failure is defined as not completely eliminating all strikes. 90% effective means less than 10% of the former number of strikes.

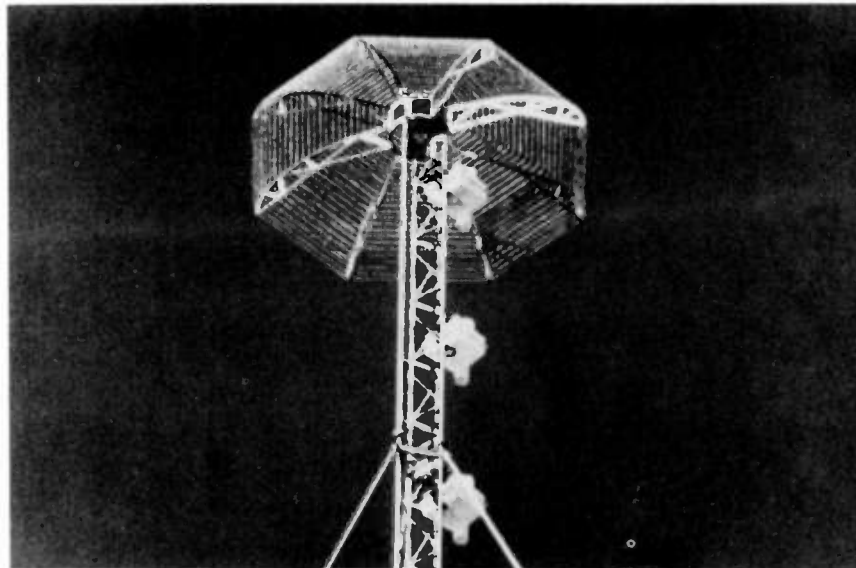


Figure 4

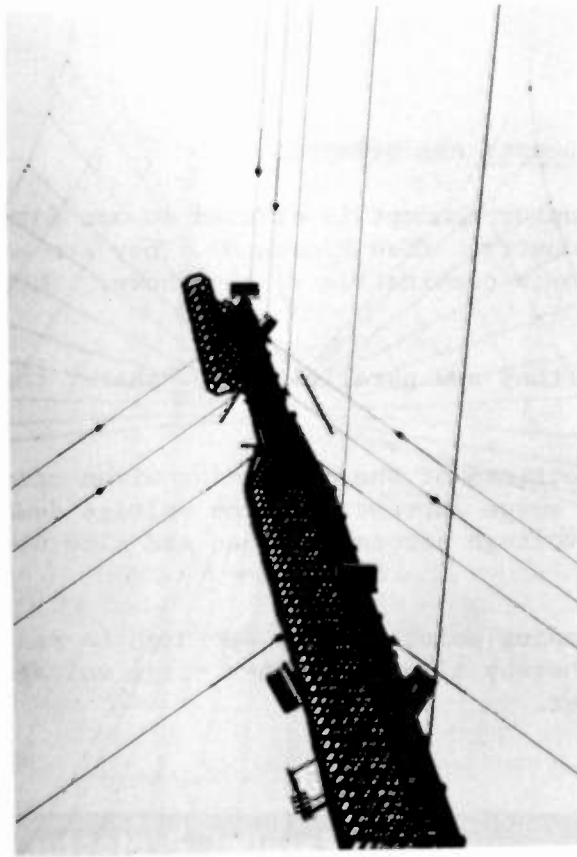


Figure 5

Most of the failures were subsequently corrected; the remainder were not at the owners choice - usually because of the negative impact on the facility.

Dealing with Power Line Surges

Most power line surges are created by lightning, the remaining causes are usually less deleterious. A composite of line voltage anomalies indicate that the protection requirements for broadcasters are as listed in Table 1. In selecting a protector, all of these must be considered in concert. Any compromises in these values in the design of the protector, will introduce some risk of losses due to inadequate protection; the actual risk being related to the compromise made.

TABLE I

Surge Protector Requirements

Clamping Voltage	no more than 1.7 times RMS
Surge Energy*	At least 10,000 Joules (watt seconds)
Peak Surge Current	160,000 amperes
Peak Voltages	45,000 Volts (at service entrance)
Response Time	< 50 nanoseconds

\* Independent of grounding

Two Protection Concepts are offered:

The Parallel Protector concept is offered in one form or another by most suppliers in this industry. (See Figure 6) They are made up of avalanche diodes, MOV's, gas tubes or a combination of the above. They all suffer from three disadvantages:

- (1) Because they are parallel, they "share" the surge energy with the load,
- (2) the inductance of the connecting wires create an impedance to the flow of surge current, and the voltage developed across them add to the voltage across the load and slow down the effective reaction time,
- (3) the clamping point must be set high to reduce the parasitic power loss, thereby allowing higher surge voltage to pass on to the equipment.

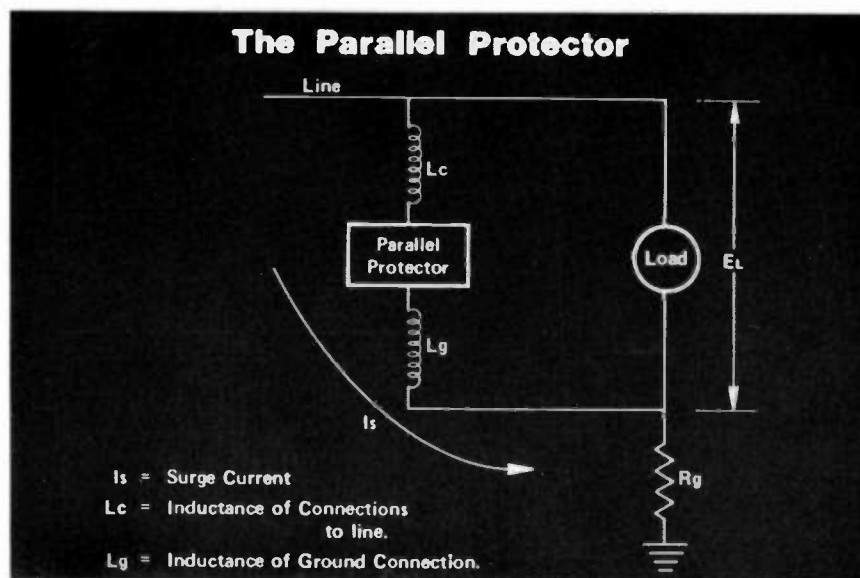


Figure 6

These must always compromise the specifications; they are often less expensive and easier to install, however, one such unit is unreasonably expensive for what it provides.

The Series Hybrid concept, made by LEA, is illustrated by Figures 7 and 8. It overcomes all of the problems that limit the effectiveness of the parallel devices, is 100% effective, if properly selected with respect to size, and installed properly.

The Series Hybrid Surge Eliminator (SE) concept is installed between the service entrance and the power distribution point as illustrated by Figure 8, thereby acting as an interceptor. Separate ground connections are used to

isolate the effect of the surge current passing through its connections to ground from the load voltage. The grounding point is used as a reference called "Common Point Ground" (CPG). The line voltage is controlled with respect to this point, where the neutral is also connected.

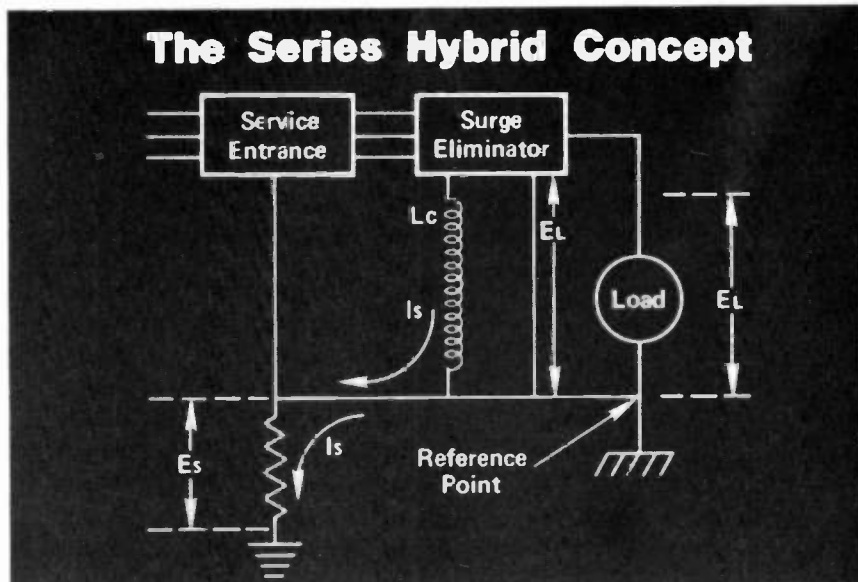


Figure 7

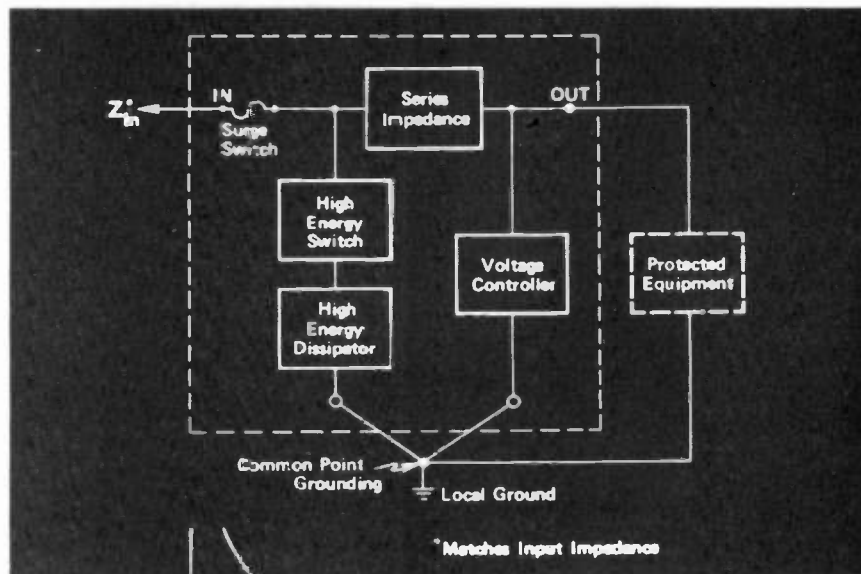


Figure 8

The SE functions as follows:

If the line voltage rises to the clamp point, usually 1.7 times nominal RMS, the Voltage Controller clamps the output to that point within 5 nanoseconds. As the input continues to rise, the excess voltage is dropped across the series impedance and the High Energy Switch (HES) is activating, diverting the excess energy to the High Energy Dissipator (HED) which dissipates over 100,000

joules of energy. The High Energy Switch can handle over 200,000 amperes of surge current without damage. If there is a constant overvoltage due to a utility accident, the HED continues to conduct, forcing the surge fuse to go open circuit, thus saving the protected equipment and SE from disaster. No customer has lost protected equipment if the SE was installed correctly in over 8 years.

The SE is designed to match the service entrance impedance. The Series Hybrid HED must dissipate all the surge energy the service entrance passes. SE's are available for service currents from 30 to 4000 amperes and voltages of up to 600 V RMS, three phase. Because of the patented design concept, these are of reasonable size and weight.

The series impedance used in larger SE's is a Triaxial Inductor, a concept that allows the SE to carry large currents through a relatively small assembly and achieve several functions. The phase conductors are superimposed on a common axis, passing through a magnetic field, resulting in common mode cancellation. The magnetic field also presents an impedance, individually to any phase to phase surges. This concept allows the SE to function without the HED and/or without the Voltage Controller and still prevent the passage of most of the surge energy. Figure 9 illustrates a typical Series Hybrid Surge Eliminator.

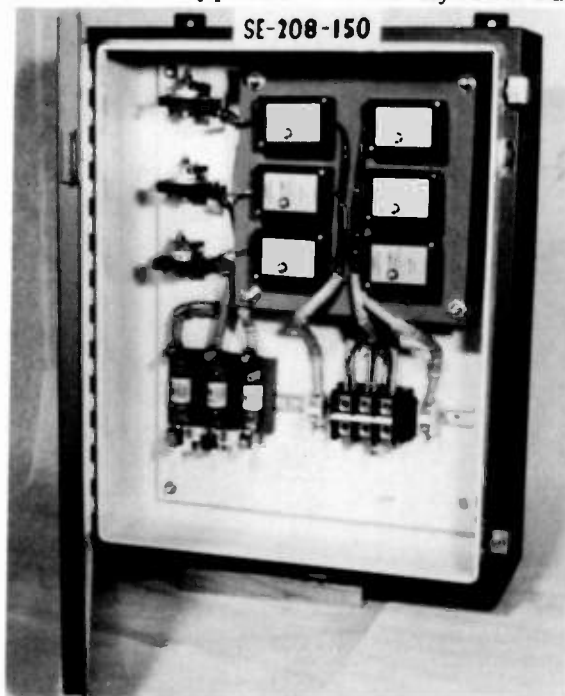


Figure 9

Finally, the tight clamp preserves the reliability of the protected equipment, the fast reaction assures no leak through of energy, the excess energy handling capability prevents damage to the SE and the protected system; it is actually 100 percent effective.

#### Protecting Communications Lines

Communications lines such as remote control, remote voice, coax, high or low level RF or Video are all subject to induced transients resulting from atmospheric currents related to lightning.

These are also protectable using the same basic technology applicable to

the power lines. LEA has developed a series of Transient Eliminators (TE's), a series hybrid protector, designed to match the impedance of the circuit to be protected, without introducing significant attenuation. Some of these are illustrated by Figure 10.

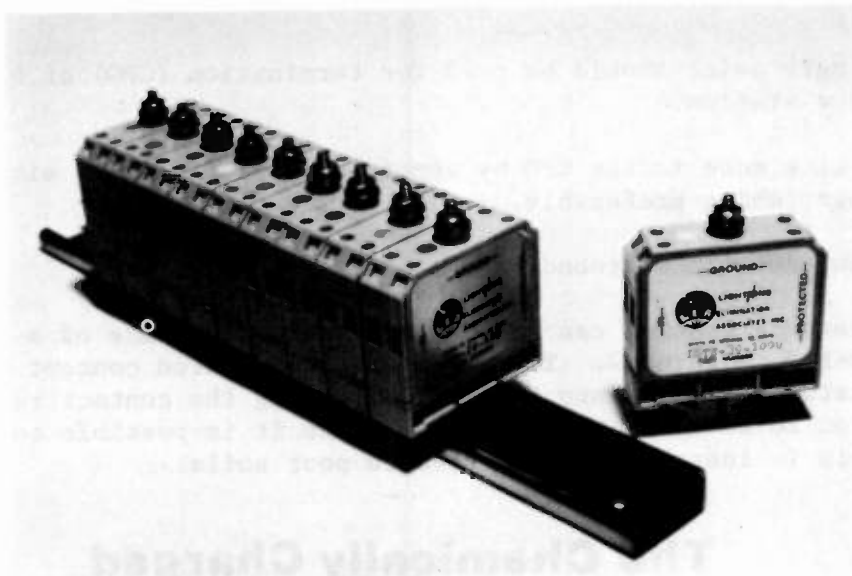


Figure 10

There are now available a series of Coaxial Surge Eliminators, a series hybrid protector applicable for use in high power RF circuits, from the HF through the UHF bands; these are also combined with notched filters where required. Some of these are illustrated by Figure 11.



Figure 11

For AM broadcasters, LEA has developed the Guy Charge Dissipation Choke. This device equalizes the potential across the insulators of an AM tower, without significantly influencing the antenna tuning. These eliminate the arcing across insulators, known as snapping.

## Grounding Considerations

An Integral part of station protection is the grounding system. There are three characteristics of concern to be considered in the design and installation:

1. A single point should be used for termination (CPG) of all grounds in the station.
2. All ties made to the CPG by separate runs of a large size wire, or copper tubing preferably.
3. A low resistance ground is mandatory.

Low resistance grounds can now be achieved through use of a new development known as Chem-Rod, Figure 12. This device is a patented concept using a chemical that constantly seeps into the soil, lowering the contact resistance by factors of from 20 to 100. Within a few months it is possible to achieve resistance levels in less than 1 ohm, even in poor soils.

## **The Chemically Charged Ground Rod**

---

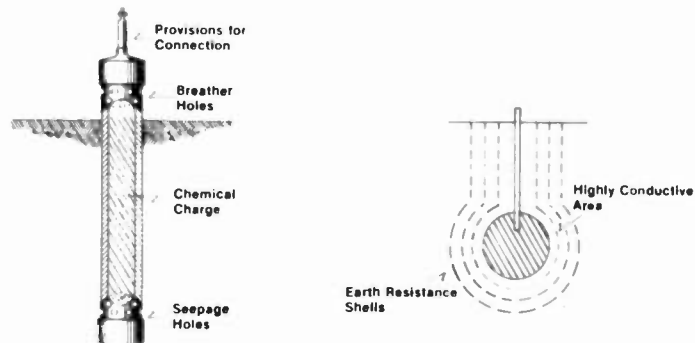


Figure 12

In summary, there is no reason why any broadcaster should continue to suffer from lightning related losses of any form. There is positive protection available for every known situation. However, the complexity of the lightning and line voltage anomalies related problems faced by broadcasters today are significantly greater than only 10 years ago. The field has become a specialty and good consultation is required.



---

Selecting and Optimizing Components  
For A  
Broadcast Graphics Creation Center

J.J. Kresnicka

American Broadcasting Company

WLS-TV Chicago

When we selected the first electronic titling system and video still storage many years ago, it was not realized that those devices would be the framework components of today's overall electronic graphic creation systems.

Back in the early 1970's, the A.B. Dick videograph surfaced as the first early graphic titling system, primarily producing alpha numeric displays for lower third and full screen insertion in News type programming.

The Chyron I was on the immediate trail of the videograph, which then followed the CBS Labs vidifont. WLS-TV's decision, based on technology and availability at the time was to embark on a system that was expandable and with the floppy disc, soon to be available, replacing the 1" tape in the cartridge termed a "VIDILOOP". This nine track, constant motion tape with one address and eight data tracks was a continuous 30" loop of tape that permitted storage of titles. The introduction of the Chyron II in 1972, and its subsequent acceptance by WLS-TV permitted the station to create on site character fonts and custom logos, or symbols, based on the graphic artists' creative requirements. For the first time, there was interchange between the ABC Owned Stations and the Network. For example, the Owned Stations Group use the Circle '7', and assorted News fonts that give the stations a uniformed look and recognition factor. A point to keep in mind is that virtually all of these early devices were single channel, single user, oriented systems.

Nine years ago, in 1976, the last NAB in Chicago, a new exhibitor displayed an existing device that had been updated and improved from its industrial application. The Arvin EFS-1 had been utilized as a non-broadcast, non-standard, black and white still video recorder in medical applications. At Julie Barnathan's suggestion, this device was modified and improved for the broadcast industry. Mr. Barnathan felt that a color still store device with a memory capacity of 400 frames per removable disc, 200 per side, at an affordable price was needed by the broadcasters. This device surfaced as the EFS-2 at the Owned Stations in 1977, and just a bit earlier on the ABC Network for Sports presentations.

The operational advantage of the removable disc was to permit Sports production personnel to shoot and store personality faces at the Network's production center in New York, store them on a disc and then hand carry the disc to the remote unit for later broadcast playback. The EFS-2, with an analog recording system was married to complex controllers, that contained memory for sequential operation of two units with the option of dissolving or cutting between two video outputs. This scheme was primarily utilized with early video compressors to create the over the shoulder graphics box still used daily on nearly every news broadcast.

On the horizon, in the mid seventies, the Chyron III surfaced as an interim and less expensive, more portable field use character generator. It was soon superceded by today's Chyron IV. The Chyron IV first introduced in 1979, was billed as an expandable software device.

The Chyron IV along with the Arvin EFS-2 were only two of many video sources available to production personnel in the control room. The two devices, housed in engineering areas with video tape machines, film projectors and slide drums, are operated as production devices whose outputs were combined to form a finished product usually in what is generally called a "pre-pack" session. During a pre-pack session an art card, produced by a graphics designer is placed on an easel in the studio, shot by a live studio camera and fed into the production video switcher. Concurrently, a title, generated by the Chyron was keyed onto the live camera's output and the composite output in turn recorded onto the Arvin recorder. The still store image could then be manipulated or repositioned in the live video and compressed to the required size. In addition to live camera video sources, slides and video tape feeds, would also be transferred to Arvin for still image recording.

What did it take to accomplish this in terms of manpower? Virtually a complete production crew, both control room and studio floor. TD, VO, camera, utility, LDE, stagehand and of course the Chyron and still store operators. These pre-pack

sessions were scheduled immediately preceding the news program, so all graphic consolidation that had been created by the artist throughout the day had to wait for the pre-pack session in the late afternoon or late evening.

In the early 1980's new devices were introduced. The McInnis Skinner Weathergraphics unit and the MCI Quantel paintbox permitted freehand manipulation of picture elements that were about to be stored, and those that have already been stored. The time had come for the personnel who had always "free handed" artwork to operate and control the weathergraphics and paintbox. The two devices are installed in the Graphic Arts area. By this time the Chyron had expanded to the 4100 series with two independent operating channels, a 10 megabyte hard disc drive permitting mass font and message storage. But most important, for the graphics designer, an option on the Chyron IV called MGM, or multi graphic mode, permitted freehand creation on the Chyron. This MGM device would be the third freehand paint system for the artist.

This, with the "EX" expansion option of the 4100, doubled the CPU and font memory to 64K each, permitting the artist to utilize 12 fonts "on line", and feature rotation, perspective, and more complex multi color logo's than previously possible. This freehand device is also installed in the traditional graphic arts area. This scheme permits creation of graphics with limited storage capability. A color graphics camera mounted on a stand is dedicated to the devices but the means to dump to external storage and receive video information from other external sources is now required.

The source most often utilized to receive graphics information, as previously described, is the video still store. By the early 1980's the analog EFS-2 had been replaced by digital still storage systems at the ABC Stations - the Quantel 6030 and Harris Iris II systems both containing mass disc storage, both fixed and removable. Because the 6030, as well as the Iris II, are multi user systems, it was decided to install one still store work station in the graphics area. The work station included alpha numeric keyboard, picture monitors, and necessary wave form monitors and vectorscopes. With the added assistance of a routing switcher keypad as an input to the still store, the artist could choose quickly which freehand device to input into the still store.

Keep in mind that while inputting takes place in the graphics area, other still store work stations permit playback of other stills for preview or air. In fact, stills are created and stored while a playback operator calls stills for insertion into a live news program. With direct electronic transfer of graphics to the still store via the routing switcher operation, it was also possible for 3/4" or 1" tape to record the outputs of these graphics devices.

With the increase in sophistication of the graphics products, the artist now required video sources to be fed to the input of the graphics tool. The camera provided only limited capability for feeding original information. To this end, another routing switcher panel was installed on the input to the freehand devices therefore providing the artist with the total video universe available within the plant. Now stills produced by the artist, and stored previously, could be reinpitted into the paintbox and updated - colors, numerical values or other elements of the graphic could be altered and given a fresh look without having to start from the original creation.

Yet with all these video source inputs available to the freehand devices, the artist was still limited in his or her production capability, when compared to the traditional non-electronic "cut and paste" methods. Though the Paintbox electronically performed cut and paste, that is the keying in graphics on existing images, remove and move images from one section of a video frame to another, limitations did still exist. The Harris Iris still store ICS panel also provides some flexibility to the artist - images can be placed over existing images - that is multiple sources can be added to one frame of video repeatedly. In addition, frames can be compressed and moved within the frame. But to achieve total flexibility, a video switcher, and in this case it should be referred to as a "video combiner" was installed in the graphics work area. The eight input "combiner" has two program outputs one to the Iris still store input and the second to a Sony BVU-820 3/4" VCR. Inputs now fed to the combiner include the dedicated still camera, outputs of the Weathergraphics computer, Quantel Paintbox, Chyron Colorizer, and a routing switcher panel for selecting any video source in the house. The BVU-820's output is also fed into one of the sources. Connected to the key input is the output of the dedicated still camera, while the downstream keyer is fed the output of the Chyron colorizer.

With this type of setup, the artist can now create just about any type of graphic that comes to mind and do it on the first pass, or first generation.

It must be emphasized, that even with the great deal of flexibility within and around this system, some limitations or shortcomings exist. Obviously, the artist could go on forever creating or drawing still images to be stored in the various still store memories. The paintbox started out with a 80 megabyte storage capability, then the size of the drives increased to 160 megabyte and now the 320 megabyte drive with multiples of the 320 added on to vastly increase its storage capability. On the other hand, the Iris is limited to eight total drives in each system, the station having two systems. Each system has a removable 80 megabyte drive with seven fixed

drives. These fixed drives are also at the 320 megabyte level, however drives are available, industry wide, up to the 602 to 800 megabyte level. The limitation of course is the controller driving the system, and until now the current controller is a relatively slow speed device, not being able to keep up with the faster drives, thus skipping images logged in sequential form on the disc drives. This will be corrected very soon with the substitution of high speed controllers with faster transfer rates to match these more powerful drives. I mentioned earlier that WLS-TV had two still store devices. One is used for production purposes, the other for on air use.

What's next? Shortly the process of reconnecting equipments with RGB inputs and outputs will begin. The freehand devices permit RGB in and out as does the Chyron. The input and output to the still store will also operate on component signals, and of course the live camera has an RGB output. To complete this very important phase of improving video quality, especially when multiple passes of one image occurs, will be the replacement of the current switcher with a component switcher. Unfortunately, some sources will have to remain composite but all efforts are being made to utilize RGB wherever possible.

---

NBC Election '84:

Results By Design

Thomas C. Alfieri

NBC/Computer Imaging Department

New York, New York

### Introduction

Election '84: Results by Design was the title given to a commitment by NBC to present a new on air look for its election night automatic display system. The system to be replaced had been in existence since the 1976 Presidential election. It utilized Chyron II character generators driven by special interfaces for the automatic display of numerical vote totals on a colored background. This system had become cumbersome to maintain, but more importantly, was incapable of utilizing the talents of graphic artists. A graphic artist's ability to enhance our daily news productions with timely, unique and innovative artwork were qualities wanted in an automated system. The Quantel Paintbox, because it had shown itself to be a reliable and operationally useful tool was selected as the graphic display system. To meet the control and development requirements, a DEC VAX 11/750 Computer system was selected.

Accomplishing our goal required the close working relationship of many various talents. Programmers, graphic artists and hardware engineers toiled for nine months developing software, creating artwork and implementing hardware. This paper will present an overview of the systems.

### Scope of Project

The scope of the hardware project was to install in a temporary facility eight Quantel DPB 7000 paintboxes under the external control of two Digital Equipment Corporation (DEC) VAX 11/750 computers. This facility would have to suffice as a software development laboratory, graphic artist design area and a graphics playback area for the Election '84 Broadcast.

Due to a tight time frame, from the installation of the first three systems the following criteria had to be met:

-Simultaneous use of the facility by programmer analysts and

graphic design artists

- All future equipment installations would not allow down time
- Ability for any system to be used by either a programmer analyst or graphic artist.
- Ability to provide demonstration tapes for project status review.

With the facility eventually going to air, distribution of program video, monitoring feeds, timing feeds, control and communication links were required. Control considerations were also needed for two additional paintbox systems installed in the WNBC graphics area.

### Facilities

Since a temporary facility would be used to house the paintboxes and their support equipment, all construction changes had to be minimized, thus resulting in various compromises. Two considerations however, which cannot be compromised are power and air conditioning. A vacated office area, adjacent to a computer room met these requirements. It was selected for installation of the first four systems. This area afforded the additional benefits of a raised computer floor and a clean air environment. The raised floor allowed for easy cable routing, thus minimizing cables on the floor and the need to construct costly overhead cable troughs. It must be noted that with existing fire laws only plenum cables are allowed to be placed in this type of raised floor. Also, cable bundle size was limited so as not to restrict the flow of air conditioning. To maintain a clean air environment, direct proper air flow and eliminate the possibility of static electricity all carpeting was removed. This 25 by 14 foot area eventually contained six racks for equipment, four design/development areas containing four paintbox work stations and six DEC computer terminals, a U-matic video tape machine and a color camera. Conditioned power was used for all technical equipment. To improve room lighting, a track light on a dimmer control was installed.

The room size was insufficient to separate the people involved with software and graphic development from the noise generated by the twelve 330 M/B disk drives. To minimize the ambient noise, a removable, sectionalized enclosure was erected around the six racks of electronic equipment. The enclosure was constructed with acoustic wall cover mounted in aluminum channels and suspended from a ceiling track. The acoustic wall covering has an unfinished side which exposes the fiberglass interior. To safeguard against particles of fiberglass being rubbed loose, a very fine nylon mesh was fastened over the exposed area. To enable the heat generated by the six racks of equipment to flow from the enclosure, openings were provided at the top and bottom of all panels.

To accommodate the installation of the remaining paintboxes an additional facility was required. Once again the primary considerations of power and air conditioning resulted in the selection of 9HC, the original election graphics display system area, overlooking the 8H studio floor. Benefits available from this location were equipment racks and work station furniture. With only a minimal amount of development time remaining, acoustic enclosures were not installed. Existing technical power for equipment, air conditioning and lighting were utilized without modification.

## System Requirements - Development Period

Graphic design requirements for Election '84 consisted of developing unique artwork for Presidential and Congressional contests. Original artwork was also required for depicting the responses obtained to the various poll and analysis questionnaires. Included in this design task was defining the look of the animation display. Approximately five hundred displays were prepared for use during the election night presentation.

Programmer analysts developed specialized software for use with Quantel paintboxes and DEC VAX 11/750 computers. The software development included writing programs for animations, creating new fonts, VAX control programs, system diagnostics and PROM programming.

Four paintboxes systems were utilized for the software and graphic design requirements of Election '84. Each system contained a Quantel DPB 7000 paintbox, synchronizing generator, safe area generator, RGB monitor and five disk drives.

Video from each system, both encoded and RGB was routed to a jackfield. The jackfield allowed for easy routing of video signals from one system's output to the input of any other system. The design of this facility and the equipment used, allowed for all picture transfers from system to system to be accomplished in either a digital or RGB format. Maintaining picture transfers in either these formats eliminated any concern of picture degradation due to NTSC encoding or decoding processes.

Included in the equipment was high quality, inexpensive color television camera, capable of producing both NTSC and RGB video signals. This camera allowed the graphic artist to shoot either 35mm slides or 8x11 photographs of candidates, from the numerous House and Senate contests. The video from the camera was then captured on a paintbox system in the RGB format. To accommodate the requirement to shoot from a 35mm slide to an 8x11 photograph a #2 close-up adapter was used on their standard 10x1 zoom lens.

All encoded signals used within the room were for either comparison or recording purposes. The comparisons allowed a graphic artist to evaluate the picture displayed on the RGB design monitor to a NTSC monitor reproduction. Recording of pictures and animation sequences allowed the review of design concepts and progress of the project.

The RGB signals were used for the transfer of analog video prior to recording onto a disk in a digital format. Once in digital form, picture information was transferred either by a floppy, RSD or 330 MByte disk. A RSD which holds approximately 70 pictures was the main means of transferring new information onto systems.

When a paintbox system was utilized for graphic design development, no operational changes were required from any manufacturer's specified procedures. A procedure could have been devised to allow the graphic artist to operate under the same hardware configuration necessary for software development. The advantages, however, of not having to retrain artists or encumber them with additional set-up procedures, outweighed the required cabling and switch setting changes.

The hardware requirements for software development, in addition to the equip-



ment previously mentioned were two DEC VAX 11/750 computers and six DEC computer terminals. The six terminals were connected to the VAX via RS232 links running at 9600 baud. These terminals were used by the programmer analyst to develop and execute all necessary programs. During software development these programs were resident in the VAX 11/750. The paintboxes used with software development were connected to the VAX 11/750 via a RS232 link running at a 19200 baud rate. The program residing in the VAX was down loaded to the paintbox by the programmer analyst utilizing one of the six terminals.

#### System requirements-Night of Air

The ten paintbox systems used for night of air were divided into four configurations. Each configuration was called a User. The four Users were: National Vote employing four systems, Summary, Poll and Analysis and WNBC, each using two systems. Each User was unique in the type of information which it displayed. The hardware for each User system was identical.

Each system consisted of a Quantel 7000 Digital Paintbox. National vote had three on line 330 M/B disk drives, Summary had one, Poll and Analysis had two, and WNBC had one. Each system within each User's group was identical. The redundancy was required to allow for back to back displays and accommodate the pace at which each User was to be incorporated into the live air production.

With the exception of the Poll and Analysis systems, two Digital Equipment Corporation VAX 11/750 computers called VAX A and VAX B controlled the picture retrieval process of the eight paintboxes. The four National Vote paintboxes referred to as Paintbox 1 to 4 were on VAX B. The two Summary paintboxes named 5 and 6 and WNBC local systems named 9 and 10 were on VAX A. A passive 2 x 1 switch at the input to VAX A and VAX B allowed the VAX System Manager to selectively redirect any paintbox to either VAX. Control data was transmitted at a 19.2K baud rate between the VAX and Paintboxes via RS232 or RS422 EIA Standards. The two standards were necessary to accommodate the various distances between paintboxes and VAX systems. Beyond 50 ft. RS232 should not be used at 19.2K baud. Since only National Vote systems were within 50 feet a RS 232 to 422 converter was necessary. The converter is an inline, self powered device which was installed in the paintbox racks.

Night of air, all paintboxes under the control of the VAX had predetermined data written on their 330 M/B disks. This data was either pictures of candidates, symbols, maps or house of senate layouts depending on the User. The VAX obtained current vote count statistical data of all races via dedicated telephone lines from the RCA computer center located in Cherry Hill, New Jersey. This data was used to update the various displays throughout the evening. The determination of which race was to be called and subsequently displayed involved four terminals. The terminals referred to as list, release, control and animate were connected to the VAX via RS232 communication links running at a 4800 baud rate.

The list operator entered data which determined what races were to be aired. The release operator, released the races stored in the VAX on a first in first out basis to the next available paintbox which brought up a static background. The animate operator initiated a command which then modified the existing display with real time generated dynamic displays such as "Towers", "Sliding Faces" or "Mushrooms". If a paintbox system had a failure the control operator's function was to eliminate that paintbox from the release operator's available paintboxes.

The two systems for Poll and Analysis also referred to as Chancellors Statistical Storyboard Package (CSSP) were VAX independent. These systems were operated by graphic artists from the air studio during the election night telecast. For noise and aesthetic reasons the paintbox mainframe end associated disk drives were located in room 9HC. The two artist work stations safe area generators and ancillary computer terminals were on the studio floor. Each work station was connected to its paintbox control input via a RS422 link. The computer terminals which were required for shifting between the CSSP and normal paint modes were connected to the paintbox.

The encoded video output of each paintbox was routed to distribution amplifiers. The two amplifiers per system supplied the required pre-equalized program and local monitoring feeds. Paintbox video for the eight network systems were routed to the central equipment area for appropriate distribution. To meet timing requirements, eight Sync Procs were used. The Sync Procs were installed in a rack on the 8H studio floor. They sent a composite black burst reference signal to each paintbox. The paintbox in turn, sent its video to the Sync Proc for video processing. After the necessary initial level and timing adjustments were made at each paintbox, all future rehearsal and night of air level and timing corrections were made by a transmission engineer at the Sync Proc rack. With video from the paintbox systems entering their appropriate production switchers the air requirements for the project was satisfied.

---

ASSEMBLING A COMPONENT VIDEO GRAPHICS CREATION CENTER

Karl Renwanz

WNEV-TV

Boston, Massachusetts

This paper is intended to assist a broadcaster in assembling a graphics creation center that operates totally in the component mode. By remaining in component form, the integrity of the visual image is maintained throughout multi-generation manipulation. Because there is little or no matrix action, degradation through normal encode/decode processes is eliminated.

#### HISTORY

In the summer of 1982, WNEV-TV made a major commitment to half-inch component analog technology through a purchase of Panasonic M-format equipment. It quickly became apparent that component analog technology could benefit our operation in other areas as well, such as graphics.

Like nearly all television stations in 1982, news, programming and promotion graphics were produced through the tedious 35mm slide process. There were two known broadcast facilities using cameras, character generators and still storage equipment in NTSC to generate graphics. While we very much liked the speed of this electronic process, we believed, based on our M-format experience, that remaining in component form throughout the graphics process would lend many more generations of quality visuals.

After taking inventory of the hardware we already owned that might enable us to move quickly into component graphics, we realized we were well on our way with our Chyron IV B, Harris Iris II still storage system and Panasonic AK-100 camera. The key to any multi-source

component system is a component video switcher. The addition of the newly developed Shintron 390 component switcher brought the hardware together as a system, capable of dissolves, effects and keys in the component mode.

The Harris frame synchronizers required a modification to allow component inputs (now standard equipment), but the camera and character generator were equipped for component use.

Our component graphics center was operating RGB in the summer of 1983. (figure 1) Dirty slides were a thing of the past. The hours of preparing a complex graphic were reduced to a few minutes, and a staff of four was now one person. Along with these obvious economic gains came the increased visual impact of complex graphics, with the average graphic consisting of six generations, both analog and digital, of visual information. (a generation occurs each time "freeze" is initiated in the still storage system)

While the pictures were visually pleasing, after numerous generations the frequency response of the RGB system proved to have peaks and valleys partially due to timing errors between channels. This was largely due to the frame synchronizer matrix converting RGB inputs to Y, R-Y, B-Y for internal operation. When performing an overlay over an existing visual, two matrix conversions occur, one on the input and one on the output of the frame synchronizer. This process forced extra care in level setting or level variations and frequency response variations would result.

This does not portray the frame synchronizer in poor light, but rather reminds us how low the distortion must be to get ten generations of high quality graphics. You must have near perfect filter characteristics and exact timing between all three channels. Whatever the measured performance of the still storage system, it is simply multiplied by the number of generations it takes to produce the final graphic.

#### CONVERSION TO Y, R-Y, B-Y

After several months of RGB operation we converted the system to Y, R-Y, B-Y to avoid the double matrix conversion in the frame synchronizer each time a generation occurred. More generations at higher quality were the result. The conversion was accomplished by removing the RGB to Y, R-Y, B-Y matrix in the frame synchronizer. Chrominance and luminance, having different filter slopes, can now be separately optimized.

This conversion required the purchase of matrix converters for the camera and character generator, allowing

direct inputing of Y, R-Y, B-Y into the still storage system. (figure 2)

Here are examples of typical graphics that are aired in our newscast:

	construction time
5th generation	3 minutes
6th generation	3 minutes
8th generation	4 minutes
10th generation	5 minutes

Material sources for graphic compilation can be as simple as a blank piece of paper with handwritten information, swatches of cloth or photographs. Video switcher features such as wipe, dissolve, color background, border, key and wipe key enhance the visual with relative ease.

The digital key feature in the Harris still storage system adds the capability of keying any number of images into a montage, while preserving first generation quality in every level of the image. It does this by processing a key signal through a unique signal stabilizer to selectively unfreeze chosen parts of the image, then blending new input video into these unfrozen areas of the picture. The result is crisp, clear assembly of the most complex composites, as well as a variety of unusual new video effects. It offers a high quality option to put Chyron or camera video over a previously stored image. It operates in conjunction with the Shintron 390 switcher or Chyron, essentially as a cut and paste approach, digitally cutting a hole and replacing information pixel by pixel.

#### TECHNICAL MEASUREMENTS

Technical measurements on our system show performance as follows:

	one generation	ten generations
luminance s/n	56db	44db
chrominance AM s/n	60db	60db
chrominance PM s/n	62db	62db
H phase stability	+/- 10nano	+/- 100nano
frequency response lum	- .2db	- 6db
frequency response chrom	- .5db 1 Mhz	- 1.5db 1 Mhz

All tenth generation measurements were made utilizing digital noise reduction within the Harris frame synchronizer.

Just to keep these numbers in perspective, our tests show that this luminance s/n measurement is equivalent to third generation one inch type C performance. Tenth generation type C yields thirty-six db signal-to-noise.

One inch type C chrominance AM and PM s/n measurements are considerably worse than those shown above from our component graphics creation center. Again, these type C measurements were made as a comparison reference because most broadcasters are familiar with the format.

Chrominance to luminance timing track each other well in our graphics system. We have found interfield timing does not exactly track. Field two does not have the same timing relationships as field one, resulting in a possible "piano keying" effect.

#### CONSTRUCTION OF YOUR COMPONENT GRAPHICS CREATION CENTER

If your station owns the following equipment you may well be on your way:

- character generator
- camera
- still storage system  
(units must operate internally in some component form)

These additional purchases put our system on line:

- Chyron keyboard, floppy drives, palette
- Harris keyboard
- Shintron 390 switcher
- Shibasoku color monitor
- graphics stand for camera
- total cost            under \$30,000

The initial installation of such a system does require you to overcome certain obstacles. Around every corner looms a detailed problem you have never faced. The engineering maintenance department will need to approach novel and unusual design and optimization problems with creativity and flexibility. Since errors can be magnified five to ten times due to multi generations, certain adjustments become very critical and errors previously hidden may surface to become objectionable, such as ringing or poor clamping.

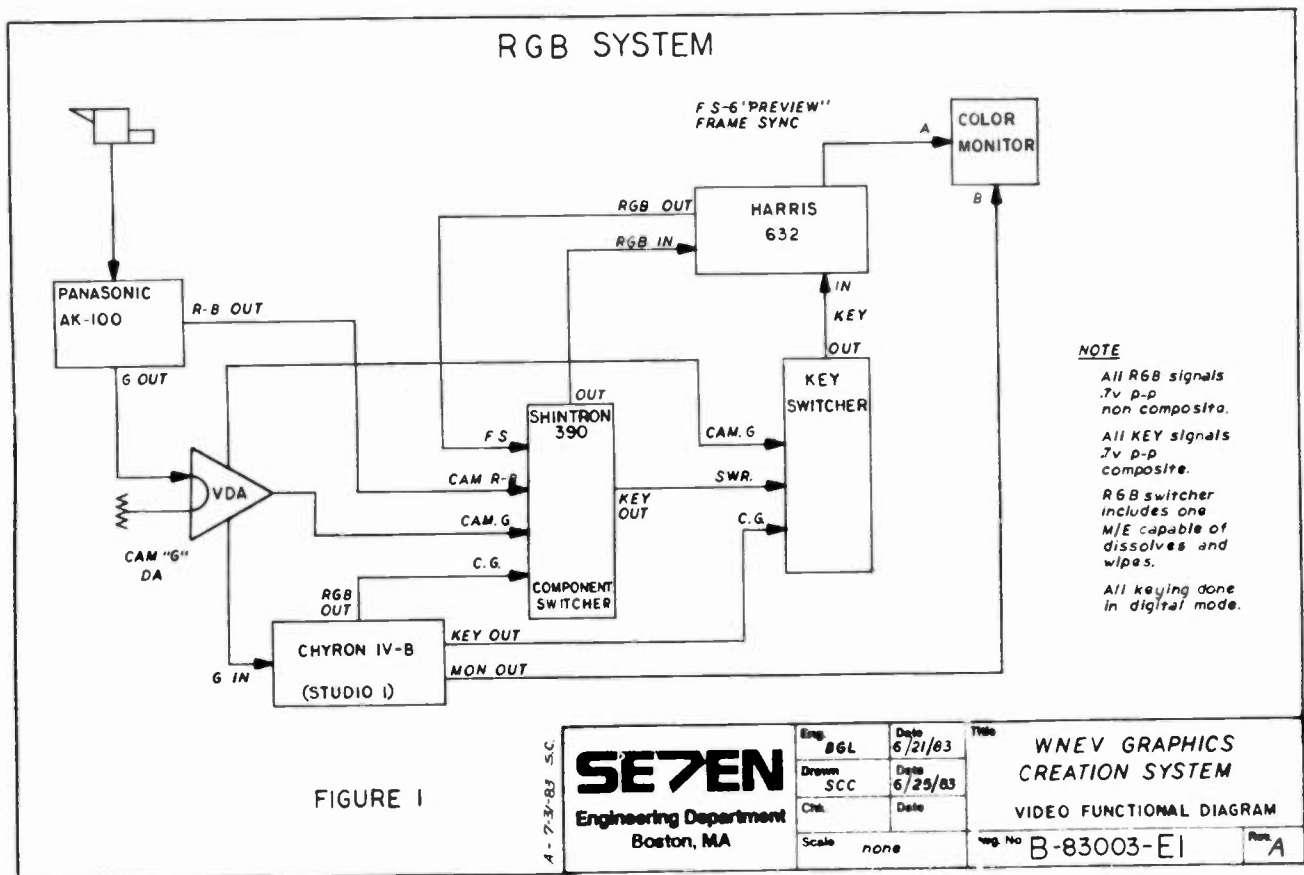
The art director and staff will drag their feet on implementation of such an electronic system. The unions will all want jurisdiction.

Fortunately for us, these problems were relatively easy to overcome. The art director, after immersion in the

system, became an advocate for component graphics. A favorable package was negotiated with the union to exclude the graphics creation center from their jurisdiction.

An artist should have freedom within the system to transfer the mind's conceptual image to a multi-generation visual or the system does not meet the most basic objective. Typical set-up procedures for equipment operation may need to be re-evaluated or abandoned altogether to allow creative minds to function with a minimum number of electronic barriers.

While we may be in the age of complex graphic systems that make elaborate, motion filled opens and closes for television programs, they are not necessarily fast enough to handle the daily graphics load for news, programming and promotion. A component graphics creation center such as the one operated at WNEV-TV is a practical tool for everyday production.



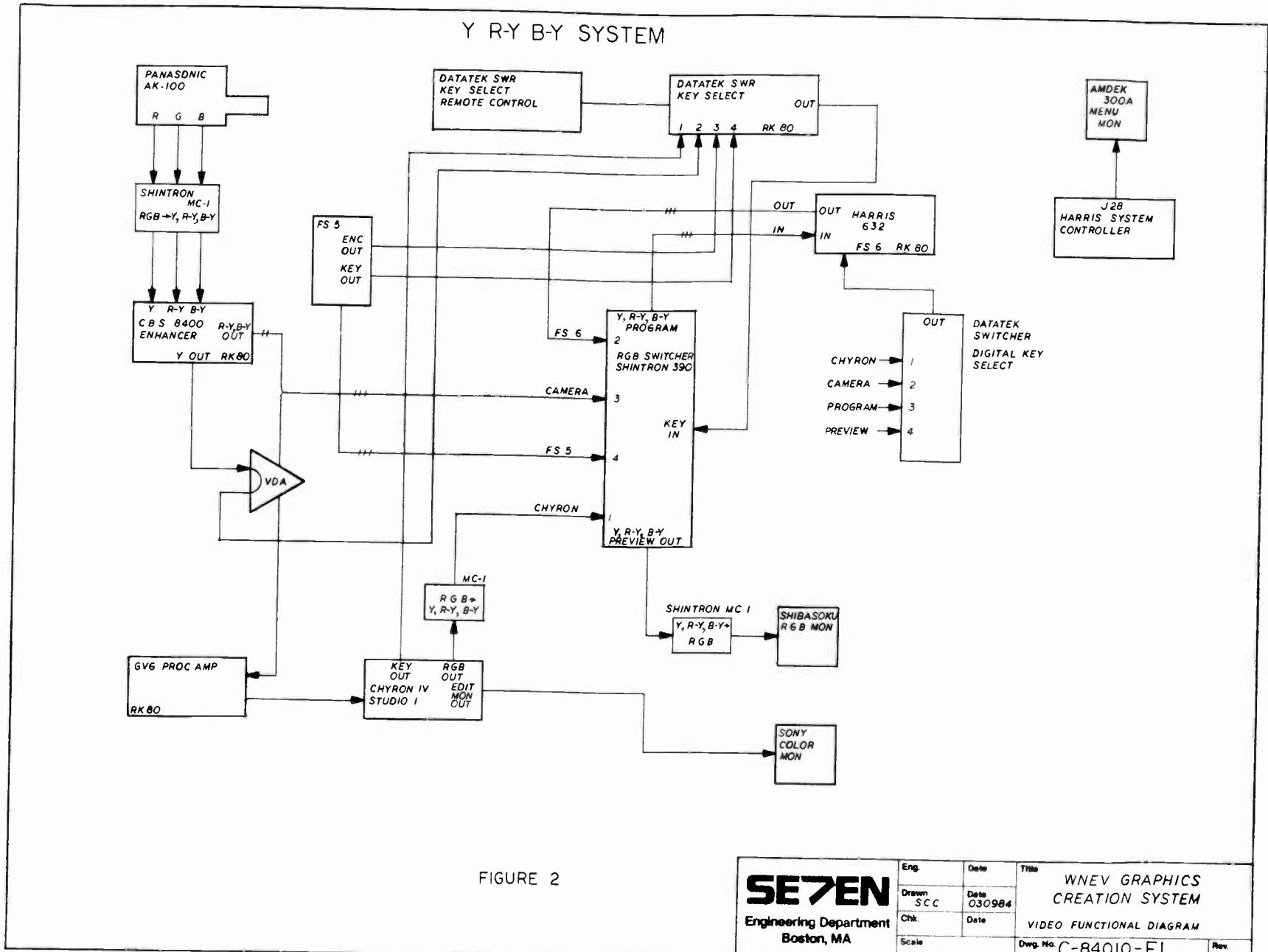


FIGURE 2

<b>SE7EN</b> Engineering Department Boston, MA	Eng.	Date	Title <b>WNEV GRAPHICS CREATION SYSTEM</b>	
	Drawn SCC	Date 030984		
	Chk.	Date	VIDEO FUNCTIONAL DIAGRAM	
	Scale	Dwg. No. C-84010-EI		



---

A Microprocessor-Based System Solution  
to Increase Access to Character Generators

Maurice R. Baker

The JET Broadcasting Company, Inc. (WJET-TV)

Erie, Pennsylvania

### INTRODUCTION

The electronic character generator is a vital component of today's television production process, particularly in news programming where timeliness of presentation content is of critical importance. This paper describes a prototype project intended for the enhancement of operational access to the graphics system from the television newsroom.

Both the quality and quantity of this access are contributing factors to overall productivity. The inherent flexibility of today's character generators requires the operator to reselect many different parameters such as character color, font style, disc address, etc. throughout the entry process. Not only is this time consuming and error prone, but it also serves to complicate the training of new personnel. Since the overwhelming majority of news graphics conform to a standard pattern, automation of display formatting can be very effectively provided.

Still, the need of three distinct staffs (news, weather and sports) to simultaneously enter information into one keyboard often creates a "bottleneck" during the crucial minutes preceding a newscast. To make matters worse, this keyboard is almost always located in the control room area some distance from the news department; personnel are then required to perform a frequent commute between their desk and the character generator. Multiple remote workstations for text entry and transmission are clearly desirable.

### HARDWARE

In the newsroom, a Commodore 64 computer with 1541 mini-floppy disc drive, 1525 printer, RS-232 interface, and light pen serves as the desktop system shown in Figure 1. At current January, 1985 prices, this configuration would cost approximately \$750.00; if hard-copy output is not required at a particular workstation, the printer may be omitted for a savings of approximately \$250.00. Although immune to radio frequency interference from the numerous sources around a television broadcast station, some RFI is produced by this equipment and has, on occasion, interfered with scanning FM receivers nearby. Careful choice of location has reduced this problem to manageable levels.

FIGURE 1  
 COMMODORE 64 WORKSTATION  
 IN WJET-TV NEWSROOM



FIGURE 2  
 EASYSRIPT EDITOR DISPLAY  
 OF TEXT FILE ENTRY

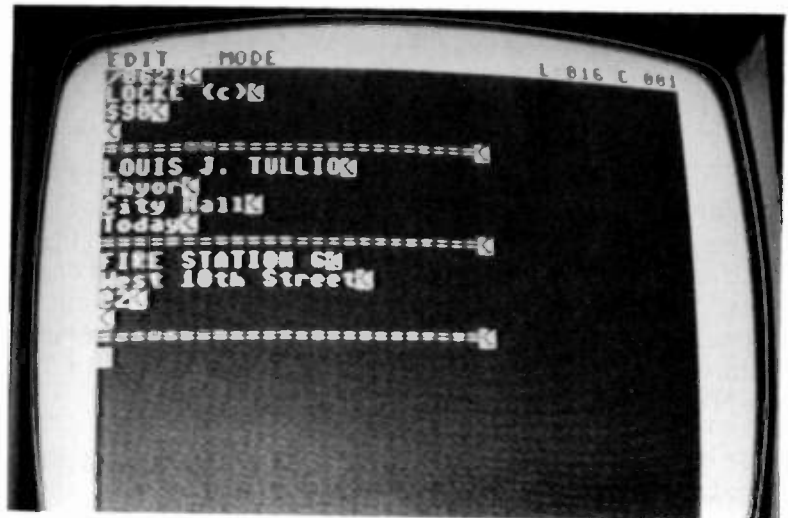


FIGURE 3  
 TYPICAL PORTIONS OF  
 NEWS GRAPHICS FORMAT FILE

```

&0059      #8      #b6
%2         &      @3
%1         #8a     #4
#d4        /0453   GOLD PRICES
/0000      #90     /0451
#90        @7      #90
#1         #9      #d2
#d2        /0454   #c7
#c5        #90     #05
#10       #05     #05
#10       ↑      #05
↑         #04     #09
#05       #05     #24
#c7       ↑      ↑
↑         #04     #09

```

Data communication with the character generator is 1200 baud ASCII over several hundred feet of twisted-pair cabling. A simple 3-wire interface has worked very well, with XON/XOFF handshaking to control data flow. While the prototype implementation contained only one remote station, several manufacturers sell inexpensive RS-232 switchboxes which can delegate access to the proper user as required. Alternatively, a "dial-up" network using modems and the in-house telephone system may become practical for larger organizations where the multiple desktop stations are not located in the same room.

The graphics system is a 3M/Datavision D8800 with two channels of character synthesis, dual 8" floppy disc drives and a serial I/O interface. The software driver for serial communications contains a buffer which accepts received characters while the D8800 is still executing earlier commands. When the buffer is filled, a DC3 (Ctrl-S) command is sent to the Commodore 64 which halts transmission until receipt of a DC1 (Ctrl-Q). [1]

Actual use in preparing news graphics has been observed to be disc-intensive; frequency of access by the two systems to their mass storage, rather than communications line speed, limits the overall throughput. For this reason, 1200 baud was chosen over higher available rates as the best compromise between error immunity and character generator utilization. Every keyboard operation may be requested through serial transmission of a corresponding 8-bit character; in addition, several graphic functions not available from the keyboard (fractional spacing, etc.) are each assigned an ASCII code. [2] [3]

#### SOFTWARE

The data formatting/transmission program which runs on the Commodore 64 is written in BASIC, and loaded from the 1541 disc drive when required. Upon execution, it reads the disc directory and displays each sequential data (non-program code) file name upon the screen in "menu" fashion. The user selects, with the light pen, the format file corresponding to the type of text material to be transmitted. This file is then interpreted by the remainder of the program to define the sequence of characters and commands sent to the D8800 character generator. The interpreter provides a rudimentary decision-making facility, transfer of control within the format file, and selective incorporation of text/commands from other CBM64 data files. Access to graphic system mass-storage addressing and underlining is greatly simplified; additionally, the 1525 printer can be used to print a hard-copy listing of text which has been transmitted.

The interpreter can accept entry of numeric values into specific spreadsheet-like "cells." This data can be converted to ASCII strings for display on the character generator, used in arithmetic calculation of additional cell values, or allowed to control repetitive transmission of a particular character/command. This is similar to CBS News' application of an IBM PC and Chyron character generator for delegate vote counting at the 1984 political conventions, under control of a specialized APL routine. [4] Unlike custom-written software which must be coded and maintained entirely in a high-level

language, the interpretively-read format file can be created and modified by teleproduction personnel without special computer skills. Calculations are easily expressed in straightforward BASIC subroutines within the interpreter itself, if required.

The first character of each format file entry is examined in order to determine whether the line is an interpreter command or actual text material for the direct transmission to the D8800. These command characters are listed below:

= (Equal Sign): Interpreter ignores the remainder of line. This is useful for comments included to self-document format files, or as a delimiter in text files.

% (Percent Sign): Interpreter accepts next character as option selection. %0 (disable hard-copy printing), %1 (enable hard-copy printing), and %2 (prompts user to preselect sequence of included text file names for "batch" operation) are the only options implemented at this time. Others may be easily added to program code.

[ and ] (Brackets): Text material encountered between opening and closing brackets is underlined when displayed on the D8800. A non-destructive backspace, and underscore command is sent following each character; specific symbols (blank, lower-case letters with descenders, etc.) may be chosen according to local custom for implicit exclusion from underlying. Material to be underlined may span multiple lines.

# (Octothorp): Followed by single numeric digit from 0 through 9. Allows user to label a particular step in format file sequence to be referenced by @ (At Sign) command.

@ (At Sign): Followed by single numeric digit from 0 through 9. Interpreter "jumps" to format file line following corresponding label, and continues sequential execution.

! (Exclamation Point): Followed by cell number. The numeric value contained within the cell is converted to an ASCII character string by means of the BASIC STR\$ built-in function, and cosmetic reformatting (comma insertion, etc.) is performed according to pre-programmed rules. The result is then transmitted to the character generator.

< (Less Than): Followed by cell number, > (Greater Than) symbol and either an ASCII character symbol or a hexadecimal constant preceded by \$ (Dollar Sign). If the numeric contents of the cell are zero, the line has no effect and the interpreter continues with the next format file entry. Otherwise, the ASCII character or hexadecimal value is sent to the D8800 "N" times, where N is the integer value stored in the cell.

\$ (Dollar Sign): Followed by two hexadecimal digits (0 through F) to form an 8-bit value between 0 and 255 decimal, which is then sent over the serial

link. Used to transmit control functions to the character generator which have no keyboard equivalent on the Commodore 64, as well as any other special character values.

? (Question Mark): Followed by a prompt message to be displayed to the user, after which the program waits for a response. The keyboard entry is then submitted to interpretation as though it had come from within the format file. This allows the entry of text or commands at the time of data transmission.

^(Up-Arrow): If no text file is open, the interpreter either opens the next file name preselected for automatic sequencing (see %2 above) or prompts the user with a menu of file names to select with the light pen. The next line of data is read from that file, and processed as if it had been present in the format file. If a "null" line is read (containing only a RETURN), and a character string followed the ^(Up-Arrow) symbol, then that string is interpreted in a similar fashion. Control is then returned to the format file. The text file is closed after the last line of data has been retrieved.

/(Slash)

& (Ampersand): These two commands control the disc addressing of the D8800 system. An 8" floppy disc drive contains 2000 pages of storage numbered 0000 to 1999; a bias of 2000 is added for each additional drive. Consequently, the dual drive system can access pages 0000 to 3999. In normal use, the desired address for recording or playback is entered from the character generator keyboard, and appears on a 4 digit LED display. However, the remote Commodore 64 system has no way of interrogating this value and must independently keep track of the current disc page.

& (Ampersand) instructs the interpreter to set the D8800 disc address to the next sequential page according to a counter kept internally in the program. The counter is then incremented. If the & (Ampersand) is immediately followed by a number between 0000 and 3999, the internal register is loaded with that value before updating the D8800 address.

/(Slash), however, is always followed by a numeric value within the above range. This command transmits the desired address to the character generator, but leaves the internal register unaffected. This is useful when a series of non-related pages are to be retrieved and rerecorded sequentially while intermixed with the other text; integration of standard identifying graphics which have been prerecorded in a "library" area on the D8800 are a common application within a newscast.

If a non-command line of text within the format file is to begin with one of the command characters, it must be prefixed by a space which is stripped before transmission, or the line of text will be mistakenly processed as a command. The situation has occurred infrequently since few of these symbols make any sense at the beginning of a plain-language text line. The choice of \$ (Dollar Sign) as a command character was an unfortunate holdover from the author's experience in 6502 assembler language coding.

All format and text files contain ASCII strings with each line terminated by the RETURN character, and can be created or edited by one of the many

Commodore 64 word processing programs. The Easy Script software product from Commodore was chosen for use in the prototype installation. This package works well, and newsroom personnel quickly become comfortable with the fairly small subset of editing commands actually required for productive use in this application.

## OPERATION

The operation of this system is best illustrated by presenting some actual hard-copy and video output produced as the text preparation and transmission sequence progressed.

Figure 2 shows the entry of three news graphics which form a text file corresponding to a particular story; each character generator page is defined by four lines followed by a "=====" delimiter. The first example is an identifying "super" for a reporter which will be retrieved from a library collection on the D8800 disc. The page number of the prerecorded graphic is entered after the "/" command character in order to load the character generator's disc address register; the interpreter's internal counter remains at the next page in the record sequence being assembled. The following line is a description which will only be echoed on the director's hard copy listing. On the third line, the "\$90" command will cause the character generator to read the previously addressed library page from its disc. The fourth line, which is empty in this example, could optionally contain a command code to force the displayed material against the right or left margin. This is useful when the scene is composed with the talent off to one side rather than at the center of the screen.

The second example is for a four entry graphic. The first two lines will be displayed centered in the lower third of the raster to identify the subject. The next two lines will be positioned at the upper left in order to establish the time and place of the actuality. The final example demonstrates the use of an optional procedure in the format file. The first two lines are handled as in the second example. The "@2" command on the third line forces an interpreter jump to the "#2" label in the format file where special commands are located which create a "24 File" icon in the upper left corner of the graphic. The empty fourth line is included to maintain consistency with the four line format; the format file contains a command to read it but it is effectively discarded. It is much easier to train the user that each text file group will always contain four lines followed by the "=====" delimiter rather than impose an arbitrary and inconsistent set of rules which depend on the option chosen.

The text file is then stored on the Commodore 64 disc under a descriptive user-chosen name relating to the contents. All news stories requiring character generator support are prepared in this manner as their scripts become available. Figure 3 shows a selected portion of the format file that controls transmission of news graphics. This file, which includes procedure for creation of the financial displays (gold and stock prices) as well as identifying "supers" for news stories, is about 150 lines long in its entirety.

Figure 4 is the interpreter program's light-pen driven menu display from which the operator selects the format file and the sequence of text files to be transmitted. By convention, format file names begin with a "+" and are displayed in reverse video; all files are grouped by type (format or text) and presented in alphabetical order. The asterisk preceding each file name must be touched twice in order to confirm the selection as correct. The sound synthesizer of the Commodore 64 is programmed to produce chime-line audible indications during this process. Once the proper format file has been chosen and the text file order established, automatic transmission begins. Figure 5 is a portion of the hard-copy printout which is supplied to the production staff; the enhanced print numbers on the left side are the D8800 disc addresses of the transmitted pages. Figures 6 and 7 show the actual graphics generated by the second and third groups of the example text file.

### ANALYSIS

The system described above is used daily for preparation of news graphics at 6 and 11 P.M. Several advantages over the previous manual entry method have become evident with regular operation. Most obvious is the reduction in D8800 time required to compose and record the character generator material. Where a typical newscast formerly required approximately 30 minutes of "keyboard" time for news items, the Commodore 64 typically completes transmission in under 10 minutes. This allows the weather and sports staffs significantly more access to the D8800, and enables them to prepare their material with more care and creativity.

The interpreter program also generates the director's hard-copy listing which previously had been manually transcribed. Through the precise format file definition, operational errors such as incorrect selection of font style, color, and edging have been eliminated. Last, but certainly not least, the system allows the entry of text material directly from the newsroom and eliminates the inefficient division of labor between the distant control room and the user's desk.

One limitation, however, is the lack of feedback from the D8800 to the Commodore 64 concerning error conditions such as disc faults and composition problems (checksum errors, running out of room on a line of text or page, etc.). The operator is essentially "flying blind" during transmission; thus the stored pages in the D8800 are always checked before the broadcast to ensure that everything is as expected. In actual use, this process takes negligible time and would probably be performed anyhow. Perhaps other graphics systems will more fully support the RS-232 channel by improving software handshaking with the remote location beyond simple data link control.

### CONCLUSION

A microprocessor-based personal computer system may be used for formatting and transmission of text information to a television character generator. This combined operation results in greater overall access to the graphics system, elimination of errors in display formatting and more productive performance of news personnel.



FIGURE 4  
MENU DISPLAY FOR SELECTION  
OF FORMAT AND TEXT FILES

```

60      LOCKE (c)
-----
      LOUIS J. TULLIO
      Mayor
      City Hall
      Today

61
-----
      FIRE STATION 6
      West 10th Street
      File

62
-----

```

FIGURE 5  
DIRECTOR'S HARD-COPY LIST  
OF TRANSMITTED GRAPHICS

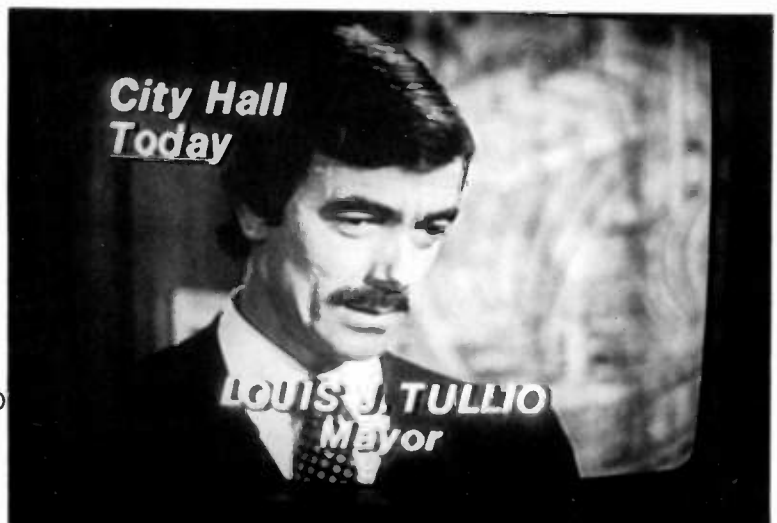


FIGURE 6  
SECOND SAMPLE GRAPHIC KEYED  
OVER PROGRAM VIDEO AFTER  
TRANSMISSION



FIGURE 7  
THIRD SAMPLE GRAPHIC KEYED  
OVER PROGRAM VIDEO AFTER  
TRANSMISSION



#### ACKNOWLEDGMENTS

The author would like to thank Don Shriver for his suggestions and constructive criticism during the development of this project, and Robert Neely for his photographic assistance.

#### REFERENCES

- [1] 3M, D8800 Character Generator Reference Manual, Volume 1, 3M Corporation, Gaithersburg, Maryland, 1980, Appendix L.
- [2] Ibid., Chapter 4.
- [3] Ibid., Appendix E.
- [4] M. Porter, "CBS Makes News with PCs," PC Magazine, November 13th, 1984, p. 204.

---

Videopticals <sup>tm</sup>

The Evolution of a Post-production Facility

Jason T. Danielson

Positive Video

Orinda, California

Videopticals is the electronic graphics and effects division of Positive Video, a leading edge video post-production facility with two locations in the San Francisco Bay Area. Founded in 1981, the goal of Positive Video has always been to provide the highest quality post-production equipment and talent available in the United States. We have always seen ourselves as a high throughput post facility, steering clear of temptations to become involved in the production phase of the business. This has allowed us to support independent producers, production companies, and regional television stations and it has allowed us to keep abreast of the digital video hardware revolution that continues to change the face of the television production industry.

This paper will focus on Positive Videoptical's use of digital graphics and effects systems, the interaction of these systems with one another, and on the producers' interaction with these systems in the process of creating motion graphics and effects. The focus will be from a producers point of view, on the possibilities provided by combining these systems. Individual devices will be discussed, followed by various combinations of systems needed to create certain graphic illusions.

In 1980, state-of-the-art electronic graphics meant the creation of type-styles and one color logos on a Chyron telesystem. Today, there are several dozen electronic graphics systems available which make the original systems look like the dark ages in retrospect. To stay abreast, a television station or facility must continually evaluate the performance of these digital graphics and effects systems, and their benefits and cost to their operation. As we have become acutely aware of, no one single digital system solves all of a post-production environments' needs. The creation of high quality, entertaining, and informative graphics and effects involves the combined use of digital still stores, switchers, keyers, paint and animation systems, digital video effects systems, telecines, etc.

Videopticals is the intelligent use of these systems to create television

graphics and effects beyond what was possible in the video domain at the beginning of this decade. Digital video equipment can now create optical effects that previously were associated only with 35mm film technology.

We can all dream about owning the newest and greatest system on the block, but ultimately, a post-production installation must work with what it has or go out of house. At our facility, videopticals are created with the following equipment:

#### Electronic Graphics Systems

- Quantel Paint Box
- Chyron IV with Font Compose

#### Cameras

- Ikegami HL 79DAL
- Black and White Matte Cameras

#### Three Dimensional Shape Creation Systems

- Quantel MIRAGE

#### Effects Systems

- Grass Valley Mark II DVE
- Ampex Digital Optics (ADO)
- Quantel MIRAGE
- Grass Valley 1600 7K Switcher

#### Keying Systems

- Ultimatte RGB Keyer
- Grass Valley Encoded Chroma & RGB Keyers
- Grass Valley Analog Borderline Keyers
- Quantel Digital Foreground/Background Keyers

#### Image Record and Playback Systems

- Sony One Inch Type "C"
- Bosch FDL 60 Film To Tape Transfer Device
- Sony BVW 40 Betacam
- Harris Iris 2 Channel Still Store
- Quantel MIRAGE

While most of our equipment, including the DVE and the ADO fit nicely into the framework of an on-line post-production operation, the Paint Box and the MIRAGE do not. Imagery is generated and developed on these two systems rather than simply composited. While these systems work quickly, development is not instant. Their flexibility requires that creative decisions and sometimes even design changes are made during the course of operating them.

The television post-production business is changing. If the equipment

manufacturers continue in the direction of more software based systems as I believe they will, we will find ourselves with more equipment both in the area of graphics creation and manipulation that fall into the category of off-line post-production. It is no longer enough to simply purchase the most enticing high-end equipment and hire the talent to run it. These systems not only require specifically trained artists/operators/programmers, (which in the case of newly released machines do not exist) they also require that the facility create a more comprehensive feedback loop between its personnel and the production group. The success of these new digital systems depends on their creative and successful use, be that by the stations' production crews, or the thousands of independent producers and production companies that use the nations' post facilities. These producers, although well versed in SMPTE timecode, A-B rolls, switcher effects, etc. are oftentimes naive when it comes to the creative possibilities that these new digital systems present.

A general knowledge of how we use the systems in our facility and how they interact is always the first step we take in working with a producer. The Chyron IV, of course, is the work horse of the graphics systems. It is invaluable in an on-line session because of its almost instant creation of text screens. Its ability of keeping text centered while quickly adjusting the letter spacing and line height usually meets both the financial and creative concerns of the client. We recommend its use for basic titles, frames needing more than a few lines of copy, or any scrolling text. We generally key Chyron text over either live video, freeze frames of live action, or Paint Box generated backgrounds.

The Quantel Paint Box serves several functions in our post environment. It is used for high quality titling. Quantel is the only video equipment manufacturer licensing typefaces from the major typeface houses and the selection and quality show. Producers with graphic design or print art direction backgrounds particularly prefer the Paint Box for titling and will spend the extra time to create a graphics B-roll a day or two before their scheduled on-line session. Although the Paint Box images can be directly recorded onto the edited master, this requires the use of both the edit bay and the Paint Box room. It is considerably more cost effective to keep from tying up both the Paint Box room and the on-line edit bay simultaneously.

We also create full screen graphics with the Paint Box. Most frames are created with the help of video camera input. Full screen informational graphics are the exception. A hardcopy schematic or map need to be recreated by hand using the stylus and digitizing pad to better fit the aspect ratio or resolution constraints of video or the color and design requirements of the art director. Video logo treatments are a common use of the Paint Box and for these we prefer black and white stats. The Paint Box grabs the live video frame, in this case a camera focused on the stat, as a 24 bit image, otherwise referred to as direct color. It then can create an 8 bit stencil of this image using the picture's luminance value. This stencil then allows the artist to use masking techniques for adding color, drop shadows, cast shadows, and glows.

Full color input either from videotape or print artwork turn otherwise time consuming graphic design problems into quick photo composition tasks. Most full screen graphics are some combination of black and white stat input,

full color video input, graphic creation, airbrush retouching, graphic primitives, and text creation.

Another use of the Paint Box is for set design and creation. More and more on-camera talent for television products are "blue screened" either on 35mm film, or component videotape. Then sets are being either partially or entirely created on the Paint Box. Using the Ultimatte during the film to tape transfer, characters or foreground imagery can be cleanly keyed over Paint Box created backgrounds. The Ultimatte RGB keyer can also be used with the trans-coded signal from the Betacam Y,R-Y, B-Y component signal to provide extremely clean chroma keys. When the blue screen is lighted correctly and the art direction space is well thought out, this is a tremendously powerful and cost-effective use of the graphics system. This technique, which originated as a live studio technique for keying weathermen in front of their maps is becoming a commonplace post-production tool for programming and commercials.

The Paint Box also comes in handy for creating mattes to feed the digital effects systems and to be used directly for cleaning up edges or creating special wipes to show motion. The Paint Box also has a very clean digital foreground/background keyer. This allows us to key color cycle animation, reflections, or live video behind a full color graphic.

The paint systems' cell animation capacity allows the creation of short animated flashes, wipe-ons, and glows. Up to a couple dozen cells can be drawn to play out in a window within the video frame. This can save the producer a few hundred to a thousand dollars. Rather than having animation cells created separately by an animator and then incurring the expense of filming or single framing the cells onto video, the Paint Box artist can usually create the animated effect in less than twenty minutes and record it in realtime onto the graphics B-roll at the same time as the stills from that session are being taped. Another method of animation for motion graphics is to create keyframes on the Paint Box which when wiped between create the illusion of motion.

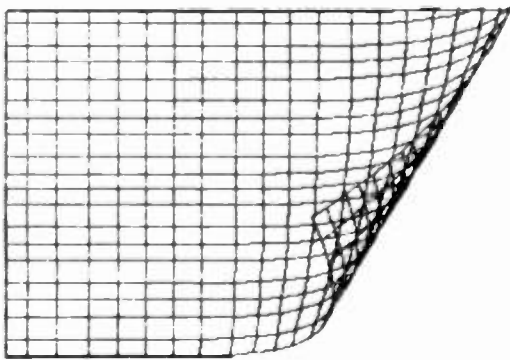
Finally, the Paint Box is used as the painting system for electronic origami. This is where the two dimensional canvas of the Paint Box is used to create artwork which will be bent or folded into a three-dimensional shape by the Mirage. The graphic may look discontinuous or warped when flat, but when passed through the Mirage it becomes a coherent shape. For instance, a Mercator-like projection of the world could warp into an accurate globe. And a flat six-panel package design layout could fold up to become a finished three-dimensional box.

So the Paint Box is a multi-purpose system, solving several different types of production problems. Judicious use of this system will optimize smaller production budgets. And projects with larger budgets will have some far reaching possibilities unavailable to producers even as recently as 1980.

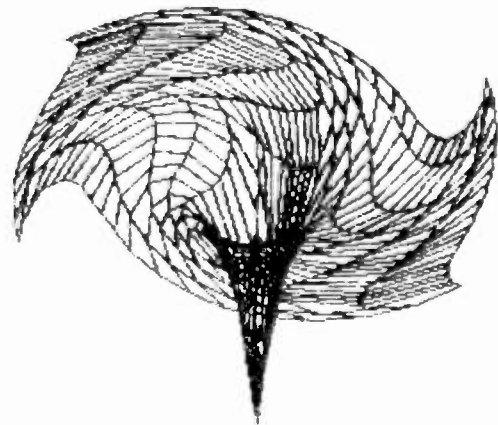
The Quantel Mirage has a split personality. In the edit bay it is a sophisticated push button effects box. Granted, the ways it can manipulate live video is categorically different than any effects box before it and granted it manipulates not one but two video feeds and cuts a key for a third to be inserted by the switcher, the way in which the producer and the editor interact with the Mirage the majority of the time during an on-line edit is

analogous to the way they would interact with the ADO or any of the many DVE's on the market. There are some exceptions to this but first let's look at the Mirage as a design tool.

A simple yet effective use of the Mirage is for designing custom transitions. The art direction of a program or particular title sequence may dictate a unique transition. Or a custom transition will be used to dress up or lend continuity to a sequence. There are two general types of previously impossible transitions that can be designed on the Mirage. First there are transitions that utilize the Mirage's ability to bend or warp the live video as it repositions it. Transitions like the soon to be omni-present "page turn", as well as the less used "vortex" and "burst" transitions make use of this feature.



"Page Turn"

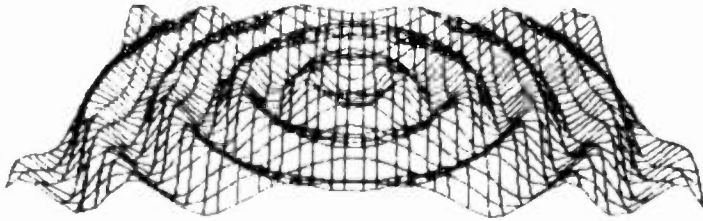


"Vortex"

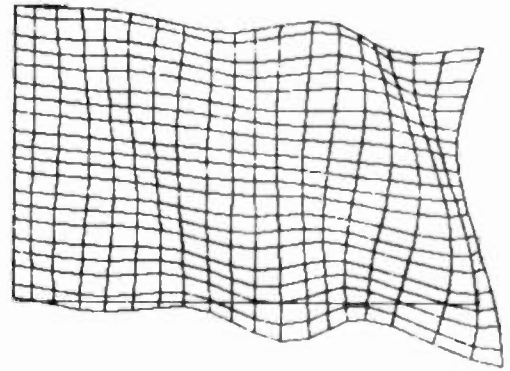
The other type of transition is characterized by the division of the active video area into many pieces, each of which can be given its own timing and trajectory. The individual pieces can scatter and fly off screen or can move and shrink to infinity. The Mirage allows picture cutting along any of 100 vertical lines and 64 horizontal lines within the frame.

Another application for the Mirage is the creation of optical effects. Rather than transitions which have the purpose of getting the sequence from one shot to the next, an effect is performed on a given shot. An example of this use of the Mirage is the wavering of the video image to make it appear as if it were taking place in a dream sequence or underwater. A wave of less amplitude produces the effect of a flag waving.

Another optical effect is the treadmill. The Mirage can roll or scroll the video image smoothly and without showing any blanking. When a seamless frame is created on the Paint Box, the Mirage turns it into a continually flying moving background. The camera angle can appear to be continually flying over a grid pattern or foreground characters can appear to be crossing in front of a background scene.



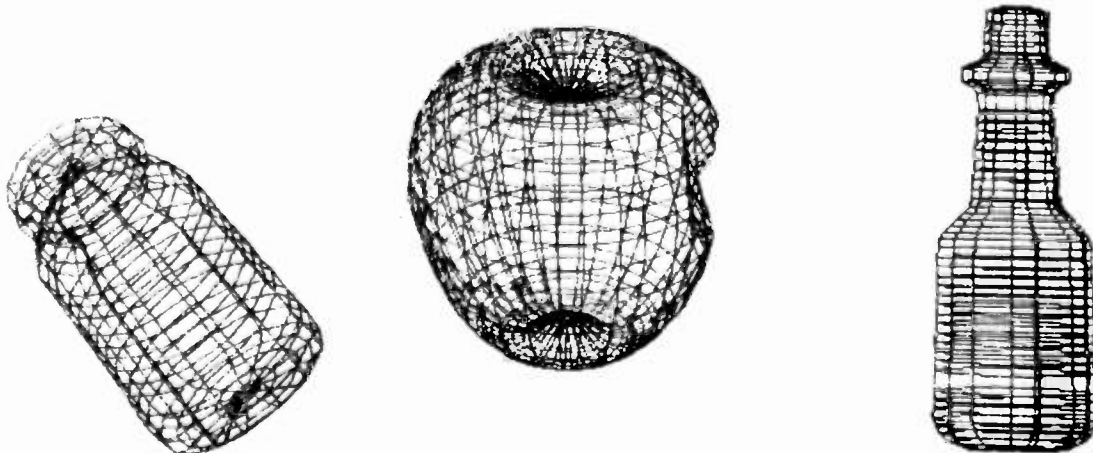
"Underwater"



"Flag Wave"

As mentioned before, maps can be turned into globes. Using the Mirage to turn two dimensional graphics into three dimensional shapes opens up another powerful application. Creating realistically painted three dimensional shapes involves close interaction between the Paint Box and the Mirage. First the Mirage designer describes the shape to the computer. In the case of solids of revolution this means working with an in-house application program designed for creating and modifying such shapes. This may take anywhere from 10 minutes to two hours depending upon the shape and the number of feedback loops that are needed before the art director is happy with the shape.

More complex shapes, ones that need to be described one face at a time, can take several hours to a day to create. Once the shape is created, the Paint Box artist can begin applying textures and graphics to the various faces. During the final stages of this painting, the video signal is sent from the Paint Box through the Mirage and back to a monitor in the Paint Box room. The artist can apply highlights to appropriate places on the shape and even have the shape rotated to be able to touch-up all the faces. Simultaneously to the shape painting, the Mirage designer can be creating possible trajectories and speeds to be tested.



"Solids of Revolution"



This process is repeated for each of the shapes in a three dimensional computer graphic animation. When all the shapes and paths meet the client's approval, the animation is ready to be composited.

The Mirage control panel will be disconnected from its port at the designer's workstation and wheeled down the hall to the on-line edit bay. The animated sequence will be composited in realtime, several elements at a time. Individual elements will be manipulated by the Mirage and recorded on tape. Key black will be used for background to assure absolutely clean luminance keying. Then, with one element coming directly out of the Mirage and the others off tape, up to four layers can be composited in one pass. Submasters containing two to four elements can be created and keyed in as a single layer if needed. During this on-line compositing of three dimensional computer graphics, the Mirage can act as a standalone playback system. Once the proper videographic image is grabbed by the Mirage's internal frame buffer, the Mirage simply plays back its sequence on cue. Differing from a tape deck, of course, in that it needs no servo lock-up time.

Other tools available in the on-line suite for developing graphics and effects sequences are the two digital video effects systems. They are the Grass Valley Mark II DVE and the Ampex ADO. The Grass Valley has some nice features for finishing graphics work done prior to the on-line session. Moving cast shadows, trails (known as decay) and dimensionality, can be added up until the edit that puts the image onto the master. Posterization and pixillation (called mosaic) of live action video can be done by this system.

The final graphic lay-out of a commercial or title sequence is implemented by the DVE and the ADO. These devices create mortices and position supers and titles. The ADO has become the work horse of the flying panel business. The video electronics are so clean that the ADO is virtually transparent through one generation. It also has very fast human interaction and can quickly add dimensionality and dynamic impact to a title sequence or commercial. The perspective capabilities of the ADO allow producers to create in minutes what would take days if done as film optical projects. Another level of Videoptical effects that the ADO is integral to is the matching of its motion to that of motion controlled cameras.

This capability brings more previously expensive film optical effects within reason. Foreground imagery can be manipulated by the ADO and keyed over background material shot with a motion controlled camera system. ADO moves can originate or finish with very tight close ups that are shot with the camera system.

We are beginning to use two methods to give video these previously film optical only capabilities. For matching foreground ADO moves to background camera moves, we have developed a secondary positioning and sizing control for the ADO. It provides the editor with extremely fine foreground/background registration. These controls are used on a frame basis to do high-end videoptical compositing. Another system utilizes software programs for existing motion control set ups to allow camera moves to mimic easily creatable ADO electronic moves. This then allows precise compositing in realtime of electronically created graphics with live action video.

Effects that were previously beyond the loftiest advertising and

programming budgets are now available with the digital video systems of the last five years. The new systems out this year promise to bring another leap in video post-production capabilities. Soon we will be compositing digital video twenty and thirty layers deep with no generational degradation. This new direction spells change for the video post-production industry. Clients will be looking to the high-end facilities for more electronic graphic and effects expertise than ever before.

Ultimately, the success of this newest generation of digital video systems hinges on the facilities' ability to promote their creative, cost-effective and successful use by the production community. We are looking forward to this challenge.

## RF Systems Considerations for Multichannel TV Sound Transmission

Verne S. Mattison

RCA Corporation, Broadcast Systems Division

Gibbsboro, New Jersey

Through the work of the EIA/BTS Multichannel Sound Subcommittee and others, considerable information has been made available on the performance requirements for satisfactory transmission of multichannel TV sound (MTS). This presents the TV station with the need to evaluate its existing transmitter plant with respect multichannel sound requirements, and to determine what will be needed to bring it up to the necessary level of performance.

This paper will address some of the practical systems considerations in adapting existing TV station transmission facilities for multichannel sound. It will describe how one equipment manufacturer, the Broadcast Systems Division of RCA Corporation, recommends adapting TV transmitters of its manufacture for multichannel sound transmission.

### TV STL Systems for Multichannel Sound

In the majority of existing TV transmitter installations where the transmitter is located at a distance from the studio, the question occurs whether to locate the MTS signal generators and associated monitoring equipment at the studio or at the transmitter site.

Figure 1 is a block diagram showing the MTS signal generating equipment located at the transmitter site. This arrangement offers the shortest possible path from the outputs of the stereo and SAP signal generating and dbx processing equipment to the transmitter input. Thus it avoids degradation of stereo separation which could be caused by nonlinearity of amplitude or phase response in a microwave STL system over the encoded signal frequency range of 50 Hz to 50 KHz.

A disadvantage of this arrangement is the requirement for four sub-carriers on the microwave STL system for separate handling of the left and

right audio channels, SAP channel audio and the professional (PROF) channel. Also, since the majority of transmitter installations are remote controlled, the MTS signal generating and monitoring equipment are accessible for observation and adjustment only during transmitter maintenance periods.

Figure 2 represents an alternative plan allowing the MTS equipment to be located at the studio. The composite stereo, SAP and PROF signal modulates a single broadband subcarrier which is fed to the STL system. At the receiving end this subcarrier is demodulated, and the composite stereo and SAP signal is fed to the transmitter. The professional channel subcarrier can be demodulated and fed to the remote control system, or it can be fed directly to the SCA input of the aural transmitter if used for an audio cue channel.

An advantage of this arrangement is that it permits access to the MTS signal generating and monitoring equipment by personnel at the studio for observation and adjustment. It requires a microwave system with a subcarrier channel capable of handling the broadband composite MTS signal with flat amplitude response and phase linearity over a range of 50 Hz to 120 KHz.

#### Transmitter Performance Requirements for Multichannel TV Sound

Few if any of the more than 1100 television transmitters that were already on the air before the development and endorsement of the BTSC multichannel sound system were designed to meet all of the requirements for MTS transmission. Most broadcasters are faced with the need to achieve satisfactory MTS transmission using an existing transmitter, within reasonable limitations of cost and modification effort.

For BTSC multichannel sound transmission, the aural modulating signal includes frequency components out to 105 KHz. Good engineering practice requires that the transmitter be capable of handling a band of modulating frequencies to 120 KHz. The FCC maximum permissible peak deviation of the aural carrier frequency by the combined MTS modulating signals is  $\pm 75$  KHz. The transmitter should be able to handle a frequency deviation of  $\pm 100$  KHz to provide ample modulation headroom with low distortion.

Per the recommendations of the EIA/BTS Multichannel Sound Subcommittee, the passband for the aural RF signal should have a bandwidth of not less than 400 KHz between 3dB points. The slope of the group delay of the entire aural transmitter system including notch diplexer should be within 50 ns at frequencies out to 200 KHz above and below carrier. Symmetrical variations in group delay should be less than 400 ns within the 400 KHz band.

Visual carrier incidental phase modulation (ICPM) should be within a maximum of 3 degrees. Signal components of the visual output signal should be attenuated by 30 dB within  $\pm 0.12$  MHz of aural carrier frequency.

RCA has developed modifications for multichannel sound adaptation of the majority of the TV transmitter models of its manufacture that are in service. In the UHF category this covers all of the klystron transmitter models that are equipped with solid state exciters. In the VHF category it embraces all of the externally diplexed transmitter models in the current family of transmitters known as the "G" line, and also the previous "F" line transmitter generation including the FH highband and FL lowband series of transmitters.

Following is a review of the modification program and its application to the individual transmitter models.

### TV Transmitter Exciter

Adaptation for multichannel sound begins with the aural exciter, to accommodate the extended modulated signal frequency range and FM deviation capability. Figure 3 is a block diagram of the RCA TTUE-44A MTS-adapted UHF exciter. A single 75 ohm input with flat response is provided for the composite stereo and SAP channels. A second 75 ohm input accommodates a PROF channel. An input isolation circuit provides balanced input with common mode rejection and ground loop isolation for both 75 ohm input circuits.

A separate 600 ohm balanced input with 75 microsecond preemphasis is provided for monaural audio. A relay provides local or remote selection between the composite MTS and monaural audio input while allowing continuous transmission of the PROF channel. This arrangement provides a means of accommodating alternate periods of stereo and monaural audio programming. It also provides a backup monaural input capability in the event of failure of the stereo input generator.

A new, wideband, low noise aural FMO is included in the UHF exciter modification. The aural IF is frequency locked to the visual IF TCXO. As a result the aural to visual carrier frequency separation in the MTS-adapted UHF transmitter is maintained within  $\pm 5$  Hz of 4.5 MHz.

Also shown in the block diagram of the UHF exciter is an aural channel delay equalizer which operates at aural IF. Aural channel delay equalization is employed in all MTS-adapted RCA transmitters to compensate for aural group delay distortion occurring within the entire transmitter system, including the notch diplexer or filterplexer when used. The function of the delay equalizer will be described further under the discussion of notch diplexers and filterplexers for multichannel TV sound.

MTS adaptation of an existing TTUE-44 UHF exciter is accomplished by replacement of the aural IF drawer unit. Adaptation of earlier model RCA UHF exciters, Type TTUE-4A or 4B, includes replacement of the aural IF drawer plus field modification of the visual IF drawer unit. The visual IF drawer modification includes the addition of a phase modulator at visual IF for ICPM correction. This correction capability is included in all TTUE-44 UHF exciters as standard.

Turning next to the VHF exciters, Figure 4 is a block diagram of an MTS-adapted exciter for a VHF transmitter of the G line family. Functionally the MTS modifications required for the G line VHF aural exciter system are similar to those previously described for the UHF exciters. The changes include adding the required three separate aural input circuits, extending the aural FMO frequency response, improving linearity and adding an aural delay equalizer operating at IF. Physically, the adaptation is accomplished by following a step-by-step field modification procedure supplied with the modification material.

Looking next at the previous "F" line generation of VHF transmitters, Figure 5 is a block diagram of an MTS-adapted exciter system for an FH

highband transmitter. Again, the aural exciter input circuit is modified to provide separate inputs for monaural audio, a composite stereo and SAP channel and a PROF channel. Since the F series of RCA VHF transmitters do not employ an intermediate frequency for modulation, aural delay equalization occurs at a channel-determined frequency. In the FH transmitter the equalizer is located between the aural FMO and the aural mixer where it operates at a frequency within the range of 29 to 36 MHz.

A block diagram of an MTS-adapted RCA FL lowband VHF transmitter is shown next in Figure 6. Here the aural delay equalizer is installed at the output of the aural multiplier where it operates at aural carrier frequency. Included in the adaptation of the FL exciter is the provision of an incidental phase corrector in the visual section of the exciter. It consists of a phase modulator which is located in the visual solid state CW amplifier chain, between the 5-watt and 20-watt amplifier where it operates at visual carrier frequency. The video input signal for the phase modulator is supplied by the video output amplifier that feeds the visual modulated amplifier tube stage of the FL visual transmitter.

#### Attenuation of Visual RF Signal Components Near Aural Carrier Frequency

A delay-equalized video low pass filter is provided to reduce the level of visual signal components in the region of the aural carrier frequency, supplementing the attenuation provided by the notch diplexer or filterplexer at the aural carrier. This filter is used at the video input of the visual exciter of each of the aforementioned VHF transmitter models.

A UHF transmitter equipped with a TTUE-44 exciter containing a surface acoustic wave (SAW) filter for visual sideband shaping does not require the use of the video low pass filter. The SAW filter, in conjunction with the video filter contained in the color phase equalizer plus the notch diplexer, provides the required degree of attenuation of visual signal components in the aural carrier frequency range.

#### UHF RF Amplifiers

For a flat, symmetrical response and minimum delay across the 400 KHz aural passband, the klystron in the aural transmitter should be tuned to handle a bandwidth of 1 to 2 MHz. In practice the aural klystron should be tuned for the maximum bandwidth obtainable within the limits of the individual klystron tuning characteristics, available drive power and beam current efficiency.

The wider aural bandwidth requires a change from the klystron tuning procedure for aural klystrons. For monaural transmission which requires a bandwidth in the order of 750 KHz it has been standard practice to tune all except the penultimate cavity synchronously at aural carrier frequency. The penultimate cavity is moved approximately 1 MHz above carrier. For multi-channel sound the required aural RF bandwidth may be accomplished by moving the first and/or second cavity below carrier while tuning the remaining cavities as before.

It should be noted that the first generation model of solid state 10-watt visual IPA units which are in use in a number of transmitters have a

deficiency in ICPM performance which is beyond the limits of correction capability. These IPA units should be replaced with current generation amplifiers which are available as a retrofit package.

### VHF RF Amplifiers

While the 400 KHz aural passband recommended for multichannel sound occupies a small part of the frequency spectrum at UHF channel frequencies, the ratio of bandwidth to spectrum becomes progressively larger at the high band VHF and low band VHF channel frequencies. VHF aural power amplifiers do not exhibit the wide bandwidths that are so readily achievable with UHF klystrons.

A modification to RCA low band VHF G line aural cavities provides some increase in bandwidth, however both the low band and high band amplifiers do contribute group delay distortion if not equalized. The RCA aural group delay equalizer provides composite equalization of both the aural RF power amplifier and the notch diplexer characteristics.

### Notch Diplexers and Filterplexers for Multichannel TV Sound

Notch diplexers or filterplexers used to combine the visual and aural transmitter RF outputs provide both advantages and disadvantages in MTS transmission. The notch diplexer or filterplexer provides attenuation of video products at aural frequencies and provides visual to aural isolation. On the other hand, all such filters have band limiting characteristics resulting in some level of group delay distortion, which results in degradation of crosstalk between subchannels.

Group delay equalization as described earlier is employed in the MTS adaptation of the aural exciter in UHF as well as VHF RCA TV transmitters. Its function is to optimize the group delay characteristic of the overall transmitter system including the notch diplexer. It provides adjustable delay equalization to accommodate RCA manufactured UHF notch diplexers or filterplexers of either the hybrid or waveguide variety.

The aural channel delay equalizer is factory preset to the station channel and the type of notch diplexer or filterplexer in use. Upon installation of the equalizer a fine tuning field adjustment is made to minimize overall aural transmitter system group delay distortion in the individual installation.

A prerequisite for the application of aural channel group delay equalization is that of adequate tuning stability of the notch diplexer or filterplexer with respect to ambient temperature change. Once optimized, the RF output system must be sufficiently stable to remain optimized within the full range of ambient temperature that will be encountered. RCA manufactured notch diplexers and filterplexers employ temperature compensation techniques including the use of negative temperature coefficient structural materials to satisfy this requirement.

Existing notch diplexers or filterplexers may need field retuning to restore performance to the original specification level, depending on the age and condition of the individual filter.

## Conclusion

Experience to date with both VHF and UHF transmitters that have been field modified for multichannel TV sound confirms that excellent MTS transmission quality can be achieved with existing transmission systems through practical and economical modification procedures.

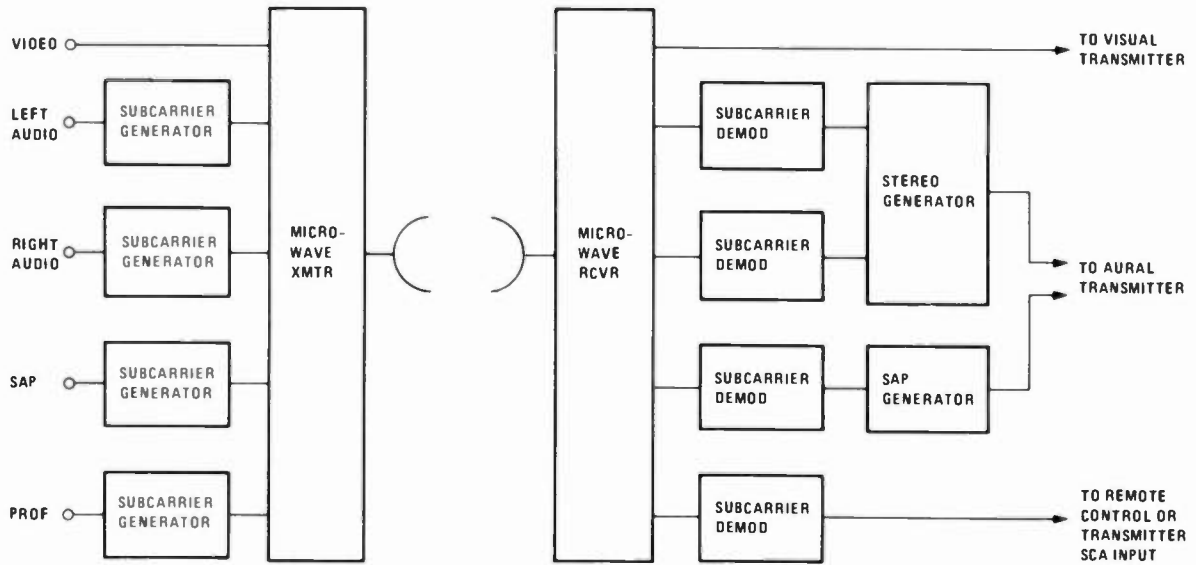


Figure 1. Studio-To-Transmitter Link, MTS Generator At Transmitter

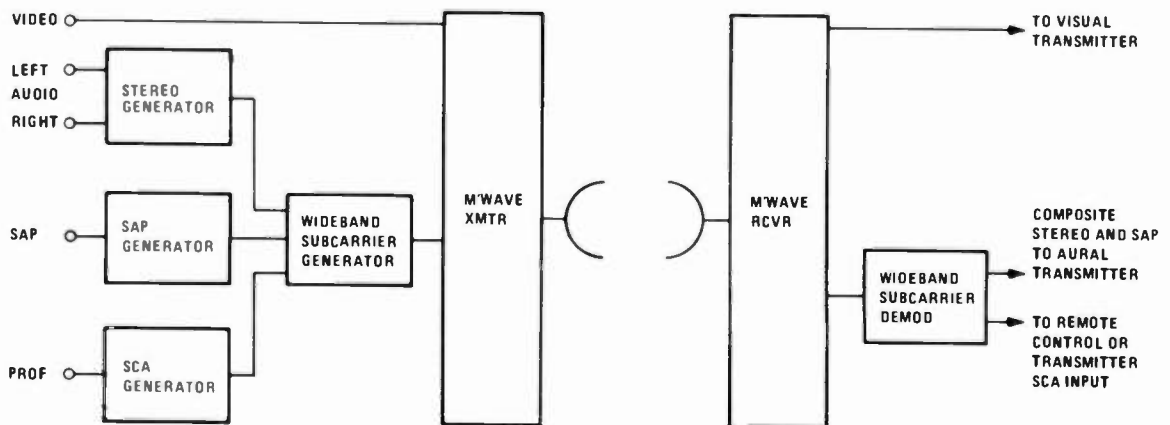


Figure 2. Studio-To-Transmitter Link, MTS Generators At Studio



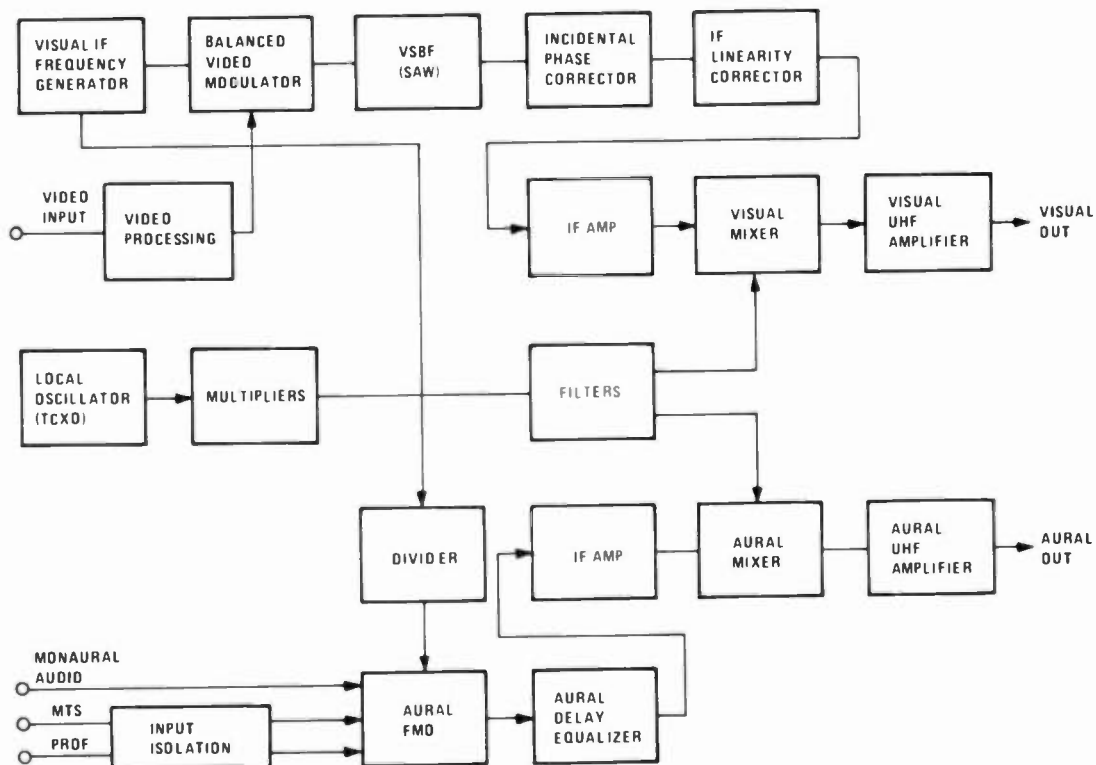


Figure 3. Block Diagram, TTUE-44A UHF Exciter

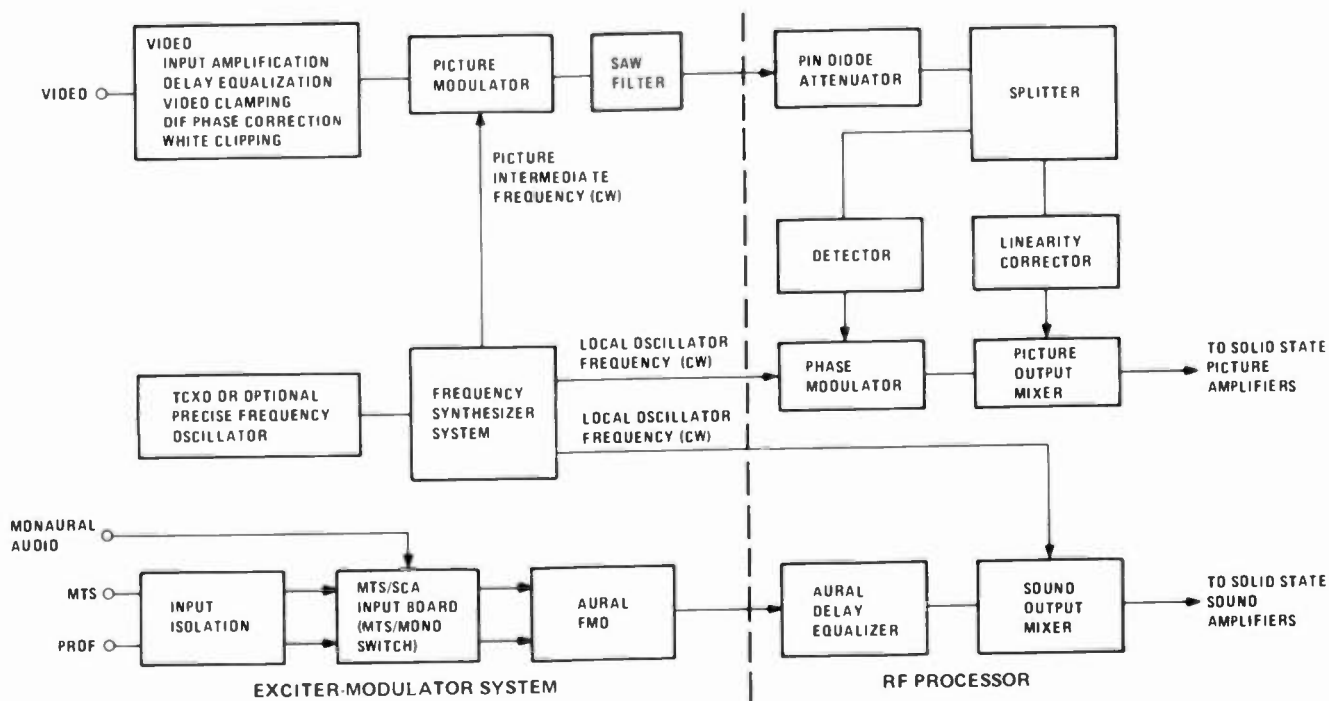


Figure 4. Block Diagram, Exciter-Modulator and RF Processor for G-Line VHF Transmitter

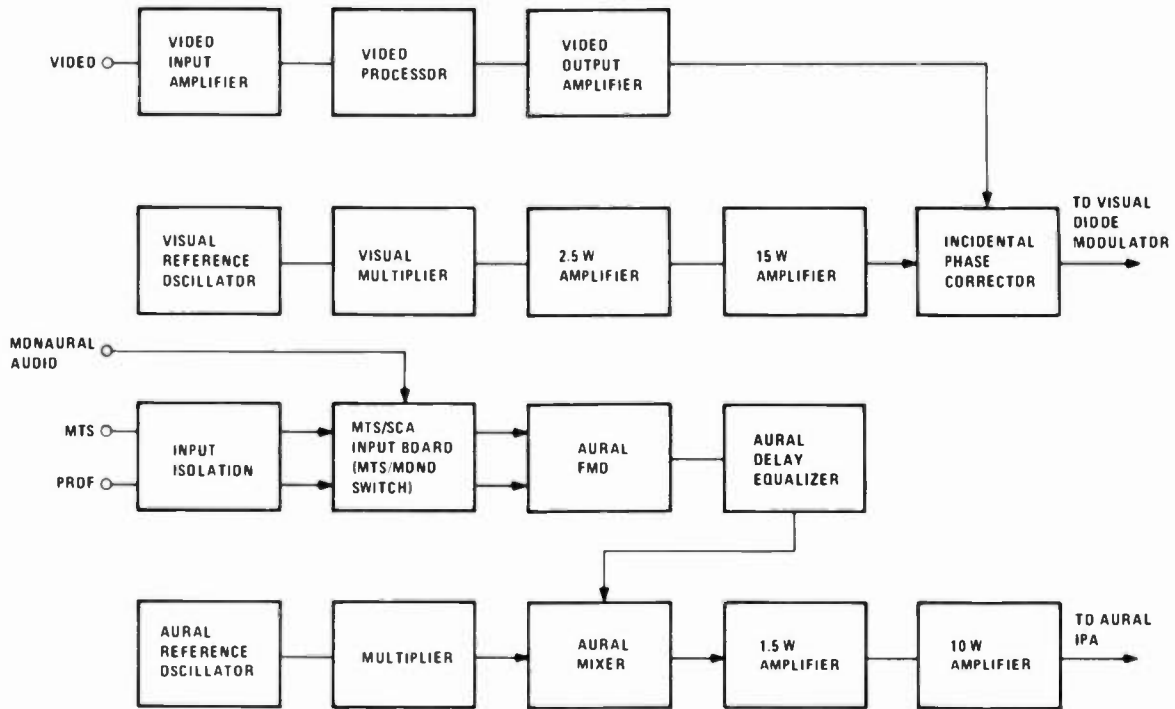


Figure 5. Exciter System for FH VHF Transmitter

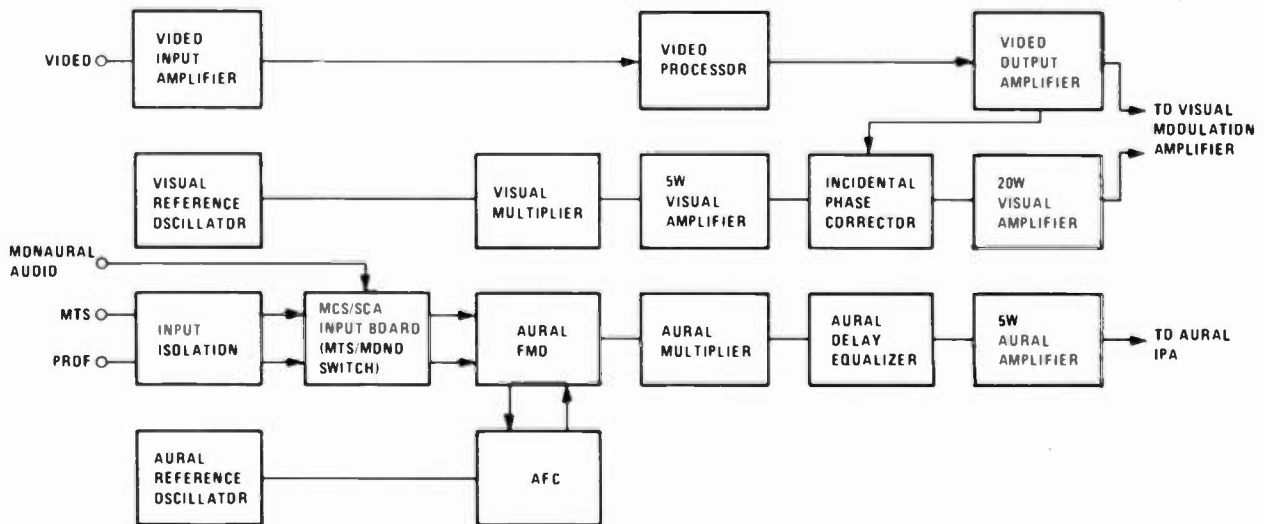


Figure 6. Block Diagram, Exciter for FL VHF Transmitter

Field Conversion of TV Transmitting

Facilities for Stereo Operation

R.W. "Sam" Zborowski

Information Transmission Systems, Corp.

McMurray, Pennsylvania

An effective plan to modify existing TV transmitters for multichannel sound transmission requires an understanding of the composite baseband signal, distortion mechanisms which affect the recovered baseband signal and an evaluation of each element of the transmission system for its contribution to overall system distortion.

The multichannel sound transmission system and details of the composite baseband signal and associated companding are described elsewhere (1,2). The fundamental baseband signal parameters are summarized in Table 1.

Service	Modulating Signal			Subcarrier			Aural Carrier Peak Deviation	
	Content	Frequency/Range	Processing	Frequency*	Modulation	Deviation		
Monophonic	L + R Audio	.05- 15 kHz	75usec pre-emp	----	----	----	25 kHz**	
Pilot	CW	----	----	FH	----	----	5 kHz	
Stereo	L-R Audio	.05- 15 kHz	BTSC Compand.	2FH	DSB-AM suppressed carrier	----	50 kHz**	
Second Audio Program (SAP)	Audio	.05- 10 kHz	BTSC Compand.	5FH	FM	10 kHz	15 kHz	
Professional Channel	Voice or Data	.3-3.4kHz or 0-1.5kHz	150usec Pre-emp or none	6 1/2FH or 6 1/2FH	FM or FSK	3 kHz	3 kHz	
(Table 1)							Total	73 kHz

\* FH = 15.734 kHz = Horizontal Scan Frequency.

\*\* Not Statistically independent, sum does not exceed 50 kHz.

A complete operational analysis of the transmission of multichannel sound must include the additional audio links from studio to transmitter, the composite stereo generator and SAP generator, the TV transmitter and antenna system and accurate modulation monitoring equipment. Most of these items are additional purchased items designed specifically for the new service. This paper will focus on existing TV transmitter and antenna system components which may be suitable for multichannel sound service or a subset of stereo sound transmission with relatively minor modifications.

Before moving into the transmitter discussion, a word about stereo generator interface considerations is in order. The requirement that the stereo pilot be phase locked to horizontal sync creates the need for video to be looped through the stereo generator. The stereo and SAP generators should have balanced, differential audio inputs, an isolated ground video input and be powered by the same AC line and safety ground as the existing transmitter input equipment to avoid the introduction of ground loop induced hum to video and audio. An unbalanced, 75ohm composite stereo input with level normalized to 1V peak-to-peak = 75 kHz deviation of aural carrier appears to be the emerging standard interface between the TV stereo generator and TV transmitter.

Transmission system requirements (3) from composite baseband input of the transmitter to composite output of the FM receiver necessary to achieve high quality stereo separation and isolation of main, second program and professional channel modulations are listed in Table 2.

Table 2

Amplitude vs. Frequency Response	+1.0 dB over 30 Hz - 120 kHz and +.05 dB over 50 Hz - 50 kHz
Phase vs. Frequency Response	+10 degrees from linear phase over 30 Hz - 120 kHz and +0.5 degree from linear phase over 50 Hz - 50 kHz

Note: All of above apply for +50 kHz deviation.

Linearity such that	1.) Crosstalk from all other audio sources into mono or stereo subchannel is less than -60 dB and 2.) Crosstalk from all other audio sources into SAP subchannel is less than -50 dB.
---------------------	--

Precise measurement of the above parameters requires an impressive array of specialized test equipment including:

- 1.) Several low distortion audio oscillators and a high quality composite stereo generator and SAP generator.
- 2.) A very linear, broadband FM demodulator.
- 3.) An audio spectrum analyzer with tracking generator or leveled audio sweep generator.
- 4.) An envelope delay or phase linearity test set capable of operation over the composite baseband frequency range.

This specialized test equipment is not generally available to the broadcaster who is contemplating multichannel sound operation. However, a good indication

of the relative suitability for multichannel sound operation of various elements of the transmission system can be obtained from measurements which can be made using more commonly available test equipment. All of the necessary equipment should be available to the broadcaster as it is either required to conduct a good TV transmitter Proof-of-Performance or evaluate audio system distortion.

### Field Tests

Tests were performed on a variety of transmitter models to examine some typical system limitations of existing transmitters relevant to multichannel sound transmission. Transmitter types included:

- 1.) RCA FL-Series lowband VHF both with bridge diplexer and notch diplexer.
- 2.) RCA FH-Series highband VHF with notch diplexer.
- 3.) RCA TTU-110 UHF Klystron Transmitter including mod-anode pulsing, variable couplers and notch diplexer.
- 4.) ITS Corp 1kW internally diplexed UHF LPTV Transmitter (not a field test - new transmitter type).

### Test Methodology

Transmitter tests included the following measurements:

- 1.) Amplitude vs frequency response of composite input of transmitter to composite output of the FM receiver.
- 2.) Amplitude vs frequency response of aural amplifier chain and diplexer using wide deviation of the VCO as a sweep generator and observation with an RF spectrum analyzer.
- 3.) Audio harmonic distortion and intermodulation distortion as displayed on a low frequency spectrum analyzer at the receiver composite output.
- 4.) Stereo separation as displayed on the low frequency spectrum analyzer while (A) setting L audio = R audio, measuring resulting (undesired) stereo (L-R) subcarrier modulation and (B) the inverse operation of setting L audio = -R audio and measuring the resulting (undesired) L + R mono channel modulation.
- 5.) Crosstalk tests from SAP to main and stereo subchannels and from main and stereo subchannels to SAP subchannel again as displayed on a low frequency spectrum analyzer at the FM receiver composite output.
- 6.) Crosstalk from video components into the recovered composite audio spectrum. These tests included crosstalk from several sources including existing limited video and IF/RF filtering, intermodulation due to gain vs level and phase vs level (ICPM) non-linearities and an unexpected intermodulation mechanism involving bridge diplexers.
- 7.) Subjective listening tests of video crosstalk components into main, stereo and SAP channels of an RCA Consumer Electronics multichannel sound TV receiver. These tests involved establishing a comfortable listening level at 100% modulation reference of 400 Hz audio, then removing audio modulation and transmitting various video test signals. Test signals used in both the spectrum analyzer and subjective crosstalk tests included field square wave, full field color bars, 60 IRE multiburst, modulated 5-step linearity staircase and a special signal using a sync and blanking adder with a 100 IRE p/p CW signal source at 2.25 MHz + several discrete offsets to place its second harmonic within the aural passband.

- 8.) FM signal to noise tests as currently defined for TV transmitter Proof-of-Performance testing.

Equipment employed in these tests included an instrument-grade composite stereo generator built by RE Instruments Corp., Frequency-Modulated function generator to simulate SAP, an instrument-grade wideband FM (split sound) receiver and a Tektronix 1450 TV demodulator modified to include split, intercarrier and Quasi-parallel modes of FM detection. Companding was not included in this test series except for its subjective effects on video crosstalk into recovered audio of the TV receiver. As of this writing, available BTSC companding equipment limits stereo separation to approximately 35 dB. The BTSC format (less companding) stereo generator used in the tests was capable of nearly 60 dB separation by the low frequency spectrum analyzer method outlined earlier, which facilitated a more accurate test of the transmission system alone.

In all of the transmitter tests, an Aural Exciter designed for multichannel sound was employed so that system measurement capability was not limited by the existing VCO. In the case of the FL-Series Transmitters which have no ICPM Correction circuits, a Visual Exciter was also employed with the existing video modulator (mod-amp) stage biased as a linear amplifier by disconnecting the normal video input and adjusting the pedestal level control. No special adjustments were made on the transmitter except normal adjustment of linearity and ICPM correction for best video performance and peaking of the aural driver and output amplifier tuning controls to provide an approximately symmetrical response around aural carrier.

#### Test Results Summary

Amplitude vs frequency response of composite audio input to FM demod output for each transmitter tested exhibited less than 0.3 dB rolloff (0.1 dB of which was contributed by the exciter alone) at 120 kHz baseband frequency, with essentially flat response through the stereo subchannel. Additional rolloff due to diplexer response was essentially negligible except for the high band filterplexer which was incorrectly tuned (see below). No attempt was made to touch up the notch tuning and the overall effect caused a total of 1.1 dB rolloff at 120 kHz and 0.3 dB rolloff at the high end of the stereo subchannel.

The RF amplitude vs. frequency response of the aural transmitter section of all the transmitters tested exhibited less than 0.6 dB rolloff over +120 kHz from aural center frequency (most were less than 0.3 dB rolloff). Addition of the notch diplexers (where used) contributed negligible additional rolloff with the exception of the high band VHF unit. This unit was tuned to approximately 50 kHz above aural center frequency and did not exhibit symmetrical response around that point. Relative to the actual frequency, -120 kHz, response was down about 2 dB, +50 kHz was up by 0.3 dB and by +120 kHz, response was about even with that at aural center frequency. This diplexer probably represents close to worst case conditions.

Recovered audio harmonic distortion products from mono channel modulation were down more than 54 dB from +25 kHz deviation reference, an equivalent of 0.2% THD for each system tested. Modulation transfer (audio intermodulation) sidebands from a 60 Hz tone onto a 7 kHz tone in the mono channel at 100% mono

channel modulation were down greater than a 60 dB from the 7 kHz reference tone. These products are correlated and their distortion contribution adds on a voltage basis, resulting in an equivalent -54 dB distortion effect to the 7 kHz tone. Some of the transmitters tested exhibited slightly better harmonic and IM distortion, but it is believed that these parameters are principally related to the VCO, which was essentially the same in all tests.

Stereo separation tests using the low frequency spectrum analyzer and stereo generator without companding as described earlier indicated very promising results. The worst separation number noted was 48 dB with most running in the mid 50 dB range including the bad diplexer described earlier.

Crosstalk tests of SAP modulation transfer into the L+R (mono) subchannel and L-R (stereo) subchannels produced no observable products in any of the tests. The composite baseband noise floor of the low frequency analyzer display was 60 to 65 dB below a +25 kHz deviation reference. Crosstalk tests of modulation transfer from L+R and L-R modulation onto an unmodulated SAP carrier produced SAP sideband products approximately 45 dB or more below SAP carrier level in the recovered composite baseband. These products were generally the same amplitude above and below the SAP carrier, indicating that they are substantially AM components which would be additionally rejected by the SAP FM demodulator.

Video to recovered baseband crosstalk test results varied widely from one transmitter to another with additional variation due to video signal in use, FM demodulation mode (split, intercarrier or Quasi-parallel), and visual depth of modulation. While each variable is probably worth serious investigation, actual test time available dictated the need to limit this study to only the most common denominators. Each FM demod mode was observed briefly, but careful data recording utilized the Quasi-parallel mode which is used in the consumer TV receivers. Visual depth of modulation was carefully set at 12.5% for reference white and the video test signals examined were limited to those listed earlier.

The highest level video crosstalk components appear at multiples of horizontal sync in the recovered composite baseband. Again, breaking up the baseband into functional groups, one can measure effects on stereo pilot, stereo subcarrier and SAP. The recovered video products at pilot frequency ranged from a minimum of 57 dB below reference 25 kHz deviation (TTU-110) to a high of 46 dB below +25 kHz deviation for the internally diplexed 1kW. Since pilot is transmitted at 14 dB below +25 kHz deviation, these measurements offer 43 to 32 dB pilot protection. In the stereo subcarrier case, video crosstalk components ranged from a low of 54 dB below +25 kHz deviation, again for the klystron transmitter, to a high of 44 dB below reference for the internally diplexed 1kW UHF. The SAP channel suffered the most from crosstalk with a range of 48 dB below +25 kHz deviation reference for the klystron transmitter to 39 dB below reference for the internally diplexed 1kW UHF. Since SAP carrier is 4 dB lower than the reference level, the actual ratio of SAP to interference in the composite signal ranged from 44 to 35 dB. It was also noted that the internally diplexed 1kW transmitter was capable of about a 10 dB improvement across the composite baseband by slight adjustment of the ICPM corrector (about 1 degree) but the ground rules of the test required adjustment for best video performance. In all cases, the 60 IRE multiburst test signal caused the worst case crosstalk. This is probably due to having both high frequency video

content which tests video and RF filtering near aural and a white bar which traverses the extremes of ICPM non-linearities. One observation regarding the various demodulator modes was that the split mode indicated about 10 dB less recovered sync products than Quasi-parallel mode as displayed on the low frequency spectrum analyzer. This result occurred almost universally, including the case of the internally diplexed transmitter.

The subjective listening tests were inconclusive in that there was not a strong, clear correlation between the low frequency analyzer baseband display and perceived buzz in the receiver. For example, while multiburst often appeared as 6 to 10 dB worse on the analyzer display, a white window or field square wave generally sounded worse on SAP. The test results were limited also by the TV receiver design; it was modified to obtain a sample of demodulated composite baseband which was found to include sync products at about 40 dB below reference  $\pm 25$  kHz deviation even with no video present. It is believed that deflection circuit fields are detected in the audio circuits. Despite the receiver limitations, subjective tests indicated no observable video crosstalk effects on stereo mode. The SAP mode in general exhibited low level video crosstalk when certain discrete audio tones were being transmitted. On a sample of voice and music program content, the SAP crosstalk was considered not objectionable. The SAP crosstalk could be demonstrated with discrete tone modulation for all transmitters tested. (Except for the high band transmitter field test, in which the TV receiver was not used). The subjective nature of the tests leaves room for individual interpretation.

FM signal to noise tests (video off, de-emphasis included) ranged from 60 to 63 dB for the transmitters tested.

#### Multichannel Sound Transmitter Considerations

The most critical section of the multichannel sound transmitter is the voltage controlled oscillator and multiplier chain or heterodyne frequency conversion section which generates the frequency modulated on-channel aural signal. It is unlikely that, in all but the most recent transmitter designs, this section will exhibit the linearity, bandwidth, FM noise performance and deviation capability required for multichannel sound. In addition, Best (4) has noted that those VCO designs which are not frequency locked to a precise intercarrier reference may exhibit noticeable carrier shift under modulated conditions and lose the benefit of having the stereo pilot locked to horizontal sync (to minimize crosstalk of visual products into recovered audio in the receiver). Nonetheless, an evaluation test is worthwhile. The VCO linearity can be tested by the familiar harmonic distortion analyzer method and by an audio intermodulation distortion test. The intermod test uses linear addition of a 60 Hz sine wave and a 7 kHz sine wave with the 60 Hz component at four times the amplitude of the 7 kHz signal. These tests are defined to include 75usec pre-emphasis and de-emphasis which puts the two tones at equal amplitude at the VCO. The intermod test is most easily done using an intermod test set which generates the tones and evaluates transfer of 60 Hz onto the 7 kHz carrier. The intermod test set is in wide usage in FM broadcast and should be available to many television broadcasters on at least a temporary borrowing basis. FM noise is measured in the familiar Proof-of-Performance format: The dB ratio of recovered audio due to  $\pm 25$  kHz deviation compared to audio recovered with no



modulation input. This test must include 75usec de-emphasis. An FM noise ratio goal of at least 60 dB is in the vicinity of an acceptable standard.

VCO bandwidth can be tested using a constant amplitude sinewave input with frequency varied across the 30 Hz to 120 kHz composite signal range (pre-emphasis off).

All of the VCO tests will be limited by the existing station aural modulation monitor's bandwidth and linearity. If the monitor specifications suggest that it is capable of wideband operation, some performance goals are harmonic distortion less than 0.5% at  $\pm 25$  kHz deviation and 1.0% at  $\pm 50$  kHz deviation (5). Audio IMD, 60 Hz onto 7 kHz, should be less than 1.0% for  $\pm 50$  kHz deviation (5). Audio frequency response should be within the limits indicated in Table 2. As a practical matter, it is difficult to obtain audio phase measurement equipment for this frequency range. However, having demonstrated essentially flat amplitude response beyond the entire range of interest one can be reasonably confident that the phase-error will not be a problem.

In order to measure the VCO bandwidth alone without the limitation of the FM demod, one can use an RF spectrum analyzer and Bessel Function approach based on the relationship:  $(\text{Modulation index, } B) = (\text{frequency deviation})/(\text{modulating frequency, } F_m)$ . Table 3 illustrates a selection of discrete modulation indices and corresponding modulating frequencies required to achieve  $\pm 25$  kHz deviation. Frequency response measurement is performed as follows:

- 1.) Adjust the spectrum analyzer to display unmodulated aural carrier and adjust for 100% indication in linear display mode.
- 2.) Adjust audio modulation frequency to 10.396 kHz (use a frequency counter) and increase audio level to reach the first carrier null. Note this reference audio level.
- 3.) Adjust the audio modulation frequency to each of those listed and adjust audio level to achieve the corresponding level of carrier,  $J_0(B)$  indicated on the chart. Movement from the reference audio level represents the frequency response error.

The chart also indicates the level of the first sideband pairs,  $J_1(B)$  as an aid in accurately setting each modulation index point. The first carrier null reference point establishes correlation with the modulation monitor, which is then used to indicate the response of lower audio frequencies.

Table 3

Modulation Index, B	Carrier Level, J0(B)	First Sideband Level, J1(B)	Audio Frequency, Fm (kHz) For <u>+25</u> kHz Deviation
0	1.0	0	-----
0.1	.998	0.50	250
0.2	.990	.100	125
0.3	.978	.148	83.333
0.4	.960	.196	62.500
0.5	.939	.242	50.000
0.6	.912	.287	41.666
0.7	.881	.329	35.714
0.8	.846	.369	31.250
0.9	.808	.406	27.777
1.0	.765	.440	25.000
1.2	.671	.498	20.833
1.4	.567	.542	17.857
1.6	.455	.570	15.625
1.8	.340	.582	13.889
2.0	.224	.577	12.500
2.2	.110	.556	11.364
2.405	0	.509	10.396

Aural amplitude vs. frequency response including the notch diplexer should be at least +200 kHz to -3 dB points and at least +120 kHz to -1 dB points and be tuned symmetrically relative to aural carrier frequency to maintain acceptable main to SAP crosstalk levels. Frequency response is easily measured by wide deviation of the VCO by a low frequency signal and observing the aural output with a spectrum analyzer.

High frequency video components and intermodulation components which fall within +120 kHz of aural should, as a goal, be maintained at least 46 dB below aural (3). The high-frequency video components can be handled by including at least 30 dB attenuation in this band by any combination of video, IF or RF filtering. The video intermodulation products which lie in this band are partially suppressed by the notch diplexer response; additional suppression is obtainable by use of IF linearity correction and ICPM correction circuits to compensate for (produce cancelling intermod products) the final stages. Approximately worst-case visual intermod distortion products can be simulated using a sync and blanking adder and 100 IRE pk-pk 2.25 MHz sinewave as the video source. Look at the region near aural carrier using a spectrum analyzer.

Transmitters which employ bridge (hybrid) diplexers may exhibit intermod products due to imperfect isolation between visual and aural output amplifiers. One field test of a transmitter of this type having output amplifiers driving into separate terminations and combining the signals at low levels indicated a much cleaner aural spectrum (by about 6 dB in composite baseband products) than the same output stages combined in a hybrid diplexer.

A reasonable ICPM goal to achieve acceptable video crosstalk performance is +3 degrees over both active video and sync regions (3). The design of receivers using Quasi-parallel detection (which is a form of intercarrier detection) causes ICPM errors at white level to be the most troublesome. Older transmitters which have no specific incidental phase correction circuitry may be capable of some correction at white through intentional carrier leakage by adjustment of neutralizing controls around the visual modulator stage. If good ICPM cannot be obtained, a visual exciter having ICPM correction may be required.

Internally diplexed transmitters have more challenging linearity requirements. For example, the 1kW LPTV transmitter cited earlier measured 3 percent diff gain, 3 percent low frequency linearity and less than +1 degree ICPM. Fortunately, the linearity requirement to achieve acceptable 920 kHz video beat products is in the same order of magnitude to achieve reasonable multichannel sound operation.

Internally diplexed frequency translating repeaters (TV translators) may be evaluated for multichannel sound use by a 3-Tone RF test with carriers at the following levels:

<u>Frequency</u>	<u>dB Relative to Peak Visual</u>
Visual	-7 dB
Visual + 2.25 MHz + approximately 2.5 FM	-16 dB
Aural	-10 dB

This 3-Tone test is the RF equivalent of the 2.25 MHz video test mentioned earlier. This test evaluates intermod performance, looking at products near aural carrier using a spectrum analyzer. One further consideration related to TV translators is that many of them include an aural notch filter to reduce the aural signal level. The group delay errors introduced by the notch may cause substantial crosstalk for L+R and L-R into SAP. If this is the case in any given translator, the notch probably should be removed. The translator could then be operated at its former peak envelope power with visual reduced by 2 or 3 dB from original conditions.

#### Conclusion

Recent tests of typical television transmitters indicate that quality multichannel sound operation is probably not precluded by bandwidth limitations of existing amplifiers and diplexers. The principal limiting factors appear to be VCO linearity and ICPM induced crosstalk of video information into the recovered composite audio within Quasi-parallel receivers. These limitations can be overcome by the addition of an aural exciter designed for multichannel sound and some form of ICPM correction either directly at the existing visual modulator or in the form of a new visual exciter driving visual amplifiers biased for linear operation.

### Acknowledgements

The author wishes to thank the following individuals:

- The staff and management of WTAE-TV, KDKA-TV and WPGH-TV in Pittsburgh, PA and of WXYZ-TV, Detroit, Michigan for contributing the use of their facilities and time in support of the field tests.
- George Jacob of ITS Corp for his technical assistance in the field tests.
- Donna Bird of ITS Corp for preparing this manuscript.

### References

- 1.) Eilers, C.G., "The Zenith Multichannel TV Sound System", proceedings of the 38th Annual Broadcast Engineering Conference, National Association of Broadcasters, 1984.
- 2.) "Multichannel Television Sound Transmission and Audio Processing Requirements for the BTSC System", Federal Communications Commission Office of Science and Technology Bulletin No.60, April 1984.
- 3.) "BTSC System Television Multichannel Sound Recommended Practices", Second Draft, Electronic Industries Association Ad Hoc Committee on Multichannel Sound, Jan. 1985.
- 4.) Best, G.L., "Transmitter Conversion for TV Multichannel Sound", proceedings of the 38th Annual Broadcast Engineering Conference, National Association of Broadcasters, 1984.
- 5.) "Electrical Performance Standards for Television Broadcast Transmitters", RS-508 (Draft), Electronic Industries Association, 1985.

---

## System Design for Stereo TV Operation

James H. Swick

WTTW

Chicago, Illinois

Investigation of stereo audio for television began at WTTW in the early 1970's with the simulcasting of locally produced stereo music programs. An FCC experimental authorization granted in September 1977 allowed the start of monophonic compatibility testing of the Telesonics stereo system. The over-the-air testing indicated that mono compatibility would not be a problem. The results of the broadcast testing were forwarded to the FCC. The WTTW facilities were subsequently chosen as the transmission site for the EIA Multichannel Television Sound over-the-air system tests.

Full time stereo broadcasting started in October 1983 using a Broadcast Electronics FM stereo generator modified for the Telesonics transmission system. Following the FCC decision to protect the Zenith/dbx system, the stereo generator was modified by Broadcast Electronics to conform to the BTSC system, and was returned to full time air service on August 7, 1984.

This paper covers general engineering considerations related to the set-up and operation of stereo television and outlines the system used by WTTW as a demonstration of one possible approach to stereo operation.

### TRANSMISSION FACILITIES

To insure quality stereo and minimize crosstalk, the transmitter system must be capable of passing aural components past 100 kHz, while maintaining stringent amplitude and phase response tolerances. In the RF chain, aural passband amplitude

and group delay become critical to good multichannel sound performance. Although all circuits in the RF path can contribute to amplitude and group delay distortions, the standard notch diplexer is likely to cause the most severe degradation of the signal. Thus the entire RF system must be tested and necessary corrections made to assure performance adequate for MCS.

### AURAL EXCITER

The composite input to the aural exciter is connected via a relay that breaks the normal audio path from the input module to the modulated oscillator. The use of a relay allows the exciter to be externally switched from the monophonic mode to stereo mode. In mono mode the stereo generator is completely out of the audio path and thus can be removed without patching or level adjustment. The input relay switch circuit also provides the composite level control and appropriate attenuation to match the modulated oscillator input sensitivity of about 10mV/kHz. Because the level matching between the stereo generator and exciter is very critical, the composite level control is an internal exciter adjustment.

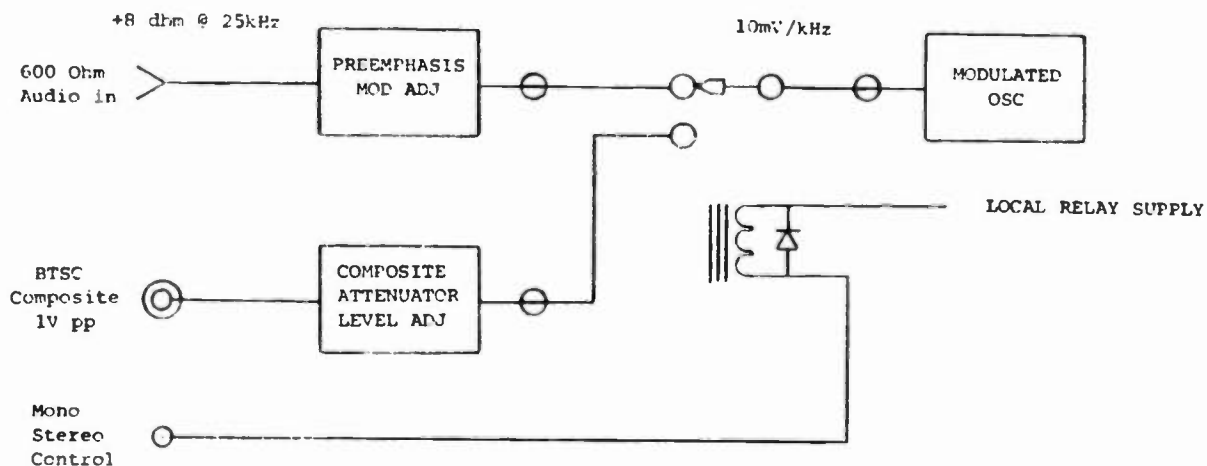


Figure 1. AURAL EXCITER INPUT SWITCHING

### STEREO GENERATOR

The stereo generator should be located as close as feasible to the aural exciter to minimize cable effects on the wideband composite signal. The companding of the difference subchannel and the location of the pilot at Fh render the composite signal much more sensitive to gain and phase errors and contamination by horizontal rate noise than the standard audio and video signals encountered at a transmitter site. The connection between the stereo generator and the aural exciter should be considered a transmission line.

## MONOPHONIC OPERATION

For routine monaural operation, provision should be made to switch the stereo generator to mono mode reserving the mono input switch of the exciter for emergency operation only. Owing to the specifications of the BTSC system, the stereo generator will likely provide more accurate preemphasis and better audio performance than the existing input processing of the aural exciter. In addition, the filtering in the stereo generator will reject horizontal frequency contamination that might be present in the audio transmission path. The input circuitry and preemphasis of the mono exciter input may boost any Fh noise present to levels sufficient to activate the stereo mode on some receivers.

## STEREO/MONO

Figure 2 shows the audio routing to the stereo generator and aural exciter. The audio distribution amplifiers are of the electronically balanced output type. This output configuration uses two essentially zero output impedance amplifiers driven out of phase followed by build-out resistors to achieve the selected impedance while providing high isolation between outputs. The outputs of the left and right amplifiers may thus be resistively combined to mono without compromising separation of the left and right feeds to the stereo generator. The left and right amplifiers are adjusted to provide the appropriate levels to the stereo generator then the mono amplifier is set to allow the existing mono system to be operated without the necessity of further level adjustment. Because the outputs of the left and right amplifiers are well isolated, the stereo generator may be removed or patched out without affecting the level in the mono system.

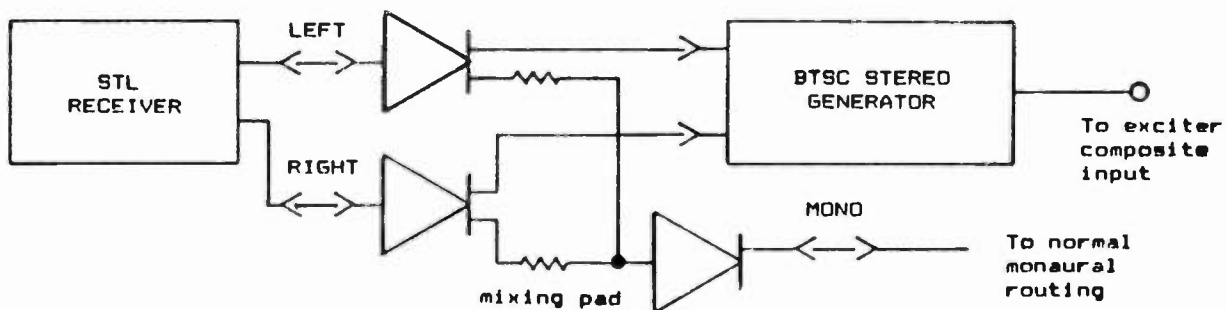


Figure 2. STEREO / MONO AUDIO ROUTING

## DEVIATION

The calibration of deviation between the stereo generator and the aural exciter is highly critical to the proper performance of the BTSC system. The BTSC difference subchannel is companded: compressed in the encoding process, and expanded in the receiver. Unlike FM stereo wherein the main and subchannels are linearly related, any overall deviation error in the BTSC system is magnified by the receiver difference channel expander resulting in drastic effects on separation. In order to attain reasonable separation results deviation must be calibrated to better than 1%. Once the relationship between the stereo generator and the aural exciter has been established, all stereo audio level adjustment must be done before the stereo encoding process -- not at the exciter.

## MONITORING

Monitoring a BTSC stereo transmission on a standard TV aural modulation monitor may yield erroneous results because the modulation monitor, being a wideband device, will respond to the pilot and the subchannel as well as the main channel audio. The action of the subchannel compressor may tend to modulate the subchannel with high levels of noise during periods of low L-R signal ( mono or silence ). The combination of the subchannel noise and the pilot may result in modulation readings of 25% or more in silence. Traditional audio monitoring for listening purposes can still be used, and in fact is helpful in evaluation of monophonic compatibility.

## VIDEO LOCK

The BTSC system specifies that the stereo pilot and subchannel be locked to the horizontal rate of the video being transmitted. The stereo generator thus requires a video lock reference; this should be provided from a stable source such as a proc amp or sync generator locked to the video.

## ICPM

To maintain good sound quality on intercarrier receivers, the incidental carrier phase modulation of the visual transmitter must be controlled. Both test equipment to check ICPM and a visual exciter capable of ICPM correction should be included in the transmission facility.

## STL

The STL must be capable not only of good frequency response and noise levels, but the amplitude and phase response of both channels must be matched. Left and right audio signals should always take identical paths and pass through similar equipment. Use of different types or even



different vintages of equipment between channels can result in unpleasant effects in both stereo and mono signals.

### AUDIO PROCESSING

Placement of the audio processing gear, especially the preemphasized peak limiter, ahead of the STL allows operation at the highest audio levels consistent with headroom protection to maximize signal to noise. All audio processing equipment should be designed for stereo to avoid degradation of stereo due to non-tracking gain control effects.

### STEREO SIMULATOR

The stereo simulator creates a stereo effect from otherwise monaural signals. The left and right outputs of the master control switcher are combined in a summing amplifier and fed to the simulator input. The simulator can be bypassed manually or it may be automatically bypassed by the master control switcher when a stereo source is selected. The bypass system is a relay which completely removes the simulator from the audio path.

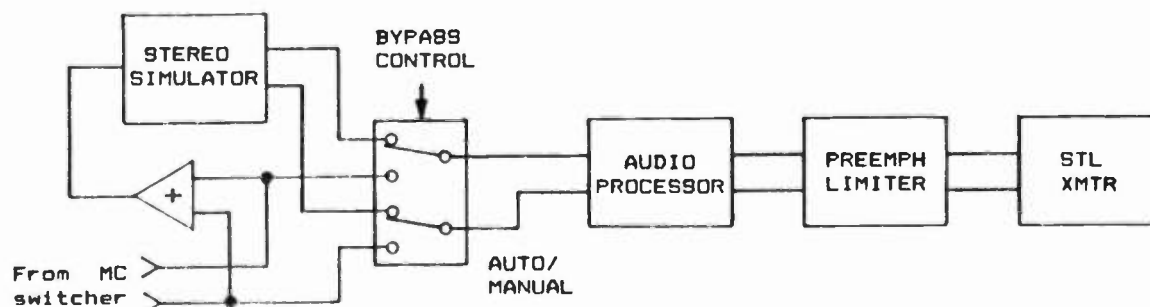


Figure 3. STEREO SIMULATOR BYPASS

### MASTER CONTROL

The master control switcher is configured with two levels of audio -- left and right. All monaural inputs, such as the auxillary inputs from the routing switcher, are placed on the left side of the control panel and the mono audio is bridged to both the left and right channels. The stereo sources, tape machines, network and studios, are on the left side of the switcher and wired as stereo. The separation of mono and stereo inputs to different sides of the switcher helps eliminate confusion. In this way in master control it is possible to take any source through the normal routing system as mono or as a direct stereo source. Appropriate video delays are inserted in the direct feeds to compensate for the delay of the routing switcher. The tallies of all the stereo inputs are diode-or connected providing the control signal to bypass the stereo simulator.

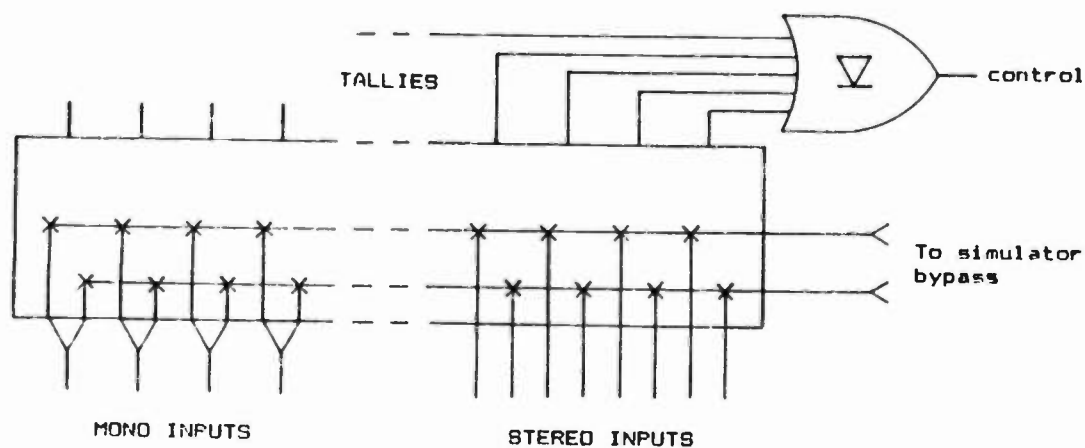


Figure 4. MASTER CONTROL SWITCHER

### AIR MONITORING

Although stereo line monitoring is available in master control, the mono air signal is monitored continuously. Frequent stereo checks during true stereo programs are certainly prudent, but listening in mono immediately alerts the master control operator of any mono compatibility problems such as channel phase reversal. Left, right and mono ( L+R ) meters help the operator evaluate the signal and make judgements on corrective action. Good levels in left and right accompanied by poor off the air mono sound and little indication on the mono meter indicate immediate phase reversal is in order.

### PHASE INDICATION

All stereo audio sources can be patched into a stereo phase indicator located near the master reference audio and video test equipment in the transmission area. Phase reversals are available in the patchfield.

### TAPE OPERATION

All VTRs capable of stereo operation are equipped with Dolby A noise reduction. Machines designated for network record and air playback are connected to the routing switcher as monaural devices. The left and right outputs are summed in an amplifier rather than with a resistive pad to provide the mono output while maintaining left and right isolation. Thus left, right and mono are available simultaneously, and the machine audio monitor can also select left, right or mono. A stereo headphone output is also available at each machine for more critical stereo quality evaluation. The ability to monitor the mono sum at the machine allows the tape operator to make a subjective mono compatibility / stereo phase judgement during set up. The mono output is connected to the routing system and the stereo outputs are connected directly to the master control switcher. The machine inputs are fed

from a switch at the machine that selects either the stereo input or the routing switcher mono feed split into both channels.

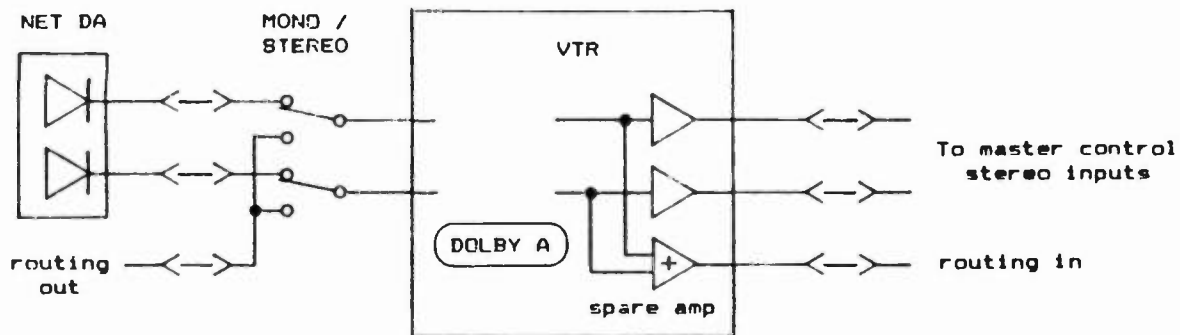


Figure 5. AIR / NET VTR AUDIO

Machines normally used for production are connected to the routing system as monaural and may be patched for stereo operation. The mono routing feed to each machine is split and fed to both inputs. Both the input and output of the splitter appear on the patchfield as normalized connections. The outputs of the machine are similarly mixed and normaled to the routing system. The use of a simple resistive mixing pad does not allow simultaneous mono and stereo outputs due to the loss of left and right isolation. Patching the machine for stereo interrupts the pad, restoring isolation. By performing the mono-stereo conversion at the patchfield the machines can be used conveniently in either mode without the immediate necessity of a stereo routing switcher.

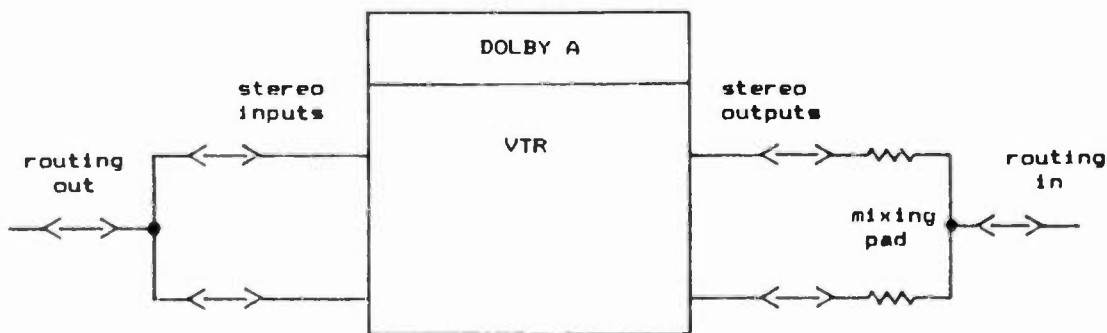


Figure 6. PRODUCTION VTR AUDIO

---

## PREPARING A VHF TRANSMITTER FOR MULTICHANNEL SOUND

RANDALL HOFFNER

NATIONAL BROADCASTING COMPANY

NEW YORK, N.Y.

The age of multichannel television sound has dawned in the United States with the adoption and implementation of the BTSC multichannel sound transmission and reception system. Multichannel television sound promises significantly enhanced viewer enjoyment in the form of stereo television sound and second audio program capability, and the broadcaster may benefit operationally from the professional channel subcarrier. Along with stereo sound comes a substantial improvement in the audio fidelity of transmitted signals and receiver sound systems, and increased consumer awareness of the quality of television sound. A particularly positive aspect of the BTSC system is that the many benefits of multichannel sound to the broadcaster and consumer are provided without any penalty being paid in the form of signal-to-noise degradation or sacrifice of monophonic performance.

Preparing a VHF transmitter for multichannel sound (MCS) transmission requires that several modifications be made to the transmitter, and that a much more critical set of performance specifications be met than are necessary to successfully transmit monophonic television sound. There are three principal areas of concern to the person considering preparation of a VHF transmitter for MCS: the aural transmitter, the visual transmitter, and the aural/visual diplexer. After all three of these subsystems have been considered separately, the transmission system must be dealt with as a whole.

### Aural Transmitter

The MCS aural transmitter is required to accept and pass a significantly more complex and demanding baseband signal than the mono transmitter. To do this successfully, a great deal more is asked of it in both audio-frequency and radio-frequency performance.

The peak deviation of the frequency-modulated aural carrier for mono operation is  $\pm 25$  kHz. For full MCS operation, the peak carrier deviation is almost tripled, to  $\pm 73$  kHz. This may require replacement and/or re-biasing of the frequency modulated oscillator's varicap diodes to attain the higher deviation while producing acceptable distortion levels. The aural exciter must be capable of accepting modulating frequencies of 50 Hz - 106 kHz as opposed to the 50 Hz - 15 kHz modulating frequency range of the mono exciter. Figure 1 illustrates the greatly increased occupied bandwidth of the full BTSC signal. The normal mono program is represented by only the small deviation  $\pm 25$  kHz from the carrier—the rest of the sidebands are created by the additional deviation owing to the 15734 Hz stereo pilot, the double sideband suppressed carrier L-R subchannel, the second audio program (SAP) subcarrier, and the professional channel subcarrier. It can readily be seen that the aural transmission system must be capable of passing a signal of much wider bandwidth for MCS than for mono operation.

In monophonic operation, 75 microsecond pre-emphasis is applied to the modulating signal as it enters the exciter. For MCS operation, the pre-emphasis characteristics are altered. The composite MCS baseband signal must be passed without pre-emphasis at the exciter input. For stereo operation 75 microsecond pre-emphasis is applied to the L+R signal in the stereo generator, while the noise reduction encoder applies its own combination of fixed and variable pre-emphasis to the L-R subchannel, and the second audio program and professional channel subcarriers are not preemphasized for modulation of the aural carrier.

For BTSC operation, the stereo pilot and the SAP subcarrier must be locked to horizontal sync of the transmitted video. This requires stereo and SAP generators to be provided with a sample of transmitted composite video or sync.

The MCS composite exciter input should be terminated in 75 ohms and fed from a 75 ohm source, per the E.I.A. recommended practice. This will protect the integrity of the composite signal even when long cables are used between composite source and exciter, a situation that will be commonly encountered in television transmitting facilities. For such long cable runs, a balanced composite source and balanced exciter MCS input are recommended to obviate the possibility of a ground loop in this connection. These balanced stages may be realized most easily using active differential stages although transformers may be used, providing they are of very high quality and capable of passing the entire 50 Hz - 106 kHz composite signal with acceptable frequency response, distortion, and group delay characteristics.

Leaving the exciter and moving on to the aural transmitter power amplification stages we find that the demands placed on this part of the system are also much more stringent for MCS than for monophonic operation. The power stages must pass an R.F. signal of far wider bandwidth than monophonic transmission requires. Attention must be paid to the bandpass characteristics of all inter-stage coupling areas. A particular point to look at is the input stage to the aural power amplifier which may operate at a high 'Q' in order to assure adequate drive for the P.A. tube, resulting in a narrow bandpass characteristic.

If the aural signal bandpass is limited to less than is required to pass the full MCS signal the result will be excessive phase shifts and group delays as the distance from the carrier is increased, and amplitude modulation of the aural carrier. Additionally and just as important, the bandpass characteristics of the transmission system must be as symmetrical on each side of the carrier as possible. If the bandpass characteristics of the upper and lower sidebands differ, it will result in different phase shifts and group delays for the upper and lower sidebands. The ultimate result of the above problems will be degraded separation and increased crosstalk between subcarriers. This problem worsens as distance from the carrier increases, and the biggest victims will be the professional channel and SAP, which will suffer crosstalk from the main (L+R) and stereo (L-R) subchannel. To sum up, amplitude and phase response of the entire system, both at audio and radio frequencies, must be as flat as possible to avoid degradation of any of the MCS signals. These characteristics of a transmission system may be determined for stereo operation by performing this simple test. A stereo generator, either a standard FM stereo generator or a BTSC stereo generator capable of being put into a test mode described below, is required. Connect the stereo generator to the exciter input, and connect an FM deviation meter such as a Boonton 82 AD or HP 8901B, to an R.F. sample port beyond the diplexer. A tone is fed into one channel of the stereo generator (pilot is off). A DC coupled oscilloscope connected to the stereo generator's output should display the waveform shown in figure 2. If the baseline is not flat, the generator must be adjusted before proceeding. Connect the oscilloscope to the output of the deviation meter's wideband detector. The oscilloscope display will reveal amplitude and phase errors introduced by the transmission system. Figure 3 illustrates faults that might be encountered. If a BTSC stereo generator is used for this test, these conditions must be met:

1. Noise reduction encoder must be bypassed,
2. Ratio of L-R to L+R must be reduced from 2:1 to 1:1.

Some BTSC generators have test modes which meet the above conditions. The BTSC stereo generator normally operates with noise reduction encoding which alters the L-R to L+R ratio depending on frequency and amplitude content of the incoming audio. After noise reduction encoding, the L-R component is doubled for transmission. For optimum stereo performance, gain and phase relationships between L-R and L+R must be held to a tight tolerance. A gain error of only one dB assures separation cannot exceed 25 dB, and a ten degree phase error assures separation cannot exceed 21dB. Combinations of gain and phase errors will quickly destroy stereo separation. A good indication of the separation that may be expected at any frequency (excluding noise reduction encoder effects) may be obtained by using the above described test. Figure 4 shows the process of calculating separation based on the oscilloscope trace.

Multichannel sound operation requires much more critical aural P.A. tuning than monophonic operation. With the transmitter modulated, the P.A. should be tuned for minimum synchronous AM noise using a precision AM detector such as the Boonton 82 AD or HP8901B. Synchronous AM noise is incidental amplitude modulation of the FM carrier by the signal that is frequency-modulating this carrier. It is generated by bandpass restriction in the R.F. path, which causes the outer sidebands to be attenuated resulting in the variation of R.F. power output with varying depth of modulation (i.e. amplitude modulation). Tuning for

minimum synchronous amplitude modulation should assure that the transmitter is tuned on carrier, and that the best possible frequency response, phase response, and group delay characteristics, as well as bandpass symmetry, are realized.

Last but not by any means least, a good signal to noise ratio must be achieved to assure good MCS operation. The signal-to-noise ratio from exciter input to a detector connected to an R.F. sample past the diplexer (measured with visual carrier off) should be at least 60 dB below 25 kHz deviation, when the detector output is subjected to 75 microsecond de-emphasis, and passed through a 15 kHz low pass filter. Attention should be paid to extraneous noises on the baseband such as those caused by reference frequency synthesis, or very low frequency products caused by AFC control. These can cause troublesome inter-modulation products on the baseband, and noises in the audible range will be much more readily heard on most stereo television receivers than on mono sets, owing to the generally much better audio fidelity characteristics of the stereo sets.

### Visual Transmitter

Multichannel television sound quality is also affected by the characteristics of the transmitted visual signal in two important ways. The visual components of the television signal can contaminate the aural signal both in the transmitter, and in the receiver.

There is an acronym that has achieved new prominence since multichannel television sound came on the scene: ICPM. The letters stand for incidental carrier phase modulation, which is incidental angle modulation of the amplitude modulated visual carrier by the visual modulating signal. Virtually all television receivers in use today employ some form of intercarrier sound detection, which beats the aural carrier against the visual carrier, resulting in an aural intermediate frequency of 4.5 megahertz. An undesirable by-product of this detection scheme is that the phase modulation of the visual carrier (the reference signal for aural detection) is translated into frequency modulation of the aural carrier. The audible effect of ICPM is a nasty buzz, the preponderance of which shows up in the L-R subchannel, resulting for the stereo listener in a buzzing sound which varies in intensity with the picture content, and becomes most severe when the picture contains a lot of white information or titling on the screen. For the SAP listener the buzz becomes "buzz beat"—the result of buzz beating with an FM carrier. Experiments indicate that ICPM from blanking level to white level is more audible than from blanking level to sync level. In any case, ICPM correction must be applied in the visual exciter. New VHF transmitters incorporate ICPM correction, although many older ones do not. For good stereo and SAP operation, ICPM must be corrected to 2° or less.

Another factor creating buzz in stereo operation is overmodulation of the visual carrier. Video white level should be restricted so that the carrier is never reduced below 12.5% above zero. The audible effect

is particularly bad when the visual carrier is completely cut-off, because the intercarrier receiver has no reference signal to produce the 4.5 MHz aural I.F. Thus, a properly set-up white clipper is mandatory for good MCS operation.

The other important visual signal contamination of MCS audio is spectral spillover of chrominance subcarrier components into the aural passband. In both figure 1 and figure 6, chrominance components can be seen to completely obscure portions of the lower aural sidebands. A chroma clipper may be employed, but the effect of clipping excessive chroma should also be considered - for instance, this can result in color titling being trailed across the screen by ghosts. To properly equip a visual transmitter for MCS operation a visual bandpass filter should be installed. The most likely place for this filter is immediately after the visual exciter. This should be a filter with proper characteristics to cut off visual energy at 4.2 MHz above the visual carrier without adversely affecting chroma components within the visual passband. For transmission systems employing a notch diplexer the aural notches will provide about 30dB of visual filtering at the aural carrier, decreasing to about 15-20 dB at the edges of the MCS passband. For those systems employing hybrid diplexers, or separate aural and visual antennas, principal reliance for visual spectrum control is vested in the filter installed after the visual exciter.

### Diplexer

A hybrid diplexer is an inherently wideband device, and will not itself present any bandwidth problems to the aural MCS signal (although as we have seen the visual filtering requirement is greater). Systems employing separate aural and visual antennas have no diplexer. But for the many systems which employ notch diplexers (figure 6), yet another bandwidth restricting impediment exists for the aural MCS signal. The aural notches reflect the aural signal and send it up the transmission line, and also function as filters which prevent some of the visual carrier components which spill into the aural passband from reaching the antenna. The aural notches in use today are not wide enough to pass the complete MCS signal unattenuated. This results in some roll-off in frequency response as we get farther away from carrier. This frequency response rolloff is of great consequence for the L-R and L+R portions of the signal inasmuch as small amplitude or phase errors between L-R and L+R result in a rapid loss of separation. Amplitude errors are less critical for the SAP and professional channel portions of the signal, as these are FM carriers, but bandpass restrictions are accompanied by damaging phase errors and varying group delays. This will produce crosstalk among subcarriers and thereby degrade performance. In addition, unless bandpass is symmetrical on either side of the carrier, group delays and frequency responses of upper and lower sidebands will differ, with resultant intermodulation between subcarriers. There are two proposed solutions to the notch diplexer problem. One proposal is to replace the single-notch type of diplexer with a diplexer containing two notches, one tuned towards the upper sidebands, the other towards the lower sidebands. The other solution is to pre-equalize the aural R.F. signal at the exciter



level to compensate for notch diplexer amplitude and phase errors.

### Review of Total Transmission System Considerations

The first step in preparation of a VHF transmitter for multichannel sound is to prepare the exciter to accept the MCS composite signal. This signal requires the exciter to provide these characteristics:

- 1) Increased deviation of the aural carrier
- 2) Wider range of modulating frequencies
- 3) No pre-emphasis internal to exciter
- 4) Very flat frequency response and phase linearity
- 5) Tighter tolerances on distortion and noise

Once the exciter meets the above criteria, there are several aspects of the total aural transmission system that need to be considered in order for the MCS signal's integrity to be preserved as it passes through the transmission system. These considerations center around possible bandwidth restrictions in the transmission path, and their concomitant amplitude, phase, and group delay errors. The possible problem areas include:

- 1) Interstage coupling between all stages in the transmitter
- 2) P.A. Tuning
- 3) Low-pass filters at any point in the transmission path
- 4) Diplexer (notch)
- 5) Any other filters or tuned circuits
- 6) The antenna

To determine if the VHF transmission system has bandpass problems that will impair MCS operation, there are three tests that may be used to analyze and optimize performance.

The first is the previously mentioned test using a stereo generator, feeding tones into one channel only, and examining the composite waveform to determine resulting L-R and L+R ratio and phase relationships. Expected stereo separation exclusive of noise reduction encoding may be calculated using this test. The previous test covers only stereo operation, and a more complete and sophisticated test of the system may be made by sweeping the entire R.F. system with a network analyzer to determine bandpass, group delay characteristics, and symmetry of these parameters on each side of the aural carrier. The third test of the aural system is to subject the entire system to one of the intermodulation tests, to determine the levels of extraneous products generated. This will give a good indication of crosstalk problems that will be encountered in MCS operation.

There are two aspects of the visual transmission system that bear on multichannel sound operation. The first of these is incidental carrier phase modulation (ICPM), which must be corrected to as low a level as

possible. The second is filtering to prevent spectral overflow from the visual signal into the aural passband.

Obviously, preparing a VHF transmitter for multichannel sound involves much more than simply hooking MCS generators up to the transmitter input. It requires a whole host of more stringent demands on the transmission system than monophonic operation does. But it opens the door to a vastly improved television aural service.

References:

EIA/BTS Multichannel Sound Committee, BTCS Television Multichannel Sound Recommended Practices.

Mendenhall, Geoffrey H., Testing Television Transmitters and Antenna Systems for Multichannel Sound Compatibility.

Main Channel (mono)

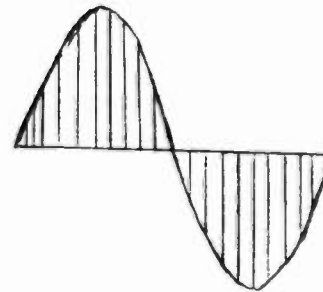
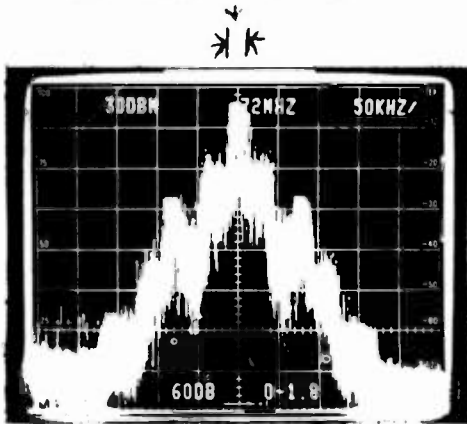


Figure 1 - Aural Carrier Modulated by all elements of BTSC system.

Figure 2 - Stereo Composite waveform --  $L-R = L+R$

Figure 3



Excessive L+R



Excessive L-R



L+R leads L-R



L-R leads L+R

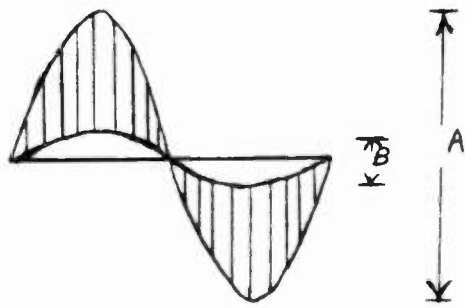
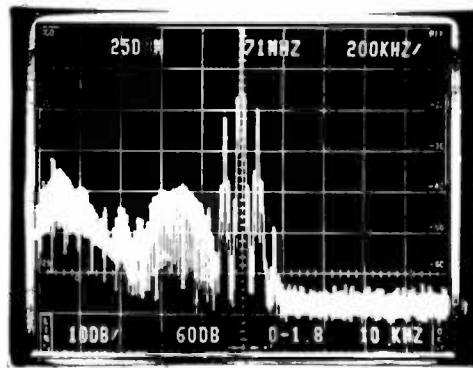


Figure 4

$$\text{Separation (dB)} = 20 \log (A/B)$$

Figure 5



Aural carrier modulated with pilot, SAP carrier and professional channel carrier, visual carrier modulated with multiburst. Note lower aural sidebands are obscured by chroma components.

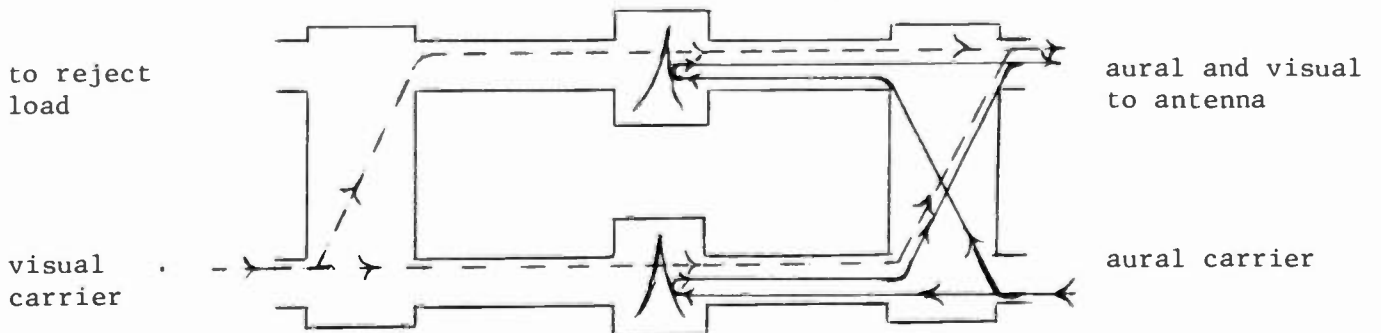


Figure 6 - Notch Diplexer - notches are shorts at aural carrier frequency.

---

WIDEBAND UHF AURAL NOTCH DIPLEXER  
FOR MULTICHANNEL TELEVISION SOUND  
MARK A. AITKEN AND RICHARD E. FIORE, SR.  
COMARK COMMUNICATIONS, INC.  
SOUTHWICK, MASSACHUSETTS

The purpose of this paper is to define a set of standards to be used by television broadcasting professionals when specifying diplexers for use in MTS (Multichannel Television Sound) Systems. Primarily it reviews the parameters which are essential for true "transparency" of the diplexer relative to the output of the transmitter system and how this is achieved.

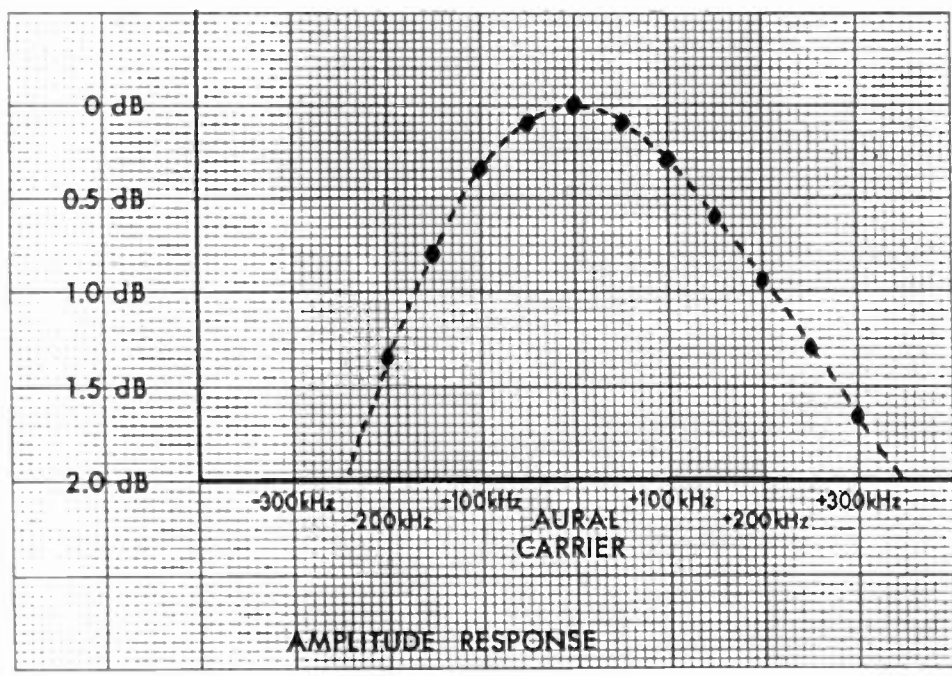
There are two parameters which must be maintained to ensure minimum Aural signal distortion. They are one, a maximally flat amplitude response and two, flat group delay characteristics. These parameters must be met without introducing major distortions to the Visual signal. (Particularly flat amplitude response to Visual Carrier + 4.18 MHz).

#### Scope of Studies and Background Information

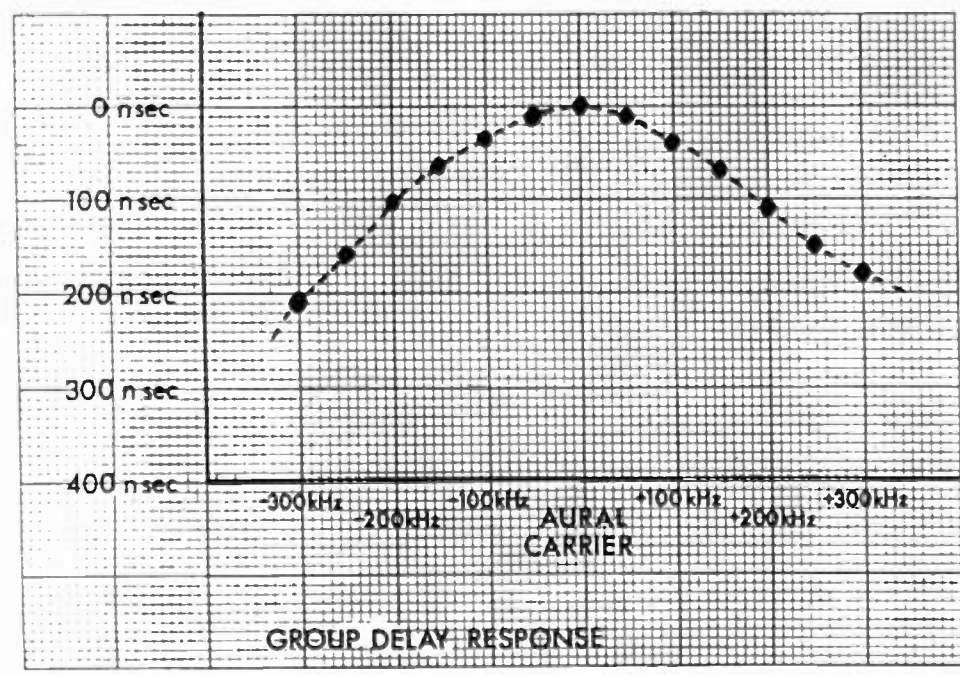
In the Spring of 1982, Mr. Eb Tingley from the EIA/BTSC committee approached Comark for information concerning the group delay characteristics of typical diplexer systems. Because his request implied that a timely response was in order, an available used Circa 1960 UHF diplexer was used for measurement purposes. Comark proceeded to take the pertinent data and after compiling the measurements, the data was forwarded to Mr. Tingley's attention in response to his urgent request. Arguably, the diplexer wasn't State of the Art, but it was the only available complete diplexer in our facility at the time. One would think all diplexers are the same, but our studies proved otherwise.

As time progressed and more and more data was accumulated, an interesting trend developed. In the quest for better Visual

response characteristics, it was determined that the Aural group delay characteristics changed as a function of its amplitude response. Put another way, as the Visual passband became more flat and the magnitude of the attenuation at the + 4.18 MHz roll-off point decreased, the Aural characteristic gradually became more narrow band, and significantly more assymetrical about the Aural Carrier frequency. Figures 1 & 2 show the amplitude and group delay characteristics of the Circa 1960 UHF diplexer which exhibited -3.0 dB roll-off @ Visual Carrier + 4.18 MHz. Note that the 1 dB bandwidth is 380 kHz and group delay ( $\tau_g$ ) is <50 ns for + 100 kHz.



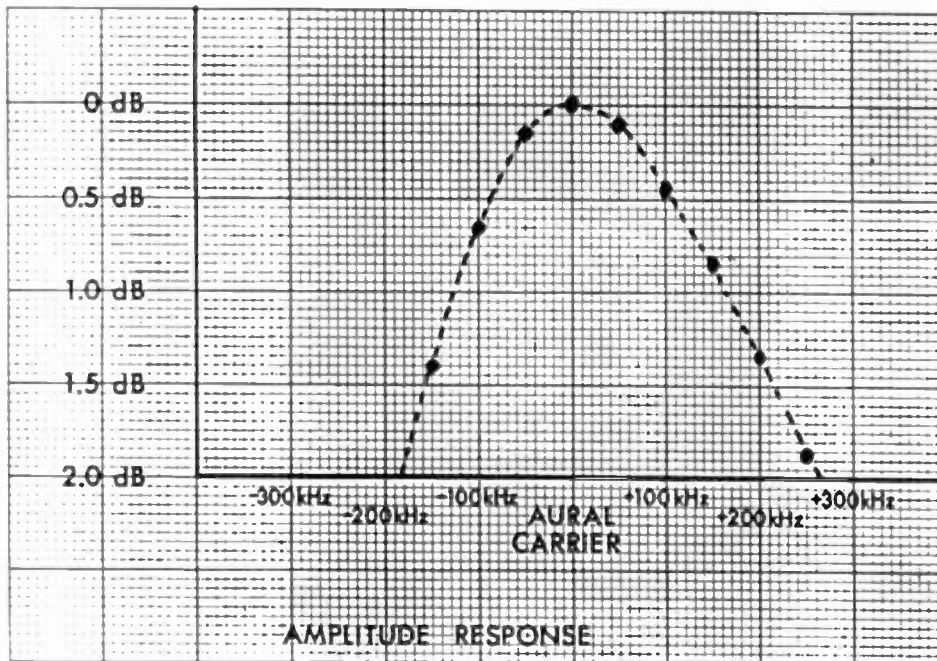
Circa 1960 Diplexer  
**FIG. 1**



Circa 1960 Diplexer  
**FIG. 2**

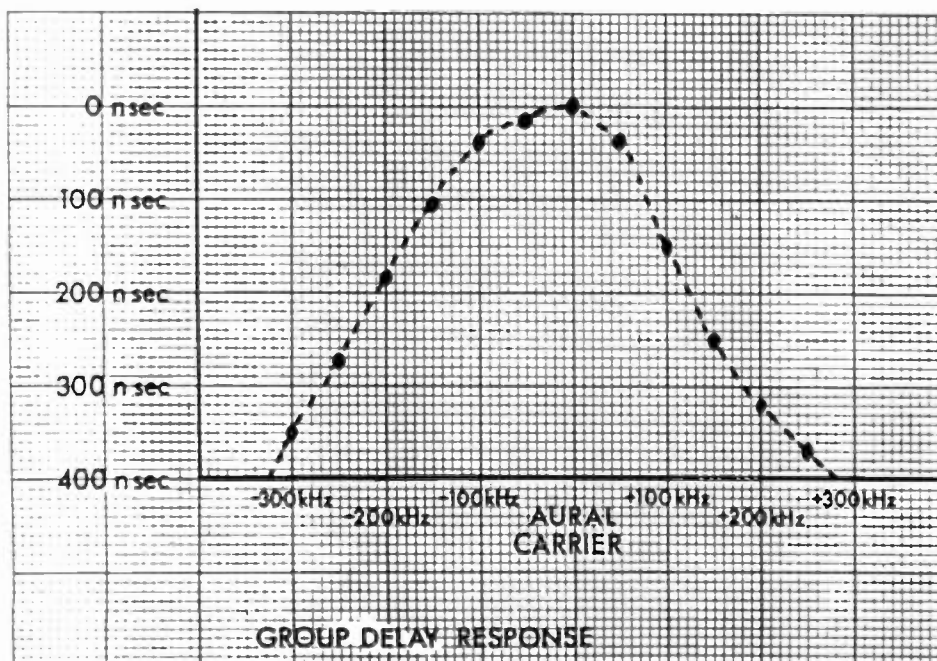
As a result of this new data, Comark began to gather detailed information on the amplitude and phase characteristics of a wide range of duplexers. From this data compiled, we were able to identify an optimum set of characteristics that could be expected from various duplexer configurations.

Figures 3 & 4 show the amplitude and group delay parameters for a typical mid-band UHF duplexer Circa 1980's, with a roll-off of 1.75 dB @ Visual Carrier + 4.18 MHz. Note that the 1 dB bandwidth is 295 kHz and the group delay ( $\tau_g$ ) is 150 ns for  $\pm 100$  kHz.



Circa 1980  
Duplexer

FIG. 3



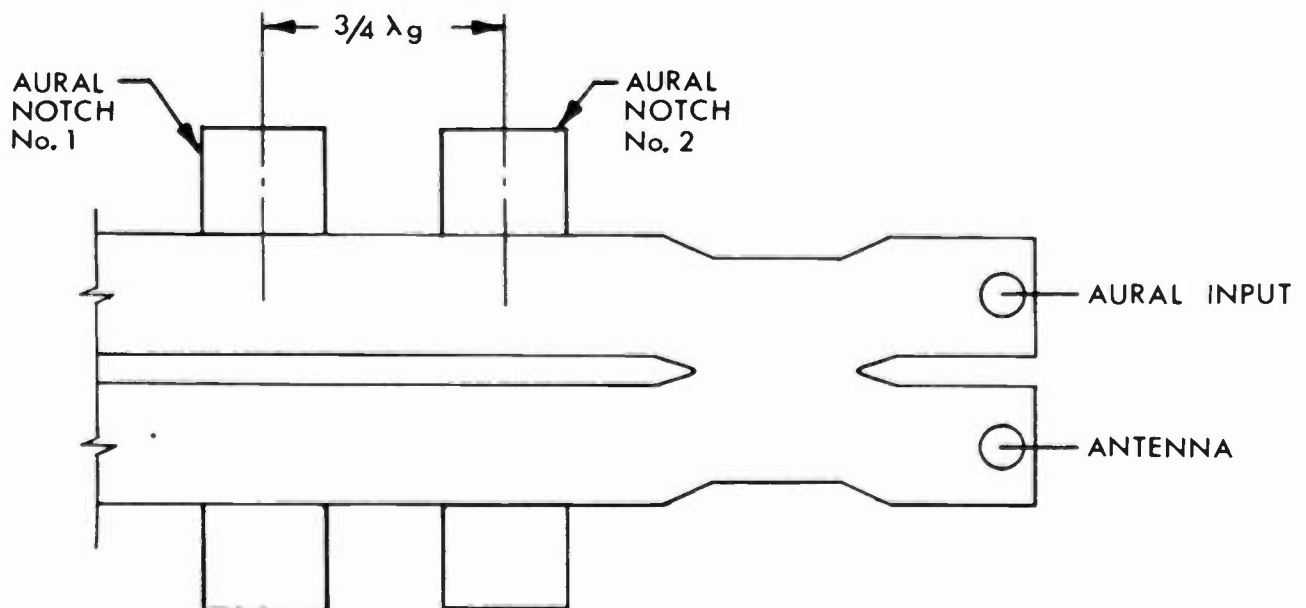
Circa 1980  
Duplexer

FIG. 4

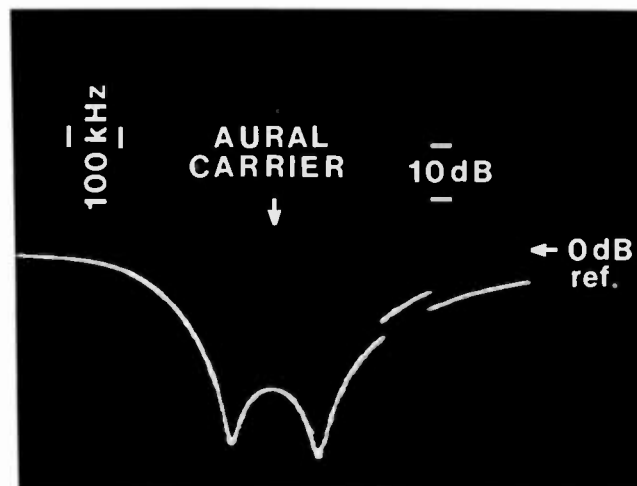
Investigations into the ways to meet the combined Visual and Aural parameters of maximum amplitude flatness with minimum group delay pointed towards the use of an optimally coupled dual notch parallel branch diplexer. If properly designed, it would provide wideband Aural amplitude and group delay characteristics as well as optimum Visual pass band roll-off at the + 4.18 MHz frequency. Another plus would be the fact that concerns over thermal instability which produce assymmetric Aural characteristics, could be greatly reduced because of the flat broadband characteristics of the dual notch diplexer. Thermal stability is important because in most cases, it directly affects optimum operational characteristics. It can be stated that even a 50 kHz shift can introduce a 0.5 dB amplitude slope and possibly an additional 50 - 75 ns in the group delay in a typical UHF diplexer.

Implementation:

In early 1984, Comark began to implement its initial design concepts into hardware form. The actual diplexer configuration derived is similar to most high power units in use today with the exception of a pair of dual Aural notch cavity assemblies. In this broadband Aural diplexer design, two optimally coupled dominant mode resonant cavities are spaced three quarters of a waveguide wavelength from one another. The three quarters of a waveguide wavelength spacing provides minimum interaction between the two cavity networks, and the coupling is designed for optimum Aural rejection. The diplexer layout is shown below.

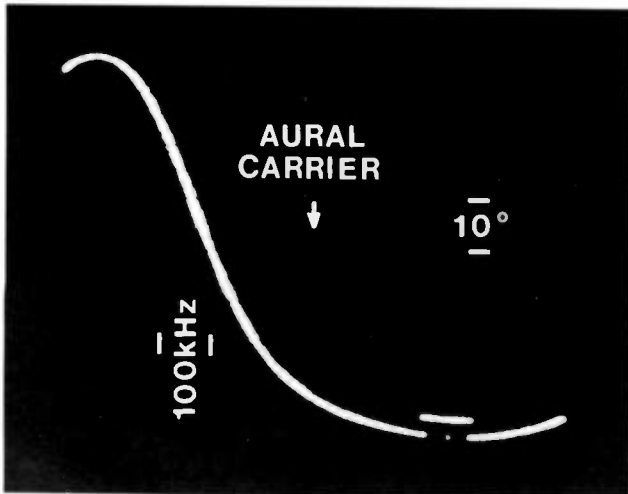


The first dual notch diplexer system put into production was for Channel 55, and was manufactured for a 60 kW, WR1150 system. Figures 5 through 11, which follow, are from this unit. In the initial set-up of this dual notch system, we were confronted with a few surprises. A 28 dB Aural carrier rejection with the cavities set-up at -90 kHz and +90 kHz relative to Aural carrier was achieved. This yielded greater than 20 dB rejection from -140 kHz thru +180 kHz (Fig. 5). With these characteristics, the Visual carrier + 4.18 roll-off was less than 2.0 dB and the Aural passband response was extremely flat with a 1 dB bandwidth of 580 kHz. More importantly, the bandwidth extended from -200 kHz to +380 kHz relative to Aural carrier. This can be seen to be a major improvement when compared to the "typical" diplexer 1 dB bandwidth extending from -130 kHz to +165 kHz relative to Aural carrier and represents an almost 100% increase in the amplitude flatness. This came as no surprise; what was surprising was that the group delay characteristics exhibited by this set-up were not at all the desired result. The group delay was 200 ns for + 100 kHz. Figure 6 shows the phase/frequency characteristics with Aural Notch 1 at -90 kHz and Aural Notch 2 at +90 kHz. There appeared to be a major role played by the actual phasing of the resonant cavities relative to the diplexer input. By changing the resonant frequency of Aural Notch 1 to +90 kHz and Aural Notch 2 to -90 kHz, the system was brought into proper alignment. Group delay was now 20 ns for + 100 kHz. Figure 7 shows the phase/frequency characteristics of the diplexer with this correct cavity alignment. Figures 8-11 show the final results for this system's basic parameters.

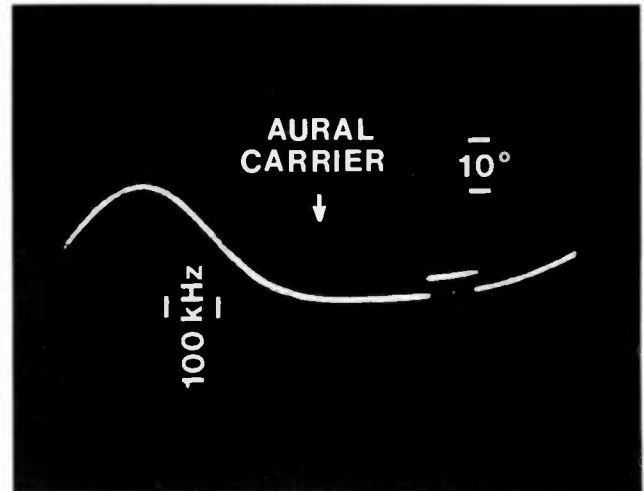


**FIG.5**  
DUAL NOTCH  
CAVITY RESPONSE

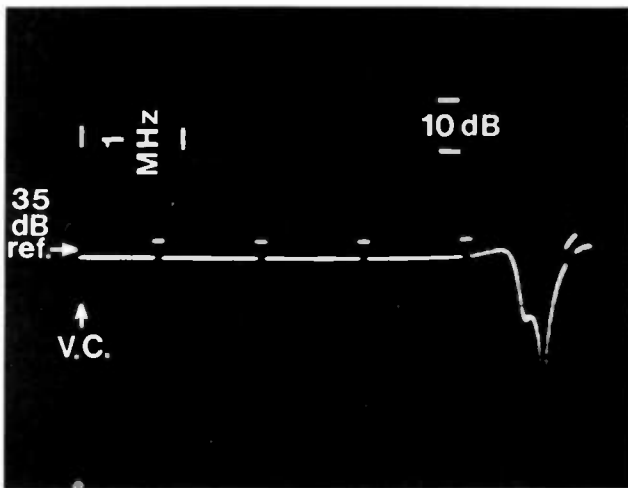




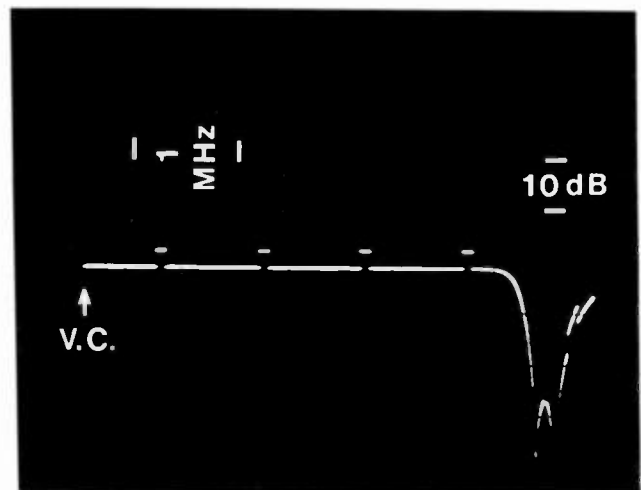
Phase/Frequency  
Unoptimized Diplexer  
**FIG.6**



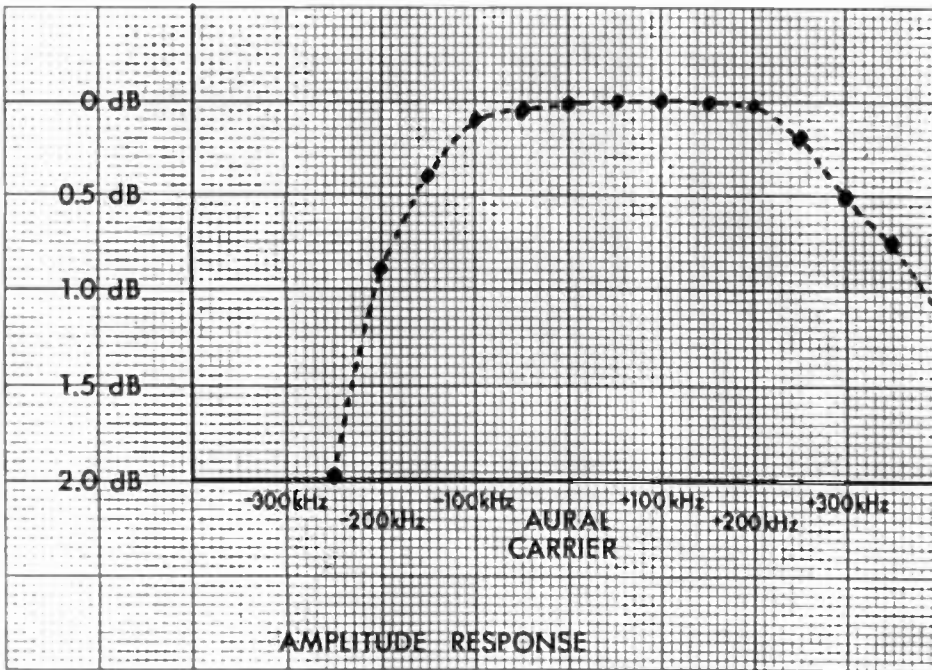
Phase/Frequency  
Optimized Diplexer  
**FIG.7**



Visual/Aural  
Isolation  
**FIG.8**

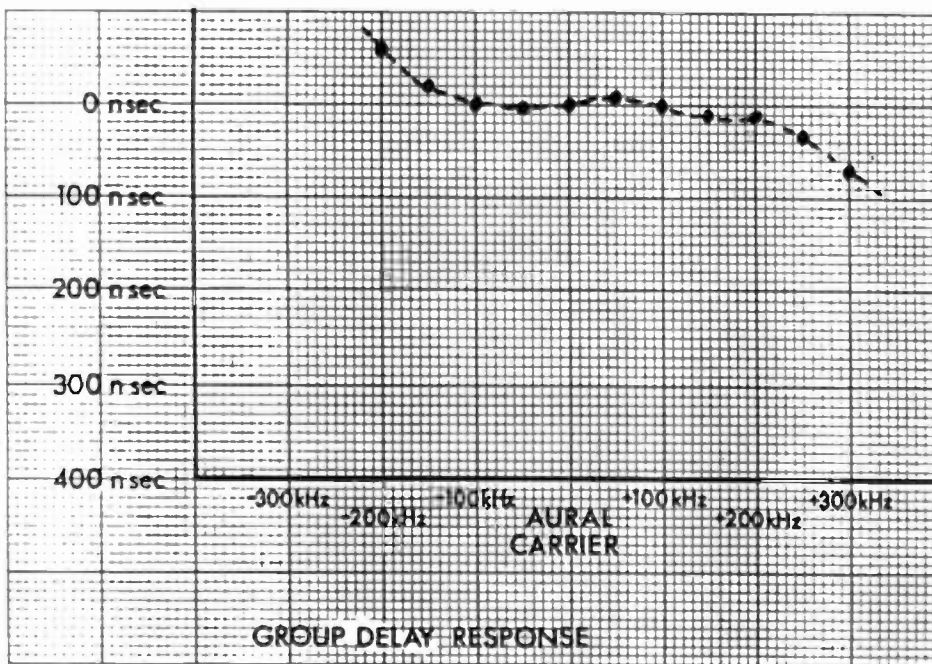


Visual/Antenna  
System Response  
**FIG.9**



Dual Notch Diplexer

FIG.10



Dual Notch Diplexer

FIG.11

Conclusions:

Since the manufacture and testing of the initial unit, several other units have been fabricated, tested and delivered. The test results obtained have substantiated our initial findings. All of the production units have exceeded current manufacturing specifications, and Comark is in the process of establishing new test specifications. The following specifications can be expected in the UHF range.

Aural Carrier Insertion Loss	.35 dB
Aural Carrier $\pm$ 150 kHz Flatness	.25 dB
Aural Group Delay ( $\tau_g$ ) $\pm$ 150 kHz	25 ns
Aural/Visual Isolation	35 dB @ Visual Carrier
	45 dB @ Aural Carrier $\pm$ 150 kHz
Roll-off @ Visual Carrier + 4.18 MHz	1.5 dB

From the results just stated, Comark feels that the Dual Notch diplexer is a requirement for optimum results to be obtained with the BTSC System in the UHF frequency range. It has been suggested that present diplexer systems are "adequate" for broadcasters wishing to transmit television stereophonic sound. It is Comark's contention that "adequate" isn't good enough to receive the full benefits associated with improving television audio quality and in realizing the full potential of the BTSC System. It should be clear, from the data already presented, that the Dual Notch diplexer is an essential part of any system providing SAP (Second Audio Program) and Professional channel programming, as well as Stereo.

Within the next several months, Comark will continue to work with the various suppliers of television stereo and second audio program generators in many tests to prove the overall operating results of complete transmitter systems. This series of tests will point out any problem areas associated with the complete system integration. It should also answer definitively that "adequate" is not good enough.

---

## RF PERFORMANCE OF MTS CONSTANT

### IMPEDANCE NOTCH DIPLEXERS

Micro Communications, Inc.

Manchester, NH 03108

Now that the age of stereo television transmission has finally arrived in the United States, it is necessary to give a hard look at the hardware realization of the various system components for the natural outgrowth of stereo, MTS. The component addressed in the present paper is the Constant Impedance Notch (CIN) diplexer.

MTS is Multichannel Television Sound. The basic concept of MTS is the efficient utilization of a TV channel's spectral resource and clearly follows from the ongoing attrition of one of our most valuable resources--usable electromagnetic spectrum. With continuing expansion of over-the-air communications the available spectrum has become an increasingly valuable asset to the communications industry, and inefficient utilization of spectral resources should be viewed as a negative cost factor, especially in commercial communications' operations. The area of inefficient use, which is of interest here, is the 570 kHz of essentially unused resource of the upper end of each television channel allocation. Presently, with only a few exceptions, the region of channel resource is occupied by approximately 50 kHz of useful information, the channel's monaural signal, or less than 10% of the available spectrum.

There are undoubtedly many practical and simply historical reasons for this situation. However, that is now old technology and old news. The advent of television stereo sound transmission in Europe and the East (more recently in the U.S.), and now, the imminence of American MTS is addressing this traditionally unused spectrum first for stereo broadcast and then for additional programming or communication (e.g., the Second Audio Program, SAP, and Professional, PRO, Channels). As presently proposed, MTS with full stereo, SAP, and PRO realizations will have sub carriers out to  $\pm 105$  kHz about the aural main carrier and will utilize 4.5 more spectrum than monaural systems, as illustrated in Figure 1. Of course, MTS must not have a deleterious effect on signals occupying the visual spectral allocation.

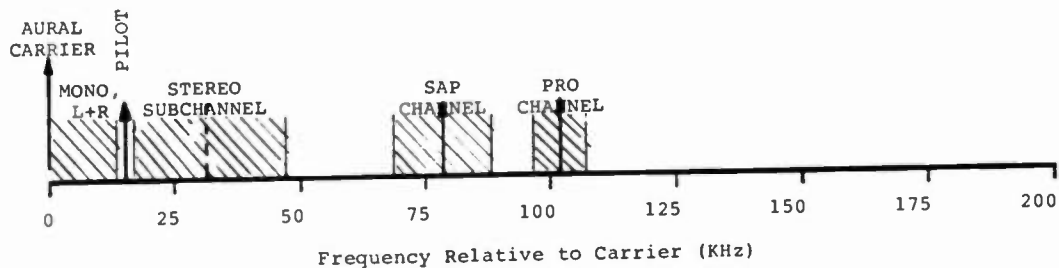


FIGURE 1. MTS SPECTRUM UTILIZATION

In a television broadcast system the visual and aural signals are amplified to high power independently and then recombined at RF, either in free space as in low VHF channels employing dual feed lines; or in a coaxial or waveguide combining device. In the former case, the combining is limited by the antenna bandwidth and, hence, is very broadband as seen from the aural or visual inputs. In the latter case, two additional subcases are found: broadband hybrid combining requiring two antenna feed lines; and narrow band combining requiring only a single antenna feed line and, hence, the smallest physical antenna for a given electrical aperture, and smallest transmission line wind load. This last combining technique is by far the most widely implemented, and the combining device is generally known as a CIN diplexer.

Figure 2 shows a schematic representation of a CIN diplexer. The representation shows a pair of hybrids separated by cavity loaded interconnecting transmission media. Three cavities are indicated on each interconnecting path or side. Each cavity can be thought of as a resonant circuit in shunt with the interconnecting paths. In the particular network of Figure 2, cavities labeled 1 are tuned such that the lower color sideband generated by the visual transmitter "sees" an extremely low impedance and is reflected back through the visual hybrid, appearing at the network dumping load where it is dissipated as heat. Cavities labeled 2 and 3 are tuned to effectively short aural signals generated by the aural band signals generated by the visual transmitter. In-band aural signals are reflected back to the hybrid and appear at the antenna port. Spurious visual emissions and out-of-band aural transmitter emissions appear at the dumping load where they are absorbed. Desired video emissions are essentially unaffected by the cavities except in the upper 180 kHz of the visual allocation and appear at the antenna port with the diplexer simply acting as an RF crossover network.

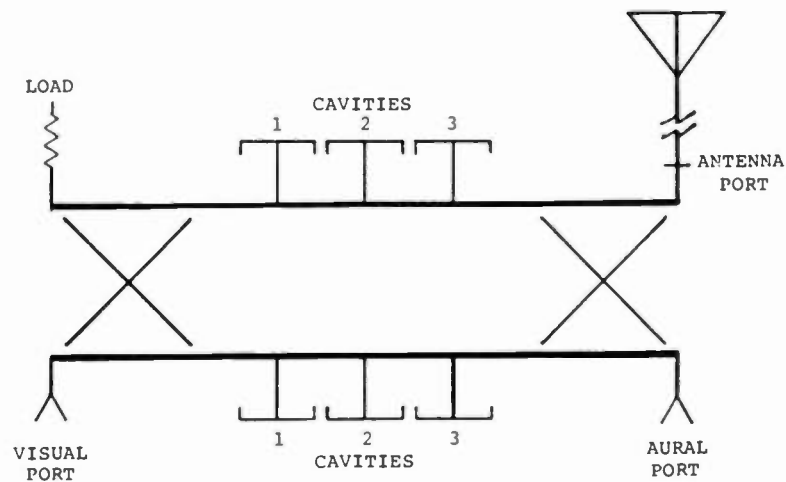


FIGURE 2. CIN DIPLEXER SCHEMATIC

### Diplexer Configurations

In current practice the CIN diplexer typically has a single cavity per side for the narrow band monaural output, and may, or may not, incorporate a lower sideband filter for the color. Such a configuration is clearly effective for monaural television sound, will undoubtedly be found to be adequate for stereo television sound, but may be inadequate for realizing full MTS capability while maintaining full video capability out to 4.18 MHz above the visual carrier. The reasons for these conclusions follow from theoretically arrived RF characteristics of diplexers employing a single aural cavity per side and from the RF performance improvements that can be realized when employing two aural cavities per side, as in Figure 2.

### Comparison of Single and Dual Cavity Diplexers

The data presented in the following discussion evaluate the performance of all-waveguide diplexers with side wall iris coupled cavities. All calculations are performed for a Channel 49 (680-686 MHz) system. This channel was selected for study for purely historical reasons. The general conclusions drawn from this data are demonstrably derivable for other channels and for coaxial realizations of CIN diplexers.

The dominant diplexer characteristics of interest here are the insertion loss from the aural input to the antenna (excluding the transmission loss between the diplexer and the antenna) and the group delay of the aural signal introduced by this path. The insertion loss is shown in Figure 3 for single and dual cavity diplexer configurations for frequencies near the aural carrier. The single cavity configuration parameters are specifically chosen to approximately yield a 400 kHz, 3 dB, aural bandwidth. The dual cavity parameters have been chosen to yield less than 3 dB visual path attenuation 4.18 above the visual carrier. The single cavity diplexer shows typical single tuned filter

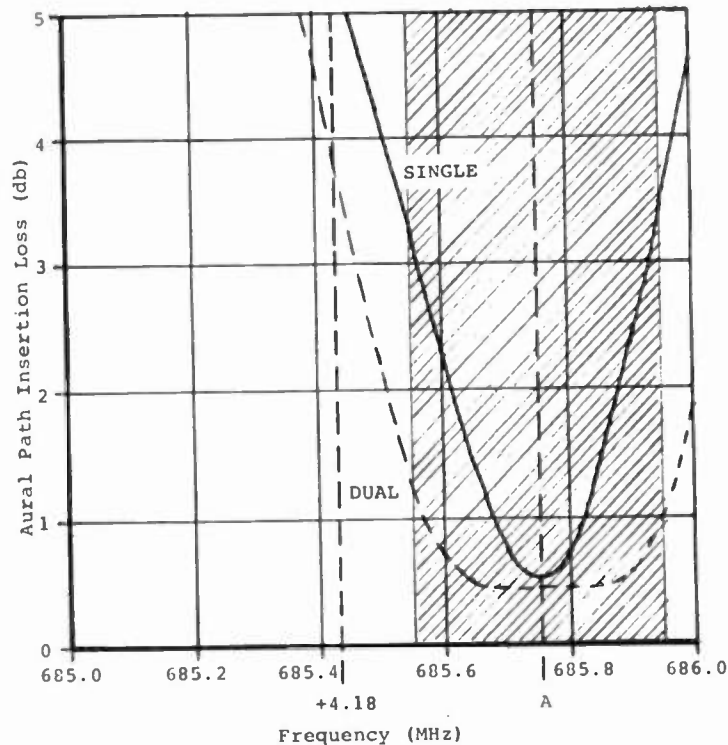


FIGURE 3. AURAL PATH INSERTION LOSS

response, particularly, steep slopes in the immediate vicinity of the carrier. For monaural and stereo sound the main and sub channels are confined to  $\pm 50$  kHz around the aural carrier, a region in which the total deviation of insertion loss is less than 0.25 dB. However, for full MTS implementation, the total deviation exceeds 1 dB out to the PRO sub carrier at 105 kHz. By contrast, the dual cavity configuration shows deviations of less than 0.05 dB out to the PRO sub carrier. This flatness of the aural path response is the primary advantage of a dual cavity diplexer over a single cavity diplexer for MTS implementation.

Figure 4 continues the comparison with the aural path group delay. Here again, the performance of the single cavity diplexer is benign out to  $\pm 50$  kHz about the carrier, though beyond this range the rapid change in group delay with frequency gives nearly twice the run-out obtained with dual cavities.

The particular significance of Figures 3 and 4 is that dual cavity configuration tuning is less critical than for single cavity diplexers. That is not to say that any less care should be taken in the manufacture or tuning of dual cavity diplexers: it is only to point out that dual cavities afford greater frequency stability. This is emphasized in Figures 5 and 6 which show insertion loss and group delay errors due to  $\pm 10$  kHz detuning around the nominal cavity operating points. Figure 5 shows insertion loss error over 400 kHz around the aural carrier. For the single cavity device this amount of detuning produces a total of 0.4 dB deviation over  $\pm 50$  kHz and 0.84 dB deviation over 400 kHz; no deviation is evident over  $\pm 100$  kHz and only 0.3 dB over 400 kHz for the dual cavity diplexer. In the worst case the dual cavity diplexer exhibits a 3:1 improvement over the single cavity diplexer. A similar improvement is noted in

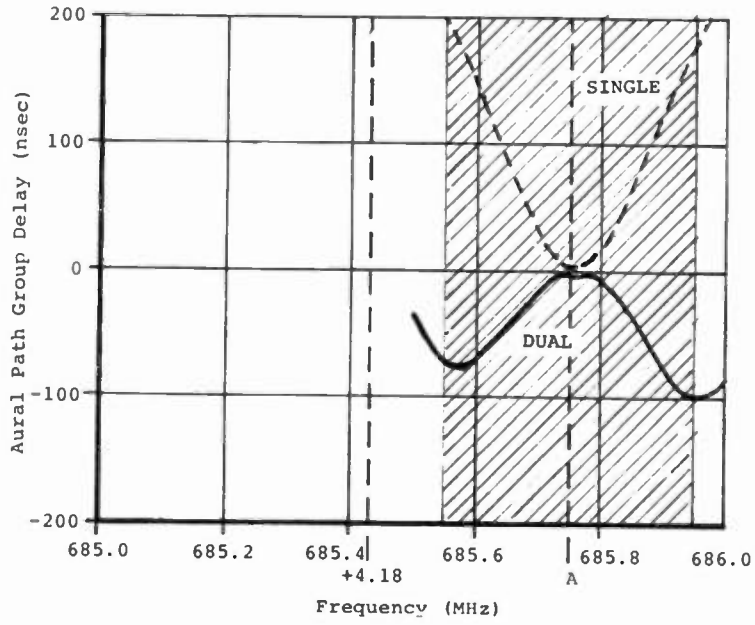


FIGURE 4. AURAL PATH GROUP DELAY

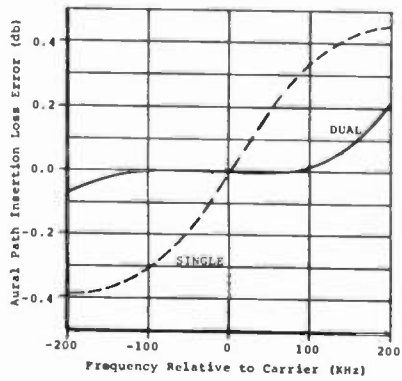


FIGURE 5. AURAL PATH INSERTION LOSS ERROR DUE TO  $\pm 10$  KHZ DETUNING

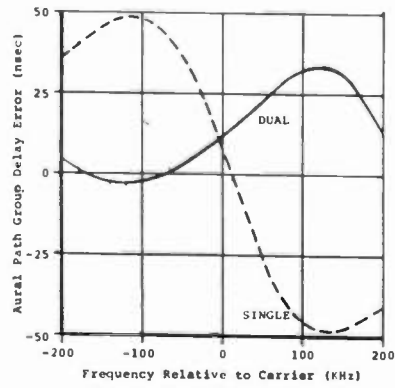


FIGURE 6. AURAL PATH GROUP DELAY ERROR DUE TO  $\pm 10$  KHZ DETUNING



comparing group errors, as in Figure 6. Over  $\pm 50$  kHz the error curve slopes are in the ratio of approximately 3:1, as is the ratio of peak-to-peak deviation over 400 kHz.

It is clear from the foregoing that aural path performance is significantly improved by use of dual aural cavities. However, it remains to be shown that the dual cavity approach does not deleteriously affect visual path performance. Figures 7 through 9 show visual path characteristics. Insertion loss is shown in Figure 7. Out to approximately 4 MHz above the carrier, there is no

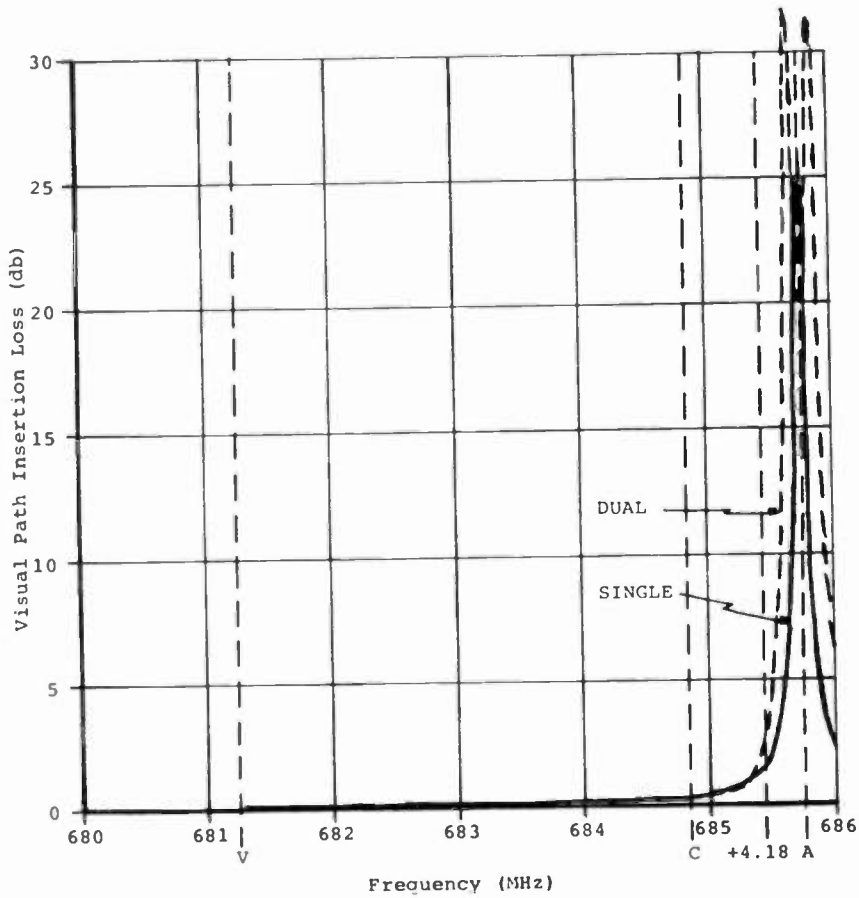


FIGURE 7. VISUAL PATH INSERTION LOSS

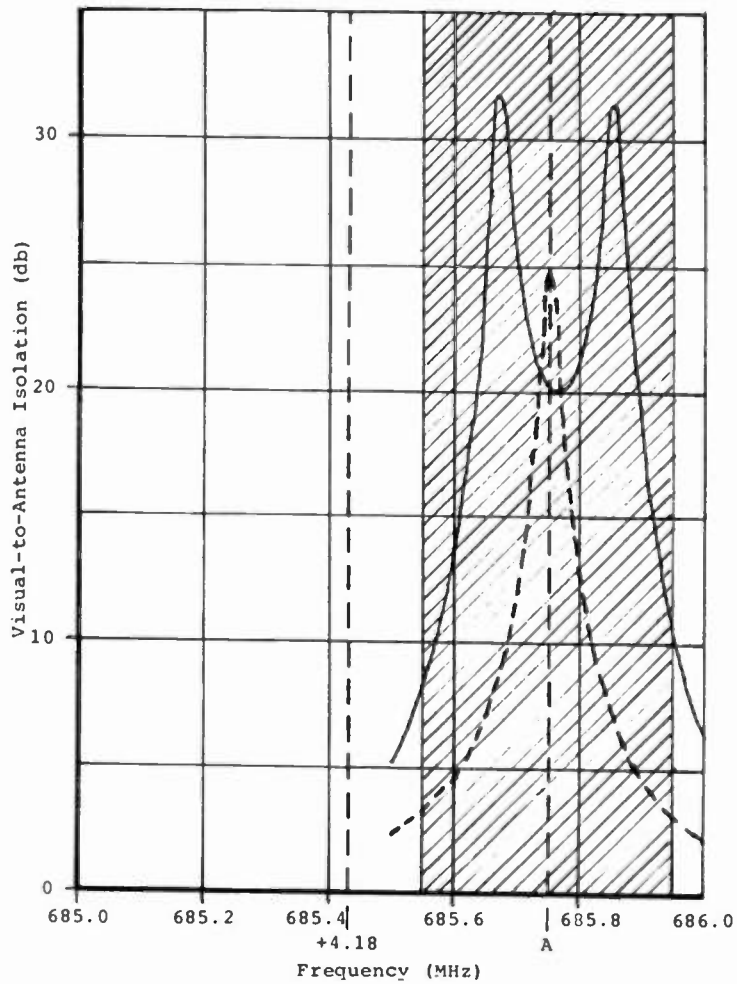


FIGURE 8. VISUAL-TO-ANTENNA ISOLATION

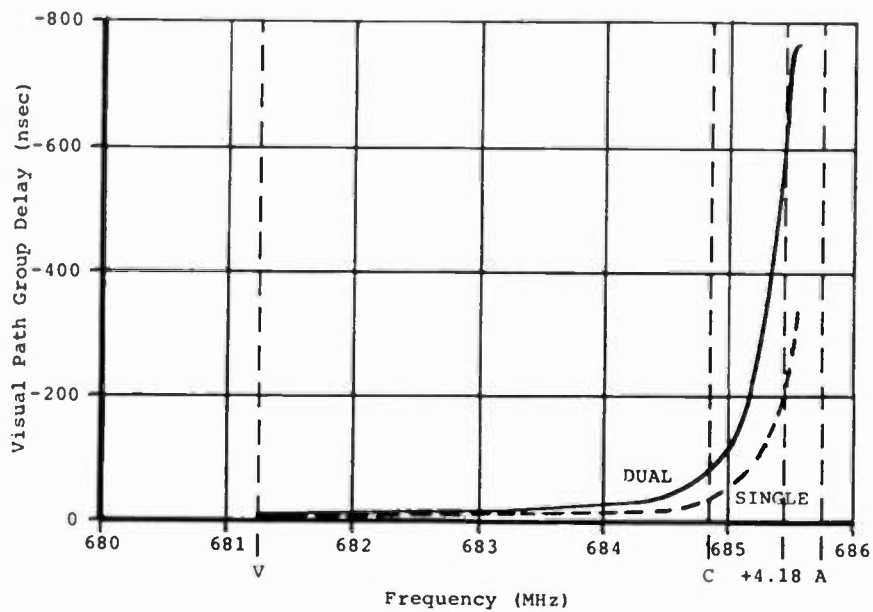


FIGURE 9. VISUAL PATH GROUP DELAY

measurable difference between the diplexers. Above this the insertion loss of the dual cavity diplexer rises more rapidly and is approximately 1 dB greater at +4.18 MHz. The isolation from the antenna is greater than 20 dB over 250 kHz for the dual cavity diplexer and over 35 kHz for the single cavity diplexer as shown in expanded scale in Figure 8. However, video spectral noise at the aural carrier is better attenuated by the single cavity device. This last is a clear area of compromise; the higher loss at +4.18 MHz is of no significance at UHF. Group delay is shown in Figure 9. Here again the rate of change is greater for the dual cavity diplexer.

In contrast to the results obtained for the aural path the more rapid variations of the dual cavity diplexer in the visual path do not necessarily result in increased sensitivity to cavity tuning. Figures 10 and 11 indicate the magnitude of errors which would occur due to  $\pm 10$  kHz detuning of the

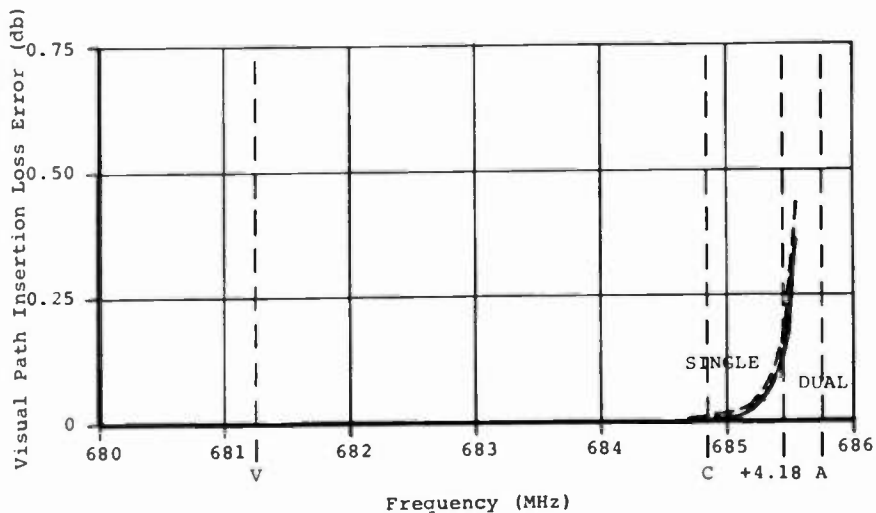


FIGURE 10. VISUAL PATH INSERTION LOSS ERROR DUE TO  $\pm 10$  KHZ DETUNING

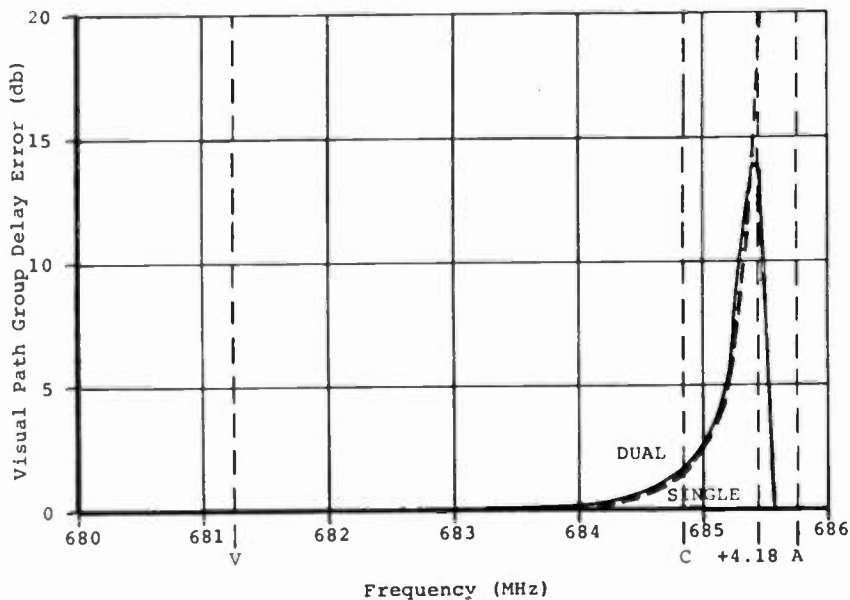


FIGURE 11. VISUAL PATH GROUP DELAY ERROR DUE TO  $\pm 10$  KHZ DETUNING

diplexers. Both figures indicate the two configurations are essentially identical in detuning sensitivity. Furthermore, errors induced by detuning are well within tolerance specifications for overall transmission system performance. This is particularly important for group delay in the vicinity of 4.18 MHz above the visual carrier. Errors in group delay on the order of the allowed tolerance of  $\pm 100$  ns at 4.18 MHz above the carrier have been recently identified as a potential cause of data smearing in Teletext transmissions. The data in Figure 11 indicate that  $\pm 10$  kHz of cavity detuning will not adversely affect Teletext.

### Conclusion

The advent of MTS has extended the broadcast spectrum through recognition of the availability of additional resource in the upper 570 kHz of channel allocation. Efficient use of this extended resource can be realized with dual cavity constant impedance notch diplexers without adversely affecting video transmission. The dual cavity configuration can provide flat aural passband response over 250 kHz resulting in reduced detuning sensitivity relative to single cavity configurations.

---

TESTING TELEVISION TRANSMISSION SYSTEMS  
FOR MULTICHANNEL SOUND COMPATIBILITY

BY:

Geoffrey N. Mendenhall, P.E.  
Vice President of Engineering  
Broadcast Electronics Inc.  
Quincy, Illinois

BACKGROUND INFORMATION  
-----

Although stereo programming is not yet widely available to most television stations, there is great interest in testing, evaluating, and preparing each station's transmission system for multichannel sound transmission. One approach to testing, is to measure the various audio parameters including; frequency response, separation, crosstalk, and distortion using a BTSC encoder with the aural exciter and a consumer type BTSC receiver/decoder for the "off-air" measurements. This approach may lead to an incorrect evaluation of the transmission system due to errors in the encoding/decoding process since precision encoders and precision modulation monitor/decoders are not yet available with guaranteed minimum performance specifications that are applicable to the entire system.

This engineering application note describes a procedure for evaluating television transmission systems using readily available standard test instruments and without relying on BTSC encoding and decoding equipment.

The primary objective is to transmit the BTSC composite waveform to the stereo decoder in the receiver at the correct level (deviation of the aural exciter) and without altering the amplitude and phase relationships of the various components within this waveform. The composite signal path from the output of the BTSC encoder to the input of the decoder in the receiver is subject to many interacting and cumulative errors so it is necessary to devise a test procedure that can identify the magnitude and type of error within each functional block in the system.

PROBLEM AREAS FOR THE COMPOSITE SIGNAL  
-----

There are three areas for signal degradation to occur:

1. The composite link to the TV aural FM modulator.  
(BTSC stereo generator, SAP generator, PRO generator, composite processor, and STL equipment)
2. The aural FM modulator.
3. The RF path to the demodulator.  
(aural exciter, IPA, PA, diplexer, and antenna system.)

Each of these three areas has its own special effect on the baseband signal and each subsystem must be individually optimized before the complete transmission system can give the best possible performance.

## THE COMPOSITE LINK

-----

The composite path from the stereo, SAP, and PRO generators to the aural FM modulator should be linear in both amplitude -vs- frequency and in phase -vs- frequency response. Simply stated, this means that no frequency component within the baseband should be attenuated more than any other frequency component. Furthermore, all frequency components should propagate thru the system at the same speed (constant group delay) and thus arrive at the modulator at the same time. Equation-1A and Equation-1B mathematically relate stereo separation to amplitude response. Equation-2A and Equation-2B mathematically relate stereo separation to phase response.

Figure-1 graphically shows the combined effect of amplitude and phase response on stereo separation between the right and left channels. Correct phasing and equal group delay of the (Fh) pilot tone is also essential to achieving stereo separation.

The final stereo performance of the complete system will be determined by the algebraic summation of the individual composite amplitude response and composite phase response of each device within the composite signal path.

The aural exciter, STL link, and any other composite device should specify these composite performance parameters so that total system performance can be easily predicted. In order to maintain a system separation capability of 40dB as suggested by Zenith, the composite amplitude response must be within +/- 0.17dB (50Hz to 47KHz) and the composite phase response must be less than +/- 1.15 degrees from linear phase (50Hz to 47KHz).

## COMPOSITE PROCESSING

In an effort to achieve maximum modulation density (loudness), some FM broadcasters use composite processing to remove the low energy overshoots in the amplitude of the composite waveform caused by complex audio input filtering. Overshoots will also occur in the peak to peak amplitude of the BTSC composite waveform, but are not considered significant to the lower modulation density (wider dynamics) desired in television broadcasting. Since overshoots have no effect on compandor tracking or any other audio performance parameter other than achieving the last dB in loudness, composite processing is not recommended for use with the BTSC system. The use of any non-linear devices, such as clippers or limiters in the composite line will alter not only the peak amplitude of the baseband, but also the frequency spectrum of the baseband. This generates several types of distortion at the receiver.

Figure 2A and Figure 2B show the waveform and spectrum of unprocessed baseband while Figure 2C and Figure 2D show the same waveform and spectrum after 1.25dB of composite clipping.

## SUMMARY OF TYPES OF DISTORTION CAUSED BY COMPOSITE PROCESSING

1. Intermodulation of all baseband frequency components causing extraneous spectral components.
2. Harmonic distortion of baseband causing degradation of crosstalk and separation.
3. Modulation of pilot injection level causing loss of lock at the synchronous detector.

STEREO SEPARATION AS A FUNCTION  
OF AMPLITUDE RESPONSE

EQ. 1A      SEPARATION (A,  $\theta$ ) =  $\left[ \frac{(\cos \theta + A)^2 + (\sin \theta)^2}{(\cos \theta - A)^2 + (\sin \theta)^2} \right]^{\frac{1}{2}}$       GENERAL  
FORM

EQ. 1B      SEPARATION (A) =  $\left[ \frac{(1+A)^2}{(1-A)^2} \right]^{\frac{1}{2}}$       IF  $\theta = 0$  (PERFECT PHASE)

WHERE:  $A = \frac{SUB}{MAIN} = \frac{L-R}{L+R}$  = AMPLITUDE RATIO

$\theta$  = PHASE ERROR IN DEGREES

STEREO SEPARATION AS A  
FUNCTION OF PHASE RESPONSE

(GROUP DELAY)

EQ. 2A      SEPARATION (A,  $\theta$ ) =  $\left[ \frac{(\cos \theta + A)^2 + (\sin \theta)^2}{(\cos \theta - A)^2 + (\sin \theta)^2} \right]^{\frac{1}{2}}$       GENERAL  
FORM

EQ. 2B      SEPARATION ( $\theta$ ) =  $\left[ \frac{(\cos \theta + 1)^2 + (\sin \theta)^2}{(\cos \theta - 1)^2 + (\sin \theta)^2} \right]^{\frac{1}{2}}$       IF A=1  
(PERFECT  
AMPLITUDE)

WHERE:  $\theta$  = PHASE ERROR IN DEGREES

$A = \frac{SUB}{MAIN} = \frac{L-R}{L+R}$  = AMPLITUDE RATIO

BTSC SEPARATION VS. COMBINED AMPLITUDE AND PHASE ERRORS IN THE COMPOSITE BASEBAND

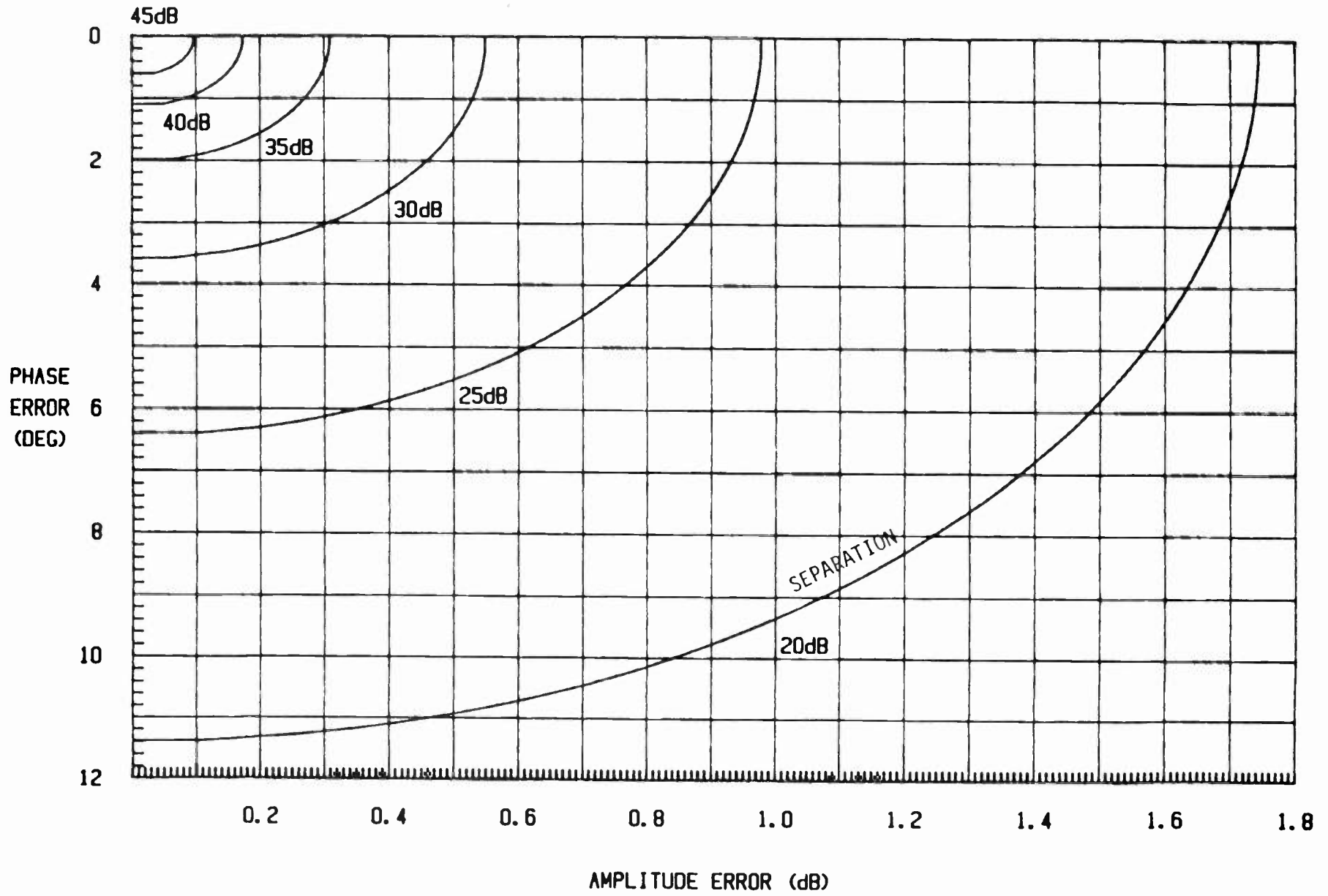


Figure-1



BASEBAND WITHOUT CLIPPING

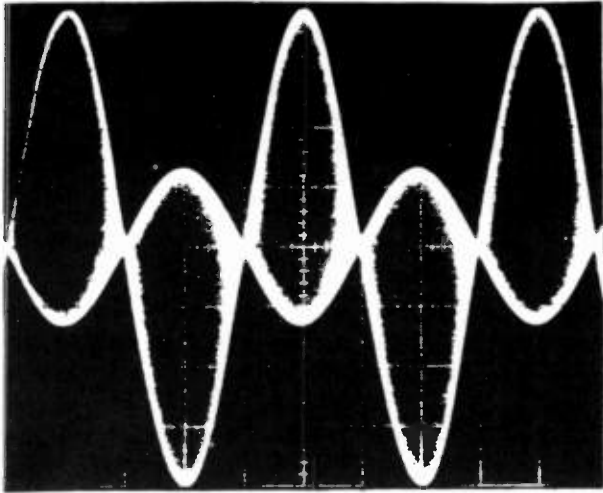


Figure-2A

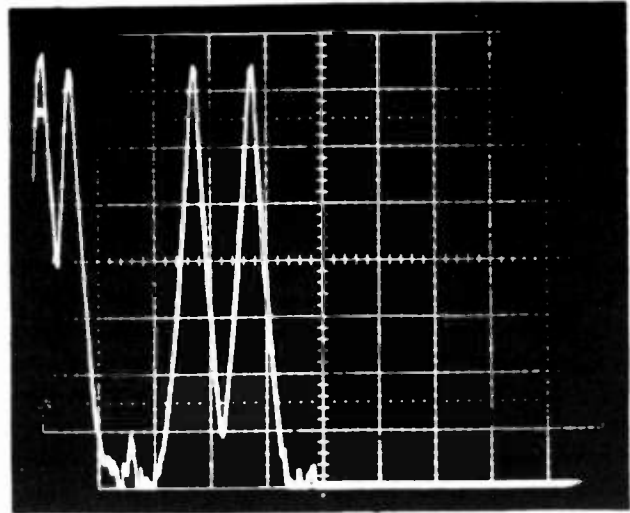


Figure-2B

(OUTPUT FROM BEI TZ-30 STEREO GENERATOR  
ONE CHANNEL ONLY MODULATED @ 5KHz)

BASEBAND AFTER 1.00dB COMPOSITE CLIPPING

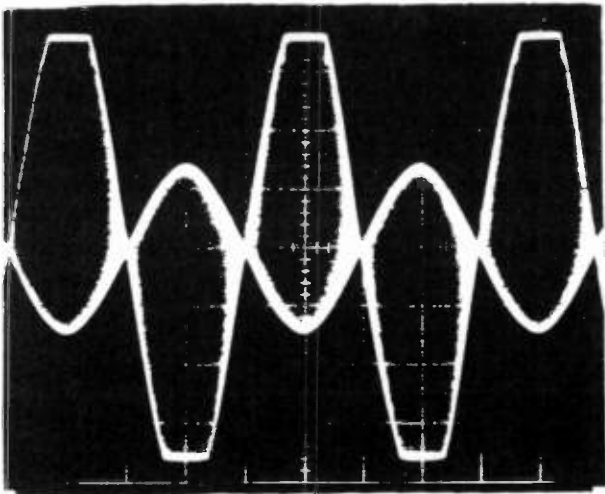


Figure-2C

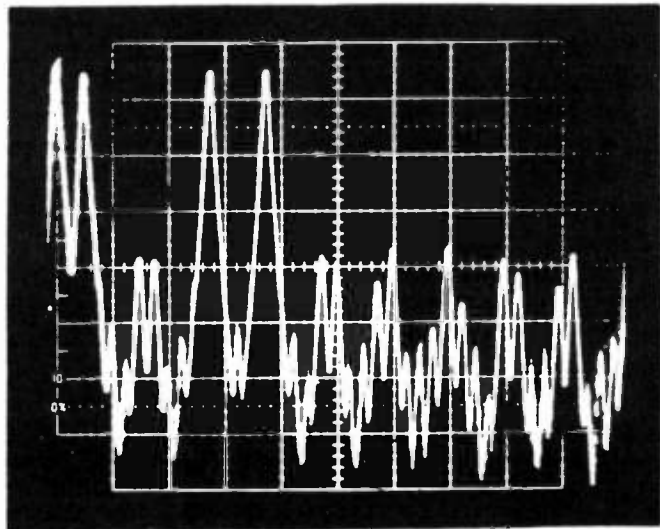


Figure-2D

(OUTPUT FROM BEI TZ-30 STEREO GENERATOR FOLLOWED BY 1.00dB  
OF COMPOSITE CLIPPING-ONE CHANNEL ONLY MODULATED @ 5KHz)

The received audio is high in intermodulation distortion and non-correlated information due to aliasing of the extraneous spectral components added by composite processing. If minimum system distortion is the goal, composite processing should not be used. Audio processing should be performed before the audio is multiplexed into baseband.

Distortion of the composite baseband signal can also be caused by transient intermodulation distortion (TIM) within the amplifier stages. Transient intermodulation distortion of the baseband signal is caused by the same mechanisms that produce TIM in audio signals. The composite amplifiers must have sufficient feedback bandwidth to accept baseband frequencies to 100kHz and should slew symmetrically to minimize slew-induced distortion. The TIM performance becomes largely a matter of operational amplifier selection and circuit configuration.

### AURAL MODULATOR LINEARITY

-----

The composite baseband signal is translated to a frequency modulated carrier frequency by the modulated oscillator. Frequency modulation is produced by applying the composite baseband signal to a voltage tunable RF oscillator. The modulated oscillator usually operates at the carrier frequency and is voltage tuned by varactor diodes, operating in a parallel LC circuit.

To have perfect modulation linearity, the RF output frequency must change in direct proportion to the composite modulating voltage applied to the varactor diodes. This requirement implies that the capacitance of the varactor diodes must change as nearly the square of the modulating voltage.

Unfortunately, the voltage versus capacitance characteristic of practical varactor diodes is not the desired square law relationship. All varactor-tuned oscillators have an inherently non-linear modulating characteristic. This non-linearity is very predictable and repeatable for a given circuit configuration, making correction by complementary predistortion of the modulating signal feasible. Suitable predistortion can be applied by using a piece-wise linear approximation to the desired complementary transfer function.

Any distortion of the baseband signal caused by the modulated oscillator will have secondary effects on stereo, SAP, and PRO crosstalk, which are quite noticeable at the receiver in spite of the rather small amounts of distortion to the baseband. For example, if the harmonic distortion to the baseband is increased from .05% to 1.0%, as much as 26dB additional crosstalk into the SAP can be expected.

### THE RF PATH

-----

#### THE AURAL TRANSMITTER SIDEBAND STRUCTURE

The frequency modulated RF output spectrum contains many sideband frequency components, theoretically an infinite number. They consist of pairs of sideband components spaced from the carrier frequency by multiples of the modulating frequency. The total transmitter RF output power remains constant with modulation, but the distribution of that power into the sidebands varies with the modulation index so that power at the carrier frequency is reduced by the amount of power added to the sidebands.

## OCCUPIED BANDWIDTH

After examining the resulting spectra, it becomes clear that the occupied bandwidth of an FM signal is far greater than the amount of deviation from the carrier that one might incorrectly assume as the bandwidth. In fact, the occupied bandwidth is infinite if all the sidebands are taken into account, so that a frequency modulation system requires the transmission of all of these sidebands for perfect demodulation of information. In practice, a signal of acceptable quality can be transmitted in the limited bandwidth assigned to the TV aural channel.

## EFFECTS OF BANDWIDTH LIMITATION

Practical considerations in the transmitter RF circuitry make it necessary to restrict the RF bandwidth. As a result, the higher order sidebands will be altered in amplitude and phase. Bandwidth limitation will cause distortion in any FM system. The amount of distortion in any practical FM system will depend on the amount of bandwidth available versus the modulation index being transmitted.

## LIMITING FACTORS WITHIN THE AURAL TRANSMITTER

Relating the specific quantitative effect of the bandwidth limitations imposed by a particular transmitter to the actual distortion of the demodulated composite baseband is a complicated problem indeed. Some of the factors involved are:

1. Total number of tuned circuits involved.
2. Amplitude and phase response of the total combination of tuned circuits in the RF path.
3. Amount of drive (saturation effects) to each amplifier stage.
4. Non-linear transfer function within each amplifier stage.

## IMPROVEMENT OF THE AURAL RF PATH

The following design techniques can help improve the transmitter's bandwidth:

1. Maximize bandwidth by using a broadband exciter and a broadband IPA stage.
2. Use a single-tube design or a broadband, completely solid-state, design where feasible.
3. Optimize both the input circuit and output circuit of the tuned stage for the best possible bandwidth.
4. Minimize the number of interactive tuned networks.
5. Use a delay equalized multiple cavity diplexer.
6. Use a broadband antenna system with a low standing wave ratio at the aural carrier frequency.

## SYSTEM TEST PROCEDURE

---

The composite amplitude and phase characteristics must be measured to a high degree of accuracy. (tenths of a decibel and tenths of a degree from phase linear)

A high accuracy audio network analyzer could be used to directly measure the composite characteristics, but most stations do not have access to this equipment.

Another simple yet effective way to evaluate the system performance is to send a multi-tone test signal consisting of a low (L+R) audio frequency and ultrasonic (L-R) frequency components of equal values through the system and display the resulting waveform on an oscilloscope whose sweep is synchronized to the low frequency audio component. The resulting waveform is shown in Figure-3.

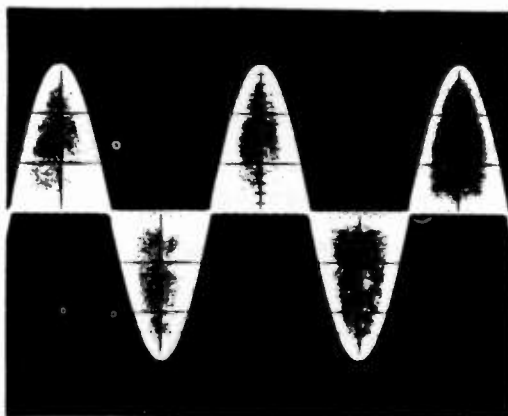


FIGURE-3

The amplitude of the (L+R) and (L-R) components should be exactly equal at each point throughout the composite system to the demodulator. The propagation time through the system should also be equal for (L+R) and (L-R) components. The key property of this test signal is that the (L+R) and (L-R) components are equal (1:1 ratio) so that any change in this ratio due to system problems can easily be observed on an oscilloscope. The composite signal output from the BTSC stereo generator does not have a fixed and equal ratio between (L+R) and (L-R) so it cannot be used for this test. Figure-4 shows what the BTSC composite baseband looks like if viewed on an oscilloscope with the peak-to-peak amplitude shown as a function of time. It is difficult to accurately measure the amplitude ratio and phase relationship of (L+R) to (L-R) since the ratios vary with the level of companding and are never equal.

The required (1:1) test signal can be obtained from a standard FM broadcast stereo generator by turning the pilot off and modulating only one channel since the (L+R) and (L-R) information is output in equal amounts under these conditions. The TZ-30 TV stereo generator has a special test mode to provide the required 1:1 ratio test signal with or without the (Fh) pilot tone.

## BTSC COMPOSITE WAVEFORM

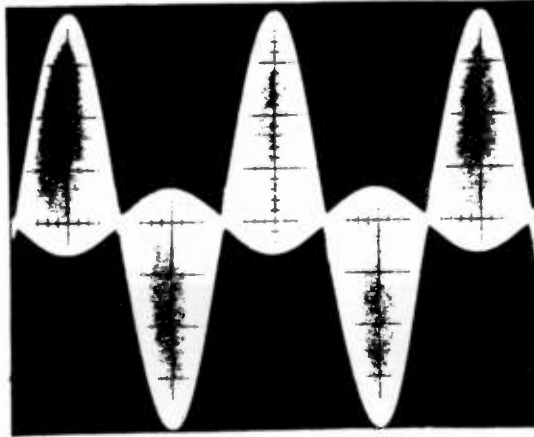


FIGURE-4

### INTERPRETING THE COMPOSITE WAVEFORM

During all of the tests the external trigger input to the oscilloscope is connected to the audio generator which feeds only one input of the stereo generator. The other audio input is shorted and the pilot is turned off. The composite output from a wideband RF demodulator such as the Boonton model 82AD or the Hewlett-Packard model 8901A modulation analyzer is fed to the wideband vertical input of the oscilloscope. The composite waveform can also be checked at other points within the system to determine the error contribution from each subsystem.

If both the amplitude and phase response are correct, the base line of the waveform will be perfectly flat even when closely examined by expanding the vertical scale on the oscilloscope as shown in Figure-5.

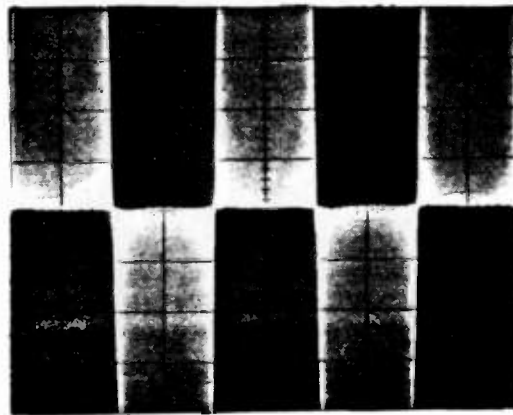


FIGURE-5

If the baseline deviates from flat in a (curved or bowed) symmetrical manner as shown in Figure-6A and Figure-6B there is an amplitude error only.

AMPLITUDE ERROR  
EXCESS L + R

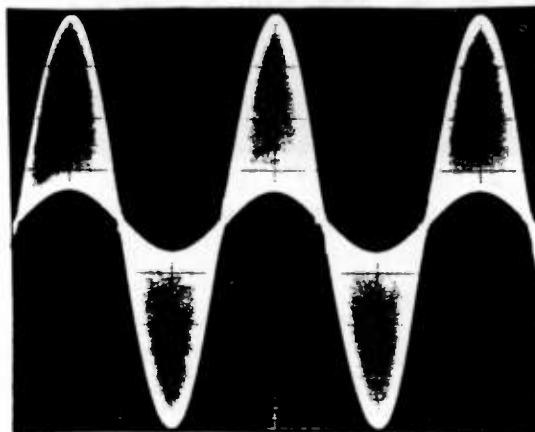


FIGURE-6A

AMPLITUDE ERROR  
EXCESS L-R

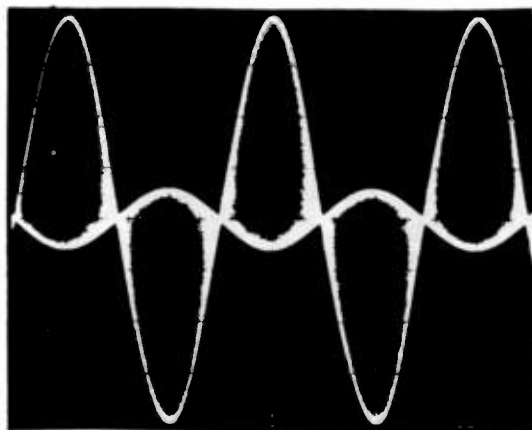


FIGURE-6B

If the baseline deviates from flat in a (straight line) tilted manner as shown in Figure-7A and Figure-7B, there is a phase (time delay) error only.

PHASE ERROR  
L + R LEADS L-R

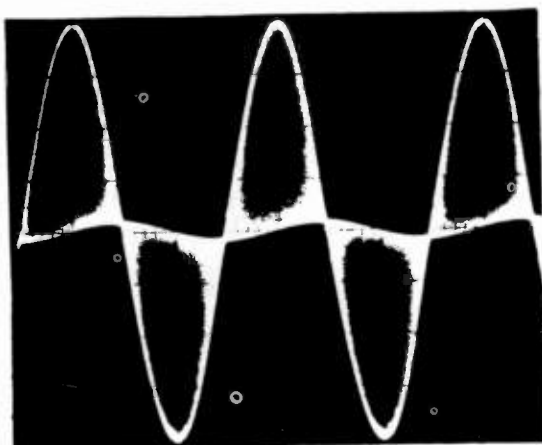


FIGURE-7A

PHASE ERROR  
L-R LEADS L + R

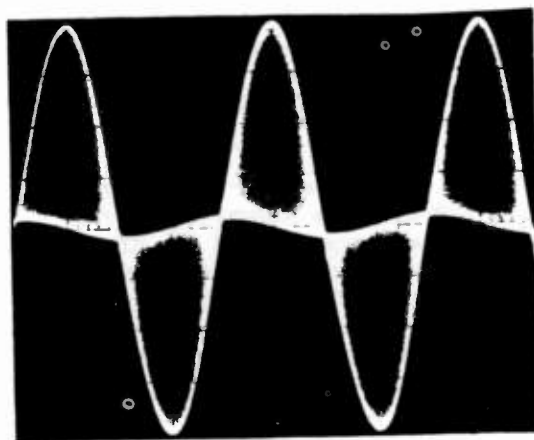


FIGURE-7B

An amplitude and delay equalizer for the composite baseband is available as part of the TZ-30 BTSC stereo generator. Equalization for amplitude and phase deficiencies in the STL or Aural exciter will improve the overall system performance. The adjustments of the equalizer are made while observing the demodulated composite baseband to minimize deviation from a flat baseline.

#### MEASURING STEREO SEPARATION DIRECTLY FROM THE COMPOSITE WAVEFORM

Figure-8 illustrates a composite waveform with a mixture of amplitude and phase errors as indicated by the asymmetrical deviation of the base line from flat. The separation can be calculated by taking twenty times the log to the base ten of the ratio of the total peak to peak value of the waveform to the peak to peak deviation from flat base line. The sample calculation in Figure-8 shows a separation of approximately 28dB.

#### ----- HOW TO ADJUST THE AURAL TRANSMITTER FOR BEST BTSC-MCS PERFORMANCE -----

All optimization should be done with the transmitter connected to the normal diplexer and antenna system. The transmitter is first tuned for normal output power and proper efficiency according to the manufacturer's instruction manual. The meter readings should closely agree with those listed on the manufacturer's final test data sheet.

A simple method for centering the transmitter passband on the carrier frequency involves adjustment for minimum synchronous AM. Synchronous AM is a measure of the amount of incidental amplitude modulation introduced onto the carrier by the presence of FM modulation. This measurement is very useful for determining the proper tuning of the aural transmitter. Since all transmitters have limited bandwidth, there will be a slight drop-off in power output as the carrier frequency is swept to either side of the center frequency. This slight change in RF output level follows the waveform of the signal being applied to the FM modulator causing AM modulation in synchronization with the FM modulation. Minimizing synchronous AM will assure that the transmitter passband is centered on the aural channel.

Care must be taken when making these measurements that the test set-up does not introduce synchronous AM and give erroneous readings which would cause the operator to mistune the transmitter to compensate for errors in the measuring equipment.

The input impedance of the envelope detector must provide a nearly perfect match so that there is a very low VSWR on the sampling line. Any significant VSWR on the sampling line will produce synchronous AM at the detector because the position of the voltage peak caused by the standing wave moves along this line with FM modulation. Unfortunately, the AM detectors supplied with some modulation monitors do not provide a good enough match to be useful for this measurement. Precision envelope detectors are available that present a good match (30dB return loss) to the sampling line.

A typical adjustment procedure is to FM modulate 100% at 400Hz and fine-adjust the transmitter's input tuning and output tuning controls for minimum 400Hz AM modulation as detected by a wideband envelope detector (diode and line probe). It is helpful to display the demodulated output from the AM detector on an oscilloscope while making this adjustment.



DIRECT MEASUREMENT OF SEPARATION FROM COMPOSITE WAVEFORM  
 (L+R AND L-R IN EQUAL RATIO WITHOUT PILOT)

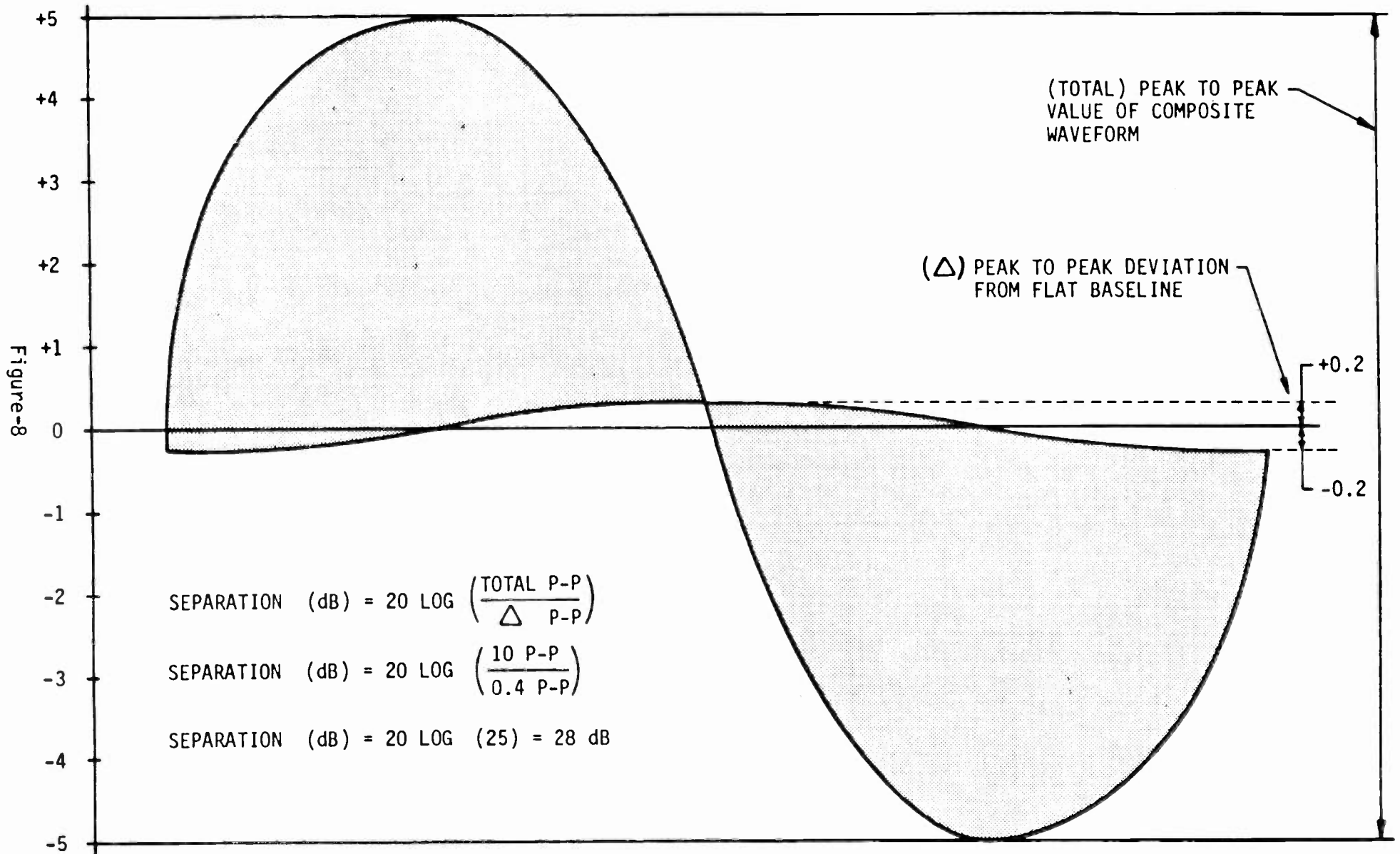


Figure-8

Note that as the minimum point of synchronous AM is reached, the demodulated output from the AM detector will double in frequency to 800Hz, because the fall-off in output power is symmetrical about the center frequency causing the amplitude variations to go through two complete cycles for every one FM sweep cycle. This effect is illustrated in Figure-9. It should be possible to minimize synchronous AM while maintaining output power and efficiency in a properly designed power amplifier.

### SYNCHRONOUS AM WAVEFORMS

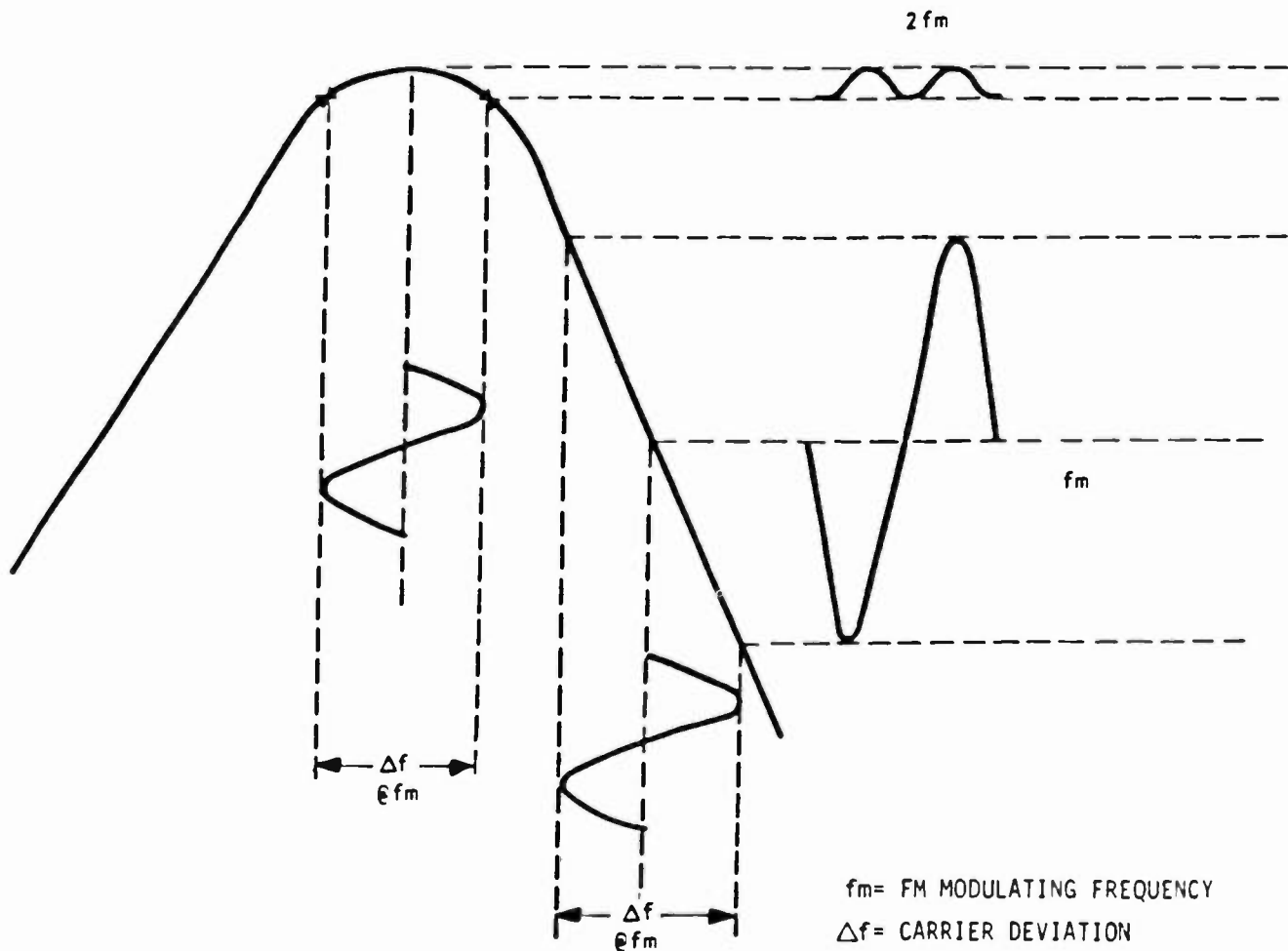


FIGURE-9

Another more sensitive test is to tune for minimum intermodulation distortion in left only or right only stereo transmissions. Stereo separation will also vary with tuning.

For stations employing a SAP, transmitter tuning becomes very critical to minimizing crosstalk into the SAP. Modulate one channel only on the stereo generator to 100% with a 7867Hz tone. This will place the upper second harmonic (L-R) stereo sideband on top of 78.67KHz SAP. Activate the SAP at normal injection level without modulation on the SAP. Tune the transmitter for minimum output from the SAP demodulator. This adjustment can also be made by listening to the residual SAP audio while normal stereo programming is being broadcast.

#### FIELD ADJUSTMENT TECHNIQUES

1. Tune for minimum synchronous AM noise.
2. Tune for minimum IMD in left or right only channel.
3. Tune for minimum crosstalk into unmodulated SAP subcarrier.

In any of these tests, the input tuning is frequently more critical than the plate tuning. This is because the impedance match into the input capacitance becomes the bandwidth limiting factor. Even though the amplitude response appears flattened when the input is heavily driven into saturation, the phase response still has a serious effect on the higher order FM sidebands.

#### TEST EQUIPMENT SET-UP

-----

Figure-10 shows a block diagram of the required test equipment set-up for making composite waveform measurements. Note that the composite baseband is checked at various points along the transmission path in order to verify the performance of each subsystem.

Observing the composite waveform while using a low modulating frequency of 50Hz will usually indicate any low frequency problems due to coupling capacitors in the system that are of insufficient size. Composite tests using a high modulating frequency of 15kHz will reveal rolloff in the high frequency response of the system which attenuates the (L-R) components more than the 15kHz component.

A precision envelope detector is also included in the test set-up so that the synchronous AM waveforms can be observed while tuning the aural transmitter.

#### ACKNOWLEDGMENTS

-----

The author wishes to thank Rick Carpenter and Bill Resch for their assistance in conducting the tests and editing this paper.

Special thanks to Kathy Klingler for typing and word processing, Jeff Houghton for the illustrations, and Kim Dopheide for word processing.

TEST SET-UP FOR COMPOSITE WAVEFORM MEASUREMENTS

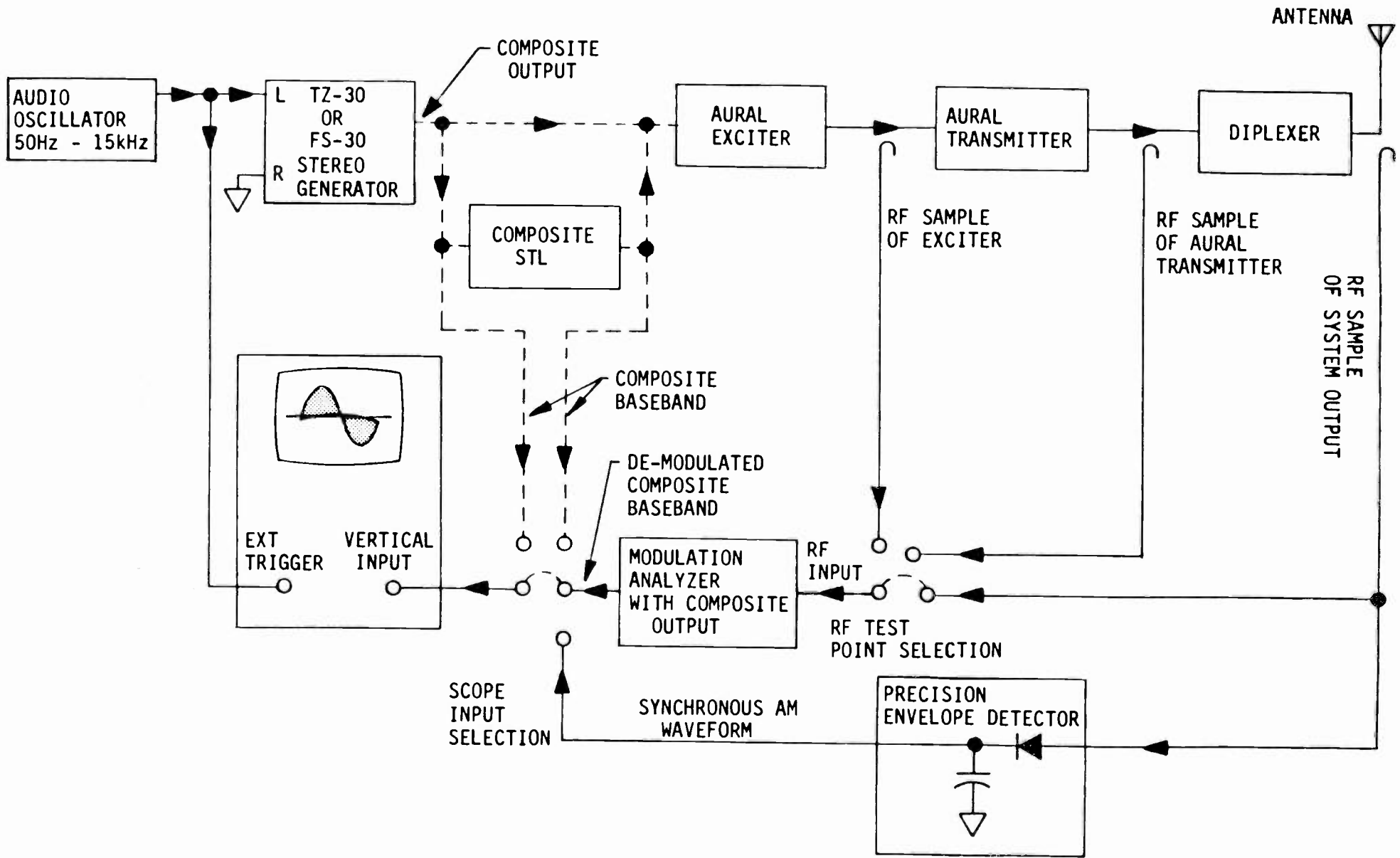


FIGURE 10

---

## COMMON PITFALLS IN COMBINING TRANSMITTER

### COOLING AND HVAC SYSTEMS

Michael V. Chiarulli, P.E.

American Broadcasting Companies, Inc.

New York, N.Y. 10023

#### ABSTRACT:

The air systems of air cooled transmitters are often combined with building HVAC systems as this can provide more efficient total heating and cooling systems. The design of three such transmitter facilities in various climates is described. The facilities include a VHF facility, a facility housing nine FM transmitter plants with a common air system, and a proposed network satellite uplink facility. Some of the problems encountered in the design of these systems are described. Suggestions and solutions are presented concerning proper transmitter exhaust-duct pressures, the sensitivity of "proof-of-air" protection systems to pressure fluctuations, operation during HALON dumps, noise control, and communicating with the HVAC designer.

#### INTRODUCTION:

Many transmitters are cooled by the forced convection of air over the power tubes and other transmitter components. This process produces an exhaust flow of hot air which must be removed from the transmitter room. This hot air has an economic value, and with a relatively small investment and some careful engineering, this resource can be used. The most obvious use for this hot exhaust air is for space heating in the winter. Due to the fact that the air is already filtered to protect the transmitter, it can be used directly for this purpose. A less obvious use for the transmitter exhaust takes advantage of its low humidity (if chilled air was used for the intake). It can be cheaper to re-cool hot exhaust air than to cool and de-humidify warm humid outdoor air. As a minimum, hot exhaust air can be ducted outside in the cooling season to lessen the air conditioning load.

Any connection to a transmitter cooling system has a potential for causing a problem with the transmitter. These problems range from causing improper cooling to automatic shutdown of the transmitter. Careful design of the HVAC

system to meet the needs of the transmitter and building, along with careful acceptance testing, can mitigate these problems.

In the following sections, three air systems are briefly described, along with the logic behind their design. Following that, is a discussion of common pitfalls to be avoided in designing similar systems.

#### AIR SYSTEM FOR VHF TRANSMITTER:

KABC-TV, the ABC owned and operated station in Los Angeles, has its transmitter plant atop Mt. Wilson. The plant consists of four Harris TVD-35H transmitters normally operated with the output of two transmitters, at 34 kW each, combined. The cooling system is sized to cool the plant when all four transmitters are on, with dummy load heat being rejected outside through a separate glycol system. Figure 1 shows a simplified concept for the KABC air system. For clarity, none of the redundant or HALON equipment is shown. The KLOS (FM) transmitter, also housed in the same building, is not shown as it has a separate air system.

During normal operation, air is drawn into the air plenum by the plenum pressurization fan. This plenum air is then forced up into the aural and visual cabinets by the appropriate blowers, which have been relocated from their standard position in the cabinets. This air cools the tubes, flushes the cabinet, and is directed into the exhaust duct. In the exhaust duct the air is joined by exhaust air from the driver cabinet and control racks, which use the chilled transmitter room and control room air as a source. The exhaust fan forces the hot exhaust to three places, as required. These are as follows:

- 1) back to the air plenum to maintain a minimum temperature during the heating season,
- 2) into the building HVAC system to provide space heat, and,
- 3) outside, if not needed elsewhere.

The building HVAC system draws air from the transmitter exhaust, a room return, and the outside as required to provide economical temperature control. A minimum amount of outside air is always used to provide a positive building pressure during normal operations. The mixture of air is forced over cooling coils and supplemental electric heaters (not shown) and distributed to the transmitter room and control room.

During a HALON dump the roof exhaust, make-up air intake, plenum pressurization intake, and emergency plenum intake are all closed by separate HALON dampers. The exhaust air is directed to the air plenum where it is re-used for transmitter cooling. This allows the transmitter to continue to operate, though a heat buildup occurs. This system is about as fully integrated as a transmitter cooling -- building HVAC combination can get. The main transmitter cooling uses ambient air because on Mt. Wilson this air can be expected to be dry and cool. The air plenum is pressurized to provide cooling for a blowers-

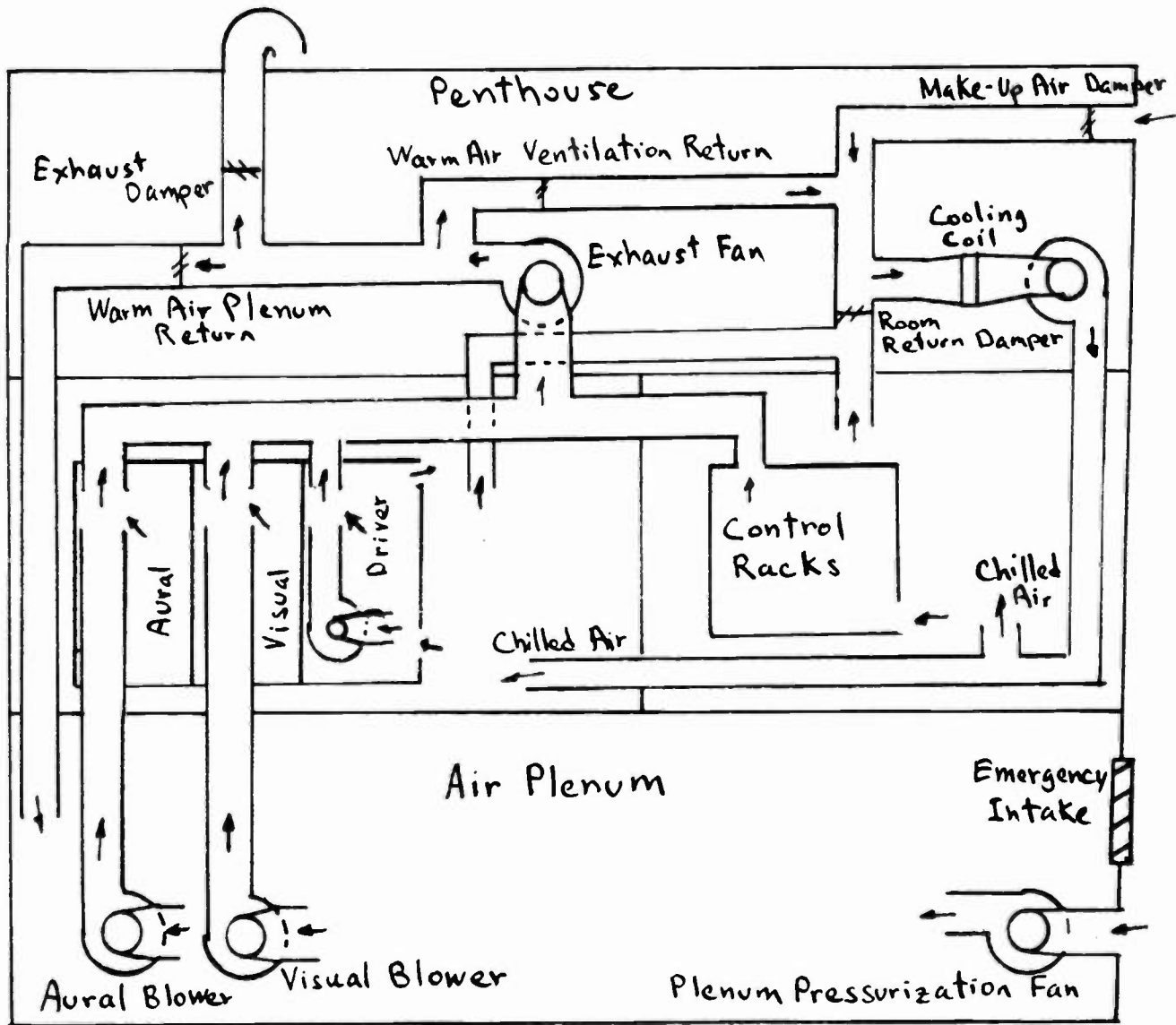


FIGURE 1

KABC-TV AIR SYSTEM CONCEPT

Mt. Wilson, Los Angeles, California

The exhaust damper and warm air plenum return damper modulate to maintain the air plenum temperature at a minimum of 60° F. The room air return damper and make-up air damper modulate to operate an economy cooling cycle for the room air. The warm air ventilation return damper supplies warm ventilation air when heating is required. The transmitter cooling uses ambient air, except for the small amount of chilled air lost to the driver cabinet and control racks. The diagram omits all redundant equipment and HALON dampers, for clarity.

off filament standby mode that is beyond the scope of this paper. Conditioned air is used to cool the driver cabinet and control racks because it was convenient to do so for these minor flows. The problems encountered in the system design are discussed later.

#### AIR SYSTEM FOR FM GROUP FACILITY:

KSRR-FM, an ABC owned and operated station in Houston, Texas, is one of nine partners sharing transmitter facilities at the Senior Road Tower Group (SRTG). The KSRR transmitters consist of two BE 30 operated at 22.5 kW and on 96.5 MHz. The cooling system is a common system serving all the stations. It is sized to serve only one transmitter for each station at a time. Running both transmitters at once leads to quick buildup in transmitter room temperature as the off-line transmitter exhaust is spilled into the room, and the dummy load heat is rejected into the room.

The SRTG air system is shown in figure 2, in concept, with redundant and HALON equipment omitted. During normal operations, conditioned air enters the KSRR transmitter room from the building HVAC system. This room air is used to cool the racks and is drawn into the transmitter blower and forced up through the power section. The exhaust air is forced into the exhaust duct where it and the exhaust from the eight other transmitters is either expelled from the building or mixed into the building ventilation intake. This intake uses a mixture of air from the outside and the hot transmitter exhaust along with a fixed amount of return air from the combiner room. The chilled air is provided to the nine transmitter rooms, the combiner room, and common areas (not shown).

HALON dumps are handled on a room-by-room basis, where a room with a dump is isolated from the HVAC system. The individual station is then free to run in a re-circulation mode or to shut down the transmitters.

In the SRTG system, all the air used for cooling has been chilled and more importantly, in Houston, de-humidified before entering the transmitter rooms. Exhaust air is re-cycled whenever it is cheaper to cool this dry hot air than to de-humidify wet outdoor air. Problems with the system will be discussed later.

#### SATELLITE UPLINK FACILITY:

An ABC network satellite earth station facility is currently being planned for New York City. Plans call for expansion capability to ten travelling wave tube transmitters and one klystron power amplifier transmitter. The cooling system will be sized to cool the maximum possible heat load. Figure 3 shows a preliminary concept for the uplink air system.

During normal operation, the control racks and transmitter racks are to be cooled by circulating room air through the cabinets. The transmitters themselves are to be cooled by room air which will be directed to an exhaust duct. Here an exhaust fan will push the hot exhaust air outside or back into the room as needed for heating. Chilled air is to be provided to the room by a system that would force a mixture of outdoor air and room air over a cooling coil.



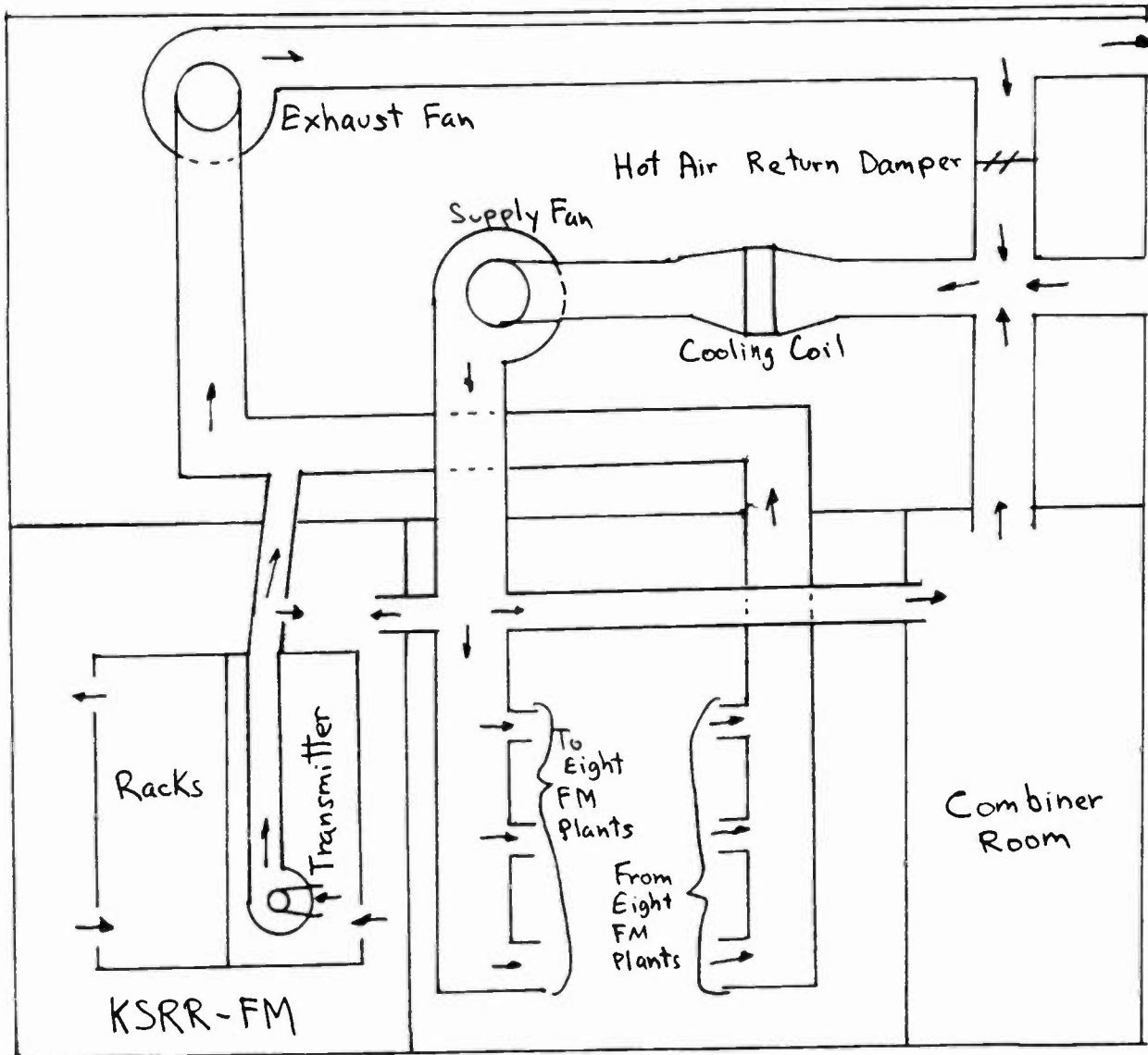


FIGURE 2

SENIOR ROAD TOWER GROUP AIR SYSTEM CONCEPT

Missouri City (Houston), Texas

The hot air return damper modulates to return hot exhaust air when economical. This is often the case, due to the high humidity of the outdoor air. All exhaust from the transmitter rooms is through the transmitters. In some cases the transmitter blower forces more air than the exhaust system draws. To prevent backpressure, some hot exhaust air is spilled into the room. All cooling uses chilled air. The diagram omits all redundant equipment and HALON dampers for clarity.

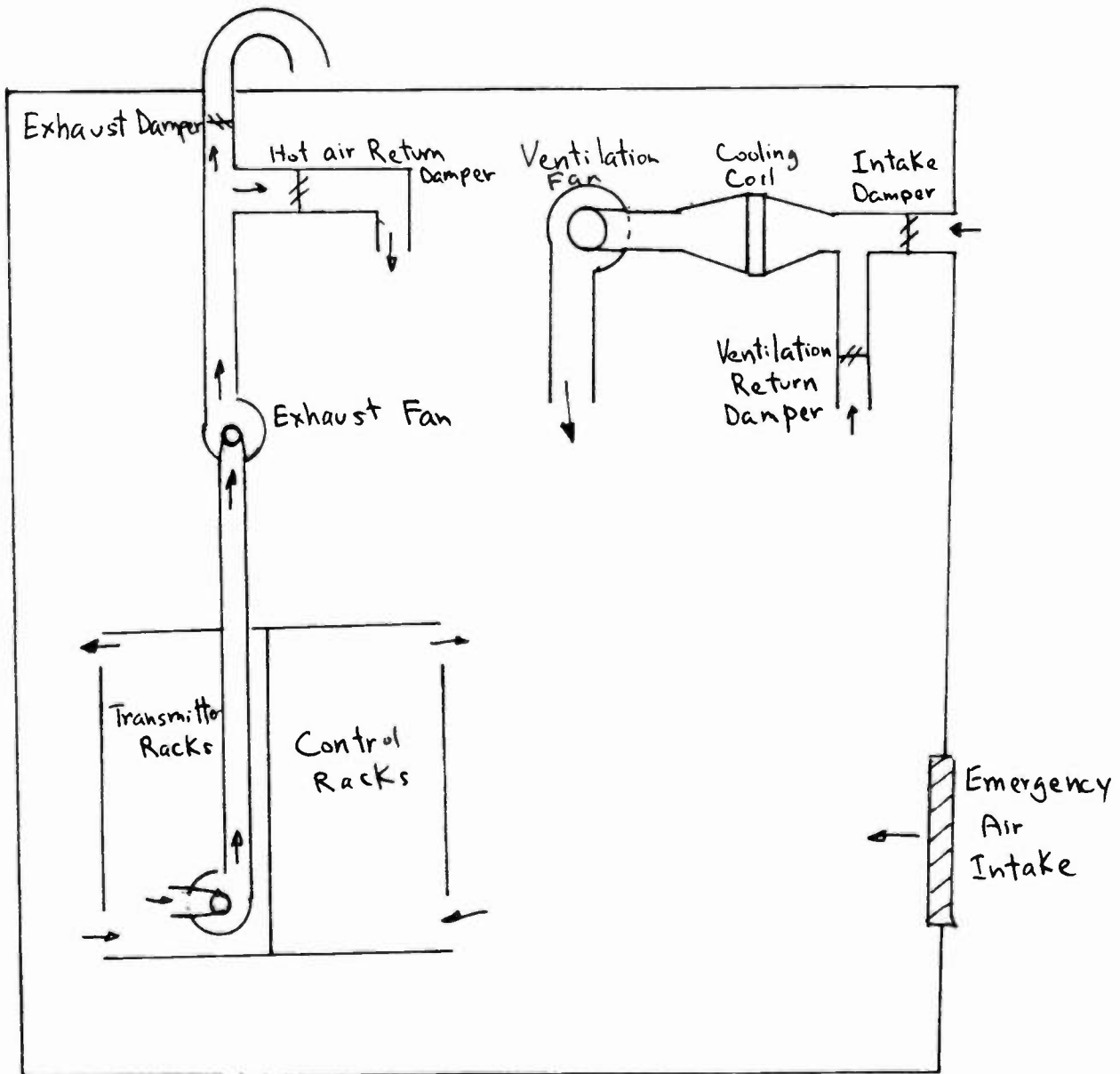


FIGURE 3

ABC SATELLITE UPLINK CENTER AIR SYSTEM CONCEPT

New York, New York

The hot air return damper and exhaust damper modulate to control room temperature during the heating season. The ventilation return damper modulate to control temperature during the cooling season, and to control room pressure. All cooling uses chilled air. The diagram omits all redundant equipment and HALON dampers, for clarity.

During a HALON dump all intakes and exhausts would close and the system would operate as a closed system. Some heat buildup would be possible, but this would be minimized by the fact that the cooling system could continue to operate.

This system is the simplest of the three described in that the exhaust system would be separate from the HVAC system. This is proposed based on the requirement for high reliability. Furthermore, as pointed out by Barlow (1), for a network facility minimum downtime is as important as mean time between failure. The proposed exhaust system would therefore have redundancies (which are not shown). In addition, since it is separate from the HVAC system it could be removed in a matter of minutes if required by simultaneous catastrophic failure of all of the exhaust system. The penalty for this separation is that careful design of the hot and cold air distribution systems will be required to provide even temperatures throughout the room.

The following sections discuss some of the problems that had to be avoided in the design of these air systems.

#### EXHAUST DUCT PRESSURE:

The back pressure imposed on the transmitter exhaust must be carefully considered. The pressure must not be too high, as this will block the exhaust flow. Less obvious, but equally important, is that the exhaust pressure should not be too low as this can lead to improper flow within the transmitter.

High back pressures were experienced at the KSRR transmitter at SRTG. Figure 2 shows a small arrow at the top of the transmitter. This represents a small amount of hot exhaust air which is spilled back into the room to relieve the high pressure in the duct. Figure 4 is a photograph of the exhaust at KSRR showing how the relief was accomplished by cutting a flap into the duct tape.

Klein (2) reports a case where an obstruction in an un-powered exhaust duct caused a high back pressure. This led to shortened tube life due to overheating. During testing of the KABC system I simulated a total exhaust system shut-down. This led not only to higher tube temperatures but also to a reversal of the cabinet flushing flow. Instead of flushing the cabinet with 75°F room air, the system was heating it with 190°F exhaust air. This was one reason that led us to modify the KABC exhaust system, so that two exhaust fans, each carrying half the load, run continuously. A third exhaust fan set to carry the full load remains in standby.

Exhaust pressures that are too low must also be avoided. This can cause an improper flow over the power tubes, where the flow takes a path that causes uneven cooling. This is referred to as "channelized flow." It is particularly insidious in that the exhaust temperature will likely drop, leading one to believe he is in good shape when, in fact, the tubes are being destroyed. Harris recommended a back pressure of 0.0 to -0.75 inches of water for the



FIGURE 4

KSRR TRANSMITTER EXHAUST

Senior Road Tower  
Group, Missouri City  
(Houston), Texas

The transmitter blower forces more air than the exhaust system draws. To maintain cooling flow some air spills through the flap cut in the duct tape.

KABC transmitters, with a limit of -1.0 inches of water. Klein (3) suggests a general level between -0.1 to -0.2 inches of water.

#### PROOF-OF-AIR PROTECTION SENSITIVITY:

During testing of the KABC system, it was discovered that pressure transients in the exhaust system induced by opening access doors would cause the transmitters to shut down. The proof-of-air circuits governed by differential air pressure switches were sensing a drop in pressure and activating protection interlocks on the assumption that the cooling blowers had stopped or been obstructed.

Pressure transient delay orifices for the pressure sensing lines were first suggested. ABC and Harris quickly realized that this was treating the symptom and not the cause, a common pitfall pointed out by Bush (4). The settings of the pressure switches was investigated. Harris discovered that the pressure settings could be lowered and still provide the required protection. Accordingly, new settings were established by Harris (5) to provide the additional leeway in this special case. Christatos (6) found that the switches in the transmitters were not set at the original specifications. Harris maintenance personnel also found that in at least one case, the pressure sensing tap in the transmitter had become misplaced, as reported by Chiarulli (7).

All the required changes and corrections were made simultaneously. Since then it is impossible to even induce a repeat occurrence. Blocking the air flow as a test assures us that the transmitters are still protected.

#### DESIGNING RECIRCULATION FOR HALON DUMP:

As described in the system descriptions above, exhaust air can be re-cycled for cooling use during a HALON dump. One problem to watch out for is that the duct work is now part of the HALON protected area. The volume of the ducts must be included in the HALON sizing. Furthermore, the ducts must be made air tight. As this is usually not the case, special attention to detail is indicated.

Another problem with recirculation systems is that heat buildup occurs. At Mt. Wilson the large air volume will delay the time before heat buildup requires a shutdown. In the satellite uplink facility, cooling will be maintained during a HALON dump.

Careful consideration should be given to the risks of continuing operations during HALON dumps. One possible method is to continue running when a smoke sensor activates the dump, but to shut down if a heat sensor is tripped. This would probably indicate a significant fire.

#### NOISE CONTROL:

The single most important method of noise control is to plan ahead. At KABC-TV the original design was for an unmanned facility where noise was of little concern. During construction this assumption was changed.

To protect the operators from the transmitter blower noise the transmitter room was divided by a glass wall. This cut the noise level in the new control room, but required modification of the HVAC system as two cooling zones had been created. In addition, supply-duct borne noise in the control room had to be reduced by re-designing the distribution system to lower air velocities. Had noise control been a criteria from the start different fan and duct choices could have been made, as discussed by McQuiston and Parker (8).

#### COMMUNICATING WITH THE HVAC DESIGNER:

If you can find a HVAC designer who has successfully designed a transmitter cooling plant you would be wise to use him. Since most broadcasters build new transmitter plants infrequently such designers are rare. More than likely, you will be working with the company that did the HVAC system for your studios. This application and transmitter cooling could hardly be more different. The solution is to educate the designer.

The major problem to expect is one of communication. The terminology used by HVAC designers and broadcasters is not consistent. For example, I have referred to the "backpressure" on the transmitter exhaust. Varian (9) uses this identical term to refer to the pressure on the opposite side of the power tube. Mistakes have also been known to result from confusing "dual" and "redundant."

Transmitter specification sheets are not always clear to a HVAC designer. Some sheets list "heat dissipation" and show values that include the heat load of the tubes only. The HVAC designer may read this and not realize that there are other heat loads in the transmitter, to say nothing of monitoring and control racks. Forgetting to account for the heat load from the dummy load is a possibility unless it is pointed out to the designer.

Bot (10) cautions designers that cooling is accomplished by pounds of air, not volume of air. This reminder to take into account the variance of air density with temperature and elevation is good advice. In addition, the critical nature of the transmitter exhaust duct pressure makes it wise to consider pressure as well. I recommend an analysis be made of volume flow rate, density flow rate, and pressure at each point in the system. The transmitter exhaust duct pressure should fall in the range recommended by the manufacturer under all possible normal operating conditions.

A final recommendation is to perform rigorous testing of the completed system. We performed such testing at KABC and plan the same for our Satellite Uplink Facility. Tests should include simulating the failure of each piece of equipment to prove that the backup systems operate. Pressure and flow measurements should be made for each mode of operation. No fan speed should be considered final until after the tests are completed.

As mentioned earlier, for example, the exhaust fan operation at KABC was altered as a result of our test program.

#### CONCLUSION:

Efficient heating and cooling systems can be designed by combining transmitter cooling and HVAC systems. Such systems must receive the detailed attention of the responsible engineer as they have the potential to effect the transmitters. Careful planning and rigorous testing will help the broadcaster avoid the pitfalls discussed here and those waiting to be discovered.

#### ACKNOWLEDGEMENTS:

The author wishes to thank Fred Faist for his leadership, Michael Christatos, of Climate Control for his assistance in troubleshooting these projects, and Maria Arango for her assistance in preparing this manuscript.

## REFERENCES:

1. M.W.S. Barlow, "Designing Broadcast Systems for High Reliability," SMPTE Journal, 91 (1982), p. 153.
2. Robert E. Klein, "Keeping Your Cool," Pre-print (Harris Corporation), p. 5 and p. 22.
3. Ibid, p. 25.
4. R.S. Bush, "Standard Broadcast Transmitters," in Engineering Handbook, ed. George W. Bartlett (Washington, D.C. : National Association of Broadcasters, 1975), p. 425.
5. "Air Leakage, Rear Door, and Air Switch Modifications; KABC," (Harris Corporation, 1983), p.5.
6. Michael Christatos, Climate Control, Inc., private communication, November 15, 1983.
7. Michael V. Chiarulli, "KABC-TV Mt. Wilson Transmitter Air Cooling System Report," private American Broadcasting Companies, Inc. report, 1983.
8. Faye C. McQuiston and Jerald D. Parker, Heating, Ventilating and Air Conditioning Analysis and Design, (New York: John Wiley & Sons, 1977), p. 378.
9. Care and Feeding of Power Grid Tubes, (San Carlos, California: Varian, Eimac Division, 1978), p. 112.
10. A. Hans Bot, "Television Transmitters," in Engineering Handbook, op cit, pp. 516-517.

---

## Guidelines for Transmitter Plant Installation and Maintenance

Homer R. Stanley and James B. Pickard

Harris Corporation, Broadcast Transmission Division

Quincy, Illinois

### INTRODUCTION

The challenge of installing a new transmitting plant occurs only a few times in the life of a chief engineer. Suggestions offered in this paper will aid in the planning and design of an installation.

### PLANNING AND DESIGN

Before the initial design can take place, a considerable amount of planning must occur. Assuming that the transmitter type has been selected, an infinite number of details are now required. Although the transmitter is the major component, the support equipment can make the operation of the new transmitter perform up to your expectations. As much thought that went into the selection of the transmitter must now be applied towards such details as the transmitter air and power systems, the building ventilation and lighting, test equipment, microwave equipment, and maximum utilization of space.

The complete transmitter technical manual and outline drawings containing input and output locations should be obtained prior to starting any detailed design. The technical manuals for any major components already decided upon should also be acquired. Once the manuals and drawings are in hand they should be thoroughly studied.

Ideas for a new transmitter installation can come from many places. One of the best methods for obtaining ideas is from existing stations. Visit as many stations as you have time for. This includes older as well as new installations. The older plants can be an excellent source of ideas of how not to design the new one. The new installations should be approached from the point of not only new ideas, but also from things the chief engineer "wished he had done". Other sources of ideas are the NAB Handbook and many of the trade magazines available today.



## AIR SYSTEMS

The transmitter will dissipate a considerable amount of power in the form of heat. The heated air must be exhausted away from the transmitter and preferably out-of-doors to prevent recirculation and additional heating. If air is exhausted from the building some consideration must be given to intake air or make up air which must replace that which has circulated through the equipment and exhausted.

The transmitter technical manual and outline drawings will provide information on the maximum altitude, maximum and minimum operating temperatures, expected temperature rise, pressure drops internal to the transmitter, and the total required CFM of air through the equipment. Certain environmental factors about the building site must also be considered. The altitude and maximum air temperature of the building will play a key role in determining the correct air system.

Unless the transmitter air is exhausted directly into the room or directly through the roof, an external exhaust fan will in all likelihood be required to overcome the external ductwork losses. It is poor engineering practice to use air that leaks from around doors and windows as the intake or makeup air. A typical installation will include a fan to supply clean and filtered air to the building and transmitter. If the environment external to the building is extremely dusty, the use of special filtering should also be considered. In some cases it may be desirable to condition the entire transmitter building. A reliable heating and air conditioning contractor can provide invaluable information and services when planning the installation. These services are highly recommended if the heat radiated into the room from auxiliary equipment must also be taken into account in the overall system.

## ELECTRICAL POWER SYSTEM

The planning of the electrical power system must take into account the available commercial power and the requirements of the transmitter and auxiliary equipment. The decision between 480 volt and 230/208 volt operation must take into account initial cost versus operating efficiencies. Room for expansion of the new panel boards should be allowed for additional equipment at a later date. The decision between circuit breakers and fuses for the station are a matter of personal preference and the existing building codes. The breaking down of the transmitter plant into many power circuits will normally allow versatility in performing repairs while staying on the air.

Normally the transmitter blowers and control circuits are on separate branches from the high voltage power supply. In the case of dual transmitters, each transmitter should be on separate circuits and sources if possible. It is desirable to place the exciters with crystal ovens on a separate circuit in order to keep oscillators warm during times the transmitter power is removed. In the case of transmitters with a separate driver cabinet a separate power feed might allow emergency operation at a lower power level while repairs are being made on the power amplifiers.

The external air system should have individual circuits for intake and exhaust fans. A dual transmitter system should have separate air systems to allow operation of individual transmitters. Auxiliary equipment racks should be

independently controlled by the use of separate circuits. The same would be true for microwave racks. The studio to transmitter link must be a different power source than the transmitter to studio link.

The emergency power generator should be capable of handling the entire transmitting plant. Emergency power to run the transmitter is worthless if the transmitter or input rack equipment shuts down due to heat because the generation cannot handle the additional load of the air conditioning system.

A varying commercial power source can be the cause of many problems. A check with the power company and existing customers in the area can determine if the power is reliable. If extreme and numerous voltage excursions are to be expected, individual line voltage regulators should be considered. Modern transmitters contain automatic gain correction circuits to help with minor line variations, but large sags in voltage can not be handled. A stable line voltage will also increase tube life and decrease component failures.

### AUXILIARY EQUIPMENT

The auxiliary equipment associated with the transmitter plant installation will normally include the program input equipment, remote control equipment, microwave link equipment, and additional test equipment. The program input equipment for the audio chain of the transmitter will include such items as a limiter, a processor, a modulation monitor, and distribution amplifiers. The video input to a television transmitter requires similar items such as a video processing amplifier, waveform monitor, and video distribution amplifiers. Planning the station should include as much test equipment as the budget will support. New broadcast technology require considerably more sophisticated test equipment than the older ones. The following is a list of the recommended test equipment for a television transmitting plant:

- Vestigial Sideband Demodulator with Synchronous Detector
- Sideband Analyzer
- Video Signal Generator
- Vectorscope
- Diode Demodulator
- Waveform Monitor
- Aural Demodulator
- Frequency Counter
- Audio Oscillator and Distortion Analyzer
- Oscilloscope
- Digital Voltmeter
- RF Voltmeter
- Scope Camera
- RF Adaptors, Connectors, and Cables

### PHYSICAL LAYOUT

In the planning and design of a transmitter plant installation a floor plan layout will provide many benefits. Primary ones will be ease of installation and accessibility to equipment. A scale drawing of the building including all doors, windows, walls, posts, trenches, and penetrations should be prepared. The use of paper cutouts (also made to scale) of the transmitter, power supplies, duplexers, and equipment racks will prove beneficial. Cutouts may not only be

used for equipment placement, but to ensure that large pieces of equipment will be able to be moved into place through tight places. By sliding the cutout along the route from the entrance to the building to the proposed location on the scale drawing the clearances may be checked.

Proper location of the program input equipment racks is very important. The test equipment located in these racks will need to be viewed while making transmitter adjustments. The waveform on an oscilloscope or the pointer on a meter can be very difficult to see from across the room. The same is true when the test equipment is mounted in line with the transmitter. The best location is normally found to be directly in front of the transmitter or slightly off to one side and perpendicular to the transmitter. Allow adequate rear access to the units. Another idea is to mount only the test equipment that will be left permanently in the program input equipment racks and mount the remaining test equipment in a rack that is on wheels. In this arrangement the test equipment can be wheeled to where it is needed and can be seen easily.

Placement of the microwave rack or racks is not quite as critical as the program input equipment rack. But it may be necessary to view the test equipment while troubleshooting the microwave equipment, so the rack should not be in a separate room or far removed from the test equipment. Most stations will place the microwave rack in line with the program input equipment rack.

The transmitter should be placed where access is provided to all four sides. Leave enough room for all doors and swinging panels to fully open. If internal units are on slides, allow plenty of clearance to extend the slides fully and still remove the unit. Removal of major transmitter components after installation can be a problem. This is particularly true of heavy transformers and blowers. Many installations build the transmitter into a sound proofed wall. This not only decreases the noise, but provides a means to hide from view the transmission lines and air system ductwork. Be sure to include convenient doors to get behind the transmitter. Floors should have sufficient strength to support the full weight of the transmitter cabinet or cabinets and the high voltage power supply. If the building contains a basement or lower level, external transmitter blowers and the high voltage power supplies may be placed there. The placement of the transmitter blowers or an external blower in the lower level can result in a more efficient air system, but the air noise will not normally be decreased due to the high air velocity through the transmitter cabinet.

Interconnecting cables may be placed in either floor trenches or overhead cable trays. There are advantages and disadvantages to both methods. The selection is normally a matter of personal preference. Audio and video cable should be separated from ac wiring by conduit. Considerable emphasis should be placed upon the station ground system. Good grounding will reduce the chance of electrical shock, provide a low impedance path for lightning, and reduce induced currents which can cause electrical noise. The transmitter, high voltage power supply, and auxiliary equipment racks should all be bonded together and in turn to the station ground with two or four inch copper strap with all joints brazed. It might also be desirable to use a #2 AWG copper wire connected to the station ground as a buss along the back of the work bench. If a steel frame building is in use the steel work should be connected to the station ground. All building penetrations (AC power, control, and coaxial) should be fitted with lightning protection devices.

Primary power panels need to be located in an area that can be reached with easy access to remove power in the event of an emergency.

Transmission line layout maybe designed using paper cutouts the same as discussed before. If transmission line components are supported from the roof beams, ensure that the beams have adequate strength for the additional load. Another consideration is roof snow load. In areas of heavy snowfall, the accumulation of snow on the roof may cause roof sag which in turn will allow the transmission to sag putting undo stress on the equipment. A station load and a method of routing the transmitter output into it should be provided. Station loads are available with air or water cooling. Water is preferred because of calorimetric power calibration. If inadequate water is available on site, the use of a self contained heat exchanger might be considered. Patch panels should be conveniently placed. Standing on a ladder to remove a stubborn U-link' eight feet in the air is a safety hazard.

Detailed design of the entire system should be completed prior to the start of installation. Wiring interconnection diagrams and layout drawing are essential to a successful installation. Complete wiring diagrams showing all connection points and wire types will speed installation and help with the ordering of parts. Detailed interconnection diagrams help forecast any interfacing problems between the equipment.

When planning for the installation some thought should be given to logistics. Some typical questions that are often overlooked until the problem occurs are:

1. How is the equipment to be unloaded from the transport and moved into place?
2. Are any special tools required for any part of the installation?
3. Will special test equipment be required to complete the proof of performance?
4. What order of installation is best?
5. Where are the fire extinguishers in the event of fire?
6. Where is the first aid kit in the event of injury?
7. Is hardware sufficient and are hand tools on site?

## INSTALLATION

Adequate advance planning and design will result in a smooth installation process. Most problems that occur during the actual installation may be traced to inadequate research of problem areas. During the installation process proper safety precautions should be observed. Proper tools should be utilized with fire extinguishers and first aid kits on site from the first day on.

All packing material should be saved and thoroughly searched for any items that might still be contained. Avoid the tendency to jury-rig any part of the installation. Things that will be fixed properly at a later date tend to still

be the same years later. Remember that the installation is to last for many years with changes of personnel. Leave a trail in the design stage of what was done. Any deviation from the planned documentation should be corrected immediately. Either write it down the way it was done or do it the way it was written. The use of high quality work and time spent to do things correctly will result in an efficient and troublefree installation that one can be proud of.

### TRAINING

Training begins the day you start to plan the new installation and continues until the next. If a manufacturer representative is present during the transmitter installation and proof of performance tests, his time should include training for maintenance personnel. Most manufacturers offer on-site training or have formal schools at their manufacturing facilities. It is highly recommended that at least one individual attend such a school. The time to learn about the equipment operation is before it malfunctions. Technical manuals should be studied upon receipt. While the equipment is being installed is an excellent time to learn the locations of components that are hard to find or identify.

### DOCUMENTATION

Proper documentation during the planning, design, and installation phases will ensure a system that will be easy to troubleshoot and modify in later years. The drawings do not have to be completed by a draftsman. The only requirement is that they be readable and accurate. Installation drawings for ac wiring, RF flow, audio lines, video line, remote control connections, and all interconnecting wiring should be completed. A copy of all documentation including a complete set of all technical manuals should be retained at the studio in the event that the originals are lost or damaged.

### MAINTENANCE

Successful transmitter plant installations will require a proper preventative maintenance program which is initiated during the installation and continued throughout the construction phase. The proper preventative maintenance program will ensure reliable operation with a minimum of down time. Successful maintenance programs will apply to all station equipment.

### PREVENTATIVE MAINTENANCE

Preventative maintenance is nothing more than a planned inspection program based on a time cycle. The long term results can reduce the amount of time spent on corrective maintenance if the schedule is adhered to. When the equipment is initially installed, the equipment technical manuals will normally provide recommended periodic maintenance charts. From these charts and recommendations the correct preventative maintenance schedule for an individual installation may be prepared. Once the preventative maintenance schedule is implemented a record should be made for each action taken.

An important part of the preventative maintenance program is the visual inspection. Close visual inspection can reveal overheated parts, loose connections, and dirty components. Corrective action should be taken immediately to ensure continued reliable operation. Transmitter and auxiliary equipment

should be vacuumed on a weekly basis to remove any accumulation of dust. The cleanliness of equipment and the surrounding area can not be over stressed. Stations that are not kept clean are the ones that usually have catastrophic chain reaction failures. Check wiring and cable harnesses for loose connections that might be subject to vibration. All interlocks and safety devices should be checked for proper operation on a regular basis.

The complete internal transmitter and external air systems should be checked. All air filters should be cleaned and cleared of obstructions as often as necessary. Blower motors and impellers should be observed for looseness and abnormal noises. Pay particular attention to boots and ducts for air leaks which will decrease the system efficiency. The air pressure readings at selected test points and blower motor currents should be recorded and compared against the original installation readings to ensure continued proper cooling.

Vacuum tubes should be properly removed from the transmitter and cleaned with warm soapy water. Ensure that any foreign matter is removed from the cooling fins. Then thoroughly rinse the tube with clean water. While the tube is removed check the tube socket for damaged fingerstock and replace as needed. Transmitter meter readings and operational parameters should be checked at least once a day and recorded in a logbook. A spotcheck of such items as noise, distortion, response of an audio transmitter and differential gain, differential phase, swept response of a visual transmitter should be done on a weekly basis. Once a month a more detailed check should be made.

#### CORRECTIVE MAINTENANCE

Corrective maintenance is mainly concerned with repair of down equipment and readjustment to return a transmitter to specification. The maintenance logbook should be used for both the transmitter and auxiliary equipment. An accurately kept logbook can be used to project possible equipment failures and aid in the troubleshooting process for inexperienced repairmen. The logbook should contain information concerning corrective maintenance on the equipment. Faults or malfunctions should be described giving all the symptoms relating to the problem. Any corrective action taken or components replaced should be noted including those parts replaced that did not contribute to the repair. The elapsed time meter reading and the name of the individual completing the repairs or adjustments should also be recorded.

It is highly recommended that readjustment of any control in the transmitting system be performed only if the maintenance individual is certain that it is the correct one. This is particularly true in the television visual transmitter. Many unnecessary adjustments are made in the exciters to correct for errors that occur elsewhere in the chain. Adjustments that will affect performance parameters should only be made after the transmitter has been at operating temperature for two or three hours.

#### CONCLUSION

Each installation is different and similar. Different in the detail of some aspects and similar in that each has: air handling, electrical power, interconnection of equipment, and physical layout. If these guidelines are followed by planning each task from start to finish, a smooth flowing transmitter plant installation will be achieved.

---

## MICROCOMPUTER CONTROL ENHANCES NICAD BATTERY FAST CHARGING

D.C. Hamill, BSc (Eng), MSc

PAG Limited

Raynes Park, London, England

A number of problems arise when nickel-cadmium batteries are fast charged. This paper describes some of them, and then discusses the main cutoff methods used to terminate fast charging. It is shown that, at best, they provide only a partial solution to the problems. PAG Limited has developed a totally new, proprietary fast charging technology, which uses accurate microprocessor control of the charging process to overcome the drawbacks normally associated with fast charging. This will be described, and then compared with three conventional methods, to show how each performs under normal and abnormal conditions.

### NICAD FAST CHARGE PROBLEMS

When a sealed nicad cell is overcharged, the energy delivered to it cannot be stored chemically by the normal reaction involved in charging. Instead, oxygen gas is evolved inside the cell. At fast charge rates pressure builds up inside the cell. If overcharging is not stopped in time, the safety vent of the cell opens, and gas and electrolyte are forced out. It is imperative that venting is avoided, because reagents are lost from the cell and its life is reduced. Overcharging also causes overheating: the energy delivered by the charger cannot be absorbed, but is given out in the form of heat. If the cell temperature becomes too high, battery life is impaired. If cells suffer overcharge at low temperatures, below about zero degrees centigrade, hydrogen can be produced as well as oxygen. Once again, the cell may vent, reducing its life. There is also a danger that the hydrogen could cause an explosion.

It is important therefore that a nicad fast charger does not damage batteries by overcharging them. But it is equally

undesirable that the batteries are undercharged. The user is generally concerned that his battery is full and will run his equipment for its normal duration. So it is important that the charger does not stop charging prematurely. However, the transition between charging and overcharging is gradual rather than abrupt, and it is not easy for the charger to choose the correct cutoff point. A battery may be presented to the charger in any state of charge, from empty to full. If the battery is already full, the charger must respond quickly and switch off the current before any damage is done.

#### CONVENTIONAL FAST CHARGE CUTOFFS

Thus one of the most difficult problems when fast charging nicads is knowing when to stop. Many different cutoff methods have been used in fast chargers, but nowadays three methods predominate:

- Voltage and temperature cutoff (VTCO)
- Negative voltage change cutoff ( $-\Delta VCO$ )
- Temperature cutoff (TCO)

Fast charge termination would be simple if an electrical signal were readily available to indicate when the battery is fully charged. With some types of battery this is so. For instance, lead-acid batteries show a sharp rise in voltage as the battery reaches full charge. Nicad batteries show a much smaller rise, comparable with the variations caused by temperature changes and other factors. This makes simple voltage sensing inconsistent, unreliable and therefore impractical. But improvements can be made to the basic method. Very high charging currents accentuate the end-of-charge voltage rise. These heavy currents are often applied in pulses (the technique known as pulse charging), sometimes alternating with short discharge pulses (reflex charging). The battery's temperature may be monitored along with its voltage, giving the charger more information about the state of the battery; this is the basis of the VTCO charger. This method works best with specially matched or selected cells. Even with these improvements, the cutoff voltage must be set carefully or the battery may be over- or undercharged.

The  $-\Delta VCO$  method depends on the negative temperature coefficient of the battery voltage. The voltage of a nicad rises somewhat at the end of charging, then levels off in overcharge, before falling slowly as the battery heats up. This voltage peak can be detected, for example by comparing successive battery voltage samples; if the most recent sample is lower than previous samples, charging is stopped. However, the battery must endure a lot of overcharge before the peak is established, and this is not good for its life. To minimise this problem, charging is usually restricted to the two-hour rate, and a sensitive peak detector is used. A very small voltage drop, about half-a-percent, will stop charging. Unfortunately, this can result in undercharging, since the charger may cut off prematurely if a spurious voltage drop occurs. This might happen because of a dip in the supply voltage, or a change in connection resistance, or perhaps because the battery is hot from prior use. Again the system is most efficient



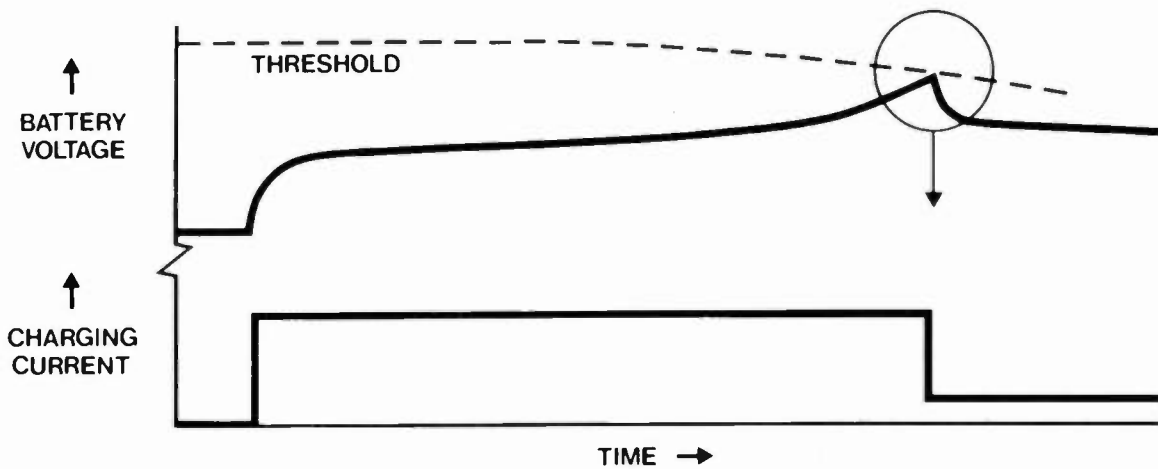


Fig. 1. In the VTCO method, charging ends when the battery voltage reaches a temperature-dependent threshold.

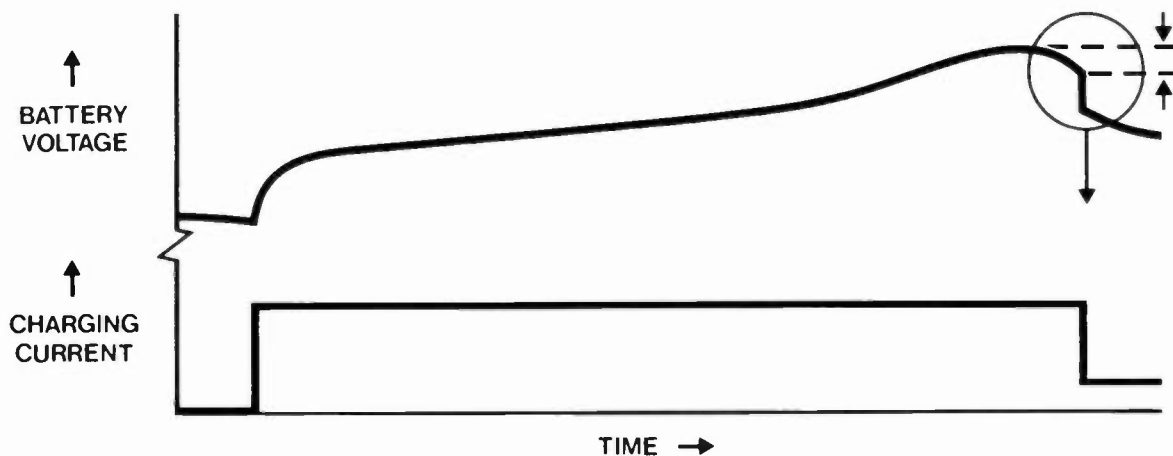


Fig. 2. In the  $-\Delta VCO$  method, the charger detects the battery voltage peak that occurs during overcharge.

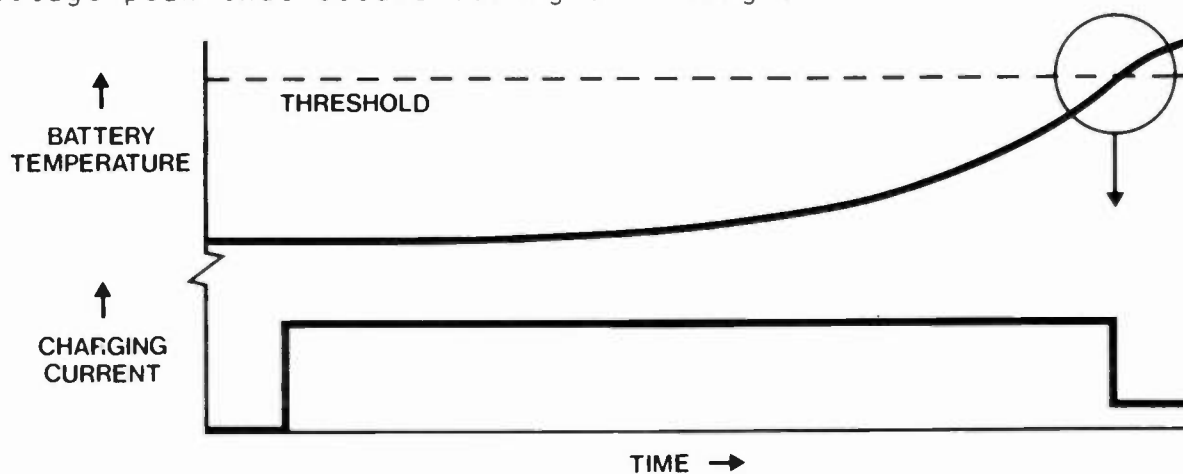


Fig. 3. In the TCO method, charging is stopped when the battery temperature exceeds a predetermined level.

when matched to specific cells since different types have different voltage peak characteristics.

When a nicad battery is overcharged it heats up, and this effect is used for fast charge termination in the TCO system. In its simplest form, one or more thermal cutouts are built into the battery pack. These are fixed temperature bimetallic switches, similar to those used in room thermostats. The cutoff temperature is generally around 45 degrees centigrade. In use, the charger forces energy into the battery until it overcharges and heats up. Eventually the thermal cutout operates, switching off the charger. TCO is a widely used but not very satisfactory technique: it succeeds with a flat battery, because the cells warm up gradually during charging, leading to a small overcharge under favourable conditions. Hot batteries cause an early cutoff, resulting in undercharging. However, if a cool but fully charged battery is connected, it can receive a large overcharge before the cutout temperature is reached. The effect is worse the colder the battery, because the cell temperature has further to rise. The considerable overcharge frequently delivered by TCO chargers is not good for battery life. Modern cells are better able to withstand such treatment, but the fundamental problems remain.

#### SPEEDCHARGE 6000

From this brief survey it can be seen that none of the common techniques of fast charge termination is totally satisfactory. It was decided that a new technique should be developed that would be as nearly ideal as possible. The charger would have to be reliable and perform repeatably under all conditions. Moreover, the battery should not contain special sensors and should not need extra connections. The resulting charging system is known commercially as Speedcharge 6000.

The design philosophy behind the new charging technique is that the cells act as their own overcharge sensors. The electrochemical reactions that occur in nicad cells are not fixed, but vary under different physical conditions. This variation is reflected in the electrical response of the battery. Consequently, it is not a straightforward task to interpret the electrical symptoms and diagnose what is happening inside the battery. Nevertheless, the microcomputer in the Speedcharge 6000 has been programmed to distinguish between the patterns that characterise normal charging, overcharging and battery faults. The microcomputer controls fast charging by allowing current to flow until it recognises that the battery cannot safely accept any more charge; then fast charging is stopped.

This approach, using the cells as their own sensors, means that the 6000 inherently operates with a wide range of batteries and conditions. In adverse circumstances, the 6000 microcomputer allows fast charging to continue until it decides that any more will lead to battery degradation. The "ready" indicator lights, showing that the battery has been fast charged to its maximum capability under the prevailing conditions.

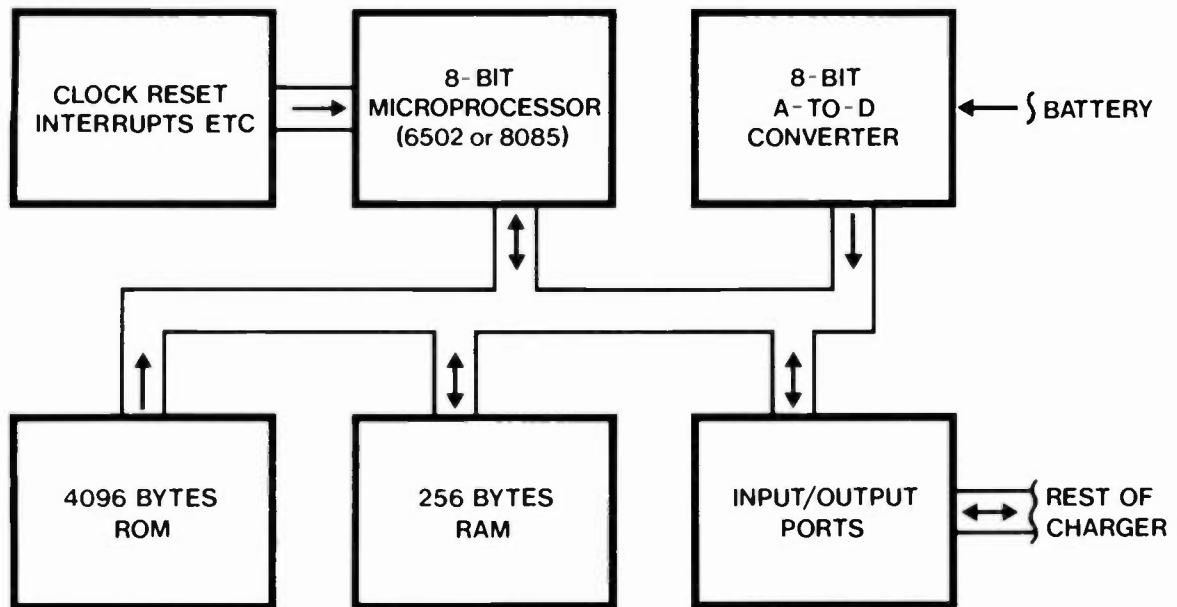


Fig. 4. The simple structure of the microcomputer used in the Speedcharge 6000 fast charging system.

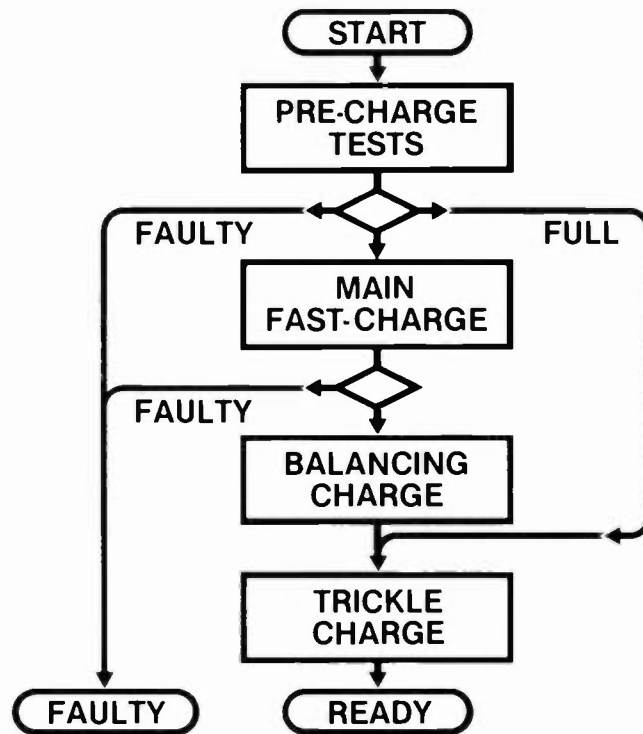


Fig. 5. A flowchart of the fast charging program of the Speedcharge 6000, showing the four charging phases.

When a battery is first presented for fast charging, the microcomputer has no knowledge of its characteristics - is it fully charged or flat? How many cells does it contain? What is their capacity? Is the battery hot or cold? So at first the charger delivers power slowly, avoiding damage to a full battery, while it gathers information. At the end of this test period, which takes about three minutes, the main fast charge is started, with the current at its full rate. The battery voltage is read 240 times per second. The microcomputer briefly interrupts the charging current 16 times per minute, making both on-charge and off-charge voltages available for analysis. This information is processed at several levels to determine whether charging should continue; short-term processing is performed continuously, but every minute a more detailed long-term analysis is carried out. Fail-safe provisions include voltage limits and a timer. At the end of the main fast charge, a good battery is typically 95 to 100 percent charged. Next, to reduce any imbalance between the cells, a balancing charge is delivered to the battery at a safe rate, in a series of long pulses. This balancing charge may be up to 5 percent of the battery's capacity.

The dedicated microcomputer has been simplified to the minimum configuration for its task of controlling and monitoring the charging process. It consists of the following blocks:

- A central processing unit (an 8-bit microprocessor)
- 4K bytes of program memory (ROM)
- 256 bytes of read/write memory (RAM)
- Input/output ports, to interface with the rest of the charger
- An analogue-to-digital converter, to read battery voltages
- Clock, reset, interrupts and other system functions.

Perhaps the most surprising characteristic of the microcomputer is the small amount of read/write memory needed for data storage. The parts cost for the microcomputer has been kept as low as possible, making it a very cost-effective controller.

Clearly, the performance of the microcomputer depends on the quality of its software. The Speedcharge 6000 software is designed to be inherently tolerant of the battery voltage and capacity. The charger will automatically adapt to batteries from 9 to 13 cells, with capacities from 2 to 12 amp-hours. This built-in flexibility is achieved by the use of several interlinked algorithms, which also ensure that the fast charge cutoff is robust and unlikely to be triggered falsely. This contributes to the high reliability of the charging system.

## PERFORMANCE COMPARISONS

The performance of the three conventional fast charge cutoff methods will now be compared with that of the new microcomputer-based method. Firstly, consider the case when the chargers are presented with a good battery, at room temperature, fully discharged. The chargers all perform well under these optimum conditions. The VTCO charger cuts off some time before the

battery is fully charged; the voltage level is set as a compromise between under- and overcharging. The  $-\Delta VCO$  charger delivers a fair overcharge, which is needed to produce the voltage peak. (A problem peculiar to this type of charger is that a similar peak can occur if the battery has been discharged too deeply. As the cells recover, their internal resistance falls; so does the voltage, causing the charger to cut off. The result is a virtually uncharged battery.) The TCO charger delivers quite a large overcharge to the battery, enough to heat it to the cutoff temperature, but usually insufficient to damage the cells. The 6000 charger cuts off at a point where the battery is virtually full but overcharging is at a safe level. It follows this with a balancing charge. The battery can then deliver about 97 percent of its capacity on load.

Next consider the case when the battery is already fully charged, and is at room temperature. Ideally, the chargers should cut off as soon as the battery is connected. In this case there is a marked difference between the responses of the four chargers. The VTCO charger cuts off very quickly, the battery voltage soon rising above its trip point. The  $-\Delta VCO$  charger takes longer, because the battery must overcharge and heat up before its voltage peaks. The TCO charger has the worst performance of the four methods, because the battery has to heat up to 45 degrees centigrade before the trip point is reached. This may take up to 20 minutes, and the cells could vent within this time. The 6000 charger cuts off quickly, typically within three minutes; moreover, during the initial test period the current is less than the full rate, avoiding battery damage.

Now suppose that a cold, fully charged battery is presented to the chargers, a battery that has been cooled to zero degrees centigrade. The VTCO charger tends to cut off earlier than at room temperature, because the battery voltage and resistance are both higher, and the end-of-charge rise is more pronounced. The  $-\Delta VCO$  charger takes quite a long time to cut off because the peak must be established at a higher voltage level. The problem is that at low temperatures, the voltage can pass the hydrogen generation threshold well before the charger cuts off. The situation is a lot worse with the TCO charger, because the battery must heat up by 45 degrees before it reaches the cutoff temperature. This could take 40 minutes and is very likely to cause hydrogen venting, with the consequent risk of explosion. The life of the battery will certainly be reduced.

To avert this danger, the better TCO systems use a low temperature lockout in the battery pack, which prevents all fast charging if the battery is below about 10 degrees centigrade. However, in solving one problem, another has been created: it is now impossible to fast charge a cold battery, even though it could be done safely. (Normal charging does not cause hydrogen generation; only overcharging does.) With the 6000, the charge delivered to the battery is less than the room temperature charge; this is because the microcomputer recognises that it is unwise to fast charge the cells further. The symptoms of overcharging are once again detected and the current is shut off before damage can

be done.

A hot battery, say at 50 degrees centigrade, can cause problems for some chargers. The end-of-charge voltage rise is much less pronounced than at room temperature. It may not reach the voltage cutoff level of the VTCO charger, which then relies on temperature cutoff. On the other hand, the  $-\Delta VCO$  charger may cut off too early. This is because the voltage-time curve is flatter than at low temperatures, making a spurious cutoff more likely. Some types of TCO charger lock out of fast charge with a hot battery. The better types wait until the battery cools below its cutout temperature, then fast charging starts. However, the battery may end up undercharged since the temperature rise needed for cutoff is now very small. (It is worth mentioning that the battery temperature may actually fall during fast charging if the battery is not full and if the current is not too high. This assists all the chargers, but particularly the TCO system.) With the 6000, the charge delivered to the battery is about 85 percent of the room temperature charge; this is because nicad cells have poor charge acceptance at high temperature, and not because the charger cuts off prematurely. Once again, the microcomputer recognises that the cells are not accepting charge, and switches off the current.

Now consider what happens when a faulty battery is connected to the chargers. There are many things that can go wrong with a battery if it is mistreated: the charge in the cells can become unequal; a cell can go short-circuit or open-circuit; the battery can develop a high resistance; the voltage can change; or the capacity can reduce. Without examining the causes of all these faults, it should be noted that poor fast charge control can contribute significantly to battery degradation. The VTCO charger handles faults well if they tend to raise the on-charge voltage; then the charger cuts off early. But faults that tend to lower the voltage cause serious problems. For instance, if a cell develops a short-circuit, the battery voltage may never reach the cutoff point. Overcharging continues unabated, with the battery heating up and possibly venting. Under these conditions, temperature must be used as an emergency cutoff. The  $-\Delta VCO$  charger is quite good at coping with faults that either raise or lower the battery voltage. This is because the charger is looking for a drop in voltage, not a specific voltage level. So a short-circuited cell is dealt with satisfactorily, for example.

Because most serious faults will cause the battery to heat up, the TCO charger detects major faults reasonably well, although after a considerable delay particularly in cold conditions. But there are cases where the temperature rise is insufficient to cause the charger to cut off. For example, the hot cell might not be near the thermal cutout. For this reason, the better TCO systems use multiple thermal cutouts distributed throughout the pack. The 6000 is very good at coping with faulty batteries. This is because it recognises the signs that the battery is performing abnormally. The 6000 tries to charge the battery as fully as it can, but stops when the battery cannot safely accept any more. Because the charger is immune to the effects of low battery voltage, a pack

that contains a totally short-circuited cell is treated as a normal battery of lower voltage.

## SUMMARY

Finally, the effects of the four different methods of fast charge termination will be summarised.

The VTCO charger needs critical adjustment and will not work with a wide range of cells. It tends to undercharge batteries under normal conditions. Cold batteries are not damaged, but hot ones may be overcharged. Faults that result in a low battery voltage, such as a short-circuit cell, cause the method to fail altogether.

The  $-\Delta VCO$  charger works well under normal conditions, but its high sensitivity makes it prone to undercharging, particularly with hot batteries and overdischarged batteries. It does not cope well with cold batteries. Because it always overcharges, it may shorten the battery life if charging is faster than the two-hour rate.

The TCO charger works well with a discharged battery at room temperature, but delivers a severe overcharge to a fully charged battery, particularly at low temperatures. If a low temperature lockout is used, to avoid hydrogen venting, a cold battery cannot be charged. The TCO charger responds to major faults that cause the battery to overheat, although after some delay. The overcharging that often occurs with this type of charger leads to short battery life.

The 6000 charger works well with batteries in any state of charge and with hot or cold batteries. It has an inherent capability to adapt itself to a wide range of battery voltages and capacities. This allows it to cope with most battery faults, because it recognises that the battery cannot accept any more charge. Damaging overcharge is avoided and a beneficial balancing charge is supplied. This means that the cells do not deteriorate unnecessarily, and long battery life is obtainable, comparable with slow charge.

## CONCLUSION

Three conventional methods of fast charge cutoff have been examined: VTCO,  $-\Delta VCO$  and TCO. They have all been found wanting in one respect or another. This finding led to the development of a new, microcomputer-controlled charging system, known as Speedcharge 6000. It overcomes the difficulties associated with the other systems, and has operational benefits as well. These include long battery life and great flexibility of use: a wide variety of batteries can be charged, over a good temperature range. The dedicated microcomputer of the Speedcharge 6000 system provides a cost-effective solution to the problems of fast charging nicad batteries in the field, and leads to enhanced performance when compared with traditional equipment.





"How International Agreements  
Affect U.S. Broadcasting"

Wallace E. Johnson, P.E.

Moffet, Larson & Johnson, P.C.

Arlington, Virginia

INTRODUCTION

The specific technical provisions of international agreements, to which the United States is a party, directly determines the technical parameters within which broadcasting develops within the United States.

AM broadcasting in the United States developed under two long standing agreements - NARBA (North American Regional Broadcasting Agreement) and the U.S./Mexican Agreement.

NARBA countries included Canada, Cuba, Bahama Islands and the Dominican Republic. Cuba ceased complying with NARBA when Castro came into power. Bahama Islands and the Dominican Republic had some problems complying with the terms of NARBA which resulted in some difficulties for the U.S. NARBA became in effect a bilateral agreement with Canada. However, they also became dissatisfied with the Agreement, particularly with regard to clear channel priorities and protections.

The U.S./Mexican Agreement is a bilateral agreement which has also permitted the development of AM broadcasting within technical parameters very similar to the NARBA.

## RIO AGREEMENT

In December of 1981, a new regional AM broadcasting agreement was concluded for our hemisphere - the Rio Agreement. This agreement will determine the technical development of AM broadcasting for at least the next ten years and will continue to run beyond that period until revised by another conference.

The Rio Agreement contains all of the technical provisions needed to develop a plan of assignments for the Western Hemisphere. Most of the provisions are very similar to the technical provisions used in the United States under the NARBA and the U.S./Mexican Agreement with some different descriptive terms and, of course, use of the metric system. One of the main differences relates to our present use of the 10% of the time interfering propagation curve. All other countries, except Canada, Mexico, Greenland and the French Department of St. Pierre and Miquelon will use a 50% of the time interference curve which will tend to increase interference to some U.S. stations. Also, clear channel stations (Class IA) will be protected to their 0.5 - 50% skywave contour within their country and not to the entire border as was provided by the NARBA and the U.S./Mexican Agreement.

The Rio Agreement has not been presented to the Senate for ratification as of this date, however the U.S., as a signatory to the agreement, is complying with its provisions.

## CUBAN INTERFERENCE

A major problem regarding the Rio Agreement continues with Cuba, who is not a party to the Agreement. Some serious interference problems exist with Cuba without any potential means for resolution.

The Radio Broadcasting to Cuba Act (Radio Marti), which authorized broadcasting to Cuba under the jurisdiction of the Voice of America on 1180 kHz, is in effect and the broadcasts should be starting soon.

The FCC has authorized some stations to modify their operations under special temporary authority (STA) in order to recover some service loss due to Cuban interference. Also, five million dollars was appropriated to the United States Information Agency (USIA) to assist broadcasters suffering losses due to Cuban interference. The FCC has developed a method for assisting in the determination of who gets how much of the monies appropriated.

Subpart M, Sections 1.701-1.712 of the FCC's Rules contains the provisions for implementing the Radio Broadcasting to Cuba Act. It contains guidelines for determining eligibility for compensation, method for calculating the level of Cuban interference and special temporary authority (STA) from the FCC to mitigate effects of Cuban interference. The Subpart also contains requirements for filing applications for compensation.

The FCC also prepares and periodically updates a public list of Cuban stations known to be operating, together with their location and calculated operating power.

#### US-CANADA AM BILATERAL

A new AM bilateral agreement, within the terms of the Rio Agreement, was negotiated with Canada and entered into force January 17, 1984. This bilateral agreement contains the provision of the Rio Agreement and three specific provisions of interest to U.S. Broadcasters such as:

1. Ability to operate unlimited time on the Canadian Clear Channels, as specified in NARBA, on the basis of protecting the Canadian Class A station within Canada to their 0.5 mV/m 50% skywave contours.
2. An extended hours provision for daytime stations which permits operation during nighttime hours between 6 a.m. and two hours past local sunset time, with protection requirements based upon use of diurnal curves.
3. Class IV stations operating on local channels able to increase nighttime operating power by a factor of four, such as 250 watts to one kilowatt.

#### US-MEXICAN AM BILATERAL

Negotiations are also taking place with Mexico regarding a new bilateral agreement to reflect the Rio Agreement, together with specific provisions, such as extended hours of operation by daytime stations as in the U.S./Canadian Agreement. The increased nighttime power by Class IV stations was concluded by a separate agreement and has gone into effect. It is expected that negotiations regarding the basic agreement will be completed within the next few months.

#### FOREIGN CLEAR CHANNELS

The FCC in a Notice of Proposed Rulemaking, Docket No. 84-281, adopted March 15, 1984, proposed technical and non-technical amendments to Part 73 of the Rules pertaining to unlimited time operation on Canadian, Mexican and Bahamian Clear Channels. The purpose of the Rulemaking is to invite comments to assist the FCC in formulating amendments to its rules governing applications for new fulltime stations on the foreign clear channels. The technical issues

to be resolved include maximum power limitations and protection standards. Until this rulemaking proceeding is resolved, applications to operate on these foreign clear channels will not be accepted.

#### AM BAND EXTENSION

The remaining international matter pertaining to AM broadcasting relates to the World Administrative Radio Conference of 1979 which provided for an extension of the AM band to include 525-535 kilohertz and 1605-1705 kilohertz. The Conference of 1979 also called for a Western Hemisphere (Region 2) planning conference to finalize use of the new spectrum. Originally 525-535 kilohertz was to be used on an equal primary basis by broadcasting and aeronautical navigation; 1605-1625 kilohertz exclusively broadcasting; and 1625-1705 kilohertz where broadcasting would be allocated on a primary basis, fixed and mobile on a permitted basis and radiolocation on a secondary basis. Broadcasting in 1625-1665 kilohertz was not to commence before July 1, 1987 and operation on 1665-1705 kilohertz not to commence before July 1, 1990.

The FCC has issued two Notices of Inquiry in "Preparation for an International Telecommunications Union Region 2 Administrative Radio Conference for the Planning of Broadcasting in the 1605-1705 kHz Band", General Docket 84-467. The purpose of the proceeding is to develop U.S. proposals for the conference which will have two sessions. The first session, scheduled for 1986, will develop technical criteria and planning methods for submission to the second session in 1988 where the plan for broadcasting use of the 1605-1705 kHz spectrum will be developed. The FCC specifically asked for comments on an updated list of requirements, powers to be used, protection standards, groundwave and skywave propagation considerations for the extended band.

The Second Notice, adopted December 20, 1984, contained recommended preliminary views for the first session of the conference scheduled for April 14 through May 2, 1986. These preliminary views indicated that the 1605-1705 kHz band should be treated as an expansion of the existing 535-1605 kHz band principally because receivers that will be developed for the expanded band will be similar to existing receivers. Also proposed are that protection ratios, class of emission and bandwidth remain the same. Three main technical issues to be resolved relate to power, class of station, groundwave curves to be employed and an effective skywave prediction method. The skywave propagation matter is important since the expanded band is shared by different services in different regions of the world, there is sharing between broadcasting and other permitted stations by several countries in our hemisphere and the need to have the most viable and promising approach to achieve the most efficient use of the expanded band.

There are some 1500 private non-government users in the United States currently operating in the 1605-1705 kHz band. They include radiolocation, experimental, petroleum, broadcast remote pickup and travelers information. How these assignments will be resolved or phased out will be a matter that the FCC will have to resolve before the expanded band can be used exclusively for broadcasting.

In the Second Notice of Inquiry, the FCC made special note of the assistance which they received in the past from the Advisory Committee on Radio Broadcasting relative to preparations for the Region 2 MF Conference as well as subsequent bilateral negotiations. Therefore, they have modified the Charter of the Advisory Committee to include preparations for the Regional Administrative Radio Conference. The Advisory Committee, as well as the Technical Subcommittee of the Advisory Committee, have been very active to date in assisting FCC personnel in preparing for the Conference. Meetings of the committees are open to the public with dates and meeting locations publicized in releases from the FCC.

It is anticipated that it will be 1990 before the expanded band agreement and FCC rulemaking procedures will be completed and applications accepted.

#### FM AND TV AGREEMENTS

New agreements for FM and TV have been in the process of being negotiated with Canada. On November 19, 1984, the FCC announced that a new FM Working Arrangement with Canada was being implemented immediately. This new arrangement affects all FM stations within 320 km (198.8 miles) of the U.S./Canadian border and replaces the previous Working Arrangement. Agreement has been reached on a new FM Agreement and when implemented through an exchange of Diplomatic Notes, the new FM Agreement and Working Arrangement will officially supersede the Canada-U.S. FM Agreement of 1947 as well as the former FM Working Arrangement. Any new applications filed with the Commission must now comply with the terms of the new Working Arrangement.

There is also a new "Working Arrangement for Allotment and Assignment of VHF and UHF Broadcast Television Channels Under the Canadian-USA Television Agreement of 1984" being finalized. This will affect the area within 400 km (248.5 miles) of the common border. Upon release, this new Working Arrangement will govern the assignment of new TV stations, or modifications of existing TV stations within the border area.

#### CONCLUSION

From this summary report, it is obvious that international activities during the last few years and in the immediate future, will have a direct and major impact on the development of broadcasting in the United States.

OPTIMIZING THE AM BAND BY EXTENDING HOURS AND INCREASING POWER

Ralph A. Haller

Federal Communications Commission

Washington, DC 20554

As part of the Federal Communications Commission's continuing desire to optimize the AM broadcast band, to provide the maximum opportunities for broadcasters, and to assure a reliable broadcasting service to the public, two rule making proceedings were initiated: 1) to extend the hours of operation for daytime only AM stations, and 2) to increase the nighttime power of Class IV (local channel) stations. Both of these rule making proceedings now have been finalized and may be examined in detail.

The first proceeding, properly entitled, "The Matter of Hours of Operation of Daytime-only AM Broadcasting Stations" (FCC Docket 82-538), began with a Notice of Proposed Rule Making and Notice of Inquiry (Notice) adopted on August 4, 1982. The Commission stated in the Notice that "a significant number of daytime-only stations are unable to obtain the benefits of pre-sunrise operation. Moreover, none of these daytime-only stations have the authority to operate after local sunset." These limitations apply to approximately 2,400 stations or approximately half of the total of AM stations licensed by the Commission.

The chief limiting factor contributing to the daytime restrictions on many AM stations relates to the differences in electromagnetic wave propagation at high frequencies between daytime and nighttime. All AM stations transmit signals that travel along the surface of the earth and can be considered stable with time of day. These signals are called "groundwaves." The groundwave pattern of a station constitutes its daytime service area and is defined by contours of equal signal strength around the transmitting plant. The Commission prevents interference between stations by prohibiting certain overlaps of the constant signal strength contours, depending on the class of station and the frequency separation between stations.

All stations also transmit a signal into space, known as the "skywave." During the daytime hours, this portion of the signal is lost to space; however,

at night, the ionosphere reflects the skywave signal back to the earth's surface. The ionosphere continually changes, requiring that the nighttime interference potentials between stations be calculated in a more statistical manner. Because these reflections from the ionosphere attenuate the signal strength very little, even low powered stations can have significant interference potential to other stations.

The problem compounds when considering the difference in effects between operation prior to sunrise (PSR) and operation post sunset (PSS). Sunset and sunrise, as everyone knows, move from east to west. This means that stations have different directions to be considered for interference potential as sunset or sunrise approaches. For example, a station operating in Lawrence, Kansas has the potential to interfere only with stations to the west at sunrise and only with stations to the east at sunset. In other words, the potential for interference near sunrise and sunset is always in the direction of darkness from the station being considered. Additionally, the rate of change between light and dark varies from the rate of change between dark and light. Actually, the effects of darkness are not immediate. The period from two hours before until two hours after sunrise or sunset must be considered for interference purposes.

The Commission has, even as early as 1940, allowed operation prior to sunrise for many daytime stations. In June 1967, the Commission reached a landmark decision on the PSR question in its Docket 14419. At that time, a basis was established for pre-sunrise operations. The Commission focused on providing appropriate pre-sunrise operations for Class III daytime stations (Class III-D, regional stations) and for Class II (secondary stations on clear channels) stations. The 1967 decision included only those Class II stations that operated on the Class I-B clear channels, or those channels on which the dominant Class I station is not required to operate at the 50 kilowatt level. The Commission has since extended the pre-sunrise rule to cover those Class II stations operating on Class I-A channels (50 kilowatt dominant station). The details of such operation are contained in Section 73.99 of the FCC Rules and Regulations.

In general, Section 73.99 allowed Class III stations to begin pre-sunrise operation at 6:00 a.m. local time with a maximum power of 500 watts, reduced as necessary to provide protection to foreign stations, as required by treaties. For Class II stations, pre-sunrise authority was allowed at a maximum power of 500 watts; but, for the Class I-A channels, the time of commencement varied with whether the primary station being protected was to the east or west. A Class II station protecting a dominant Class I-A to the west could not operate pre-sunrise. A Class II station protecting a dominant Class I-A to the east could begin operation at local sunrise for the Class I-A station. Those Class II stations within the 0.5 mV/m 50% skywave contour of a co-channel Class I-B station to their east could begin at sunrise for the eastern station, but must protect Class I-B stations to the west. Finally, Class II stations not within the 0.5 mV/m 50% skywave contour of a station to the east could sign on at 6:00 a.m. local time, subject to the condition that no interference could be caused to Class I-B stations to the west. No provision was made in the rules for post-sunset operation by the daytime stations.

The Commission originally proposed to relax the restrictions on pre-sunrise operation of Class II stations operating in Class I-A channels.

This would have had the effect of treating Class II stations on the Class I-A channels in a similar manner as those operating on the Class I-B channels. Although this relaxation was important, the more significant part of the proposal was to allow for post-sunset operation. Under the original proposal, Class III and Class II-D (daytime only) stations would be allowed to operate until 6:00 p.m. local time with a maximum power of 500 watts. Protection of co-channel Class III or Class II stations was not required. Therefore, Class II stations located outside the 0.5 mV/m 50% skywave contour of the dominant Class I-A or Class I-B station would have been permitted to operate from sunset until 6:00 p.m. local time. Other Class II-D stations could operate until 6:00 p.m. or sunset at the nearest Class I station located to the west, whichever was earlier. Additionally, the Commission proposed allowing Class II full-time stations to operate in their daytime modes at 500 watts until 6:00 p.m. local time.

In addition to the proposed changes in the hours of operation, the Commission considered use of diurnal curves in calculating the interference that could be caused. Diurnal curves depict the changes in propagation during the four-hour transitional times from day to night and from night to day. Use of such curves could allow development of tables of operating powers based on the time-varying propagation changes.

The Commission adopted a Report and Order (R&O) in this matter on September 9, 1983. The R&O provided for: 1) allowing additional Class II stations to operate pre-sunrise with daytime antenna systems, 2) permitting Class II and Class III daytime stations to operate post-sunset, and 3) using diurnal curves in making the interference calculations.

Most commenting parties in the matter of post-sunset operation for Class III stations concurred with the concept, but they believed that interference protection should be provided. The Commission conducted some representative interference studies and found that interference would be excessive, as indicated in the comments. The Commission therefore adopted rules to permit post-sunset operation, but at the highly restrictive powers calculated two hours past sunset in the most restrictive time of the year.

For Class II-D stations, the Commission chose a post-sunset protection scheme for the dominant stations that assumed the nighttime 0.5 mV/m 50% contours for the Class I stations had fully developed at the time of sunset at the Class I station locations. The approach provided a margin of safety, as the actual contour develops slowly during the entire transitional period. The Commission concluded that the Class II-D station operating post-sunset could not produce a skywave signal of more than 25 uV/m at the Class I station's 0.1 mV/m contour. This restriction allowed post-sunset operation while protecting the Root-Sum-Square (RSS) interference value.

The actual power levels permitted were such that once sunset occurred at the daytime-only station, it would reduce power (using daytime or critical hour facilities) sufficiently so that at the time sunset occurred at the dominant station, the daytime-only station would produce a skywave signal of no more than 25 uV/m at any point on the dominant station's 0.1 mV/m contour. Additionally, if the daytime-only station was outside the dominant station's 0.5 mV/m 50% contour, then a further power reduction would be necessary to protect the skywave contour. Daytime-only stations east of a dominant station



and within its protected skywave contour would have to go off the air at sunset at the Class I station. Finally, daytime-only stations west of the dominant stations and within the protected skywave contour would not qualify for post-sunset operation. Power was limited to 500 watts, or the daytime power, whichever was less. Pre-sunrise operation for Class II stations was adopted as proposed in the Notice.

The Commission received a petition for reconsideration from the Daytime Broadcasters Association (DBA) to relax further the power restrictions on daytime-only stations. Specifically, the petition called for a modification in the way the diurnal curves were applied to Class II protection criteria. DBA also urged the Commission to use other than "worst-case" conditions for calculation of permitted power for Class III stations. DBA supplemented its petition and several other parties filed comments.

As a result of the reconsideration, for Class III stations, the Commission broke the two-hour post-sunset period into two sections for those months when sunset occurs before 6:00 p.m. local time. The calculation of power for the first hour after sunset (or until 6:00 p.m.) would be determined based on the effects at a half hour after sunset. This provided substantially higher powers than the two-hour after sunset worst case calculations. After the first hour or after 6:00 p.m. local time, whichever is later, the worst case power would be used. The Commission also adopted a 100 watt minimum for the first period.

The Commission studied the proposals in the petition for reconsideration, as supplemented, for Class II stations and concluded that excessive interference could result if the previously adopted rules were relaxed. Therefore, no changes were adopted for Class II stations. The Commission did note that there might be some additional options for daytime broadcaster relief, such as, a preference for daytime stations seeking unlimited-time AM assignments or a preference for FM assignments.

The Commission then received a petition to reconsider its previous reconsideration. The petition was filed by the Association for Broadcast Engineering Standards (ABES) and DBA. The petition urged termination of the proceeding with resolution of outstanding matters. A compromise position was offered relating to Class III post-sunset operation. The Commission accepted the compromise and terminated the proceeding on November 30, 1984. The following modifications were adopted: 1) for the first 30 minutes following sunset, powers would be calculated at sunset plus 30 minutes, 2) for the next 30 minutes, powers would be calculated at sunset plus 60 minutes, and 3) for the next hour, powers would be calculated at sunset plus 120 minutes. Finally, during the period until 6:00 p.m. local time, power would be as follows:

<u>Calculated Power</u>	<u>Adjusted Minimum Power</u>
From 1 watt to 45 watts	50 watts
Above 45 watts to 70 watts	75 watts
Above 70 watts to 100 watts	100 watts

The compromise provided a "sound public interest basis on which to resolve the outstanding issues," according to the Commission's Order. Thus, a very complex issue was resolved in a manner that provided extended opportunities for daytime-only broadcasters without causing excessive interference to unlimited-time stations.

In a similar, but unrelated, issue, the Commission acted to consider allowing increases in the nighttime power levels of Class IV stations. On October 19, 1983, the Commission adopted a Notice of Proposed Rule Making and Memorandum Opinion and Order (Docket 79-265) to examine what relief might be available to enhance Class IV nighttime coverage. Class IV stations were operating with nighttime powers of 250 watts or less and the Commission proposed a four-fold increase in power.

Comments were received from 177 radio stations and five broadcast trade organizations. All favored the increase in power, but differed in the details of implementation. Although some suggested that increases in antenna height could be used to assist in nighttime coverage, the Commission remained with its original proposal of the power increase, noting that some stations could not take advantage of antenna changes.

Most stations that were already operating non-directionally daytime at the 1,000 watt level were automatically allowed to increase nighttime power to 1,000 watts. Stations operating with directional antennas or with less than 1,000 watts daytime had to file Form 301 proposing to increase power. The Commission, for purposes of this proceeding, considered such an application as a minor change.

Although the FCC adopted the procedures for Class IV nighttime power increases in March 1984, implementation had to be delayed until December 1984, because of the need to finalize treaties with Mexico and Canada. The modified Rules became effective December 15, 1984.

Both of the above described actions constitute significant steps toward enhancing opportunities in the AM band, especially with regard to post-sunset and nighttime operation. The Commission, as indicated in Docket 82-538, will be considering other issues to improve further the options available to AM broadcasters.

NOTE: The opinions and interpretation of facts presented in this paper are those of the author and not necessarily those of the Federal Communications Commission.

---

The GRAIL System - SCA Technology Meets With Success !

Howard M. Ginsberg, President  
Communications Engineering, Inc.  
Essex Junction, Vermont

The Greater Resort Area Information Link (GRAIL) is certainly a marketing success, making use of the de-regulated Subsidiary Communications Authority (SCA) available through most domestic FM stations.

The Federal Communications Commission (FCC) lifted strict regulations on FM SCA frequencies in the spring of 1983 and at that time, John L. Eddy, GRAIL, Inc. founder, approached Communications Engineering, Inc. to design a system that would allow the use of current technology, whether it be FM SCA's, telephone lines, television SCA's, SAP's or whatever, to transmit data from computers, for reception as television graphics and text - Teletext via radio ! There was certainly a need for the dissemination of "resort" information to hotels and condominium units throughout the Stowe and Sugarbush Valley areas of Central Vermont, ski capital of the Northeast.

Stowe and Sugarbush are quickly becoming year-round resort communities. Resort information includes advertisements, directions to restaurants, movie theatres, and ski slopes, as well as ski conditions, ski preparation, weather conditions, entertainment options, etc.

The FM SCA was recommended to broadcast this data at whatever speed might be necessary, up to the bandwidth limitations inherent with the use of an SCA channel. Three-hundred baud was chosen since it took approximately twenty-five seconds to read a television screen of text information with the font style specified. At this rate, the viewer was not rushed while reading the information and it was not displayed for too long a period of time. Three-hundred baud, a common data

transmission rate, was certainly adequate for the GRAIL use.

The method used is not at all complex (see Figure 1), using a dedicated Telco type 3002 data circuit to transmit the host computer information to the SCA 67KHz generator at the WNCS(FM) transmitter site located in rural Middlesex, Vermont. WNCS is a Class A FM station operating with 400 watts effective radiated power and an antenna height of 700 feet above average terrain. WNCS was chosen since its 1 mV/M (60dBu) coverage area encompassed the Sugarbush Valley area and Stowe was just beyond this contour.

WNCS was built in 1977 and has a state-of-the-art transmission system including a transmitter and FM antenna with sufficient bandwidth to accommodate an SCA signal with no degradation to the baseband audio or SCA itself.

Because of hilly terrain, mountains of 2000 feet above sea level not uncommon, it was imperative that each GRAIL receiving site have the best off-air reception possible. McMartin FM SCA receivers were chosen because of their availability, specifications and capability to provide an SCA and main channel audio output simultaneously.

WNCS had previous concerns about "birdies" on their received signal. The concerns were certainly justified after the station manager had attended an NAB teleconference during which this was expressed as a major "problem" after an SCA was added to a stations signal. If this were to become a problem with the addition of the GRAIL subcarrier on WNCS, the GRAIL would cease operation. This has not been reported as a problem and to this date the GRAIL has had to remove the SCA generator for minor repair and calibration and has lost only six hours of broadcast time over its fourteen month existence.

During installation, SCA injection was set to four percent of total FM modulation with 4 KHz deviation of the subcarrier. The Gates TE-3 exciter was modified to accept an external SCA generator signal and audio proof of performance measurements were conducted on WNCS.

Audio performance was found to be typical of previous measurements with no measurable difference in stereo separation, 38 KHz suppression, crosstalk (subchannel to main channel or main to subchannel) or baseband FM noise. All measurements exceeded the FCC's minimum specifications for FM stereo facilities.

The GRAIL/WNCS agreement required WNCS's audio to be available during teletext transmission and the Commodore 64 receiving computers were modified to accept the SCA receivers main channel audio output and broadcast WNCS's audio, along with the computers video output, through the video/audio modulator of each receiving computer. The TV/RF signal was distributed to individual hotel units through the master antenna systems of the

receiving sites. Commodore VICMODEMS were modified to accept SCA data, rather than telephone transmissions.

Commodore 64 home computers were chosen since they made graphics, communications and text information available at a low price. Fourteen year-old Wilson Snyder, son of another Vermont broadcast engineer, developed the software necessary to edit and send the GRAIL text and graphics information as well as receive and decode this information for distribution throughout the receiving sites.

Although a disc drive based system was used for the host/transmitting computer, it was found to be inadequate for the receiving sites since its was inherently slow and required operator intervention after a power failure or transmission equipment problem. A PROM cartridge was programmed for the Commodore 64 game port. The PROM software is necessary to decode the received ASCII data into teletext information. Receiving computers now boot automatically after a power failure and at most, an operator may have to cycle the receiving computer off and then on again to re-boot the receiving software. All receiving computers are self-sufficient and not a burden on the condominium/hotel operators and owners.

Since there is no need for receiving and host computers to talk to each other, synchronous data transmission (e.g. one-way) is used. The computers are "synchronized" to each other through software control and if the data stream is interrupted, a one-page lock-up is required.

Certainly the GRAIL system has proven that data transmission can generate income and make efficient use of SCA's available on most FM broadcast stations. Technically, the equipment necessary is inexpensive and easy to operate. Financially, it generates income from advertising through the use of text and graphics pages and through subscriber fees based on condominium or hotel units receiving the GRAIL information. This information can be quite unique in nature and can be updated as often as necessary.

The potential of the GRAIL system is enormous. It can easily handle higher data transmission rates. The existing GRAIL system is constantly looking for improvements and is currently considering downloading of high-resolution (hi-res) graphics overnight at higher transmission speeds. This is necessary because of the large amount of data necessary for hi-res graphics. The receiving computers can then call up this information from their own memory during regular transmissions with a default page should something have gone wrong with the hi-res data transmission. Bank-switched memory on receiving computers would increase the capabilities of Commodore 64 hi-res graphics pages.

Teletext systems currently allow transmission of much higher data rates - - - is it really necessary? The GRAIL has proven that 300 baud is adequate for transmission of a page of

information and still allow plenty of time for the viewer to understand it.

Future needs, however, may dictate increasing transmission rates and FM SCA's will still be adequate since data transmission rates well in excess of 300 baud, such as 9600 baud (a 32 fold increase in data transmission speed), have been used successfully when sending data in this so-called indirect mode. Data is transmitted as frequency shift keyed audio. Increased data rates would require using a wider bandwidth SCA channel and receiver. An alternative method is direct modulation which actually turns on and off certain subcarrier frequencies at varying rates. Direct and indirect methods are discussed in greater detail in the 1984, 38th Annual Broadcast Engineering Conference Proceedings (see Data Transmission Via FM Subcarriers by Eric Small). Direct SCA modulation can increase the efficiency of data transmission on SCA's in that audio bandwidth is not increased when transmitting data at higher rates.

The GRAIL has chosen to present itself in a "viewer-friendly" manner which is easy and pleasing to read, yet does not rush the viewer. In addition, it cycles once every sixteen minutes allowing the point to get across but not bore the viewer.

The GRAIL system had been an overwhelming success for both a local entrepreneur and a small market, low power FM station. The use of the SCA as a simple audio channel and transmission of data from a well thought out programming technique has stemmed into a lucrative venture with endless possibilities.

#### GRAIL TRANSMITTING SYSTEM



#### GRAIL RECEIVING SYSTEM

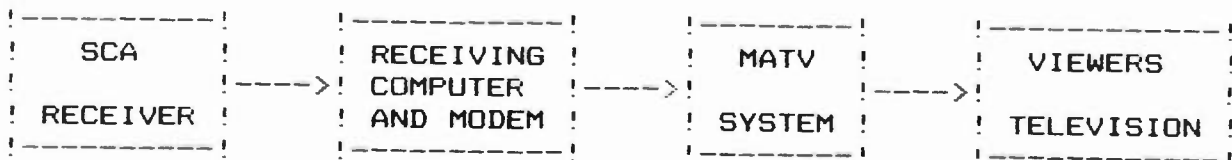


FIGURE -1-

#### THE GRAIL SYSTEM

#### BLOCK DIAGRAM

---

A STUDY OF THE FEASIBILITY OF USING  
COMMERCIAL AM BROADCAST STATIONS FOR TRANSMITTING  
ELECTRIC UTILITY LOAD MANAGEMENT SIGNALS

By Frank M. Hyde, Consultant  
Pacific Gas and Electric Company

Notice: The report, from which this paper was extracted, was prepared by Pacific Gas and Electric Company (PG&E). Neither PG&E, nor any of its employees, or agents, make any warranty, express or implied, or assumes any legal liability or responsibility for the accuracy, completeness, or usefulness of any information, method, product, or process disclosed in this paper.

BACKGROUND

Pacific Gas and Electric Company (PG&E), headquartered in San Francisco, serves approximately 3.6 million electric and 3 million gas consumers throughout most of Northern California. Its sales of electricity in 1983 exceeded 58,000,000,000 Kilo-Watt hours.

Residential direct load control, which is the primary focus of this paper, is a specific implementation of load management. Load management, or as it is known generically demand side planning, is defined by the Institute of Electrical Engineer's Load Management Subcommittee as follows:

"Demand-side management is an emerging concept which provides an option in (electric) utility planning incorporating customer end use or demand-side activities as alternatives to supply-side options to optimize the utility's objectives consistent with achieving corporate or institutional goals."

Although demand-side management can take many forms, direct load control has been the prevalent method used to date in this country. Residential direct load control is remote control of major consumer appliances, e. g. air conditioners and water heaters by electric utilities. The criterion for invoking control is usually when the margin of electric generation deteriorates to a level at which continuity of system operation is jeopardized.

In the U. S. A., load control is almost exclusively based on voluntary participation. An incentive is paid to those consumers who participate. In some countries, load control is a condition of service.

The growth of demand-side option activity has been motivated by utilities attempting to stem the increasing cost of electricity, provide consumers with options to reduce their energy costs, respond to mandates from public utility regulatory agencies and improve public relations. Figure 1 illustrates the growth of direct load control in the U. S. A.

PG&E's experience with direct load control began in 1977 with a small test project employing VHF radio to remotely control air conditioners. This project was the first step in complying with a mandate from the California Energy Commission (the Commission). In that year, the Commission adopted a standard requiring eligible utilities in the state of California to have eight percent of its consumers' residential central air conditioners and two percent of its water heaters under control. This required PG&E to install approximately 55,000 air conditioner controllers and 8,000 water heater controllers.

By the end of 1983, the number of installations had grown to in excess of 70,000 control points. At that time, the water heater program was terminated because of low customer participation and insufficient load reduction. Figure 2 shows the growth of direct load control at PG&E. Subsequently, the Commission charged PG&E to investigate and resolve several issues related to the cost-effectiveness and long term viability of the load management. The project has not been expanded during this period of study,

PG&E has studied several alternative communication media in evaluating methods of improving the cost effectiveness of direct load control. The subject of this paper is a summary of results from the interim report of the study of one of these media, the use of Secondary Multiplexed Transmission (SMT) via commercial Amplitude Modulated (AM) broadcast radio stations.

The AM-SMT study was conducted by a project team composed of representatives from various PG&E departments and a broadcast industry consultant, Hammett & Edison, Inc. The complete interim report may be obtained by contacting Mr. Vincent A. Baclawski, Project Manager, PG&E at (415) 972-4843.



# RESIDENTIAL DIRECT LOAD CONTROL--USA

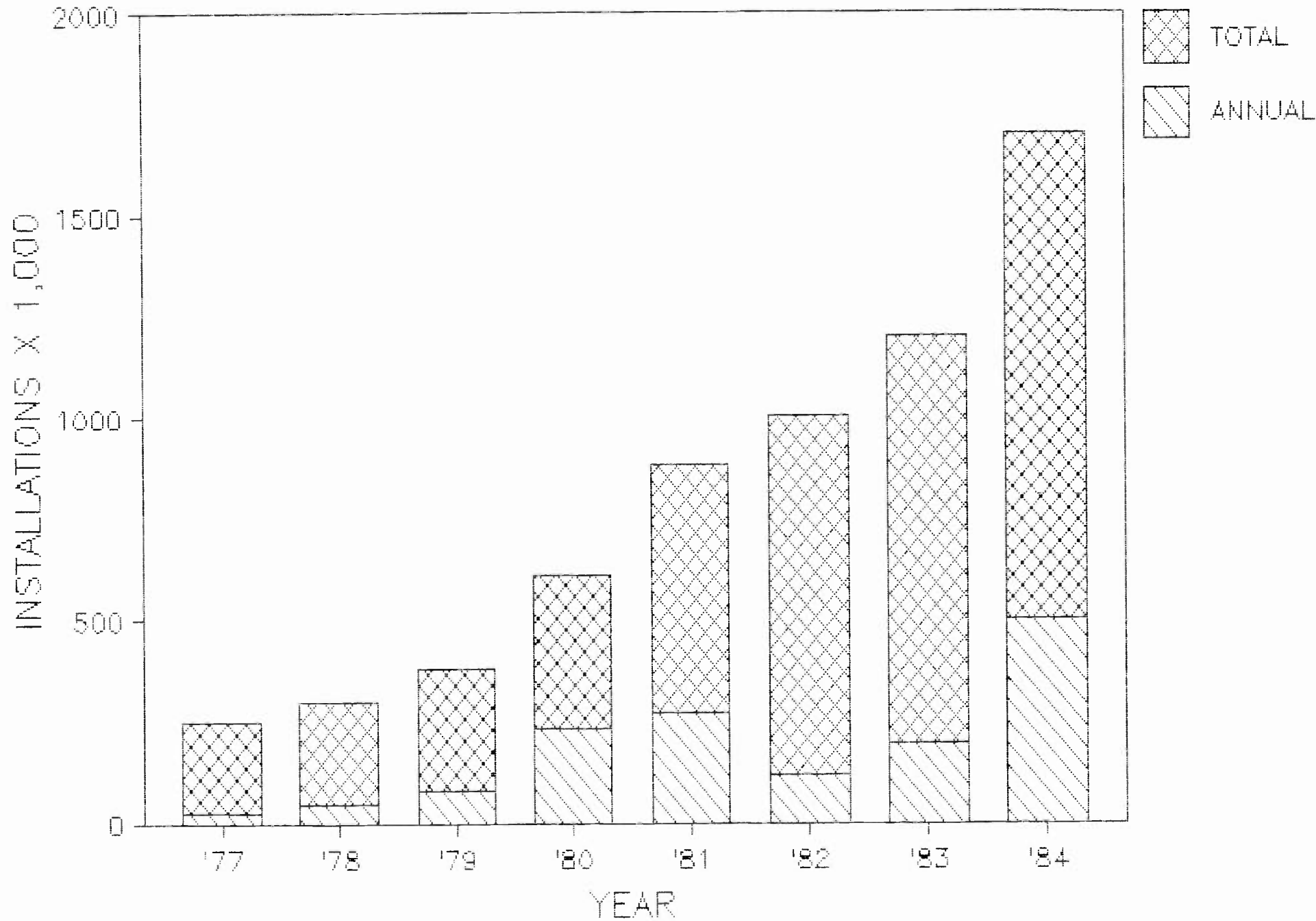


Figure 1

# RESIDENTIAL DIRECT LOAD CONTROL--PG&E

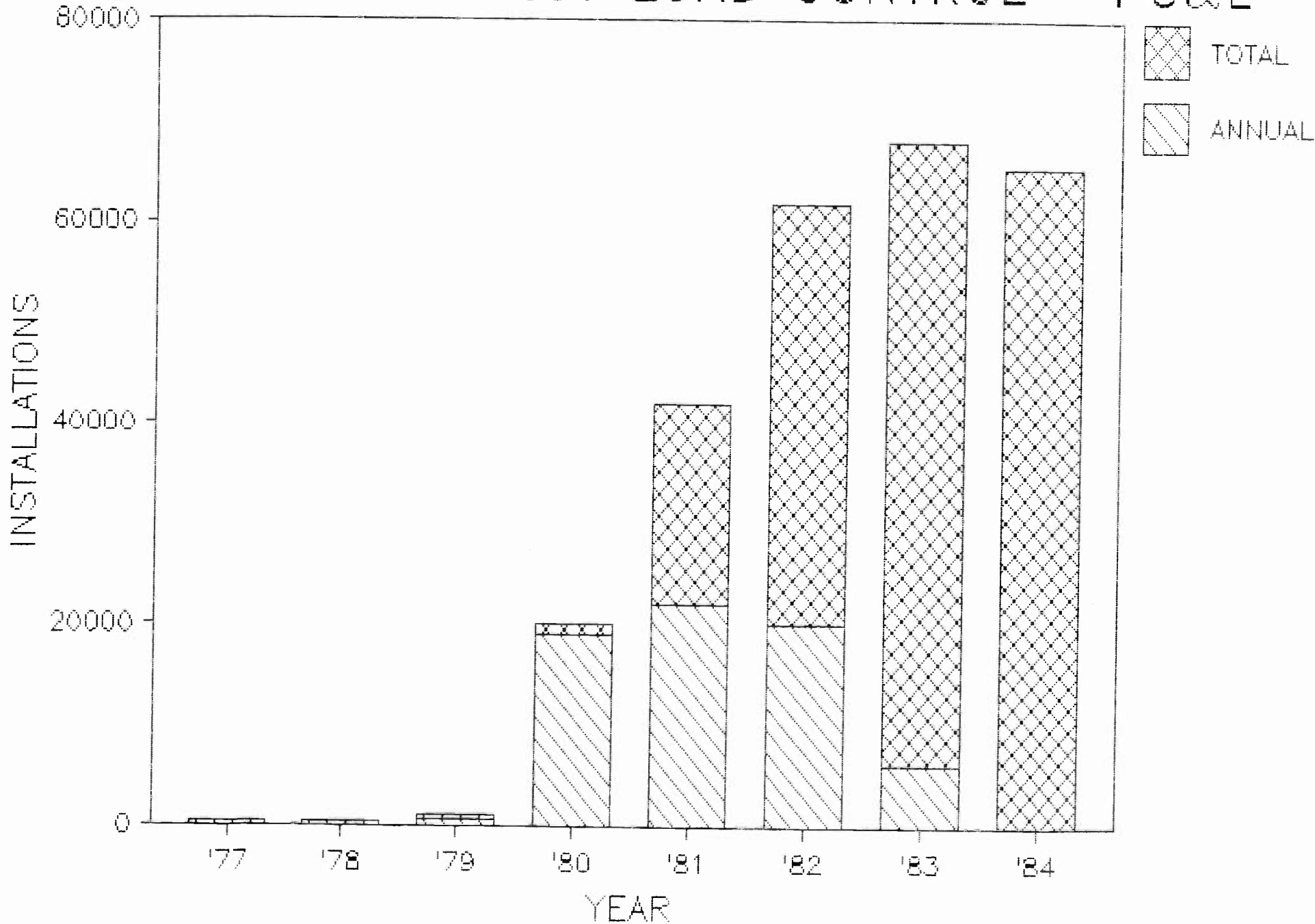


Figure 2

## INTRODUCTION

PG&E is deeply committed to the development of load management programs to supplement supply-side planning so that future electric demands can be met. Much of the LM activity to-date involves the use of VHF radio for direct control of residential consumers' air conditioners. To accomplish this, PG&E has installed a network of 12 VHF radio transmitters in strategically selected locations throughout its service area. Figure 3 shows the PG&E service area and the deployment of these transmitters.

The performance and reliability of the existing VHF communication system has generally been judged to be sufficient for current LM applications. However, the following factors restrict its performance.

- o PG&E must time-share the VHF frequency allocated for LM use with the Southern California Edison Company and the Sacramento Municipal Utility District. This sharing significantly reduces the effective signalling capacity and response time of the LM system.
- o The VHF system has not yet demonstrated adequate signalling reliability to be used for remote control of revenue meter functions.

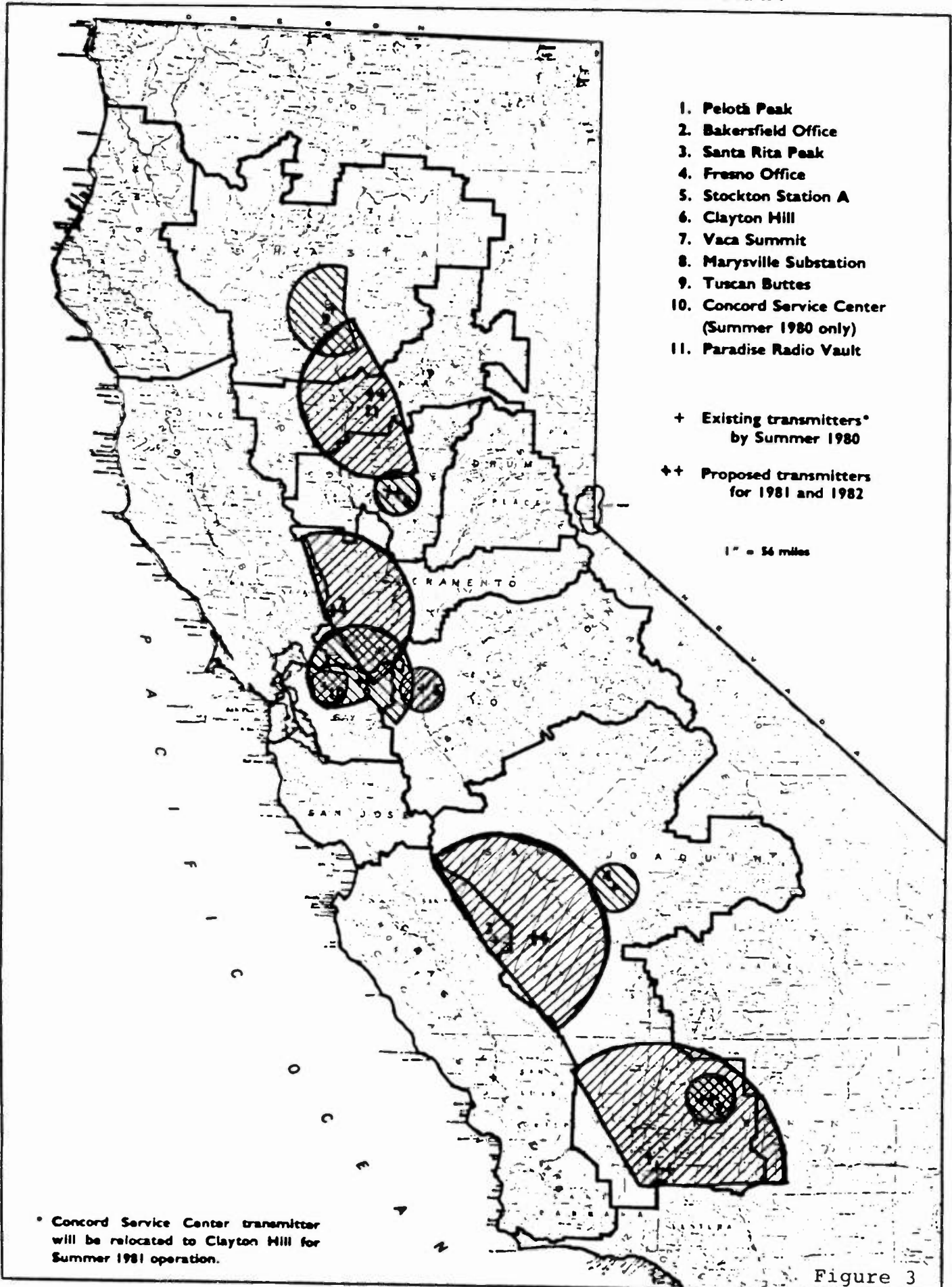
As part of an ongoing effort to keep abreast of emerging communications technologies that could improve LM performance, PG&E has tested the following communication technologies.

- o High frequency, bidirectional powerline communications
- o Low frequency, unidirectional "Ripple" powerline communications
- o VHF radio
- o AM broadcast radio

On July 1, 1982, the FCC authorized Secondary Multiplexed Transmission (SMT) of LM signals by AM broadcast radio stations. The potential advantages of AM-SMT are a direct result of the favorable technical characteristics of the AM broadcast band and FCC rules governing its use.

- o AM stations in this country are licensed to transmit at an effective radiated power of up to 50,000 watts.
- o Favorable propagation characteristics of the AM groundwave can provide reliable coverage over an extensive area.

**PACIFIC GAS AND ELECTRIC COMPANY  
 RADIO CONTROL SYSTEM TRANSMITTER RANGE  
 FOR RESIDENTIAL PEAK LOAD REDUCTION PROGRAM**



- 1. Pelotó Peak
- 2. Bakersfield Office
- 3. Santa Rita Peak
- 4. Fresno Office
- 5. Stockton Station A
- 6. Clayton Hill
- 7. Vaca Summit
- 8. Marysville Substation
- 9. Tuscan Buttes
- 10. Concord Service Center  
(Summer 1980 only)
- 11. Paradise Radio Vault

+ Existing transmitters\*  
by Summer 1980

++ Proposed transmitters  
for 1981 and 1982

1" = 56 miles

\* Concord Service Center transmitter will be relocated to Clayton Hill for Summer 1981 operation.

Figure 3

- o The extensive coverage of AM broadcast transmitters simplifies the design, installation and operation of LM communications network and can reduce maintenance costs.
- o AM receivers can be designed with fewer components, resulting in lower equipment costs and increased reliability.

Signals from a single AM broadcast station can provide reliable coverage over a large area. Figure 4 illustrates the coverage of radio station KMJ atop Santa Rita Peak. KMJ's coverage extends over an area of 44,200 square miles. PG&E's VHF LM station, also atop Santa Rita Peak, provides 11,700 square miles of coverage. Most VHF stations serve a much smaller area. Figure 5 compares the coverages of the Santa Rita Peak VHF transmitter and KMJ's transmitter.

The coverage contours in Figure 5 were calculated using actual transmitter parameters and accepted propagation prediction techniques. The signal level used for the calculation of AM signal coverage was based on an LM receiver with a sensitivity of 0.5 Millivolt per meter, not the level required for acceptable reception on an aural receiver.

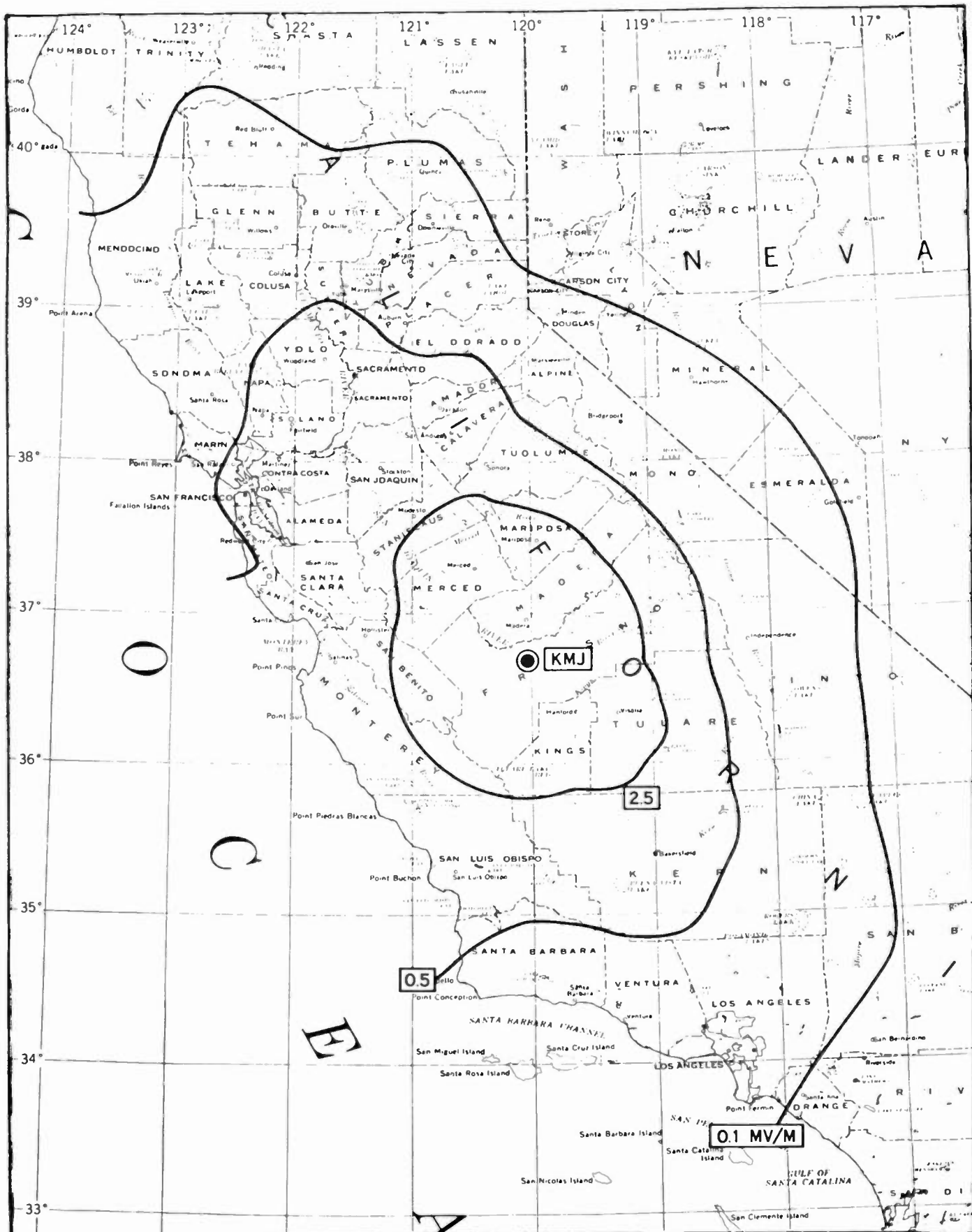
For AM-SMT to be a viable LM communications option, the advantages of the technology must offset its potential disadvantages. Contract terms must be developed and successfully negotiated with radio station owners to solve the following potential disadvantages of AM-SMT.

An element of uncertainty is introduced by PG&E's dependence on AM stations owners who might eventually view the transmission of LM signals as restrictive to his business opportunities.

LM and other potential uses of AM-SMT are recent business opportunities for AM station owners. As a result, no tariffs have been established. Furthermore, while utilities would prefer a tariff based on marginal business, broadcasters have traditionally based advertising tariffs on listenership. Broadcasters may, therefore, be inclined to base their tariffs for LM on the number of control points installed. This could result in costs that are greater than those required to upgrade the performance of the existing VHF. Or, the costs may be too great for a favorable cost-effectiveness ratio for LM.

While utilities may expect to negotiate contracts reserving exclusive use of a broadcaster's AM-SMT channel for a 10 to 15 year period, it is not unusual for radio station ownership to change more frequently.

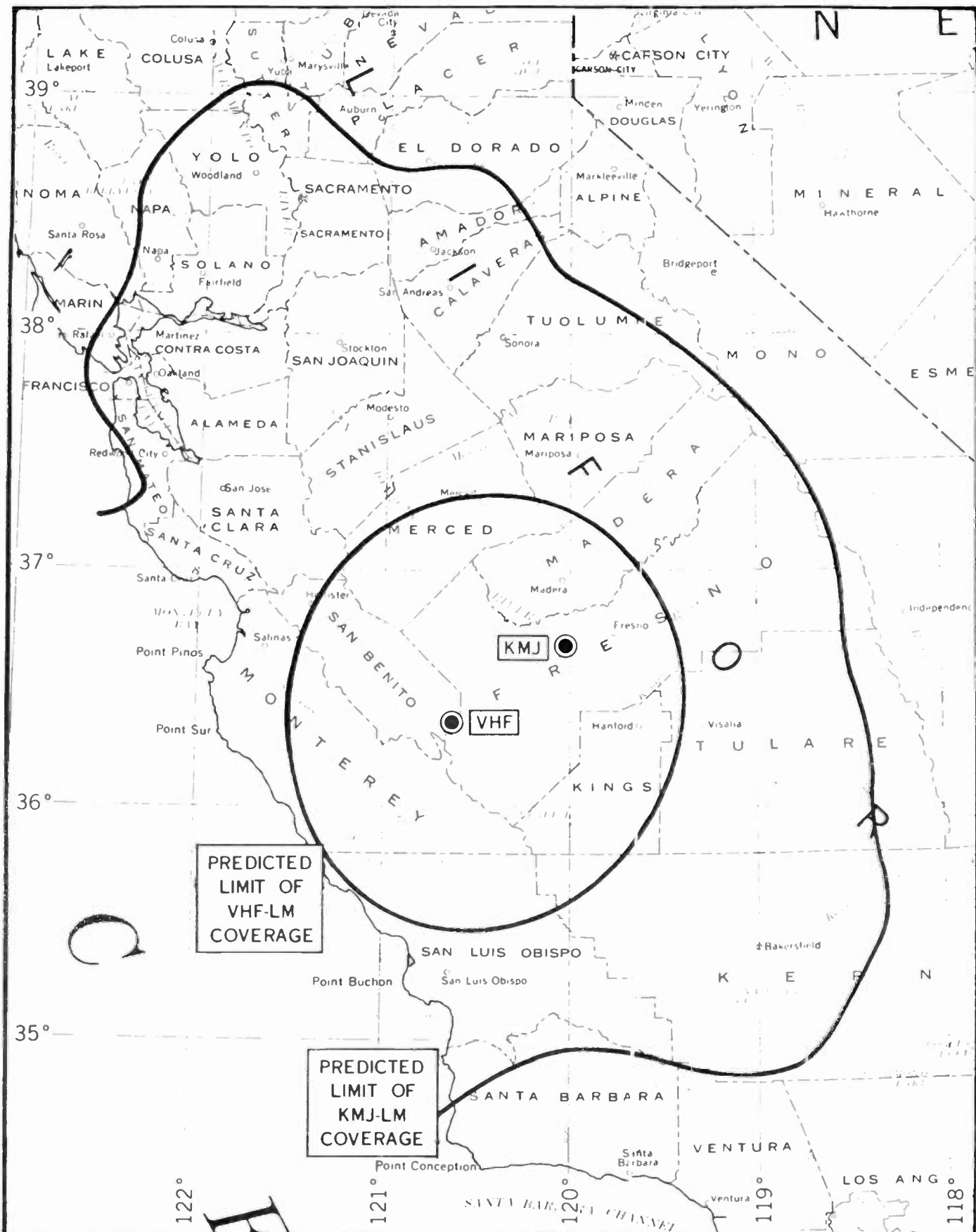
If the final solution to AM stereo compatibility necessitates exclusive use of monaural radio stations with restrictions preventing conversion to stereo transmission, then station owners may be reluctant to participate.



**GROUNDWAVE COVERAGE**  
**RADIO STATION KMJ**  
**580KHZ. 5KW. ND-U**  
**FRESNO, CALIFORNIA**  
**BASED ON M3 SOIL CONDUCTIVITIES**  
**JUNE 22, 1984** **FIGURE 4**

HAMMETT & EDISON, INC.  
 CONSULTING ENGINEERS  
 SAN FRANCISCO

© COPYRIGHT 1984  
 PACIFIC GAS AND ELECTRIC  
 COMPANY



PREDICTED  
LIMIT OF  
VHF-LM  
COVERAGE

PREDICTED  
LIMIT OF  
KMJ-LM  
COVERAGE



THEORETICAL DAYTIME  
LOAD MANAGEMENT COVERAGE  
FOR AM STATION KMJ  
AND SANTA RITA PEAK  
VHF STATION

HAMMETT & EDISON, INC.  
CONSULTING ENGINEERS  
SAN FRANCISCO

© COPYRIGHT 1984  
PACIFIC GAS AND ELECTRIC  
COMPANY

OCTOBER 24, 1984

FIGURE 5

The FCC recently removed the exclusive use of AM-SMT for LM. Utilities must now compete with other potential users of AM-SMT. As a result, the preferred radio stations may not be available and costs for the use of AM-SMT may escalate.

The Project Team has taken a conservative attitude in this investigation. Conservatism is justified in view of the following: PG&E has no pressing requirement for a system-wide expansion of LM; there are a number of unresolved issues relating to the feasibility of AM-SMT for load management; and, as a result of the stereo issue, the AM broadcast industry is in a state of flux. The Project Team's conservatism is especially evident in the position taken with regard to the emerging influence of AM stereo.

### CONCLUSIONS

The results of the Project Team's investigation stem from paper studies supplemented by laboratory testing. The decision to precede field testing with paper studies allowed the costs of purchasing and installing equipment to be avoided. Furthermore, the conclusion of these studies is that currently available AM-SMT-LM equipment is unacceptable because it is incompatible with AM stereo. The benefits of the decision to precede equipment testing with paper studies are apparent when compared to other studies that proceeded directly to field deployment of equipment.

Other electric utilities' studies have had an important influence on the results of this project. Information obtained from these studies has augmented the Project Team's work and influenced the design of the feasibility study.

The Project Team has concluded that additional testing is required to ascertain the communications reliability of AM-SMT. The results of this testing will provide valuable input for the final feasibility assessment, influence the design of the AM communications network and provide a benchmark for comparing AM-SMT with other communication options.

Acceptance of AM stereo in the broadcast market is not dependent on technical feasibility nor on equipment availability. AM stereo modulators with proven performance are commercially available. These modulators permit a monaural station to convert to stereo transmission at minimal cost and without degrading the quality of monaural reception.

The availability of AM stereo receivers through normal distribution channels and as original equipment from several leading automobile manufacturers is rapidly increasing. Motorola is consolidating its leading position by expanding the manufacturing capacity of its decoder chip and licensing other inte-



grated circuit manufacturers. This momentum will create an AM stereo market of sufficient size that compatibility must be considered as a criterion for selection of an AM-SMT technology. In light of the above and AM-SMT's subsidiary service classification, compatibility with stereo became a central topic of this study.

The Project Team has assumed a conservative posture regarding the need for compatibility with AM stereo. This conservatism is warranted because of the potential for PG&E to make a long term, large scale commitment to this technology. The current state of flux in the AM broadcast market is also an argument for conservatism.

It is necessary to state, however, that differing opinions have been expressed concerning the impact of AM stereo on the viability of AM-SMT load management. One contention is that AM stereo will not develop sufficient marketplace stature to warrant consideration. Another contention is that the responsibility for assuring non-interference with AM stereo resides with the radio station and should not concern PG&E. Until these conflicting opinions are resolved, the Project Team will maintain its conviction that compatibility is a criterion of feasibility.

Compatibility of load management modulation techniques with AM stereo is not easily resolved. While analytical and laboratory measurements can identify obvious sources of incompatibility, in the final determination, subjective judgments of the threshold of listener annoyance will be the deciding factor.

To complicate this determination, there is considerable variation in the performance of monaural and stereo AM receivers. Variations in receiver performance are due to the lack of universally applied technical design standards. As illustrated in Figure 6, many combinations of conditions must be assessed. For example, exclusive use of monaural stations for LM is not necessarily a solution to the stereo compatibility issue. Tests have demonstrated that a monaural station transmitting LM signals can create annoying distortions of main channel reception on a stereo receiver tuned to that station. This is because the LM signal may inadvertently activate the stereo decoder circuit. Figure 7 shows the results of laboratory measurements made to quantify some of these factors.

No viable solution to the compatibility issue can occur without cooperation of the stereo proponent whose technique is selected as a standard by the broadcast industry. Motorola's agreement to assist in the evaluation of LM modulation compatibility is a major step towards achieving a viable solution. It is hoped that recently initiated collaboration between Motorola and LM suppliers will expedite the development of a compatible modulation technique for LM. Motorola has told PG&E that it views the development of a C-QUAM compatible modulation technique as beneficial to its marketing strategy.

## FACTORS AFFECTING VIABILITY OF AM/SMT

OTHER STATION		
VARIABLES		
FREQ.	STEREO	SMT
0	0	0
0	0	1
0	1	0
0	1	1
1	0	0
1	0	1
1	1	0
1	1	1

EFFECTS			
PG&E RECEIVER		AURAL RECEIVER	
INTER	FALSE ACT.	STEREO	MONO
		X	X
		X	X
		X	X
		X	X

STATION IN USE	
VARIABLES	
STEREO	SMT
0	0
0	1
1	0
1	1

EFFECTS			
PG&E RECEIVER		AURAL RECEIVER	
INTER	FALSE ACT.	STEREO	MONO

**KEY:**

**FREQ (FREQUENCY OF BROADCAST STATION CARRIER):**

0 = NEAR CHANNEL

1 = ON CHANNEL

**STEREO (STEREO MODULATION OF STATION CARRIER):**

0 = NOT IN USE

1 = IN USE

**SMT (SECONDARY MULTIPLEXED TRANSMISSIONS)**

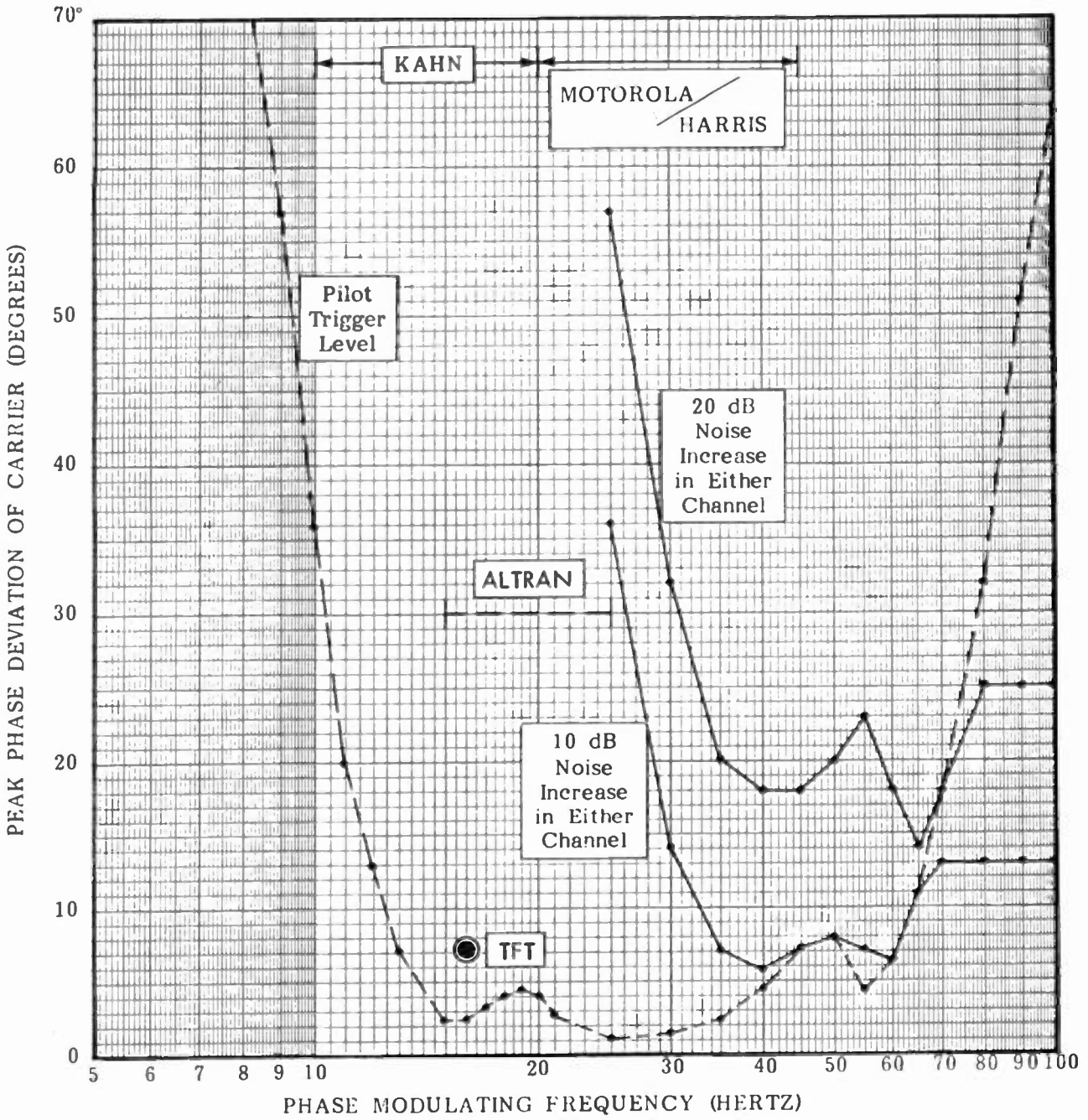
0 = NOT IN USE

1 = IN USE

**OBJECTIVE: FOR EACH COORDINATE, DETERMINE THE FOLLOWING:**

- 1) ASSESS PROBABILITY OF OCCURRENCE
- 2) IDENTIFY PARAMETERS WHICH CREATE UNFAVORABLE EFFECT
- 3) QUANTIFY
- 4) REFERENCE BASES OF CONCLUSIONS

EFFECT OF SINEWAVE PHASE DEVIATION  
ON SANSUI TU-S77AMX



Hammett & Edison, Inc.  
Consulting Engineers

840608.1

FIGURE 7

Development of an open AM-SMT LM technology has been promoted by the project team. Availability of a nonproprietary technology would enhance the possibility that multiple sources of supply will be available in the eventuality that PG&E makes a commitment to a full scale LM system.

AM listenership for the past several years has been lost to FM stations. AM station owners, seeking to regain lost income, are enthusiastic about the opportunity to market AM-SMT. A long term contract with an electric utility would provide a reliable source of income to the station owner. To PG&E, the potential for an inexpensive and reliable communication network that provides essentially total coverage of PG&E's service territory is appealing.

The potential benefits of AM-SMT for LM combined with the results obtained to date and the current activities to develop a viable modulation technique warrant PG&E's continued support of this technology.

#### FUTURE ACTIVITIES

The study of the feasibility of AM-SMT for load management will be restricted to the following activities until acceptable equipment is available.

- o Monitoring the progress of the AM broadcast industry in selecting an AM stereo standard.
- o Monitoring the progress of LM equipment manufacturers that are developing stereo compatible techniques.
- o Completing the design of the AM field test.
- o Maintaining communication channels with other electric utilities, EPRI and the stereo proponents.

A field test will be conducted when LM equipment with demonstrated stereo compatibility is available. The emphasis of the field test will be to study communications performance over typical communication paths in PG&E's service area. Should this study conclude that AM-SMT is a viable communication medium for LM, a recommendation will be made to conduct an equipment trial.

---

**A Compatible Data Transmission System**  
**For AM Stereo Stations**

Charles R. Patton, III

McGraw-Edison Co., Advanced Controls

Carson, California

**Synopsis**

A method of transmitting data by quadrature modulation of the AM stereo pilot tone and some of the considerations taken.

**History**

For some years, McGraw-Edison has promoted and sold a patented system of data transmission over AM stations. The system involves synchronous phase shift ( $+30^\circ$ ) modulation of the AM carrier at low baud rates, typically in the 20 to 50 baud region. Due to the phase-shift nature, low shift and low frequency used, there is no interference to the normal AM station listener. The special receivers used to recover this modulation are crystal controlled, phase-locked with matched (integrate and dump) detectors, yielding high noise immunity and reliable operation for use in utility load management programs. With the advent of AM stereo, stereo compatibility questions were asked, so research was undertaken to answer them. To ensure compatibility, the following questions must be answered satisfactorily:

- (A) Does the data effect the stereo?
- (B) Does the stereo effect the data?
- (C) If the answer is yes to either or both, then what compromises will be made?

A brief description of the monaural form and its evolution to the stereo form follows with answers to these questions.

### AM Monaural Plus Data

The process involves  $\pm 30^\circ$  phase modulation of a crystal oscillator with the data which is fed to the TX exciter (Figure 1).

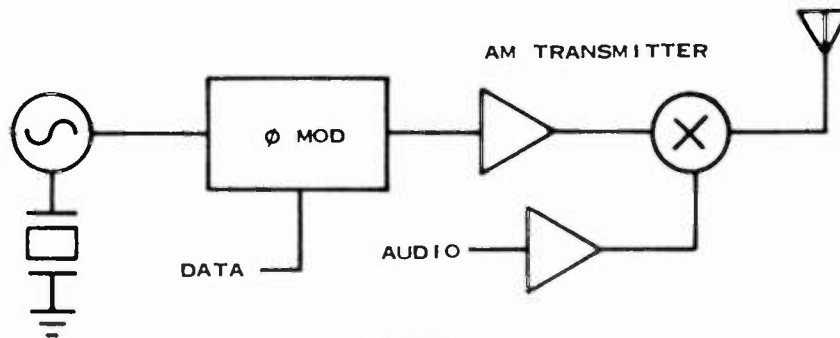


Figure 1.  
AM TX + Data

The data receiver (Figure 2) phase-locks to the AM carrier and recovers the data.

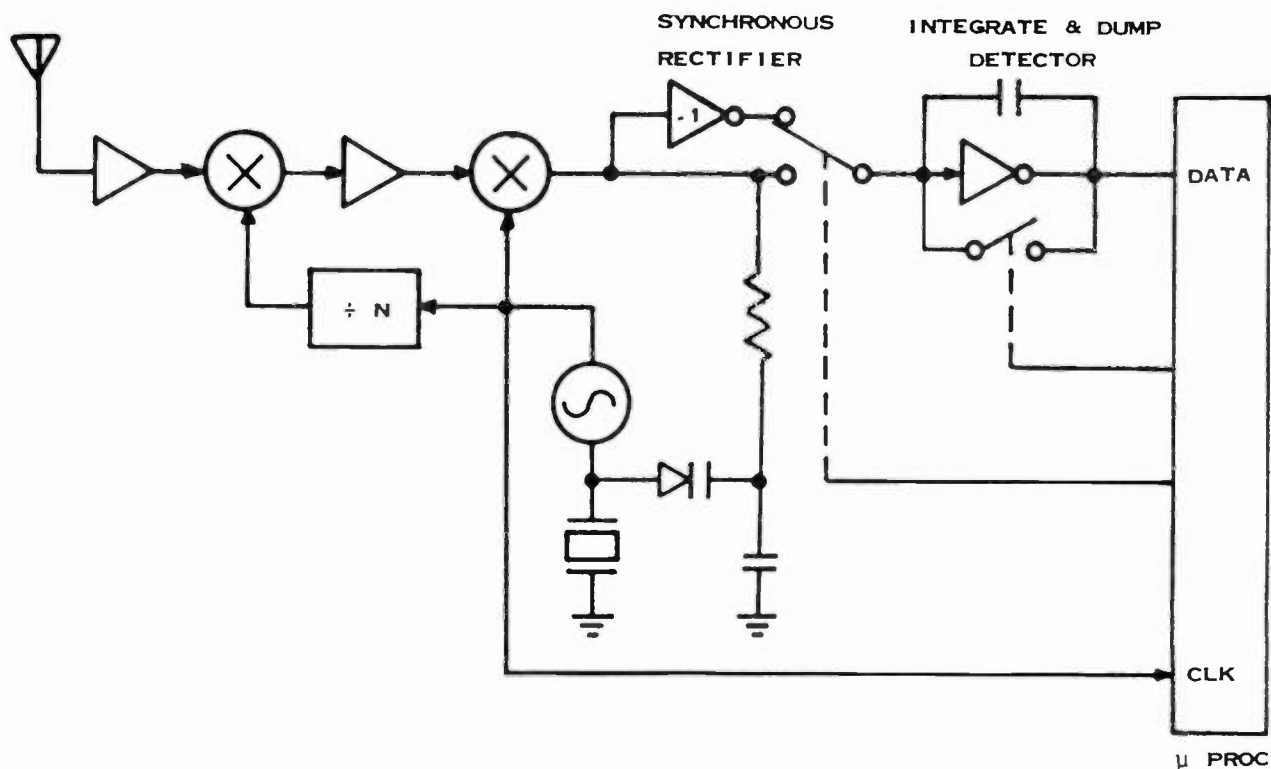


Figure 2.  
Receiver

### Stereo Plus Data

Due to the use of quadrature side bands to carry stereo information, stereo AM receivers are sensitive to phase modulation. Since the process of data modulation has been to phase modulate the AM carrier, it's necessary to reduce the frequency/baud rate of the data to the minimum possible to take advantage of the naturally declining human perception and speaker responses. Frequency choices of 30 Hz or less can give some 50 DB attenuation. Lowering the frequency however cuts down on the data throughput. Therefore, compromise is necessary and 20 to 30 Hz is a nominal range.

A first approach was to continue sending data as previously and add on the stereo information. Two immediate problems arise. Both involve data interference to the stereo system. First, the relatively high phase shift of  $\pm 30^\circ$  for the data signal can become audible as it is recovered by the stereo receiver, primarily as a L-R signal only 3.5 DB down from maximum modulation. Second, the frequency spectrum of choice, 20 to 30 Hz is also used by the AM stereo systems for a pilot tone to control the stereo indicator light. So, with the variable energy density nature of the data modulation, together with the stereo indicator pilot tone detector response window, false triggering on or off of the various systems' tone detectors may occur.

The next approach which is currently used is to use the pilot tone as a data carrier. By quadrature modulating the pilot tone (Figure 3) and thereby the phase  $\pm 45^\circ$  with biphase Manchester code, there is no average DC phase shift and the stereo pilot tone detector sees only the average monaural tone. (Figure 4).

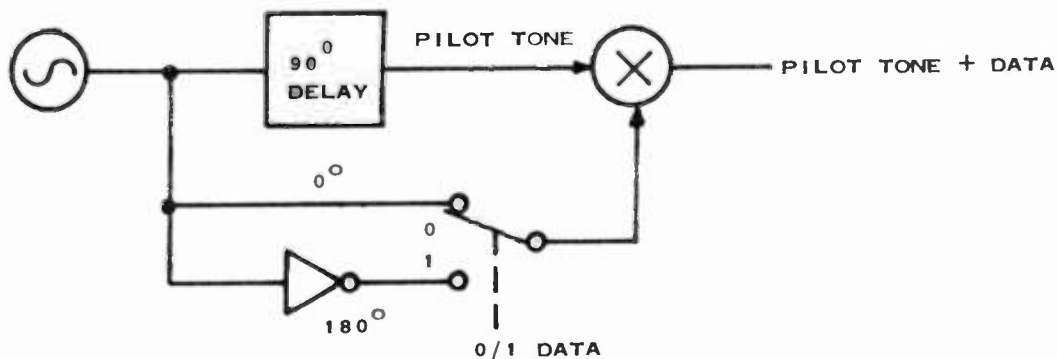
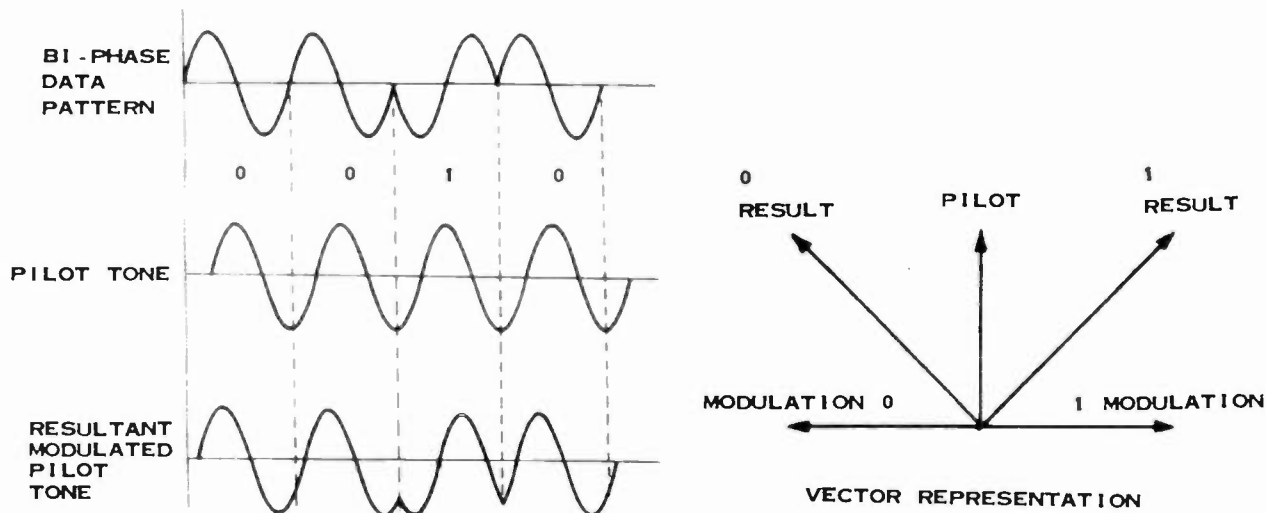


Figure 3.  
Pilot Tone Modulator



**Figure 4.**  
**Biphase Manchester Modulation**

This pilot tone/data is then injected normally into the sideband modulator of the stereo exciter. In Motorola's C-Quam<sup>®</sup> for instance<sup>1,2</sup>, this 25 Hz pilot tone results in 5% (-26 DB) quadrature modulation of the AM station carrier. Since nominal S/N ratios on the order of 50 DB for the AM radio station are expected, a S/N ratio of 24 DB (50 - 26 = 24 DB S/N) can be expected for the tone/data.

The transmitted Motorola C-Quam envelope is linear, but the I and Q sidebands are non-linear per:

$$\begin{aligned} \theta &= \tan^{-1}((L - R)/(1 + L + R)) \\ I &= (1 + L + R) \cos\theta && \text{:In-phase sidebands} \\ Q &= (L - R) \cos\theta && \text{:Quadrature sidebands} \end{aligned}$$

The significance is that since our data receivers are really phase-locked quadrature detectors, (Figure 1) during those periods of program material with high levels of stereo separation material, the AM carrier phase shift can equal  $45^\circ$  and therefore the non-linear modulation factor  $\cos\theta = .707$ .

This means that the recovered tone, consisting of the Q sidebands, is decreasing under heavy stereo material. However it does not undergo any phase shift, therefore with the matched detector, this decrease only shows as a minor degradation of the S/N (3 DB for the worst case example shown).



Of more general concern is the amount of stereo (L-R) energy placed in the pilot tone/data frequency spectrum by actual program material. This is still an open question and we are running laboratory tests and planning a field trial to gain data on this point. It is felt that there will only be sporadic energy content at this frequency and that for the few error bits caused, the error detection being used will give reliable data throughput.

### **Conclusions**

The process of using the pilot tone to carry data satisfies several criteria:

- 1) There are no extra carrier frequencies -- the pilot tone serves as the data carrier.
- 2) The levels are compatible with the pilot tone levels.
- 3) The in-audibility is comparable to that of the pilot tone since the data is in the same spectrum and of the same amplitude.
- 4) The process should be compatible with any AM stereo system that uses a pilot tone for stereo indication.
- 5) Lab tests confirm the viability of the process. Further co-company lab tests are scheduled. A field trial is in negotiation.

### **References**

1. Norman W. Parker, Francis H. Hilbert, "Compatible AM Stereo Broadcast System", U.S. Patent #4,218,586
2. Chris Payne, "Introduction to the Motorola C-Quam AM Stereo System", Motorola Technical Publication, Jan.'83

---

COMPUTER SIMULATION OF FSK DATA TRANSMISSION IMPAIRMENTS

ON FM AND AM SUBCARRIERS

Harry R. Anderson, P.E.

Consulting Engineer

P.O. Box 1547, Eugene, Oregon 97440

1.0 INTRODUCTION

The analysis of the performance of data transmission systems has traditionally involved the development of analytical solutions based on theories or models of how the various components of the system function. An analytical solution is an equation made up of known mathematical functions which, when supplied with the necessary dependent variables such as carrier-to-noise ratio (CNR), yields a desired performance parameter such as long term average bit error rate (BER). For example, the equation for BER in a binary FSK system operating in additive gaussian noise and using coherent detection is

$$\text{BER} = \frac{1}{2} \text{erfc} \left( \sqrt{\frac{A^2}{2\sigma^2}} \right) \quad (1)$$

where A is the signal amplitude,  $\sigma^2$  is the variance of the noise (hence,  $A^2/\sigma^2$  is the CNR), and erfc is the complementary error function. This equation was derived using mathematical functions which reflect the operation of the coherent detector and the impact of the gaussian noise. For an ideal transmission system with these characteristics, equation (1) provides the exact solution.

When the transmission system becomes more complicated, finding an analytical solution may become extremely difficult or impossible. Contemporary techniques for FSK detection use phase locked loop (PLL) detectors operating as frequency detectors. Unlike the coherent detector, the frequency detector is a nonlinear processor; the additive effects of the signal and noise at the output cannot be calculated by superposition. In fact, with gaussian noise present at the input to a frequency detector, the probability density function (pdf) of the output noise is decidedly nongaussian, although for certain circumstances a gaussian noise approximation does provide usable results [1]. The situation is further complicated when one or more interference components is also present at the input. The detector will generate harmonic distortion

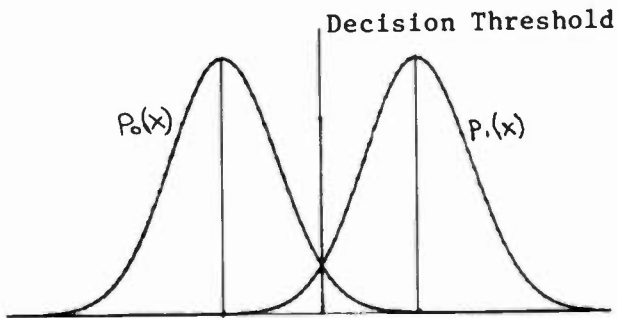


FIGURE 1A - Output Probability Density Function For Coherent Detector with Noise Only.

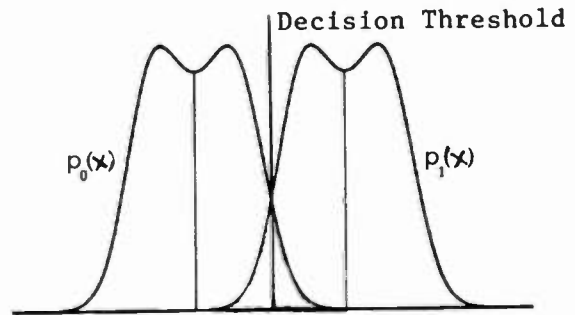


FIGURE 1B - Output Probability Density Function for Coherent Detector with Noise and Interference.

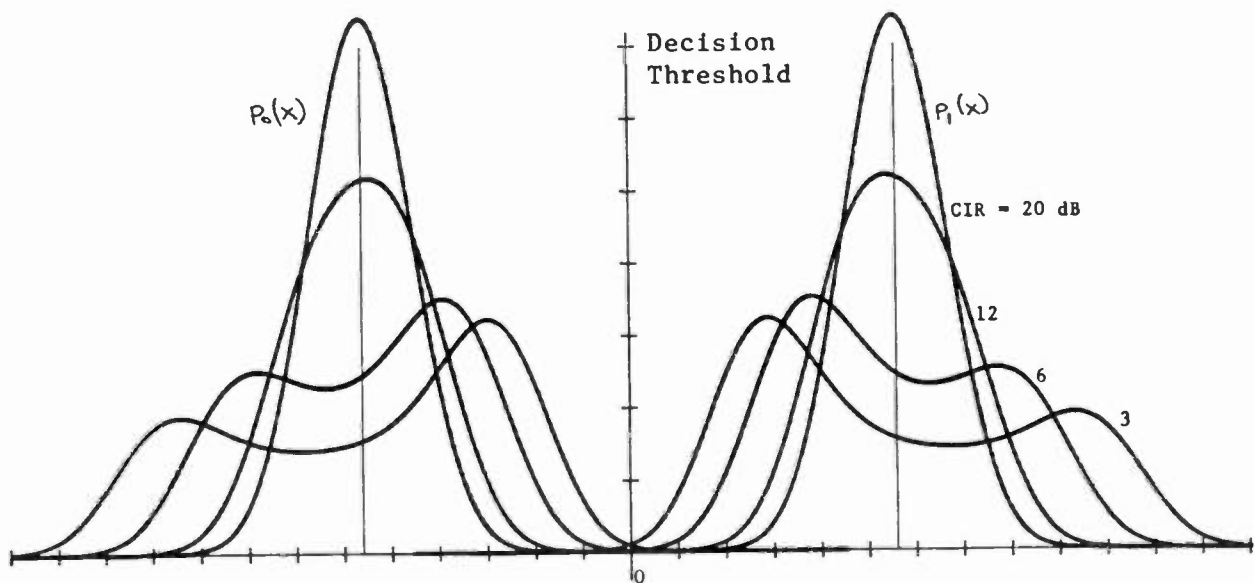


FIGURE 1C - Output Probability Density Function for Frequency Detector with Noise and Interference at the Input. CNR = 15 dB.

products at the output which, when considered with the noise, result in an output pdf which does not easily yield to an analytical solution. Figure 1A shows the output pdf for the coherent detector case with gaussian noise only at the input. Figures 1B and 1C show the output pdf for the coherent detector case with noise and a single sinewave interference at the input, and the frequency detector case with noise and a single sinewave interference at the input, respectively. Figure 1C was obtained by numerical methods. Clearly the pdf becomes unusual when the transmission system involves a frequency detector and a complex input signal.

When the transmission system is this complicated, the use of computer simulation becomes more attractive. A computer simulation does not derive answers based on analytical solutions. A computer simulation is a collection of software blocks which mimic (simulate) the performance of the hardware blocks in the actual transmission system. For example, using a random number generator in the computer software, a routine can be written which generates a

number (voltage) which is approximately a gaussian distributed random variable. The noise number is added to another number which represents the signal voltage at some point in time. The detector block is represented by an equation which is its transfer function. The result is a computer program which, as it is run, provides as output a series of numbers which represent the received output voltage of the transmission system. By evaluating these voltages in terms of a binary decision (i.e. if the output is greater than 0 volts, a binary 1 was sent), and comparing that to the data bit which was actually sent by the transmitter block, those bits in error can be recognized and an error rate calculated. The simulation is thus operated for thousands or millions of "transmitted" bits just as if it were an actual hardware system. Since the various channel impairment effects are represented by software variables, they can easily be changed to analyze different transmission situations.

The main drawback to simulation, and it is substantial, is the large number of program iterations which must be run to provide worthwhile results. The simulation must typically run 10 to 100 times as many samples as the inverse of the error rate; i.e.,  $10^7$  samples for a system with an expected error rate of  $10^{-6}$ . Even on large computers this can be time consuming, especially if the simulation includes the effects of filters and the real (nonideal) operation of circuit components.

The intent of this paper is not to provide an extensive tabulation of BER results with different subcarrier transmission impairment circumstances, but rather to show how computer simulation techniques can be applied to FSK data transmission on FM SCA subcarriers. The techniques can be equally well applied to low speed PSK data transmission on AM broadcast carriers. In particular, the impact on BER of interference components in the SCA channel can be addressed. Such interference may result from by-products of the stereo generator, bandwidth limitations in the transmission system, and multipath reflections. Characterizing the statistical nature of these interference sources is a subject for further research. However, by approximating the interference as multiple sinewaves of different frequencies and amplitudes in the SCA channel, a computer simulation could provide BER results which cannot be obtained by analytical methods or by simply considering the signal-to-noise or signal-to-interference power ratios in the SCA channel.

## 2.0 FUNDAMENTALS OF FSK TRANSMISSION

To better understand the system variables in the simulation, a brief review of frequency shift keying (FSK) transmission is in order. FSK is one of the oldest forms of digital modulation. It conveys information by the use of a discrete frequency to represent a single or sequence of data bits. In the binary case, two frequencies are used corresponding to a binary "0" and "1". Use of multiple frequencies can represent longer bit sequences (i.e., four frequencies can represent bit sequences "00", "01", "10", and "11").

Early forms of FSK modulation used step switching between frequencies in response to the data stream. Recent improvements to FSK include continuous phase FSK (CP FSK) [2], in which the phase of the carrier wave is adjusted at the switching instant to provide a smooth phase transition, and tamed FSK (TFM), in which the data stream is lowpass filtered (or otherwise subjected to an operation to lengthen bit-to-bit transition times) so as to provide

smooth rather than abrupt frequency transitions [3]. Rather than improve error rates, these methods primarily result in reduced spectrum occupancy as compared to hard switched FSK.

## 2.1 FSK Frequency Spacing

With binary FSK, one of the main parameters available to the system designer is the frequency spacing between the tones representing "0" and "1". To make the task of distinguishing between a 0 and 1 as easy as possible for the receiver, and thus achieve the best possible error rate, it is desirable to make the transmitted signals corresponding to 0 and 1 as different as possible. This can be done by minimizing the product of the two signals over one bit period,  $T$ . The two frequencies corresponding to 0 and 1 can be written as

$$S_1 = A \cos\left(\omega_c + \frac{\Delta\omega}{2}\right)t$$

$$S_2 = A \cos\left(\left(\omega_c - \frac{\Delta\omega}{2}\right)t + \theta\right)$$

where  $\Delta\omega$  is the frequency difference in radians between the two tones. The angle,  $\theta$ , is the phase difference between  $S_1$  and  $S_2$  at the switching instant.

The product integrated over  $T$  is

$$E = \int_0^T S_1 S_2 dt$$

which after some manipulation and eliminating terms which are small enough to be ignored, results in

$$E = \frac{A^2 T}{2} \cos\theta \left(\frac{\sin \Delta\omega T}{\Delta\omega T}\right) + \frac{A^2 T}{2} \sin\theta \left(\frac{\cos \Delta\omega T - 1}{\Delta\omega T}\right) \quad (2)$$

For  $\Delta\omega T = 2\pi n$ ,  $E = 0$  regardless of the value of  $\theta$ .

For  $\Delta\omega T = 1.15 \cdot 2\pi$ , the expression assumes its minimum value of  $-0.217$  if the transition phase is zero. This explains one virtue of continuous phase FSK. For  $\theta \neq 0$ ,  $E$  is not  $-0.217$  but can actually be greater than zero. Since setting the frequency spacing at  $\Delta f T = 1$  always yields  $E = 0$ ,  $\Delta f T = 1$  is often used.

Assuming  $\theta = 0$ , the first term takes on the familiar shape in Figure 2 showing  $E$  plotted as a function of  $\Delta f T$ . Orthogonality of the two signals occurs when  $\Delta f T = n/2$ , for  $n = 1, 2, 3, \dots$

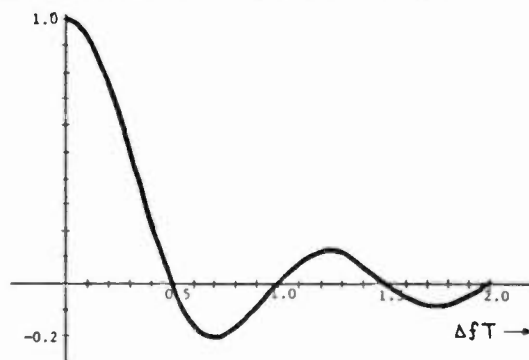


FIGURE 2 - Plot of First Term of Equation (2), normalized.

When the tone spacing is set so that  $\Delta f T = 0.5$ , it is known as minimum shift keying (MSK). When combined with continuous phase techniques at the switching time, CP MSK produces a narrow, rapidly decaying occupied spectrum and hence improved efficiency in terms of transmitted bits per occupied Hertz of bandwidth. It can also be shown that by using coherent detection with CP MSK and averaging over two bit periods ( $2T$ ) at the detector, the error rate performance of CP MSK is superior to FSK and identical to binary coherent PSK [4].

## 2.2 Detection of FSK

The types of FSK detectors usually analyzed in textbooks consist of two filters centered around the transmission frequencies, followed by envelope detectors. The outputs of the detectors are compared to determine which is the greater voltage, and a received 0 or 1 decision made on that basis. This is the noncoherent FSK detector. While this is the classic detector suggested by decision theory, it is hardly ever used in practice. Current day detectors are usually frequency detectors; that is, a circuit which produces a voltage which is proportional to the instantaneous input frequency. This has come about because of the availability of inexpensive integrated circuit phase locked loop (PLL) devices which serve as a quite linear frequency detector with low FM threshold levels [5]. Because of the commercial viability of this method, it will be most likely found in FM SCA receivers and therefore was chosen for use in this simulation.

## 3.0 SIMULATION OF AN FSK TRANSMISSION SYSTEM

Figure 3 shows a block diagram of the system to be simulated. Each of the major elements will be discussed in turn.

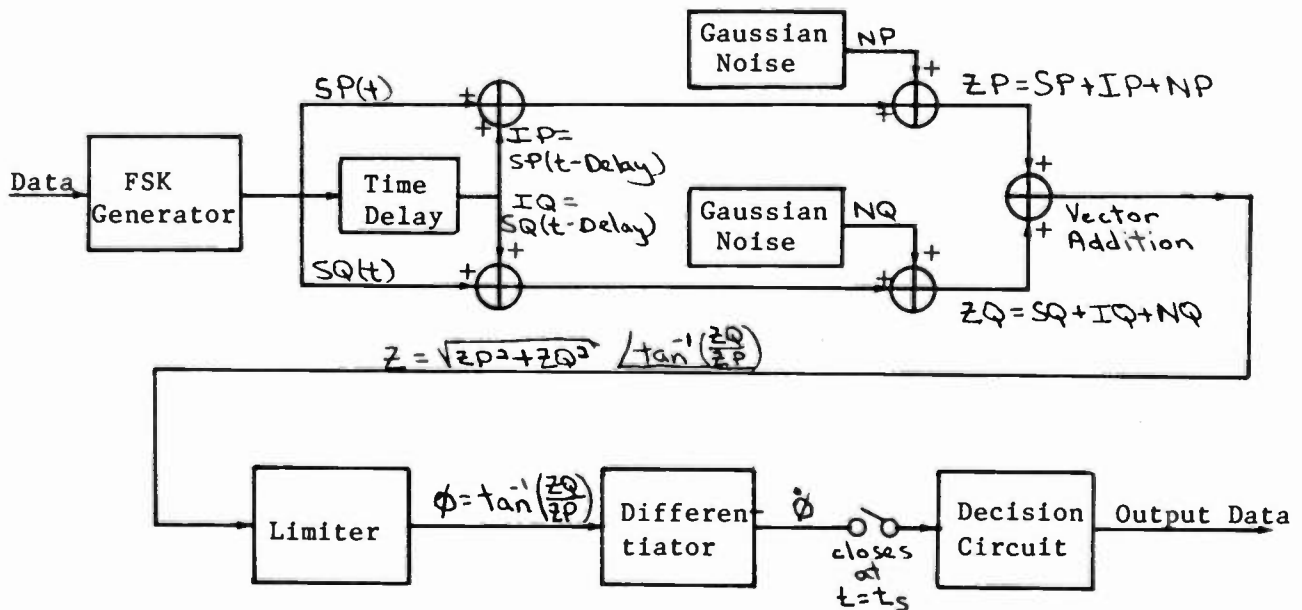


FIGURE 3 - Block Diagram of FSK Transmission System Simulation

### 3.1 FSK Transmitter Simulation

The FSK generator in this simulation produces a sinewave signal of frequency  $\omega_1$ , or  $\omega_2$  depending on whether a 0 or 1 data bit is being transmitted. The FSK signal is resolved into orthogonal vectors to facilitate addition to the interference and noise vectors, as shown in Figure 4. In the simulation itself, the signal vectors are sampled at some time,  $t_s$ , which occurs in the middle of each data pulse period. In order to simulate a typical FM SCA operation, the following numbers were chosen:

$$SP = \cos(\omega_1 t)$$

$$SQ = \sin(\omega_1 t)$$

$$\omega_1 = 2\pi \cdot 62,000 \text{ rad/s}$$

$$\omega_2 = 2\pi \cdot 72,000 \text{ rad/s}$$

$$\text{data rate} = 9600 \text{ bps}$$

where  $\omega_1$  is the transmitted frequency.

Note that this yields a  $\Delta f$  of approximately one, closely corresponding to the orthogonal case discussed in Section 2.1.

### 3.2 Interference Simulation

Two types of interference situations were simulated. The first was a single unmodulated, constant amplitude sinewave interference at  $f_i = 67 \text{ kHz}$ . This is midway between the FSK frequencies and can be shown to result in worst case error rates for a single tone interference of any given frequency in the FSK passband [6]. The phase of the interference in this case is taken as a random variable (r.v.) uniformly distributed over  $2\pi$ . The interference vector is again resolved into orthogonal components, viz:

$$IP = b \cdot \cos(\omega_i t + 2\pi \cdot U(0.5, 1/12))$$

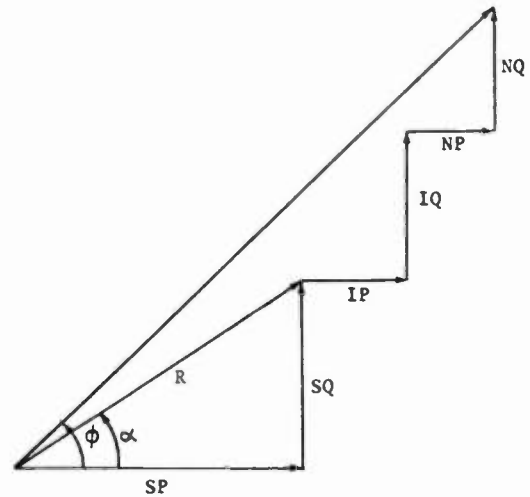
$$IQ = b \cdot \sin(\omega_i t + 2\pi \cdot U(0.5, 1/12))$$

The multiplicative factor,  $b$ , is set for a given carrier-to-interference ratio (CIR) assuming the amplitude of the desired FSK signal is 1. The  $U(0.5, 1/12)$  represents the uniform random variable with mean = 0.5, and variance = 1/12.

A second form of interference, which is illustrated in Figure 3, is a delayed and attenuated version of the transmitted FSK signal. This is intended to simulate interference from multipath transmission. In this case the orthogonal interference vectors are represented by:

$$IP = b \cdot \cos(\omega_i(t + \text{Delay}))$$

$$IQ = b \cdot \sin(\omega_i(t + \text{Delay}))$$



SP and SQ are the signal vectors  
IP and IQ are the interference vectors  
NP and NQ are the noise vectors

FIGURE 4 - Vector Diagram of Input Signal to Limiter.

The phase is a function of delay rather than being random as in the previous case. The values of delay chosen for study correspond to a range of phase shifts at one of the FSK tone frequencies.

These two interference situations were specifically run with the described simulation. Simulating other interference which more closely represent the frequency and amplitude variability of interference actually found in FM SCA channels is discussed in Section 5.0.

### 3.3 Noise Simulation

Simulation of white gaussian noise is easily accomplished using the random number generator function available in many computer languages. These generators usually produce random numbers which are uniformly distributed over the range 0 to 1. To make a gaussian random variable (r.v.), a number of uniform r.v.'s can be summed. By the central limit theorem, as the number of summed random variables increases, the probability density function of the sum will approach a gaussian, or normal, distribution. A gaussian r.v. with 0 mean and a variance,  $\sigma^2$ , of 1 is thus given by

$$N(0,1) = \frac{\sum_{m=1}^M U(.5, 1/2) - M/2}{\sqrt{M/12}} \quad (3)$$

M is usually taken as 12 so that the square root operation in the denominator is eliminated. It must be remembered that for a given M, the highest amplitude the r.v. can achieve is M/2. For M = 12, this extends out to a probability of about  $10^{-9}$ . If error rates on this order are to be investigated, M must be increased so that the noise has the opportunity to achieve these low probability amplitudes. Gaussian noise generated this way does not have an exactly gaussian pdf due to the imperfect nature of the random number generator and the finite number of r.v.'s in the sum.

The bandwidth assumed for the signal and noise is important in this simulation. For the 67 kHz SCA operation at 9600 bps, a bandwidth of about 20 kHz was found to be adequate in previous experimental tests [7]. For simplicity, an ideal rectangular filter shape was assumed, as shown in Figure 5A. The corresponding autocorrelation function  $R_{xx}(\tau)$  is shown in Figure 5B. Since the noise is zero mean, the variance,  $\sigma_x^2$ , is given by  $R_{xx}(0)$ , or  $A \cdot BW/2\pi$ .

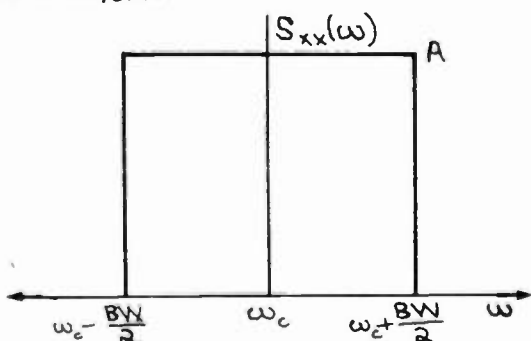


FIGURE 5A - Bandpass Filtered Noise Power Spectrum.

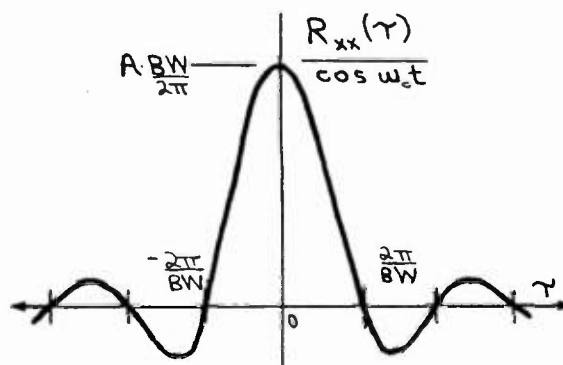


FIGURE 5B - Autocorrelation Function of Filtered Noise.



As will be seen in the next section, the time derivative of the noise r.v.,  $\dot{X}$ , will be important for simulating the frequency detector operation. The derivative of a zero mean gaussian random process is also a zero mean gaussian process [8]. The variance of the derivative,  $\sigma_{\dot{X}}^2$ , is given by the inverse Fourier transform of the spectrum of the original gaussian noise multiplied by  $\omega^2$ .

$$\sigma_{\dot{X}}^2 = \frac{1}{2\pi} \int_{-\infty}^{\infty} \omega^2 S_{XX}(\omega) d\omega \quad (4)$$

In Figure 5A the power spectrum was assumed constant (amplitude A) over  $-BW/2$  to  $BW/2$ .

$$\sigma_{\dot{X}}^2 = \frac{1}{2\pi} \int_{-BW/2}^{BW/2} A \cdot \omega^2 d\omega = \frac{A \cdot BW^3}{24\pi}$$

The relation between  $\sigma_{\dot{X}}^2$  and  $\sigma_X^2$  is then found as

$$\sigma_{\dot{X}}^2 = \sigma_X^2 \frac{BW^2}{12} \quad (5)$$

At a particular sample time a random variable and its derivative can be shown to be uncorrelated, or independent for gaussian r.v.'s. [9]

As for the transmitted FSK signal and interference, the noise is also resolved into orthogonal vectors, which are also independent. The four noise components of interest are therefore all mutually independent and generated using equation (3).

### 3.4 Frequency Detector Simulation

An ideal frequency detector produces a voltage which is a linear function of the instantaneous input frequency. The instantaneous frequency is the time derivative of the phase of the signal. Figure 4 shows how the three sets of orthogonal vectors are added to produce a resultant vector which is presented to the frequency detector. The phase,  $\phi$ , of this vector is given by:

$$\phi = \tan^{-1} \left[ \frac{SQ + IQ + NQ}{SP + IP + NP} \right] \quad (6)$$

For a computer simulation of a PSK transmission system on an AM SCA channel, this equation for phase is all that is needed. For such a simulation, the angle,  $\phi$ , at a given sample time is compared against phase detection boundaries as in [10] to determine when errors occur.

For FSK, the instantaneous frequency is needed. It is given by

$$\dot{\phi} = \frac{d}{dt} \tan^{-1} \left[ \frac{SQ + IQ + NQ}{SP + IP + NP} \right]$$

$$\dot{\phi} = \frac{(SP + IP + NP)(\dot{S}Q + \dot{I}Q + \dot{N}Q) - (\dot{S}P + \dot{I}P + \dot{N}P)(SQ + IQ + NQ)}{(SP + IP + NP)^2 + (SQ + IQ + NQ)^2} \quad (7)$$

This equation represents the output voltage of the detector. The dots over the variables indicate differentiation with respect to time. Based on the discussion in the previous sections, the variables are given by:

$$\begin{aligned}
 SP &= \cos(\omega_c t) & \dot{S}P &= -\omega_c \sin(\omega_c t) \\
 SQ &= \sin(\omega_c t) & \dot{S}Q &= \omega_c \cos(\omega_c t) \\
 IP &= b \cdot \cos(\omega_i (t + \text{Delay})) & \dot{I}P &= -\omega_i \cdot b \cdot \sin(\omega_i (t + \text{Delay})) \\
 IQ &= b \cdot \sin(\omega_i (t + \text{Delay})) & \dot{I}Q &= \omega_i \cdot b \cdot \cos(\omega_i (t + \text{Delay})) \\
 NP &= N(0, \sigma_x^2) \\
 NQ &= N(0, \sigma_x^2) \text{ independent of } NP \\
 \dot{N}P &= N(0, \sigma_x^2) \text{ independent of } NP, NQ \\
 \dot{N}Q &= N(0, \sigma_x^2) \text{ independent of } NP, NQ, \dot{N}P
 \end{aligned}$$

The signal-to-noise ratio which determines  $\sigma_x^2$  must be selected to represent the noise power in the post-detection bandwidth which, for a 9600 bps data signal, is approximately 5 kHz. The FSK carrier-to-noise ratio, CNR, is a measure of the CNR ratio at the input to the detector which has a previously selected bandwidth of 20 kHz. The post detection baseband noise power spectrum will increase as the square of the frequency and extend from -10 kHz to +10 kHz. Since only +5 kHz of this noise spectrum will be present at the output of the lowpass filter following the detector,  $\sigma_x^2$  must be reduced to reflect the difference. This is an approximate but simple way to account for the bandpass and lowpass filters without having to specifically include their operation in the simulation.

### 3.5 Running the Simulation

Using the descriptions for all the pieces of equation (7), a computer program was written to generate each of the 12 variables and the resulting output sample value calculated at a decision time which was set to occur in the middle of each transmitted bit. This sample value was compared against a threshold which was set midway between the detector output values when a 0 and 1 were sent without noise or interference. If a sample value is above the threshold, the receiver decides that a 1 was transmitted. By comparing this decision with the data bit which was actually sent, it can be determined whether a transmission error has occurred. For a transmitted binary 0, the converse reasoning is used. The BER is then calculated by dividing the number of errors by the total number of bits transmitted. The error rate thus calculated can be plotted as a function of CNR and CIR for different levels of interference and delay times.

### 4.0 SIMULATION RESULTS

Figures 6 through 9 show the resulting simulation error rates for a variety of circumstances. Figure 6 is a "calibration" check of the simulator which compares the results with theoretical results for the gaussian noise-only case. The simulator was typically run for 10 times as many transmitted bits as the inverse of the expected error rate. Figure 6 shows that the simulator provides BER results which closely match the theoretical curve,

especially at CNR levels above the FM detection threshold at a CNR of about 6 to 8 dB.

Figure 7 shows the simulator results with a single random phase sinewave interference at 67 kHz and CIR values of 3, 6, 12 and 20 dB. Curves have been drawn through the data points to better illustrate the changes in error rate as CIR is changed. For the lower values of CIR, the error rate predictions are considerably more optimistic than those obtained by the methods in reference [1]. Those previous studies, however, explicitly considered the impact of the lowpass filter following the frequency detector. The lowpass filter attenuates the higher frequency harmonics of the interference-caused error voltage at the detector output. Attenuating the higher harmonics changes the pdf of the output and therefore, the predicted error rate. Since the lowpass filter is almost always used in practice, the FSK simulation described here could be improved by adding its effects to the output data signal. Because of the additional computer runtime necessary to include the effect of the filter, it was omitted from this simulation.

After these tracking tests were run, the simulation program was set up so that the interference was represented by the delayed FSK signal. The delay times were chosen to be particular phase shifts at one of the FSK tone frequencies, 62 kHz in this case. Figures 8 and 9 show the variation in error rate as CNR and CIR are held constant and the delay time is moved through one cycle of 62 kHz. As expected, the error rate reaches a peak when the out of phase (180 degree) condition occurs. This happens because the effective 62 kHz

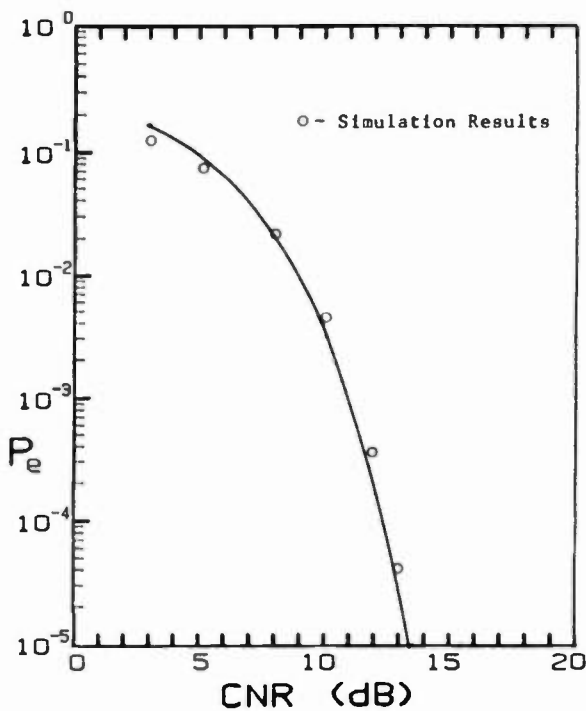


FIGURE 6 - Simulation Results with Gaussian Noise Only.

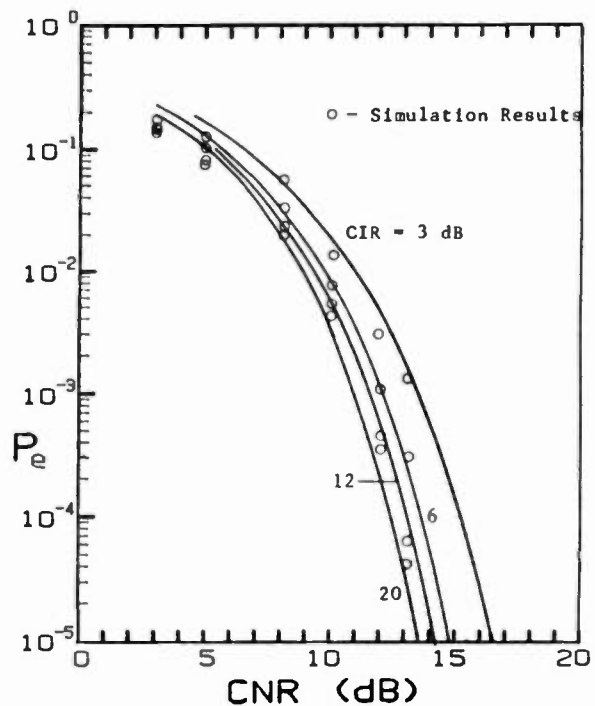


FIGURE 7 - Simulation Results with Gaussian Noise and a Single Random Phase Sinewave Interference at 67 kHz.

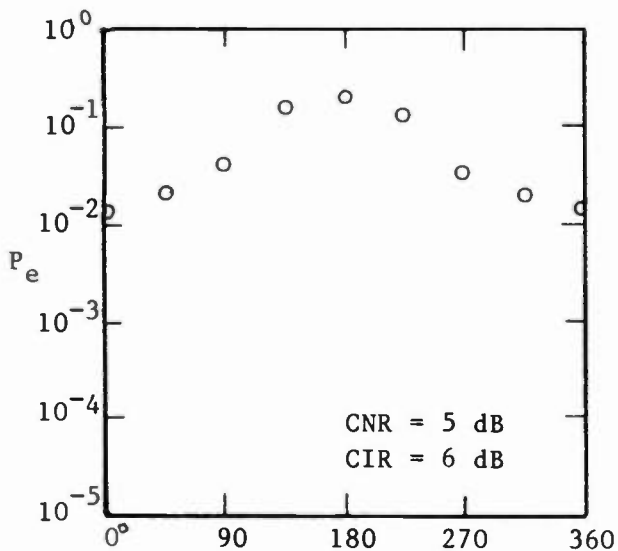


FIGURE 8 - Change in Error Rate versus Phase Shift of Interference

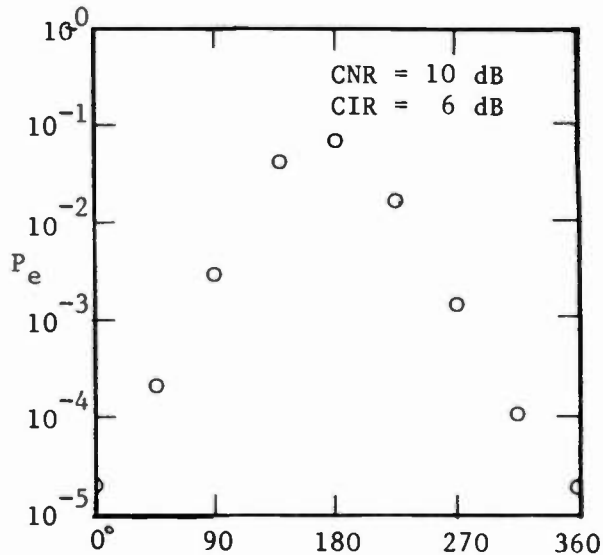


FIGURE 9 - Change in Error Rate versus Phase Shift of Interference

tone amplitude has been reduced by the out of phase addition of the interference. For the 0 degree delay, the converse situation occurs; the effective 62 kHz tone amplitude is increased above its nominal value so that the error rate is actually better than for the no interference case.

These interference situations are highly simplistic compared to actual SCA operations where the interference is a complex waveform largely dependent on the stereo modulation levels. The simple interference tests run here do show that the simulation responds as expected to predictable interference. The simulation could therefore be confidently extended to predict error rates with more complex and realistic interference signals.

#### 5.0 SIMULATING OTHER CHANNEL IMPAIRMENTS

The flexibility of the computer simulation allows other types of channel degradation to be easily modelled.

A common feature of high frequency radio channels is fading. The amplitude of the fading signal is usually described as a Rayleigh-distributed random variable. A Rayleigh distributed r.v. can be generated by:

$$R = \sqrt{X^2 + Y^2}$$

where X and Y are independent gaussian r.v.'s which can be created described in Section 3.3. By multiplying the amplitude of the transmitted signal by R, a Rayleigh fading signal is simulated. The same could be done for an interfering signal, or the ratio between the desired signal and the interference.

For interference with unusual statistical properties, such as interference in an FM SCA channel resulting from multipath-created byproducts of the stereo signal, simulating the interference is more difficult. The computer does make the use of empirical data (i.e. a measured record) to modify the amplitude and frequencies of the interference a straightforward operation. The simulation of multiple interference vectors with time varying amplitudes and frequencies could be added into the vector diagram in Figure 4 and into equation (7) and the simulation run as before. For high amplitude, low probability interference (i.e. due to stereo modulation peaks), the "10 times" rule for the number of samples would likely have to be increased.

## 6.0 CONCLUSIONS

This paper has demonstrated the application of computer simulation techniques to the analysis of FSK data transmission on FM SCA subcarriers. The simulation results show reasonably good agreement with theoretical predictions in the noise-only case where an analytical solution is available, and predicts error performance under multipath conditions which corresponds to an intuitive interpretation of the interference impact. Error rates were shown to be worst when interference in the channel tended to phase cancel one of the FSK frequency tones. The results also show that accuracy of the simulation in representing actual system performance could be greatly improved by explicitly including the impact of the bandpass filter ahead of the detector and the lowpass filter following the detector.

For the data transmission system designer, the important results are the relative rather than absolute BER values which reflect the impact of changes in various channel parameters. Simulation can then provide a useful tool for developing new modulation schemes with improved performance in the presence of noise and interference.

## 7.0 REFERENCES

- [1] H.R. Anderson, "Theoretical and Experimental Investigations of FSK Data Transmission in the Noise and Interference Environment of Broadband Two-Way Cable Television Systems," Thesis, Oregon State University, 1984.
- [2] W.P. Osborne and M.B. Luntz, "Coherent and Noncoherent Detection of CPFSK," IEEE Transactions on Communications, Vol. COM-22, August 1974, pp 1023 - 1036.
- [3] F. deJaeger and C.B. Dekker, "Tamed Frequency Modulation - A Novel Method to Achieve Spectrum Economy in Digital Transmission," IEEE Transactions on Communications, Vol. COM-26, May 1978, pp. 1752 - 1792.
- [4] B.P. Lathi, Modern Digital and Analog Communication Systems, New York: Holt, Reinhart and Winston, 1983, pp. 517 - 518.
- [5] D.L. Schilling, E. Hoffman, E.A. Nelson, "Error Rates for Digital Signals Demodulated by an FM Discriminator," IEEE Transactions on Communications Technology, Vol. COM-15, No. 4, August 1967, pp. 507 - 517.

- [6] See Reference [1], pp. 47 - 50.
- [7] H.R. Anderson and R.C. Crane, "A Technique for Digital Information Broadcasting Using SCA Channels," IEEE Transactions on Broadcasting, Vol. BC-27, No. 4, December, 1981, pp. 65 - 70.
- [8] P. Beckmann, Elements of Applied Probability Theory, New York: Harcourt, Brace & World, Inc., 1968, page 147.
- [9] See Reference [8], page 149.
- [10] H.R. Anderson, "Theoretical Performance of Binary Coherent PSK on AM Channels," IEEE Transactions on Broadcasting, Vol. BC-29, No. 4, December, 1983, pp. 113 - 120.

---

## The Electronic Newsroom. An In-House Approach

Tim Black and Warren Happel

Scrrips-Howard Broadcasting Company

Cleveland, Ohio

### INTRODUCTION

At Scrrips-Howard Broadcasting we have reviewed several packaged newsroom computer systems. Similar applications using computers have been used in the newspaper industry for many years.

We have found good systems which should serve most newsroom needs, but no single system met the combined requirements for all our TV stations. Our goals were defined after studying and prioritizing the needs of each news department. While the requirements such as rundowns, assignment sheets, photo logs, and archives were similar at each station, the priorities were not. Many news personal feel it imperative to rush into some type of computer system. They may know that any computer system is better than a manual, paper type operation, or may think they are getting left behind as technology marches on. We decided that any vendor supplied system would not be flexible enough to fit our goal of total station wide computer compatibility. In looking at the long term needs, we slowly came to a decision to develop our own newsroom computer system.

In Oct. of 84 we began to establish our in house facility for development and evaluation. Since it is not our purpose to market a system , the development is simpler than a commercial system would be.

In this paper we will explain the considerations which led us to begin the development of our own computerized newsroom system. We are not providing an answer for the question "should you develop your own newsroom computer system?" . We have tried to organize and define our considerations so you may answer the question for yourself.

## "The problems of computers"

### Obsolescence and the falling cost of computer power

In the late sixties one of the integrated circuit (IC) chips available was a primitive resistor-transistor-logic (RTL) dual latch. If used as a memory it would hold 2 bits. It cost about \$6.00 and was in a small plastic package. In 1985 the same sized package still costs about \$6.00, but now holds 256 thousand bits! This pace may slow down as the chips approach the limits of processing technology. But before long the small plastic packages may hold 4 million bits each, without much change in the unit cost. In just the last 10 years the cost of computer memory has dropped by a factor of roughly 100. The rapid advance of computer hardware is unmatched in the history of technology. Even in the face of the U.S. inflation rate, the cost of computer power falls more rapidly each year.

This changing hardware has appeared in the TV industry as powerful effects generators, frame synchronizers, and still-store devices. However many of the advanced data processing functions possible with current computers have not been applied in TV stations. I am writing this paper on an Apple Macintosh, and it is a good example of the pace of change in the computer industry. The central processor unit (CPU) chip in this computer is more powerful than a large mini-computer of just a few years ago. In the Macintosh this extra power is used to create a better interface with the user, and I am sure other new computers will follow the Macintosh example. However, the Macintosh does not support any standard operating system, and this has reduced the amount of software available for it. The pace of change in the current market is so rapid that a new computer model will be "state-of-the-art" for only a few months. In this rapidly changing environment, standards become more important than ever. Standard operating systems, languages, and interfaces are the only defense the computer purchaser has to safeguard his ever-increasing software investments. We must plan to take advantage of the fact that it will cost much less for the same computer power next year.

### The high cost of software

With the price of hardware falling all the time the most important cost in a computer system is the software. In many projects the software may represent more than 80% of the total system cost.<sup>(4)</sup> Obviously protecting this investment must be a high priority in any evaluation of a new purchase. Most commercial software is worth the price asked for it. Software is the packaged thoughts of a programmer and may represent years of work. It is unavoidable that this type of work is expensive. Often, a useful program will outlast the hardware and if it cannot be run on a different computer, the program must be recreated. Considering that software will remain a product of human labor in the near future, the costs of new software development will continue to rise.

### The never-ending job of software revision

Programming is like writing a script for a fast and stupid actor who never ad-libs over a poorly worded line. By this I mean that the computer is a completely literal performer of the instructions in a program. A single missing comma or extra decimal point may cause a problem that is nearly impossible to locate.



In a large program there are thousands of possible paths of activity and it may take months or years of use before a program can be assumed to be correctly written (bug-free). I say assumed to be correct because it is said "there is always one more bug". Testing can show the existence of bugs, but only long term use can show their absence<sup>(3)</sup>. With all this in mind the value of a tested and bug-free program is apparent. But it is just when a program has existed long enough to be thoroughly tested and debugged that a newer piece of hardware comes along and starts the whole process over again.

### **Portability considerations**

Many programs in use today are dedicated to a specific model of computer. This is often necessary because different computers require different commands to get the same thing done. The computer industry has developed standard operating systems (OS) to help with this problem. Some standard operating systems are CP/M and MS-DOS for single user computers, UNIX for multi-user systems. These OS are collections of programs that serve to mask the incompatibilities between hardware from different vendors. A program must be written to take advantage of the standard interface offered by an OS or it will not be portable.

Many vendors avoid standard OS and create a custom or "proprietary" system. This allows the vendor control of his market, because after the first sale the customer must buy all new software through the original vendor. It is bad for the customer for the same reason. If a program is "portable" the effort spent creating and correcting it will not be lost. Porting old software reduces the high cost of retraining personnel and results in programs that keep getting better because of long-term debugging. For a program to be portable it must be written in a standard language and have all hardware dependent sections isolated from the main body of the code. If this is done then a skilled programmer can change the dependent section to run on new hardware and re-compile the program for the new computer.

In between hardware and disk based software there are programs called firmware. Firmware is software that is completely merged with a hardware package. The firmware is stored on programmable read only memory (PROM) chips and mounted on the printed circuit (PC) boards of the hardware. Firmware is the most secure method of selling software, and the most non-portable type of program. Since firmware has no standards to meet it can get the most performance out of a given type of hardware. It is also the hardest type of software to develop and the hardest to fix if a problem is found. Systems that rely too heavily on firmware are very hard to modify or add to, and nearly impossible to maintain if the vendor withdraws support.

### **Proprietary systems**

A proprietary system can sometimes offer an advantage over a system based on standards, but these advantages are seldom worth the risk of having only one source for the support of an important system. All television stations know the problem of orphaned equipment. Once a vendor no longer supports a model of hardware or a version of software, the equipment becomes difficult to keep working and may eventually become stored in a back room "for parts". Once people become familiar with computer systems, they soon become dependent on them. To keep our systems working it is important to acquire full documentation and have alternate sources for parts and software.

## The pointed index syndrome.

No one vendor can supply the range of equipment that we foresee needing for our stations. When a problem involving two different computer devices occurs, the vendors may not agree regarding whose equipment caused the problem. If the problem goes away all parties may blame the electric service. If the problem persists both vendors may point at each other and say "the problem is not in MY equipment". This situation can remain a stalemate until a third party, who understands both systems, attacks the problem rather than stonewalling. If we have full control of our own system we are in a good position to isolate problems without misdirecting our attention toward who is to blame.

## Licensing agreements

After a vendor has created his custom system, he usually wants to be protected from all who may want to steal it. The most common device for doing this is the "software license agreement". The License agreement typically says that you cannot buy the software in question; you cannot even buy a copy of it. You can pay for the right to run one copy of the software on one computer of the vendors choosing. The vendor is not responsible for bugs or improvements. You pay for the right to use the copy AS IS. From the users point of view this is counter productive.

This policy dates from the days when computer users knew very little about programming and software was sold to support hardware sales. We think the time has come for a better approach to software. For example some vendors have supplied Scripps-Howard with the entire source code to their systems. Some commercial software packages now come with money-back guarantees of performance. Scripps-Howard has purchased source code for database systems and screen based text editing. We look for source code to be available on future software purchases.

## "The needs of newsrooms "

### The need for easy use

An easy to use system needs more computer power than might at first be thought, and much planning must be done before any programs are written. The software must meet the needs of news-gathering and reporting before anything else. Many packages currently on the market are one-sided, the package may do one thing very well while other functions seem poorly added on. For example, one system may have a wonderful fast editing section, but poor database ability. Another system may have a good wire-service receiver, but lack tele-prompter interface or script-editin.

In designing our system we are looking for a balance of current and future needs. The first functions will all be news oriented, with the long term goal being the inter-connection of all computer systems in a TV station. For the newsroom system we want a daily events file and archive with free-form access (all words are keys, giving a NEXIS-like search capability). We want optical character reader (OCR) input to our data bases to speed data entry. We want an interface between story editing and graphic chart and text generation, so reporters can directly enter their supers and electronic slides. We want on-line status displays of incoming data and stories in progress. We want a production system that can handle the changing demands of a news show with variable length live feeds and interviews. These and other features will put our on air product ahead of off-the-shelf newsroom systems.

## The need for high reliability

Data must always be available, stored in multiple locations with multiple paths for the retrieval of data. A highly reliable computer should monitor its environment, power, and data storage to warn of problems before they cause a loss of service. All data handling systems in a newsroom must have an uninterruptable power supply (UPS), and be able to monitor the UPS status. An otherwise reliable computer can fail because of clogged dust filters or a loss of ventilation. A highly reliable computer must monitor its internal and external temperatures. Most computer problems are "soft", that is, a problem will happen once in a great while and not happen again in the same way. Problems like this are not uncommon with dynamic random access memory (DRAM), the memory chip used in many current computers. This chip stores data in 16 to 256 thousand tiny storage cells that hold data for 2-4 thousandths of a second. A memory controller circuit must constantly "refresh" the DRAM chips or the data will fade away after this fraction of a second has passed. Anything that disturbs this "refresh cycle" (static discharge, power supply glitch, and even cosmic rays) will cause some data to be lost. The DRAM is the lowest cost memory system and can be found in almost all small computers. The errors caused by soft memory faults range from a dropped character in a single story, to a complete computer lock-up. Error rates have a random distribution and can range from once a year to twice a week. A list of some memory types from least to most reliable :

DRAM - unprotected dynamic memory (very common and fault prone, errors will cause RAM data to be lost, and may destroy disk data)

DRAM with parity ( if a fault occurs this will halt the computer, preventing further damage, in theory anyway)

SRAM - static ram ( less likely to have soft errors and can be protected from power failure by a small battery)

EDCM - error detecting and correcting memory (an entire memory chip can fail and this will report the error and continue normal operation).

Note that these memory types are also listed in order of price. EDCM can be 10 times the price of unprotected DRAM. For our needs SRAM or EDCM is best suited to reduce the risk of mysterious problems.

## New devices for use in future systems

By retaining control of our software we will be able to interface new devices into our system as they become available. Some devices almost ready to use include :

- low cost Optical Character Reader (OCR) data entry
- low cost Laser printers
- giga-byte optical disk storage systems
- chart and map graphics interfaces
- still store interface and control
- voice input and output

Different vendors seldom agree on data formats for interfaces and this leads to a compatibility problem. Many computers have RS-232 ports and some vendors would have you believe that this is a standard interface.

In the current computer market RS-232 does not imply anything except a DB-25 connector and +-3 volt data on 3 pins (RX data, TX data, and sig. ground). A RS-232 interface may support from 2 to 12 signals and may be in any data format. The same type of problem occurs with RS-422 and other interfaces. Getting a RS-232 or RS-422 path working between two computer devices can be easy or impossible depending on the depth of information supplied by the two vendors. Sometimes the operating system of one or both computers must be modified (patched) and this may not be possible with non-standard systems.

## **"The Scripps-Howard solution"**

### **Build an in-house development and evaluation facility**

Having an in-house facility for software development and evaluation is what makes this a practical approach for Scripps-Howard. If we only had a couple stations the overhead would preclude development of our own system. With the growth of the Scripps-Howard station group it is economical for us to own the computer systems we need. In the current computer market the only software package you can own is one you write yourself.

### **Use commercial software wherever possible.**

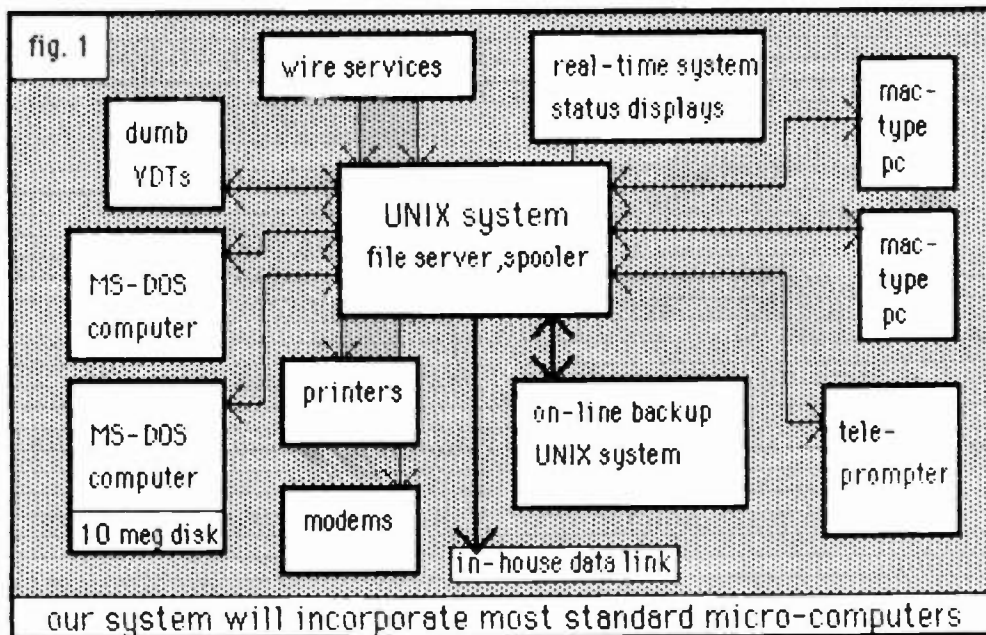
Mass markets make good products, and wherever we can use a commercial program we will merge it into our overall system. For example a workstation may run a modem communication or data-base program as an off-line task, and send results to the main computers for printing or mail to other users.

### **Design the system to grow by evolution**

We are planning to create a core system with basic functions in place, then place equipment in a pilot site as soon as possible and let the user feedback guide the project. This does not mean that we expect the end users to write any of the system software, rather that we are designing the system to expect changes instead of excluding them. In any software project the best ideas often come from the people who use the system every day.

### **Use portable code on a portable operating system**

We will buy source code when possible, and make all custom software conform to our portability standards. The design we are planning to use has been called a "Federated system" because it is organized as a structure of stand-alone sub-systems connected by a supervisory data base computer<sup>(1)</sup>. UNIX is the most widely used portable O.S. available today and most likely will become the de-facto standard<sup>(2)</sup>. While UNIX is often criticized as difficult to use, it has the power we need to do this job. We will use UNIX for the core of the system, and use MS-DOS and Macintosh workstations where local editing and storage is needed. Where dumb video display terminals (VDT) are needed we will use VT-100 compatible types. Programs will be written to hide the complexity of the OS and maintain a simple user interface. At the larger stations over 50 locations may have some type of VDT or workstation. The drawing (fig.1) shows a UNIX system as a central controller for single user computers and VDTs. In the final system a second UNIX computer would serve as an on-line backup.



## Conclusion

We do not imply that every TV station can justify building their own newsroom computer system. The newsroom systems on the market have a great deal of work in them and the vendors are asking reasonable prices. TV stations have always pursued each other in a never ending game of purchasing the newest equipment. We at Scripps-Howard Broadcasting have decided that to be a market leader we must innovate. I am not saying we will write all of our own software, but our computer systems will be a unique solution to newsroom problems.

Broadcasters have always led in the application of electronics, and we generally receive excellent support from equipment suppliers. Although some television equipment manufactures have slipped from the support that made them famous, all systems we have purchased for video, audio, and RF functions have been expected to include complete circuit drawings and operation discriptions. The time has come to expect the same level of support from vendors of computer based systems. All custom software we buy will include the source code and full documentation. This applies not only to newsroom computers, but to all systems purchased in the near future. Very few vendors are willing to supply the level of support we want, so the in-house approach is best for us. If you do decide to do-it-yourself, examine your equipment and labor needs carefully. You cannot tinker an integrated electronic newsroom into existence. It takes commitment, planning, and patience.

## References

- (1) H. Austin Spang III, "The Federated Computer-Aided Control Design System"  
*Proceedings of the IEEE*, VOL. 72, NO. 12, Dec. 1984, page 1724-1725
- (2) Ray Weiss, "Software Standards - Operating Systems"  
*Electronic Design*, Dec. 27, 1984 page 119-128
- (3) Edsger W. Dijkstra "The Humble Programmer"  
*Comm. ACM* Vol. 15, No. 10 Oct. 1972 page 859-866
- (4) B. W. Boehm "Software and Its Impact: A Quantitative Assessment"  
*Datamation*, May 1973 page 48-59  
and  
B. W. Boehm "The Hardware/software cost ratio: Is it a myth?"  
*IEEE Computer*, March 1983 page 78-80

## trademarks

UNIX is a trademark of AT+T  
MS-DOS is a trademark of Microsoft  
CP/M is a trademark of Digital Research  
Macintosh is a trademark of Apple Computers  
VT-100 is a trademark of DIGITAL Equipment Co.  
NEXIS is a trademark of MEAD Data Services

---

## THE CCD CAMERA -- A NEW WAY TO LOOK AT TELEVISION

Thomas M. Gurley and Carl J. Haslett

RCA Broadcast Systems

Gibbsboro, New Jersey

The substantial improvements in camera performance made possible by the use of CCD imagers have become well known since the RCA CCD-1 was introduced to the NAB audience last year.\* But, the opportunity to achieve "film look" video and to benefit from the many advantages of CCDs presents a new challenge to television engineers. Basic differences in operation between tubes and CCDs require new ways of looking at performance parameters such as resolution. This paper will cover both static and dynamic resolution from a theoretical viewpoint and relate these concepts to the performance of RCA's new CCD-1 and CCD-1S cameras.

### CCD VS. TUBE OPERATION

First, a brief review of some differences in tube and CCD operation may be helpful. As Figure 1 depicts, tubes contain a photoconductive layer upon which the scene is imaged. Charge is developed and stored capacitively proportional to the illumination at each point. An electron beam converts this charge image into a signal current. Ideally, the beam is focused to a circular spot and deflected continuously over the image area in two interlaced fields of horizontal lines, scanning a given point every 1/30 of a second.

Now, consider the operation of a frame-transfer CCD. This paper will cover only this type of CCD since it has a number of advantages over others-- sensitivity, signal-to-noise ratio, highlight handling, and absence of lag--that led to its use in the RCA CCD-1 camera. As Figure 2 shows, photoelectrons are integrated in the "A" register, upon which the scene is imaged. Channel stops divide the register into discrete elements horizontally. Blooming drains beneath the stops eliminate excess charges from highlights. The device is illuminated from the back side, so that all of the incident light is used and the picture elements are effectively contiguous.

---

\* Dennis J. Woywood, "The RCA CCD-1 Broadcast Color Camera." 38th Annual NAB Broadcast Engineering Conference.



At each vertical interval, every 1/60 of a second, the entire charge image is transferred to an unilluminated "B" register. During the next field, it's clocked out line-by-line through the "C" register. The A-to-B transfer is rapid. But, meanwhile, the "A" register is still integrating. So, some vertical smearing can occur unless the CCD is shuttered during the transfer time.

These fundamental differences in operation result in differences in a number of parameters. We'll consider four: exposure time, lag, highlight handling, and sensitivity.

Exposure time is the interval during which charges integrate between successive readouts. Both fields integrate simultaneously in a tube. As a result of the interlacing technique used to read out the signal, a given point on the photoconductive surface is scanned once every 1/30 of a second. This fact alone would lead to a 1/30-second exposure time. However, the scanning spot does not have a sharp boundary. So, in reading out the lines of one field, it partially discharges the interlaced lines of the other field. Thus, the 1/30-second exposure for each field is effectively weighted toward the latter 1/60-second.

In the CCD, only one field integrates at a time. So, the device's exposure time is 1/60 of a second--the interval between successive A-to-B transfers. However, in a CCD camera, the required frame-transfer-smear shutter shortens the exposure time. The CCD-1's effective exposure time is about 1/100 of a second.

Lag is a delay in response of the video signal after a change in illumination. A tube's response is exponential--due to beam resistance and photoconductor capacitance. A CCD has no lag--the charge is all clocked out at once.

When a highlight hits a tube, excess charge is created--requiring many scans of the electron beam to neutralize it. The electrical image may persist for dozens of fields after the highlight has gone. A common effect is comet tails on moving lights. Another is blooming--from attraction of the beam to the highly-charged area when it scans nearby. The CCD's blooming drains bleed any excess charge and give the CCD essentially unlimited highlight-handling capability.

A tube camera's signal-to-noise ratio, or SNR, is limited by the output capacitance of the tube and by the external preamplifier circuitry. The frame-transfer CCD has very low capacitance and an on-chip amplifier. External signal recovery circuitry can use filtering and sample-and-hold techniques that take advantage of the signal's time-discrete nature to further reduce noise. Of course, in a camera design, the imager's higher SNR can be traded off to gain sensitivity. At the present time, CCD imagers have a threefold or better advantage over pickup tubes.

#### STATIC RESOLUTION

Resolution measurement is an attempt to quantify the ability of a pickup device to reproduce picture detail. In practice, it's often used to compare the performance of different cameras on the assumption that the measurement bears a direct relationship to the subjective picture quality. For tube cameras, there's a long record of experience in developing static resolution test charts that optimize this relationship--from the early "Indian Head" to the familiar EIA and SMPTE charts and the more recent RCA P200 and P300. Historically, "resolution" was understood to denote "limiting resolution"--the point at which a pickup



device has no response to fine detail. But limiting resolution is very difficult to measure. Moreover, greater limiting resolution does not always correspond to greater subjective sharpness of the picture.

So, today, resolution is normally expressed as the ratio of the response at a specified horizontal spatial frequency (typically, 400 TV lines per picture height) to the response at a low frequency (such as 50 lines). It's understood that these two points are located on a curve of the modulation transfer function, or MTF, whose shape is generic to the particular type of pickup device. The curve is mainly determined by the size and shape of the resolving aperture-- which is different for a CCD than for a tube.

The resulting theoretical MTF curve for a tube (Figure 4) is Gaussian-shaped and depends on the beam radius and a factor "k" related to the type of photoconductor. The CCD has a sin x/x-shaped MTF curve (Figure 5) whose null point depends on the aperture width.

The ideal MTFs for a 403-element CCD and a 2/3-inch Saticon tube are comparable, as Figure 6 indicates. Both have 42-percent response at the conventional reference point of 400 TV lines per picture height. So, what impairs the measurement and specification of CCD resolution using tube methods? Clearly, the aperture response is not a limiting factor. The answer lies in the fundamental difference in operation of the two devices. In a tube, the resolving aperture is a single circular aperture that scans across the image continuously. In a CCD, the resolving aperture is actually an array of discrete rectangular apertures that are fixed in position relative to the image. Therefore, in the CCD, the line is represented by a finite number of samples--one from each aperture.

In any sampled system, "aliasing" occurs for signal frequencies that exceed half the sampling frequency. To avoid aliasing, there must be at least two samples per cycle or two samples within the transition time of an edge. Historically, television images have always been discrete vertically-- composed of a finite number of lines. We are all familiar with the effects on lines and edges in the scene that are nearly horizontal. The CCD image is also discrete horizontally. So, we can expect similar effects on lines and edges that are nearly vertical, even though a tube shows no effects on them.

Conventionally, a tube's horizontal resolution is measured using wedges of nearly-vertical lines on a standard test chart. A CCD can respond to the high spatial frequencies far down the same wedges--even though they may exceed the Nyquist frequency and excite aliasing. Because of this contamination, the determination of a number that accurately reflects the perceived response of the CCD is impossible. Let's calculate the point at which aliasing should begin to occur for a 403-element CCD:

$$\frac{403 \text{ SAMPLES}}{\text{PICTURE WIDTH}} \times \frac{1 \text{ CYCLE}}{2 \text{ SAMPLES}} \times \frac{2 \text{ TV LINES}}{\text{CYCLE}} \times \frac{3 \text{ PICTURE WIDTHS}}{4 \text{ PICTURE HEIGHTS}}$$
$$= 302 \text{ TV Lines / Picture Height}$$

Expressed in resolution terminology familiar to television engineers--in round numbers, 300 TV lines per picture height is the Nyquist frequency for this device. At this point on the MTF curve of Figure 3, the response is 64 percent. So, it's far from being the point of limiting resolution. This, then, is the theoretical basis for the response that extends well beyond the aliasing point on the resolution test chart.

Of course, filtering can theoretically prevent aliasing. But related digital video experience has shown that more subjectively pleasing pictures result if frequencies somewhat above the Nyquist limit are allowed to alias. Thus, the recommended filtering has a response such as that shown in Figure 7--a compromise between in-band roll off that softens the picture, and sharp cut off that causes ringing on edges, which is more objectionable than aliasing.

Subsequent camera processing--including contouring--can provide full response at 320 lines, or 4 MHz, as plotted in Figure 8. Since the introduction of the CCD-1, numerous industry experts have assessed pictures from this camera, whose design follows these recommendations. Their consensus is that the apparent picture sharpness equals or exceeds that of the best tube-type ENG cameras.

Even when higher-resolution devices become available to extend CCD imager applications beyond ENG and into EFP and studio-quality cameras, designers are likely to exploit the subjective "snap" that aliasing contributes to typical pictures, rather than incorporate textbook frequency responses. What's more, we have a moving target since even higher-definition systems are emerging.

We conclude, then, that the effects of spatial sampling must not be ignored in our solid-state-imager future. Since conventional test methods--based on tube technology--cannot be used, the emphasis must be on subjective picture performance until we learn how to make correlated quantitative measurements.

#### DYNAMIC RESOLUTION

Any assessment of overall picture performance must also consider that typical pictures move. So, dynamic resolution is at least as important as static resolution. Dynamic resolution is the ability to preserve image detail during movement. Of course, good dynamic resolution provides sharper real-time pictures. But, it's even more important because of the increasing use of non-real-time video for stop-action effects in television productions. Figure 20 is one example. In this application, any blurring due to poor dynamic resolution is much more noticeable.

Dynamic resolution may be affected by two factors. Primarily, any motion that occurs during the effective exposure time will be blurred. Secondly, if the pickup device exhibits image retention, then further blurring will occur on motion from one exposure time to the next.

For tube cameras, both factors must always be considered. In addition to short-term lag, long-term image retention--or comet-tailing--occurs on moving highlights. But for CCD cameras, only the exposure time need be considered. This fact is one contributor to the so-called "film look", since the ability of film to resolve moving detail is purely a function of the amount of motion that occurred during the exposure time.

Unlike the case of static resolution, there is no conventional measurement technique for dynamic resolution. The poor dynamic performance of all photoconductive tubes traditionally has been accepted without the need to quantify it for comparison purposes. A convention for lag measurement is more or less established. But mere extrapolation of lag data fails to provide an accurate indication of dynamic resolution because it gives little weight to the primary contributing factor of exposure time.

We've devised a test pattern and measurement technique to compare the dynamic resolution of tubes and CCDs fairly, considering both exposure time and image retention. The loss in response to fine detail that's moving may be thought of, and graphically represented as, the change in the static MTF curve when the spatial frequencies it's based on are moving with respect to the sensor. To generate data points for such a graphical representation, a pattern having a known frequency is moved past the sensor at a uniform and calibrated rate. The pattern is of relatively low frequency to avoid spatial sampling effects.

Figure 9 shows the test pattern of alternating black and white lines of constant pitch--calibrated in TV lines per picture height--that was printed on a paper belt. This belt was moved by a "teleprompter" mechanism whose speed was calibrated in picture widths per second for horizontal travel of the pattern across the picture. The CCD measurements used a 403-element CCD camera with a shutter having a variable exposure time from 1/110 to 1/1200 of a second. The depth of modulation of the green channel device was measured on a line-selecting waveform monitor. The same procedure was used for tube camera measurements on a TK-86 equipped with 2/3-inch Saticons. The results of these tube camera measurements are presented in Figure 13. The same tests were performed on the CCD camera with a 1/110 of a second shutter speed. The results are shown in Figure 14.

Figure 15 represents a comparison of the 50 TV line per picture height data for both cameras at the different chart speeds. This quantitative comparison of dynamic performance shows that the tube camera's response falls off substantially compared to that of the CCD camera.

A dynamic modulation transfer function, that accounts for the resolution loss due to motion during the exposure time, may be derived mathematically. Figure 10 is a graph of the function. The product of this expression and the other MTFs of an imaging system specifies the system's dynamic resolution.

The effect of shortening the exposure time of a CCD camera is shown in Figure 11. Quantitative data measured at five different shutter speeds are presented. It is obvious that dynamic resolution increases with increasing shutter speed, but the amount of improvement from one shutter speed to the next diminishes. The data compare well with the values predicted by the dynamic MTF expression for the different exposure times.

Somewhat surprisingly, the measurements from tube cameras generally follow the curve for a 1/60-second exposure time, even though each point on the photoconductive surface is scanned once every 1/30 of a second. This result may be explained by recalling that a tube's actual exposure time is heavily weighted toward the latter 1/60 of a second. Curve B of Figure 12 is obtained by summing 90 percent of the dynamic MTF evaluated at 1/60 of a second and 10 percent evaluated at 1/30 of a second. Tube data measurements agree more closely with the shape of this modified curve than with the 1/60-second curve--Curve A. The

remaining disparity may be theorized to result from image retention from more than one field ago, including the effect of lag as it is commonly measured.

We conducted an evaluation to compare subjectively the dynamic performances of a tube camera and a fast-shutter CCD camera. Sports action was recorded simultaneously from both using a split screen. Off-monitor photographs of a runner and a golf swing are reproduced in Figures 16 and 17, respectively. Shown in Figure 18 are dynamic response curves for both cameras, measured using the moving chart method, for the speeds of action in the photographs. We can see that the quantitative measurements correlate well with the subjective clarity.

Operating a shutter ahead of the imager to shorten the exposure time proportionately reduces the amount of light falling on the imager and the signal level it generates. The light level may be restored by using a wider lens aperture, at the expense of depth of field. Or, the signal level may be restored by using additional video gain, at the expense of SNR. So, either sensitivity or SNR, or both, must be traded off. With present technology, the frame-transfer CCD achieves at least an 8-dB margin in sensitivity over state-of-the-art pickup tubes. Figure 19 tabulates some of the ways in which this margin may be traded off in a camera design that includes a shutter to prevent vertical transfer smear.

Ideally, a camera design should incorporate a variable-speed shutter to maximize artistic flexibility in terms of depth of field and stop-action clarity under a variety of lighting conditions. But, when the design is restricted to a fixed shutter speed, the sensitivity margin tradeoff should be optimized to satisfy the majority of anticipated applications. For ENG use, a 1/100-second shutter, as employed in the CCD-1 camera, is preferred. The tradeoff used in its design corresponds to the third line in the table of Figure 19. For typical sports production, a shutter speed of 1/500 of a second should suffice. RCA has designed an optional 1/500-second shutter for the CCD-1 to serve this application. The option is designated CCD-1S. Its design trades off depth of field to achieve greater dynamic resolution.

## CONCLUSION

In this paper, we've examined briefly a couple of the technical parameters impacted by the fundamental differences in tube and CCD operation.

In the case of static resolution, the accepted quantitative evaluation technique for tubes has proven to be unusable for CCDs--subject to sampling effects--because of poor correlation with subjective picture quality. We continue to search for an effective means to measure this parameter. In the meantime, subjective assessments by industry experts have confirmed that a color camera using three 403-element CCDs, the RCA CCD-1, has an apparent picture sharpness equal to or better than the best tube-type ENG cameras.

In the case of dynamic resolution, no quantitative test method has existed for tube cameras. We've suggested one that permits fair comparison of tube and CCD performance and whose results do correlate with those of both subjective testing and theoretical analysis. The CCD camera has proven superior in this comparison. Enhanced dynamic response, for crisp stop-action effects, is provided by the RCA CCD-1S camera.

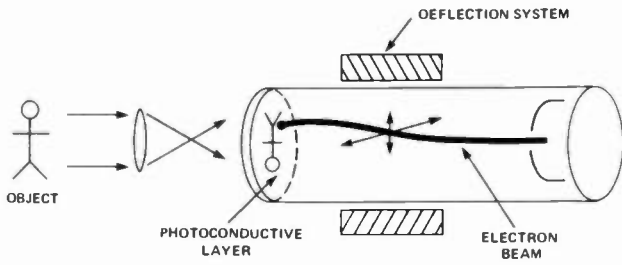


Figure 1. Basic photoconductive tube operation.

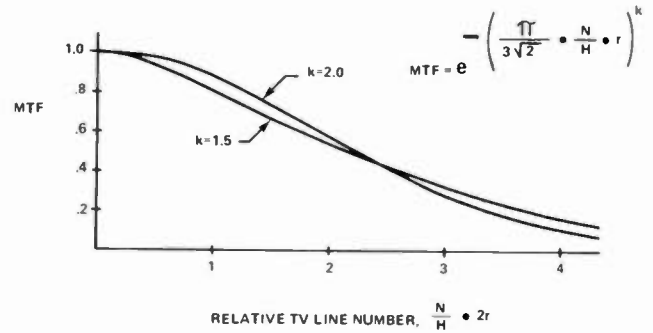


Figure 4. Theoretical MTF curves for photoconductive tubes.

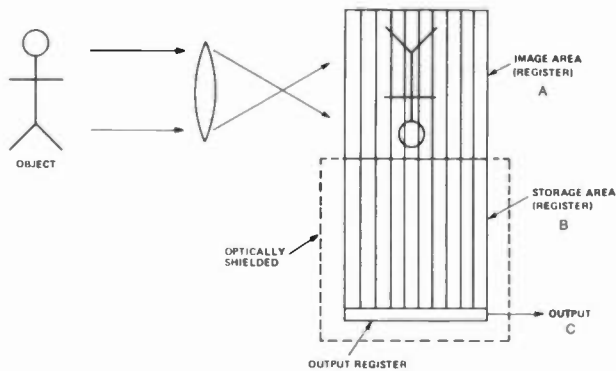


Figure 2. Basic frame-transfer CCD operation.

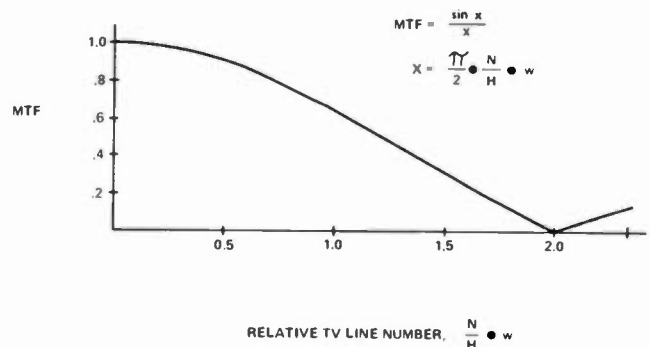


Figure 5. Theoretical MTF curve for CCD.

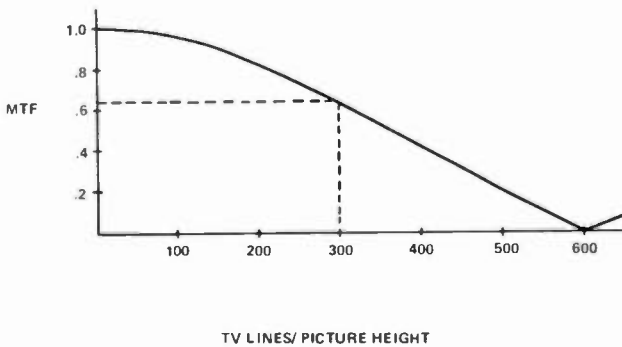


Figure 3. Theoretical MTF curve for 403-element CCD, showing response at the Nyquist frequency.

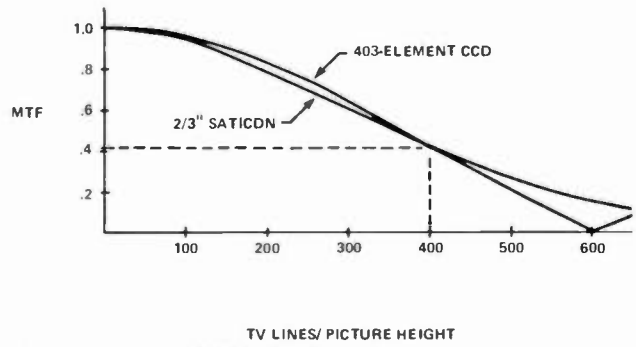


Figure 6. Ideal MTF curves for 2/3-inch Saticon tube and 403-element CCD.

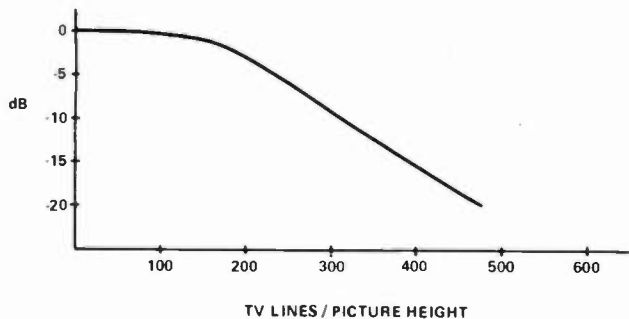


Figure 7. Recommended anti-aliasing filter characteristic.

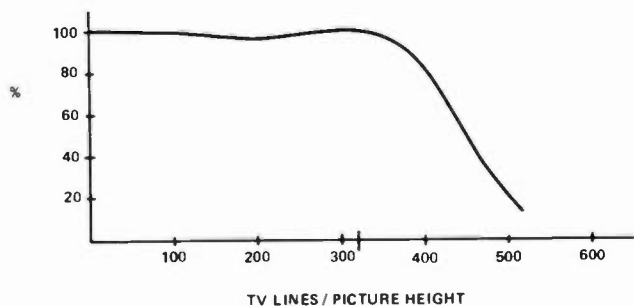


Figure 8. Camera response after processing, showing full level at 320 lines.

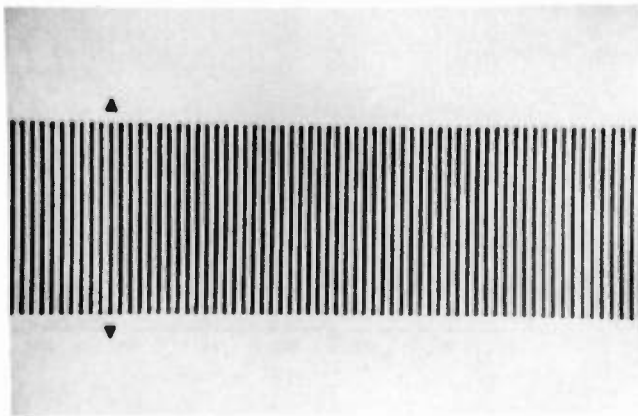


Figure 9. Dynamic resolution test pattern.

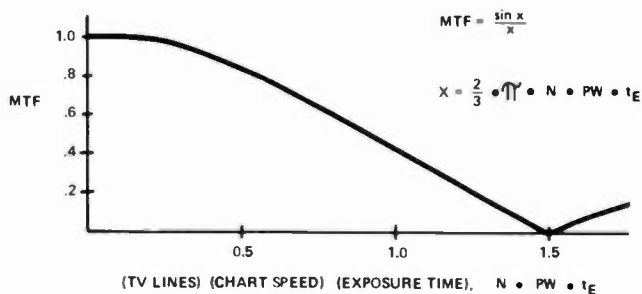


Figure 10. Theoretical dynamic MTF curve.

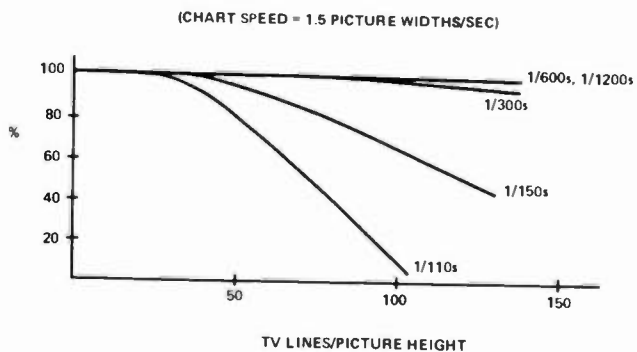


Figure 11. CCD camera dynamic response at five shutter speeds.

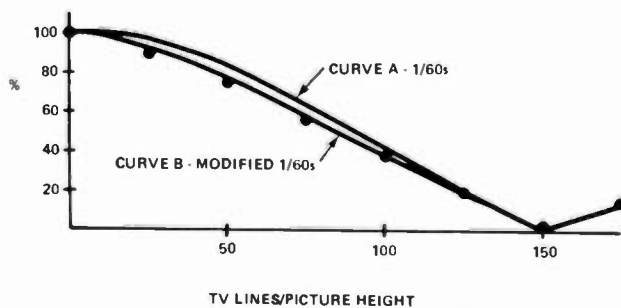
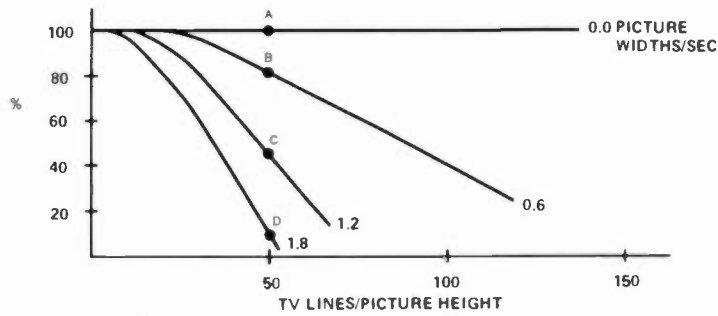


Figure 12. Theoretical dynamic MTF curves, showing effect of weighted exposure time in a tube. Dots correspond to measured tube data.



This graph compares the tube camera dynamic response at chart speeds of 0.0, 0.6, 1.2, and 1.8 picture widths per second. The corresponding off-monitor photographs at 50 TV lines/picture height are reproduced below.

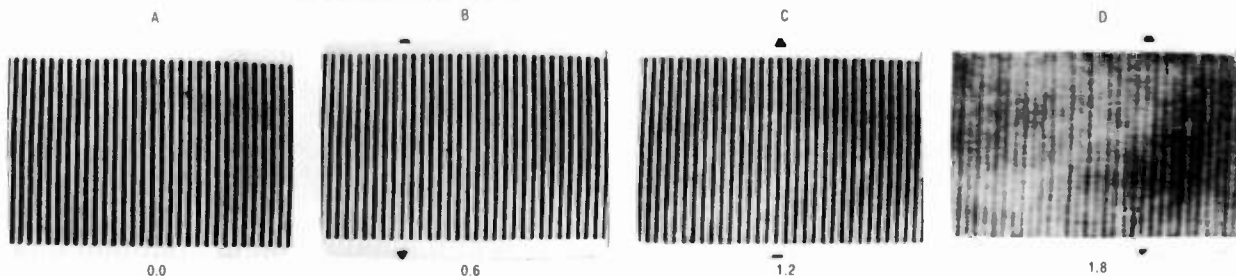
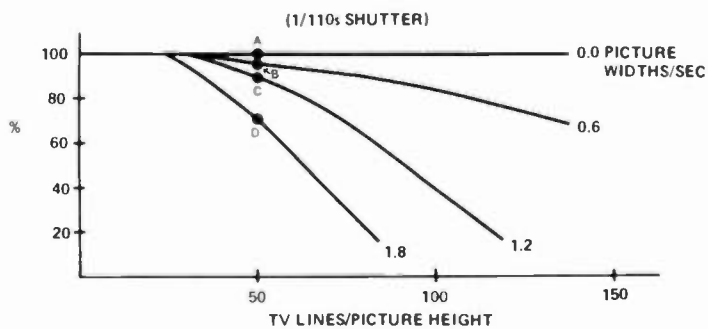


Figure 13. Tube camera dynamic response.



This graph compares the CCD camera dynamic response at the same four chart speeds of 0.0, 0.6, 1.2, and 1.8 picture widths per second. Again, off-monitor photographs at 50 TV lines/picture height are reproduced below.

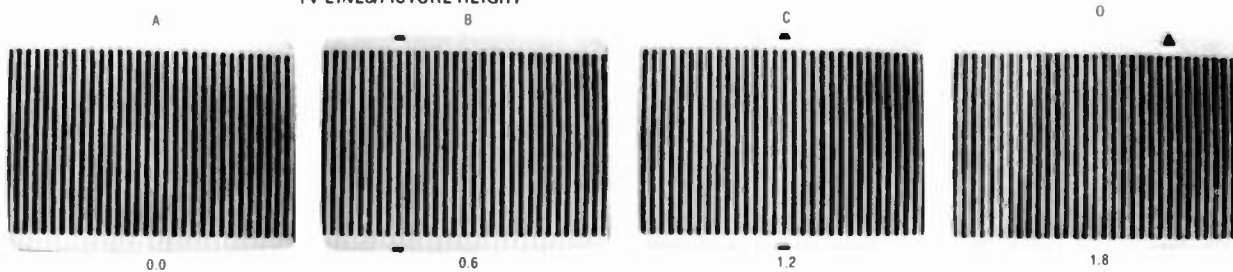


Figure 14. CCD camera dynamic response.

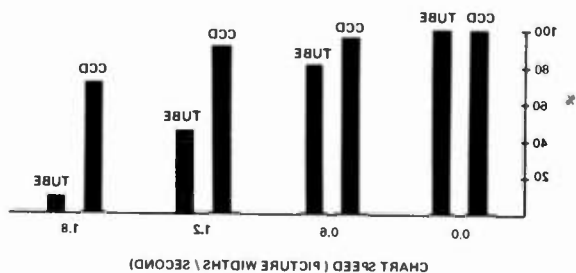


Figure 15. Comparison of dynamic responses of tube and CCD cameras at 50 TV lines per picture height. The shutter speed of the CCD camera is 1/110 of a second.

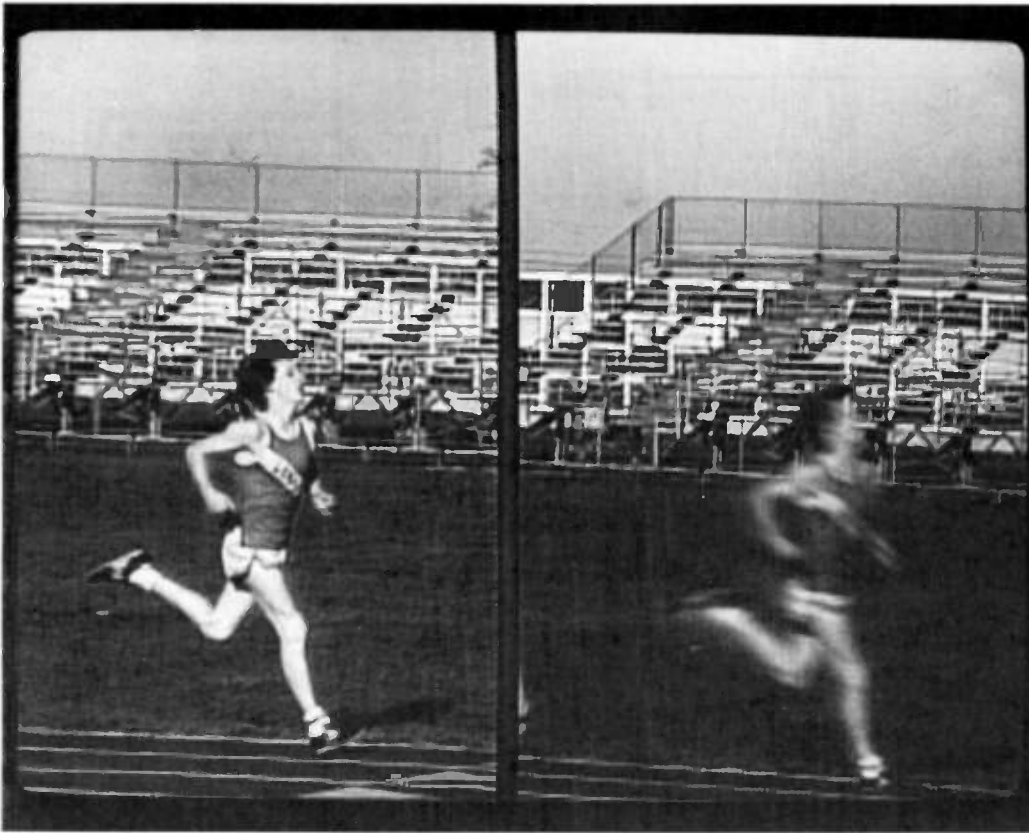


Figure 16. Split-screen comparison on runner moving at 1.2 picture widths per second.

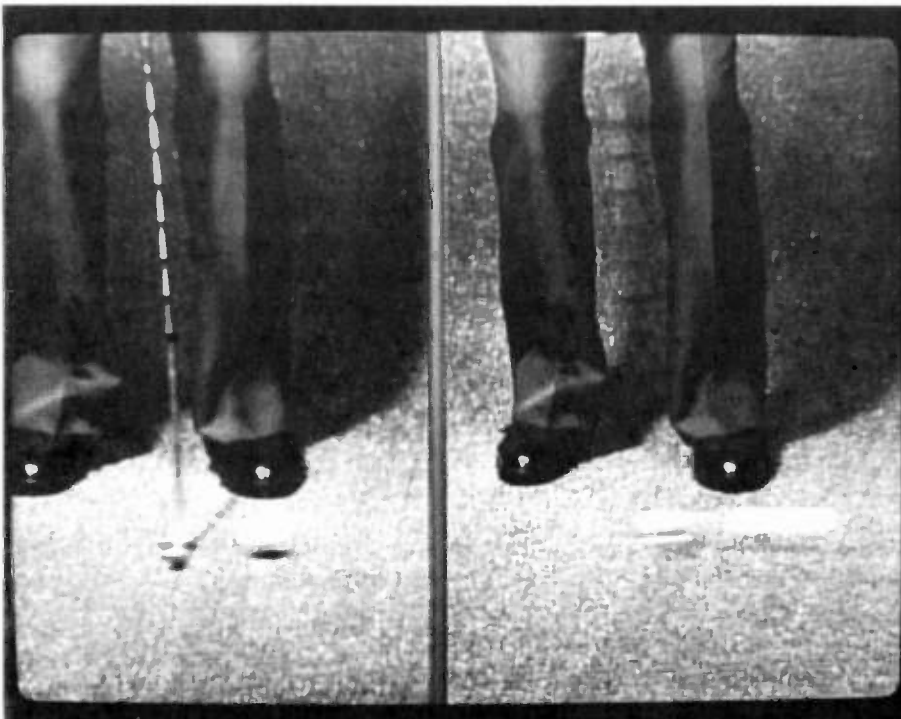


Figure 17. Split-screen comparison on golf swing. Head of putter is moving at 3 picture widths per second.



CCD CAMERA SHUTTER SPEED	SHUTTERING TRADEOFF	REMAINING MARGIN TRADED OFF BETWEEN SENSITIVITY & SNR		DYNAMIC RESOLUTION IMPROVEMENT OVER TUBE
UNSHUTTERED	—	8dB	—	10%
1/100s	4dB	4dB	—	50%
1/100s	4dB	—	4dB	50%
1/150s	8dB	—	—	63%

Figure 18. Comparison of dynamic responses of tube and fast-shutter CCD cameras for typical sports action.

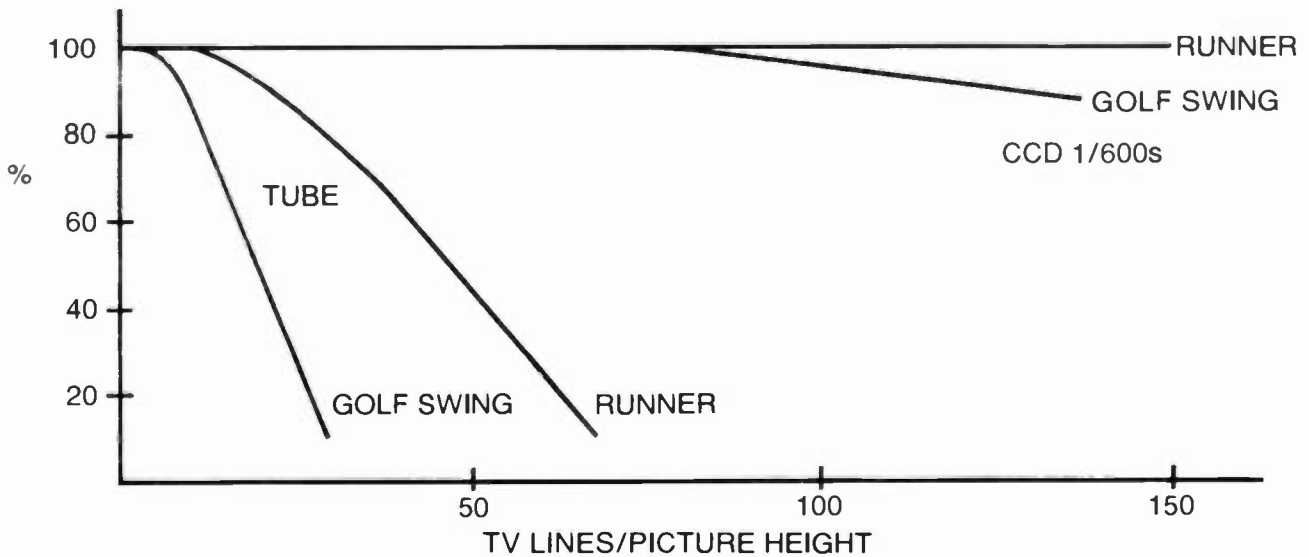


Figure 19. Possible camera design tradeoffs for CCD's 8dB sensitivity margin.

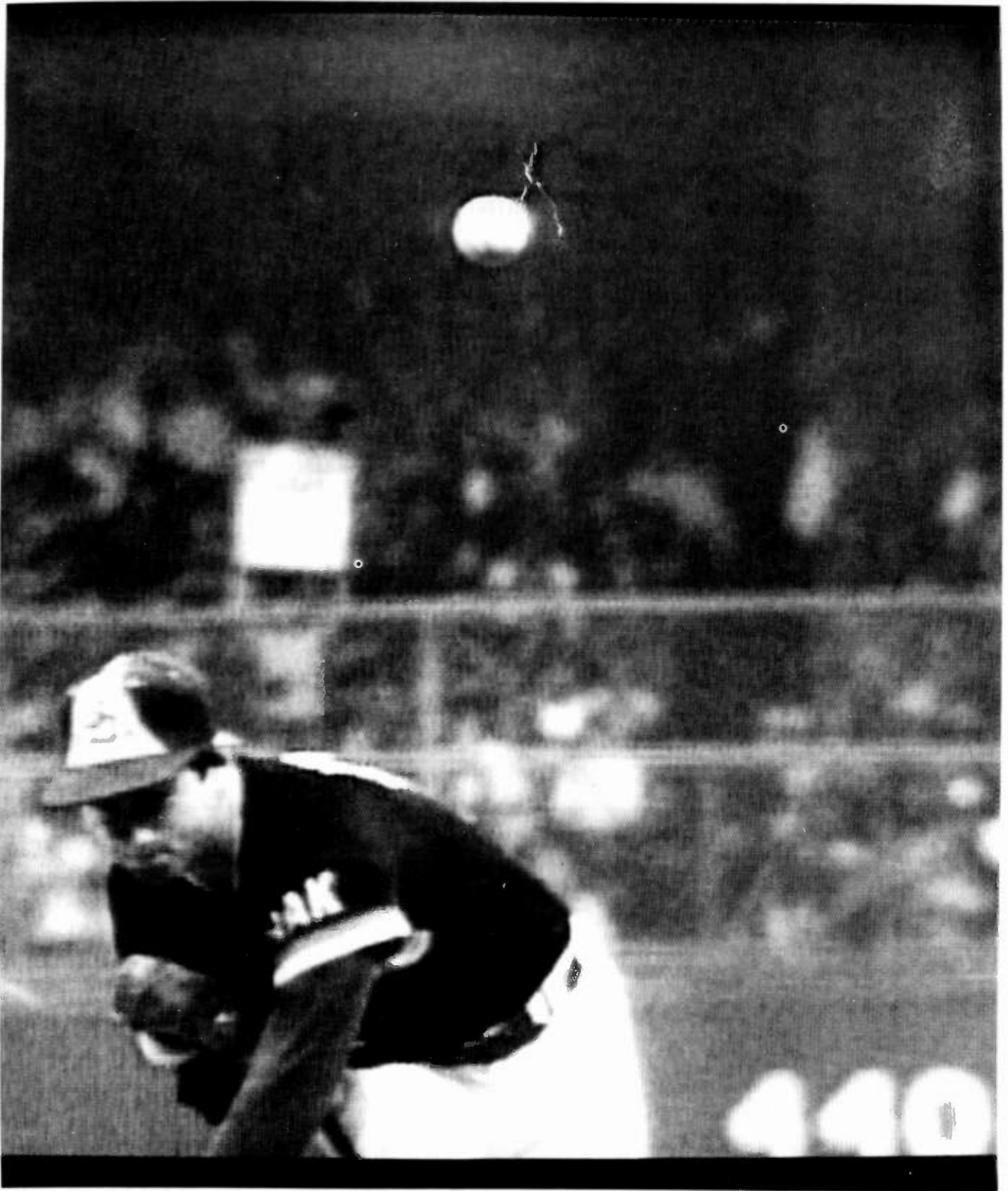


Figure 20. Off-monitor photograph of stop action, captured by NBC Sports during coverage of a night game of the 1984 World Series, with a CCD-1S camera

having a 1/500-second shutter. Viewers could clearly see the seams on the ball to analyze its spin in slow motion.

---

Novel Procamp ("PIXPROC") Corrects Video Level and Contrast

Blair Benson, Karl Kinast and Robert Murch

WPIX-TV

New York, NY

One of the fundamental and most troublesome in-plant technical problems encountered regularly by broadcasters, and one disturbingly visible to viewers, is that of maintaining proper video levels. For example, low white levels will reduce the picture brightness. On the other hand, an increase in black level is apparent as a washed out picture because of the reduction in contrast.

The problem is not amenable to correction by simple signal processing because, unlike constant and periodically redundant sync and blanking signals, video waveforms are complex in nature and involve interrelated white and black levels, all varying with picture content.

In an attempt to address the problem of maintaining consistent video levels, especially on incoming ENG and other remote feeds, Otis Freeman, Director of Engineering for Tribune Broadcasting, engaged Blair Benson as a consultant to investigate and solve these problems. Initially the work focused on solving the problem of maintaining proper black levels.

Although automatic black-level control has been used with limited success for some time in camera channels, a survey revealed that no equipment is commercially available to provide this type of control on an encoded NTSC signal. Therefore with the design efforts of engineer Karl Kinast in New Jersey, development of a stand-alone automatic black level processing amplifier was undertaken.

The result of this work was a prototype automatic black level corrector device which was placed into operation at WPIX about a year ago. Operational experience with this unit showed that in addition to automatic black level correction, there was a need for incorporating into the same unit, a similar correction for white levels. Accordingly, late last year an additional circuit board for automatic white level control was developed and put into service.

The culmination of this work has resulted in a video processing amplifier, called the "PIXPROC", which automatically corrects both the black and white levels of an NTSC signal. Although our main application of the PIXPROC has been to control levels of incoming ENG, satellite and other remote signals, other applications are possible. The corrections are done by using novel circuit techniques; the PIXPROC is NOT a simple automatic gain control (AGC) device. Instead, it functions as a "predictor corrector". The circuitry of the PIXPROC will now be discussed on a block diagram level. Later we'll see how the PIXPROC will handle certain signal conditions.

### PIXPROC General Description

The PIXPROC does not employ feedback for its main functions. As stated above it functions as a "predictor-corrector". To illustrate what is meant by a predictor-corrector, compare it to a traditional control system that does not employ feedback. An example of a predictor-corrector is the automatic exposure control system of a photographic camera when it is operating in a fixed preset iris mode. In this case the system measures the input signal, uses this signal to compute the solution to an algebraic equation and outputs an error correction signal which controls the speed of the shutter. Based on such predicted information, the shutter can be expected to correct the exposure. Note that such a system never has actual information regarding the success of the prediction.

A feedback system, such as the auto-iris function of a television camera, operates by detecting an error in the final output, and sending a correction signal back to the controllable input element, in this case the iris of the lens. A typical feedback system, including an auto-iris system, cannot respond instantly and completely to the first piece of information fed back. It requires time in order to drive the error to zero. Attempts to make the system response faster than its slowest natural time constant produce overshoots or oscillation. Thus the typical feedback system is able to achieve its ultimate solution only after a period of many sampling intervals. In other words the first correction attempt results in an error, the second attempt a reduced error, and so on until the error is ultimately reduced to zero.

A predictor-corrector however, reduces the error to zero on the first attempt. In the case of the PIXPROC the error is predicted on the basis of one field, and the correction is applied to the succeeding field. While one could argue that for a rapidly changing input signal the error is not quite reduced to zero, consider that a feedback system would produce a much greater error.

Consider such a rapid field to field change in a video signal. In this application, the PIXPROC can respond completely within one field and yet be completely immune from overshoot or oscillation. Even a very large error is correctable almost instantaneously.

There are however some reasons to slow down the rate of correction. One reason is so the white level corrector will not be tricked into creating an undercorrection that persists for a single field when switching to a scene with a radically different black level. Other reasons for slowing down the response rate include avoiding a sudden large response to an isolated noise spike and avoiding field to field fluctuations that are part of the original scene. The former reason is mitigated by spike filtering in the PIXPROC's detector. Large sudden excursions are slew-rate limited in the PIXPROC' corrector circuitry. Finally, a 50 millisecond time constant is adaptively switched in for small fluctuations in black level, reducing the tendency to follow the inter-field fluctuations sometimes caused by picture sources.

The philosophy on which the PIXPROC design is based assumes that any constant error in black or white is produced by either an ENG camera or the relay transmission equipment, and that it should respond to the changes in these errors quickly.

Previously available proc amps used AGC circuitry and performed black level correction inadequately or not at all. We considered the black level problem to be paramount, since a high pedestal results in washed out pictures. Thus we initiated the automatic black level corrector project first and completed it before considering the white level aspect.

#### PIXPROC Circuit Description

The PIXPROC consists of two independent predictor-corrector blocks connected in series (see Figure 1). A signal passing through goes first to the black level corrector and then the white level corrector. Throughout the PIXPROC an effort is made to reduce the complexity of the main video path to a minimum. The benefits obtained from such a minimization are low distortion, short throughput delay and a high degree of stability.

As can be seen in Figure 2 the input video goes through a gain control to a feedback clamped amplifier. This maintains the D.C. level of the backporch constant with millivolt accuracy.

The first measuring path to be encountered is arranged to measure the voltage error between the backporch and the blackest luminance that occurs in a picture. This information is accumulated, pixel by pixel, by means of a differential detector. At the end of the accumulation period of one field, and after further D.C. amplification, the error signal is transferred to a sample and hold stage. As soon as the information is transferred, the detector is reset to zero. Thus, after a new field begins, the detector starts accumulating data on the new field.

Meanwhile the data regarding the just completed field is available at the output of the sample and hold stage as a constant D.C. voltage which will maintain a constant amplitude throughout the new field. Its amplitude is exactly correlated to the actual black error in the previous field, and is expressed in terms of volts D.C. per IRE unit of black error.

Since the voltage held in the sample and hold stage is an exact measure of the black error predicted for the new field, it can be used to exactly offset the error by injecting it via a calibrated resistor into the internal summing network in the main video path. However, injecting this predicted value as a steady state signal would only result in a D.C. shift of the entire video waveform.

In order to shift only the black level, this correction signal must be converted into a signal that has the same shape as a black level error. Accordingly, the injected signal is converted into a negative pedestal waveform that is proportional to the amplitude of the D.C. voltage yielded by the sample and hold stage. In other words, the injected correction signal is caused to fall exactly to zero during blanking time. At all other times it cancels out the pedestal level of the signal coming into the PIXPROC. Thus at the output of the black corrector the signal has zero pedestal similar to a PAL signal. A fixed pedestal of 7.5 IRE units could be added at this stage, but will be added after white correction instead.

The white corrector is essentially a multiplier, and to be mathematically correct, both the black level and the blackest luminance should be at ground potential at the multipliers input. This necessitates that there be no NTSC setup on the signal at that point. This is why addition of setup is deferred until further downstream.

In order to keep differential gain and phase distortions below one percent and one degree, the multiplier does not use any variable semiconductor parameters. Instead, it is in the form of a resistive attenuator. It is also important that the phase angle of the subcarrier frequency does not vary as a function of attenuation, when compared to the burst phase. Sync and burst are transmitted via a fixed attenuation so that their amplitude at the final output is a constant 40 IRE despite the variations in attenuation that are commanded for the active portion of each video line.

Figure 3 shows the white predictor corrector block. The corrector portion is the commandable attenuator that has just been described. As with the black corrector an error signal is produced which then adjusts the commandable attenuator.

The prediction is based on the maximum luminance encountered during the previous field in a manner similar to that explained for the black predictor. The voltage accumulated at the output of its detector is a measure of the peak highlight encountered in the previous field. The predictor's amplification is scaled so that 5 volts D.C. corresponds to 100 IRE units of video. The subsequent analog stages convert any signal that differs from a 5 volt level to an error signal suitable for commanding the attenuator. The attenuator produces an insertion loss that just compensates for the error in the white level of the signal appearing at the input of the attenuator.

In order to accomplish this form of control, the input for the white measuring system is tapped off before the attenuator. This is the essential difference compared to the architecture of a feedback system. If the PIXPROC were based on feedback instead of prediction correction, its measuring sub-systems input signal would have been tapped off after the attenuator.

The white corrected signal is now passed through a stable amplifier to a summing network where the 7.5 IRE pedestal is injected. This signal with both black and white correction now goes through an amplifier to the output connector of the PIXPROC.

The complete block diagram (Figure 4) shows that a moderately complex timing block is required to supply pulses for activating sampling gates, resetting them, and controlling the sample and hold stages. The timer itself is driven from signals extracted from a sync stripper in the input stage.

Not shown are the various limiting stages which limit black correction to 25 IRE units and inhibit white correction of signals having a peak luminance of less than 60 IRE units.

### System Performance

Consider the case where a NTSC signal with proper video levels is applied to the input of the PIXPROC. The black level corrector will first remove the existing 7.5 IRE pedestal. The amplitude of the video signal is now reduced from 100 IRE to 92.5 IRE units. Since this is the correct video amplitude at the input to the white level corrector stage for a normal signal, no correction will take place. At the output of the white level corrector, the 7.5 IRE pedestal is added and the white level is restored to 100 IRE. Thus, in this case, there has been no change in the video levels of the signal going thru the PIXPROC. This is important to note from the viewpoint that a signal passed thru a PIXPROC more than once will not be "over corrected". Certain other processes such as noise reduction and image

enhancement generally do not yield good results if repeated on the same signal.

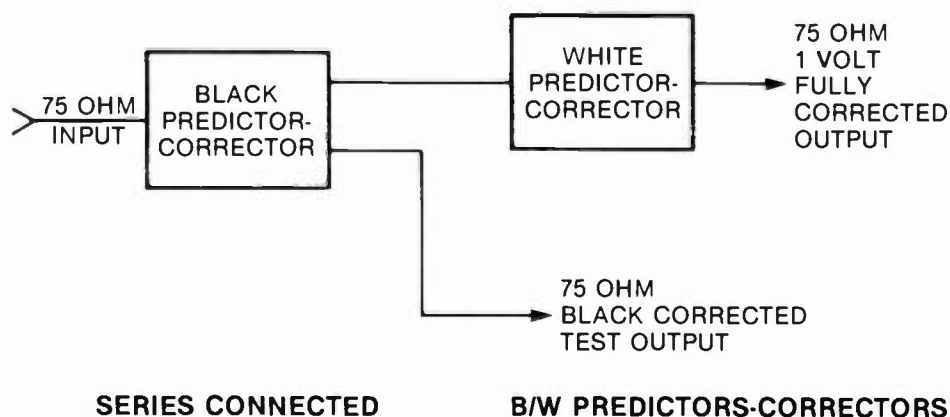
In the situation where the pedestal is high, the PIXPROC will first remove the high pedestal, correct for the corresponding lower white level, and then add a proper 7.5 IRE pedestal. This correction mode is the one we find to be needed and performed the most. Due the predictor corrector nature of the PIXPROC, such correction is performed in a most satisfactory manner.

In situations where the white level is either a little high or a little low, the PIXPROC will correct the signal to have the peak whites be at 100 IRE. Recall that the PIXPROC will inhibit correction of signals having a peak luminance value of less than 60 IRE units. This circuitry allows for more natural fades to and from black to occur than would an AGC type corrector. Also there is less tendency for the PIXPROC to "over correct" night time scenes and other dark scenes.

### Conclusions

The PIXPROC has shown itself to be of value in automatically correcting the frequent varying and improper video levels of incoming ENG, satellite, and other remote signals. Correction of the black level has been most helpful in improving the contrast of the picture on the home receiver, especially those with poor D.C. restorers. We feel the "predictor-corrector" approach to control has been superior to that of the AGC type.

Use of a PIXPROC device may be of value to other broadcasters who wish to automatically correct both the black and white levels of video signals within their stations.



**FIGURE 1**



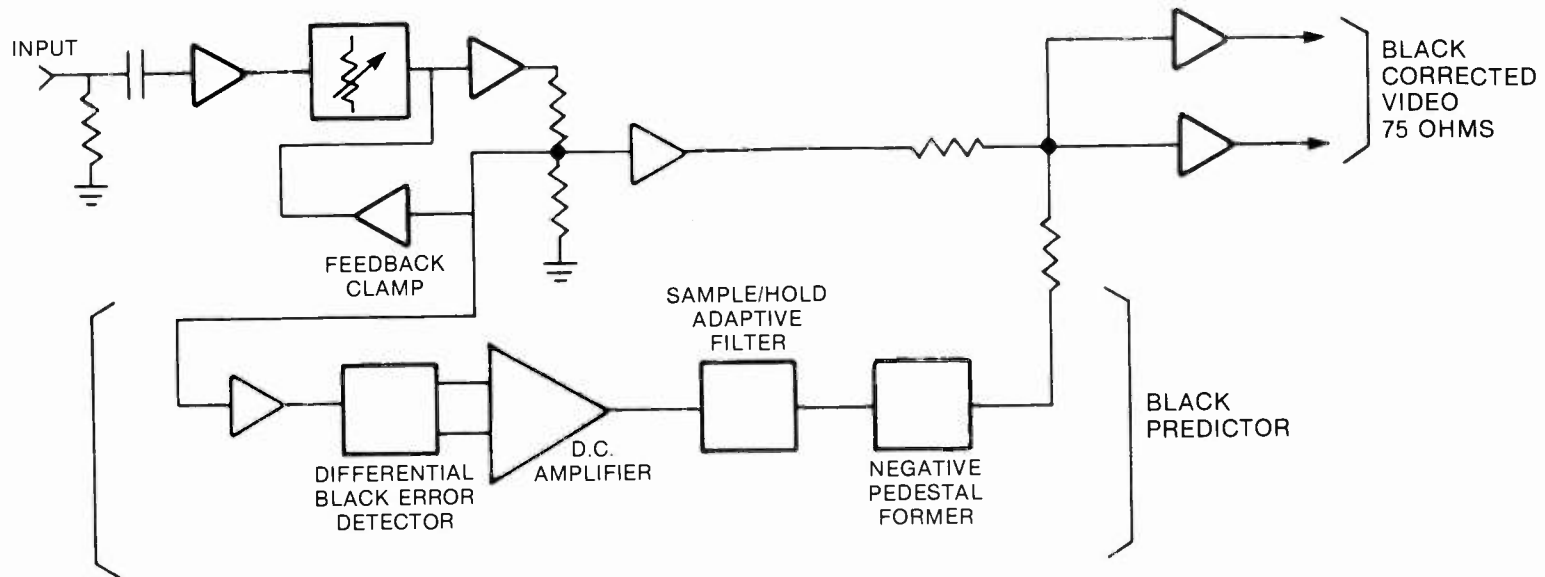


FIGURE 2

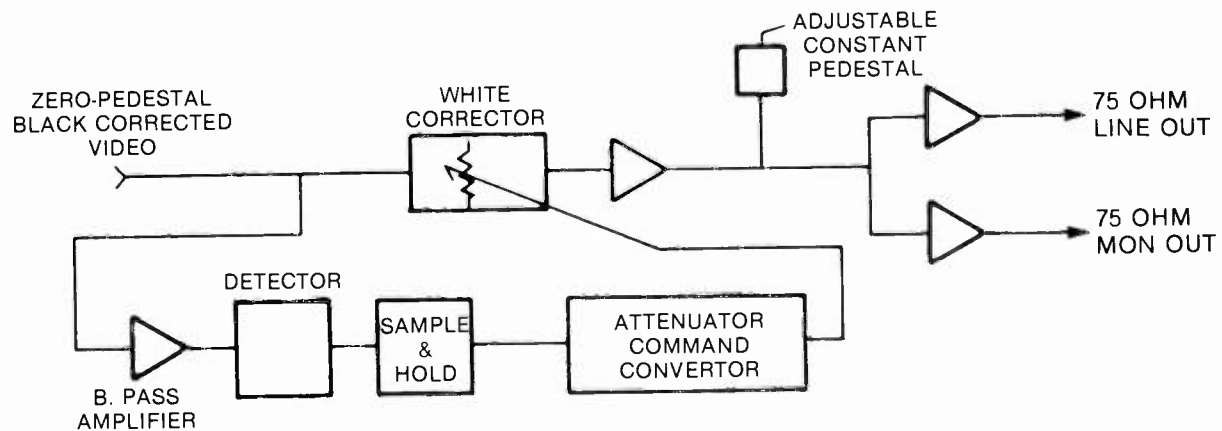


FIGURE 3

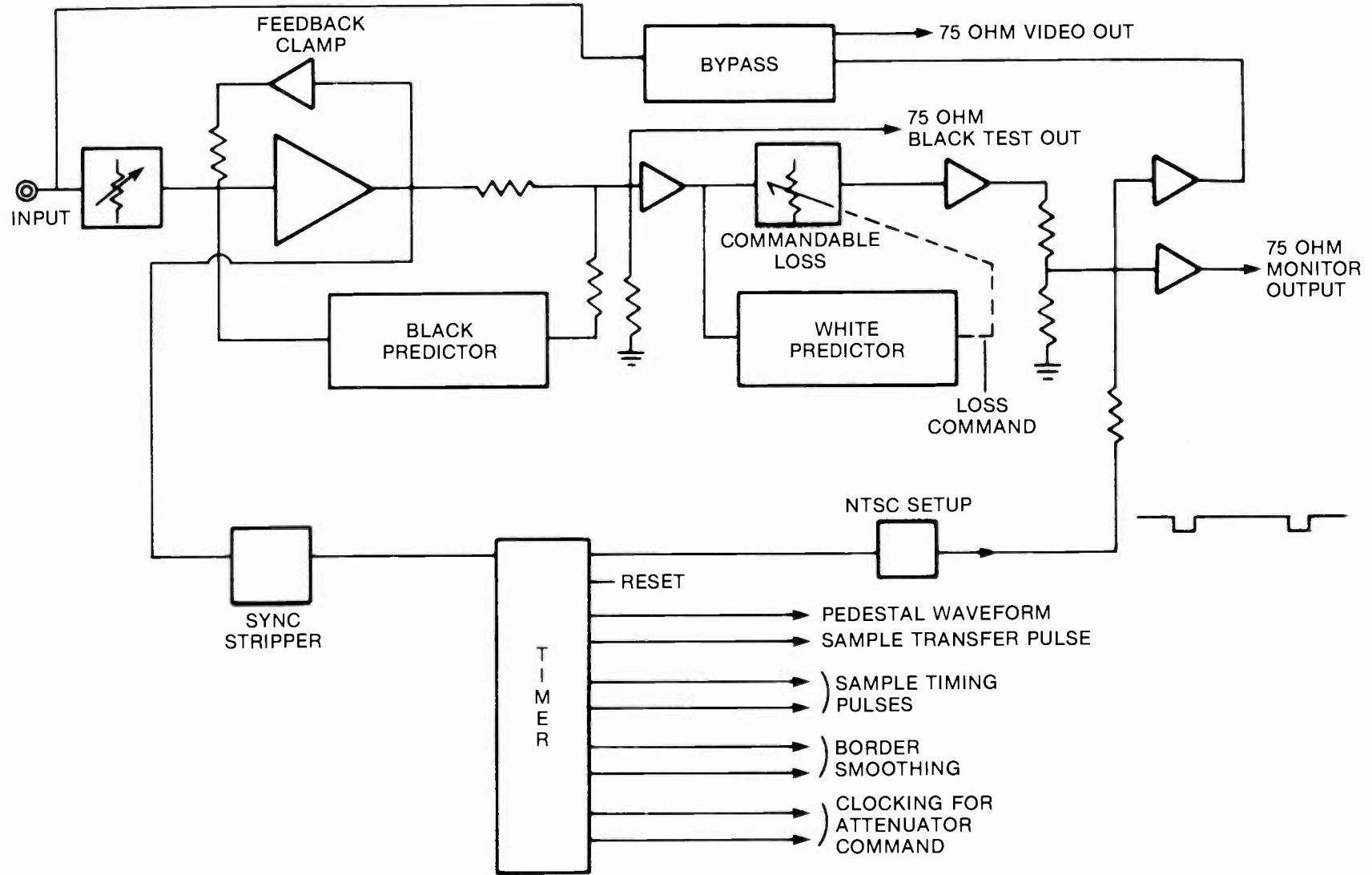


FIGURE 4

---

A CASE FOR THE USE OF MULTI-CHANNEL  
BROADBAND ANTENNA SYSTEMS

M.B. Anders  
Alan Dick & Company, Ltd.  
Cheltenham, England

INTRODUCTION

Historically, broadcasters have always owned and operated their own facilities. The tower and antenna system located on appropriate high ground in the coverage area is a landmark to which a broadcaster would point to with pride. Today, broadcasters still need a high profile in their communities but a new reality has surfaced.

With new frequency allocations being made in many areas, land to construct new transmitter site facilities is now at a premium. The cost of purchasing land and constructing a transmitter facility is very high, as a result, more and more broadcasters are becoming aware of the advantages to be gained from combining their transmitter site facilities with other broadcasters in the same market.

With today's technology, it is possible to combine several frequencies in a single broadband antenna system including a single transmission line run.

ECONOMIC FACTORS

The high cost of land is not the only factor compelling broadcasters to co-site their transmitter installations. Pressure from environmentalists and the FAA to minimize the number of towers and the limiting of their heights are other major factors. Additionally, there is the necessity to provide power to a site and depending on the location, this can be a major portion of the capital cost. It therefore makes sense to share a transmitter site on economic grounds. With more broadcasters competing in a very volatile market for a market share, it is essential to make every dollar count.

A further indirect benefit of operating from a shared facility is the ease with which the viewer can set up his receiving antenna. Signals arriving from a common direction mean that he will at least keep his antenna pointed in your direction.

Having made the decision to transmit two or more Channels from a single site, it is not advisable to radiate from more than one tower, not only because of the increase in land required but also because of re-radiation or multipath signals from the adjacent structures. It is therefore not surprising that there are a number of shared towers in North America. These, in the main, take the form of a candelabra structure with several narrowband antennas mounted on the arms of the candelabra. This configuration has largely come about because broadcasters are a competitive breed and each wants to be at the top of the tower.

An alternative arrangement would be to mount separate antennas colinearly on a single tower shaft. Of course there is a penalty to be paid if your not as high as possible, however, in practice, the penalty is usually extremely small. For instance, consider two colinear UHF antennas with centers of radiation at say 1460 ft. and 1405 ft. above average terrain, the reduction in field strength and grade 'B' coverage from the lower antenna compared with the upper is typically -0.3 dB or 2/3 of a mile less in 60 miles based on 5 MW ERP's. (Perhaps, in such a situation, the FCC could be persuaded to allow a marginal increase in ERP of the above order of dBs to compensate for this).

At first sight the candelabra tower and antenna configuration has a lot to commend it. Its main disadvantages are, however, that it is prone to "ghosting" and pattern distortions resulting from multiple reflections from adjacent antennas. The antenna design engineer has to carefully balance the distance between antennas and thus the delay in re-radiation, with the magnitude of re-radiation, which is dependent upon the antenna cross-sections and the inverse of the distance between them. Not forgetting of course that at the end of the day a practical tower design is required.

A further alternative to the candelabra which is widely accepted outside of North America is the use when feasible of broadband antennas. These antennas permit the simultaneous radiation of two or more broadcast channels. The number of channels being limited in the main by the power handling capability of the equipment and its bandwidth.

A single broadband antenna is likely to have a lower wind area and thus a lower tower loading than multiple single channel antennas. There are therefore significant savings to be made on the tower capital cost due to the simpler design. Another very significant factor is that only one single main transmission feed line is necessary which not only further reduces the tower loading but has again obvious economic advantages. The extra

cost of a combining unit to combine the various operational channels into a single feed line is generally small compared with the main transmission line costs.

A very rough comparison is shown in Table 1 for typical transmitting site capital cost for a stand alone installation, a combined site, as well as indicating the economic benefits of employing broadband antennas.

TYPICAL RELATIVE COSTS in "1000s" of \$

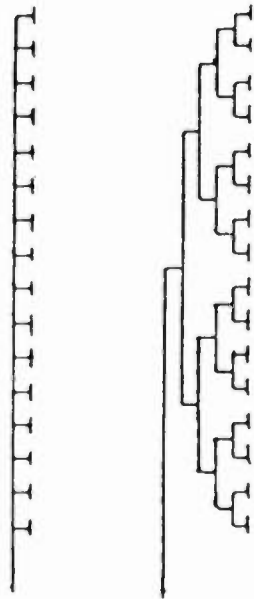
Item	Single Channel	TWO CHANNELS			THREE CHANNELS		
		Separate Sites	Candelabra	Broadband Antenna	Separate Sites	Candelabra	Broadband Antenna
Land & Access	65	130	65	65	195	65	65
Power Line (1 mile)	300	600	330	330	900	360	360
Tower 1500 ft.	1600	3200	1800	1600	4800	1800	1600
Antenna	200	400	400	230	600	600	240
Feed Line (W/C)	240	480	480	240	720	720	240
Channel Combiner	-	-	-	40	-	-	80
<b>TOTAL</b>	<b>2405</b>	<b>4810</b>	<b>3075</b>	<b>2505</b>	<b>7215</b>	<b>3545</b>	<b>2605</b>
Relative saving) by sharing site)	-	-	1735	2305	-	3670	4610
Relative saving) using broadband) antenna)	-	-	-	570	-	-	940

Table 1: Typical relative costs of shared and separate sites as well as candelabra tower and antenna versus broadband antenna costs. Items that are fixed and common (e.g. transmitters) are omitted. Three UHF channels are assumed with nominal 3.5 MW ERP for 110 KW transmitters.

### TECHNICAL CONSIDERATIONS

The main difference between the standard traditional narrow band antenna and its wide band counterpart is the way in which its large array of elements are fed. The principle of the feed arrangements are shown schematically in Figure 1. The narrow band antenna relies on all the elements being fed in series. It is usual that the nominal length of the line between elements is a wavelength. The reason this arrangement is narrow banded especially for large antenna apertures is the change of electrical length of the series line feeder with frequency, such

that out of band the elements would no longer be fed with nominally co-phased currents. The effect is to produce large beam tilts out of band. As it is, it is usual for compensation networks to be employed to maintain a stable beam tilt angle within a single channel.



(a) (b)

Figure 1: Basic concept feed arrangement for  
(a) narrow band antenna  
& (b) a broadband antenna

The branch feed configuration (Figure 1B) normally employed by the broadband antenna ensures that the relative electrical length of line between transmitter and each radiating element is virtually independent of frequency. Therefore, the vertical radiation pattern and in particular, the beam tilt of such an antenna are stable over a wideband of frequencies. An antenna's input impedance in terms of VSWR is essentially the average VSWR of each radiating element assuming an ideal branch feed system. For the narrow band series fed antenna the VSWR is the complex sum of all the individual elements after being transformed down their respective line lengths to the antenna input.

The result is an input VSWR that changes rapidly with frequency. With TV stereo plus other sub-carriers now being added to both TV and FM channels there may well be "narrow band" antennas whose bandwidth is too narrow giving rise to intermodulation and cross talk.

Because of the nature of the branch feed arrangement employed by the broadband antenna, it often has a larger cross-section than its narrow band counterpart. This unfortunately, in some cases, degrades the broad band antenna's horizontal radiation pattern.

However, antennas mounted in a candelabra arrangement will also be found to produce horizontal radiation patterns that vary

noticeably with azimuth angle. Furthermore, because of the relatively large distance between the antennas, the variation in the antennas horizontal pattern can be quite significant and in some instances, unacceptably so, over an operating channel.

In addition to levels of re-radiated multipath signals having to be considered when analyzing a candelabra antenna system, there are other factors which also have to be studied. These include the effects of the relative wind sway of antennas, and mutual coupling between antennas. The latter can produce long delayed re-radiation and lead to the generation of intermodulation products. Another factor is the delay in the multipath signals directly reflected from the adjacent antenna(s). In the case of the latter with antennas typically separated by 30 to 50 ft the multi-path delay can be of the order of 0.1 micro second. Such a delay dictates that the level of the multipath signal should be below -15 dB relative to the direct signal in order to avoid perceptible "ghosting". For a three antenna system, the reflection/re-radiation from a single antenna may well have to be below -21 dB.

The level of re-radiation resulting from the mutual coupling between antennas mounted on top of a candelabra should normally be at least -40 dB down because of the long path length between the antenna and transmitter. In addition, if the mutual coupling between antennas is significant the question of intermodulation generation taking place at the transmitter output when two or more signals are mixed has to be considered. Such spurious radiated signals should be below -80 dB.

The variation of field strength at any given azimuth over the video channel should be kept small and ideally within 1 dB. Because of the electrical distance between antennas changing noticeably over a channel, it is possible to produce unacceptable variances. This situation does not exist for a single broadband antenna which has little variation. Figure 2 depicts the type of pattern variation with frequency within a channel for both a candelabra antenna system and a single broad band antenna.

As has previously been stated, a broadband antenna's VSWR is largely dependent on the VSWR bandwidth of its individual radiating elements. It is in the main the VSWR of such an antenna that limits its bandwidth rather than its radiation patterns unless special measures are taken. Such measures include one or more of the following:

- (a) Applying compensating networks to the individual radiating elements.

- (b) Feeding all elements with a phase perturbation scheme such that the results of all individual reflections with the antenna cancel out.
- (c) The insertion of discontinuities within the antenna system such that the reflections they produce are equal and opposite in phase to that of the antenna in its own right.
- (d) Employing radiating elements such as crossed dipoles that are required to be fed in phase quadrature for circular polarization.

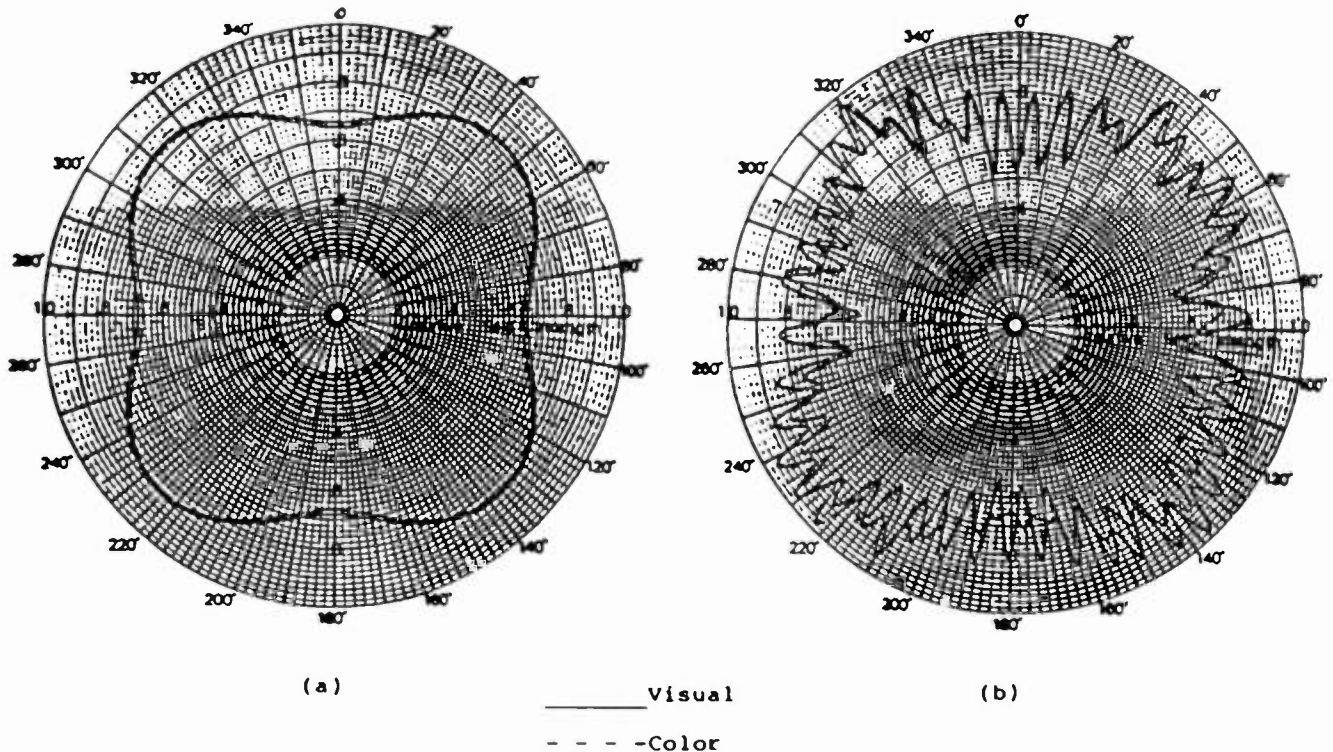


Figure 2: Typical horizontal radiation patterns for (a) a broadband single antenna and (b) a single channel antenna in a three antenna candelabra configuration. Both antennas are assumed to be high band VHF turnstiles.

To consider the above in a little more detail, the radiating element impedance bandwidth can be improved by the addition of short and/or open circuit stubs of varying lengths or some other device which is frequency dependent. These arrangements can get quite complex and because of the usually large number of elements can add a considerable cost to an antenna. Therefore, a compromise is normally reached so that little compensation is added to antennas in the UHF band while one, two, or even three stubs may well have to be added to the low band VHF antenna element.



Schemes by which an antenna array can be phased are endless. They essentially fall into 3 groups.

First, a phase perturbation system is applied over an antenna's vertical aperture that will not only produce an acceptable vertical radiation pattern, but, on the assumption that all radiating elements within the antenna have similar impedance characteristics, it will cause their reflections to cancel out at the antenna's input.

Secondly, phase rotation is applied within a bay of the antenna, with the antenna elements mechanically displaced in order to maintain the horizontal radiation pattern (see Figure 3). Such a system is not always appropriate for certain directional antennas.

A third method which is similar to the second except that the antenna element array lends itself to being fed using a phase compensating method. The Batwing superturnstile antenna is a good example.

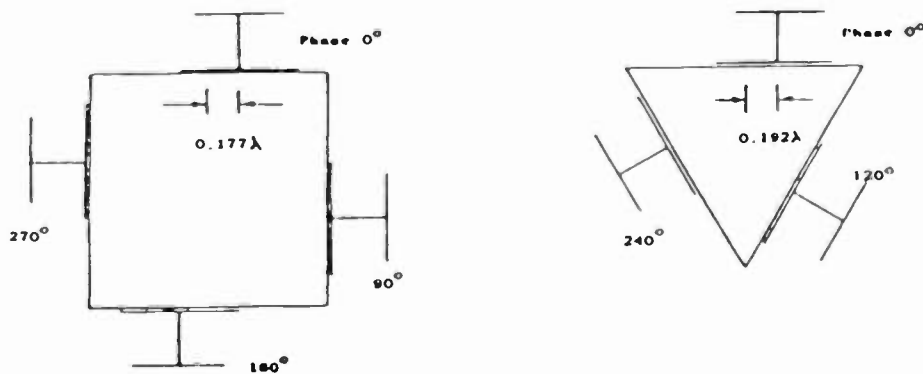


Figure 3: Phase rotation scheme within an antenna bay to improve input VSWR. Panel offset required to maintain same pattern as for co-phased non offset panels.

There is perhaps a fourth group which relies on mechanical radial displacements of elements over the antenna aperture. Such an arrangement is not normally recommended as it leads to vertical radiation patterns that distort with azimuth.

The insertion of discontinuities within the antenna system is ideal for matching the antenna input impedance at specific frequencies such as a number of vision carriers. To a lesser extent, it is useful for improving the overall bandwidth of an

antenna. The discontinuities generally take the form of patches or slugs that are applied to the inner conductor of a coaxial line. For a two channel antenna, the distance between the matching devices is ideally a quarterwave at the difference frequency. For three or more channels, the ideal separation of the slugs is more complex. (This is dealt with in more detail in reference 1). The idea is that the net effect of the discontinuities is not just dependent on their respective sizes but also the electrical length between them which changes with frequency.

Circular polarized antennas have an inherent advantage in that one of the best ways of producing circular polarization is by feeding two similar orthogonal elements in the same plane in phase quadrature thus the combined input VSWR is low over a wide band.

While the foregoing phase perturbation schemes can be powerful tools for improving an antenna's bandwidth, they should not be used at the expense of allowing the VSWR specification of an element to be relaxed. It is important to remember that large miss-matches within the antenna system are likely to cause a distortion to the power dividing branch feed system that could result in variations of an antenna's radiation pattern with frequency.

Carefully designed broadband antennas can be built to have a VSWR of better than 1.1:1 over a wide band of frequencies and can be even as low as 1.05:1. For television transmission, the antenna match can be further improved within an operational channel.

While it is possible to produce very broadband antennas for the whole UHF band, it is desirable to restrict the bandwidth of high gain antennas to about 25% bandwidth in order to provide a stable performance. For instance, a 32 wave length aperture at say 470 MHz becomes 52 wavelengths at about 760 MHz. Such a large aperture would certainly produce an unacceptably narrow main lobe in the vertical plane.

There are already a number of broadband antenna systems in service in North America. These include several two and three channel UHF antennas, as well as three channel VHF systems in both the low and high bands. There are also numerous FM antennas that cover the full 88 to 108 MHz band including one designed with an eleven channel capability.

## PRACTICAL IMPLICATIONS

As has been previously stated, because of the nature of the branch feed system employed by the broadband antenna, they generally have larger cross-sections than the narrow band antenna. The latter normally consists of a pole which is fed from its lower end up inside the pole.

For the broadband antenna it is normally convenient to divide up the antenna into a number of panels. Each panel consisting of one or more radiating elements mounted in front of a reflecting screen. Panels (having a single input) within a bay are then fed via a single bay power dividing network. These power dividers are then combined via a combination of other power dividers to provide a single antenna input. There are those who regard this feed arrangement to be more complex than that employed by the series fed narrow band antenna, thereby questioning its reliability. The same argument could perhaps be applied to a 747 Jumbo Jet aircraft in comparison to an automobile, in practice (fortunately) the opposite is the case. Panel antennas if properly engineered are as reliable if not more so than any other type of antenna. Good engineering includes ensuring adequate power safety factors. It is recommended that such factors should be of the order of 1.5:1 on a components normal rating. This is after allowing for the effects of maximum ambient temperature, maximum VSWR, as well as ensuring that the system is adequately pressurized with dehydrated air or nitrogen. Because of modular configuration, accessibility is easy simplifying servicing. To repair a narrow band antenna, the whole antenna probably has to be lowered to the ground and shipped back to the manufacturer - a major exercise particularly if the antenna is part of a candelabra system necessitating the use of counter weights to balance the structure when the antenna is removed. More often than not, access to all parts of a panel antenna can be gained from within the antenna support structure. Also as the structure is usually completely screened, it can be climbed safely (from an R.F. point of view) on the inside to change an aviation beacon even when the antenna is fully powered.

Another feature of the panel antenna is that it lends itself to being split into two halves each being fed by separate transmission lines. Such an arrangement does away with the necessity to employ separate "stand by" antennas. In the event of an antenna fault ever occurring, the "good" half of the antenna can be fed while the faulty component is located and repaired. The effect is to radiate from virtually the same height with an ERP that is either 3 or 6 dB down from normal.

## CONCLUSIONS

With the constant need to improve transmitting facilities and at the same time cut costs, it is not surprising that more and more broadcasters are getting together to combine their resources. This is particularly evident in the FM radio market which is an extremely competitive market with little spare capital. It is in this broadcast sphere where there has been a dramatic increase in demand for Master FM antennas, especially now with many "Class C" stations being faced with the need to increase their antenna height in order to maintain their "Class C" status. Now TV broadcasters are beginning to look at the advantages that are offered by employing broadband antennas.

With the advent of computer aided design, it is now possible to build highly sophisticated and reliable antenna systems capable of handling a number of TV channels. The development of waveguide components for the broadcast band as well as high power combining units have also made it possible to handle very high powers even in the UHF band.

While the broadcast industry is a very competitive business with little management cooperation in the same market, this is usually not true at engineering levels. Engineers, like doctors, cover for each other and it is through engineers that these ideas will have to be advanced.

Reference (1) M. B. Anders, "Impedance Correction of Multi Channel UHF Aerials", I.B.C. 1970, p. 61

---

DIGITAL TV TAPE RECORDING  
F. M. Remley  
Chairman, SMPTE WG-DTTR  
The University of Michigan  
Ann Arbor, Michigan

The digital television tape recorder promises ten to twenty near perfect tape generations, four digital audio channels and a variety of other features. The format has been designed for top quality performance in all aspects. This brief paper will provide a general overview of the new format and of the processes that have led to its creation.

The digital television tape recorder (more simply, the DTTR) is near to becoming a reality. The new digital recorder will use an entirely new tape format. In contrast to the Type C and Type B recorders that we all know and sometimes love, the DTTR is not similar to earlier designs. The new format will address the present and future needs of broadcasters and production organizations, combined with past experience in digital data recording and digital audio recording, and will capitalize on the experience derived from nearly 30 years of analog video recording equipment design and manufacture.

After many years of study and discussion of digital video technology in SMPTE engineering committees, it became apparent in mid-1983 that a practical digital VTR was nearly within sight. The Society responded by disbanding the then existing digital video recording Study Group and establishing in its place a new DTTR Working Group to develop actual standards for such equipment. I became chairman of the new WG-DTTR in early 1984. Administratively, the Working Group reports to the Video Recording and Reproducing Technology Committee (VRRT), the permanent engineering group charged with responsibility in video recording standards efforts within SMPTE.

The formal work assignment of the WG-DTTR is as follows:

"The Working Group on Digital Television Tape Recording, formed under the rules of the SMPTE, has the objective of developing proposed standards and recommended practices necessary for interchangeability of video tapes among recorders designed to these standards. Priority will be given to a format ensuring compatibility with the 525/60 component digital system as defined by CCIR Rec. 601 (with appropriate consideration being given to 625/50 commonality). Consideration will also be given to the application of the mechanical system to other signal forms such as lower members of the digital component family and composite NTSC."

"The Working Group will cooperate with other SMPTE engineering committees and other organizations involved in developing standards in these areas, such as the AES, EBU, CCIR, IEC and IEEE."

The WG-DTTR has been a hard-working group of individuals. During 1984 it met at intervals of about every six weeks. Meetings were held in Montreal (at the 1984 SMPTE TV Conference), in Las Vegas (at NAB), at O'Hare and JFK airports, Redwood City, CA, Winchester, England (with the EBU MAGNUM

group), in New York at the SMPTE Fall Conference, in San Jose, CA, and again in San Francisco in February. It will meet again in Las Vegas following the 1985 NAB Convention. In addition, three meetings of MAGNUM, the European Broadcasting Union group responsible for drafting 625-line digital VTR specifications, were held and most of the same experts attended both SMPTE and MAGNUM meetings. This meant much travel, many tens of thousands of miles of it, and much talk and thinking. Luckily, there still remained enough time for some laboratory work to be completed!

One of several important accomplishments of the SMPTE WG-DTTR was the establishment of a useful and productive group of experienced users of video tape recording equipment to help in balancing the pros and cons of many aspects of the new DTTR system. For example, although there was general agreement among both manufacturers and users that the DTTR should be a cassette loaded machine, it was the future users of the equipment who finally decided the tape width and who provided most of the decisive input on such matters as maximum cassette size and weight, playing time, and tape protection conditions. In addition, it was the users who insisted on making provision for all the features now commonplace in Type C recorder applications -- still-frame operation, slow and fast motion, picture recognition while in tape shuttle modes, multiple full quality audio channels, a longitudinal utility audio track, and comprehensive provisions for editing time code.

It is well known that the DTTR will use tape 19mm wide. This width is near to, but not the same as, the 3/4 inch width dimension of the tape used in the U-format machines. However, the DTTR tape will be very thin! Since the linear speed from spool-to-spool will be about 11 inches/second (compared to 3 3/4 in/s for the U-format equipment), the length of tape in a cassette of a given recording capacity must be nearly three times the length supplied in a U-format cassette of the same playing time. Given the constraints stipulated by the users group for cassette length, width, and weight, the only solution is to use thin tape. Normal DTTR tape will be 16 um thick--about 0.6 mil--and future long-play tapes will be even thinner. It is obvious that such thin tape will require gentle handling and complete isolation from contaminants in the operational environment. Hence, cassette loading is mandatory and the design of the cassette must provide the fullest possible protection to the tape. In addition, the cassette must provide for easy extraction of the tape loop that is threaded into the tape transport for recording and playback and for proper tension control during all machine running modes.

Three sizes of tape cassette will be standardized--small (11 minutes), medium (34 minutes) and large (76 minutes, or 94 minutes with thin tape). The medium-sized cassette is roughly the size of a 60-minute U-format cassette, but of very different design. Figure 1. shows the general form of the cassette. The tape is protected on both sides by the cassette door mechanism. Brakes are provided for the two double-flanged spools. A record lockout is provided together with four holes for coding by the tape manufacturer so that the machine can adjust itself properly for tape characteristics on insertion of the cassette. User information of several types is provided for by a user hole and by the tape label area.

The DTTR will be a helical scan machine. Planning has taken into account, from the beginning, the possibility that a variety of mechanical arrangements will be able to generate the standard format on the tape. In

other words, the scanner size, the number of recording heads and the details of the tape guides are all left for the designer to choose for the specific application of the machine. However, the DTTR committee believes that an example of a tape transport design is necessary to enable the reader of the standards documents to visualize the entire system. Such an illustration is being prepared to be part of the standards documents.

Figure 2. shows the assignments of track space on the tape and represents a simplified definition of the format soon to be standardized. The video/audio tracks are 170 mm (about 6.7 in.) long and about 40  $\mu$ m (1.6 mil) wide. As you can see, some interesting decisions were reached in using this long, narrow tape area. First, it has been decided that the four digital audio channels will use the same data rate as the video channels. Hence, combining track segments containing either audio or video information is not a problem for the digital signal processing system. The video track is divided in two pieces, with four sectors of audio information inserted in the center of the track. This track format was subject to much discussion and to several experimental investigations. The so-called audio-in-the-middle approach offers advantages that outweigh any greater complexity of the recorder electronics. The four audio channels are well protected from the effects of tape edge-damage in this central location. In addition, the ease of electronically editing the four channels, individually and in groups, is improved by this arrangement.

I might note in passing that, as seems to be the case with many modern video tape recording systems, deciding the DTTR audio format and signal processing was fully as difficult as were the decisions about the video format and signal processing. The basic system uses, as input, the AES/EBU digital audio coding system and a total of 20 audio data bits per channel are available.

Note that there are three longitudinal tracks indicated in the format. They are, at first glance, similar to longitudinal tracks used in earlier video recording formats. However, only the reference audio track really resembles earlier designs. It is an analog track, lower in quality than the digital channels and intended for use as a cue track. Specific applications for the track are left to the wishes of the machine user.

The other two longitudinal tracks are digital tracks. The time code track is assigned to the SMPTE time and control code used in editing systems. It is likely that digital processing of the actual recorded signal will permit even more flexibility in use of time code than has been possible in the past. The control track will be a new kind of control track. It will contain large amounts of information important to the proper operation of the DTTR. Not only will it keep the machine informed about things like the start of fields and frames but it also will relay information about the video standard being used (525/625, since this DTTR will be a universally used machine) and other items. The digital audio system, using standard AES/EBU 48 kHz sampling, must observe a 5-field sequence in NTSC television use, because of the 59.94 Hz field rate of the NTSC signal. The control track will keep tabs on this sequence. Many other pieces of information will be conveyed in this track, as well. There is even a plan to read a portion of the control track data with the rotating video heads, allowing information retrieval during stop-frame operation. This is possible because of the shallow track angle of the video/audio tracks.

Let's turn for a minute to the matter of signal processing. Before going very far into the topic, however, I'd like to describe some terminology that is important to the understanding of how the digital video and audio signals are processed in the DTTR. The DTTR system described here is called a 4-2-2 system. This term refers to the CCIR Recommendation 601 studio digital video standard; the luminance component of the input signal is processed at 13.5 Mb/s, the 4 factor that derives from the historical discussions of introducing a 4X color subcarrier frequency digital sampling rate. The chrominance components, R-Y and B-Y, are sampled at 6.75 Mb/s, the 2 factor. It is possible to visualize a 2-1-1 machine, where the sampling rates are halved and presumably a smaller, less complex DTTR could be made for, perhaps, ENG or EFP work. It is also possible to envision a 4-0-0 machine, one that would be a composite digital recorder operating at 13.5 Mb/s, and even a 4-4-4 machine for ultra-high studio performance.

The Figure 3. shows a conceptual block diagram of a standard 4-2-2 digital recorder. As noted earlier, the audio and video signals will be combined into a single data stream. Also note that a considerable amount of electronics will be assigned to the recording data processing. A larger amount will be used for the playback electronics, not shown here.

A term often encountered in DTTR work is error protection strategy. Here we enter the real, and sometimes confusing, domain of the digital signal specialist. Digital signals contain binary information. Many tricks, or more properly techniques, can be applied to the recorded binary information to check for errors in decoding the data. The errors are, of course, "ones" where there should be "zeros" and vice versa. These correcting techniques all make use of precisely defined extra information added to the words of data that represent the audio or video signals being recorded. A data word contains a specified number of binary bits. A specific number of data words are organized into groups of words, called blocks and more extra bits of error protection and synchronizing information are added to the block identification data. Since the added information does not contain video or audio information in itself, it is called overhead, usually expressed as a percentage of the data bits carrying audio and video information. It is considered to be a penalty that the system must bear to minimize errors in audio and video playback. The amount of overhead that a system must bear is a function of the error rate of record/playback process. An error-free recording/reproducing channel would have no need for an error protection strategy and, hence, require no overhead. Real systems fall far short of this goal because of noise, dropouts, etc., and so the error protection strategy chosen for the DTTR has been the topic of hours of discussion and man-years of development work.

Using a system to correct as many errors as possible, and recognizing that some kinds of error-causing problems will generate large numbers of errors and possibly overload the error correction process, a backup system must be available. This is termed error concealment and, as its name suggests, it consists of calculating the most probable contents of the erroneous data and inserting a new, "artificial" word in place of the erroneous word. When well designed, the error concealment process can be very effective. One interesting technique that can be applied to improve the concealment process is known as data shuffling. Shuffling involves scrambling the data in a known fashion during recording and, figuratively, distributing it over the entire video raster. Since each element of the data is identified, such scattering is perfectly feasible. Then, if a dropout or other large



error burst occurs, the error concealments applied to the data will also be spread over the raster area and will be much less apparent to the viewer of the final picture.

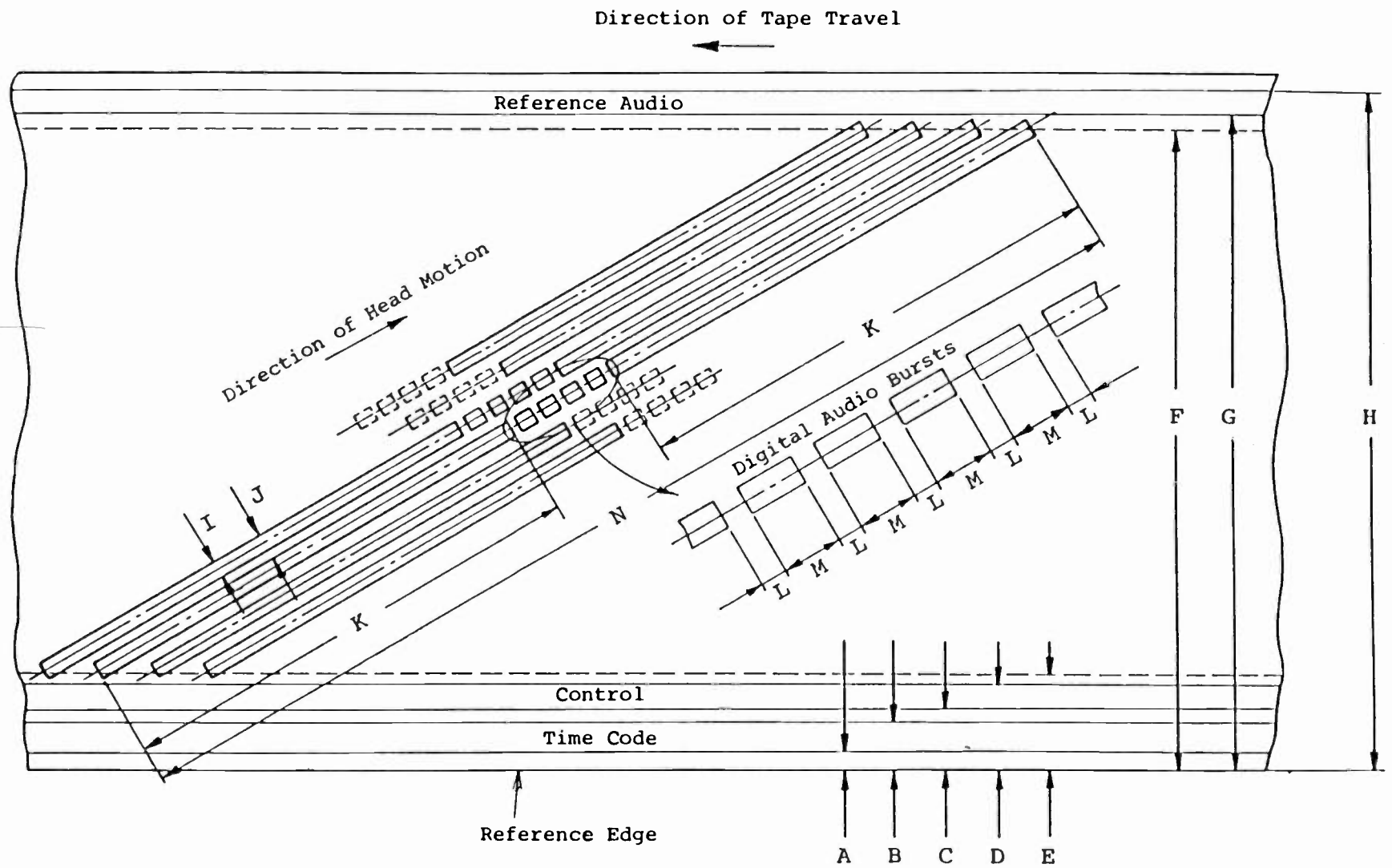
Another strategy may be employed, although it tends to be wasteful of channel capacity. This is called redundancy and is as the name suggests a process of recording the same data more than once in the hope that at least one copy will survive the recording/reproducing process intact. Redundancy causes high overhead--100% overhead if the data is recorded twice. Given that audio signals do not contain the inherent redundancy of video signals, and thus make error concealment more difficult, it has been decided to use recording redundancy for the audio data blocks; each data block of the audio channels is recorded twice and a decision is made on replay whether a given block, or its identical twin, will be used.

I hope that this brief overview of the new SMPTE/EBU DTTR format will give you a useful preview of the system. Many, many details have been left out, but most of these will, in the long run, be invisible to the user just as the details of the complex high-pass, low-pass and phase-correcting filters used in analog recorders are invisible. Each detail required study and agreement, though, and it is remarkable that such a complex system could be agreed to in the brief time that has passed. Remember that it took the better part of a decade to standardize the quadruplex recorder and work on details of that format continued for nearly another decade after that!

Some details of the SMPTE/EBU 4-2-2 DTTR are not settled even now. However, the basic format parameters are determined and will be submitted to the CCIR in the near future. Work will continue in the WG-DTTR for some months yet; ultimately, the Working Group will disband and the final phases of work will be turned over to the permanent SMPTE Video Recording and Reproducing Technology Committee for long-term maintenance.

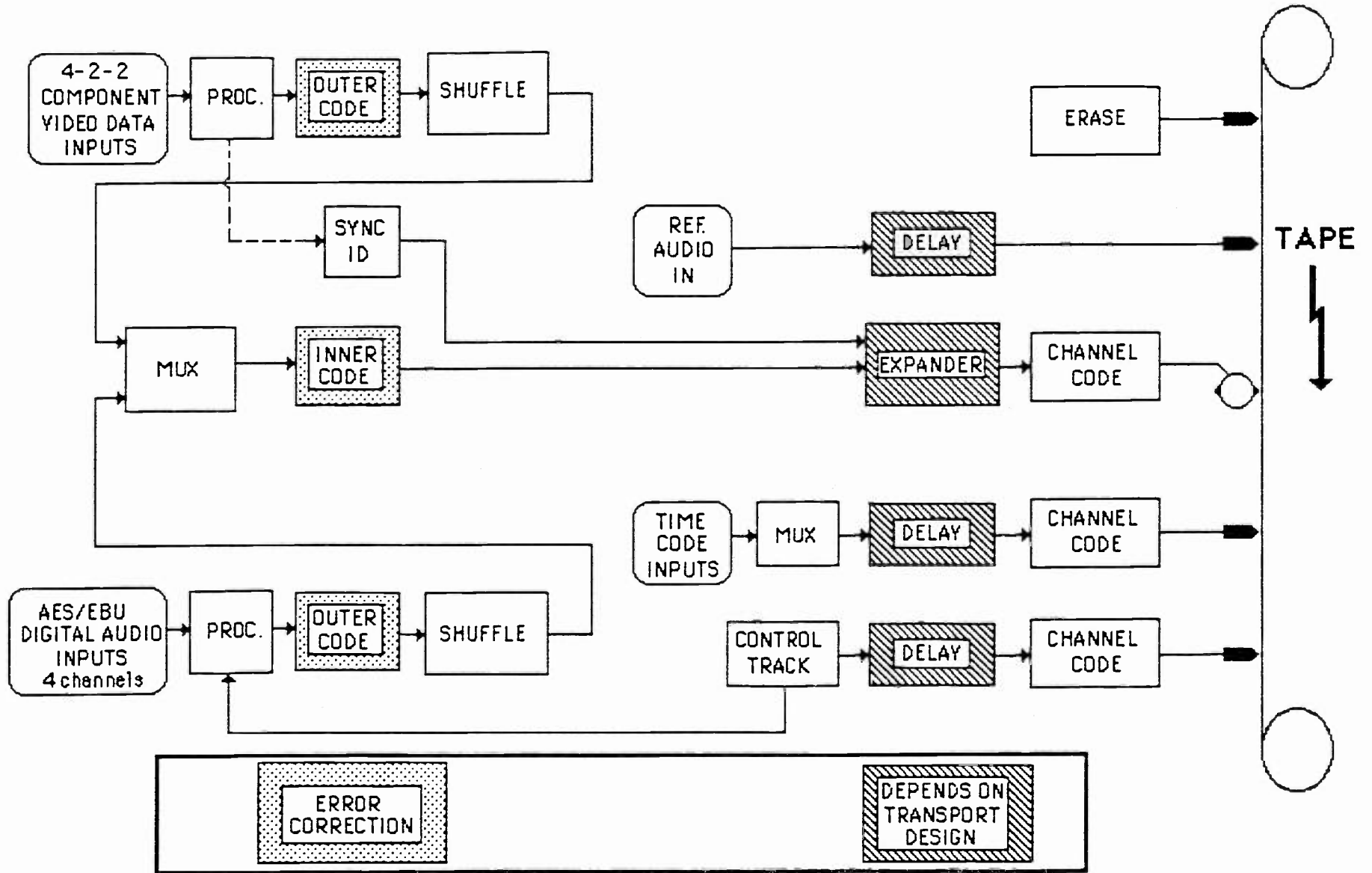
I cannot end my paper without expressing admiration for the individual engineers from all over the world who have contributed to the development of this specification. In particular, I wish to acknowledge the work of Takeo Eguchi of Sony, chairman of the Mechanical and Format group, John Watney of Ampex, who chairs the Video Signal System group, Ken Davies of the CBC, chairman of the Audio and Data group and Charles Magee of Westinghouse who chairs the User group. They and the other members comprise a remarkable group of people who have, in spite of many initial disagreements over the details of this format, remained active, constructive participants and who have made compromises when necessary to assure the success of the effort. In the months and years ahead we will see many SMPTE papers describing the details of the DTTR standards and describing the actual machines built to these specifications. It should then become even more clear that this joint SMPTE/EBU effort has been successful and that the usefulness of the format is a tribute to those experts who participated in its design.





Tape viewed from oxide side (not to scale)

F.M.R.  
2-6-85



## **A Systems Approach to Audio Console Design for Stereo and Multichannel Television**

**Douglas F. Dickey**  
**Solid State Logic Ltd.**  
**Oxford, England**

The production of stereo and multichannel television programs will require many changes in the broadcast plant. The one item of equipment on which the greatest new demands will fall is the audio console. This may seem an obvious statement. In truth, however, many chief engineers have been so (necessarily) occupied with transmitter conversion, VTR and switcher upgrades and other storage and distribution related issues that their attention is only now beginning to turn to the critical area of the audio consoles themselves.

What, exactly, are the requirements for a stereo television audio console? One of the problems in answering that question is that audio consoles of many types are used throughout the broadcast industry for a variety of specialised functions, ranging from edit and continuity suites to live production studios and master control. While there is, therefore, no universal console definition, there are a number of features which most consoles must have for efficient and effective stereo and multichannel television sound production.

In researching the requirements for the new generation of MTS-capable audio consoles, several themes recurred sufficiently that they can be taken as fundamental design requirements. Interestingly, many of these themes are not specifically technical in nature. Rather, they are concerned with fitting stereo into existing operations with as little distress or disruption as possible, as quickly as possible, and with the greatest flexibility for meeting future needs.

A major concern is that stereo must not significantly impact on individual productions' budgets. While broadcasters seem prepared to invest the necessary capital for stereo equipment, that equipment is expected to turn out suitable product without increasing either production time or daily operating costs.

This is not an easy trick. The new generation of broadcast audio consoles must handle greater numbers of mono and stereo inputs than their predecessors. They must also provide greater numbers of stereo and mono outputs, and accommodate advanced formats such as Triphonics and Stereo plus SAP. The audio which they produce must compete with that which the consumer has come to expect from Beta and VHS Hi-Fi and Laser Discs. Yet all of this must be accomplished in basically the same timeframe as mono!

Moreover, because the operators of these new consoles will continue to have widely varying degrees of skill, basic operations must remain very simple and require a minimum of retraining. Yet this simplicity cannot not be obtained at the sacrifice of versatility, as that would slow the advanced operators and limit the ultimate sophistication which the consoles are intended to deliver.

Further, while the new generation of broadcast audio consoles must provide more advanced features than their predecessors, they must be rugged and reliable workhorses. Routine maintenance must not only be infrequent, it must also be easy and familiar, requiring a minimum of retraining.

To obtain the requisite versatility and operating speed, these new consoles must allow the user to precisely match console features and panel layouts to the exact requirements of highly specialised control rooms. However, the traditional drawbacks of custom consoles (such as long delivery times, prohibitive costs and inadequate adaptability to future changes) must be eliminated.

Finally, the need to increase the number of functions available while maintaining or decreasing the time required to obtain those functions implies an increased reliance on microprocessors and computers - a precedent that has already been set on the video production side of television. On the audio side of things, the challenge is to implement this computer assistance inexpensively whilst retaining the flexibility of custom specification.

Having established these basic criteria, the Solid State Logic Design Group at Oxford realised that the specification was not for a new console, per se, but rather for a new system of console architecture, based on a series of modular subassemblies which would interlock in an unrestricted fashion to allow all of

the fundamental requirements to be met throughout a broad range of individual console sizes and types. Each of the subassemblies was to be highly engineered from a production standpoint, and sufficiently standardised to allow the use of Automated Test Equipment and CAD/CAM techniques. In addition to maximising reliability and minimising costs, this approach facilitates generation of vital technical and operating documentation - often a weak point in custom systems.

A variety of approaches were examined, including digital and assignable technology, but it was decided that the closest match to all of the fundamental criteria could best be obtained using a combination of "super-analog" electronics based on thin and thick film hybrid technology, digitally controlled electronic switching, and extensive interface for optional computers. Local controls were retained for most functions to provide on-air security and to minimise operator retraining. Centralised Master Controls were employed where they could provide greater operational speed and/or where they could increase useful functions while decreasing local channel control density.

The resulting system architecture was dubbed the SL 5000 M Series Audio Production System, and it can be visualised as consisting of four basic types of building blocks:

1. A series of 150mm X 40mm Eurocard-style cassettes, each of which houses the electronics for a particular function. In the case of some master functions, the width of these cassettes is doubled.
2. A series of mechanical elements for constructing frames which can vary in length to accept from 8 to 64 mono or stereo channels, and in depth to accept either 3, 4, 5 or 6 cassettes - the appropriate number being determined by the tasks which the console must serve.
3. A modular bus card structure which carries audio, control and computer lines both horizontally and vertically throughout the mainframe. This has been designed to allow each block of four channel positions to house different cassettes in different positions as dictated by each facility's needs.

These first three elements provide a completely interlocking system of electronically balanced audio buses plus control and data lines, which support an initial range of 30 mono and stereo function cassettes, which in turn can be slotted into over 72 sizes and styles of mainframes to create an almost infinite variety of control functions and panel layouts.

4. The fourth element is the computer system, which is built from a series of distributed microprocessors functioning either as stand-alone elements or as parts of a network controlled by a host computer. The extent of this network depends on the complexity of the application.

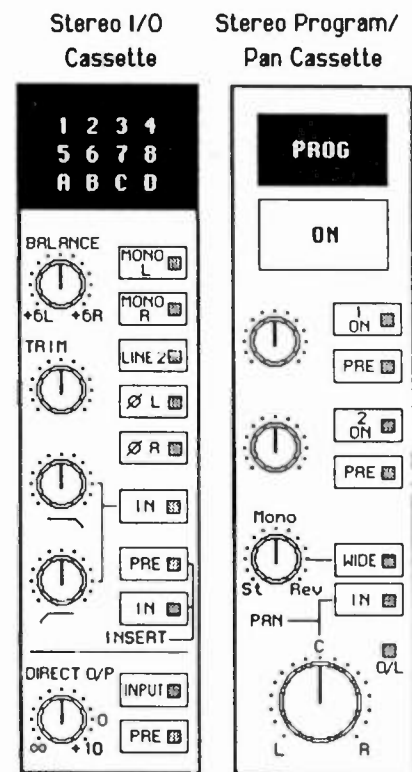
A given console's capabilities are determined by the cassettes fitted to it. All of the cassettes were designed to serve the greatest possible range of broadcast sound requirements, but it is necessary to look at only a few of them to understand how the system works. Because of space limitations, I have chosen here to examine a sampling of cassettes which will help to illustrate some of the special requirements of complex stereo television production.

While most consoles will have both stereo and mono inputs, we'll look here at a stereo channel, since most readers are familiar with mono requirements. At a minimum, a stereo channel requires two 40mm X 150mm cassettes plus a stereo fader cassette.

The Stereo Channel I/O cassette provides two line level stereo inputs. Versions which convert Sum & L-R or Sum & L+R inputs to standard left & right signals are available. These switches are followed by a line trim pot and a Left/Right offset pot for adjusting the stereo balance of the source. "MONO LEFT" and "MONO RIGHT" buttons provide a mono signal (Left, Right or L+R) to the channel. Separate Left and Right phase reversal switches are provided.

Stereo high and low pass filters may be switched into the path following the source selection. Switchable Insert send and return points are also provided, as are direct stereo and L+R channel outputs for P.A. or multitrack feeds.

The two large illuminated buttons are a channel On/Off switch and a switch which routes the stereo output of the channel to the Program mix. Beneath these are two Auxiliary Sends, with individual level, On/Off and Pre/Post Controls. The only controls which may present an unfamiliar appearance are the Stereo Image and Width controls. These operate along with the pan pot to match the perspective of stereo sources with the images they accompany.





With the Image pot set to Stereo, the L & R signals are sent to their mix buses unaltered. Rotating the Image pot towards Mono gradually collapses the stereo image into a mono signal, simultaneously introducing the pan pot's effect. This allows music and effects originally recorded for wide-screen film formats to be matched to the narrower aspect ratio and smaller screens of video and television. It also provides audio equivalents of special video effects. For example, with the pan pot set full right, rotation of the Image pot from stereo to mono collapses the stereo image into mono and folds it into the right speaker. Continued rotation of the Image pot towards Reverse re-opens the aural image into both speakers, reversing the L & R channels, for a pretty neat audio flip!

The "WIDE" button adds selective out-of-phase L & R signals into their opposite numbers, moving the apparent stereo stage outside of the speakers. This is quite effective for exterior ambiances and dramatic crowd effects.

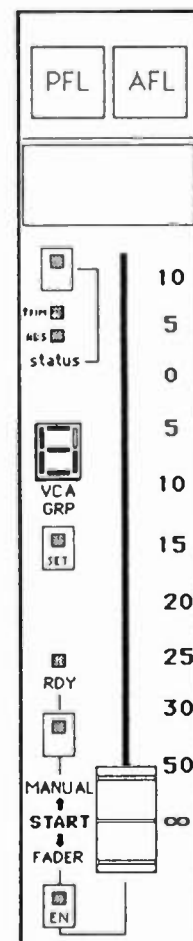
The final cassette in a "minimum" configuration is the VCA Fader cassette. This provides Stereo AFL and PFL buttons, as well as a PFL backstop overpress function. Additionally, there is a manual "Start" button for activating an external source machine, and a "Fader Enable" button, which starts the machine automatically when the fader is lifted. Identical mono channel faders and faders without machine start functions are also available.

At the top of each fader panel is a soft key called the "Status" button, and its two associated LEDs. These are used to request and indicate various functions for systems equipped with the full SSL Studio Computer complement.

A numeric LED readout is provided on each fader panel to indicate VCA Control Group assignments, if any. These assignments are selected by using the "SET" button in conjunction with the VCA Control Group masters.

Selection of the SET button gives that channel access to the central control system which is used to assign the channel's output to the various Stereo Audio Subgroups and Independent Main Outputs. In post-production versions, it accesses the multitrack routing assignment master as well.

Fig 2: Stereo Fader

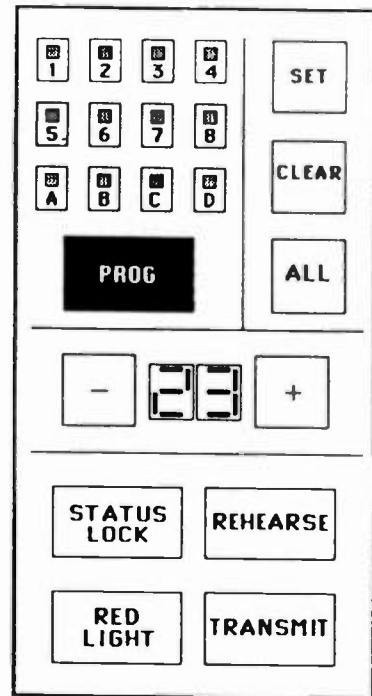


Multichannel Television Sound consoles will be called upon to provide a large number of mono and stereo outputs. In the SSL system, as many as 12 stereo mix buses may be specified in addition to the stereo Program bus and the auxiliary send buses. Two types of stereo mix buses are provided: Stereo Audio Subgroups and Independent Main Outputs. Before defining these terms further, a look at how they are assigned is in order.

The Program Assign and Status Master Cassette

Fitted at the stereo centre of the console, the Program Assign and Status Master cassette is accessed either by pressing a SET button or by using the + and - keys to on the panel to select a specific channel, subgroup, IMO or Echo Return.

The section which has been selected to the Assign Master is displayed on an alphanumeric readout. Above this readout are 12 buttons for routing the assigned source to the desired Subgroups or IMOs. The current routing of the accessed channel is indicated by the LEDs set into each button. It is also always displayed on the hidden-til-lit panels fitted to each local channel. A routing button marked PROGRAM is also fitted to the Assign Master, and this is duplicated on the local channels, allowing assignment of any source to the Program mix without reference to the central controls.



Once the Assign Master has been accessed, any desired changes in that channel's routing can be made by touching the routing buttons. Assignments can be transferred directly to any other channels by pressing their SET buttons. If this is not desired, a second press of the original channel's SET button releases the Master for the next assignment.

Master controls labelled "SET", "CLEAR" and "ALL" allow console routing to be accomplished in a different manner. When the SET button is selected, it lights, and any desired routing combination may be selected. Operation of any local SET control will add the master routing to its pre-existing assignments. The ALL button adds the Master routing to all channels, groups, echo returns and IMOs.

The Master CLEAR button works similarly, allowing any or all channels to be

deselected from any or all output routings from the central location. The Master SET and CLEAR buttons automatically deselect if no entries have been made after 30 seconds, and may also be electronically locked out when the console is in TRANSMIT mode and/or when the STATUS LOCK button is operated.

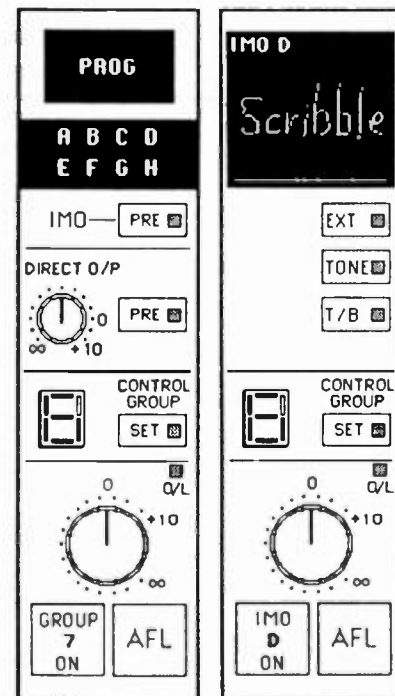
The ability to route post-channel fader outputs to additional mix buses via Master Assignment is a good example of how advanced functions and controls may be integrated to gain both additional flexibility and increased operational speed. The provision of two distinct types of mix bus configurations - Audio Subgroups and Independent Main Outputs - is another key to this achievement.

Briefly, an Audio Subgroup is a composite of selected channel outputs which have been mixed together for common processing and routing. An example would be "All Audience Channels", which could be collectively assigned to an audio subgroup rather than individually routed to the Program Mix. The group signal can then be processed through a single compressor and equaliser prior to being routed to the Program Mix. Cue and Echo feeds can also be sent from a single set of controls.

An Independent Main Output, on the other hand, is a separate mix consisting of selected post-fader channel and/or audio subgroup outputs which may or may not have been also routed to the Program Mix. IMO's are used to create splits, clean feeds, international sound feeds and mix minuses. For example, while all music, effects and dialogue channels may have been routed to the Program Mix, each type of channel can be independently routed to a separate output. All music channels can be assigned to IMO A, all effects to IMO B, and all dialogue to IMO C. Another important use of IMOs is the rapid creation of foreign language feeds for the Secondary Audio Program channel.

For each IMO or audio subgroup desired, a minimum of one additional cassette must be fitted. As shown in the illustration, the cassettes are similar. Each has an On/Off switch, a stereo AFL switch, an overload indicator and a rotary gain control with a range from  $\infty$  to +10dB, with a detent at unity.

Audio Subgroup Master      Independent Main Output



The Audio Subgroup cassette provides gain control for a stereo Direct Output which may be derived either pre or post the subgroup fader. Subgroups may also be assigned to the Program mix using either the local button or the Assign Master. The Assign Master is also used to route the subgroups to IMOs. Local indication is provided of all assignments, and a local switch decides whether the IMO feeds are to be taken pre or post the subgroup fader.

Because it functions as the final output control for its stereo bus, the IMO cassette does not provide a separate Direct Output or further routing facilities. Instead, it is fitted with three switches. The first adds an external source to the IMO mix at unity gain. The second and third buttons are used to allow or disable Tone and Talkback to the IMO output.

Both the Audio Subgroup and IMO cassettes are fitted with an alphanumeric readout and a Control Group SET button. A console may be fitted with up to 8 assignable VCA control group faders, each with a CUT and AFL button. These faders may be assigned to audio subgroups and/or IMOs in cases where a fader is preferred over the rotary level control. The VCA Control Groups may also be used to provide common level control over groups of mono and stereo channel faders whilst maintaining their separate signal paths.

In addition to Audio Subgroups and IMOs, a vital aspect of any stereo television console is the provision of ample auxiliary sends, which are used to create mixes for echo and effects as well as foldback for talent and crew. Two aux sends are provided on each channel's mandatory Program/Pan cassette; these will suffice in many smaller applications.

Larger systems such as those for news operations and feature program production will require additional auxiliary sends on channels and subgroups. These requirements are accommodated by adding local Auxiliary Send cassettes, which provide 8 additional sets of send controls. An additional Auxiliary Send Master cassette is required for each pair of extra sends.

Each local Aux Send cassette is fitted with eight rotary pots, which normally serve as mono send level controls to their respective send buses. Eight "ON" switches are also fitted. These are provided with bi-colour LEDs, allowing them to indicate not only whether a local send is On, but also whether or not it is deriving its signal pre or post the channel (or group) fader.

The pre/post function is determined by buttons on the Auxiliary Send Master cassettes located at the console centre.

Each Aux Send Master cassette controls two send buses. Rotary Send Master level pots, AFL and ON buttons are provided for each Send.

Normally, all sends are post-fader, indicated by a red LED which lights when the local ON buttons are selected. The Master PRE button selects a pre-fader source for its local sends, and changes the colour of the local ON buttons' LEDs to green. Operation of the Master PA button and the PRE button causes the pre-fader sends to cut when their channel fader or its associated group fader is closed. Master SET and CLEAR buttons allow each set of local sends to be turned on and off with a single control.

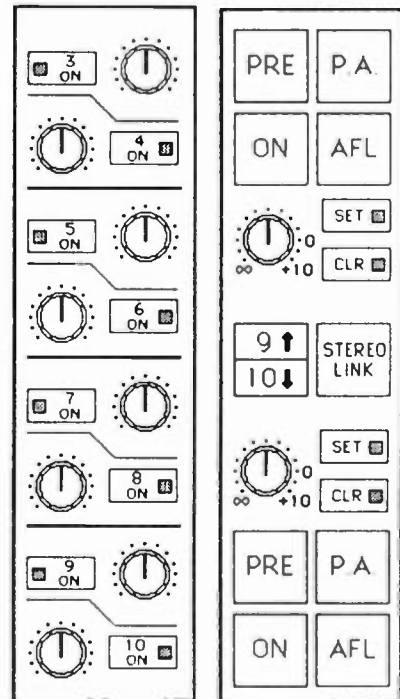
To accommodate the increased need for stereo sends, any or all of the odd/even send pairs may be configured as a stereo send by selecting the STEREO LINK button on their Aux Send Master. The even numbered controls on the master operate the send. The even numbered local pots become stereo gain controls, and the odd numbered local pots become stereo pan controls.

While space limitations prevent a detailed look at other cassettes in the Solid State Logic SL 5000 M Series, an overview of the additional requirements for stereo television audio consoles is in order. Both mono and stereo channels should have some form of equalisation. Continuously variable gain and frequency selection will provide the greatest creative control, and selection of the "Q" or slope of the equalisation is also quite useful.

Dynamics control on each channel and group is a highly desirable feature which can greatly improve the overall quality of the final mix while saving a lot of time. Dynamics controls should include a compressor/limiter and noise gate at a minimum. Features such as expansion and dynamic noise filtering are also real time-savers, particularly for cleaning up poorly recorded source material.

For elaborate productions, some method of recording multitrack backups of the proceedings should be provided. Full multitrack capability is a must for effective stereo post-production.

Local Auxiliary Send Cassette      Master Auxiliary Send Cassette



The ability to monitor all of the various feeds on both high quality and "typical home stereo" speakers is important, and the ability to switch between stereo and mono monitoring for compatibility checks is absolutely vital.

Finally, we get to the subject of computers. Mixing automation and machine control systems play an increasingly important role in television audio post-production. Unfortunately, even a cursory examination of the advantages they offer would require another paper of this length.

I do want to take a moment to describe a computer assisted function developed as part of the SL 5000 system and known as Instant Reset™, because it is an excellent example of the kind of design which makes it possible to achieve a greater number of functions with fewer operations and consequently greater speed and simplicity.

Briefly, the Instant Reset system allows the engineer to store up to 48 complete "memory maps" of the entire switching of the console in Random Access Memory or on micro-floppy disc. Any of these settings can then be called at the touch of a few buttons, instantly re-configuring the console switches to their previously stored values.

Thus, the engineer can create a detailed setup for a particular program, with all input sources, output and group assignments, send configurations and so forth - store this setting once - and recreate it instantly at any time. The ideal setup for the evening news can be called in an instant; this can be replaced by a completely different console configuration for the midnight movie or the breakfast show. In a fully equipped system, the transition from live to post-production configurations is a snap. Within a given program, setups can be instantly changed between segments. The preferences of different engineers can also be accommodated.

This type of computer assistance has been available on some video switchers for quite awhile now. Its appearance in an entire range of custom-configurable Stereo TV audio consoles is a strong indication that multichannel sound is ready to take its rightful place as an equal component in broadcast television production, and indicates the sophistication which audio mixing has attained.

Before stereo television can be transmitted it must be produced. This is not a job for the networks alone. The tools now exist to do a superior job within the constraints outlined at the beginning of this paper. It is up to the broadcaster to understand their value and their use. I hope this overview has helped.

---

STEREO SOUND CONVERSION FOR THE TCR-100 VIDEO CARTRIDGE RECORDER

C.R. Thompson

J. Tom

T.V. Smith

RCA Broadcast Systems  
Gibbsboro, New Jersey  
United States of America

The advent of stereo sound for television prompts close examination of a number of elements of the television plant. One key element of a commercial television facility is its source of revenue - the commercials. One of the most popular means of "airing" commercials is still RCA'S TCR-100 Video Cartridge Recorder. This unit was designed more than sixteen years ago and its final production run has recently been completed. A few units remain in the warehouse as of this date - mid-February 1985.

Industry activity toward a replacement product for the TCR-100, and its rival the Ampex ACR-25, has increased during the last several years. It may reach a fever pitch at the 1985 NAB Convention about two months from now.

One of the most important developments toward such a replacement is the NAB User Requirements Document. This document provides a detailed product description, including performance and features, for future cart machine requirements. Any new product intended to compete in this market must be measured against those requirements. Stereo capability is a key part of the new requirements. We expect that people who pay as much as \$10,000 per second to produce a commercial may be desirous of having full sound quality available on-air. It is obvious that we must try to provide stereo for the TCR-100. During 1984, we received a number of inquiries regarding conversion to stereo.

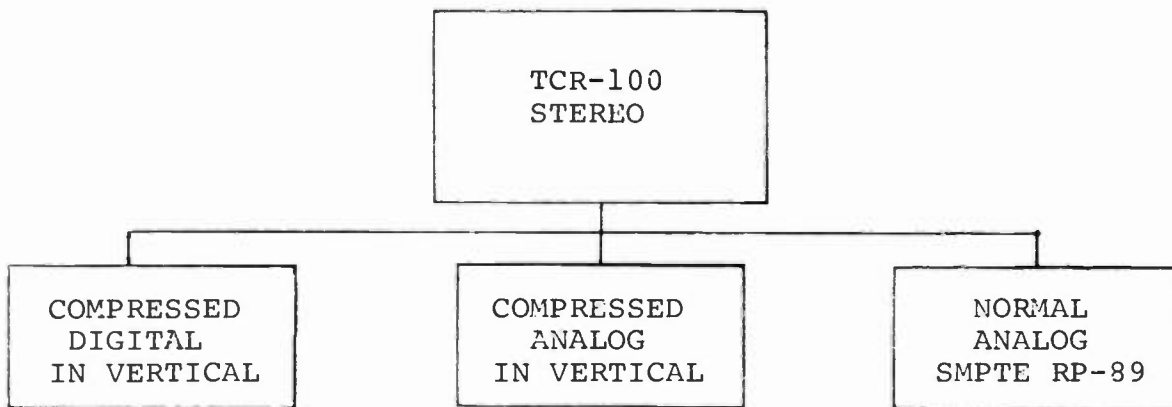
## STUDY PROGRAM

These inquiries led to a study program that was aimed at answering the following questions:

1. What are the technical possibilities?
2. What are the schedule realities?
3. Is there an affordable approach?

A number of technical possibilities were discussed. Of those, only three warranted further consideration.

### FIRST CUT TECHNICAL POSSIBILITIES



#### COMPRESSED DIGITAL

This possibility came to light in our digital recorder group - they have been recording digital sound in the vertical interval since construction of our first digital television recorder in 1978. The technical results have been excellent. Digital sampling and quantization had been implemented in accordance with the proposed world standard (48KHz and 16-Bit); powerful dropout protection circuits were also implemented. A compression ratio of 64 to 1 would have enabled an appropriate amount of protection overhead (approximately the same as current 4:2:2 digital VTR audio) to permit use of 12 TV Lines in the horizontal interval to be recorded on the tape at approximately 50 Megabits per second. In the end, however, schedule and cost proved to be unfavorable.

#### COMPRESSED ANALOG

This possibility came to light during our digital audio project using VHS cassettes. It gained further credibility during industry efforts in 8 mm VTR sound recording. Under this alternative, the analog sound would have been 1) converted to digital, 2) compressed by a ratio of 27 to 1, 3) converted back to analog and 4) recorded during the vertical interval. This permits recording one channel of sound during 52 microseconds of each of 12 TV lines in the vertical interval. The sample rate of the best analog to



digital converter for the playback processor, combined with the aforementioned compression ratio, to result in a record processor sample rate of only 33KHz. At first, the 33KHz sample rate appeared adequate for Broadcast Quality. However, our digital sound experts reminded us of several of the basics of Broadcast Quality sound:

THREE BROADCAST QUALITY SOUND REQUIREMENTS

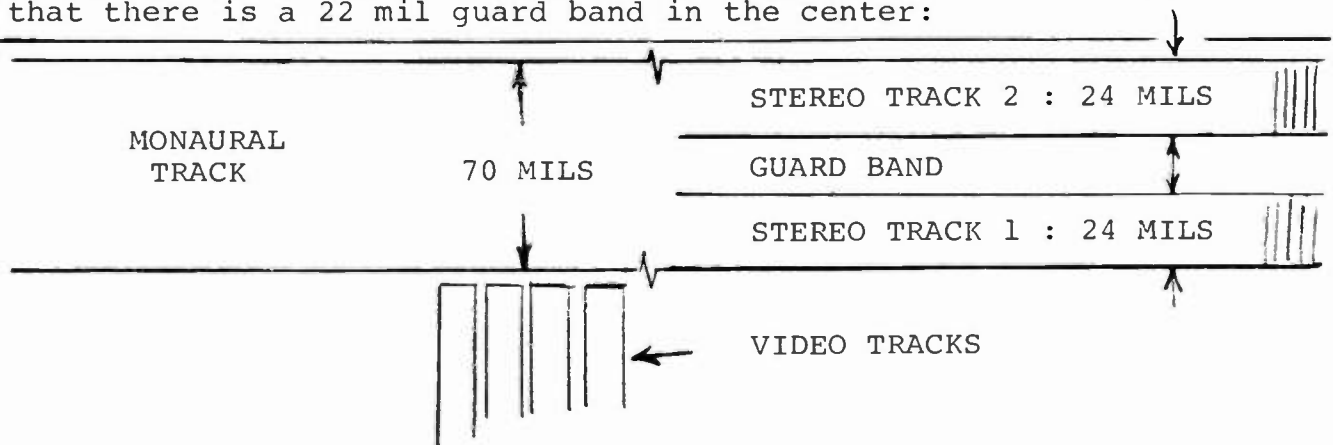
1. 15KHz Frequency Response
2. No Aliasing
3. No Ringing

The maximum allowable sample rate of 33KHz results in design constraints that permit any two of the three above to be satisfied, but not all three together. For example, to eliminate aliasing, an anti-alias filter must be employed prior to the analog to digital converter, it must be approximately 40 dB down at the Nyquist frequency of 16.5KHz. If the same filter is to be no less than 2 dB down at 15KHz to satisfy number one above, the result is a ringing impairment, even with a filter having ideal phase characteristics.

In addition, we were not able to strategize a method to protect against dropouts. We expected occasional large clicks and pops, after a number of "plays" on the same tape.

NORMAL ANALOG

During the Study Program we were surprised to find that someone had already invented stereo sound for quadruplex recorders. In fact, we received a formal document describing details of the recording standard - in the form of an SMPTE Recommended Practice (RP89-1984 approved 25 June 1984). This RP describes dimensions of tracks at the upper edge of the two inch tape. Each 24 mil audio track is placed in the former location of the 70 mil monaural track, such that there is a 22 mil guard band in the center:



STEREO TRACK LOCATION

In addition, the SMPTE RP specifies "if the two tracks are used for stereo recording, the left channel shall be recorded on the track closest to the reference edge of the tape." This saved us a lot of time which would have been spent discussing sum and difference vs. left and right. Our greatest concern for the Normal Analog technique centered on loss in performance due to narrower track widths - and the resultant loss in number of magnetized particles. We decided to create a decision matrix based on our expectations that a particle analysis and laboratory tests would result in achieving the goal - C-Format sound quality:

DECISION MATRIX

	<u>COMPRESSED DIGITAL</u>	<u>COMPRESSED ANALOG</u>	<u>NORMAL ANALOG</u>
TRANSIENT RESPONSE	EXCELLENT	POOR	EXCELLENT
DROPOUT PROTECTION	EXCELLENT	POOR	EXCELLENT
SCHEDULE	POOR	GOOD	BEST
COST	POOR	GOOD	BEST

SMPTE RP89-1984 had come to the rescue. But much work remained to be done:

1. Particle Analysis
2. Laboratory Tests
3. Monaural Compatibility
4. Hardware Design

We took them one at a time.

PARTICLE MAGNETIZATION ANALYSIS

The key performance parameters affecting magnetic recording channel capacity are bandwidth and signal to noise ratio. Magnetic recording channels support these parameters in direct proportion to playback recovery of tape particle magnetization. Thus, the volume of recovered tape particles is proportional to channel capacity, and in turn, bandwidth and signal to noise ratio.

Our first order of business was to compare tape particle magnetization between C-Format and TCR-100 Stereo. We surmised that magnetic head technology had advanced substantially between the time that 2-inch quadruplex heads were developed and the development of C-Format audio heads. That advancement would be used to achieve C-Format audio performance if the particle magnetization was adequate. We used the conventional equation:

$$V = K \times L \times W \times D$$

Where:

- V equals recovered volume of tape particles magnetized
- L equals along-track length of one cycle
- W equals track width
- D equals relative depth of particle magnetization
- K equals efficiency of recovery

Terms L and D were computed at 15KHz maximum recorded frequency. We were surprised to learn that the TCR-100 Stereo compares favorably to C-Format:

TAPE PARTICLE MAGNETIZATION COMPARISON

	<u>TCR-100</u> <u>Stereo</u>	<u>C-FORMAT</u> <u>AUDIO</u>
V In Cubic Micrometers	63,000	34,000
L In Micrometers	25.4	16.3
W In Micrometers	610	800
D In Micrometers	25.4	16.3
K In Efficiency	.16	.16

It is clear from the table above that TCR-100 advantages are in length (L) and depth (D) of recording. This occurs due to the longer wavelength recorded which is a result of higher longitudinal tape speed: 15 IPS for TCR-100 Stereo and 9.6 IPS for C-Format.

The relative depth of particle magnetization at 15KHz (D) is also a function of wavelength, since magnetic head gap lengths and their resultant record and playback performance is directly affected by minimum wavelength - that is, the wavelength at 15KHz.

Our second order of business was to introduce the remaining factors contributing to recovery of tape particle magnetization; and compare them with the particle volume advantage:

FACTORS AFFECTING RECORDING CHANNEL CAPACITY

	<u>TCR-100</u> <u>STEREO</u>	<u>C-FORMAT</u> <u>AUDIO</u>	<u>UNITS</u>
Particle Volume	63,000	34,000	Cubic Micrometers
Particle Orientation	Transverse	Longitudinal	
Tape Retentivity	650	1250	GAUSS
Tape Oxide Thickness	10	5	Micrometers
Particle Size	0.5	0.4	Micrometers

The 85 percent advantage in particle volume is reduced by several additional factors. Transverse recording has a number of video advantages over helical recording, but one disadvantage is longitudinal track information recorded perpendicularly with respect to rotating head track information. The tape particles are oriented

transversely. Our experimenters have determined that this results in an approximate 3 dB channel capacity disadvantage. A second disadvantage occurs in tape retentivity, or the ability of each given volume of tape to support magnetization. Particle size, distribution and content were all improved between the time that standards were set for 2-inch quadruplex VTR'S and current C-Format VTR'S. This led to improvement in retentivity. We summarized our particle analysis as follows: The TCR-100 Stereo disadvantages of particle orientation and retentivity might be overcome by the advantages in magnetized particle volume. The analysis enabled us to gain a better understanding of factors affecting recording channel capacity in quantitative terms. We were now ready for laboratory tests.

#### LABORATORY TESTS

The first order of business was to examine feasibility on an actual TCR-100 in the laboratory. We chose a C-Format magnetic head for these tests and thus enjoyed a temporary 20 percent track width advantage. Since C-Format Technology was established in 1975, we reasoned that our head design group could use 1985 technology to overcome the track width reduction for a final design with comparable performance - many thanks to D.C. Pastore for accomplishing that goal.

Channel capacity results met our highest hopes:

Response: 50 HZ to 15KHz	+2dB
Signal To Noise Ratio	56dB
Distortion At 1KHz Ref. Level	0.8%

The numbers looked very good but we reasoned that some of our customers might be more interested in subjective sound quality. We borrowed a high quality subjective test set from our colleagues in the digital recording group: this equipment included a turntable, receiver, 200 Watt amplifier and Acoustic Research Model 9 loudspeakers.

Our first big mistake occurred during a customer demonstration. In the recording process we placed the loudspeakers too close to the turntable and adjusted loudspeaker volume too high. Sound from the loudspeakers vibrated the turntable and caused a noticeable impairment. We remedied that problem very quickly and further decided to augment the magnetic recording engineers on the project with audio engineering talent. We now use a digital audio disc for source material.

#### MONAURAL COMPATIBILITY

The customer demonstration resulted in additional requirements. The customers asked a very simple question - how do we use tapes from our existing library, once the TCR-100 is converted to stereo? Under this condition, each of the two heads is playing back

identical information from the wide monaural track. We investigated several choices:

#### MONAURAL COMPATIBILITY CHOICES

1. Use channel 1 to Feed L and R to Transmission System
2. Use Channel 2 to Feed L and R to Transmission System
3. Combine Channels 1 & 2 to feed L and R to Transmission System
4. Use Channel 1 to Feed L to Transmitter, and Use Channel 2 to Feed R to Transmission System

In the end, we decided to provide the customer with his choice of any of the four, since the various choices are affected by skill of the individual in alignment. This alignment was made much easier via design of an additional proprietary mechanism to adjust the stereo head. This mechanism permits alignment of high frequency phase and permits it to be "zeroed".

#### HARDWARE CONFIGURATION

In addition to the new magnetic head, the TCR-100 is modified to include an additional pre-amp for each transport and additional modules as follows:

1. Playback Amplifier
2. Bias - Erase Power Amplifier and Control
3. Record Amplifier

The hardware comes in kit form and is designed for easy installation by RCA'S Tech Alert engineers.

#### CONCLUSIONS

In order to achieve Broadcast Quality stereo in a TCR-100, along with reasonable cost of ownership, schedule and monaural compatibility - the Normal Analog recording method in accordance with SMPTE RP-89 - 1984 was chosen. It has proven to be a good choice.

---

NETWORK DISTRIBUTION OF DIGITAL AUDIO  
FOR  
TELEVISION MULTI-CHANNEL SOUND

Chieu Nguyen

M/A-COM TELECOMMUNICATIONS Division  
Germantown, Maryland, U.S.A

ABSTRACT

Although FM subcarriers have been in use for years for Television Sound, the new era of Multi-Channel Sound can be better implemented Digitally.

This paper examines the fundamentals of FM Audio and the extraordinary Digital Audio; and the viability of using the exciting Digital Technology for the upcoming world of Stereo TV Sound. Existing Digital TV Sound system in the Public Broadcasting Service (PBS) is reviewed, along with other state-of-the-art implementations of Digital Audio.

Two important concepts are discussed: Time-Division Multiplex (TDM), and Frequency-Division Multiplex (FDM), and their respective system designs.

For network distributions, compatibility to the AT&T Digital Cross Connect System is an important factor in planning the FDM system, leading to several possible Digital formats. These designs will be presented.

## I) REVIEW OF F.M. AUDIO SUBCARRIER PERFORMANCE

The use of subcarriers placed above video to deliver sound program services by satellite has rapidly evolved. Fully loaded, the baseband spectrum above video can support as many as 15 subcarriers [1] (most of them 15 KHz bandwidth).

The simplicity and popularity of F.M. Subcarrier Audio makes it very appealing to Television Networks for use in the Multi-Channel Sound program distributions. However, a closer look at the performance of this "old" technology versus the current state-of-the-art Digital technology will reveal many limitations of F.M., and with the fast developments in Digital Processing as well as Large-Scale Integration (L.S.I.), Digital Audio can be very competitive.

First, the theoretical limitation of F.M. is analyzed. The program audio channel signal-to-noise ratio is given as [2] :

$$S/N_{rms} = (3/4) \left( \frac{C}{N_0} \right) \frac{\Delta F_c^2}{f_{sc}^2} \frac{\Delta F_{sc}^2}{B_{na}^3}$$

where

$C/N_0$  = carrier/noise density before discriminator

$\Delta F_c$  = peak deviation of main carrier by subcarrier

$\Delta F_{sc}$  = peak deviation of subcarrier by audio program

$B_{na}$  = audio baseband noise bandwidth

Note that this equation is only valid above the FM threshold.

Using typical performance for 5-meter antennas, audio programs at 5.8 MHz carrier will have about 58 dB S/N, whereas programs at higher subcarrier frequencies will suffer worse S/N (54 dB for example at 8.055 MHz).

Typical distortion of FM subcarriers is about 1 % at 1 KHz, and much higher for bass and treble frequencies.

Now, there are many compelling reasons for considering Digital Audio as an alternative to FM Audio :

- Comparisons have always favored Digital Audio Sound [3].

- The success of the Digital Compact Disks has indicated the increasing awareness in consumers for very high-quality audio. Higher consumer education in sound quality (evidenced by products such as PCM tape recorders, Stereo Dolby Video Cassettes, Laser CD Disks) creates an expectation for very high quality TV Stereo Sound from the Network Sources.

- The advent of the separate TV Stereo Sound Tuners promises the TV Networks a new audience, the SOUND audience. Since Audio audience has been typically exposed to very high fidelity, the best possible Audio should be used for TV Stereo Sound.

- The emphasis on Digital Audio will certainly capture more attention from viewers. An added benefit of implementing Digital Audio Technology now in the network distribution links is no need to update equipment for years to come, since the possibility of outgrowing the Digital proven performance and reliability is almost nil in the next few decades.

## II) ADVANTAGES OF DIGITAL AUDIO

The extra-ordinary performance of Digital Audio is dictated by the resolution of the conversion processes between Analog and Digital signals, as given below for Signal/Distortion :

$$S/D = 6.02 N + K \quad (\text{dB})$$

where N is the number of bits per sample, and K is a constant dependent upon the audio source.

Using the state-of-the-art 16-bit Converters, the theoretical S/D approaches 98 dB ! (many orders of magnitude above FM).

The phenomenal performance of the above magnitude can be further demonstrated using the following real-life example :

If one sets the lowest Digital Audio level to a whispering sound level of 30 dB SPL, the dynamic range of Digital Audio can, and will, deliver an ear-splitting level of 130 dB SPL !

Security :

-----

An added advantage of Digital Audio is security. Basic decoding of the digital data is quite complicated and will discourage any potential piracy. Moreover, digital scrambling and sophisticated encryption can provide an ultimate secure transmission.

Enormous Power of Digital Signal Processing :

-----

The Digital Signal Processing field is forever-developing, many ideas are explored and invented within the last few years. Our era is a privileged one to experience such an exploding technological advance. With Analog Audio (FM, AM), the highest level of sophistication has been reached several decades ago, any more investment of time and money will only marginally improve the technology (if the technology can be improved at all !).



On the other hand, Digital Technology is making fabulous advances ; and thanks to the accuracy and simplicity of Digital Nature, advances in LSI's are also taking place, further bringing down the cost.

The significant Processings for audio are summarized below :

- Error Detection and Correction : many powerful Error Codes can be implemented to recover data bits, corrupted by the transmission, that are identical to the original bits, thus Digital systems can maintain their original performance [4].

- Interpolation, Extrapolation : even when the errors cannot be corrected, their audible side effects can be made imperceptible by Extrapolation and/or Interpolation from good bits.

- Digital Companding : improves transmission efficiency by reducing the required bit rates. Instantaneous Quantization resolution will suffer but the idle noise performance is still kept intact and equals that of the original Conversion resolution. The accuracy of Digital processing also prevents any gain mismatch which are so devastating in Analog Companders.

- Digital Enhancement, Echo Removal, Blind Deconvolution [5].

Direct Digital Transmission between Studios and Transmission

-----  
Links :  
-----

Since Digital Transmission is very reliable, Digital Audio can be transmitted through the Digital Transmission Networks and arrive at the Transmission Links with the same high quality as generated in the Studios.

At the Receive side, Digital Audio can go through the Digital networks and be decoded at the Affiliate's Studio in perfect condition.

The AT&T Digital Cross-Connect System, as discussed in later section, can provide this potential with minimum time differential between Video and Audio.

### III) DIGITAL AUDIO CONCEPTS AND REVIEW OF EXISTING SYSTEMS :

Designs of Digital Audio for Television are based upon two following concepts:

- Time Division Multiplexing (TDM ) (Figure 1):  
-----

In this system, audio is digitized ; and the digital bits are interleaved with the Video signal. The most popular technique is to embed the Digital Audio bits in the Vertical Interval pulses and the Horizontal Pulses.

The Audio can be coded by any method ; Pulse-Code Modulation PCM or Delta Modulation DM or others ; although DM appears to be easier due to its "frameless" nature. The sampling rate in any case must be synchronized to the Video Color Subcarrier Burst frequency of 3.579545 Mhz .

- Frequency-Division Multiplex (FDM) (Figure 2) :  
-----

A more independent process, where the audio can be digitized at any sampling rate, and the Digital samples are modulated by a subcarrier above Video .

Frequency band-seperating filters completely isolate Video and Audio to prevent any Intermodulation effects between the two programs [6].

Hence the FDM concept closely resembles the FM Audio practice and offers several degrees of freedom to network planners:

- Video is left untouched, whereas the TDM approach alters the Video signals.

- More capacity above Video ; as many as the transmission can support.

- Independence from Video transmission, plus backups are possible.

M/A-COM TELECOMMUNICATIONS DIVISION (an integration of M/A-COM Linkabit and DCC) has been developing Digital Audio systems using both concepts for Television Networks for almost a decade now.

The FDM system, known as D.A.T.E., has been in use in the Public Broadcasting Service (PBS) network for many years [7].

The TDM system, known as VIDEO CIPHER, is being incorporated in Home Box Office Cable Network.

Their performances are summarized in Table 1 and Table 2

TABLE 1

D.A.T.E. DIGITAL AUDIO PERFORMANCE  
(Sampling Rate 34.4187 KHz)

PARAMETER	MEASUREMENT
Frequency Response	
50 Hz	0.0 dB
100 Hz	-0.1 dB
1 KHz	0.0 dB
5 KHz	0.0 dB
15 KHz	-0.7 dB
Distortion	
50 Hz	- 56 dB
1 KHz	- 72 dB
5 KHz	- 65 dB
Intermodulation Distortion	< - 50.0 dB
Noise Level	- 74 dB
Crosstalk	- 72 dB
Phase Difference Between Channels (degrees)	
50 Hz	- 1
400 Hz	0
1 KHz	0
5 KHz	0
15 KHz	- 4
Number of channels	4

TABLE 2

VIDEO CIPHER DIGITAL AUDIO PERFORMANCE  
( Sampling Rate 44.056 KHz)

PARAMETER	MEASUREMENT	
	VC - 1	VC - 2
Audio Bandwidth	15 KHz	18 KHz
Harmonic Distortion		
1 KHz	0.2 %	0.5 %
Noise	- 80 dB	- 75 dB
Crosstalk	- 80 dB	- 75 dB
Number of Audio channels	2	2

FOLLOWING SECTIONS CONCENTRATE ON FDM (SUBCARRIER) DIGITAL AUDIO

IV) AT&T DIGITAL CROSS-CONNECT (DSX-1) COMPATIBILITY :

Compatibility to the AT&T Digital Cross-Connect DSX-1 Network is a very important factor in designing the FDM Digital Audio system for Network Distribution, since the Cross-Connect Network offers the following advantages :

- Digital transmission directly between Studios , the DSX-1 network, and the transmission links (microwave, satellite).

- Regeneration, Monitor Capabilities on the AT&T Network. These services guarantee the preservation of the Digital Audio Quality.

- A backup for the normal transmission is available, also additional digital services can be offered by the TV Networks and maintained through the DSX-1 system.

Possible Digital Formats :

a) Linear PCM :

Using 16-bit Linear PCM, possible sampling rate 50 KHz and audio bandwidth upto 20 KHz.

This format would have very little realistic applications since it does not comply to any existing standards; although from Manufacturing standpoint it can be quite attractive because all design parameters can be optimized for the easiest hardware implementation.

b) Companded PCM :

Using the industry standard sampling rate of 32 KHz, with audio bandwidth upto 15 KHz, and digital PCM companding from 16 bits to 12 bits per audio sample.

c) Digital Compact Disk (CD) Compatible:

Still using the industry standard sampling rate of 32 KHz, compatibility to CD format can be achieved by Digital Decimation from CD 44.1 KHz rate to 32 KHz rate in the transmit Encoder; and by Digital Interpolation from 32 KHz rate to CD 44.1 KHz rate in the receive Decoder. Note that the 20 KHz audio bandwidth of the CD source will be digitally filtered to 15 KHz bandwidth to avoid aliasing problems during the Decimation/Interpolation processes [8].

Considerations must be given to possible slips in a situation where the FDM system has to be synchronized to the AT&T 1.544 MHz reference. Assume the CD 44.1 KHz rate is accurate to 0.1 parts-per-million, the slip rate will be approximately once every 4 minutes. Therefore concealment must be employed in the Encoder.

V) DESIGNS OF THE ABOVE FORMATS :

The spectrum above Video will be exploited for the FDM Digital Audio carriers ; in planning the system the installation of the Network Links must be thoroughly investigated.

Figure 3 depicts the typical Links in the TV Network, where the signals from the Studios go through cable, microwave links before satellite transmissions. In this scenario, the cable link will be the neck of the bottle due to its limited bandwidth. All other links, microwave and satellite, can support wider bandwidth and hence more than one DSX-1 Digital Audio carriers.

FOLLOWING ANALYSES ARE PRESENTED FOR SATELLITE TRANSMISSION  
HOWEVER,APPLICATIONS TO OTHER LINKS CAN BE DEDUCED.

Theoretical Performance :

The Audio Subcarrier Signal-to-Noise performance before the  
Receive Video Discriminator is given as [2] :

$$S/N = \frac{1}{2} \frac{(C/N_0)^2 (\Delta f_c)^2}{(f_{sc})^2 B_{sc} \left[ 1 + \frac{1}{12} \left( \frac{B_{sc}}{f_{sc}} \right)^2 \right]}$$

The Bit-Error-Rate performance is given by [9] and plotted  
in Figure 4.

Considerations for Interference, Fading Conditions :

To avoid interference, Video signals must be filtered to more  
than -50 dB for frequencies above 5 MHz; and the Audio carrier  
level must not exceed -10 dB from the Luminance level [6].

In practice, the Digital Audio carrier level should be made  
adjustable from -10 to -20 dB so that individual link degradations  
can be compensated for.

A guideline by EIA RS-250B specification gives Video Fade  
condition as having Video S/N fallen below 37 dB. This low level  
translates to C/N<sub>0</sub> (Fade) of 20 dB and C/N<sub>0</sub> (Normal) of 30 dB  
for typical 5-meter antennas [2]. Thus the Fade Video condition  
will certainly cause Digital Audio to lose synchronization.

Bit-Error Performance of Digital Audio :

The performance of Digital Audio is summarized in Table 3  
for three typical subcarrier frequencies.

TABLE 3

DIGITAL AUDIO PERFORMANCE ON VIDEO FM		
SUBCARRIER (MHz)	NORMAL	FADE
6.12	5E-5	No sync
6.8	2E-4	No sync
7.695	9E-4	No sync

Subjective effects of digital bit errors are summarized in Figure 5. From the chart, it is quite obvious that the above bit error rates will produce very poor Audio performance. Therefore a form of Forward Error Coding and Correction is necessary to protect the Digital Audio samples from being corrupted by the transmission abnormalities.

#### Error-Correction Coding Requirements:

-----

It appears from Table 3 that a CONVOLUTIONAL Forward Error Correction Code of rates between 2/3 and 1/2 is required. The complexity of these circuits can be prohibitive for use in a low-cost satellite FDM system.

A close scrutiny of the situation leads to a possible simpler scheme of Error Correction, patterned after PCM recordings [10].

Note from calculations that the S/N for most FDM carrier frequencies are about the FM threshold region, where noise peaks can exceed the carrier level, resulting in an apparent phase inversion of the signal. The Video FM Discriminator reacts to this with rapid transients, giving rise to transients or impulse disturbance.

These FM threshold-effect impulses in turn produce bursts of bit errors in the demodulated QPSK digital Audio, resulting in very loud clicks and pops.

Therefore an Error Correction scheme that is more resilient against bursty bit errors is more appropriate for FDM systems.

One simple scheme is to use one parity word for every pair of PCM samples from the stereo channels, along with Cyclic Redundancy Check (CRC) bits, and delaying the transmitted samples, as follows:

$R(n), L(n)$  = Left, Right digital samples at time  $n$

$P(n)$  = parity word =  $L(n) * R(n)$

where symbol  $*$  denotes Exclusive-Or function

The transmitted data stream is :

$L(n), P(n-1), R(n-2l) \dots L(n+m), P(n+m-1), R(n+m-2l), CRC(q)$

where  $l, 2l$  are the delays for  $P$  and  $R$  words, and  $CRC(q)$  is the CRC check bits for a group of  $m$  words.

This is shown in Figure 6 for  $m = 3$

The CRC generating polynomial is CCITT V.41 :

$$G(x) = x^{16} + x^{12} + x^5 + 1$$

with detection capability of better than 0.999984741

The Error Correction Algorithm is an Reverse Exclusive-Or function of two good words (L \* P to recover R, or R \* P to recover L) or using L,R directly if they are without errors.

In the cases of two or all three words are in errors, an error concealment of sample-reuse (extrapolation) or the more effective linear interpolation of the two good samples adjacent to the one in error. More sophistication of error concealment (high order Lagrange Interpolation for example) is found to provide little more improvement.

Optimum delay l has been found to be between 27 and 30 samples.

The above scheme is equivalent to a rate 2/3 Convolutional Code and its error correction capability is calculated as follows :

Let P be the uncorrected bit-error rate for one-sample errors. It is errors in two current samples and errors in all three L,R,P samples that the scheme cannot correct and error concealment must be use. Let P2,P3 be probability of two and three erroneous samples respectively. Then :

$$P_2 = 3 P^2$$

$$P_3 = P^3$$

The Corrected Bit-Error Rate performance is shown in Table 4.

TABLE 4

DIGITAL AUDIO PERFORMANCE WITH ERROR CORRECTION

SUBCARRIER (MHz)	P2	P3
6.12	7.5E-9	1E-13
6.8	7.5E-7	1.25E-10
7.695	2.5E-6	7.3E-10

FROM CHART IN FIGURE 5, IT IS EVIDENT THAT THE ABOVE BIT ERROR EFFECTS ARE IMPERCEPTIBLE .

It is also interesting to note how often error concealment occurs due to two and three words in errors. Using sampling rate of 32 KHz, the frequencies of error concealment are shown in Table 5.



TABLE 5

FREQUENCY OF ERROR CONCEALMENT

SUBCARRIER(MHz)	P2	P3
6.12	once every 23 min	once every 80 yrs
6.8	once every 14 sec	once every 23 hrs
7.695	once every 4 sec	once every 4 hrs

General Design Parameters for TV Multi-Channel Sound :

The general design for an FDM system is formulated from all above theoretical calculations as follows :

Transmission Bit Rate = 1.544 MBPS  
 Available Information Rate = 1.536 MBPS  
 Error Correction Redundancy = approximately rate 2/3

The design objectives (EIA specification compliant) are :

Two main 15 KHz channels  
 One SAP channel  
 One Auxiliary channel  
 Control Channel of approximately 4800 BPS

Therefore the general design can be planned as below :

Two Main 15 KHz Channels :  
 =====  
 12-bit Companded PCM for both Left (L) and Right (R)  
 Parity word P of 12 bits  
 Sampling Rate of 32 KHz  
 CRC every 4 groups of L,R,P

Total of 1.28 MBPS

One SAP Audio Channel :  
 =====  
 Delta Modulation at 219.2 KBPS  
 Audio Bandwidth of 10 or 15 KHz

Auxiliary Channel :  
 =====  
 Delta Modulation at 32 KBPS

Control Data Channel (Synchronous) :  
 =====  
 4800 BPS ,EIA RS-232

The use of Delta Modulation for the SAP and Auxiliary Channels completely eliminates the need for Error Correction for these as Delta Modulation is very resilient to bit errors [11].

Expected performance of the FDM system is shown in Table 6.

TABLE 6

FDM SYSTEM FOR TV MULTI-CHANNEL SOUND PERFORMANCE SUMMARY

PARAMETER	PERFORMANCE
VIDEO	Compliant to EIA RS-250B
AUDIO	
* Main channels :	
THD	less than 0.3 %
Idle Noise	90 dB below full level
Gain Match	within 0.5 dB
Phase Match	within 5 degrees
Frequency Response	within +/- 0.5 dB
* SAP channel :	
THD at 1 KHz (10 KHz BW)	less than 0.5 %
THD at 1 KHz (15 KHz BW)	less than 0.5 %
Idle Noise	75 dB below full level
Frequency Response	within +/- 1.0 dB
* Auxiliary channel :	
THD at 800 Hz (3 KHz BW)	less than 4 %
Idle Noise	70 dB below full level

FOLLOWING DESIGNS ARE SHOWN FOR ENCODING FUNCTION ONLY.

Design for Companded PCM System :

The block diagram of the design is shown in Figure 7.

The main Audio channel are digitized by a 16-Bit Analog-to-Digital Converter. These samples are compressed to 12-Bits, a Parity word of 12-Bits is generated, then the words are delayed according to the error correction scheme described above. CRC check bits are coded to every group of 4 L,R,P samples,

The SAP (10 KHz or 15 KHz) and Auxiliary (3 KHz) channels are low-pass filtered and digitized by their respective Delta Modulator. Control Data at 4800 BPS are synchronously input to the system. All digital samples, data are finally multiplexed with the DSX-1 Frame Format and then modulated by the QPSK Modulator.

VIDEO input signal is low-pass filtered to 5 MHz, and combined with the Digital QPSK spectrum to form the FDM composite output.

## Design for the Compact Disk (CD) Compatible FDM System :

-----

The design shown in Figure 8 is basically identical to the above case, except for the following front-end processings :

- \* Synthesis of 1.544 MHz from CD 44.1 KHz
- \* Input Digital Finite Impulse Response (FIR) filter to limit CD spectrum to 15 KHz.
- \* Elastic buffer in case the 1.544 MHz must be synchronized to AT&T master reference.
- \* Digital Decimator to convert from 44.1 KHz to 32 KHz .

Note that CD compatibility is provided only in the Main two Audio channels, the SAP and Auxiliary channels are still coded by Delta Modulation. The rest of the design is identical to above.

## VI) VIABILITY OF DIGITAL AUDIO :

The advantages of Digital Audio described throughout this paper clearly indicate the superior and dramatic performance of Digital Technology, they also demonstrate the capability of both science and engineering practices to carry Technology beyond every bounds of expectation.

The recent success of Digital Compact Disks (CD's) in the consumer market signifies a revolution in society readiness for innovations and state-of-the-art quality.

The limitations of "old" technologies such as FM Audio make these technologies inevitably "mature". This is an important factor for the system planners to consider in implementing a totally new world of Sound entertainment , THE ENORMOUS HIDDEN COST OF HAVING TO UPDATE THE ENTIRE SYSTEM IN JUST A FEW YEARS BECAUSE OF THE CHOICE OF OLD TECHNOLOGY NOW.

Digital Audio, with its proven reliability and established performance [7], can fulfill the needs for DECADES to come.

In planning the new TV Multi-Channel Sound system, the planners must keep in mind the COST/PERFORMANCE ratio. Digital Audio can become economically viable in a large-scale system implementation. The main cost consideration will be in the total number of decoders at the Affiliates' TV stations. At last count there are more than 200 Affiliates in each major network, making Digital Audio systems very cost-competitive to FM Audio.

## REFERENCES

- 1) Gordon, "More dollars for the same space", Television/Broadcast January 84, pp 68-69
- 2) Nettles, "Link Analysis, Earth Station Seminar", Scientific-Atlanta, October 79
- 3) Group W Broadcasting, Project MUZAK October 82.
- 4) Doi, "Error Correction for Digital Audio Recordings", DIGITAL AUDIO, pp 147-177, Audio Engineering Society
- 5) Rabiner, Gold' "Theory and Applications of Digital Signal Processing", Prentice-Hall 75
- 6) Shelswell, "Subjective Effect of Intermodulation Distortion when Sound and Television signals are amplified in a common amplifier", BBC Research Report October 74
- 7) Wight, "Plant Conversion for TV Multi-Channel Sound", Public Broadcasting Service, presented at NAB'84
- 8) Schafer, Rabiner, "A Digital Signal Processing Approach to Interpolation", Proc. IEEE, pp 692-702, June 73
- 9) Sunde, "Ideal Binary Pulse Transmission by AM and FM", Bell System Technical Journal, pp 1357-1425, November 59
- 10) Ishida, et. al., "Rotary-Head PCM Recorder Employing Error Correction Technique", IEEE Trans Consumer Electronics p 526, November 78
- 11) Johnson, "Calculating Delta Modulator Performance", IEEE Trans Audio ElectroAcoustics, pp 121-129, March 68

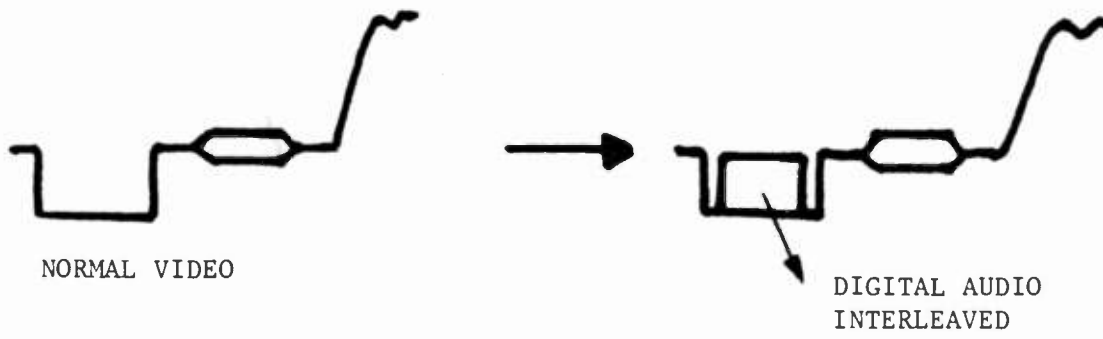


FIGURE 1. TDM

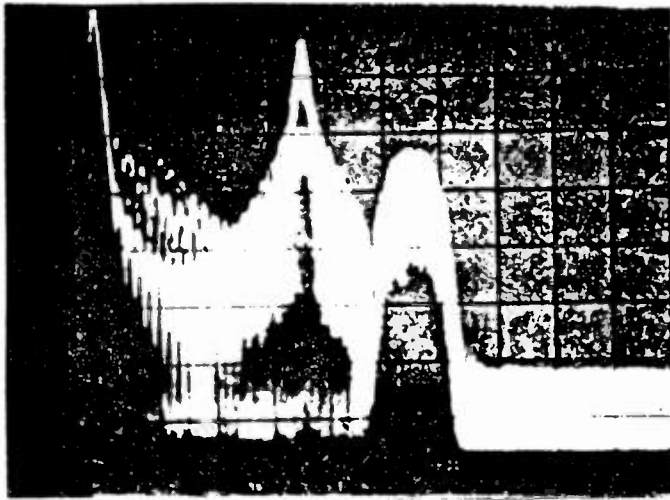


FIGURE 2. FDM

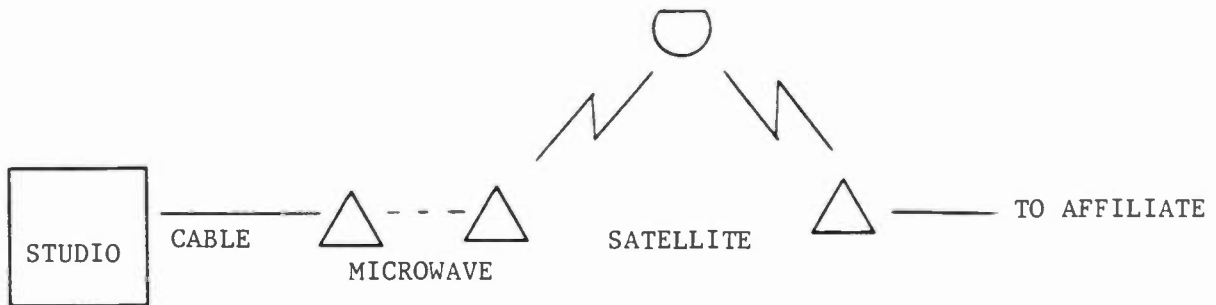


FIGURE 3. TYPICAL NETWORK DISTRIBUTION

TOP POINT IS 18.00 DB  
BOTTOM POINT IS 8.80 DB  
SCALE IS 1.53 DB PER DIVISION

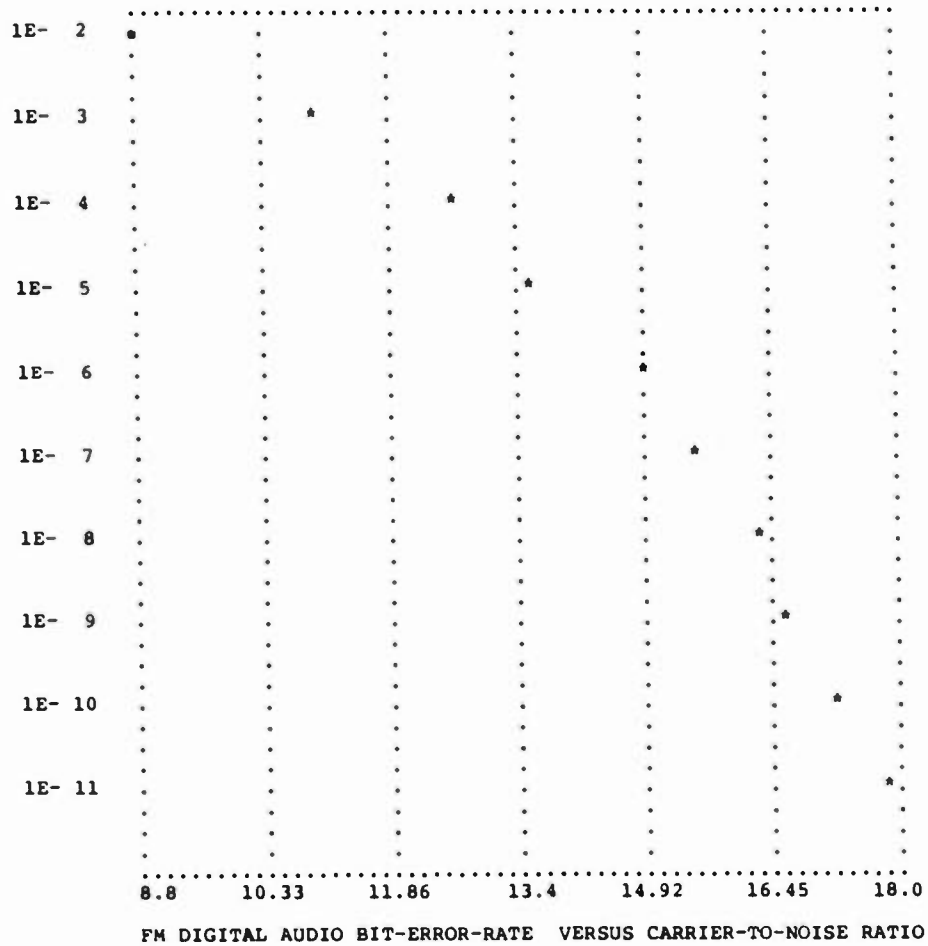
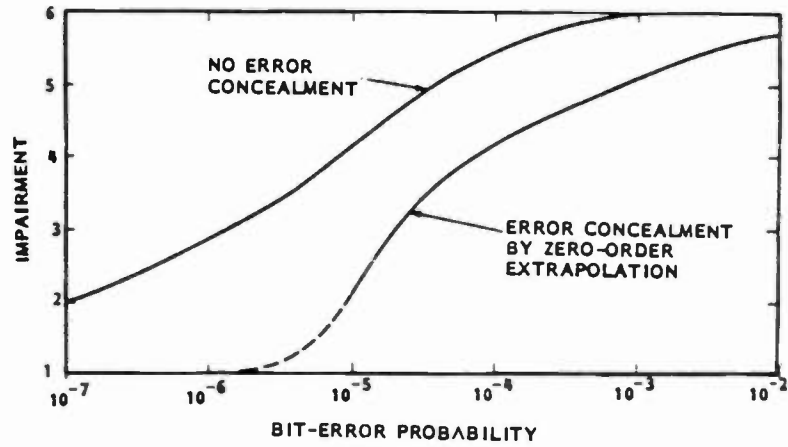


FIGURE 4



**IMPAIRMENT SCALE:**

- 1 = IMPERCEPTIBLE
- 2 = BARELY PERCEPTIBLE
- 3 = CLEARLY PERCEPTIBLE BUT NOT DISTURBING
- 4 = SOMEWHAT OBJECTIONABLE
- 5 = DEFINITELY OBJECTIONABLE
- 6 = UNUSABLE

FIGURE 5. SUBJECTIVE EFFECTS OF PCM BIT ERRORS

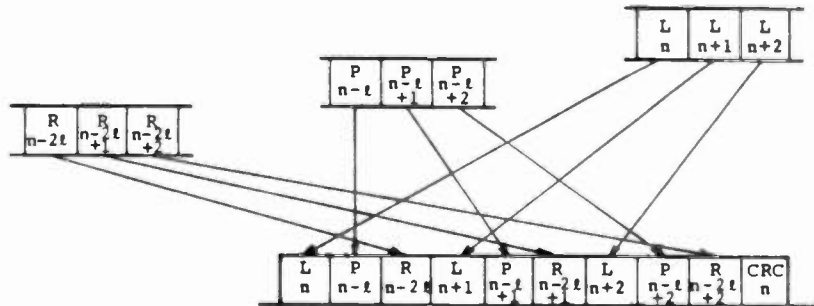


FIGURE 6. INTERLEAVE BIT ERROR CORRECTION CODING

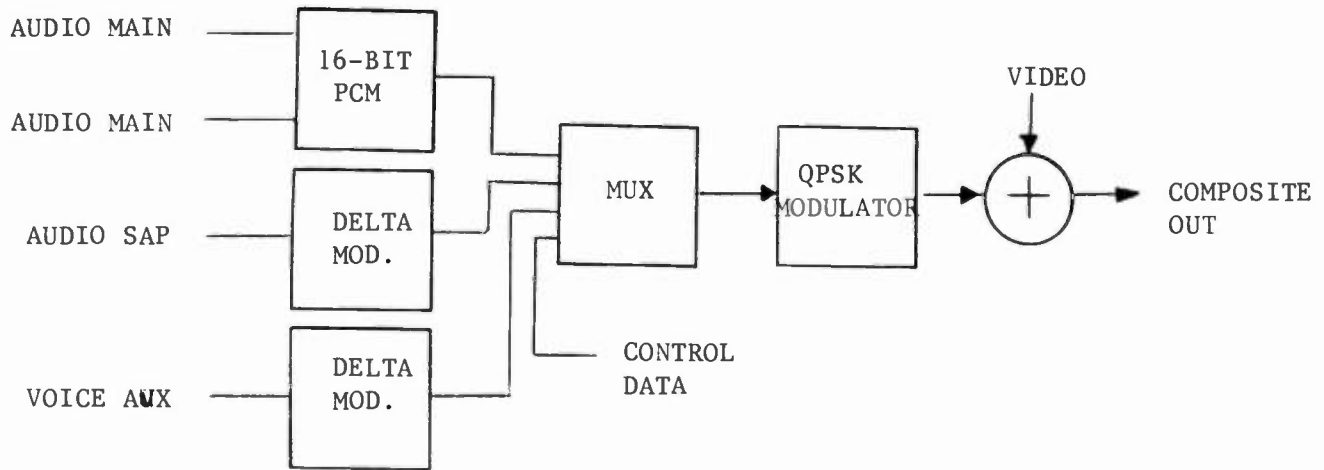


FIGURE 7. COMPANDED PCM FDM SYSTEM

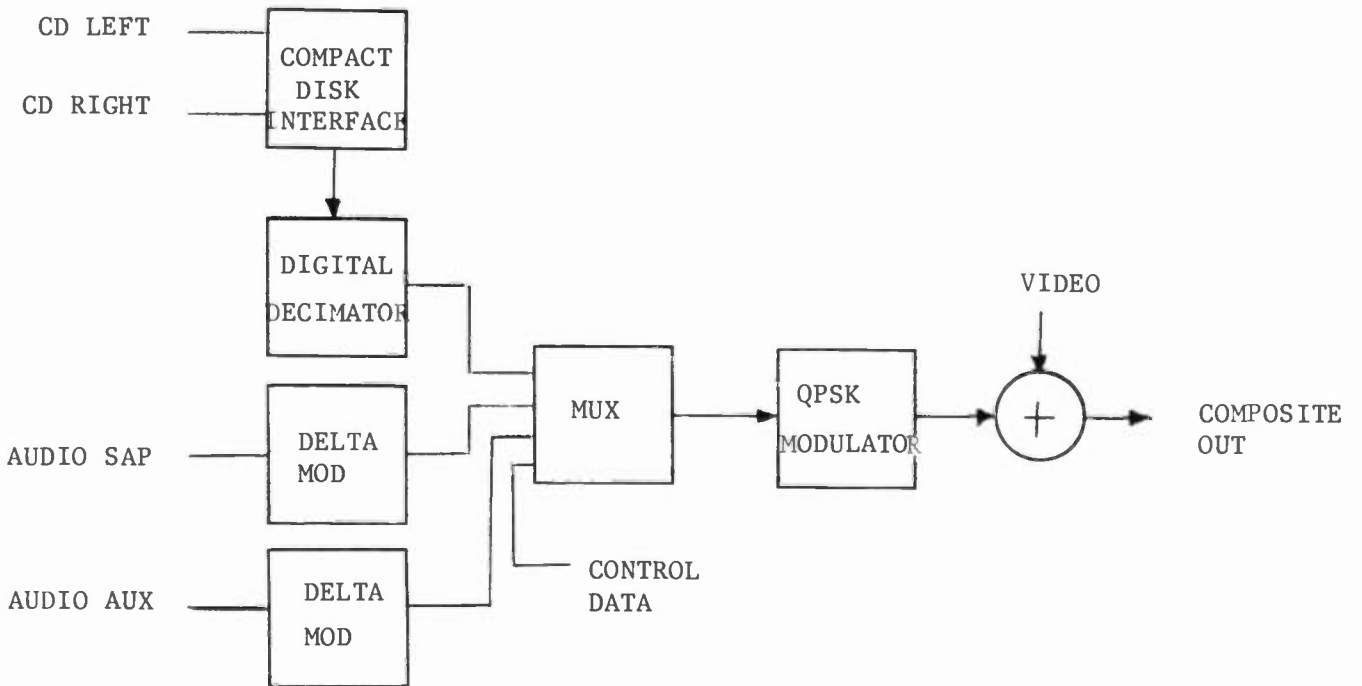


FIGURE 8. COMPACT DISK (CD) COMPATIBLE FDM SYSTEM



---

## Stereo Synthesizers Enhance Monophonic Sound for TV

John J. Bubbers

Kintek, Inc.

Waltham, MA

The recent standards for multiple channel TV sound have presented the TV broadcaster with a new set of challenges, especially for program material previously recorded monophonically. While these monophonic sound tracks lack the aural excitement of stereo audio tracks, many have great intrinsic, financial or artistic value. A similar dilemma confronted the record industry in the late 1950's when newly introduced stereophonic disc recording swept through that industry. Most of the masters were then available only in monophonic versions. Many approaches were tried to make some form of simulated stereo out of these mono masters, such as frequency splitting between channels, reverboration, and comb filters. Ultimately the comb filter method was the most successful for processing mono record masters. While this method seems to be the best one for stereo TV sound, it does not take into account the coupling of the video presentation to the immediately related dynamics of picture and dialogue.

It is the purpose here to present an overview on early attempts at stereo sound presentation, some observations on hearing and perception, means for simulating ambient sound, and how to most effectively present a correlated synthesized TV audio performance. A short bibliography is appended for those who wish to further study the historical concepts, relating to the overall subject of auditory perception and sonic imaging.

One of the earliest modern references to electrical transmission of stereo sound appears in the December 3, 1881 issue of the Scientific American. It reports on the transmission of Paris Opera performances to the Palais d'Industrie, and the problems encountered. Attendees at the Palais listened on two magnetic receivers, one for each ear. Great attention was given to Mr. Ader, who had developed the stereo hardware and his comments about the improved performance over ordinary monophonic transmission. He is quoted as saying that "unlike the ordinary telephone, ...with this system the singers appear at a fixed distance in the mind of the listener". Many of the other comments on this

stereo demonstration begin to sound similar to the jargon of modern hi-fi advertising copy. This early stereo demonstration did create a great deal of listener excitement. Mr. Ader understood that the perceived improvement was "in the mind of the listener". This is precisely the area we are trying to stimulate more than 100 years after that Paris demonstration.

Subsequent to the Paris demonstration work was done trying to determine how we hear and the brain to hearing relationship, sometimes called psycho-acoustics. Scientific literature of the acoustical and audio communities is filled with learned papers on the effects of three dimensional sound, how they are perceived, how we differentiate frontal sounds from rear-ward sounds, and the attempts to quantify our perception of these effects. Precise measurement of human perception of amplitude and phase had to wait until magnetic tape equipment and statistical analysis were readily available in the 1950's; less definitive work had been done earlier. The concentration on understanding and using psycho acoustic principles is best expressed by B.B.Bauer in 1963 in his comment on the experimental work at C B S Laboratories when he wrote, "...experimental work was performed...to define the nature of psycho acoustic phenomena of stereo in terms of physical characteristics of the human listener".

In 1965 Bauer suggested that stereo recordings should be modified with all-pass constant phase networks when listening with headphones and this would improve the listening quality. He argued that stereo recordings had been made for widely spaced loudspeaker reproduction and for headphones this was a suitable modification. In this work he referred to earlier work using a similar method for converting monophonic source material "to make it sound diffused over stereophonic loudspeakers without adding reverberation or altering relative energy in the various frequency bands".

Modern studies indicate that both phase and amplitude cues are used in the psycho acoustic mechanism for localizing sound sources and experiencing ambient sounds. Above approximately 4000 Hertz the psycho acoustic mechanism is amplitude sensitive, while below approximately 1500 Hertz phase sensitivity is the dominant sense for localizing. Localization of sound sources is generally poor in the spectrum from 2500 Hertz to 4000 Hertz, although diffuse sound sources are identified as such over distinct point sources. Although most recordings are primarily amplitude dominated because of the recording methods, there are still phase cues, especially at the longer wavelengths. Modern rock recordings generally are dominated by amplitude cues, since multiple track recording techniques are used; any added phase cues will greatly enhance the ambience and sonic image of these recordings.

Mechanisms for generating phase differences are wellknown. The basic system for introducing these phase differences in synthesizers is illustrated in Fig. 1. The incoming signal is divided, so one branch is fed to two summing junctions of two amplifiers. The second branch from the input signal is fed through a delay system. Various practitioners have used delay systems unique to the particular end effect. Time delays can have a modulated clock frequency, which then introduces small frequency shifts, or a tremolo. Others have used simple time delay systems, while some have used all-pass networks with specific phase shifts occurring at discrete frequencies.

At those frequencies when the phase shift through the delay system is 180 degrees, the output signal at L or R will null out, assuming the amplitudes at B and B' are equal to those from M. The phase shifts introduced into the outputs will be complementary, L to R. The number and frequencies of the nulls will be a function of the design of the delay system and the overall system.

It is important to note that if there are only a few null frequencies within the audio spectrum, the energy will tend to shift from left to right instead of being evenly distributed; this leaves the listener with much the same result as the early frequency band splitting attempts at synthesizing stereo, see Fig. 2. When large portions of the spectrum are shifted the result is very unnatural sounding, although summing the outputs will still replicate the input signal. There are two possible immediate solutions to the frequency or band shifting problem; reduce the null depths by making B unequal to M or increase the number of null points. The first solution reduces the apparent stereo width tending to defeat the original purpose; the second solution is more costly, but produces a far greater ambience enhancement, especially in those programs having broad spectral content.

The sum signal (L+R) is the monophonic signal in the M T S format. From the signal flow diagram, Fig. 1, the addition of the Left and Right output channels is  $2M$   $((M+B)+(M-B)=2M)$  or twice the amplitude of the original signal. Similarly, the subcarrier signal is the delay system output. The monophonic listener does not experience any of the stereo effect, since his signal remains completely unchanged.

Human perception of real acoustical events takes into account phase and amplitude information. To transmit phase and amplitude coherent events it is necessary to have a two channel system, at a minimum. By their very nature, monophonic systems cannot carry phase or relative amplitude information; at best monophonic systems are good communications channels. They lack the ability to convey the subtle information which creates a realistic sound image. Telephones, for example, have served the public well in mono format, but their major purpose is communication. M T S, stereo records and FM, are intended to bring a greater illusion of reality.

A well designed synthesizer takes into account the human factors which can create this illusion of realism from monophonic material. However, video requires the sound and picture to have a coherent relationship. Cognitive circuits to steer synthesized sound tracks will further enhance the coherence of sound to picture. Sophisticated recognition circuitry has been developed and used in the motion picture theater systems.

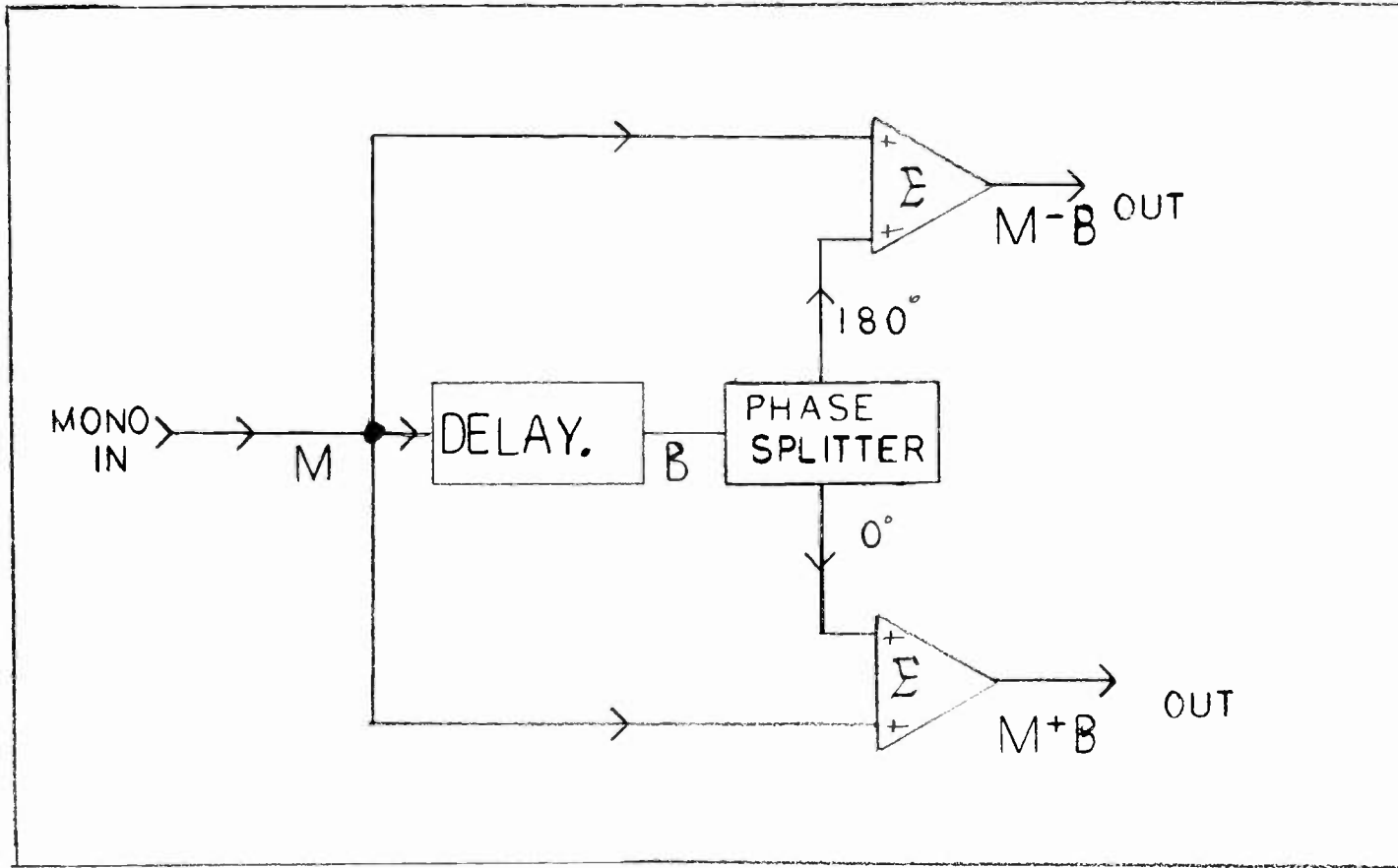
During the introduction period of wide screen motion pictures and stereo, it was learned that widely spaced voice tracks did not lend themselves to credible viewing. It was found preferable to keep the dialogue centrally positioned on the screen, while the music and effects track was put into stereo format. Broad, indiscriminate use of synthesizers has results similar to the early wide audio stage approach used in motion pictures. Dialogue when processed through synthesizers takes on a larger than life aspect to the picture. Ideally, the voice track should be centrally located while music and effects should be in an enhanced ambience mode. This gives the viewer a lifelike performance

with an intimate correlation of sound and picture.

A well designed modern synthesizer offers the TV broadcaster the immediate opportunity to convert existing mono material into a stereo format. Sophisticated, cognitive steering of synthesizers to conform to the listener's psycho acoustic mechanisms provides a realistic viewing format for monophonic programs.

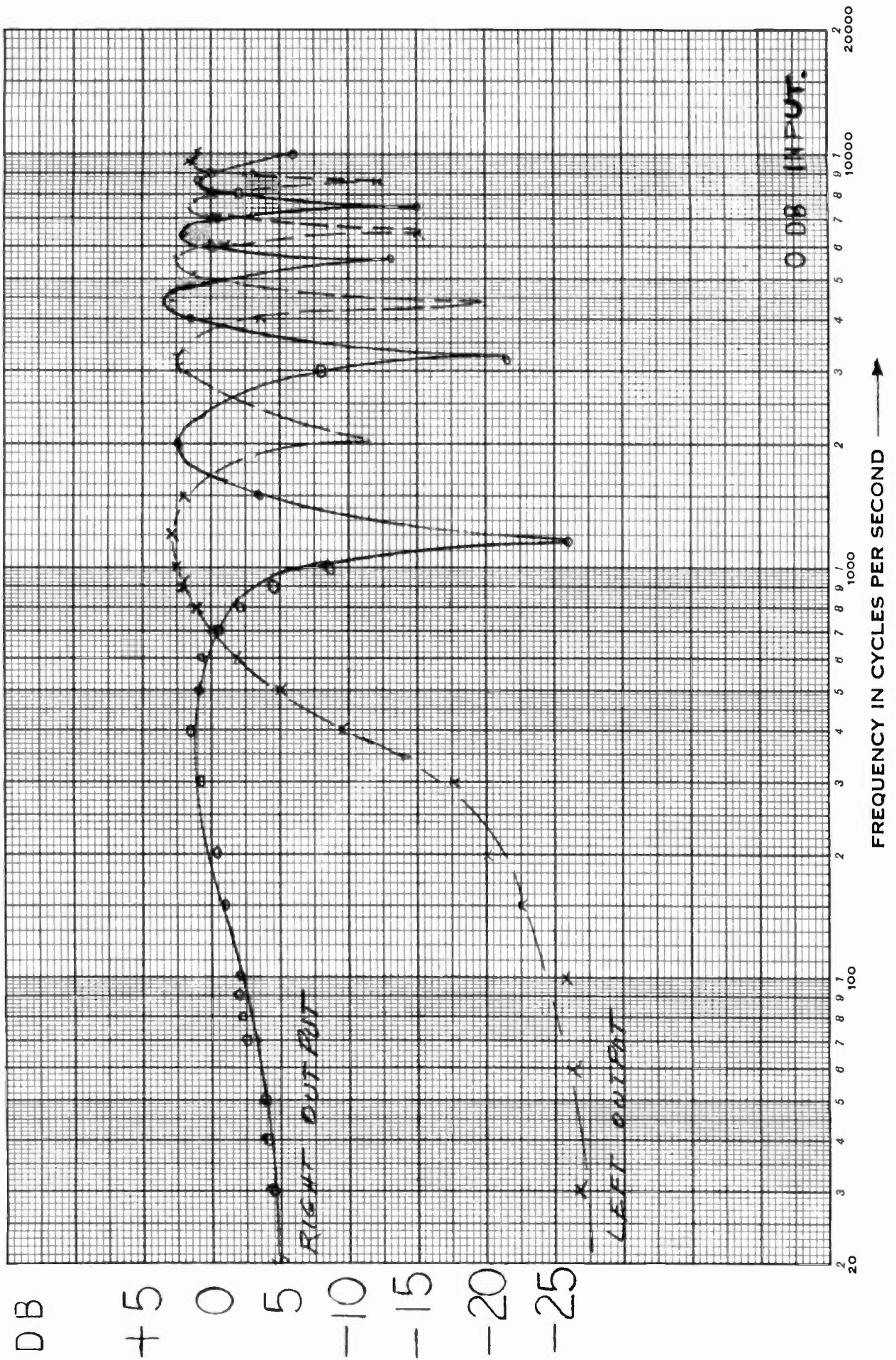
### Bibliography

1. JAES Vol.29#5,pp368-372 100 Years with Stereo
2. JAES Vol.29#4, pp274-286, Keller, Early Hi Fi and Stereo Recordings at Bell Laboratories(1931-1932)
3. ~~IEEE~~ Trans. on Audio-AU11-88 May June 1963,Bauer, Some Techniques toward Better Stereophonic Perspective.
4. JAES Vol.13#4,pp300-302,Bauer, Improving Headphone Listening Comfort
5. JAES Vol.13#4,pp397-403, Torrick et al.,An Electronic Dummy for Acoustic Testing.
6. JAES Vol.29#4,pp226-233,Rogers, Pinna Transformations and Sound Reproduction.
7. JAES Vol.20#2,pp82-91,Long,The Effects of Transit Time and Intensity Differentials upon Recreating Acoustic Fields.
8. JAES Vol.25#4,pp196-200,Thiele and Plenge,Localization of Lateral Phantom Sources.
9. JAES Vol.25 4,pp200-203,Boremius,Moving Sound Images in Theaters.
10. JAES Vol.25#9,pp560-565,Bloom,Creating Source Elevation Illusions by Spectral Manipulation.
11. JAES Vol.28#1/2,Cable and Enerson,Those Early Late Arrivals,Mr. Haas, What Would You Do?
12. JAES Vol.20#2,pp146-159,Haas, The Influence of a Single Echo on the Audibility of Speech.
13. JAES Vol. 29#11,pp794-799,Clegg et al. Controlling Sound Image Localization in Stereophonic Reproduction.
14. Popular Electronics, June 1982,pp55-59,Cohen, Enhance TV Sound with Stereo.



BASIC COMB FILTER.

FIG. 1.





---

## EFFICIENT DIGITAL AUDIO CODING & TRANSMISSION SYSTEMS

Craig C. Todd

Dolby Laboratories, Inc.

San Francisco and London

### 0. ABSTRACT

A digital audio coding method is described which is particularly suited to the requirements of the broadcast industry. High audio quality is achieved at relatively low bit rates (200 k bits/sec to 350 k bits/sec). Decoder circuitry is simple so receiver cost is minimized (important in point to multipoint transmission). The system is robust, and with increasing error rates, degrades gracefully and gradually. A simple error concealment scheme further reduces the audibility of errors.

### 1. INTRODUCTION

Digital techniques have a number of advantages for the distribution of audio signals. A primary one is that the channel coding can be considered independently of the audio coding so a great deal of flexibility exists to optimize these two items independently, which is not the case with practical analog techniques. Digital audio can be encrypted with no effect on audio quality, which is not possible with analog techniques. Given sufficient channel capacity and funding, arbitrarily high quality audio may be transmitted with conventional straightforward A-D, D-A conversion techniques and error correction systems. This paper sets forth an audio coding method which has a number of advantages over conventional techniques. These include: cost of circuitry at the receiving end of the transmission; required channel capacity to achieve perceptibly excellent audio quality; and performance under impaired reception conditions.

Note: Some of the material in this paper is derived from a paper presented at the 75th convention of the Audio Engineering Society (Paris, March 1984) and is used with the permission of the AES.

## 2. CONVENTIONAL APPROACHES

Receiving equipment must provide demodulation, demultiplexing, decrypting (if program security must be provided), error correction/concealment, digital to audio conversion, and output filtering. Most of the delivery systems proposed to date have employed Pulse-Code Modulation (PCM) for the audio conversion and require on the order of 350 k bits/sec to 1000 k bits/sec of data per audio channel. Well designed systems of this type can provide a quality of reproduction better than any available analogue distribution technique but they carry with them disadvantages. One of these is cost, and another is performance under impaired reception conditions.

In order for a PCM system to produce a dynamic range of 80 dB or more, circuitry is required which can produce an output with a relative tolerance of on the order of 0.01% and such precision is not inherently low cost. In order for a PCM system to operate at a reasonably low data rate it is necessary to reduce the sampling rate to only slightly greater than twice the desired audio bandwidth. This requires the use of relatively elaborate filters, which again are inherently not negligible in cost.

When reception conditions are not optimal, the received digital data will contain some errors. PCM systems are notorious for the extremely objectionable sounds that result from the reproduction of digital audio data containing even small numbers of errors. PCM systems are simply not viable without the addition of error correction or error concealment systems. With the use of such systems acceptable performance can be achieved under moderately adverse reception conditions, but when some error rate is reached the system will degrade catastrophically and the audio must be muted.

## 3. COMPANDED SYSTEMS

Any digital audio system employed for broadcasting can save channel capacity by employing companding techniques to reduce the required bit rate. Companding can increase the dynamic range of a low bit rate digital audio coding system. If the coding system inherently has adequate instantaneous signal to noise ratio but insufficient dynamic range, then simple companding systems can easily increase the dynamic range to whatever is required. If the SNR is not adequate the increased dynamic range will be accompanied by audible noise modulation.

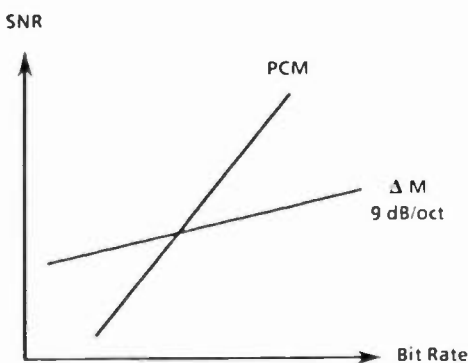
Typical broadcast digital audio coding systems reduce bit rate to the point that the instantaneous SNR is not quite adequate (for example companding to 10 bit resolution) and increase the SNR by means of emphasis networks. Fixed emphasis networks typically reduce the high frequency noise modulation accompanying low frequency audio program material but actually increase the amount of low frequency noise modulation in the presence of high frequency signals. There is also a loss of high frequency headroom with fixed emphasis networks.

The perceived audio performance of a digital audio system operating at a low data rate will be dominated by the performance of the noise reduction system in use. The sophistication of the coder-decoder will lie in this area. The actual audio-digital-audio coder inside the noise reduction system can be chosen for some desirable characteristics and then a suitable noise reduction system placed around it.



#### 4. DELTA MODULATION

Delta Modulation (DM) has some significant virtues which has lead us to consider it as the core of a digital coding system. DM circuitry does not require any precision components and can be manufactured very economically with today's technology. Since all bits have equal value, isolated bit errors always have a minor audible effect (there is no MSB to create a huge error impulse). As shown in Fig. 1, the inherent SNR of DM is a gradual function of bit rate (9 dB/octave) in sharp contrast to the steep slope of PCM SNR vs. bit rate (where the SNR expressed in dB doubles when the bit rate is doubled). From this simple illustration it is clear why PCM is so attractive for professional recording applications where the data rate is of little concern. Given adequate data rate the performance of PCM is theoretically superb. However, when the data rate is lowered, as in the case of an efficient broadcast system, it is apparent that the performance of PCM will become inferior to that of DM.



SNR of PCM, Delta Modulation vs Bit Rate

Figure 1.

Companded DM systems are typically referred to as Adaptive Delta Modulation (ADM) systems. In contrast to companded PCM, noise modulation in an ADM system is caused not by high amplitude signals but by high slope signals. Noise modulation is worst in the presence of high frequency signals but the fact that high frequency signals effectively mask noise makes this characteristic acceptable and perhaps preferable to that of companded PCM where high amplitude low frequency signals will produce noise modulation which may not be masked by the signals. The application of emphasis around a PCM system moves its characteristics in the direction of a DM system by improving low frequency performance at the expense of high frequency performance.

A judicious choice of fixed emphasis characteristic applied around a low data rate ADM system can provide a good compromise between audible noise modulation with mid frequency signals and high frequency handling capability, but is unsatisfactory when program material contains predominately high frequency energy. The problem is not so much that the signals might overload the system (it is easy to provide adequate dynamic range), but that the low frequency noise which is boosted by the de-emphasis may not be sufficiently masked.

The usual technique for ADM is to use a fixed emphasis characteristic and to code into a single bit-stream both the audio information and the companding (often referred to as step-size) information. The adaption is usually output controlled (operating from the output bit stream) so transient performance is not perfect but may be acceptable. The significance of individual bits to the adaption control signal depends on the nature of the adaption algorithm. Some individual bits will become very significant to the algorithm and a small percentage of data transmission errors which happen to hit these critical gain control bits will cause the gain to significantly deviate from its proper value. We refer to this as the gain blipping effect. The gain blipping effect may be the most noticeable degradation of such a system operating with data errors. The effect can be reduced in magnitude by making the control signal move more sluggishly at the expense of poorer transient response. The adaption characteristic is therefore a compromise between speed of response (necessary for handling transient signals) and tolerance of errors.

## 5. OUTLINE OF NEW SYSTEM

A novel approach to the application of delta-modulation to audio coding for broadcast will now be described. A fundamental aspect of this new approach is that the complexity of the encoder (of which few are required for point to multipoint distribution) has been raised in order to lower the cost of a decoder and to remove the performance limitations of a simple ADM system.

The dynamic range of simple DM is improved by means of wide band gain control as in the case of ADM. SNR is improved by the use of emphasis networks but the compromise inherent in the use of fixed networks is avoided by the use of a variation on our 'sliding band' variable emphasis system. This powerful technique gives a larger improvement in noise modulation than fixed emphasis yet does not incur a penalty of reduced high frequency headroom, or low frequency noise emphasis in the presence of predominantly high frequency program material.

The 'gain blipping' effect has been eliminated by sending the noise reduction control signals via a separate low data rate bit stream. A simple algorithm is used to convert this bit stream into a control signal of limited bandwidth and in this algorithm all bits have equal weight. It is thus impossible for a bit error to cause a very significant control signal deviation.

A low data rate control signal suggests a sluggish response which would yield poor transient performance. This is avoided by analyzing the input audio signal, generating the control signals, and delaying the audio main path, so that the control signals respond in advance of the arrival of the audio to be encoded.

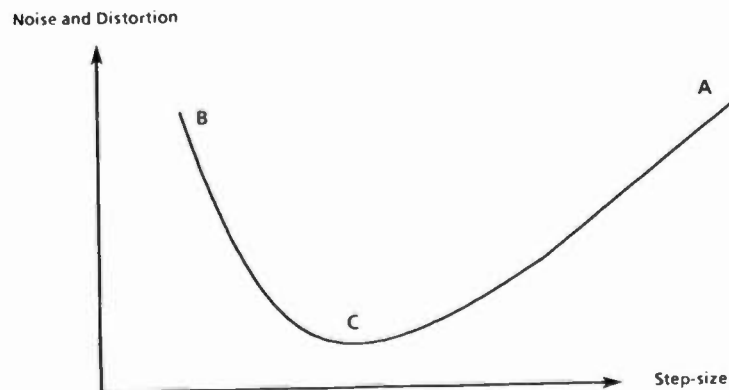
## 6. LIMITED BANDWIDTH CONTROL SIGNALS

The operation of changing the gain or frequency response of an audio signal in response to a control signal is essentially that of multiplication. When one waveform is multiplied by another, the output signal spectrum is the convolution of both input spectra. In audio signal processing, we consider that the original audio spectra has been contaminated by modulation products, and these products may be highly objectionable. In a complementary noise reduction signal processing system, the introduction of modulation sidebands in the encoder should be accompanied by a subtraction of the same sidebands in the decoder, which is sometimes theoretically possible.

In any practical system the encoder and decoder will not track perfectly because of component tolerances and/or channel errors. The modulation products generated by the signal processing will not be completely canceled. In a system where very fast responding control signals have been employed, discrepancies between encoding and decoding will leave remnants of modulation products splattered all over the audio spectrum; if the noise and distortion of the overall system are not to be audibly degraded, the accuracy of the control signals must be of the same order as that of the audio. In a system with very slowly responding control signals, the remnant spectral energy will be found only close to the original spectral energy and may be audibly masked by the original energy. Hence the slower the control signals, the less audible will be the modulation products of mistracking, or the greater amount of mistracking can be tolerated.

## 7. OPTIMIZED ADM

The noise and distortion emerging from an ADM codec depend on the audio input signal and the step-size in use; both of which are varying. Consider a codec handling a single sine wave. As a function of step-size, the output noise and distortion will vary as shown qualitatively in figure 2. In the region labelled A, the step-size is too large, which produces excessive quantizing noise. In region B the step-size is too small and the system is in slope overload which produces high noise and distortion. There is an optimum value of step-size for the particular input condition labelled C. For each short time segment of real audio there is a curve like fig. 2, and an optimum step-size. In a conventional output controlled ADM system the step size rarely achieves the optimum value, but remains in region A most of the time, moving into region B on signal transients. Our optimized ADM system essentially always operates in region C, so the core DM is always fully loaded. This is possible because the step-size determination is done in the encoder and is input controlled.



- A. Excess noise because system not fully loaded.
- B. System in slope overload
- C. Optimum operation

Optimum step-size

Figure 2.

## 8. VARIABLE EMPHASIS

As mentioned above, the use of conventional high frequency emphasis is effective when the predominant spectral components of the input signal are at low or middle frequencies. However with high frequency signals this actually degrades performance. Consideration of the noise levels and spectra delivered by an optimized ADM codec operating at 200 or 300 k bits/sec shows that there are three (overlapping) regimes to be considered if noise shaping is to be effective in eliminating audible noise modulation.

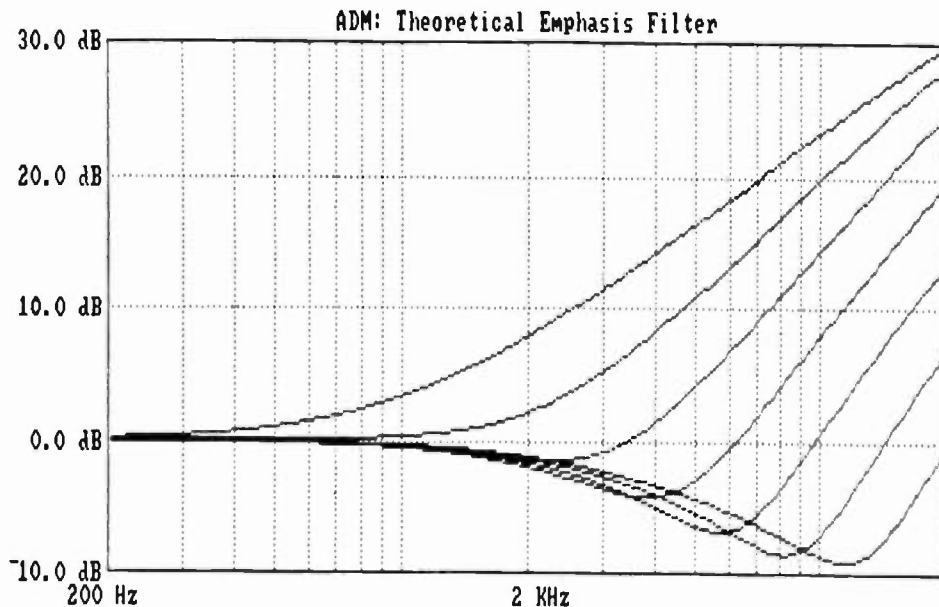


Figure 3: Emphasis Curves.

- A. When the predominant audio spectral components lie below roughly 500 Hz, a large high frequency pre- and de-emphasis will reduce noise sufficiently that audible noise modulation will not occur. An example of a practical emphasis characteristic is shown in curve 1 on figure 3.
- B. As the predominant spectral component is increased up to 2 or 3 kHz, it is necessary to slide the emphasis upwards in frequency so as to retain high frequency noise reduction relative to the spectral component (curves 2 and 3). Low frequency noise is not yet an audible problem.
- C. When the predominant spectral component is above about 3 kHz, noise both at low and at very high frequencies must be reduced. An emphasis curve with a dip at the predominant component will reduce the step-size and hence the broad-band noise emerging from the codec, while the subsequent complementary de-emphasis peak will pick out the wanted signal component, while attenuating high frequency noise and retaining the reduced low frequency noise level which resulted from the smaller step-size. For example, if the predominant signal lies at 6 kHz, curve 5 is a desirable emphasis characteristic.

This explanation has assumed that the predominant components of an audio signal at a particular moment are concentrated in a narrow region of the spectrum; such a signal is in fact the most critical case. When the spectral components are more distributed, their masking properties cover more of the noise, and the emphasis shape is less critical.

Thus a variable emphasis circuit giving a family of response curves of the form shown in figure 3 preceding the delta-modulator, with the complementary de-emphasis following the demodulator will provide efficient subjective noise reduction under all signal conditions, provided that circuitry can be designed to analyze the input audio and to give suitable instructions to the emphasis networks.

## 9. THE SIMPLE DECODER

Figure 4 illustrates the decoder required in the receiver. Each audio channel of decoding receives three data bit-streams. The audio data is at a moderately high rate, on the order of 200 to 300 k bits/sec. The two control bit streams are at much lower rates, typically about 8 k bits/sec each; for TV sound in sync type systems a convenient rate is half the television line frequency.

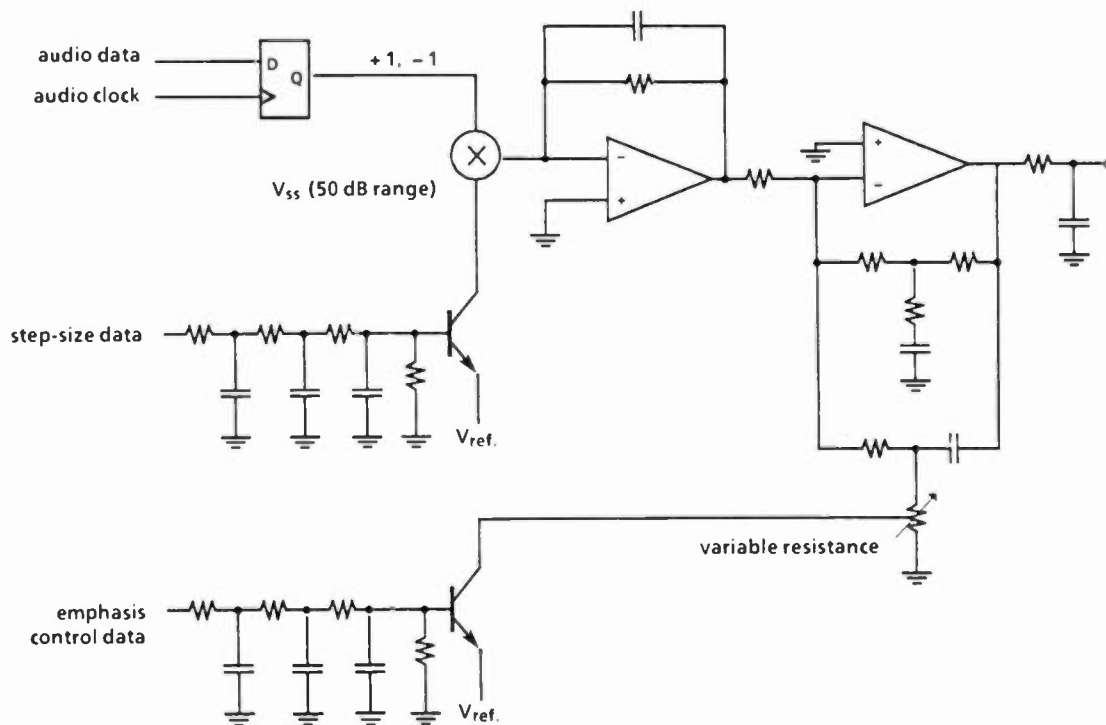


Figure 4: Consumer Decoder.

The product of the audio data and the step-size control signal is integrated in a leaky integrator. The step-size control bit-stream contains the logarithm of the required step-size coded as delta-sigma modulation. The control signal is recovered by low-pass filtering the bit stream and exponentiating the resulting voltage. The de-emphasis control signal is handled identically but instead of a variation in gain, it produces a variable pole frequency in the de-emphasis network. The final single pole of the de-emphasis network yields enough attenuation of clock and spurious out-of-band signals that no output filter is required.

The decoding circuitry is inherently simple and low cost and no precision is required in any of the components. Any component errors produce typically analog types of errors such as incorrect frequency response or level. There are no mechanisms (as in a PCM converter) for the creation of any intolerable sorts of non-linearities; there is little chance that tolerances or long term drift will produce objectionable sounds.

## 10. THE ENCODER

Figure 5 is a block diagram of the encoder required at the broadcast center. The encoder is more elaborate and expensive than the decoder; since only a few encoders are required in many broadcast systems this is acceptable. It is the sophistication of the encoder which allows such a simple decoder to produce such high audio quality. The fundamental requirement of the encoder is to deliver bit-streams which when decoded by the simple decoder yield the best perceived audio.

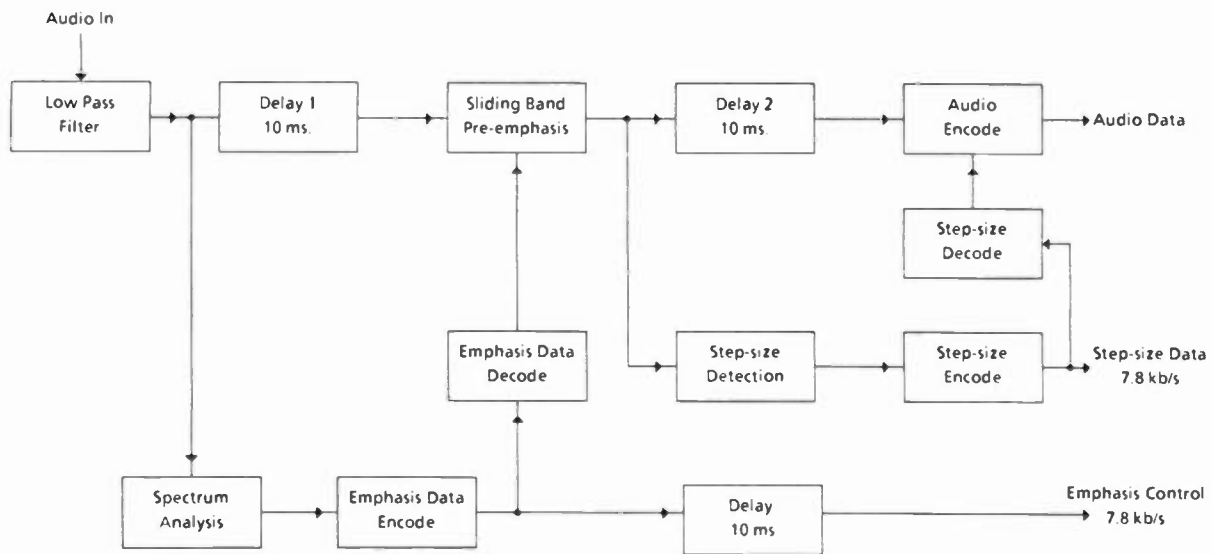


Figure 5: Professional Audio Encoder. Block Diagram.

The emphasis control block analyzes the spectrum of the input audio to determine the optimum emphasis characteristic to minimize the audibility of codec noise in the presence of that signal spectrum. This information is coded into the low bit rate emphasis control data stream. The conversion of this bit stream back to a signal suitable for operating on the variable emphasis network includes limitation of the bandwidth to about 50 Hz, corresponding to a rise-time of 10 ms. Hence the audio is delayed by this time before entering the variable emphasis circuit.

Emphasized audio is passed to the step-size detection block which measures the slope of the signal to determine the optimum step-size (point C on the curve in Fig. 2). The logarithm of this value is coded into the step-size control data. Again conversion back to actual step-size voltage restricts the rise-time so the audio is again delayed before entering the actual delta-modulator. An equal delay is applied to the emphasis control data so that all data will arrive properly timed at the decoder.

## 11. AUDIO PERFORMANCE

The coding has been designed so that the dynamic range of the system easily may exceed 100 dB, though actual circuit implementations may not reach this figure. Frequency response may in theory extend to one-half of the audio clock, but it is wise to low pass filter incoming audio at 16 kHz to eliminate spurious signals. The input filters may be much gentler than those required with low sample rate PCM. Non-linear distortions are not inherent in DM but practical circuits yield levels on the order of 0.1 to 0.2%. With an adequate audio data rate the audible performance of the codec is superb. What one considers adequate can be the subject of some debate. Our feeling is that a very high level of performance is achieved with an audio clock at around 300 kHz. We typically recommend operation at about 200 kHz, as performance at this rate is still so good that it is only with the most critical listening conditions and program material that one can begin to detect noise modulation. For some applications a clock rate as low as 157 kHz may yield more than adequate performance.

## 12. ERROR CONCEALMENT

The effects of bit errors on PCM or DM systems are very different. An error in a PCM system produces an impulse lasting one sample period, with an amplitude dependent on the significance of the bit in error. MSB errors will produce impulses of half of full scale. An error in a DM system produces a small step which lasts for a long time (the step decays by the integrator leak time constant). The spectra of the errors is such that the PCM impulse is essentially always audible, whereas the DM step will often be audibly masked by the program material. Reproduced errors, while certainly somewhat objectionable, can be tolerated with DM systems. They cannot be tolerated with PCM systems because of their possibly huge amplitude.

Error concealment in PCM works by reducing the amplitude of the error impulse. To work, errors must be reliably detected, and a previous or interpolated word substituted for the word in error. As long as errors are reliably detected concealment can give fair results but at some error rate error detection will become unreliable, concealment will break down and many unconcealed errors will be reproduced. Because the reproduction of these errors is intolerable, the audio will have to be muted in this situation, although audio which erratically mutes is also intolerably annoying leading the listener to turn it off.

Error concealment in DM works by reducing the length of the small step which the error created. The approximate location and polarity of an error is determined and an opposite polarity error is artificially introduced near the original error; this terminates the step the error created. The step typically is shortened to a length similar to a PCM sample period. The performance of PCM or DM concealment successfully operating is similar since both produce small steps of similar duration. When high error rates break down the error concealment in a DM system some unconcealed errors are reproduced. Since these errors may be tolerated, there is no need to mute or turn off the audio. A DM system is typically usable at an error rate something like an order of magnitude (or more) higher than a PCM system.

## 13. APPLICATIONS

The system is being applied to the transmission of audio with video and audio only. Application of the system requires that the encoder output data be formatted into blocks and provision made for synchronization, so that the receiver can

determine the function of each received bit. Two general types of formats are used: those with bursty data and those with continuous data. An example of a bursty format is the transmission of audio data in the horizontal interval of an NTSC or PAL TV signal, or in the B-MAC format. Since the choice of data rate is very flexible (the quality of sound varies gradually as the bit rate is changed) it is common to choose a rate conveniently related to video frequencies. Systems have used one-half of the horizontal line rate for control data and a multiple of the line rate for audio data. The most common audio data rate in use is 13 fh or 204 k bits/s. Error concealment blocks are conveniently chosen to be groups of one or two lines worth of data.

Continuous data formats are used where the digital data is sent without interruption over a link. Sound only transmissions or those with video but using an unrelated carrier are examples. Common bit rates for stereo audio transmissions will include 512 k bits/sec (or 1/3 of T1 rate) and 772 k bits/sec (or 1/2 of T1 rate).

#### 14. CONCLUSION

The digital audio coding method described here fills the need for a rugged, tolerant, efficient, practical system which can be implemented today. Numerous application areas are being developed including consumer delivery systems via DBS, cable TV and terrestrial broadcasting. Professional applications include network broadcast sound distribution and STL links. Integrated circuit decoders are under development. New techniques will significantly lower the cost of the encoding hardware which will allow more applications to become feasible.



---

## HIGH DYNAMIC RANGE

### RECEIVERS

Ernest M. Hickin

M/A-COM MAC\* Inc.

Burlington, Mass

#### SUMMARY

Increasing congestion in the ENG bands demands ever-improving receiver characteristics.

The paper describes the latest in a line of portable and central-site receivers with greatly improved dynamic range.

Four areas have been tackled, namely careful disposition of gain, high-level mixing, choice of intermediate frequency and a tracking filter, leading to the avoidance and suppression of high-order responses.

The results of increasing the dynamic range have been dramatic giving greatly improved selectivity and immunity from high-level interfering signals in a receiver with 700 MHz of frequency agility in the 2, 7 and 12 GHz bands.

#### HIGHER-ORDER RESPONSES

The mixer of a superheterodyne receiver is designed to beat together the local oscillator and wanted signal to produce the chosen intermediate frequency.

But the mixing process, involving non-linearities, can produce the intermediate frequency from other unwanted signals by third, fourth and even higher order processes. Because these spurious responses produce the desired I.F. they cannot be removed by an I.F. Filter.

As an example take one which is all too familiar in the 2 GHz band. A receiver tuned to Channel 5 suffers interference from Channel 3 despite an I.F. filter with ample rejection of signals at +/- 34 MHz. A spurious response is being produced by the second harmonics of the unwanted signal (UW) and the

\* MICROWAVE ASSOCIATES COMMUNICATIONS

local oscillator (LO): -

$$2 \times UW - 2 \times LO = I.F. \text{ or } (2 \times LO + I.F.)/2 = UW$$

In this example the LO is at 1997.5 MHz (2067.5-70) to receive channel 5. But  $(2 \times 1997.5) + 70$  divided by 2 = 2032.5 MHz, one megahertz away from channel 3. No IF filter can assist in this problem. In a fixed point-to-point system the unwanted signal can be attenuated by an RF filter but this solution is not readily available in a frequency-agile receiver where the front end is open to all signals in the band.

Since this response is almost at IF/2 MHz away one solution is to raise the intermediate frequency. This also removes the image frequency which (with a 70 MHz IF) is sometimes going to be inband in the 7,12 or 13 GHz domestic bands, and also in the 2 GHz international band.

But the prime solution is to ensure that the stages before the IF Filter are operated in as linear a condition possible over the maximum range of inputs (a high dynamic range). This coupled with a high-level mixer, will reduce the generation of high-order distortion products. To ensure linearity amplifiers must be operated at as low a gain as is consistent with a good noise figure. For this reason the SAW IF Filter was rejected early in the design when it was recognized that the need to drive that filter at high level (to overcome the coupling loss without sacrificing noise figure) leads to the very non-linearities we are striving to avoid. Figure 1 shows the RF and IF circuits with approximate gains and losses. There are two LNA Stages, each with about 12 dB

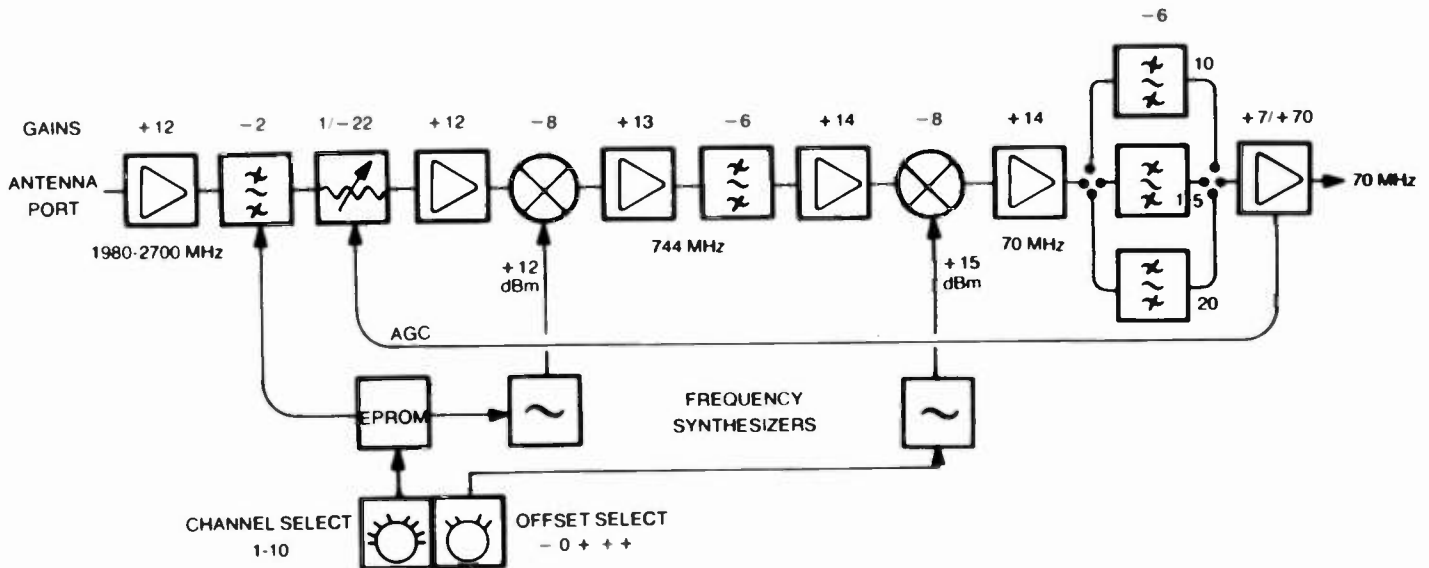


Figure 1 RF and IF stages of MR and MRC receivers gain from antenna port to input of main IF amplifier is 34 dB for low-level signals, dropping to 12 dB for strong wanted signals.

gain, separated by a tracking filter and a voltage-controlled attenuator. The attenuator is controlled by the a.g.c. line and introduces a loss of 1 to 23 dB which comes into action about the time that the main IF gain has reached its minimum. This increases the dynamic range by at least 20 dB.

As a result of the attenuator the front-end to main IF gain goes from 34 dB for low-level signals to 12 dB for high wanted signals. Since it is in the broadband circuits prior to the main IF filter that the high-order intermodulation products will be generated, the attenuator gives a significant reduction in those products.

The varactor-tuned two-stage tracking filter is controlled by the same EPROM as controls the L.O. frequency synthesiser and is tuned to give a response about 200 MHz wide around the desired signal frequency. Thus selectivity for adjacent channels comes from the IF Filter, while higher order products are attenuated by the tracking filter and discouraged by the low gain (and therefore good linearity) of the front-end amplifiers.

As a further move to ensure linearity the drive to the first mixer is 12dBm, and to the second mixer +15dBm, reflecting the fact that signal levels are higher at the second mixer.

#### CHOICE OF IF

Figures 2 and 3 show the responses of a frequency agile receiver tuning from 1990 to 2700 MHz.

The first figure is with the LO on the low side of the signal, and shows the fundamental response, and the image, third and fourth order spurious responses, for 70, 500, 600, 700 and 800 MHz first intermediate frequencies.

The second figure similarly shows those responses when the LO is on the high side of the signal.

Note that with the receiver tuned to channel 5 (2067.5 MHz) for example, any signal at a frequency where a diagonal line crosses the 2067.5 MHz vertical will produce the chosen IF and cannot therefore be filtered at intermediate frequency.

From both figures it is clear that 70 MHz is too low. Frequencies between 500 and 800 MHz are all suitable if a high LO (Figure 3) is chosen. The final choice in the 2MR and MRC receivers was arbitrary, encouraged by the availability of highly stable SAW resonators at 674 MHz, giving 744 MHz for the first IF and 70 MHz for the main IF filter and amplifier.

In the MRC multiband receiver the second oscillator is switched to 814 MHz to invert the IF sense of modulation when receiving the 2 or 12 GHz bands, so that a 70 MHz output is available for non-demodulating receiver applications. The second LO is fully synthesized and switchable between 814 and 674 MHz under the control of the band switch. (Figure 1). The inversion arises from the use of a 9-10 GHz oscillator in the down-converter for both 7 and 12 GHz reception, being on the low side for 7 GHz and the high side for 12 GHz.

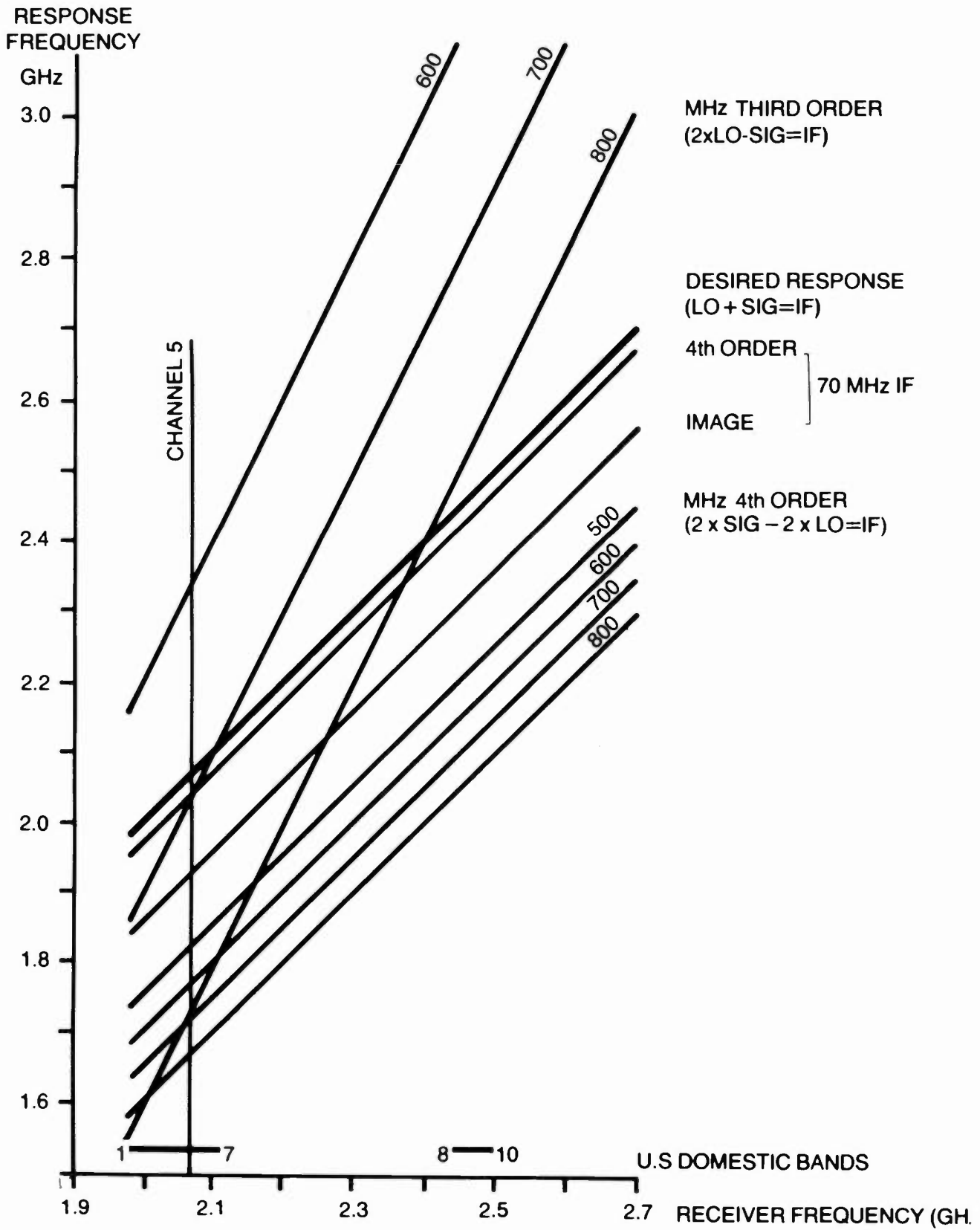


Figure 2. Responses, wanted and unwanted, for various first intermediate frequencies with LO below signal.

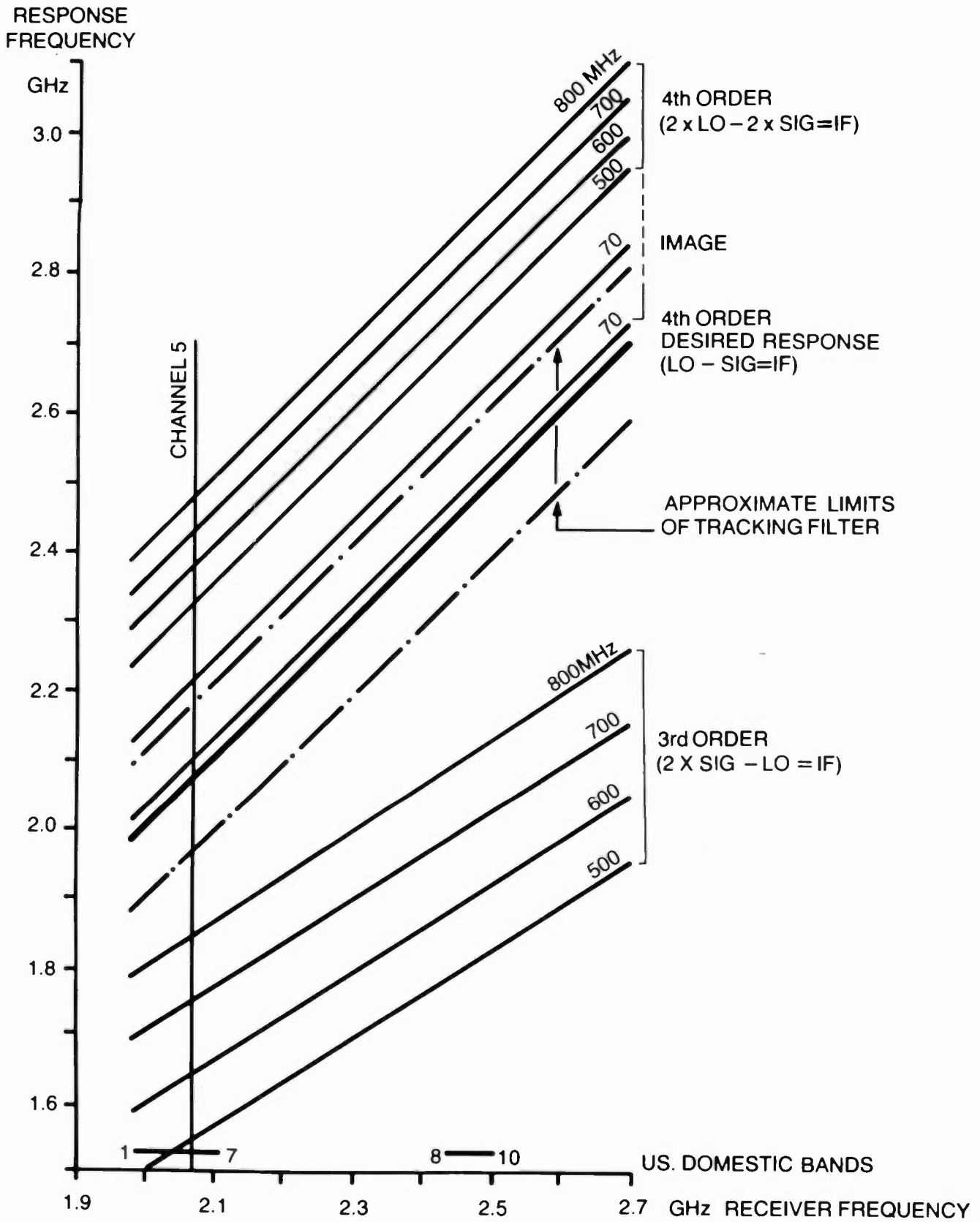


Figure 3. Responses, wanted and unwanted, for various first intermediate frequencies with LO above signal.

## LOW-NOISE AMPLIFIERS

While range can be increased by higher transmitter powers, in the long run it is everyones interest to use the best receiver noise figure and the lowest transmitted power needed to meet a given situation.

In this way the general level of interference is kept down, and the transmitter power consumption is lowered (an advantage with portable links).

Both the portable and central receiver versions of the MR have two-stage low-noise amplifiers. The first stage comprises a fixed gain 2dB nominal noise figure unit with two FET amplifiers fed in parallel by a hybrid circuit, with a similar combiner at their output. The second stage is similar but preceded by a variable attenuator controlled by the receiver a.g.c. line. As already described, this enables the front end gain to be varied from 0 to 22 dB, giving low-noise performance when required, and preventing distortion in the mixer - I.F. preamplifier when strong inputs are being received. In this way the dynamic range is increased by 22 dB, as indicated in Figure 4.

The tracking filter interposed between the two stages has a bandwidth of about +/- 100 MHz (shown in Figure 3 as dashed lines) which further reduces vulnerability to unwanted signals when these are so high as to make fourth and higher order intermodulation inevitable.

The above description fits both the 2MR portable and the MRC central receiver front ends. In the former case the 2MR is normally tripod-mounted and antenna (such as the Disc-rod or the wide-band Dis-cone) is coupled directly to it by a quick-acting Twist-loc connector (Figures 5 and 6).

The MRC also can be mounted close to the antenna at the mast head, and remotely operated (tuning, I.F. bandwidth and even audio sub-carrier frequencies can be remotely selected).

However, many times it will be mounted in an equipment room at the foot of the tower, fed through 1000-2000 feet of coaxial cable. In that case an antenna such as the Superscan or Miniscan, with a built-in LNA, is used to overcome the feeder losses and ensure the best overall noise figure. The noise figure of a two-stage LNA system is given by:

$$NF = NF_1 + \frac{NF_2 - 1}{G_1}$$

(Where  $NF_1$  and  $G_1$  are the noise figure and gain of LNA1 and  $NF_2$  the noise figure of LNA2, all units being power ratios, not decibels)

Thus it would appear that the higher  $G_1$ , the gain of the first LNA, the more nearly the overall noise figure will approach  $NF_1$ .

While this is true it ignores the requirement to ensure that all stages prior to the I.F. filter are operated in a linear condition. Failure to do this due to excessive gain will lead to distortion products which increase by 4dB for every 1 dB of unwanted gain.

Figure 7 shows overall noise figure when an antenna LNA of 1.6 dB NF (such as the Superscan or Miniscan) drives a receiver with a front-end NF of 2, 4 or 6 dB. The horizontal scale is overall gain, ie amplifier gain less cable loss. It will be seen that if the following receiver has a noise factor of 2 dB (such as the MRC) an overall gain of 6 dB will give an overall NF of less than 2.1 dB. To get the same noise figure with following receivers of 4 dB or 6 dB NF would require gains of 10 dB and 13 dB respectively, with 16 dB or 28 dB increases in susceptibility to high-order spurious.

If there is 2000 feet of 2 GHz coaxial feeder with a loss of 30 dB, a 36 dB LNA will be required. If the cable loss is lower the amplifier gain should be reduced, or a pad inserted to ensure that signals reaching the front end of the receiver are no larger than is necessary to give good noise performance.

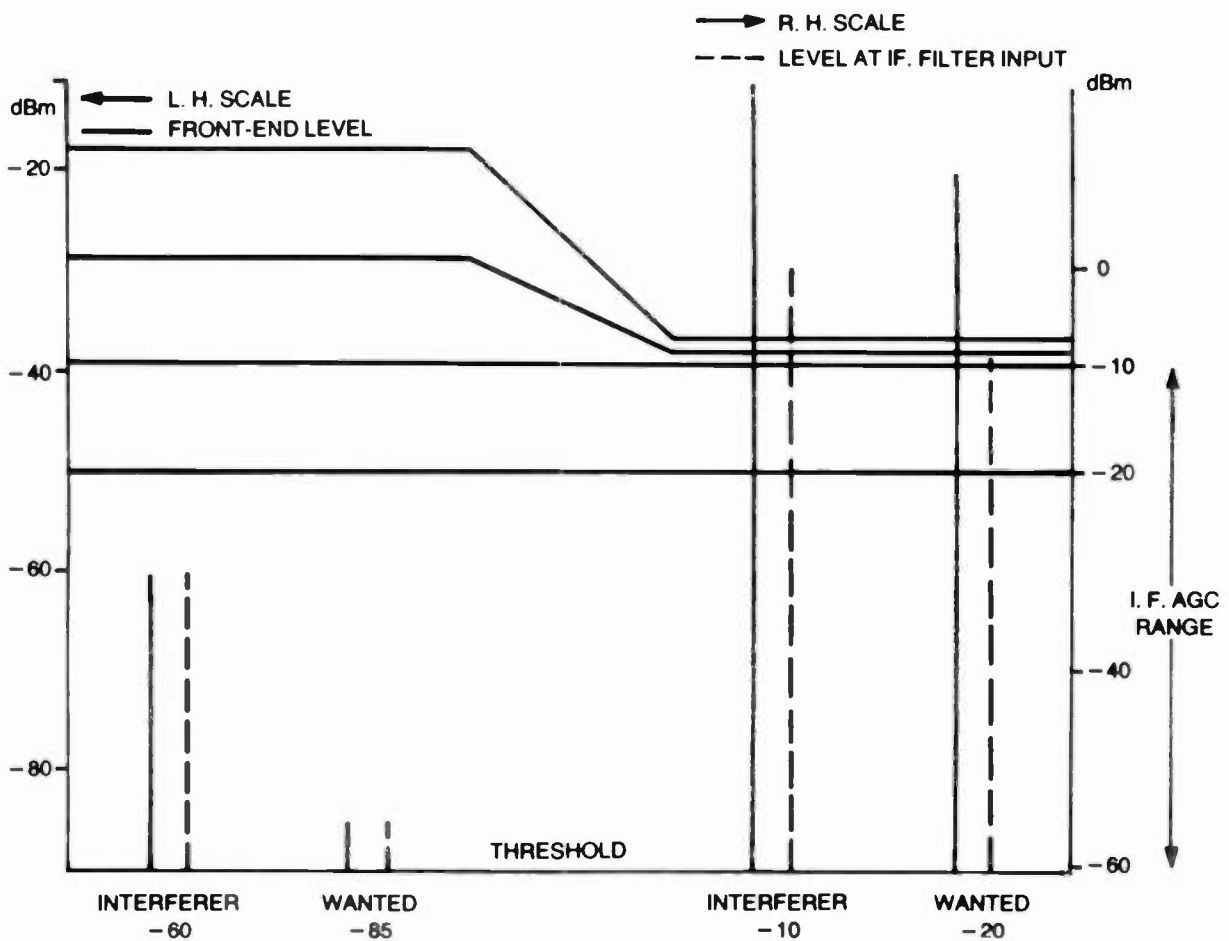


Figure 4. Illustrating the increase in dynamic range from the use of a voltage-controlled RF attenuator in the low-noise front end of the receiver which extends the a.g.c. range and prevents overloading of the wide-band circuits; wanted signals at -85 dBm (left) and -20 dBm (right).



Figure 5 (left)  
Super 2MR receiver

Figure 6 (below)  
Super 2MR receiver on  
tripod with Disc-rod  
antenna and Twist-loc  
connector





## OTHER FEATURES

In the portable receiver a choice of IF bandwidth is available at time of order (20, 15 or 10 MHz between 3 dB points). The twin audio sub-carriers can be set to a wide range of frequencies by controls within the weatherproof box. Front-panel switches enable channels 1-7 (2 GHz) and 8-10 (2.5 GHz), with + and - offsets, to be selected. For overseas markets any group of frequencies within the 1990-2700 MHz band can be set up on the EPROM memory.

The MRC is available in the same 2-2.7 GHz band, with the option of wide-band down converters for the 6.4 - 7.2 and 12.7 - 13.25 bands, making it a 3-band receiver. The EPROM is supplied pre-programmed for 14 channels with 3 offset positions in the 6 - 7 GHz band (channels 1 -10 at 6.9 GHz and 11 - 14 at 6.4 GHz) and for 10 channels each with 4 offset positions in the CARS band (12.7 - 12.95 GHz) and 12 channels each with 4 offset positions in the broadcast band (12.95 - 3.25 GHz).

The MRC is designed for local control, or for remote control over a microwave or telephone channel. All 160 channels mentioned above can be remotely selected (or any other combinations in steps 250 KHz can be customer programmed).

The remote control can also select the I.F. bandwidth (20, 15 or 10 MHz, all individually equalized). As an option the two audio sub-carriers can be remotely switched to any of 8 pre-determined frequencies covering the EIA and CCIR recommendations.

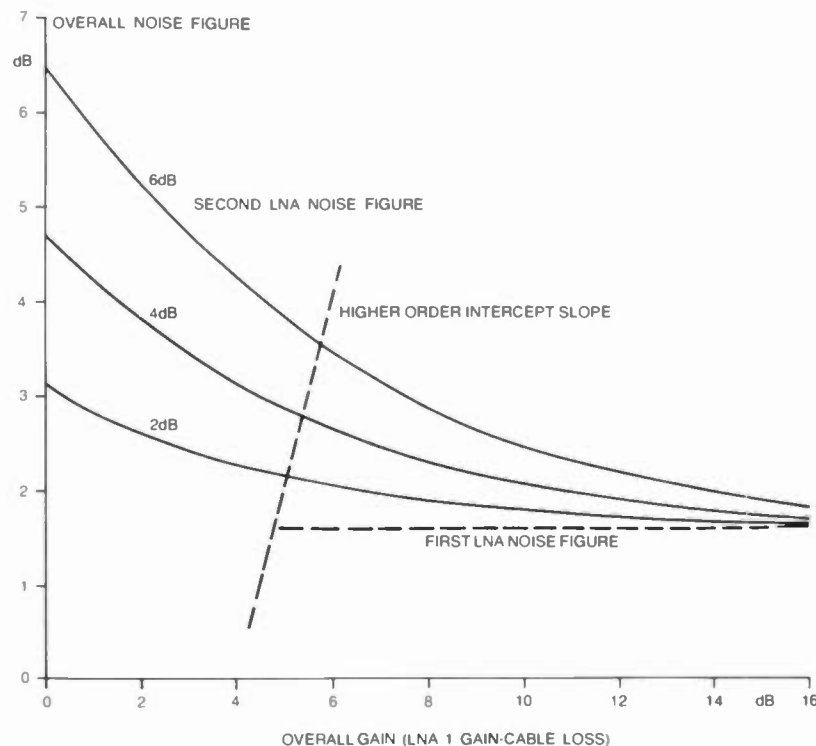


Figure 7. Illustrating the interaction of LNA<sub>2</sub> noise figure and overall gain on overall noise figure and dynamic range.

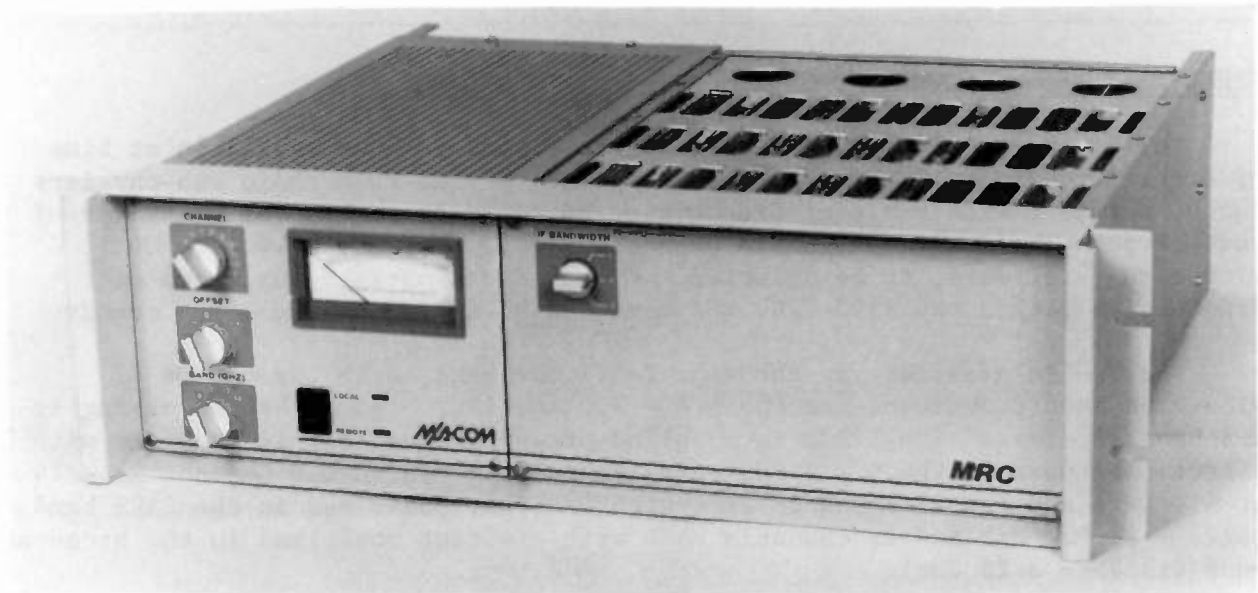


Figure 8, MRC receiver showing local controls for Channels (14), off-sets (4), RF Band (2,7,12,13 GHz) and IF Bandwidth (20,15,10 MHz).

Figure 8 shows the front panel with the channel selector, offset selector (-,0,+,++) and 2,7,12,13 GHz band switches on the left. The manual IF bandwidth selector is on the I.F. module and operated by a control through the detachable panel.

Figure 9 shows the panel detached to reveal the screening of the individual modules, necessary for a receiver which may be mounted close to high power TV or FM transmitters or antennas.

The author wishes to thank the design team members W. Collier and J. Carroll for their help in preparing this paper.

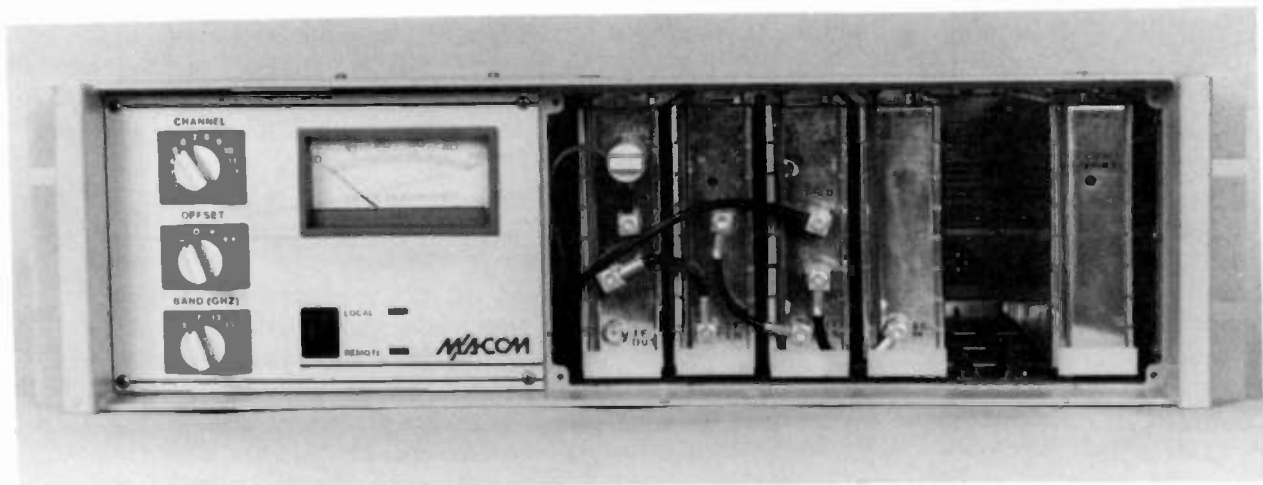


Figure 9. MRC receiver showing screened modules for IF Filter, IF Amplifier, Video Demodulator, Dual Audio Demodulator and Remote Interface.

---

## Using LORAN-C for Automatic ENG Antenna Pointing

Vincent E. Rocco

Nurad, Inc.

Baltimore, Maryland

### History

Before the development of today's sophisticated tracking antennas, a helicopter TV system consisted of a microwave transmitter connected to an omnidirectional linear antenna. On the ground, a receiver, in conjunction with a highly directional antenna was used to manually track the helicopter while a picture monitor was used to indicate video quality. A sketch illustrating such a system is shown in figure 1a. Since the effects of multipath and other propagation problems are contained for the most part in the high frequency region of the video baseband, the resulting subjective picture quality was deemed mostly acceptable for use with a monochrome TV system.

With the advent of NTSC color television, this was no longer true. It became necessary that the integrity of the transmitted signal be maintained within very narrow limits. Not only frequency amplitude response, but also phase characteristics of the video signal seriously affected color picture quality. It became apparent that considerable change in picture quality would result from improving the propagation characteristics of the TV transmission system. As a result, several forms of circularly polarized directional antenna systems were tried to reduce the serious signal impairments resulting from propagation errors. The first of these attempts is illustrated in figure 1b in which a hand-held directional antenna is oriented in the direction of the receiving station. While there appeared to be considerable improvement in picture quality using this system, it still met with limited acceptance due to its obvious operational limitations, e.g., additional manpower requirements, aircraft maneuverability and possible radiation hazards to personnel.

As a next step, an array of directional antennas were used in conjunction with an RF switch. These antennas were selected sequentially for connection to the transmitter. This allowed the system to be operated by remote control and external to the aircraft. As is seen in figure 1c, a control signal is linked

to the aircraft for purposes of commutating the antenna system from a ground control point. A local override feature is included in the airborne system so that the crew can take control of the antenna should the need arise. Automatic ground control was then tried as an attempt to minimize operational errors and manpower requirements. This met with limited success as it appeared that more problems arose than were solved by this method of controlling the airborne antenna system.

Throughout all this TV system development history, very little effort was devoted to developing an automatic tracking receive antenna system. When a tracking receive antenna was tried, it was done in conjunction with an omnidirectional transmitting antenna installed on the aircraft as shown in figure 1d. Although some improvement in signal quality resulted because of the elimination of ground operating errors, this effort did not lead to any significant improvement. What was required for this to occur was a tracking receive antenna operating in conjunction with an automatic directional transmit antenna. The system illustrated in figure 1e is an early attempt at attaining this goal. It should be noted that the automatic transmit antenna is of the commutating type; the switching being controlled by a gyroscopic compass. Except for interruptions due to switching transients and some multipath effects resulting from the use of widebeam (90 degrees) antenna elements, this system met with widespread acceptance. However, not until a system is developed that can eliminate the above transmission anomalies, while approaching a point-to-point system type of operation, will airborne TV transmission become practical.

Such a system is illustrated in figure 1f and will be described in detail. As can be seen, a highly directional antenna is used at each end of the microwave link. Thus, multipath is reduced to a very low level and has little discernible effect on subjective picture quality. There are no switching transients because both antennas are of the steerable type. Moreover, the automatic systems at both ends are capable of being over-ridden for manual control. The ground station, a Nurad SUPERTRACK TM, has been described in other publications so that this work will deal only with the airborne portion of the system. Suffice to say, that the ground station tracking can be automatically accomplished either through a standard monopulse or a sequential antenna lobing sensing system. The ground station used with the subject helicopter is of the latter type. The objective here is for the high gain, narrow beam, airborne antenna to maintain its original orientation toward the receiving station. This is accomplished using a Loran navigational receiver and computer.

#### Loran C System Description

Loran (LONG RANGE Navigation) is a pulsed, low-frequency, long range hyperbolic radio navigation system. Hyperbolic navigation systems operate on the principle that the difference in time of arrival of signals from two transmitters, observed at a point in the coverage area, is a measure of the difference in the distance from the point of observation to each of the stations.

Loran C stations are located on land and are grouped to form a "chain" of which one station is labeled the master (designated M) and the others are called secondary or slave stations (designated W, X, Y or Z). Signals transmitted from the secondaries are synchronized with the master signal.

As an example, in Figure 2 the master station (M) and the secondary station (X) transmit synchronized pulses at precise time intervals. The on-board Loran C receiver measures the slight difference in time that it takes for these pulsed signals to reach the aircraft from this pair of transmitters. The time difference (TD) is measured in microseconds (usec), and is displayed in one of the receivers readouts. When at position "A" the TD displayed is 13000.0 microseconds. This time difference can be plotted on a special Loran C latticed chart as a line-of-position (LOP). With just this one number, the aircraft could be located anywhere along the 13000 LOP.

Next a TD measurement is taken from the master station (M) and another secondary station (in this case Y). The Loran C receiver displays this TD between M and Y. Continuing with the same example, the TD displayed is 31000.0 usec. Again, this TD is plotted on a Loran C chart as a LOP, so that the aircraft's exact position is where they intersect or at position "A" in figure 2.

The transmitting stations of a Loran C chain transmit groups of pulses at a specified group repetition interval (GRI). Each pulse has a 100 KHz center frequency and requires a 20 KHz bandwidth. The stations transmit 8 pulses to a group. The Loran C rate structure is such that a GRI of between 40,000 and 99,990 microseconds is chosen for a chain, which makes a pulse transmission rate from 80 to 200 pulses per second. The designation of a Loran C chain is by the first four digits of the specific GRI. For example, the U.S. East Coast chain has a GRI of 99,600 usec. and is designated Rate 9960.

#### Range And Accuracy

a) Range — Each Loran C transmitter radiates a different pulse power, typically varying from 150 kilowatts to 2 megawatts. This gives ground wave (the signal which hugs the earth) coverage ranges on the order of 500 to 1000 nautical miles over various terrains. During periods of good propagation, this range may be greater; during periods of high noise and interference, it may be less. The signal range from a particular station is dependent upon the transmitter power, receiver sensitivity, noise or interference levels, and losses over the signal path.

Skywaves are the portion of the signal which reflects from the upper atmosphere, Skywaves travel longer and less predictable paths making them less accurate for navigation at ranges of 1200 to 2000 n. miles where the groundwave is marginally receivable.

b) Accuracy — The Loran C system has various factors that collectively determine the accuracy of a fix: location of transmitters, the medium over which the signals travel (land and water), receivers, charts, and the operator. Each component contributes a small error, that is, each component has its own individual accuracy limitation. Overall, system accuracy is the result of the combination of the individual accuracies of all these components.

#### Antenna Control System

The Loran system is functioning throughout most of the United States and a large part of the world as shown in figure 3. The Loran system enables an

aircraft or ship to quickly determine its exact position in geographical co-ordinates, or in terms of polar co-ordinates relative to a point chosen by a navigator. Most Loran receivers are also capable of storing other useful information, such as multiple waypoints relative to an arbitrary point chosen by the navigator. This information, whether in real time or stored in the system's memory, is presented in a digital format at the receiver output and also as an integrated display. This digital output data may be inserted into an external data processing system such as the control system being described. For this application, the Loran output data is used to continuously update an antenna control computer as to its exact position relative to a chosen point such as a microwave television receiver location.

In order to maintain proper control, the antenna orientation system must respond to three sources of information. They are as follows:

1. A Gyro-Magnetic Compass
2. An Antenna Position Sensor
3. The Loran Navigational Receiver

There are two modes of operation for this system. The first is the manual or semi-automatic mode, whereby the initial antenna orientation is implemented by manually adjusting the azimuth control for a desired heading. In this mode, antenna orientation remains constant while the helicopter maneuvers through changes in position and heading.

Proper antenna orientation is maintained by correctly combining information from the gyro-compass with that of the antenna position sensor. Both sources of information are derived from synchro-rotational machines and are presented in analog form. The resulting error signal (the antenna position sensor angle subtracted from the compass angle) is used to drive a servo-mechanism consisting of a DC motor, a servo power amplifier and a mechanical feedback loop.

The antenna rotor will turn until the error signal is zero. The desired antenna heading at which the error signal is zero is manually selected by the adjustment of the azimuth control, consisting of a differential synchro connected in series with the compass synchro transmitter. Each time the helicopter changes location sufficiently as to render the antenna heading inaccurate, an adjustment must be made to the azimuth control to maintain proper orientation.

In order to achieve the second mode, fully automatic operation of the antenna orientation system, the differential synchro or azimuth control is replaced by a Loran receiver. The Loran receiver then supplies the servo system with continuous heading-to-target information which is subtracted from the compass azimuth angle in accordance with the aircraft's change in location. The automatic control functions are carried out in the System Servo Logic Control Box.

The automatic system when used with Loran, operates as follows: referring to the block diagram of the control system figure 4, it can be seen how the information from the gyrocompass, the antenna position sensor, and the Loran receiver, are combined to derive a composite angle or error signal for the

antenna pedestal drive.

The information obtained from the gyro-compass is combined with that of the antenna position sensor, a differential transformer mechanically geared to the antenna rotational system. The resulting error signal is converted into digital information by an AD converter, U2. This signal is then combined with the digital data output of the Loran navigational computer.

Since the data output of Loran receiver is presented in a serial plus and minus format, it will be necessary to convert it to a form that can be used by the servomechanism. This is accomplished by the integrated circuit U9, a UART data link.

The resulting parallel 8 bit data is combined with the compass data or error signal into subtractors, U7 and U8. After subtraction, the resulting angular data is applied to the address lines of EPROM U12, where it selects direction and speed information. The output of U12 is then converted into analog form by the D/A converter U14.

This analog direction and speed signal is then fed into a differential servo power amplifier (U15-U17) for application to the DC servo motor and antenna rotator. The resulting antenna position will remain constant until an error signal is generated by a change in either the compass output or the Loran position data resulting from a moving aircraft or vehicle.

There are currently three such systems in operation. The first of these was made operational during October of 1984 in Kuwait. The second system went into operation in December of the same year at WCVB-TV, Boston. A third is installed at WBTW-TV, Charlotte, N.C. It is expected that a fourth system will be operational at WPLG-TV, Miami, by April of 1985. Performance specifications for these systems are as follows:

### Specifications

#### SUPER POD TM ANTENNA ASSEMBLY

DIMENSIONS	Flange diameter: 23.5 in (59.69 cm) Radome diameter (MAX) : 21.5 in (54.61 cm) Radome depth: 8.75 in (21.97 cm)
WEIGHT	25 lbs. (11.23 kg)
FREQUENCY	1990-2700 MHz
POLARIZATION	RHCP Standard (LHCP Optional)
TRANSMIT ANTENNA	Gain 16 dB* Azimuth HPBW 16 degrees Elevation HPBW 56 degrees

ANTENNA VSWR 1.5 to 1, maximum

ANTENNA AXIAL RATIO 1 dB, maximum

\*Gain referenced to a like polarized isotrope.

Figures 5 and 6 show the Murad SUPERPOD™, with its low profile, installed aboard a Bell Jet Ranger helicopter during flight testing. These flight tests have clearly demonstrated the viability of automating a microwave antenna orientation function regardless of whether the mobile application is airborne or otherwise, the only operational requirement being a condition for line-of-sight.





OMNI - DIRECTIONAL TRANSMIT ANTENNA  
WITH MANUAL GROUND TRACKING



FIGURE 1a



DIRECTIONAL HAND - HELD  
TRANSMIT ANTENNA WITH MANUAL  
GROUND TRACKING

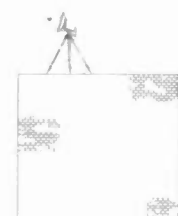


FIGURE 1b



SEMI - AUTOMATIC DIRECTIONAL  
COMMUTATING TRANSMIT ANTENNA  
WITH MANUAL TRACKING

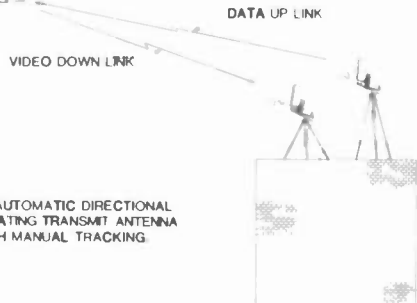
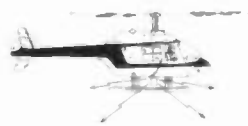


FIGURE 1c



OMNI - DIRECTIONAL TRANSMIT  
ANTENNA WITH AUTOMATIC  
GROUND TRACKING

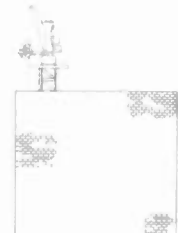


FIGURE 1d



GYRO - CONTROL

AUTO COMMUTATED DIRECTIONAL  
TRANSMIT ANTENNA WITH  
AUTO GROUND TRACKING

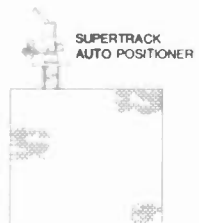


FIGURE 1e



GYRO - CONTROL  
WITH LORAN NAVIGATIONAL  
DATA

SUPER POO  
AUTO DIRECTIONAL HIGH GAIN  
TRANSMIT ANTENNA WITH  
AUTOMATIC GROUND TRACKING

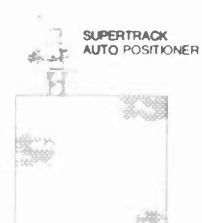


FIGURE 1f

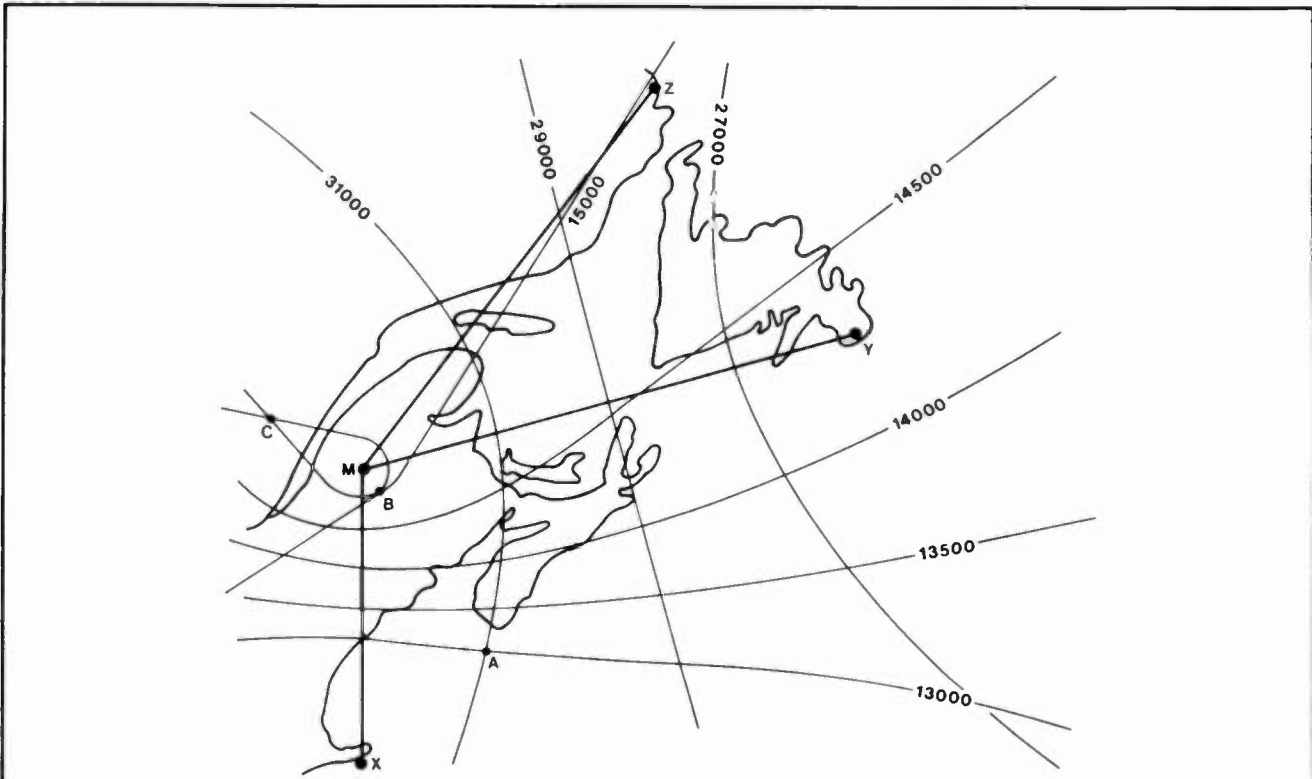


FIGURE 2

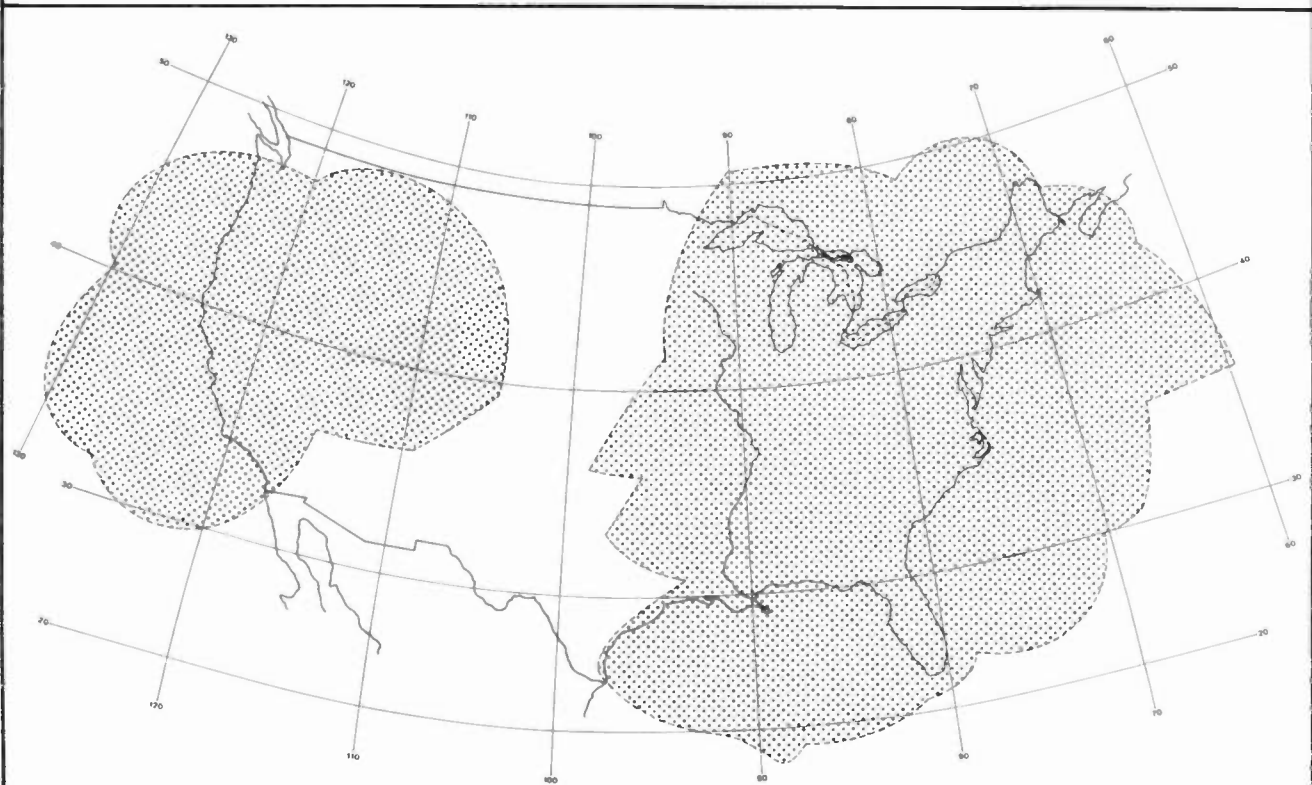
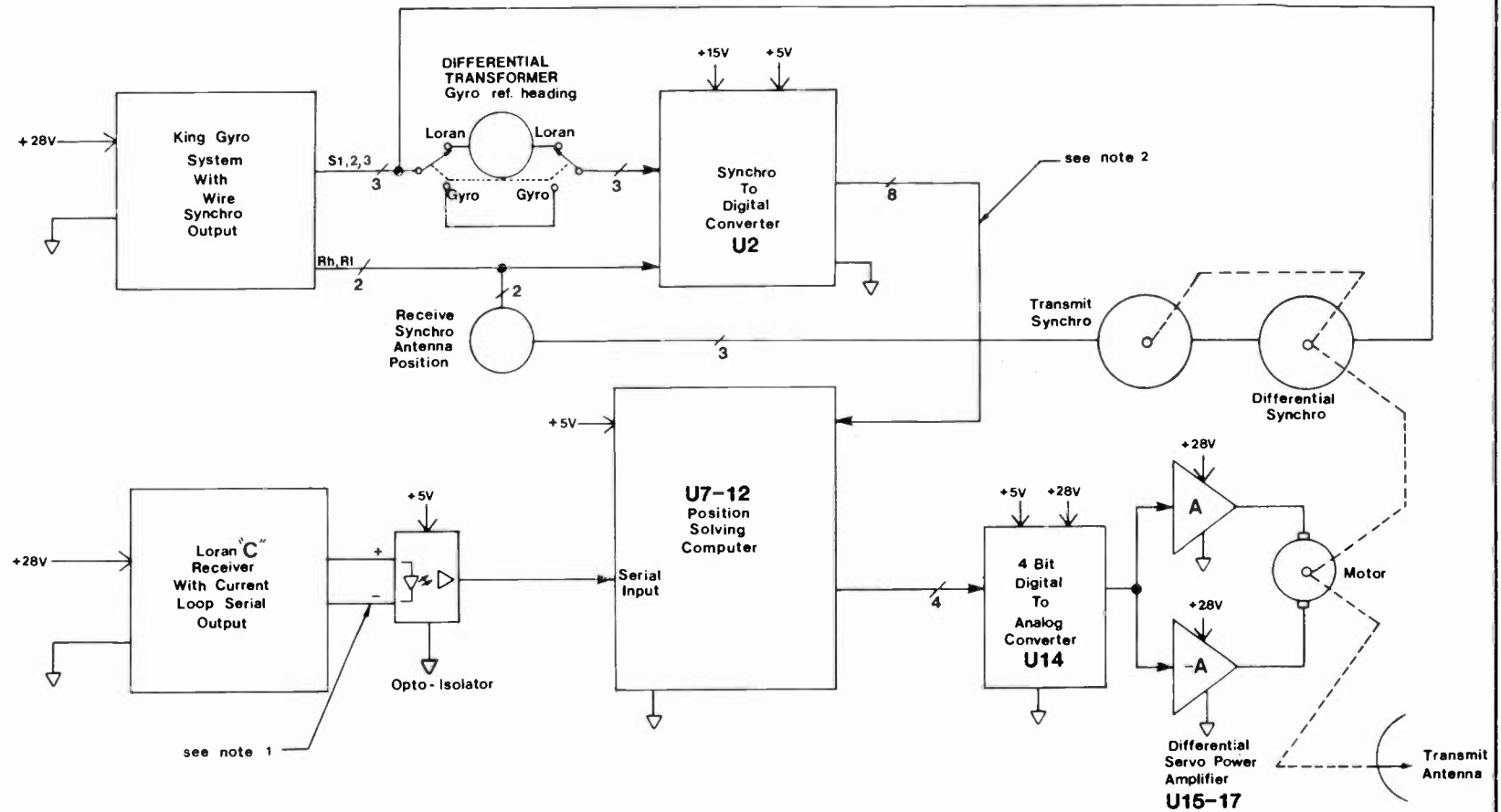


FIGURE 3



**Notes:**

1. Loran system has modified software to provide "bearing to waypoint" output in degrees. Format is NRZ serial, 1200 baud 8 bits + parity - stop bit parity is odd
2. Present ant. position plus bearing W.R.T. magnetic north.  
Total resolution =  $360^\circ / 256$  or  $\pm 1.4^\circ$

**FIGURE 4**



**AIRBORNE VIEW OF  
SUPER POD INSTALLATION  
FIGURE 5**



**SUPER POD INSTALLATION  
SHOWING GROUND CLEARANCE  
FIGURE 6**

---

Using a Small Computer to Evaluate R.F. Coverage of Co-located F.M. Stations

Michael D. Callaghan

Radio Stations KIIS AM/FM

Los Angeles, California

A number of different factors may be involved in assessing the performance of the F.M. facilities in a market. The actual evaluation process will vary in difficulty depending on which element is being appraised.

A station's ratings are easily compared by looking in a book, and its different loudness and processing characteristics can be surveyed by using a pushbutton car radio and simply listening to a few records as you switch between the stations.

However, when the program director asks why the competition seems to come in better than your station in certain areas, the time has come to scrutinize your R.F. signal penetration -- and that requires much more effort.

A series of field strength measurements must be made, and the resulting data must then be analyzed.

Historically, these signal comparisons are difficult to make and interpret, especially for non-technical programmers and managers.

Also, if the stations being compared are using radically different power levels, drawing meaningful conclusions will be that much more difficult.

Most markets have just a few good F.M. transmitter locations. Many F.M. stations may be co-located at these few sites. This sharing of a site can be used to advantage in comparing the performance and efficiency of the F.M. transmitter systems located there.

The following describes a method whereby one can generate meaningful, easily interpreted data that will indicate just how effectively (or ineffectively) a particular transmitter plant is operating, in comparison with other stations at the same location.

Comparisons may also be made between the different horizontal and vertical components of the stations involved, (the vertical component is proving extremely important in markets with highly mobile audiences, such as Los Angeles), and the results may be used to evaluate the pattern of a directional antenna system.

Most F.M. stations are supposed to be non-directional, so different stations at the same site should have similar radiation patterns. By comparing these patterns and the different field strength readings, we can get a very accurate idea of how well different stations are operating.

You will notice I said 'supposed to be non-directional'. In reality tower faces, buildings, and other structural considerations at the transmitter site all tend to distort the theoretical circular pattern.

A particular station may be weak in one direction and make up for it in another. Learning about this can be an enlightening experience for both your engineering and programming people, particularly if it's your station!

This possibility makes it important that a series of measurements are made using points at a number of different azimuths and a number of different distances from the antenna.

If you find there are locations or points of special interest (i.e., places where you seem especially weak or that make up especially desirable demographics), be sure to include these locations in the measurements.

### Basic Concept

---

Visualize three different F.M. stations on the same mountaintop. If all three use the same Effective Radiated Power (ERP.) then it is logical that their field strength readings and radiation patterns should be similar.

In this first case, with all three stations using the same power, comparing coverages should be easy. If your signal were the weakest of the three at most of the test locations, you would obviously want to investigate to see why. By comparing the readings from your station with those of the others, you could derive a percentage difference in the coverages. This would specify more accurately the actual difference in the signals than just accepting the fact that yours was "lower".

As a second case, if these three stations have powers that are multiples of each other, the comparison becomes more complicated. Assume station A has four times the power of station B. This corresponds to twice the

voltage, so we would expect that at a given location A would have twice the field strength of B. But if it happened that A measured dramatically less than twice that of B, it would seem to indicate that either B was working better than we should expect, or that perhaps something was not right with A's transmission system.

Now let us further suppose station C is licensed for the same power as station B. If we find that B and C both produce the same readings, and yet A is still less than about twice that of either of them, we can probably conclude that B and C are operating properly, and that A is not working right. So in this second case the comparison is still plausible without getting into complex mathematics.

In practice, however, it is much more likely the three stations have unrelated powers. When this happens our comparison becomes more difficult.

As an example, Figure 1 shows the power levels of some of the Los Angeles F.M. stations that broadcast from Mt. Wilson. Trying to sort this variety of powers out and to compare their field strength readings becomes rather involved.

Mt. Wilson F.M. Stations

KBIG . . . . .	104.00 KW.
KLOS . . . . .	72.00 KW.
KMET . . . . .	58.00 KW.
KRTH . . . . .	58.00 KW.
KKHR . . . . .	54.00 KW.
KLVE . . . . .	34.00 KW.
KKGO . . . . .	18.00 KW.
KOST . . . . .	12.50 KW.
KIIS . . . . .	8.00 KW.
KIQQ . . . . .	5.00 KW.
KUTE . . . . .	0.64 KW.

- Figure 1 -

At this point a computer becomes truly helpful. A program has been developed which can provide the comparisons we seek, starting with some basic assumptions:

- 1) Most stations at a given site operate properly and are more or less equally efficient.
- 2) By knowing the measured field strength voltages of the F.M. stations at a given location as well as their licensed ERP.'s, it is possible to manipulate these values and derive an average value

of voltage for each Kilowatt of ERP. (Because power is a function of the square of voltage, this 'average voltage' is expressed as  $mv^2/KW$ . of ERP.)

$$mv^2/KW = \frac{(mv(1))^2}{ERP(1)} + \frac{(mv(2))^2}{ERP(2)} + \frac{(mv(n))^2}{ERP(n)} + \dots$$


---

N

Where:

- $mv^2/KW$  = average  $mv^2/KW$ . of ERP.
- $mv(n)$  = Measured Field Voltage for each station (mv/meter)
- $ERP(n)$  = Licensed ERP. for each station
- N = Number of stations

The more stations at one site that are included in the survey, the smaller the chance that an isolated aberration in one of them will slew the computation.

This derived voltage will be an average value based on all the measured transmitters included in the survey. Again, the integrity of this averaging increases as more stations are included, so as many stations as possible should be tabulated, even those that represent no competition and have nothing to do with your format.

3) Once this value of voltage<sup>2</sup>/KW. is obtained, it may be used to derive the voltage we would expect to measure based on the ERP. for any given station.

Then a comparison can be made between this 'hypothetical' voltage and the actual measured voltage of each station. This in turn can be used to calculate an "Observed ERP." which will be higher or lower than the licensed ERP.

$$CP = (mv(x))^2 / (mv^2/KW)$$



Where:

CP = Computed Power (Observed ERP.)  
mv(x) = Measured Field Strength of station  
mv<sup>2</sup>/KW = average mv<sup>2</sup>/KW. of ERP.

This "Observed ERP." may then be expressed as a percentage above or below the licensed power.

The computer program uses these assumptions to develop the following data:

For each test location:

The average value of mv<sup>2</sup>/KW.

For each station measured at the location:

- 1) The field strength voltage that should be expected based on licensed ERP., and the average value of mv<sup>2</sup>/KW.
- 2) Observed ERP., based on measured field strength and average mv<sup>2</sup>/KW.
- 3) Percentage deviation between licensed and observed ERP.

These figures, along with call letters, measured field voltage and licensed ERP. figures, are all printed out in tabular form to make comparison easy. An explanation of each column is included in the printout to further clarify the results.

The program is written in Microsoft Basic, and is easily convertible to most other Basic interpreters.

Some special printer codes are included -- these may be modified in any way necessary to drive your particular printer.

### F.M. Field Strength Measurements

---

As the recipe for old-fashioned rabbit stew starts out: First - catch a rabbit! So we should start our efforts to use F.M. field strength readings by reviewing the steps involved in taking accurate F.M. field strength measurements.

Choosing the right field strength meter is important for the best results. It must have a flat response across the band, and should be as easy as possible to use. Personally, I greatly prefer the Potomac Instruments FIM-71. It's light, very rugged, and is extremely easy to use.

Typically, when measuring different stations it is necessary to readjust the element lengths of the meter for each frequency. A nice feature of this program is that you may, at your option, include a routine that will eliminate this necessity.

This utility is accomplished by deriving a correction factor for each station which is entered into the program as you type it into the computer. This factor is then used to correct the voltage values you enter to allow using one standard element length for all the measurements.

To make use of this feature, you need to initially find a good location as free of multipath as possible and, using the instruction manual for the meter, set the dipole arms to the correct length for each station.

Write down the value of the measured voltage and then immediately slide the elements to a standard length selected to match a frequency near the center of the band.

I chose 70 cm. as a good compromise. It corresponds to about 99 MHz. Note the voltage for this length, and then divide the standard length voltage into the individual length voltage. Because of the critical nature of this measurement, you should make a series of five tests in the same immediate area and average the results before deciding on a final value. Do this for each station you include in your survey. This will give you the correction factor, which can then be entered into the data lines as you enter the program.

Having done this, you need only set the dipole arms to the standard length, 70 cm. each, to make measurements at each new location.

The choice of locations is simple to determine. Use a road map of the area, and draw a series of concentric circles about your transmitter point. Your choice of spacing will depend on how densely you want the measurements and the number of special locations you want to include.

Then draw out the radial lines, and use the intersections of the radials and the concentric circles as starting points for the tests. Remember to include the points of special interest. Try to find locations close to these points that are easily accessible.

As you arrive at each test location, look around to see how it might be adversely affected by multipath. Things to avoid are large metal surfaces and other objects that may cause signal bounce into the meter.

Extend the dipole arms, raise the antenna, tune in a station, and start walking in a straight line. You should see little deflection in the meter.

If you see dips of 10-20 db, then you've found an unusable location and will have to try again somewhere else.

If you are fairly certain the site will work, put the meter up on a tripod, with the antenna still extended. Tune the meter to your station, and watch the reading as you rotate the meter. You should see a fairly sharp peak and a dip another 90 degrees around as the meter is swivelled. If the dip is not there, or if there are two or more dips, you should move to a different location in the same area, and try again.

Once you are confident the location is acceptable, then you can start the tests.

Make sure the dipole arms are at the standard length you have selected, and the antenna is raised. Write down the results as you measure each station in turn.

Take five sets of readings in the same general area of each location. Walk a distance of 100 feet in a straight line and take the five readings at random distances along the way. Then discard the two lowest and the two highest readings and use the median value that remains. This extra step should preclude an aberration from unduly affecting the integrity of a location.

If you are also gathering information about the vertical components, this is the time to make those measurements. It is difficult to obtain precise vertical readings without a complex antenna structure, so these will have to be relative. Potomac Instruments suggests using the dipole to approximate a quarter-wave vertical whip. Their manual gives detailed instructions on this technique. Using this method, walk the 100 feet again. Take another five readings, and write them down.

Carefully note the precise place each measurement was made so you may return later. This will be a help in evaluating future antenna work, transmitter changes, etc.

Finally, once you have finished the footwork and have the data you need, you may enter the values into the program and let it analyze the information you have gathered.

As you enter the results of each locale into the program, the computer will ask for a Test Date, and a Location Number and Description. Use the description to note if you are comparing vertical readings. This information is included in the printout to aid in evaluating the results.

Once the data for a given location has been entered, the program asks for a printer prompt. It then tabulates the derived data and produces the comparisons.

Interpreting the printout is gratifyingly simple. By looking at the values of ERP. you are producing at the different locations and azimuths,

you will be able to quickly tell where your transmitter is and is not doing an effective job, as well as how it performs against the competition.

In using the program it is not uncommon to find places where only a small portion of the expected ERP. seems present. It is important to note that an occasional drop or low reading shouldn't be cause for concern - many F.M. stations have a number of locations where penetration seems deficient.

Only if the results show glaring deficiencies in a large number of places should concern be appropriate. There is a reason the numbers are low, and it simply becomes a diagnostic exercise to discover why. A comparison of your facility with others at the same site is a good place to start looking. Evaluate antenna height above the ground, type, mounting technique and location. A vertical component deficiency may often be traced to the way the antenna is mounted on the tower. A broad faced tower has been shown to cause vertical nulls in areas that should seemingly be enhanced by the tower face.

Your specific placement on the hilltop may also be significant. If your antenna is shielded by other towers, it will affect the radiation pattern. Stations at the same site may have very different operating heights. Also, any topographic feature or obstruction that affects all the stations on your mountaintop will not be evident in the printout. The program simply compares the stations with each other, not with any theoretical intangible result. As you take steps to improve your coverage, the new results may be compared with the old to gauge your progress.

### Conclusion

---

In summary, this concept and program greatly simplify the assessment of your signal coverage in relation to other stations at the same transmitter site. They provide an easily used yardstick for present and future comparisons not only with other stations but also with yourself.

An easily interpreted readout is developed to provide non-technical staff members with information they may use to sell your station and to compare your coverage with that of some of the other stations in the same market.

Special Thanks to Roy Stype of Warmus and Associates and Bob Gonsett of Communications General for review of the manuscript.

## Mt. Wilson FM Transmitter Performance Data

Location Number : 3

Test Date : July 6, 1983

Location : Interstate 5 & Hollywood Way

Avg.  $\text{mv}^2/\text{KW}$  = .708135

Station	Expected Voltage	Measured Voltage	Licensed E.R.P.	Observed E.R.P.	Deviation (Percent)
KAAA	5.71	7.69	65.00	117.81	+81.24 %
KBBB	5.11	4.38	52.00	38.26	-26.43 %
KCCC	5.11	4.64	52.00	42.84	-17.61 %
KDDD	6.01	5.50	72.00	60.32	-16.22 %
KEEE	1.23	1.15	3.00	2.64	-12.09 %
KFFF	5.01	4.60	50.00	42.20	-15.61 %
KGGG	1.50	1.66	4.50	5.49	+22.00 %
KHHH	2.00	1.30	8.00	3.35	-58.18 %
KJJJ	2.79	2.28	15.50	10.40	-32.91 %
KKKK	2.65	2.70	14.00	14.54	+3.84 %
KLLL	2.74	2.20	15.00	9.65	-35.65 %
KMMM	3.47	5.99	24.00	71.43	+197.64 %

Using values averaged from the above Mt. Wilson FM stations, this program indicates the expected signal strength from each one of them, based on their amount of licensed power in Kilowatts (E.R.P.).

The second column shows the amount of signal voltage we would expect to measure.

The third column shows the actual amount of signal measured at this location.

The fourth column is the licensed power (E.R.P.) for the station.

The fifth column shows the observed E.R.P., based on the measured voltage in comparison with the average signal from all the stations.

The last column shows the deviation between the Licensed and the Observed amount of power for each station.

```

0   REM: Coverage Evaluation Program
1   CLEAR500:REM: M. Callaghan 11/83 for KIIS FM
2   N=12:DIM F(N):X(N):REM Set Arrays : N=# of Stations
3   P$="###.##":E$="##.##":PC$="+###.##":PR$="###.##"
4   INPUT"Do You Want To Use Dipole Corrected Values
    (Y/N) ";RP$
5   IF RP$="Y" OR RP$="y" THEN RP=1 ELSE RP=0
10  CLS:INPUT "Enter Location Number ";N
20  PRINT:LINEINPUT "Enter Date of Measurement > ";D$
30  PRINT:LINEINPUT "Enter Location > ";L$
40  PRINT:PRINT
50  X(0)=0 : REM : Clear Accumulator

100 FOR C=1 TO N
105   READ CL$,ERP,FF
110   PRINT"Enter Field Strength for ";CL$;" ";
115   INPUT F(C):IF RP=1 THEN F(C)=F(C)*FF
120   IF F(C)<0 THEN GOTO110
125   X(C)=(F(C)*F(C)/ERP)
150   X(0)=X(0)+X(C)
155 NEXT C

200 AX=X(0)/N :REM: Divide by # of stations
205 PRINT : INPUT "Press <ENTER> to start printer";RP$
210 LPRINT CHR$(20) :REM: Output Form Feed Command
215 GOSUB500
220 RESTORE

300 FOR C=1 TO N
305   READ CL$,ERP,FF
310   CP=(F(C)*F(C)/AX)
315   MV=SQR(AX*ERP)
320   DP=-100+((CP/ERP)*100)
325   REM: Tab Values:5=CL$;20=ERP;30=Expected;
        40=Measured;50=Difference

330   LPRINTTAB(5)CL$;TAB(20);:LPRINTUSING
        E$;MV;:LPRINTTAB(32);:LPRINTUSING
        E$;F(C);:LPRINTTAB(45);:LPRINTUSING
        PR$;ERP;:LPRINTTAB(60);:LPRINTUSING
        PR$;CP;LPRINTTAB(75);:LPRINTUSING
        PC$;DP;:LPRINT"  %"

```

```

335     LPRINT
340 NEXT C

400 GOSUB2000
405 RESTORE : GOTO 10
410 END

500 REM: PRINT HEADING : Change Line 510 to show
      Transmitter Location.

505 LPRINTCHR$(27);CHR$(20);CHR$(27);CHR$(14);:LPRINT:
      LPRINT:LPRINT: REM Printer Wideprint Format

510 LP$="Mt. Wilson FM Transmitter Performance Data":
      GOSUB3000
515 LPRINT:LPRINT:LPRINTCHR$(27);CHR$(19);CHR$(27);
      CHR$(15);:REM: Format Printer (Normal Print)

525 LPRINT"Location Number : ";N;TAB(57)"Test Date : ";D$
530 LPRINT:LPRINT" Location : ";L$;TAB(55)"Avg. MV2/KW =
      ";AX
535 LPRINT:IF RP=0 THEN LPRINTTAB(30)"*** Uncorrected
      Dipole Values ***"

540 LPRINT:LPRINTTAB(5)"Station";TAB(20)"Expected";TAB(32)
      "Measured";TAB(45)"Licensed";TAB(60)"Observed";
      TAB(75)"Deviation"

545 LPRINTTAB(20)"Voltage";TAB(32)"Voltage";;TAB(45) "
      E.R.P. ";TAB(60)" E.R.P. ";TAB(75)"(Percent)"

550 LPRINT:RETURN

1000 REM:DATA "Call Letters",E.R.P.,Dipole Correction
      Factor

1002 DATA "KAAA",65,1.098
1004 DATA "KBBB",52,1.095
1006 DATA "KCCC",52,1.03
1008 DATA "KDDD",72,1.0
1010 DATA "KEEE",3,1.0
1012 DATA "KFFF",50,1.0
1014 DATA "KGGG",4.5,1,1.037

```

```

1016 DATA "KHHH",8,1.0362
1018 DATA "KJJJ",15.5,1.038
1020 DATA "KKKK",14,1.08
1022 DATA "KLLL",15,1.1
1024 DATA "KMMM",24,1.33

2000 LPRINTCHR$(27);CHR$(23);: Rem Printer Format
2005 LPRINT:LPRINT:Z=5: REM: Set Tab
2010 LPRINTTAB(Z)"      Using Values averaged from the above
      Mt. Wilson F.M. Stations, this program"
2015 LPRINTTAB(Z)"indicates the expected signal strength
      from each one of them, based on their"
2020 LPRINTTAB(Z)"amount of licensed power in Kilowatts
      (E.R.P.)."
2025 LPRINT
2030 LPRINTTAB(Z)"The second column shows the amount of
      signal voltage we would expect to measure."
2045 LPRINT
2050 LPRINTTAB(Z)"The third column shows the actual amount
      of signal measured at this location."
2055 LPRINT
2060 LPRINTTAB(Z)"The fourth column is the licensed power
      (E.R.P.) for the station.""
2065 LPRINT
2070 LPRINTTAB(Z)"The fifth column shows the observed
      E.R.P., based on the measured voltage in"
2075 LPRINTTAB(Z)"comparison with the average signal from
      all the stations."
2080 LPRINT
2085 LPRINTTAB(Z)"The last column shows the deviation
      between the Licensed and the Observed"
2090 LPRINTTAB(Z)"amount of power for each station."
2095 LPRINTCHR$(12):REM: Form Feed
2100 RETURN

3000 REM: Center Print
3005 S=66:REM: Set Line Length for Expanded Printer Mode
3010 LPRINTTAB((S-LEN(LP$))/2);LP$;
3015 RETURN

```

```

5000 END

```



---

## NEWSROOM COMPUTERS FOR RADIO BROADCASTING

Kenneth R. MacBride  
National Broadcasting Company  
New York City, New York

### INTRODUCTION

Radio newsrooms are moving into the "Computer Age". In this paper, I will describe what a newsroom computer system can do for a radio station, why a station might want one, and how to go about getting one.

### FUNCTIONS OF A NEWSROOM COMPUTER SYSTEM

Computers can help a radio news operation. They can sort, distribute, and file newswire stories. They can streamline script preparation both within the newsroom and (by telephone) direct from a reporter's portable terminal in the field. They can help you control your inventory of audio actualities. They can keep an up-to-the-minute record of personnel assignments: "who's where", "how can they be reached", and "what are they doing"? Newsroom computers also excel as a repository for "tickler files", "contact books", and "logs".

### Newsires

Connect one or more newsires to a newsroom computer system and you have given each user access to stories of interest at the push of a button or two on the terminal keyboard.

Fig. 1 shows a typical newswire menu display. The menu shows one line of information for each story which has "moved" on a newswire connected to the computer. To see the full text of a story, the user "selects" the desired story by positioning the "cursor" on the appropriate menu line and striking a function key. In Fig. 1, the cursor is positioned on the story slugged "bc-amtrend 12-26".

## Scripts

Preparation of news scripts is easy with the "word-processing" capabilities of most newsroom computer systems. Newswriters are no longer limited by the inflexibilities inherent in typewriter and paper methods. Rewrites, additions, and corrections can be done up to moments before air-time; the computer can then print out a "clean copy" of the newscaster's script. Fig. 2 shows a typical page of a newscast script. The two lines at the top give information about the story. The paragraph beginning "WITHIN" is the intro to a tape cut (title: WEBER, cart #: B-86, outcue "...VIRUS", running time: 14 seconds). The final paragraph, voiced by the newscaster completes the story.

## Cart Inventory

News actualities, on carts or reel-to-reel tape, can be inventoried in a radio news computer system. This will enable a writer or producer to locate a recording of "the mayor's speech of September twenty-second" or to get the in- and out-cues of the third cut of this morning's UPI Audio feed. Fig. 3 shows a computer printout of the details of one 10 second cart. In this case, the editor chose to include associated background information from the UPI newswire to give potential users a perspective on the actuality.

## Assignments

Assignment information: "who's covering what" today, tomorrow, and next Thursday can be kept in the computer. If reporters carry briefcase-size terminals, they can check the latest information about their next assignment when they call in to feed their script into the computer. Fig. 4 shows a typical bureau assignment page.

## Tickler File

A newsroom computer system can be used to maintain a list of future story and coverage possibilities. Fig. 5 shows a portion of a national/international tickler file.

## Contact Book

The dog-eared contact books and rolodex cards found in most radio newsrooms can be replaced by the newsroom computer system. Any terminal user, including people in the field, can have relatively instant access to general contact information. Sensitive or private contact lists can be stored under special passwords which limit access to only one user or a specified group of users. Most newsroom computer systems can display contact information by category (such as CAR SERVICE, see Fig. 6) or by personal or institutional name.

## Logs

Many medium to large radio newsrooms use logs to keep a record of operations, to permit smooth shift turnover, and to inform management of items requiring attention. A newsroom computer

system can provide the latest log information to any terminal user, without the delays associated with duplicating and distributing paper logs. Fig. 7a is a typical Producer/Assignment Editor Log. Fig 7b is a tape editor's log.

### WHY COMPUTERIZE RADIO NEWS?

The decision to computerize a radio news operation usually is driven by one or more of the following factors.

#### Productivity

A computerized radio newsroom is typically more productive than a typewriter-and-paper newsroom. The computer system makes it easier for news people to do their jobs. This can result in higher story-counts, more thorough coverage, and better journalistic content in a station's newscasts.

#### Speed

A radio newsroom computer system is fast. Newswire stories are available to all terminal users the moment they move on the wire (no waiting for a copy clerk to strip and distribute the paper copies). Most systems give users an alert on the terminal screen and a "beep" whenever an urgent or bulletin moves on one of the newswires. Rewrites, looking up a contact, finding a key Presidential statement on cart, adjusting the running order of the 2 PM newscast, and changing a reporter's assignment are all faster with the computer.

#### Competitive Advantage

Depending on a station's format, market, commitment to news, sales plan, network affiliation(s), competition, and size, newsroom computerization may or may not provide a competitive advantage. Small stations which offer "rip-and-read" newscasts and little or no local coverage are probably better off without newsroom computerization. Stations, whether small or large, which do make an attempt at coverage, will frequently find that a computerized news operation helps to improve profits.

#### Reduced Costs

Replacing a manual radio newsroom with a computerized news operation can reduce costs. In theory, a newsroom computer system can all but eliminate the need for paper. Scripts, notes, logs, wire stories, etc. can be entered, read, filed, manipulated, and discarded without ever being put onto paper. This saves paper costs. Most newsroom computer system configurations include printers which can double as newswire printers in case the computer is broken. This saves the cost of wire service printers. If a station has a bureau at the state capitol or elsewhere and uses facsimile, TWX, or Telex to transmit scripts, assignments, newswire stories, etc., the newsroom computer system can process these communications more effectively and at lower cost.

## TYPICAL CONFIGURATIONS

The size of a news operation frequently determines the size of the newsroom computer system which supports it. Arbitrarily, I have categorized newsroom systems as small (up to 6 terminals and/or printers), intermediate (7 to 30 devices), and large (over 30 devices).

### Small News Operation

Fig. 8 shows a small configuration in which a personal computer (PC) services two video display terminals, a printer, one newswire, and a modem for incoming calls from field personnel. The PC, the printer, the newswire, and the modem typically would be located at a small station's newsdesk. One VDT might be placed at the "combo" talent position; the other in the newscaster's booth.

### Intermediate News Operation

News operations which require more than a handful of devices will need a more powerful computer system. See Fig. 9, a configuration with multiple VDTs, printers, newswires, and dial-in modems. One VDT is shown connected through a data private line (a leased telephone circuit which connects a distant terminal to the computer system). The distant terminal might be in the station's bureau at the state capitol. Also, this drawing shows a "console". The console is used to control the computer system, correct problems, and make backup copies of the information stored in the system.

### Large News Operation

Fig. 10 shows a large news operation with computers at several locations linked through data private lines. This configuration might serve an all-news station with multiple bureaus or a group of stations. Depending on requirements, a location might need either a personal computer system or something with more power.

## PLANNING A RADIO NEWS COMPUTER SYSTEM

Like other technical projects, the installation of a newsroom computer system requires planning. The better the plan, the better are chances for successful project completion. This section addresses planning issues associated with the installation of a broadcast newsroom computer system.

### Define Objectives

The first step in planning a newsroom computer system is to define the objectives of the change to a computerized news operation. This includes descriptions of current (probably manual) means of handling news information, of the proposed computerized means (possibly in several stages over time), of the anticipated benefits through computerization, and of the estimated effect on the station's business.

The definition of objectives should include both quantitative and qualitative factors. A quantitative example would be a station which currently processes fifty news stories a day through manual means and needs to process eighty stories per day to compete effectively in its market. Qualitative factors which tend to improve the newscast product include more rapid distribution of story and news program development information throughout the news operation, greater efficiency for writers and editors through automated "word-processing" features, and with these a productivity increase which can provide the newsroom staff more time to concentrate on broadcast journalism rather than the "mechanics" of getting a story on the air.

A useful tool in this stage of planning is the "work-flow diagram". One should be done to show how information flows through the current newsroom; another should depict the flow after computerization.

Fig. 11 presents a simple work-flow diagram. The sources and destinations of news information, the means by which the information is transmitted (in this case "delivery"), and the volume of information are each depicted in the diagram.

These diagrams should include items such as how the newswire stories are sorted and distributed, how crews and correspondents get their assignments, how the content and running order of news programs are created, how contact information is maintained, etc. The resulting drawings may be as simple or complex as the scope of a news operation warrants. They are useful in discussions with computer system vendors, station management, and the news operation staff.

#### Determine Workstation Requirements

The number of workstations, printers, and other devices to be connected to the newsroom computer system should be determined through careful analysis of the work-flow diagrams. Generate a list of functions and allocate the appropriate equipment to each function, see Fig. 12.

Make a drawing or list of relationships between the terminals and the peripheral equipment. For example, Fig. 12 shows only one printer for two Assignment Desk VDTs and no printer for the Editor's Desk VDT. Most systems will permit a single printer to make printouts for several VDTs. In this case, it might be logical to have the Assignment Desk printer serve both the Assignment Desk's and the Editor Desk's printing needs. Definition of such relationships is part of determining workstation requirements.

#### Determine Newswire Requirements

Most newsroom computer systems excel at sorting and distributing incoming newswire stories. The computerized newsroom needs fewer newswire printers, uses less wire printer paper, and provides faster access to stories which "move" on the wire. Planning should answer three questions: "Which wire services are required?"; "How

will they be distributed?"; and "How will newswires be processed in the event of a computer failure?".

Which newswire services to buy is normally determined by past practice at a station. However, computerization of a news operation frequently offers cost reduction through elimination of newswire printers and paper supplies. The savings might be used to offset the cost of computerization, or to add additional newswire services which could not be cost-justified previously.

Distribution requirements should be determined from the work-flow diagrams. Newswire stories on most wire services contain "header" information which specifies the story's classification: state, regional, national, business, sports, weather, etc. The computer "reads" each story header and can be instructed to route the story to one or more newsroom users. This can replace the "wireroom clerk" who used to tear, sort, and deliver printed newswire stories to specified newsroom desks. In a computerized newsroom, the users are alerted to an incoming story which relates to their function. The local editor is advised of local stories, the weatherman gets weather stories, sports gets sports, etc. Flashes, bulletins, urgents, and other advisories are frequently distributed to all terminals in a newsroom computer system. A distribution plan should be developed for each terminal in the system.

If the newsroom computer fails, some backup means of processing newswire stories should be available. One approach is to retain at least one newswire printer for each wire in the newsroom.

Another, offered by several newsroom computer vendors, is to use the computer system printers to print the newswire stories while the computer is out of service. A switch is provided for each printer which transfers it between the computer system and an incoming newswire line (see Fig. 13). Newsroom computer system planning should include either, or a combination, of these approaches to keep the newswires flowing when the computer system is unavailable.

#### Determine Data Communications Requirements

Data communications lines are required in newsroom computer systems whenever terminals, printers, or other computer peripherals are remotely located. Direct interconnection of computer equipment through twisted-pair or coaxial cable is limited to maximum runs of up to several thousand feet at best. Station newsroom requirements for intercommunication with bureaus or field personnel beyond such cable limitations must include a data communications "network specification".

A network specification can be as simple as one dial-in auto-answer modem for a tiny station, or as complex as a worldwide communication system serving hundreds of workstations for a major broadcast news organization. It should include, per each location, the quantities and types of equipment required. The location's work-flow diagrams, estimates of remote workstation data communications character-

counts over time, and relative costs can then be used by the computer system vendor and/or an outside communications common carrier to define a data communications network architecture which meets station requirements.

### CHOOSE A VENDOR

Few, if any, broadcast organizations can commit the resources in manpower, equipment, time, and materials required to create a newsroom computer system "from scratch". Fortunately, there are a number of newsroom computer system vendors active in the marketplace. This section presents suggestions on choosing a broadcast news computer system vendor.

#### Request for Proposals (RFP)

A "Request for Proposals" (RFP) describing the station's requirements and desired features of a newsroom computer system should be created. This might be a few pages for a single small station or several hundred pages for a group of stations or a major network. At a minimum, the RFP should include the newsroom's present and proposed work-flow diagrams, a description of the broadcasts supported by the newsroom, and an estimate of the workstation requirements. If possible, the RFP should include a job-by-job breakdown of the work done by each person in the news operation, sample forms and documents used in the current manual newsroom, floorplans showing the layouts of the newsroom and studios, descriptions of the station's technical facilities which might be connected to the newsroom computer, timetable requirements for the conversion to a computerized news operation (initial installation and possible phased expansion), business considerations, procurement terms and conditions, etc. Extensive detail in an RFP gives the responding vendors a better chance to propose a system which will meet the station's needs.

#### Proposal Analysis

The analysis of vendor proposals is more an art than a science. Some vendors will respond to an RFP with specific proposals; others may respond with few specifics but many sales brochures, testimonials from current customers, and a stream of sales-oriented correspondence directed at a station's "decision makers"; still other vendors may not respond at all. Sorting the "wheat from the chaff", discovering and understanding the specific benefits a proposed system can offer a station is important, but often difficult and time-consuming.

Whether a station receives a proposal from one vendor or several, the preparation of a "scoring matrix" will aid proposal analysis.

The scoring matrix should show detailed station requirements, one line for each, at the left of the page. A column for each vendor responding should then be established further to the right, leaving space for a score or a "YES/NO" entry for each requirement line



item. Fig. 14 shows a short example; a real station's list of requirements would probably be longer.

A numerical scoring system (a scale of 0 to 10 or 0 to 100%) might be used instead of the "YES/NO" approach used in Fig. 14. If a computerized "spread sheet" system is available, it may be useful in proposal analysis based on numerical scoring.

#### Visit Vendor Installations

Key people in the station's News, Engineering, Financial, and/or Purchasing departments should visit at least one of the leading vendor's newsroom installations and possibly the vendor's plant. Discoveries made in such visits may reinforce or alter tentative vendor selection decisions based on RFP responses alone. Choose a vendor's newsroom of similar size and with similar requirements to those in the RFP.

#### Demonstration System

Some vendors may be willing to install a small "demonstration system" at a station for evaluation on a no-charge or "token payment" basis --if the station indicates a strong interest in the vendor's system. Such an arrangement is beneficial for several reasons. First, the station can evaluate the vendor's system under actual operating conditions, using the station's own newsroom procedures and information. Second, the vendor will have an opportunity to learn more about the station's news operation and possibly be able to suggest better ways of using the system when the full computerized newsroom is implemented. Third, the demonstration system can be used to train the newsroom staff prior to cutover to the full system. Finally, vendor and station personnel will gain experience in working together; a rapport or the lack of it will become obvious.

#### CONCLUSION

This brief overview has concentrated on some of the issues unique to radio newsroom computerization. For more information, talk with stations who have computerized their news operation. Talk with the newsroom computer vendors. And finally, talk with your station's own news people.

It has been said that "The question is not WHETHER to computerize a radio newsroom, but WHEN".



WIRES ALL  
WIPE SLUG

URGENT am-happyreturnsrdp 1

	FROM	MOVED	TIME
bc-ny5-f 12-26 0	APufu	Wed Dec 26 17:30	3:16
am-contras 12-26	UPInair	Wed Dec 26 17:30	2:38
am-manhunt 12-26	APaar	Wed Dec 26 17:29	2:45
^sports-review 5	DAFIir	Wed Dec 26 17:29	1:32
bc-ny5-f 12-26 0	APufu	Wed Dec 26 17:29	2:56
network-hourly-feed	UPInurr	Wed Dec 26 17:29	1:21
bc-nyactu 12-26	UPInfr	Wed Dec 26 17:29	:40
bc-yields 12-26	UPInfr	Wed Dec 26 17:29	1:02
bc-ny5-f 12-26 0	APufu	Wed Dec 26 17:28	3:37
bc-atrend 12-26	UPInfr	Wed Dec 26 17:28	:10
am-ethiopiafamine	APair	Wed Dec 26 17:28	2:49
bc-atllist 12-26	UPInfr	Wed Dec 26 17:26	:39
am-farmdebt 12-2	UPInaud	Wed Dec 26 17:26	1:13
stocks-close-more 00	UPInurr	Wed Dec 26 17:26	:13
am-metroforecasts 13	APnnu	Wed Dec 26 17:26	:54
am-metroforecasts 13	APonu	Wed Dec 26 17:25	:54
am-armored sked 12	UPIyjur	Wed Dec 26 17:25	2:44
stocks-close-more 00	UPInurr	Wed Dec 26 17:24	:19
am-fumes 12-26 0	APonr	Wed Dec 26 17:24	:50
stocks-close-more 01	UPInurr	Wed Dec 26 17:24	:27
stocks-close-more 01	UPInurr	Wed Dec 26 17:24	:36
^sports-review 4	DAFIir	Wed Dec 26 17:23	1:28

Pg	Slug	Writer	Date/Show	Ed Status	Start	Tape	Copy	Total
B-2	AIDSTEST	hall	3-3-85 1AM	do READY		0:14	0:30	0:44

WITHIN a matter of days, thousands of hospitals and blood banks will get new material to begin screening donated blood for possible AIDS contamination. The test won federal approval Saturday...and Chuck Weber of Abbott Laboratories in Chicago, which has the first manufacturing license, says the process is simple.

WEBER....B-86..."...VIRUS"..;14

A gay rights group objects to the new test, contending it gives too many false results, and that people who fear they have the disease may donate blood...just to get the test. Federal officials insist the test is not intended for diagnosis.

Fig. 2

```

<<RADIO NEWS TAPE INFORMATION>> <Date/Time>Sun Mar 3 10:59 <Cart #>
<Slug> heart <Where> louisville <Ed/Eng> jl/sw
<Who> bob irvine, spks, humana hosp audubon
<IN> dr devries <OUT> last tuesday. <RUNS> :10
<Type> ack <Audio Source> fone <Quality> fair
<From> leone foner <S.S.#> - - <Usage>
Summary:

```

feels it'll set him bad two or three days, but they lost quite bit of time due to bleeding problem that's occurred since last tuesday.

ans q: will this surgery delay haydon's overall recovery alot?

LOUISVILLE, Ky. (UPI) -- Murray Haydon, 13 days after becoming the world's third permanent artificial heart recipient, was ``critical but stable'' Saturday following 1 1/2 hours of emergency surgery to stop bleeding near his mechanical heart.

Haydon, 58, was awake and alert following the surgery performed by Dr. William DeVries, who implanted Haydon's plastic and metal Jarvik-7 heart Feb. 17, said Robert Irvine, spokesman for Humana Hospital Audubon.

Fig. 3

BUREAU	DATE	
State Capitol	February 11, 1985	
NAME.....	STATUS.....	REACHABLE #.....
Assignments:		
Governor	Smith/Jones: labor leaders conference at Gov's mansion 10AM	
	Jones: 12:30PM Gov's wife luncheon for labor leaders' wives	
	Smith: 2:00PM Gov. news conference	
State Senate	Brown covers	
Staff:		
Smith	Gov.	
Jones	Gov.	
Brown	State Senate	
Walker	Bureau...various topics	
White	off (1st. of 2 days)	555-8765
Susy	Bureau	
Blake	Editor	
Dugan	off	555-5432

Fig. 4

## TICKLER FILE February 4 - 14, 1985

- Feb. 4 -- President Reagan submits his proposed budget for fiscal 1986 to Congress.
- Feb. 4-11 -- 40th anniversary of the Yalta conference.
- Feb. 5 -- Spain opens the border between Spain and Gibraltar and begins talks with Britain on the future of the British colony.
- Feb. 6 -- President Reagan delivers his State of the Union message to a joint session of Congress.
- Feb. 7 -- Australian Prime Minister Robert Hawke meets with President Reagan in Washington.
- Feb. 8 -- Dissident South Korean political leader Kim Dae Jung plans to return to South Korea after living in forced exile in the U.S. for two years.
- Feb. 9 -- First anniversary of the death of Soviet President Yuri Andropov. Konstantin Chernenko was selected to succeed him as general secretary of the Soviet Communist Party on Feb. 13, 1984.
- Feb. 11 -- Saudi King Fahd meets with President Reagan in Washington.
- Feb. 12 -- Elections in South Korea.
- Feb. 13 -- 40th anniversary of the bombing of the German city of Dresden by British and American bombers during World War II, Feb. 13-14, 1945.
- Feb. 13-20 -- American Bar Association holds its mid-year meeting in Detroit.

CONTACTS: CAR SERVICE

---

COMPANY: CAREY CADILLAC	CONTACT: SID	PHONE #: 599-1122
COMPANY: FUGAZY RESERVATION	CONTACT: MARIE	PHONE #: 426-6600
COMPANY: LONDON TOWN CARS	CONTACT: LARRY	PHONE #: 988-9700
COMPANY: PETE SMITH LIMO	CONTACT: GAIL	PHONE #: 247-0711
COMPANY: TAXI & LIMO SVCE	CONTACT: JOE	PHONE #: (DIAL) THE TAXI

Fig. 6

RADIO	DAY	DATE	SHIFT	PROD/ASSGN-ED
PRODUCER/ASSIGNMENT EDITOR LOG	saturday	3/2/85	515p115a	jones

Note: a lazer printer has been hooked up for the tape rooms. it is printer number 9. you still have to tell the computer to print on 9...if you're in a tape room that is. it is not automatic at this point.

also, speaking of laser printers, number 11 is either very low or out of toner which i'm told has not been delivered yet. so we're using printer 12 for scripts.

now for the news:

because of threats, several border points between the us and mexico have been closed at sundown and border police are now packing guns. we're getting ack from customs people in houston.

the writers guild in california has voted to strike...and the new york writers vote on monday. we have acks from both a guild spokesman and a producer type.

oops, almost forgot...murray haydon went back under the knife late this afternoon to stop some internal bleeding. came thru operation okay and is listed in critical but stable condition which is what they were saying about him before the operation this afternoon. we did a couple of phoners with humana hospital for the latest updates.

WISH LIST ADD: it might be helpful to have digital clocks at the correspondent positions...1 digital on each side. the on air folk agree it's easier to tell time with the digitals compared to looking up at the wall clocks. right now we keep a tv on the menu...there's a digital available.

personnel problems: none

updates: 945pm cast for editorial adjustment

## AUDIO TAPE OPERATIONS LOG

NEWS RADIO

Date: Fri Mar 1 15:02 LOG FOR TAPE ROOM 2. 3PM TO 10 PM

Editor: SMITH

Time Comment

3pm SMITH IN TAPE ROOM 2.

3:03PM PROCESSED VOICER FROM MADRID RE GROMYKO STATEMENT  
(INTAKEN BY PREDECESSOR IN THIS ROOM). RWS

3:30PM ROLLING ON TV CIRCUIT FOR PROMISED FEED FROM URUGUAY (RE SHULTZ  
VISIT) RWS

3:43PM INTOOK ACT OF HUMANA HOSPITAL SPOKESWOMAN FROM RICK JONES, WAVG,  
LOUISVILLE. PROCESS TWO COPIES, ONE FOR UPCOMING CAST, THE OTHER FOR  
THE FEATURE. RWS

3:48PM URUGUAY FEED BEGINS.....MONITORING (DIFFICULT, BECAUSE THERE'S NO TV  
AT EDITORS' POSITIONS IN TAPE ROOMS). RWS

4:45PM URUGUAY FEED FINALLY YIELDS SOME SEGMENTS....PULL TWO AS  
" Q AND A"S.

5:50PM EFFORTING SOUND ON DECISION OF ILLINOIS FERRIS WHEEL MANUFACTURER TO  
HALT PRODUCTION OF THE RIDES UNTIL DEMAND PICKS UP. PRESIDENT OF  
COMPANY BUSY DOING INTERVIEW...WILL CALL BACK. RWS

6:15PM CALLBACK FROM FERRIS WHEEL MAN...DO INTERVIEW...HE'S LONG-WINDED AND  
HARD TO CUT...AND LINE DETERIORATES....AFTER MUCH EDITING, PATCH  
TOGETHER TWO CUTS. RWS

6:48PM INTAKE VOICER AND Q AND A FROM CORRESPONDENT AT CAPE CANAVERAL RE  
SHUTTLE. TURN AROUND Q AND A (SECOND TAKE) FOR UPCOMING  
PRE-HOURLY. RWS

7:45PM ATTEMPT TO INTAKE MATERIAL FROM MANAGUA BUT CAN'T  
GET DECENT LINE, DESPITE SEVERAL CALLBACKS. TELL HIM WE'LL TRY A  
LITTLE LATER. RWS

8:15PM CALL MANAGUA AGAIN....HAVE HIM FEED OVER AND OVER UNTIL WE GET FOUR  
ACCEPTABLE PIECES. TWO VOICERS AND TWO Q AND A'S. RWS

9:05PM SIMILAR PROBLEMS WITH FEED FROM KXOX, ST. LOUIS. CALL BACK  
THREE TIMES FOR BETTER LINE, THEN HAVE TO HAVE HIM REDO WRAP.  
FINALLY INTAKE WRAP AND TWO  
ADDITIONAL CUTS OF ACT RE JAPANESE AUTO IMPORTS.

9:45PM INTAKE LONG FEED FROM L.A. BUREAU. LEAVING FOR SUCCESSOR. RWS

10PM SMITH OUT. RWS

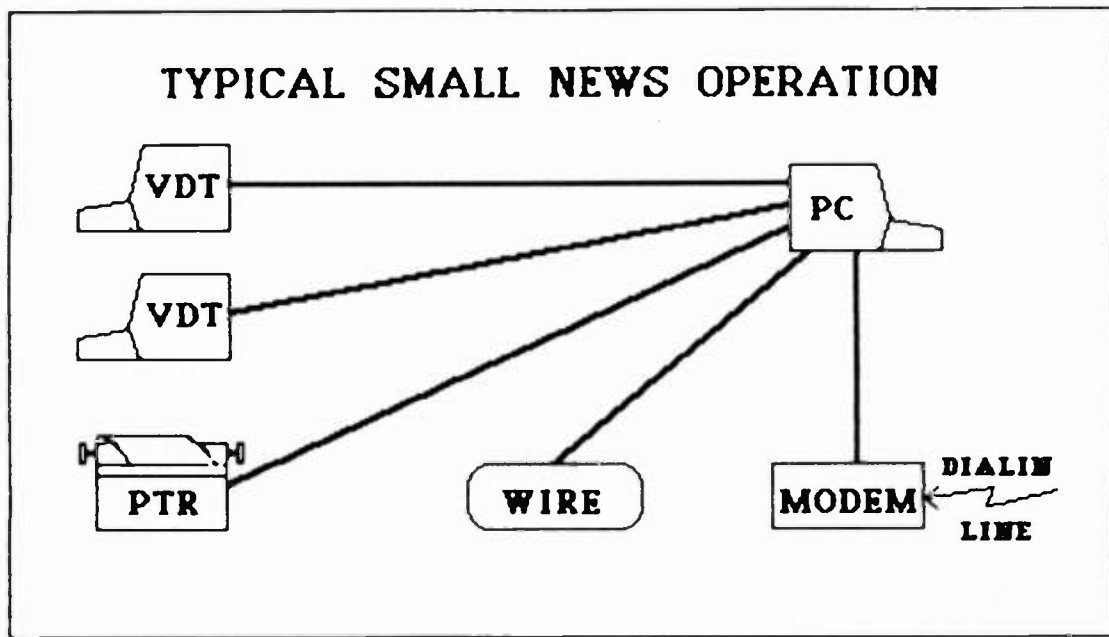


Fig. 8

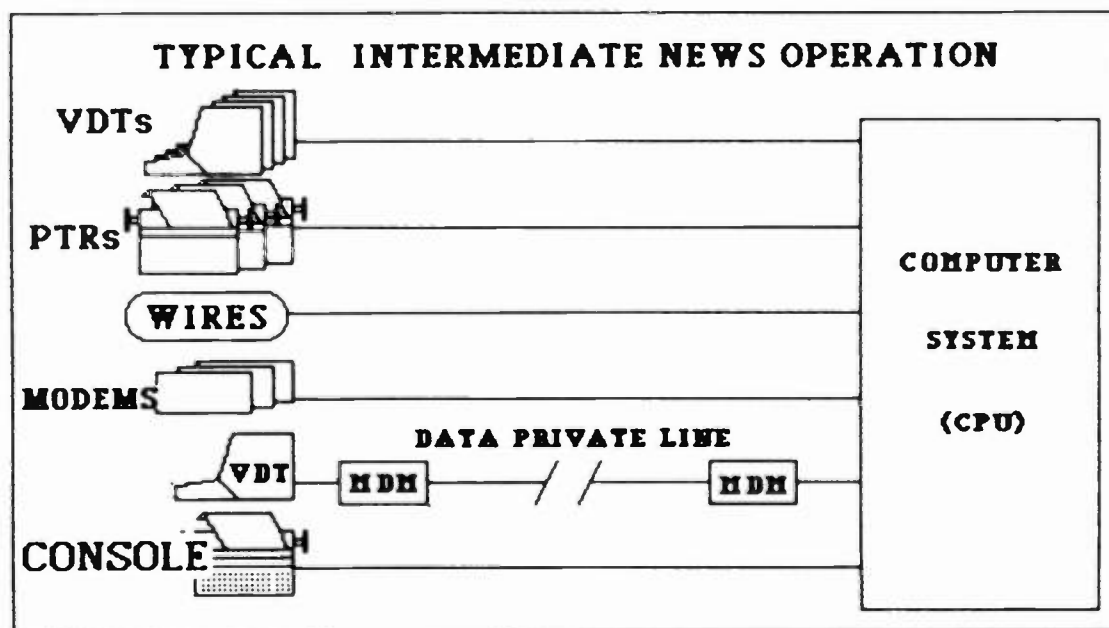


Fig. 9



# TYPICAL LARGE NEWS OPERATION

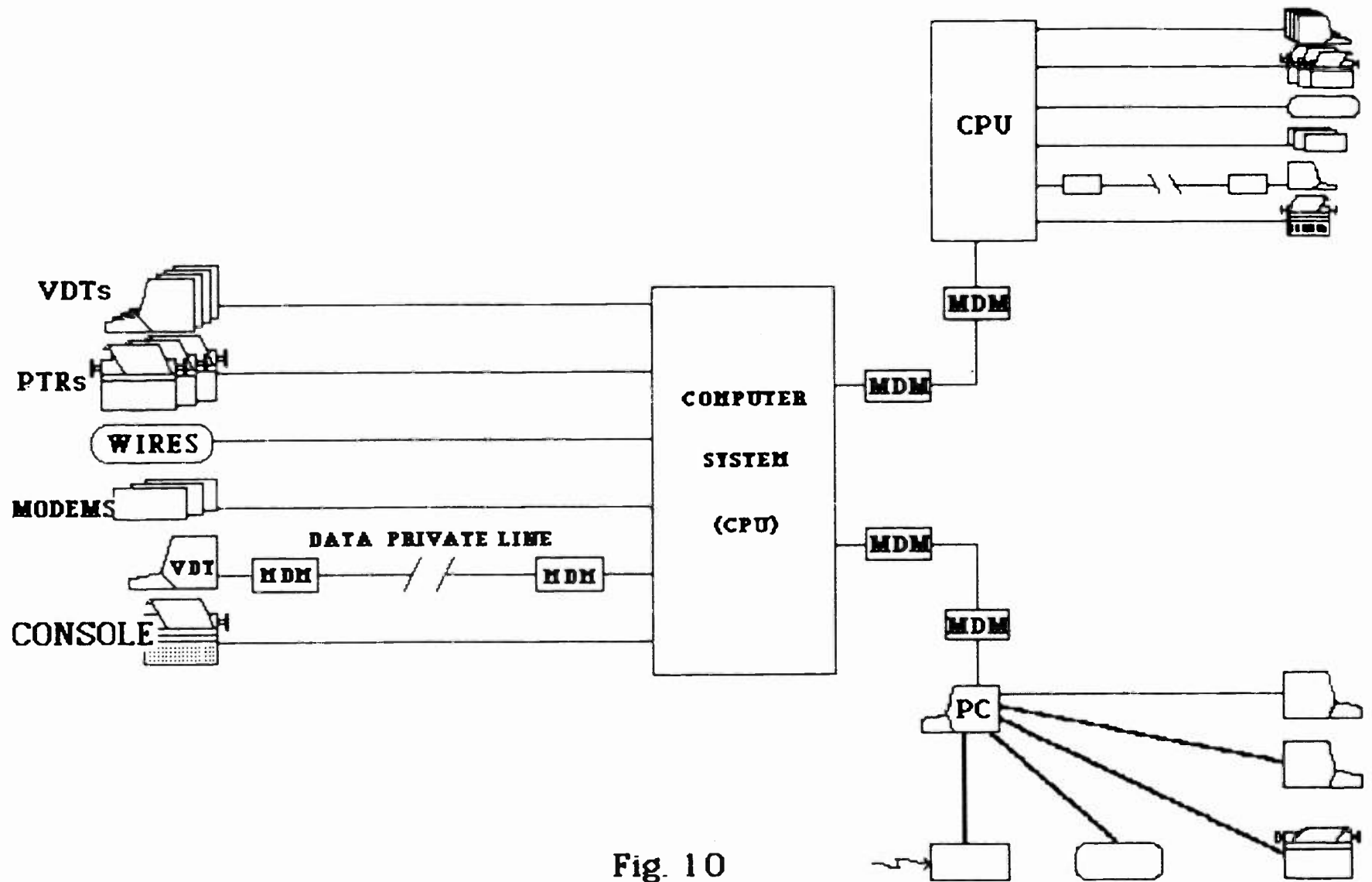


Fig. 10

## SIMPLE WORK-FLOW DIAGRAM

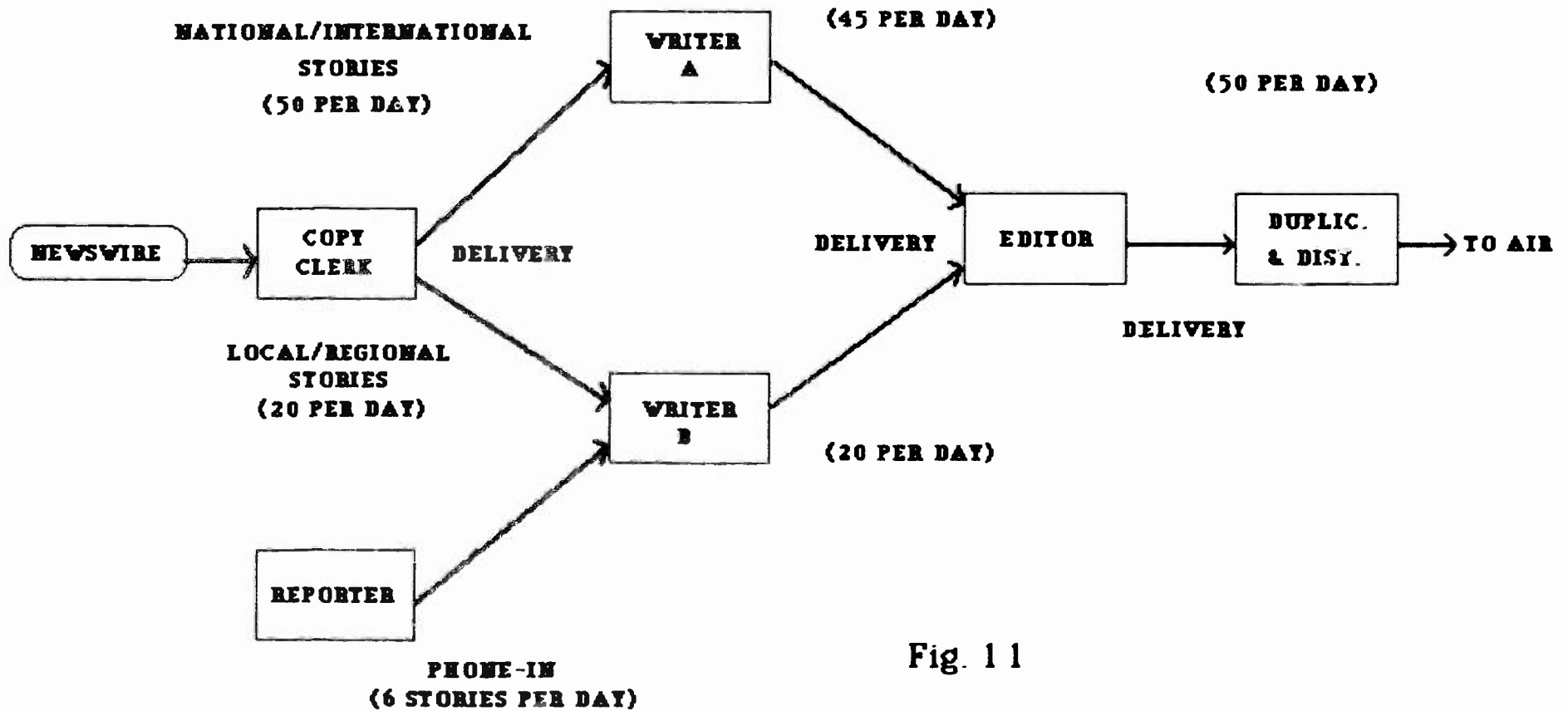


Fig. 11

Radio News Workstation Requirements

=====

Function	VDTs	Printers	Misc.
Assignment Desk	2	1	2 modems
Editor's Desk	1		
Writers	3	1	
Producer's Desk	1		
Talent Office	1		
Studio A Control Room	1	1	
Studio A Talent Position	1		
Tape Room	2	1	1 label printer
Tape Library	1	1	1 label printer
Reporters and Crews	3	1	2 portable terminals
News Director	1	1	
	—	—	
Totals:	17	7	

Miscellaneous:

- 2 Modems
- 2 Label Printers
- 2 Portable Terminals

Fig. 12

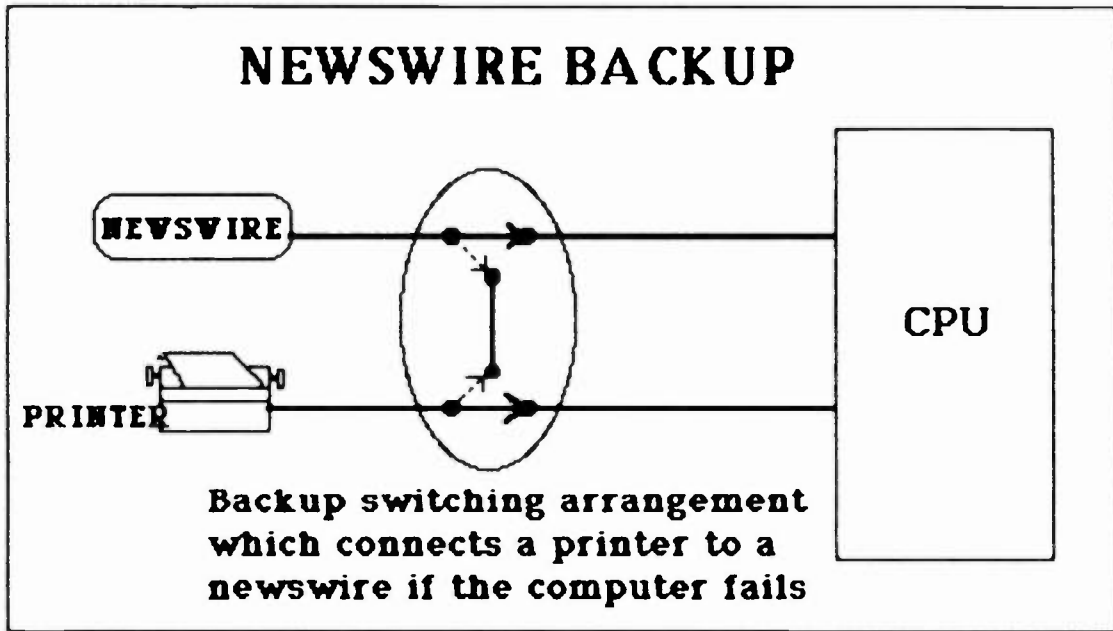


Fig. 13

Radio News Scoring Matrix  
=====

RFP Requirement	Vendor A	Vendor B	Vendor C
<b>Workstation Quantities:</b>			
Initially 20	20	20	20
Expansion to 50?	YES	YES	max. 40
<b>Remote Terminal Support:</b>			
Lap-portables	YES	NO	YES
Fixed-site Workstations	YES	YES	YES
Data Communications	YES	limited	YES
<b>Newsroom Functions:</b>			
Assignments	YES	YES	YES
Script Preparation	YES	NO	YES
Newswires	YES	YES	YES
Desk Logs	YES	NO	YES
<b>Studio Functions:</b>			
Change Running Order	YES	n/a	YES
Prompter	YES	n/a	NO
On-line Bulletin Alert	YES	n/a	YES
<b>Installation and Maintenance:</b>			
Installation by Vendor	YES	3rd. pty.	YES
Hardware Maintenance	GOOD	limited	GOOD
Software Maintenance	GOOD	n/a	limited
<b>Costs:</b>			
Turnkey 20 Workstations	\$_____	\$_____	\$_____
Hardware Maintenance/mo.	\$_____	\$_____	\$_____
Software Maintenance/mo.	\$_____	\$_____	\$_____

Fig. 14

---

## COMBINING NEW TRANSMISSION AND COMPANDING

### SYSTEMS FOR IMPROVED FM RECEPTION

Emil Torick

CBS Technology Center

Stamford, CT

#### INTRODUCTION

At a previous Broadcast Engineering Conference of the NAB, I presented a paper which described a new technique for improving the received signal-to-noise ratio and resultant coverage of FM stereo broadcasts. The new method utilizes a second stereophonic subcarrier in quadrature at 38 KHz, modulated by a heavily-compressed audio difference (L-R) signal. New generation receivers appropriately expand this difference signal, resulting in noise-free stereo reception to the geographical limits of equivalent monophonic reception. The evidence presented in the original paper was entirely theoretical, having been based in part on earlier analyses by the National Quadraphonic Radio Committee (NQRC). I am pleased to report now that the original assumptions have been validated by actual laboratory and broadcast tests. Furthermore, significant progress has been made in the development of a companding system for this new service and it will also be described in this paper.

#### BROADCAST FORMAT

Figure 1 shows the format of the new composite signal. No alteration has been made of the components which constitute the present-day standard for stereophonic transmission -- the monophonic sum signal (M) extending to 15 KHz, the pilot at 19 KHz and the double-sideband suppressed-carrier stereo difference channel (S) at 38 KHz. Only a second difference channel (S') has been added in quadrature at 38 KHz, maintaining the existing upper spectral limit of 53 KHz. (Figure 1 does not include the identification signal for the new service, but it will be described here later.)

The early calculations by the NQRC described the coverage area of an FM broadcast station in terms of contours of reception with a 50 dB signal-to-noise ratio. This is illustrated in Figure 2 for a representative set of broadcast and reception conditions.\* As shown here, the limit of station coverage is at a radius of 128 miles when monophonic transmission only is employed. With stereophonic transmission, monophonic reception at 50 dB S/N is reduced to 100 miles, and two-channel reception extends only to a 60-mile radius. The reduced area for stereo coverage is a consequence of the well-known 26 dB signal-to-noise penalty in stereo receivers. Although real-life reception contours are limited by other factors in addition to receiver considerations, the new broadcast system has achieved its goal of providing stereophonic reception to the limits of equivalent monophonic reception and improved reception throughout the service area. Furthermore, by judicious control of modulation levels in the quadrature channel, it accomplishes this without reduction of the existing service area of a station.

### IDENTIFICATION SIGNAL

The inclusion of an identification signal is a useful feature because it can permit new receivers to automatically identify and properly decode those stations which are providing the new service. In initial broadcast tests, amplitude modulation of the 19 KHz pilot was employed. Laboratory tests seemed to indicate that the choice of 593.75 Hz (the sixth sub-harmonic of the pilot) as the modulation frequency was acceptable. This frequency is high enough to be outside the capture range of phase-locked loop detectors in receivers. A modulation level which causes the pilot to vary between 8.5 and 9.5 percent total modulation is adequate for reliable detection, and it keeps the 19 KHz level within FCC standards. Unfortunately, the success in the laboratory was not duplicated in on-the-air tests. After approximately two weeks of broadcasting, three listeners called to report that they could hear a strange tone from their home receivers. (One characterized it as an E-flat!) Subsequent investigation showed that the effect could be duplicated in some receivers, especially by mistuning them. Although in the worst case observed the detected level of the 600-Hz sound was down nearly 60 dB, its continuous nature caused it to be audible even in the presence of random noise at higher levels. The exact mechanism for this fault was not determined, but it appeared to be caused by an intermodulation process in the receivers. The signal generator was not at fault.

Pilot modulation was subsequently abandoned in favor of a different identification signal. A subsonic tone at approximately 10 Hz is transmitted in the new quadrature channel at a level equivalent to one-percent overall modulation. Experience to date has revealed no adverse effects with this method, and it is likely to be recommended for future use.

---

\*The NQRC used the FCC FM Engineering Charts for the estimated field strength exceeded at 50% of the potential receiver locations for at least 50% of the time, with a dipole receiving antenna height of 30 feet. The transmitter height was assumed to be 1000 feet, with a 10 kilowatt effective radiated power at 98 MHz. The receiver was assumed to have a 10 dB noise figure.

## COMPANDING

The choice of a companding characteristic is an important specification for the new broadcast system. Companding systems achieve various degrees of noise reduction by raising the modulation of low-level audio program prior to transmission and restoring the program to its original dynamic range in a receiver. The selection of steady-state and dynamic characteristics determine the potential effectiveness of a compander for any particular application.

Recently the Multichannel Sound Committee of the EIA/NAB-sponsored Broadcast Television Systems Committee investigated the application of companding systems for stereo audio in television. One of the problems now being encountered in this first year of TV stereo broadcasting is a less than adequate stereo separation in many receivers. (Values of 12-15 dB have been reported by equipment reviewers for consumer magazines.) The problem can usually be attributed to improper tracking between broadcast compressor and home expanders. Even if alignment were perfect at one signal level, any error in tracking will result in reduced separation at other levels. The reduction of separation with various tracking errors is illustrated in Figure 3. It can be seen that separation will be limited to a maximum of 25 dB when there is a 1 dB error in the L-R level.

## COMPRESSION CHARACTERISTIC

A compression characteristic with several unique aspects is employed for the new quadrature channel. Conventional companding systems generally operate with a compression slope of 2 or 3:1. In some applications such slopes are desired for compatibility reasons, i.e. reception without complimentary expansion. In conventional systems where expanding is employed, a finite positive slope is also required in order to provide sufficient signal level discrimination for complementary tracking by the expander. A higher compression ratio would permit more effective loading of the transmission channel, but proper decoding would be difficult or impossible.

A theoretically-ideal compressor would use a slope of infinity to 1. Figure 4 illustrates major benefit of such a slope, as compared with a 2:1 characteristic. As shown here the  $\infty$ :1 compressor achieves its maximum effectiveness at an input level of -30 dB. For signals below this value a complementary expander needs only to have fixed gain for maximum noise reduction. In contrast, the 2:1 compander will not operate at the same fixed gain until signals corresponding to input levels of -60 dB are reached. Since its expander must provide dynamic control down to this -60 dB point, the 2:1 compressor will always exhibit a greater tendency to audible modulation of background noise.

The new companding system has none of the above limitations. A unique re-entrant compression characteristic is configured to prevent overmodulation by the sum of the S and compressed S-channels at high signal levels, and to provide optimum channel loading at mid levels with a compression slope of approximately  $\infty$ :1. Figure 5 illustrates the response of the compressor (upper solid line), the uncompressed S-channel (lower solid line) and the combination of the two signals (dashed line). At low signal levels the response of the compressor is linear, but with approximately 26 dB higher gain than in the uncompressed



channel. At mid-level inputs the compression characteristic exhibits a slightly negative slope, changing at high levels to a rapidly-changing negative slope. When the compressed and uncompressed characteristics are combined, the result is shown as the dashed-line of constant maximum modulation.

## EXPANDER

Although the compression characteristic of Figure 5 provides optimum loading of the transmission channel, it cannot be decoded in a traditional open-ended system. Fortunately, the presence of the standard S-channel in a receiver permits the operation of an adaptive expander which uses this uncompressed full-bandwidth signal as a decoding reference. In fact, the use of such an adaptive expander allows the encoding of audio signals with any arbitrary compression characteristic or time constants, although the characteristic of Figure 5 is preferred, because it offers the greatest amount of noise reduction without overmodulation.

An important requirement for the expander is that it accurately restores the S' signal amplitude at its output to be identical with the original uncompressed S signal amplitude. Failure to meet this requirement would lead to incorrect dematrixing of the M and S signals, and hence a reduction in stereo separation. The adaptive expander is a powerful device to ensure that this requirement is met, since its function is to provide an output S' signal which is identical in level and dynamic characteristics to the reference uncompressed S signal. It is not sensitive to the normal alignment constraints of conventional companders. A further advantage of this technique is that the alignment of the compressor at the transmitter is also less critical. Variations of the broadcast compressor characteristics are automatically compensated for in the receiver.

In the earliest embodiment, the new receivers demodulated the S-channel at  $0^\circ$  carrier phase and the compressed signal at  $90^\circ$ , the S-signal being used as the reference, and the expanded S'-signal dematrixed for quiet stereophonic reception. In a later, preferred, embodiment the  $0^\circ$  reference signal is maintained, but the signal for expansion is demodulated at  $45^\circ$ . The  $45^\circ$  demodulation produces the sum of the compressed and uncompressed signals, resulting in an additional 3 dB of noise improvement. A modified expansion characteristic is necessary for these combined signals, but the adaptive expander performs such decoding automatically.

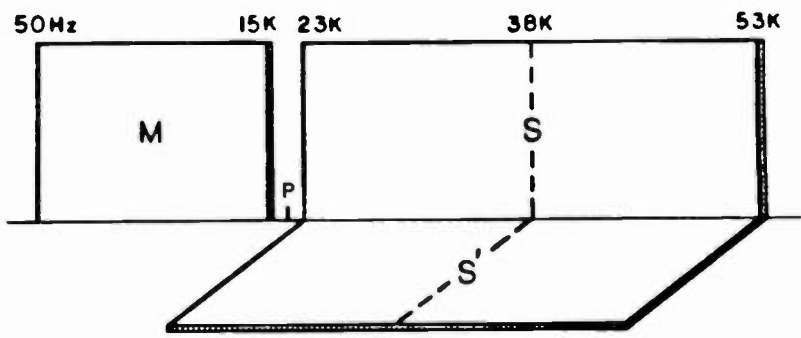


FIG. 1 - SPECTRUM OF COMPOSITE SIGNAL

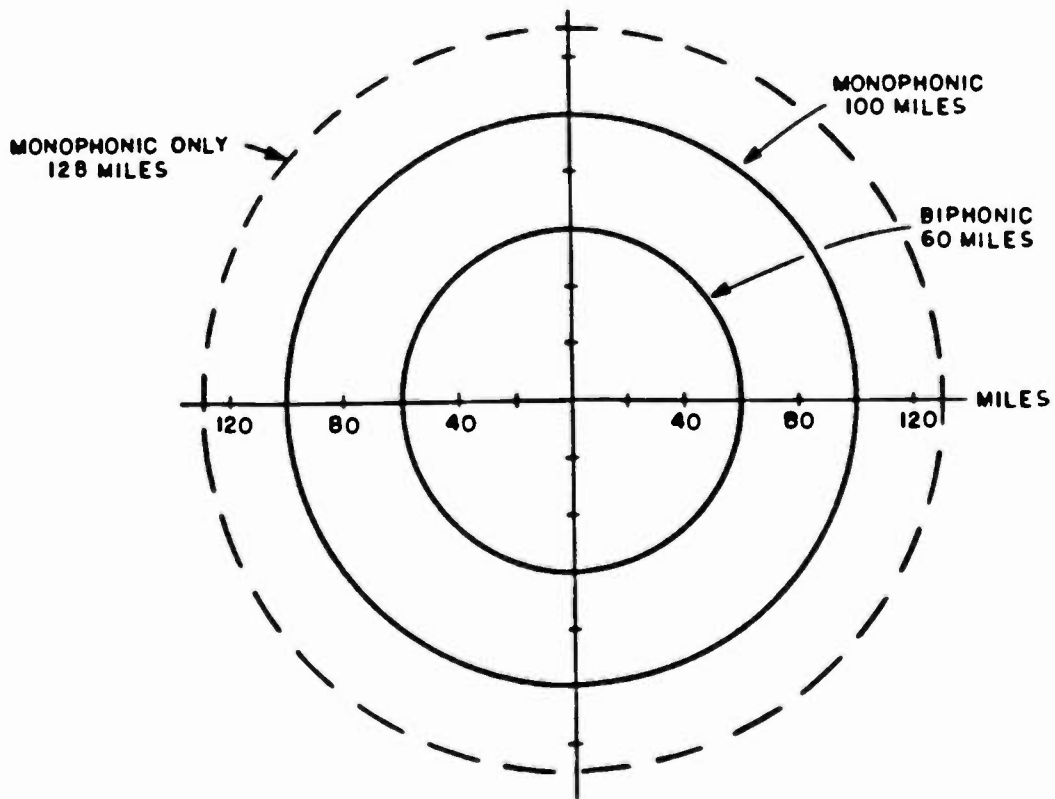


FIG. 2 - RECEPTION LIMITS FOR 50 dB SNR

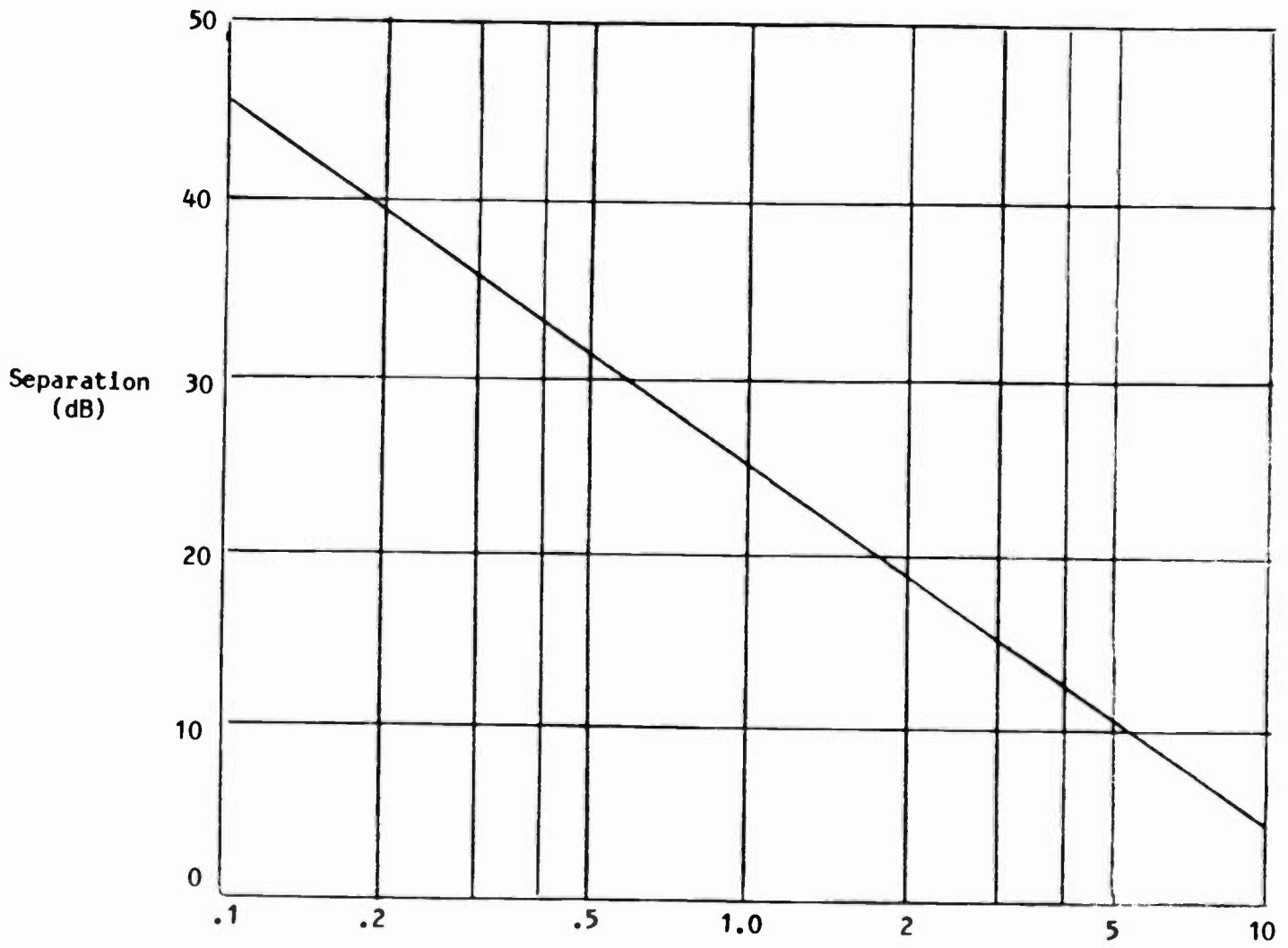


FIG. 3 - SEPARATION vs. TRACKING ERROR (dB)

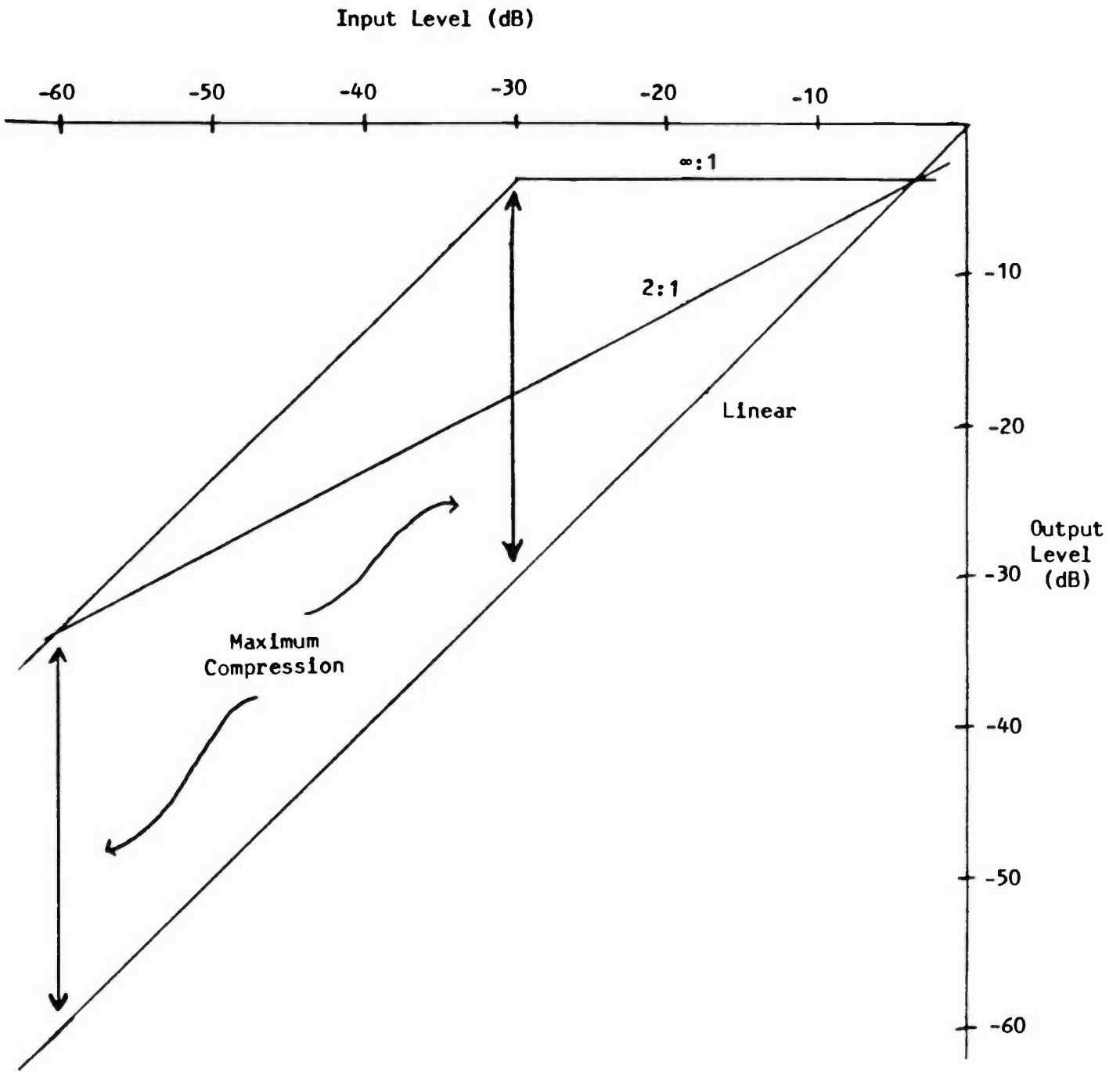


FIG. 4 - COMPRESSORS COMPARED

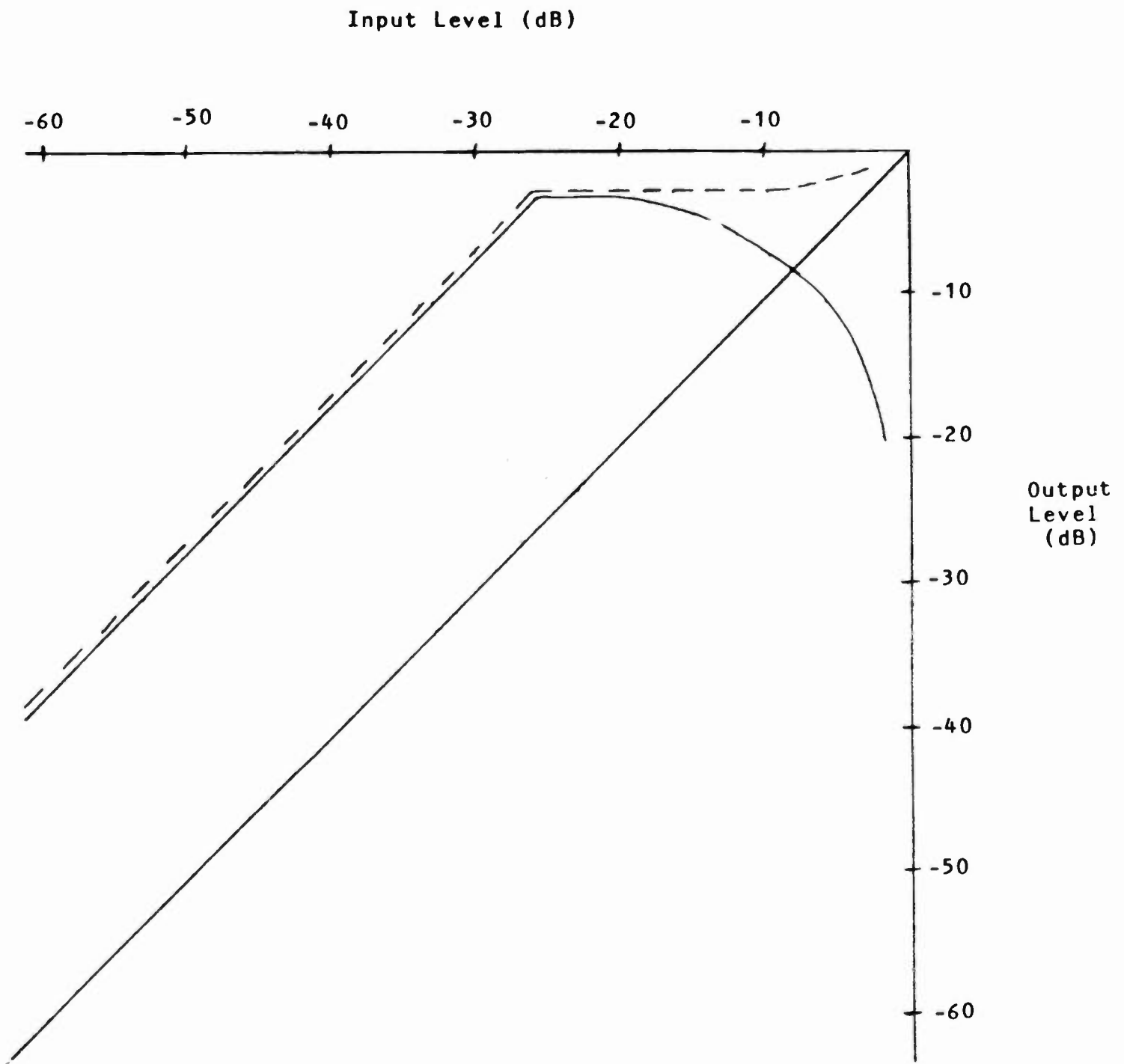


FIG. 5 - RE-ENTRANT COMPRESSOR



---

High Performance Telephone Interfacing  
Using Digital Signal Processing Technology

Steve Church  
WNDE/WFBQ Radio  
Indianapolis, Indiana

In the beginning, there was only Ma Bell.

When life was simpler and we had no choice, "high performance" two-way telephone interfacing usually meant a surreptitious connection to a speakerphone. Low performance interfacing meant you didn't bother with the connection - it was much easier, and certainly more legal, to simply position a spare mike near the unit's speaker grille and hope for the best. The better installations provided a gooseneck mount for the speakerphone's microphone unit, so that it could be positioned for optimum pick-up! A rare few of us tried to make a "hybrid transformer" arrangement work. Most of the time it didn't.

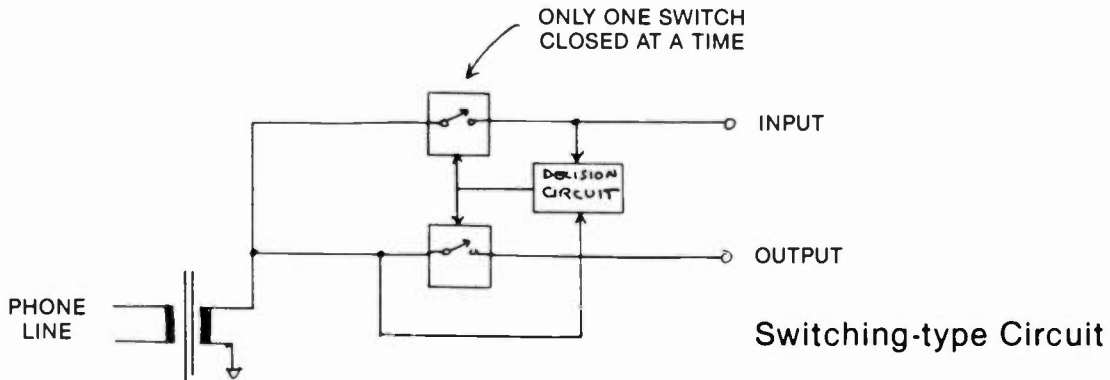
With the passage of time, the introduction of new technology, and all of us wiser, we can now explore new and better ways of making the broadcast-telephone connection.

What follows is a look at the available two-way telephone interfacing technology - including a new, truly high-performance Digital Signal Processing approach. A prototype unit which uses the DSP approach will be described.

The Switching Approach -

This technique uses simple switching to keep the send audio from appearing at the receive output. Two electronic switches are used in such a way as to ensure that either the send or the receive path is closed at any given time - but, never both simultaneously.

A decision circuit compares the send and receive levels, with the direction of transmission being determined by the relative signal strength.

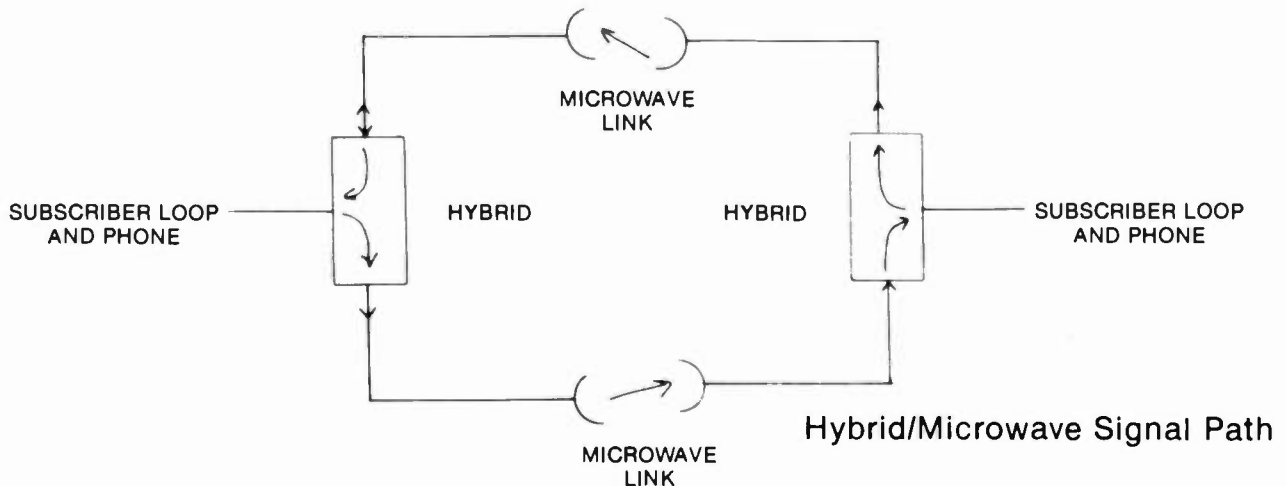


Often Voltage Controlled Amplifiers (VCA's) are used in place of the switches to provide soft-switching rather than the absolute on-off of simple switches. The common telephone company-supplied speakerphones work this way.

The disadvantages of the switching technique result from the uni-directional nature of these systems. The primary problem is that the caller cannot be heard while the announcer is speaking - or laughing! This was a big problem when our AOR morning show used the phones with a switching-type interface. Also, noises in the studio can sometimes cause a caller to "disappear" momentarily - especially on weak calls.

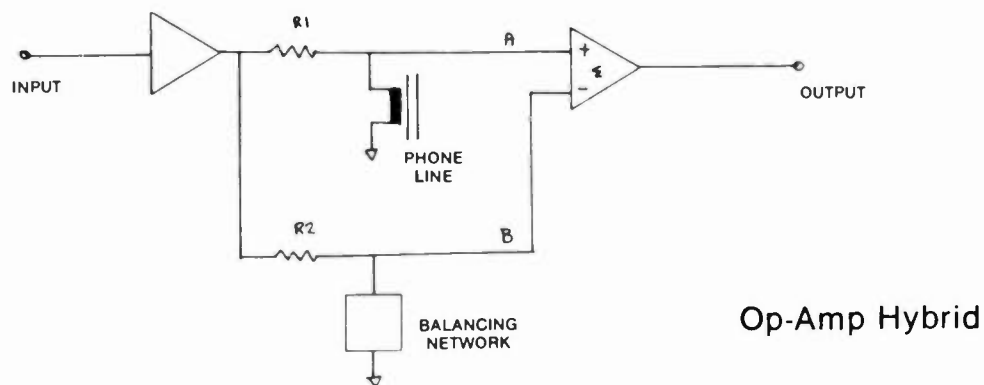
The Hybrid Approach -

Hybrids were invented by the phone company many years ago in order to separate the send and receive signals from a standard two-way phone pair. Long distance calls went by microwave, and, of course, microwave links only go one way. Thus, the need for some way to split the two signal directions.





The first hybrids were made from transformers with multiple windings. Nowadays, most hybrids are made with active components - op-amps or transistors - and are known as "active hybrids" (naturally). Both circuit types use the same principle, and achieve the same effect. Let's look at an op-amp version:



The first op-amp is simply a buffer. The second is used as a differential amplifier - the two inputs are added out of phase (or subtracted, if you prefer). If the phone line and the box labeled "balancing network" have identical characteristics, then the send signals at A and B will be identical, and no send audio will appear at the output of the second op-amp.

The balancing network is a circuit consisting of capacitance and resistance, and sometimes inductance, forming an impedance network. Depending on the hybrid's application, this circuit can be very simple, or be made of a large number of components, with a very complex impedance characteristic.

Notice that R1 and the phone line form a voltage divider, as does R2 and the balancing network. If you think of the phone line and balancing network as pure resistances, then it is apparent that the phone line and the balancing network must have the same value in order for the signals at A and B to have the same amplitude, and full cancellation to occur.

In the real world, the phone line is not purely resistive, but rather a complex impedance, causing both the amplitude and phase to vary at A as the send signal frequency varies.

Only when the impedance of the balancing network is the same as the phone line, and the signal at B is matched to that at A in both amplitude and phase, will full cancellation of the send signal be achieved. Otherwise, leakage results - the scourge of hybrid circuits.

Since the phone company's requirements were not generally too stringent, they usually used (and still do) a simple network with

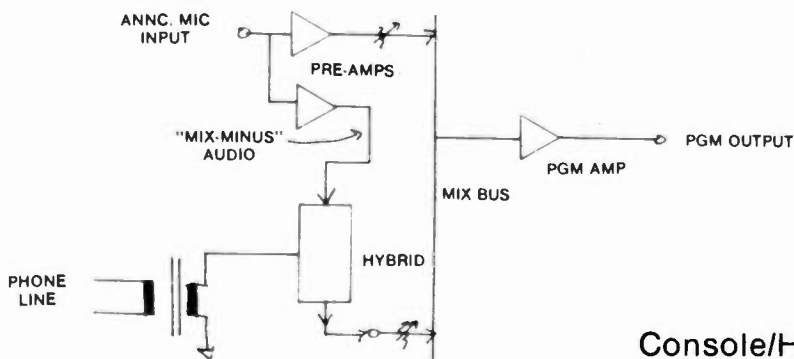
compromise values of resistance and capacitance. The phone company's design goal is to get an average of about 12db rejection, with 6db acceptable on difficult lines. When better performance is required, modules with a number of R and C elements which can be switched in or out are employed, the switches being set to match the network to a particular line.

The amount of hybrid rejection is sometimes referred-to as "trans-hybrid loss". Trans-hybrid loss is NOT the loss from the phone line audio to the output.

Incidentally, while we're talking terminology, a standard phone pair is called a "two-wire" circuit in telephone engineering jargon, and the hybrid has two ports - send and receive (in addition to the telephone line and balance network connections), requiring four wires to connect - thus, a hybrid is sometimes called a "two-to-four wire converter."

What use is a hybrid to us, as broadcasters? It depends.

In broadcast application, the telephone audio, including hybrid leakage - consisting of the local announcer audio phase-shifted because of the phone line reactance - is mixed with the original announcer audio.

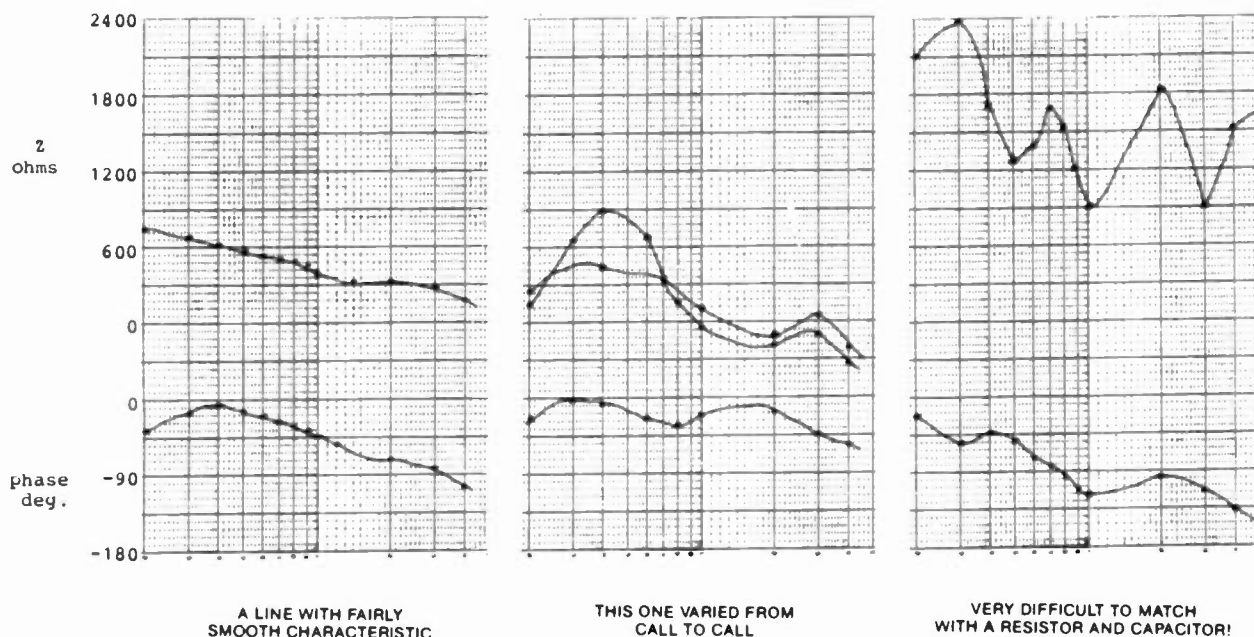


Console/Hybrid Mix Path

If the amount of the leakage is too great, and/or the phase shift too extreme, the announcer audio will suffer degradation. When this occurs, the announcer most often sounds "hollow" or "tinney" as the phase cancellation affects some frequencies more than others. Also, feedback can be a problem when it is desired to have the caller on a speaker in the studio.

Clearly, a hybrid will be useful only when leakage can be kept acceptably low.

Moving on, here are some graphs of impedance vs. frequency for some phone lines we have encountered:



## Phone Line Graphs

While some of these are relatively smooth curves, others are pretty terrible. That last one is a real doozy. It a shop phone line at a radio station in the midwest.

The lines with the smooth curves have impedance characteristics which can be simulated with a simple resistor-capacitor combination. These lines would work very well with a hybrid type interface device, since a practical RC balance network would make the cancellation of send audio at the receive output port high enough to prevent announcer audio coloration. Of course, if the hybrid is to be switched among a number of lines, they would all have to have nearly the same curve. Another consideration: the line characteristic would have to be consistent from call to call.

While it would theoretically be possible to make a balance network to match the more difficult lines, practical considerations usually keep this approach from being used - the line impedances are often inconsistent from call to call, or the impedance characteristic required is too difficult to produce.

Interfaces with an automatically-adjusted resistor-capacitor balance network work well when the phone lines to be used have a smooth impedance curve, but poor performance will still result when the line impedance characteristic is not a simple first-order RC curve and can't be adequately matched by a simple RC network.

Another way to improve hybrid performance on widely varying or difficult lines is to trade off single-frequency rejection for wide-band loss by making the phone line look less reactive to the hybrid with some series resistance.

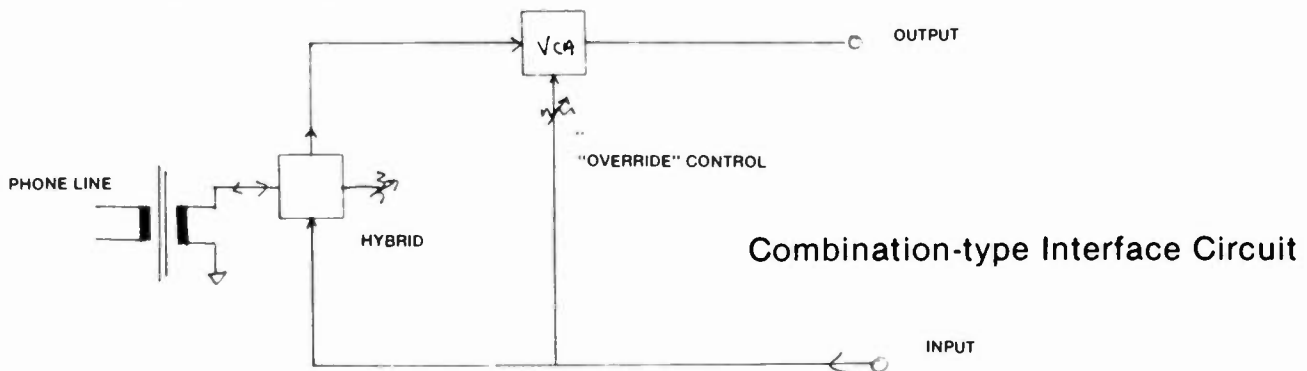
Before we leave the subject of hybrids, another point should be made:

THE TRUE TEST OF HYBRID PERFORMANCE IS DETERMINED BY MEASURING THE AMOUNT OF REJECTION ACROSS THE ENTIRE AUDIO FREQUENCY RANGE, PREFERABLY WITH WHITE NOISE AS A TEST SIGNAL AT THE SEND INPUT.

Any hybrid with an adjustable R and C balance network can claim high rejection at any given frequency, since both phase and amplitude at a single frequency can be tweaked for good cancellation. Voice is rarely a single-frequency source.

#### Combination systems -

The best systems for broadcast use combine the hybrid and VCA-type switching techniques. Here is one such configuration:



The hybrid is used to produce as much send to receive isolation as can be achieved. The "override" or "caller-control" VCA causes the "dynamic" rejection to be greater than the hybrid alone can produce. When send audio is present, the VCA reduces the gain of the receive signal. Thus, leakage is reduced on a dynamic basis. However, it should be apparent that the level from the phone is also reduced when the announcer is speaking. A control pot in the VCA control signal path is often used to adjust the amount of receive ducking, allowing full duplex operation (when the hybrid alone produces sufficient rejection), or a speaker-phone-like effect whereby the caller is turned-off when the announcer speaks. As a practical matter, this control is usually set to provide the minimum amount of ducking which provides adequately low send-to-receive leakage.

#### The Digital Signal Processing Hybrid Approach -

Because of the limitations of the previously-described techniques, a new type of interface unit has been developed. The new unit uses the combination approach with a high-performance Digital Signal Processing hybrid.

Let's take a quick look at DSP generally before we see how it is applied to the hybrid problem.

Digital signal processing means, simply, the process of operating on continuous, analog signals which have been represented digitally.

The advantages of conversion of analog signals to digital for storage and retrieval are well known, and the technology is now common - i.e. CD players, digital tape and satellite links. The next frontier is the processing of digitized signals. Digital processing offers a number of advantages:

- Digital makes possible complex processing that would be impractical in analog implementation. This feature is of primary importance to the telephone hybrid application.
- Digital accuracy is predictable and repeatable, so component selection and system tweaking are not needed.
- Stability is more easily achieved in digital systems.
- In most instances, signal degradation occurs only at the analog/digital interface. Thus, a more complex signal path is possible, since signal quality is not reduced as it passes through each stage.
- Software instructions determine circuit function. Improvements are possible without PC board modification.

The block diagram below illustrates the basic components of a general-purpose system using a digital signal processor:



The system is comprised of the following basic parts:

1) Anti-aliasing filter - This filter is used to bandlimit the incoming analog signal prior to sampling. If a signal too high in frequency, relative to the sample rate, is passed to the S/H, aliasing distortion results.

A very simple rule applies - the sampling rate must be at least twice as high as the highest signal frequency present at the output of the anti-aliasing filter. This rule is called the Nyquist theorem, and is fundamental to digital signal processing. If this rule is observed, the original analog signal will be preserved and correctly reproduced. In the real world, however, distortion may occur in the A-to-D or D-to-A converter.

- 2) Input sample and hold (S/H) - The S/H samples the signal at the system sampling rate. Each resulting sampled amplitude is held long enough for the A/D converter to accurately convert.
- 3) Analog-to-Digital converter. The A/D converts the sampled amplitude to a digital word.
- 4) Digital Processor - Performs mathematical operations on the digitized signal to simulate analog processes. Using the appropriate combinations of mathematical manipulations, it is possible to "simulate in real time" analog functions, such as gain control, filtering, and signal generation and detection.

While a general-purpose microcomputer (such as a Z80) is capable of this sort of calculation, it would be far too slow for real-time audio processing. Signal processor chips are optimized for speed, and have instruction sets especially suited to signal processing applications.

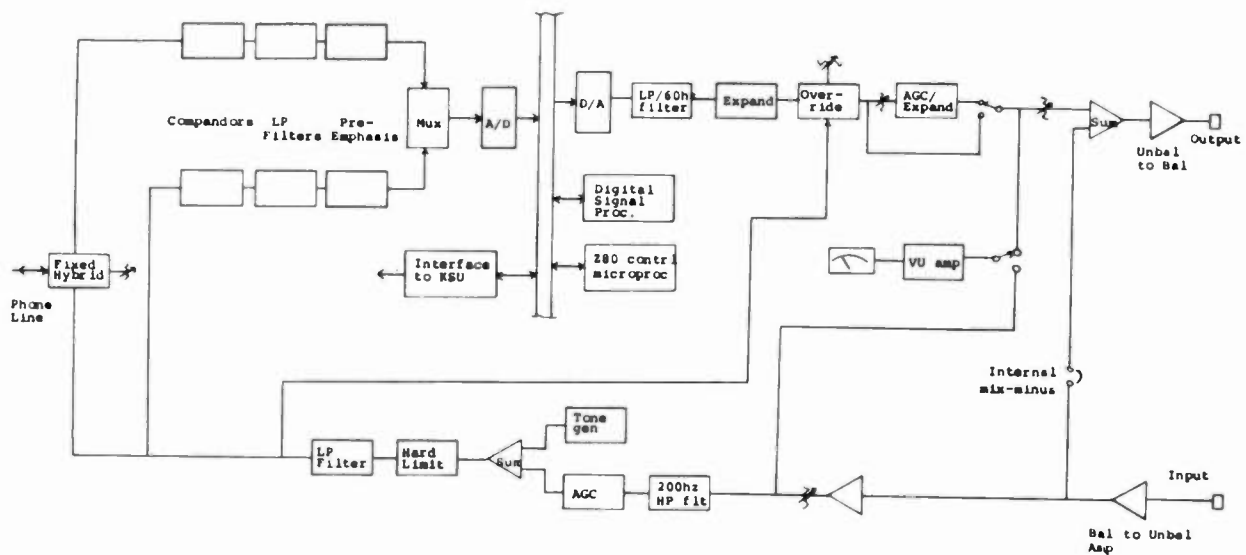
- 5) Digital-to-Analog converter (D/A) and output S/H - converts the digitized samples back to analog.
- 6) Reconstruction filter - Sometimes called a "smoothing" filter, which describes what it does. This is a low-pass filter which, by removing the high-frequency components created by the sampling process, reconstructs the desired analog signal.

All of these elements are present in the prototype Digital Hybrid. A unique digital processing algorithm programmed into a special signal processor chip implements an automatic balancing hybrid function. The digital hybrid's balancing network can adjust itself to match quite complex phone-line impedance curves for optimum rejection of the send signal at the output port.

Typically, the digital balancing system causes an additional 20-25 db rejection enhancement over simple hybrids. Thus, if, on a given line, the simple hybrid produces a 10 db null (on bandlimited white noise), the digital system could be expected to produce a null of 30 - 35 db. This is sufficient to allow full duplex operation on the vast majority of phone lines.

With the improved trans-hybrid loss performance of the digital system, it is usually possible to have an open speaker in proximity to the announce mike without feedback. In radio application, this means the unit can be used as a speakerphone-like device off the air; in TV application, "IFB" phone feeds to talent are usually not needed. Also, with two units, very high-quality conferencing with gain in the phone-to-phone path can be achieved without any of the common feedback "singing" effects.

The block diagram shows the overall system configuration. While the automatic/adaptive hybrid balancing function is implemented in digital, the other audio functions, such as input and output AGC, are performed with typical analog circuits.



Telos 10 Block Diagram

A 280 microprocessor is used to control the system. The signal processing chip operates as a peripheral to the 280. Also connected to the unit's data bus are 12 bit A/D and D/A converters. While a call is in progress, the 280 switches the digitized audio from the A/D to the signal processor, and, after processing, retrieves the result and sends it to the D/A.

The A/D's input comes from the input and output of a fixed hybrid circuit. It is passed through a single-IC 5th order elliptical low-pass filter for anti-alias protection.

A companding scheme is used to increase system dynamic range and to assure low-distortion performance with weak callers.

The send audio input to the fixed hybrid is filtered and AGC/limited to make send level consistent and to conform to FCC requirements regarding out-of-band energy. A tone generator allows hybrid balancing to be completed prior to a call being put on the air. The tone generator is active during a 300 ms mute period each time a line is selected.

The D/A output is applied to another single-IC low-pass filter for re-construction. This stage also filters 60/120 HZ hum. The phone audio is then applied to the "override" VCA, which is controlled by send audio level. Next is an AGC/Expander and the output amplifier.

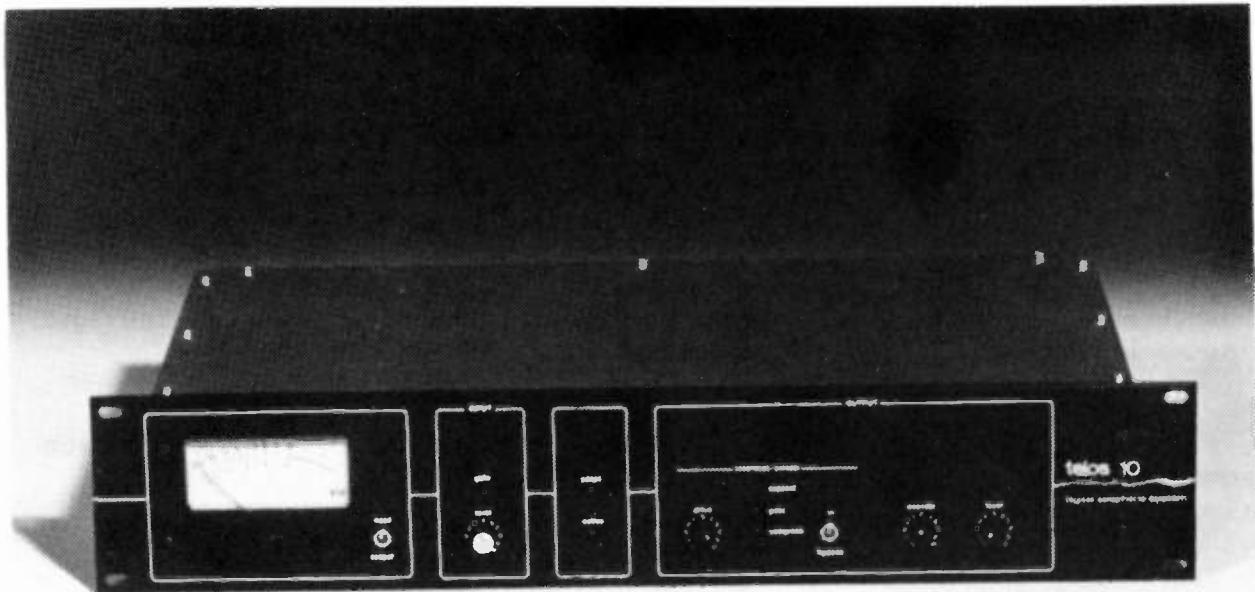
The 280 is also used as a controller for the line selection and Key Service Unit interface. Provision for switching of up to 10 phone lines is incorporated. Tip and Ring from each line are switched by relays; the "A leads" are controlled with opto-isolators. The relays and opto-isolators are interfaced to the system bus through standard peripheral interface IC's.

The system's electronics are fully contained on a 10" by 10" PC board housed in a 3 1/2" high rack unit. The line-select pushbuttons are external to the rack-mount unit. At WFBQ, we have mounted the buttons on a spare console panel.

The prototype unit has performed satisfactorily for approximately a year at WFBQ, and a number of other stations now using the device have found the digital hybrid technology beneficial.

#### References

1. Harrison Klein, "What We Found When We Measured Telephone Line Impedances," BM/E, March 1981, p. 71.
2. G. Mark Durenberger, "The Technical Tactics That Make the Telephone Interface Work," BM/E, March 1981, p. 61.
3. L. Rabiner and B. Gold, THEORY AND APPLICATION OF DIGITAL SIGNAL PROCESSING, Prentice-Hall, Englewood Cliffs, New Jersey, 1975.



(The author is now with WMMS/WHK radio, Cleveland)



---

## AN OVERVIEW OF STEREO MICROPHONE

### TECHNIQUES FOR RADIO BROADCASTING

Skip Pizzi

National Public Radio

Washington, DC

Now that stereo audio has become established in all US broadcast mediums to one extent or another, it is important for the broadcaster to understand more about stereo than the mere fact that records and tapes have left and right channels. Locally originating programs can be produced by stations in stereo, and such is the concern of this paper. Much of the research was originally conducted for a previous paper presented at the 76th Audio Engineering Convention of October 1984. The information therein relevant specifically to radio has been distilled, annotated and updated, and is presented here in a manner hopefully appropriate to the "typical" radio broadcaster's situation.

#### COMPATIBILITY

Stereo/mono compatibility is an essential ingredient in any stereo broadcast, but especially when a new format is introduced (AM or TV currently), since the majority of listeners will still be receiving monaural audio for some time to come. Yet, the stereo signal must at the same time provide a significant improvement (without degrading the mono below previous levels of quality), in order for the listener to be convinced that the stereo format is eventually worth upgrading receiving equipment for.

The microphone techniques employed in a broadcast have great impact on its mono compatibility. To understand how to optimize both stereo and mono reception and reproduction in terms of microphone technique, we must first examine the phenomenon of "localization", i.e. the human hearing sense's ability to detect the direction from which a sound originates. This is, after all, what stereo is all about.

The ear perceives directional information in many ways; foremost among these are:

a) Differences in perceived volume of a sound between ears -- the sound is louder in the ear that is closer to it. We refer to these "intensity differences" as  $\Delta i$ .

b) Differences in arrival time of sound between ears -- the sound gets to the closer ear first. We call these "time differences"  $\Delta t$ .

In natural spaces, both of these factors combine to provide localization. This works quite well for live sound, where the listener is the end-user. There is no one downstream of his/her ears who is listening in mono. For sound reproduction/broadcast, the same principles which apply to left and right ears cannot be applied directly to left and right channels, since we must consider both the mono and the stereo listener. Large amounts of  $\Delta t$  information between stereo channels may sound great in stereo, but will provide cancellation in mono, since much of the audio will be out-of-phase. This will cause a loss of mono loudness (in all broadcast formats), as well as a measurable loss of L+R modulation, thereby reducing the S/N for the mono receiver. It can also compromise the aesthetic impact of a broadcast to the mono listener, since these cancellations introduce aberrations in mono frequency response (comb filters), and alter the musical balance and relative levels between program elements. (See Fig. 1)

If we isolate or at least maximize the  $\Delta i$  information ("intensity stereo"), we have no such cancellation problem. This is how most popular records (and some classical ones as well) achieve compatibility. For your own local origina-tions, a few rules and tips follow.

#### MAXIMIZING $\Delta i$

The pop technique of close-miking all voices and instruments, then creating a stereo image through the use of pan-pots and artificial reverb is one approach to maximizing  $\Delta i$ . As long as the 3:1 rule is followed, (see Fig. 2) nothing changes when going from stereo to mono except the separation, ideally. The worst case here occurs when a microphone is assigned to one channel only; it will drop 6 dB in the mono sum. How this really affects the mix aesthetically is determined by the relative levels and pan positions of the other microphones. If there is only one other microphone in use, and it too is assigned to only one channel, the mono sum will be fine. If, on the other hand, there are microphones panned in the center along with these extreme left and right microphones, there will be a different balance in mono than there is in stereo. Therefore, caution must be exercised when panning microphones in such a multi-mic situation; whenever something is panned "hard left" or "hard right", or nearly so, be sure to check the mono sum in the monitors to verify that the relative levels are not seriously compromised in mono.

#### COINCIDENT MICROPHONY

For situations where the 3:1 rule cannot be followed, such as in classical music or sports broadcasts, where most sound sources are at some distance from the microphones, the way to maximize  $\Delta i$  is to use the so-called coincident microphone techniques. These provide "intensity stereo" through the use of a pair of directional microphones placed at the same virtual location, with their

axes of maximum sensitivity oriented in different directions. In this way, all sound arrives at both microphones at virtually the same time, thus minimizing  $\Delta t$ , but a stereo image is created by the differing output intensities of the two microphones, since they are directional microphones pointed in different directions.

The simplest of these techniques is the "X-Y" approach, in which two well-matched cardioid microphones are coincidentally placed, and oriented at right angles to each other, each of them  $45^\circ$  off-axis from the center of the sound source. (See fig. 3.)

A superior although more complex approach involves the "M-S" (Mid-Side) technique, pioneered by Alan Blumlein of Great Britain in the 1930's. Here, one microphone (usually cardioid) is oriented directly at the center of the sound source; this is the mid or M microphone. Meanwhile, a bidirectional (figure-8) microphone is oriented at right angles to the M microphone; this is the side or S microphone. By convention, the S microphone has its  $0^\circ$ -axis ("front") oriented to the listener's left. (See fig. 4.) The outputs of these two microphones are sent to a sum-and-differencing network (preferably after having been preamplified to line level - see fig. 5), which extracts a left and right signal in the following manner:

$$M + S = L \quad (1)$$

$$M - S = M + (-S) = R \quad (2)$$

$$\begin{aligned} L + R &= (M + S) + (M - S) \quad (3) \\ &= M + S + M - S \\ &= 2M \end{aligned}$$

In (1), a left output is created by the matrix when the outputs of the M and S microphones are summed, since they are coincident, and the S microphone is always of bidirectional pattern. This occurs because the rear lobe of the S microphone picks up sound coming from the right at an equal level and an opposite polarity to the M microphone (the two lobes of a bidirectional microphone are polarity inverted by definition). Therefore, the right-arriving sound is cancelled out of this sum function, and the left-arriving sound remains, being the sum of the front lobe of the bidirectional microphone (positive polarity relative to M) and the uncancelled portion of the M microphone's output. Therefore,  $M + S$  provides a left output, assuming the convention on orienting the S microphone mentioned above is followed.

In (2), the opposite effect occurs, since the S microphone's output is now polarity inverted, and then summed with the M microphone's output. This reverses the relationships of the bidirectional lobes, making the right-facing lobe now positive with respect to M, and the left-arriving sound is cancelled out of this summing function.

The equations in (3) show the derivation of a mono sum function in an M-S pair, which is shown to be simply the output of the M microphone. The S outputs cancel, and the remainder is  $2M$ , providing a level-matched mono signal, since it is the M microphone's output increased by 6 dB.

An additional feature of this matrix is an attenuator on the S microphone's level, ahead of the sum/difference network. This allows the stereo image width to be controlled, by varying the amount of "side" information injected into the matrix. This is especially helpful in compromising for problematic acoustics.

### MUSICAL APPLICATIONS - Classical

For classical music, optimum results can be achieved with two coincident pairs of microphones (preferably both M-S, each with its own matrix), where one pair is placed in the front of the hall, and one in the rear. (See fig. 6.) The front (or "main") pair is usually placed somewhere just over or behind the conductor's head (or at the geometric focus of the ensemble if there is no conductor). The rear (or "ambient") pair is placed somewhere in the middle of the hall, not more than 75 feet or so away from the main pair. Usually, this ambient pair is placed high, and oriented towards the back of the hall, unless there is a noise source or highly reflective surface nearby, in which case it can be lowered a bit, or oriented upwards or forwards. The main pair's height is a more critical adjustment, and should usually be as low as possible over the conductor's head height. These height suggestions provide for both a full orchestral sound (high placement over the orchestra or other classical ensemble usually results in a rather "thin" sound), and a homogeneous ambient and audience sound (low ambient pair placement can result in a dryer sound, with the applause from the nearby audience members -- and other unwanted audience sounds -- to be too "close" sounding).

When two M-S pairs are not possible, an M-S main pair and an X-Y ambient pair can suffice.

There are those who feel that coincident microphony lacks the "warmth", spaciousness, "richness", etc. of spaced microphone stereo techniques for classical recording (these employ 2 or 3 omnidirectional microphones spread across the front of the stage, usually), and that omnidirectional microphones are free from the undesirable coloration that directional microphones possess. These may be indeed valid criticisms. Nevertheless, the advantages of coincident techniques in terms of mono compatibility, accurate and stable stereo imaging, proper ensemble perspectives and presences, and efficiency of set-up for good results on quick, one-shot remotes, arguably outweigh those shortcomings, and with careful use of the dual M-S approach outlined above (using the highest quality directional microphones available), even those points can be adequately countered, in my opinion. Another option is a main M-S pair and a widely spaced (25 feet or more) pair of omnidirectional microphones back in the hall for ambient pickup. There may be some cancellation of ambient and audience sound in mono, but in some cases this may not be an altogether undesirable or unacceptable effect. This technique may serve as a reasonable compromise to those who are dogmatic devotees of the spaced-microphone camp.

On large classical works, "spot" or highlighting microphones may be required on certain instruments or sections to help them stand out sufficiently. This is often the case if it is not possible to place the main pair in the optimum location due to other constraints. Spot mikes should never be used as a matter of course, but only when they are absolutely necessary. Extreme care must be taken in their use: their panning assignments must match precisely the location of the instrument(s) they are highlighting in the stereo image of the

main pair. Their level must be minimal, so as not to give too close or "dry" a sound from these instruments. To aid in this, equalization, time delay, and artificial reverb may be used on spot microphones, but again, only as necessary, and with a careful ear. Although usually mono, spot microphones on large sections can themselves be stereo pairs, with the left and right pan assignments appropriately nested inside the main pair's image.

#### OTHER TECHNIQUES IN USE FOR CLASSICAL MUSIC

It should be mentioned that some other so called "near-coincident" techniques (ORTF, DIN, and others), and the "binaural" dummy-head microphone system ("Kunstkopf") are particularly inappropriate for broadcast in most cases, due to extremely poor mono compatibility. Stereo imaging on the near-coincident systems is also arguably inferior to coincident styles, and binaural, while good in this respect on headphones, suffers upon stereo loudspeaker reproduction, thus rendering it more applicable to record/tape distribution, where the listener can decide when headphone use is preferred. Some broadcast audio processing may also disrupt the delicate phase relationships essential to this system for satisfactory realism on headphone reproduction.

#### M - PATTERN VARIATIONS IN M-S MICROPHONY

The M microphone of the M-S pair need not always be a cardioid (although the S microphone must always be bidirectional). Varying the M pattern will affect the stereo image in interesting ways. The typical M as cardioid gives the effective result of two crossed cardioids at  $90^\circ$  (when M and S are at equal levels in the matrix), like the X-Y approach mentioned earlier. The M-S version is superior, however, since the center of the sound source is always directly on-axis to the M microphone, instead of  $45^\circ$  off-axis to each in the X-Y pair. Further, the mono sum of the M-S is just the output of the M microphone, instead of the in-phase sum of two (hopefully) matched microphones, as in X-Y. This accounts for the M-S technique's improved stereo imaging and mono compatibility. Of course, the additional advantage of electronically manipulating stereo width by means of the S-level control is an M-S exclusive.

Choosing an omnidirectional pattern for the M microphone gives the equivalent of two cardioids with  $180^\circ$  spacing (back to back). A bidirectional M microphone produces the effect of  $90^\circ$ -oriented bidirectional microphones (the so-called "Blumlein pair"), with each of the bidirectionals  $45^\circ$  off-axis to the center-line. This can provide marvelous stereo, and good mono, but placement of the pair is extremely critical and often difficult, because there is no discrimination between what's in front of and what's behind the microphones -- both are picked up equally. Variable pattern microphones can provide resultant patterns between these listed, for customizing to specific applications.

#### MUSICAL APPLICATIONS - Pop

These same coincident techniques can also be used successfully on pop music for close-miking in stereo of instruments whose sonic output make such effort worthwhile. These include drum sets, acoustic piano, percussion, background vocalists, and even acoustic guitar, at times. For live recordings of this type,

an X-Y or Blumlein ambient/audience pair is also quite useful in conveying the excitement and "space" of the live environment to the listener.

#### OTHER RADIO APPLICATIONS

Stereo microphony should not be limited to musical programming. It can be a valuable asset to documentary, sports and even news broadcasts -- whenever there is an aural panorama worth capturing and presenting to the listener. A surprising degree of enhancement to the realism and audience involvement in the program can be added by these techniques.

An interesting interview technique for location recordings (where the aural environment warrants it) involves the use of an M-S pair with the M pattern set at bidirectional. The interviewer and guest are seated on-axis to the two lobes (0° and 180°) of the M microphone. This creates a pleasing stereo image for the interview, and keeps both voices in the center of the image, rather than the more primitive "ping-pong" technique where one voice is panned left and the other panned right. See fig. 7.

Moreover, in this or any remote/portable situation where only one M-S pair is used, the sum and difference matrixing need not take place on location during the original recording, but the M and S outputs may be recorded directly onto the two tracks of a stereo recorder, and matrixed upon playback or dubbing in a studio. On-site monitoring is performed by listening to the M-track only.

Another use for such a set-up is in "stereo soundgathering", a sort of ENG for radio documentaries. Elements other than interviews (SFX, actualities, ambiences, etc.) are recorded with some sort of coincident (also called "single point") stereo pair. Care must be taken here to insure sufficient shock-mounting and windscreening on the microphones.

On occasions where general outdoor ambiances are required, widely spaced (25 feet or more) omnidirectional microphones are useful as a stereo pair, if the set-up does not require hand-held mobility. Use good wide-range dynamic or electret condenser omni's on stands, or pressure-zone type microphones on the ground or another boundary surface. Omnidirectional microphones are less susceptible to wind and vibrational noise, and with that wide a spacing, a very "big" stereo image is produced, with mono cancellation usually reduced to acceptable amounts. Often, a "hole-in-the-middle" of the stereo image may occur, but this can actually be helpful when recording ambience that is planned to be voiced-over, since the announcer's voice can sit right in the hole, with the stereo sound of the bed enveloping it nicely.

#### STUDIO VOICES

For most announcing or studio interviewing, stereo microphony is usually more trouble than it's worth. For multiple-guest interviews, you might just try a bit of pan-pot manipulation on the different guests, or the use of stereo synthesis on announcer (or any) microphones. The latter can apply on a D.J. microphone as well. Beware of mono-incompatibility on some stereo synthesizers. The mono sum of the output should be indistinguishable from the input, at any

setting of the unit's controls.

### SPORTS APPLICATIONS

Radio has a distinct advantage over television here in that unlike TV's constantly changing camera angle, location and perspective, radio's "sound of the game" is relatively static throughout a broadcast. Therefore, a very literal stereo image can be built for the listener, using the layout of the field as a guide. Start with a centrally placed coincident pair, and add spot "action" microphones where appropriate, panning them corresponding to their location on the field. Mix all these down to a stereo submaster, and add the announce microphones (with panning or stereo synthesis as described above, perhaps), stereo carts, etc., and you have a stereo sports program. See fig. 8.

### MONITORING

For stereo remote recordings and broadcasts, it is important to monitor on a reliable set of stereo speakers, in a reasonably quiet, isolated room, rather than on headphones in the same room as what you are recording/broadcasting. Also, always have a simple way of checking the mono sum of your mix in a level-matched fashion, i.e.:  $(L+R) - 6$  dB.

### CONCLUSION

It is essential to recall throughout these discussions of technology, that a program's content must dictate the means of its presentation, not vice versa. So rather than forcing stereo upon a program, be open to programs' content for ways that stereo presentation may enhance their listenability.

With that in mind, be on the lookout for new applications; but be aware of the extra work and perhaps expense involved in a stereo application as compared to its mono counterpart. Think also in terms of capturing the natural space of a soundfield, rather than going simply for a "ping-pong" approach. And always remember to check the mono sum in the monitors.

Although a lot has been covered here, we have really just scratched the surface. Consult the references below for further information, and above all, try some of these things out for yourselves. Make stereo sound a part of your routine, and bring your listeners a higher class of audio fare.

### REFERENCES

Wesley L. Dooley and Ronald D. Streicher - "M-S Stereo: A Powerful Technique for Working in Stereo". Journal of the Audio Engineering Society, Vol. 30, #10, October 1982, pp. 707-718.

John Eargle - Sound Recording (2nd Edition). Van Nostrand Reinhold Co., New York, NY. 1980.

John Eargle - The Microphone Handbook. Elar Publishing Co., Plainview, NY. 1981.

Skip Pizzi - "A 'Split-Track' Recording Technique for Improved ENG Audio". Journal of the Audio Engineering Society, Vol. 33, #4, April, 1985.

Skip Pizzi - "Stereo Microphone Techniques for Broadcast". AES preprint #2146 (D-3). Presented at the 76th AES Convention, New York, NY, October 1984.

John Woram - The Recording Studio Handbook (Updated Edition). Elar Publishing Co., Plainview, NY. 1982.

FIG. 1 -  $\Delta t$  of A Spaced Microphone Pair

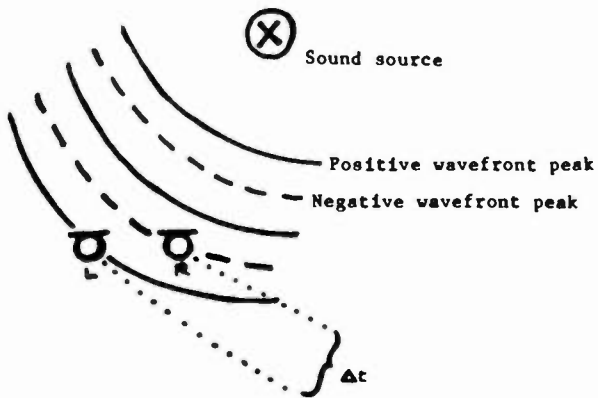


FIG. 2 - The "3 to 1" Rule

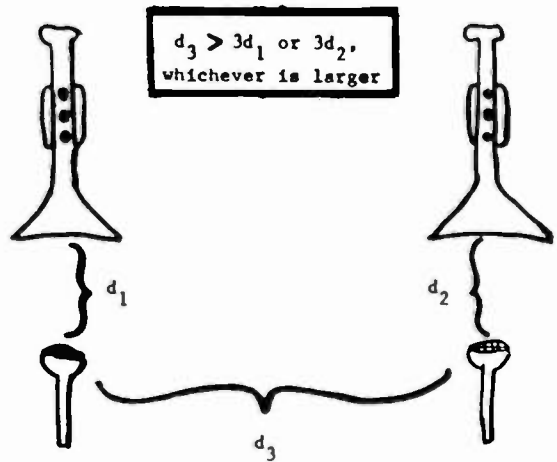


FIG. 3 - X-Y Polar Plot

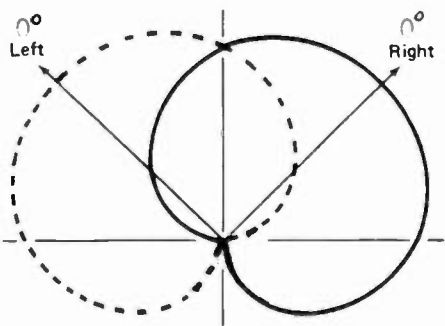


FIG. 4 - Typical M-S Polar Plot

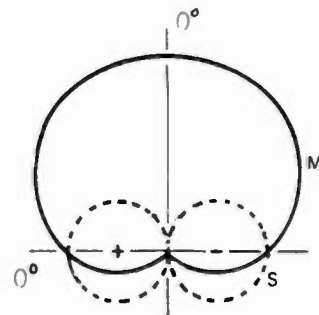
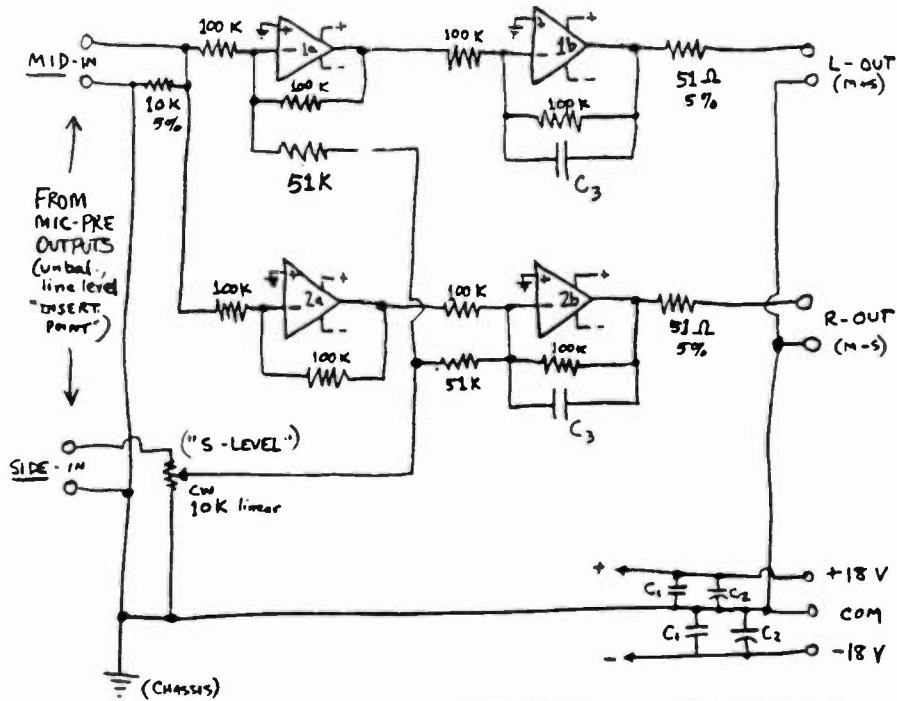




FIG. 5 - M-S Matrix Schematic



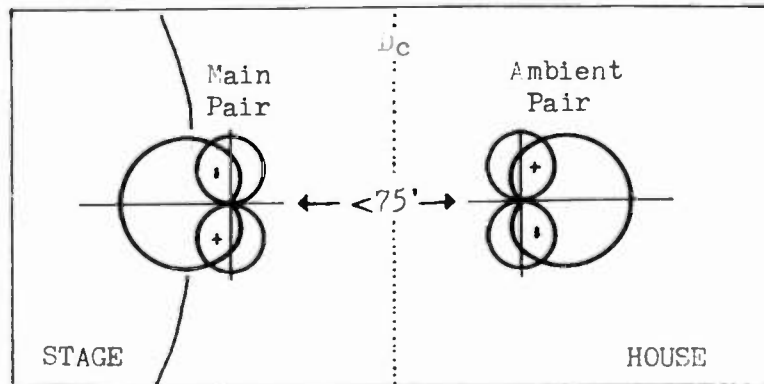
**OPERATION:**

- 1) W/S-LEVEL OFF (CCW), ADJUST MID MIC-PREAMP GAIN TRIM FOR PROPER LEVEL. THEN SET SIDE MIC-PREAMP GAIN TRIM TO THE SAME APPROX. POINT.
- 2) ADJUST S-LEVEL FOR DESIRED STEREO IMAGE WIDTH.

IC 1, 2 = 5532  
 ALL R = 1%, 1/2 w. metal film  
 $C_1 = 0.1 \text{ mf}$  polystyrene  
 $C_2 = 100 \text{ mf}/25\text{v}$  electrolytic  
 $C_3 = 10 \text{ pf}$  polystyrene

Designed by Neill Muncy

FIG. 6 - Dual M-S System Plan



$D_c$  = Critical Distance, i.e.: point at which direct sound = reflected sound.

FIG. 7 - M-S Interview Plan

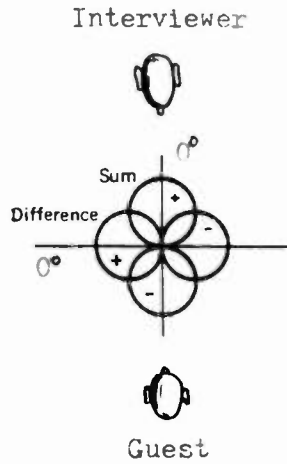
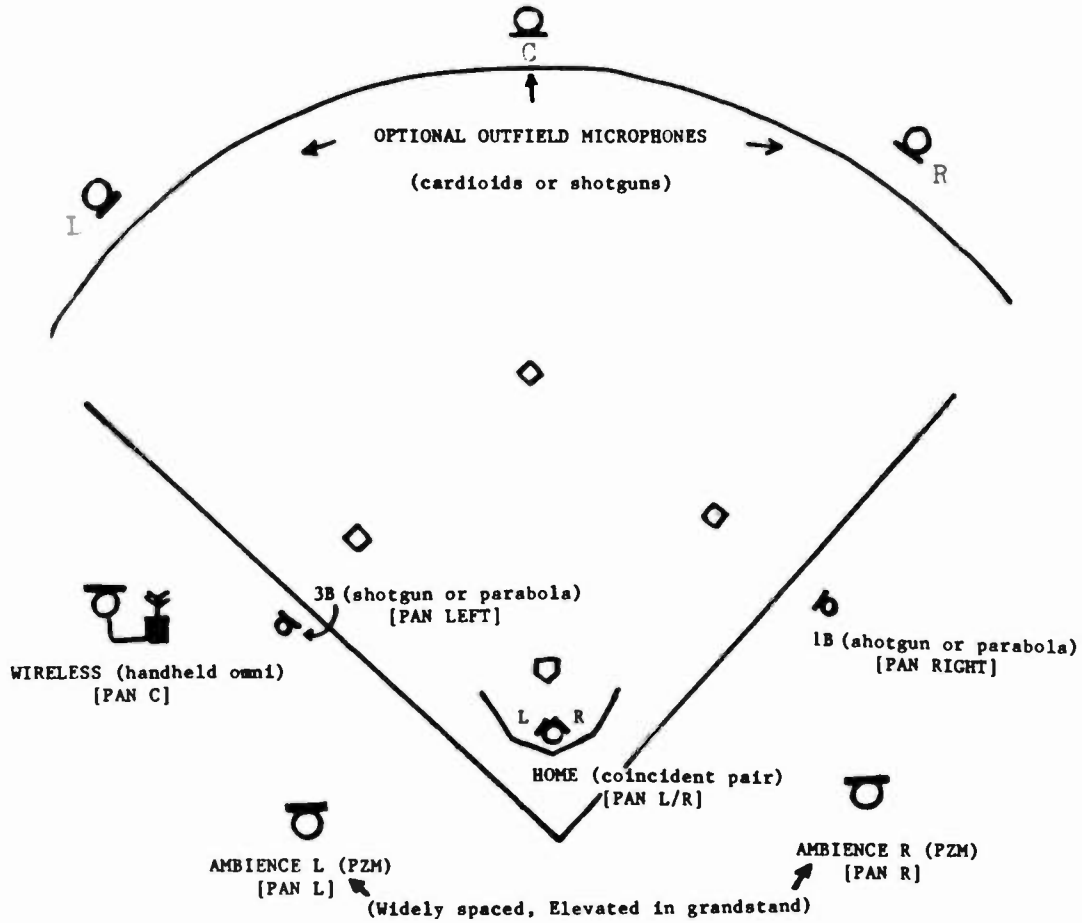


FIG. 8 - A Proposed Stereo Baseball (for Radio) Plan



---

## THE CONUS DUAL VIDEO SNG SYSTEM

**Raymond A. Conover**

**Conus Communications Company**

**Minneapolis/St. Paul, Minnesota**

The concept of a highly mobile satellite news gathering system was first discussed at Hubbard Broadcasting, the managing general partner of Conus Communications, in the late 1970's. The discussion was prompted by the success of terrestrial microwave systems that had received wide use as television news operations turned to electronic journalism. Another factor that affected our thinking was the need to cover the rather large coverage areas of our television stations. Truck and portable microwave systems, while very effective in a metropolitan area, were simply not providing the necessary range for television stations that had wider distribution via translators and cable systems. With the additional signal distribution by translators and cable systems, television stations such as ours were effectively regional television stations, and we were exploring ways in which the new technologies of television might allow us to match on the input side of our broadcasting system the coverage provided on the output side. Then there was the additional problem of how to cover news events that happened in distant cities but nevertheless had an impact in our viewing area. The state-wide coverage problem could be solved with terrestrial microwave links, but only at a very great cost and with a rather limited number of access points into such a system.

The emerging domestic satellite business appeared to provide the most logical solution to our immediate statewide problems, as well as to the more difficult problem of how to deal with live remotes from distant cities. With our SNG (satellite news gathering) requirements in the back of our minds, and realizing that an economical distribution medium was upon us, we did what many other television operations did, and installed C-band receive facilities. However, in analyzing the existing C-band capacity at that time, we realized that our goals of a highly mobile satellite news gathering unit would not be realized at C-band. The complications of frequency coordination would be a continuing headache in operating such a unit. We speculated at the time about what a Ku-band unit might look like, and how it might perform, but since there was no existing domestic Ku-band capacity at that time we realized that we would just have to wait until such time as the space hardware would be available to us.

With the advent of appropriate spacecraft capacity in the 1980's, we went ahead with a prototype program to test the practicality of a satellite news gathering system. The first unit was built for us by Telesat Canada based on a successful unit of theirs that was designed to work with their Anik-C series satellites. The success of this system in our early tests gave us the necessary incentive to go ahead with a broadcasting partnership that eventually became the Conus Communications system.

### THE CONUS SYSTEM

The Conus system was created as a means of providing economical access to satellite news gathering by local television stations. Stations participating in the Conus system are actually partners in the business. We realized very early that it would not be practical for any one television station to own a transponder, yet this seemed to be the only way to achieve an attractive rate and sales structure as well as guaranteeing short notice access to space time. On the other hand, a number of television stations sharing a transponder seemed to be a very practical approach to moderating the cost of ownership while at the same time securing the benefits of ownership for all the partners. With a guaranteed minimum amount of space capacity, it would also be possible to configure a control center for the expressed purpose of supporting television news gathering in the field. This support includes communications services, flexible scheduling arrangements, time sales in small increments, and other support services that would be difficult or impractical for any one station to do alone.

Each partner station is expected to bring to the partnership the necessary receive hardware for its own use, as well as its own mobile uplink truck. Stations are free to equip these trucks in as elaborate or as simple an approach as they deem necessary for their requirements. By having a large number of partners spread over a wide geographic area, a partner station has rapid access to news events happening in remote areas. In many cases, stations are only required to cover with their vehicle their own immediate coverage area. Major news events happening outside that area can frequently be accommodated through another partner's mobile uplink truck, thus requiring a station only to fly a reporter, photographer, and perhaps a producer to the scene of a distant news event.

### DESIGN GOALS AND REQUIREMENTS

Economic and traffic considerations dictated right from the start that each transponder used in the system must accommodate at least two video channels that could originate from two different geographic locations. Since considerable performance is traded away in requiring two video channels per transponder, that criteria drove most of the rest of the design process in terms of video performance. Most of the existing literature on performance of dual video systems indicated that some degree of transponder input backoff beyond the 3db required for power sharing would be needed to avoid crosstalk problems in the transponder. Input backoff has a db for db impact on the uplink C/N, and a nearly direct impact on the video S/N. Analysis of other dual video systems indicated that if crosstalk was eliminated, and a satisfactory video S/N was obtained, then other signal characteristics would be satisfactory for the type of news service we contemplated.

There was considerable discussion on what S/N was good enough, since this quantity, once arrived at, would determine in large measure whose transponder we

would buy. As demonstrated by a large pool of ENG experience, we realized that getting the news was frequently more important than what the news looked like once you got it. So, we looked at a variety of ENG performance values that had proven to be acceptable in day-to-day broadcast operations, as well as over-the-air tests of satellite circuits. Since there are no bad paths in satellite transmissions, the pictures always appear sharp and clean (assuming they started out that way) even when they are fairly noisy. After much discussion and comparison with existing ENG material we decided on a video signal to noise ratio of 48db as being the minimum acceptable standard over our satellite system. With our 48db in hand we set off to design a system that would deliver this performance or better.

### The Mobile SNG Unit

The mobile SNG unit, in order to meet our design goals of high mobility, had to be based on a truck body of medium size that would be easy to park, easy to drive, and not face any special problems in going anywhere roads go. This dictated a truck size in the range of a large van to a small RV. Since quick, easy operation of the antenna system was a fundamental goal, we decided that antennas that fold were not acceptable. Since maintaining a modest height requirement and a simple hands-free antenna deployment method were also important, we limited our antenna diameter to eight feet, the maximum width that most states allow for ordinary vehicles. Having committed to such a small antenna diameter did not stop us from being equally insistent that our small antenna would meet the necessary 2° requirements so that its use would have a long life. Andrew Corporation promised to deliver an 8 ft. antenna meeting the 29-25 log θ requirement. This antenna became available for the first production trucks, and has performed better than anticipated.

Having made these fundamental decisions on the size of the vehicle and the size of the antenna, we turned our attention to the RF power system that would be a likely candidate. The ability of this sized vehicle to generate electrical power, as well as its size and weight restrictions, indicated to us from our survey of available RF equipment that transmitter powers on the order of 500 to 600 watts would be the maximum size that would conveniently fit into this kind of truck while still allowing for a modest amount of video production equipment. This combination of antenna size and transmitter power will produce a power output of over 75dbW. (See Figure 1.)

<u>Maximum SNG Unit EIRP</u>		<u>SNG Unit G/T</u>	
Frequency	14.32GHz	Frequency	12.02GHz
Antenna Diameter	2.40M	Antenna Diameter	2.40M
Antenna Gain	49.50db	Antenna Gain	48.00db
Power (600W)	27.78dbW	Miscellaneous Losses	.20db
Tx Line Loss	-1.70db	System Noise	230.00K
Uplink EIRP	75.58dbW	Receive G/T	24.18db-K

(Figure 1)

(Figure 2)

On the transmit side I can trade transmitter power for antenna size, but I can't do that on the receive side. (See Figure 2.) The eight foot antenna produces a rather poor receive site. Our requirements for video reception, though, are only that the quality is sufficient for monitoring our transmissions. As a

result, the mobile unit's receive system tends to have rather poor video quality, especially when viewing the two carrier per transponder transmissions.

The units employ a low phase noise frequency stable 180° block down converter that would be unnecessary if video was the only receive equipment. The sophisticated down converter approach was employed to allow the reception of our SCPC-based communications system. Since I do have control over the power level of the communications carriers, I can dedicate more power to them, thus accommodating the small receive antenna without stealing significant power from the two video carriers.

### The Receive Only Terminal

In order to receive transmissions from its own mobile unit as well as from the mobile units of its partner stations, a television station must install a receive only terminal. The specification for the receive only terminal calls for an antenna of 5 meters or greater in diameter, and a noise temperature of 180° or better. Antennas larger than 5 meters but smaller than 7.5 to 8 meters are easy to license as either transmit-receive or receive only antennas, while still being a size that is not unreasonably expensive or difficult to install. The 180° noise temperature was chosen simply because that's the point where the price of low noise amplifiers starts to rise dramatically. Using these criteria our receive terminal has a G/T of 31.5db-K or better. (See Figure 3.)

#### Typical TVRO for Broadcast Stations

Frequency	12.02GHz
Antenna Diameter	5.60M
Antenna Gain	55.30db
System Noise	230.00K
Receive G/T	31.68db-K

(Figure 3)

#### Selection of a Transponder

We evaluated three satellites that would be available to us with the necessary capacity in the time frame that we required. The satellites we looked at were GTE's G-STAR and Spacenet, and SBS's SBS-III. All of these satellites employed approximately the same RF power output in the 16 to 20 watt range. With the same power levels to choose from, it was simply a matter of selecting which satellite did the best job of using its power and which satellite had the best uplink characteristics. The G-STAR spacecraft had an interesting downlink beam switching arrangement that allowed the use of a half conus beam that would increase the satellite's effective transmit power. Our evaluation of the location of potential partner stations, however, suggested that beam configurations of other conus coverage would be desirable. The Spacenet and G-STAR also had switchable attenuators in their receivers that would allow a constant receive G/T, but vary the saturating flux density. This gain setting ability is an advantage in that it lets you use the optimum transmit power from your uplink stations, enabling you to maximize your carrier to noise ratio while producing output saturation.

Our evaluation revealed that the SBS-III had, by a significant margin, the best uplink G/T as well as high sensitivity. The satellite also had the best

downlink antenna pattern, producing more consistent EIRP's across the most populated parts of the country, as well as at higher EIRP levels. The spacecraft's only drawback was its somewhat narrower bandwidth, which would have a significant impact on two-carrier operation. Computer analysis revealed that all three satellites produced roughly the same video performance since the greater bandwidth of the GTE satellites allowed using higher video deviation, thus producing an improved video signal to noise ratio even though the carrier to noise was somewhat lower than the SBS satellite.

The final decision swung in favor of SBS on the basis of essentially equal video performance, but with a higher value of carrier to noise in the link budget. The half-transponder video would have greater fade resistance if the signal consisted of more real carrier to noise than FM improvement ratio. The SBS spacecraft also had the distinct advantage of already being in orbit and available immediately. Additionally, the engineering staff at SBS claimed that we could operate our two video carriers with the transponder at saturation, giving us an uplink carrier to noise improvement of 2db over what was recommended to us by GTE for their satellites. I was skeptical of this operating strategy since past work done in two-carrier video transmissions suggested that an input backoff of greater than 3db would be required to keep intermodulation, and intelligible crosstalk, at acceptable levels. To allay our fears, SBS arranged for extensive tests of their satellite to demonstrate that operation with two carriers at saturation would be feasible, and to define the technical characteristics of our system.

Definition of the Conus Dual Video Transmission Format

The SBS series of satellites was designed to support SBS's TDMA (time division multiple access) digital transmission system. Knowing this, the spacecraft design called for extremely good transponder characteristics and good transponder output filters. It was on the basis of this superior spacecraft design that SBS was confident that we could operate our dual video system at saturation.

The tests consisted of an empirical analysis of various IF filter bandwidths, carrier spacings, deviation levels, and subcarrier parameters. We consumed about four days at SBS in varying these values to arrive at the transmission standard that is shown in Figure 4. Once we achieved a dual video standard that worked when it was set up properly, we proceeded to test the robustness of the system by intentionally doing things wrong. These tests included over powering one of the two carriers, under powering one of the carriers, putting up improper sub-carrier frequencies, as well as a variety of smaller mistakes that would likely be made.

Conus SBS Transmission Standard

Frequency 1	-12.00MHz	ref Tx center
Frequency 2	+12.00MHz	ref Tx center
Video Deviation	7.50MHz	
Subcarrier 1	5.41MHz	
Subcarrier 2	5.76MHz	
Upconverter BW	24.00MHz	
Receive BW	20.00MHz	

(Figure 4)

After defining the system, we set out to measure the performance of the system when it was properly implemented. The measured value is within the error window of the calculated value. (Figure 5.) The error window consists of pointing errors and atmospheric absorption errors that may or may not have been present at any given point in time. The much-feared operation at saturation worked as advertised, and did not seem to produce undesirable side effects. All the intermodulation products that were of serious consequence fell at frequencies that were effectively removed by the transponder's output filter, causing no harmful interference to our neighboring transponders.

### Clarksburg Dual Video Tests

#### Uplink

Frequency	14.46GHz
Antenna Diameter	7.70M
Antenna Gain	59.00db
Tx Power	11.01W
Tx Line Loss	1.70db
Uplink EIRP	67.71db
Pointing Error	.80db
Atmospheric Absorption	.30db
Pathloss	207.13db
PFD at Sat	-96.00dbWM <sup>2</sup>
Sat G/T	4.00db-K
Uplink BW	20.00MHz
Uplink C/N	19.06db

#### Downlink

Frequency	12.16GHz
Antenna Diameter	7.70M
Antenna Gain	57.46db
System Noise	260.00K
Downlink G/T	33.31db-K
Sat EIRP	42.00dbW
Pathloss	205.61db
Pointing Error	.80db
Atmospheric Absorption	.20db
Bandwidth	20.00MHz
Downlink C/N	24.30db
Interferences C/I	31.50db
System C/N	17.74db
Video S/N	53.13db

#### Measured Performance

Video S/N	53.76db
-----------	---------

(Figure 5)



In the course of the tests we discovered certain characteristics that are crucial to dual video operation. It is vitally important that the overall modulation level be maintained to close tolerance so as to not deviate the carrier into the neighboring video carrier's bandwidth. The most common cause of cross-talk was due to camera video generating components well above the normal video pass band, and thusly overdeviating the carrier. A good quality 4.5MHz video low pass filter successfully eliminates this problem. Other problems relating to audio transmission were successfully resolved by reducing the overall carrier deviation by employing lower frequency audio subcarriers. The common audio subcarriers of 6.2 and 6.8MHz were needlessly high for our SNG system.

The uplink performance of the dual video transmission is uniform across the Continental U.S. The transmitted power is varied in each location to produce a signal half the strength required for saturation. This produces an uplink C/N of 20.06db for receiver 2 (normal) or 19.06db for receiver 1 (spare). This operating point can be reached with a Conus unit anywhere in the Continental U.S. The power required varies from about 80 watts in the Washington, D.C., area to over 500 watts in Miami.

The system performance is thus determined solely by the downlink performance. For example, in Figure 6 we see the link budget for Las Vegas where a 16.75db system C/N produces a 52.13db video S/N. In Washington, D.C., where the signal is 2db stronger, a system C/N of 17.62db and a video S/N of 53db would be expected.

#### Link Budget

##### Uplink (Las Vegas)

Antenna Gain	49.10db
Tx Power	253.06W
Tx Line Loss	1.70db
Uplink EIRP	71.41db
Atmospheric Absorption	.30db
Pathloss	207.13db
Satellite G/T	.50db-K
Uplink C/N	20.06db

##### Downlink (Las Vegas)

Antenna Diameter	5.60M
Antenna Gain	55.30db
System Noise	230.00K
Receive G/T	31.68db-K
Sat EIRP	39.00dbW
Pathloss	205.61db
Pointing Error	.60db
Receive Losses	.30db
Receive BW	20.00MHz
Downlink C/N	19.77db
Interferences C/I	31.50db
System C/N	16.75db
Video S/N	52.13db

(Figure 6)

When the mobile unit is used to provide an uplink of a full transponder saturating signal, its performance cannot be distinguished from that of any other uplink. When operating with the SBS satellite, the 600 watt transmit capability provides a saturating signal in nearly all of the United States. The only transmitting advantage that a larger size uplink has with the SBS system is the ability to oversaturate a transponder. This is a technique that is sometimes used as a method of uplink fade margin. Maximum oversaturation that SBS allows of its transponders is 3db. Three db oversaturation is possible from the mobile unit in many areas of the country where the satellite's uplink pattern is most sensitive. In these situations, the performance of the mobile unit is identical to any fixed station, and allows end-to-end video performance of over 60db.

#### Communications Sub-system

As amazing as the transmission of video from such a highly mobile truck might seem, the ability to talk to it is far more difficult to implement. The frequency stability and noise requirements of all the components in the system are far more demanding when a simple audio channel only a few tens of kilocycles wide is transmitted through frequencies in the tens of gigahertz. As important as the video part of our system is, it becomes useless if we cannot support it with communications that enable us to control and coordinate our television transmissions. Toward that end Conus has designed and is equipping trucks in the system with a communications system that will greatly enhance the capabilities of the small mobile truck. Speed and efficiency are the keys to a news system, and the burden of connecting to telephone lines is not conducive to speedy operation. So we set out from the beginning to provide a truck that could operate without the previously necessary connection to the telephone network, a totally satellite-based system. We wanted to provide every truck with the basic necessities of live news remotes.

Our communications system was designed to provide each truck with an IFB (interruptable feedback), a duplex PL (private line), and a satellite-based two-way radio. The IFB and PL are available on a dedicated basis to those trucks that are uplinking video. The two-way radio is available to those trucks that are not transmitting video. The two-way radio circuit can be used even if the transponder is full of video traffic.

The communications sub-system also includes a data system featuring a microcomputer that serves as a technical watchdog in the mobile unit to prevent errors, and to protect other users against equipment failures. In addition to its watchdog function, the computer provides schedule information, and other information that would otherwise keep a voice channel needlessly busy. The data system, which can also be received at the television station's receive only terminal, will provide valuable information to news producers as well as to crews in the field. The data system also will allow trucks and stations alike to transmit electronic mail through the system, once again taking the burden off the voice circuits.

Conus has established a control center in St. Paul to provide the interface between stations and the satellite communications circuits. IFB and PL circuits will go to St. Paul by telephone, and then by satellite to their mobile unit. The data system, which is part of our Master Control facility in St. Paul, stores and routes electronic mail and other system information between points in the Conus system.

## The Future

In the future we look toward expanding our inventory of space capacity as well as having our communications and data systems move us toward greater efficiency with our existing space capacity. During the peak news hours of the day when the demand is at its highest for space time, the efficiency of the communications system can make a dramatic difference in the number of stations that can be accommodated in a small amount of time. We will work toward expanding the role of the communications system at the television receive terminal so that the system provides more and more information to the assignment editor and ready communications with the mobile crews wherever they might be.

We also look forward to new technologies to bring us even smaller and more portable uplinks for news events that are tough to reach by conventional vehicles. These same technologies may also allow more than two videos to be sent through one transponder. Someday, naturally, I would enjoy designing a satellite specifically for satellite news gathering. The existing domestic satellites typically ignore the requirements of a principally uplink-sensitive customer, concentrating instead on the downlink side.

## Conclusions

While the purpose of this paper has been to discuss video performance, we at Conus have developed a satellite news gathering system that represents more than just transmission of video from the field; rather, it represents a complete system of communications, video, and support of stations' news gathering efforts. It allows for the first time economical access to satellite news gathering technology for local television news.

---

DESIGN CONSIDERATIONS FOR---  
NEWS EXPRESS: THE FLORIDA NEWS  
NETWORK'S MOBILE KU BAND SATELLITE SERVICE

W. Bramwell Flynn

Dalsat, Inc.

Plano, Texas

In the fall of 1984 Dalsat began discussions with a group of Florida Broadcasters. This group representing Jacksonville, Tampa/St. Petersburg, Orlando and Miami were in the process of forming what is now known as the "Florida News Network" (FNN). The key individuals tasked with developing this network had investigated alternative methods for exchanging video products and had selected satellite for their transmission medium. It was also decided that the network would be built around transportable video uplinks and fixed receive only downlinks.

The intent of this paper is to outline critical areas which must be addressed when architecting an SNG (Satellite News Gathering) network.

Why satellite? Their desire was to increase coverage within news market areas. Areas in which current microwave Electronic News Gathering Systems (ENG) were limited in operation. They also sought the ability to share any product live or taped, in real time within the group. Given the proper system design considerations, Satellite represented maximum flexibility for multipoint access and distribution within the continental United States or its bordering neighbors. It allowed any member within the group direct access to any story being uplinked from a group members transportable. Satellite facilitated discrete frequencies in the network design. The frequency formats available on domestic communications satellites are C-band with the transmit/receive frequencies of (5.925-6.425)/(3.7-4.2) gigahertz and Ku-band whose transmit/receive frequencies are (14.0-14.5)/(11.7-12.2) gigahertz.

C-band or Ku-band? When evaluating this system design alternative, pros and cons of the two formats must be considered.

C-band systems are typically designed around 2-3 dB fade margins which yield excellent system availabilities with respect to rain fall. However, transportable C-band video systems require careful frequency coordination prior to FCC approval for uplinking. This can be time consuming and restrictive to operations. The reason for this coordination is that the majority of the backbone microwave system in this country operate in the same frequency band as satellites. A typical C-band video transportable system designed to saturate a transponder from anywhere within the United States requires a 4.5 meter antenna system and a 3 KW klystron amplifier.

Ku-band systems require careful design considerations with respect to fade margins due to their susceptibility to rain attenuation. Frequency coordination for Ku transportables present few problems for FCC licensing of uplink operations. The reason for this, there are only four areas where satellite Ku-band frequencies are shared with other users. The locations of these areas as identified by Compucon are:

- 0 Vandenberg A.F.B., California
- 0 Pt. Magoo N.A.S.: Oxnard, California
- 0 Ft. Bragg, Fayetteville, North Carolina
- 0 Bolling A.F.B., Washington, D. C.

These areas will require careful coordination prior to uplink approval to eliminate potential frequency interference. There are other users operating at Ku band, however, they are considered secondary users with respect to satellite operations. Transportable Ku band video systems allow a broader design range for hardware configurations.

All points considered, for a news department to virtually unrestricted its geographical access, and response time, in originating a satellite news story, a Ku-band system would be required.

The Florida group through its extensive evaluations had identified Ku-band for its network operation.

It should be noted that an SNG network pioneered by CONUS Communications is in operation. Offering turnkey 2.4 meter transportables, R/O hardware and Ku-band satellite distribution, this network has demonstrated its dynamics for broadening news gathering.

The initial meeting with the Florida Group (FNN) identified the variables to be considered in standardizing their networks. The highlights of which are:

- 0 Autonomy
- 0 Maximum Connectivity
- 0 Ku-band Propagation Reliability
- 0 System Analysis and Design Tradeoffs
- 0 System Growth

Autonomy. In discussion of their goals concerning this point several key issues must be addressed. As a newly formed statewide satellite news network this group perceived other regions establishing similar networks. They desired unconditional control of their product allowing them the ability to exchange product with any other such network as they developed. They also sought total control of their daily coordinations and operations of their system. Mel Martin, Vice President News for WJXT, summarizes these points by saying "I want the ability to interface with the world".

Maximum connectivity. In order to achieve the goals for autonomy the network would have to be built around a non-partisan common carrier. A carrier who could offer the maximum flexibility and growth potential for multi video transponder access, which would ease foreseeable congestion during peak news periods. This would also increase the user base which would enhance the opportunities for news sharing from a single point.

Another key area to be addressed for achieving maximum connectivity is coordination circuits. In a news gathering environment the necessity of coordination circuits is imperative. As a minimum there should be two circuits available. One to cue a reporter in the field under live feed conditions, i.e., IFB (Interrupt Feed Back), and another to operate as a standard telephone which would be available prior to video uplinking for pre coordination. Several methods for obtaining these circuits in a transportable are available, one being direct telco interface the other being cellular radio, however, in order to assure access from any location satellite circuits would be required. This capability further defines requirements of the service capabilities a common carrier must furnish. In summary the necessary service to compliment the network needs would require video and FM SCPC (Single Channel per carrier) voice.

The common carrier best suited for addressing the Florida news network needs, for partial voice and occasional video transponder access was GTE Spacenet. They had three satellites offering Ku-band service in orbit and two more scheduled for 1985 launch. The marketing department at GTE was currently investigating the trends in SNG. When approached by Dalsat and the FNN they were very interested in discussing these needs. GTE was asked to make video and voice segments available for occasional use. In addition they were asked to consider using their existing TT & C (Tracking Telemetry and Control) centers for the head-end of the voice circuits allowing interface to standard 2 wire telco lines. A network configuration of this type would be very advantageous to the broadcaster because they would not require up-link capability from their fixed R/O earth station. This would allow a substantial cost savings in hardware and operations. The recurring monthly costs would also be limited when sharing these SCPC circuits with other users on a daily basis.

What has developed from the efforts of the three parties is a very flexible network scheme offering video and voice access thru GTE's Spacenet II Satellite, achieving the goal for maximum connectivity. Figure 1 depicts the block diagram of the voice circuits operating into GTE's Woodbine, Va., earth station. The FM SCPC carriers will be placed in a transponder dedicated to voice and data

carriers. On a daily basis at scheduled times, operators will be assigned a video transmist frequency and channel number for the telco and IFB circuits in their transportable. The design of the voice system is totally automatic requiring no operator intervention. When the transportable operator has peaked the antenna system on Spacenet II, selected and activated the telco circuit the FM SCPC carrier from the transportable will be received at Woodbine which in return will transmit back the associated duplex carrier. The standard touch tone or rotary dial, telephone in the transportable will then become an extension of the associated telco line at Woodbine. The transportable may now originate or receive long distance telephone calls. The equipment used for achieving this service is standard to the telco industry. The IFB circuit associated to the feed will be originated by the broadcast station. When communications with the transportable via the satellite telephone have been initiated, prior to the video feed, and last minute details have been addressed, it will now be necessary to activate the IFB circuit. For the broadcast station to originate the IFB circuit to the transportable, a telephone call to Woodbine, Va., will be required. Dialing the number associated to the assigned IFB channel will cause the Woodbine telco lines to automatically answer. When the line has answered, the FM SCPC carrier associated to this circuit will be transmitted to the satellite. The IFB receiver in the transportable will then detect the carrier and pass the audio originating from the broadcast station. To further enhance the system capabilities emergency coordination circuits will also be available for addressing unscheduled feeds. These circuits will be assigned a channel number selectable from the telco channel selector in the transportable. When an emergency coordination circuit has been selected and activated via Spacenet II the transportable operator need only lift his satellite telephone off hook. An auto dialer associated to the telco interface line will automatically call the GTE operator assigned to coordinating SNG video and voice circuits. The initial phase one voice circuits which will be made available by GTE will include four assignable telco channels, four assignable IFB channels and one emergency coordination telco channel. Preliminary discussions concerning growth capacity will allow for up to thirty telco channels, eighteen IFB channels and two emergency coordination channels.

Ku-band propagation reliability. The following is a summary of Dalsat's conclusions regarding the recent rain study for NBC. Bob Butler of NBC has given his permission for this information to be made available for your evaluation.

We were asked to measure the amount of time that receive only earth stations are unavailable due to the effects of rain on the propagation of television signals from a Lower Power Ku-Band satellite transponder. In particular, 10 foot Ku-band antennas and nominal electronics were used in the rain belt cities of West Palm Beach, FL, and Dallas and Houston, TX. A signal was declared unavailable when the Signal to Noise Ratio was reduced by 6 dB, which meant an absolute Signal to Noise below 45 dB.

The table below summarizes the results. The figures expressed are in minutes with the exception of Availability Ratio. The total test period consisted of 218,880 minutes.

<u>Site Location</u>	<u>Op Test Time</u>	<u>Service Interrupted</u>	<u>Availability Ratio</u>
West Palm Beach	154,920	268	.99827
Houston	175,798	316	.99820
Plano	183,640	162	.99912
<u>Annualized</u>			
West Palm Beach		910	
Houston		945	
Plano		432	

Although 3 meter antennas and a low power transponder on the SBS-3 satellite were used, availability ratios of .998 or greater were achieved at all locations.

Rain attenuation is determined by the length of the signal path which is experiencing the rain and is affected by the rain rate, expressed in inches per hour.

The standards used by most Engineers indicate that rain will attenuate Ku-band downlink signals by 1 dB/Km per inch/hour.

According to National Weather Bureau data, rain does not occur above approximately 14,000 feet. Therefore, the vulnerable path length is that portion of the rain path which is below 14,000 feet.

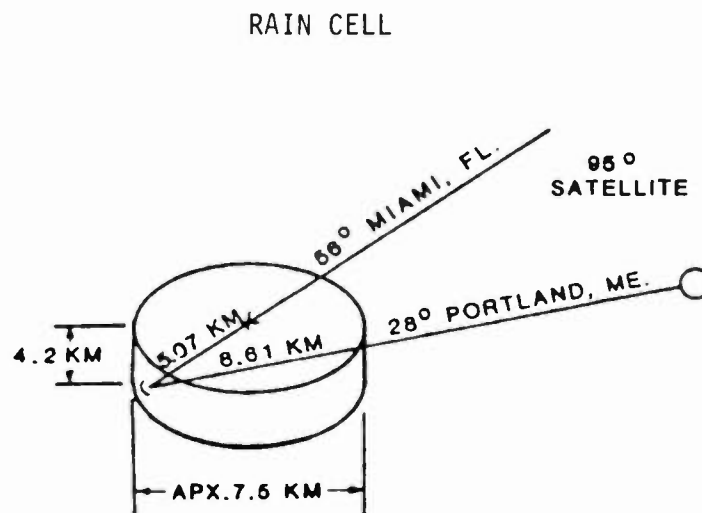
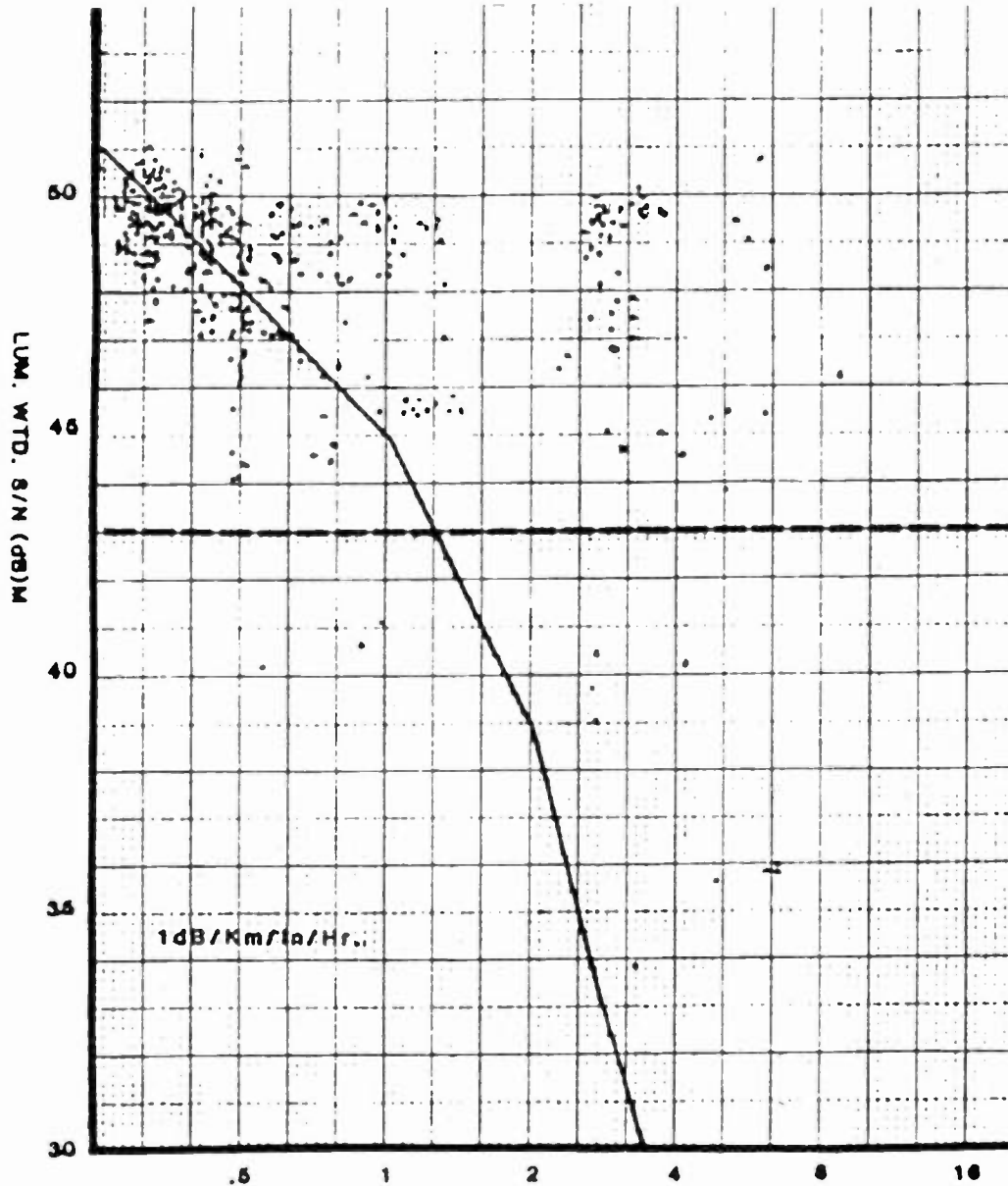


Figure 2



As shown in Figure 2, vulnerable path length varies as a function of elevation angle to the satellite. The path lengths represented here would occur at Portland, Maine and Miami, Florida.

The elevation angle at the Houston earth station used in the test was 55°. the vulnerable path length (below 14,000 feet) was calculated as 5.13 Km. A one inch-per-hour rainfall rate over the entire vulnerable path would therefore result in a signal fade of 5.1 dB.



RAIN RATE (inches/hr)  
Houston Test Site  
Figure 3

In Figure 3, the "X" axis represents Rain Fall rate in Inches/Hour and the "Y" axis represents Signal to Noise Ratio. The plotted points represent the occurrences in the Houston test data, of rains and associated loss in Signal to Noise. The solid line indicates the predicated attenuation had the rainfall rate been uniform along the entire vulnerable path.

The data points to the left of the line represent instances where the rainfall rate along the path was greater than that measured at the antenna. The points to the right of the line represent instances where either the rainfall rate along the path was less than that at the antenna, or the rain was falling from the altitude of less than 14,000 feet and thus the vulnerable path was shorter than maximum of 5.1 Km.

It is important to note that most of the points, especially at higher rainfall rates, fall to the right of the line. The conclusion is that attenuation due to heavy rain is usually less than would be calculated using the formula 1 dB/Km/inch/hour. Figure 4 is a chart demonstrating the grouping of rainfall rates, for all sites, and the number of occurrences of the rate/observation.

System analysis and design tradeoffs. When designing a network for operation over Ku-band satellites careful consideration must be given to the margins for the discrete subsystems. In the case of FNN these areas would involve:

- Transportable Earth Station
  - Up-link margin (Video)
  - Up-link margin (FM SCPC voice)
  - Down-link margin (Video)
  - Down-link margin (FM SCPC voice)
- Fixed TVRO Earth Stations
  - Down-link margin (Video)

The FNN offers an excellent case study due to the disadvantage in geographical location. Operational margins desired for the systems were assigned the following:

- Transportable Earth Station
  - Up-link margin (Video) 2 dB min.
  - Up-link margin (FM SCPC VOICE) 6 dB min.
  - Down-link margin (Video) - 4 dB min.
  - Down-link margin (FM SCPC voice) 6 dB Min.
- Fixed TVRO Earth Station
  - Down-link margin (Video) 6 dB min.

It should be noted that the transportable up-link video margin corresponds to the amount of back-off from saturation of the system HPA (High Power Amplifier) when saturating a video transponder under blue sky conditions. What this means to the operation of the system may be explained by defining the characteristics of a standard satellite transponder. When the transponder TWT (Traveling Wave Tube) amplifier is saturated its input vs output back-off is not linear. For example a 3 dB input back-off from saturation corresponds to an output back-off of approximately .4 dB. This is typical of TWT amplifiers. With this satellite characteristic, an uplink designed with the ability to increase its up-link power

by 2 dB could withstand a 5 dB rain fade which would only degrade the down-link signal from the satellite by .4 dB. The rest of the system margins correspond to the daily operating points above threshold.

To further define the operational requirements of the network it was desired by FNN and GTE for the systems to operate under a dual video per transponder format. This would double the video capacity. Prior to the standardizing on this format a test was conducted by GTE, FNN and Dalsat. The purpose of this test was to investigate potential chroma cross talk problems between two independently operating video carriers. The data tabulated from the Tektronix Answer machine used in the test showed no measurable degradation in video quality. The results and discussions of this test will be covered in a paper authored by Vincent Walisko of GTE.

Two important operation points were learned from this test. The first defined the up-link power required to saturate GTE's transponder 21 for single video. Using a 4.5 meter antenna, the actual power from the HPA in St. Petersburg, Florida, was 130 watts, Plano, Texas, required 100 watts. The numbers track nicely with GTE's published Ku-band G/T performance data sheet for Spacenet II. This sheet assigns Dallas (or suburban Plano) a space craft G/T of  $-.2 \text{ dB}/^\circ\text{K}$  and Orlando (which is in close proximity to St. Petersburg) a G/T of  $-1.4 \text{ dB}/^\circ\text{K}$ . The difference of 1.2 dB in these numbers means St. Petersburg would require 1.2 dB more up-link power. The dB delta between 100 watts and 130 watts is 1.14 dB. Using this data sheet, one could interpolate an up-link power for operating in Chicago with a G/T of  $.2 \text{ dB}/^\circ\text{K}$ , whose difference from Dallas says .4 dB less power or 91 watts. The spacecraft G/T performance sheet used for this comparison is available to the industry through GTE.

The second parameter defined the exact loss in video down-link EIRP (Effective Isotropic Radiated Power) from the space craft when operating dual video carriers which was measured to be 4.5 dB. This would be a critical factor in the design of the TVRO earth stations. Now that the system operational parameters have been defined and certain points addressed let us evaluate hardware alternatives respectively. Figure 5 represents up-link EIRP's obtainable from various combinations of antenna systems and HPA's. The graph references the three areas previously addressed: St. Petersburg, Dallas, and Chicago. The area above the EIRP line associated to a given city with respect to a corresponding antenna diameter and HPA size denotes the amount of up-link margin above saturation; the area below is the amount of back-off from saturation. This graph assumes a waveguide loss from the HPA to the antenna power combiner of 1 dB for all systems. EIRP's are with respect to single video carrier saturations.

It should be noted that in dual video per transponder cases, the amount of up-link EIRP required for a transportable to saturate the transponder would be 3 dB less than single video cases. This offers a design alternative to be considered. Should the system be designed for the dual video per transponder required up-link EIRP and take advantage of a 3 dB savings thru cost of the system or design for single video required EIRP? If the up-link goal for the network is maximum flexibility the system designed around dual video, with 2 dB margin, operating in a single video mode, will be 1 dB away from saturation. Where the system designed around single video with a 2 dB margin has just increased its up-link margin an additional 3 dB for the dual video mode. This increases

up-link availability further enhancing the network. Preliminary up-link operation considerations being evaluated by GTE would allow video up-links the ability to operate 3 dB into saturation of the transponder in dual video cases. A decision has not been reached regarding this at the present time.

The operation of the FM SCPC circuits in the system have the most critical effect on the network operation. A poor design in this area can limit the accessibility and/or greatly increase recurring satellite costs associated to their use. A typical uplink EIRP for an SCPC carrier from a transportable ranging from 2.4 to 4.5 meters in size is approximately .3 to .09 watts accordingly. The SCPC carriers used in GTE's service have an occupied band width of 26,000 hertz. The Woodbine, Va., earth station receiving and transmitting these carriers uses a 9.2 meter antenna with an associated receive G/T in excess of 34.5 dB/°K. Given the bandwidth of the carriers and the G/T of the 9.2 meter system and the requirement for operating the carriers into Woodbine at a downlink EIRP capable of yielding a typical 8 dB margin above threshold, the previously mentioned up-link powers are all that is required.

The downlink margins for the voice and IFB circuits are a function of the power (EIRP) being transmitted from the Satellite associated to the carriers. Recurring monthly costs for SCPC operation over a satellite will vary as a function of this power. The equation for this is:

$$\text{Recurring monthly \$} = \$/\text{Watt} \times \text{Satellite Power (Watts)}$$

A typical cost per watt is \$50.00.

Given fixed EIRP from a satellite with respect to Woodbine, Va., the operational down-link voice margins in a transportable will vary with respect to the designed G/T of the system and geographical location.

Figure 6 is a graph depicting systems receive G/T as a function of antenna size. The equation for G/T is:

$$G/T = G_{ant} - 10 \log T_s$$

Where:

$G_{ant}$  - antenna gain at 11.7 GHz (dBi)

$T_s$  - Noise temperature of the system in degree Kelvin

Note:  $T_s$  is a function of antenna, LNA (Low Noise Amplifier) and miscellaneous additions due to transmission lines, waveguide switches, transmit reject filters, etc.

For this graph a  $T_s$  of 260°K will be assumed.

The FNN transportables have been designed around a  $G/T \geq 28$  dB/°K.

It was decided that the large antenna system operating with a 300 watt HPA and a 210°K LNA would yield the maximum availability while keeping the recurring satellite costs to a minimum. The satellite EIRPs' associated to the voice

circuits, for which GTE had set a rate structure, will allow margins of 6-8 dB for FNN operations in Florida.

The difference in G/T for transportables will relate to operational margins for the voice carriers. For example a system operating with a G/T of 23 dB/°K in Florida corresponding to the FNN satellite EIRP's would have only 1-3 dB voice margins. To match the FNN margins would require 3 times as many watts from the satellite thereby impacting recurring monthly costs. However, this same system (23 dB/°K) operating in Oklahoma would have 4.5 to 6.5 dB margins with respect to FNN EIRP's. The reason for this is the Satellite EIRP performance varies with geographical location. The EIRP performance chart for GTE Spacenet II is available on request.

The fixed station video down-links for the FNN were designed for dual video per transponder reception. This represents a worse case design consideration because of the 4.5 dB degradation in satellite EIRP associated to this operation. They also had an EIRP disadvantage due to their geographical location. Figure 7 is a graph defining down-link receive C/N VRS satellite EIRP. The G/T's used are with respect to figure 6. A video occupied bandwidth of 30 MHz was assumed for this graph. The equation used for calculating C/N is:

$$C/N = E - L + G/T - 10 \log B + 228.6$$

Where:

- E = satellite EIRP (dBw)
- L = space loss at 12 GHz (dB)
- G/T = (receive station figure of merit (dB/°K))
- B = 2 ( $f_d = 4.2$ ) (MHz)
- $f_d$  = video peak deviation (MHz)
- 228.6 = Boltzmann's constant (dBW/ohz)

This graph does not take into consideration uplink C/N or C/I (carrier to interference) effects on receive system C/N. When addressing these effects approximately 2 dB degradation in receive performance will occur, however, this will vary on a system design basis. Figure 8 is a graph defining S/N and C/N as a function of peak video deviation. The intent of the graph is to show the variations in S/N which occurs over operational bandwidths for 36 to 72 MHz transponders operating dual video. When designing for a network capability (dual video transponder) which will allow the video receive only earth stations the ability to operate reliably (margins) and be transparent to the video quality (S/N) being transmitted operational bandwidths (peak deviations) must also be considered. The equations used for this graph are the C/N equation previously defined which assumed:

- E = 34 dBw (worse case dual video Spacenet II Miami)
- L = 206 dB
- G/T = 32.85 and 28.9 dB/°K (two cases)
- B = 17.5 thru 36 MHz (plotted)

and:

$$S/N = C/N + 20 \log (f_d/4.2) + 10 \log (B/4.2) + 20.88$$

Where:

C/N = reference above  
 $f_d = 4.6$  thru  $13.8$  MHz  
 $B = 2 (f_d + 4.2)$  MHz  
20.88 = Emphasis Improvement

GTE's Spacenet II offers 72 MHz transponders. The bandwidth selected for daily operation for the FNN is 30 MHz, 36 and 22.5 MHz operations are patchable.

The system design of the FNN will yield the following margins.

#### Transportable Earth Station

##### Up-link margin

Video - 2 dB (Miami single video saturation)

Voice - 3 dB (operational)

##### Down-link margin

Video - 2 dB (Miami dual video)

Voice - 6 dB (operational Miami)

#### Fixed TVRO Earth Station

##### Down-link margin

Video 6 dB min, 8 dB typ. (dual video)

The transportable systems being supplied by Dalsat (Figure 1) consist of a 4.5 meter antenna, 300 watt HPA and 210°K LNA. The video electronics are all frequency agile and include an exciter with two audio subcarriers and a video receiver. The voice subsystem consists of a fixed frequency up/down converter, two FM SCPC radios, (one telco, and one IFB,) a channel selector which interfaces with the FM SCPC radios programmed for GTE's format and the telco baseband equipment which consists of an echo canceller, FXS signalling unit, and ring generator. The base band video/audio system includes two video switchers, an 8 channel audio mixer, four video monitors, assorted VDA's and ADA's, four jackfields and a curbside interface. The curbside interface will process four video inputs, four line or microphone audio inputs, four video outputs, four line level audio outputs, two telephone inputs, three IFB outputs and two intercom drops. The system also includes an edit bay. The test equipment in the system includes a spectrum analyzer, vector scope, waveform monitor extended range meter and a satellite test loop translator. The power system consists of a 20 kw generator, isolation transformer, 4 kva power conditioner and discrete utility and technical power panels. The equipment is housed in an 8.5 x 8 x 8 foot shelter with redundant HVAC system. The system will ride on a Volvo F6-13 cab over truck with 80 cubic feet of storage. The overall length of the system is 28 feet. The height is 12 feet.

System Growth Designed growth provisions for the FNN transportables will allow for redundant subsystem electronics, terrestrial microwave system and

additional edit bay related equipment. Prime power, electrical drops, RF switching, signal patching, alarm annunciators, rack space and floor plan will require fore thought for desired growth. Initial design considerations regarding these areas will minimize time and or costs associated to expanding the system.

In conclusion, the intent of this paper is to outline the critical areas which must be addressed when designing an SNG network.

The hardware selection for implementing such a network will require careful evaluation to insure compliancy to FCC rules and regulations governing 2° satellite operations, and desired network performance criteria.

The graphs included in this paper referencing characteristics of various equipment compliments and operation parameters may be used as a means for interpolating network needs when referenced to satellite performance data for other geographical regions.

The Florida News Network through its desired goals has made available to the industry a standard which will increase capacity for Satellite News Gathering. We at Dalsat plan to address the broadcasters needs and be an available resource to the future of Satellite News Gathering.

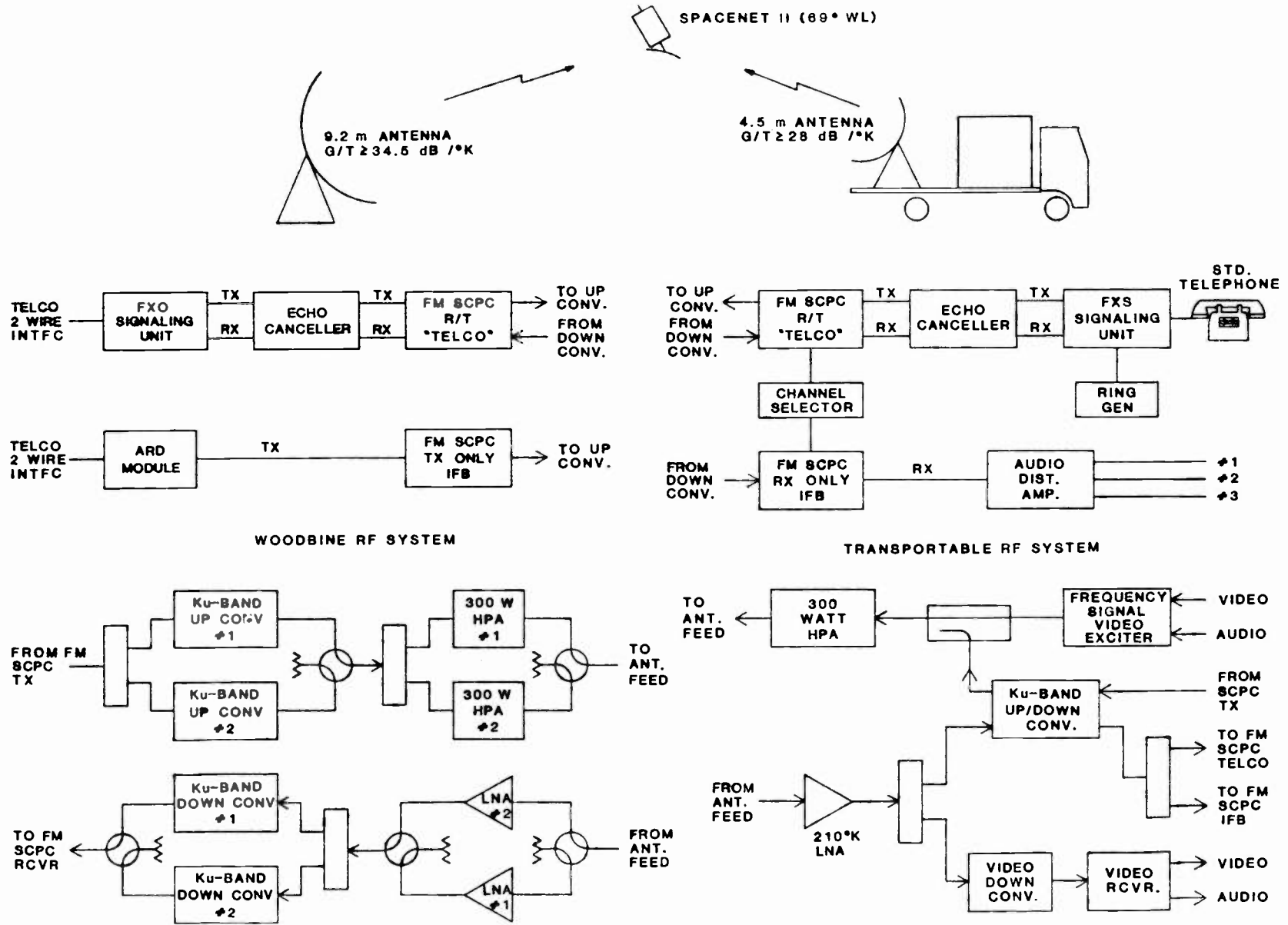


FIGURE 1. SYSTEM BLOCK DIAGRAM



W. Palm Beach Operational Test Time 154,920 mins. or 108 days

Houston Operational Test Time 175,798 mins. or 122 days

Plano Operational Test Time 183,640 mins. or 127 days

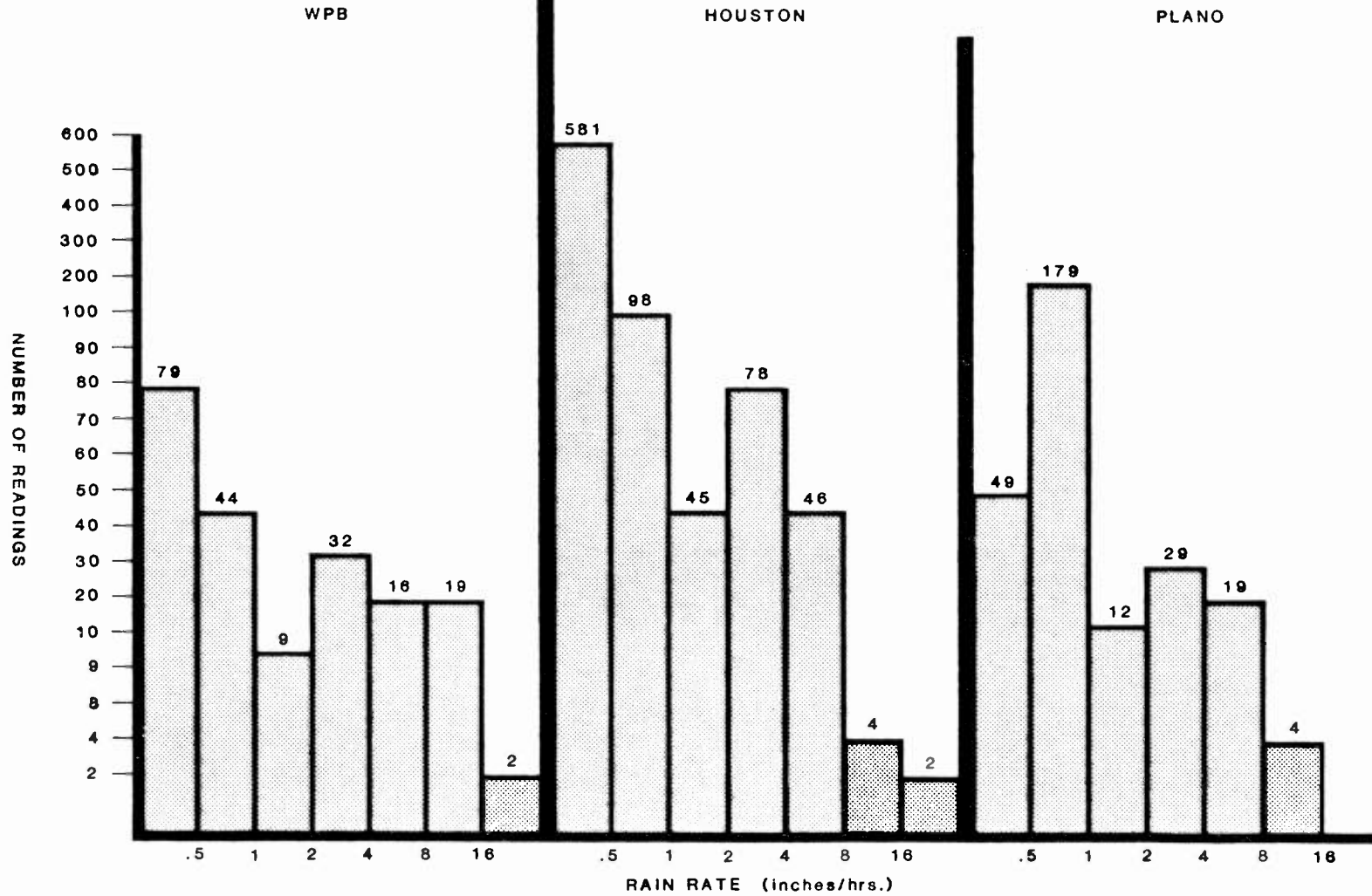


FIGURE 4. RATE OBSERVATION VRS. RAIN RATE

UP-LINK EIRP (dBW)

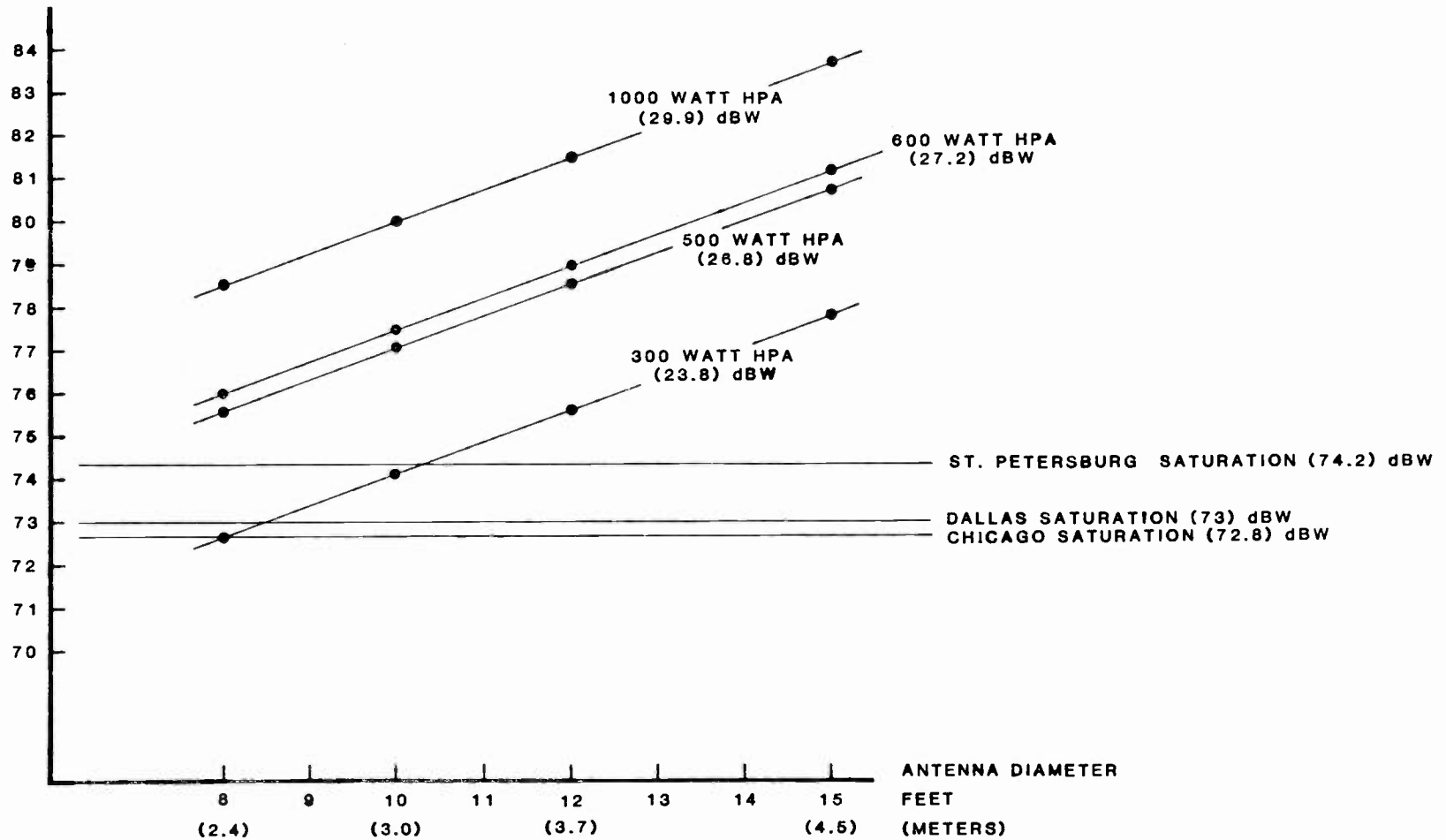


FIGURE 6. UP-LINK EIRP'S

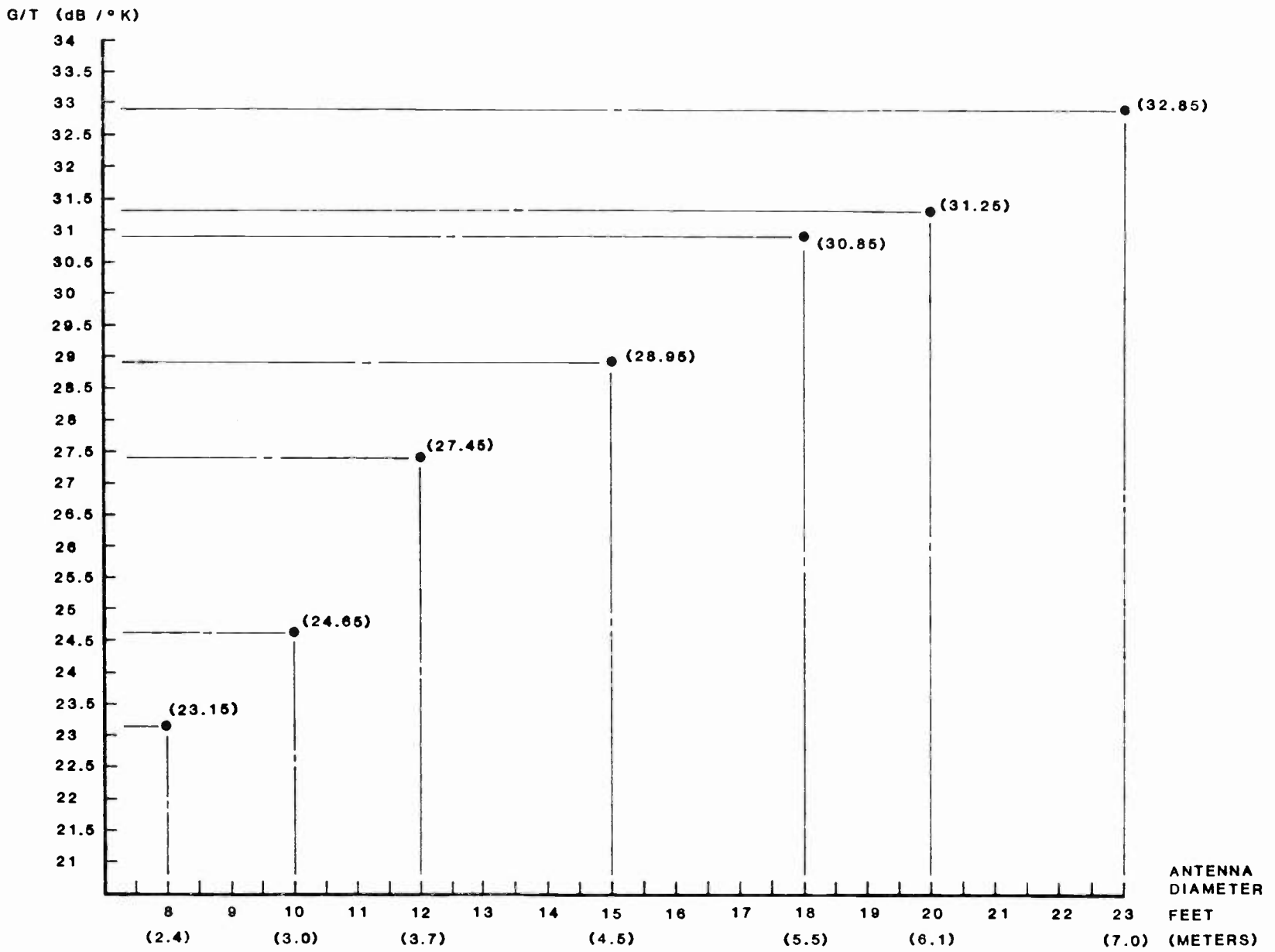


FIGURE 8. SYSTEM G/T

DOWN-LINK EIRP (dBW)

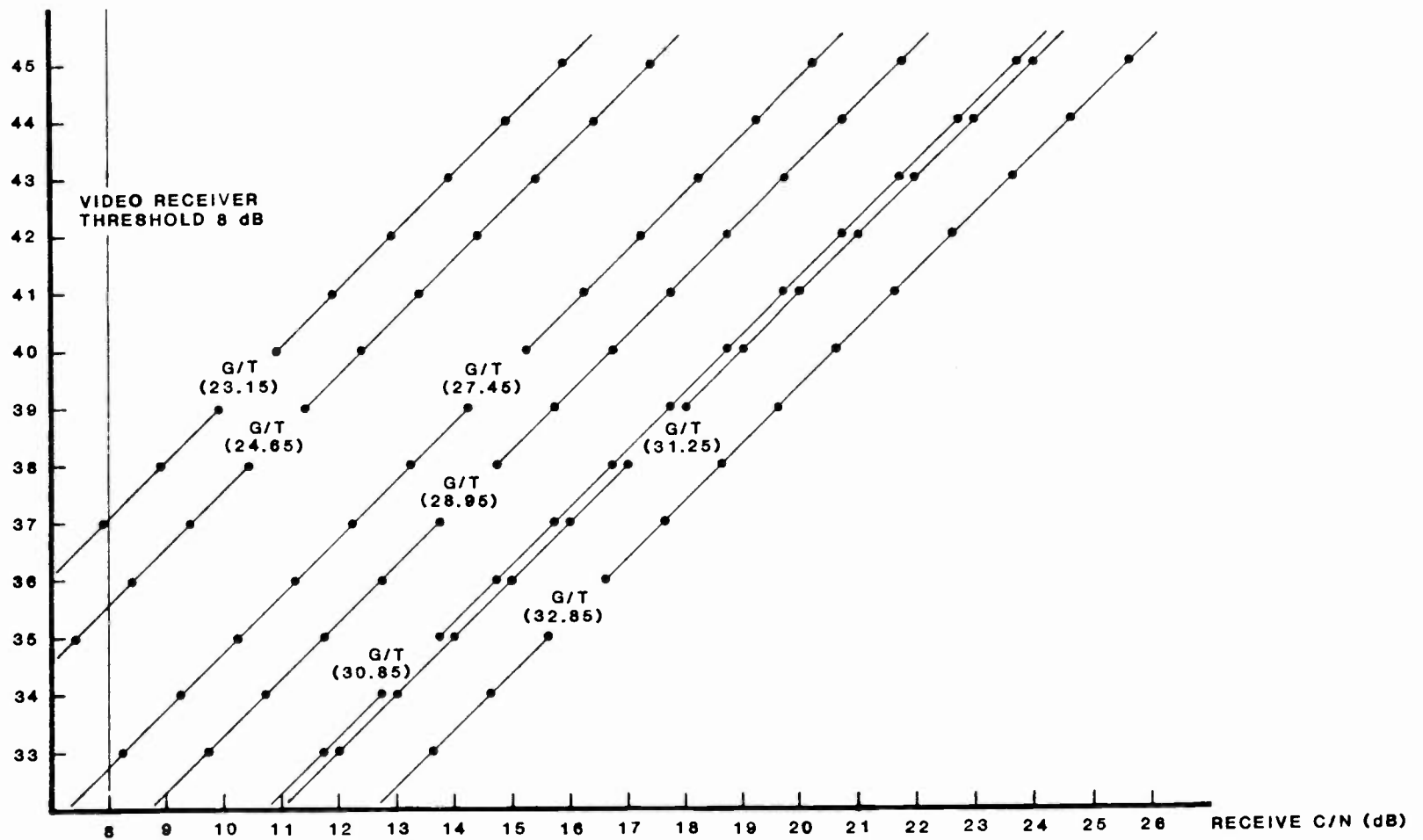


FIGURE 7. SYSTEM VIDEO PERFORMANCE

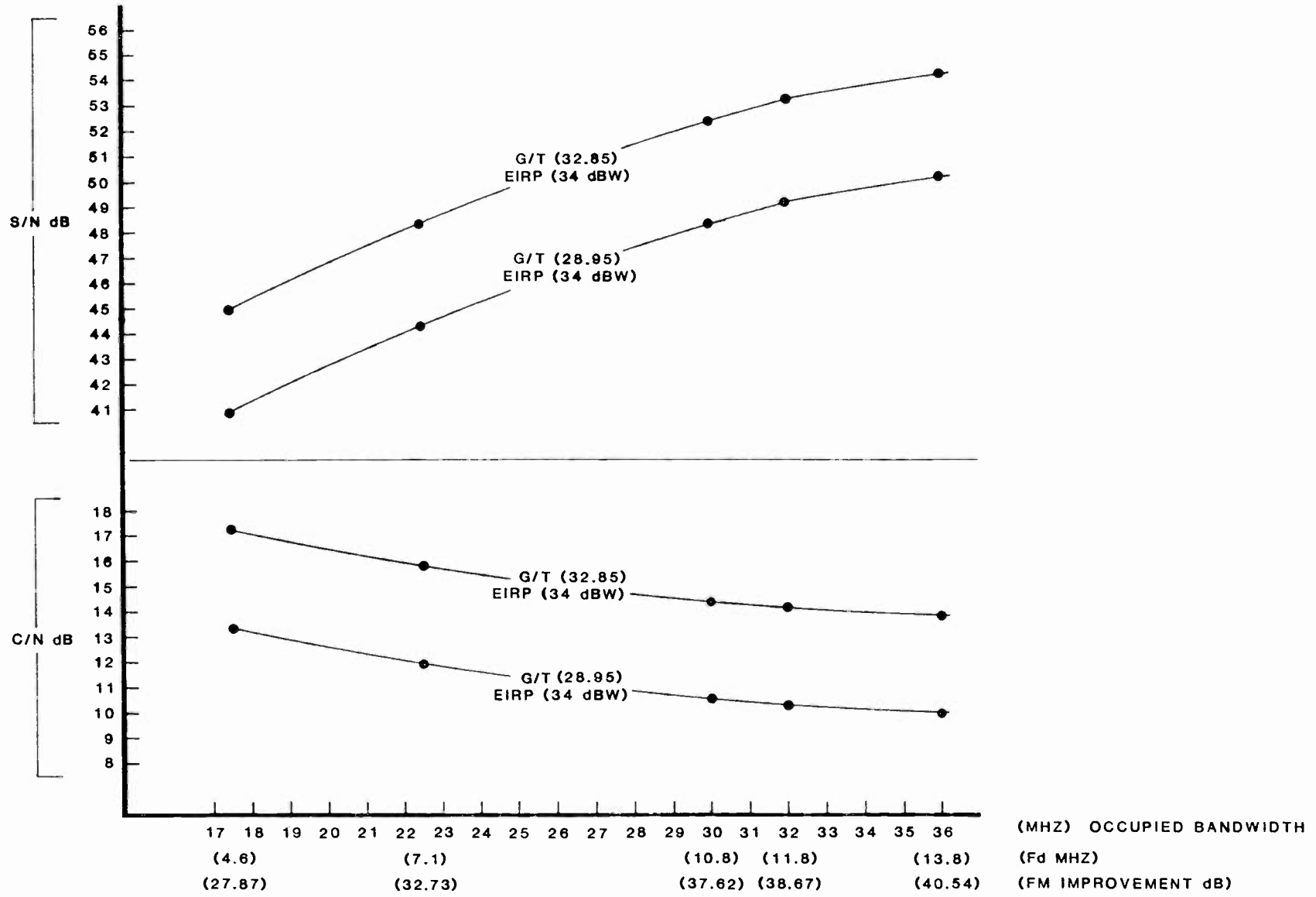


FIGURE 8. C/N, S/N PERFORMANCE VRS. OCCUPIED BANDWIDTH

---

## Fly-Away Satellite News Gathering

### Utilizing Portable Ku Band Antennas and Digital Compression Techniques

Dave Garrod  
Eric Schechter  
GEC-McMichael Limited  
Scottsdale, Arizona

#### INTRODUCTION

GEC-McMichael has pleasure in presenting this topic discussion document which briefly describes some of the company background and experience which allows us to offer unique ability to satisfy a requirement for a small, rapidly deployable satellite earth terminal station.

As a result of the extensive experience held by GEC McMichael in the relevant fields of broadcasting, satellite communications and video compression technology, we are able to offer a range of integrated terminals.

#### Difficulties of Satellite NewsGathering

News Gathering Operations have primarily entailed a portable or transportable mode of movement. Attempting to configure a news gathering operation into a transmission scheme via satellite not only presents a problem of size and weight, but also the ability to live two way reporting. In trying to take the standard approach to satellite transmission via transportable (via road) or portable (via air and/or hand carried) equipment puts difficult and even unworkable constraints upon an equipment manufacturer. Since large vans and trucks have taken the "traditional approach" to satellite news gathering, this discussion will only deal with the portable (or "fly-away") type SNG equipment.

#### Needs of Satellite News Gathering Operations

Up until this period in time there have been only a couple of approaches to SNG type vehicles. These options have been primarily in the form of larger, transportable road units. For a percentage of news personel, a transportable unit for local area coverage is best suited. However for other types of applications such as: remote news coverage, national or local stories grater than 300 miles away from the main base, national or local stories not accessible by a road vehicle and other types of news/data gathering operations, a truly portable unit is needed. The Fly-Away news gathering unit is designed to be transported by commercial aircraft, private aircraft, small "Econoline-type" vans or station wagons. Because of this rapid deployment and shipment medium, careful attention must be given to link budgets and fade margins, as well as size, weight and available power.

## Technical Problems of Portable SNG Equipment

For a number of years, GEC McMichael and others attempted to achieve a portable news/data gathering unit which would be able to maintain broadcast quality and remain truly "portable". In this attempt, the conventional route of FM transmission created many insurmountable problems. Achieving link budgets and rain fade margins while keeping the total unit small enough was nearly impossible. Typical designs yielded 3 meter "fold-up" antennas with 300-600 watts of power, 2-3 additional flight cases and a 6 KW "portable" generator. This design was not to be delivered and never came out of design. This paper will go through the problems of the conventional SNG FM satellite link and its requirements. Then, the areas of compromise will be detailed, yielding a workable proven product for portable satellite news coverage.

## DISCUSSION

### Systems Options

To overcome the limitations with respect to coverage and availability from using conventional FM signals GEC-McMichael has drawn upon its established expertise in video compression and developed its T1 teleconferencing codec, already established as a world leader in its own right, to operate at higher data rates and thereby offer superior movement portrayal than is necessary for teleconferencing. This option offers the dual advantages of:

- 1) The RF bandwidth required is greatly reduced compared to any analogue system which reduces the EIRP required.
- 2) The use of a digital signal allows perfect energy density spreading and hence greatly reduces the possibility of causing adjacent satellite interference.

This component system allows some flexibility in operational use. In fine weather at beam center full motion/bandwidth video may be relayed. In the event of poor weather or edge of coverage operation, the wideband video is simply encoded by the digital encoder and this signal is transmitted through the same small RF system and antenna.

GEC-McMichael consider that the system described here offers a good overall compromise for a given picture quality. However we recognize that if a different overall performance is specified then the system chosen would differ correspondingly.

### Broadcast Quality Specification

In order to first establish the size of the transmitting earth terminal required to achieve a "full broadcast" quality satellite link, it is necessary to make some assumptions with respect to the minimum performance which is accepted as broadcast quality.

If we assume full bandwidth NTSC encoded signals modulated using frequency modulation in the normal way, the satellite link may be considered virtually transparent with respect to the majority of the normal video parameters. The only parameter which shows a significant degradation as a result of being transmitted over a good quality satellite link is that of received signal to noise ratio.

In defining the minimum performance required from the satellite link therefore it is only S/N which need be defined.

The received S/N is directly related to the received carrier to noise ratio (C/N). The exact relationship is determined by the RF bandwidth used and the corresponding frequency deviation. If we establish a minimum S/N required it is then possible to establish the minimum EIRP necessary from the transmitting earth terminal by making assumptions with respect to the satellite performance and weather margins.

Using CCIR measurement procedures and assuming a minimum weighted S/N of 48 dB as being the minimum acceptable performance, this may be translated to a minimum C/N by making further assumptions: an RF bandwidth of 30 MHz is used in the satellite link and that the frequency deviation is 20 MHz/Volt.

To achieve a 48 dB S/N using a normal professional quality demodulator and the RF parameters chosen above the C/N required is approximately 14 dB with a NTSC signal.

Given 14 dB as the minimum overall link C/N if we take an SBS (Satellite Business Systems) satellite as an example in the USA, the minimum uplink EIRP for a full quality signal may be established.

For the purposes of this discussion therefore it is assumed that if a 14 dB C/N can be achieved then this represents a broadcast quality signal.

For news gathering operations the requirement for a small terminal is largely aimed at the transmitting terminal in the field rather than the receive terminal. It is assumed therefore that a large antenna is used at the receive terminal, in the interests of achieving smaller transportable SNG terminals.

The uplink C/N is in turn determined by the satellite G/T. This parameter of course varies widely according to the satellite in question and your position in its footprint. In order to establish a basic system requirement two typical satellites have been taken as examples.

Assume the following for a typical SBS Satellite

	<u>SBS</u>	
RF bandwidth	30.0	MHz
IPFD for saturation	-83.0	dBW/m
Saturated EIRP	44.0	dBW
Path Attenuation (up)	10.0	dB
Satellite G/T	-1.0	dB/K
Receive Antenna diam.	6.1	m
Path Attenuation (down)	0.5	dB

Given these assumptions the EIRP necessary for a 14 dB loop C/N may be calculated. Table 2.1 below shows the link budgets obtained.

The down path attenuation has been taken as only 0.5 dB since the probability that the worst case fade on the up path occurring at the same time as a significant fade on the down path is low. The uplink path attenuation is given as a maximum of 10 dB.

It may be seen from the link budgets that to achieve a 14 dB loop C/N EIRP's of 79.3 dBW are required.

This EIRP is therefore the minimum EIRP which will allow guaranteed performance from anywhere in the foot-print and offer a good weather margin. We can conclude therefore that a full specification earth terminal must be capable of an EIRP of say 79.5 dBW.



Clearly this has been derived only after making many assumptions, some of which may be argued. However it represents a good overall analysis and agrees well with actual transportable terminals available to fulfill this requirement.

#### Earth Terminal Requirement for Full Broadcast

The implementation of an earth terminal capable of an EIRP of 79.5 dBW offers some flexibility. In principle, a trade-off may be carried out between the power available from the final high power amplifiers (HPA), the efficiency of the waveguide run between the HPA and the antenna and the gain available from the antenna.

The need for a small physical size would dictate higher power amplifiers and smaller antennas. However such a solution does present a number of disadvantages:

- 1) High power amplifiers are very inefficient devices and consequently an increase from say 600 watts output power to 1200 will require approximately an additional 2.5 kilowatts of prime power.
- 2) The cost of "EIRP per dB" is in general very much higher if the increased EIRP is obtained from higher power amplifiers than if it is obtained from larger antennas.
- 3) HPA's still represent the lowest reliability component in the earth terminal. In general their reliability reduces further as their output power is increased. Consequently using large high power amplifiers results in a lower terminal reliability than if smaller units are used.
- 4) If large HPA's are used then clearly smaller antennas may be used. The off-axis gain performance obtainable from small antennas is poorer than that from an equivalent larger diameter antenna since any given sidelobe is inherently using a small antenna implies that not only is a large amplifier used and hence a lot of power is fed into the feed, but the sidelobe performance is also relatively poor resulting in very high levels of off-axis energy being radiated and creating a high risk of adjacent satellite interference.

If smaller terminals are required it is unavoidable that some degree of relaxation is accepted.

#### Performance Trade-Offs Options

If the size of the terminal is to be reduced, so too must its EIRP capability. In reducing the EIRP capability some aspect of its performance must be reduced. The three areas of compromise include availability, coverage area and video performance.

#### Availability

The amount of attenuation of signals passing through the atmosphere in the 14 GHz band is largely determined by the amount of water in the signal path. Hence the rainfall rate and cloud thickness and constituency are the prime determining factors. RF beam slant angle and type of rainfall also affect the result as does the polarization in use and temperature.

## LINK BUDGET ANALYSIS

GEC MCMICHAEL'S LINK BUDGET ANALYSIS  
FULL BROADCAST VS FLY-AWAY SYSTEM

CUSTOMER: NAB TECHNICAL SESSION

BASE DATA INPUT SELECTION	Units	FULL BROADCAST TSET	FLY-AWAY SYSTEM WITH CODEC
=====			
CODEC DATA RATE(1)	Mbit/s	ANALOG	8.00
CODING RATE(2)		0.75	0.75
SATELLITE SPACING FACTOR(3)		1.00	1.00
RF BANDWIDTH	MHZ	30.00	5.33
HPA POWER REQUIRED	WATTS	600.00	160.00
WAVEGUIDE LOSS	dB	1.00	1.00
TX ANTENNA DIAMETER	M	4.10	1.45
TX ANTENNA EFFICIENCY	%	61.00	61.00
TX FREQUENCY	Ghz	14.25	14.25
TX GAIN 1) COMPUTED	dBi	53.59	44.56
TX GAIN 2) INPUT	dBi	44.50	44.62
MINIMUM VALUE TAKEN	dBi	53.10	44.56
TX ELEVATION ANGLE	deg.	30.00	30.00
IPFD FOR SATURATION(4)	dBW/m <sup>2</sup>	-88.00	-88.00
SATURATED EIRP	dBW	44.00	44.00
RX ANTENNA DIAMETER	M	6.10	6.10
RX ANTENNA EFFICIENCY	%	65.00	65.00
RX FREQUENCY	GHz	11.95	11.95
RX GAIN 1) COMPUTED	dBi	55.78	55.78
2) INPUT	dBi		
MINIMUM VALUE TAKEN	dBi	55.78	55.78
RX ELEVATION ANGLE	deg.	30.00	30.00
RX SYSTEM NOISE TEMP(5)	Kelvin	225.00	225.00
RX G/T 1) COMPUTED	dB/dBK	32.26	32.26
2) INPUT	dB/dBK	32.20	32.20
WHICH FIGURE 1) OR 2)	dB/dBK	32.26	32.26
-----			
UPLINK LINK CALCULATION			
=====			
TRANSMIT EIRP	dBW	79.88	65.60
FREE SPACE LOSS	dB	207.10	207.10
PATH ATTENUATION	dB	10.00	0.50
RF BANDWIDTH	MHz	30.00	5.33
	dBHz	74.77	67.27
BOLTZMAN'S CONSTANT	dB/K	-228.60	-228.60
SATELLITE G/T(6)	dB/dBK	-1.00	-1.00
-----			
UPLINK C/N	dB	15.61	18.33
=====			
EIRP ACHIEVEMENT			
=====			
TRANSMIT EIRP	dBW	79.88	65.60
SPREADING LOSS	dB	162.60	162.60
PATH ATTENUATION	dB	0.50	0.50
IPFD	dBW/m <sup>2</sup>	-83.22	-97.50
i/p BACKOFF	dB	10.30	9.50
o/p BACKOFF(7)	dB	4.90	3.80
-----			
SATELLITE EIRP RESULT	dBW	39.10	40.20
=====			
DOWN LINK BUDGET			
=====			
FREE SPACE LOSS	dB	205.58	205.58
PATH ATTENUATION	dB	0.50	0.50
RF BANDWIDTH	dBHz	74.77	67.27
BOLTZMAN'S CONSTANT	dB/dBK	-228.60	-228.60
RX TERMINAL G/T	dB/K	32.26	32.26
-----			
DOWNLINK C/N ACHIEVED	dB	19.11	27.71
-----			
LOOP C/N ACHIEVED	dB	14.01	17.85
-----			

### FOOTNOTE NOTATION

- 
- (1) Output after audio multiplexing from the codec
  - (2) Codec Coding Rate established at .75
  - (3) Utilizing GTE Spacenet I or SBS 3
  - (5) Utilizing a 190 deg. Kelvin LNA
  - (6) Utilizing Spacenet I or SBS 3

Attenuation of signals in any particular part of the world is therefore very difficult to accurately determine.

The margin allowed for this must be determined with regard to the operational requirement of the earth terminal. Fades of 13 dB have been measured in the USA. The duration of these however are less than five minutes at any time and probably do not occur more than once or twice a year.

Before this margin is taken out in the interests of EIRP reduction, the operator must first be convinced that he will on occasions accept performance inferior to that specified as broadcast quality.

If the region in which the terminal will be used can be defined some reduction may be possible after studying that regions weather patterns.

#### Coverage Area

The terminal's EIRP may also be reduced if operation from the edge of satellite coverage is not required.

A reduction of say 3 dB in the case of SBS would still provide a fairly good coverage of the United States with only a few areas falling below specification notably in Florida and South Texas.

#### Video Performance

Advantage may be taken of a reduction in the specification of the video signal by effectively reducing the video bandwidth. This may be done by performing a variety of video processing techniques. The two primary options are

- 1) MAC processing
- 2) Digital Video compression

By using a MAC (Multiplexed Analogue Components) color encoding system rather than NTSC, PAL or SECAM the video bandwidth may be reduced simply by low pass filtering without loss of the color sub-carrier. It does of course dramatically reduce the luminance bandwidth.

With a digital video compression technique, some reduction in luminance bandwidth is also suffered but a greater bandwidth reduction is achieved since the high level of pixel to pixel and frame to frame redundancy of most television pictures is taken advantage of and significantly less information is transmitted. The penalty resulting from digital compression is degraded movement portrayal.

GEC-McMichael pioneered the development of both of these forms of video processing equipments and each is discussed more fully in the next section.

#### Conclusion

EIRP reduction by means of reducing availability or coverage area is obviously an option. If some compromise can be accepted in these two then it should be used. However the scope for this is limited.

If a reduction of say 4 dB is made on EIRP then the rain margin is SBS 6 dB. This represents a very small margin and would result in relatively frequent outages due to weather.

Such a reduction would also provide only a very limited coverage area thereby losing the major advantage of a satellite system.

Further a 4 dB EIRP reduction would result in an antenna of 2.5 meter diameter instead of 4 for the same 600 watt amplifiers. This terminal, as well as having its severely limited operational capacity, is still not eminently transportable since it is still very large and heavy.

If a dramatic reduction in terminal size is to be achieved then only the video processing technique offers sufficient scope. Using this approach an EIRP reduction of over 10 dB may be achieved without limiting the availability or the coverage area at all and with only a small degradation of video performance.

## KEY SYSTEM COMPONENTS

### Introduction

Before describing in detail the GEC-McMichael SNG terminal, this section describes in some detail the background to three equipments which are highly relevant to any discussion regarding small satellite earth terminals.

These are:

- 1) Low sidelobe antennas
- 2) Compression Equipment
- 3) Digital compression codecs

### Low Sidelobe Antennas

In the autumn of 1982 GEC-McMichael began a program to develop a new generation of earth terminal antennas to operate in the KuBand. This was spurred by the growing demand for closer satellite spacings in the geo-synchronous arc demanding lower off-axis radiation.

The work was carried out at the GEC Research Laboratories in Great Baddow, Essex, England (formerly Marconi Research Centre). These laboratories have been in the forefront of many areas of radio technology ever since the days of Marconi himself.

The first antenna developed under the low sidelobe program had an elliptical aperture 5.6 metres by 2.8 metres. The identical scaled down version of the antenna shall be utilized with the fly-away configuration. The elliptical shape was chosen for a number of reasons:

- 1) These antennas are specifically designed and intended for portable application. (By 747 for the 5.6m x 2.8 m, and by Lear or commercial aircraft for the 2m x 1m). Also the low profile of these antennas eases road transport and a reduction in wind loading is achieved.
- 2) By arranging the major axis to be nearly parallel to the geo-synchronous arc (in most applications) the sidelobe performance is preferentially improved (for a given aperture) in the plane of the satellite orbit at the expense of the North-South direction where there are no satellites.

The antenna was designed using a Diffraction Profile Synthesis (DPS) procedure which generates a profile for both main and sub reflectors (neither of which are hyperbolic functions). The feed horn illumination taper is also carefully controlled to give the best performance trade off between high aperture efficiency and low sidelobe performance. (Low sidelobes may be easily obtained by simply under illuminating the reflector. This results in a very poor efficiency however).

The 5.6 by 2.8 meter antennas designed in this way have been measured on an antenna far-field test range. A copy of measured performance is included in Figure 3.2.1. All sidelobe peaks are below a line defined by  $26-25 \log \theta$  between 1 and 48 degrees, which represents a margin of 3 dB over the FCC requirements. The Eutelsat specifications are less severe than those of the FCC and are therefore easily met also. The wide angle sidelobe performance is also easily met. The first sidelobes are 25 dB below the main beam peak. The 2 x 1 meter antenna has achieved this as well in the E Plane Axis. This sidelobe performance is unmatched by any other commercially available antenna.

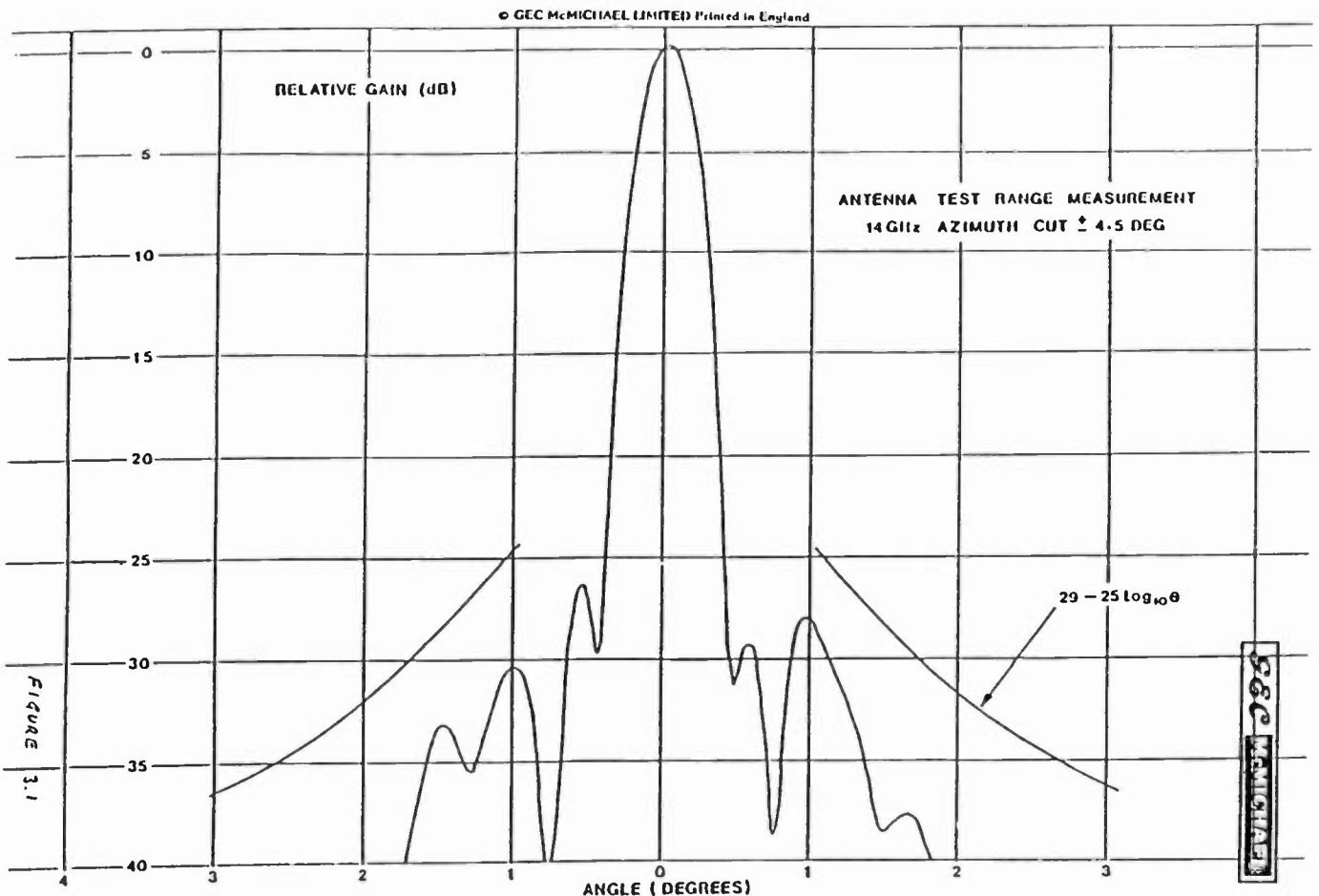
The antenna operates instantaneously over the range 10.95 to 14.5 GHz. Its gain is 53.4 dB at 14 GHz and 52.2 dB at 10.95 GHz. The aperture efficiency at the receive frequency is over 75% which greatly exceeds efficiencies obtainable from conventional parabolic antenna designs.

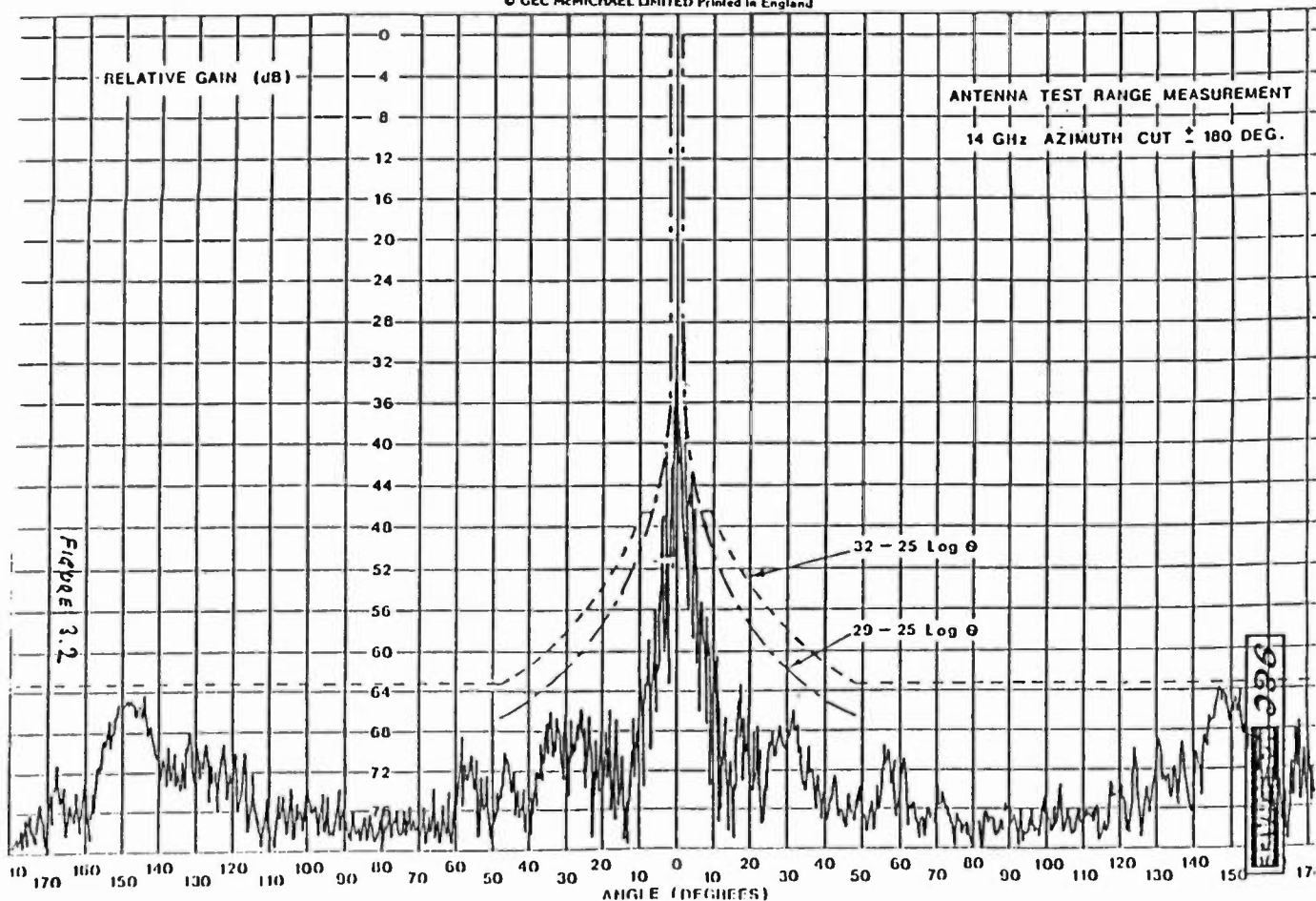
### MAC Video Compression

In 1982 GEC-McMichael was the first company to take a license from the Independent Broadcasting Authority (IBA) in Winchester, Hampshire, England to develop and manufacture Multiplexed Analogue Components (MAC) encoding and decoding equipment together with the necessary FM/QPSK modem.

GEC-McMichael produced the first commercially available MAC equipment and were the first to demonstrate it, and so, at the Montreux International Television Symposium in 1983. The demonstration was performed using the company's own transportable earth station

FIGURE 3.2.1 RADIATION PATTERNS





transmitting and receiving the signal via OTS (Orbital Test Satellite).

MAC encoding is of interest for SNG applications since it offers a color encoding system which does not place the chrominance information at the top end of the baselband video spectrum as with NTSC, PAL and SECAM.

With this vital part of the television signal at the lower end of the spectrum it becomes possible to low pass filter the video signal and thereby reduce the bandwidth prior to transmission over the satellite.

If the luminance signal is filtered down to say 2.5 MHz, which is broadly comparable to U-matic tape recorder performance, the effect on the satellite terminal EIRP may be calculated as follows:

To achieve the time division multiplexing of the luminance, chrominance and audio signals in the MAC waveform, each of these is compressed in time. The luminance component is compressed by a ratio of approximately 3:2. Hence if the luminance signal is first filtered to 2.5 MHz, after time compression the bandwidth of this component is increased to 3.75 MHz. We can assume that this is the widest bandwidth component to be transmitted and hence determine the RF bandwidth needed in the satellite link.

Since this is now only 3.75 MHz instead of 5.5, the 30 MHz RF used in FM Wideband Transmission bandwidth may be reduced to 20.4 MHz. This assumes a frequency deviation of only 13.6 MHz/volt instead of 20 and a corresponding relationship between modulation index and RF bandwidth, that is a similar degree of "over-deviation".

Reducing the RF bandwidth to 20.4 MHz allows the EIRP of the earth terminal to be reduced by 1.6 dB.

This approach does not therefore offer a significant advantage such as is sought to allow a major size reduction of the SNG terminal.

More developments of the MAC system are however being pursued which may allow significantly greater advantages. These developments while being closely followed are not recommended by GEC-McMichael at this time since we are unable to guarantee their availability until the fall of 1985.

### Digital Compression Codecs

#### Background

GEC-McMichael has worked closely with the British Telecom Research Laboratories in Martlesham Heath, Essex over the past five years in developing hardware and defining standards for a CEPT agreed system for International teleconferencing. The Europe wide program was known as COST 211 and involved all European national PTT's. Its objective was to establish the optimum data rate and video compression algorithm to provide teleconferencing throughout Europe and allow easy line standard conversion from 625 to 525.

GEC-McMichael is the only manufacturer in production with this codec and has already supplied over 100 units in the USA with more operational in many parts of Europe. Its design is the result of a very large development program carried on in many parts of Europe and funded by the entire membership of the CEPT which includes most of Europe. A development of this magnitude could not have been countenanced by a single private company.

The result is the only codec in the world which operates on a component system (RGB) and is therefore uniquely capable of operation in any line standard. It operates at a frame rate of either 25 or 30 and therefore offers the best movement portrayal compromise by not discarding alternate frames.

The bit rate reduction performed by the codec is possible as a result of the fact that many parts of any static scene are identical. For example a studio scene with a plain background need describe only one pixel of the background and all other pixels of the same background need not be transmitted again. Further, picture content changes between one frame and the next is frequently minimal. Taking advantage of all this information redundancy, by only transmitting it once, allows the transmission channel capacity to be dramatically reduced.

The digital studio distribution system proposed for broadcast use is 216 Mbits/sec whereas with this codec that data rate may be reduced to 8 Mbit/sec.

#### Application to SNG

As a result of the low output data rate of the standard teleconferencing codec (TI), its movement portrayal is of course limited. If this video compression technology is to be applied to broadcast applications, some improvement is required in the movement portrayal capabilities.

Drawing on our extensive experience of these techniques, GEC-McMichael has developed a higher bit rate codec which allows considerably greater movement in the picture. This is similar to the production teleconference codec but is switchable between a variety of bit rates according to the requirement.

It is proposed to use a codec with a data rate of 7.2 Mbits/sec in the SNG terminal proposed in the following section. Once muxed with the audio portion (up to 15 KHz) the effective digital speed is 8.0 Mbit/s

#### RF Transmission Performance

Use of a digital video codec offers a number of unique advantages over any analogue system with respect to satellite transmission.

Frequency modulated analogue television signals produce very spiky spectra with high energy peaks. It is these peaks which cause interference to adjacent satellite channels.

Attempts at reducing the effects of these peaks are made by the addition of energy dispersal to the video waveform. This simply sweeps the carrier up and down over a bandwidth of anything between 600 KHz and 4 MHz.

The effect of this is to average the amount of energy in any narrow bandwidth channel by the ratio of the narrow channel to the peak to peak bandwidth of the dispersal signal. Hence wide dispersal waveforms provide better energy averaging than narrow dispersals. However, the ED waveform increases the peak to peak amplitude of the composite video signal and this causes some of the video signal information to be cut off by the IF filter in the output of the modulator. This results in distortion of the video signal.

When a digital signal is transmitted however, it is normally modulated with a form of phase shift keying, eg QPSK. If a pseudo-random data stream is added to the wanted signal prior to modulation in a modulo-2 adder, this results in another pseudo-random digital stream. When this is modulated the resulting spectrum is almost flat across the entire RF passband and consequently does not cause interference to the same extent.

The use of QPSK for example as the modulation scheme, provides a very efficient use of the RF transmission channel. The RF bandwidth needed to transmit the 8.0 Mbit/sec signal recommended is approximately 5 MHz. It is this effect which allows the SNG terminal to be dramatically reduced in size.

#### SNG TERMINAL DESCRIPTION

##### General

The SNG terminal described in this section comprises four sub-system components:

- The antenna and mount
- Converter and HPA system
- FM exciter and receiver
- Video codec and QPSK modulator

The system takes advantage of the dramatic variation experienced between the two extremes of operational conditions, namely beam center operation in good weather compared to edge of coverage operation in heavy rainfall.

The antenna has an elliptical aperture of 2 meters by 1 designed specifically to provide an antenna which is both easily transported in normal vehicles and is fully compliant with FCC etc. sidelobe regulations. No electronics are mounted on the antenna assembly except the low noise amplifier. It is mounted on an adjustable low profile tripod base. The packing case will serve as part of the antenna's mount. The remaining three sub-systems are housed in identical small flight cases.



## Basic Description

The Fly-Away System consists of three sub-systems which are housed in identical small flight cases. Each of these is 27 by 24 by 21 inches and include built in shock mounts to protect the electronic equipment. The weight of the heaviest of the three system components is the flight case containing the high power amplifier and converter. The total weight of this unit is 95 lbs due largely to the 160 watt HPA. The weights of all other units are less than 90 lbs. The fourth system is the elliptical antenna and it's portable packing case, which also is utilized in securing the antenna.

## Antenna

The antenna has an elliptical aperture of 2 by 1 meters and is designed specifically to provide an antenna which is both easily transported in normal vehicles and is fully compliant with FCC and Eutelsat sidelobe regulations. No electronics are mounted on the antenna assembly except the low noise amplifier. It is mounted on an adjustable tripod base.

The antenna sub-system comprises the antenna itself, including its feed horn and sub-reflector together with the receive filter and low noise amplifier. The assembly is mounted within it's own packing case.

For transport, the antenna sub-system is disassembled into two major components the antenna together with its receive electronics and the packing case.

The antenna uses an off-set fed Gregorian configuration. The corrugated feed horn is circular in section and illuminates the elliptical sub-reflector. The Diffraction Profile Synthesis design ensures the FCC and Eutelsat sidelobe regulations are met.

Polorization adjustment is carried out by rotating the feed horn assembly. A calibrated scale is provided to allow accurate setting 90 degrees from the cross-polar null. An OMT allows duplex operation with the transmit band covering 14.0 to 14.5 GHz and the receive 11.7 to 12.2 GHz.

The antenna is a one-piece construction in order to ensure the good sidelobe performance is not only obtained when new, but is retained throughout the lifetime of the antenna. Cracks in the main reflector surface resulting from folding designs, cause diffraction effects which serve to generate higher level sidelobes. Furthermore, folding or collapsible designs will not retain the main reflector profile accuracy after repeated assembly/disassembly operations without an excessively heavy jointing system.

In view of the necessity for a one piece antenna, the maximum size was determined by assessing the requirements for ease of transport in a variety of likely operational circumstances. Among those considered were a normal station wagon car, the requirements for using a small hotel elevator, loading the terminal into a private light aircraft and a normal scheduled airline.

The results of this study led to the elliptical shape which may be easily moved in any of the above circumstances.

The mount is basically an elevation over azimuth type to allow the maximum ease of satellite pointing. It also has a limited range third axis of mvoement. This is the cross-level axis and is above both the elevation and azimuth axes.

During the initial setting up procedure the antenna is arranged with the cross-level axis horizontal giving a normal elevation over azimuth 2 axis mount. After the satellite has been acquired and the antenna peaked, the cross-level axis may be used to align the major axis of the ellipse of the antenna to be approximately parallel to the plane of the geo-

synchronous arc. This ensures that the lowest off-axis radiation performance is obtained from the terminal.

In most instances this would not be necessary since the orbital plane is frequently nearly parallel to the azimuth axis. Further the sidelobe performance is compliant in all planes (except very close to the elevation axis where the feed arm causes interference to the beam) and the energy density with the digital signal is extremely low.

Rotation around the cross level axis does not alter the antenna pointing angle.

The antenna mounted electronics is limited to the receive filter and the low noise amplifier.

The receive filter is necessary to prevent the output signal from the HPA from saturating the sensitive input of the LNA. It is a short waveguide section approximately 5 ins. in length and is directly connected to the feed flange to maximize the G/T. The low noise amplifier is directly mounted onto the filter output and has a waveguide input. The output of the LNA is coax and this output is fed to the HPA and converter sub-system. The noise temperature of the LNA is 200 K giving a G/T of over 19 dB/K.

As a result of the off-set fed configuration the filter and LNA do not degrade the system G/T since they are not in the main beam of the antenna.

#### RF Electronics Sub-System

The sub-system is contained in one of the three flight cases. It comprises the high power amplifier together with an integrated up and down converter.

The interface to the antenna is a waveguide flange on the transmit chain and an N-type coaxial connector on the receive. The HPA output is connected to the antenna by means of flexible waveguide and the receive chain with coaxial cable. These connections are the only two necessary between the two sub-systems.

The interface to the remainder of the system is at 70 MHz on both transmit and receive channels.

It is important that the RF electronics system is located as close as possible to the antenna. This allows the minimum length of flexible waveguide to be used providing the most efficient use of the available power.

The high power amplifier chosen for this application is a 160 or 300 watt travelling wave tube amplifier. These amplifiers have been selected because it is the smallest and lightest unit available at this power. The 300 watt amplifier and its TWT are manufactured by the EEV company in the UK and the 160 watt TWT is by Morgan Communications (MCL) in LaGrange, Illinois. Its light weight is achieved by the use of a switched mode power supply. This is built into one drawer unit of 9 units height (15.75 ins.). It operates from mains power of either 115 V ac or 240. The up and down converter unit is designed to operate with either the FM video signal or the QPSK data signal. It uses a common SHF local oscillator which is not field tunable but separate first up-converter LO and second down-converter LO. These are tunable over a 40 MHz range to allow some flexibility in channel access. The phase noise performance of the oscillators are adequate for the QPSK signals. All the oscillators are crystal referenced to provide the necessary stability for the narrow bandwidth signals. This is particularly important with the receive signal since the satellite acquisition time is determined to a large extent by the accuracy to which the frequency of the receive carrier is known. The converter unit is housed in a single 3 U drawer unit above the HPA.

### FM Exciter and Receiver

The second flight case houses the modulation equipment for the FM transmissions, a receiver for an SCPC receive voice signal and baseband interfaces. The power distribution system is also included. The FM transmission system may be used when the satellite sensitivity and the weather losses are such that a satisfactory link may be obtained. The modulator is a conventional FM system with NTSC and PAL pre-emphasis characteristics available together with energy dispersal and automatic frequency control.

Up to 3 audio signals may be applied to the modulator each of which is modulated onto its own carrier above the video baseband signal. Standard pre-emphasis circuits are included in the modulators. Each of these channels is capable of full music quality performance. The receiver accepts a signal from the downconverter at a frequency of 70 MHz.

During initial setting up a signal is transmitted from the network control center over the satellite at a frequency specified to the field crew prior to their departure. This allows the down-converter to be tuned to the exact frequency of the transmission.

The frequency uncertainty of this transmission is less than 20 KHz. The narrow frequency uncertainty enables the receiver to instantly recognize any received signal and aids satellite acquisition by removing the frequency uncertainty leaving only the spatial uncertainty. This is possible due to the highly stable local oscillators used.

Once the satellite is acquired the audio signal is demodulated which can be used to authorize the start of the transmission from the SNG terminal.

A signal strength indication is provided to allow antenna pointing to be optimized. A very narrow bandwidth is available in the receiver for aligning the polarization of the feed by finding the null seen on the received signal when the feed is 90 degrees away from the correct polarization.

### Video Codec and QPSK Modulator

The third flight case contains the digital compression codec and its associated modulator. The unit accepts conventional wideband video and two audio signals. One of the audio signals is used as an engineering/co-ordination channel and provides only 3 KHz bandwidth while the second channel is used as the program channel and has a bandwidth of 6 KHz. These two audio signals are digitized and multiplexed into the output of the video encoder.

The analogue video signal is encoded in the vision encoder to provide a digital output at 8.0 Mbits/sec. This signal is then multiplexed with that from the audio signals into a composite data stream of approximately 8 Mbits/sec. The modulator used with the digital signal uses Quadrature Phase Shift Keying and provides an output at 70 MHz. The RF bandwidth of this signal is 5 MHz.

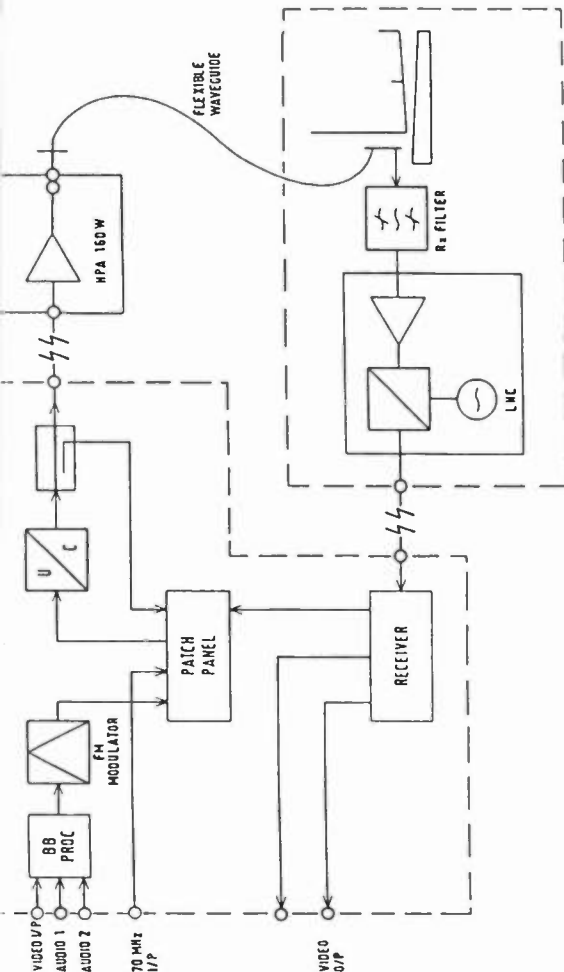


FIGURE 1, SYSTEM BLOCK DIAGRAM

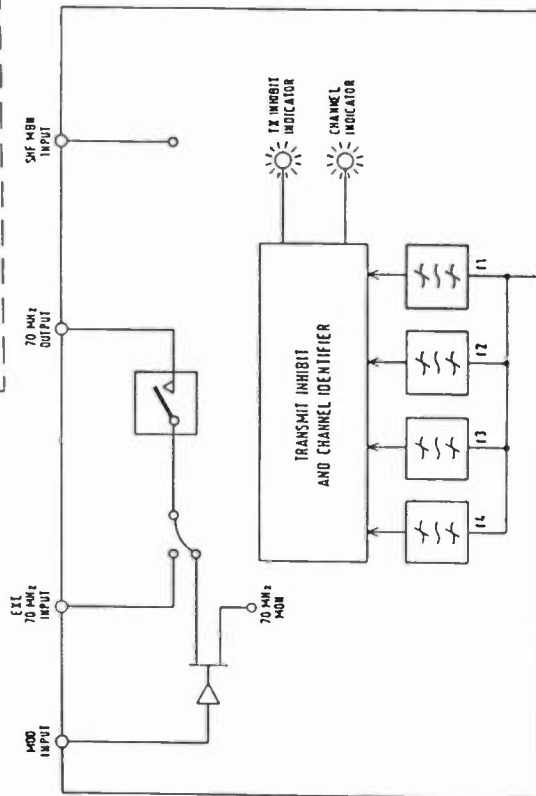


FIGURE 2, PATCH PANEL AND TRANSMITTER CONTROL UNIT

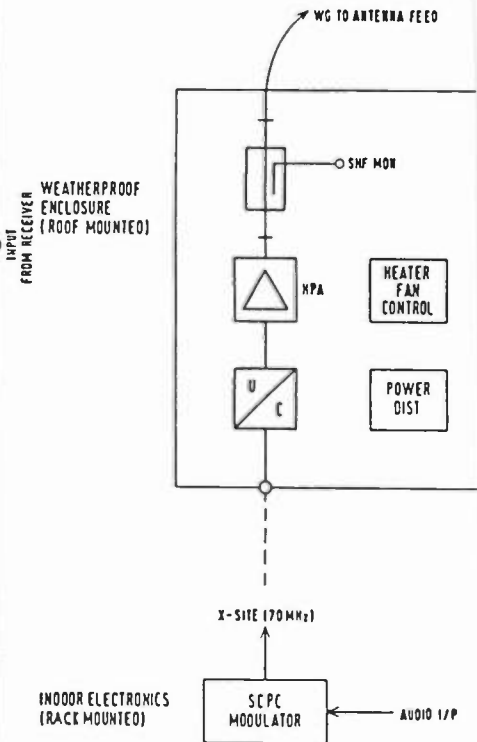
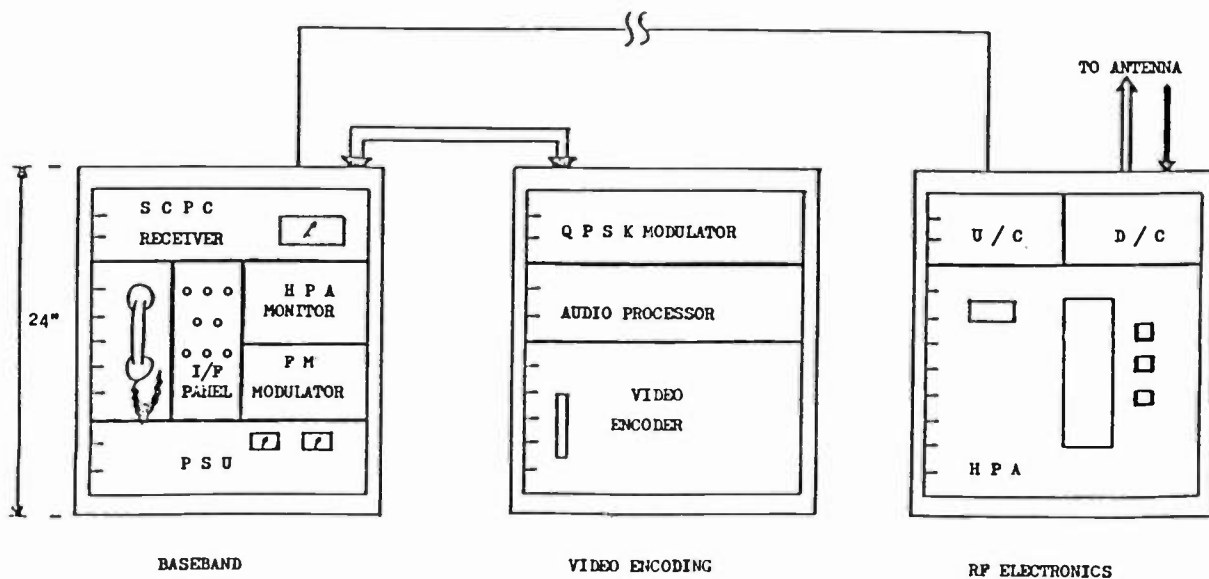


FIGURE 3, BASE STATION - TRANSMIT ELECTRONICS



BASEBAND

VIDEO ENCODING

RF ELECTRONICS

---

Report of Activities of the ATSC Enhanced 525-Line

Television System Technology Group

Daniel R. Wells

Satellite Television Corporation

Washington, D. C.

The Joint Council on Intersociety Coordination (JCIC) established the Advanced Television Systems Committee (ATSC) to explore the need for voluntary national standards for advanced television systems and where appropriate to coordinate the development of those standards. The work of ATSC is divided among three Technology Groups:

Improved NTSC

This Technology Group deals with new standards for NTSC that involve compatible changes. These changes will improve quality in new television receivers but do so with minimal and acceptable impairments to old receivers.

Enhanced 525-Line Television

Improvements considered by this Technology Group may involve a different set of standards but are constrained to a 525-line system.

High-Definition Television (HDTV)

Improvements considered by the HDTV Technology Group are not constrained to 525-line systems.

The subject of this paper is Enhanced 525, which represents an intermediate step between Improved NTSC and HDTV.

All three of the ATSC Technology Groups have the responsibility of looking at improvements throughout the system from pick-up devices through transmission to display in the home. Within the transmission portion are four predominant distribution means to the public, namely:

- Terrestrial broadcasting on VHF, UHF and MDS bands employing VSB-AM
- Cable distribution employing VSB-AM
- Direct-broadcast satellite employing FM
- Pre-recorded tape and disks

In addition to voluntary national standards, ATSC is charged with developing a single national position for international standards in advanced television systems and submitting its proposals to the U.S. Committees of CCIR.

Whereas other groups, such as the FCC and the Regional Administrative Radio Conference of 1983 have dealt with radio spectrum utilization, orbital assignments and interference constraints, ATSC is concerned mainly with the choice of signal format and the technical quality of the service.

ATSC is taking due regard of existing standardization organizations and activities to take advantage of work already underway and to either undertake new work as needed within ATSC or to assign standard activities to others, as appropriate.

The scope of investigation in Enhanced 525 includes:

- o Improvements in video by employing wider bandwidth and separate transmission of luminance and chrominance.
- o Multiple sound channels.
- o Conditional access wherein receivers are addressed and video and audio are scrambled.
- o Ancillary signals, such as data and teletext.
- o Potential extensibility, including backward extensibility to avoid obsoleting present TV sets and forward extensibility to provide growth potential to high-definition television.

The work of Enhanced 525 is handled by four Specialists Groups. The first is Production and Origination.

The Production and Origination Specialists Group, chaired by Don Klein, has prepared a Recommended Systems Approach for video. Its main points are:

1. CCIR recommendation 601 for a studio digital standard should be the starting point for developing standards for in-plant distribution.
2. Using CCIR recommendation 601, EBU and SMPTE have defined parallel bit streams for Y, R-Y and B-Y components. Further work is being done to define a serial bit stream which employs the same components and evolves from the existing CCIR 601 parallel standard.

An area requiring more investigation is whether a serial version of 601 would provide sufficient bandwidth to meet the needs of Enhanced 525.

3. Video signals from all source facilities, such as live cameras, telecine pick-up devices, satellite receivers and videotape machines, should be converted to a serial version of CCIR Recommendation 601 for in-plant distribution.
4. At the output of the studio plant, the serial digital video signals would be converted, as necessary, to the appropriate transmission format which may vary, depending on whether the transmission is terrestrial broadcast, cable, satellite or other.
5. While the assumption of this systems approach is that video signals from all sources would be converted to the serial version of 601 for in-plant distribution, it is recognized that other formats may be utilized during the transition period, one of which may be component analog video (CAV).
6. There should be a worldwide electronic capture standard for television cameras and telecine pick-up devices. Eventually, this would include a higher line rate than 525 lines and a wider aspect ratio than the present 4:3.

Remaining work includes definition of an audio signal format for in-plant distribution and its transcoding to a format requiring less bandwidth for transmission such as adaptive delta modulation; characterizing the envelop of chrominance frequency response at the source as a compromise between anti-aliasing and higher chroma resolution; developing the serial version of CCIR Recommendation 601. SMPTE has been asked to assist with the latter task in an effort that was already well underway.

The Production and Origination Specialists Group is also arranging for source material to be used in comparative tests of transmission formats, as discussed below.

The Transmission and Distribution Specialists Group, chaired by Jules Cohen, has identified several candidate systems. A chart was prepared comparing the technical characteristics of each. From this, a "strawman" of technical specifications was drafted for FM transmission based on a time-multiplexed analog component signal format. The "strawman" contained ranges in some of the parameters, rather than single values, in order to encompass the differences in the proposed systems. The ranges will be narrowed and eventually resolved as a result of further analysis and as a result of tests and demonstrations that are now being arranged.

In the strawman, the blanking intervals are utilized for multiple channel digital audio, data services, synchronization and encrypted conditional access control. The reliability of this information in the blanking intervals related to transmission link impairments is a key consideration.

The candidate systems are likely to be close in performance based on evidence at hand to date. Comparative demonstrations, therefore, shall be side-by-side. In a cooperative effort with the DBS Association, the Specialists Group is preparing a set of evaluation criteria to be applied in the demonstrations, some of which will be objective and some of which will be subjective. The test conditions and procedures are also being carefully defined in advance.

The work of the Reception and Display Specialists Group has until now been deferred pending further resolution of the production standard and the transmission format.

The Test Procedures Specialists Group, chaired by Charles Rhodes, has developed several new test signals for testing time-multiplexed analog component transmission systems. One reason for this is that some presently used test signals when demodulated to RGB produce signal excursions below black or above white. A camera could not produce chrominance without luminance. There is no reason why the dynamic range of the chrominance portion of the component transmission system should be extended to cover negative values of RGB nor values significantly above white level.

With time-multiplexed analog component decoders now being developed as a consumer product, charge coupled devices may be used initially for line stores. Due to the line-sequential transmission of chroma, a particular CCD does not always process the same chroma component. This places stringent requirements on the matching of the gain and offset of these devices. A special test signal may be needed.

These and other special test signals can be produced by custom programming of PROM integrated circuits so that existing digital test signal generators can be used.

The noise weighting characteristic for 525-line systems was determined many years ago. Since then, picture tube resolution has been improved, which suggests that the presently used weighting function may not be appropriate for Enhanced 525.

In multiplexed analog component systems, it is not sufficient to have only a luminance noise weighting function. In such systems, trade offs can be made in luminance and chrominance noise and resolutions by selecting the time compression factor to be applied to each. Experimental work is required for chrominance weighting as well as luminance weighting.

\*\*\*\*\*

Any proposed improvements in Enhanced-525 systems involving a change of standards must be compared against a benchmark of the existing NTSC system, including advancements in NTSC that can be foreseen in the next few years. The Improved NTSC Technology Group is in the process of providing a demonstration system that can serve as a benchmark. This will provide a means of assuring that if a change of standards is recommended for Enhanced 525, the resulting improvements will be significant enough to make the changes worthwhile.



---

Experimental Camera and Recording System for  
Reduced Bandwidth HDTV Studio Production

W.E. Glenn, Ph.D., J.W. Marcinka, Karen G. Glenn, Ph.D.

New York Institute of Technology

Dania, Florida

At the 1984 NAB Convention<sup>1</sup> we proposed a compatible bandwidth reduced transmission system based on design parameters derived from psychophysical experiments in vision. The use of these principles has now been extended to the design of a high definition television camera and to recording its output at reduced bandwidth in analog component format.

In a studio production system we assume that the quality of the image that is recorded should exceed that in an HDTV transmission system. The most important reason for this is that it should be capable of either transfer to film or direct electronic projection at a quality somewhat higher than that of a transmission system where bandwidth is at a premium. In this paper we will not address the issue of the exact number of scan lines, but will assume that line numbers of 1049, 1125 or 1249 will be used. From the psychophysical measurements previously reported<sup>1,2</sup> we will also assume that the R-Y color signal requires half the resolution of luminance, both horizontally and vertically. Since post-production frequently uses blue as a color key, we suggest that B-Y be recorded with the same resolution even though this is not required in the transmission system or display of the final release. These color signals can be derived from a standard 525-line, 4.2 megahertz R, G, B camera.

In our previous work we have found that detail luminance (the top octave of vertical and horizontal resolution) can be updated or transmitted at a rate of 7.5 frames per second or less without visible degradation of the image. This is based on the fact that perception of detail in the visual system is much slower than perception of low resolution in rapidly changing portions of the image. In spatial sampling with raster lines of an image, Wendland<sup>3</sup> and other workers have recommended oversampling the image and pre-filtering in order to reduce the degradation of resolution below the Nyquist limit. This process also can be used to eliminate aliasing. A similar situation occurs in temporal sampling introduced by the frame rate of the camera. Jitter and temporal aliasing can be reduced by oversampling the image temporally. Consequently, for a production system we suggest that the low resolution luminance and color signals be derived

from 525-line, 60-field interlaced signals. The detail luminance can be over-sampled two-to-one by using a frame rate of 15 Hz. This can later be temporally filtered using frame stores to derive a 7.5 frame rate detail signal for transmission.

Our original analysis of detail perception during motion is based on the assumption that the viewer fixates on static portions of the image as objects in the scene move through the field of view. Subsequently, we have studied detail perception when the viewer carefully tracks a moving object. In this study<sup>4</sup> we found that the reduction in contrast at low spatial frequencies caused by lag in the 525-line camera tubes was far more important in reducing perceived sharpness than the loss of the top octave of detail in the direction of motion. Consequently, in a production system it is desirable to use a low lag camera for the basic 525-line camera such as the CCD camera developed by RCA.

To experiment with these parameters we have built an experimental HDTV camera. The low resolution luminance and the R-Y and B-Y signals are derived from a Sony Model BVP3 R, G, B satican camera. A fourth camera tube has been combined optically with this camera. This uses a high resolution 45 x Q plumbicon made by Amperex to provide the detail information. A photograph of the camera is shown in Figure 1.

The high resolution camera tube is progressively scanned with 1050-lines per frame at 15 frames per second. As we and other workers have observed, a progressively scanned camera tube has unusually high resolution, both vertically and horizontally. Since this tube is only used to derive the high resolution detail information, the camera tube does not have to have low lag. The long time constant lag in a camera tube reduces the contrast at low spatial frequencies during motion. Since these spatial frequencies are filtered out of the detail signal, lag in this camera tube does not degrade the image. Since the camera tube is scanned at 15 frames per second, its sensitivity is unusually good and the bandwidth required is only 8.4 megahertz for a resolution of double that of standard television, both vertically and horizontally. Since all of the luminance detail is derived from a single tube, the registration requirements of all four tubes correspond to those of a 525-line camera. The high resolution image is spatially filtered using four one-line delays. The spatial filter uses diagonal sampling in a five-line by five-pixel array with appropriate coefficients to derive the detail information. Our previous work<sup>1,2</sup> indicates that the "oblique effect" in vision makes diagonal sampling preferred in sampled images. This recommendation agrees with the subjective test results obtained by Wendland and Schroder<sup>5</sup>. Figure 2 shows a block diagram of the signal processing used to produce a 1050-line display. The detail information was scan-converted to a 60-field interlaced format and added to the 525-line luminance information. 4.2 MHz, R-Y and B-Y information is derived from the 525-line R, G, B camera tubes to provide the color information.

In the image displayed as described above, the detail luminance information was at a bandwidth of only 2.1 megahertz. It was found that, as in a woofer-tweeter system in audio, there must be some overlap of the high and low bandwidths in the crossover region. Also, a 1050-line progressive scan camera produces more than double the resolution of the interlaced scanned camera. Consequently, at this detail bandwidth the vertical and horizontal resolution was only about 600 lines. The detail bandwidth required to extend this to 800 lines was estimated

to be about 4.2 megahertz. In order to verify this estimate, the system was reconfigured with the detail at 2.1 megahertz using cardinal sampling derived from a 1050-line diagonally sampled image. The low resolution information was limited to about 200 lines. This produced a simulation of the final system scaled down a factor of two in resolution. It also provided the opportunity to record the output at reasonable bandwidth.

To illustrate the image quality that could be recorded, we have made a 525-line recording from the output of the camera on a Sony Betacam recorder in analog component format. In this recording the detail luminance information, both vertically and horizontally, is derived from the 1050-line progressively scanned camera tube at 15 frames per second. R-Y and B-Y are recorded in analog component format at 1.5 megahertz each. This recording represents a "scaled down" version of a 1050-line recording. As in the proposed HDTV production recording system, the detail is at 15 FPS and the low resolution luminance and color components are at half the resolution of the detail. The recording produced color images of either static or moving objects with somewhat better resolution than can be obtained with an interlace scanned camera.

In HDTV studio production recording higher bandwidths are required than the recording described above. The following table shows the expected bandwidths:

low resolution Y	-	4.2 MHz	525 lines, 60 fields
R-Y	-	4.2 MHz	525 lines, 60 fields
B-Y	-	4.2 MHz	525 lines, 60 fields
Detail Y	-	4.2 MHz	1050 line, 15-frame progressive diagonally sampled
		-----	
TOTAL:		16.8 MHz	

A further advantage of the recording format described above is that for release for standard 525-line NTSC transmission the output of the first three channels does not require scan conversion. It is simply encoded in NTSC format.

One might wonder if the resulting tape might be degraded by editing since the detail is recorded at a 15 FPS rate. Our tests of detail masking<sup>2</sup> and the results of Seyler and Budrikis<sup>6</sup> indicate that the detail cannot be detected for about 300 milliseconds after a scene change. Consequently, the tape can simply be edited as if it were a standard 525-line recording. Loss of detail for one or two frames after an edit cannot be detected.

In this paper we have described a camera and recorder experiment that combines the "best of both worlds" of interlaced and progressive scanning. By deriving detail luminance from a progressively scanned camera tube at 15 frames per second, this signal can have unusually good resolution at good sensitivity and modest bandwidths. Lag in the high definition tube produces no image degradation. The remaining signals are standard R, G, B, 525-line, 60-field interlaced scan. These provide good spatial and temporal resolution for recording and post-production and need no scan conversion for 525-line NTSC release.

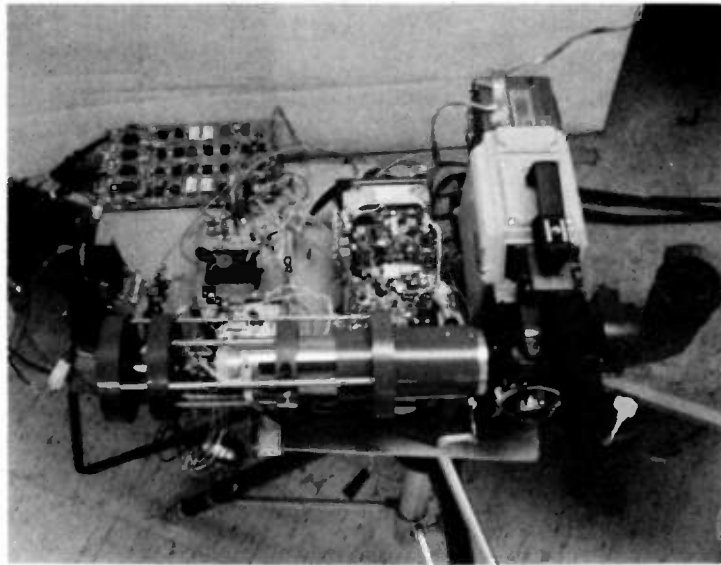


FIG. 1

Experimental Four-Tube HDTV Camera

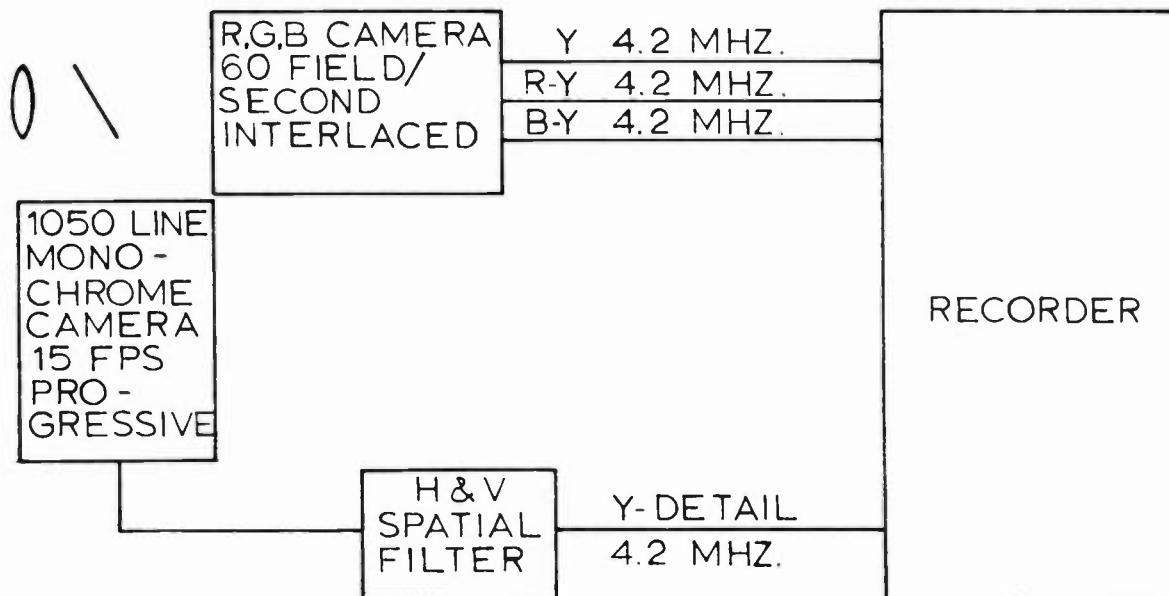


FIG. 2

HDTV Production Recording System Block Diagram

### References

1. Glenn, W.E., Glenn, K.G., Marcinka, J., Dhein, R., Abrahams, I.C. "Reduced bandwidth requirements for compatible high definition television transmission." Presented at National Association of Broadcasters, 1984.
2. Glenn, W.E., Glenn, K.G., Bastian, C. "Imaging system design based on psychophysical data." Presented at Society for Information Display, 1984.
3. Wendland, B. "Extended definition television with high picture quality," SMPTE Journal, 92. pp. 1028-1035, 1983.
4. Glenn, W.E., Glenn, K.G., Bastian, C. "Apparent sharpness of moving objects." To be presented at Society for Information Display - 1985.
5. Wendland, B. and Shröder, H. "On picture quality of some signal processing techniques," SMPTE Journal, 93. pp. 915-922, 1984.
6. Seyler, A.J. and Budrikis, Z.L. "Detail perception after scene changes in television image presentation," IEEE Transactions on Information Theory. pp. 31-43, 1965.

---

RESOLUTION REQUIREMENTS FOR HDTV BASED UPON  
THE PERFORMANCE OF 35 mm MOTION PICTURE FILMS FOR THEATRICAL VIEWING

Arthur Kaiser, Henry W. Mahler, Renville H. McMann

CBS Technology Center

Stamford, Connecticut

INTRODUCTION

High Definition Television, HDTV, is being actively developed in laboratories throughout the world. The goal is to produce a picture vastly superior to that which we are accustomed to seeing with either the NTSC or PAL system. But how "superior" should our target be? The Advanced Television Systems Committee has set a goal of twice the horizontal and twice the vertical resolution of 525-line NTSC. This, it is assumed, will produce a picture subjectively equal to, or better than, 35 mm film. The problem with this goal is that nobody has published the results of experiments to determine the end-to-end performance in resolution of 35 mm projected motion pictures, although estimates have been made in recently published works<sup>(1,2)</sup>. This paper will report on such an end-to-end 35 mm performance test, and relate the results to those to be expected from an HDTV system.

EXPERIMENTAL APPROACH

To obtain reasonable verification of the resolution achievable from the "live scene" to the "large screen", the decision was made (1) to produce a 35 mm test motion picture film containing appropriate subject matter, (2) to project the print onto a large screen in a theater, and (3) to obtain direct photometric data from the projected image. From this data, it was assumed that an objective assessment could be made of the overall system's resolution.

It was further decided that all materials, equipments, and processes required for implementing the test would be state-of-the-art insofar as available practitioners of film-making and exhibiting would judge them to be.

Since the principal objective of this undertaking was to determine resolution requirements for HDTV, it appeared most practical to employ television measurement methods and units as much as possible. Using the normal wide-screen projection format of 1.85:1 as a reference, the picture height on the film is 0.446 in. (11.3 mm) and the width 0.825 in. (21.0 mm). Therefore, wherever spatial frequency is expressed as TV lines per picture height, 11.3 mm will be used for the height of the film frame in the projector gate.

Finally, in the interest of a conservative approach, and to minimize the effects of intervening picture impairment, it was decided that the projection tests would be conducted using a first-generation print made directly from the original negative. Of course, at least two additional intermediate stages, with their attendant degradations, would be the practice in commercial distribution.

#### PRODUCTION OF THE TEST FILM

The test film was made at the CBS-Fox Studios in Studio City, California, at 11:00 a.m. (P.S.T.) on a clear day. The subject matter consisted of an exterior establishing shot of a small town square followed by the introduction of the Marconi Television Resolution Chart No. 1, and closing with the same exterior shot. Approximately 1000' of 5247 Eastman color negative were exposed.

The camera used was a carefully adjusted Panaflex-X, Serial No. PFX-130X. A Panavision 20-100 lens, T/3.1, Serial No. 25-46 and type 85 plus Harrison ND9 filters completed the photographic equipment. Both the Director of Photography and the Camera Operator were professionals from the CBS-Fox Studio staff. Two of the authors of this paper supervised the shooting.

The film-to-test chart distance was 9'8", and with a 90° shutter angle\*, two exposures were used successively, T/5.6 and T/8.0. With the test chart framed to occupy the correct picture height for the desired normal wide-screen format, the lens was operated at about a 75 mm focal length. With this framing, 800 TV lines per picture height was the maximum spatial frequency available from the test pattern. Subsequently, the framing was changed to cause the chart to occupy exactly one-half picture height, thereby doubling the spatial frequencies available for measurement to 1600 TV lines per picture height.

On the day following the shooting, after processing at Consolidated Film Industries, the timed workprint (Type 5381 stock) was viewed in CBS-Fox Studios' Screening Room C and examined under a microscope in the camera laboratory.

---

\*The combination of 90° shutter angle and the neutral density filter was required to obtain four T-stops of light attenuation. This was done in order to shift the lens aperture from T/22 to T/5.6, the aperture of optimum resolution.

Data from Kodak on the 5247 negative shows a 30% response at 50 cycles per mm (1100 TVL) and 60% response for 5381 print film at the same spatial frequency. By extrapolation from manufacturer information, it was calculated that the Panavision lens provides 30% response at that frequency. Assuming no loss of MTF from the printing process itself, the cascaded response at 1100 TVL would then be 0.3 x 0.6 x 0.3 or 5.4%. This was judged to be the case under microscopic examination of the print; observers saw a limiting resolution at 1100 TVL (50 cycles per mm).

Therefore, satisfied that the workprint demonstrated the estimated response, prints identical to the workprint were made from the original negative for use in subsequent projection tests.

#### PROPOSED METHOD OF MEASURING PROJECTED IMAGE MODULATION

Based upon the assumption that a theater with a 20' high screen was available for the tests, the plan was to use a Photo Research Spotmeter, Model UBD 1/4°, to measure luminance (in foot Lamberts) of the projected black and white elements of the resolution wedges, proceeding from the coarsest pattern to the finest. If the Spotmeter aperture was positioned 12" from the screen, a resolution element for 1000 TVL occupying 1/1000 of 240" (screen height) or 0.24" would represent an angular subtense of greater than 1 degree. Therefore, a 1/4 degree photometer could be expected to produce useful results for plotting an MTF curve.

#### PROJECTION MEASUREMENTS AND OBSERVATIONS

Before running the test film described above, it was necessary to determine the performance of the projection system against accepted standards. For this purpose, SMPTE Test Film 35-IQ was used. This film was made in accordance with SMPTE Recommended Practice RP-40-1971 (Reaffirmed 1977), "Specifications for 35 mm Projector Alignment and Screen Image Quality Test Film". Figure 1 is a print made from a single frame of this film. When projected in accordance with published directions, the resulting picture may be properly framed and its image quality judged. The modulation transfer at 80 cycles per mm (1800 TVL) is at least 80% over the entire field. The 35-IQ was a new print, projected for the first time during these tests. Figure 2 is a print of a Kodachrome slide obtained by photographing the stationary slide projection of a single frame taken from the 35-IQ. From this, the quality of this particular film could be verified by observing useful response at 1800 TVL. Note the shadow of the photographer's forefinger on the shutter release and the perforations in the screen which are useful in establishing camera focus. Figure 3 is a print of another slide made while projecting the identical 35-IQ frame on a non-perforated screen at the CBS Technology Center which shows essentially the same resolution.



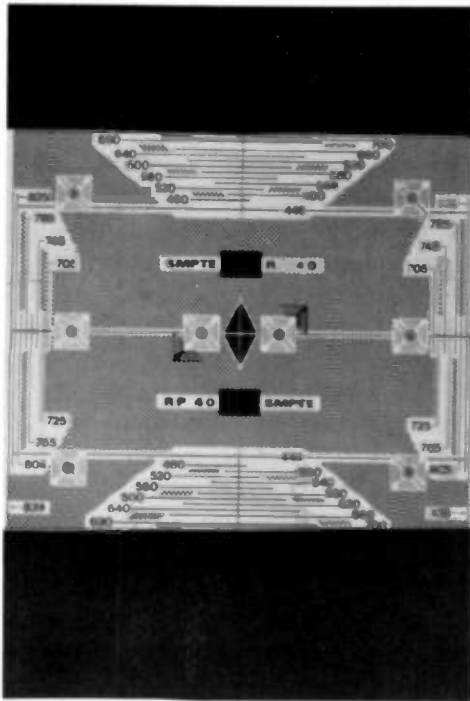


Fig. 1: Print of single frame of SMPTE 35-IQ Test Film.

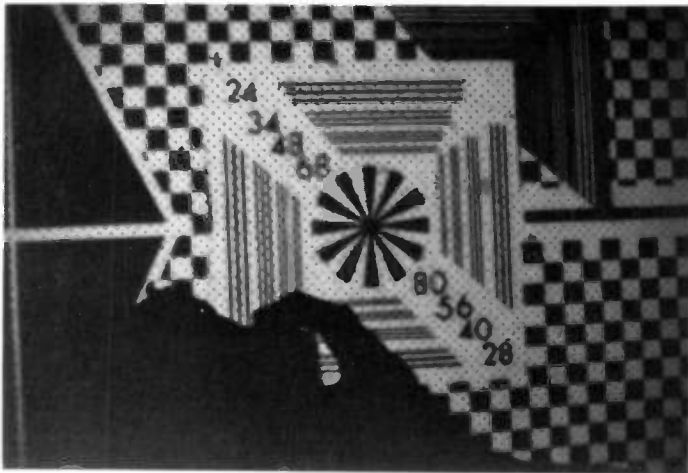


Fig. 2: Photograph of projected slide taken from SMPTE 35-IQ Test Film. Photographed at Museum of Modern Art.

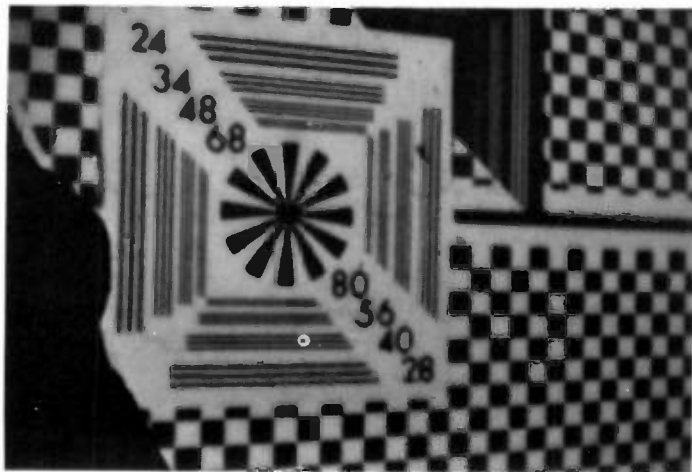


Fig. 3: Photograph of projected slide taken from SMPTE 35-IQ Test Film. Photographed at CBS Technology Center.

For reasons of accessibility to the theater and the quality of projection equipment available, the site chosen for the projection tests was the theater at the Museum of Modern Art (MOMA) in New York City. The screen at MOMA is a non-directive, 12' high perfect diffuser. The motion picture projection equipment consists of a Xenon arc source in an Orcon 2000 Watt Lamp Assembly, a Simplex 35 Model PR 1014 film transport with 3-bladed shutter, and a high resolution Isco 70 mm lens (distributed by Schneider) at F/1.6. The projector was operated with a 1.85:1 aperture mask. At different times, open-gate luminance was measured between 8.5 and 10 ft - L.

After establishing the proper framing of the 35-IQ test film, first attempts were made to measure percentage modulation using the Spotmeter. However, the degree of picture horizontal and vertical jitter that was encountered, even from this high quality projector, made it completely impossible to hold the aperture of the tripod-mounted instrument on either the black or white resolution elements long enough to make a measurement.

Referring to the Instructions furnished with the 35-IQ Test Film, the following statement was found:

"Vertical image unsteadiness and lateral image weave can be readily evaluated using this test film. By placing a rod or a pole near the screen to produce a sharp shadow adjacent to one of the squares in the screen image, the actual amount of image unsteadiness or weave can be measured and expressed in percent of the screen width. Movement equal to one square represents 0.5% of the screen width. An acceptable amount of image unsteadiness should not exceed 0.125%, or 1/4 square."\*

For most of the runs attempted, this performance requirement was easily satisfied. It was noted that the observed jitter had horizontal and vertical components of sufficient temporal frequencies to cause visual averaging of high spatial frequencies. A calculation of the significance of 1/4 square image unsteadiness shows this to be equivalent to 26.2 microns on the film. A spatial frequency of 40 cycles per mm has approximately the same spatial period. This would render it impossible to visually resolve 900 TV lines if the jitter rate caused visual integration.

---

\*When converted to a fraction of picture height, this becomes 0.23% PH, and one side of the square equals approximately 1% of picture height.

## FRAME UNSTEADINESS, CAUSES AND EFFECTS

One of the most definitive and relevant works published on 35 mm picture steadiness which the authors could locate was performed by Prof. Dr.-Ing Karl Otto Frielinghaus of the Institute for Photographic and Cinematographic Engineering in East Germany<sup>(3)</sup>. In addition, a considerable body of work has been described (4,5,6) which is concerned with 16 mm frame steadiness in the context of telecine requirements. However, none of the published materials deals specifically with the effects of picture unsteadiness upon attainable resolution. At this juncture, therefore, conclusions on resolution must be inferred from the previous work on frame unsteadiness by applying psychophysical studies on visual perception of moving objects and by experimental verification of these inferences.

The phenomenon of frame unsteadiness in motion picture film results from the existence of measurable frame positioning errors. Television professionals would call this "frame-to-frame registration errors". In general, these errors are caused by the mechanical characteristics of the film transport equipment such as cameras, contact printers, and projectors. They also arise from tolerances in perforating film stock, film stock shrinkage, and other material-related causes. Since the overall process of shooting the film, three generations of printing, and projecting the release print introduces frame positioning errors at each stage in a random manner, the overall frame unsteadiness may be represented by the root mean squared sum of such errors.

The net effect of frame unsteadiness is to introduce a degree of picture impairment in the finally viewed projected image. These impairments have been given considerable study with the result that a criterion for acceptable picture steadiness has emerged. One version is embodied in SMPTE RP-40 for theatrical film use.

The key question now arises, "How does the human visual system respond when the image stimulus is in a state of randomly oriented intermittent motion?" Psychophysical research points to a marked drop in visual acuity. In a study described last year in Great Britain<sup>(7)</sup>, the angular threshold of visual acuity was shown to be degraded by a factor of at least 4 for intermittent exposure of 1/4 second when target motion of 3° per second was compared with a stationary target. While these test conditions do not adequately describe the problem under discussion, the intermittent exposure prevents the use of eye tracking for a continuously moving target. Eye tracking is surely precluded when viewing a randomly moving intermittent image. Because the random frame positioning errors have a sampling frequency of 24 per second, one may expect frame unsteadiness at frequencies of 12 Hz or less.

A twice RMS unsteadiness of 0.23% of picture height can be translated to 1/3" on a 12' high screen. At a viewing distance of 36' (3 x PH), this represents an angular subtense of 3 arc minutes. As a random motion, this would not be visually detectable. However, as applied to a resolution grating of 800 TVL, one line of which occupies one-half of the frame unsteadiness, the visual response can be expected to be zero when visual integration occurs.

## A PHOTOGRAPHIC ALTERNATIVE TO IMAGE PHOTOMETRY

It was observed during the experiment that direct photometry of the projected image would be futile for spatial frequencies exceeding about 300 TVL. Therefore, a photographic alternative was suggested. This consisted of taking a close-up photograph (35 mm) of the screen so that the highest spatial frequency of interest in the projected image would be well below the limit of the Kodachrome 64 film used for this purpose. An exposure of 250 milliseconds was deemed to be a proper value for simulating the temporal response of the human visual system<sup>(8,9,10)</sup>. This was subsequently confirmed after viewing the photographic results; the transparencies do indeed portray the visual averaging effects of frame unsteadiness with impressive accuracy.

Figures 4, 5, 6, and 7 are enlarged prints of the Kodachrome slides made during a projection run of the SMPTE 35-IQ Test Film. They show the very center only and were photographed in rapid succession, each at 1/4 second, F/2.0. Because these were shot very close to the subject but at an angle to the projection axis (to avoid casting a shadow), the depth of field is limited. However, the screen perforations offer a clear indication of the region of optimum camera focus. It is worth noting that this was one of the least unsteady runs we experienced; there was very little horizontal jitter, and vertical jitter was well within SMPTE RP-40 guidelines. During other runs (not photographed), horizontal and vertical jitter were about equal to the allowable 1/4 square. Table 1 shows the 8 different spatial frequencies, on the 35-IQ film, at their television equivalents in TVL.

TABLE 1

<u>Cycles per mm</u>	<u>TVL</u>
24	542
28	633
34	768
40	904
48	1085
56	1266
68	1537
80	1808

The reader is reminded that the modulation on this film, at all spatial frequencies shown, exceeds 80%. This would not be true for a normal theatrical release print.



Fig. 4: Photograph of SMPTE 35-IQ Test Film Taken at 1/4 sec., F/2.0. Area of optimum focus may be determined by noting screen performance.

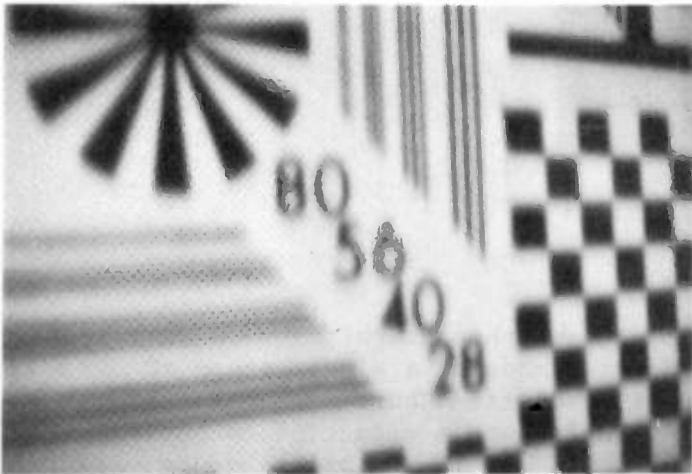


Fig. 5: Photograph of SMPTE 35-IQ Test Film taken at 1/4 sec., F/2.0. Area of optimum focus may be determined by noting screen perforations.



Fig. 6: Photograph of SMPTE 35-IQ Test Film taken at 1/4 sec., F/2.0. Area of optimum focus may be determined by noting screen perforations.

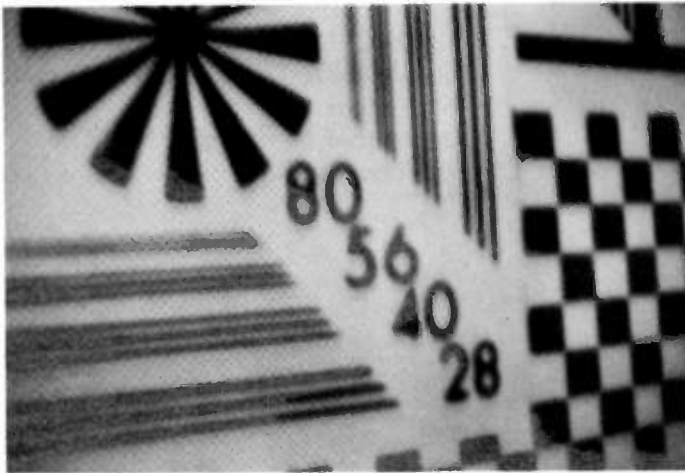


Fig. 7: Photograph of SMPTE 35-IQ Test Film taken at 1/4 sec., F/2.0. Area of optimum focus may be determined by noting screen perforations.

The authors next proceeded to project and photograph the CBS-produced test film. Figure 8 is a print made of a single frame of this film showing the Marconi Television Resolution Chart scaled for 1:1 use. Figure 9 shows the same subject with 2:1 scale reduction to permit measurements up to 1600 TVL. Figures 10, 11, and 12 are prints of Kodachrome slides showing the central areas of the stationary projections of the test chart in both 1:1 and 2:1 formats, including the corner crossed wedges of the 2:1 in which the value of all indicated spatial frequencies must be doubled. The crossed wedges are useful here for determining vertical resolution. Figure 13 is a print of a slide made from the middle of the auditorium while the moving test film was being projected during the test chart 1:1 format. This location was approximately 3 x PH. Figure 14 shows a close-up of the screen during running of the 1:1 test chart. One can see the relative steadiness horizontally but the vertical jitter is clearly visible in the numerals. Figure 15 shows the 2:1 test chart confirming the horizontal resolution and vertical jitter seen in Figure 14.

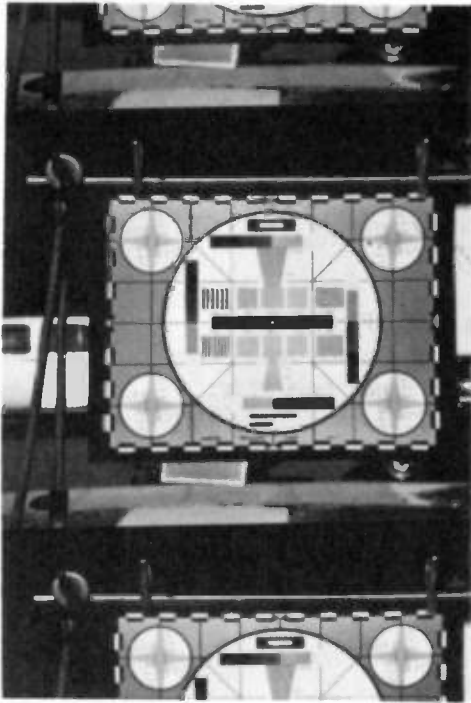


Fig. 8: Print of single  
frame taken from  
CBS-produced test film.  
Framed 1:1.

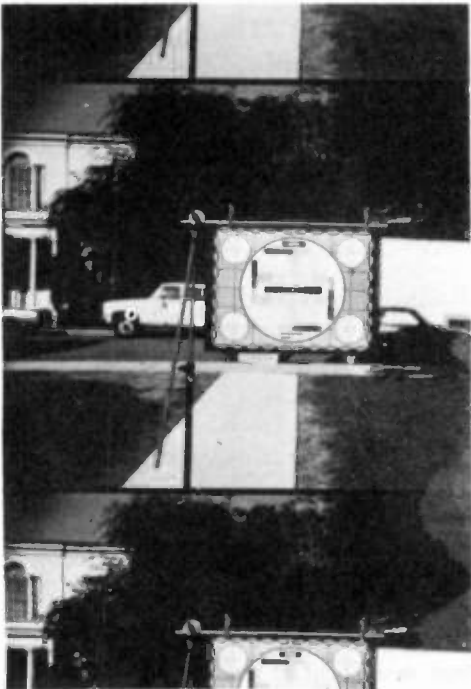


Fig. 9: Print of single  
frame taken from  
CBS-produced test film.  
Framed for 2:1 scale  
reduction.

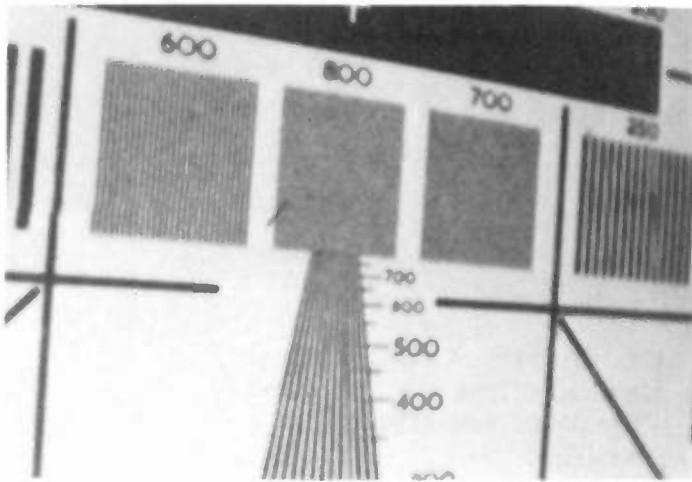


Fig. 10: Photograph of projected slide taken from CBS-produced test film. Framed 1:1.

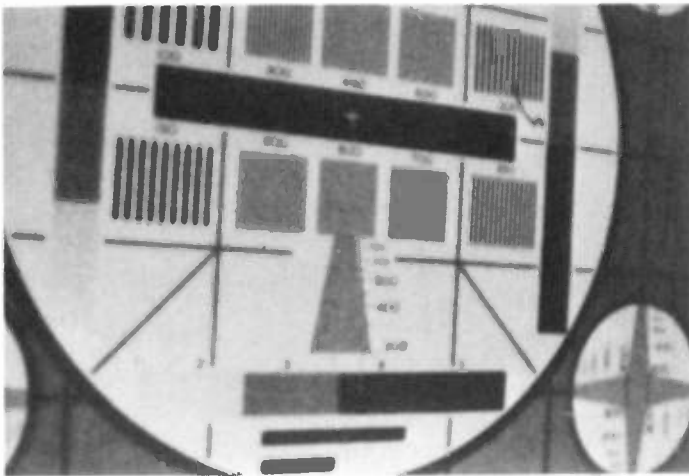


Fig. 11: Photograph of projected slide taken from CBS-produced test film. Framed for 2:1 scale reduction.

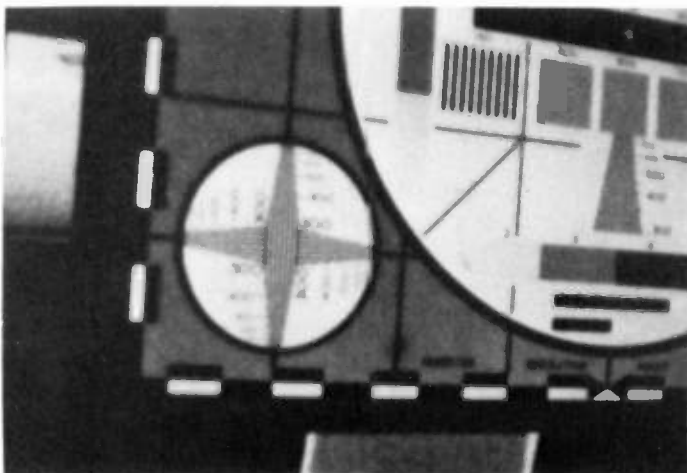


Fig. 12: Photograph of projected slide taken from CBS-produced test film. Framed for 2:1 scale reduction. Corner crossed wedges are located near center of full frame.



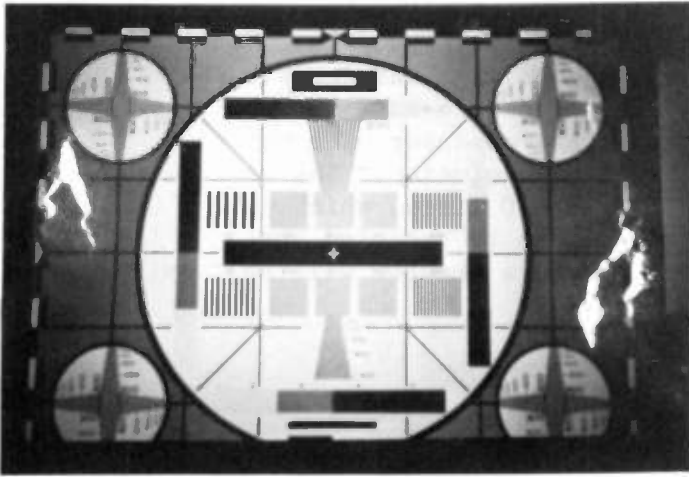


Fig. 13: Photograph of projected CBS-produced test film. Photographed at distance of 3 X PH.

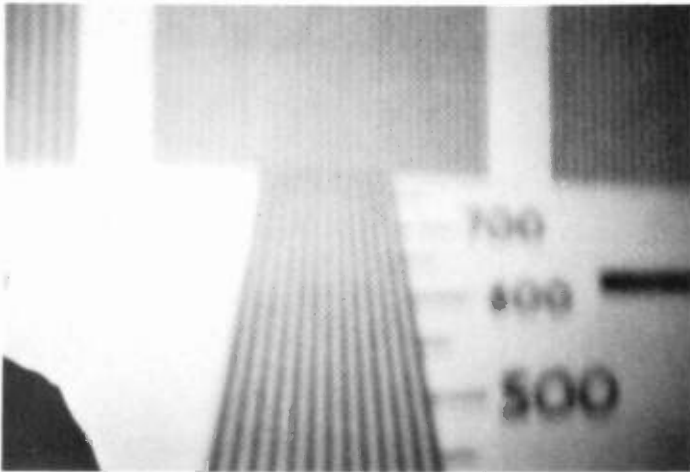


Fig. 14: Photograph of CBS-produced test film taken at 1/4 sec., F/2.0. Framed 1:1.

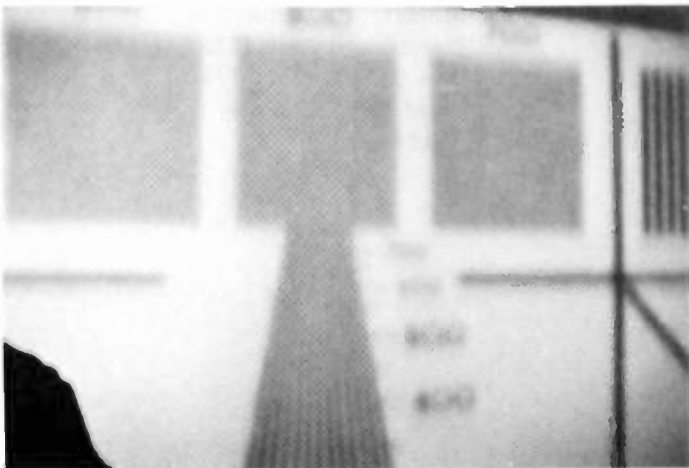


Fig. 15: Photograph of CBS-produced test film taken at 1/4 sec., F/2.0. Framed for 2:1 scale reduction.

Finally, figures 16 and 17 are successive shots of the crossed wedges using the 2:1 test chart format. In the first, vertical resolution is poorer than 600 TVL; in the second, one can detect slightly better than 800 TVL. The two exposures were made within seconds of each other, thus indicating that the observer of a motion picture sees a picture of constantly changing resolution. The observed resolution fluctuated rapidly between 600 and 800 lines, which gave a visual average of about 700 lines. Thus, it can be expected that the resolution observed in the average motion picture theater will be less than 700 TVL per picture height.

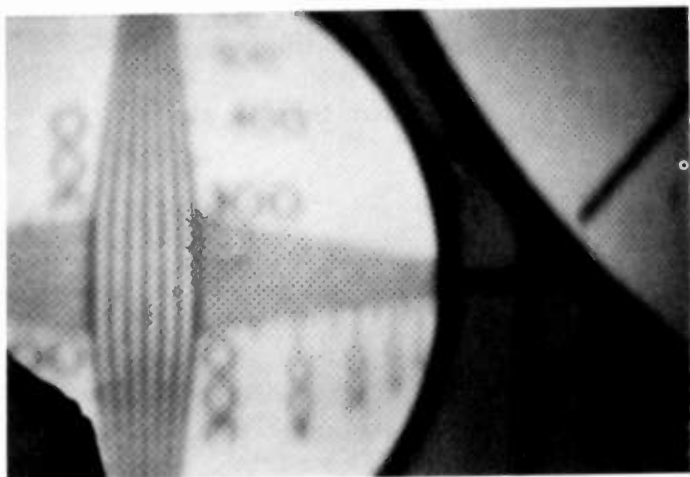


Fig. 16: Photograph of CBS-produced test film taken at 1/4 sec., F/2.0. Framed for 2:1 scale reduction.



Fig. 17: Photograph of CBS-produced test film taken at 1/4 sec., F/2.0. Framed for 2:1 scale reduction.

## CONCLUSIONS

In attempts to perform precise measurements of modulation transfer function of a projected 35 mm motion picture film, the authors have been confronted with a phenomenon that is statistical in character, i.e., frame unsteadiness. Although unsteadiness of film has been the subject of considerable research and investigation by others for the past three decades, there has been a lack of information about its effects on observed resolution. This paper has been concerned primarily with its effect upon attainable resolution. After repeated observations of test results and review of relevant literature, several conclusions seem inescapable:

1. Microdensitometric data on individual frames of a motion picture print are indicative only of the ultimate possible goal for a projected image.
2. The mechanical realities of projecting films have limited the degree to which the projection systems and the contact printers (often operated 24 hours daily) can be improved with respect to frame unsteadiness. Therefore, a permissible total frame unsteadiness has been established as a recommended practice by the SMPTE.
3. With a permissible twice RMS unsteadiness of 0.23% of picture height and significant unsteadiness components up to 12 Hz, dependable resolution beyond 800 TVL is beyond the acuity of the human visual system.
4. For the viewing audience seated beyond 3 x picture height, resolution of less than 700 TVL must be expected.
5. Because of the statistical nature of frame unsteadiness and its attendant resolution loss, the vast majority of motion picture viewers have been enjoying their entertainment experience with a good deal less than 700 TVL.
6. It appears that for HDTV to equal 35 mm projected film, a resolution of 700-800 lines is required. This can be achieved by a TV system with twice the resolution of 525-line NTSC which has 350 lines vertical and 400 lines horizontal resolution for a studio bandwidth of 5 MHz. Thus, a 1050 or 1125-line HDTV system of 20-22 MHz bandwidth should fully equal, and very likely exceed, the quality of 35 mm projected film.

## ACKNOWLEDGMENTS

The authors wish to express their sincere appreciation to the management and staff of the Department of Film of the Museum of Modern Art for their valued cooperation and assistance in this project, with particular thanks to Mary Lea Bandy, Director, Warren Jacobs and Jeff Schulman, and to Jim Sater and Norm Brown of the CBS Studio Center staff.

## REFERENCES

1. "High Definition Television as It Stands Today", Tom Mann, BKSTS Journal, September 1983.
2. "Eastman Color Negative Film 7291", R. C. Sehlin et al, J. SMPTE, Dec. 1983.
3. "New Investigations on Picture Steadiness of Motion Pictures in Projection", Karl Otto Frielinghaus, J. SMPTE, Jan. 1968.
4. "Image Unsteadiness in 16 mm. Film for Television", Wood, Sanders and Wright, J. SMPTE, October 1971.
5. "Method of measurement of Film-Frame Steadiness", Contribution from IRT, EBU #GT G3 010.
6. "The Influence of the Precision of the Sprocket-Hole Spacing on Picture Steadiness of Television Films", Contribution by M. Rotthaler, EBU #GT G3 026.
7. "Exposure Duration Affects the Sensitivity of Vernier Acuity to Target Motion", Morgan, Watt, and McKee, Vision Research, Vol. 23, No. 5, 1983.
8. "Vision and Visual Perception", Edited by C. H. Graham, (John Wiley & Sons 1965), pp. 305, 576, 586.
9. "Noise Limitations to Resolving Power in Electronic Imaging", Coltman and Anderson, Proc. of IRE, May 1960, p. 865.
10. "Reduced Bandwidth Requirements for Compatible High Definition Television Transmission", W. E. Glenn et al, Conference of the Institute for Graphic Communication, 1983.

---

STEREO PHASE ERROR DETECTION AND AUTOMATIC PHASE CORRECTION

USING AN AUDIO CROSS-CORRELATION TECHNIQUE

David A. Howe

Howe Audio Productions, Inc.

Boulder, Colorado

Broadcasters have a mandate to deliver entertainment and other programs through electronic communication. Delivering video or audio or both from one point to another is a principal objective. This paper discusses the problems associated with the distribution and transmission of two channels of a stereo audio signal, a seemingly straightforward task. One can simply think of doubling the task involved with the distribution of a monaural audio signal. However, if a phase or time mismatch occurs between two audio signals, left and right, then a problem occurs in any combining of the two signals, such as in their reduction from stereo to a monaural signal.

Channel-to-channel phase instability shows up in the combining process as an easily distinguishable loss or change in the high frequencies, a "whirling" effect, or even a hollowness in the medium frequencies. This is because a time-delay error between channels causes high-frequency audio signals to be combined out of phase. The frequency at which out-of-phase cancellation occurs becomes lower and more noticeable as the time-delay error increases.

We can express the two audio channels as continuous functions of time:

$$L(t), R(t)$$

and if we assume a single tone model, we have:

$$L(t) = V_0 \sin(\omega t + \Delta T)$$

and

$$R(t) = V_0 \sin(\omega_0 t)$$

where  $V_0$  is the peak voltage swing,  $\omega$  and  $\omega_0$  are the frequencies of the left channel and right channel respectively, and  $\Delta T$  is a fixed phase offset of the left channel.

Assume that  $\omega = \omega_0$  and  $\Delta T \neq 0$  that is, both channels will carry the same single tone but with a different phase offset. Summing, we have:

$$L + R = 2V_0(\sin(\omega t + \Delta T) + \sin(\omega t))$$

and this expression goes to zero for values of  $\omega = \frac{(2n - 1)\pi}{T}$   $n = 1, 2, 3 \dots$

Therefore, all frequencies  $f = \frac{\omega}{2\pi} = \frac{(2n - 1)}{2T}$   $n = 1, 2, 3 \dots$   
 yield no L + R component.

The problem of channel-to-channel phase mismatch has been with us since the early days of stereo. In fact, the inferior sound of many early stereo records played on high-quality monaural systems delayed the acceptance of stereo. For several years, recordings were released in stereo and mono due in part to incompatibility in the needle and cartridge pickup. But even fully compatible pickups did not make recordings sound as good in monaural. Today's music recording studios are fully outfitted with the highest quality equipment in a controlled recording environment to guarantee precise phase control in a multi-channel audio mix (let alone, a two-channel mix such as stereo).

But the complexity of recording and playback, audio distribution worldwide, and the need for speed and efficiency of productions, has created greater opportunities for phase mismatches. Engineers are involuntarily involved in situations where phase control, hence mono compatibility, will not exist.

The following three types represent common phase-error problems:

- (1) Channel-to-channel phase dispersion error,
- (2) Channel-to-channel time delay error,
- (3) Channel phase reversal.

Each will be discussed separately.

#### CHANNEL-TO-CHANNEL PHASE DISPERSION ERROR

The transmission of any signal through any real media will create a phase shift in the reproduced signal. This is because of two effects: First, the media cannot move a signal any faster than the speed of light. Furthermore, the quality of the interconnecting link introduces a velocity factor which, when multiplied by the speed of light, is the real delay through the link. High-quality links, such as coaxial cable, yield velocity factors near 1.00. Links normally associated with audio, such as common, shielded twisted pairs, have velocity factors considerable less than one. In addition, the velocity factor is not constant but varies as a function of frequency. The interconnecting media is referred to as anisotropic because of this behavior. Functionally, this is because the dielectric constant and dielectric loss varies as a function of frequency in the linking cable.

The second effect which causes phase shift in the interconnecting link is due to the link's non-infinite bandwidth. All links are modeled as a type of filter. All filters require phase shift in order to "roll off." It is the combining of a phase-shifted and amplitude-shifted signal model with the direct signal which produces characteristic filter response for a given type of link.

Real-world audio interconnecting links typically have bandwidths that are no more than twice the maximum allowable audio frequency and velocity factors are usually approximately 0.5. This is true even for microwave and satellite links because of the uplink and downlink filtering, decoding, and processing which is required to limit bandwidth and prevent adjacent frequency-domain and time-domain channel interference. Digital systems are particularly bad because of the anti-aliasing filters required and the larger than usual time delays through digital-to-analog data conversion. In fact,

the more advanced D/A converters involving error correction and aperture correction provide the greatest opportunities for uncontrolled phase shift through the interconnecting link.

A transmission time delay and its corresponding phase shift is by itself a problem. All real audio signals distribute power over a group of frequencies in the allowed transmission bandwidth. This is the so-called real time power spectrum of the signal. Even though the amplitude response may be perfectly flat, a transmission-related phase shift as a function of frequency will affect substantially the reproduction of an audio wave at the receiving end. Figure 1 shows the phase relationship of the distributed harmonics up to the 7th harmonic associated with a simple, positive-going step function (composite). Figure 2 shows the resultant same step function when passed through a single-pole RC filter in a phase-lead configuration. In this mode, the phase is advancing as frequency increases. This configuration is a normalized-amplitude, high-pass single-pole transfer characteristic and is a common effect associated with the low-frequency rolloff characteristic of the audio link.

Figure 3 shows the resultant effect on the positive-going step function through a link modeled as a single-pole phase lag in which the phase delay increases with increasing frequency. Again, this is a lowest-order (first-order) mode for an RC. This configuration is the normalized amplitude, low-pass transfer characteristic of the link. The effect is due to the high-frequency rolloff associated with a finite bandwidth link.

The examples used here assume a simple first-order phase shift effect through the media. The resultant transient distortion at the receive end will increase with higher-order transfer characteristics. Except for digital systems, passband transfer characteristics are reasonably modeled by single-pole, first-order phase shift networks.

The kind of error described here through a transmission media is called a phase-dispersion error. In stereo transmission phase dispersion becomes a serious negative effect because the phase dispersion is not identical in the left channel versus the right channel. Using the left channel as a reference, Figure 4 shows a typical phase difference of the right channel with increasing audio frequency. This phase difference is not attributable only to the media of the audio link but also may originate from encoding, decoding, filtering, equalizing, and other processing stages for the left channel and right channel separately. When the left and right channels are combined such as in a monaural rendering, the summed signal (L + R) are not combining in phase as the frequency increases. Thus, the monaural signal has a degraded quality. Figure 5 shows varying degrees of phase dispersion modeled by a single-pole phase shift transfer characteristic. It is well to point out that channel-to-channel phase dispersion errors of the type shown as plot G of Figure 5 routinely occur. This is largely due to the fact that no tariff (link specification) exists on the phase difference between two discrete channels for virtually all common distribution systems. Furthermore, Plot G represents a possible case in which one extra coupling transformer is in the right channel versus the left channel. Amplitude response (frequency response) in all cases is assumed to be flat over the bandwidth of interest.

#### CHANNEL-TO-CHANNEL TIME DELAY ERROR

Because of the finite propagation speed of an audio signal through any interconnecting link, a time delay occurs in the arrival of a signal at the receiving end. Since the propagation speed is never the speed of light but rather some lesser speed determined by the link's velocity factor, the time of arrival of the signal is directly dependent on this equivalent velocity factor. The equivalent velocity factor for a left channel versus a right channel is never equal even in systems using one channel in a frequency- or time-domain multiplex system. When combining left and right audio signals to produce a monaural rendering, the time of arrival of the combined signals must be

identical to produce a signal in monaural with full fidelity. A channel-to-channel time-delay error will create a degraded monaural signal in the same way in the same way a channel-to-channel phase dispersion error will degrade. A fixed time-delay error causes a linear phase shift error as a function of frequency rather than the curve as shown in Figure 4. The negative consequence is similar in that high-frequency components of the discrete left and right signals are not combined in phase as the frequency increases. In the worst case, some frequencies create an exact out-of-phase error in the L + R combining process.

Satellite, microwave, and telephone audio links can have significant channel-to-channel time delay errors. Multi-channel digital audio systems are also prone to this error due to the conversion processes involved. A very common source of channel-to-channel time delay error exists when a stereo tape playback occurs with a tape head azimuth misalignment. Also, spacially-offset stereo pickup microphones create time-delay errors. That is why it is highly recommended that a coincident pair stereo microphone technique be used wherever possible.

#### CHANNEL PHASE INVERSION

The delivery of stereo audio to new markets such as television and AM radio adds a new layer of difficulty to the industry. Traditionally, monaural-based audio production, mixing, and distribution has been a complex task for routine air material. The additional burden of dual-channel audio and the requirements for controlled delivery creates greater opportunity for mistakes. Keeping track of changing program events, multi-channel mixing, and a myriad of audio parameters increases the chances that an accidental phase inversion may occur somewhere within a program's audio delivery. This, of course, means that the L + R (monaural rendering) will be significantly degraded and in the exact case will be non-existent. A channel-phase inversion error even occurs often during a controlled recording session for musicians. Sound recording and sound reinforcement engineers are constantly on guard to watch for summed, inverted channels which may occur in complex multi-channel mixing situations.

A channel phase inversion error is not an electronic error but rather a configuration or operator problem. Nevertheless, channel phase inversion errors have occurred and will continue to occur frequently enough that it is considered a class of error in this paper.

#### ACTIVE PHASE CORRECTOR

The detection and correction of all common kinds of stereo phase error problems has been developed, tested and marketed by the author. The overall system is called an active phase corrector, or APC, and is described in this section. For comparison, a passive phase corrector describes a fixed equalizer or delay network used to compensate for a fixed-time or phase error such as in the matching of stereo telephone lines or other discrete studio-to-transmitter links.

The APC is a device which automatically aligns the time and phase relationship of two (left and right) audio signals. It accomplishes this by using the audio program material itself to sense a system-related time and phase difference between the signals. Then a correction time delay and phase compensation (via feedback loops) is applied to one signal or the other to compensate for the detected error.

Figure 6 shows a block diagram of the principal parts of the APC. Both left and right channels have analog time-delay and phase compensation devices whose transfer characteristics are voltage-controlled.

A system-related phase error is sensed using a cross-correlator at the left and right outputs.



If a phase error exists, a positive (or negative) correction DC signal is applied to an integrator, a device which adds up the errors as they are sensed. The output of the integrator is a correction, or "steering," voltage to the compensation networks. Time delays are controlled in opposing directions so that relative time between the two channels will advance or retard. The feedback loop then drives the channel-to-channel time difference to zero equilibrium. It also applies a first-order all-pass phase equalization to compensate for detected channel-to-channel phase dispersion.

A significant concept of the APC is that it is automatic and uses only program material to determine the existence of a channel-to-channel phase error. No reference tones, encoding, or special protocols are needed, although they can be used if desired. The device uses both time and phase analysis of the program material to apply a correction.

Figure 7 shows X-Y oscilloscope displays of the input and output of the APC for a tone at 5 kHz. Left channel is the vertical axis; right channel is the horizontal axis. Figure 7(a) shows the input phase relationship to have an error of greater than 90 degrees. After the APC (Figure 7(b)), the left and right outputs show considerably reduced phase error.

Figure 8 shows input and output phase displays with a 20 Hz to 20,000 Hz white noise source. The noise was recorded on tape with both channels in phase and having equal levels. The output of the tape machine is shown in Figure 8(a). Figure 8(b) shows the same signals after passing through the APC. Again note the improvement in the phase alignment across the noise spectrum.

#### CROSS CORRELATOR

For two signals  $L(t)$  and  $R(t)$ , the degree of signal coherence is given by the average cross-correlation function defined as(1,2):

$$Z(\text{Corr. Fcn}) = \frac{1}{T} \int_0^{T_1} L(t) * R(t + \Delta T) dt$$

This function precisely defines the extent to which two signals are related to each other in phase and amplitude. For non-coherent, random signals, the correlation function averages to identically zero for all values of  $\Delta T$ . But for signals showing any degree of coherence, the average value over some sampling interval will yield a non-zero result. A common use of electronic cross-correlators is in the identification of weak signals in the midst of a high degree of receiver noise such as in reception of signals from deep space probes. The presence of a known signature signal buried in noise will produce a non-zero result when the noise is cross-correlated with the signature simulator produced at the tracking receiver station.

Two audio signals  $L(t)$  and  $R(t)$  feeding a cross-correlator will produce an output which is a function of relative time difference (lead or lag time). For two channels of a stereo signal showing some degree of coherence, the correlation function might look like that depicted in Figure 9.

Circuitry has been developed which will quickly find the value for  $\Delta T$ , the maximum value of the correlation function, for audio signals  $L(t)$  and  $R(t)$ . The method involves finding the maximum value of the function by computing its first derivative. A block diagram of the cross-correlator is shown in Figure 10 along with an output integrator. The first derivative scheme uses a traditional synchronous modulation and demodulation lock-in of phase. The synchronous reference modulation is at 1000 Hz which produces a correlator sample every 1 ms. This is an adequate sample rate for audio signals.

A unique feature of the cross-correlator is its ability to discriminate between a systematic time/phase error and normal phase fluctuations in stereo music material. The detection of a phase error by other common schemes such as zero-crossing detection or linear phase detection results in the sensing of music-related phase effects. This, of course, is unacceptable. But because the electronic cross-correlator described here is taking an average of a first derivative of a multiplied  $L(t)*R(t)$  signal, music phase fluctuations are not detected and only the component representing true coherence is analyzed.

The development of a cross-correlator for audio signals was the first major advancement which moved research toward successful implementation of an automatic phase corrector. Conventional audio phase detection techniques fail because almost all music material contains intentional, random phase variations. However, it is known that human ears can separately perceive a system-related phase problem when stereo signals are combined. It is reasonable to assume then that an appropriate electronic circuit can do likewise.

#### VOLTAGE-CONTROLLED TIME AND PHASE COMPENSATOR

Figure 11 shows a schematic representation of the network used in the left and right channels to be phase and time corrected. This circuit is a class of all-pass, phase-shift network using a feed-forward technique(3). The audio signal passes through only one amplifier (the top amplifier) for all values of phase shift. As the voltage control increases, a four-pole bandlimited audio signal is fed forward and summed at the output. Amplitude response is automatically normalized, but the time delay of signal harmonics is shifted relative to signal fundamentals. The circuit then emulates a time delay network using all-pass, phase-shift circuitry. At the same time there is virtually no signal degradation due to the nature of the feed forward technique.

#### MATRIX ENCODING AND DECODING

The solution to the problem of stereo phase shift has been so elusive that some audio distribution systems are advocating the use of matrix encoding and decoding. This process sends  $L + R$  in one channel and  $L - R$  or simply  $R$  in the other. The decoding process adds and subtracts the two channels appropriately to recover  $L$  and  $R$  discretely. But there are two problems with the implementation of matrixed audio.

First, matrixed two-channel encoding and decoding does not solve any of the three fundamental phase-error problems. It simply reintroduces the media phase error in another form. Since there is phase instability in the audio link, there will be instability in the matrix decode. The result is poor stereo separation and worse, a poor stereo image for the listener. The monaural signal may be excellent, but now the stereo reproduction is inferior.

Second, signal-to-noise ratio can be considerably degraded. Most stereo material has more  $L+R$  than  $L-R$  or  $R$  audio. In fact, a voice announcement driving both left and right equally and in-phase (which very commonly occurs) has no  $L-R$  audio and a -6dB  $R$ -only component. The  $L+R$  channel must be 6 dB lower than if discrete, conventional  $L$  and  $R$  channels were sent (since  $L+R$  equals twice  $L$  or  $R$ ). Furthermore, the decoded additive noise from the  $L-R$  channel is directly mixed into the output. Being random, its contribution is a 3 dB increase in noise. The net effect is as much as a 9 dB degradation in signal-to-noise for a commonly occurring  $L+R$  only broadcast. The  $L+R$  and  $R$  matrix approach would have its worst case in an  $L$ -only broadcast. Nonetheless, some degradation would be present in any usual case.

Some manufacturers are recommending dynamic noise reduction to solve the noise problem of

matrixed two-channel formats. If noise in the transmission system is a problem, this solution cannot be recommended. This is, at best, a bandage solution leading to other questions. Which noise reduction technique? What about the highly discussed issue of the audio effect and quality of all approaches? How much additionally will this cost?

Matrixing is useful in many situations. For example, in cases where one transmission channel has differing noise and bandwidth characteristics, matrix (or composite) encoding can be very useful because the trade-off for separation and image is more acceptable than a stereo rendering with different L and R channel parameters and noise characteristics.

But matrixing is not a solution to any stereo phase-error problem in which the two channels are matched otherwise. Again, matrixed audio distribution does not solve a stereo phase-error problem.

#### CONCLUSION

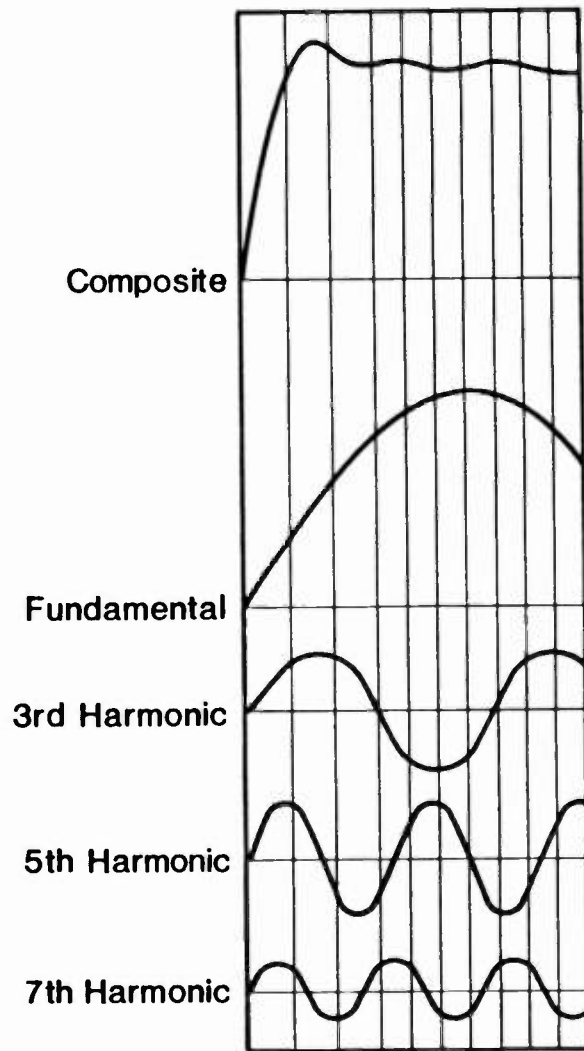
The automatic phase corrector (APC) described in this paper which corrects for channel-to-channel phase dispersion and time-delay errors is manufactured by Howe Audio Productions, Inc., Boulder, Co. and is called the PHASE CHASER. A picture of the Phase Chaser is shown in Figure 12. Future products designed for stereo television audio will include enhancements to the Phase Chaser which will automatically correct for a channel inversion error and provide phase monitoring using an optional oscilloscope.

The APC is the first successful electronic solution to the problem of a systematic phase error between left and right channels of a stereo audio signal. It provides stable, time-aligned output signals and automatically compensates for channel-to-channel phase dispersion for optimum combining either spatially by stereo loudspeakers or for monaural compatibility. No other audio parameter is affected.

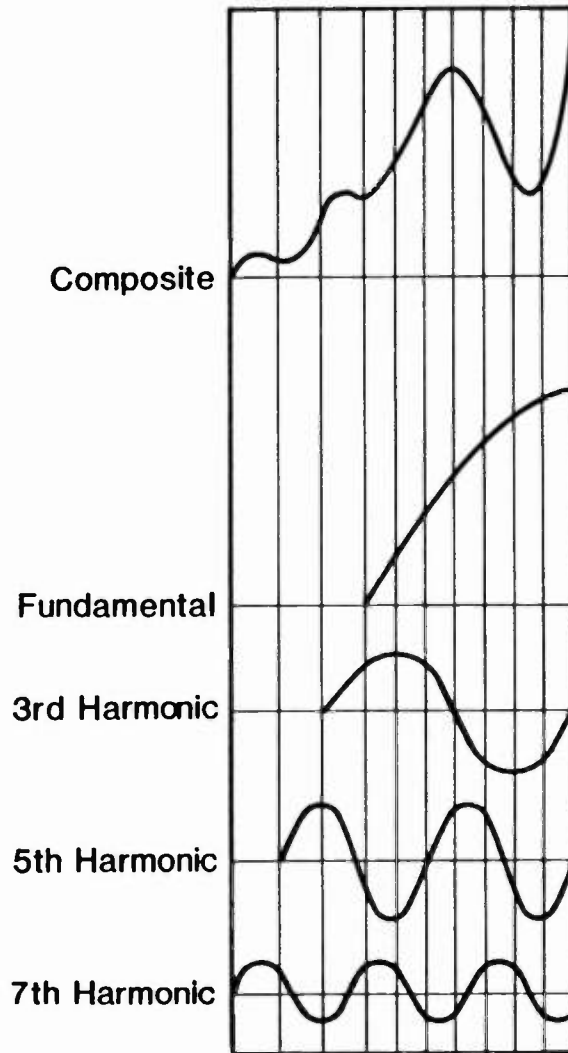
It is noteworthy to point out that the APC performs a relative time and phase correction for any two-channel source. This includes reel tape and cartridge playback systems having unstable phase alignment(4). And the APC is compatible with many proposed phase-error correction schemes using reference or subcarrier tones. The APC will read these and any tones and/or subcarriers contained in the audio channels and will use this signal (along with program material) to apply a phase correction. The only requirement is that the tones and subcarriers be sent in phase, a generally true initial condition.

#### REFERENCES

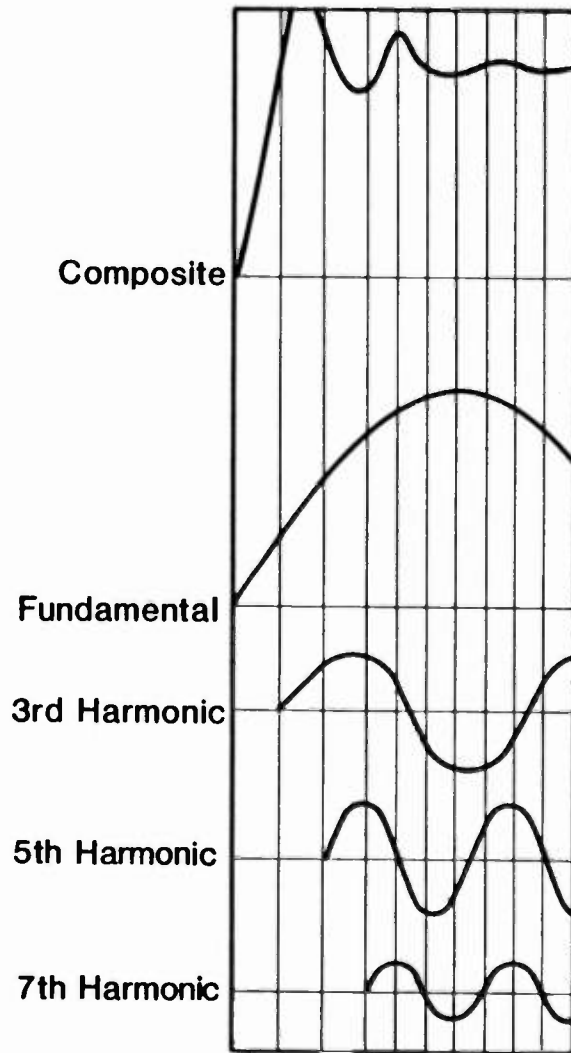
1. D. A. Howe, D. W. Allan, and J. A. Barnes, "Properties of Signal Sources and Measurement Methods," Proc. 35th Annual Symposium on Frequency Control, Philadelphia, PA, May 1981.
2. M. Javid and E. Brenner, "Analysis, Transmission, and Filtering of Signals," McGraw-Hill, New York, NY, 1963, pp. 234-260.
3. Studer Technical Report, "Phase Compensation of the A810," Summer 1983.
4. D. A. Howe, "A Solution to the Stereo Cartridge Phasing Problem," Broadcast Engineering, April, 1982.



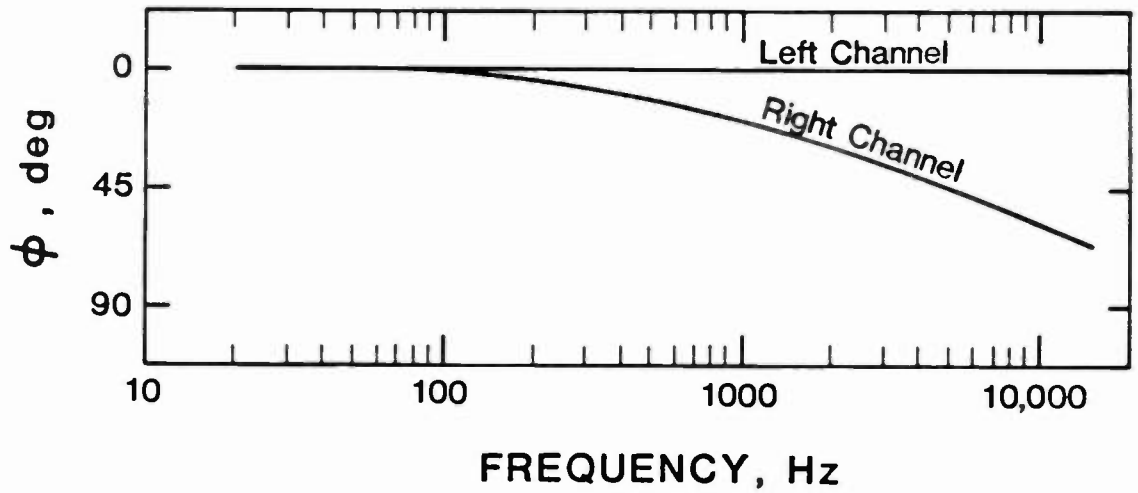
**Fig. 1**  
**Harmonic Phase Match**  
**Effect On Step Function**



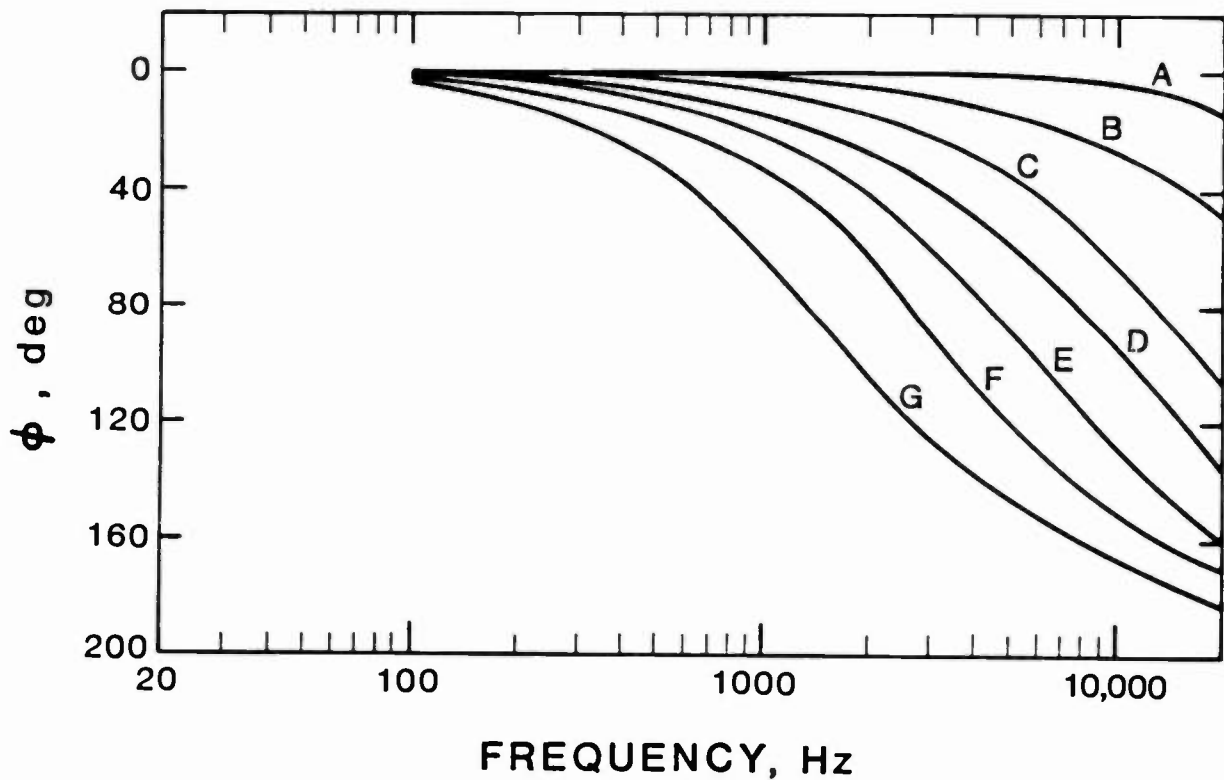
**Fig. 2**  
**Single-Pole Phase-Lead**  
**Effect On Step Function**



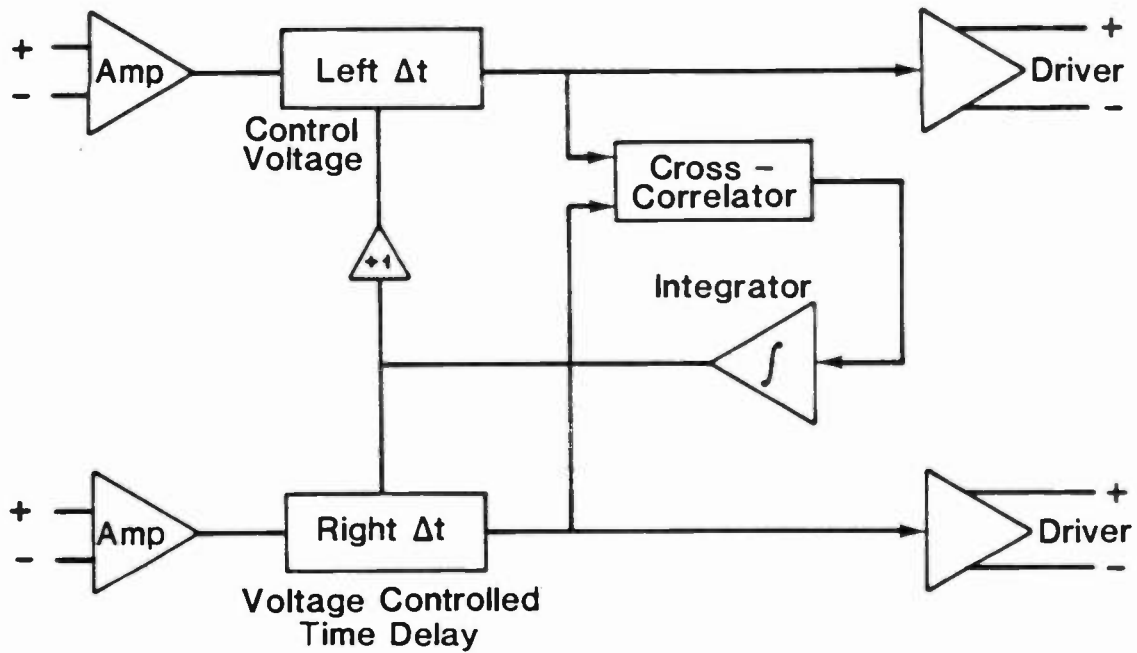
**Fig. 3**  
**Single-Pole Phase-Lag**  
**Effect On Step Function**



**Fig. 4**  
Single-Pole Phase Difference Characteristics

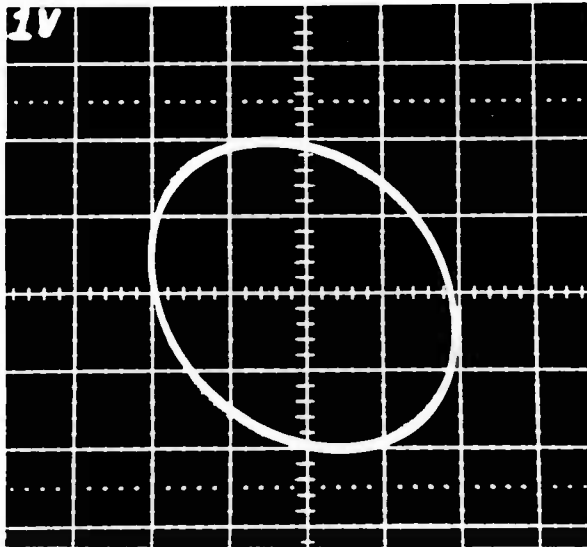


**Fig. 5**  
Single-Pole All-Pass Phase Shift Transfer Characteristics

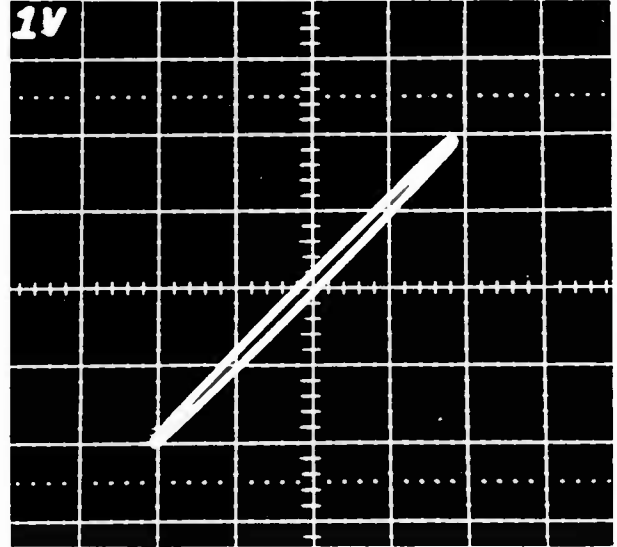


**Fig. 6**  
**Schematic Diagram of HOWE Phase-Chaser**



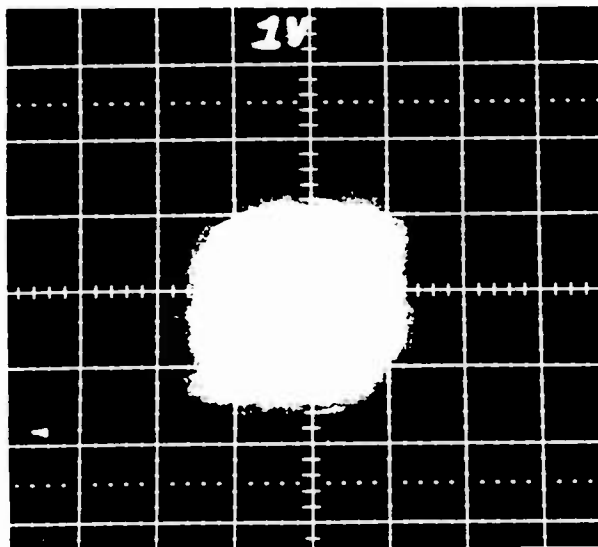


(a) Before active phase equalizer

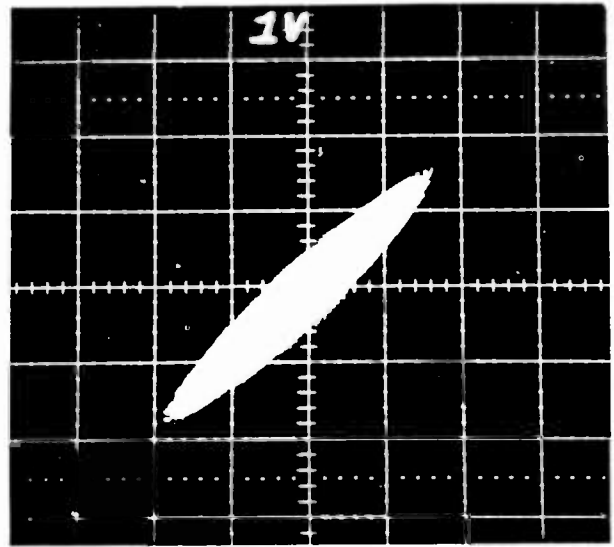


(b) After active phase equalizer

**Fig. 7 5 kHz tone.**

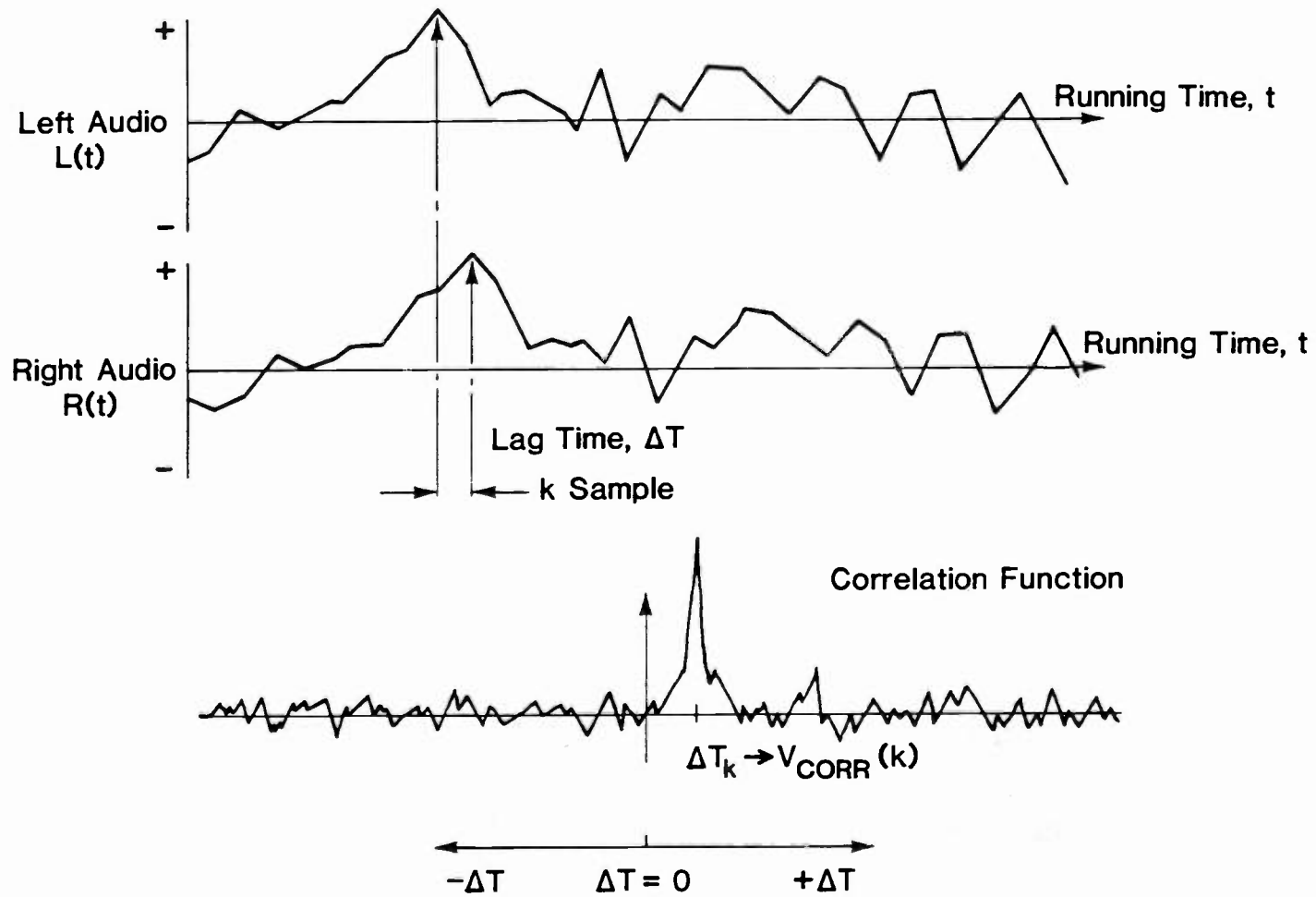


(a) Before active phase equalizer

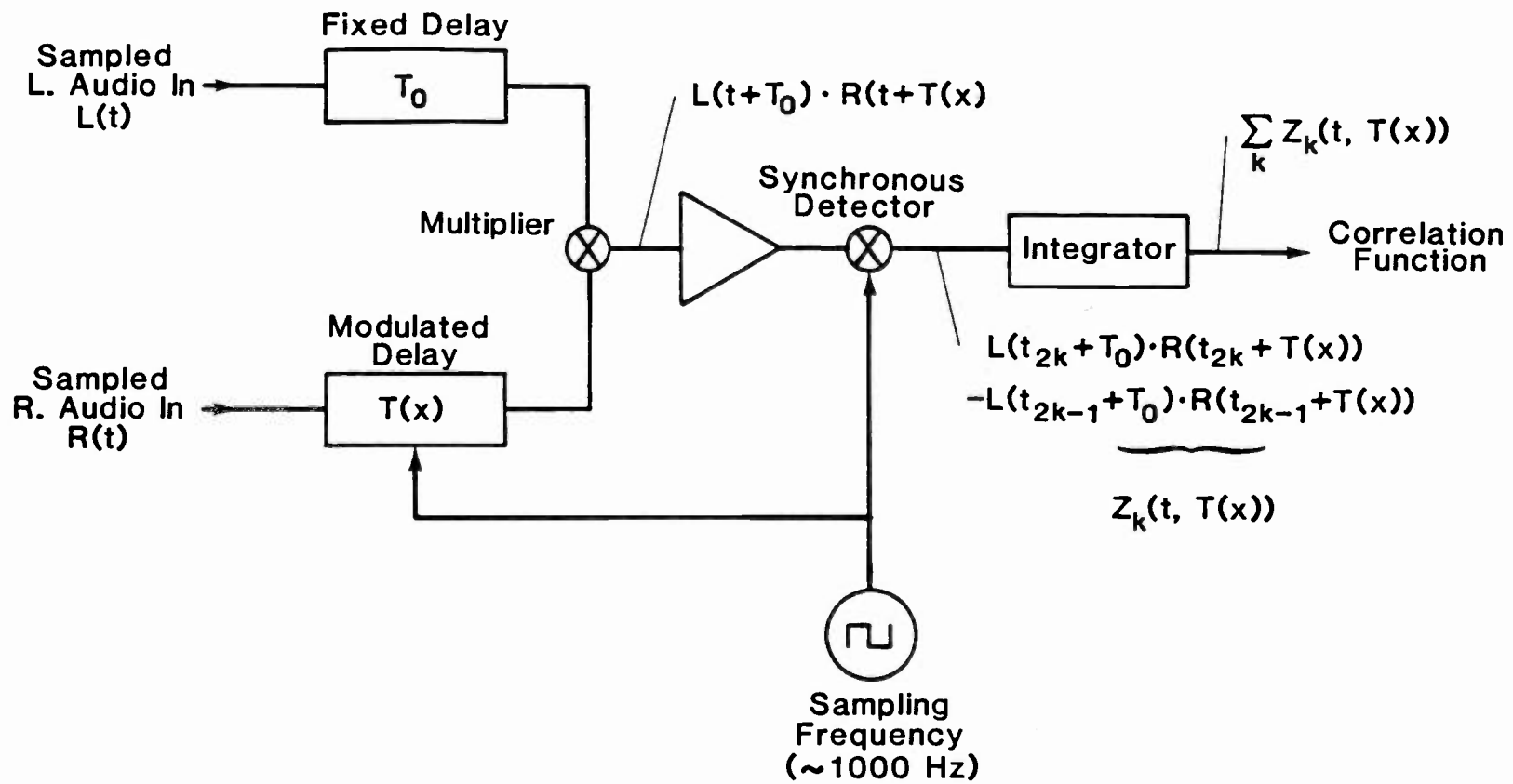


(b) After active phase equalizer

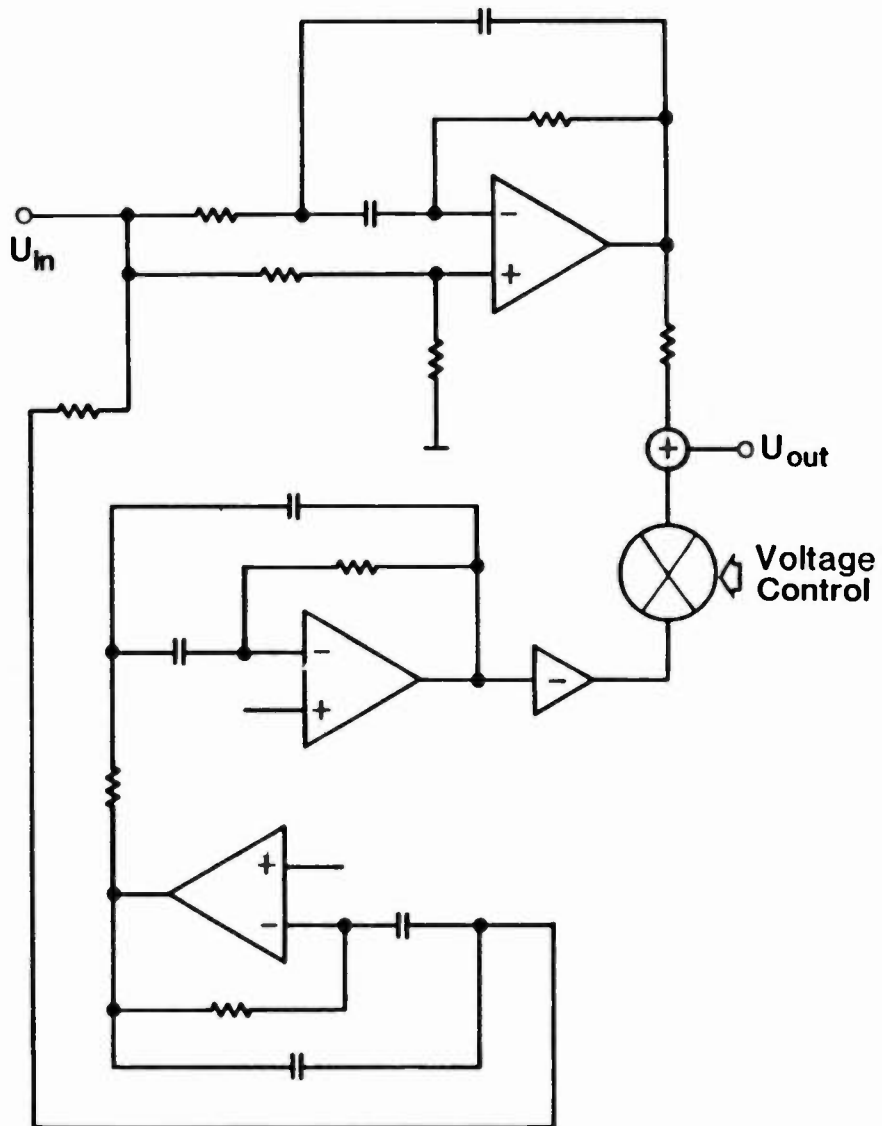
**Fig. 8 Wideband noise.**



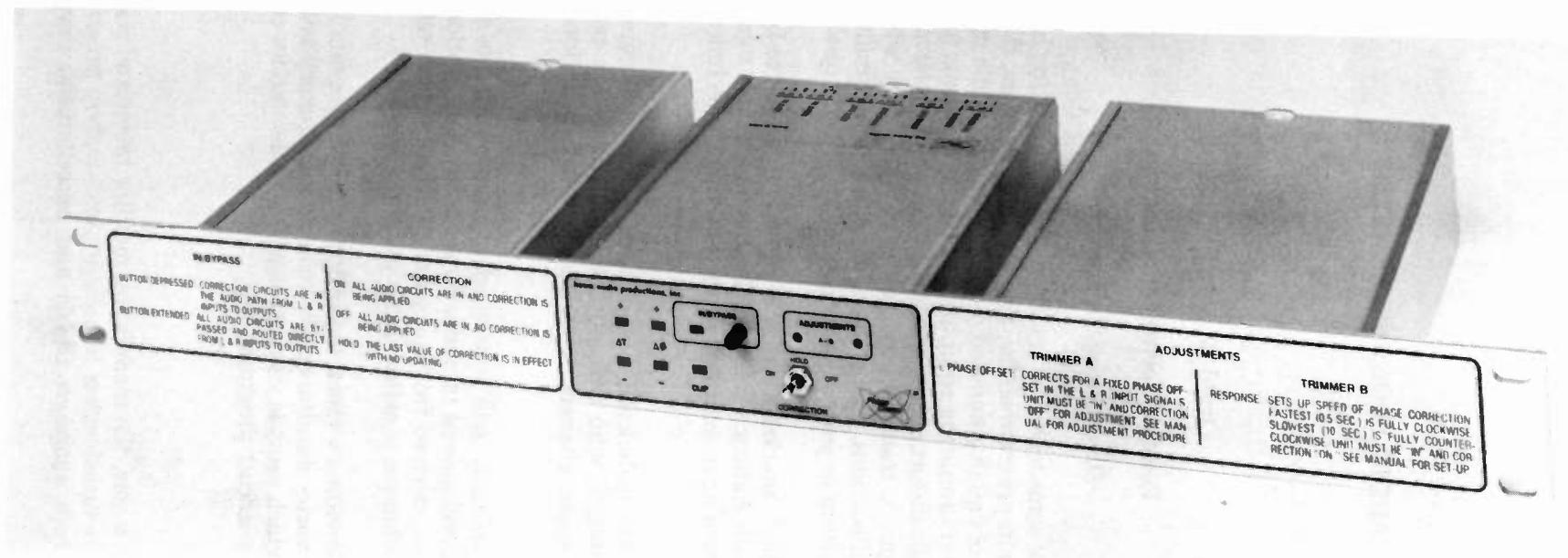
**Fig. 9 Cross-correlator output voltage corresponds to  $\Delta T$ .**



**Fig. 10**  
**Schematic Diagram of Cross-Correlator**



**Fig. 11**  
**Four-Pole Voltage-Controlled**  
**Time Delay Network**



**Fig. 12 Howe Audio PHASE CHASER.**

---

## AUDIO PROGRAM ANALYSIS

David G. Harry

Potomac Instruments, Inc.

Silver Spring, Maryland

The recent FCC deregulation of some technical standards for broadcasting has expanded the freedom which broadcasters have to transmit program audio. For a number of years, the FCC has allowed radio stations a nearly unlimited range of equalization and audio processing, while maintaining technical performance minimums on the basic transmitting equipment. The requirements to measure and record frequency response and total harmonic distortion at various modulation levels have been eliminated. Broadcasters now have the total freedom to transmit any quality of signal they wish provided they remain within RF spectrum and power allocations. They now assume full responsibility for the quality of their products. And, they will benefit from or suffer the consequences of their quality control procedures.

Under this scenario, the so-called "marketplace" will provide feedback to broadcasters, presumably rewarding the desirable signals with audience and rejecting the undesirable signals. Of course, radio station programming is the major variable in audience attraction, but the technical considerations are also very important.

The adjustment and control of the technical considerations of the audio signal is often left to the subjective judgements of station personnel, who typically listen to their station and to competitive stations on several selected radios and make changes in equipment and operations to suit their personal preference.

Although human evaluation probably will continued to be the ultimate judge of audio program technical considerations, recent development in audio program instrumentation will provide some new quantitative technical information, derived from program material, which will significantly augment the listening judgements. This technique is called audio program analysis.

The idea of quantifying and providing a visual indication of audio program level is not new. Because the sensitivity of the human ear varies simultaneously with both frequency and amplitude, various instruments have been developed which provide visual indications of the various complex characteristics of the types of signals typified by broadcast programming.

### Conventional Program Indicators

Several devices such as the VU meter, the modulation monitor meter and peak flasher, and the peak program meter (PPM) are used by broadcasters to measure and analyze program audio. Also the CBS loudness meter, real time spectrum analyzers (RTA) and miscellaneous devices have been used to

evaluate program audio. Each device has its own characteristics and application. A review of the technical characteristics of these devices will outline the present state of the art.

The VU meter, pictured in Figure 1, was introduced in 1939 as a standard program level indicating device.<sup>1</sup> Its purpose was to better standardize audio transmission levels between program suppliers such as broadcasters and telephone companies. The VU meter is simply a combination of a bridge rectifier, a resistor network and a microammeter to produce an average responding AC voltmeter. The VU meter is calibrated so that 0 VU is set at 0.744 volts RMS on a steady state sine wave. This is equivalent to 1 milliwatt into 600 ohms or zero dBm.

The definition of a standard VU meter goes beyond the continuous tone reading characteristics. Its dynamic characteristics are set so that it will read 99 percent of its ultimate reading on a sine wave tone burst 300 milliseconds long and will fall to 5 percent of the reading also in 300 milliseconds. The overshoot characteristics are very tightly specified and the frequency response is flat.

The VU meter is fundamentally an average responding device with a relatively long time constant. On unprocessed program material, it will not respond to short duration program peaks and, therefore, program peaks can be 20 dB higher than the VU indication. If no program clipping is desired, a transmission system with about 20 dB of head room following the VU meter is necessary.

### Modulation Monitor

The modulation meter and peak flasher in a modulation monitor, pictured in Figure 2, are both designed to read the highest peak value of the shortest duration components of the demodulated signal. The electronic circuitry driving the meter or flasher typically uses a sample and hold technique which looks for the highest amplitude of the waveform and stores it for a sufficient time so that the panel meter can reach the peak value and provide a trigger signal for the flasher. The peak reading circuitry is usually capable of reading the positive or negative going peaks separately or the highest value of either. The flasher threshold can usually be set for a range of peak values often from 50 to 100 percent modulation. Modulation monitor calibration is set to read percentage of modulation and the frequency response is flat.

### Peak Program Indicator

There are several versions of the peak program meter (PPM) one of which is pictured in Figure 3. The British standard PPM,<sup>2</sup> which is gaining popularity in the U.S., is designed to read nearly the full peak value of the audio signal. The meter requires some active electronic circuitry to drive the meter movement which is able to read 99 percent of the steady state value in 12 milliseconds and will fall very slowly taking 3 seconds for the pointer to fall 26 dB. Similar to a modulation monitor meter, the PPM electronic driving circuitry uses a sample and hold technique to provide time for the needle to reach the correct peak or near peak reading of the audio waveform. The frequency response of a typical PPM is flat and some have logarithmic voltage (dB) scales.

### CBS Loudness Meter

Extensive psychoacoustic experiments by CBS led to development of a relative loudness meter,<sup>3</sup> pictured in Figure 4. This device samples a number of separate frequency bands, detects the output of each band separately, and sums the DC signals according to a time constant similar to that of the human ear. The output indicator can be either a panel meter or an LED bargraph usually calibrated with a logarithmic voltage (DB) scale. The loudness meter has a frequency response weighted according to experimentally derived frequency response of the human ear at a certain sound level.

1. A New Standard Volume Indicator and Reference Level, Proceedings IRE, January 1940, pp. 1-17.
2. C.C.I.R. Report 292-3, Measurement of Programme Level in Broadcasting, Volume X, XIIIth Plenary Assembly, Geneva, 1974, p. 206.
3. SMPTE Journal, September 1981, p. 772. A New Loudness Indicator for Use in Broadcasting, B. L. Jones and E. L. Torick



Figure 1. VU Meter



Figure 2. Modulation Monitor



Figure 3. Peak Program Meter



Figure 4. Loudness Meter



Figure 5. Real Time Analyzer



The latest version of the loudness meter has been independently confirmed<sup>4</sup> to be quite accurate in indicating loudness variations due to a variety of reasons including variations in program material and in audio processing.

### Real Time Analyzer

A real time audio spectrum analyzer (RTA)<sup>4</sup> typically consists of a family of one octave or one third octave filters and individual detectors and indicators. The program audio is simultaneously fed to the input of all the filters and the output of each filter is proportional to the amount of information in the program material occurring in that particular frequency band. The readout devices are typically LED bargraphs with a dB scale. The RTA often is arranged so that the bargraphs provide a simultaneous indication of the activity in each frequency band so that a graphical presentation of amplitude vs. frequency is made. An advanced RTA such as the unit pictured in figure 5 operates under microprocessor control, has options for one sixth octave filter, processes signals in both peak and average modes, contains "A" weighting filter, memory functions, and a built in pink noise generator.

### Other Devices

A variety of other devices have been marketed with various combinations of meters or LED bargraphs with detectors which respond to peak, average VU and other combinations of time constants.

### Use of Popular Indicators

All of these existing devices have some merit in measuring audio program signals. However, to date, no single popular device has put together the important features of the existing techniques in an organized manner. With such a concern for tailoring audio signal for competitive advantage, we believe there is a need for a more coordinated and complete method of quantifying audio program signals. We are calling such a process "audio program analysis."

### Audio Program Analysis

It is very difficult to quantify audio program material. It contains electrical signals which vary in amplitude and frequency with time in a very complex manner. Furthermore, the human perception of audio is also very complex. However, we can begin the difficult task of quantification of program audio by reviewing its fundamental characteristics. Also to assist in understanding the various measuring techniques, comparisons between common electronically generated test signals and program audio will be made.

### Unprocessed Audio

All audio transmission systems are limited by two amplitude constraints. They are: the maximum undistorted peak amplitude excursions and the noise floor. For the best transmission quality, the audio signal level should be set for the highest value before clipping or substantial distortion occurs. This allows transmission with the least degradation in signal to noise while limiting the distortion within prescribed limits.

To set the audio level within the transmission system amplitude window, the wideband (unweighted) peak value of the audio must be known as well as the peak amplitude capability of the transmission system. For instance, in a high quality program channel using +30 dBm sine wave capability amplifiers, a  $\pm 34.6$  volt swing is the limit before clipping. Therefore, the peak audio level in that circuit must be held below  $\pm 34.6$  volts to prevent clipping.

4. White Instruments, Incorporated. Publication #200-1181.

Thus the first and most fundamental value of program audio to be quantified is the wideband peak value of the audio waveform.

### Measuring Peak Audio Voltage

Although an oscilloscope can be used to measure peak audio voltages, this technique is impractical for daily operations because it is difficult for an operator to read the random waveforms typical in audio. A peak reading panel meter or solid state bargraph indicator seems to provide the most practical display. Figure 6 shows a simplified schematic diagram of peak detecting circuitry used to drive either indicator.

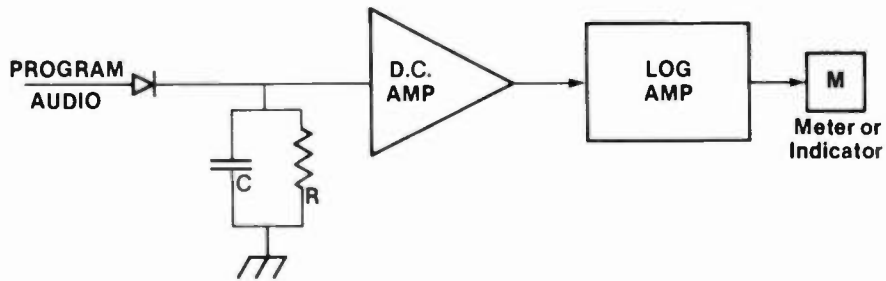


Figure 6. Peak Indicator

Basically, the audio waveform is rectified through a diode and the resulting single polarity signal waveform is used to charge a capacitor. The capacitor is charged up to the peak value of the rectified audio and the charge is held long enough by the capacitor so that the panel meter or other indicator has sufficient time to correctly indicate the stored peak value of the waveform. The resistor across the capacitor discharges the capacitor and the resulting time constant provides the fall time for the output indicator.

The peak detector can be designed to detect positive going peaks, negative going peaks, or the larger of either of the peaks. Detectors can be designed to capture the very shortest of audio peaks and store them so that any panel meter can be true peak reading.

### Average Value

Figure 7 shows the amplitude vs. time graph of two waveforms, unprocessed program, and a sine wave. Each has its peak value set to  $\pm 34.6$  volts, the peak value of a  $+30$  dBm sine wave.

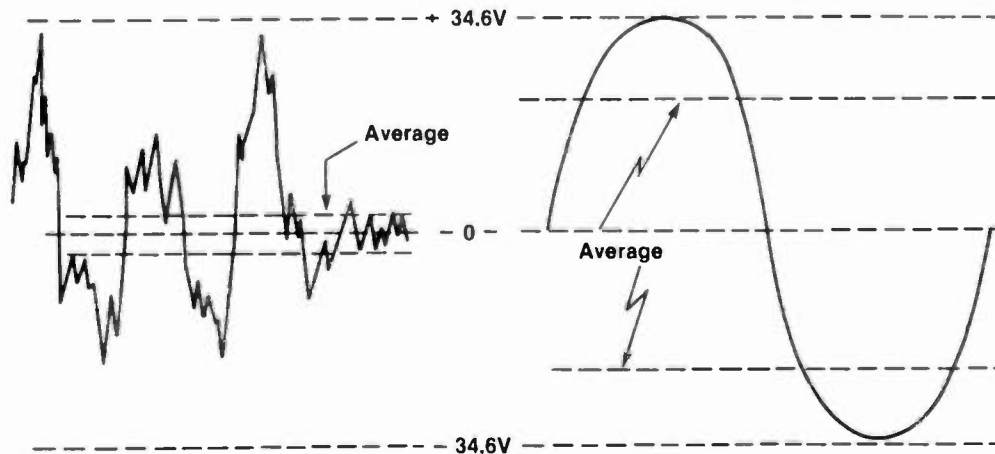


Figure 7A. Unprocessed Program

Figure 7B. Sine Wave

Although the peak values are set to be the same, the average value of the two signals are very different. The average value of the sine wave is 64 % of the peak value or 3.92 dB below the peak. The unprocessed program signal however, typically has an average value that is often at least 20 dB below the peak value. Compared to a continuous sine wave, unprocessed program material contains many peaks having a much shorter duty cycle and a much higher crest factor. Figure 8 shows the equivalent circuit for an average responding voltmeter.

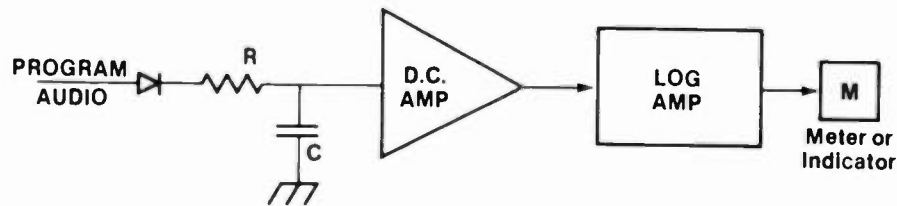


Figure 8. Average Responding Indicator

Therefore, the second fundamental measurement of program audio is the wide band average value. This is essentially the parameter to which a VU meter responds, and it explains why about 20 dB of headroom is required above the waveform which often can be 20 dB below the peak value of unprocessed audio.

Audio processing for the purpose of modulation peak control or to increase loudness, changes the average and or peak audio waveforms, reducing the separation between peak and average value. Fast compression increases the average value of the audio and the fast peak limiting and/or peak clipping controls the wide amplitude excursions of peak values. The net effect is a higher average to peak ratio. While unprocessed program audio often has an average to peak ratio of -20 dB, sophisticated audio processing equipment can change that ratio to as high as -10 dB while maintaining a quality that apparently is still acceptable to the radio listener.

Thus, the average value of the program audio waveform is an important indication, and the effectiveness of audio processing can be fundamentally characterized by measuring the average to peak ratio.

Note that it is not necessary to know the absolute value of the peak audio voltage in modulation percentage in order to analyze the effects of processing. It is the ratio of average to peak that is most important.

### Quasi-Peak

The human ear does not act like either a peak detector or an average detector. Many psychoacoustical tests have been conducted to determine an electrical analogy of the integration time of the ear. Values such as 100 ms. attack and 500 ms. decay and 75 ms. attack and 300 ms. decay have been reported.<sup>5</sup> Also in the CBS loudness meter, the detectors for the individual bands were reported to have time constants of 20 ms. attack and 200 ms. decay.

### Peak Density

Peak control is a very important part of audio processing. Many audio processors use an automatic gain control amplifier followed by a peak clipper to produce a controlled distortion peak clipping. Some stations use various combinations of equipment and a composite clipper to increase loudness.

5. United States Patent #3,594,506. Loudness Level Indicator, E. L. Torick, R. G. Allen, and A. J. Rosenheck, issued July 20, 1971.

When observing the modulation monitor at a radio station which uses this type of audio processing, the meter seems to stay up at a very high value such as 95 percent. Figure 9 depicts the modulation meter deflection for lightly processed and highly processed program material. If the peak flasher threshold of the modulation monitor is adjusted between 60 and 90 percent, the observer will note that modulation peaks occur much more frequently than if the station audio were unprocessed. Of course the reason is that the modulation hits higher values more often because the modulation waveform has been modified for a higher peak density, pushing the waveform to higher values more often.

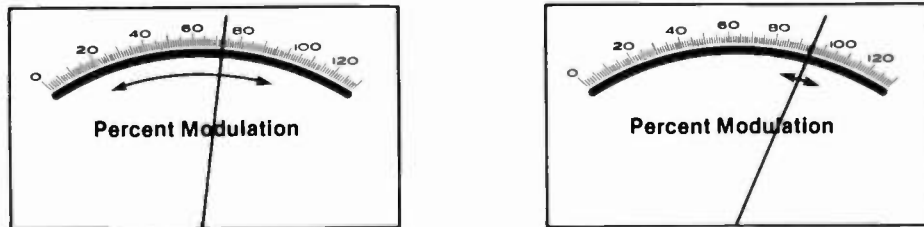


Figure 9. Modulation Meter Dynamics

Another way of describing the effects of processing is to say that the amplitude distribution has changed. Measurements on a number of radio stations has shown significant differences in the peak amplitude distribution which can be described as its processing signature. Measurements of the amount of time modulation peaks exceed 60, 70, 80 and 90 percent of the maximum peak value provide an excellent indication of the station's control of peak modulation. The percentage of time peaks exceed a certain modulation percentage is referred to as "peak density." A readout technique has been developed which graphically displays the amount of time certain specified peak values are exceeded. Figure 10 illustrates peak density as presented on a bargraph display.

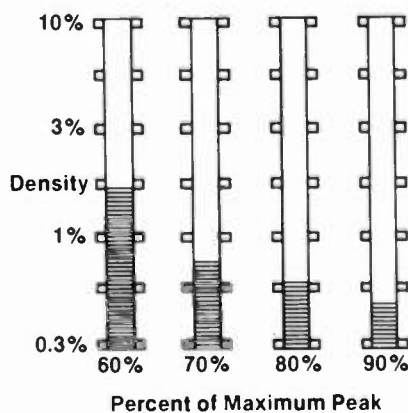


Figure 10A. Lightly Processed

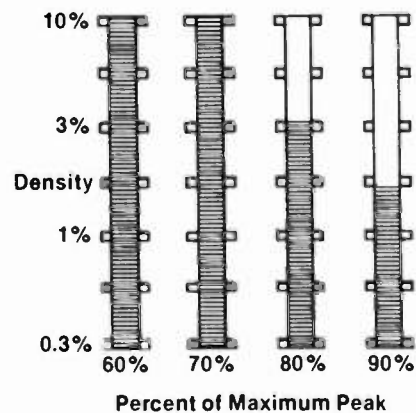


Figure 10B. Heavily Processed

Four bargraphs are arranged so that each is reading the activity occurring at specific peak thresholds. For instance, the left hand bargraph indicates the amount of time the audio waveform exceeds 60 percent of its maximum peak value. The scale is logarithmic with 10 percent of the time set to be the top of the bargraph and the bottom of the bargraph being 0.3 percent of the time.

The other bargraphs operate similarly with the three others representing the percent of the time the input waveform exceeds 70, 80, and 90 percent of the maximum peak amplitude of the modulation waveform.

Referring to Figure 10A, note the display for a lightly processed audio signal. The bargraphs are indicating that peaks are exceeding 60 percent of the maximum peak value approximately 2 percent of the time, peaks are exceeding 70 percent of the maximum peak value 0.6 percent of the time, 80 percent of maximum peak value 0.5% of the time and 90 percent or greater peaks about 0.4 percent of the time.

When measuring a highly processed signal, the picture looks very different. In Figure 10B, notice that the 60 percent of peak value occurs more than 10 percent of the time, 70 percent of peak value also more than 10 percent of the time, 80 percent of peak 3 percent of the time and 90 percent of peak threshold 2 percent of the time. This means the modulation waveform has probably been substantially processed and clipped, pushing the waveform up so that it occupies higher peak values more often.

In order to measure peak density accurately, the program analyzer must be capable of automatically ratioing the instantaneous peak value to the wide band peak value over time.

### Audio Spectrum

Many modern audio processors employ systems of filters which break up the spectrum into a number of bands, process separately, and then recombine this together with other equalization and filtering. This enables the processor to use attack and decay time constants tailored for the individual frequency bands which permits heavier processing with less distortion than what is possible on a wide band basis. Also the tonal characteristics can be readily changed by adjusting the gain of the summing networks which recombine the outputs of the individual bands.

Tonal enhancement is often used to make a radio station sound louder or brighter on consumer type receivers. Usually the adjustment of this equipment is done by the subjective method of making an adjustment and then listening to the station and its competition on several radios to determine appropriate settings.

In the business of sound, the tonal characteristics are often described by referring to the bass, the midrange, the presence frequencies and the highs. These qualitative frequency bands have been taken to center at approximately 140 Hz, 700 Hz, 3.5 kHz, and 10.5 kHz. Although many real time spectrum analyzers take a mathematical approach to dividing up the audio spectrum into octave or third octave bands, these four basic bands seem to represent how we describe sound.

Since any audio program evaluation should include spectrum information, comb filters may be used to define the four frequency bands of interest. By combining the output of the comb filter, quasi peak detectors and appropriate switching networks, the bargraph display can be used as a conventional Real Time Analyzer with limited resolution.

With the objective being to display frequency spectrum according to the manner in which the human ear perceives it, the gains of the bargraphs in the spectrum mode are set so that when evenly distributed, unequalized program material is monitored, the bargraphs read the same on all four frequency bands.

When equalized program material is observed on the spectrum display, the deviation from the straight line becomes the approximate amount of equalization used. For instance, if 10 dB of preemphasis is used, the 3.5 kHz bargraph could read 5 dB higher and the 10.5 kHz bargraph 10 dB higher.

The amplitude indications of the bargraph readout will also read higher for a processed signal than for

an unprocessed one. This can also be used to compare the processing techniques of various radio stations. Figure 11 compares the bargraph frequency spectrum display for a normal spectrum and a preemphasized spectrum.

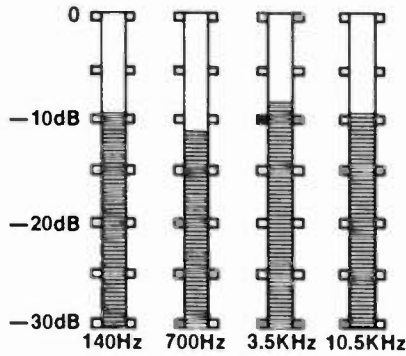


Figure 11A. Normal Spectrum

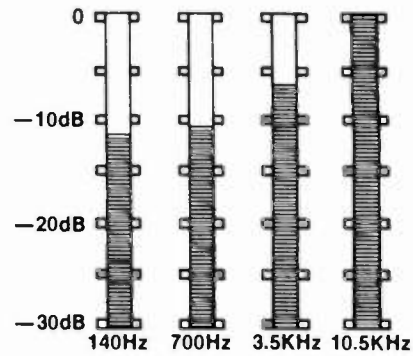


Figure 11B. Preemphasized Spectrum

### Stereo

Although stereo modulation monitors often provide peak modulation readings of left, right, L + R, and L-R signals, seldom is this available without access to a monitor. Much information can be derived from observing these signals.

L + R is of course the monophonic compatible signal for both AM and FM stereo. If a station is interested in providing a loud processed signal to its monophonic audience, then the L + R signal is the one to study. Most FM and many AM stations are operating in stereo, and stereo information is contained in the L-R signal. For instance, some beautiful music stations desire a wide stereo image and the level of L-R can be as high as L + R. For FM stereo this means the L + R must be reduced in amplitude to accommodate the higher L-R level. Many FM country and western stations want a very dense L + R signal for mono loudness and are willing to sacrifice stereo levels. In that case, the L-R level can be up to 15 dB below L + R.

All of the analysis capability of an audio program analyzer can be made available for observing L, R, L + R and L-R signals for parameters including peak, quasi-peak, average, peak density and spectrum. A very detailed picture of a station's stereo processing can then be obtained.

By observing the L-R spectrum when a monaural tape cartridge is played on a stereo playback machine any azimuth errors clearly show up as high frequency L-R information. Monitoring this way can quickly identify bad carts, an imbalance in stereo processing or misaligned cart machines. The bargraph display of this condition is depicted in Figure 12.

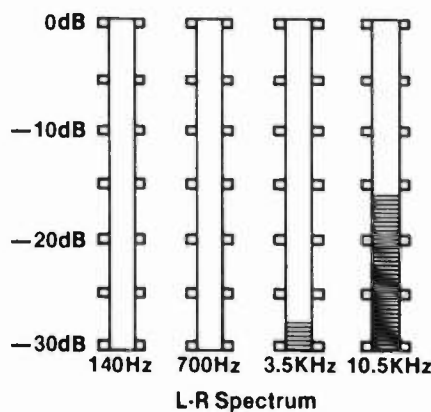


Figure 12. High Frequency Channel Imbalance

## Conclusion

We believe that audio program analysis will prove extremely valuable to the competitive, real world, broadcasting and professional audio industry. Practical instruments such as the QuantAural QA-100 Audio Program Analyzer manufactured by Potomac Instruments, Inc. will provide additional analytical information and insight using these measurement techniques. It is our hope that the additional information provided by such analysis will contribute to improvements in the quality of broadcast operations and toward a better understanding of audio control.





---

AUDIO PROCESSING FOR  
AM STEREOPHONIC TRANSMISSIONS

RON JONES

Circuit Research Labs

Tempe, Arizona

ABSTRACT

The introduction of stereophonic transmission to AM broadcasting has allowed it to be more competitive with its counterpart, FM stereo. However, just as its actual transmission process is more complex than FM, so are the requirements of its audio processing in order to maximize both its monaural and its new stereophonic compatibilities.

## INTRODUCTION

With more AM radio stations converting to stereo broadcasting, numerous transmission problems unique to AM stereo face them. One of the more important concerns is the proper understanding and choice of the audio processing technology for it. As different as AM stereo technology is from existing FM stereo technology, so are its problems of audio processing. Because AM stereo is achieved by separate monophonic and difference information modulation paths, FM-type left and right audio processing does not provide the best results for AM stereo. Under varying amounts of separation, left and right processing can cause up to a 6db loss of monophonic loudness and result in fringe coverage losses. The following is a brief discussion of these problems and their cures.

### FM-TYPE LEFT AND RIGHT STEREO LIMITING

In FM stereo transmission, the left and right channel information can be fundamentally described as sent via the same transmission path as shown in figure 1. The following equation describes the general stereo transmission signal:

$$f(t) = (L+R) + (L-R)\sin \omega t + P\sin (\omega/2)t$$

In the equation above,  $\omega t$  represents the 38 Khz subcarrier and  $P\sin (\omega/2)t$  represents the fixed amplitude 19 Khz pilot. From inspection of the equation, it is apparent that when L and R are equal to each other and are limited to a peak amplitude of 1, the (L-R) term equals 0 and the peak amplitude of  $f(t)$  equals 2 plus the pilot amplitude. Additionally, the equation shows that the peak amplitude of  $f(t)$  is still equal to 2 plus the pilot amplitude when left only or right only single channel conditions are transmitted. This occurs because the equation's  $\sin \omega t$  function reaches numerical extremes of 1 and -1 and forces  $f(t)$  to equal either  $2*L$  or  $2*R$  during those conditions.

Thus when properly matched, left and right audio processing results in the identical 100% modulation limits for left channel only, right channel only, or both together (monaural during stereo) transmissions. This demonstrates that separate left and right audio processing is the most appropriate choice for maintaining modulation limits of FM stereophonic type transmissions.

### AM STEREO LIMITING REQUIREMENTS

AM stereo broadcasting has brought about a need for a different form of stereo audio limiting. This is because the left and right transmitted audio channels are first transformed into L+R and L-R terms through a matrix summer and subtractor and then applied to two different modulation points as shown in figure 2. The most basic equation for a transmitted wave is as follows:

$$f(t) = E_{cm} \sin (\omega c t + \theta)$$

In the basic equation, either AM monaural audio or a form of the AM stereo L+R term are used to modulate the  $E_{cm}$  (or carrier amplitude) variable of the equation. In stereo, a form of the L-R term is used to modulate the  $\theta$  (or phase) variable.

Because the algebraic sum and difference of left and right channels occur PRIOR to the points of the modulation, AM stereo broadcasting is best supported by stereo "matrix" limiting since its processing action has been shifted to the sum (L+R) and difference (L-R) axis of the stereo sound field where the actual transmitted modulation components exist. This method produces significantly improved performance over the previous FM "conventional" types which operate on the left and right channel axis.

#### DISPLAYING AM STEREO LIMITING PATTERNS

The diagrams presented next are in a form which can easily be seen on an oscilloscope when monitoring the X-Y Lissajous patterns produced at the right and left outputs of the station's limiters or stereo modulation monitor. If the limiters have L+R and L-R outputs instead, the patterns at these outputs will be shifted counter clockwise by 45 degrees from those illustrated. Field experience has shown that once familiarity with these patterns is gained, they are often more helpful in checking for proper processing alignment and show more information about what is being transmitted than any other modulation monitoring system.

#### LEFT AND RIGHT LIMITING AND MONAURAL COMPATIBILITY

Figure 3 illustrates the oscilloscope X-Y display of the right and left limiter outputs of conventional stereo limiting. When applied to AM stereo transmissions, the amplitude limit levels of the left and right channels must be set equal to each other for proper stereo balancing. As shown, the levels are perpendicular to the right and left channel axis and intersect with each other to form the L+R and L-R modulation limits. The L+R axis represents the main monaural component transmitted by the AM envelope of the transmitter and the L-R axis represents the main stereo information component transmitted by the phase modulation of the carrier frequency. As long as the program input is mostly monaural, this limiting system produces nearly full 100% envelope modulation and monaural reception remains normal.

However, the figure also demonstrates how such limiting creates serious monaural transmission and reception problems during varying stereo conditions. When stereo inputs temporarily shift to the full left only (vertical) or right only (horizontal) modulation axis, stereo reception is acceptable but monaural is not. The L+R modulation component is forced to drop to 50% as is shown by the dotted line intersection of the lower right modulation scale with the tips of the left channel or right channel limit levels. This indicates an immediate 6 db drop in loudness in monaural reception. Obviously this is an unacceptable condition to AM broadcasters since the existing monaural coverage as well as the monaural loudness is reduced.

Although most stereo program material does not contain significant amounts of single channel passages, this form of limiting causes significant losses of monaural loudness and coverage on nearly all stereo program material. The losses are usually directly proportional to the stereo content and become greater as separation increases.

#### BASIC STEREO MATRIX L+R/L-R LIMITING

Figure 4 represents the oscilloscope X-Y display of the right and left limiter outputs of full monaural support matrix limiting. With this system, the output levels of the L+R and L-R are adjusted for equal modulation levels which is the point of maximum separation. As shown, the amplitude limit levels are perpendicular to the L+R and L-R axis and intersect with each other at the left channel and right channel axis. When stereo inputs temporarily shift to the full left only or the right only axis, these limit levels allow the L+R component to remain at a 100% modulation which maintains full monaural reception compatibility during such transmissions. The shaded area shown in the illustration shows the increased areas of monaural support modulation produced by this system as compared to the figure 3 conventional left and right limiting.

Unfortunately, further analysis shows that stereo reception will have a 6 db INCREASE in the single channel receptions. While this obviously is going to be noticeable to listeners, critical listening tests have demonstrated this to be far more acceptable than the LOSS of 6 db in monaural loudness. It should also be kept in mind that the majority of stereo program contents do not contain full single channel transmissions.

#### MODIFIED STEREO MATRIX L+R/L-R LIMITING

Under light and moderate amounts of limiting, full matrix processing produces outstanding results in both monaural and stereo. Heavy amounts of limiting or processing can produce different results. Heavy or extreme levels of audio processing as demanded by many existing AM radio stations may cause certain types of overloads in present stereo decoding and reception techniques. In an effort to reduce the chances of these problems, a modified full matrix processing has been developed by Circuit Research Labs.

Figure 5 represents the oscilloscope X-Y display of the right and left limiter outputs of the CRL modified monaural support matrix limiting system. The significant difference between this limiting pattern and the one shown in figure 4 is visible in the left and bottom corners of the pattern. Here, the corners formed by the L+R and L-R axis are removed by an adjustable single channel limiting network. This system allows full monaural compatibility during most stereo conditions, but causes a reduction of L-R and negative peak L+R modulation levels during left only or right only stereo conditions. In the illustration, the single channel limits are shown set for a left or right only L+R negative limit of 70% instead of the 100% level which would occur without such limiting.

This modified matrix system is designed to reduce the potential problem areas associated with stereo transmissions. At the removed corners shown in the figure, both L+R and L-R modulations are at maximum and can cause decoding difficulties. If high density negative peak L+R modulations are allowed to consistently reduce the transmitter carrier, the L-R decoding process has little or no carrier to demodulate. The result can be that either stereo decoding returns to monaural or produces distortions. Depending upon the degree of processing used and maximum L+R modulation depth, the single channel limiting network can be adjusted from a point having only minor effects (for stations employing small amounts of processing) to a level which prevents or substantially reduces stereo receiving problems (when heavier processing levels are employed).

#### CONCLUSION

It has been shown that because AM stereo is a new and different technology, a different form of audio processing is needed to conform to its demands. The proper form of audio processing can result in outstanding monaural and stereophonic performance realizations while an improper one can result in both inconsistent and poor monaural performance as well as substantial fringe reception coverage losses. These points should be kept in mind for any AM station now broadcasting in stereo or which is considering conversion to stereo in the future.

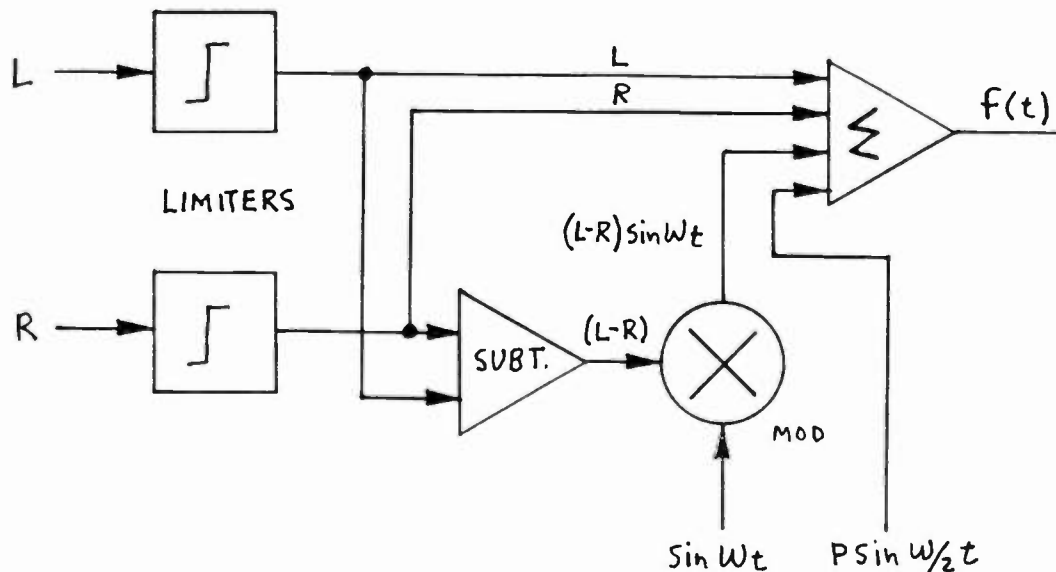


FIG. 1 - FM STEREO LIMITING & GENERATION

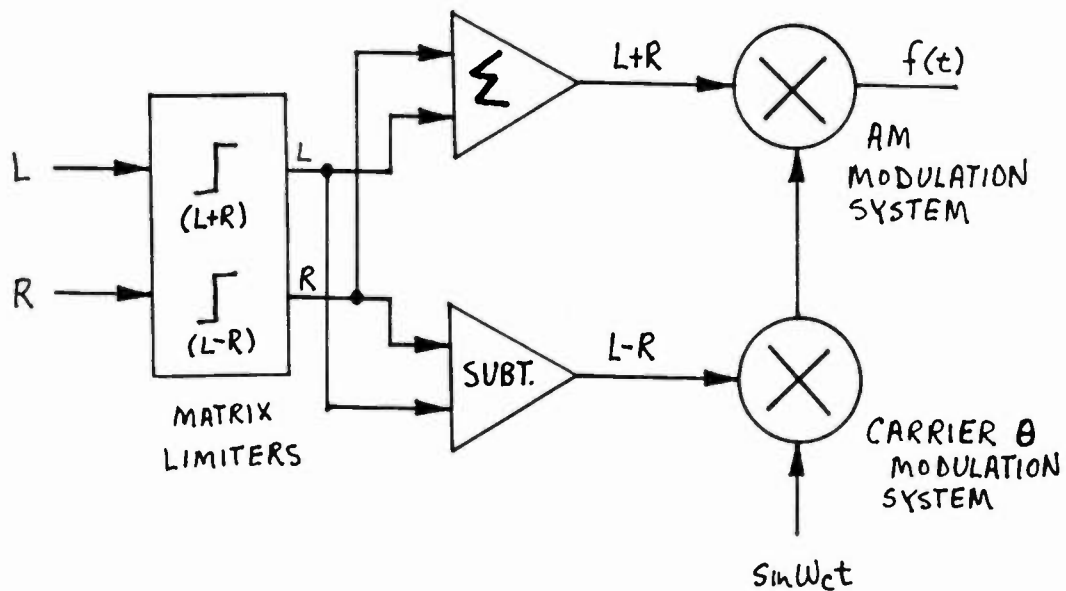


FIG. 2 - SIMPLIFIED AM STEREO LIMITING & GENERATION

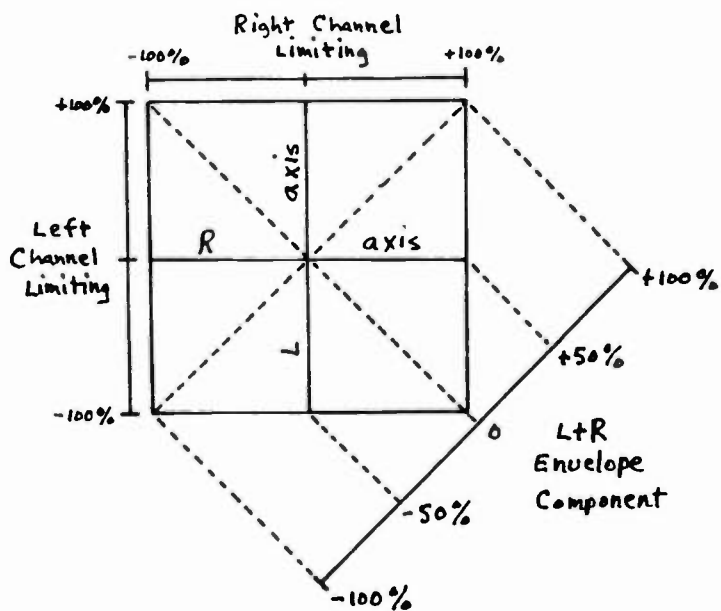


FIG. 3 - CONVENTIONAL LEFT AND RIGHT STEREO LIMITING PATTERN

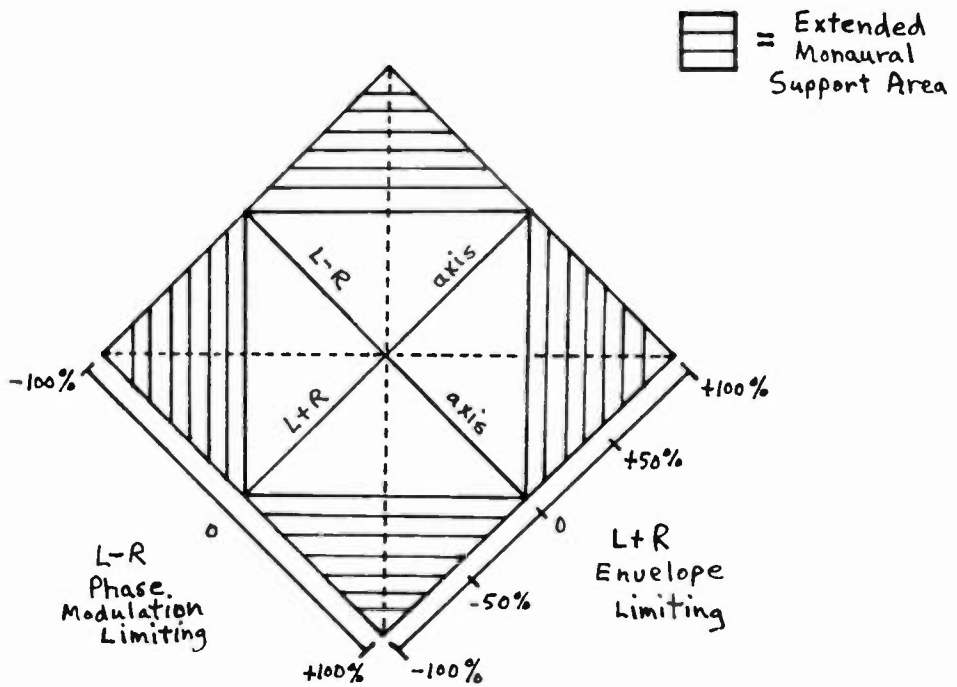


FIG. 4 - FULL MONAURAL SUPPORT MATRIX STEREO LIMITING PATTERN

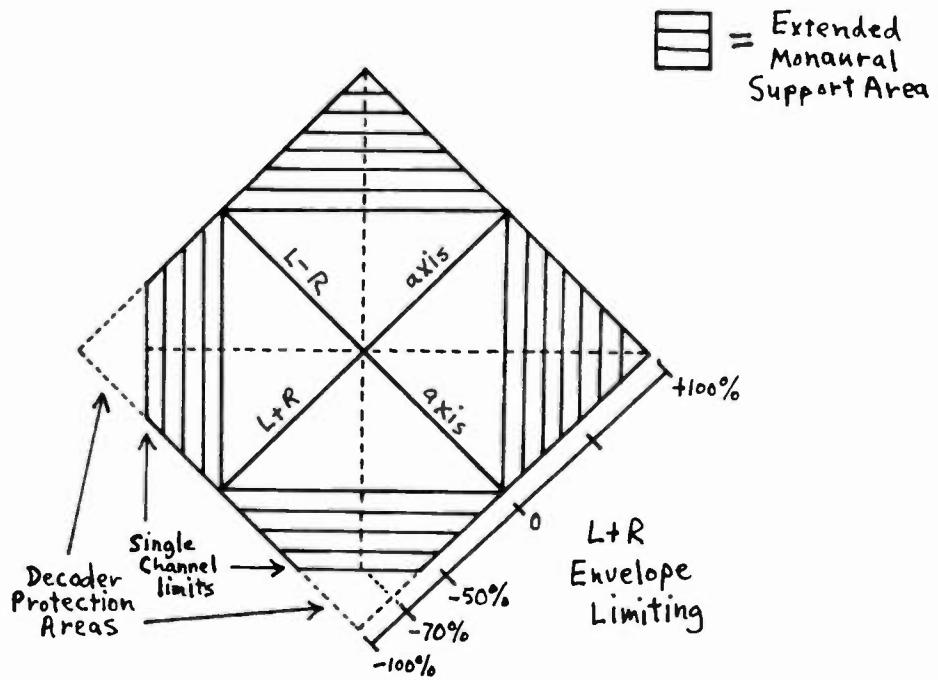


FIG. 5 - CRL MONAURAL SUPPORT MATRIX STEREO LIMITING PATTERN  
WITH ADJUSTABLE DECODER PROTECTION





---

## SECOND GENERATION TECHNIQUES

### FOR AM STEREO EXCITER DESIGN

Edward J. Anthony

Broadcast Electronics, Inc.

Quincy, Illinois

#### I. INTRODUCTION.

With the introduction of AM stereo to the broadcast industry, a new transmission mode has been defined with a new set of complex and unique problems to be overcome. Not only are there multiple systems available to transmit stereo due to the FCC marketplace decision, but within each system it is possible to improve the design quality and stereo performance.

During the infancy of AM stereo, there were only the system proponents manufacturing their own equipment. This first generation hardware was not broadcast quality and often fell short in producing the best possible performance for its particular system. Controls for alignment and operation were frequently inaccessible.

Today there is a great need for more flexible and reliable hardware. Motorola, Inc., the inventor of the C-QUAM system, has licensed several experienced broadcast equipment manufacturers to fill this need. This presentation will review some of the improvements and new approaches developed by Broadcast Electronics, Inc. during the design effort for the AX-10 exciter: an all new, second generation C-QUAM AM stereo system.

#### II. SECOND GENERATION REFINEMENTS.

After reviewing the currently available hardware for AM stereo, several areas for improvement were discovered. Many of these improvements were based on state of the art design techniques employed in the BE FX-30 FM exciter and the BE FS-30 FM Stereo Generator. Others were new innovations developed to improve the C-QUAM system performance. These refinements include:

1. Digital, independent IF modulation technique.
2. Simplified transmitter interfacing.
3. Extended RF output power range.
4. AM SCA capability.
5. Transmitter protection circuitry.
6. Balanced, transformerless audio inputs and outputs.
7. External reference capability to eliminate "platform motion".
8. Human engineering for easy accessibility.
9. Remote control and status.

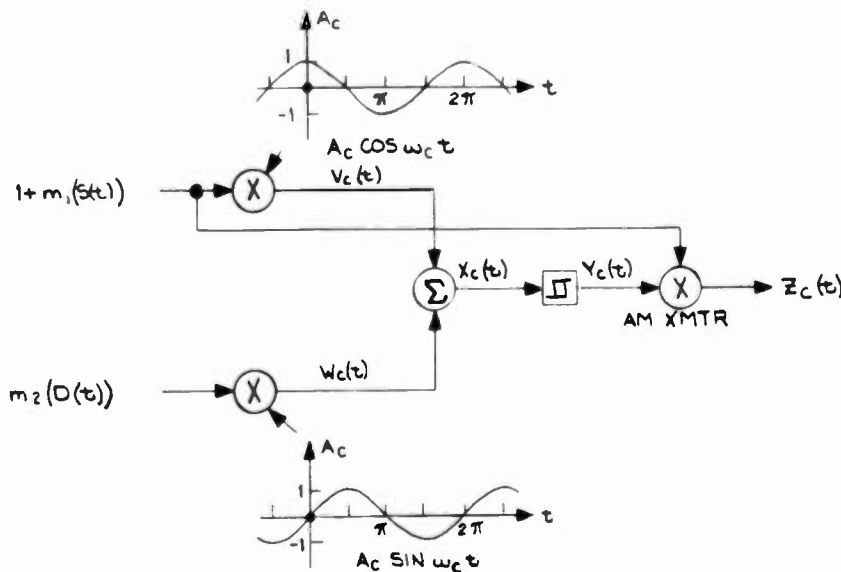
##### 2.1 Digital, Independent IF Modulation.

Digital, independent IF modulation is the heart of the BE AX-10 AM stereo exciter. All clock signals are derived from a single 10 MHz temperature compensated crystal oscillator (TCXO). This highly stable reference improves overall stability.

\* C-QUAM is a registered trademark of Motorola, Inc.

The stereo signal is generated at an intermediate frequency of 250 kHz for all station frequencies assuring equal stereo performance across the entire AM band. Each audio channel is modulated separately, then summed to L+R and L-R, hence the term independent IF modulation. This scheme provides independent equalization of left and right channels for best separation, distortion and frequency response. The total system provides a stable carrier frequency output across the AM band without successive retuning or nulling, and with repeatable stereo performance at all frequencies.

Figure 1 shows the conventional matrix modulation approach to C-QUAM stereo generation. The summed L+R information, together with a DC offset to produce a carrier [1+M<sub>1</sub>(S(t))] is modulated with a 0 degree RF signal [A<sub>c</sub> (COS ω<sub>c</sub>t)]. The difference L-R information [M<sub>2</sub>(D(t))] is modulated with an RF signal phase shifted by 90 degrees [A<sub>c</sub> (SIN ω<sub>c</sub>t)]. These two signals are summed, providing a quadrature modulation signal [X<sub>c</sub>(t)]. At this point, stereo information is fully present and can be decoded by a synchronous detector. However, this signal is not mono compatible on an envelope detector. Therefore, it is amplitude limited to produce a quadrature phase-only signal [Y<sub>c</sub>(t)]. This phase modulated RF signal is then amplitude modulated with the 1+M<sub>1</sub>(S(t)) signal in the AM transmitter to produce the mono compatible C-QUAM signal [Z<sub>c</sub>(t)].



$$I. \quad V_c(t) = [1 + M_1(S(t))] A_c \cos \omega_c t \quad (a)$$

$$W_c(t) = M_2(D(t)) A_c \sin \omega_c t \quad (b)$$

Where  $M_1(S(t))$  and  $M_2(D(t))$  are the sum and difference modulating components respectively.

$$II. \quad X_c(t) = A_c [ [1 + M_1(S(t))] \cos \omega_c t + M_2(D(t)) \sin \omega_c t ]$$

$$= A_c \sqrt{ [1 + M_1(S(t))]^2 + M_2(D(t))^2 } \cos(\omega_c t + \theta)$$

$$\text{Where } \theta = \tan^{-1} \left[ \frac{M_2(D(t))}{1 + M_1(S(t))} \right]$$

$X_c(t)$  Represents Quadrature Modulation

$$III. \quad Y_c(t) = A_c \cos(\omega_c t + \theta) \quad (\text{Quadrature Phase Information Only})$$

$$IV. \quad Z_c(t) = A_c [1 + M_1(S(t))] \cos(\omega_c t + \theta)$$

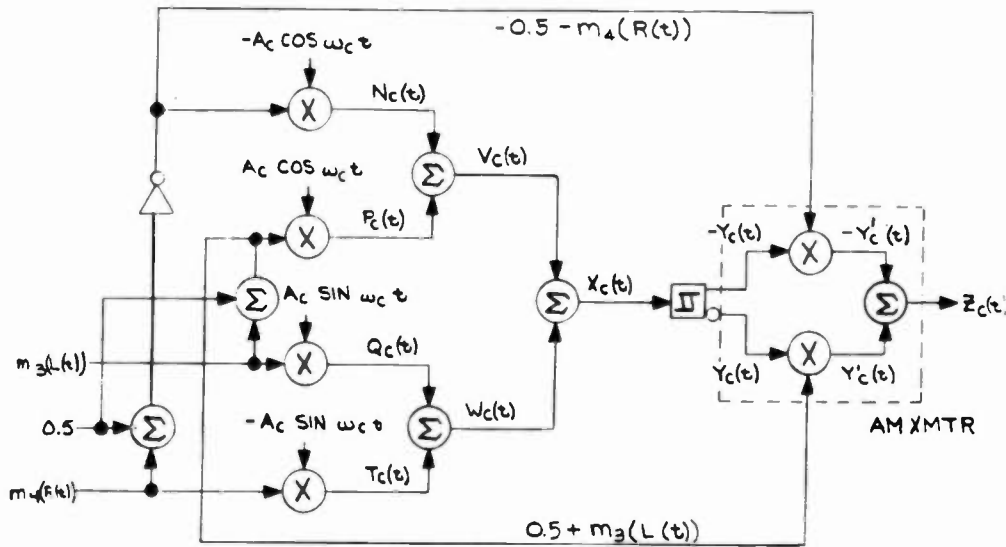
$Z_c(t)$  Represents C-QUAM Modulation

FIGURE 1. CONVENTIONAL MATRIX C-QUAM STEREO GENERATION

Figure 2 describes a fully independent modulation C-QUAM stereo system developed by Broadcast Electronics. In this configuration, the left channel  $[M_3(L(t))]$  is modulated with a 90 degree phase referenced RF signal  $[A_c (\sin \omega_c t)]$  to produce  $Q_c(t)$ . The right channel  $[M_4(R(t))]$  is modulated with a 270 degree phase referenced RF signal  $[-A_c (\sin \omega_c t)]$  to produce  $T_c(t)$ . These two signals are summed to produce  $W_c(t)$ .

$M_3(L(t))$  is also summed with a DC offset to produce a carrier signal of half-magnitude, then modulated with a 0 degree phase referenced RF signal  $[A_c (\cos \omega_c t)]$  to produce  $P_c(t)$ .  $M_4(R(t))$  is summed with a DC offset of half-magnitude, inverted, then modulated with a 180 degree phase referenced RF signal  $[-A_c (\cos \omega_c t)]$  to produce  $N_c(t)$ . These signals are summed to produce  $V_c(t)$ .

$V_c(t)$  and  $W_c(t)$  are summed to produce the identical quadrature modulation as in Figure 1  $[X_c(t)]$ . This signal is amplitude limited producing two quadrature phase-only RF signals 180 degrees out-of-phase  $[Y_c(t)$  and  $-Y_c(t)]$ . These RF signals are amplitude modulated independently by left channel plus half carrier  $[0.5+M_3(L(t))]$  producing  $Y'_c(t)$  and -right channel plus -half carrier  $[-0.5-M_4(R(t))]$  producing  $-Y'_c(t)$ . These signals are summed to produce the identical C-QUAM signal  $[Z_c(t)]$ .



$$V. \quad N_c(t) = [ -0.5 - M_4 ( R(t) ) ] [ -A_c \cos \omega_c t ]$$

$$P_c(t) = [ 0.5 + M_3 ( L(t) ) ] [ A_c \cos \omega_c t ]$$

$$\text{Where } M_3 L(t) = \frac{M_1 ( S(t) ) + M_2 ( D(t) )}{2}, \quad M_4 R(t) = \frac{M_1 ( S(t) ) - M_2 ( D(t) )}{2}$$

$$V_c(t) = N_c(t) + P_c(t)$$

$$= [ 1 + M_3 ( L(t) ) + M_4 ( R(t) ) ] A_c \cos \omega_c t \quad \text{Equivalent to I(a)}$$

$$VI. \quad Q_c(t) = M_3 ( L(t) ) A_c \sin \omega_c t$$

$$T_c(t) = M_4 ( R(t) ) - A_c \sin \omega_c t$$

$$W_c(t) = Q_c(t) + T_c(t)$$

$$= [ M_3 ( L(t) ) - M_4 ( R(t) ) ] A_c \sin \omega_c t \quad \text{Equivalent to I(b)}$$

$$VII. \quad -Y'_c(t) = 0.5 A_c \cos ( \omega_c t + \theta ) + M_4 ( R(t) ) A_c \cos \omega_c t + \theta$$

$$Y'_c(t) = 0.5 A_c \cos ( \omega_c t + \theta ) + M_3 ( L(t) ) A_c \cos \omega_c t + \theta$$

$$VIII. \quad Z_c(t) = -Y'_c(t) + Y'_c(t)$$

$$= A_c [ 1 + M_3 ( L(t) ) + M_4 ( R(t) ) ] \cos ( \omega_c t + \theta )$$

Which is equivalent to IV.

FIGURE 2. B.E. INDEPENDENT MODULATOR C-QUAM STEREO METHOD

This configuration has the potential of having completely independent equalization of left and right channels, but has one serious problem. Currently, there are no AM transmitters available that can accept a differential RF signal and have capabilities for independent modulation. Therefore, a modified independent modulation system was developed for use in the BE AX-10 exciter. This is shown in Figure 3.

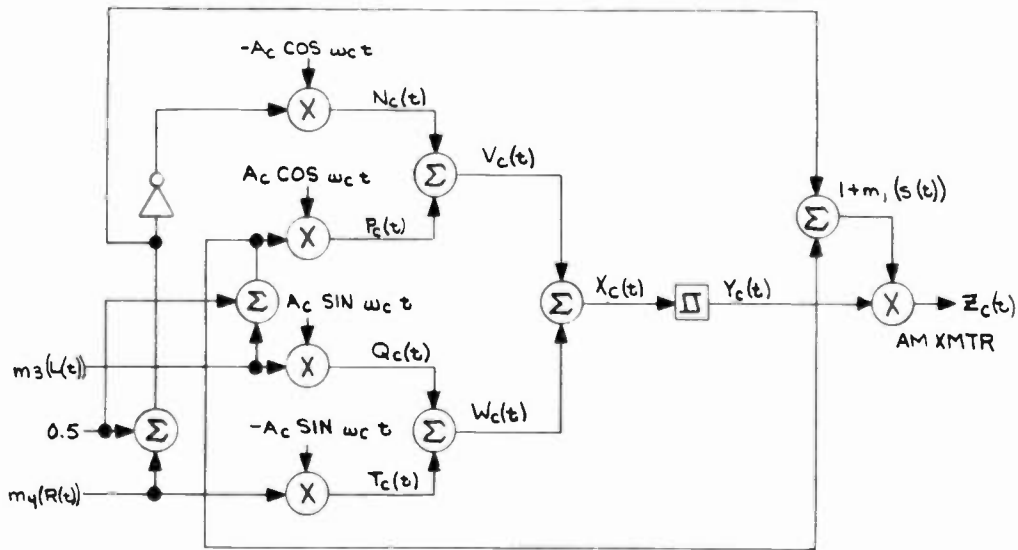


FIGURE 3. MODIFIED INDEPENDENT MODULATOR SYSTEM FOR USE WITH EXISTING AM TRANSMITTERS

In this configuration, the left channel  $[M_3(L(t))]$  is modulated with a 90 degree phase referenced RF signal  $[A_c (\sin \omega_c t)]$  to produce  $Q_c(t)$ . The right channel  $[M_4(R(t))]$  is modulated with a 270 degree phase referenced RF signal  $[-A_c (\sin \omega_c t)]$  to produce  $T_c(t)$ . These signals are summed to produce  $W_c(t)$ .

$M_3(L(t))$  is also summed with a DC offset to produce a carrier signal of half-magnitude, then modulated with a 0 degree phase referenced RF signal  $[A_c (\cos \omega_c t)]$  to produce  $P_c(t)$ .  $M_4(R(t))$  is summed with a DC offset of half-magnitude, inverted, and modulated with a 180 degree phase referenced RF signal  $[-A_c (\cos \omega_c t)]$  to produce  $N_c(t)$ . These signals are summed to produce  $V_c(t)$ .

$V_c(t)$  and  $W_c(t)$  are summed to produce the identical quadrature modulation as shown in Figure 1 and Figure 2  $[X_c(t)]$ .

From this point, the system is identical to that of Figure 1. It is amplitude limited to produce a quadrature phase-only signal  $[Y_c(t)]$ . This phase modulated RF signal is then amplitude modulated with the  $1+M_1(S(t))$  signal in the AM transmitter to produce the mono compatible C-QUAM signal  $[Z_c(t)]$ .

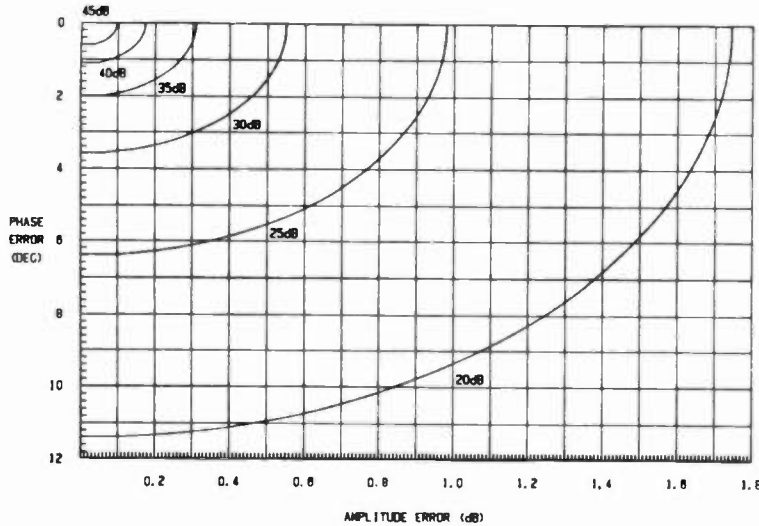
While the end result in the transmitter is a matrix type modulation, the phase modulated RF signal is derived through independent modulators, thereby providing much less interaction of left and right channels. Although the derivations and diagrams for the fully independent and the modified independent modulation techniques appear much more complex than their matrixed counterpart, in reality the circuitry remains virtually the same.

## 2.2 Transmitter Interfacing Requirements.

In any AM stereo system employing some form of phase modulated RF signal combined with conventional audio amplitude modulation of that signal, equalization must be used in the phase modulated signal and/or the mono audio signal to the transmitter. This is necessary to match the time delay characteristics of the two paths to construct the proper C-QUAM sideband distribution at the transmitter output, thereby insuring correct de-matrixing to left and right channels in the receiver. Figure 4 shows the relationship of amplitude and phase matching required between the mono L+R signal and the phase modulated L-R signal to achieve any given separation when de-matrixed.

Due to the wide variety of AM transmitters in use today, the task of equalizing these paths to transmit accurate stereo becomes complex. Equalization requirements differ greatly from one transmitter to another, but in most cases the required equalization can be divided into three requirements:

1. Group delay in either the RF or transmitter audio path to match the propagation differences between the two.
2. Some form of phase and amplitude correction for higher frequencies due to transmitter and antenna bandwidth/phase characteristics.
3. Low frequency phase correction in some cases.



General Equation:

$$\text{Separation } (A, \theta) = \left[ \frac{(\cos \theta + A)^2 + (\sin \theta)^2}{(\cos \theta - A)^2 + (\sin \theta)^2} \right]^{\frac{1}{2}}$$

Where:  $A = \frac{L-R}{L+R}$  Amplitude ratio

$\theta = \frac{L-R}{L+R}$  Phase error in degrees

FIGURE 4. STEREO SEPARATION AS A FUNCTION OF AMPLITUDE AND PHASE RESPONSE

Determining the exact requirements for a particular transmitter can be a confusing task, and often a series of trial-and-error experimentation results. This process involves trying various equalizers in the RF and audio paths, thereby testing their effect on stereo separation and distortion. Until specific transmitter equalization requirements are documented, alignment will prove to be an involved undertaking.

Because of the need to route any or all of the equalization circuits to either the RF or transmitter audio paths, some form of "patch bay" setup would be advantageous for block equalization selection. In the BE AX-10, this patch bay approach is accomplished by miniature matrix switches accessible under the top cover (see Figure 5). Once the basic layout of the switch is understood, it becomes extremely fast and easy to select any equalization and to route its output to either the input of another equalization block, or directly to the required path.

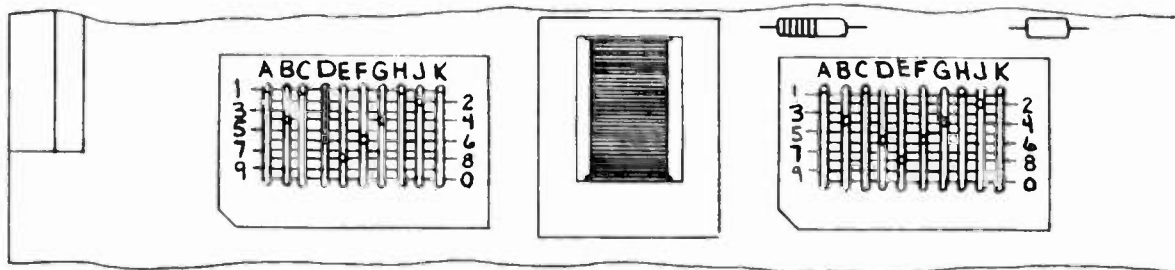


FIGURE 5. MATRIX SWITCHING

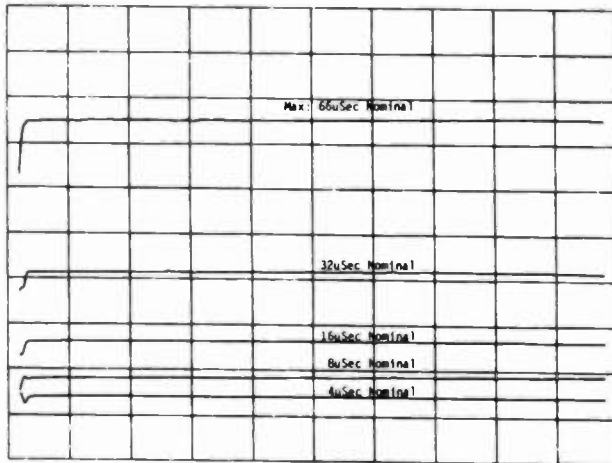
The type and amount of available equalization varies from exciter to exciter, but in general it can be said the greater the available range of equalization, the more transmitters can be easily converted to transmit AM stereo. As an example of one set of equalization, the next few paragraphs will discuss in detail the equalization circuitry used in the BE AX-10 exciter. The amount of available equalization was chosen after researching AM stereo consultants and users.

Two identical and independent sets of equalization are provided for day and night correction of changing antenna patterns, low power setting, or for a standby transmitter. Day/night equalization selection and status are remote controllable with either momentary ground closure, or by constant ground closure which may be initiated by antenna selection.

It was found that some AM stereo exciters did not contain enough available group delay. Systems may require more than 40 microseconds of delay. For that reason, any amount of constant group delay from 0 to 66 microseconds can be selected. This is accomplished by a miniature rotary switch selecting coarse delay in 4 microsecond increments followed by a 0-6 microsecond fine delay adjustment (see Figure 6). In addition, by routing day equalization through night equalization via the matrix switching, a single equalization of 0-132 microseconds of group delay is possible. So far, only the RCA BTA-5SS solid state transmitter has required more than 60 microseconds. This installation required over 100 microseconds of group delay equalization. The amplitude response remains constant in this equalizer from 20-20,000 Hz.

The low frequency phase equalizer is primarily required by plate modulated AM transmitters to correct for time delays introduced at low frequencies by the plate transformer. Figure 7 shows that this first order all-pass network provides a 0 to 90 degree phase shift maximum at 100 Hz while maintaining flat frequency response.

REF LEVEL /DIV  
0.0SEC 10.000μSEC

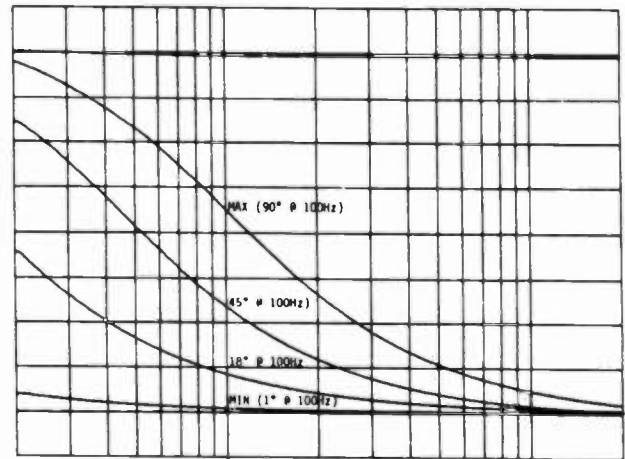


START 50.000Hz STOP 15 000.000Hz  
AMPTO -20.0dBm

FIGURE 6. GROUP DELAY

REF LEVEL /DIV  
0.000dB 0.500dB  
0.0deg 20.000deg

AMPLITUDE / PHASE  
FIRST ORDER ALL-PASS NETWORK

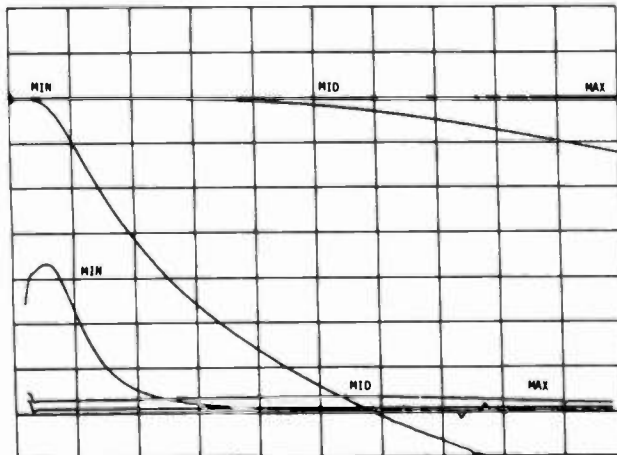


START 20.000Hz STOP 2 000.000Hz

FIGURE 7. LOW FREQUENCY EQUALIZATION

REF LEVEL /DIV  
0.000dB 5.000dB  
0.0SEC 10.000μSEC

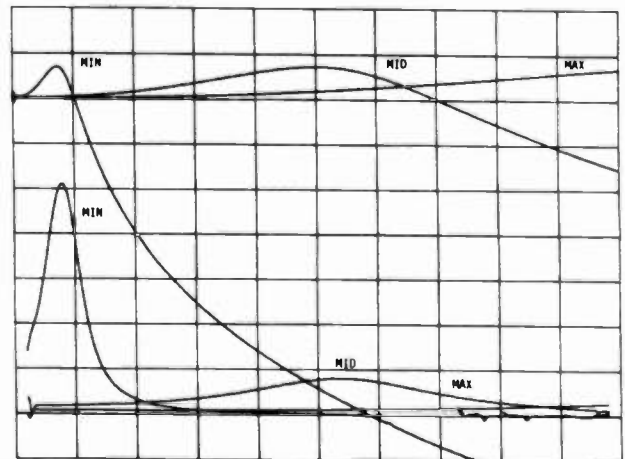
AMPLITUDE / GROUP DELAY  
MINIMUM PEAKING -3dB



START 50.000Hz STOP 100 000.000Hz  
AMPTO -20.0dBm

REF LEVEL /DIV  
0.000dB 5.000dB  
0.0SEC 10.000μSEC

AMPLITUDE / GROUP DELAY  
MAXIMUM PEAKING +3dB



START 50.000Hz STOP 100 000.000Hz  
AMPTO -20.0dBm

FIGURE 8. HIGH FREQUENCY EQUALIZATION

Due to the different phase and amplitude responses of the RF and transmitter audio chain at higher frequencies, correction must be made to provide good separation and distortion. Figure 8 shows some typical responses used to equalize the system at high modulating frequencies. Because of the separate turnover and peaking available, the responses can be tailored to fit the particular installation.

Another interfacing requirement for the exciter is the available range of RF output power. It is generally better to inject the RF signal as far as possible into the transmitter to diminish the effect of bandpass or lowpass filters in low level stages. These filters will degrade overall stereo performance and must be corrected with equalization circuitry in the exciter. By providing 150 milliwatts to 10 watts RMS, a suitable insertion point should be found for good stereo performance. 150 milliwatts into 50 Ohms corresponds to standard TTL signal level to drive transmitters with digital inputs. Some digital transmitters require an asymmetrical duty cycle square wave for best performance. In this case, an optional TTL interface provides from 25% to 75% continuously adjustable duty cycle.

In an effort to remove any phase and amplitude mismatches between the RF and transmitter audio chain due to audio transformers, the mono envelope signal from the exciter is actively balanced. A high output level of +20 dBm provides additional headroom and permits the use of lossy modulation enhancement devices. This output is continuously variable to accommodate transmitters with different input level requirements and more importantly, to exactly match corresponding L+R to L-R levels for good separation and crosstalk. For those transmitters requiring different daytime and nighttime audio levels, separate output level adjustments are included.

### 2.3 AM SCA.

With the recent FCC deregulation of AM SCA, AM stations are now able to use subsonic phase modulation for services such as load management. For conventional mono AM stations, this requires additional equipment. For AM stereo stations, however, the addition of AM SCA can be extremely simple.

Figure 9 shows the block diagram for the AX-10 pilot tone and AM SCA insertion method. The information to be phase modulated as AM SCA is inserted via the rear panel "Auxiliary Pilot Input". This signal is lowpass filtered to insure higher frequency components are not transmitted, then summed with the digitally derived and filtered 25 Hz pilot tone. This signal is then summed differentially with the left [ $m_3(L(t))$ ] and right [ $m_4(R(t))$ ] channel information for modulation (refer to Figure 3).

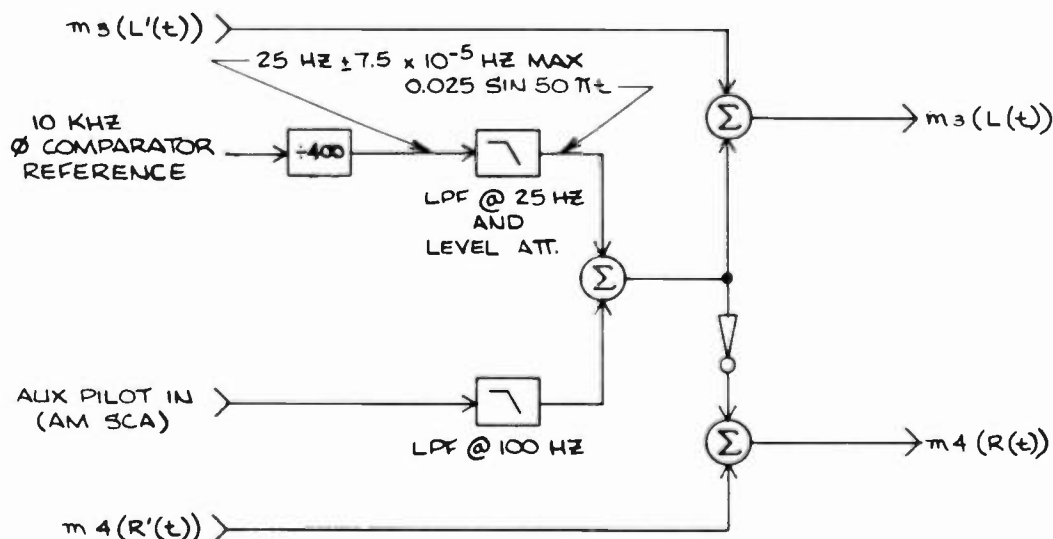


FIGURE 9. PILOT TONE AND AM SCA INSERTION CIRCUITRY

### 2.4 Transmitter Protection.

In any transmission system using a frequency synthesizer to derive individual station frequencies, some form of muting signal should be included during initial lockup time, or if phase lock is lost during normal operation. For safety reasons, a muting signal must be available if the exciter fails to output RF to the transmitter. Some transmitters can be seriously damaged if RF drive is lost.

Figure 10 details the transmitter protection circuitry in the AX-10 exciter. If the synthesizer loses phase lock or if a loss of RF presence is detected at the output, an external open collector mute signal is initiated to drive a 40 mA ground closure. This signal could be used to remove high voltage to protect the transmitter. Internal to the AX-10, the mute signal will extinguish the day or night LED on the front panel as a local indication.

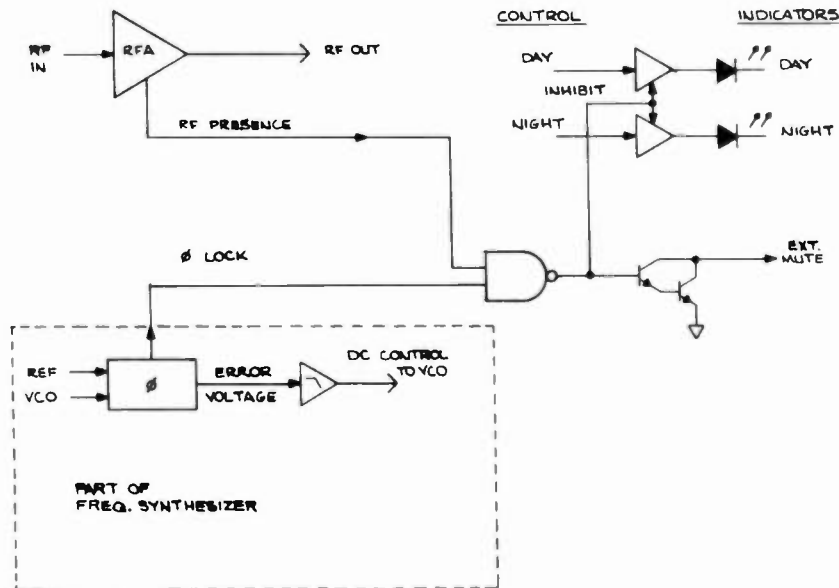


FIGURE 10. B.E. AX-10 PHASE LOCK AND RF PRESENCE PROTECTION CIRCUITRY

## 2.5 Audio Circuitry.

The audio inputs of an exciter should be completely transparent to the applied program content. Some desired characteristics include:

1. Actively balanced inputs.
2. High common mode rejection ratio (CMRR).
3. Good transient response.
4. Low distortion and noise.
5. Flat frequency response from  $\leq 1$  Hz to 15 kHz.
6. Identical phase and amplitude characteristics for both inputs.

Transformers are capable of balanced input, CMRR and acceptable noise and distortion, but are lacking in transient response, frequency response, phase and amplitude matching of inputs. Incorrect phase and amplitude matching will result in poor main-to-sub and sub-to-main crosstalk, just as poor amplitude and phase matching of main and sub channel response throughout the transmitter results in poor separation (refer to Figure 4).

Fully balanced instrumentation inputs are capable of frequency response from DC to well above 15 kHz, distortion below 0.005%, signal to noise of greater than 100 dB, excellent CMRR, and superior transient response. They also provide excellent phase and amplitude matching.

## 2.6 External Reference Capability.

For AM stereo systems employing phase modulation, nighttime co-channel interference known as "platform motion" can occur under some conditions. While this phenomenon occurs only in fringe areas where even mono reception is poor, there has been some concern about its presence. Platform motion is caused by co-channel stations having a slightly different station frequency due to the timebase employed. In AM stereo, a rotational effect is created as the receiver decodes the frequency difference from one channel to another at a rate equal to the difference in frequency of the co-channel stations. Because the AX-10 is a digital modulation system deriving all station frequencies from one 10 MHz source, the master oscillator can be replaced with a reference source from WWV or some other standard. If all co-channel stations become frequency locked, platform motion is eliminated.



Figure 11 shows the frequency conversion technique used in the AX-10. The 10 MHz master clock is used to generate all other frequencies. If the internal oscillator is used, this reference will be within  $\pm 30$  Hz from  $0-50$  degrees C. The tolerances after the other clock frequencies are maximum deviations due to the TCXO employed.

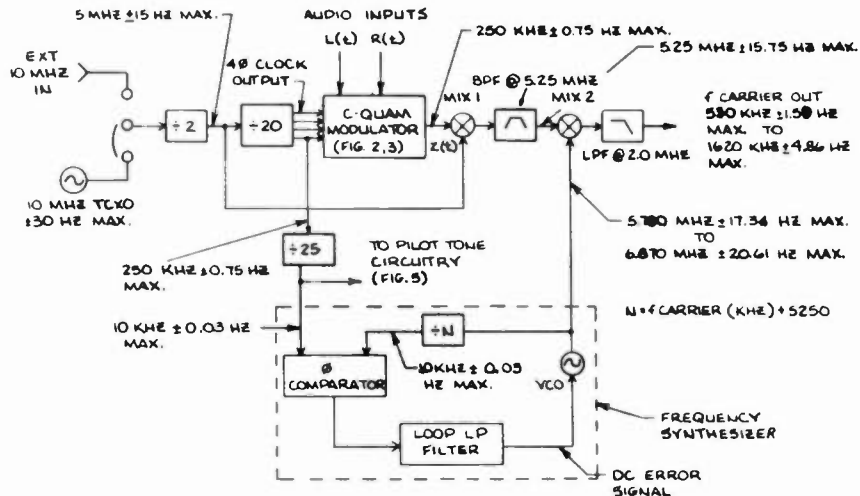


FIGURE 11. FREQUENCY CONVERSION TECHNIQUE

The 10 MHz is first divided by 2 to obtain 5 MHz. This is used in two places. First, it is divided by 20 to obtain a 4 phase clock generator at 250 kHz to drive the IF C-QUAM modulator. After stereo generation, the 250 kHz signal is mixed with the second 5 MHz signal, thereby up-converting to 5.25 MHz. This second IF frequency passes through a linear phase bandpass filter to remove other mixing products.

Phase  $\emptyset$  from the 250 kHz clock generator is divided to 10 kHz to provide a reference frequency for the synthesizer. This synthesizer operates from 5.780 MHz to 6.870 MHz. This frequency is mixed with the second IF frequency of 5.25 MHz to produce a difference frequency from 530 kHz to 1620 kHz which is lowpass filtered to remove higher order mixing products. The up-down conversion scheme provides a frequency agile system without retuning and eliminates the need for individual bandpass filters assigned to the station's carrier frequency. The difference term from the last mixer is free of images in the AM band. Since there are no bandpass filters or other tuning adjustments specific to the station frequency, the AX-10 can be quickly moved to any channel assignment by simply reprogramming the frequency synthesizer. This technique also guarantees identical stereo performance across the AM band.

Because the synthesizer is phase locked to the master clock and high side injection is used in the last mixer (i.e. the difference term is the one of interest), the frequency errors due to crystal drift subtract, thereby increasing frequency stability. This provides a total error of no more than 5 Hz at carrier frequency across the entire AM band over the  $0-50$  degree C rating of the TCXO.

## 2.7 Human Engineering.

Due to the need for flexible interfacing capabilities, any AM stereo exciter must contain a wide range of adjustments from audio, RF and pilot levels to transmitter equalization controls. Accessibility to these controls is of prime importance to the engineer who must align and maintain the exciter. It would be most advantageous for these controls to be available without removal of the unit.

Not all adjustments require immediate access, however there are some which need to be readily available. These include:

1. Transmitter equalization controls (day/night).
2. Transmitter audio level (day/night).
3. RF output level control.
4. Pilot injection level.

Beyond these, any user helpful controls such as mode selection, pilot off switch, single channel limiter defeat switch, manual day/night equalization selection switch, or any required monitoring or diagnostic ports should also be located on the front panel.

Should access to internal circuitry be required, the exciter is mounted on standard 19" slide rails for convenience. The top cover can be easily removed. Care must be taken to insure good RFI shielding for AM, FM, and TV frequencies.

Figure 12 shows the location of controls on the AX-10 exciter. All transmitter equalization controls, together with transmitter audio levels, RF output level, pilot injection level, pilot off switch, mode selection, single channel limiter defeat, local day/night equalization selection, and an audio monitoring point are located behind the front panel door.

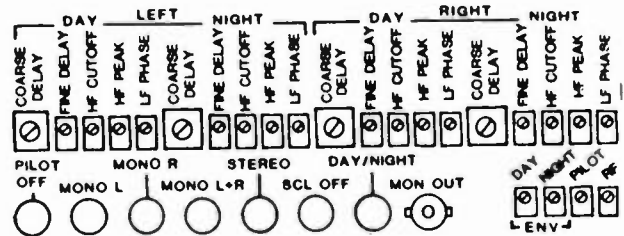
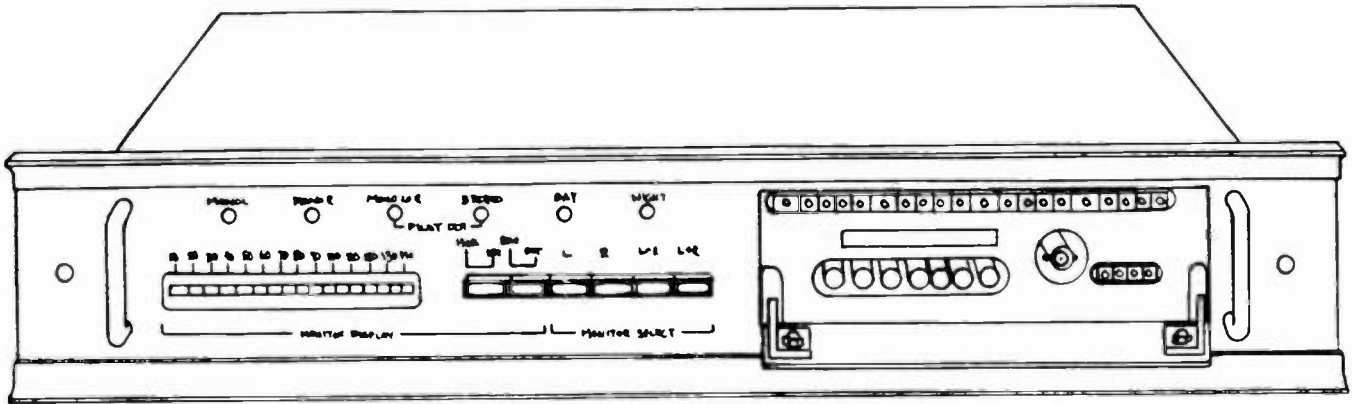


FIGURE 12. AX-10 ALIGNMENT CONTROL LOCATION

2.8 Remote Control and Status Indication.

Under no circumstance should there be any loss in mono loudness to the mono listener during a stereo broadcast, and in fact under normal operating conditions there is not. It is possible, however, to lose up to 6 dB of mono loudness if one audio input to the stereo exciter is lost. For this reason, some form of alternate mode selection should be used. The exciter should be capable of single channel operation with no loss in mono loudness.

The BE AX-10 can be run in one of four modes:

1. Mono Left
2. Mono Right
3. Mono L+R
4. Stereo

If one channel to the exciter should fail, the unit can be switched to the opposite channel with no loss in mono loudness. In all mono modes, the 25 Hz pilot tone is muted to return the C-QUAM only receivers to their mono state. Because of this, the exciter can be run in the Mono L+R mode during long mono transmissions.

All modes and equalization states are remote selectable with momentary ground closures. Their status indications are also provided. The transmitter mute signal is also provided on the same connector. All remote controls and indications are optically isolated to reduce ground loops and RFI contamination. The inclusion of a standard remote system removes the need to add additional interfacing equipment in the field. It also speeds changeover time to mono modes in case of failure.

III CONCLUSION

Figure 13 shows the overall block diagram of the Broadcast Electronics AX-10 AM Stereo exciter. This products reflects 20 months of in-depth research and development which has provided the fore-named improvements to the C-QUAM AM Stereo system.

Such second generation design techniques offer improvements to look for in the selection of an AM stereo exciter.

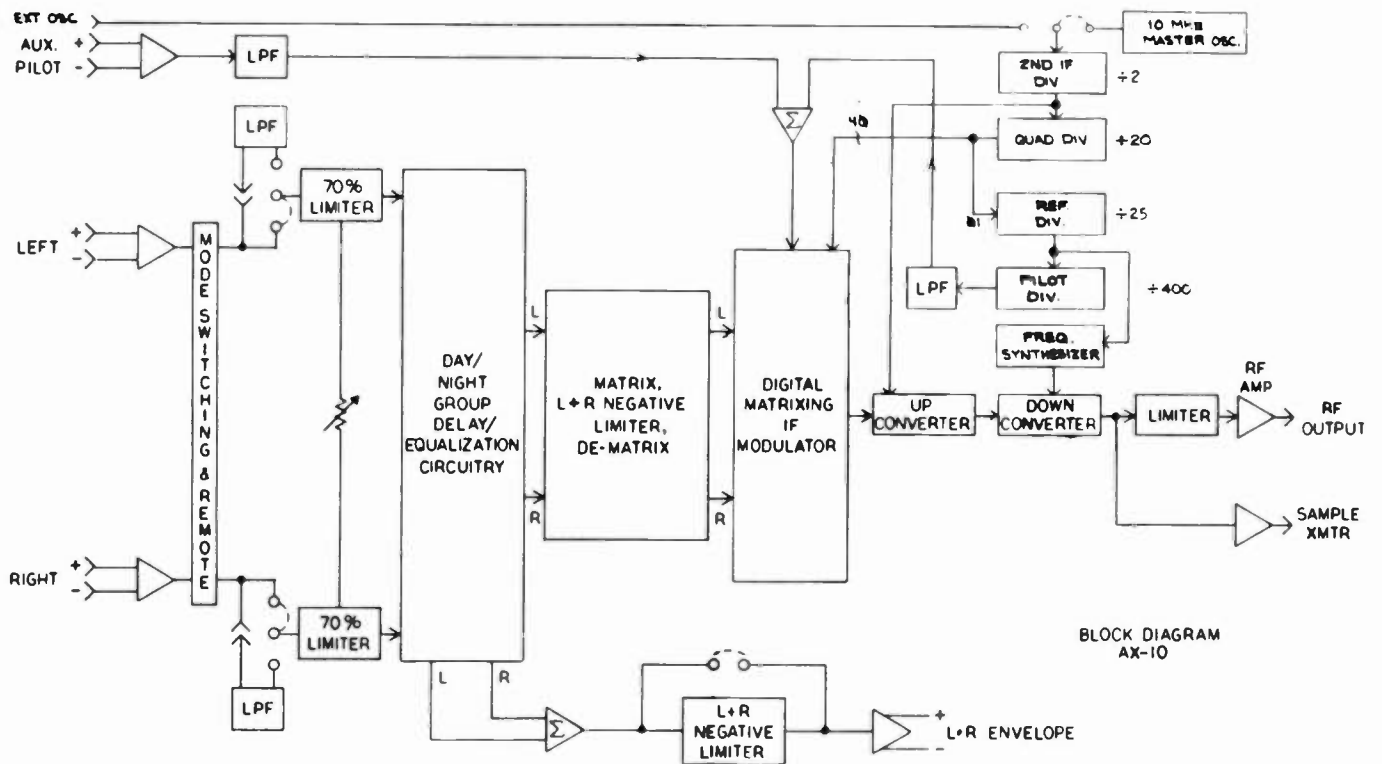


FIGURE 13. AX-10 OVERALL BLOCK DIAGRAM

#### IV. ACKNOWLEDGEMENTS

I would like to express my appreciation to Mr. Stanley Salek, formerly the AM Stereo Project Engineer at Broadcast Electronics for his design work on the AX-10 and his contributions to the content of this paper. I would also like to thank the members of the engineering and drafting departments at Broadcast Electronics who helped prepare the illustrations and manuscript.

#### V. BIOGRAPHICAL INFORMATION

Edward Anthony is an Audio Design Engineer in charge of the AM Stereo project at Broadcast Electronics, Inc. in Quincy, Illinois. He has also contributed to the TV Stereo design. Previously, he held the position of Test Engineer at Broadcast Electronics where his main responsibility was implementing test procedures and supporting the design quality of the FX-30 FM exciter, FS-30 FM Stereo generator and FC-30 SCA generator.

Ed received a BSEET degree in 1982 from Central Missouri State University where he worked as an engineer at KMOS-TV. He is also a member of the Institute of Electrical and Electronics Engineers and a member of Phi Kappa Phi honor society.

#### VI. REFERENCES

- (1) Chris Payne - "Introduction to the Motorola C-QUAM AM Stereo System", Motorola, Inc., Copyright 1982.
- (2) Geoffrey N. Mendenhall - "The Composite Signal - Key to Quality FM Broadcasting", Broadcast Electronics, Inc.



---

## A Modern Independent Side-Band AM Stereo Exciter

Leonard R. Kahn  
Kahn Communications Inc.  
Garden City, New York

### ABSTRACT

Description is provided of the block diagram of the newly patented Kahn ISB Exciter, now in operation in a number of major AM Stereo stations in the United States and Canada.

The new model, STR-84, provides lower noise and distortion and greater stereo separation over a greater frequency range than the original model.

Paper points out the importance of monophonic characteristics in providing full loudness because of their impact on a station's ratings.

Also discusses major problems of stereo AM reception i.e., "picket fencing", increased noise and "platform motion."

Of particular interest to receiver designers is a discussion of a new receiver concept that will lead to greatly reduced "picket fencing" and provide improved performance by maintaining receivers in Kahn/Hazeltine Stereo mode even for mono stations. This technique, especially when implemented with a new form of synchronous demodulator, significantly improves both mono and stereo reception. This non switching operation is only applied to sideband stereo (Kahn/Hazeltine) mode because of "platform motion" problems inherent in all quadrature modulation systems. Another reason why the new circuit is not applied to the Motorola system is that if monophonic stations, with high amounts of incidental phase modulation, are received with a Motorola decoder, annoying distortion results and/or the sound appears to come from one speaker only.

The problems of quadrature modulation reception will also require constant receiver noise and interference monitoring so as to allow the receiver to switch back to mono whenever listening conditions are poor, but still acceptable for monophonic or Kahn/Hazeltine stereo reception.



---

UHF-TV KLYSTRON MULTISTAGE DEPRESSED  
COLLECTOR PROGRAM - A PROGRESS REPORT

Earl McCune

Varian Associates, Inc.

Palo Alto, California 94303

1. INTRODUCTION

UHF-TV stations are particularly concerned about reducing operating costs. The cost of electric power is a significant segment of the overall costs and results mainly from the power consumption of the final power amplifier klystron. Maximizing klystron efficiency has been a continuing effort at Varian, but the present designs represent close to an optimum design considering the desire for high efficiency. The characteristics of the amplitude modulated television signal result in klystron operation at power levels below the optimum efficiency condition such that the true operating efficiency is typically 20% even though the klystron can provide over 50% efficiency at the peak sync power level. Depressed collector technology can overcome this problem; by recovering energy from the spent electron beam, the efficiency can be maintained at a high level even for reduced rf power levels.<sup>1,2,3</sup>

A program to incorporate depressed collector technology into the Varian line of UHF-TV klystrons was initiated in June 1984. Support for this program is being provided by a cooperative group including NASA, NAB, PBS, transmitter manufacturers and Varian. This paper describes the goals and objectives of the development program followed by a description of progress to date. A preliminary design has been achieved, and based on this design, performance characteristics of a Multistage Depressed Collector (MSDC) klystron are described.

2. PROGRAM OBJECTIVES

Multistage depressed collector technology is to be incorporated in UHF-TV klystrons with the objective of adequate efficiency improvement to reduce prime power consumption by at least half. The MSDC designs are to be applied to the 30 and 55 kW klystrons of both integral and external cavity design. Ten experimental models are to be constructed and evaluated to demonstrate achievement of the performance objectives.

Seven tasks have been identified to be accomplished during the program:

1. Computer Simulation: This task is to develop a mathematical model to describe the klystron in order to determine electron velocity distribution at the collector entrance.
2. Computer Aided Design: The electron beam defined above is injected into the collector region while the electrode shapes are adjusted to maximize recovered energy but yet minimize returned electrons.
3. Material Evaluation: Collector electrodes need to have low secondary electron yield since secondary electrons degrade power recovery and can also cause regeneration problems (sync pulse ringing).
4. Collector Assembly: At least ten collectors are to be constructed.
5. Test Equipment Design and Construction
6. UHF-TV Klystron Assembly

Tasks 5 and 6 are provided by Varian to allow test and evaluation of the ten collectors of Task 4.

7. Performance Demonstration

The overall program schedule is shown in Figure 1.

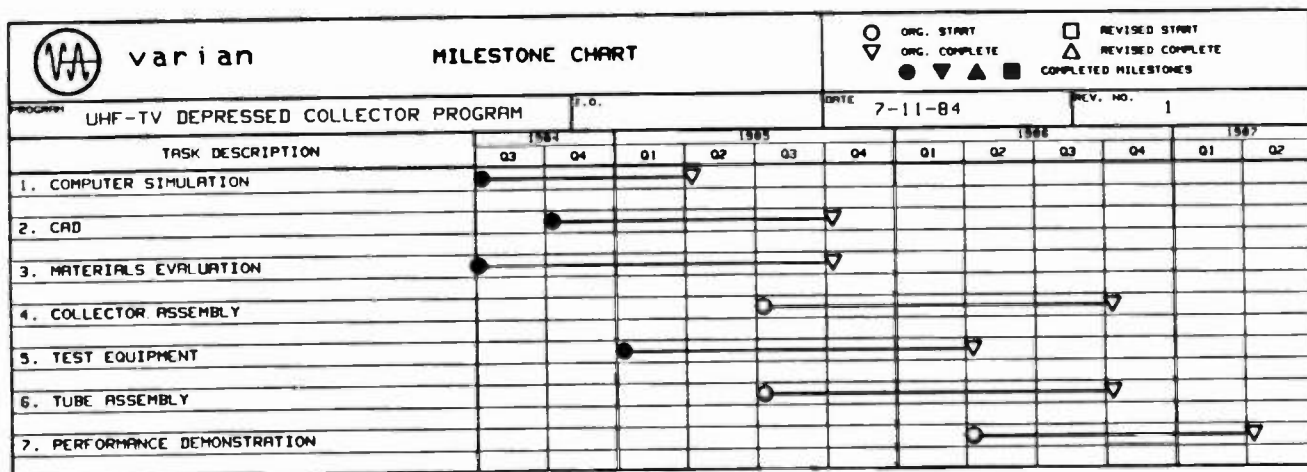


FIGURE 1. PROGRAM SCHEDULE

### 3. PROGRAM ACCOMPLISHMENTS

The computer simulation task is essentially completed. A step-by-step process was used to model klystron performance and compare computed results with measured performance to give confidence to the validity of the model. Figure 2 shows the computed vs measured performance for small-signal gain. Good agreement was also achieved for large-signal gain and efficiency. The main objective of the mathematical model is to determine the electron velocity distribution at the collector entrance. Figure 3 shows the results of these calculations using a



one-dimensional program. Two-dimensional calculations were also performed and these results were used for final collector design purposes.

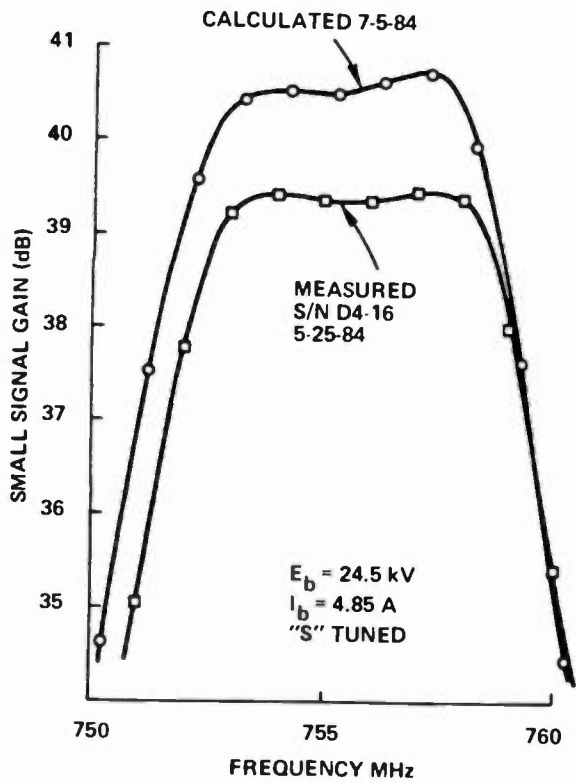


FIGURE 2. VKP-7555S BANDPASS CHARACTERISTICS MEASURED AND CALCULATED

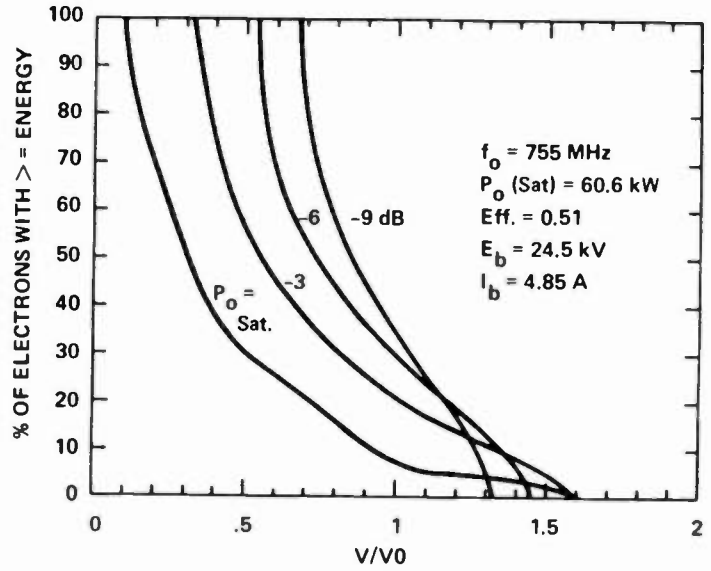


FIGURE 3. CALCULATED ENERGY DISTRIBUTION OF THE SPENT BEAM FOR THE VKP-7555 KLYSTRON

A preliminary collector design was selected which was based on a geometry that provides a decelerating electric field with moderate outward radial acceleration. There are no regions of refocusing which could lead to reflected

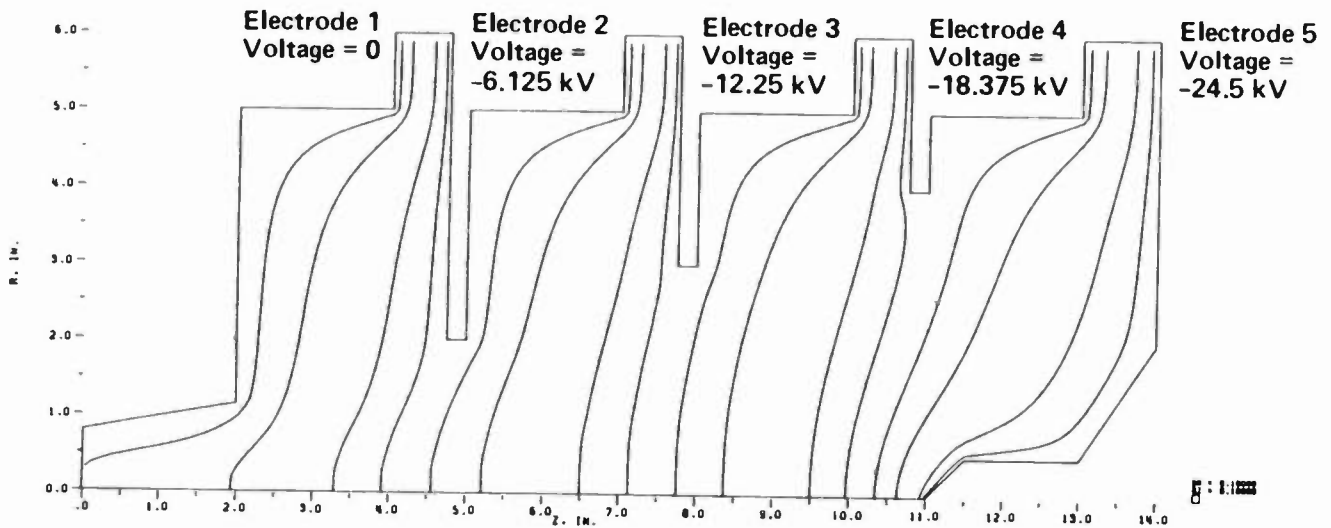


FIGURE 4. COLLECTOR ELECTRIC FIELD DISTRIBUTION

electrons back on the electron beam. In addition, the geometry is simple and easily fabricated, and fits within the size of the present collector. Although this design was selected somewhat arbitrarily, subsequent calculations have shown quite good performance for this geometry. The electric field equipotentials for the collector are shown in Figure 4. The electrode potentials were selected at equally spaced intervals, mainly to simplify power supply design. However, power recovery should be close to optimum, considering the wide velocity distribution of the entering electrons.

Electron trajectories in the collector region were calculated using the two-dimensional entrance conditions previously determined. Calculations were

Output Power = 90% Saturation = 50 kW  
 Beam Voltage = 24.5 kV Beam Current 4.85 A

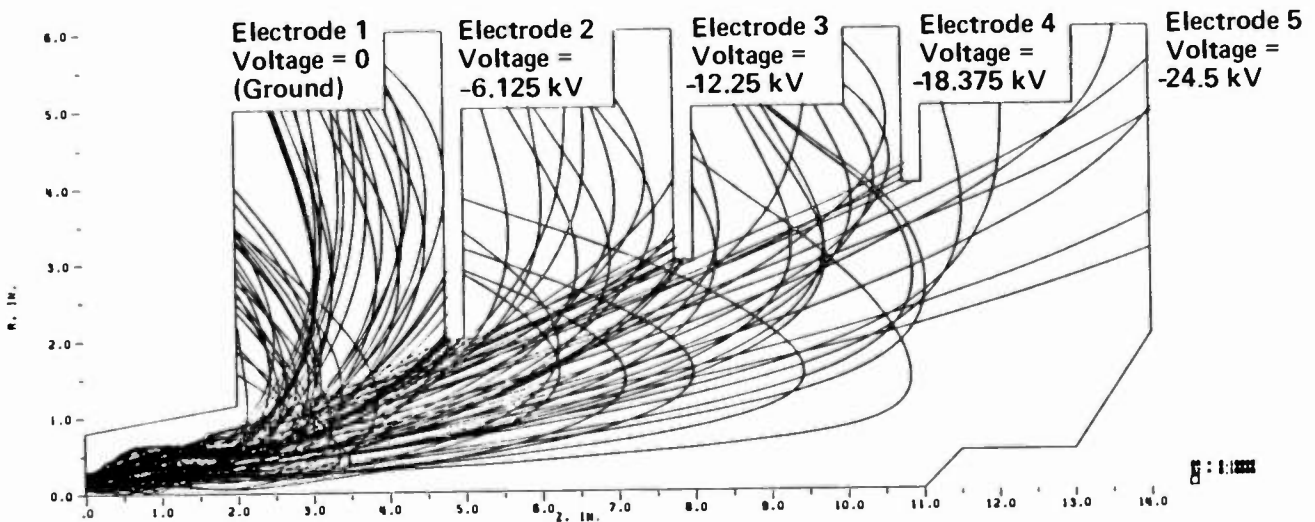


FIGURE 5. COLLECTOR ELECTRON TRAJECTORIES

Output Power = 50% Saturation = 30 kW  
 Beam Voltage = 24.5 kV Beam Current = 4.85 A

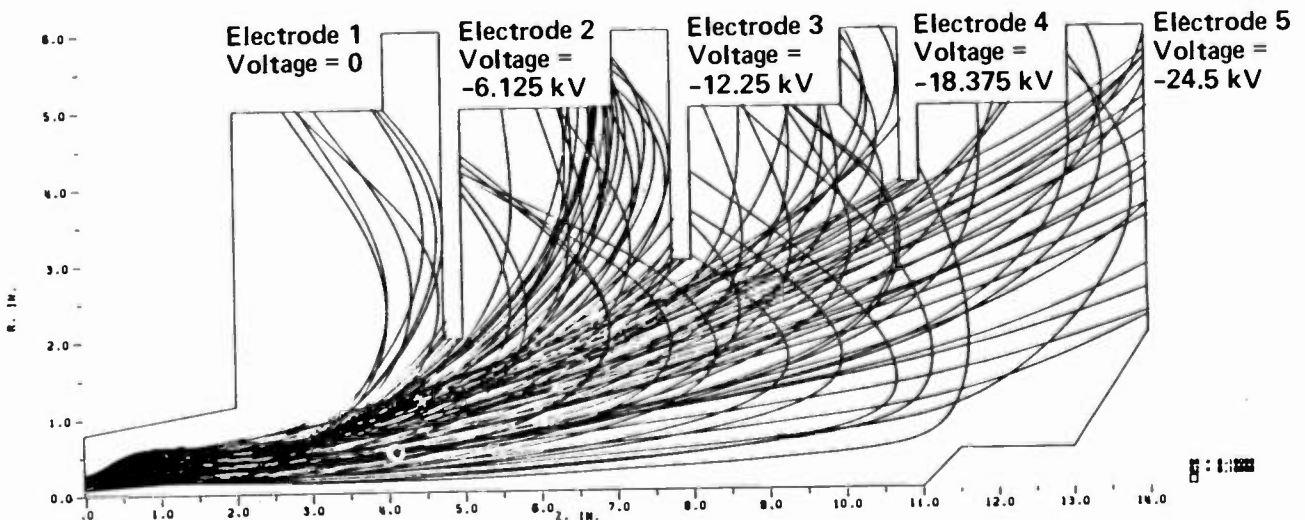


FIGURE 6. COLLECTOR ELECTRON TRAJECTORIES

performed for 90, 50 and 25 percent of full saturation output power; in this case 55, 30 and 15 kW. The results are shown in Figures 5, 6 and 7. Also determined were the trajectories for the no-drive case where all of the current goes to electrode 4.

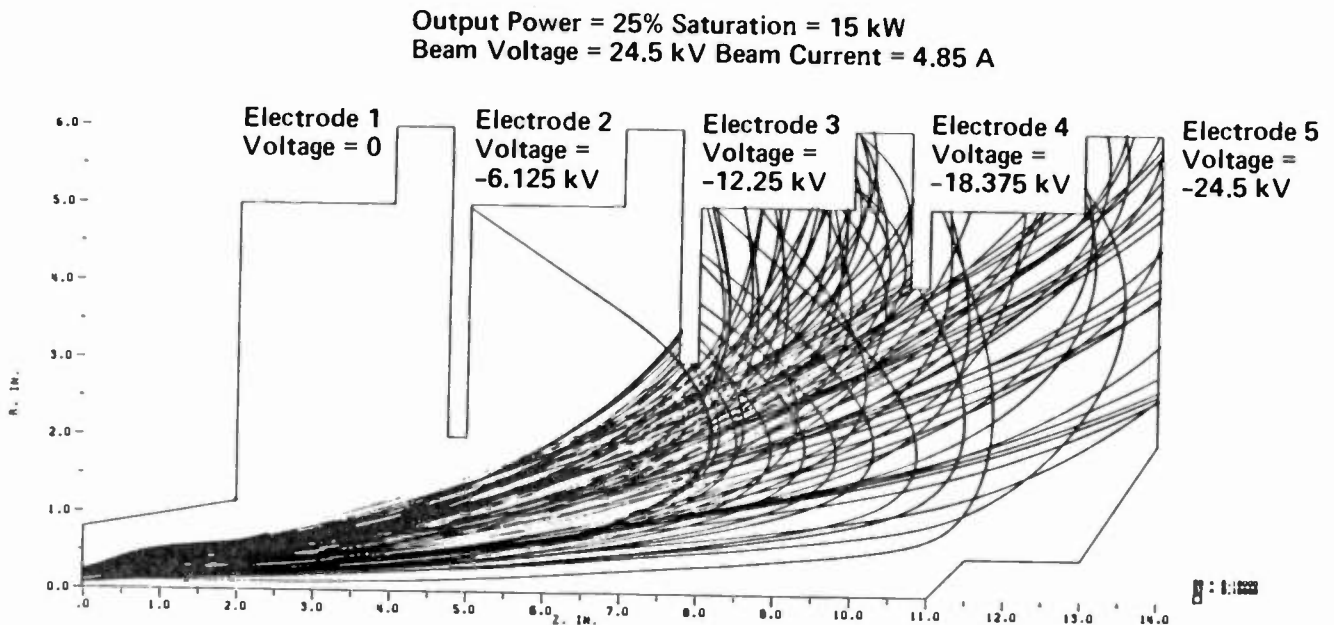


FIGURE 7. COLLECTOR ELECTRON TRAJECTORIES

The current and power distributions among the collector electrodes are listed in Table 1. Also calculated is the collector efficiency, defined as the power saved (collector input power less the power dissipated) divided by the collector input power.

Table 1  
Collector Current and Power Distribution

Beam Voltage = 24.5 kV  
Beam Current = 4.85 A

RF Output Power	Electrode Current/Power					Collector Efficiency
	1	2	3	4	5	
0 kW	0	0	0	4.85	0	75.0 %
	0	0	0	29.7	0	
15	0	0.1	2.6	1.4	0.8	71.2 %
	0	0.7	12.6	9.9	6.7	
30	0.3	1.8	1.3	0.7	0.8	60.7 %
	2.4	12.2	6.5	4.7	9.1	
55	1.9	1.4	1.1	0.3	0.2	41.8 %
	12.2	9.3	8.9	4.3	3.0	

An important consideration is the effect of secondary electrons on collector performance. An estimate of this effect was determined by assuming a secondary ratio of 0.5 for the electrodes, which is appropriate for copper electrodes with a carbon coating. Sample coatings have been achieved and it is expected that coated electrodes will be used. All primary electrons striking the electrodes in regions of accelerating electric field away from the surface will liberate secondary electrons and, for this estimate, the secondaries are assumed to go to the next adjacent electrode. Using these assumptions results in the revised current and power distribution listed in Table 2. Comparing Tables 1 and 2 shows the deleterious effects of secondary electrons and demonstrates the importance of effective secondary suppression. Using the data of Table 2 we can calculate the overall tube efficiency which is plotted as a function of power level in Figure 8.

Table 2  
Collector Current and Power Distribution  
Including Secondary Electron Effects

Beam Voltage = 24.5 kV  
Beam Current = 4.85 A

RF Output Power	Electrode Current/Power					Collector Efficiency	
	1	2	3	4	5		
0 kW	0	0	0	4.85	0	A	75.0 %
	0	0	0	29.7	0	kV	
15	0	0.5	2.5	1.5	0.4	A	65.3 %
	0	2.8	14.1	12.4	6.7	kV	
30	0.5	1.8	1.2	1.0	0.4	A	54.5 %
	3.6	13.4	7.1	7.2	9.1	kV	
55	2.2	1.4	0.9	0.3	0.1	A	34.4 %
	14.0	11.1	9.5	4.9	3.0	kV	

#### 4. PERFORMANCE CHARACTERISTICS OF MSDC KLYSTRON

The data of Table 2 can be used to determine the power supply operating conditions. Two power supply configurations were considered, a parallel and a series arrangement as shown in Figure 9. Either arrangement will work and there is no obvious advantage of one over the other. The current and power distributions are different for each case, however, as listed in Tables 3 and 4.

We can calculate the power requirements for this MSDC klystron design and compare it to other designs using the standard of comparison described by Priest and Shrader.<sup>4</sup> For a typical TV signal this klystron provides a figure of merit value of 1.09 compared with 0.55 for the standard klystron (assumes no sync pulse modulation), where the figure of merit equals peak sync power divided by dc beam input power for an average picture.

The preliminary MSDC klystron design described here would result in an overall klystron not very different from existing designs in size, weight,

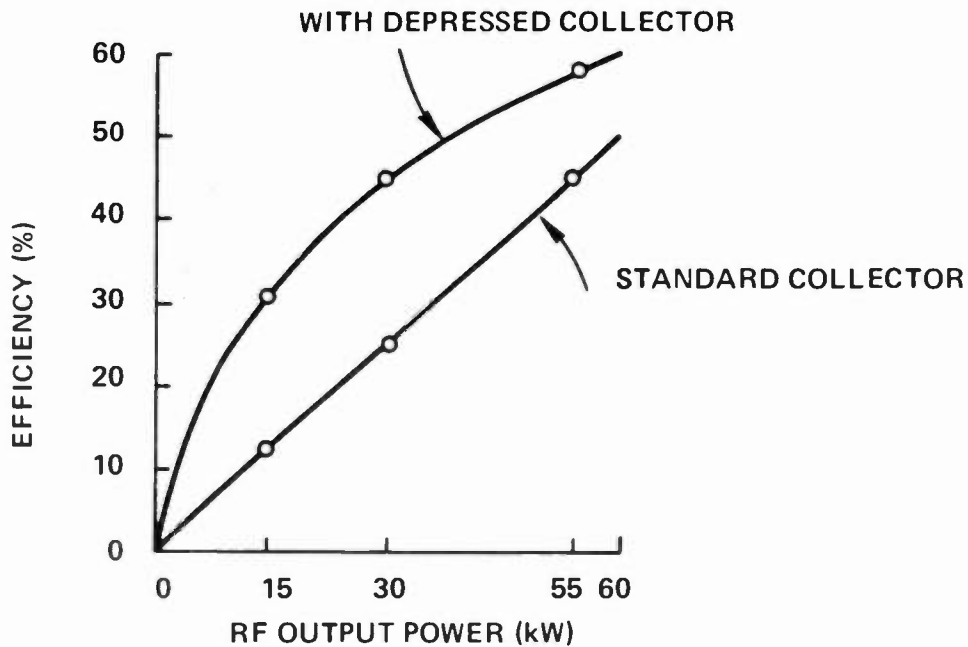


FIGURE 8. OVERALL TUBE EFFICIENCY

Table 3  
Power Supply Requirements  
Parallel Configuration

RF Output Power	Power Supply Current/Power				
	1 (24.5 kV)	2 (18.375 kV)	3 (12.25 kV)	4 (6.125 kV)	
0 kW	0	0	0	4.85	A
	0	0	0	29.7	kW
15	0	0.5	2.5	1.6	A
	0	8.3	30.6	9.5	kW
30	0.5	1.8	1.2	1.0	A
	12.3	33.1	14.7	6.1	kW

configuration, etc. The first models will use water cooling, but vapor and air cooling are being considered for later models.

## 5. CONCLUSIONS

The MSDC klystron development program is proceeding well following the schedule of Figure 1. A preliminary design has been achieved which should meet the program objectives. Design refinement is continuing, however, as electrode geometries are being optimized and beam refocusing is being evaluated. Consequently, there is reason to be optimistic that even better performance will be achieved by the experimental models.

Table 4  
Power Supply Requirements  
Series Configuration

RF Output Power	Power Supply Current/Power				
	A (6.125 kV)	B (6.125 kV)	C (6.125 kV)	D (6.125 kV)	
0 kW	0	0	0	4.85	A
	0	0	0	29.7	kW
15	0	0.5	3.0	4.5	A
	0	2.8	18.1	27.6	kW
30	0.5	2.3	3.5	4.5	A
	3.1	14.1	21.4	27.6	kW
55	2.2	3.6	4.5	4.8	A
	13.5	22.1	27.5	29.4	kW

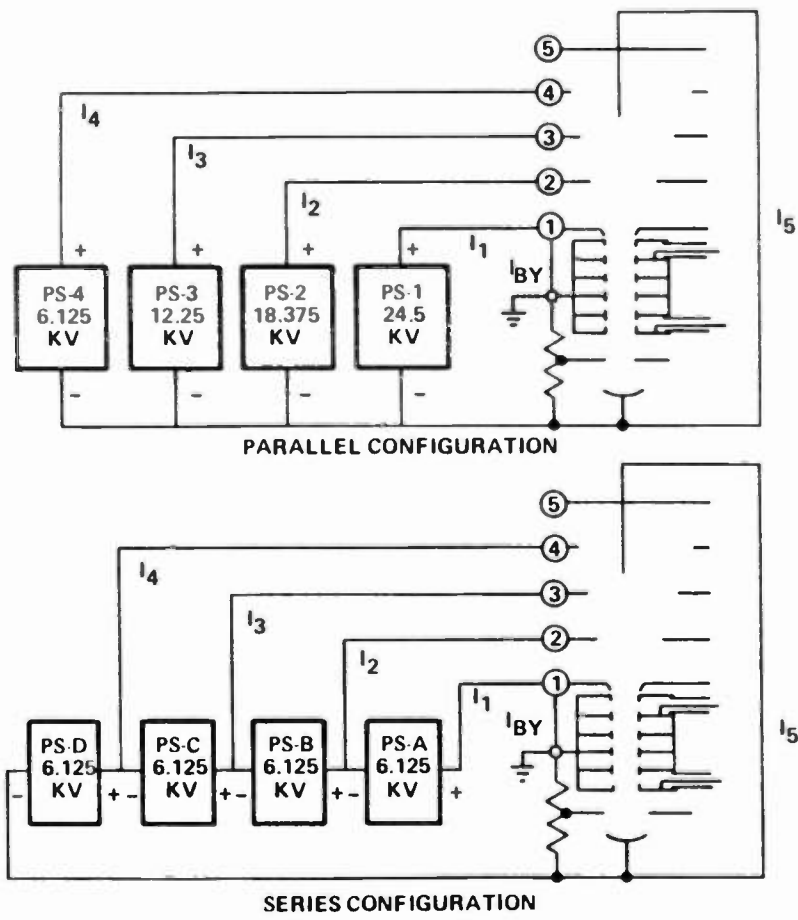


FIGURE 9. MSDC POWER SUPPLY SCHEMATICS

## REFERENCES

1. Kosmahl, H. G.: "Multistage Depressed Collectors (MDC) for Efficiency Improvements of UHF Broadcast Klystrons", IEEE Broadcasting Symposium, Washington D.C., September 1982.
2. Symons, R. S.: "Depressed Collector Klystrons for High Efficiency UHF Television", NAB Convention, Dallas, April 1981.
3. Cutter, C.C.: "New Opportunities for UHF Television Transmitters", UHF Comparability Task Force, Office of Plans and Policy, Federal Communications Commission, Washington, D.C., Feb. 1981.
4. Shrader, M.B.; Priest, D. H.: "Klystrode Update", IEEE International Electron Devices Meeting, Washington D.C., December 1984.

---

## THE DEVELOPMENT OF A 110 KILOWATT

### HIGH EFFICIENCY UHF TV KLYSTRON

Howard Foster

Varian Associates, Inc.  
611 Hansen Way  
Palo Alto, CA 94303

#### INTRODUCTION

In the USA for technical, socioeconomic, and geopolitical reasons, UHF TV transmitters tend to be sized at 30, 55 and 110 kW (1). In recent years, new transmitters placed in service have been predominantly 55 to 60 kW equipment with a trend toward 100 to 110 kW equipment for the larger advertising markets or where substantial market growth is projected.

Until the present time, 110 and 220 kW systems have been configured using multiple 55 kW klystrons power combined at the output. In such systems, each 55 kW tube has had its own dedicated high voltage power supply, command and control circuitry, interlocks, heater supplies, focus magnet supplies, cabinets, etc. Needless to say, this is not a particularly economical method of obtaining transmitter power. Due to the high initial acquisition cost of such systems, many broadcasters have chosen to live with lower powered equipment even though that decision may not be in their best long-term interest.

In 1980, Varian was approached to investigate the feasibility of a 100 kW UHF TV klystron incorporating all of the efficiency and reliability techniques known at that time (2). This study effort resulted in a development contract in mid-1981 for the development of six prototype klystrons. Two each at the low, mid and high band channels. One of the goals of the development contract was to provide 55% minimum conversion efficiency at a saturated output power of 110 kW.

Figure 1 is a simplified diagram of a typical integral cavity klystron used as the final high-power amplifier in a UHF TV transmitter. The rf input signal is coupled into the input cavity by an inductive loop. The rf voltage impressed across the capacitive gap of this cavity applies an rf component to the beam current. The intermediate cavities enhance this process until at the gap of the output cavity the electron plasma is formed into more or less tight bunches. By judicious (3) design of the output cavity, output cavity gap, and the output loading loop, the energy in the bunched beam can be efficiently extracted and



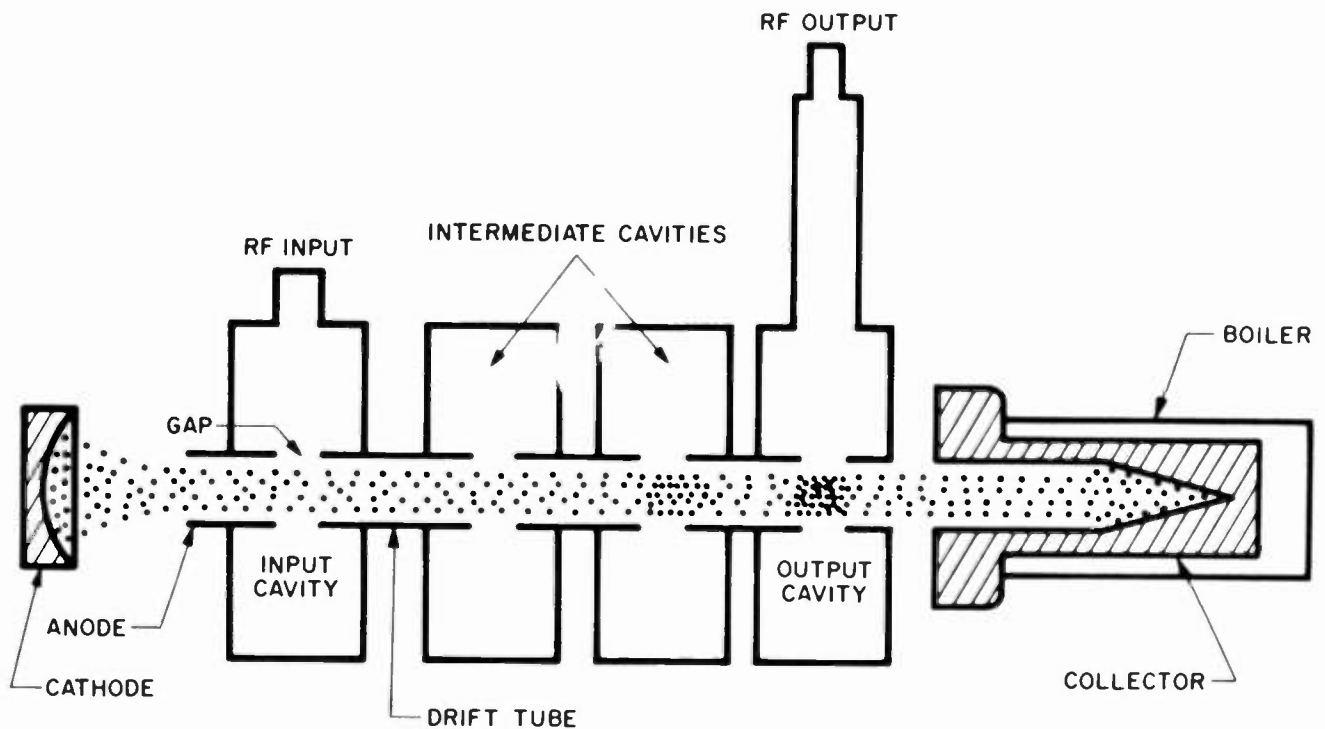


Figure 1

delivered to the rf transmission line. The conditions for high conversion efficiency are the formation of bunches which occupy a small region in velocity-space and the formation of interbunch regions with low electron density (4). The latter is particularly important since these electrons are phased to be accelerated into the collector at the expense of the rf field. Feenberg (5) has analyzed the energy exchange between the rf fields across the gap and an electron beam of given initial velocity and plasma wavelength. It can be shown that the energy loss due to an electron accelerated into the collector can exceed the energy delivered to the field by an equal but properly phased electron.

#### DESIGN CONSIDERATIONS

To take full advantage of recently proven techniques in both efficiency enhancement and reliability improvement, it was decided to initiate a new design of the 110 kW tube.

It has been recognized for some time that klystrons with lower perveance are more efficient than tubes which operate at low voltage and high current. As shown in Figure 2, the perveance of an electron beam is defined by the equation  $I_b = k(E_b)^{3/2}$  where  $I_b$  is equal to the beam current in amperes,  $E_b$  is equal to the beam voltage in kilovolts and  $k$  is a constant called microperveance which is a function of the dimensions of the electron gun. High efficiency in low perveance beams is due mainly to the fact that the charge density in a bunched electron beam is limited by the mutual repulsion of the electrons in that bunch. This mutual repulsion tends to deform the bunches and causes low efficiency.

The VKP-7853 series of 110 kW klystrons utilize an electron gun having a perveance of  $1.0 \times 10^{-6}$ . For purposes of comparison, the perveance of

$$I_b = kE_b^{3/2}$$

WHERE:

- $I_b$  = KLYSTRON BEAM CURRENT — A
- $E_b$  = BEAM VOLTAGE — kV
- $k$  = MICROPERVEANCE CONSTANT WHICH IS A FUNCTION OF THE DIMENSIONS OF THE ELECTRON GUN

TYPE	DESCRIPTION	PERVEANCE
VA-953H	COMMONLY USED 55 kW KLYSTRON	$2.0 \times 10^6$
VKP-7553S	NEW HIGH EFFICIENCY VARIANT OF VA-953H	$1.5 \times 10^6$
VKP-7853	110 kW KLYSTRON	$1.0 \times 10^6$

Figure 2

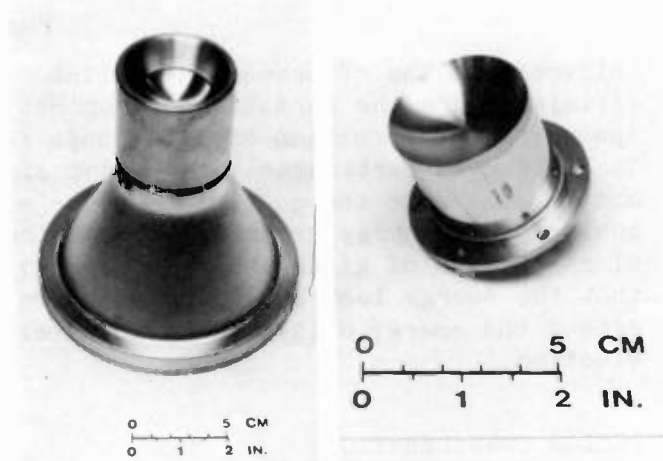
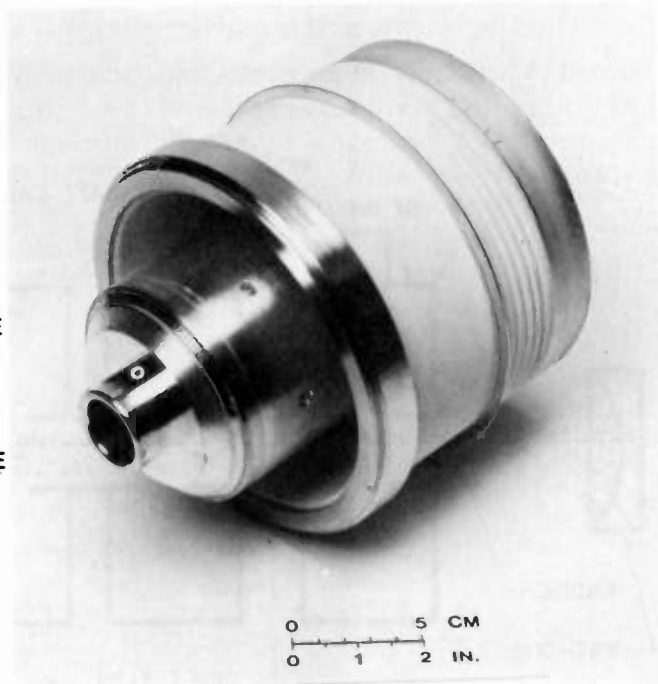


Figure 3

an early model 55 kW klystron, type VA-953H is  $2.0 \times 10^{-6}$  and the perveance of a new high efficiency variant of that tube, the VKP-7553S (6) is approximately  $1.5 \times 10^{-6}$ . Unfortunately, the bandwidth decreases and the linearity degrades decreasing beam current for a constant output power. Also, of course, there are many practical reasons to limit the operating beam voltage to manageable levels. Therefore, perveance reduction to enhance efficiency is a matter of design trade-off.

The relatively low value of perveance selected here takes into consideration the fact that excellent bandwidth can be realized from a five-cavity klystron design. Also, in recent years significant progress has been made in pre-emphasis circuitry and in GASFET and BI-POLAR transistor technology. As a result, it is now possible to pre-correct for the higher levels of differential phase and gain generated by low perveance tubes, while driving the tube harder to overcome the gain loss due to broadband tuning.

Figure 3 shows the low perveance electron gun design which incorporates a modulating anode. The convergence of the gun results in a cathode emission density of less than one A/cm<sup>2</sup> and provides generous interelectrode spacing to optimize high voltage reliability. The cathode itself is an indirectly heated, impregnated tungsten matrix "dispenser" type cathode. This cathode is inherently capable of exceeding 100,000 hours of emissive life.

The VKP-7853 employs pseudo-harmonic prebunching for efficiency enhancement. The original work on this concept at Varian was performed by Erling Lien (7) who introduced cavities resonant to the second harmonic of the signal frequency in the pre-buncher section. Figure 4 shows several design approaches which were modeled by Lien using a large signal computer simulation program. The resulting analysis showed that with proper phasing of the second harmonic fields an electron density distribution pattern could be established at the output gap which satisfies the criteria for high efficiency, very well indeed.

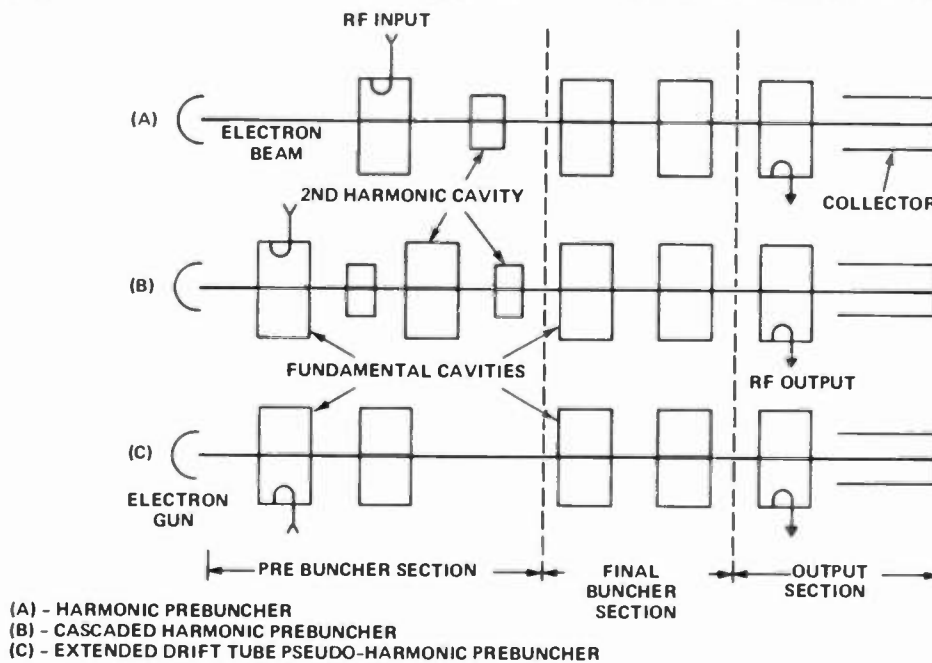


Figure 4

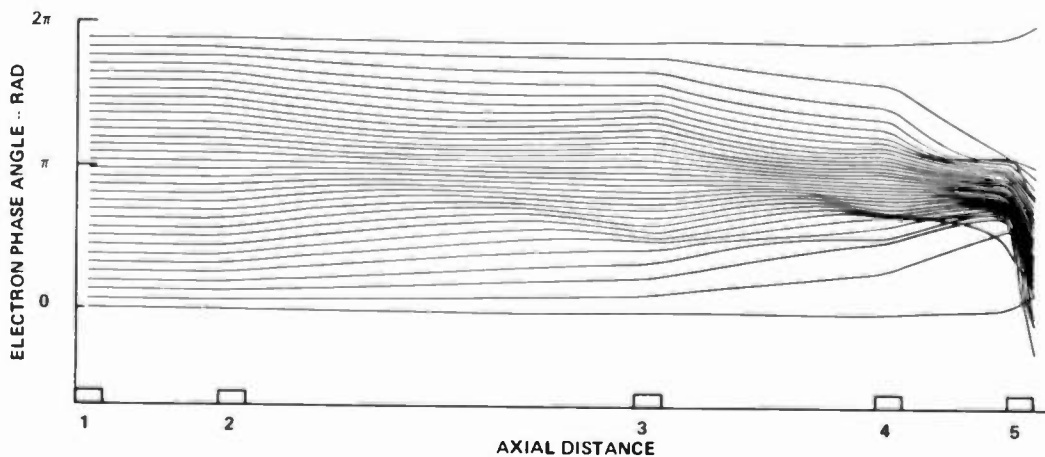


Figure 5

More significantly, it was also determined from the Lien model, that this condition could also be established by replacing the harmonic cavities with an extended drift tube in the pre-buncher region. This is true because the second harmonic of the space-charge acts upon the interbunch region in a manner similar to second harmonic rf fields. The significance of this is that klystrons having adequate bandwidth for television service can be designed using this technique.

This technique was incorporated in the design of the VKP-7853 110 kW klystron. Figure 5 is a phase-space diagram for a tube of this type. The curves are a plot of the relative phase of the reference electrons as a function of axial distance down the tube. Electrons having negative slope have been decelerated. Electrons having positive slope have been accelerated with the respect to an unaccelerated electron parallel to the axis. The figure shows how the electrons are nicely grouped at the output cavity gap while the interbunch regions are relatively free of electrons.

Viewing this interaction in another way, Figure 6 is a plot of the normalized rf beam currents as a function of distance along the tube. The curves show that the fundamental component of the plasma wave has a negative slope at the third gap. This normally would be a poor condition, however, due to the drift of the interbunch electrons, the fundamental current peaks at nearly 1.8 times the dc beam current. The theoretical limit for perfect bunching in a delta function is 2.0. It can be seen that the second harmonic of the plasma wave also peaks at the output gap both giving rise to high conversion efficiency.

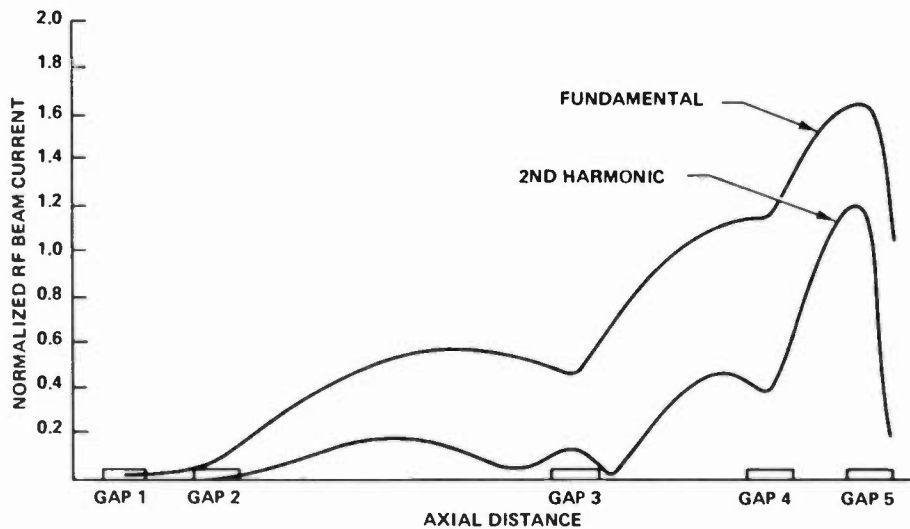


Figure 6

The five integral cavities are machined and assembled using high temperature hydrogen brazing techniques. Figure 7 shows a typical reentrant cavity assembly utilized on this tube. The cavity end walls are liquid cooled. Tuning is accomplished by a noncontacting capacitive tuner actuated by a jackscrew and a metal bellows assembly. The output loop and rf window are also liquid cooled as can be seen in the photograph. The collector section is machined from a solid billet of forged copper and is water cooled at 50 gallons per minute.

## PERFORMANCE CHARACTERISTICS

Three tubes are required to cover the UHF TV band. Figure 8 is a photograph of the low-band tube which covers channels 14 through 29. The tube is nearly 7 feet high, weighs 525 pounds not including the electromagnet, and operates with a variable transformer attached to the output window.

The major performance characteristics are listed in Figure 9. The tube operates at 33 kV beam voltage and 6.2 amps beam current. Gain at saturated output power is 37 dB requiring 50 watts rf drive power. Conversion efficiency at saturation is 55% minimum, 58% typical. Under pulsed conditions, (8) peak of sync efficiency is expected to approach 70%. Figure 10 is a plot of the typical transfer characteristics for the low, mid and high band tubes.

At this time, the klystron development program is complete. The low, mid and high band tubes have been delivered and release of the tube to production status is now underway.

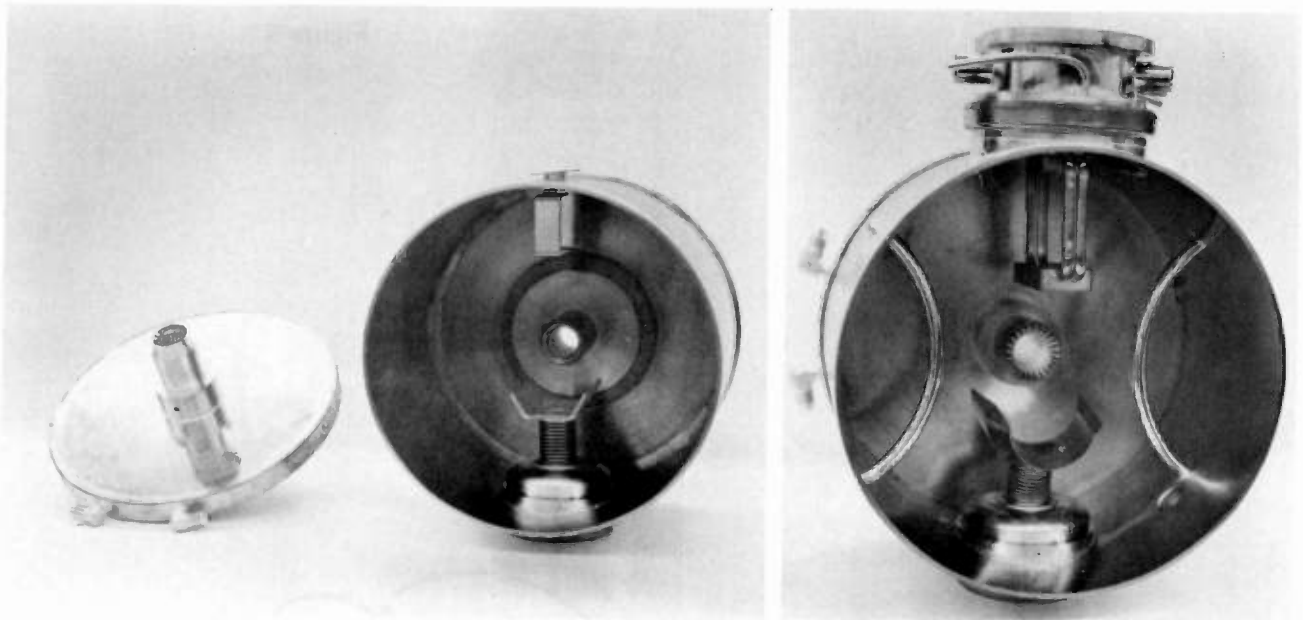


Figure 7

We believe the inherent economies of scale derived from a single 110 kW tube, coupled with its excellent conversion efficiency, will provide UHF broadcasters with significantly reduced cost of ownership for this type of equipment.

## REFERENCES

- (1) R. S. Symons, "Klystrons of UHF Television", IEEE Proceedings Vol. 70. No. 11, pp. 1304-1312, November 1982.
- (2) T. Kageyama, Y. Morizumi, and E. Watanabe, "Large Signal Analysis of Broadband Klystrons with Design Applications. IEEE Transactions on Electron Devices, January 1977.

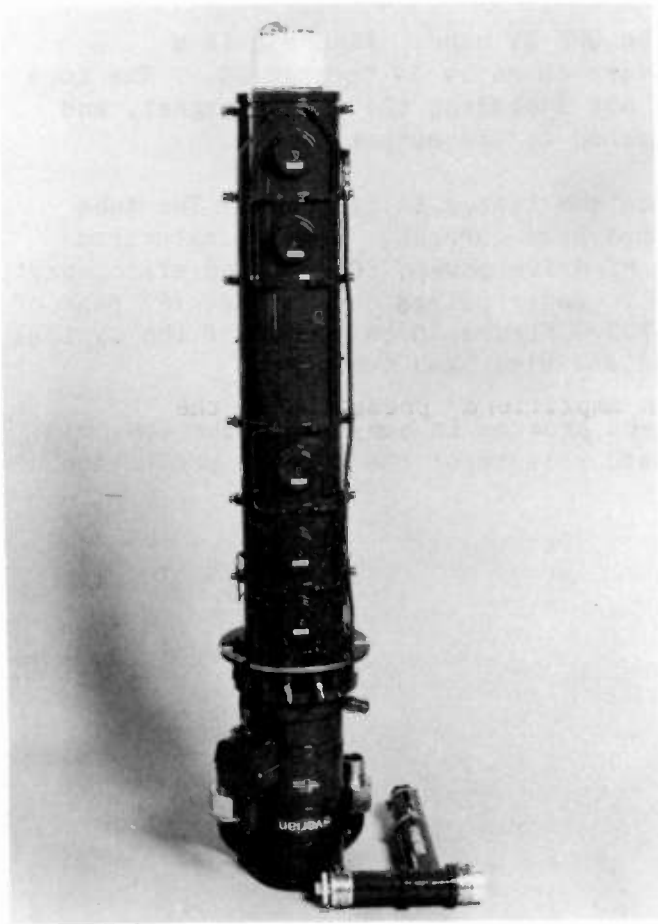


Figure 8

<u>PERFORMANCE CHARACTERISTIC</u>	<u>TYP.</u>	<u>UNITS</u>
SATURATED OUTPUT POWER	118	kW
GAIN AT SATURATION	37	dB
RF DRIVE POWER (REQ'D)	50	W
BEAM VOLTAGE	33	kV
BEAM CURRENT	6.2	A
CONVERSION EFFICIENCY	58	%
INSTANTANEOUS BANDWIDTH (1 dB)	6.5	MHz
LOAD VSWR	1.1	—
MOD ANODE VOLTAGE	27	kV
BODY CURRENT	50	mA
HEATER VOLTAGE	7.5	V
HEATER CURRENT	20	A
VAC ION PUMP VOLTAGE	3	kV
COLLECTOR COOLANT FLOW	50	GPM

Figure 9

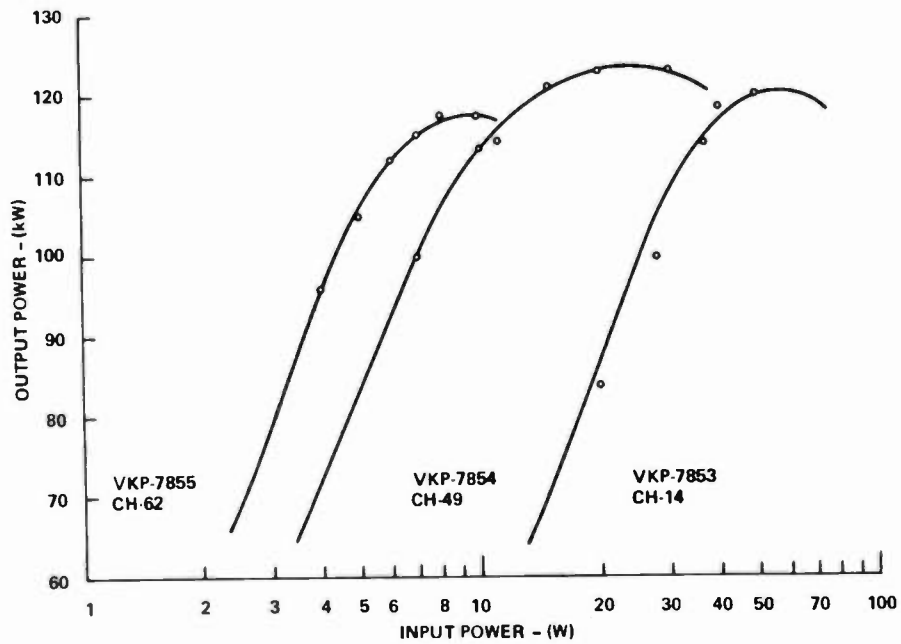


Figure 10

- (3) H. G. Kosmahl and L. V. Alhers, "3-Dimensional Evaluation of Energy Extraction in Output Cavities of Klystron Amplifiers", IEEE Trans. Electron Devices, Vol. ED-20, pp. 883-890, October 1973.
- (4) R. S. Symons, "Increased Efficiency from Five-Cavity Klystrons", Proceedings, 37th Annual NAB Broadcast Engineering Conference.
- (5) E. Feedberg, "Notes on Velocity Modulation", Sperry Gyroscope Co. Report No. 5221-0143 September 1953.
- (6) H. B. Foster, "Recent Developments in High Efficiency Klystrons", Proceedings, 38th Annual NAB Engineering Conference.
- (7) E. L. Lien, "High Efficiency Klystron Amplifiers" presented at the Conference on Microwave and Optical Generation and Amplification, Amsterdam, The Netherlands, 1970.
- (8) C. Cutler, "New Opportunities for UHF-TV Transmitters", UHF Compatibility Task Force, Office of Plans and Policy, F.C.C. Washington, D.C., February 1980.

#### BIOGRAPHY

Howard Foster presently is product manager with Varian Associates Microwave Tube Division. In that capacity he is responsible for the direction of Varian's UHF-TV klystron product line. Mr. Foster has over twenty years of experience in microwave systems and components for radar, electronic counter-measures and communications. He is a graduate of the University of Massachusetts in physics and MIT Sloan School of Business Administration.

---

AN INTEGRATED EXCITER/PULSER SYSTEM FOR  
ULTRA HIGH EFFICIENCY KLYSTRON OPERATION

N. Ostroff, A. Whiteside, L.F. Howard

Comark Communications Inc. and Marconi Communication Systems Ltd.  
Colmar, Pennsylvania

1. INTRODUCTION

This paper will present an analysis which will show that the optimum efficiency improvement of a beam pulsed klystron is 1.69 times its D.C. bias operating efficiency for NTSC System M operation.

The paper will then describe a series of hardware developments both at Comark Communications, Inc., U.S.A., and Marconi Communication Systems Limited, U.K., which together permitted the assembly of an integrated system to obtain the maximum efficiency improvement in actual practice.

Finally, the paper will present data from the actual transmitter in the field operating at 77.4 percent beam efficiency. The magnitude of the linearity correction required and the system necessary to maintain this performance in field broadcast service will also be presented.

2. THEORETICAL DISCUSSION

To establish the basis of the calculations used to define the optimum performance of a pulsed television klystron it is necessary, briefly, to examine the D.C. biased operating conditions and to define the terms we shall be using.

The majority of television klystrons in service today operate with fixed D.C. potentials applied to the cathode and modulating anode electrodes (D.C. biased operation). This mode of operation yields a constant beam current and hence a constant D.C. beam input power. The efficiency of operation under these conditions is universally defined as:

$$\text{Beam Conversion Efficiency } \eta_c = \frac{\text{Peak Sync R.F. output power} \times 100\%}{\text{Klystron D.C. beam input power}}$$



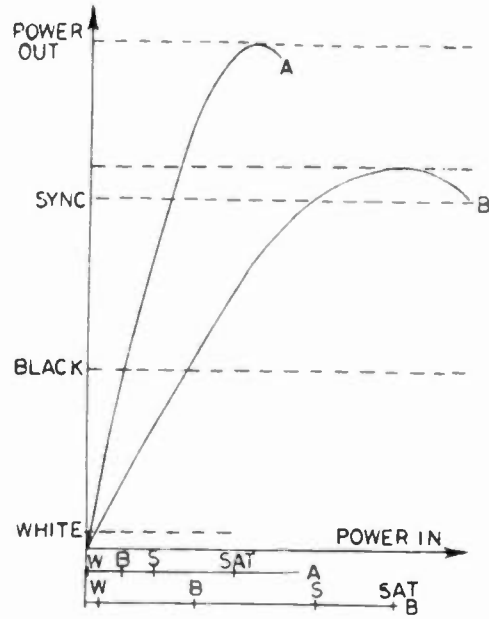
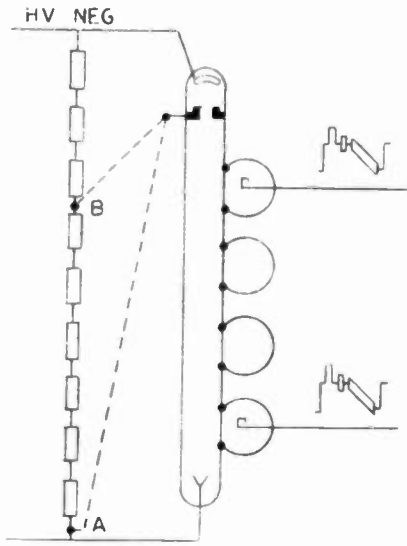


FIGURE 1. D.C. BIASED OPERATION

W = WHITE  
 B = BLACK  
 S = SYNC  
 SAT = SATURATION

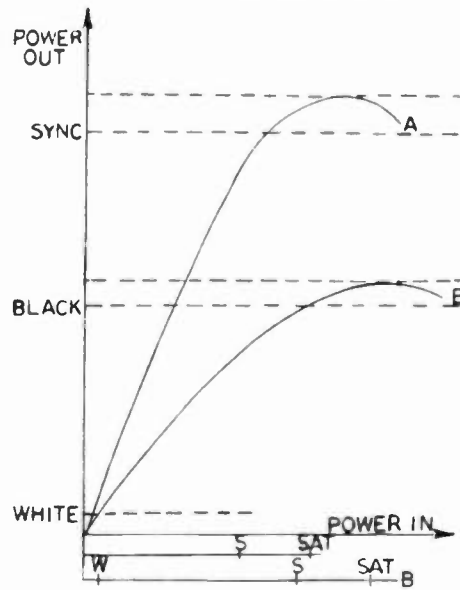
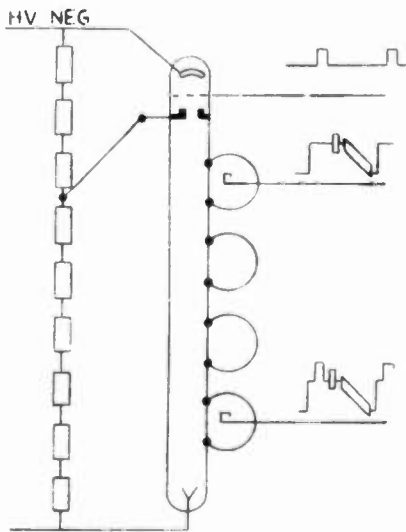


FIGURE 2. PULSE MODULATION

If we let  $P_s$  = Peak Sync R.F. output power  
 and  $P_{SDC}$  = Klystron D.C. beam input power

$$\text{We have } \eta_c = \frac{P_s \times 100}{P_{SDC}} \% \text{ ----- (1)}$$

The operating efficiency of D.C. biased klystrons had advanced from the 30% or so achieved in the 1960's to the present day values of 47% for four cavity and 52% for five cavity klystrons. The advance has been achieved principally as a result of operating the klystron closer to saturation during the sync pulse period.

Figure 1 shows the effects of biasing the modulating anode to achieve operation close to saturation and its effects upon drive power requirements and transfer characteristic non-linearity.

For maximum efficiency consistent with stable nonpulsed operation, D.C. biased klystrons are currently operated with sync to saturation power ratios of 0.95 (FIG 1 CURVE B). \*1

Let us consider now the operating conditions pertaining to optimum efficiency when the klystron is pulse modulated.

From the D.C. biased operating conditions it is reasonable to assume that stable operation during the picture interval can be achieved with black level set to 95% of a second lower saturated output power level.

The klystron operating conditions are shown in Figure 2. Curve A is for the sync bias periods and curve B is for the video periods.

If we assume that for given saturation ratios at sync and at black level, the same beam conversion efficiency results, we can derive the following expression for beam input required during the picture interval.

$$\text{D.C. input during picture} = \frac{\text{Black level R.F. Power}}{\eta_c} = P_{Pbc}$$

$$\text{From Eqd (1) we have } P_{SDC} = \frac{P_s}{\eta_c}$$

Now for relative modulation levels of sync = 100% and black = 75% prescribed for CCIR System M, we can see that,

$$P_{Pbc} = (0.75)^2 P_{SDC} \text{ ----- (2)}$$

We can now derive the following expression for the theoretical optimum pulsed efficiency for system M,

$$\eta_p = \frac{P_s \times T \times 100}{(P_{SDC} \times T_1) + (P_{SDC} \times 0.75^2 \times T_2)} \text{ ----- (3)}$$

Where  $\eta_p$  = overall pulsed efficiency

$$T = \text{Line interval} = T_1 + T_2 = 63.55 \text{ usecs} \quad *2$$

$T_1 = \text{Line sync pulse interval} = 4.61 \text{ usecs} \quad *2$

$T_2 = \text{Picture interval} = 58.95 \text{ usecs}$

$$\text{Whence } \eta_p = \frac{P_s 63.55 \times 100 \%}{P_{SDC} (4.61 + 33.16)}$$

$$\eta_p = 1.69 \eta_c \text{ ----- (4)}$$

It is important to note that the absolute value of the pulsed efficiency is directly proportional to, and therefore limited by, the efficiency obtained for nonpulsed D.C. biased operation.

In defining the conditions necessary for optimum pulsed efficiency black level power was assumed to be set at 95% of the saturated output during the picture interval. This assumption has no practical value unless the non-linearities introduced by the klystron can be pre-corrected within the IF correction circuits of the exciter.

Examination of the power transfer characteristics of Figure 2 reveals the extent of the additional correction problems. In curve "A," we have the power transfer characteristic effective during the sync pulse interval, this characteristic represents the normal high efficiency D.C. biased mode of operation.

To create the necessary compensating characteristic within the correction circuitry we have to introduce gain stages at discrete operating levels between zero and black level. In practice this is achieved by detecting modulation depths of the luminance waveform. The gain necessary at each modulation level sampled is calculated from the gain slope of the tangent to the transfer characteristic at the sampling point, thus at black level on curve "A" we have,

Under nonpulsed conditions with sync. at 95% of saturation and black level required at 75% of sync, where sync = 100% of output power, then black level power  $P_B$  is given by

$$P_B = 0.75^2 \times 0.95\% \text{ of saturation} = 0.53\% \text{ saturation}$$

Since we can assume the transfer characteristic to be sinusoidal \*3, the gain slope at black  $G_B$  will be given by

$$G_B = 20 \text{ Log } f'(\sin x)$$

where  $\sin X = 0.53$ ,  $X = 32 \text{ degrees}$

Thus  $G_B = 20 \text{ log cos } 32 \text{ degrees}$

$$G_B = -1.43 \text{ db}$$

This is the gain slope at black level under normal high efficiency nonpulsed operation.

Under the pulsed conditions derived earlier and with reference to curve

"B" in figure 2 we see that during the picture interval the gain slope at black level has increased since black level is now at 95% saturation. We compute the gain slope  $G_{B2}$  to be:

$$G_{B2} = 20 \log f'(\sin X) \text{ where } \sin X = 0.95 \text{ \& } X = 71.8 \text{ degrees}$$

$$G_{B2} = -10.1 \text{ db}$$

The order of magnitude of the correction problem can now be clearly seen.

The effects upon incidental carrier phase modulation (ICPM), differential gain, and differential phase can be similarly determined. Simply put however, we have introduced at black level, the orders of magnitude of nonlinearities previously only present at sync tip.

Having determined the order of magnitude of the correction capability three further design constraints have to be considered if the correction circuit is to be stable, logical in operation and easy to use, the constraints are,

1. Each corrector function should be free from incidental effects which may enhance or deduct from the non linearities in the klystron.
2. The order of application of the correcting functions should be such that it is not necessary for the process to be repeated to achieve the desired result.
3. Some form of gain control should be introduced such that correction may be applied without introducing modulation level disturbance.

A series of coincident hardware developments on both sides of the Atlantic has resulted in the practical implementation of this theoretical analysis. A fully integrated production system capable of operating close to the maximum theoretical efficiency improvement factor for pulsed visual klystrons has been demonstrated. The elements of this system and the details of the demonstration test will now be discussed.

### 3. HARDWARE REQUIREMENT AND DEVELOPMENT

#### A. THE B7500 MODULATOR

Initial work began in early 1982 as the result of experiments conducted by Marconi and the BBC at the Crystal Palace transmitter in London. These tests used the Marconi B7400 modulator and were intended to develop the data which would permit the design of a new modulator having full linearity pre-correction capability. These early tests resulted in the design specification for the B7500 modulator.

After a period of pre-correction circuit development where unwanted side effects of pre-correction were designed out of the hardware, a test was mounted at Crystal Palace. This test used a B7400 with the new B7500 pre-corrector circuits included.

The following results were obtained:

1. A repeatable klystron alignment routine was established and proven.
2. Correction of pulsed operation at 69% efficiency resulted in specification complaint performance on several occasions.
3. Timing delay compensation circuits were incorporated to allow the V.S.B. filter and sound notch group delay equaliser to be automatically compensated for during initial transmitter alignment.
4. Synchronising pulse timings, shaping and ICPM compensation refinements were achieved with clean sync pulses at the transmitter output.
5. Mains voltage variation experiments showed a high degree of system tolerance. Plus/minus 5% variation of supply voltage being tolerated without loss of specification.
6. The aural performance was shown to be immune to voltage regulation induced upon its beam supply voltage when the vision klystron was pulse modulated.
7. Program material transmitted by the pulsed transmitter operating at 68% efficiency was critically examined in Chelmsford some 35 miles distant and no discernable defects noted.

In late 1983, a pre-production B7500 modulator was available for test with the I.B.A. in their Hannington transmitter.

The test program agreed with I.B.A. called for the use of both Valvo and EEV, annular beam controlled external cavity klystrons, to be operated at the maximum efficiency attainable, and automatically monitored at hourly intervals to record television performance, the stability of R.F. output and the stability of D.C. feeds to the klystron under test.

After some initial system proving tests in Chelmsford the experimental equipment was installed and commissioned into the Hannington transmitter system during the first week of April 1984. Efficiency measured at the transmitter output was 65% (an improvement factor of 1.6 times), and performance was within the operational limits operated by the I.B.A.

After two months of operating, the EEV klystron was replaced by a Valvo klystron and an efficiency of 69% obtained. The transmitter operated at this efficiency until the conclusion of the tests.

The nature of the test program was changed during the course of the experiment so that at the conclusion of testing in August 1984 the following aspects of performance had been investigated,

1. Cold start performance repeatability.
2. Longer term performance stability.
3. Sideband re-insertion level control.
4. Pulsed klystron R.F. drive input requirements.
5. Automatic gain control effects upon performance stability.

The experience gained from the Hannington experiments allowed further definition of the B7500 circuits to be effected before the design was committed to production. The B7500 was now ready to be incorporated in a state-of-the-art transmitter system.

## B. THE COMARK "S" SERIES TRANSMITTER (FIG. 3)

This transmitter was introduced at the NAB Convention in Las Vegas, 1983 and has found wide application in the industry. It was designed primarily around the new generation of low-cost, wideband, external cavity klystrons from both Valvo and EEV in Europe, with particular attention paid to implementing high efficiency pulsing techniques. The amplifier cabinet dimensions were chosen such that integral cavity klystrons could also be incorporated into the transmitter design if so desired.

The relative merits of external and internal cavity klystrons are well known and will not be discussed in detail here. Perhaps the most significant advantage of an external cavity klystron, besides their lower cost, is where beam pulsing is concerned. The fully variable coupling and loading available as standard on all cavities allows fine tuning of the loading of each cavity to accommodate beam impedance changes during pulsing. This permits stable operation to be obtained during both black and sync level periods. Without variable cavity loading, stable operation could be difficult to obtain or be maintained.

The transmitter system was designed to interface with the Comark CTP-20 high energy modulating anode pulser since the mod-anode, up until recently, was the most widely used electrode for beam pulsing. The "S" Series transmitter was carefully detailed to provide maximum electromagnetic isolation between the high power and low level stages in the equipment. This effort minimized the effects of large pulsed energies on the overall system.

In short, the Comark "S" Series equipment was ideal for the incorporation of the new B7500 Modulator and the effort to achieve maximum pulsed efficiency improvement.

## C. THE MOD ANODE PULSER (FIG. 4)

The CTP-20 Mod Anode Pulser was designed in 1982 to provide up to 10kV pulse amplitudes with a maximum dielectric strength of 12kV. This high energy level, higher than any available in the industry, was chosen based on the ultimate objective of achieving the maximum efficiency improvement.

The pulser is controlled by fiber optic links from a low level control unit in the transmitter's exciter rack. All pulse timing, shaping and corrections are done at low level. The design philosophy of the CTP-20 was ideally matched to the B7500 modulator interface circuitry.

The high voltage pulse amplitude capability designed into the CTP-20 is achieved by using linear solid state drive circuits and a pair of high voltage planar triodes as switch tubes. Actual long term operational field data to date indicates a tube life in excess of 12,000 hours.

The pulse voltages actually required to achieve the desired results on a 60kW klystron are: video level - 9.7kV, and sync level - 3.3kV. Thus the CTP-20's capability is an absolute necessity for maximum klystron efficiency improvement when the Mod Anode is used for beam pulsing.

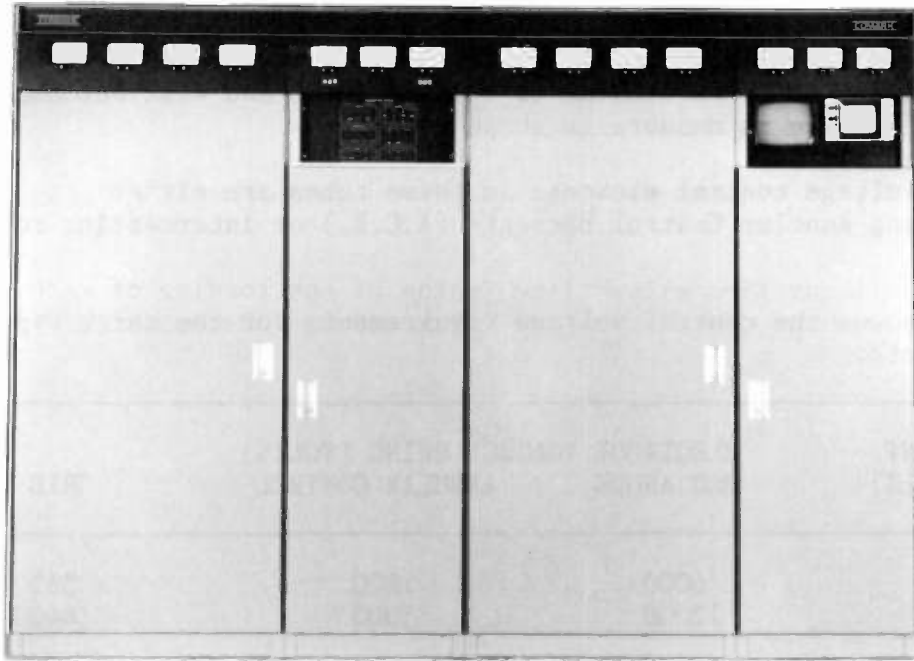


FIGURE 3. COMARK "S" SERIES TRANSMITTER

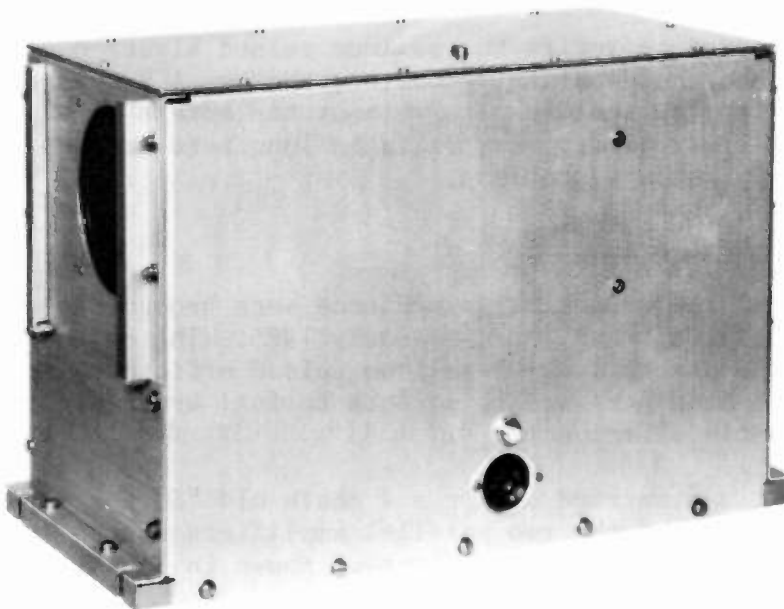


FIGURE 4. CTP-20 HIGH VOLTAGE PULSER ASSEMBLY

#### D. RECENT DEVELOPMENTS IN HARDWARE

The B7500 in conjunction with the "S" Series transmitter and mod anode pulser, while providing the desired results, do not take full advantage of current klystron technology.

Both EEV and Amperex/Valvo now provide low voltage control elements which permit solid state circuits to modulate the beam current. The effect of these elements on the klystron is similar to the Mod Anode and will not change the linearity performance as measure in these tests.

The low voltage control elements in these tubes are either non-intercepting Annular Control Elements (A.C.E.) or intercepting robust grids.

Table 1 shows the control voltage requirements for the three types of control elements.

BEAM CURRENT REDUCTION (%)	ELECTRODE VOLTAGE SWING (VOLTS)		GRID
	MOD ANODE	ANNULAR CONTROL	
40	6000	1600	315
70	12000	5000	440

NOTE: Voltage Magnitudes shown

TABLE 1. BEAM CURRENT REDUCTION FACTORS FOR 60kW KLYSTRON \*4

The tests performed to verify the maximum pulsed klystron efficiency were carried out with a mod anode pulser. However, the new ACE pulser hardware now available will permit identical results without the stress of high voltage pulsing. This will truly permit very reliable long term service with minimum danger of high energy failure problems.

#### 4. TEST CONSIDERATIONS AND SET-UP

The hardware and the historical experience were brought together at WTTE-TV, Channel 28 in Columbus, Ohio in early 1985. The objective of the test was to prove the assumptions of maximum pulsed efficiency improvement and the ability of the system hardware to perform to full broadcast specifications at the highest possible efficiency.

The system test was carried out on a 7 month old "S" Series CTT-U-110S Comark transmitter. One of the two parallel amplifiers was patched into the station test load and operated with the set-up shown in Fig 5.

All signal correction was carried out in the B7500 drive at I.F. with the exception of the pulsed incidental phase correction necessary in the sync region. This was carried out in the standard CTP-20 Phase Modulator also at I.F.



Using the theory developed earlier in this paper in conjunction with the klystron manufacturers data sheets, initial bias points for the two modulating anode levels were selected as follows:

	<u>PEAK SYNC</u>	<u>BLACK LEVEL</u>
POWER kW	60	33.75
SATURATED kW	63	35.5
OPERATING EFFICIENCY %	46	46
BEAM POWER kW	137	73.4
BEAM VOLTAGE kW	23.5	23.5
BEAM CURRENT A	5.6	3.12
CATHODE/M-A kV	20.2	13.8
M-A TO +kV	3.3	9.7

One of the consequences of the mod anode pulser voltage source design is a change in the resistor bias tap point voltage due to the charging/discharging current of the pulser chassis and klystron mod anode capacitance. At these pulse levels the current is approximately 6 MA. Referring to the simplified block diagram Fig. 5, this has the effect of pulling the two tap points closer together during pulsing. Simply changing the tap points to accommodate this shift is generally all that is required. However, in this high voltage case, the unregulated unpulsed video tap point could exceed the 12kV rating of the pulser. Therefore, a variable bias supply was added to the transmitter to provide a more stable video (most negative) tap point.

After selecting and proving the bias points for pulsing, the next consideration was the klystron tuning, in particular the bandpass and output coupling.

As is well known during pulsing, the electrical length of the electron beam and the beam loading of the RF cavities change causing the characteristic tilt in frequency response from vision carrier down to the upper band edge. Starting from a flat response ( $\pm 0.5$ dB) when tuned as a conventional, non-pulsed, DC bias, amplifier at 60kW peak sync the 44 percent decrease in beam current caused a downward tilt of approximately 7dB over the visual passband.

Obviously the klystron had to be retuned for flatness during pulsing. This was done primarily with the input cavity, although some fine tuning of the remaining cavities including loading loops was required.

One of the requirements of the theory presented earlier in this paper was that the klystron efficiency remained the same at the lower beam current as at full beam current. For this type of klystron that requirement is generally met, within a couple of percent. However, since the RF beam impedance increases as the beam current decreases, the output loading must also be changed to achieve optimum power transfer and therefore, optimum efficiency.

Referring to Fig. 6, one can see, in external cavity klystrons, that the output coupling loop is usually set in the over-coupled position for maximum stability (Positions A', B'). This is reached by rotating the coupling loop to the maximum output power then "backing off" towards vertical (over coupled) by approximately 10 percent of the loop angular rotation. This effectively

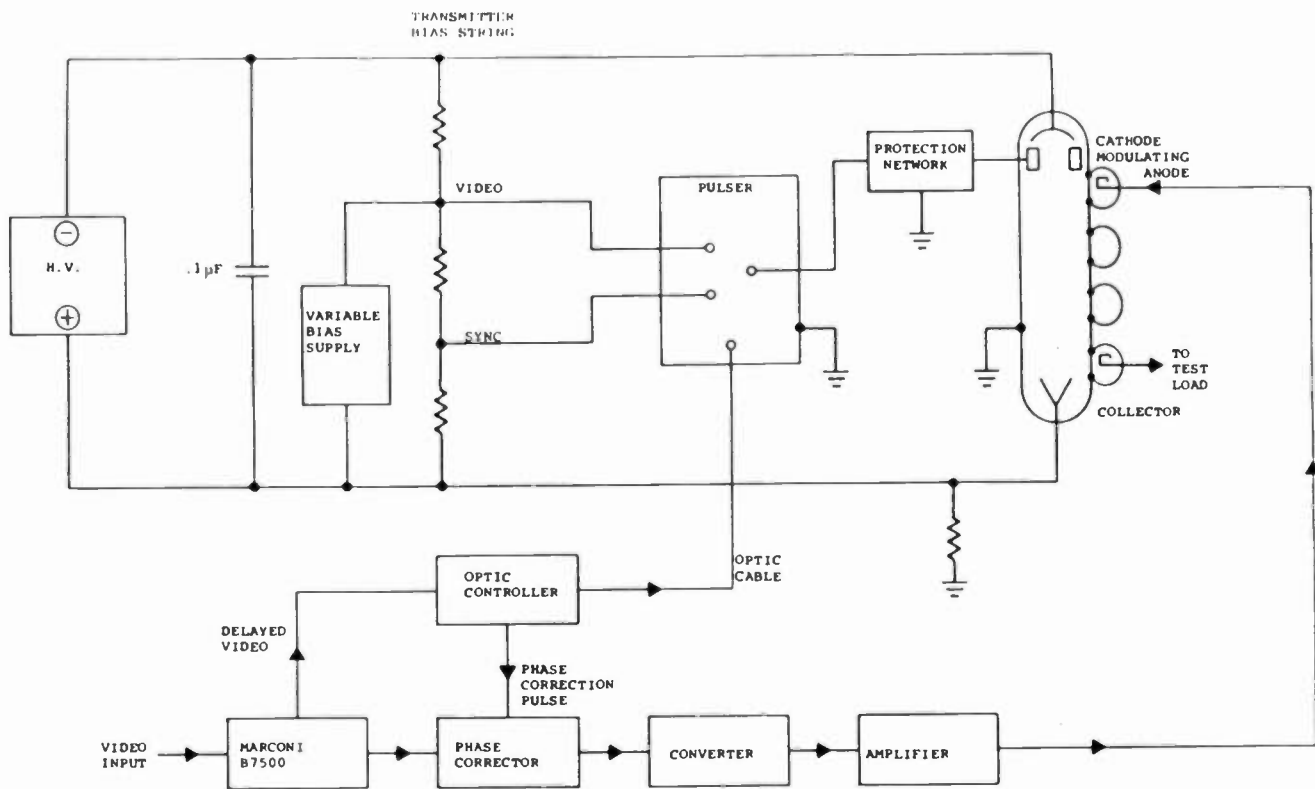


FIGURE 5. SIMPLIFIED SYSTEM INTER-CONNECT

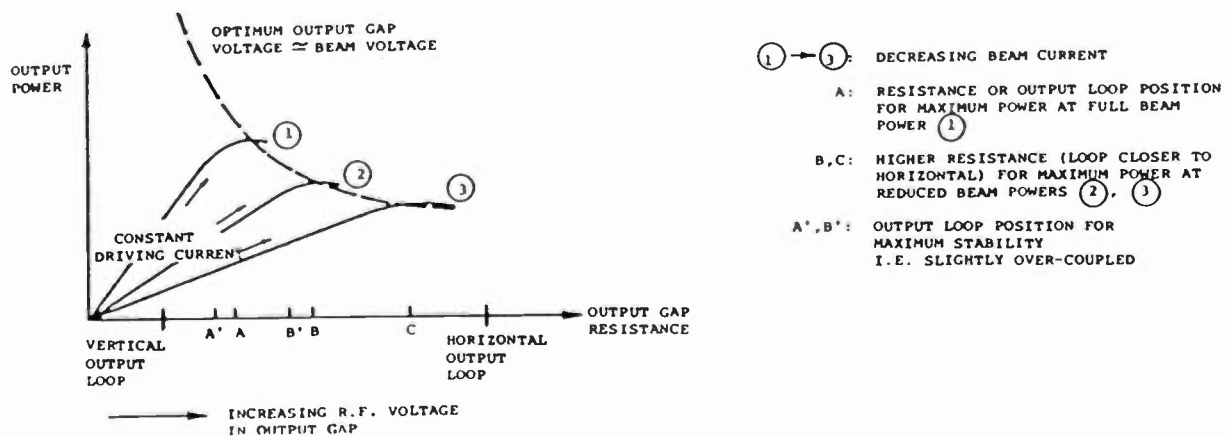


FIGURE 6. VARIATION OF OUTPUT POWER WITH OUTPUT GAP RESISTANCE

reduces the RF voltage in the output cavity by about 5 percent.

For lower beam currents Fig. 6 (curve 2) it can be seen that the equivalent position of the loop is closer towards the horizontal. If the output loop was set in this position for optimum efficiency at the lower current, there was the possibility of being under-coupled at the higher current for peak sync output.

It was decided to start with the output coupling set in the over-coupled position for peak sync output at the high beam current. The klystron was then pulsed and tuned flat without adjusting the output coupling loop.

A study of the klystron transfer characteristics shows that the maximum theoretical efficiency could be attained with essentially no sync pulse on the drive signal i.e. the drive for black level and peak sync are the same. The klystron generates the sync pulse due to the gain change caused by the beam current pulse. The klystron/pulser combination becomes a sync pulse modulator.

Using the sync strip facility present in the B7500 drive and setting the drive to the level required for peak sync output, the output sync amplitude was in excess of 40 IRE units.

Driving the klystron harder caused instability at sync-tip and uncorrectable non-linearities in the video signal, indicating that the klystron was in fact close to drive saturation at both levels even though the black level power was low.

At this stage it was decided to set the klystron tuning and coupling for operation at 95 percent of saturation at the black level beam power, as determined earlier, assuming the 46 percent beam efficiency measured at sync did not change at the new black level saturation point. The pulsed sync beam current was then adjusted to give the necessary RF output sync pulse amplitude.

This method had been used by Marconi during their IBA and BBC tests and it proved to be successful here. The black and sync levels were readily achieved with fully correctable waveform performance.

Pulsed ICPM correction was then applied in the phase modulator and the set of photographs (P7-12) taken. The drive photographs (P1-5) are shown opposite the relevant klystron output to indicate the amount of pre-correction required at this level of efficiency. P6 is a photograph of the klystron output swept response with all pre-correction removed, showing the effect of klystron non-linearity on the lower side band regeneration.

## 5. TEST RESULTS

Table 1 shows the beam operating conditions, pulsed and nonpulsed, as well as some significant waveform parameters. Photographs P7-12 show that the system is fully compliant with the FCC rules at this level of efficiency. Final measurements at the klystron output revealed the beam efficiency to be 77.6 percent. The nonpulsed efficiency of this tube had been measured prior to the start of the test as 46 percent. Thus, the tests established an

improvement factor of 1.687 which verifies the theoretical analysis. When diplexer and RF system losses are taken into account it is estimated that the visual transmitter efficiency will be about 74 percent, giving a 40 percent saving in beam power.

		<u>D.C. BIASED</u>	<u>PULSED</u>
POWER O/P	kW	60	60
BEAM VOLTAGE	kV	23.5	23.8
BEAM CURRENT	A	5.55	3.25
EFFICIENCY	%	46	77.6
L.F. LINEARITY	%	-	2
DIFF. GAIN	%	-	3
DIFF. PHASE	DEG.	-	+1
ICPM	DEG.	-	2
L.S.B.	dB	-	-20
U.S.B.	dB	-	+0.5

PULSED EFFICIENCY  
IMPROVEMENT FACTOR 1.687

TABLE 1 FINAL RESULTS

## 6. DISCUSSION

Perhaps the most significant factor in achieving the above results, apart from the extensive linearity correction available in the B7500, was the necessity for optimizing the output cavity coupling to attain high efficiency at the low beam current.

Once the set-up described earlier was achieved the drive power and output coupling were varied to observe exactly where on the transfer curves the klystron was operating. It appeared that the sync pulse was at 97-98 percent of saturation and still slightly overcoupled, whereas the black level was at 95 percent of both RF current and RF voltage saturation.

## 7. CONCLUSIONS

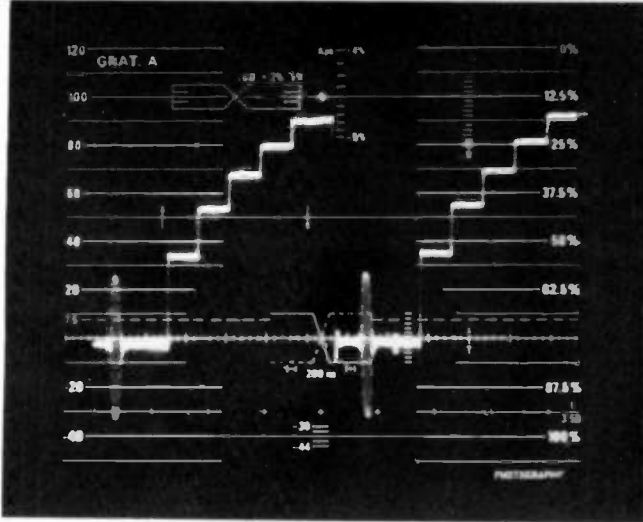
This paper has developed an analysis of klystron beam current pulsing which shows that the optimum efficiency improvement ratio over nonpulsed operation is 1.69 for System M.

An integrated hardware system was also presented that was used to prove the theory along with producing field operating data. The field tests at Columbus, Ohio, Channel 28, WTTE-TV clearly demonstrated that pulsing to optimum efficiency is possible and that stable, effective, pre-correction circuitry can be achieved.

The test data also proved that operating near saturation at black level does not destroy the chroma burst signal. Correction of the burst is easily obtained through the differential gain pre-correction capability in the modulator. This is true as a consequence of the single sideband nature of the chroma information.

INPUT/OUTPUT WAVEFORMS AT 77.4% BEAM EFFICIENCY

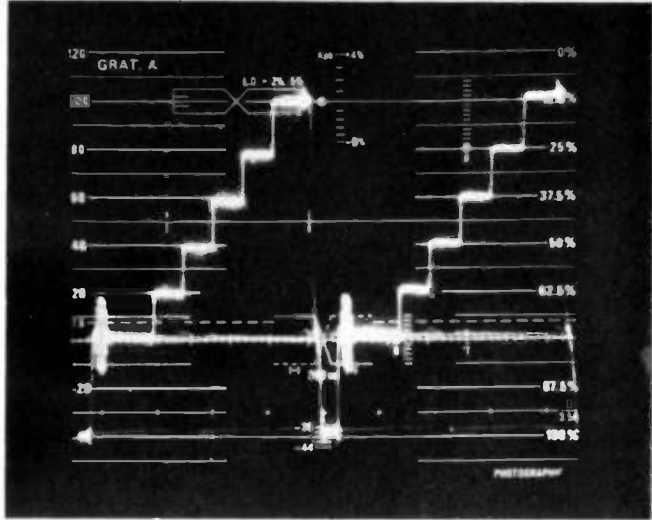
DEMODULATED RF DRIVE SIGNAL  
TO KLYSTRON



P1

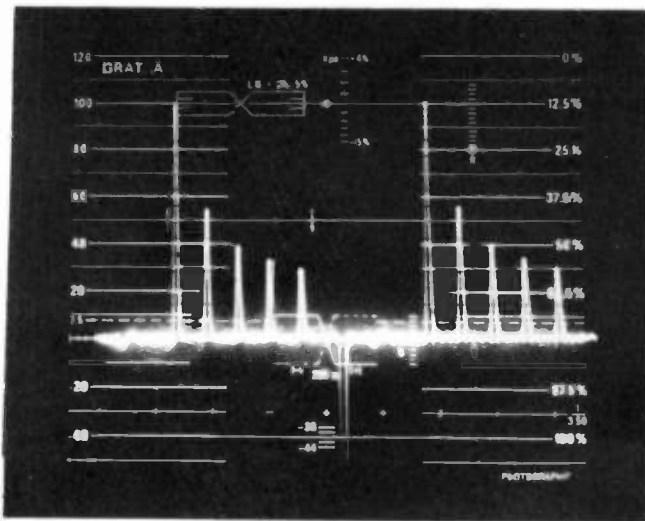
\*Note Lack of Sync

DEMODULATED FINAL KLYSTRON  
RF OUTPUT SIGNAL



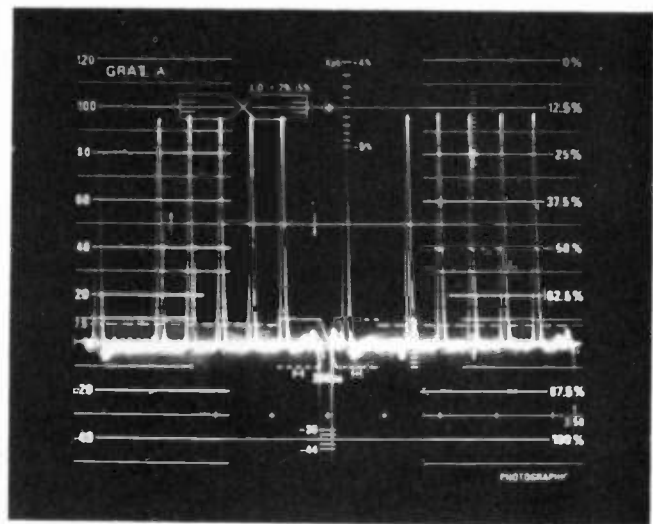
P7

DEMODULATED RF DRIVE SIGNAL  
TO KLYSTRON



P2

DEMODULATED FINAL KLYSTRON  
RF OUTPUT SIGNAL

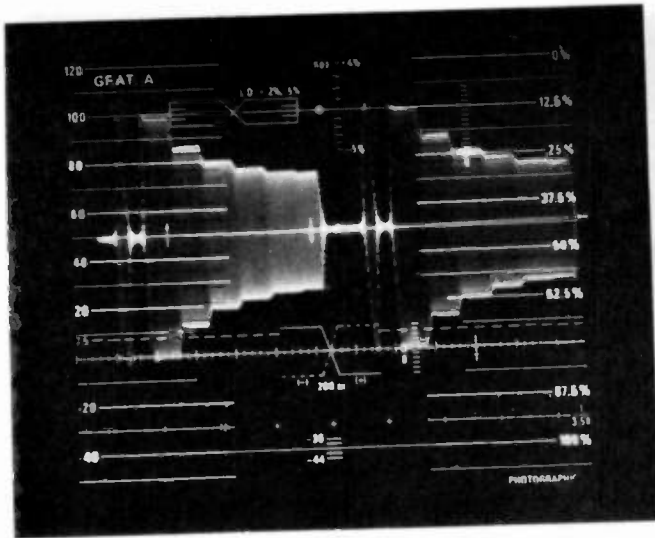


P8

LOW FREQUENCY LINEARITY

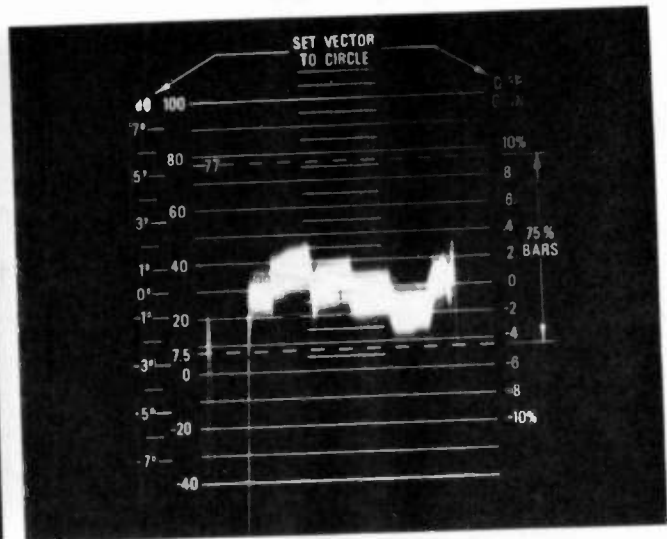
INPUT/OUTPUT WAVEFORMS AT 77.4% BEAM EFFICIENCY

DEMOMULATED RF DRIVE SIGNAL  
TO KLYSTRON



P3

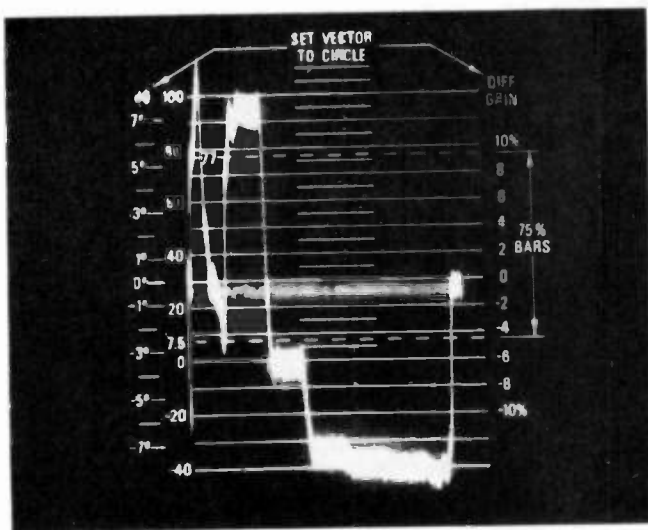
DEMOMULATED FINAL KLYSTRON  
RF OUTPUT SIGNAL



P9

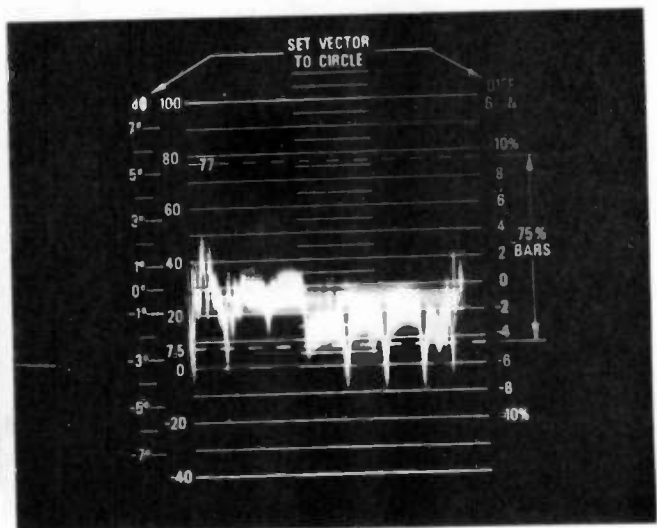
DIFFERENTIAL GAIN

DEMOMULATED RF DRIVE SIGNAL  
TO KLYSTRON



P4

DEMOMULATED FINAL KLYSTRON  
RF OUTPUT SIGNAL



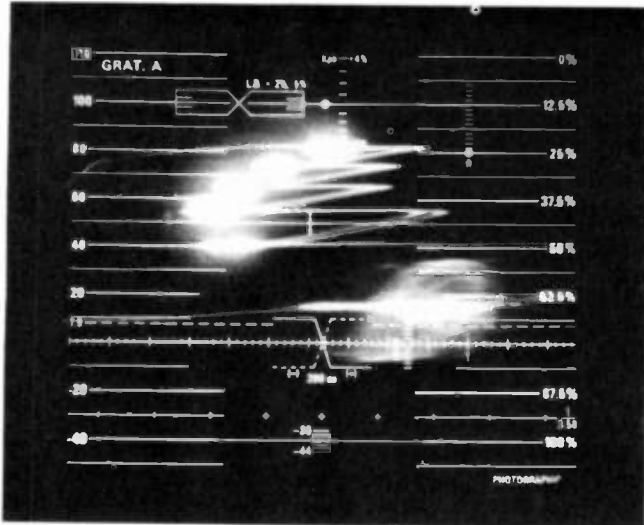
P10

DIFFERENTIAL PHASE

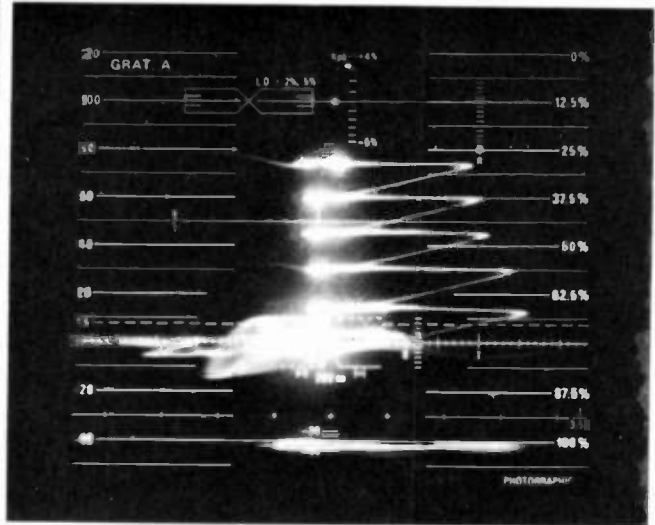
INPUT/OUTPUT WAVEFORMS AT 77.4% BEAM EFFICIENCY

DEMODULATED RF DRIVE SIGNAL  
TO KLYSTRON

DEMODULATED FINAL KLYSTRON  
RF OUTPUT SIGNAL



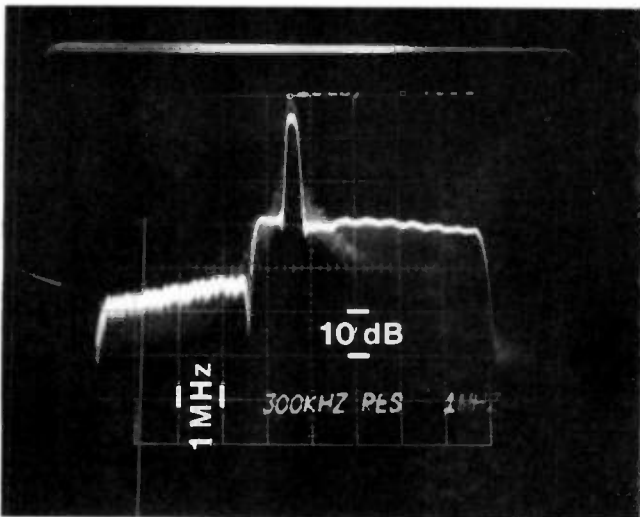
P5



P11

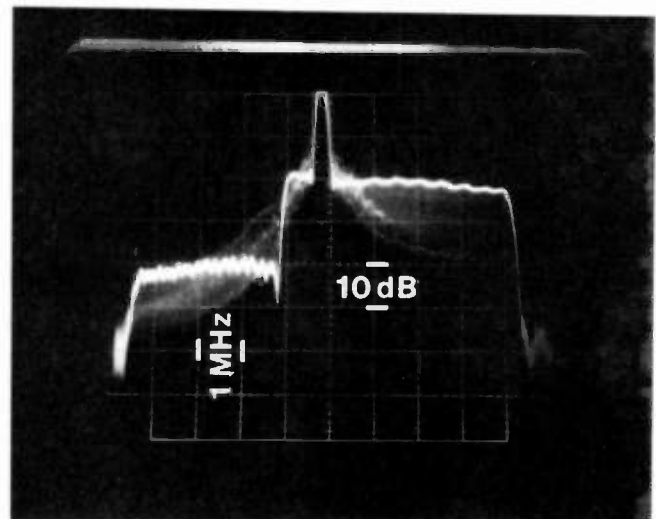
INCIDENTAL CARRIER PHASE MODULATION

\*Note: Input Sync Phase is Off Scale (P5).



P6

KLYSTRON OUTPUT WHEN DRIVEN WITHOUT  
IF PRECORRECTION, NOTE L.S.B.



P12

FULLY CORRECTED KLYSTRON  
OUTPUT

Lower sideband regeneration was easily controlled as a result of the modulator's I.F. correction circuits and the exciter's wideband amplifiers. The klystron contribution to lower sideband energy is canceled by the modulator component. To achieve stable and consistent lower sideband performance, the klystron is tuned to provide a flat phase and amplitude response into the lower sideband region. This was easily achieved using the loading and coupling adjustments available with the external cavity tubes.

RF drive at 60kW pulsed was approximately 15 Watts at black level. Sync was generated by the pulsing technique itself.

The tests at WTTE-TV have proven a system of hardware that has evolved through the efforts of both Comark Communications and Marconi Communication Systems Limited. The production systems now available are the result of several years of methodical testing and development on both sides of the Atlantic. The authors believe that as a result of this detailed developmental approach, trouble-free operation of klystrons at efficiencies consistently greater than 73 percent is now possible. While 77.6 percent was achieved at Channel 28, lower frequency channels or increased operating margins could trim 2 percent to 3 percent from this figure.

The availability of production hardware capable of achieving optimum klystron pulsed efficiency raises the klystron to average operating efficiency levels that are comparable to tetrodes.

The authors wish to acknowledge the help and cooperation of the engineering and management staffs of WTTE-TV, English Electric Valve and Amperex/Valvo.

#### REFERENCES

- \*1 THE CHANGING CONCEPTS OF TELEVISION KLYSTRON OPERATION -  
HOWARD, L.F. I.U.C. 1984
- \*2 CCIR RECOMMENDATION 624
- \*3 TELEVISION MEASUREMENTS AND THE KLYSTRON AMPLIFIER -  
O'LOUGHLIN, C.M. AND EDGCOMBE, C.J. EEV, CO. LTD.
- \*4 A REVIEW OF BEAM CURRENT CONTROL TECHNIQUES IN HIGH EFFICIENCY  
KLYSTRONS -  
HEPPINSTALL, H. I.E.E. DIGEST NO. 1984/22
- \*5 THE TELEVISION PERFORMANCE OF THE KLYSTRON AMPLIFIER -  
EDGCOMBE, C.J. AND O'LOUGHLIN, C.M. EEV, CO. LTD.



---

## THE KLYSTRODE™, A NEW HIGH-EFFICIENCY

### UHF TV POWER AMPLIFIER

George M. Badger

Varian EIMAC

San Carlos, California

#### INTRODUCTION

VHF television transmitters are more energy efficient than UHF television transmitters. The physical size and capital cost of VHF transmitters are less than UHF transmitters of the same power. This paper explores the reason. It traces the history of television power amplifier tube development and discusses current efforts to increase UHF TV transmitter efficiency.

A recently developed medium power hybrid tube, the Klystrode is described. This tube is expected to bring UHF transmitter efficiency up to a level approaching the operating economy of VHF transmitters.

Because most of the energy consumed by a television transmitter is used by the final power amplifier tube, this is clearly the area where creative engineering will pay the greatest dividends.

#### EARLY HISTORY

VHF transmitters were developed and put into operation long before the first UHF transmitters. When the first UHF transmitters were designed

special UHF power grid tubes had to be developed, because of the unique demands of UHF.

Despite excellent engineering, performance and reliability of these early UHF transmitters were far from satisfactory. The wavelength at UHF is very short so UHF tubes had to be smaller for a given power level than their VHF counterparts. High power density in these small tubes stressed the elements to their limit which severely compromised reliability and life. A new approach was needed to make high power UHF practical.

#### THE KLYSTRON

The principal of velocity modulation as conceived by one of the founders of Varian, Russell Varian, and his colleagues, is the basis of the success of klystrons. This marvelous concept causes a long continuous electron beam to be converted to a density-modulated beam at UHF. UHF energy is extracted from the modulated beam in a large optimum-shaped output cavity. The spent electron beam is dissipated in a separate electrode known as a collector which can be made very large and independent of frequency. Power density is

low throughout the tube so life and reliability are exceptional.

Velocity modulation applied to a long continuous electron beam gives the klystron another important feature: high gain. These advantages were so significant that the klystron soon dominated UHF broadcasting; of the more than 500 UHF TV stations in the United States, at least 90% use klystrons, a revolutionary reversal from the beginnings of UHF TV.

At the time the klystron was introduced into UHF the requirement for a continuous beam of electrons was not a disadvantage. Efficiency in those days was secondary to the achievement of high power with good reliability. High gain was important, because UHF low level amplifiers were expensive.

Today the broadcaster is faced with a different set of problems. Certainly, the cost of electricity is a major factor in the financial success of a UHF TV broadcast station.

### THE KLYSTRODE

As its name implies the Klystrode is a hybrid between a klystron and a tetrode. The high reliability and power handling capability of the klystron derives, in part, from the fact that the electron beam dissipation takes place in the collector electrode, quite separate from the rf

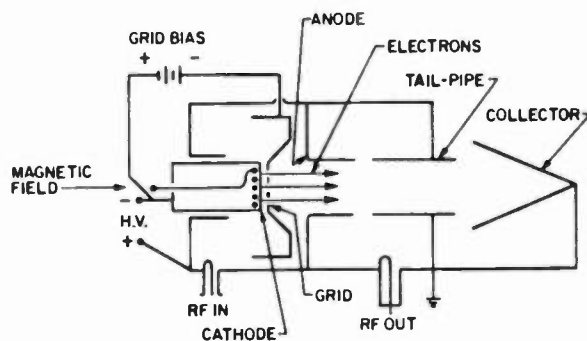


FIGURE 1 - KLYSTRODE SCHEMATIC

circuitry. The electron dissipation in a tetrode is at the anode and the screen grid, both of which are an inherent part of the rf circuit and must, therefore, be small at UHF.

The tetrode, on the other hand, has the advantage that the UHF modulation is produced directly at the

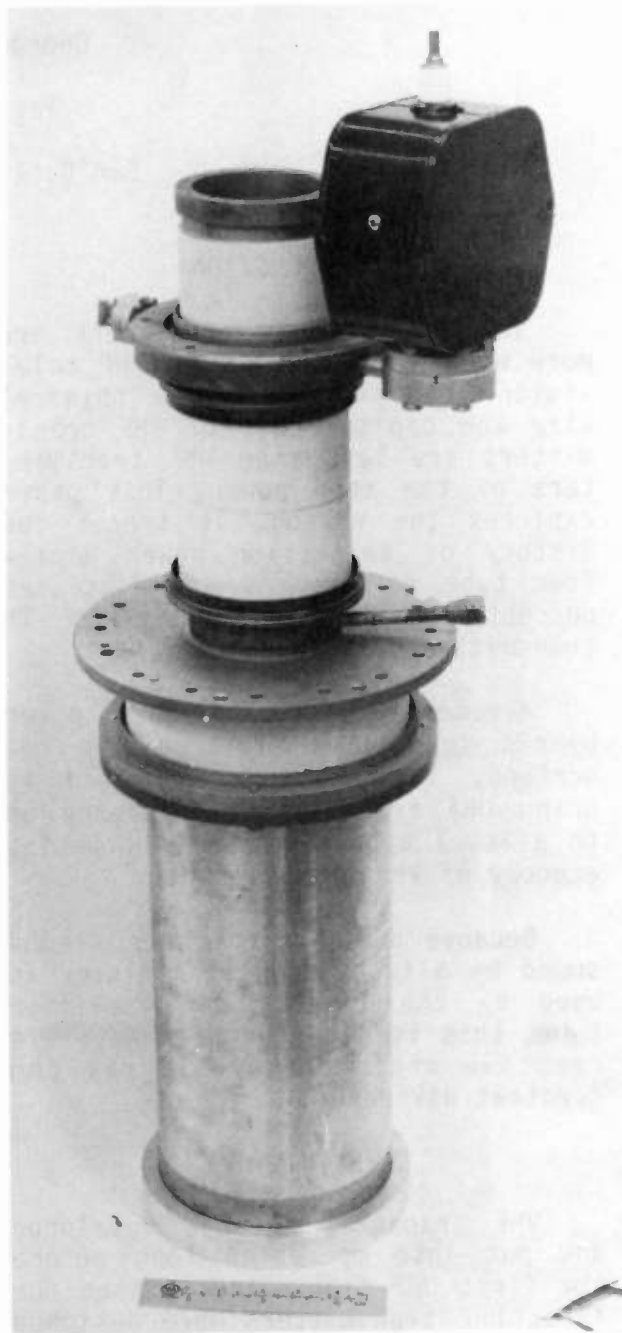


FIGURE 2 - KLYSTRODE

cathode by a grid so that a long drift space is not required to produce density modulation.

When we combine the components of the klystron necessary for reliable power-handling capability (specifically the output cavity and the collector) with the grid-cathode components of a tetrode (which directly create a density-modulated electron stream) we have a Klystrode.

#### KLYSTRODE DESCRIPTION

The Klystrode is shown schematically in Figure 1. The electron beam is formed at the cathode, density modulated with the input rf signal by a grid, and then accelerated through the anode aperture. In its bunched form, the beam drifts through a

field-free region and then interacts with the rf field in the output cavity. Power is extracted from the beam in the same way as in a klystron. The input circuit resembles a typical UHF power grid tube input circuit. The output circuit and collector resemble a klystron.



FIGURE 3 - KLYSTRODE WITH CIRCUITRY

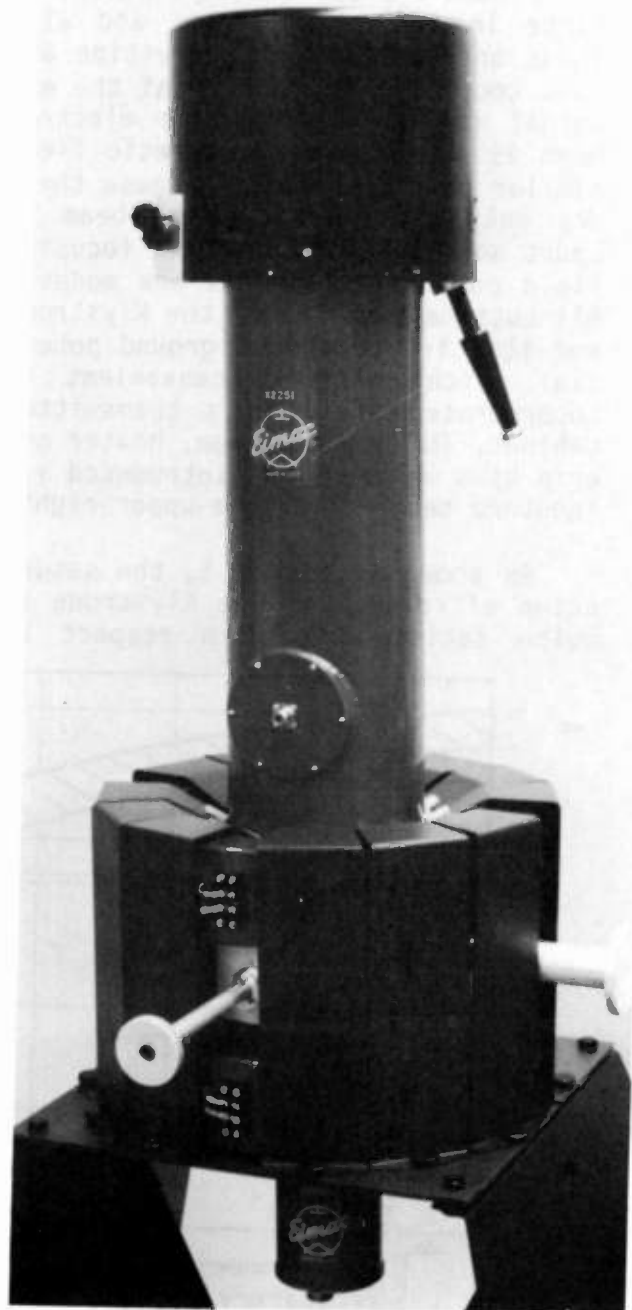


FIGURE 4 - KLYSTRODE IN MAGNET FRAME

The photograph of Figure 2 shows a 30 kW Klystrode without cavities and magnet. Notice the small size. It can be lifted easily by one person.

To indicate physical size, Figure 3 shows a Klystrode with rf circuitry in place.

Figure 4 shows the Klystrode complete in its magnet frame and with input and output tuning cavities and load coupler. The tube is of the external cavity variety. The electron beam is confined by a magnetic field similar to a klystron. Because there are only two cavities, the beam is short and therefore magnetic focusing field power requirements are modest. All outside surfaces of the Klystrode and its circuit are at ground potential which makes it convenient to incorporate safely in a transmitter cabinet. The high voltage, heater and grid bias voltages are introduced via feedthru terminal at the upper right.

As shown in Figure 5, the saturation efficiency of the Klystrode is quite satisfactory with respect to

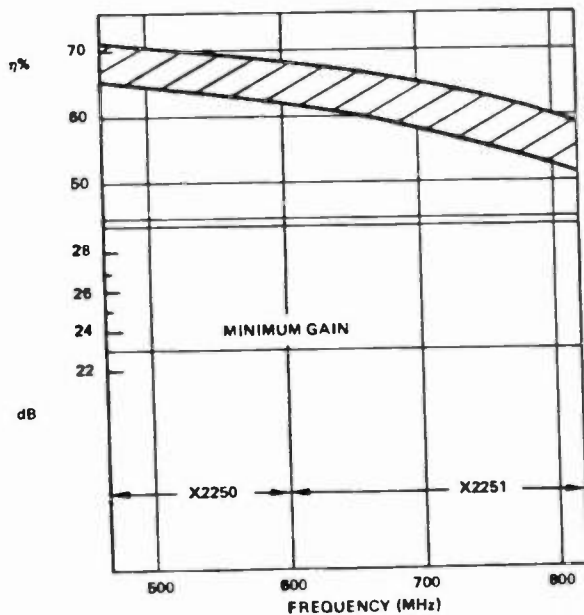


FIGURE 5 - EFFICIENCY & POWER GAIN  
FM Sound Conditions  
3-30 kW Power Output

klystrons and power grid tubes at VHF. The efficiency is substantially higher than power grid tubes at UHF. Notice that at the low end of the UHF spectrum Klystrode efficiency exceeds 65% and exceeds 50% at the high end of the band. This data was taken under aural conditions. Power gain is of the order of 23 dB under both aural and visual conditions.

FIGURE 6 - KLYSTRODE SCHEMATIC  
(A) SOUND (B) VISION

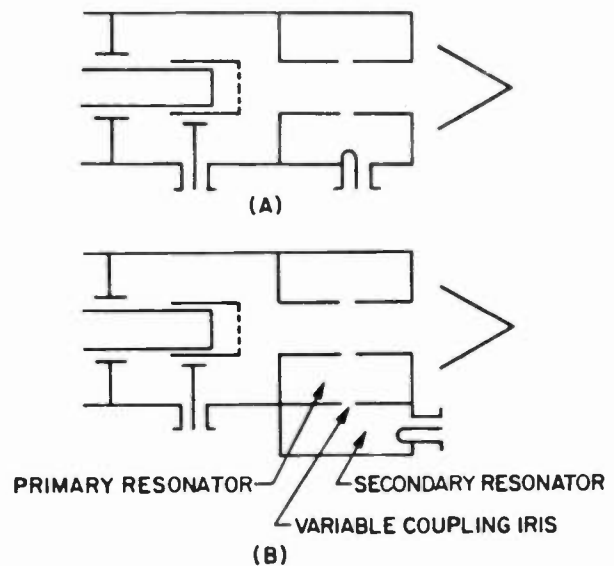


Figure 6 shows the present configuration of the input and output circuits for both aural and visual service. For aural service, the bandwidth requirements are modest and a single output tuned circuit is sufficient.

#### KLYSTRODE VISUAL PERFORMANCE

While the Klystrode is a good aural power amplifier and may be operated from the same beam supply as the visual Klystrode, in visual service the Klystrode makes its greatest contribution to operating cost reduction.

To obtain visual bandwidth, a

secondary cavity is coupled to the primary cavity, producing the bandwidth response shown in Figure 7. In this figure the swept rf power output and beam current are shown as a function of frequency. The bandwidth exceeds TV requirements.

FIGURE 7  
SWEPT BEAM CURRENT & POWER OUTPUT  
VERSUS FREQUENCY

X2251 KLYSTRODE

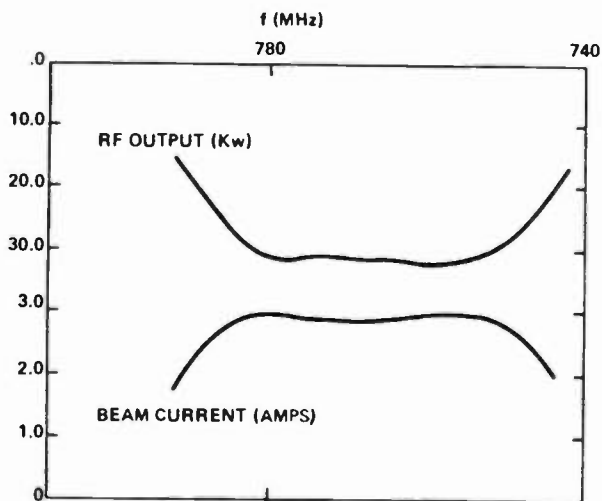


Figure 7 serves to demonstrate a unique characteristic of the Klystrode: the beam current is a function of the input circuit bandwidth as the frequency is swept from below to above the desired pass band. The beam current is a precise indicator of the rf drive. The input circuit is adjusted to produce the beam current waveform shown in Figure 7. The output circuits are then adjusted to produce the rf output wave form shown.

Another important characteristic of the Klystrode is demonstrated by this curve. As the output circuit is tuned, there is no effect on the beam current wave form. The reason is that there is superb isolation between the input and output circuits because they are separated by a drift tube

which is long compared to its diameter. This simplifies adjustment and assures stable, feedback-free operation. This kind of isolation cannot be achieved with tetrodes, even at VHF. Further, the cavities are not staggered as they must be in a klystron.

Figure 8 shows Klystrode measured performance under visual conditions. Notice that at 32 kW, the efficiency at peak-of-sync is 48% with full 8 MHz  $\pm$  0.25 dB bandwidth. The grid bias is modulated during the sync period to increase gain so that only 140 watts of drive power are required at 32 kW peak sync.

#### CLASS A, CLASS B

In the words of an old-time radio engineer, the Klystrode, like a tetrode, can be operated in Class B. The klystron, by its very nature, requires operation in Class A. In a Class B amplifier the power taken from the power supply is a function of the signal level. In a Class A amplifier power supply current is constant and must be high to support the peak power output.

Students of broadcasting history will remember the revolution which took place in AM broadcasting during the 1930's. With introduction of the Class B modulator, AM broadcast transmitter efficiency was dramatically improved. The broadcast industry rapidly switched from Class A to Class B modulation.

High power VHF television transmitters are built with power grid tubes operated in Class B. That is the reason VHF transmitters are much smaller, much less costly and much less expensive to operate than UHF transmitters of the same power level. Clearly, what is needed is a device with the advantages of the klystron which can operate in Class B. That

FIGURE 8 - X2251 KLYSTRODE MEASURED PERFORMANCE  
 JUNE 1984 - VARIAN EIMAC, SAN CARLOS, CAL.

Carrier Frequency .....		785	MHz
Bandwidth ( $\pm 0.25$ dB) .....		8.00	MHz
Beam Voltage .....		24.30	Kv
Beam Current (P.S.) .....		2.70	A
Beam Current (B.L.) .....		1.87	A
Beam Current (A.P.) .....		1.00	A
RF Power Output (P.S.) .....		32.00	Kw
RF Power Output (B.L.) .....		18.00	Kw
RF Power Output (A.P.) .....		6.47	Kw
Conversion Efficiency (P.S.) .....		48.00	%
Conversion Efficiency (B.L.) .....		39.50	%
Conversion Efficiency (A.P.) .....		26.50	%
RF Drive Power (P.S.) .....	320	140*	W
RF Drive Power (B.L.) .....	140	140*	W
Frequency Response vs Brightness .....	-0.5	-0.5*	dB
Differential Gain (L.F.) .....	-55	-55*	%
Differential Gain (fsc = 4.1 MHz) .....	-55	-55*	%
Differential Phase at fsc = 4.1 MHz .....	8	8*	Deg.
Incidental Phase .....	Not Measured		
Sync Compression .....	50	0*	%

\*With Sync Pulsing by Grid Bias Modulation

$$\text{Figure of Merit} = \frac{\text{Peak Sync Power Out}}{\text{Average Picture Power Input}} = 107\%$$

All Measurements Taken with Uncompensated RF Driver

device has been developed and we refer to it as a klystrode. The efficiency improvement of the klystrode over other means of high power UHF power amplification is significant.

#### EFFICIENCY

Some tentative steps have been taken to make klystron amplifiers operate in some rudimentary form of Class B. These steps are variously known as mod-anode pulsing, ABC pulsing, BCD pulsing, ACE pulsing, full-time modulation, etc. Before these are discussed. A practical way to describe the efficiency of a TV transmitter is recommended.

The broadcaster is not interested in the average power output of his transmitter or in many of the other parameters important to tube engi-

neers in comparing the efficiency of power devices. A broadcaster is only interested in the peak sync power output of his transmitter. This is for all practical purposes, fixed. The only other efficiency parameter of importance to the broadcaster is the power bill at the end of the month. Thus the expression should include only two parameters, the peak sync power output and the average power input.

$$\text{FIGURE OF MERIT \%} = \frac{\text{PWR OUT, PEAK SYNC}}{\text{PWR IN, AVERAGE}}$$

The average power includes the video signal, sync pulses and blanking pulses.

This is not true efficiency. It is a peak number divided by an average number, which cannot be called efficiency. However, it is the most

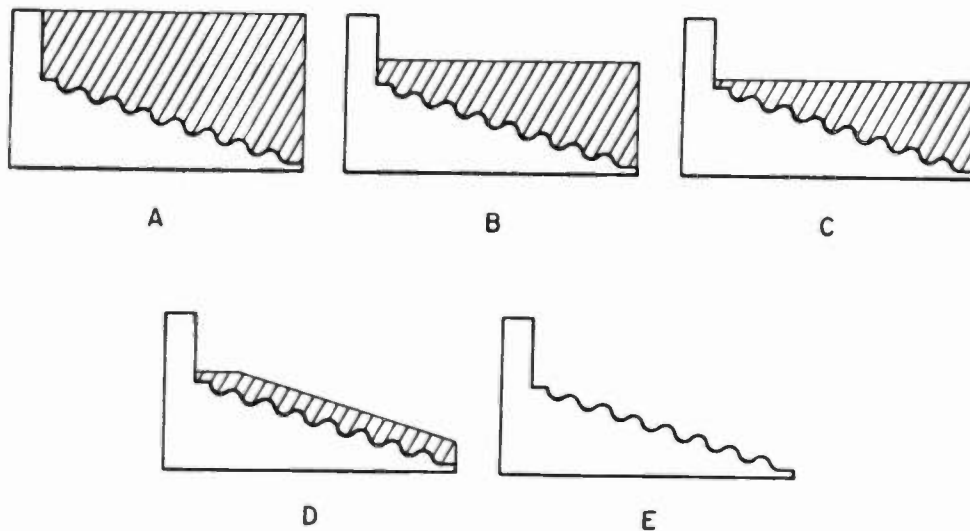


FIGURE 9

useful criterion for a broadcaster to use in comparing final power amplifiers. This number should be described as a figure of merit. The figure of merit is especially important in characterizing the Klystron and in anticipating the performance of future devices such as the multi-segment depressed collector because in both cases the number exceeds 100%!

#### RECENT STEPS TOWARDS CLASS B

Figure 9 is a representation of a single line of a television signal, including the sync pulse, the back porch and an arbitrary video signal. It is a plot of power versus time. The line across the top of Figure 9A extending from the peak-of-sync to the right is a representation of the power taken from the power supply required to produce the rf power output in the waveform shown. Power input and power output are shown on the same vertical scale for clarity.

Figure 9A is a representation of a typical klystron operated in Class A. The power drawn from the power supply is constant. Because the input

power is constant while the output varies as a function of the signal level, there is wasted energy. The shaded area represents wasted energy.

Figure 9B shows the result of the first of the steps taken by Varian to achieve Class B operation. This is known as mod-anode-pulsing. Introduction of this technology has made a significant contribution to increasing the efficiency of UHF TV transmitters. Notice the wasted energy is substantially reduced from that shown in illustration A.

Recently there has been some further progress in the field of beam pulsing. This is represented in Figure 9C. It is an extension of illustration B where power input to the beam is reduced nearly to the level required for black level. Because color burst information is on the back porch, black level cannot be reached. The increase in the degree of mod-anode pulsing has further increased efficiency. The black level signal is taken nearly to klystron saturation. This has been made possible by recent advances in exciter video distortion compensation.

ABC, BCD and ACE pulsing are European variations of illustrations B and C. The klystron focus electrode is pulsed instead of the modulating anode. These variations reduce the pulse voltage swing but fundamentally do not improve efficiency over mod-anode pulsing.

Figure 9D is representative of a possible advance which has not yet been proven. It is known as full-time modulation. Here the klystron beam is modulated not only during the sync period but also during the video period. During this period the beam is modulated with the low frequency

FIGURE 10  
OPERATING COST COMPARISON  
VARIOUS TUBE TYPES AND OPERATING SYSTEMS

TUBE TYPE AND MODULATION SYSTEM	FIGURE OF MERIT %	COST PER ANNUM PER KWPS \$	COST PER ANNUM AT 30 KWPS \$
Varian Klystron (typ.) (microperveance = 1.2)	41**	84.7	25,425
Tetrode TH584	65*	53.5	16,037
Valvo Klystron (B.C.D. or gridded sync pulsed)	70**	49.6	14,892
Varian S Klystron (mod. anode sync pulsed) (calculated)	75	46.5	13,899
Valvo Gridded Klystron with full-time modulation (calculated)	94**	37.0	11,089
Klystrode (measured)	107	47.0	9,742

\* Calculated from data at black level quoted in paper No.2 of IEE colloquium, February 27, 1984, "Efficiency Improvements in UHF transmitters".

\*\* Paper No.5 Direct Quote.

#### ASSUMPTIONS

- (1) 17 hours operation per diem = 6205 hours per annum
- (2) Energy cost 5.6 c/kW hr (U.S.A.)
- (3) Basic equation for operating costs:

$$\text{Cost per annum} = \frac{6205 \times \text{cost/kW hr} \times \text{kw Peak Sync}}{\text{Figure of Merit}}$$

$$\text{Where Figure of Merit} = \frac{\text{Peak Sync Power, kw}}{\text{DC Beam Input Power for Average Picture*}}$$

\* Equivalent to signal output = 0.45 x Peak Sync signal output

From D.H.Preist and M.B.Shrader, Klystrode TV Amplifier Performance at U.H.F. IBC 22 Sept.1984



components of the visual signal. In other respects the klystron is operated in the normal fashion. Full-time modulation may hold promise of reducing the wasted power further as shown in the diagram. However, because the beam current loading of the klystron buncher cavities is changing during the visual period, the requirement for sophisticated compensation is severe. For example, the shape of the pass band characteristic of the klystron is caused to vary with signal level. Compensation for these wide variations is extremely difficult and perhaps impractical.

The answer is to go all the way to Class B to eliminate the wasted power. Klystrode operation is depicted in Figure 9E. This is not intended to show that the true efficiency is 100% ; it shows that at any time during the video line there is no more power being fed to the tube by the power supply than is necessary to produce the power output at that instant in time. The power drawn from the power supply continually follows the wave form of the modulation. The Klystrode operates in true Class B and delivers the same high efficiency in UHF TV service we have learned to expect at VHF.

#### DOLLARS AND CENTS

What does all this mean in dollars and cents at the bottom line for the UHF TV broadcaster? In September of last year Don Preist and Merrald Shrader of Varian EIMAC presented a paper at the International Broadcasting Convention in England entitled KLYSTRODE TV AMPLIFIER PERFORMANCE AT

UHF. In this paper they showed a cost comparison for various tube types and operating systems. This is shown in Figure 10. Notice that the Klystrode figure of merit is 107%. The substantial savings in annual operation cost for a 30 kW Klystrode power amplifier are shown in the right hand column.

#### CONCLUSION

The power tube industry is working hard and has made excellent progress toward making UHF TV transmitters as economical to purchase and to operate as VHF TV transmitters. The Klystrode is a major contributor. It has the technical characteristics necessary to design compact UHF TV transmitters of exceptionally low operating cost.

#### BIBLIOGRAPHY

Shrader, Merrald B., and Donald H. Preist, "Klystrode Update", Varian EIMAC, San Carlos, Cal.

Preist, Donald H., and Merrald B. Shrader, "Klystrode TV Amplifier Performance at UHF", Varian EIMAC, San Carlos, Cal., September, 1984.

Preist, Donald H., and Merrald B. Shrader, "The Klystrode - An Unusual Transmitting Tube With Potential for UHF-TV", Proceedings of the IEEE, Vol 70, No.11, Nov.1982 (0018-9219/82/1100-1318).

Shrader, Merrald B., and Donald H. Preist, "The Klystrode: An Old Idea With New Applications", Varian EIMAC, San Carlos, Cal.

---

High Efficiency UHF  
Klystron Transmitter Technology

Glenn V. Wild and John P. Shipley

RCA Corporation

Broadcast Systems Division

Gibbsboro, New Jersey 08026

Recent developments in klystrons have made possible the introduction of new state-of-the-art UHF television transmitters which satisfy two recent trends in the broadcast industry. More than ever before in the past, the industry demands the ultimate in overall efficiency because of spiralling power costs.

Yet, at the same time, UHF station managements are asking for more practical ways to increase station ERP's.

If it were not for the development of super high-efficiency, high power klystrons, these two demands from the industry would seem to be mutually exclusive.

This paper describes a new family of UHF transmitters using these new klystrons and which meet these two diverse objectives.

Papers by Symons and Foster in previous years at this conference and in other forums have reported on the progress made in developing these new klystrons. At last year's NAB convention, two transmitter manufacturers, Harris and RCA, introduced versions of UHF transmitters utilizing the Varian VKP-7553 series of 60kW integral cavity klystrons. RCA also introduced a completely new 100kW transmitter using the new Varian VKP-7853 series of 100kW klystrons.

With introduction of the new 60kW "S" tubes, existing transmitters could now be rerated from 55 to 60kW visual peak-of-sync output while power consumption was actually reduced. Because the new series of klystrons could be operated in the "H" mode, most replacements in the

past year have been with the "S" tubes. Conversion to operation in the "S" mode can be made at any point in time, usually when all of the "H" series klystrons have been retired.

As reported elsewhere, the VKP-7853 series 100kW klystron, while using similar fundamental electron bunching techniques and asynchronous tuning and cavity loading techniques employed with the 60kW "S" tube, is not simply a higher power version of existing types. Instead, additional developments have been incorporated to achieve still higher levels of efficiency. Figure 1 shows the VKP-7853 installed in the Visual PA cabinet of the TTG-100U.

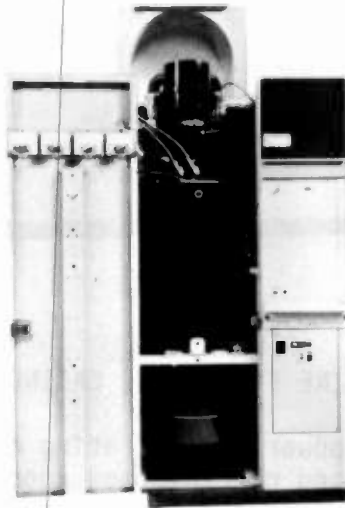


FIGURE 1.  
100KW KLYSTRON, FRONT ACCESS

Fundamentally, the 60kW and 100kW klystrons are similar however, and can be characterized with similar descriptions. Both have reduced overall gain, closer to 35dB typically than 50dB as is generally the case with five-cavity klystrons. Both require increased drive power, up to 25 watts for the VKP-7553 and up to 50 watts for the VKP-7853. Both utilize loading of the asynchronously tuned second cavity to reduce Q and to obtain the proper phase relationship between the plasma wave and the RF fields in the intermediate cavities.

Our measurements on a number of channels, pulsed and with output couplers, indicate peak-of-sync efficiencies between 70 and 75% for the VKP-7553 and between 75 and 80% for the 100kW VKP-7853 series. Higher efficiency levels could be achieved with both tubes but with some compromise in performance as saturation levels are approached. We have chosen instead to use conservative transmitter ratings.

Both klystrons are ideal types to incorporate into new transmitter designs. As mentioned earlier, RCA introduced its TTG-100U 100kW single-ended transmitter using the VKP-7853 at last year's NAB. This year,

at this NAB, we are showing the newest member of the G-line UHF family of transmitters - the 60kW, TTG-60U shown in Figure 2 which uses the VKP-7553 series.

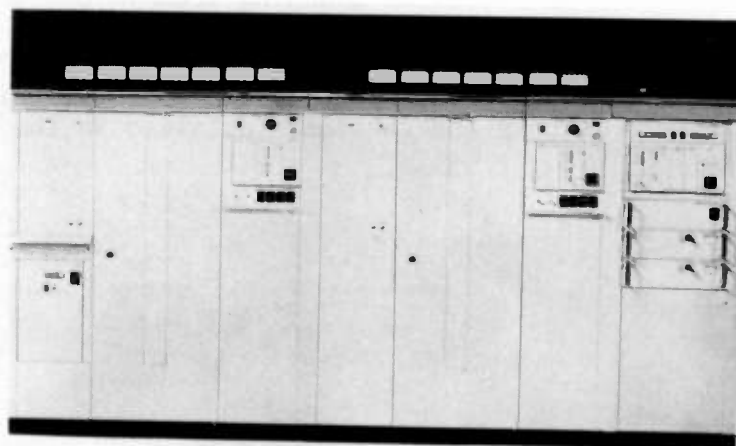


FIGURE 2.  
UHF G-LINE FRONT LINE CABINETS

Except for the higher power output rating of the TTG-100U and, of course, higher beam voltage and current, mod anode voltage and drive, the two transmitters are sufficiently similar to permit description of the two models as a family.

Requirements for higher output powers have existed in the past but, to achieve peak-of-sync powers over 55kW, it was necessary to parallel two or more amplifiers. An added advantage of paralleling was the increased on-air reliability which resulted. A major design consideration in developing a family of transmitters using the new higher power klystrons was that it must be done with no significant reduction in reliability.

One well-known way to increase on-air reliability of a single-ended transmitter is to provide facilities for multiplexing aural and visual carriers through the visual klystron in the event of failure of the aural PA. The bandwidth of both the VKP-7553 and VKP-7853, when operating in the super high efficiency mode, is adequate to support multiplexing aural on the visual carrier. This has long been an emergency mode of operation but only through the visual amplifier. This emergency mode is standard in the UHF G-line. But, in accordance with Murphy's Law, the visual PA will probably fail more often which means a klystron change.

Why not provide multiplexing of aural and visual through either the visual or aural PA's? All G-line transmitters provide push-button selection of multiplexing through either klystron. When multiplexing through the visual PA, the aural notches in the notch diplexer are detuned about

1MHz. Multiplexing through the aural PA requires switching the aural output around the diplexer as shown in Figure 3. Of course, efficiency is reduced since the aural klystron cannot be tuned semi-synchronously and an aural coupler cannot be used.

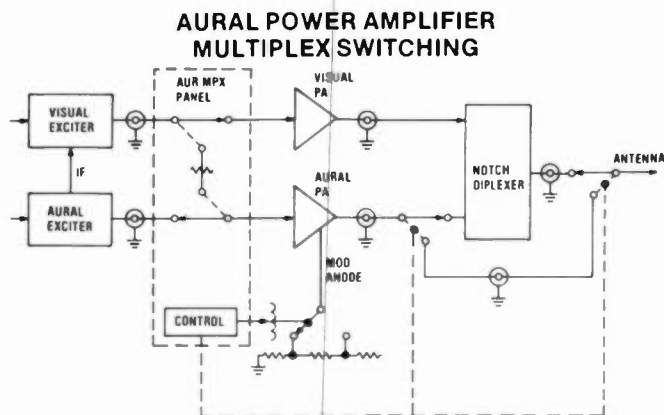


FIGURE 3.

As was the case with earlier designs at this power level, the TTG-60U uses the same klystron in both PA's. As a result, multiplexing through either klystron is possible locally or remotely with a peak-of-sync power reduction of less than 1 dB if the appropriate output switching is provided.

The TTG-100U however does not use the same klystron in both PA's. The familiar 30kW VA-890 is used as the aural klystron, thus multiplexing through the aural PA results in a 6 dB reduction in peak-of-sync visual power as a result.

For that reason, an optional version, the TTG-100U/HA has been developed using the same VKP-7853 in the aural PA as is used in the visual. With the required output switching, aural multiplexing can be accomplished through either the visual or aural PA with the push of a button. On-air reliability is now at least as high as with a parallel configured transmitter and the reduction in power is considerably less.

It should be obvious by now with three new members of the UHF G-line family, the 60kW TTG-60U and the 100kW TTG-100U and TTG-100U/HA, that there will be at least three more - parallel versions of each. There are: the 120kW TTG-120U which is the TTG-60U with an added visual PA, and the TTG-200U/HA which also adds a second visual PA.

All six new members of the G-line family of UHF transmitters share the same basic design philosophies and are identical in external appear-

ance. Figure 4 shows the simplified block diagram of the TTG-100U or TTG-100U/HA. Each single-ended type is made up of three cabinets - the 72-inch wide exciter/control cabinet on the left which can accommodate a dual exciter system, next the aural klystron PA cabinet and finally the visual PA cabinet.

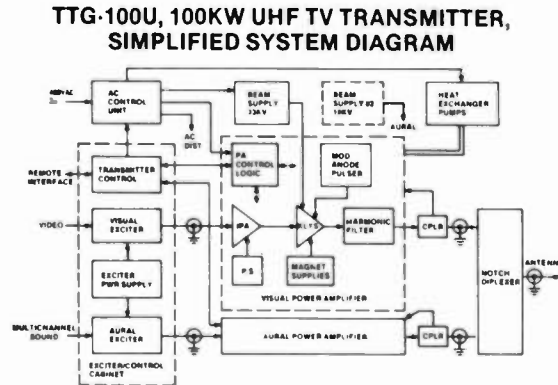


FIGURE 4.

This configuration, coupled with the distributed control system, assures minimum floor space requirement and ease of installation. In addition, since most interconnection is of simple plug-in design, expansion from single-ended to parallel systems is accomplished with ease.

All feature a dedicated solid state control logic with the transmitter master control logic at eye level in the exciter/control area and the individual dedicated power amplifier cabinet control systems in the upper left corner of each klystron cabinet, also at eye level. This approach lessens the likelihood of single-point failure effects and permits simple expansion to parallel transmitter configurations with a single ribbon cable interface to the added visual amplifier.

The remote interface for each transmitter is located in the exciter cabinet transmitter master control area and provides 22 control inputs, 32 status outputs and 19 analog telemetry outputs. The CMOS logic is battery supported and permits automatic restart in the event of a power interruption.

A separate A.C. Control Cabinet (see Figure 5), which can be placed in any convenient location, contains the main transmitter breaker, individual distribution breakers and the pump selection panel. Automatic standby pump switching, controlled by pressure sensors, is optionally available.

AC step-start contactors and the associated series resistances for limiting initial turn-on transients and for 0.4 second initial start-up at reduced beam voltage are also located in the AC Control Cabinet.

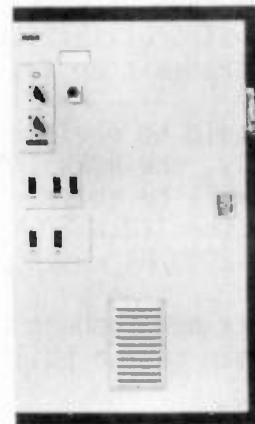


FIGURE 5.  
AC CONTROL UNIT

Each beam supply is a unitized assembly containing the beam voltage transformer, rectifier stacks, filter reactor and AC snubbing networks in an oil-filled enclosure. The diode stacks can be easily accessed through a port at the top of the tank. The beam supplies are designed for outdoor installation. External delta-wye switches are provided to permit initial klystron tuning at reduced beam voltage. Individual beam voltage disconnects are provided for each klystron cabinet and are automatically selected in emergency aural multiplex modes.

A new exciter system has been designed for the new series of transmitters and fortunately multichannel television sound arrived on the scene during the design stages, permitting the inclusion of MTS capability as standard. Local and remote switching between standard pre-emphasized and wideband inputs is provided. If precise intercarrier separation proves to be a consideration for MTS operation, it should not present a problem since the Aural IF frequency is synthesized from the visual IF. Aural carrier is thus permitted to vary no more than 5Hz from the visual carrier frequency.

Since precorrection for exciter output, klystron non-linearity and ICPM change with the enabling and disabling of modulating anode pulsing and also when aural multiplexing is chosen, precorrection circuitry is automatically switched with operating mode selection.

As discussed by Foster earlier, the increased efficiency of both the VKP-7553 and the VKP-7853 is partially a result of the lower microperveance of the two series. Since visual and aural bandwidths are somewhat decreased as a result, and since some delay asymmetry may be exhibited by the aural notches in notch diplexers, group delay correctors are provided in both the aural and visual IF paths.

The increased drive requirements of klystrons operating in this super high-efficiency mode are satisfied by a single 50 watt Class AB IPA in the 60kW transmitter and by a 100 watt IPA for the 100kW version. Both of these solid state IPA's incorporate overdrive detection, thermal fault sensors and gain status monitoring.

#### VKP 7854 AURAL PERFORMANCE

<u>POWER OUTPUT</u>	<u>BEAM VOLTAGE</u>	<u>BEAM CURRENT</u>	<u>IPA OUTPUT</u>	<u>BEAM EFFICIENCY</u>
11 KW	33.2 KV	1.15 A	11 W	28.8%
22 KW	33.0 KV	1.6 A	32 W	41.7%
44 KW	32.8 KV	2.35 A	52 W	57.0%

1. KLYSTRON TUNING ADJUSTED FOR 2 MHz, 3 dB BANDWIDTH
2. VISUAL OUTPUT COUPLER

FIGURE 6.

Performance measurements have been made with both the TTG-60U and the TTG-100U operating on low-, mid- and high-band channels. Performance of each klystron was quite uniform.

Since the TTG-100U/HA and TTG-200U/HA units use the 100kW VKP-7853 series klystron in the aural as well as in the visual PA's, the aural efficiency is of interest. Figure 6 illustrates the aural performance of a mid-band VKP-7854 operating at three different output power levels. Klystron tuning was adjusted to provide approximately 2 MHz, 3 dB bandwidth for minimum multichannel sound distortion.

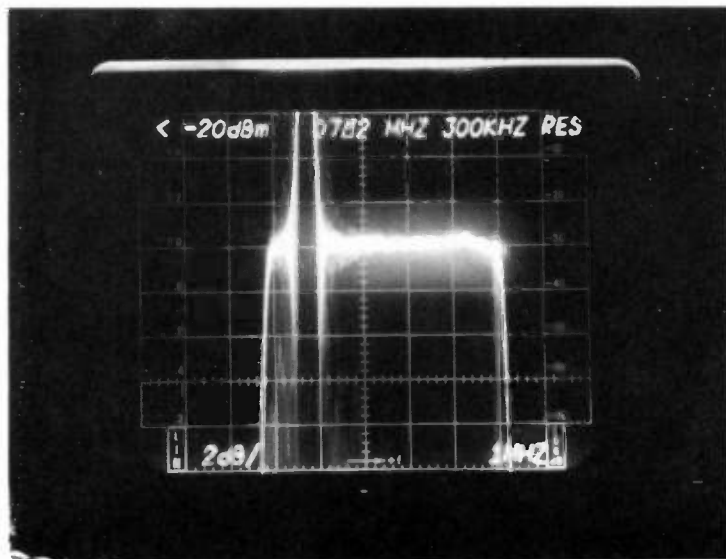


FIGURE 7.  
FREQUENCY RESPONSE WITH PULSING  
2dB/DIVISION

Passband performance for the TTG-100U on Channel 66 operating at 105kW peak-of-sync output with full mod anode pulsing is shown in Figure 7. Measured collector efficiency was 58% non-pulsed and up to 79% pulsed. Significant visual parameter performance is shown in Figure 8 illustrating the effectiveness of exciter precorrection.

**TTG-100U VISUAL PERFORMANCE, PULSING**

DIFFERENTIAL GAIN	2%
DIFFERENTIAL PHASE	1°
LOW FREQUENCY LINEARITY	3%
ICPM	± 1°
2T K FACTOR	1%
12.5 T K FACTOR	2%

FIGURE 8.



Similar performance has been exhibited by the TTG-60U, obtaining 75% pulsed efficiency.

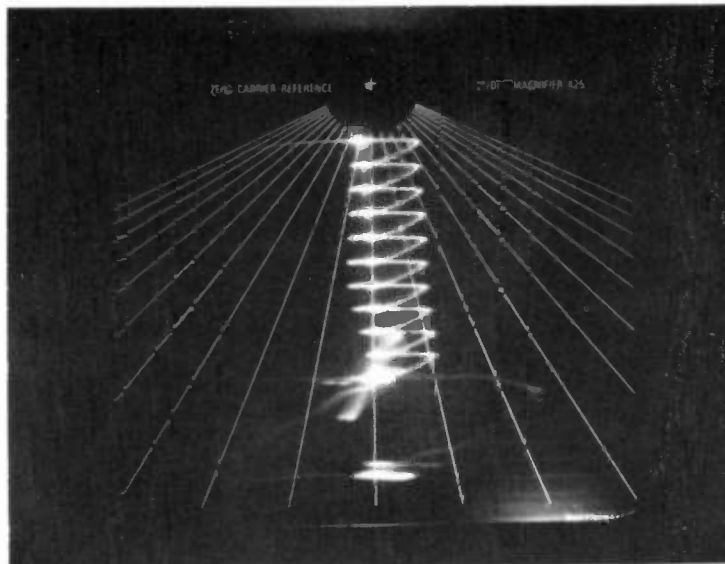


FIGURE 9.  
ICPM, 2°/DIV, CORRECTED KLYSTRON OUTPUT

The development of these two new series of klystrons and of modern transmitters designed to realize their benefits have narrowed or perhaps eliminated the advantage gap between parallel and single-ended UHF transmitters. Previously unachievable levels of efficiency are available without performance compromise while the reliability of parallel operation is equalled or exceeded.

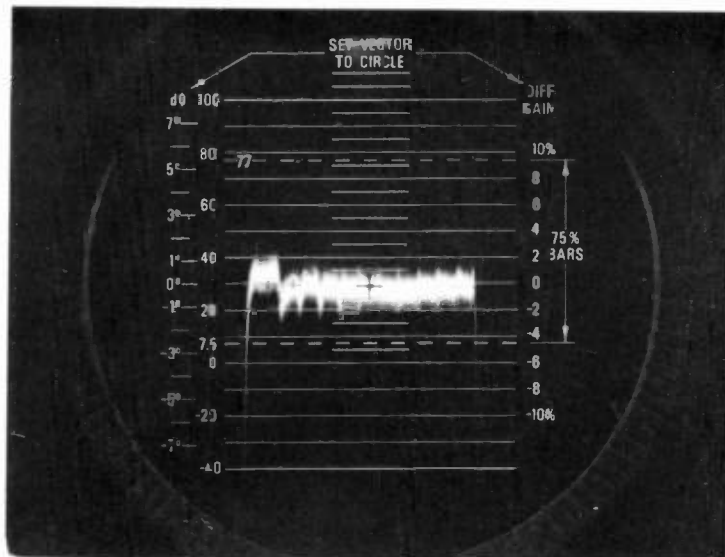


FIGURE 10.  
DIFFERENTIAL GAIN, CORRECTED KLYSTRON OUTPUT



---

'Non-Ionizing Radiation--

Measurement Methods and Artifacts

Edward Aslan

Narda Microwave Corporation

Hauppauge, New York

The proper measurement goal is to quantify the fields without perturbing the field by the instrument or the operator. Prior to measurement, you should have an estimate of what power density to expect, frequencies of the radiations, and modulation characteristics. These must be in agreement with the characteristics of the measuring instrument. Particular attentions should be made to out of band responses of the monitor equipment and multiple frequency sources, particularly when the ANSI C95.1 1982 standard is being used as a guide. This standard has a variation in recommended limit of 20 dB over its frequency range. Of course use correction factors when supplied with calibration. In the frequency region below approximately 300 MHz, where almost all the readings may be in reactive fields, it is necessary to measure both the electric and magnetic fields. The use of an isotropic probe is essential in these exposure measurements. Figure 2 shows the attitude of the probe and position of the personnel. The probe should be pointed toward the radiation with the arm outstretched in front of the operator. This will produce minimum perturbation of the field caused by induced currents in the probe handle and operator. See figures 1 & 2.

The term Artifact used in the papers title is not as defined by most dictionaries as an object related to archeology, but rather the definition used in scientific community, referring to artificial actions during a measurement procedure. The artifacts produced by various commercially available equipment under various monitoring conditions are discussed below. The various artifacts and phenomena to be described are not related to any single probe, type probe or manufacturer. They are not all defects in design since they may nor may not contribute any significant error.

(MULTIPLY BY INDICATED CORRECTION  
FACTOR TO OBTAIN ACTUAL  $\text{mV}/\text{CM}^2$ )

FREQ (MHz)	CORRECTI FACTOR	FREQ (MHz)	CORRECTI FACTOR
300	1.826	8200	0.990
1700	1.011	9300	0.964

Figure 1. Don't forget to use Corrective Factors.

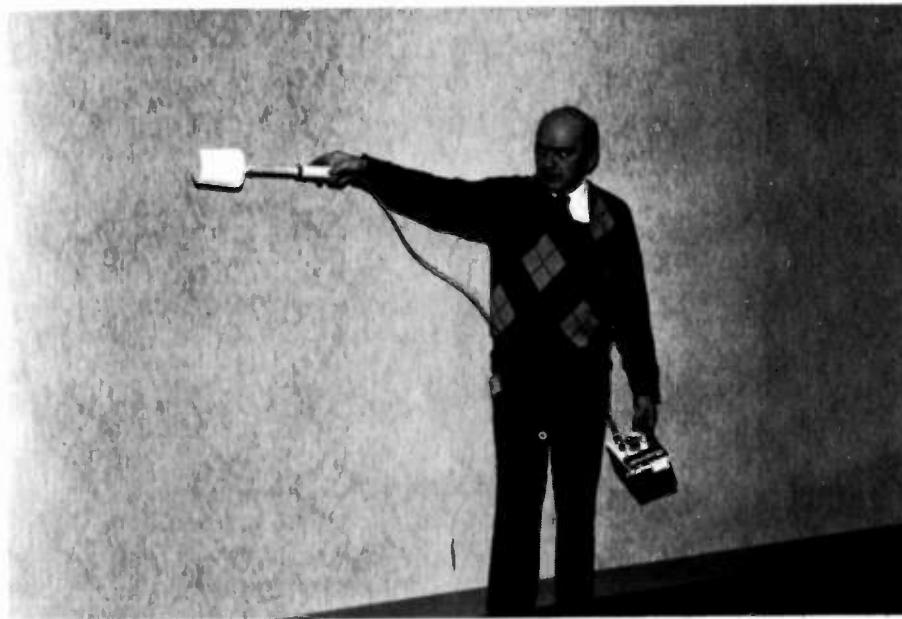


Figure 2. Proper probe measurement attitude.

## MAGNETIC FIELD MEASUREMENTS IN HIGH IMPEDANCE FIELDS:

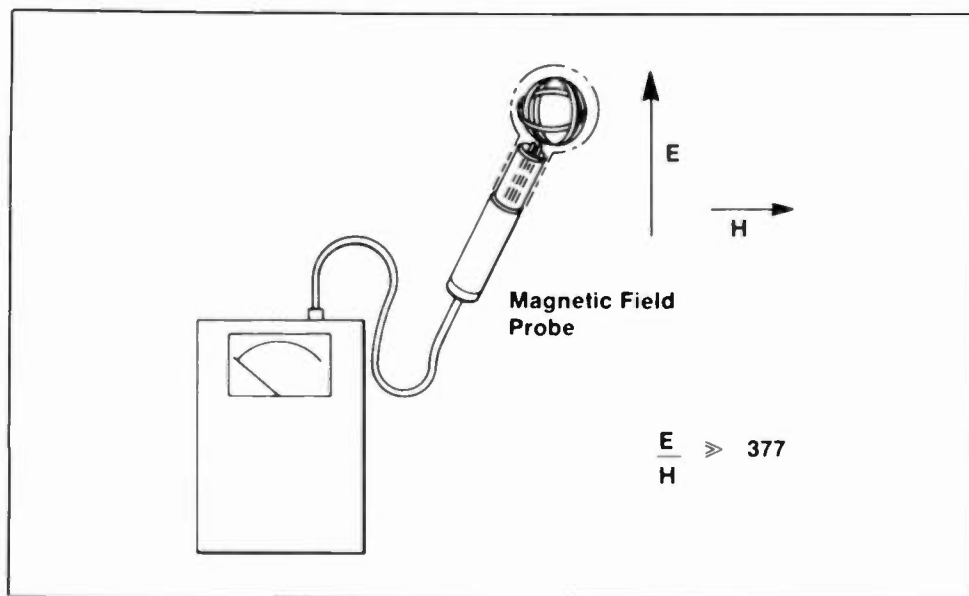


Figure 3. A magnetic field measurement in an extremely high electric field can produce a suspicious indication.

When using a magnetic field probe in a field where most of the energy is in the electric field, a negative reading may occur. A high impedance field may produce a downscale reading. This may be due to a thermoelectric effect produced by deposition of energy in the resistive transmission line. Resistive transmission lines are used in almost all isotropic radiation monitors. It is virtually impossible to perfectly match the resistive lines over their entire length. Differences in resistance result in differences in power dissipation and the resultant differences in temperature of the lines. The variation in resistivity produces a variation in Seebeck coefficient which is proportional to resistivity. See figure 4. All this results in different temperatures and different coefficients for the lines and thermoelectric voltage being produced. This effect produces generally negligible error in quantifying a hazardous field. If there is a reasonably amount of energy in the magnetic field to produce an upscale reading, the contribution by this effect would be negligible. If almost all of the energy were in the electric field, this small thermoelectric contribution would also go unnoticed as not being peculiar except if the reading produced a downscale indication. In assessing a hazard, this would indicate that you were measuring the wrong field since almost all the energy was in the other field.

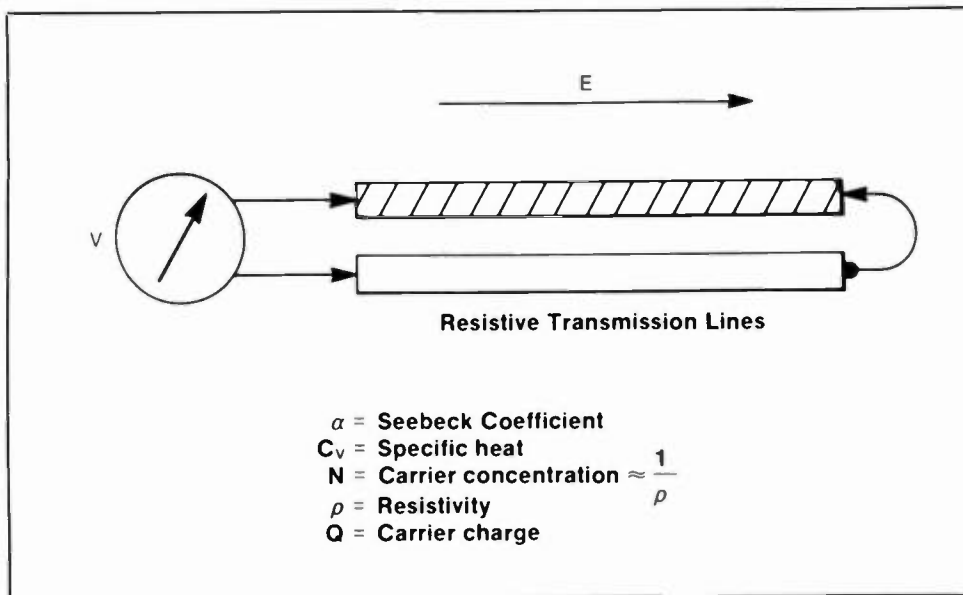


Figure 4. Thermoelectric voltages may be produced in resistive transmission lines.

#### TRANSMISSION LINE ANTENNAS:

In the low frequency region principally below 1 MHz, the impedance of the dipole antennas used for measurement sensors increase to where they approach the magnitude of the resistive transmission line. When this occurs, the transmission line may deliver an induced signal to the antenna producing a higher indication than the true value.

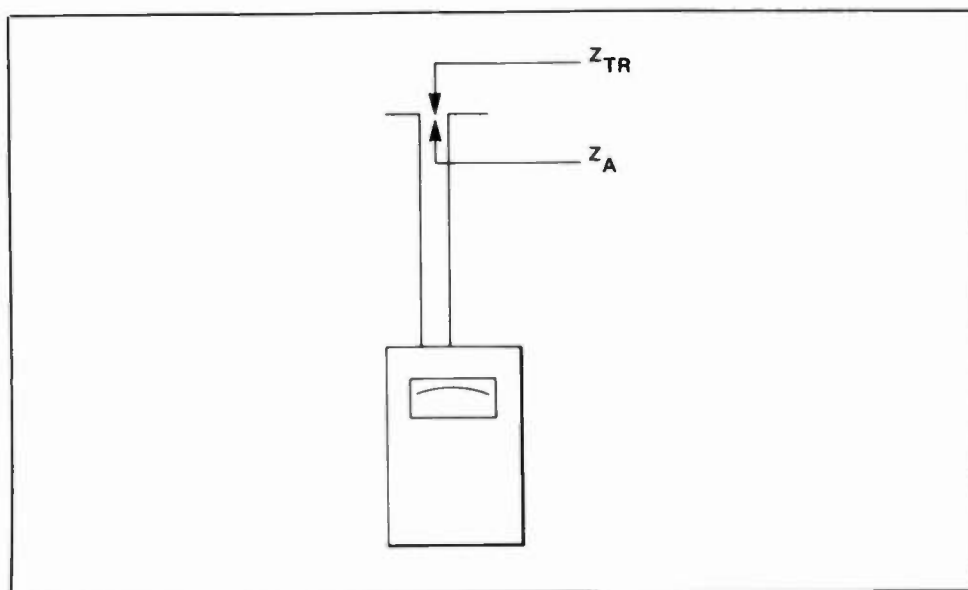


Figure 5. The transmission line can become the antenna.

Maintaining the probe handle normal to the electric field will minimize this induced signal and the resultant error. This can generally be accompanied by aligning the probe handle tangential to the Poynting Vector. Point the probe towards the radiating source.

#### LIGHT SENSITIVITY:

A downscale meter indication produced when going from a shaded area to a sunlight area could occur with some commercially available probes.

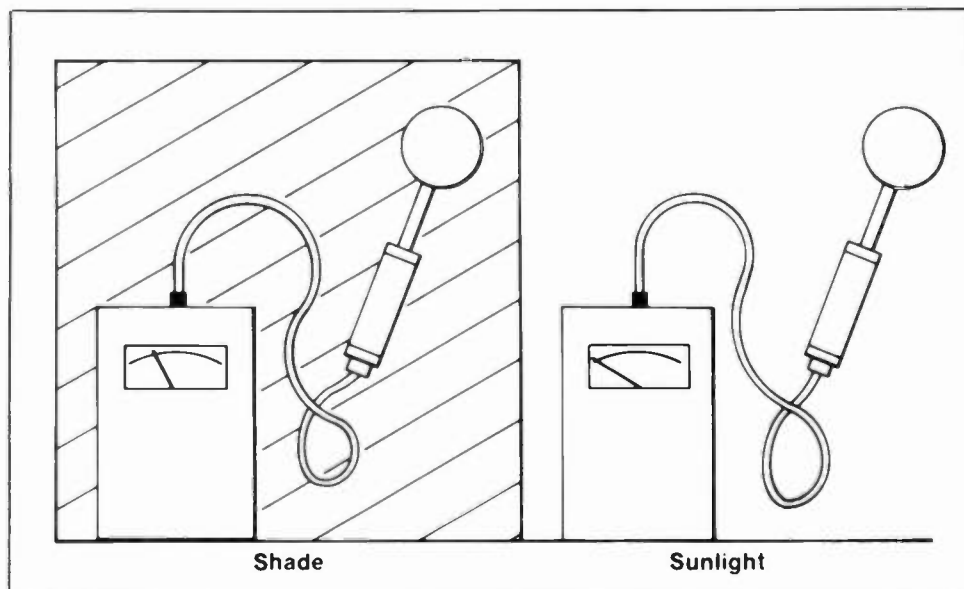


Figure 6. Hybrid schottky diodes can produce electrical output voltages when illuminated by sunlight.

These radiation monitor probes use hybrid Schottky diodes as detectors. They exhibit a very high sensitivity to light and infra red energy and will produce downscale readings. Illuminating the junction of these beam lead diodes with light will inject minority carriers. This reduces the barrier level and produces a voltage across the junction equal to the reduction. This voltage is opposite to that developed across the junction by the RF signal.

#### MAGNETIC LOOPS IN A CORNER ARRANGEMENT:

Measuring a magnetic field with a probe that has its mutually perpendicular loops arranged in the three adjacent perpendicular planes of a cube, will exhibit a high ellipse ratio. The corner arrangement causes spatial shadowing in certain attitudes of the probe. With the loops positioned one loop behind another such that the same flux lines pass through both loops as in figure 7, the resultant indication will be 3 dB lower than the indication when the loops are oriented alongside each other. In the latter case the fields illuminating the loops will not be modified by the companion loops and the indications will be higher.

The spatial shadowing is caused by the re-radiated field of the loop. When the scattering aperture is large relative to the effective aperture, the orientation and relative positioning of the loops become critical to obtaining an isotropic response. The effect can be made uniform for any attitude of the probe relative to the field vector. This is accomplished by placing the three loops centralized on a single point.

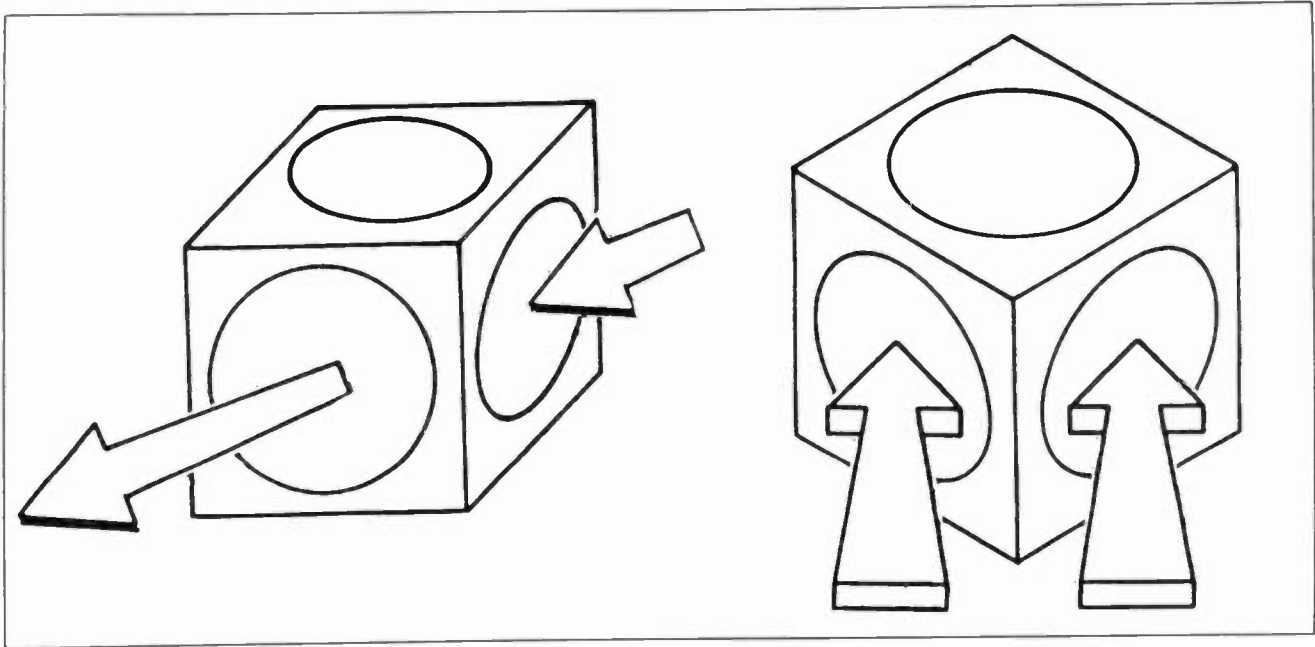


Figure 7. Spectral shadowing of magnetic loops can result in a high ellipse ratio.

#### STATIC CHARGE FIELDS:

Inherent in the design of radiation monitor probes is generally a high impedance sensor and high gain input circuits. Moving such a probe there a static charged area could produce up or downscale deflections while the probe is in motion.

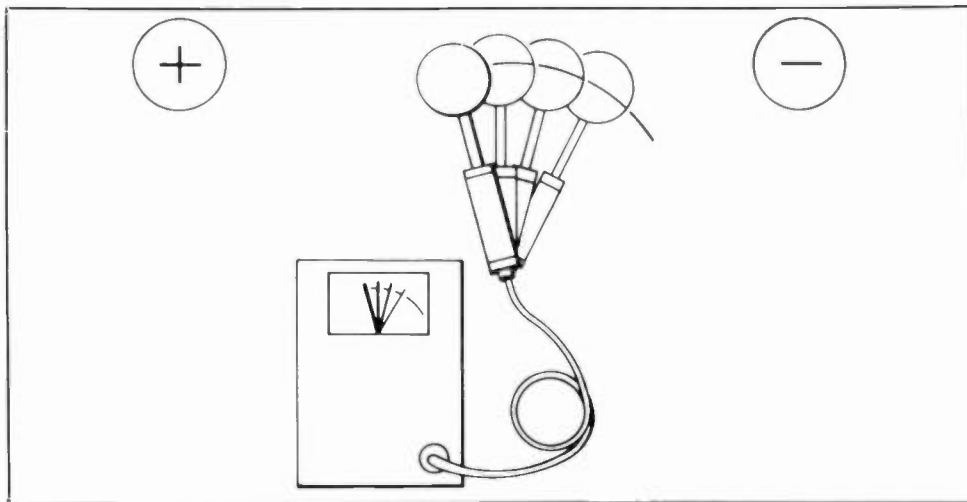


Figure 8. Static charged areas can produce transient meter deflections.



A well designed probe will minimize these effects by providing good common mode rejection - principally in matching the transmission line resistances, see figure 4, and through the use of true differential amplifiers and a static shield. The static shield consisting of a very high resistance film surrounding the sensor which provides a discharge path for the currents yet is transparent to the RF energy. The phenomena produced through the static charges is transient, and will disappear when the probe is motionless.

POTENTIAL FIELD EFFECTS:

When a measurement is made close to a radiator, especially in the low frequency region a false indication is possible by capacitively coupling into the potential scaler field. Figure 9 shows the physical relationship of the components and the resultant circuit schematic.

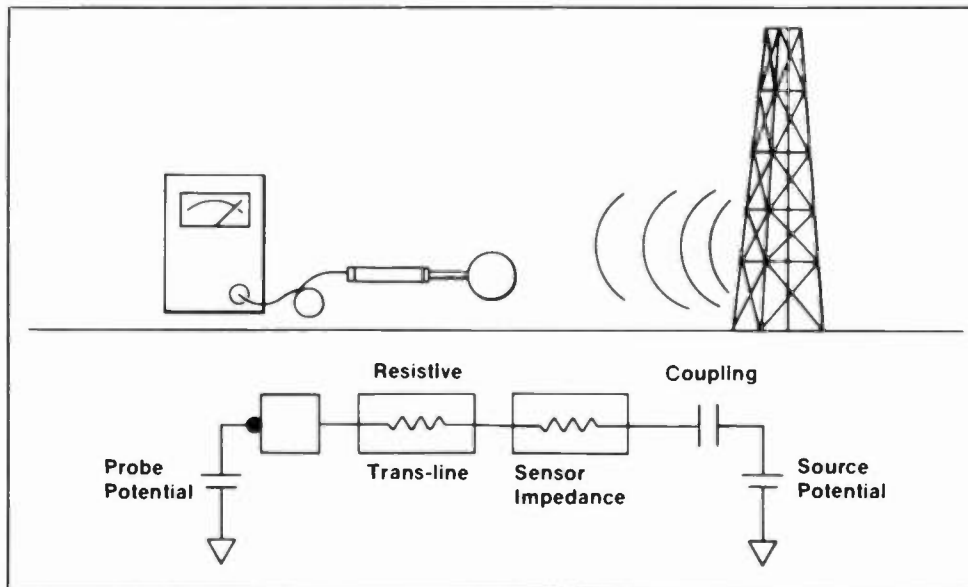


Figure 9. In the low frequency region a probe can capacitively couple into the scaler potential field.

This type artifact occurs in the low frequency region as the impedance of the sensor antenna becomes appreciably larger relative to the transmission line impedance, generally below 1 MHz. It can usually be remedied by placing the meter and probe in a zero potential field, see figure 10, such as near the ground. A second solution is to elevate the meter to the same potential as the probe. Bring the probe and meter in close proximity and insulate the instrument from any grounding circuits like contact with the operator's body. This can be accompanied by holding the meter with a heavy gloved hand as in figure 11. A test which may help identify this potential field is illustrated in figure 12. Cover only the sensing elements of the probe with aluminum foil, insuring that the foil does not contact ground, the probe, or meter shield. If the meter indications are approximately the same as without the foil, the instrument readings are in error.

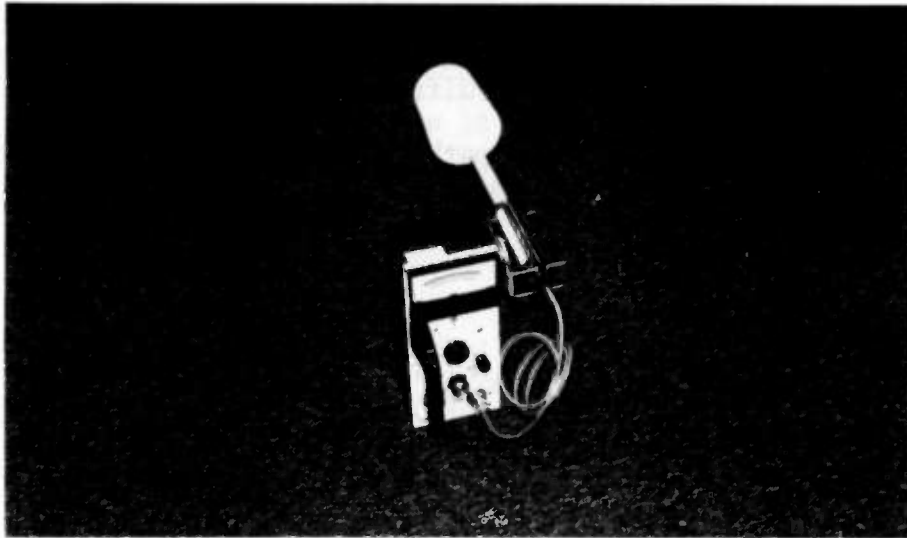


Figure 10. Low frequency measurements with the probe in a zero potential field will eliminate an artifact.

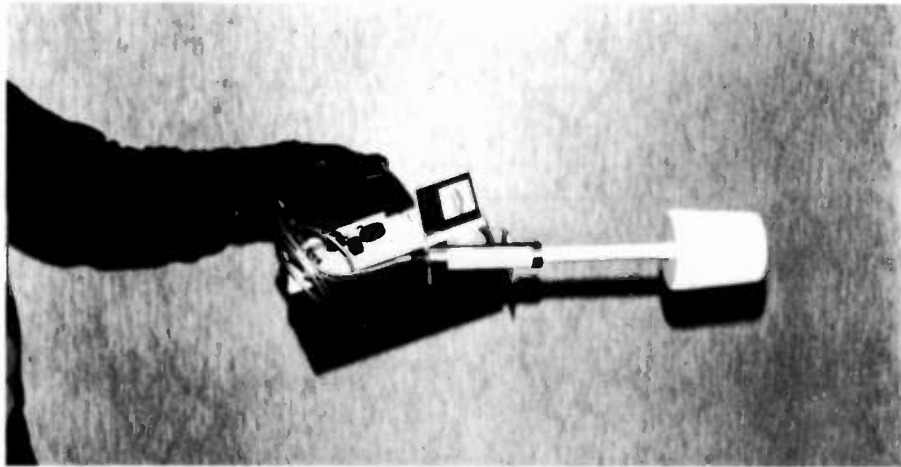


Figure 11. Keeping probe and meter at the same potential can minimize an artifact.

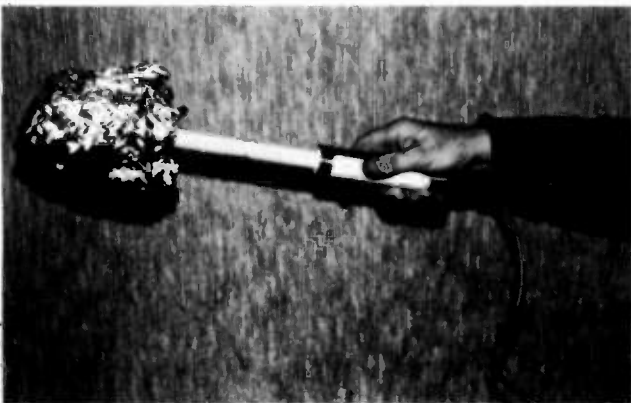


Figure 12. The same measurements with and without foil about the probe sensor is indicative of coupling into the potential field.

### PULSE MODULATED FIELDS AND DIODE SENSORS:

Radiation monitors utilizing diodes as sensors are generally inadequate for making measurements on pulsed systems, such as Radar. This defect may also carry over to measurement of TV Broadcast signals due to the relative low duty factor of sync and equalizing pulses. This defect produces errors in measuring pulsed field of a factor of 10 to 100. The diode type probes or radiation monitors read higher than their CW calibration by this factor. Diodes have a square law detection characteristic at low levels and a linear characteristic at high levels of power or power density. This transition from variable CW to pulse performance arises from the change in video resistance of the diode with level of RF current through the diode. The resistance decreases with the height of the pulse increasing the efficiency of the diode as a rectifier. The low resistance allows rapid charging of the circuit capacitance. The diode becomes a peak detector as opposed to providing an integrated averaged dc output.

The Narda Model 8682 probe which is designed to operate over the ranges of 300 KHz to 1.5 GHz uses some unique circuitry in conjunction with the diode detectors to eliminate this artifact.

### ZERO DRIFT:

Premature commencement of a survey may result in error caused by zero drift of the metering instrument. A change in ambient temperature such as when removing a monitor from a hot closed trunk of a car, and starting the survey without allowing sufficient time for the instrument to normalize to the new temperature will possibly manifest itself as zero drift during the initial phase of a survey. It is best to periodically check the zero of an instrument by removing it from the field and observing a zero meter indication.

It may be convenient to slip a "fruit juice" can over the probe, figure 13, to provide the zero energy density environment. Some transit cases are metal foil lined to enable a zero energy density environment for the probe.

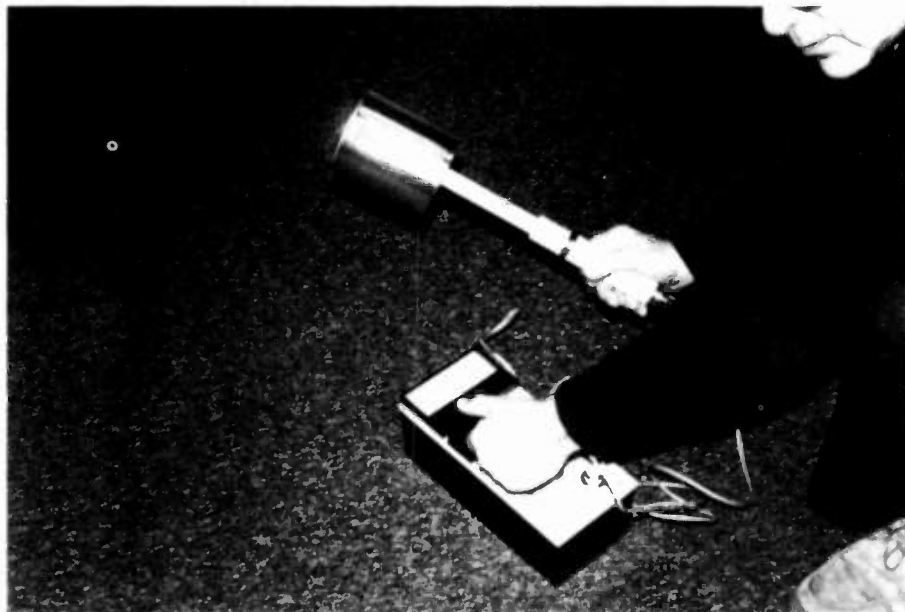


Figure 13. Zero drift can be checked by shielding with a fruit can.

### OUT OF BAND RESPONSES:

Where a probe is used in the presence of signals outside of its frequency range, the possibility of error occurs. Magnetic field probes have periodic resonances above their rated band and require additional consideration of its out of band response. If a signal frequency coincides with an out of band resonance frequency of the probe, a high false indication may prevail. This can occur to a lesser degree with electric probes. It is less likely to occur where resistive dipoles result in very damped resonances. A probe such as the Narda Model 8682 has a very neat high frequency roll off, see figure 14, to enable it to be used in conjunction with higher frequency probes for broader frequency surveys, or in the presence of higher frequency signals.

### MULTIPLE SIGNALS:

The ANSI C95.1-1982 radio frequency protection guide being used as the exposure limit may introduce additional difficulties. The RFPG states that "the fraction of the radio frequency protection guide incurred within each frequency interval should be determined and the sum of all such fractions should not exceed unity".

If the signals cannot be measured independently, then a probe which mirrors the RFPG may be required. Such a probe is the Narda 8682 which covers the frequency range of 300 KHz through 1500 MHz and has a shaped frequency sensitivity that is the reciprocal of the guide. The readout is in percent of exposure limit rather than equivalent power density.

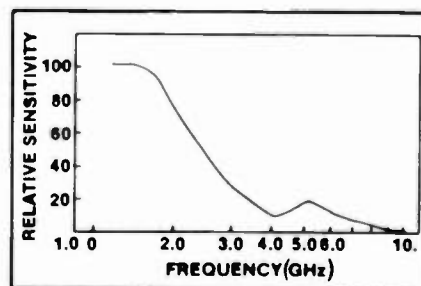


Figure 14. NARDA 8682 ANSI Probe out-of-band response.

## Bibliography

- (1) ANSI C95.1-1982, Safety Level with Respect to Human Exposure to Radio Frequency Electromagnetic Fields. Published by the Institute of Electrical and Electronic Engineers, New York, New York 10017.
- (2) ANSI C95.5-1981, Recommended Practice for the Measurement of Hazardous Electromagnetic Fields - RF and Microwave. Published by the IEEE, New York, New York 10017.
- (3) H.R. Kucia, "Accuracy Limitation in Measurement of H.F. Field Intensities for Protection Against Radiation Hazards.
- (4) E.E. Aslan, "An ANSI Radiation Protection Guide Conformal Probe". Microwave Journal, April, 1983.
- (5) A.W. Schwartz, "RF Radiation Hazards Measurement and Evaluation". RF Design, July/August, 1983

---

IN-SERVICE MEASUREMENT  
OF NON-IONIZING RADIATION

Neil M. Smith

SMITH and POWSTENKO

Washington, D. C.

The measurement of power density as a result of biological concerns is nothing but an extension of the sort of field strength measurement with which most broadcast engineers are familiar. However, the differences in technique are such that one might think no relationship exists between the two.

In most measurement situations, we measure neither field intensity nor power density. With AM field strength meters, we really measure magnetic field strength, but the meter is calibrated to read the equivalent electric field strength. With VHF and UHF field strength meters, we read the input voltage level and determine field strength by calculation, based on antenna and transmission line data. Although such measurement processes are indirect, the manufacturers of the measurement equipment simplify it for us so that we don't have to think about these details.

Consider, too, that when we measure field strength, we are normally measuring rather weak fields. In AM one rarely makes a measurement at a distance of less than 0.2 miles; in FM and TV, both the TASO technique and the Commission's Rules suggest that radial measurements begin at a distance of ten miles. Further, one selects measurement locations that are free from such local influences as power lines. Thus, we broadcasters are used to looking at our transmissions from a distance and at locations that are fairly representative of the area around the measurement spot.

These are sensible approaches, since service and interference are properly related to voltage, which generally diminishes in direct proportion to distance. However, biological effects are more properly related to power density, which diminishes in proportion to the *square* of the distance. For example, while a typical Class B FM station has a primary service radius of 32.5 miles, its power density exceeds the current ANSI standard of 1.0 mw/cm<sup>2</sup> only at distances closer than 84 feet.

While the specific distances of concern about biological effects vary for

different frequencies and powers, all such distances are best measured in feet rather than in miles. We are therefore talking about making measurements in close proximity to the transmitting antenna, where power density is highest, not at locations far away, where we would seek to find a median value.

This is an important difference. When one is concerned about biological effects, one will be measuring on a tower or a supporting building, or on land or buildings immediately adjacent to the transmitter site, where one expects the worst-case conditions to occur. It is virtually inevitable that such locations will not be free from the sort of localized influences one tries to avoid when the concern is about service or interference. Instead, the measurement maker must walk into an area where a non-homogeneous field is the rule, not the exception, and attempt to measure the maximum power density to which one might be exposed.

To complicate the matter, though the biological effects of non-ionizing radiation are not agreed to be totally thermal in nature, it seems to be the consensus that a rise in body temperature is more indicative of biological effects than is some arbitrary reference, such as power density. Thus, if we ignore special cases wherein the frequency and modulation of the radiation is such that it produces unusual responses, we may say that the biological impact is essentially the sum of all the fields to which the body is exposed. In other words, where the area of concern is near a number of transmitting installations, one must observe the total energy, which has been normalized to reflect the relative effects of the various frequencies, that impinges upon a given location. This means that one cannot properly use the tuned receivers and directional antennas that we ordinarily employ for field strength measurements. Instead, we want an instrument that will record the total power arriving at a particular spot, from any direction and on any frequency.

If this sounds suspiciously like the mythical isotrope, you're right. Interestingly enough, devices remarkably close to the ideal have been developed, so that we have essentially what we need to make such measurements. By following an approach first developed by the National Bureau of Standards, manufacturers are producing probes that use three small mutually orthogonal antenna elements. Such probes, when properly designed, can be essentially isotropic over a broad bandwidth. On the other hand, they are extremely inefficient antennas, but such inefficiency is not particularly important, since we use them to measure relatively high field strengths--in the range of volts rather than millivolts.

On this basis, one may use any of several commercially available instruments for the general measurement of power density. These instruments may or may not be direct-reading, but the conversion factors, if required, are not complex. Therefore, in the simplest of situations, one may probe the area of concern, and, assuming that the ANSI standard is being relied upon, one may determine an absence of harmful biological effects if the total power density does not exceed  $1.0 \text{ mw/cm}^2$ , which is the lowest level for any frequency covered under this standard. In fact, one need not know the specific frequencies involved in such a convenient case.

Where there is only a single transmitter at a specific site, with no other nearby transmitters in operation, common sense dictates that only a single frequency need be considered, and one may then relate the measured power density to the ANSI standard for this frequency. Where one runs into trouble is where one is dealing with a large number of nearby transmitters that create a complex

field which is at or near the standard being considered. One can then establish compliance or non-compliance for a particular transmitter only by ascertaining the frequencies involved. To do this, one must revert to conventional field strength measurement equipment or employ an instrument such as a spectrum analyzer. It is our experience that measurement studies in the immediate vicinity of multiple transmitters must be laid out on a case-by-case basis, using whatever instrumentation seems most logical under the circumstances.

As is the case with conventional field intensity measurements, one must determine the field strength levels that are expected to exist in the measurement area before one can conduct proper measurements. Such preparation is mandatory since, for example, the instrumentation may not be adequate if it was designed to measure only within a particular frequency band or range of voltage levels. More critically, one may come away from such a study with erroneous data, due to some minor error that could have been noted and corrected in the field if one had recognized the aberrance of the readings at the time.

This is an aspect of measurement technique, of any sort, that is understood by experienced practitioners, but which is seldom formally discussed. Measurement in the field involves a great many sources of error that are not present in the laboratory, but laboratory accuracy is desired, or even demanded, from most field studies. The engineer in the field cannot afford simply to assume that his data is correct because it's what his meter reads; he must relate it to prediction. When he returns from the field and analyzes his data, what does he do if his measurements differ from calculation by about 20 dB? Had the measured field actually been that different, or had he perhaps incorrectly noted a step-attenuator setting?

As a practical matter, one normally commences a power density measurement program with a broadband measurement device, such as those now manufactured by NARDA and Holaday Industries. Such instrumentation affords a quick answer under most circumstances. For example, one will usually know the frequency under study around an earth station, and, if one is using equipment that is properly responsive at such a frequency, one will normally observe values well below anyone's idea of a hazard threshold. Indeed, the problem is usually the inability to obtain an on-scale reading so that one may know that the meter is at least functioning.

It is often difficult to decide how to report the measurement data. The area surrounding the transmitting antenna may be rather large and irregular. If one feels the need to provide an abundance of data, one might record the power density level at the intersections of an imaginary three-dimensional grid laid out within the area. Alternatively, one might make measurements at intervals along several radials from the antenna. However, one most often probes the area somewhat randomly and notes where the highest values are observed. This is a less than elegant approach, but it accomplishes the purpose. Where one has an assistant at the site, it is generally convenient to record the data in narrative form, with entries such as "along the south fence, the average level is about two microwatts per centimeter squared, with the maximum being about ten microwatts per centimeter squared about three feet from the east end of the fence."

There is some controversy about how to handle isolated "hot spots." Such localized higher power densities are normally associated with metal objects and can often be higher by a factor of more than ten than the power density level only a few inches away. It is our practice to note such hot spots and leave the



interpretation of their importance to someone in the medical or biological field. Since the ANSI standard is based on whole-body absorption, the fact that the standard may be exceeded within a volume of a few cubic inches ought not to be significant unless the hot-spot level substantially exceeds the permissible value.

It should be noted in this regard that the standard requires that power density be measured no closer than 5 cm from an object. When using typical broadband probes, one easily meets this standard because the probe is surrounded by a Styrofoam ball with a 5 cm radius. Otherwise, one should exercise care not to get too close to such objects.

At sites where there are a number of transmitters, and the ANSI standard appears to be exceeded, based on a broadband study, it is necessary to determine the frequency makeup of the combined field. One way to do this, where possible, is to have transmitters turned on and off. It will often be found that virtually all the measured energy is from a single source. With luck, one may find that the standard is not exceeded for this particular frequency. If one has no control over the various transmitters, the sources of significant energy levels would have to be determined with a tunable receiver or a spectrum analyzer.

A somewhat exotic approach to such close-in measurements is to bypass the measurement of electrical and/or magnetic field and instead make direct calorimetric measurements. Since the ANSI standard is based on absorption that produces a specific heat rise, such data goes to the heart of the matter and leapfrogs the question of whether or not the radio frequency energy would couple with a human body to produce heating. This sort of approach is not complicated, but an electrical engineer should seek advice from a scientist familiar with such laboratory techniques before embarking on such a study.

Our firm has conducted a number of power density surveys at multiple transmitter sites. Our earliest studies were made in Chicago at the John Hancock Center and at the Sears Tower in 1975 and 1976. There were two important factors in those days that are no longer applicable. First, there were no commercially available instruments of acceptable accuracy, so we obtained the services of the National Bureau of Standards, which had its own excellent instrumentation. Second, the ANSI standard at that time was 10 mw/cm<sup>2</sup> at all frequencies. While the current ANSI standard is doubtless more defensible in scientific terms, it was certainly convenient to work with the old standard, since there was no need to identify the frequency being observed, and the threshold was higher than the current standard.

In our first studies, conducted for NAB, we made measurements on the roof and penthouse of each building and in both public observatories. As we expected, power density levels in the observatories were quite low. These findings were particularly interesting to the management of the Sears Tower, since our data resolved a law suit in which it was alleged that a gentleman's pacemaker had failed due to high RF levels in the Sears Tower observatory.

In the roof/penthouse areas, the only power density levels that exceeded the 10 mw/cm<sup>2</sup> reference were associated with non-broadcast facilities and were, in any event, isolated hot spots. This news was particularly helpful to WLS-TV, since it was using a temporary antenna on the Sears Tower and was maintaining its previous main facility at Marina City because it had been assumed that when the permanent facility was constructed at the Sears Tower, workers on the roof would

be exposed to high power density levels. Based upon our data, WLS-TV could abandon the Marina City site and the expense associated with it.

Subsequently, the Chicago Broadcast Antenna Committee ("CBAC"), which is made up of the television stations located at the Hancock Center, retained us to make additional measurements in and on the two antenna stacks that extend 350 feet above the building roof. This study was prompted by the fact that certain tower maintenance projects were being delayed due to uncertainties about the power density levels on the towers.

While we found the power density to be well below the ANSI standard at most locations, there were a number of locations where the standard was exceeded by a substantial margin, and some of these were not necessarily mere hot spots. During the study, we noted a series of hot spots along parallel transmission line runs, and we found that the addition of grounding straps at these locations significantly reduced the fields. On this basis, grounding straps were permanently installed at all appropriate spots, and we then conducted a second set of measurements. We found that the grounding had eliminated many of the problems, although power density had increased at certain other locations. This was, of course, understandable, since we were simply redistributing the energy. However, the result of the grounding treatment was to reduce to a small number the locations with excessive fields. These locations could then be identified for the benefit of maintenance personnel. Further, the study permitted us to establish a plan by which work could take place on any portion of the structure, through the use of auxiliary antennas and/or power reductions, without the need for the constant monitoring of power density.

With increasing concern about the biological effects of RF transmissions, it seems clear that there will be an increasing need for power density measurements. Fortunately, such measurements will usually show that the public is exposed to no danger, but there will be instances in which the ANSI standard will be exceeded. Proper measurements can reveal the exact power density circumstances for a given area so that the problem can be resolved as effectively and efficiently as possible.

It should also be clear that, if one uses his imagination and applies good engineering judgment, it is not difficult to make power density measurements. However, this statement is correct only if one is dealing with a reasonably generous standard.

We all know that it is easier to measure larger quantities accurately than to measure smaller quantities, within reasonable bounds. Indeed, a fundamental aspect of the uncertainty principle in particle physics is that the act of observing a small quantity affects the quantity that is being observed. While this particular problem is not encountered in power density measurements, we do face the difficulties of reradiation, with the resulting focusing effects and hot spots. We must also identify frequencies when total power density exceeds the lowest threshold in the standard.

One manufacturer is developing an instrument that incorporates a response which matches the ANSI standard, so that frequency identification will not be required unless the standard is actually violated. This could be a significant advantage, but, where the standard is exceeded, the frequencies of the contributing signals would still have to be determined if one intended to do something about the problem.

The fact remains that the lower the level at which the hazard standard is set, the more difficult are the measurements to make. When the standard was 10 mw/cm<sup>2</sup>, one could ignore 2 mw/cm<sup>2</sup> hot spots. Under the present standard, those 2 mw/cm<sup>2</sup> hot spots must be considered, but 0.2 mw/cm<sup>2</sup> hot spots can be ignored. If the ANSI standard should be lowered by a factor of ten, as has been suggested, then those 0.2 mw/cm<sup>2</sup> hot spots would require study. If, heaven forbid, an even lower standard is adopted, even lesser aberrations in power density could become critical.

This is not to suggest that the adopted standard should be higher than the facts support, simply to make measurement easier. On the other hand, there may be a tendency to resolve uncertainties by lowering the standard, even though such a lowering has not been justified. The adoption of an unnecessarily low standard not only puts more RF facilities in violation, but it makes it more difficult to determine whether or not a violation exists.

The ANSI standard was intentionally conservative, and, on its adoption, it incorporated a safety factor of about ten. While our firm is not qualified to express opinions on the biological effects of any particular level of power density, we are formally certified as readers of the English language, and we have read no indication that health hazards exist due to broadcast operations even at the ANSI standard levels.

From the standpoint of the person who must measure power density, we urge the standard setters to refrain from arbitrarily lowering the standard just to satisfy a few dissidents. While such action would make life simpler for the standard setters, it would complicate the lives of the measurers. Based on our measurement experience, the health of the public would be protected in either event; it would just be harder to prove it with the lower standard in place.









**national association  
of broadcasters**