

Scanning - Shortwave - Ham Radio - Equipment  
Internet Streaming - Computers - Antique Radio



# Monitoring Times

A Publication of Grove Enterprises

Volume 28, No. 10  
October 2009

U.S. \$6.95  
Can. \$6.95  
Printed in the  
United States

## Second Guessing the Sun

### Any Surprises for Cycle 24?

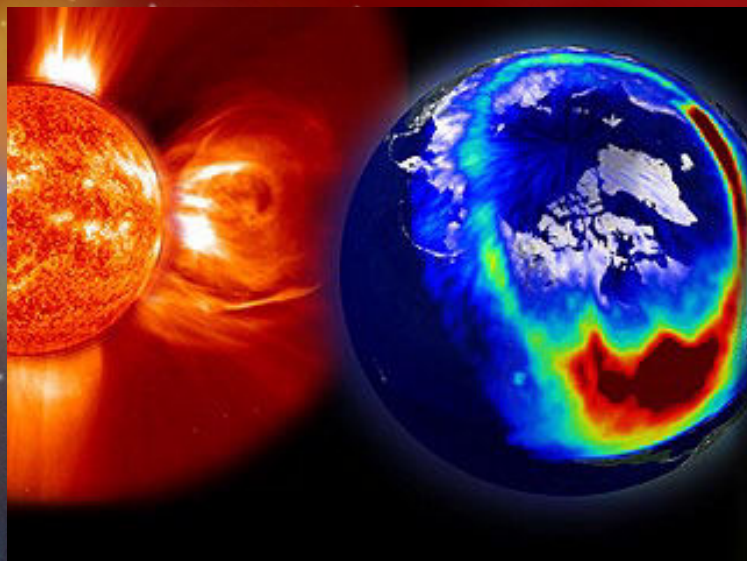

#### **Also in this issue:**

- **Bob Heil's Amazing Electronic Journey: Wurlitzers & The Grateful Dead**
- **The Mystery of Amelia Earhart: Still Searching for Radio Clues**
- **The Story of DZKits**



NOW  
AVAILABLE

# AR-ONE

## Communications Receiver

The AR-ONE gives law enforcement and government professionals total command of frequencies, modes, tuning steps and more. It is possible to tune in increments of one Hz.

**FOR  
PROFESSIONAL  
USE ONLY**



**Monitor Any Frequency  
from 10 KHz to 3.3 GHz**

**Ultra-stable reference  
frequency oscillator (0.1ppm)**

**The AR-ONE is a  
new beginning for  
wide-range monitors.**

*The AR-ONE is designed to support computer controlled operation. Link up to 99 receivers for control by a single PC. The AR-ONE can be used for mobile or fixed monitoring operations.*

Surveillance operations are enhanced. Monitoring multiple frequencies is easier and faster. Computer control gives you maximum flexibility and unleashes the many features found in this advanced technology receiver.

The AR-ONE is the right choice for the new world we now monitor.

- Super wide coverage: 10 KHz ~ 3.3 GHz
- 1000 memory channels
- 10 VFOs
- Monitor AM, NFM, WFM, USB, LSB, CW, Data
- Ultra-stable reference frequency oscillator
- Two RS-232C ports
- Control up to 99 AR-ONE Units with one PC
- Triple conversion superheterodyne front end
- Antenna input level readout
- Adjustable BFO
- High intercept +2dBm (-1 dBm above 2.5 GHz)
- Multi IF signal output (10.7 MHz or 455 KHz)
- Excellent sensitivity

*The AR-ONE is designed for use by the monitoring professional. The AR-ONE is so advanced, you'll be thinking of new applications for its powerful capabilities.*



Authority on Radio  
Communications

**The Serious Choice in Advanced  
Technology Receivers™**

AOR U.S.A., Inc.  
20655 S. Western Ave., Suite 112, Torrance, CA 90501, USA  
Tel: 310-787-8615 Fax: 310-787-8619  
info@aorusa.com • www.aorusa.com

*Available only to authorized users in the USA.  
Documentation required.*

## Advanced Trunking on your PC

- Analog, digital and mixed trunking
- SmartNet, EDACS and MPT1327 modes in one package
- Full APCO P25 implementation (if optional APCO decoder installed)
- System information displays
- Trunking system database
- Control channel logging
- User traffic logging
- Raw data displays and logs

WINRADIO software-defined receivers open new possibilities for monitoring trunked communications, because computer control offers more flexibility and power for processing of trunking signals, with the potential of offering far more facilities and performance than conventional receivers.

In one package, support is offered for the four most common trunking systems: Motorola SmartNet, MPT1327, EDACS and APCO P25 (with optional APCO decoder).

The Advanced Trunking Option is available for WINRADIO WR-G305 and WR-G315 receiver series. The WR-G305 receiver version satisfies the needs of a radio monitoring enthusiast. The WR-G315 version is suited for a serious professional, offering unprecedented monitoring functionality.

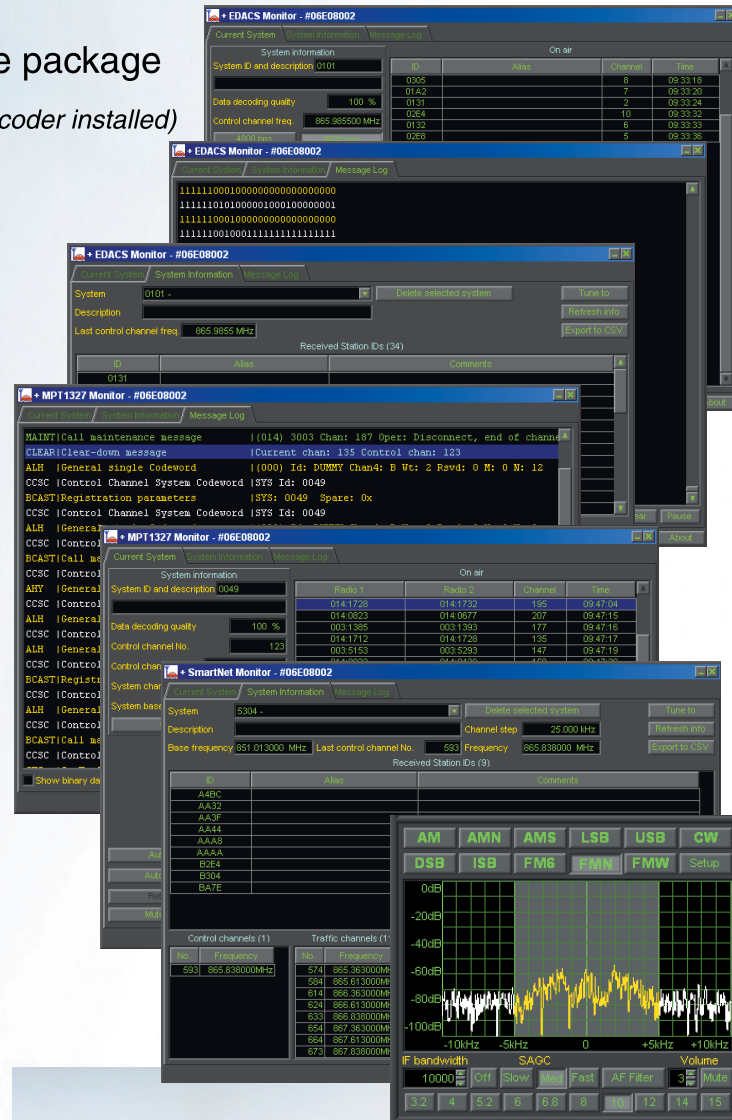



## Second Guessing the Sun:

*What will solar cycle 24 really do? The jury's still out!*

By Tomas David Hood NW7US

Shortwave listeners and hams alike depend on solar activity to fuel their radio hobby. With Cycle 24 now upon us, what will it be like? Some say it could be the beginning of a historically long sunspot drought. Others say there could be no sunspots after 2015. Tomas Hood has looked at all of the predictions and he's found at least one respected scientist on whom we might pin our radio hopes. Cycle 24 may yet hold a surprise worth waiting for.

Hood also lays out the prospects for shortwave listening over the next six months as we transition from the summer to winter DX seasons. Find out when the best times to tune in will happen in your area and where you should be listening.

**On Our Cover:** This artist's illustration shows the relative sizes of – and definitely not the relative distances between – the sun and the Earth and their magnetic fields. NASA/JPL-Caltech/S. Hill

# C O N T E N T S

## First Person Radio:

**In the Right Place at the Right Time .....8**  
By Bob Heil K9EID

In this inaugural column, one ham talks about his extraordinary life and the role that radio played in starting him down a lifelong road of unending interest. Bob Heil K9EID, shows what happens when you combine an ear for music and a knack for electronics. And, he tells what can happen when a young person's curiosity is taken seriously. Inspiration may be all around us; sometimes all we need is a little encouragement and a little luck.

## The Enduring Amelia Earhart Mystery:

**Could unidentified radio signals provide new clues? ..... 10**  
By Eric Beheim

The disappearance of Amelia Earhart has all the elements of a great mystery, to say nothing of a motion picture: A daring young woman in her prime, flying over a vast ocean, disappears forever amid a never-ending cloud of controversy. Eric Beheim picks up the threads of her disappearance, and takes us day-by-day from the moment her plane is no longer in contact with Coast Guard cutter *Itasca*. Did she and her navigator make a crash-landing on an uninhabited Pacific atoll? Did they go down to a deep, watery grave? Why couldn't anyone pinpoint their location? Didn't anyone hear their call?

## Living the Dream:

**One ham's effort to update the tradition of kit building ..... 14**  
By Ken Reitz KS4ZR

During the 1960s radio kits were all the rage. Not only were they fun to put together, but budding hams as well as veteran hams could learn a lot about their hobby while they did so. Now, a ham who grew up with his trusty Heathkit GR-64 wants to introduce another generation of hams to this aspect of the radio hobby. But, he's added a digital twist. Brian Wood W0DZ wants you to build the most sophisticated radio available.

## Reviews

**The Degen DE1103/Kaito KA1103:  
A Second Look**  
By Eric Bryan



Wait a minute, are we reviewing the Kaito KA1103 again? Are we crazy? Yes! We're still crazy about this little portable all-band, all-mode, can-do shortwave radio. But, this time Eric Bryan looks at its China-factory look-alike and, after using it daily for the last four years, explains the ins and outs of getting the most out of it. Sure, it's tricky, but at the price, so worth it!

## TABLE OF CONTENTS

### Departments:

Letters .....	4
Communications .....	6
Stock Exchange.....	76
Advertisers Index.....	76

### First Departments

<b>Getting Started</b>	
<b>Beginners Corner</b> .....	20
<i>Complain, Complain, Complain: the FCC takes your complaints seriously</i>	
<b>Global Net</b> .....	22
<i>Internet Radio Gadgets Galore!</i>	
<b>Scanning Report</b> .....	24
<i>Keeping Tabs on Your Community</i>	
<b>Ask Bob</b> .....	27
<b>Utility World</b> .....	28
<i>Monitoring Mexico's Green Angels</i>	
<b>Digital Digest</b> .....	31
<i>Decoding Software and the Hobby Market</i>	
<b>Programming Spotlight</b> .....	32
<i>Be Afraid, Be Very Afraid</i>	
<b>Global Forum</b> .....	34
<i>Working for Radio Habana Cuba vs China Radio International</i>	
<b>Broadcast Logs</b> .....	37
<b>The QSL Report</b> .....	38
<i>'Tis the Season...of the Witch</i>	
<b>English Language SW Guide</b> .....	39

### Second Departments

<b>Milcom</b> .....	52
<i>European Military HF Communications</i>	
<b>AM Bandscan</b> .....	54
<i>"Translating" AM and FM</i>	
<b>BOATS, Planes, Trains</b> .....	56
<i>Marine VHF Winter Freeze-Up</i>	
<b>Below 500 kHz</b> .....	58
<i>Underground VLF and Uncovering Noise</i>	
<b>Outer Limits</b> .....	59
<i>Thirty-four Venezuelan Radio Stations Pirates</i>	
<b>On the Ham Bands</b> .....	60
<i>10th Month - 10 Meters</i>	

### Technical Departments

<b>Antenna Topics</b> .....	62
<i>A Noise that Improves Antenna Performance</i>	
<b>Radio Restorations</b> .....	64
<i>The S20-R: It's a Wrap!</i>	
<b>On the Bench</b> .....	66
<i>"Sky-Wires &amp; Inhalers" Part 1: Catching Photons</i>	
<b>Sky Surfing</b> .....	68
<i>VLF Detection of the Sun</i>	
<b>First Look</b> .....	70
<b>What's New</b> .....	74

## EDITORIAL STAFF Email [firstlast@monitoringtimes.com](mailto:firstname.lastname@monitoringtimes.com)

TJ "Skip" Arey .....On the Ham Bands  
 Rachel Baughn .....Letters to the Editor  
 Kevin Carey.....Below 500 kHz  
 Mike Chace.....Digital Digest  
 Marc Ellis .....Radio Restorations  
 Bob Grove.....Ask Bob  
 Glenn Hauser.....Global Forum  
 Jeffrey Lichtman.....Sky Surfing  
 Chris Parris.....Fed Files  
 Ken Reitz .....Features Editor  
 .....Beginners Corner  
 .....Communications  
 Iden Rogers .....Planes  
 Clem Small .....Antenna Topics

Doug Smith .....American Bandscan  
 Hugh Stegman .....Utility World  
 Ernest Robl .....Trains  
 Gayle Van Horn.....Frequency Manager  
 .....Broadcast Logs  
 .....QSL Corner  
 Larry Van Horn .....Milcom  
 .....Reviews Editor  
 .....What's New?  
 Loyd Van Horn.....GlobalNet  
 Dan Veeneman.....Scanning Report  
 Ron Walsh .....Boats  
 Fred Waterer .....Programming  
 .....Spotlight  
 George Zeller .....Outer Limits



MONITORING TIMES  
 (ISSN: 0889-5341;  
 Publishers Mail Agree-  
 ment #1253492) is  
 published monthly by  
 Grove Enterprises, Inc.,  
 Brasstown, North Caro-  
 lina, USA.

Copyright © 2009 Grove Enterprises, Inc.  
 Periodicals postage paid at Brasstown,  
 NC, and additional mailing offices. Short  
 excerpts may be reprinted with appropri-  
 ate credit. Complete articles may not be  
 reproduced without permission.

Address: 7540 Highway 64 West,  
 Brasstown, NC 28902-0098  
 Telephone: (828) 837-9200  
 Fax: (828) 837-2216 (24 hours)  
 Internet Address: [www.grove-ent.com](http://www.grove-ent.com) or  
[www.monitoringtimes.com](http://www.monitoringtimes.com)  
 Editorial e-mail: [editor@monitoringtimes.com](mailto:editor@monitoringtimes.com)  
 Subscriptions: [order@grove-ent.com](mailto:order@grove-ent.com)

Subscription Rates: \$32.95 in US; \$42.95  
 Canada; and \$58.95 foreign elsewhere,  
 US funds. Label indicates number of is-  
 sues left. Renewal notice is cover sheet 3  
 months before expiration. See page 76  
 for subscription information.

#### WRITE FOR MONITORING TIMES:

See how at  
[www.monitoringtimes.com/  
 html/write\\_for\\_mt.html](http://www.monitoringtimes.com/html/write_for_mt.html) or  
 write to [editor@monitoringtimes.com](mailto:editor@monitoringtimes.com)

Postmaster:  
 Send address changes to *Monitoring Times*,  
 7540 Highway 64 West, Brasstown, NC  
 28902-0098.

#### Disclaimer:

While *Monitoring Times* makes an effort to ensure the  
 information it publishes is accurate, it cannot be held  
 liable for the contents. The reader assumes any risk  
 for performing modification or construction projects  
 published in *Monitoring Times*. Opinion or conclusions  
 expressed are not necessarily the view of *Monitoring  
 Times* or Grove Enterprises. Unsolicited manuscripts are  
 accepted. SASE if material is to be returned.

**Subscription Questions?**  
[belinda@grove-ent.com](mailto:belinda@grove-ent.com)

#### Owners

Bob and Judy Grove  
[judy@grove-ent.com](mailto:judy@grove-ent.com)

#### Publisher

Bob Grove, W8JHD  
[bobgrove@monitoringtimes.com](mailto:bobgrove@monitoringtimes.com)

#### Managing Editor

Rachel Baughn, KE4OPD  
[editor@monitoringtimes.com](mailto:editor@monitoringtimes.com)

#### Assistant and Reviews Editor

Larry Van Horn, N5FPW  
[larryvanhorn@monitoringtimes.com](mailto:larryvanhorn@monitoringtimes.com)

#### Features Editor

Ken Reitz  
[kenreitz@monitoringtimes.com](mailto:kenreitz@monitoringtimes.com)

#### Art Director

Bill Grove

#### Advertising Svcs.

Beth Leinbach  
 (828) 389-4007  
[bethleinbach@monitoringtimes.com](mailto:bethleinbach@monitoringtimes.com)

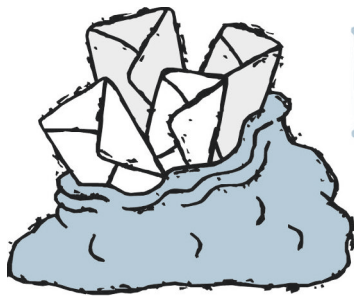

# LETTERS

editor@monitoringtimes.com

## MT Welcomes Ken Reitz to Its Editorial Staff

Long-time *MT* readers will recognize the name of Ken Reitz which has graced the bylines of countless features for more than 20 years. Those of us who go back as far as the *MT* conventions in Knoxville, TN, and Atlanta, GA, recall Ken's offerings at the popular seminars. His talks were well attended, and with good reason – Ken knows his stuff and presents it in an interesting and informative manner.



A resident of Virginia, Ken is an Extra-Class amateur radio licensee (KS4ZR). But ham radio is just one aspect of this multi-faceted writer/editor. We expect

to see much more of his writing in our pages in the coming years.

Ken's appointment as Feature Editor will help relieve the load of that specialty category from *MT*'s Chief Editor, Rachel Baughn. Rachel admits that her editorial contributions to *MT* for more than nearly three decades has created quite a vacuum in her personal time. She can thank Ken for giving her a little more time for church and hobbies!

But Ken's professional experience is hardly limited to the pages of *MT*; his credentials wipe a wide swath through the publishing corps. His articles have appeared in two issues of *Consumer's Digest*, covering multiple consumer electronics. Topics included round-ups of hand-held GPS units, and specialty radios such as two-way communications, HD reception, portable shortwave listening and weather broadcast monitoring.

An intermediate professional placement found Ken as a writer/editor for the communications department at the University of Virginia School of Law, where his articles were disseminated to a variety of legal offices and institutions.

As a columnist for *Satellite Orbit* magazine for several years, Ken contributed monthly columns and answered subscribers' questions. But as our intrepid, frequency-hungry readers will respect, he also kept viewers on target with his channel and transponder listing updates.

However, even before that, Ken's interest in satellites was manifest. He was responsible for writing feature articles and product reviews for several satellite magazines, including *Satellite Entertainment Guide*, *Satellite Direct*, and *MT*'s former sister magazine, *Satellite Times*.

Sensing the need for additional information for satellite devotees and aficionados, he even founded his own publishing company, Xenolith Press. It was through this endeavor that he wrote

and published "*The Satellite Television Sourcebook*," and "*The Baseball Listener's Guide*."

Ken also has a lengthy background in commercial broadcasting. He was heard on-air over much of the southeast for many years as a professional announcer for WPAS-AM, Zephyrhills, FL; WLPR-FM, Mobile, AL; as well as WOKA-AM and WDMG-AM, Douglas, GA. His duties there included news editing as well as production of commercials and public service announcements.

It is with great pleasure, and great expectations, that we proudly add the name of Ken Reitz to our editorial masthead.

- Bob Grove, Publisher

## Sky Surfing

Actually, the sky and beyond is the topic of a new column we are testing in response to your interests expressed in our recent readers' survey. This column will cover topics such as amateur satellites and radio astronomy, as in this month's installment. We are glad to have Jeff Lichtman join *Monitoring Times* as a pleasant reminder of when he also wrote for *Satellite Times*. As indicated in his article on page 68, Jeff's business is radio astronomy, as owner and operator of Radio Astronomy Supplies.

Jeff served in the US Army, attached to a Nike Hercules Company, McGregor Missile Range, NM and US Army school at Redstone Arsenal (Marshall Spaceflight Center), Huntsville, AL. He obtained a degree in Electronics and has worked for companies such as Grumman, LEM (Lunar Excursion Module), and Lockheed Martin as an Avionics Technical Writer for the C-130H program.

## Global Forum Completes a Long Run

We will be saying good-bye this month to Glenn Hauser, who has been compiling shortwave and other radio news for the hobby as a labor of love for more years than he would probably like to remember. He has been writing for *Monitoring Times* since 1988, by our records!

Back then, it was a different world when it came to finding and sharing information about stations and schedules and interesting anomalies. Glenn provided an enormous service to all hobbyists – and still does, though that world is changing. Nowadays, such information – including his – is ubiquitous. Glenn's attention to detail and long experience in the hobby is no doubt the reason why his compilations of logs and information now appear in almost every club bulletin, as well as in *World of Radio* and other web pages. We know you will continue to appreciate Glenn's contributions and irascible style wherever you find them.

## EDITOR'S SOAPBOX

By Ken Reitz KS4ZR  
Feature Editor  
kenreitz@monitoringtimes.com

### Introducing First Person Radio

The *MT Letters* page is undergoing a transition. In addition to publishing letters from readers, this page will feature the "Editor's Soapbox" within which any of *MT*'s editors will be able to direct the attention of readers to various points of interest. For instance, last month, editor Rachel Baughn called your attention to the expansion of *MTXpress* to include *MTXtra*'s expanded language coverage.

I'd like to highlight a new column being added this month called "First Person Radio." The idea is for a different person each month to tell about their personal experience with radio: how they got started, what keeps them interested, and how their involvement with radio has changed their lives.

This month's column is written by Bob Heil K9EID, known to most radio enthusiasts for his line of microphones for the amateur radio industry. But, Bob, like so many others in this hobby, is multidimensional. He has enjoyed an association with some of the biggest names in rock music over the last 40 years, groups such as the Grateful Dead and the Who, thanks to his pioneering work in concert sound re-enforcement.

He's also known for his product innovations such as his TalkBox that launched 70s rocker Peter Frampton to the top of the charts. And, Bob is a renowned organist who got his own start as a paid musician playing clubs as a teenager. I think you'll find his story interesting.

We'd like to hear your story. You don't have to be famous to appear in *First Person Radio*, you just have to have an interesting story. So, write us and tell us how radio inspired you and how it has changed your life. You may be writing a future First Person Radio column. If your story is accepted, you'll even get paid!

I'd also like to draw your attention to the new *MT* web page [www.monitoringtimes.com](http://www.monitoringtimes.com). It's been given a total makeover. We've added many new features, but have kept many of the old ones that you've used most, such as the *MT Reference Library* and the archive of *MT Reviews*.

## Coming Up: Foreign Languages

One thing *Monitoring Times* has never done on a regular basis is to present station schedules for non-English broadcasts. That has changed. *MT Express* subscribers already have available to them, as part of their \$19.95 subscription, a 114-page pdf file dubbed *MTXtra Shortwave Broadcast Guide* to broadcast schedules in all languages, including English.

Starting next month, *MT* print subscribers will get a small foretaste of these foreign language schedules. We will publish a few pages of schedules from four or so of the major languages on a rotating basis, so that you won't

be entirely left out. However, if you, as a print subscriber, would like access to the complete online schedules, it's only an additional \$11 to add *MT Express* to your print subscription. Just go to [www.grove-ent.com/MT.html](http://www.grove-ent.com/MT.html) for all your subscription options or call 1-800-438-8155.

## Perseus Review Updated

A couple of folks called to our attention a correction and an update on the Perseus Software Defined Radio review by Larry Van Horn that appeared in our September issue. First the correction: a misplaced tab appeared in the ratings table between the 1 and 0 for the dynamic range, which should have read "10".

The article also indicated that the Perseus could display and record bandwidths up to 800 kHz wide, which is what the reviewer experienced and the manual specified. However, we are informed by both the manufacturer and the Perseus user's group that the radio now has actually has twice that capacity – an incredible 1600 kHz of spectrum to display and record and explore at your leisure!

## Handheld J-Pole

By the way, in an unrelated correction, "Bob, W8JHD" should not have appeared at the end of last month's *Letters* item about baseball. That call belongs to Bob Grove, and the sign-off was a remnant from the following story which was cut from last month's column.

Dear Bob Grove,

"I needed to get a little more 410 MHz



signal in my home for my BCD396XT, so I built a j-pole antenna on a Binding-Post/BNC connector. I got the design and formula from [www.hamuniverse.com/jpole.html](http://www.hamuniverse.com/jpole.html)

"Below are pictures of my j-pole. The materials used are:

- (1) Fine piano wire (the upper segments of the 1/4-wave and 1/2-wave elements. The lower segments of the two elements are below the feed point. Of course, I did not include the 20" portion for mounting on a mast (as in K4ABT's diagram).
- (2) Vinyl tubing for separators
- (3) Tie wraps for the separators and anchoring elements to binding posts

- (4) A small piece of stiff, pliable picture-hanging wire for the bottom halves of the antenna elements.

My question: Am I true to form with K4ABT's design? I have the element separation according to his antenna calculator. I do not have any antenna measurement gear and I am wondering if I am doing anything wrong in the design.

Does a J-Pole need a ground plane?

I get better signal than my stock antenna, but do not know what the gain of a J-Pole is over a 1/4-wave antenna.



Peter Leong

Hi, Peter:

"I certainly see no fault in the construction you've done. If there is any weak spot, it would be in the plastic BNC adapter which has some stray wiring rather than shielded channels, possibly becoming inductively reactive at those short wavelengths. But the proof is in the pudding, and if it works better than a quarter-wave whip, it's doing its job.

"Theoretically, the J-pole has a gain of 1.5 dB over a quarter-wave ground plane. Your photo reveals you've done a neat job!"

Bob W8JHD



# Listening is only half the fun... POPULAR COMMUNICATIONS is the other half!

If you enjoy radio communications in all its variety, you'll love

## POPULAR COMMUNICATIONS

Since 1982 Pop'Comm has delivered thousands of pages of great reading for both the radio enthusiast and the professional communicator.

Every month Pop'Comm is crammed with scanner frequencies, shortwave listings, broadcast and utility loggings, radio nostalgia, and technical information. Plus you'll find great features on amateur radio, public service communications, DXing, pirates, clandestines, and much, much more.

**YES! Enter my subscription to Popular Communications today!**

Name \_\_\_\_\_

Address \_\_\_\_\_

City \_\_\_\_\_ State \_\_\_\_\_ Zip \_\_\_\_\_

Check  MasterCard  VISA  AMEX  Discover

Card No. \_\_\_\_\_ Expires \_\_\_\_\_

Signature \_\_\_\_\_

	USA	Canada/Mexico	Foreign
1 Year	<input type="checkbox"/> 32.95	<input type="checkbox"/> 42.95	<input type="checkbox"/> 52.95
2 Years	<input type="checkbox"/> 58.95	<input type="checkbox"/> 78.95	<input type="checkbox"/> 98.95
3 Years	<input type="checkbox"/> 85.95	<input type="checkbox"/> 115.95	<input type="checkbox"/> 145.95

Popular Communications, 25 Newbridge Road, Hicksville, NY 11801 • Phone: 516-681-2922 • Fax 516-681-2926

Visit our web site: [www.popular-communications.com](http://www.popular-communications.com)



# COMMUNICATIONS

by Ken Reitz

*“Communications” is compiled by Ken Reitz, KS4ZR (kenreitz@monitoringtimes.com) from news clippings and links supplied by our readers. Many thanks to this month’s fine reporters: Anonymous, Rachel Baughn, Robert Fraser, Bob Margolis, Brian Rogers, Greg Smith, Larry Van Horn, Ed Yeary, George Zeller*

## AMATEUR RADIO/SHORTWAVE

### ARRL Nails FCC on BPL Issues

The American Radio Relay League (ARRL) fought the FCC’s initial endorsement of Broadband over Power Lines (BPL) for years and now it’s finally won. David Summer K1ZZ, ARRL Chief Executive Officer, writing in the August issue of *QST* magazine, detailed the League’s four year effort to get the FCC to come clean on how they reached their original conclusions. Having to resort to Freedom of Information Act filings and finally dragging the Commission kicking and screaming to court, the murky truth of the Commission’s deception was finally exposed.

In part, the Commission used an unrealistic yardstick to measure interference to confirm their original decision to okay the service. According to the ARRL, the Commission then attempted to conceal the methodology from public scrutiny. You can read the details here: [www.arrl.org/news/features/2009/08/01/10909/](http://www.arrl.org/news/features/2009/08/01/10909/) The ARRL’s actions have re-ignited the smoldering BPL debate and should force the industry to look again at its usefulness.

### KY County Sponsors Ham Class

A report from the Associated Press said that 25 people showed up for ham radio classes that began the first of August in Owensboro, Kentucky, hit hard last winter by an ice storm that saw county communications services knocked out for a day and a half. Local hams received widespread media coverage when they stepped in last winter to provide a vital communications link for the county. Local officials hope the current five week course will produce yet more amateur volunteers ready for this winter’s action.

### DRM-FM Tested in Paris

Digital Radio Mondiale reports that its DRM Plus technology has been successfully demonstrated on an FM station broadcasting north of Paris, France. This was the first VHF band test of the DRM+ system, broadcast on 64.5 MHz and received 6 miles away, in 5.1 Surround Sound stereo. The broadcast was accompanied by DRM’s Dynamic Labels, JournalLine text information, and SlideShow graphic images, which were received on the DRM-equipped radio.

Following the demonstration, journalists were invited to experience 5.1 Surround Sound reception in a car touring the area.

The DRM+ system is not expected to challenge iBiquity’s franchise on U.S. FM spectrum, but is of big interest to Eurozone broadcasters and shows the technological difference between the two systems. DRM is an open-sourced digital

system, while iBiquity’s HD-Radio is a commercial, proprietary system.



*Listening to DRM Plus at a public demonstration near Paris, France. (Courtesy: Digital Radio Mondiale)*

## BROADCASTING

### DTV Coupon Program R.I.P.

At long last our national DTV nightmare is over. Final statistics, according to TV Technology.com, show that almost 34 million DTV coupons were redeemed, though 64 million coupons were requested. Congress appropriated some \$1.5 billion for the program and has more than \$300 million left in the cash drawer. According to the report, the program peaked on July 31, the last day to request a coupon, when almost 170,000 coupon requests were made.

Word is now trickling in from the two satellite TV systems that may indicate how much of a bump the two might have received as a windfall from the general DTV confusion. A Reuter’s article from August 10 showed that second quarter profits for DISH Network fell, while subscribers numbers rose, just barely. The company, which lost subscribers the previous two quarters, claimed a net of 26,000 for the quarter, bringing their overall subscription total to 13.8 million.

Meanwhile, DISH competitor, DirecTV, added 224,000 net subscribers to bring its total to 24.2 million. The two satellite companies’ big advantage against cable-TV systems, High Definition-channels, has been countered by cable’s rapidly growing assortment of HD-channels, expanded video-on-demand platforms, high-speed digital internet access, and telco combinations that neither DISH nor DirecTV can match. DirecTV’s advantage over DISH stems from being able to offer Major League Baseball and NFL football channels.

### FL Reading Service, Funding Victim

The Orlando *Sentinel* reported on June 16 that state budgets were forcing as many as eight

radio stations across Florida to drop their radio reading services for the sight-impaired. While some will replace their local readers with the satellite-delivered national service In-Touch Radio Network, that service will not provide local news stories.

At a time when technology has made possible more room to broadcast such services – multi-casting on HD-Radio, SAP channels on TV stations, and even old-fashioned Subcarrier Authorization – funding cuts have turned the sight-impaired into second class citizens.

### Recording Artists Seek FCC Help

An article in the Washington *Post* from August 11 examines the problem of royalty payments for music played on conventional radio. According to the piece, a group of recording artists, calling itself “MusicFirst Coalition,” has asked the FCC for help.

The trouble started when the group sought to advertise on radio stations to promote a bill that would require a change in how radio stations would make royalty payments to artists. But, radio stations refused to run the ads, and the group complained to the FCC. The National Association of Broadcasters is against the proposed bill, saying that stations would go out of business or switch to an all-talk format. The FCC said it would study the issue.

## SATELLITE

### ISS to De-orbit in 2016?

Despite the hoopla over the 40<sup>th</sup> anniversary of the Apollo moon landing and the fact that there’s little else on NASA’s manned spaceflight agenda, an article in the Washington *Post* from July 13 reported the comments of the program manager for the International Space Station (ISS), saying that the ISS could be de-orbited in the first quarter of 2016 unless funding is found to keep it flying.

According to the article, the ISS is caught between the Space Shuttle’s retirement next year, with no replacement in sight, and the huge



*Possible victim of budget cuts, public indifference and lack of American vision, the International Space Station could be on borrowed time. (Courtesy: NASA)*



cost of keeping the space station operating at a time when budgets are tight and a new direction for American space participation has yet to be defined.

### New Satellite Finds Earth-like Planet

The New York *Times* reported August 6 that NASA's Kepler satellite, launched last March, discovered its first planet after just 10 days on the job. While scientists had earlier known about the planet, the satellite's task is to scan the skies looking for just such objects. The fact that it had so quickly reported the planet's location encouraged scientists that the design of the satellite was right on the money.

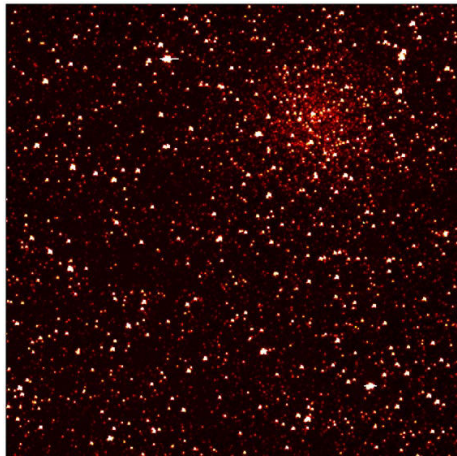

*Eight billion year old star cluster in the Milky Way and 13,000 light years away, NASA's Kepler satellite's first light image. (Courtesy: NASA)*

### Satellite Messenger from Space

Now there's truly no hiding place if someone wants to send you a text message and you're equipped with a SPOT Satellite Messenger. The company, a subsidiary of Globalstar, provides life-saving communications technology that lets users communicate from anywhere on the globe. Previous models have been one-way devices designed to send a distress signal to the company's headquarters where the user's location is quickly determined and official rescue services notified.

Their new Satellite Messenger allows users to send and receive text messages no matter where on Earth they are and without the use of cell phone technology. According to a company press release, the SPOT messenger will cost \$150, with monthly and multi-year service subscriptions available.



*Original SPOT Tracker, now available with text messaging. (Courtesy: SPOT, Inc.)*

### New In-Flight Wi-Fi Gets FCC OK

In-flight magazines may be an endangered species if a company called Row 44 becomes a success. The company will equip airliners across the U.S. to provide satellite-based, in-flight Wi-Fi service to passengers. According to a report

in *Information Week*, Row 44 will provide high-speed internet service through transponders leased on geostationary satellites.

But, Row 44 is not the first. AirCell's Gogo in-flight service, which uses land-based, cell phone technology, has already seen installation in all of AirTran's fleet as well as American, Delta and Virgin America.

Despite these advances in in-flight transmissions, use of cell phones is still banned by the FCC.



*High power transceiver for Row 44's In-Flight Wi-Fi, up-converts the signal from 950-1450 MHz range to 14.0 to 14.50 GHz. (Courtesy: Row 44)*

## PUBLIC SERVICE

### PA County Fed Up with "OpenSky"

Lancaster County (PA), after nearly 10 years of frustration, has given up on M/A-Com's "OpenSky" communications system for its county radio services, according to an article in LancasterOnline.com.

Burdened by expensive equipment costs, bankrupt contractors, technical glitches and hassles with software upgrades; the county was forced to throw in the towel, having spent more than \$13 million on the poorly functioning system.

The county has yet to choose a different system, but believes it can complete the digital transition for less than the \$35 million originally budgeted in 1999, according to the report.

### CTA Bootlegger Arrested

A man, apparently using a stolen Chicago Transit Authority (CTA) radio and accused of using it to break into frequencies used by the CTA, was arrested in Chicago by the FBI. According to an article in the Chicago *Tribune* from August 4, the man, posing as a dispatcher for more than a year, made more than 300 transmissions, sometimes giving bogus instructions to train operators. The man and his brother were arrested when they tried to collect a reward for turning in a stolen CTA radio.

### Mall Radio Jammer Busted

A report in the Ventura County (CA) *Star*, tells of the arrest of a man who holds a GMRS license, suspected of breaking into radio frequencies used by The Oaks Mall in Thousand Oaks, California, and broadcasting obscenities. According to the article, FCC agents and Ventura County Sheriff's officers found the alleged perpetrator as he was making demands to security officers working at the mall.

FCC documents show the search for the perpetrator began when the local FCC Field

Office received an interference complaint from the manager of mall security. FCC investigators located the source of the interference as coming from a repeater located within a secured radio communications facility on Oat Mountain in the Santa Susana Mountains. The investigators found radio equipment at the site used to transmit the signal including a beam antenna pointed in the direction of the mall.

The next day FCC agents, monitoring the repeater frequency, attempted to locate the direction of the originating signal source while mall authorities kept the subject talking on the frequency. At that point the subject switched off his mike and plugged in the audio from the local NOAA weather radio station, totally jamming the repeater frequencies. Using direction finding gear, FCC agents located the originating signal as coming from a vehicle parked across the street from the mall.

The FCC has fined the man \$24,000. Additional criminal charges may be pending.

## FCC ENFORCEMENT

### Companies Cited for Selling Illegal Gear

A Spokane, Washington store known as "The Spy Store," has been cited by the FCC for selling a product capable of jamming GPS devices. According to FCC documents, the store sold some 90 of the devices through its internet web site over a period of a year and a half.

The store said it had stopped selling the device after being told by the FCC the unapproved devices were illegal in the U.S. The FCC warned the company that additional sales would result in a fine of \$16,000 for each subsequent violation or each day of continuing violation.

A similar citation was issued to a San Jose, California business, "Future Hobbies," for selling audio/video transmitters capable of operating on restricted frequencies. That company sold the product for a similar amount of time and was given the same warning.

Illinois-based FM equipment seller, Inter Tech FM, was hit with a \$22,000 fine for "marketing unauthorized FM broadcast equipment in the United States," according to FCC documents published July 8, 2009.

## Discover Longwave!

### BeaconFinder II Directory

- 75+ pages, ready for 3-ring binding
- Covers 0-530 kHz spectrum
- Lists 100's of Beacons
- \$13.95 Postpaid



### Sounds of Longwave

- Discover the intrigue of LW
- Hear Natural Radio, Milcom, WWVB, Beacons, Euro-BC, Lowfers, & more!
- \$13.95 Postpaid (Specify CD or Cassette)



Kevin Carey, Box 56, W. Blmfld, NY 14585

# IN THE RIGHT PLACE AT THE RIGHT TIME

By Bob Heil K9EID



I am extremely fortunate that in 1955 one of my high school classmates introduced me to amateur radio. He was studying Morse code and invited me to join him. I could never have guessed then that amateur radio would become my college education.

## Doorway to the Future

When I was just 15 my loving parents bought me a wonderful Harvey Wells TBS 50D transmitter, a Hallicrafters SX 99 receiver and an RME 152A converter that allowed me to operate 6 and 2 meters. It was my luck to enter amateur radio at the height of a huge sun spot cycle that made it possible to make 6 meter contacts almost daily - worldwide. It was an amazing time and I lived the very limits of the Technician Class license I had earned.



*KN9EID and later K9EID original shack circa 1956*

One night, a few months after getting my license and getting my feet wet on the VHF bands, I heard a very strange signal on the low end of six meters. After trying to understand the horrible audio coming from the SX 99, I discovered it was SSB [single-side band] on six meters! Holy smokes, in those days there were very few SSB stations on the HF bands and here was someone on six meters. The station turned out to be Larry Burrows K0DGE in St. Louis, about fifty miles away. Each night we'd get together on that same frequency and he would do adjustments on his rig. I was fascinated by this nightly experimentation and he was glad to find someone who would give him reports as he made the changes to his home brew rig.

Once, Larry invited me to visit him at his workplace. My mother made a weekly trip to St Louis to take me to my theatre organ lesson at the Fox Theatre, and after one of those lessons she drove me to Larry's work address. We discovered that he was the chief engineer of the 50kW AM station KMOX-CBS radio! Larry invited us in, showed us around and on one of his work benches I saw a new 6 meter SSB transmitter he was building.



*K9EID vintage gear includes original Harvey Wells transmitter and Hallicrafters SX 99 receiver*

I asked him if he would build one of those for me. His answer was quick and firm. "No, but I will *teach* you how." And so it began. On the back benches of CBS radio Larry taught me the resistor color code; what a condenser was and did; how to use a Greenlee punch; a nibbler, and of course, how to solder! The thrill of being able to layout a design, pick out the right size Bud chassis, Stancor transformer and end up with a transmitter that allowed me to talk to the world, just cannot be described in words. It truly *was* the beginning of my electronic education.

## Studying the Wurlitzer and Building Gear

Meanwhile, my career as a theatre organist blossomed. I became the protégé of world renowned theater organist Stan Kann, who is still performing at the Fox Theatre. As a substitute organist there, I had lots of time in between the shows - time that I could spend working on that back bench at KMOX where Larry continued to help me learn about receiver design, transmitters and of course, antennas.

In 1959 I began a paying gig playing the theatre organ in a restaurant in St Louis - right across the street from the Mosley antenna factory. The job required playing four hours a night, six nights a week so I still had lots of time during the day for building and experimenting.

With the fantastic band conditions of that time, even VHF communications were incredible. One of my most memorable contacts was waking up one morning, stumbling into the radio room, turning on a newly acquired Gonset Communicator. I spun the dial and of course, the band was wide open. So, after listening a bit, I heard a Cuban station, CO2ZX. I called him and he came right back! I got a nice report, logged him and was thrilled. But, as I looked up at the Gonset, I discovered that I had been using the 54" whip that screwed onto the top of the radio instead of the 3 element home brew antenna on the roof that Larry helped me build. I had just worked Cuba on 6 meters from southern Illinois on a 54" whip mounted on top of the transmitter inside the house! I was amazed.

In 1962 I met a representative of the J-Beam antenna company from England. They were looking for someone who could help them with an experiment. They had built a 128 element two meter antenna and wanted to do some testing. I had a spare lot beside our home which would be perfect for this experiment. So, again, my loving parents allowed me to rent a crane and put up this monster array. Using prop pitch motors from a B-29 WW2 airplane, I was able to rotate and tilt the array easily.

By then, I had a Collins 51J4 receiver with a 3B28 home built VHF converter; a Central Electronics 20A (that I built from a kit), that was driving a home brew transmitting converter (that I had written about in an article in 1962 for *CQ* magazine). I had also built a Johnson 6 n 2 Thunderbolt 1200 watt amplifier and all of this was plugged into this 128 element antenna. In addition, I had an 11 element 35' long 6 meter Telrex antenna on a 110' Rohn tower.

My organ playing gig each night gave me lots of time during the day and the early morning hours for radio experiments. But, I was also learning how to "voice" and tune that monster Fox Theatre Wurlitzer which taught me how



*Bob Today with the brass trumpets of the Wurlitzer*

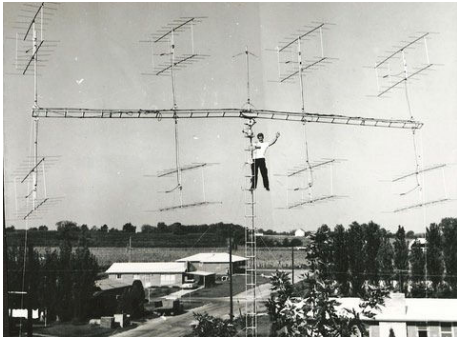

*128 element monster J-Beam 2 meter antenna from 1962*

to listen. Looking back on it, I realize that my amateur radio experience gave me the electronic education while voicing and tuning the Wurlitzer taught me to listen and make things sound better. These two things actually became my college education – thanks to Larry Burrows for showing me the soldering iron and Stan Kann for training my hearing.

## A Truly Dead Experience

In 1966 I opened a small music shop in my home town of Marissa, Illinois. As it turned out, “Ye Olde Music Shop” became a national icon to professional musicians from the Grateful Dead to Jeff Beck and Joe Walsh to the Who. In the shop we were building large sound systems for their international tours. Because of my amateur radio background, I was able to design and build things that had never been built before, but hey, I didn’t know that! I had spent the last 14 years focused on the world of the Wurlitzer theatre pipe organ and amateur radio. I had paid little attention to rock and roll or any other type of music.

But, as these prominent music groups came to Marissa to purchase guitars and amplifiers, I soon learned that no one was bringing any high-powered, low distortion sound system technology to their stages. That all changed when I built several multi-kilowatt sound systems for the Grateful Dead and they asked me to tour with them.

Later, I got together with Joe Walsh WB6ACU, who had been with the James Gang and was launching a solo career. We started doing all kinds of experiments in audio and one of them became the Heil Talk Box that I built for him to play on his Top 40 hit “Rocky Mountain Way.” Later, I gave one of my Talk Box inventions to Peter Frampton for a Christmas present. He used it on his live smash hit “Do You Feel Like We Do,” and the rest is pretty much history.



*With Joe Walsh WB6ACU and new PR-series mic at a recent sound check*



*Bob Heil K9EID in front of the exhibit erected in the Rock and Roll Hall of Fame and Museum*

Drawing from some of my early amateur radio experience, I was able to bring many firsts to the pro-sound industry: modular, multi-channel mixers, modular high-power amplifiers; equalizers, analyzers and the very first quad sound system which I built for the Who for their Quadrophenia tours. Many of these pieces of technology are now on display at the Rock and Roll Hall of Fame and Museum in Cleveland, Ohio. Heil Sound is the only manufacturer exhibited at the museum. None of it would have been possible without the knowledge I learned and the experiences I had from amateur radio.



*The original Heil Talk Box from the early 1970s*



*The HM1000, concert audio’s first modular mixer*

## Return to Ham Radio

In 1980 I became interested in the home satellite television craze. As with TV and the VCR, here is another industry that was started by ham radio operators. Who else could find a small satellite 22,000 miles up in the sky! Over the next nine years I built and installed thousands of C-band satellite TV systems which led Heil Sound to become the Satellite Dealer of the Year in 1989. At that same time Heil Sound was in-

strumental in pioneering real home-theater audio systems that featured Dolby SurroundSound and anticipated the whole HDTV revolution.

About this time I began getting back on the ham bands after a twelve year “quiet time.” But, what I discovered was that the great, articulate audio from the original Collins radios had diminished as new import companies brought boomy and muffled audio that was difficult to understand. Borrowing the equalization board from the console I had built for the Who, I came up with the EQ200 microphone equalizer. This one product began an entirely new category for hams to experiment with and improve the muffled, flat audio of their imported rigs.



*The original EQ-200 ham mic equalizer from 1982*

Not being satisfied with the microphones I was seeing, I designed a tailored response dynamic microphone element, the HC-series that helped thousands of hams improve the articulation of their station’s audio.

A few years ago, Joe Walsh invited me to build a better microphone for him for his live stage performances with the Eagles and a reunion tour with the James Gang. He felt his traditional ball microphone was no longer reproducing his voice and guitar as he wanted. So, with his guidance, the Heil PR series professional microphones entered the market.

I look at a microphone exactly as I do one of those massive antenna systems: they both have forward gain, rear rejection and frequency bandwidth—only at different frequency responses. This design has produced microphones that are now being used by over 50 of the leading concert artists such as Stevie Wonder, Charlie Daniels, Peter Frampton, Joan Baez, and Larry Junstrom—bass player for 38 Special and, as K4EB, an avid ham radio operator.

I am still on the ham bands almost daily and I still have many of those original pieces of vintage gear which I use to check into the AM and vintage SSB nets each weekend. After all these years my passion for amateur radio has never dwindled.

**MT**



*At the time of her world flight in 1937, Amelia Earhart was one of the best-known women in America. She is still considered by many to be the most famous woman pilot of all time.*



# THE ENDURING AMELIA EARHART MYSTERY: Could Unidentified Radio Signals Provide New Clues?

By Eric Beheim

**O**n the morning of July 2, 1937 the U.S. Coast Guard cutter *Itasca* was stationed off Howland Island, a tiny speck in the Pacific, midway between Lae, New Guinea and Hawaii. Beginning at about 2:45 a.m. that day, the *Itasca's* radio room had been receiving messages from an inbound airplane that had taken off from Lae the previous morning. On board were Amelia Earhart Putnam and her navigator Fred Noonan, engaged in an around-the-world flight that had begun in Oakland, California on May 20<sup>th</sup>.

## Last Confirmed Transmission

In order to accommodate the cruising range of her plane, a Lockheed twin-engine Electra that had been specially modified for long distance flying, Earhart had planned her World Flight as a series of "legs," each requiring 20 hours or less of flying time. When flown at its most economical cruising speed of 150 mph, the *Electra* could stay aloft for more than twenty-four hours. By limiting each flight to no more than 20 hours, Earhart would always maintain an emergency fuel reserve of at least four hours.

Flying the distance between New Guinea and Hawaii was clearly beyond the *Electra's* fuel capacity, but by good fortune, the United

States had recently colonized three small, desolate islands near the equator that were ideally located for use as a mid-point refueling stop. Largely to accommodate Earhart, several of her highly-placed friends in the United States government

*Fred Noonan, Earhart's navigator on the world flight, was a former lead navigator for Pan American Airways and had helped to develop procedures for navigating commercial aircraft long distances over open water to small island destinations.*



had arranged for a small airfield to be hastily built on Howland, one of the three islands. There, she would be able to land, refuel, and rest before continuing on to Hawaii. Earhart's Washington friends had also arranged for the Coast Guard to order the *Itasca* to proceed from the West Coast of the United States to Howland to provide radio support and act as "plane guard" when she arrived.

The 2,500-mile flight from Lae to Howland was the longest and most difficult leg of the entire journey and would require Fred Noonan to navigate over open water to an island that was only 1.5 by 0.7 miles across and with no prominent landmarks. However, while serving as lead navigator for Pan American Airways in 1935-36, he had helped to develop procedures for navigating the famous Pan Am "Clippers" vast distances to small Pacific island destinations.

For the Howland flight, his plan was to use celestial navigation to keep the flight on course until it was within range of the *Itasca*. Then, the plane and the ship would use their radio direction finding equipment to locate one another and determine the specific course needed to reach Howland safely.

As the Earhart flight arrived in the vicinity of Howland Island, serious problems began to arise. *Itasca's* attempts to call Earhart and establish two-way voice communications were not successful and, since neither Earhart nor Noonan were proficient in Morse code, they were not able to understand the messages that *Itasca* was sending to them in code. Even more serious, the *Itasca* was unable to obtain bearings from Earhart's radio transmissions.

At 7:42 a.m. local time Earhart radioed: "KHAQQ [her plane's call letters] calling *Itasca* we must be on you but cannot see you, but gas is running low, been unable to reach you by radio, we are flying at 1000 feet."

Then at 8:00 a.m.: "KHAQQ calling *Itasca* we received your signals [a series of A's sent in code] but unable to get a minimum. Please take bearing on us and answer 3105 [Earhart's night time frequency] with voice."

Again *Itasca* tried to take a bearing on Earhart's transmission and failed. And then at 8:43 a.m.: "KHAQQ to *Itasca* we are on the line 157 337 will repeat message, we will repeat this

on [her daylight frequency] 6210 KCs wait." A minute or so later she added, "We are running on line north and south."

This message, received some twenty hours and thirteen minutes after Earhart had taken off from Lae, is the last one that can be confirmed as having come from the World Flight.

After repeated and unsuccessful attempts to establish contact with Earhart, the *Itasca* got underway at 10:40 a.m. local time to begin search and rescue operations. Although no one knew for certain where Earhart's plane was, the *Itasca's* captain, Commander Warner K. Thompson, believed that she had passed to the north and west of Howland and had missed the island in the glare of the rising sun. It was also believed that, if the plane was down at sea, its large and now empty tanks would allow it to float almost indefinitely. The *Itasca* set a course for the northwest and proceeded at top speed.

In her last transmission, the only indication that Earhart had given as to her intentions was that she on a line 157 337. This meant that she was either flying on a heading of 157 degrees or its reciprocal 337 degrees. If Earhart had been north of Howland Island and was steering a course of 337, there was nothing ahead of her but open ocean for thousands of miles. However, if she had been south of Howland and was steering a course of 157, she was within a few hours flying time of the Phoenix Islands, a cluster of small, mostly uninhabited islands under British authority.

The two islands closest to this 157 course were McKean and Gardner. Both were uninhabited and neither had a landing field. Gardner Island, however, was surrounded by a smooth, flat coral reef that, in an emergency, could be used to make a forced landing.

## The Navy Becomes Involved

When news was received in San Francisco that Earhart had not reached Howland and might be down at sea, the Navy's Hydrographic Office there broadcast an "all ships" alert, requesting that any ship in the vicinity of Howland listen for voice transmissions on either 3105, 6210 or 500 kc.

In Pearl Harbor, Hawaii, Rear Admiral Orin G. Murfin, Commandant of the Fourteenth Naval District, ordered that a PBY Catalina flying boat be dispatched to Howland to assist with the search effort, but that flight was later forced to return due to adverse weather conditions encountered while in route.

The battleship USS *Colorado*, which had onboard three catapult-launched floatplanes, was ordered to leave from Pearl Harbor on July 3<sup>rd</sup> and proceed to Howland to join in the search.

At North Island Naval Air Station in San Diego, the aircraft carrier USS *Lexington* and her four destroyer escorts were ordered to make ready to get underway for Howland. In less than 24 hours, the necessary stores and supplies for a four-week cruise were loaded. When the *Lexington* left San Diego on July 5<sup>th</sup>, she had onboard 62 planes capable of searching a vast area.

### EVENING, DAY #1

While the *Itasca* searched to the north of Howland, the ship's radio room continued to monitor Earhart's frequencies. At that time, it was still not generally known that Earhart's plane could not transmit if it was in the water.

At 6:00 p.m. local time, a weak signal was heard behind the static on Earhart's nighttime frequency of 3105. Although no words could be made out, it was assumed that it was a message from Earhart. *Itasca* immediately responded by voice and in code, but there was no reply.

As the sun sank below the horizon and reception conditions improved, the voice was back, but very weak and unreadable. The Pan American Airways station on Mokapu Point in Hawaii also heard a "steady carrier on 3105 – no modulation, very weak." If the signals were coming from Earhart, it meant that her plane had to be on land.

At 6:30 p.m., *Itasca* requested Earhart to send a series of long dashes. Following this request, and a thousand miles to the southeast, the New Zealand Navy cruiser HMS *Achilles* heard intermittent transmissions on 3105, which it interpreted as dashes. At about this same time, the steamer SS *New Zealand*, 1200 miles from Howland, heard dashes on 3105 kc. At 6:37 p.m. *Itasca* heard these signals as well as the word "Earhart."

*Itasca* again called the plane in both voice and code, and this time a man's voice was heard "still distorted and unreadable." Since the *Itasca* had never been informed that Fred Noonan was on board the flight, this transmission was logged as "phone signals definitely not Earhart." At about 7:00 p.m. the garbled voice transmissions stopped.

Then at 8:30 p.m., government radio operators in Hawaii heard dashes on Earhart's other frequency of 6210 kc. Still monitoring 3105, *Itasca* didn't hear this transmission. Thirty minutes later, however, *Itasca* heard a weak signal on 3105 that was unreadable.

A thousand miles to the west on the British island of Nauru, a radio operator monitored "fairly strong signals" on 6210 kc. Once again, speech could not be interpreted because of bad modulation.

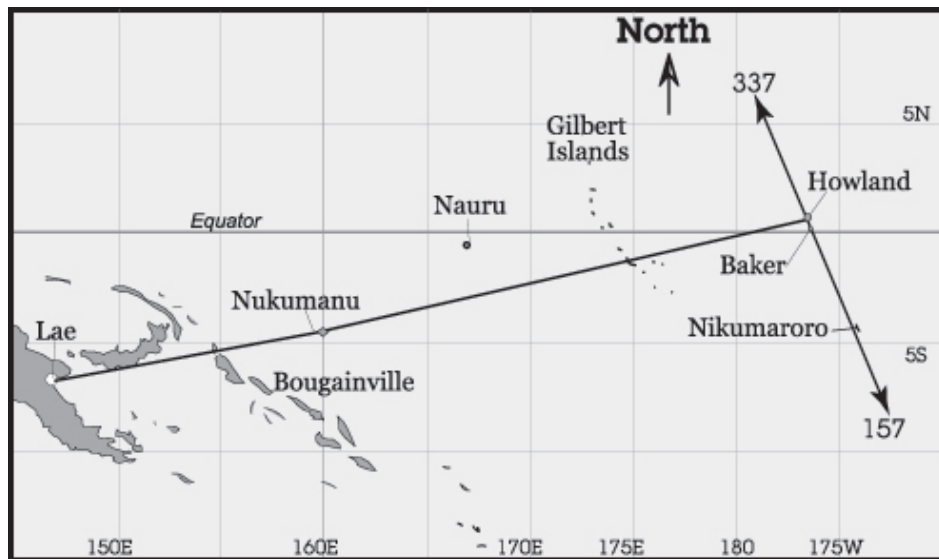

*"We are on the line 157 337."* Based on her last radio transmission, it is possible that, failing to find Howland Island, Earhart turned southeast and flew on a course of 157 degrees towards the Phoenix Island group, located some two hours flying time away.

At about 9:30 p.m., the voice signals stopped.

### EVENING, DAY #2

In Oahu, the Coast Guard's Hawaiian Section enlisted the aid of two of Honolulu's major commercial radio stations, KGU and KGMB. It was known that Earhart was familiar with both of these stations from her previous visits to Hawaii, and, on the chance that she might be listening to one of them for news of rescue efforts on her behalf, these stations were asked to broadcast a special message to Earhart. If she replied, direction-finding receivers in Hawaii, Midway Island, Wake Island and San Francisco would attempt to obtain bearings on these signals to determine where they were coming from. *Itasca* was instructed to "not, repeat not, use 3105 or 6210 kc next two nights to permit absolute check on authenticity of calls and to permit monitoring of above frequencies by use of directional antennae."

At 10:00 p.m. in Honolulu (9:00 p.m. aboard *Itasca*) KGU made a special broadcast on its regular frequency, asking Earhart to reply. Shortly afterwards, a faint carrier on 3105 was heard in Hawaii by Pan American and by the Coast Guard. Since no one had informed *Itasca* about the special KGU broadcast, the ship's radio room was not initially monitoring 3105. When it did start listening, however, it picked up a weak carrier.

KGMB made special broadcasts to Earhart at 10:30 p.m. and at midnight. In Hawaii, Pan American, the Coast Guard, and the U.S. Navy radio station at Wailupe heard faint signals. All told, about four hours of intermittent reception on Earhart's frequency were heard by *Itasca*, the Coast Guard, the Navy, and Pan American.

Five thousand miles away in Rock Springs, Wyoming, 16-year-old Dana Randolph was listening to a commercial radio set that received shortwave bands. The set was connected to a special antenna that Dana had just erected. At about 8:00 a.m. on the morning of July 4<sup>th</sup>, while

listening around 16,000 kc, he heard a woman say, "This is Amelia Earhart. Ship on a reef south of the equator. Station KH9QQ [sic]." The signal then died away.

Dana and his father reported what he had heard to the local Department of Commerce radio operator. The operator realized that the frequency Dana had been monitoring was most likely 15,525 kc, the fifth harmonic of 3105. From personal experience, the operator knew that freak reception of harmonics were possible and immediately forwarded this information on to Washington.

### EVENING, DAY #3

At 8:00 p.m. on the evening of July 4<sup>th</sup>, KGMB began broadcasting the following special message at intervals of 15 minutes: "To Earhart plane. We using every possible means establish contact with you. If you hear this broadcast, please come in on 3105 kc. Use key if possible, otherwise voice transmission. If you hear this broadcast, turn carrier on for one minute so we can tune you in, then turn carrier on and off four times, then listen for our acknowledgement at 0645 GCT."

As the evening wore on and reception conditions improved, more stations began to hear the replies. The Pan American stations on Mokapu Point, Midway Island and Wake Island were able to take directional bearings that placed the source of the signals as somewhere in the area of McKean Island and Gardener Island in the Phoenix Island group.

Based on this new information, the Navy concluded that, after failing to find Howland, Earhart and Noonan had turned southeast in an attempt to reach the nearest land. This theory is consistent with the "we are on the line 157 337" message received from Earhart during her last transmission and, since Earhart's radio would only work if the plane was on land, it stood to reason that she was most likely on one of the Phoenix Islands.

Accordingly, the *Colorado* was ordered to



*Uninhabited Gardner Island (later renamed Nikumaroro) is one of two islands in the Phoenix Island group that is closest to Howland Island. An examination of historical records has turned up evidence to suggest that Earhart's world flight ended here with a forced landing on the island's flat, smooth coral reef.*

change course and proceed to and conduct an air search of the Phoenix Group. Incredibly, no one bothered to inform *Itasca* that the unknown signals received on Earhart's frequency appeared to have originated in the Phoenix Islands. *Itasca* continued to search the waters north of Howland Island.

In St. Petersburg, Florida, 15-year-old Betty Klenck was listening to her family's large console radio. Her father, an amateur radio enthusiast, had invested in the best radio he could afford and had it connected to a special antenna that he had strung up in the backyard. That afternoon, as Betty listened, she doodled and jotted down bits of information about what she was hearing in a notebook that she always kept close by the set.

While tuning through the shortwave bands, she heard a woman who sounded quite upset say, "This is Amelia Earhart." For the next hour and forty-five minutes, Betty heard a woman and a man trying to send what sounded like distress calls. Both sounded like they were under extreme physical and emotional stress. Although the jumble of words, letters and numbers coming from the radio's speaker were too fast for Betty to take down verbatim, she copied down as much of what she heard as possible. When her father returned home from work, he heard the last part of this broadcast. Convinced that it was genuine, he drove to the St. Petersburg Coast Guard station to report what he and his daughter had heard. There, the duty officer assured him that the Coast Guard already had a ship in the area and was on top of the situation.

Years later, Earhart scholars who examined this notebook would focus on one of the seemingly meaningless sentences that Betty had copied down: "George, get the suitcase in my closet." Amelia Earhart kept the most private

of her personal papers inside a briefcase that was stored in a closet in her North Hollywood, California home. Over the years, and on several occasions, she had instructed family members and her husband George Putnam to burn the contents of this briefcase should anything ever happen to her. Betty would have had no way of knowing this. Therefore, this reference in her notebook to "the suitcase in my closet" might suggest that, like Dana Randolph, she may have been tuned to a harmonic of one of the Earhart frequencies and possibly heard the voices of Amelia Earhart and Fred Noonan.

#### EVENING, DAY #4

In contrast to the previous three evenings, almost nothing was heard on 3105 on the fourth night after Earhart and Noonan had disappeared. By this time, both fliers would have been suffering from dehydration and lack of food, and were perhaps in need of medical attention. The *Colorado* was due to arrive in the Phoenix Islands the next day, and it was hoped that an air search would quickly be able to locate the missing pair.

Beginning on July 7<sup>th</sup>, the *Colorado's* three aircraft, under the command of the Senior Aviator on board, Lieutenant John O. Lambrecht, flew search operations in the area of the Phoenix Islands. A fly-over was made at each island, and a landing was made in the lagoon at Hull, the only island of the group that was inhabited. The search lasted four days and covered some 25,490 square miles.

Lambrecht's fly-over of Gardner Island occurred on July 9<sup>th</sup>. It was later estimated that the total time he spent over the island was about 10 minutes. In a report later submitted to the Bureau of Naval Aeronautics, this is how he described what he had observed there:

"Gardner is a typical example of your south sea atoll . . . a narrow, circular strip of land . . . surrounding a large lagoon. Most of this island is covered with tropical vegetation with, here and there, a grove of coconut palms. Here signs of recent habitation were clearly visible but repeated circling and zooming failed to elicit any answering wave from possible inhabitants and it was finally taken for granted that none were there."

Years later, when asked what he meant by "signs of recent habitation," Lambrecht replied, "Markers of some kind."

In his official report, the commanding officer of the *Colorado* Captain Wilhelm F. Friedell, stated that "No one was seen on either Gardner Island or McKean Island," and "(n)o dwellings appeared on Gardner or any other signs of inhabitation."

The inconsistencies between the Lambrecht and Friedell reports continue to baffle Earhart researchers to this day.

On July 12 the *Lexington* and her destroyers arrived and took over the search, which now shifted away from the Phoenix Group to the open waters north and west of Howland. In all, some 151,556 square miles of trackless ocean were searched by the *Lexington's* pilots without success.

On July 18<sup>th</sup>, the search was officially called off. The general opinion was that the plane had probably run out of gas, gone down at sea, and sunk without a trace. Radio signals received after the presumed loss of the plane were dismissed as misunderstandings or outright hoaxes.

#### Bones on Gardner Island

In September 1940, Gerald B. Gallagher, the young officer in charge on Gardner Island, (later renamed Nikumaroro) radioed his superiors in Suva that the skull and partial skeleton of a castaway had been discovered in a remote area of the island and in a place where it was unlikely to have been seen by an air search. Close to the remains was found a woman's walking shoe, an empty bottle, and an empty sextant box. Also nearby were the remains of a fire, as well as turtle and bird bones, indicating that the deceased had survived for a time after coming ashore.

Realizing that these might be the remains of Amelia Earhart, Gallagher radioed his superiors for instructions. He was told to carefully search the area where the bones had been found and then send all bones and artifacts recovered to the High Commission Office in Suva. He was also told keep this matter "strictly secret for the present." In January 1941, the bones, sextant box, shoe, etc. were shipped to Suva where, in April, the bones were examined by Dr. D. W. Hoodless, Principal of the Central Medical School in Suva.

Dr. Hoodless' official report contains detailed measurements of the skull and bones, and ventured the cautious opinion that they might be those of someone of European or mixed European descent. After the Hoodless report was submitted and acknowledged, it was carefully filed away and forgotten. There is no evidence that the High Commission Office in Suva ever contacted American authorities with news of the discovery.

## A New Search Effort Begins

In 1988, **The International Group for Historic Aircraft Recovery (TIGHAR)** opened its own investigation into the Earhart mystery. TIGHAR's hypothesis was that stronger than normal winds had caused Earhart's plane to drift off course so that it ended up south of Howland Island. When the island was not sighted visually, and when radio bearings could not be obtained from the *Itasca*, Earhart and Noonan had turned southeast, flying on a course of 157 degrees towards the Phoenix Island Group, hence the "We are on the line 157 337" message received during Earhart's last transmission.

In this hypothesis, Earhart and Noonan eventually reached Gardner Island, made a forced landing on its smooth, flat coral reef, and after attempting to send radio distress calls, the two waded ashore and survived for a time as castaways. Left unprotected on the reef, her plane was eventually broken up by wave action and swept out into deep water.

To prove this hypothesis TIGHAR's network of volunteer investigators began seeking and re-examining historical records to look for facts that would support a Gardner Island landing. Among the documents they eventually uncovered were the Freidell and Lambrecht reports of the air search of Gardner Island, the radio logs of the *Itasca*; Betty Klenck's notebook; transcripts of Gallagher's radio messages about finding the bones on Gardner Island, and Dr.

Hoodless' official report with detailed measurements of the skull and bones that Gallagher had found.

TIGHAR researchers journeyed to Suva in an attempt to locate the partial skeleton and other artifacts recovered on Gardner Island, but, as of this writing, the whereabouts of these items remains unknown. TIGHAR also sponsored several scientific expeditions to Gardner/Nikumaroro Island to search for identifiable pieces of Earhart's plane and for personal items that can be linked to Earhart and Noonan.

These expeditions conducted archaeological surveys in a manner similar to those being conducted at military crash sites in Vietnam to locate and identify the remains of U.S. aircrews still officially listed as "Missing in Action." While a number of artifacts have been recovered, none of these have proven to be the "smoking gun" needed to resolve the Earhart mystery once and for all. However, more expeditions are planned and archival research is on-going. With each new piece of information that comes to light, we move that much closer to learning what really happened to the world's most famous aviatrix and her navigator on July 2, 1937.

## Suggested Reading

By far, the best account of the radio messages associated with the Earhart mystery is contained in *Finding Amelia – the True Story of the Earhart Disappearance* by Ric Gillespie and published in 2006 by the Naval Institute Press,

Annapolis, Md. In addition to a well-researched, well-written text, the book comes with a DVD containing over 5,000 historical messages, telegrams, letters, maps, radio log pages, relevant pages from Betty's notebook, etc.

Those interested in learning more about the scientific search methods that are being used to help solve the Earhart mystery should read *Amelia Earhart's Shoes*, by Thomas King, Randall Jacobson, Karen Burns and Kenton Spading, and published 2004 by Altamira Press.

Additional articles about Amelia Earhart can be found on-line at TIGHAR's *Earhart Project* website:

<http://www.tighar.org/Projects/Earhart/AEdescri.html>

## Acknowledgement

The author would like to thank Ric Gillespie, Executive Director of **The International Group for Historic Aircraft Recovery (TIGHAR)** who took time from his busy schedule to review this article for accuracy and who suggested several important corrections and clarifications. Any errors in presenting the facts are this writer's alone.

Eric Beheim is a life-long radio enthusiast and a member of TIGHAR. You can e-mail him at [quondam32346@aol.com](mailto:quondam32346@aol.com).

All graphics courtesy TIGHAR

MT



Using scientific methodology, an ongoing series of archaeological surveys is being conducted on Nikumaroro Island in search of evidence that Earhart and Noonan survived there for a time as castaways.

# Living the Dream: One ham's effort to update the tradition of kit building with a digital twist

By Ken Reitz KS4ZR

Over the course of a person's life there are some things you just don't forget. For many of us it was our first radio. And, even though those radios might not have been the finest available, there's a sweet nostalgia for them that's hard to shake. But, for most of us, there remains only the wistful memory of late nights tuning the bands and hearing the sounds of the world through a set of cheap headphones. For one ham though, the desire to recreate that wonderful memory has led to a new career.

## From SWL to Ham via Heathkit

For Brian Wood W0DZ, being a kid in Scottsdale, Arizona in the 1960s was a fun time and a precursor to a world of electronic design that would earn him a good living for the next 40 years. As a pre-teen he put together a small AM transmitter and was playing his dad's 33 1/3 RPM records through it for the whole neighborhood to enjoy. That was followed by an intriguing gift: a Heathkit GR-64, a four tube shortwave radio complete with BFO that cost \$39.95 in the mid-60s. The trouble was that this radio was a kit. He had to put it together.

But, young Wood was up to the challenge. While he ended up, like so many of us in those days, taking the finished unit to a local repair shop for troubleshooting, he couldn't have been happier with the final results. He had discovered not only the joy of kit-building, but the equally mysterious segments on the radio's slide rule dial labeled "amateur."

When he asked his dad what that was all about, his dad simply took him down to the local ham radio store and the world of amateur radio magically opened before him. It wasn't long after that introduction that he got his Novice ticket and the WN7FIK call sign. By 1966 his General class license arrived with the new call WA7FIK.

After graduating from the University of Arizona in 1973 with a Bachelor of Science degree in electrical engineering, he went immediately to

work at Hewlett-Packard in their research and development division where he spent the next 22 years. After that he worked in the marketing department of H-P's spin-off company, Agilent Technologies.

Throughout his working years he was also active on the ham bands and even had time to write for *QST*, the monthly magazine for hams published by the American Radio Relay League. His first article, "A Microprocessor-Controlled Contest Accessory" appeared in April, 1982, long before personal computers were common gear in most ham shacks.

Other articles Wood contributed were: "A 3 Element 'Monobander' for 17-10 Meters with 2 Elements on 20!," which appeared in the July 2001 issue, and "The Return of the Slide Rule Dial" from February 2002 (which won him the *QST* Cover Plaque Award that month). This article was an inventive way to restore the one nostalgic thing missing from our otherwise terrific modern transceivers: a glowing analog

slide rule dial. It was done via a program he wrote specifically for the Yaesu FT-1000, but could be adapted for other similar modern rigs with digital readouts.

He also wrote "The Incredible Saga of a DX-100 Restoration Run Amok" for the January 2004 *QST* which was a realistic look at restoring a "boat anchor" (non-functioning, tube-era radio). The article was a tutorial on keeping alive a segment of amateur radio not only for its historic value but to enhance one's own electronic education.

## An Idea is Born

The events of September 11, 2001 had an effect on Wood as it did all other Americans but, the ensuing collapse of the "dotcom bubble" was worse for those in computer-related industries. His division manager at Agilent warned that there could be lay-offs and that everyone should consider what their next move would be in the event they were let go. That set Wood to thinking about the idea of bringing back the ham radio kit, but relating it to the contemporary world of computer technology.

As it turned out he wasn't laid off, but by then he was inspired and the concept of a kit-related company really had him. What he had learned during his years at HP/Agilent was that people want innovative products and, if those products are good enough, they'll be willing to pay for them. Not long after that he took early retirement from Agilent and got his once-in-a-life chance to live the dream.

At first he surveyed the current world of ham kits and was intrigued by some of the self-contained digital mode transceivers available and thought to himself, "How hard can this be?" It wasn't long before he found out. For one thing, during the 10 years he had been in marketing, substantial changes in electronics, notably the use of surface-mount circuitry and the availability of pre-made modules, had swept the industry. But, his 22 years in R&D paid off and he was quickly up to speed on those aspects.

By 2005, after numerous attempts, he

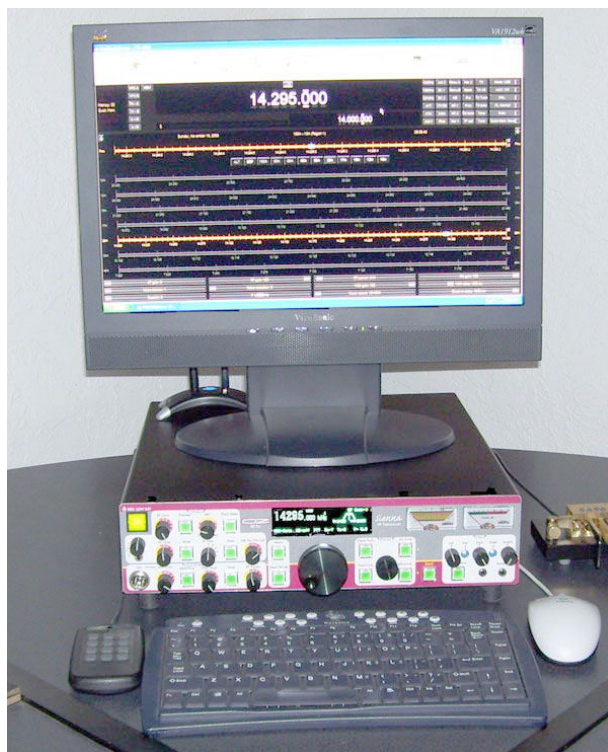

DZKit's Sienna Model SF-100 HF transceiver kit with front panel. (Courtesy: DZKit)



had an original prototype that he could take to the Dayton HamVention and show to potential buyers. The feedback he got from that trip resulted in significant changes and he also realized he would also have to learn about all kinds of production methods he had hadn't given a thought to before. That's when he enrolled in his local community college to learn new skills such as metal working. But, Wood is a quick study and in little time had mastered many of the mechanical skills necessary for production work and had yet another generation prototype finished. "I don't discourage easily," Wood said.

## Innovative Products

With quite a few kit companies in the ham radio market today, Wood realized he would have to have products that no one else was making in order to carve out a niche for his own company. Having come to ham radio at a time when amplitude modulation (AM) was king, Wood thought it could be fun to make an AM transceiver kit for 40 meters. But, since advances in circuitry have made it possible to miniaturize transceivers, why not make it a handi-talkie (HT)?

The product he brought to the market was DZKit's HT-7, a 2 watt, crystal-controlled, AM modulated, HT transceiver designed to operate on 7.290 MHz, the 40 meter AM calling frequency. The unit features a 6-8 MHz band-pass filter intended to keep high-powered shortwave stations out of the receiver; a built-in electret microphone element (though you can attach your own external mic through a top-mounted mic jack); a built-in speaker (or you can listen privately through the headphone jack, also mounted on the top), and a BNC antenna connector. The unit accepts a standard (though not included) Lithium Ion 11.1 volt 4 Ah battery pack (\$45). Wood is happy enough with this product that he's working on an AM HT for 80 meters. The HT-7 sells for \$150 plus shipping.

Another early DZKit product is the HM-17 SWR meter. While there are many inexpen-



**40 Meter AM HT? You bet, and you can build it yourself for \$150! (Courtesy: DZKit)**

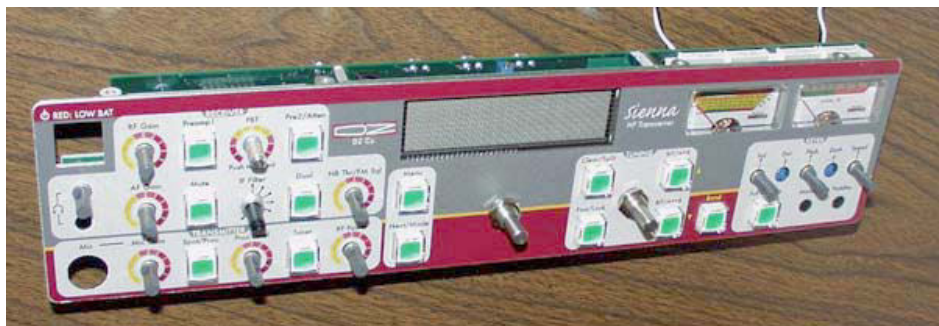

**Close-up of optional front panel of DZKit's Sienna computer radio. (Courtesy: Brian Wood W0DZ)**

sive SWR meters available already assembled, Wood believes his has at least one advantage: education. The kit is to be completely hand-wired with no printed circuit boards and comes with a Theory of Operation in the assembly manual that lets new hams (and old ones) learn just how these devices measure the SWR.

Wood has also learned from other companies' production techniques and has taken the few extra steps that make his SWR meter a cut above. He's added rubber feet that screw into the chassis (not glued-on); extra weight in the front to keep the box from tipping over when coax cables hang off the back, and it will handle up to a kilowatt CW through the HF bands and including 6 meters. Cost for the HM-17 is \$100 plus shipping.



**Build your own heavy-duty SWR meter with DZKit's HM-7 for \$100 (Courtesy: DZKit)**

## Ultimate Computer Radio

While the AM HTs and the SWR kit were fun products to bring to life, this is what Brian Wood had been dreaming about when contemplating his new career: a totally digital HF transceiver kit that doesn't need to be hooked up to a computer to do all the things hams need computers for, because the computer is built-in. His base model, the Sienna Model SF-100, starts out as a full-function, all-mode HF receiver that tunes from 500 kHz to 30 MHz and includes HF ham bands 160 meters through 10 meters in addition to 6 meters (VHF) and costs \$900.

The beauty of Wood's design is that it can be expanded as you get more interested in the radio hobby and get your ham license. By adding a front panel module you take more control of the internal PC. Later you can add a 10 watt transmitter and even a 100 watt amplifier for the transmitter stage to make it a full-function, all-mode, full-power, HF-6 meter transceiver. In this ultimate configuration the

price is \$1,400.

The Sienna series offers a host features including dual 10 dB preamps and attenuator; full duplex transmit and receive (allowing real cross-band capability for amateur satellite operation); triple conversion tuning with up to 6 crystal and/or mechanical filters; a 20 kHz roofing filter at the first IF; gas-discharge-protected antenna connectors; 10 band graphic equalizer, 147 built-in memories and more.

If the price puts you off, Wood asks you to consider this: Back in the old Heathkit days there was nothing cheap about their products, and to prove his point he adds up the price of one of their most popular kits, the SB-101 (an 80-10 meter transceiver). With typical accessories (external speaker, power supply, SWR meter, keyer, microphone, and LMO for split operation) the 1968 price would come to about \$650 which, adjusted for today's monetary environment, would cost almost \$3,000. For that you still wouldn't get 6 meters, digital readout accuracy and tons more features modern hams just take for granted today.

## Slow Road to Success

Brian Wood is not out to set the ham radio world on fire. He has already enjoyed a successful professional career. Now he intends to do his dream business at his own pace. He and two other partners also run a ham radio retail store, called "Valley Ham Shack," in his hometown of Loveland, Colorado. The store harkens back to the "old days" when hams could just drive down to their local ham radio store and find not just parts but camaraderie. The store also stocks the usual assortment of ham-related goodies: antennas, microphones, code keys, and a full line of amateur radio books.

Wood is determined to move at a slow pace. "The worst thing you can do is rush a product onto the market," he said. "You antagonize customers and create problems for yourself." He is determined to give today's hams a sense of what it was like for him as he opened up the box that contained the parts for his Heathkit GR-64. He hopes that his radio kits will someday enjoy the same reverence so many older hams now give their old Heathkit products.

For more information about the DZKit Company call 877-426-7422 or [www.dzkit.com](http://www.dzkit.com) or write:

The DZ Company, LLC  
4321 W. Eisenhower Blvd.  
Loveland, CO 80537



# What Will Sunspot Cycle 24 Really Do? The Jury is Still Out

By Tomas Hood NW7US

One year ago the discussion centered on whether or not Solar Cycle 24 would begin any time soon, and whether or not it would be a weak cycle. Would it be so weak as to resemble the *Maunder Minimum* (1645 to 1715), an incredible 70 years during which sunspots were rarely observed? That period coincided with the infamous “Little Ice-Age,” a series of extraordinarily cold winters occurring in the Northern Hemisphere.

Most solar scientists think that this is not the case at present. Dr. David Hathaway, Solar Physics Group Leader at the Marshall Space Flight Center, confirms that Cycle 24 is underway and believes that the official date of the solar minimum between the last cycle and the new cycle will end up falling at November 2008. Other scientists put that date at December.

## Most Intense Solar Peak since 1958?

Because there have been more sunspot regions seen since January of 2009 than in the first 20 years of the Maunder Minimum, Dr. Hathaway believes that we are not headed into another extended period of very low solar activity. However, any prediction about what the sun will do is difficult. Hathaway points to several aspects of the current cycle that do not match up with any others on record. He explained that the strength of the polar magnetic fields at the current minimum are about half those of the previous three cycles, despite indications beginning in 2003 that those fields would be very strong. “Exactly the opposite (of what was predicted so far) is happening,” he said. But, along with the majority of other scientists making a sunspot cycle forecast, he is predicting a weak Cycle 24.

There is one scientist, however, who is not in agreement with the majority. Dr. Mausumi Dikpati of the National Center for Atmospheric Research in Boulder, Colorado, still predicts a very intense cycle. This prediction is based on Dr. Dikpati’s “Flux Transport Dynamo” prediction – the solar dynamo theory that is now generally accepted as correctly explaining the movement of solar materials and magnetic fields on the sun and their relationship to sunspot cycles.

There currently exist at least fifty different predictions, and the results of each range from a very weak cycle peak, to Dikpati’s very strong peak. In nearly two centuries since the 11-year sunspot cycle was discovered, scientists have



*The way of the future? Declining sunspots may be in the future for hams and SWLers alike for many years, but could there be an unexpected peak next year? (Courtesy: SOHO/MDI)*

struggled to predict the size of future maxima. Mostly they fail, though some recent models fit better with recent cycles than some of the other predictions. Whichever prediction ends up being correct will most likely be correct not because they figured out the exact science, but by pure chance!

The prediction from the official Space Weather Prediction Center (SWPC) is that we’ll see a very weak cycle, peaking somewhere between a smoothed monthly sunspot count of 80 and 90. Given the track record of these “official” predictions so far for this new cycle, who can say what Cycle 24 will actually do?

Back in March 2006, the research team led by Dr. Dikpati of the National Center for Atmospheric Research (NCAR) announced that Cycle 24 will be the most intense solar maximum in fifty years. Researcher Dikpati said, “The next sunspot cycle will be 30 percent to 50 percent stronger than the previous one.” If this prediction is correct, solar activity in just a few years will be second only to the historic solar cycle maximum of 1958.

Dikpati discovered years ago that the sun has a “conveyor belt” consisting of electrically-conducting gas which is a key to her prediction model. We have something similar here on Earth, known as the “Great Ocean Conveyor Belt,” a network of ocean and atmospheric currents that carry water and heat from ocean to ocean.

The sun’s conveyor belt is a current that flows in a loop from the sun’s equator to the poles

and back again. Just as the Great Ocean Conveyor Belt controls weather on Earth, this solar conveyor belt controls weather on the sun. Specifically, it controls the sunspot cycle.

Solar physicist David Hathaway, “First, remember what sunspots are – tangled knots of magnetism generated by the sun’s inner dynamo. A typical sunspot exists for just a few weeks. Then it decays, leaving behind a ‘corpse’ of weak magnetic fields.”

Hathaway further explains that “the top of sun’s conveyor belt skims the surface of the sun, sweeping up the magnetic fields of old, dead sunspots. The ‘corpses’ are dragged down at the poles to a depth of 200,000 kilometers where the sun’s magnetic dynamo can amplify them. Once the corpses (magnetic knots) are reincarnated (amplified), they become buoyant and float back to the surface.” And that’s how we get new sunspots.

All this happens with massive slowness. It takes about 40 years for the belt to complete one loop. However, the speed of these loops do vary, anywhere from a 50-year pace (slow) to a 30-year pace (fast).

When the belt is turning fast it means that lots of magnetic fields are being swept up and that a future sunspot cycle is going to be intense. This is a basis for Dikpati’s current forecast. The belt was turning fast in 1986-1996. Old magnetic fields swept up then should re-appear as big sunspots in 2010-2011, with the peak occurring in 2012. This prediction is still on target, even though we are seeing very few spots so far in the current drawn-out solar cycle minimum.

The sunspots we are now seeing clearly belong to the new Cycle 24. However, many of the new-cycle spots appear weaker than the new spots seen at the start of recent past solar cycles. This might indicate that something else is happening in the sun. Startling new research indicates just that. Evidence shows that another cycle of some sort is at work, independent of the 11-year cycles. It should also be noted that, in actuality, the 11-year average cycle is half of a 22-year cycle. During the first eleven years of this cycle, the sun’s magnetic poles are opposite in polarity than during the next eleven years. The sun actually flips its magnetic poles from cycle to cycle!

## Vanishing Sunspots

In 1990, a time of maximum sunspot activity in Cycle 22, S. K. Solanki and his students from Zurich took advantage of the new infrared

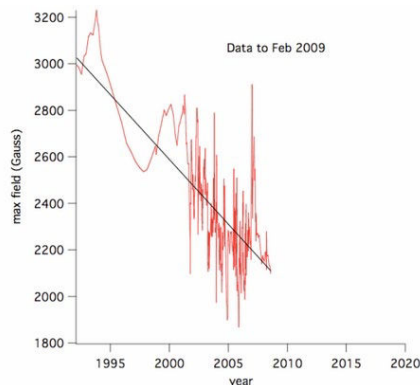

*The maximum sunspot field strength is plotted versus time, during the period from 1992 to February 2009; a 12-point running mean is shown, and a linear fit to the data is plotted. Apart from a few measurements, the linear trend has been seen to continue throughout this solar minimum. (Courtesy: Matthew Penn, U.S. National Solar Observatory)*

capability at the McMath-Pierce Solar Telescope on Kitt Peak in Arizona. They made observations of sunspots, mapping magnetic fields, along with other spectral data. These observations continued through the minimum of Cycle 22. In 1998 the observing runs were made more systematic by measuring all sunspots visible on the disk during the run. The work has continued through Cycle 23 up to the present (2009).

Out of these observations an interesting trend has emerged. In 2005, scientists led by Matthew Penn from the U.S. National Solar Observatory (NSO) closely examined these solar measurements made over the previous 13 years. The observations showed that the strength of the magnetic field in sunspots was decreasing with time, independent of the sunspot cycle. A simple linear extrapolation of those data suggests that sunspots might completely vanish by 2015.

Four years after the first draft paper, the predicted cycle-independent dearth in sunspot numbers has proven accurate. The vigor of sunspots, in terms of magnetic strength and area, has greatly diminished. Figure 2 (above) shows the decrease in field strength now found with respect to time (1992–2009), which still shows a linear trend independent of the solar cycle. The mean infrared intensity of sunspot umbrae is also

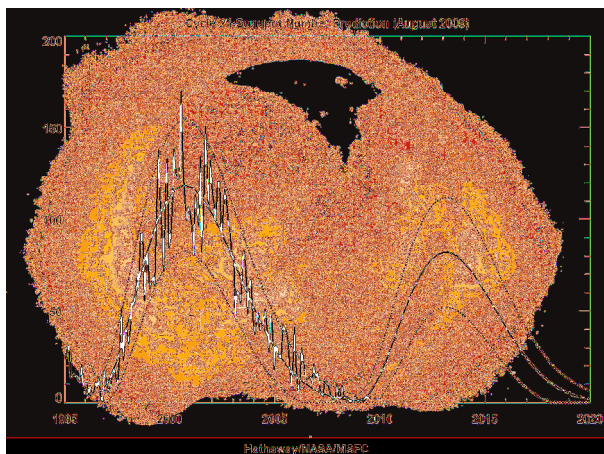

*Dr. David Hathaway's Cycle 24 sunspot number prediction (August, 2009). (Courtesy: Hathaway/NASA/NSFC)*

increasing with time. If this trend continues, it indicates that sunspots will not be visible by 2015.

In simple terms, the sunspots observed since the 1990's have been increasing in brightness, while decreasing in magnetic field strength. When the brightness becomes the same in the sunspot as the brightness of the rest of the solar disc, we will no longer be able to see these weak sunspots. They will simply vanish.

Indicators of the solar activity cycle suggest that sunspots must return in earnest within the next year (2010). It is possible that the cycle will have a high number of spots (per Dikpati's model), but these sunspots will be weaker than those of recent cycles. And, at the close of Cycle 24, the sunspots may vanish altogether. Whether this is an omen of long-term sunspot decline, analogous to the Maunder Minimum, remains to be seen. In one year, I will report whether or not the trend is continuing.

## Autumn and Winter Shortwave Season

The start of the Autumn DX season with the annual 'sweet' HF propagation begins right after the September Autumnal Equinox. This year's season is gearing up to be moderately active.

As is typical of the autumn and winter HF season, low-frequency activity vastly improves over summer conditions due to the decrease in lightning storms, and the longer daily periods of darkness. Even during the solar cycle minimum, these bands (below 20 meters) are alive and well.

But, what can you do on the higher frequencies this season? The higher shortwave frequencies are alive, too. During the winter months the maximum usable frequencies (MUF) are generally higher during the daylight hours than during the summer daylight hours due to the shorter distance between the Earth and sun during this season.

This provides short but strong openings on higher shortwave bands during the winter day. Then, at night, the MUF dips down much lower than what would be seen during the summer nights. Summertime MUFs are generally higher during the night hours than during the winter nights, due in part to the fact that the ionosphere stays energized through the short nights. Winter nights are longer, so recombination of the ionosphere (which results in a lowering of the MUF) is more complete.

This also means that the D layer of the ionosphere is less ionized during the winter, allowing medium wave and shortwave frequencies to propagate through the D layer and off the E and F layers. Finally, the seasonal decrease in weather-related noise makes it easier to hear the weaker DX signals on lower frequencies. With thunderstorms few and far between, storm-related static and noise is greatly reduced.

Seasonally, the geomagnetic activity tends to be quiet during the winter months. The most active geomagnetic seasons are centered on the two equinoxes, in the spring and autumn. Com-

bined with the seasonal decrease in geomagnetic activity, the lull in the eleven-year solar cycle geomagnetic activity translates to generally quiet conditions on lower HF and on the MF spectrum.

December is well enough past the autumnal equinox and the associated peak auroral activity to support transpolar propagation. With this overall reduction of geomagnetic activity, and the decrease of radio signal absorption, comes more stable high-latitude propagation. Medium wave DXers enjoy catching broadcast station transmissions from over the North Pole. Shortwave DXing over high-latitude paths becomes exciting, even if the higher frequency bands might be dead.

During October, signals below 75 meters are still hard to hear under the seasonal static. The static then steadily decreases as we move into the longer hours of darkness during the winter months. With the seasonal reduction in thunderstorms and atmospheric static noise in the Northern Hemisphere, it becomes easier to hear the weaker signal DX.

As we get closer to January, expect DX openings during the hours of darkness and into the sunrise period. Look for openings from Europe and the south if you are listening in the eastern half of the United States, and from the south, the Far East, Australasia, and the South Pacific if you are in the western half of the country.

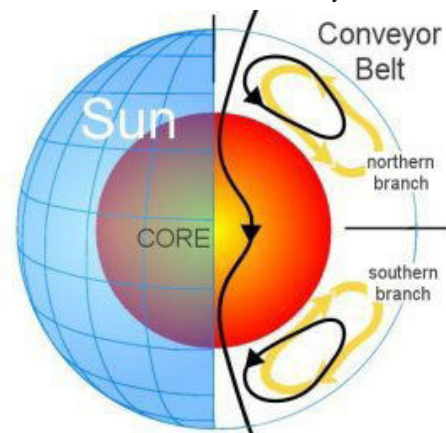

*The sun's "conveyor belt" shows how sunspots are created. In 2006 Dr. David Hathaway said this belt has slowed to a record crawl. (Courtesy: NASA)*

Expect long-range DX on the low bands, starting right after sunset, and extending farther as the night develops. Signals here should peak from Europe, and from a generally easterly direction, around midnight. DX paths will move farther west through the night. By morning, openings from Asia should be common. For openings in a generally western direction, expect a peak just after sunrise. The band should remain open from the south throughout of the night. Propagation in this band is quite similar to that expected on 41 meters, except that signals will be somewhat weaker on the average, noise levels will be a bit higher, and the period for band openings in a particular direction will be a bit shorter.

Forty-one meters should be the hottest DX band during the dark hours as the seasonal static levels are lower than they were during the summer. The band should be open first for European DX in the eastern United States during the late afternoon. Signals should increase in intensity

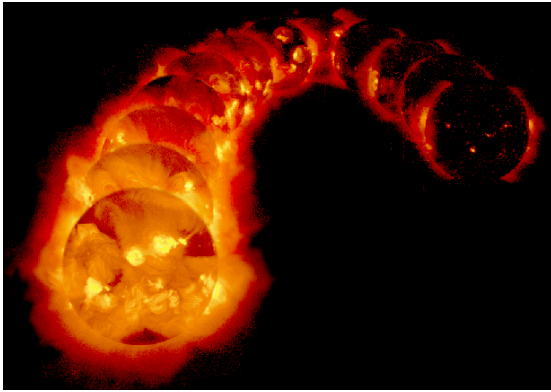

*The sun from maximum to minimum in the last solar cycle (Courtesy: NOAA/Space Weather Prediction Center)*

as darkness approaches. During the hours of darkness, expect good DX openings from most areas of the world. Signals should peak from an easterly direction about midnight, and from a westerly direction just after sunrise. Excellent openings toward the south should be possible throughout most of the nighttime period.

The all-season bands, 31 and 25 meters, are crowded and signals are usually very strong and steady. These bands will often remain open into many areas late into the night and will open early in the morning, especially when part of the propagation path moves through sunlit regions. Twenty five meters is expected to be an excellent band for medium distance reception (500 to 1,500 miles) during the daylight hours. Longer distance reception (up to 2,000 to 3,000 miles) should be possible for an hour or two after local sunrise, and again during the late afternoon and early evening. Heavy congestion will occur here since many international and domestic broadcasters make use of 25 meters. Thirty-one meters, the backbone of worldwide shortwave broadcasting, will provide medium-distance daytime reception ranging between 400 and 1,200 miles. During November, reception up to 2,500 miles is possible during the hours of darkness, and until two to three hours after local sunrise. Thirty-one meters, too, is highly congested, making reception of weak exotic signals a bit more of a challenge.

Twenty-two through 19 meters compete with 16 for the best daytime DX band during October. They will open for DX just before sunrise and should remain open from all directions throughout the day, with a peak in the afternoon. Nighttime conditions will favor openings from the south and tropical areas. Since the southern hemisphere has long daylight hours, DX paths on these bands from stations in the south will be common. Nineteen through 25 meters compete with 16 for the good daytime DX during November and December. They will open for DX just before sunrise and should remain open from all directions throughout the day, with a peak in the afternoon. Nighttime conditions will favor openings from the south and tropical areas. Since the Southern Hemisphere has long daylight hours, DX paths on these bands from stations in the south will be common.

Sixteen through 13 meters will be open occasionally. Paths from Europe and the South Pacific as well as from Asia are possible, especially on 16 meters. Look for best conditions

from Europe and the northeast before noon and from the rest of the world during the afternoon hours. Reception from the South Pacific, Australia, New Zealand, and the Far East should be possible well into the early evening. When flux levels remain lower, these openings may be short-lived.

The best propagation aid is a set of sunrise and sunset curves, since DX signals tend to peak when it is local sunrise at the easterly end of the path in question. A good Internet web site featuring a gray line map display is found at [www.fourmilab.to/earthview](http://www.fourmilab.to/earthview). Follow the link, "map of the Earth" showing the day and night regions.

For short-skip openings during December, try 90 through 41 meters during the day for paths less than 250 miles, and 90 down to 120 meters at night for these distances. For openings between 250 and 750 miles, try 41 meters during the day, and both 90 and 120 at night. For distances between 750 and 1,300 miles, 22 through 31 should provide daytime openings, while 41 down to 90 will be open for these distances from sunset to midnight. After midnight, 90 meters will remain open out to 1,300 miles until sunrise. Try 31 and 41 meters again for about an hour or so after sunrise. For openings between 1,300 and 2,300 miles, openings will occur on 22 through 16 meters, with fewer on higher bands, during the daylight hours. During sundown to midnight, check 22 through 41 meters for these long-distance openings, and then check 41 down to 90 meters after midnight until sunrise. Try 41 and 31 meters again for an hour or so after sunrise.

Propagation changes again after January, as the hours of daylight increase. March is one of the optimal DX months. As the spring equinox approaches, the gray line terminator begins to run straight North and South. The return of sunlight to the polar north creates north-south openings on 11 through 25 meters.

By March, 16 meters will still stay open long into the evenings. You will occasionally find 16 meters open all night long. Daytime paths will not degrade much until midsummer. You will see more early closures if you live closer to the North Pole.

Twenty-two and 19 meters will remain in excellent shape. Both short and long path circuits are reliable and solid. All nighttime paths are wide open during March. Prime time evening hours in the United States are sunrise hours across Russia, Africa, and both the Near East and Far East. Expect a lot of short and long path DX from these areas of the world.

Between sunset and midnight, expect occasional DX openings on all bands between 15 and 41 meters. Conditions should favor openings from the east and south. These bands should peak for openings from Europe and Africa near midnight.

From midnight to sunrise, expect optimum DX conditions on 31 through 90 meters, and occasionally, 120 meters. Conditions should favor openings from the west and south. Some rather good openings on 19 and 22 meters should also be possible from the south and west during this time.

Noise levels are slowly increasing as we move toward the spring season. Geomagnetic storms will increase, disrupting the mid- and high-latitude ionosphere. During the spring equinox, earth's magnetic field is sufficiently disturbed by solar wind particles flowing into the auroral zone (between 50 and 70 degrees north geographic latitude) to cause the ionosphere to be depleted.

## Propagation on VHF and Above

Quite a bit of meteor shower activity is expected in November and December, providing conditions for meteor-scatter openings on the VHF bands for distances up to about 1,000 miles. When a meteor burns up in the atmosphere, its intense heat creates an ionized trail, making it possible for radio signals to propagate off that trail much like they would off of the ionosphere. Look for the November Leonid to peak on the 17<sup>th</sup> at 21:43 UTC, according to NASA. After the Leonids, check out the Geminid meteor shower which is expected to peak after midnight December 14. Both of these showers provide great opportunities to experience VHF DX via the plasma vapor trails left by the intense heat caused by the meteor as it burns up in the atmosphere.

Meteor scatter propagation is a mode where radio signals are refracted off the trains of ionized plasma. Because the height of these plasma trains is in the E layer of the ionosphere, the range of a meteor scatter contact is between 500 and 1,300 miles. The frequencies that are best refracted are between 30 and 100 MHz. However, with the development of new software and techniques, frequencies up to 440 MHz have been used to make successful radio contacts using these meteor trains.

Lower VHF frequencies are more stable, and last longer, when signals are bounced off these ionized trails. A six-meter contact may last from a second to well over a minute. The lower the frequency, the longer the specific "opening" made by a single meteor train. Conversely, a meteor's ionized train that supports a sixty-second refraction on six meters might only support one-second refraction of a two-meter signal. Special high-speed digital modulation modes are used on these higher frequencies to take advantage of the limited available time. These modes, like high-speed CW, can run in the neighborhood of hundreds of words per minute.

## Write to Me

Do you have questions about space weather and radio propagation? Do you have observations about Aurora, Sporadic-E, or Meteor Shower propagation that you would like to share? Please write me an e-mail message or a letter.

I also invite you to check out the NW7US Space Weather and Radio Propagation Podcast available at <http://podcast.hfradio.org> – where you can listen to past and current editions. You can listen to the interview with Matthew Penn from the National Solar Observatory in Episode 4 of this podcast. I wish you a happy radio-monitoring season! E-mail Tomas David Hood NW7US at [NW7US@arrrl.net](mailto:NW7US@arrrl.net) or write P.O. Box 9, Stevensville, Montana 59870.

# Big Savings on Radio Scanners

## Uniden® SCANNERS



### Bearcat® 796DGV Trunk Tracker IV with free scanner headset

Manufacturers suggested list price \$799.95  
**CEI Special Price \$519.95**

1,000 Channels • 10 banks • CTCSS/DCS • S Meter  
 Size: 6<sup>15</sup>/<sub>16</sub>" Wide x 6<sup>9</sup>/<sub>16</sub>" Deep x 2<sup>3</sup>/<sub>8</sub>" High

Frequency Coverage: 25,000-512,000 MHz., 806,000-956,000 MHz.  
 (excluding the cellular & UHF TV band), 1,240,000-1,300,000 MHz.

When you buy your Bearcat 796DGV TrunkTracker package deal from Communications Electronics, you get more. The GV means "Great Value." With your BC796DGV scanner purchase, you also get a **free deluxe scanner headphone** designed for home or race track use. Headset features independent volume controls and 3.5 mm gold right angle plug. The 1,000 channel Bearcat 796DGV is packed with features to track Motorola Type I/II/III Hybrid, EDACS, LTR Analog Trunk Systems and Motorola APCO 25 Phase I digital scanner including 9,600 Baud C4FM and CQPSK. Also features control channel only mode to allow you to automatically trunk many systems by simply programming the control channel, S.A.M.E. weather alert, full-frequency display and backlit controls, built-in CTCSS/DCS to assign analog and digital subaudible tone codes to a specific frequency in memory, PC Control and programming with RS232C 9 pin port (cable not supplied), Beep Alert, Record function, VFO control, menu-driven design, total channel control and much more. Our CEI package deal includes telescopic antenna, AC adapter, cigarette lighter cord, DC cord, mobile mounting bracket with screws, owner's manual, trunking frequency guide and one-year limited Uniden factory warranty. For maximum scanning enjoyment, order magnetic mount antenna part number ANTMMBNC for \$29.95. For complete details, download the owners manual from the [www.usascan.com](http://www.usascan.com) web site. For fastest delivery, order on-line at [www.usascan.com](http://www.usascan.com).

### Bearcat® BCT8 Trunk Tracker III

Manufacturer suggested list price \$299.95  
**CEI Special Price \$169.95**

250 Channels • 5 banks • PC Programmable  
 Size: 7.06" Wide x 6.10" Deep x 2.44" High

Frequency Coverage: 25,000-54,000 MHz., 108,000-174,000 MHz., 400,000-512,000 MHz., 806,000-823,995 MHz., 849,012-868,995 MHz., 894,012-956,000 MHz.

The Bearcat BCT8 scanner, licensed by NASCAR, is a superb preprogrammed 800 MHz trunked highway patrol system scanner. Featuring TrunkTracker III, PC Programming, 250 Channels with unique BearTracker warning system to alert you to activity on highway patrol link frequencies. Preprogrammed service searches makes finding interesting active frequencies even easier and include preprogrammed police, fire and emergency medical, news agency, weather, CB band, air band, railroad, marine band and department of transportation service searches. The BCT8 also has preprogrammed highway patrol alert frequencies by state to help you quickly find frequencies likely to be active when you are driving. The BCT8 includes AC adapter, DC power cable, cigarette lighter adapter plug, telescopic antenna, window mount antenna, owner's manual, one year limited Uniden warranty, frequency guide and free mobile mounting bracket. For maximum scanning enjoyment, also order the following optional accessories: External speaker ESP20 with mounting bracket & 10 feet of cable with plug attached \$19.95. Magnetic Mount mobile antenna ANTMMBNC for \$29.95.



### Bearcat® BCD396T Trunk Tracker IV

Suggested list price \$799.95/CEI price \$519.95

APCO 25 9,600 baud compact digital ready handheld TrunkTracker IV scanner featuring Fire Tone Out Paging, Close Call and Dynamically Allocated Channel Memory (up to 6,000 channels), SAME Weather Alert, CTCSS/DCS, Alpha Tagging. Size: 2.40" Wide x 1.22" Deep x 5.35" High

#### Frequency Coverage:

25,000-512,000 MHz., 764,000-775,987.5 MHz., 794,000-823,987.5 MHz., 849,012-868,876.5 MHz., 894,012-956,000 MHz., 1,240,000 MHz.-1,300,000 MHz.

The handheld BCD396T scanner was designed for National Security/Emergency Preparedness (NS/EP) and homeland security use with new features such as **Fire Tone Out Decoder**. This feature lets you set the BCD396T to alert if your selected two-tone sequential paging tones are received. Ideal for on-call firefighters, emergency response staff and for activating individual scanners used for incident management and population attack warning. **Close Call Radio Frequency Capture** - Bearcat exclusive technology locks onto nearby radio transmissions, even if you haven't programmed anything into your scanner. Useful for intelligence agencies for use at events where you don't have advance notice or knowledge of the radio communications systems and assets you need to intercept. The BCD396T scanner is designed to track Motorola Type I, Type II, Hybrid, SMARTNET, PRIVACY PLUS, LTR and EDACS analog trunking systems on any band. Now, follow UHF High Band, UHF 800/900 MHz trunked public safety and public service systems just as if conventional two-way communications were used. **Dynamically Allocated Channel Memory** - The BCD396T scanner's memory is

organized so that it more closely matches how radio systems actually work. Organize channels any way you want, using Uniden's exclusive dynamic memory management system. 3,000 channels are typical but **over 6,000 channels are possible** depending on the scanner features used. You can also easily determine how much memory you have used and how much memory you have left. **Preprogrammed Systems** - The BCD396T is preprogrammed with over 400 channels covering police, fire and ambulance operations in the 25 most populated counties in the United States, plus the most popular digital systems. **3 AA NIMH or Alkaline battery operation and Charger** - 3 AA battery operation - The BCD396T includes 3 premium 2,300 mAh Nickel Metal Hydride AA batteries to give you the most economical power option available. You may also operate the BCD396T using 3 AA alkaline batteries. **Unique Data Skip** - Allows your scanner to skip unwanted data transmissions and reduces unwanted birdies. **Memory Backup** - If the battery completely discharges or if power is disconnected, the frequencies programmed in the BCD396T scanner are retained in memory. **Manual Channel Access** - Go directly to any channel. **LCD Back Light** - A blue LCD light remains on when the back light key is pressed. **Autolight** - Automatically turns the blue LCD backlight on when your scanner stops on a transmission. **Battery Save** - In manual mode, the BCD396T automatically reduces its power requirements to extend the battery's charge. **Attenuator** - Reduces the signal strength to help prevent signal overload. The BCD396T also works as a conventional scanner to continuously monitor many radio conversations even though the message is switching frequencies. The BCD396T comes with AC adapter, 3 AA nickel metal hydride batteries, belt clip, flexible rubber antenna, wrist strap, SMA/BNC adapter, RS232C cable, Trunk Tracker frequency guide, owner's manual and one year limited Uniden warranty. Not compatible with AGEIS, ASTRO or ESAS systems. Order on-line at [www.usascan.com](http://www.usascan.com) or call 1-800-USA-SCAN.

## More Radio Products

Save even more on radio scanners when purchased directly from CEI. Price includes delivery in the continental USA excluding Alaska.

Bearcat 898T 500 channel TrunkTracker III base/mobile.....	\$209.95
Bearcat 796DGV 1,000 channel TrunkTracker III base/mobile.....	\$519.95
Bearcat BCD396T APCO 25 Digital scanner with Fire Tone Out.....	\$519.95
Bearcat 246T up to 2,500 ch. TrunkTracker III handheld scanner.....	\$214.95
Bearcat Sportcat 230 alpha display handheld sports scanner.....	\$184.95
Bearcat 278CLT 100 channel AM/FM/SAME WX alert scanner.....	\$129.95
Bearcat 248CLT 50 channel base AM/FM/weather alert scanner.....	\$104.95
Bearcat 92XL 200 channel handheld scanner.....	\$109.95
Bearcat 72XL 100 channel handheld scanner.....	\$99.95
Bearcat BR330T up to 2,500 ch. TrunkTracker III with Tone out.....	\$274.95
Bearcat BCT8 250 channel information mobile scanner.....	\$169.95
Bearcat 350C 50 channel desktop/mobile scanner.....	\$104.95
AOR AR16BQ Wide Band scanner with quick charger.....	\$199.95
AOR AR3000AB Wide Band base/mobile receiver.....	\$1,079.95
AOR AR5000A+3B Wide Band 10 KHz to 3 GHz receiver.....	\$2,599.95
AOR AR8200 Mark III Wide Band handheld scanner.....	\$594.95
AOR AR8600 Mark II Wide Band receiver.....	\$899.95
AOR AR-ONE Government/Export sales only 10 KHz-3 GHz.....	\$4,489.95
Scantcat Gold For Windows Software.....	\$99.95
Scantcat Gold for Windows Surveillance Edition.....	\$159.95

### Bearcat® BC246T Trunk Tracker III

Suggested list price \$399.95/CEI price \$214.95  
**Compact professional handheld TrunkTracker III scanner featuring Close Call and Dynamically Allocated Channel Memory (up to 2,500 channels), SAME Weather Alert, CTCSS/DCS, Alpha Tagging. Size: 2.72" Wide x 1.26" Deep x 4.6" High**

#### Frequency Coverage:

25,000-54,000 MHz., 108,000-174,000 MHz., 216,000-224,980 MHz., 400,000-512,000 MHz., 806,000-823,987.5 MHz., 849,012-868,876.5 MHz., 894,012-956,000 MHz., 1,240,000 MHz.-1,300,000 MHz.

The handheld BC246T TrunkTracker scanner has so many features, we recommend you visit our web site at [www.usascan.com](http://www.usascan.com) and download the free owner's manual. Popular features include **Close Call Radio Frequency Capture** - Bearcat exclusive technology locks onto nearby radio transmissions, even if you haven't programmed anything into your scanner. **Dynamically Allocated Channel Memory** - Organize channels any way you want, using Uniden's exclusive dynamic memory management system. 1,600 channels are typical but **over 2,500 channels are possible** depending on the scanner features used. You can also easily determine how much memory is used. **Preprogrammed Service Search (10)** - Makes it easy to find interesting frequencies used by public safety, news media TV broadcast audio, Amateur (ham) radio, CB radio, Family Radio Service, special low power, railroad, aircraft, marine, racing and weather frequencies. **Quick Keys** - allow you to select systems and groups by pressing a single key. **Text Tagging** - Name each system, group, channel, talk group



ID, custom search range, and S.A.M.E. group using 16 characters per name. **Memory Backup** - When power is lost or disconnected, your BC246T retains the frequencies that were programmed in memory. **Unique Data Skip** - Allows the BC246T to skip over unwanted data transmissions and birdies. **Attenuator** - You can set the BC246T attenuator to reduce the input strength of strong signals by about 18 dB. **Duplicate Frequency Alert** - Alerts you if you try to enter a duplicate name or frequency already stored in the scanner. **22 Bands** - with aircraft and 800 MHz. The BC246T comes with AC adapter, 2 AA 1,800 mAh nickel metal hydride batteries, belt clip, flexible rubber antenna, wrist strap, RS232C cable, Trunk Tracker frequency guide, owner's manual and one year limited Uniden warranty. For more fun, order our optional deluxe racing headset part #HF24RS for \$29.95. Order now at [www.usascan.com](http://www.usascan.com) or call 1-800-USA-SCAN.

## Buy with Confidence

### Order on-line and get big savings

For over 36 years, millions of communications specialists and enthusiasts worldwide have trusted Communications Electronics for their mission critical communications needs. It's easy to order. For fastest delivery, order on-line at [www.usascan.com](http://www.usascan.com). Mail orders to: Communications Electronics Inc., P.O. Box 1045, Ann Arbor, Michigan 48106 USA. Price includes \$30.00 UPS Ground shipping/handling/insurance per scanner to a street address in the continental USA excluding Alaska. Add \$20.00 shipping for all accessories. For shipments to Canada, Puerto Rico, Hawaii, Alaska, Guam, P.O. Box, APO/FPO, USPS Priority Mail or UPS 2 business day delivery, add \$30.00. Michigan residents add sales tax. No COD's. For Bearcat scanners your satisfaction is guaranteed or return item in unused condition in original packaging within 61 days for refund, less shipping charges. 10% surcharge for net 10 billing to qualified accounts. All sales are subject to availability, acceptance and verification. Prices, terms and specifications are subject to change without notice. We welcome your Discover, Visa, American Express, MasterCard, IMPAC or Eurocard. Order toll free, call 1-800-USA-SCAN or 1-734-996-8888 if outside Canada or the USA. FAX anytime, dial 1-734-663-8888. Dealer and international inquiries invited. Order your radio scanners from Communications Electronics today.

For credit card orders call  
**1-800-USA-SCAN**

e-mail: [cei@usascan.com](mailto:cei@usascan.com)

[www.usascan.com](http://www.usascan.com)

PO Box 1045, Ann Arbor, Michigan 48106-1045 USA  
 For information call 734-996-8888 or FAX 734-663-8888

**COMMUNICATIONS ELECTRONICS INC.**  
 Emergency Operations Center

Visit [WWW.USASCAN.COM](http://WWW.USASCAN.COM) • 1-800-USA-SCAN

## Complain, Complain, Complain

### ❖ Something to Complain About

Every time the 20 meter net starts its scheduled operation, some idiot begins tuning up on the frequency with the key down for a minute or more at a time. Just as you start to watch your favorite show on TV, your half-witted neighbor fires up the linear amplifier on his CB set and starts spewing gibberish that comes in on the speaker of your TV. You're monitoring the aircraft band but there's this constant hash that shows up at certain frequencies and you've traced the source to a utility pole in front of your house. The phone rings during dinner, you check the caller ID but it's "out of area." When you answer, it turns out it's a "robo-call" wanting you to sign up for a car warranty program if you just dial this 800 number...

Taken all together, the above paragraph aptly describes common occurrences in our modern lives. You'd have to be Amish not to have experienced any or all of them at one time or another over the last several years. Most of us take these electronic punches in stride and just move on. But sometimes, as with an e-mail in-box stuffed with 300 spam e-mails, it's time to act. What can you do? Who can you turn to for help? For each of the examples listed above, there's a one-stop complaint department that will help with them all: the Federal Communications Commission.

### ❖ FCC's Consumer Protection Role

If you're a federal agency that set public policy that creates a near monopoly for broadcast conglomerates in many of the nation's top markets; create outright monopolies, such as Sirius/XM satellite radio; and stand by while cable-TV systems rack up huge profits while the rest of the economy is flat on its back, the least you can do is offer a "complaints department" where disgruntled Americans can queue to look for some sort of relief.

Given the scope of the Commission's portfolio (awarding broadcast licenses, policing scores of clumsily worded rules and regulations, and planning for America's unknown electronic future), it's easy to see that the Commission's staff is stretched tighter than a broadcast tower guy wire. No wonder it takes years to resolve a dispute. Still, you have to start somewhere

and that's what the FCC attempts to do with its on-line "Consumer Center" on their homepage [www.fcc.gov](http://www.fcc.gov).

The center provides extensive consumer support on a broad range of issues. Of course, you've got to have access to a computer to take advantage of any of the online consumer support, but most public libraries offer free public access to the internet, so even that shouldn't be a problem.

In addition, the online consumer page offers Spanish language help. They even offer a "Kids Zone" hosted by a cat named Broadband featuring graphics-filled tutorials about satellite communications. For fun go to Broadband's home ([www.fcc.gov/cgb/kidszone/room\\_items.html](http://www.fcc.gov/cgb/kidszone/room_items.html)), turn up your computer's volume; run your mouse quickly over the various electronic items in his house and listen (don't forget to go over the dish image, too!).



The FCC's "Kids Zone" features a cat name Broadband. Here he is enjoying a typical modern cat's life at home. Don't forget to drag your cursor over each electronic item. (Courtesy: Federal Communications Commission)

### ❖ Ham v. Ham

Despite what many old timers believe or hams with full legal power output capabilities can accomplish, amateur radio frequencies are not awarded to privileged individuals or organizations, no matter how public service-oriented they may appear. And, regardless of how often or how long any group of hams has ever met on a frequency, it cannot be claimed by them.

While the FCC does not weigh in on issues of who is using what frequency, there is an expectation at the Commission that, in return for licensing hams, protecting their frequencies from non-amateur interference, and allowing them to experiment with home-made transmitters and antennas, they'll be able to sort out whatever disagreements hams may have among themselves. That's where the Amateur Auxiliary of the FCC comes into play.

The Amateur Auxiliary is an organization of some 700 volunteer hams who are also ARRL members and known as *Official Observers* (OOs). To be an OO you must have been licensed for at least four years; have a Technician Class license or higher, and have passed a written exam based on materials in the ARRL's Amateur Auxiliary Training Manual. Details on becoming an OO are found here: [www.arrl.org/FandES/field/org/oo.html](http://www.arrl.org/FandES/field/org/oo.html). You can apply online.

OOs monitor the various ham bands for infractions, typically improper ID; poor operating practices; malfunctioning equipment, interference, and the like. Instead of engaging the offender on-air, they are allowed to dispense *Official Observer Advisory Notices*, postcards (see below) that are sent to an offending station operator listing the offense, and advising the operator to review the appropriate FCC rules and regulations regarding the offense. OOs are not supposed to be "frequency cops," and Advisory Notices are supposed to be for substantial problems, not nitpicking on-air issues.

Hams who receive such cards should remember that they are not citations. The effort is to prevent the offending ham from hearing instead from the FCC with a rules violation notice. While the OO does identify himself or herself in the Advisory Notice, they aren't required to respond to further communications by the person to whom it is sent. However, the card is made a permanent record and could be used as evidence in the event an FCC investigation targets that same individual.

Additionally, the ARRL maintains a monitoring system called "Intruder Watch" that concerns itself mainly with issues of international interference. Frequency watchers can be hams or SWLers. Reports are coordinated at ARRL headquarters which works with the International Amateur Radio Union (IARU) to investigate such reports. You can learn about this program here: [www.arrl.org/FandES/field/intruder.html](http://www.arrl.org/FandES/field/intruder.html).



The International Amateur Radio Union

Since 1925, the Federation of National Amateur Radio Societies  
Representing the Interests of Two-Way Amateur Radio Communication

The ARRL works with the International Amateur Radio Union in its global "intruder watch" program.

### OFFICIAL OBSERVER ADVISORY NOTICE

Radio: \_\_\_\_\_, your call was heard calling \_\_\_\_\_ at \_\_\_\_\_ UTC.  
working \_\_\_\_\_

Date: \_\_\_\_\_ 19 \_\_\_\_\_ Frequency \_\_\_\_\_ kHz. Mode \_\_\_\_\_ Your RST \_\_\_\_\_

The following is noted in the interest of maintaining Amateur Radio's reputation for good operating/technical practices: 1  FREQUENCY INSTABILITY 2  CHIRP 3  SPURIOUS 4  HARMONIC 5  HUM  
6  KEY CLICKS 7  BROAD SIGNAL 8  DISTORTED AUDIO 9  OVER DEVIATION 10  OUT OF BAND  
11  IMPROPER ID 12  LANGUAGE 13  CAUSING INTERFERENCE 15  CARRIER 20  OTHER

Remarks: \_\_\_\_\_  
\_\_\_\_\_  
\_\_\_\_\_

Please refer to FCC Regulation \_\_\_\_\_ Please take a few minutes to determine what equipment factors or operating practices might have contributed to this apparent departure from the rule or the good amateur practice standard. The intent of this notice is to alert you to the above noted operating condition. NO REPLY IS NECESSARY. The undersigned ARRL Official Observer has fulfilled this helping role by simply alerting you, and is not required to reply to any correspondence. Thank you for your attention and any cooperative efforts to enhance the high standards of the Amateur Radio Service which we all share with pride.

FSD-213(835) Signature \_\_\_\_\_ Call \_\_\_\_\_

Here is a sample Official Observer Advisory Notice. (Courtesy: ARRL)

Most on-air issues stem from various disputes involving VHF repeaters. Sometimes disgruntled club members, individuals who couldn't pass their license exam, or other malcontents cause mayhem on local repeaters. When these disputes can't be resolved, the FCC is then brought in to settle the issue. Typically, while fines are possible, license suspension or revocation is more likely to be the remedy for serious infractions.

While it may be preferable for hams to work within the ARRL system for reporting flagrant violations, the FCC provides a direct way for hams and non-hams, who may not be familiar with the various ARRL reporting systems, to report such complaints. Details for filing complaints against hams are found here: [www.fcc.gov/eb/AmaCmpt.html](http://www.fcc.gov/eb/AmaCmpt.html). Still, the FCC expects hams to do their part in trying to resolve the various issues among themselves before asking for FCC help.

If you are experiencing problems with a CB operator nearby who is interfering with your home electronics, you can e-mail the FCC at [fccinfo@fcc.gov](mailto:fccinfo@fcc.gov) stating the time, date and nature of the interference. It will help their investigation if you can provide a recording of the transmission at question.

#### ❖ Cable-TV leakage

For decades the cable-TV industry has been wiring this nation's cities and towns for service. That means that in some cases installations can be decades old. Traditionally, cable-TV companies rent or lease pole space from other utility companies and – even when it's done perfectly – wiring, connectors, amplifiers, and associated equipment breaks down. This sort of breakdown sometimes manifests itself as interference that can wreak havoc on various frequencies.

People who don't monitor the HF and VHF bands never know there's a problem, but for radio hobbyists it can be very frustrating. The key here is that cable-TV providers

are *secondary* users of assigned spectrum and therefore must prevent their activities from interfering with primary users, such as licensed amateur operators.

The FCC has a well written fact sheet on cable leakage that spells out who is responsible and what steps should be taken to eliminate the problem. While such rights don't extend to SWLers, the cable company should still be informed of the suspected leakage. They would much sooner want to correct the problem themselves than have the FCC on their case.

If they don't, whether or not you're a ham and you have exhausted all other means of correcting the problem, you can go to the FCC with your complaint. Following your formal complaint, if it's determined that the interference is due to their signal leakage, the FCC will not only require them to fix the problem but will likely hit them with a substantial fine as well. Here's the FCC Fact Sheet on Cable-TV Leakage: [www.fcc.gov/mb/facts/sig\\_leak.html](http://www.fcc.gov/mb/facts/sig_leak.html).

#### ❖ Nuisance Phone Calls

Any phone call from someone you don't know may be a nuisance, but it may also be legal, even if your number is on the Do Not Call Registry. The FCC allows companies to solicit business by phone or FAX machine if "... You or anyone else in your household gave the caller permission to call... [or] If you have established a business relationship with the caller... made any purchases of property, goods, or services from the individual or company that called, or made any inquiry or filed an application with the individual or company prior to receiving the call." This holds for wired as well as wireless phone numbers.

To prevent those without such a relationship from calling, you have to add your number to the National Do Not Call Registry here: [www.fcc.gov/cgb/donotcall](http://www.fcc.gov/cgb/donotcall) or you can call 888-382-1222 from the phone number you want to register. FCC rules require call-

ers that are *not* exempt from the rules to stop telemarketing calls 30 days after you register a number. There is no deadline for registering a number on the Do Not Call list.

You can file a complaint against a telemarketer if you think they are violating the rules by going to [www.esupport.fcc.gov/complaints.htm](http://www.esupport.fcc.gov/complaints.htm); by calling 888-225-5322; by e-mailing [fccinfo@fcc.gov](mailto:fccinfo@fcc.gov) or faxing 866-4180-0232. When you file, you'll be asked to give your name, address, e-mail address, phone number (and state that your number is on the Do Not Call list), as well as answer a series of questions to determine if, in fact, the call is allowed under the rules. You'll also need to know the number, date and time of the call; whether the call advertised or sold property, goods or services and any other information, such as company name, etc.

More than 99% of people called do not file complaints against such companies with the FCC, which is why the practice is still used and why it is so lucrative. But, even if you are the only person who files and the FCC has determined that the call violated the Do Not Call rules, the company will be fined \$4,500. A recent case involved a company that sent out junk FAXs to who knows how many people, but two filed complaints and the company was slapped for a \$9,000 fine. Obviously, that fine was well worth the business they drummed up by the junk FAX. But, if as many as 1,000 people file against a particular company, the fine would be \$4.5 million. Now, *that* will stop them!



## CCRadio-SWP

### Pocket Shortwave Radio

- Exceptional AM, FM, SW Reception and Audio for its 5"x3" Size
- 200 Memories with Memory Scan
- Direct Key Entry
- Covers 70-108.8 MHz FM for World Use
- Runs 70 hrs. on 2 'AA' Batteries (not incl.) or Optional AC Adapter
- Incl. Carry Pouch, Earbuds, Lanyard

\$49<sup>95</sup>

## C. CRANE

### Free Catalog

800-522-8863 • [ccrane.com](http://ccrane.com)

## Internet Radio Gadgets Galore!

It seems every time I turn around, a new gadget or device is hitting the streets that is aimed at streaming Internet radio, or other audio content.

The biggest explosion I have seen is in the mobile streaming market. Cell phone providers are now literally giving away smartphones capable of streaming services like Pandora, Slacker and other Internet radio streamers.

But there are also new home Wi-Fi radios being released in a steady stream, meaning that no matter where you are or what you are doing, you can have access to whatever audio stream you have the urge to tune in at the moment.

What does it mean for streaming enthusiasts? For one thing, it is a bit of a relief to see the surge in popularity of streaming Internet radio.

As a former broadcaster, I was a bit anxious to see if satellite radio and the iPod would kill terrestrial radio stations. Thankfully, that hasn't happened. If nothing else, while regular broadcast listening is down, when you add in those listening online, we are seeing a new wave of radio listeners coming in to the fray.

So here are just a few of the recent Internet radio-themed products that have hit the market recently, giving even more choices for those in constant search for streaming content. This might even give you a jump-start on ideas for holiday shopping for the streaming fan in your home.

### ❖ My new portable radio – the iPhone 3GS

After owning my Blackberry Curve for about eight months with moderate happiness, I decided to make a switch to Apple's iPhone 3GS. I was just looking for a little bit more functionality than my Blackberry could provide. All I can say after roughly three weeks of iPhone use is *WOW!*



The scope of this column being what it is, I will not go into an in-depth review of the phone, but I will touch on some of the high spots that you, the Internet streaming fan, can put to use.

The first streaming applications I down-

loaded were the big ones: Pandora, Slacker and iHeartRadio. I have to say the iPhone's touchscreen interface was much more enjoyable to use with these services than the interface on my Blackberry.

#### iHeartRadio

As an editorial aside: if Clear Channel hopes to have any success keeping up with the rest of the Internet radio world, they are going to have to improve their iHeartRadio application.

*“Internet radio is booming, and new gadgets are feeding the addiction”*

For one thing – and I suppose the same argument could be said of their radio station content – much of the content on it is generic. I was disappointed with the overwhelming lack of stations available throughout the application. Yes, some of the larger markets have their streams available. But, how difficult would it be for them to include their smaller markets as well? For instance, not one of my local Greenville, South Carolina stations was available. As a listener, this is a glaring flaw.

Clear Channel would most likely see a huge surge in popularity for the application if listeners could listen to stations in their own market, no matter how large or small it is.

#### ooTunes

Next, I wanted to step up to the real “streaming radio” applications. I first started with ooTunes. Although downloading the application broke my first promise I had made to myself when buying the phone (“Free applications only,” I swore), at \$3.99 it isn't what I would call a large infraction.

The interface on ooTunes is fairly simple. You can search from all of the available streams on the service – a combination of streams from Radio Reference (formerly ScanAmerica), RadioTime, Icecast, XM Satellite Radio, Live365, Reciva, ShoutCast, NOAA Weather Radio, AOL Radio, Air Traffic Controller streams and more. The service claims to have more than 11,000 stations from around the world. It supports streams in AAC, AAC+, MP3, WMA, OGG Vorbis and a few flash streams.

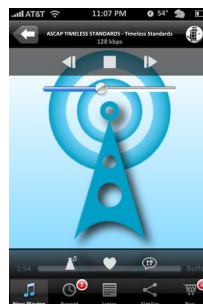

For those who really want to take their music with them, ooTunes even offers a full-featured “server” program that lets you stream your entire iTunes music catalog over your iPhone or iPod. It costs about \$20 and can be downloaded from the ooTunes Web site. The iPhone application can be downloaded from iTunes' App Store.

#### Radio Apps

A quick search of the App Store yields a plethora of applications for the radio hobbyist as well. Here are a few of the more interesting ones.

Scanner enthusiasts will love the iPhone, because even if you forget your

scanner at home, there are a number of scanner streams available. Emergency Radio, from developers EdgeRift is a great start, with more than 1,000 streams available from a number of different agencies. Emergency Radio even comes with a handy list of 10-codes, for those wanting to keep up with the action but don't 10-4 all of the lingo.

Intersect World has also developed a couple of radio hobbyist-friendly applications for the iPhone. One, simply called Radio, is a mobile streaming application that boasts more than 7,000 radio station streams, including NOAA Weather Radio and Radio Reference streams. At \$.99, it is a bit cheaper than ooTunes, but doesn't pack nearly the number of streams.

Another Intersect World application is the aptly-named Scanner (nothing like keeping it simple). This application is priced at \$1.99 and has more than 1,400 streams, including more than 1,000 from Radio Reference.

As with most iPhone applications, each of these applications is fairly easy to install, use and maintain. Updates come automatically through the App Store on the phone itself through your iTunes account.

Branching out, there are a number of other





applications for radio enthusiasts, especially Hams, including study material for ARRL Amateur Radio exams, Amateur Satellite tracking applications, loggers, grid square maps and more. There are even several applications that allow you to tune in HF Beacons on your shortwave receiver. Hold the phone up to the speaker and it will decipher the Morse code to tell you which beacon you are tuned into and where it is located. This provides an invaluable DX tool for both amateurs looking for band openings and DXers alike.

All of the applications can be downloaded through the App Store directly in iTunes or from your iTouch or iPhone itself.

Don't have iTunes? It is a free download from Apple. See the link in the table at the end of this article for the Web address.

For those who aren't yet on the iPhone bandwagon, it will require you to switch to AT&T (in the U.S.; carriers vary by country). There are two models available, a 16GB and a 32GB model. I skimped on size and bought the 16GB, thinking it would be difficult to fill. If you have a lot of music, movies, etc., you might want to look at the 32GB because those will fill it up quickly.

Those who want the fun of the iPhone but don't want the commitment of a new cell phone contract (or just want to stay with their current provider) should look at the iTouch. You can use all of the applications from the App Store on the iTouch, except those that are made for the phone aspect of the iPhone. To use the on-line components, you will need to be at a Wi-Fi hotspot. There are 8GB, 16GB and 32GB models available.

## ❖ Want a BlackBerry Free from Slacker?

The Internet streamer Slacker is so happy with the success it has enjoyed, it is partnering with the four major U.S. Cell phone carriers to pick up the tab for a new BlackBerry Curve for those willing to sign a new two-year contract.

In an effort to broaden the reach of their BlackBerry application even further, Slacker is hoping the new promotion will have cell phone users who initially balked at the upfront cost of the smartphones to warm to the idea. Users will still have to sign a 2-year contract and pay the additional data plan fees associated with the BlackBerry (which vary with each carrier). But, for those wanting to dabble their toes in the smartphone waters, this should be a fantastic promotion with which to get on board.

While I have recently replaced my own Curve with an iPhone, it isn't because the BlackBerry wasn't sufficient. From a hobbyist's point of view, actually, the BlackBerry might be a fantastic way to have streaming radio and a scanner in your pocket. Now, for free!

## ❖ Wi-Fi Radio Options in the Home

Along with the portable devices, every day more Wi-Fi radios are hitting the market. The most recent, the Myine IRA, is an interesting twist on the typical design.

The Myine IRA is not a stand-alone Wi-Fi

Radio. In order to hear audio from the device, you have to connect it to an external stereo or home theater system. But from the looks of it, the quality of the Myine IRA should be worth the \$150 price tag.

First, the Myine IRA sits upright and has a large blue-backlit LCD screen. The included remote should help those who want to navigate their streams from the couch. The unit is shipped with an RCA cable and even an RCA to 1/8" phono adapter for hooking the unit into just about any home stereo set up.

Want to skip the middle-man and stream Internet radio directly through your home theater's receiver? Onkyo has released a new receiver capable of onboard streaming audio from Pandora, Rhapsody, Sirius and Internet Radio through vTuner. You can even stream audio files from your home computer.

The Onkyo TX-NR807 is THX certified, decodes Dolby TrueHD and DTS-HD Master Audio, has a whopping six HDMI inputs, supports up to 9.1 configurations (through Audyssey DSX processing) and boasts a hefty \$1,100 price tag.

Finally, a new product being premiered this month might have the ability to "turn" Internet radio on to thousands of "non-techie" types.

The new Q2 Cube from Armour Group and Cambridge Consultants claims to be the world's first "dial-free" radio. Users use their home computer to select four preset stations; then by turning the radio on one of four faces, the stations will begin streaming through the speaker. A fifth "face" allows the user to control the volume by simply tilting the cube forward or backwards.

While it might be a bit of a novelty for serious streaming fans, the Q2 Cube could open the door of Internet radio to the masses.



The **Microtelecom Perseus** is a cutting-edge, multimode, software defined receiver covering 10 kHz to 30 MHz. Enjoy world class performance: 3rd order IP: +31 dBm, Sensitivity: -131 dBm, Dynamic Range: 104 dB (BW 500 Hz CW). An impressive full span lab-grade spectrum display function is featured. An almost magical spectrum record feature allows you to record up to an 800 kHz portion of radio spectrum for later tuning and decoding. The audio source is via your PC soundcard. The Perseus operates from 5 VDC and comes with an international AC power supply, AC plug converter, SO239 to BNC RF adapter, USB cable and CD with software and detailed manual. Made in Italy. Visit [www.universal-radio.com](http://www.universal-radio.com) for details!

**Universal Radio**  
6830 Americana Pkwy.  
Reynoldsburg, OH 43068  
◆ Orders: 800 431-3939  
◆ Info: 614 866-4267  
[www.universal-radio.com](http://www.universal-radio.com)

### GLOBALNET LINKS

- iTunes  
[www.apple.com/itunes/](http://www.apple.com/itunes/)
- Slacker's free phone promotion  
[www.slacker.com/promo/freephone](http://www.slacker.com/promo/freephone)
- More information on the Slacker phone promotion:  
[www.informationweek.com/news/personal\\_tech/blackberry/showArticle.jhtml?articleID=219200204](http://www.informationweek.com/news/personal_tech/blackberry/showArticle.jhtml?articleID=219200204)
- Myine IRA  
[www.myine.com/ira.php](http://www.myine.com/ira.php)
- Cnet Review - Onkyo TX-NR807  
[http://news.cnet.com/8301-17938\\_105-10306387-1.html](http://news.cnet.com/8301-17938_105-10306387-1.html)
- The Q2 Cube  
[www.telegraph.co.uk/culture/tvandradio/6009556/Worlds-first-dial-free-radio-unveiled.html](http://www.telegraph.co.uk/culture/tvandradio/6009556/Worlds-first-dial-free-radio-unveiled.html)
- Cambridge Network - The Q2 Cube  
[www.cambridgenetwork.co.uk/news/article/default.aspx?objid=62034](http://www.cambridgenetwork.co.uk/news/article/default.aspx?objid=62034)

## Sangean Wi Fi Radios

Now you can enjoy the excitement of accessing over 16000 Internet Radio Stations almost anywhere when you own a new Sangean WFR-1 Internet Radio and in addition enjoy any of your local standard FM broadcasts using the built in FM tuner with RDS or upload your favorite or any internet station to your Sangean WFR-1's "My Station" allowing quick and easy future access. You no longer need to be glued to your computer to access your favorite Internet station nor do you even have to have your computer on. All you need is a broadband internet connection and a wired or wireless router. Add to your listening pleasure by creating your own Digital Music Library. The Sangean WFR-1 offers the ultimate in Internet Radio listening.



Order RCV56  
**\$349<sup>95\*</sup>**  
\* plus \$13.95 UPS Ground shipping in the U.S.



800-438-8155  
828-837-9200 fax: 828-837-2216

[www.grove-ent.com](http://www.grove-ent.com)

## Keeping Tabs on Your Community

Scanner listeners come from all walks of life and have a variety of reasons for getting started in the hobby. This month we answer questions from two scanner owners who want to find out what's happening in their community.

### ❖ Scanning San Francisco

Dan,

*I have a Pro-34 scanner that's twenty years old but in excellent condition and I want to start using it again. Problem is the Radio Shack frequency guide I have is also twenty years old and I'm having trouble finding a current one. I live in San Francisco. Any suggestion where I can buy a current list of public safety radio frequencies? Or have they stayed the same?*

*Many thanks for the help.  
Ron in San Francisco*

Congratulations on wanting to get back into scanning!

Unfortunately, as you've discovered, the old *Police Call* guides that Radio Shack used to sell are no longer published, and have been largely replaced (like so many things) by the Internet.

I would recommend joining the Yahoo! Group BayScan at <http://groups.yahoo.com/group/bayscan/>

It is dedicated to scanning in the San Francisco Bay Area and has more than 900 members. You'll need to sign up for a Yahoo! profile, which is free, and then join the group. Once you're a member, you can post questions to the group and access frequency lists and other local radio information in the files section. I've found these groups to be generally friendly and welcoming to new (or returning) hobbyists and can really make a difference in making your scanning sessions worthwhile.

You can also find helpful information at Lindsay Blanton's Radio Reference web site, at [www.radioreference.com](http://www.radioreference.com). Here you will find information on public safety and business radio systems across the country, submitted and maintained by volunteers. There are also discussion areas ("forums") dedicated to particular topics, including scanning in California.

The PRO-34 is a 200-channel handheld

scanner introduced about 20 years ago and sold through Radio Shack. It provides coverage between 30 and 54 MHz, 108 to 174 MHz, 380 to 512 MHz, and 806 through 960 MHz, with a factory block for the old analog cellular frequencies. It scans about 8 channels per second.

Although the PRO-34 is a nice scanner, it likely won't be much help these days to monitor public safety operations in San Francisco. For more than a decade the city has been using a trunked radio system (the "Citywide Emergency Radio System," or CERS) for police, fire, EMS, and other services. This means that conversations can take place on any one of 20 or so frequencies, and potentially changing frequency with each transmission.

For such systems, the usual solution is a "trunk-tracking" scanner, which are newer models that can automatically follow conversations from frequency to frequency.

If you're intent on using the PRO-34, you can try listening to conversations on the frequencies listed below. If the activity level on the system is low, you might be able get a sense of what's going on, but if it's busy (like on a warm summer Friday night when everyone is out and about), you'll only hear snippets of many different conversations. This is a recipe for frustration.

### San Francisco, California

The City of San Francisco covers about 48 square miles and has just over 800,000 residents. The city and county operate a Motorola Type II SmartZone carrying voice in both analog and APCO Project 25 digital formats. Eight repeater sites and two dozen frequencies provide service to about 5,000 portable (handheld) and mobile (vehicle-mounted) radios.

Frequencies on CERS are: 866.0500, 866.2500, 866.4500, 866.5750, 866.6500, 866.7750, 866.8250, 867.2250, 867.2750, 867.4375, 867.4625, 867.6500, 867.7000, 867.9000, 868.0625, 868.5375, 868.7375, 868.7875 and 868.9000 MHz.

There is also a smaller Public Works Radio System (PWRS) operating on the following frequencies from three repeater sites: 856.2375, 857.2375, 858.2375, 866.6750, 866.8625, 867.1250, 867.3500, 867.7250, 868.1125 and 868.3375 MHz.



Active talkgroups on the system are listed below. Talkgroups in a Motorola system are identified by a single number, which can be in either decimal (base 10) or hexadecimal (base 16) format. Note that some CERS talkgroups carry voice activity in digital format, as specified by the APCO Project 25 Common Air Interface (CAI), which means that you will need a "digital-capable" scanner to hear them. Some talkgroups are also encrypted, so you will not be able to hear those conversations regardless of what model scanner you might have. Encrypted talkgroups include some emergency medical service activity and police narcotics officers.

Decimal	Hex	Description
208	00D	Police Special Investigations
240	00F	Police Vice
272	011	Police Command
944	03B	Emergency Medical Services 1 (Hospital)
976	03D	Emergency Medical Services 2 (Hospital)
1008	03F	City Fire Prevention
12848	323	Police, Central and Southern (Dispatch)
12880	325	Police, Central and Southern (Service)
12912	327	Police, Bayview and Mission (Dispatch)
12944	329	Police, Bayview and Mission (Service)
12976	32B	Police, Northern and Park (Dispatch)
13008	32D	Police, Northern and Park (Service)
13040	32F	Police, Richmond, Ingleside and Taraval (Dispatch)
13072	331	Police, Richmond, Ingleside and Taraval (Service)
13104	333	Police Command (Dispatch)
13136	335	Police Command (Dispatch)
13168	337	Traffic Command
13200	339	Police Tenderloin (Dispatch)
13232	33B	Police Station Service
13264	33D	Police Station Service
13296	33F	Parole and Probation
13520	34D	All City Event 1
13552	34F	All City Event 2
13584	351	City Public Safety Event 1
13616	353	City Public Safety Event 2
13648	355	City Public Safety Event 3
13680	357	Mobile Assistance Patrol
13808	35F	Police Tactical 1 (Administration)
13840	361	Police Tactical 2
13872	363	Police Tactical 3
13904	365	Police Tactical 4
13936	367	Police Tactical 5
13968	369	Police Tactical 6
14000	36B	Police Tactical 7
14032	36D	Police Tactical 8
14064	36F	Police Tactical 9 (Robbery Apprehension Team)
14096	371	Police Tactical 10
14128	373	Police Tactical 11

14160	375	Police Tactical 12
14192	377	Police Tactical 13
14224	379	Police Tactical 14 (Event)
14256	37B	Police Tactical 15
14288	37D	Police Narcotics 1 (Administration)
14544	38D	Police Investigations 1 Administration
14576	38F	Police Special Investigations Division
14704	397	Police Training 1
14736	399	Police Training 2
14800	39D	City Fire Division 1 (Dispatch)
14832	39F	City Fire Division 2 (Dispatch)
14864	3A1	City Fire Division 3 (Dispatch)
14896	3A3	City Fire Division 1 (Command)
14928	3A5	City Fire Division 2 (Command)
14960	3A7	City Fire Division 3 (Command)
14992	3A9	City Fire Battalion 7 (Tactical)
15024	3AB	City Fire Battalion 8 (Tactical)
15056	3AD	City Fire Battalion 9 (Tactical)
15088	3AF	City Fire Battalion 10 (Tactical)
15120	3B1	City Fire Battalion 1 (Tactical)
15152	3B3	City Fire Battalion 2 (Tactical)
15184	3B5	City Fire Battalion 3 (Tactical)
15216	3B7	City Fire Battalion 4 (Tactical)
15248	3B9	City Fire Battalion 5 (Tactical)
15280	3BB	City Fire Battalion 6 (Tactical)
15312	3BD	Ambulance (Non-Emergency)
15344	3BF	Private Ambulance Services
15472	3C7	City Fire Auxiliary Water Supply System
15504	3C9	Coroner
15760	3D9	City Fire Bureau of Equipment
15792	3DB	City Fire Training
15856	3DF	Sheriff Jail 1
15888	3E1	Sheriff Jail 2
15920	3E3	Sheriff Jail 5 (West)
15952	3E5	Sheriff Jail 5 (East)
15984	3E7	Sheriff Jail 8
16016	3E9	Sheriff Jail 9
16048	3EB	Sheriff Classification Unit
16080	3ED	Sheriff City Hall Patrol (Dispatch)
16112	3EF	Youth Guidance Center/Laguna Honda Hospital Security
16144	3F1	Courts (Security)
16176	3F3	Sheriff Transportation
16208	3F5	Sheriff
16240	3F7	Sheriff Emergency Services Unit
16272	3F9	Sheriff Field Support
16464	405	Parking Control Officer (Dispatch)
16496	407	Public Transportation Commission (Engineering)
16528	409	Traffic Signals
16560	40B	Parking Meters and Signs
16592	40D	Public Transportation Commission (Special Events)
16624	40F	Traffic Control Center
16656	411	Parking Enforcement
16688	413	Parking Enforcement (Towing)
16816	41B	Water Department (Administration)
16848	41D	Water Department (Operations)
16912	421	Recreation and Parks (Administration)
16944	423	Recreation and Parks (Maintenance)
16976	425	Recreation and Parks (Urban Forestry)
17008	427	Recreation and Parks (Security)
17040	429	Recreation and Parks
17424	441	Emergency Operations
17456	443	Emergency Operations
17488	445	Emergency Operations (Administration)
17840	45B	San Francisco State University (Dispatch)
17872	45D	San Francisco State University
17904	45F	San Francisco State University
18544	487	Mayor's Office
49200	C03	San Francisco General Hospital (Security)
50000	C35	Public Library Security
64976	FDD	Street Sweepers

There are also regional and statewide conventional (non-trunked) analog frequencies dedicated to mutual aid operations that you may be able to hear in your area. This includes CLEMARS, the California Law Enforcement Mutual Aid Radio System, operated by the Governor's Office of Emergency Services.

Frequency	Description
39.46	CLEMARS
154.920	CLEMARS (Channel 1)
154.935	CLEMARS (Channel 2)
155.475	CLEMARS (Channel 3)
460.025	CLEMARS
866.2000	CLEMARS
866.6125	Region-wide Mutual Aid
867.2625	Emergency Medical Services
867.7875	Northern California Federal/Local Coordination
868.5125	CLEMARS
868.9875	Statewide Fire/Emergency Medical Services

### BayRICS

A consortium of Bay Area jurisdictions are currently working on a region-wide radio system called BayRICS, short for Bay Area Regional Interoperable Communications System. Ten counties, Alameda, Contra Costa, Marin, Napa, Santa Clara, Santa Cruz, San Francisco, San Mateo, Solano, and Sonoma, intend to settle on a common architecture and technology to allow police, fire, and other public safety providers to communicate directly with each other during emergencies.

BayRICS is made up of four major components: a digital voice network, a high-speed wireless data network, an interconnected microwave backbone, and an information sharing system for law enforcement.

The BayRICS voice network will be based on APCO Project 25 digital standards using 700 and 800 MHz frequencies in populated areas and VHF frequencies in rural areas. The idea is to enhance the various public safety radio systems already in place and install equipment that will connect them together. This "system-of-systems" network has an estimated cost of \$600 million for infrastructure upgrades and replacement of radios. Build-out and deployment is expected to take place in urban areas first, with a goal of having the system fully operational by 2012.

### ❖ Scanning Arvada, Colorado

Hi Dan,

*I was wondering if you can help me, I have read your web site and kind of understand it. I just bought a Uniden BCD396T scanner and I just want to listen to the city of Arvada's EMS, Fire and Police. I found the following on a web site and I'm not sure what is the input frequency and the LCN. I'm just a nosey stay at home Mom.*

*This is the link to the web site where I got the info. [www.panix.com/clay/scanning/Frequencies/States/denver.co](http://www.panix.com/clay/scanning/Frequencies/States/denver.co)*

*And the following is where I need help.*

# UNIDEN BCD996XT



- TrunkTracker IV with Control-Channel Only scanning and I-Call monitoring: Tracks voice traffic on P25, Motorola, EDACS, and LTR Trunked systems
- Supports scanning of Rebanding systems
- APCO25 Digital Audio decoding
- Support for P25 Conventional channels that include NAC and TGID user differentiation (P25 One-Frequency Trunk)
- Adaptive Digital Threshold - Automatically sets the digital decode threshold for APCO 25 systems
- EDACS ESK support
- Control Channel Data Output
- Close Call RF Capture

Order SCN21 \$ **499<sup>95\*</sup>** \* plus \$17.95 UPS Ground shipping in the U.S.

800-438-8155

828-837-9200 fax: 828-837-2216

**GROVE** order@grove-ent.com  
7540 Highway 64 West  
Brasstown, NC 28902

[www.grove-ent.com](http://www.grove-ent.com)

## WWW.SCANCAT.COM

**ORDER TOLL FREE  
888-722-6228**

### COMBO CD SPECIAL

Reg.  
ScanCat-Lite-Plus.....\$29.95  
Mr. Scanner FCC Public Safety .....\$29.95  
Nat-Com's FCC Scancat Files .....\$9.95  
Bonus Disk Of Frequencies.....\$15.00

**NOW \$49.95** \$84.85

**PLUS FREE** Scanning Magazine(s)  
*(With Purchase Of Special. While Supplies Last)*

**SUPPORT JUST ADDED FOR  
RADIOHACK PRO-106/197/404/405  
UNIDEN BCD-346XT/396XT/996XT**

### ScanCat-Lite-PLUS

Reg. \$39.95 - Limited Time Special \$29.95

**Now It's Easier Than Ever To  
Use Your ScanCat Software.**

**FREE walk-you-through set up  
video to get you going fast.**

[www.scancat.com](http://www.scancat.com) **You Tube**  
Click on learn as you view.

Scancat-Gold for Windows  
Version 8.50 \$99.95

Scancat-Gold for Windows-SE -  
\$159.95

Skysweep Decoder Software \$99.95

**COMPUTER AIDED  
TECHNOLOGIES**

ORDERS: (318) 687-4444 FAX: (318) 686-0449  
Info/Tech Support: (318) 687-2555  
(9 a.m. - 3 p.m. Central M-F)

**WWW.SCANCAT.COM**

**ARVADA  
POLICE/LOCAL MULTI-AGENCY TRUNKED  
800 G.E. EDACS SYSTEM]**

Sequence # Repeater Input  
R-1 866.0625 821.0625  
R-2 866.7625 821.7625  
R-3 867.0625 822.0625  
R-4 867.3250 822.3250  
R-5 868.9250 823.9250  
R-6 866.3125 821.3125  
R-7 867.1625 822.1625  
R-8 867.8875 822.8875  
R-9 868.3500 823.3500  
R-10 868.6500 823.6500

TALK GROUP I.D.s  
Channel 1 Dispatch  
Channel 2 Clearances  
Channel 3 Undefined  
Channel 4 Car to Car  
Channel 5 Undefined  
Channel 6 Tactical Use  
SIU Investigators  
ICALL Dispatch to Individual Car  
**[FIRE]**  
453.150 F-1 Dispatch  
453.550 F-2 Fireground/Admin.  
154.280 S FERN



*Please help if you can. Thank you.  
Kristin in Colorado*

Kristin, being “nosey” can be a good thing. You have as much right as anyone else to know what is going on in your community. Staying informed and aware is certainly better than, say, watching soap operas or other stereotypical stay-at-home activities. Listening to police, fire and emergency medical services can help you to understand and appreciate your local public safety operations, which are paid for with your tax dollars!

Arvada is a northwest suburb of Denver, Colorado, and has a population of about 106,000 people. Readers of fiction might also recognize Arvada as the home of Clive Cussler.

Arvada, together with the adjacent town of Westminster, operates a trunked radio system for their public safety and municipal employees. The system is an EDACS (Enhanced Digital Access Communications System), originally developed by General Electric, but after a series of corporate purchases is now sold by Harris Corporation.

EDACS is a trunked radio system, meaning that conversations may occur on any of the voice channels assigned to the system. There are ten frequencies in use on the Arvada/Westminster system, and the order in which these frequencies are programmed into your scanner is important.

EDACS uses a scheme called Logical Channel Number (LCN) to identify what frequency a radio should use. Instead of transmitting the actual frequency over the air, EDACS transmits a shorter number, the LCN. Each EDACS radio is programmed with a list of LCNs and the associated frequency.

LCN	Frequency
01	851.0625
02	851.7625
03	852.0625
04	852.3250
05	853.9250
06	851.3125
07	852.1625
08	852.8875
09	853.3500
10	853.6500

The frequencies listed here are the *output* frequencies of the repeater. The smaller numbers you mention are the *input* frequencies to the repeater. When a police officer or other municipal employee is talking into their radio, it is transmitting a signal to a repeater. The repeater receives the signal on its input frequency and immediately re-transmits it, with much higher power, on a corresponding output frequency. Because the signal on output frequency is so much stronger than the input signal, scanner listeners almost always tune to the output frequency of a repeater.

The Uniden BCD396T is a 6000-channel handheld scanner introduced in 2005 that is capable of monitoring analog and APCO Project 25 digital systems, including the Arvada/Westminster EDACS system. The only caveat here is that the system is reported to occasionally use a proprietary digital voice format called “ProVoice” that cannot be monitored by the 396T or any other scanner on the market. However, much of the system voice traffic is in analog format, which the 396T handles without trouble.



The BCD396T Owner’s Manual includes instructions for programming EDACS systems beginning on page 67. Page 68 describes the frequency entry process, which prompts you to enter the frequency and its associated LCN. Do this for each of the ten Arvada/Westminster frequencies and you’ll be on your way to monitoring in no time.

Conversations on trunked radio systems are organized into talkgroups. EDACS talkgroups are identified either with a single decimal (base-10) number or a pair of numbers called “Agency-Fleet-Subfleet” or AFS. By dividing talkgroups into agencies, fleets and sub-fleets, the system operator can more easily keep track of assignments and leave room for future expansion. For instance, on the Arvada/Westminster system it appears that the Arvada Police Department has been set up as Agency 02 while the Fire Department is Agency 06.

Decimal	AFS	Description
273	02-021	Arvada Police Channel 1 (Dispatch)
274	02-022	Arvada Police Channel 2 (Clearances)
275	02-023	Arvada Police Channel 3
289	02-041	Arvada Police Channel 4
290	02-042	Arvada Police Channel 5
291	02-043	Arvada Police
292	02-044	Arvada Police (Detectives)
293	02-045	Arvada Animal Control
296	02-050	Arvada Police Scout-14
322	02-082	Colorado Law Enforcement Emergency Radio
324	02-084	Arvada Police (Radio Technicians)
353	02-121	Arvada Water/Irrigation
354	02-122	Arvada Water Department
356	02-124	Arvada Public Works
358	02-126	Lake Arbor Golf Course 1
359	02-127	Lake Arbor Golf Course 2
360	02-130	Arvada Parks Department

369	02-141	Arvada Water Department
370	02-142	Arvada Public Works
371	02-143	North Jefferson County Parks
372	02-144	Arvada Sewer Department
373	02-145	Arvada Water Department
374	02-146	Arvada Water Department
512	04-000	Westminster Police (Agency-wide)
529	04-021	Westminster Police Channel 1 (Dispatch)
530	04-022	Westminster Police Channel 2 (Clearances)
531	04-023	Westminster Fire Channel 1 (Dispatch)
532	04-024	Westminster Police Channel 4
533	04-025	Westminster Police Channel 8 (Traffic Operations)
534	04-026	Westminster Police Channel 5 (Animal Control)
535	04-027	Westminster Police Detectives
536	04-030	Westminster Police Channel 9 (Detectives/Special Units)
537	04-031	Westminster Police Channel 6 (Detectives/Special Units)
538	04-032	Westminster Police Channel 3
541	04-035	Westminster Police Courts
545	04-041	Westminster Fire Channel 2
546	04-042	Westminster Fire Channel 3
547	04-043	Westminster Fire Channel 4
549	04-045	Westminster Fire Department
553	04-051	Westminster Fire Department
554	04-052	Westminster North Metro Fire and Rescue (Simulcast)
562	04-062	Westminster Streets
563	04-063	Westminster Water Plant
564	04-064	Westminster Public Works
566	04-066	Westminster Public Works
567	04-067	Westminster City Services
568	04-070	Westminster Public Works
578	04-082	Stanley Lake Rangers
579	04-083	Westminster City Services
581	04-085	Westminster Special Events
592	04-100	Westminster Water Department
594	04-102	Westminster City Services
600	04-110	Westminster Water Department
785	06-021	Arvada Fire Department (Dispatch)
786	06-022	Arvada Fire Department Tac-2
787	06-023	Arvada Fire Department Tac-3
801	06-041	Arvada Fire Department Training-1
803	06-043	Arvada Fire Department Training Tac-3
804	06-044	Arvada Fire Department Tac-4
862	06-116	Statewide Emergency Medical Services (Mutual Aid)
1034	08-012	Arvada Police (All Call)
1697	13-041	Metro Net (Dispatcher-to-Dispatcher)
1698	13-042	Denver Metro Command 1
1699	13-043	Denver Metro Command 2
1700	13-044	Law Enforcement Mutual Aid (Denver Metro Northeast)
1701	13-045	Fire/EMS Mutual Aid (Denver Metro Northeast)
1702	13-046	Law Enforcement Mutual Aid (Denver Metro)
1703	13-047	Fire/EMS Mutual Aid (Denver Metro Northwest)
1967	15-057	Arvada Police Patches (Interoperability)

That’s all for this month. You can check my website at [www.signalharbor.com](http://www.signalharbor.com) for more detailed information on scanners, frequencies and other radio-related material. I also welcome electronic mail at [danveeneman@monitoring-times.com](mailto:danveeneman@monitoring-times.com). Until next month, happy scanning!

**Q.** Are the little battery chargers that claim to revive and recharge all types of batteries – alkaline, NiCad, NiMH, etc. – really effective, or are they just a scam? (Bill Speerstra, KC9BSL, Minocqua, WI)

**A.** Different battery chemistries require different charging methods. While it's true that a simply hooking an external DC source to a discharged battery will charge it somewhat, the method doesn't fully charge every kind of battery. Some require a constant voltage and some require a constant current.

Alkaline chemistry is destructive; once the chemicals have been used up in their internal reaction, they can't be fully recharged, and only partially recharged a few times before they are dead as a doornail!

I'd say that this device is in the same class as the glue-on strip that claims to increase cell phone range, and the plastic ball to put on the top of your mobile whip to do the same – Oh, and don't forget to wrap your TV rabbit ears with aluminum foil!

**Q.** When I can hear lightning crashes quite some distance away on my shortwave receiver, I don't hear them on my scanner. Is this because the scanner receives FM and the lightning strokes produce an AM signal?

**A.** Yes and no. While lightning does, in fact, produce an AM signal, it is rich in harmonics which dissipate the higher in frequency you go. You can hear lightning for hundreds of miles down in the low frequencies, and tens of miles in the shortwave bands, but by the time you are in the VHF spectrum, if you hear the lightning on a scanner, you'd better duck – It's close!

As a side note, if you have your shortwave receiver hooked to an outdoor antenna, tune to a dead spot so you don't even hear electrical noise, and then disconnect the antenna; you'll note that the background hiss diminishes. That hiss was the combined lightning-stroke energy radiated by over 2000 worldwide electrical storms going on at any one time!

**Q.** When I hook a voltmeter between the neutral wire on a household lamp and an actual earth ground, I get a voltage reading. How is this possible if both are connected together at the power line service entry? I've even done

this with a gasoline generator which isn't even connected to the power service.

If I hooked 10 car batteries in series and connected the above bulb to the end terminals, would I get a reading on both sides of the bulb? (Mark Burns, Terre Haute, IN)

**A.** In a perfect (no resistance) household distribution system, there would be no voltage difference between the ground wire and the neutral wire of an AC system. But plugging in appliances produces unconformities in resistance between the neutral and ground wires, resulting in voltage differences in them. Add in the resistance of the soil between the AC ground and your earth ground, and you have yet another path of electrical difference.

I suspect that the reason you saw the same phenomenon when you measured the voltage between the gasoline generator and earth ground could well be attributed to the fact that the metal generator was sitting on the ground, providing an electrical leakage path.

While many appliances have three-wire cords, others have two. This changes the resistance balance between the neutral and ground on the total line. If all wiring had zero resistance, there would be no voltage difference between the neutral and ground.

Minor power leakages in appliances result in a voltage difference between the neutral and ground references. That is one reason why the third wire is required in the first place – to protect the user from electrocution from such leakages from imperfect insulation and isolation of the powered circuitry. Many modern appliances are safe with just two wires because there are no exposed metal parts that would produce a shock hazard.

So far as the light bulb question, discounting the resistance of the wires, yes, you would get the same voltage reading across the bulb as you would across the battery terminals. But with real wires with real resistance, you'd see slightly less voltage across the bulb than you'd measure across the battery terminals. If you measured the voltage across the bulb, and across the lengths of each of the two wires, they would add up to 120 VDC.

**Q.** I monitor the same signal on two receivers, each connected to a separate antenna, one north/south and the other east/west. When the signal fades on one, it picks up on the other. But if I simply connect the two antennas together on one receiver, I still get the fading. Why

is this? (Jim Moodie, KA7CIC)

**A.** Connecting separate receivers to separate antennas in different positions, both monitoring the same frequency, is called dual diversity reception.

Over distances, an arriving signal may have multiple components, reflected by the earth and distorted by the ionosphere; thus, these components arrive at various angles and even different timing. As the composite signal shifts less favorably from one antenna, it aligns better with the other.

If you simply tie the two antennas together, you really have made one antenna, and multiple signal components arriving out of phase with each other produce radio-frequency AC voltages that cancel each other.

A simplified mechanical analogy would be when two people shake a rope up and down in rhythm; if one of them briefly stops and starts again, the out-of-phase waves cancel the motion.

**Q.** When steam rushes out of a pipe into the air, it's invisible for a short span, then turns cloudy. Is steam, and are all other gases, invisible? (Mark Burns, Terre Haute, IN)

**A.** The steam remained invisible for the first few inches because it hadn't had time to cool down enough to condense back into water droplets. When you see "steam," it's actually a mist of water droplets; steam is invisible.

Solids have color of their own because only certain wavelengths reflect from their surfaces. Liquids may either reflect certain colors while absorbing the others, or may filter light passing through them, allowing only certain wavelengths to be transmitted.

The molecules of most gases are widely separated, lowering the likelihood of reflecting light waves. If the gas is compressed or dense enough, it may filter and scatter light going through it, transmitting only certain wavelengths depending on the size of the molecules and the wavelengths of the light.

Nitrogen, the most abundant gas in the atmosphere (78%), makes the sky blue because its molecules scatter blue light in all directions. When iodine crystals are heated, the vapor absorbs most wavelengths except for purple.

Questions or tips sent to Ask Bob, c/o MT are printed in this column as space permits. Mail your questions along with a self-addressed stamped envelope in care of MT, or e-mail to [bobgrove@monitoringtimes.com](mailto:bobgrove@monitoringtimes.com). (Please include your name and address.)

## Monitoring Mexico's Green Angels

**M**ike Chace-Ortiz edits the *Digital Digest* column that always appears right after this one. His regular beat is the digital side of the utility world, which is why the columns appear side by side.

This month, *Utility World* builds on some great investigation done by Mike, listener Jon in Florida, and some other people who hang out on an Internet Relay Chat channel for hard core utility fans. If you haven't read Mike's July 2009 column about all this, it's probably good to do so.

Around the beginning of this year, Jon discovered one of those nice utility mysteries that just keeps on giving. This time it was a net on 7790 kilohertz (kHz), using voice in Spanish and Automatic Link Establishment (ALE).

Place names and various radio regionalisms quickly established the source as coming from several Mexican states north of Mexico City, in the country's south central region. They named this the "M42 Net," from one frequently used callsign.

The ALE addresses just kept turning up on new frequencies. Those so far discovered are: 7536, 7640, 7790, 7802, 7815, 7828, 7920, 8115, 8175, 9043, 9960, 10364, 10369, and 10803 kHz. All are upper sideband (USB). Most are used for the ALE autolinking. The voice seems to be almost entirely on 7790.

So far, everything on shortwave (HF, 3-30 megahertz) has come from this single area. However, web sites and other sources provide ample evidence that we've stumbled onto the tip of the proverbial iceberg here. We are hearing a relatively small piece of a vast, national, interlinked radio system primarily using higher bands.

Early theories suggested a police net. Now, though, it's known to be a growing new radio system for a federally funded service patrol called Los Angeles Verdes – The Green Angels. It's a little like the American "Triple-A," only far larger and funded mostly from taxes.

### ❖ Green Angels?

People who've driven long distances in Mexico usually have good things to say about the Green Angels. Every day, from dawn to dusk, hundreds of distinctive trucks patrol tens of thousands of miles on Mexican interstate toll highways. They provide assistance with flat tires, breakdowns, accidents, and other emergencies on what can be some very long

and desolate stretches of road. The service is free, though they charge for parts needed. Tips, apparently, are welcome.

This huge organization is run out of the Ministry of Tourism in Mexico City. Attempts are made to have at least one English speaker per truck. Along with the general public safety, another stated mission is to improve the tourist experience and create international goodwill. Given the present scary news coming out of Mexico daily, this is probably more important than ever.

For 40 years after their start in the 1960s, the Green Angels got by with ham radios for communication. This practice was actually quite common in Mexico at the time. One still sees ham-grade antennas by companies like Cushcraft all over the country.

This gear is now giving way to a comprehensive new system with telephone interconnect and links from HF to higher bands. Another new feature provides a nationwide quick-dial number, 078. This facilitates help calls from cell phones connected to the Mexican phone system.

The traditional green trucks are gradually being replaced by white ones with green stripes. These have Global Positioning System receivers and automatic vehicle location. At least 200 of these are in service, and more are being added.

Pictures of the new trucks show antennas large enough for Citizen's Band (CB), where the Green Angels use two channels. Some vehicles also show a larger antenna that would work on lower HF frequencies.

More details about the Green Angels and their new radio system are on their web site. The English version is [www.sectur.gob.mx/wb/secturing/sect\\_eng\\_angeles\\_verdes](http://www.sectur.gob.mx/wb/secturing/sect_eng_angeles_verdes)



### ❖ First Impressions

Hours of listening by various people suggest a highly centralized network. The ALE traffic consists of dispatches and information for mobiles.

Apparent base stations have ALE addresses with a letter followed by two numbers. These have the best signals and identify on voice with place names. Here in California, the loudest one is "C03" on ALE, and "Mexico" on voice. It's probably the central dispatch in Mexico City.

The second group has ALE calls with numbers only, and they use the same numbers on voice. These have far weaker signals. They are undoubtedly the mobile units.

So far, every single ALE call I have decoded is from the first group to the second. No answers are ever heard. Even automated link checks, which require a response, never seem to get one, unless the signals are just too weak to detect.

The extremely narrow ALE frequency range is also odd. Either there are a lot more ALE channels that haven't come up yet, or this net is optimized for a single place and time.

Some ALE callups pass text in the Automatic Message of the Day (AMD). Most common is "CONTESTE," a Spanish imperative verb. This is probably a procedural signal meaning something like "come in, please." Sometimes the AMD strings contain vehicle descriptions. Finally, there's an "&CB" command, which might refer to the CB channels.

The ALE is fairly easy to detect and log. The 7790 kHz USB voice is far more interesting, but it will challenge even native Spanish speakers.

Most stations are down in the noise and often off-frequency. While procedural discipline is good, everything happens fast. Dispatch stations do periodic, rapid-fire roll calls. Mobiles work each other on channel, even if the base is talking. Good band conditions reveal truly frenetic activity, which eventually drops off at night.

I really think that links to the higher bands are in use. Sometimes a dispatch station will have a beep at the end of each transmission, but other times it won't. Despite common Mexican radio practice, they never use this for a "roger." It sounds more like a link reset tone.

One place name heard frequently is "Salamanca," a small city at a highway junction in Guanajuato. There are others, but so far they're all too remote or local to appear on even the best maps.

Obviously, we need a lot more monitoring here. Everyone can help. See you next month.

## ABBREVIATIONS USED IN THIS COLUMN

AFB	.....	Air Force Base
ALE	.....	Automatic Link Establishment
AM	.....	Amplitude Modulation
ARQ	.....	Automatic Repeat reQuest, all variants
AWACS	.....	Airborne Warning And Control System
CAMSLANT	.....	Communications Area Master Station, Atlantic
CAMSPAC	.....	Communications Area Master Station, Pacific
CW	.....	On-off keyed "Continuous Wave" Morse telegraphy
DEA	.....	US Drug Enforcement Administration
E07	.....	Russian 5-figure numbers, 20-minute repeats
EAM	.....	Emergency Action Message
FAX	.....	Radiofacsimile
FEMA	.....	US Federal Emergency Management Agency
HFDL	.....	High-Frequency Data Link
HF-GCS	.....	High-Frequency Global Communication System
LDOC	.....	Long Distance Operational Control
LSB	.....	Lower Sideband
MARS	.....	US Military Affiliate Radio System
MFA	.....	Ministry of Foreign Affairs
MFSK-n	.....	Multiple Frequency Shift Keying, n tones
NAT	.....	North Atlantic air control, nets A-F
OPBAT	.....	DEA Operations, Bahamas and Tortugas
PACTOR-1	.....	Packet Teleprinting Over Radio, mode 1
PR	.....	Puerto Rico
RTTY	.....	Radio Teletype
S06	.....	5-figure numbers in Russian, male or female voice
Selcal	.....	Selective Calling
SHARES	.....	Shared Resources, US Federal frequency pool
SITOR-A/B	.....	Simplex Telex Over Radio, mode A or B
UK	.....	United Kingdom
Unid	.....	Unidentified
US	.....	United States
USAF	.....	US Air Force
USCG	.....	US Coast Guard
VOLMET	.....	Formatted voice aviation weather

All transmissions are USB (upper sideband) unless otherwise indicated. All frequencies are in kHz (kilohertz) and all times are UTC (Coordinated Universal Time). "Numbers" stations have their ENIGMA (European Numbers Information Gathering and Monitoring Association) designators in ( ).

- 501.0 EIOCF-Experimental medium-wave beacon, Ireland, CW identifier at 0303 (DL8AAM-Germany).
- 2505.0 BP25-German Water Police boat Bayreuth, working BPLEZS, Cuxhaven, at 2231 (MPJ-UK).
- 2705.0 XSS-UK Defence High-Frequency Communication System, TASCComm (Terrestrial Air-Sea Communications), Forest Moor; also on 3236.5, 4168.5, 4239.5, 6416.5, 6691, 8107, 8182, 8980, 9019, 9022, 10575, 11208, 14855, and 18403.5, at 0619 (MPJ-UK).
- 4149.0 WBN 3016-Crowley Maritime Tug Defender, working WPE Jacksonville (FL), at 1245 (Mark Cleary-SC).
- 4518.0 Unid-Probable UK military, message in Piccolo (MFSK-32) at 0225 (Prez-MD).
- 4721.0 PLA-USAF, Lajes Field, Azores, calling ICZ (Sigonella Air Base, Italy), ALE at 0523 (PPA-Netherlands).
- 4900.6 Shark 69-USCG Cutter Alligator, calling Sector St. Pete (FL), at 1325 (Cleary-SC).
- 5081.0 RFH61-Russian Navy vessel, working RMP, Baltic Fleet headquarters in Kaliningrad, CW at 1919 (MPJ-UK).
- 5258.0 BP21-German Water Police boat Bredstedt, working BP26, vessel Eschwege, also on 7597, with ALE and serial data at 0448 (PPA-Netherlands).
- 5295.0 FS20-Algerian military and Ministry of Information, working QM20, ALE at 2109 (MPJ-UK).
- 5405.0 RHI-Saudi Arabia airfield availability net, working AAI, ALE at 1853 (MPJ-UK).
- 5409.0 Unid-Russian Intelligence "Oblique" English "female," null-message callup "649/00 for 3 minutes, then "Out," at 0420 (PPA-Netherlands).
- 5424.0 BJ51-Algerian military, calling FS50, ALE at 2114 (PPA-Netherlands).
- 5687.0 219-German Air Force, calling DHM 91 "on Echo," at 1849 (PPA-Netherlands).

- 5714.0 FUJ-French Navy, Ajaccio, voice coordination in French for RTTY traffic, at 0731 (PPA-Netherlands).
- 5732.0 PAC-USCG CAMSPAC, Point Reyes, CA, many ALE calls to 716, also tried as UCG, at 0310 (ALF-Germany). 24C-US Joint Task Force, working Panther (DEA OPBAT, Bahamas), at 1422 (Cleary-SC).
- 5865.0 TWVL2-Spanish Guardia Civil, Leon, working TXX2, Madrid, ALE at 2129 (MPJ-UK).
- 5908.5 FAV22-French Army training school, Favieres/Vernon, CW code practice at 2125 (MPJ-UK).
- 6255.0 1C3Z-Venezuelan Navy vessel, calling T8R1, also on 6280 and 6284, LSB ALE at 0344 (ALF-Germany).
- 6532.0 JA-8911-Japan Airlines Boeing 747, flight JAL640, HFDL position for Shannon at 1952 (MPJ-UK).
- 6617.0 Unid-Russian VOLMET, Rostov-on-Don, AM aviation weather in Russian, at 1725 (PPA-Netherlands).
- 6631.0 M64-Israeli air force passed a message in coded ALE text to AAA (Tel Aviv), also on 10642, at 20:29 (PPA-Netherlands).
- 6679.0 Honolulu-US Federal Aviation Administration, HI, Pacific Basin VOLMET and sign-off identification, at 0430 (Prez-MD).
- 6745.0 Pathfinder 30-Canadian Forces, probably a CP-140, working Halifax Military at 2310 (ALF-Germany).
- 6761.0 Steel 64-USAF KC-135T tanker, calling C-17A Grits 18, at 2334 (Cleary-SC).
- 6796.0 TWBA2-Spanish Guardia Civil, Barcelona, working TXX2 at 1657 (MPJ-UK).
- 6825.1 FAV22-French Army, CW code practice at 0841 (MPJ-UK).
- 6897.8 S3D0063-Moroccan weather net, PACTOR-1 log-in at 0031. Also S3D005D at 0046 and S3D0064 at 0239 (ALF-Germany).
- 6925.0 SIBB8-Romanian Police, Sibbiu, calling IASB8, ALE at 0646 (PPA-Netherlands).
- 6963.0 1Z8C-Venezuelan Navy, raised 1EW1 in LSB ALE, then calling "Comandante" in LSB voice, at 0215 (ALF-Germany).
- 6967.5 ICI01-Italian Coast Guard, Genoa, English and Italian radio checks with ICI11, at 1002 (ALF-Germany).
- 6998.0 SH7-"The Italian Crazy Pirate," usual CW political and religious text, at 1715 (ALF-Germany).
- 7245.0 Unid-Russian Intelligence, AM female voice numbers (S06), callup 418 536/7 and message, at 0800 (Mike-West Sussex, UK).
- 7522.9 Unid-Swedish Volunteer Radio Organization (FRO), calling F17H-PR and several others in PACTOR-1, at 1250 (ALF-Germany).
- 7527.0 Rescue 1502-USCG HC-130, patch to Sector Miami at 1329 (Mark Cleary-SC). OPB-DEA OPBAT, Bahamas, calling J08 (USCG MH-60J Coast Guard 6008), ALE at 2249 (MDMonitor-MD).
- 7596.0 Unid-French Forces, time stamped CW traffic at 0730 (PPA-Netherlands).
- 7637.0 S06, AM female null-message callup 407 00000, at 1900 (Mike-UK).
- 7709.0 Iqaluit-Canadian Marine Communications and Traffic Services, Resolute, NWT, Arctic FAX surface chart at 0105 (Prez-MD).
- 7790.0 C03-Mexican Ministry of Tourism "Los Angeles Verdes" (The Green Angels, a highway service patrol), ALE-initiated Spanish dispatch of "250" to a broken-down vehicle, at 2342 (Hugh Stegman-CA).
- 7831.0 FAV22-French Army, CW code practice at 0848 (PPA-Netherlands).
- 7954.0 BI10BI99-Algerian Intelligence, calling BI13BI99, ALE at 2155 (ALF-Germany).
- 7976.0 RDN-Saudi Arabia military, calling DAN in LSB ALE, at 1919 (PPA-Netherlands).
- 7980.0 RJF94-Russian Naval Air Transport, Moscow, working RCH84, Vladivostok, CW at 2007 (ALF-Germany).
- 8012.0 RIC-US Civil Air Patrol, VA, also AVS (CAP national "Avenging Spirit"), ALE soundings at 0300 (ALF-Germany).
- 8023.7 SSE-Egyptian MFA, Cairo, SITOR-A selcal to TVVK (Rabat), then SITOR-B markers, at 2004 (ALF-Germany).
- 8121.0 Unid-Russian Governmental, 5-figure and 5-letter group RTTY messages, then signed off in frequency-shifted Morse, at 2045 (ALF-Germany).
- 8127.0 The English Man-Russian AM "male" machine voice (E07), preamble 445/137 and message, at 0700, 0720, and 0740 (Mike-UK).

- 8156.0 Coral Harbour Base-Royal Bahamas Defence Force, working C6SH, C6NU, and C6R2066 at 1143 (Cleary-SC).
- 8301.6 Sector San Juan-USCG, PR, working Swordfish 17 at 2216 (Cleary-SC).
- 8337.6 Shark 21-USCG Cutter Valiant, working Blackjack at 2352 (ALF-Germany).
- 8638.5 HEB-Bern Radio, Switzerland, CW identifier in Global Link Network PACTOR idler, at 2340 (ALF-Germany).
- 8681.0 Unid-USCG, Pt. Reyes, CA, Pacific FAX surface chart at 0225 (Prez-MD).
- 8688.9 WHL-Global Link Network/ St. Augustine Radio, FL, CW in Global Link Network PACTOR idler, at 2333 (ALF-Germany).
- 8728.0 Monaco Radio-Naya Mobile Communication, service announcements in English and French, at 1156 (MPJ-UK).
- 8747.5 LGL-Global Link Network/ Rogaland Radio, Norway, CW in Global Link Network PACTOR idler, at 0956 (ALF-Germany).
- 8765.0 HYE-Polish Military, working "2-T-Z" in Polish, at 2256 (ALF-Germany).
- 8846.0 New York-Caribbean air control net B, position with Speedbird 201A (British Airways), at 2320 (MDMonitor-MD).
- 8891.0 Reykjavik-NAT air control net, Iceland, position check with United 981, at 0239 (Prez-MD). Gander-Oceanic air control NAT-D net, gave a Continental Airlines flight a backup of 4675 for Reykjavik, at 2300 (MDMonitor-MD).
- 8912.0 Coast Guard 1502-USCG HC-130, position for Sector Key West, at 1311 (Cleary-SC).
- 8918.0 New York-Oceanic air control, selcal and position checks with Swiss 65, at 0035 (MDMonitor-MD).
- 8923.0 4XZ-Israeli Navy, long coded CW messages at 0030 (MDMonitor-MD).
- 8950.0 Murmansk Control-Russian Aero, position from Continental 89, at 2303 (ALF-Germany).
- 8971.0 Fiddle-US Navy, FL, clear and secure with Red Talon 711 (US Navy P-3C), at 1342 (Allan Stern-FL).
- 8977.0 JY-AYG-Royal Jordanian A321, HF DL log-on with Reykjavik, at 1927 (MPJ-UK).
- 8983.0 CAMSLANT Chesapeake-USCG, VA, securing with Coast Guard Rescue 2006, landing in Bermuda, at 0042 (Stern-FL). CAMSLANT, radio check with Coast Guard Air Station Savannah (GA), at 1739 (Cleary-SC).
- 8992.0 Reach 1023-USAF Air Mobility Command transport, asking Andrews HF-GCS for a relay to Bangor, ME, at 1408 (Cleary-SC).
- 9004.0 Unid-GOL Intelligent Airlines flight, working São Paulo, Brazil, LDOC, at 2300 (ALF-Germany).
- 9018.0 Reach 1012-USAF Air Mobility Command, calling Reach 1010 at 1643 (Cleary-SC).
- 9023.0 Sanctified-US military, data for Andrews HF-GCS, at 2327 (Cleary-SC).
- 9025.0 240067-USAF C-17 number 94-0067, calling OFF (Offutt AFB, NE), at 1505 and 2030. JNR-USAF, Puerto Rico, ALE-initiated patch with 719 (USCG C-130H Coast Guard 1719), at 1620 (MDMonitor-MD).
- 9031.0 Bed Camp-US military, possible E-6B airborne command post, no joy calling Aperture at 1825 (MDMonitor-MD).
- 9034.0 NOJ-USCG, Kodiak, AK, calling 700 (Coast Guard 1700), ALE at 0330 (Cleary-SC).
- 9086.0 RHP-Saudi Arabia military, calling AAP, also on 10677 and 11161, ALE at 2017 (PPA-Netherlands).
- 9106.0 KGD825-US Environmental Protection Agency, Boston, MA, ALE sound at 0100. KGD34NCC-SHARES National Communications Center, VA, ALE sound at 0500 (ALF-Germany).
- 9136.0 RJF94-Russian Naval Air Transport, Moscow, coded CW 5-figure group messages, then working RCB (Kaliningrad), RCJ48 (Sevastopol), and RCG84 (Vladivostok), at 0348 (ALF-Germany).
- 9201.0 K4MT-Unknown Commonwealth of Independent States military, CW with NT9P, went to RTTY for a message at 0651 (PPA-Netherlands).
- 9222.0 Unid-Russian Air Defense, time-stamped CW 14-character tracking strings, at 0413 (PPA-Netherlands).
- 9271.0 RAP-Saudi Arabia airfield net, working JAP, ALE at 1941 (MPJ-UK).
- 9380.0 BE113-Venezuelan Navy, Training Ship Simon Bolivar, calling 1DV6 in LSB ALE, at 0100. BE113, calling CGA3 (Headquarters), at 0200 (MDMonitor-MD).
- 9462.0 FC6FEM-FEMA Region 6 comm manager, TX, calling FR5FEM (Region 5, MI), ALE at 1314 (MDMonitor-MD).
- 10000.0 PPE-Brazilian National Observatory, Rio de Janeiro, time and Portuguese identifier at 2056 (ALF-Germany).
- 10051.0 New York-US Federal Aviation Administration, NJ, VOLMET at 0035 (MDMonitor-MD).
- 10096.0 Piarco-South American oceanic air control net 2, Trinidad, working COTAM 1024, French Air Force Military Air Transport Command, at 0020 (MDMonitor-MD).
- 10156.5 SK1-Austrian military, ALE with OEY71, then traffic using a 39-tone modem, at 1043 (PPA-Netherlands). OEY51-Austrian military, probably Vienna, working OEY71, part of United Nations Golan Heights operation, Syria, ALE at 1156 (MPJ-UK).
- 10230.0 S06, AM female callup 831 462/5 and message, at 1200. Repeated on 12165 at 1210 (Mike-UK).
- 10242.0 Coast Guard 1707-USCG HC-130, working Sector Key West at 0043 (Cleary-SC).
- 10290.0 S06, AM female callup 516 839/7 and message, at 0930 (Mike-UK).
- 10392.0 Unid-French Air Force, male voice loop in French for receiver adjustment, at 1914 (PPA-Netherlands).
- 10470.5 FDI 22-French Air Force, Norborne, RTTY "brick" test loop at 0746 (PPA-Netherlands).
- 11089.0 KVM70-US Government, Honolulu, HI, Pacific FAX sea state analysis at 0225 (Prez-MD).
- 11090.0 JCP-Saudi Arabia airfield net, working RFP, ALE at 1804 (MPJ-UK).
- 11175.0 Andrews-USAF HF-GCS control station, MD, unusually long EAM (123 characters), at 1110 (Stern-FL). [Looks like the Saturday exercise activity is back. -Hugh]
- 11181.0 HAWSPR-USAF Secure Internet Protocol Routing Net gateway, Ascension Island, ALE sounding at 1800 (MPJ-UK).
- 11217.0 DHM91-German Air Force, Muenster, working 204, at 0940 (PPA-Netherlands).
- 11232.0 Coast Guard 2006-USCG HC-130J, patch via Trenton Military to International Ice Patrol for iceberg reports, at 1728 (Cleary-SC).
- 11300.0 Tripoli-Oceanic air traffic control, Libya, position from KLM 567, then handed off to 126.5 megahertz, at 0050 (Prez-MD).
- 11418.5 OEY71-Austrian military Syria contingent, ALE with OEY51, then 39-tone modem traffic, at 1123 (MPJ-UK).
- 11436.0 CAMSLANT-USCG, radio checks with Sector Charleston, Sector Jacksonville, Sector Key West, Air Station Elizabeth City, and Air Station Clearwater, at 1317 (Cleary-SC).
- 11494.0 Panther-DEA OPBAT, Bahamas, working 34C (USCG MH-60J Coast Guard 6034), at 2045 and 2103 (Stern-FL).
- 11573.1 FAV22-French Army, CW code practice at 1110 (MPJ-UK).
- 12164.0 WGY9441-FEMA, calling 010CDCNHQ, US Centers for Disease Control, GA, at 1322 (Cleary-SC).
- 12222.0 November 03-USCG HC-144A, Aviation Training Center, Mobile, AL, setting guard with CAMSLANT at 1159 (Cleary-SC). LNT-CAMSLANT, working J28 (MH-60T Coast Guard 6028), at 1625 (MDMonitor-MD).
- 12224.0 LCR154-Polish military, calling ACZ326, ALE at 1104 (PPA-Netherlands).
- 12353.0 WBN 3015-Crowley Tug Adventurer, working WPE Jacksonville, at 1348 (Cleary-SC).
- 12823.5 CTP-Portuguese Navy, Oeiras, RTTY marker at 1303 (MPJ-UK).
- 13215.0 490434-USAF KC-10A, calling PLA (Lajes Field, Azores), ALE at 1238 (Cleary-SC).
- 13488.0 OH5-Ohio State Emergency Operations Center, calling 010CDCNHQ, (Centers for Disease Control). ALE at 1641. (Cleary-SC).
- 13907.0 IKL-USCG Cutter Tampa, calling LNT (CAMSLANT), ALE at 2020 (Cleary-SC).
- 13927.0 Reach 381-USAF transport, working USAF MARS AFA5QW, at 1641 (Cleary-SC). Hawk 53-USAF B-1B, patch via USAF MARS AFA9PF, CA, regarding air refueling schedule, at 2020 (Stern-FL).
- 14439.0 AR1-Unknown station calling ON3 in hand-keyed CW, at 1333 (MPJ-UK).
- 14498.6 Unid-North Korean diplomatic, no decode of ARQ message, at 1146 (PPA-Netherlands).
- 14580.0 S06, AM female null-message callup 729 00000, at 1000. Repeated on 16020 at 1010 (Mike-UK).
- 15091.0 PLASPR-USAF secure Internet Protocol Routing Net gateway, Lajes, Azores, ALE sounding at 1119 (MPJ-UK).
- 18003.0 E30353-USAF E-3 AWACS, calling ADW (Andrews AFB, MD), ALE at 1721 (Cleary-SC).
- 18594.0 Panther-DEA OPBAT, Bahamas, called J29 in ALE as OPB, then voice working USCG MH-60J Coast Guard 6029 (unheard), at 2342 (MDMonitor-MD).
- 20890.0 LNT-USCG, raised J01 (MH-60J Coast Guard 6001) in ALE, then voice as CAMSLANT getting position of Juliet 01, at 2040 (MDMonitor-MD).



# Decoding Software and the Hobby Market

**W**e present a mixed bag this month as we catch up on some old friends and report some interesting developments with decoder software.

## ❖ Budget Hoka Decoder

As regular readers will know, the “Digital Towers” station runs the Hoka Code300-32 decoder software. I’ve been very happy with the service and support from the company over the years, and their decoders continue to be the standard by which I measure others.

Of course, the kind of capability offered by the Hoka line doesn’t come cheap: the latest version costs around \$6,000, and that’s just for the basic software. However, that is all about to change.

Recently announced at the Friedrichshafen Hamfest (Europe’s equivalent of Dayton) is a new budget version of the decoder called the Code3-32 Platinum. Early indications are that the price will be about 799 Euros, which is currently around US\$1100 for the base version, plus an additional 100 Euro for automatic control of the popular Perseus series of Software Defined Receivers. Few details are available yet, especially on which items are left out of the budget version in order to bring the price down. I hope to have more news and a review very soon.

## ❖ SkySweeper Gone

Unfortunately, a few days before the Hoka announcement came the sad news that the SkySweeper line of decoders will no longer be offered to the hobby market. The Finnish company cited a change in strategy as the cause for dropping the hobby version while continuing to focus on the commercial and government sectors.

This is a major blow for us digital utility enthusiasts, as SkySweeper was the lone option between high-end software like that from Hoka and WaveCom and those offerings which are free but much less capable. It was also notable for offering most of the modern modes (MIL-188-141A ALE, MIL-188-110A high-speed modem and STANAG4285 HF modem) at a reasonable price.

This development surely demonstrates the considerable difficulties that developers of good, modern software face when attempting to make money in this niche market. I’m constantly amazed by the grumbling on mailing lists like UDXF when new software is announced, only for it to be met with a torrent of comments like “Why isn’t this free?” or “Why is this so expensive?”

Unfortunately, if you don’t buy, withdrawal

of the product is the eventual result. No matter what your personal view of this issue, this is surely a major blow to our particular part of the shortwave hobby.

## ❖ MultiPSK?

How about some better news? I’ve been in contact with Patrick Lindecker, author of the well-respected MultiPSK software, regarding the addition of MIL-188-110A HF modem support. While focused more on amateur radio modes, Patrick has steadily added to MultiPSK’s capabilities over the years and the inclusion of 110A will be a big boon to us, especially in the light of the news from Finland.

## ❖ RFSM2400 News

I was also in correspondence recently with Dmitry who writes the RFSM2400 suite after I noticed that the standard MIL-188-110A version no longer copies received traffic off-air. Dmitry cites not wanting to compete with vendors of other 110A software as the reason for not enabling this feature. Sadly, another free option disappears.

## ❖ Ecuadorian Navy Update

Continuing on the MIL-188-110A theme, I recently bumped into some modem traffic on the memorable frequency of 12345 kHz USB. Traffic was very regular with long bursts every minute.

Contrary to most transmissions which use synchronous 8 bit traffic, this one took a long time to resolve. With the Hoka, this requires recording the received audio to disk and replaying the file through the decoder while trying different combinations of 5, 7 and 8 bit asynchronous, in addition to their synchronous counterparts. Given that the asynchronous versions have 0, 1 and 2 stop bits as well as parity, this can take some time to step through, all the time hoping that the traffic isn’t encrypted, of course!

Eventually, while the majority of traffic was encrypted, a few words of plain text, like FRAPAL and CORGAL appeared from time to time with the 7N0 (7 bit ASCII, No Parity, No Stop bit) setting.

Luckily, I remembered seeing CORGAL being used previously over ALE by the Ecuadorian Navy. Sure enough, over a few more days of continuous monitoring, more of their identifiers were found in the decoded traffic:

CORGAL	Corvette “Galapagos”
CORLOJ	Corvette “Loja”
ESPIRIT	Unidentified

CORESM	Corvette “Esmeraldas”
CORGAP	Corvette “”
MARUBA	Unidentified
FRAPAL	Frigate “Presidente Alfaro”
DL006-06	Unidentified
COSUNO	Unidentified

This network has subsequently appeared on 8973 kHz using the same traffic patterns. Previous channels used by the Ecuadorian Navy include the following:

7667.7cf, 7668.5cf, 7900U, 8165U, 8901.5cf, 12323.5cf, 16416.4cf, 18201.5cf, 18450U and 18451.5cf kHz  
(U = USB, cf = center of data)

Remember this organization has also used the unique 109bd/400Hz shift SITOP-B mode.

## ❖ Technical Handbook

Buried away in the useful *PC Frequency Manager* software package from ISK ([www.frequencymanager.de](http://www.frequencymanager.de)) is a PDF file containing a very comprehensive guide to digital signals.

Roland Proesch, ISK’s owner and developer of PCFM, appears to have committed the document to hard copy print, and I was lucky enough to receive a copy recently.

Occupying some 500 pages and liberally illustrated with screenshots of audio spectra, the

*Technical Handbook* is an excellent guide to just about anything digital you are likely to encounter on-air these days: new or old. Well indexed, the book starts with an introduction to modulation types, signaling formats and coding schemes, before presenting a very useful table of characteristics (speed, shift, number of channels, channel shift, etc.) for around 200 different systems.

The bulk of the book is taken up with detailed, two or three-page descriptions of many systems. Not just HF digital modes are covered, but also VHF, UHF and satellite systems, making this a truly “DC to Blue Light” guidebook.

The *Technical Handbook* finishes up with a very comprehensive reference section with Q and Z codes, country codes, abbreviations, and even a NATO routing indicator. *TH* is a tremendous resource to have around the shack, and sometimes it really is just nicer to have a book rather than a PDF.

The book costs 49 Euros plus shipping, or around \$70 at the time of writing. My thanks to Roland for the review copy.

That’s it for this month. Have fun in the HF digital sections.

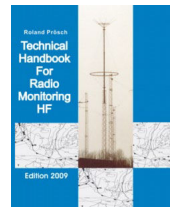

## Be Afraid, Be Very Afraid

To borrow a phrase from my friend Michael Godin (pictured), welcome to the “Spooktacular” edition of *Programming Spotlight*. Last year at about this time we featured programming about elections and politics. Politics, of course, derives from the Greek *Poli* meaning “many” and *tics* meaning “blood suckers.” (I heard that on a Radio for Peace International broadcast many years ago.)



This year we'll shine the *Programming Spotlight* on something a little less scary than politicians making promises and knocking on your door, but spooky nonetheless. And we will revisit a few topics covered in past editions of the column.

### ❖ War of the Worlds

On October 30, 1938, with war looming around the globe, Orson Welles pulled off perhaps the most famous Halloween prank ever, with his **War of the Worlds** broadcast on the CBS Mercury Theatre. Based on H.G. Wells' novel of the same name, Orson Welles (no relation) moved the location of the fictitious Martian invasion from London to New Jersey and region. Because of the realistic nature of the broadcast, featuring cut-ins and “live reports” from the scene, more than a few

people were taken in, especially those who hadn't heard the full broadcast.

Of course it was all just a radio play. Welles famously ended his broadcast with these words: “This is Orson Welles, ladies and gentlemen, out of character to assure you that *The War of the Worlds* has no further significance than as the holiday offering it was intended to be. The Mercury Theatre's own radio version of dressing up in a sheet and jumping out of a bush and saying Boo! ...

“We annihilated the world before your very ears, and utterly destroyed the CBS. You will be relieved, I hope, to learn that we didn't mean it, and that both institutions are still open for business. So goodbye, everybody, and remember the terrible lesson you learned tonight. That grinning, glowing, globular invader of your living room is an inhabitant of the pumpkin patch, and if your doorbell rings and nobody's there, that was no Martian ... it's Halloween.” <http://sacred-texts.com/ufo/mars/wow.htm>

You can download the broadcast at [www.mercurytheatre.info/](http://www.mercurytheatre.info/) Also at [www.radio4all.net/index.php/program/13189](http://www.radio4all.net/index.php/program/13189) is a 2005 program which contains sections of the *Chase & Sanborn* and *Mercury Theatre* broadcasts of October 30, 1938, edited together in a manner approximating the sequence believed to have generated the reported panic.

Many radio stations carry “Old Time Radio Shows.” For instance, CHML 900 in Hamilton, Ontario, and AM 740 in Toronto run these gems from yesteryear almost every night. Check around the radio dial on Halloween and you may hear any number of Halloween related programs of old, even the Martian attack on Grover's Mill, NJ, all over again. But remember: it's only a play!

In June 2009, BBC Radio 2 presented **Jeff Wayne's War of the Worlds**, a 90-minute stage adaptation of the 1978 album. As a teenager into such things, the album blew me away when it came out. There is a stage production based on the album, apparently touring the UK. The BBC recorded a performance during this tour.

“Steve Lamacq presents *The War of the Worlds* performed live at London's O2 Arena, with Jeff Wayne conducting The Black Smoke Band, The ULLadubULLA Strings; and featuring Jennifer Ellison, The Moody Blues' Justin Hayward, Manfred Mann's Chris Thompson; and the voice of Richard Burton.

“Inspired by HG Wells' famous novel, the prog rock and classical album was released in

June 1978, and has since spent over 330 weeks in the UK Album Chart and won two Ivor Novello Awards. This multi-media stage version was produced to mark the 30th anniversary of the album's release and was recorded by Radio 2 on 21 June 2009.” [www.bbc.co.uk/programmes/b00lqpl7](http://www.bbc.co.uk/programmes/b00lqpl7)

While Halloween seems to be more of a North American tradition, perhaps this excellent program will be re-aired on BBC 7 or one of the other BBC networks. There will be more about BBC 7 later in this column. As a side note Toronto music station Mix 99.9 used to play the album every Halloween, billing it as *War of the Worlds – The Next Generation*. It was an annual tradition for many years hosted by the late Chris “Punch” Andrews. For this one night per year he was “Punchkin” Andrews.

As referenced at the outset, one of my favorite Halloween traditions is to listen to the **Treasure Island Oldies Halloween Spooktacular**, hosted by Michael “Count Michael” Godin: four hours of great rock and roll novelty tunes with a Halloween theme. This year the program can be heard on October 25 at 6pm Pacific Daylight Time, 9pm EDT or 0100 UTC. Treasure Island Oldies is one of the pioneer net broadcasts, on the air via the web since 1997. The program will also be archived for a few weeks after the broadcast. Listen at [www.treasureislandoldies.com](http://www.treasureislandoldies.com)

**Coast to Coast AM**, aka *The Art Bell Show*, now hosted by George Noory, has traditionally had a spooky show on Halloween. Well...spookier than normal. For many years, the Halloween program has been re-named “Ghost to Ghost” with a night of ghost stories and scariness from listeners across North America. It's always worth a giggle or two, and sometimes the stories are really good.

Due to other things in my life getting in the way, I am no longer much of a “night crawler,” but when I was, I often spent the night with Art or George. They are both great interviewers. I particularly remember an interview Art did with a gentleman from the NYFD who was (literally) the last man out of the World Trade Centre. Riveting radio.

The Halloween shows are a lot of fun. Just remember to bring a grain of salt to take with it. More details at [www.coasttocoastam.com](http://www.coasttocoastam.com)

### ❖ History Programs Revisited

One of the most popular hobbies today is genealogy, the tracing of one's family tree. I

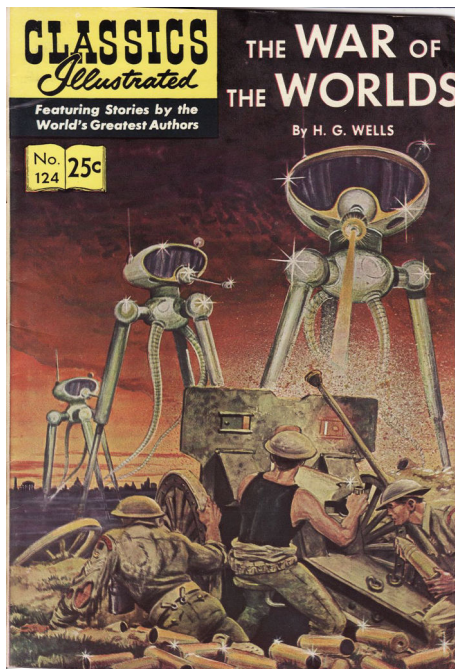



have dabbled on and off with my family tree over many years and have made many fascinating discoveries about my own background.

BBC Radio 4's excellent program on family history called **Tracing Your Roots** returns in the fall. The program is due to begin in October. I have found it to be the premier program of its type and well worth a listen. The host, Sally Magnusson presents information suitable to both the beginner and the long-time genealogist.

Whether you have a family shrub, or a great spreading chestnut tree, there is something for you in the program. Keep an eye out for its return this month at [www.bbc.co.uk/radio4/history/tracingyourroots.shtml](http://www.bbc.co.uk/radio4/history/tracingyourroots.shtml) or sign up for the podcast, using your podcatching software of choice, at [www.bbc.co.uk/podcasts/series/tyr/](http://www.bbc.co.uk/podcasts/series/tyr/)

The other program of this type worth noting returned in August to BBC Radio Wales and may still be available by the time you read this. It is the delightfully named **Look Up Your Genes**. While it has a decidedly Welsh outlook, there is always something of interest here, too, no matter where you live.

The hosts, Charlotte Evans and Cat Whiteaway are wonderfully enthusiastic about the topic at hand. Each week, they help listeners to get answers about an ancestor or an event in that ancestor's life. The program can be accessed at [www.bbc.co.uk/programmes/b006x98n](http://www.bbc.co.uk/programmes/b006x98n) or go to the home page for links and other goodies at [www.bbc.co.uk/wales/radiowales/sites/lookupyourgenes/](http://www.bbc.co.uk/wales/radiowales/sites/lookupyourgenes/)

## ❖ History of a Different Sort

There are two rather unique programs, which deal with death. I know; it's an odd topic, oftentimes avoided.

**Last Word** is BBC Radio 4's obituary program, highlighting notable people from around the world who have passed away in the past week. Sometimes they are famous (Michael Jackson for instance) or not so fa-



mous (the last known living survivor of Hitler's bunker). It's an interesting program at times, and can be heard Fridays at 1600, Sundays at 2030 (and it's archived for 7 days thereafter). Check it out at [www.bbc.co.uk/programmes/b006qpmv](http://www.bbc.co.uk/programmes/b006qpmv)

Taking a slightly different path, CBC Radio One's **The Late Show** provides "an unconventional take on art of the obit. This documentary series unveils the lives of ordinary, yet extraordinary Canadians. We will meet a remarkable range of characters that have passed on but still left a mark – from a street kid with dwarfism to an elderly man obsessed with sailing through the Northwest Passage. Compelling, provocative and uplifting. A weekly tribute to the human experience."

The real charm of the program is that renowned Canadian actor Gordon Pinsent hosts it. The program can be heard across Canada and online at 9:30 am local time, Fridays. Or try the CBC Northern Quebec Service on UTC Fridays at 1330, on 9625 kHz.

KBS World Radio Korea has a relatively new history program during Monday broadcasts called Korean History 101. Each week the presenter, improbably named "Abbie Rhodes" (either that's a pseudonym or her parents were extreme Beatles' fans), looks at some event in Korea from that week in history. Recent programs have looked at events of the Korean War, Chinese invasions of the 7<sup>th</sup> century and the 1980 civil uprising against the military. [http://world.kbs.co.kr/english/culturelife/culturelife\\_history101\\_list.htm](http://world.kbs.co.kr/english/culturelife/culturelife_history101_list.htm)

## ❖ Science Fiction

I'm a bit of a contrarian when it comes to a lot of things. I'm a bit set in my ways; I prefer many older modes of communication – radio, obviously, and shortwave. I often print things out rather than read them online. I prefer books and paper to computer screens. Things like computers and software aggravate me, quite easily.

This past month alone I have been through three laptops. The second went back yesterday because it was, well, demon possessed (not a scientific explanation, but how else could one explain so many different and untimely errors?). Its last defiant act was to swallow whole the first draft of this column.

On the other hand, I am a futurist, a *Star Trek* fan (but, please, not a Trekkie) and a fan of good science fiction. I was turned onto science fiction by a particularly good teacher in high school, who opened my eyes to the work of H.G. Wells, Isaac Asimov, Ray Bradbury, and many others. My father was very optimistic about the future as well.

If you like science fiction, then BBC Radio 7 is the place for you. Almost every day of the year, one can tune in to **The Seventh Dimension** where one can hear a smorgasbord of sci-fi readings, plays and dramas.

Many times, the writers of these books or programs were wildly off in their predictions, anticipating revolutionary scientific breakthroughs that in their minds would have happened by now (like manned Mars explora-



tion by the 1970s). One can listen every day, on demand, to great works of science fiction, like *Brave New World*, *Day of the Triffids* (great book, fabulous radio adaptation, truly bad 1960s sci-fi film) and *I Am Legend*. You can hear space serials like *Journey Into Space* and *Space Force*. And, coming full circle, some very spooky stories from *The Twilight Zone*, narrated by Stacey Keach. You can also hear classics like *Dr Jekyll and Mr Hyde*, *Animal Farm*, and the dark stories of Edgar Allan Poe.

While it is impossible to tell you too far advance when some or all of these programs may air, I recommend that you subscribe to the BBC Radio 7. Not only will you get a heads up on science fiction programming, but all the fine programs at BBC 7. Just go to the Radio 7 page at [www.bbc.co.uk/radio7](http://www.bbc.co.uk/radio7) and click the "Newsletter" link at the bottom. To paraphrase Poe, "Quoth the raven, (miss a program?) 'Nevermore'".

## NASB

### National Association of Shortwave Broadcasters

Representing the privately-owned shortwave stations in the USA

- Find links to all of our members at [www.shortwave.org](http://www.shortwave.org)
- Subscribe to our free Newsletter: [nasbmem@rocketmail.com](mailto:nasbmem@rocketmail.com)
- Listen to "The Voice of the NASB" on the third Saturday of each month on HCJB's DX Party Line: 12 midnight Eastern Time on 9955 kHz
- Next annual meeting May 21, 2010 in Hamilton, ON, Canada
- More info at [www.shortwave.org/meeting.htm](http://www.shortwave.org/meeting.htm)

NASB is a member of the HFCC (High Frequency Coordination Conference) and the DRM (Digital Radio Mondiale) Consortium

## Working for Radio Habana Cuba vs China Radio International

We remarked that some RHC announcers are barely proficient in English; perhaps they should try to attract a few more hijackers from the USA? Keith Perron, Taiwan replied in *DX LISTENING DIGEST*:

"It is not that easy for RHC to get foreign staff. When I was at RHC, my closest friend was Michael Finney (*a.k.a.* Langston Wright), an American who in the early '70s hijacked a plane to Cuba, and from that moment until he passed away a few years ago from cancer, was on the FBI's most wanted list for the shooting death of a US state trooper.

"Mike was one of the nicest people you could ever meet and always helpful. Amazing that one of my best friends there was a former member of the Black Panthers and on the FBI's wanted list. From when that plane arrived in Cuba, he never left.

"When I was at RHC, our salary was 350 Cuban Pesos, and \$100US a month. The contract also included a huge apartment and some of us were lucky to also get a car. I had a Polish-made Polski 650 (based on the Fiat 650). We also had a [ration] book to get our food, not what you would call a lot. Cuban nationals would get less. Salary at RHC for Cubans was 150 Cuban Pesos a month. How did you survive? The black market. Since I left, things have gotten worse. Salary is still 350 Cuban Pesos, but now in hard currency it's \$20US a month. So it is not

an easy task to get people.

"People always ask me, why go to RHC and why stay so long? I really enjoyed working there. It was the most fun I've ever had at any station. Havana is a wild city and there are always things to do.

"Wake up at 9 am, go to the beach, stay until 2 pm, then head into work. On weekends also go to the beach. The staff at RHC, except for maybe one, were a ball and always liked to have fun. On Fridays the English, French, Creole would have parties in the station. Not much food, but lots of drinking.

"Cuba was fun and people had a sense of humor. At CRI [where Keith worked later], it was totally different. In Cuba most people know the system (revolution) does not work and is crazy. But they say, let's make the best of it, things will change sooner or later.

"In China, it's do anything to support the CCP and to show respect, whoever the waxwork is who is running the country. Mind you, maybe three people at RHC feel the cold war is still on."

Aha, mornings at the beach explains why there are no English broadcasts before 2030, or lately, 2300 UT. A true (guest)workers' paradise!

**AFGHANISTAN** ? R. Solh closed down 6700 early this year and was dismantled, but now something heard there again (gh) 6701-USB around 0300 almost daily, Arabic call to prayer, religious speeches and chats, from a mosque? (Tom DL8AAM, Germany, *WORLD OF RADIO*) Saudi ATC is listed there (Ron Howard, CA, *DXLD*) Doubt it; maybe an anti-Solh station of the Taliban, but why in USB? Maybe a military feeder to a training camp in the Mideast. Sometimes starts as late as 0308 (Tom DL8AAM, *ibid.*) Also on 6700 at 1740, non-stop Afghan sounding music. Apparently reduced carrier with audio on both sidebands. Sounds pretty much same as Radio Solh used to (Jari Savolainen, Finland, *ibid.*)

**ALASKA** At the DRM USA annual meeting in May, Don Messer gave a report on DRM tests to cover Alaska at any time and any day. Tests will be done in central Alaska using 10 to 20 kHz channels with various error correction and constellation options. They are putting in place a receiver network of around 18 sites. Then, they will conduct field tests. They plan to report the results to the FCC after a two-year interval.

Three 100 kW transmitters are being used: DRM at 10 or 20 kHz wide; 4, 16 & 64 QAM; Coding rate of 0.5 & 0.6 (50% voice or 60% voice), 3 crossed half-wavelength dipole antennas (5, 7, and 9 MHz).

Key is using ionospheric propagation. High latitude (near vertical incidence) "bounce back" propagation will require careful experimentation. Power levels of 10 kW to 100 kW will be used.

Testing should begin by the end of the year. Up to four speech programs can be used in a 20 kHz channel, full stereo in a 20 kHz channel, or quasi-stereo in a 10 kHz channel (David Creel, *NASB Newsletter*)

[non] The operators of KNLS talk about gearing up to produce Spanish programming for Latin America, but we think they must really be referring to transmissions from their Madagascar station nearing completion, previously mentioned as to serve LAM as well as Africa and Mideast; while KNLS has no antennas suitable for LAM and is hardly in a good position to reach it. On the homepage there are also links to pages concerning Africa and Arabic, as well as existing Chinese, English and Russian: [www.worldchristian.org/](http://www.worldchristian.org/) (gh)

**ANTARCTICA** After its mid-winter outage, LRA36, 15476 was back on the air in August, and we hope still is (gh) Fair from 1800 with several clear IDS (Rik van Riel, NH, *HCDX*)

While picking raspberries and blueberries in the woods surrounding our house, my wife and I were tuned to LRA36 on a portable Lextronix E5 receiver with telescopic antenna only. "Música and cultura" was on the menu, tangos and zambas from 1805, slowly improving to fair by 1900; temp at the Esperanza base was -15 C (Henrik Klemetz, Sweden, *WORLD OF RADIO*)

**ARGENTINA** Feeder on LSB moved to new 11133.5, with several Radio Continental IDs at 2300, pretty good signal (Rik van Riel, NH, *HCDX*)

3240, second harmonic of AM 16-20, Mar del Plata, heard at 2208 with light songs, IDs; fundamental also audible the night before at 2212-2227 (Carlos Gonçalves, Portugal, *WORLD OF RADIO*)

**AUSTRALIA** After relocating antenna to a timber yard in Inner Sydney at Mar-rickville, R. Symban was back on the air testing with Greek music on 2368.5, July 29 at 0350 with 50 watts, to be increased. Daytime is yielding fair to good results around the target area of Sydney, and further in eastern Australia at night (John Wright, *ARDXC*) 0815, very minimal – maybe I'm too close, only 10-15 km away (Wayne Bastow, Wyoming, NSW, *DXLD*) Good signal here in Northland NZ at 0708 (Bryan Clark, *ibid.*) 900 km away, S9+50 at 1215, continuous music loop (David Sharp, NSW, *ibid.*)

I had a weak carrier at 2000 on 2368.486 kHz here in Finland (Mauno Ritola, *ibid.*) 2368.50, Radio Symban (presumed), 1253-1337, best after my local sunrise, which was about 1311, Greek style music and singing. Then e-mail confirmation received from Angelo Matsoukas, Managing Director (Ron Howard, Asilomar Beach, CA, *ibid.*) Raised power on August 3 at 0410, sounds more like at least 200 watts (Ian Baxter, NSW, *ibid.*) Heard again better August 3 at 1213-1341, now announcements along with music (Ron Howard, CA, *ibid.*) Also heard here between 1100 and 1300, sometimes fairly good levels (Walt Salmaniw, Queen Charlotte Islands, *ibid.*) Off the air again August 5-6 (Ron Howard, *ibid.*) Switched off Aug 4 due to signal getting into local phone lines with 400 watts power; probably OK at 50 watts (John Wright, *ibid.*) Heard again August 13 at low power (Ian Baxter and Ron Howard, *ibid.*)

Following the latest conviction of Aung San Suu Kyi, Australian PM Kevin Rudd said Radio Australia would resume broadcasting to Burma in a "gesture of solidarity" (*Sydney Morning Herald* via Gary Daly, *DXLD*)

Initial stories were unclear whether it would really be in Burmese, which RA has not used before. RA has always been broadcasting to Burma along with the rest of S and SE Asia in English, and Mandarin (gh) Then RA press release made clear it would be in Burmese, but no further details (via Mike Bird, *Media Network* blog) Relay via Thailand would be best, and scheduling could conflict with Burmese from BBC, VOA or RFA (Kim Andrew Elliott, [kimandrewelliott.com](http://kimandrewelliott.com))

**BOLIVIA** 4451.12, Radio Santa Ana, Santa Ana del Yacuma, 2330 to 2355v\*, present many nights in July, good audio, music with drums, flute and percussion, ID (Bob Wilkner, FL, *Cumbre DX*) As early as 2240; after 2300 *El Mensajero de la Mosquitania* program (Rafael Rodríguez, Colombia, *playdx* yg) 4451.2, 2225-2230, very weak and noisy, audible only on LSB (Manuel Méndez, Spain, *WORLD OF RADIO*) 2326-2339, weak with pop music, not traditional Indian type as in most 60 m Bolivians (Carlos Gonçalves, Portugal, *DXLD*)

4699.32, at 2240-2250, R. San Miguel, Riberaila (presumed) Spanish talk (Anker Petersen, Denmark, *playdx* yg) 4699.3, 2227-2238, light songs (Carlos Gonçalves, Portugal,

*All times UTC; All frequencies kHz; \* before hr = sign on, \* after hr = sign off; // = parallel programming; + = continuing but not monitored; 2 x freq = 2nd harmonic; sesqui = one and a half; B-09=fall/winter season; [non] = Broadcast to or for the listed country, but not necessarily originating there; u.o.s. = unless otherwise stated*

DXLD) 4699.4, at 2219-2225, Spanish announcer and Lam songs, poor (Manuel Méndez, Spain, *ibid.*) 4699.305, at 1110, several mentions of "Bolivia" and "Riberalta." The most reliable Bolivian here, audible most nights but exceptionally strong 29 July, S9+10 (David Sharp, NSW, *ibid.*)

**BRAZIL** 2380, Rádio Educadora de Limeira, SP, SINPO 55555, as clear as FM at 2355 (PY5AAP, Morato, Paraná, *dxclube Parana* yg) Great news, also 55555 here (Adalberto Marques de Azevedo, Minas Gerais, *radioescutas* yg) We certainly won't get it 55555 in NAM, but this may indicate a power increase or some other improvement (gh)

2379.96, at 0842 long-winded dissertation in Portuguese, contemporary music, poor copy (Phil Ireland, NSW DXpedition, *Australian DX News*) 90 mb Brazilians are difficult enough from Eastern Australia, let alone 120 mb! Portuguese talks 0844 tune-in, into vocals. Apparent ID 0851, still audible 0930. Quite satisfying (Craig Seager, *ibid.*) 2379.954, 1038, threshold with occasional Portuguese talk by a man cutting through, no ID so tentative, but excellent ZY opening (David Sharp, NSW, DXLD) 2380, fair at 0312 (Arnaldo Slaen, *et al.* in Chascomús ("the Argentina DX paradise"), DXLD) 2379.9, 0940, 1000, 1030 very weak on four mornings, also a harmonic on 2379.83 from 1100 one day, on 2380.62 the next (Bob Wilkner, FL, DXLD) At 2230 with *A Voz do Brasil* (Carlos Gonçalves, Portugal, *ibid.*)

Rádio Educadora de Limeira operates on AM as ZYK-531, 1020 kHz, and on SW as ZYG-852, 2380 kHz, with 250 watts; founded in 1939, website [www.educadoraam.com.br/](http://www.educadoraam.com.br/) E-mail [bruno@educadoraam.com.br](mailto:bruno@educadoraam.com.br) Program schedule includes at 0700-0900 UT winter, 0600-0800 summer, *Sertanejo Educadora* with Oliveira Júnior (@*tividade* DX)

**CANADA** CHU time station on 3330, I have personally heard on 6660 and 9990. Chris Smolinski in Maryland has heard CHU on the 4th harmonic, 13320 (Rik van Riel, NH, *harmonics* yg)

CFRX, Toronto, 6070, after months of reliable good signals, was missing or at very low power from the last week in July (Brandon Jordan, TN, Steve Lare MI, Julian Smith, Ont., gh, DXLD; Sheryl Paszkiewicz, WI, NASWA yg; Liz Cameron, MI, *MARE Tipsheet*)

Engineer confirms it's off; problem with ATU at base of the vertical, which created a very high SWR for the transmitter (via Steve Canney, QSL manager via Julian Smith, VA3SAJ, DXLD) Components damaged, so transmitter back to New York state for repairs (Canney via Harold Sellers, *ibid.*)

Still off as of mid-August. When it's back, don't expect to hear *Peter Anthony Holder* talkshow at 05-07 UT weeknights; he and several other hosts were fired by originating station CJAD Montreal (via Sheldon Harvey, *radioinmontreal* yg)

**CHINA** By mid-August, Firedrake music-only jamming had declined and no longer heard on most of the frequencies listed last month. It was still audible mixed with CNR-1 program jamming on 12040, 11805 and others against VOA (gh)

7245, CNR-2/China Business Radio, changed time of *English Evening* to one hour later at 1430-1500 and expanded to 7 days a week. Weekday programs are presented by John and a Chinese woman, plus an edition of *Studio Classroom* (SC); Saturday show is about movies, along with an edition of SC; Sunday repeats various segments of SC from the previous week, [www.studioclassroom.com/](http://www.studioclassroom.com/) (Ron Howard, CA, *WORLD OF RADIO*)

*Studio Classroom* is produced here in Taiwan. A large number of radio stations in China are running this show, most of them except CRI and CNR-2 illegally from black market without paying broadcast rights (Keith Perron, DXLD)

**COLOMBIA** Improvements have been made to antenna of Marfil Estéreo, 5910 for wider coverage, while LV de tu Conciencia, 6010 antenna has been changed for optimal coverage within Colombia, and reduced intensity elsewhere, due to complaints from R. Mil, México; and also transmitter modifications. DX reports wanted for new QSL; see last month (Rafael Rodríguez, Colombia, *playdx* yg) Probably now NVIS "Lazy-H" antenna on 6010, and is much weaker here (gh, OK)

**COSTA RICA** unID on 2859.8 kHz, presumably 2 x 1430v, sign-off around 0200z, heard many times (Jerry Lenamon, TX, *WORLD OF RADIO*) Listening to his clip: I am hearing "Radio San Carlos" at end of the jingle. Listed on 1440 in *WRTH*, and so says logo on webpage <http://radiosancarlos.co.cr/> However, if you open the "Nosotros" file, actual frequency is 1430, power 3 kW, both differing from *WRTH* 2009 info. Says "*Haciendo la diferencia*" prior to jingle. This slogan is part of the station logo (Henrik Klemetz, Sweden, DXLD)

unID on 5955 with lite-rock Mexican music, *grupo Maná*, in daytime at 1850 August 7 (Steven C. Wiseblood, Brownsville TX, DXLD) Remember the never fully explained transmitters tests from ELCOR, Guápiles, CR around 5954.1 in August 2008? Suspect it is back. But no further reports by mid-August despite tries by Steven and by Terry Krueger, FL (gh)

**CUBA** China is sending an ALISS rotatable antenna to Cuba, and two more 250 kW transmitters (Keith Perron, DXLD) On *RHC Mailbag*, 'Ed Newman' said that from August a new service to Africa would start (Alan Pennington, BDXC-UK *Communication*)

**DOMINICAN REPUBLIC** Besides the usual DRM tests into Punta Cana for the mid-August HFCC meeting, Jeff White announced that his R. Discovery would be on 4730 testing WinDRM as well as AM and SSB, with 100 watts to a half-wave dipole. After that it would move to Santo Domingo as a newly authorized station. However, this is its second life, the first being circa 1986 on the 15 and 6 MHz bands (gh)

**ECUADOR** Originally planned to close down the Pifo SW site next April, HCJB

moved up the date to September 30 – except for one transmission, Kulina and Portuguese at 2245-0230 on 11920 which would remain until mid-November. Also unlike previous plans, nothing was said about moving some Quichua-service transmitters on 49 and 90m from Pifo to AM690 site which is not being dismantled. At press time it was also unknown whether *DX Partyline* would finally be cancelled, even though it was already dropped by HCJB itself years ago (gh, from HCJB press releases via Wesley Smith, Allen Graham) Also, Jorge Zambrano, producer of *Música del Ecuador*, lost his long battle with cancer in July at age 63 (Yimber Gaviria, Colombia DXLD)

On the surface, it looks as if HCJB has been free of government interference all these years, but Ecuador is moving in the direction of Venezuela to close down or nationalize private broadcasters, so HCJB may be cutting back, diversifying just in time (gh)

**ERITREA** Voice of the Broad Masses of Eritrea, Asmara, 7175, transmitter turned on at 0344, running open carrier until 0352 lovely stringed instrumental IS. Excellent signal, but destroyed by [Ethiopian] white noise jamming at 0358 (Brandon Jordan, TN, DXLD)

**GREECE** VoG's English program *Greek in Style* heard at new time on Sundays, 1305-1400 on 15630 and 9420 (Edwin Southwell and Alan Roe, UK, DXLD) Older and contemporary Greek songs inaudible here on SW, but on ERA5 via  <http://tvradio.ert.gr/radio/liveradio/voiceofgreece.asp> (John Babbis, DXLD)

In late July and August, the multilingual *Radio Filia* program at 0500-1000, including English at 06-07 on 11645 was suspended due to holidays, replaced with all-Greek program // 15630 and 9420, except Tuesdays off for maintenance (Wolfgang Büschel, DXLD) The English hour is quite well-produced, including material from BBC World Service and Deutsche Welle (Mike Barraclough, *ibid.*)

**GUINEA** R. Conakry, 7125, good carrier but very weak modulation, irregular schedule observed with Perseus SDR one day at \*0624-0704\*, other days at \*2150-0000\* and \*0601-0706\* (Brandon Jordan, TN, DXLD)

**INDONESIA** 4925, RRI-Jambi. Very different here! New or improved transmitter? Vast improvement in reception, hearing them almost daily! One day at 1343, with pop and EZL songs; 1403 DJ taking phone calls on air; the next day at 1229 but off by 1301 (Ron Howard, CA, DXLD)

**IRAN** [non] Dr Arash Irandoost, a pro-democracy activist, has floated the idea of starting a shortwave radio station, Radio Neda, to force regime change in the country. Writing on the *Right Side News* website, Dr Irandoost says: "Almost all Iranians own radios and use them regularly to get news and entertainment. Radios are not illegal and almost all automobiles are equipped with shortwave band." (via *Media Network* blog)

**KURDISTAN** Clandestine, V. of Iranian Kurdistan, presumably from Salah Al-Din, Northern Iraq, jumps around to avoid Iranian jamming; usually on 4795, or 4789, 4790, 4791, but one occasion was on 4780.01 at 0245-0300, then up to 4795.42 while the jammer stayed on 4780 (Anker Petersen, Denmark, *playdx* yg) And thus might cause confusion with Djibouti on 4780 at the same time (gh)

**MALAWI** James Burnett, Regional Engineer at Trans World Radio Africa, tells me their partner has committed to getting the Malawi shortwave relay station on air by yearend (Brandon Jordan, TN, DXLD) 1 kW on 4870 (*WRTH* 2009) So just for local/area coverage. But will revive Malawi as an SWBC radio country, as MWC left SW 3380 several years ago (gh)

**MALAYSIA/SARAWAK** Klasik Nasional Sarawak FM via RTM closed down 7130 March 30 when that segment became a hamband instead. But it came back July 19 with a different transmitter on 7130.50, heard between 1204 and 1355 with pop songs, singing IDs and news from Kuala Lumpur, // 5030 under China. Taiwan [q.v.] and Chinese jamming also at times on 7130v. On August 12, RTM adjusted to 7130.0 (Ron Howard, CA, DXLD) This one was supposed to move to 7235, 10 kW from Stapok site (gh)

**MÉXICO** [and non] Radio Mil signal on 6010 varies greatly during the day, or even during the half hour 1230-1300 from SINPO 24423 to 44444, music, ads and IDs as "NRM" (Núcleo Radio Mil). Newscast at 1330-1400. At 0030 has a program *Radio Conciencia* not to be confused with the Colombian [q.v.] station; QRM from Cuba on 6000 (Ing. Civ. Israel González Ahumada, M.I., Yucatán, DXLD)

**NETHERLANDS** The hour-by-hour guide to what's on RNW2 (our 24-hour English stream) is now available at

 [www.rnw.nl/english/article/hour-hour-programme-guide](http://www.rnw.nl/english/article/hour-hour-programme-guide) (Andy Sennitt, ODXA yg) Only a fraction of which is still aired on SW (gh)

[non] The Mighty KBC will test on Saturdays 20 and 27 Sept, 4 Oct at 1030-1059 on 9770 to Australia and New Zealand (Sarmiento Campos, via Célio Romais, *Panorama*, @*tividade* DX) Via LITHUANIA (gh)

**NIGER** Last heard in Dec 2008, ORTN again on 9705.0 in mid-August, 1802-1845\*, and carrier hitting Ethiopia 9704.2 before 1800. Local language and music but 1830 ID in French as *La Voix du Sahel*, more French at 1900; also heard until 0700\* in French (Thorsten Hallmann, Germany, <http://www.africalist.de.ms> DXLD)

**NIGERIA** 15120, V. of Nigeria put a new final stage tube into service. Now with superb modulation, not that shredded splattering audio. French at 07-08 UT (Wolfgang Büschel, Germany, *WORLD OF RADIO*)

New Abuja installations, info from Bodo the technician: There are three TSW2300 transmitters from Thomson (250 kW, 5.9-26 MHz), fully DRM-ready. Currently they have "only" the curtain antenna, a 16-dipole array with azimuth of 0 degrees and another 16-dipole array with azimuth of 285 degrees. Beam can be slewed to +15, +30 and -15, -30 degrees. Another antenna in the works, will be a rotatable with 32 dipoles, 16 for

high and 16 for lowbands (Ian Baxter, *shortwavesites* yg)

4769.971, FRCN-Kaduna, at 2105 7 August, English, Radio Nigeria news until 2128, then local programs with ID by a woman. Audio on Radio Nigeria relay somewhat over-modulated but completely readable, but local announcer "whispery quiet" and the local programming so over-modulated, as to render it almost unreadable. Still, a nice surprise. Haven't heard this one in a long time (David Sharp, NSW, DXLD)

DSWCI TB Monitor says it was last reported this May (gh) 4770, also at 0533-0550 Aug 8, hip-hop vocals, 0544 ID. While music was at fair to good levels, talk/voice modulation very weak (Rich D'Angelo, PA, NASWA Flashsheet)

**PERU** 4790, Radio Visión, reactivated in mid-Aug after a couple of months, heard at 0915-0930 with Huaynos music, 0926 canned ID over the music (Chuck Bolland, FL, DXLD) 4790.1, Radio Visión, Chiclayo, 0513-0620 religious songs, and *La Voz de la Salvación*, very poor (Manuel Méndez, Spain, DXLD)

On 4888.2 in mid-July, unID with praise music, announcements mostly in vernacular, little Spanish, undermodulated mike, at 2330-0106, and around 1106. ID sounded like Radio Félicy o Felici. Don't know if a new station or reactivation of R. Macedonia (Rafael Rodríguez R., Colombia, *playdx* yg)

Maybe, but WRTH 2009 lists four Peruvians in this area, R. Virgen del Carmen on 4887, R. Huanta on 4899 (nom 4890), R. Macedonia on 4890 and R. Chota on 4890v (gh) Also weak signal at 2330-2350 on 4888.27. Later, drifting to 4888.17 at 2350-0020 and 1135-1200, and on as early as 1030 (Bob Wilkner, FL, DXLD) Also 4888.2 unID at 1050 with religious talk (Arnaldo Slaen, Argentina, *ibid.*)

**PHILIPPINES** Several DXers in Japan monitored 6170.4 reactivated relay of PBS Radyo Magasin-DZRM on 1278 kHz. I receive at +1130 until 1300 KO'ed by RNZI 6170. Live streaming: [www.pbs.gov.ph/dzrm/](http://www.pbs.gov.ph/dzrm/) (S. Hasegawa, NDXC, WORLD OF RADIO) Weak and nondescript at 1217-1259 on 6170.40 (Ron Howard, CA, *ibid.*)

Radio Pilipinas, 1730-1830 on 15190, 11720 and 9395 on Sunday was carrying recording of a Manila domestic FM station instead of its own programming. 1730 ID "Business Talk on DWBR 104.3 FM - Business Radio", then references to it being "Saturday morning" in Manila. DWBR is another PBS station (Dave Kenny, BDXC-UK yg) Roland Schulze, ex-Philippines, confirms it's a Sunday-only special (Wolfgang Büschel, DXLD)

But Radyo Pilipinas on 15285 also relaying DWBR FM 104.3 at 0240-0300 on a UT Wednesday (Supratik Sanatani, India, DXLD)

**RUSSIA** For some time now, VOR external service in Russian, 'Golos Rossii', has been using a brief audio segment at end of most half hours with repeated sound of what I can only describe as someone hand-sharpening a sickle. This seems particularly sinister and harkens back to the Soviet era. Home service similarly plays a segment at top of most hours of a hammer striking chimes. Signals that the old Soviet bear is coming out of hibernation? I wonder with some dread (Douglas W Johnson, WA, NASWA Journal)

**SAINT HELENA** Radio St. Helena Day 2009 will be on Saturday, 14 November, "Party On-The-Air", 11092.5-USB:

2000-2100	India, Southeast Asia
2100-2200	Japan, Asia
2200-2330	Europe
2330-0100	North America, Central America, Caribbean

QSL and other details: [www.sthelenase/radioproject/Broad-cast\\_Times\\_2009.htm](http://www.sthelenase/radioproject/Broad-cast_Times_2009.htm) (Robert Kipp, DXLD)

**SAUDI ARABIA** 15205, BSKSA, August 1 at 1715-1756\* melodic muezzin, perfect lullaby for a rare noontime nap. I had wisely chosen this instead of *Sawt ul-Buzz* on 15435. Per Aoki, 15205 is 500 kW, 320 degrees from Riyadh (gh, OK)

**SERBIA** Ministry of Culture and Radio Yugoslavia/International Radio Serbia have concluded a contract for the station to continue broadcasting via satellite and Internet and in 11 foreign languages plus Serbian, valid by the end of this year. And talks will be held on the social programme for a certain number of radio employees (IRS via Media Network blog)

The only distribution platforms mentioned are satellite and the Internet, so it appears the station intends to drop shortwave distribution for at least some languages, which explains planned discussions on the 'social programme,' another term for redundancy (Andy Sennitt, *ibid.*) Which is another term for getting fired (gh) I would not be surprised if Bijeljina transmitters soon start to relay nothing but CRI (Kai Ludwig, Germany, DXLD)

In case SW was about to close, we checked several times by mid-August. The daily 0100 English to NAm on 9675 was gone, while the 0030 except Sundays appeared sporadically (gh)

**SUDAN** Radio Peace technical team is performing maintenance, and retuning 4750 to 4740 to eliminate interference from a broadcaster in Uganda [R. Dunamis, also missionary] who began using the frequency about four years after R. Peace started 4750. We'd appreciate monitoring reports to [pete@emedia.org](mailto:pete@emedia.org) And see [www.GlobalEndeavor.org](http://www.GlobalEndeavor.org) (Pete Stover, Manager, Radio Peace via Patrick Robic, WORLD OF RADIO)

Aside from CODAR, other uses, only other station on 4740 is per EiBi and Aoki, Son La, Vietnam at different times, but DSWCI TBM says it was last heard in April on 4739.6 (gh) Sei-ichi Hasegawa, Japan says that's inactive (Ron Howard, DXLD)

R. Peace still on 4750 as of Aug 3 at \*0226, IDs in English (Scott Barbour, NH, DXLD) And as of Aug 5 at \*0245 (Anker Petersen, Denmark, *playdx* yg) First heard Aug 10 on 4739.97 at \*0222, threshold at sign-on,

but dawn enhancement rapidly strengthened from 0325 organ music, English and Arabic until just before 0400 fade, peaking 0340-0350 (Brandon Jordan, TN, *ibid.*) Also peaking here 0345 (J. D. Stephens, AL, HCDX) 4740, sermon, tentatively by long-path, 1439-1455 (Ron Howard, CA, *ibid.*) See schedule last month; also 5895.

**TAIWAN** RTI Tainan transmitter site not usable due to damage by Typhoon Morakot, so Japanese and Indonesian services 0800/1400 on 11605, 9735, 11550 temporarily replaced Aug 9 by 7130 from another site [Kouhu, per Aoki] (S. Hasegawa, NDXC, DXLD)

Really 7129.88v, clashing with reactivated Sarawak [see MALAYSIA] on 7130.5. Also mainland jamming on 7130 after 1355 when RTI is in Chinese (Ron Howard, CA, *ibid.*) Heard 1300 Japanese with het. Neither has any business still broadcasting in the exclusive 40m ham band! (gh)

**USA** Despite being a member of the DRM consortium, IBB showed little interest in actually broadcasting DRM, until finally in August prompted by the upcoming HFCC meeting in Dominican Republic, tests started from Greenville, assisted by HCJB (gh)

Initial schedule, subject to change, and may continue for weeks:

0000-0400 9405 at 45 degrees with log periodic  
2000-2200 15475 at 306 degrees with a rhombic antenna (Gerhard Straub, DXLD)

15475 would blow away Antarctica until 2100, but no DRM heard at the outset (gh) Monitored 9405 from 0000: Despite continued strong signal strength, fading distortion made the signal completely undecodable by 0145. A comparable analog broadcast would still be booming (Terry Wilson, MI, DXLD)

As soon as evangelist Tony Alamo was convicted July 24 on ten counts of sex crimes against young girls, he was finally removed from the WWCR schedule, replaced the following week M-F at 1300-1400 on 15825 by black gospel music. But WINB kept broadcasting Alamo three or four times a day on 9265, 13570, as did R. Africa, Equatorial Guinea around 2200 on 15190, and European Gospel Radio/IRRS Slovakia, Mondays at 0430 on 9510 – presumably old tapes replayed. Sentencing and appeal were still pending, but even if in prison for life, he might still be radiated. After all, you don't even have to be alive to maintain a profitable radio ministry business (gh)

The WWCR-2 transmitter, which for years had been sold out 24/7 to The University Network on 13845/5935, began to lose some airtime in August, and then mornings were turned over from the Scotts to Brother Stair. The exact times were not published, and seemed to vary, but roughly 1200-1800, as monitored by Rick Barton and myself (gh)

It sounds like a Cuban clandestine broadcast, Spanish speeches rather than conversational tones, but it's really a ham net featuring exile Nelson Roig in Pennsylvania, around 1215 on 7210.0-LSB, reading anti-Castro, anti-Chávez, anti-Zelaya diatribes, pausing for IDs as N1NR, and contacts with WT4WT and others (gh) Also heard Hondurans participating (Yimber Gávrira, Colombia, DXLD)

Most of the DXing with *Cumbre* times on the WHR online schedule are imaginary – tune them in and hear something else, or no transmission at all, but we ran across one that really existed, Sundays 1200 on WHRI 9410 (gh)

WBOH 5920 at 2320 July 12 announced "We will be having to make some very important decisions about WBOH in the near future." Thinking about cutting back shortwave or even closing down? (Alan Pennington, BDXC-UK Communication) This and the sibling WTJC 9370v transmitter are problematic, the latter putting out noisy spurs +/- 25 to 30 kHz bothering other stations (gh)

New York City MW stations heard on third harmonics; why is suppression so hard for them? WOR 710 on 2130 kHz, peaking at 0100; WEPN 1050 identified on 3150. Also unID harmonic (?) on 2720.25, Nirvana, REM music-only, tests? around 0450, 2 x 1360v or 4 x 680v (Rik van Riel, NH, HCDX and harmonics yg)

**URUGUAY** Inauguration of SW 6045-USB, CXA61, by R Sport 890, Montevideo, was delayed again in August, but has been authorized, 2.5 kW to be 24 hours, says tech manager Gustavo Cirino, [cx7at@adinet.com.uy](mailto:cx7at@adinet.com.uy)

AFAIK, SODRE is inactive on 6125, but Juan Brañas of Radio Universo, Castillos says that since mid-July it runs 6055 at 0000-0130 and planned to increase power; unheard here (Horacio Nigro, Montevideo, DXLD) Tsk, 6055 occupied by Spain (gh)

**ZIMBABWE** [non] Zimbabwe Community Radio heard on 3955 via South Africa at 1755-1820+, a 3-day test in August; they were not too happy with reception via UAE on 5950 at 20-21. Would try 60m next (Jari Savolainen, Finland, DXLD)

🔊 For our latest **WORLD OF RADIO** schedule and audio see [www.worldofradio.com/radioskd.html](http://www.worldofradio.com/radioskd.html)

*And so concludes our long tenure as an MT columnist. These pages have been deemed expendable since "everything has already appeared all over the place" on the Internet. Maybe, but nowhere else laboriously compiled and translated into a handy monthly report of all the most significant SWBC news. Now to stay well-informed, prepare to do a lot more screen-reading.*

*There won't be any Next, and 73 de Glenn!*

# BROADCAST LOGS

NOTEWORTHY LOGS FROM OUR READERS

Gayle Van Horn, W4GVH

gaylevanhorn@monitoringtimes.com

http://mt-shortwave.blogspot.com

## 0007 UTC on 6145

CANADA: NHK/Radio Japan relay. Focus program featuring reports and interview with lifelong teacher. SIO 544. Learn Japanese program 11705, 1415. South Korea's **KBS World Radio** relay 9650, 1245; **Radio Canada International** 9515, 1750; 6100, 2315. (Bob Fraser, Belfast, ME). CKZU 6160, 1300-1330 (John Wilkins, Wheat Ridge, CO)

🔊 RCI streaming audio [www.rcinet.ca/](http://www.rcinet.ca/)

🔊 Streaming audio NHK [www.nhk.or.jp/english/](http://www.nhk.or.jp/english/)

## 0020 UTC on 6925USB

PIRATE: (USA) Voice of the Robots. Station ID to music and robot-style voice announcement of Gmail address. Signal very weak with fades. Minor signal peak at 0032 that included pop music and station ID at 0045. **Red Rhino Radio** 6925USB, 0058 including clear ID and Gmail address as: [redrhinoradio@gmail.com](mailto:redrhinoradio@gmail.com). **Cat Butt Radio** 6925USB, 0125. DJ with punk rock/pop music to ID. Fair signal. (Sam Wright, Biloxi, MS). Additional pirates heard on **6925USB**; **Radio Mushroom** \*0112-0138.\* (George Zeller, FRW). **Long Range Radio** 0125-0135.\*; **Thinking Man Radio** \*0135-0154 (Scott Barbour, Intervale, NH). **Wolverine Radio** 0342-0410 (Joe Wood, Greenback, TN). **Barnyard Radio** 0340-0357 (Harold Frodge, MI/Cumbre DX).

## 0030 UTC on 4857.39

PERU: Radio La Hora. Male announcer, Spanish program comments and promos noted between static crashes. Poor signal. Noted at 2347-2359. Peruvians monitored in Spanish: **Radio Victoria** 6019.41, 0955-1005; **Radio Marañón** 4835.42, 1020-1030. **Radio Tarma** 4775, 1029-1040; **Radio Libertad** 5039.19, 1034-1045. **Radio Cusco** 6195.65, 2324-2335 (Chuck Bolland, Clewiston, FL). **Radio Marañón** streaming audio [www.radiomaranon.org.pe](http://www.radiomaranon.org.pe) **Radio Tarma** 4775, 0138-0142 (Robin Tancoo, Trinidad, WI)

## 0032 UTC on 5010

INDIA: All India Radio-Thiruvananthapuram. Presumed news in vernacular language to English news regarding Pakistan and Sri Lanka. Tentative ID at 0040 into Hindi music program. Signal fair at best. (Barbour). **AIR-Shillong** 4970, 1317-1335. English news to presumed interview with Prime Minister Dr. Manmohan Singh // 4775 (AIR-Imphal). Both signals poor. (Ron Howard, Asilomar, CA).

## 0039 UTC on 11905

SRI LANKA: SLBC. Presumed station noted with subcontinental music to announcer intermittent program breaks. Extended talk 0115-0127 to choral song (possibly national anthem) to 0130. Subcontinental music resumed at 0131 (Dave Valko, PA/Cumbre DX). VOA Sri Lanka relay 9780, 0139-0150 (Barbour).

## 0104 UTC on 7430

KUWAIT: Voice of America relay. VOA News Now program including items on Israel and Palestine. Sports roundup, station URL and identification. Political news on Japan and Indonesia. Signal fair at tune in, poor by tune-out (Barbour).

## 0130 UTC on 6000

CUBA: Radio Habana Cuba. News item on Cuba to attend Bogota Fair, SIO 453 (Fraser). 6000, 1100; 15120 Spanish, 1521, 17660, 2107 *Dxers Unlimited* (Tancoo)

## 0238 UTC on 7200

SUDAN: Radio Sudan (Khartoum). Station sign-on with Qur'an recitations to 0248. Male speaker in Arabic with brief announcements, including what sounded like a mention of "Radio Sudan." Men's a cappella singing and chanting. Excellent signal on 7200, 0340. Traditional music with lute accompaniment to Arabic "magazine" style program format. Time pips signal at 0400, followed by ID and news. Transmitter suddenly off at 0429 and did not return until 0528, at which time signal was poor. Intermittent but significant amateur radio interference on SSB. (Brandon Jordan, Memphis, TN/Cumbre DX).

## 0320 UTC on 13740

IRAN: VOIRI: Presumed Iran in Dari service. Announcer's updates to traditional music at 0327. Poor signal, fading into the noise after 0330. VOIRI on 11665, 0323-0335. Arabic text to music at 0329. Mentions of Iran amid poor signal with small amount of fading (Jim Evans, Germantown, TN).

🔊 Streaming audio [www.irib.ir/English/](http://www.irib.ir/English/)

## 0358 UTC on 7275

TUNISIA: RDTV Tunisienne. Open carrier to station sign-on announcement at 0358 by lady announcer in Arabic. Traditional vocals to 0400, followed by news bulletin (Jordan). 7275, 0440-0450 in Arabic (Wood).

🔊 Streaming/on-demand audio [www.radiotunis.com](http://www.radiotunis.com)

## 0430 UTC on 7245

RWANDA: Deutsche Welle relay via Kigali. Interview with a composer mentioning Ezra Pound and James Joyce as being musical influences. Continued with comparisons of literature and music (Wood). Rwanda on 11865, 2115 // 15205 (Fraser).

🔊 Streaming audio [www.dw-world.de/](http://www.dw-world.de/)

## 0620 UTC on 9575

MOROCCO: Radio Medi Un. Tune-in to French and Arabic ads, followed by North African and Middle Eastern music to 0630. French station identification to French newscast and correspondents' reports. Additional ad cluster and Medi 1 promos. Signal fair-poor quality (Barker).

🔊 Streaming audio [www.medi1.com](http://www.medi1.com)

## 0645 UTC ON 5995

MALI: RTV du Mali. Tuned in to presumed radio skit in vernacular language to 0653. Musical bridge to announcements. Native African music to 0659, followed by jingle and French newscast (Bruce Barker, Broomall, PA).

## 0934 UTC on 6075

BOLIVIA: Radio Causachun Coca. Music presentations to Spanish time check and station ID, followed by a lengthy discourse-probably a newscast. Signal dipping during broadcast as announcer conducts phone talk. Recheck at 1043 during signal still at fair level. Subsequent log 1050-1105. Additional Bolivians monitored in Spanish: **Radio Fides** 6155.25, 0952-1000/2312-2330; **Radio Santa Cruz** 6134.77, 1000-1030; rechecks noted on 6134.80, 1030-1045, 6195.65, 2324-2335. **Radio Yura** 4716.65, 0005-0040 (Bolland) 4717, 0124 (Tancoo)

🔊 **Radio Fides** streaming audio [www.radiofides.com](http://www.radiofides.com)

## 1005 UTC on 4750

INDONESIA: RRI Makassar. Indonesian comments to Qur'an recitations to 1012. Lady's music presentation during fair signal quality. **Voice of Indonesia** 9524.90, 1025-1035 in English. **RRI-Jakarta** 9680, Indonesian 1033-1045 (Bolland). **RRI Manokwari** 3987.05, Indonesian 1236-1250 VOI 9525.88 English \*1300-1308 (Wilkins).

## 1100 UTC on 6060

VENEZUELA: Radio Nacional de Venezuela via Cuba. English news to 1112. Heard on 13680 // 15250 2300-0000. English generally the first half-hour. Alo Presidenté recorded program from Chavez (Fraser; Tancoo).

## 1308 UTC on 7145

LAOS: Lao National Radio. Best reception so far in French with musical fanfares between items. English commencing at 1331 with announcers alternating with presumed newscast. Band noise and ARO interference at 1329 made for poor reception, but French segment was almost fair. LNR 6130, 1416-1423. Begins in Laotian for *Functioning in Business*. Mentions of "VOA" who produces this program in English (Howard).

🔊 Streaming audio [www.lnr.org.la](http://www.lnr.org.la)

## 1750 UTC on 15120

NIGERIA: Voice of Nigeria. *Africa Now* program of news and views. SIO 453 (Fraser). VON 9690, 0815-0822. Listed as Hausa service. Possible newscast during band noise and weak signal. (Barker)

🔊 Streaming audio [www.voiceofnigeria.org](http://www.voiceofnigeria.org)

## 2222 UTC on 9665

MOLDOVA: Voice of Russia relay. Item on Russian anti-piracy fleet in the Gulf of Aden, SIO 454. (Fraser; Tancoo) VOR via Moscow 7395, 2030 // 12040; 9890, 2345 *Time Lines* program, SIO 555 (Fraser).

Additional loggings excluded for space constraints are posted as **Blog Logs** on the **Shortwave Central Blog** at the above web address.

Thanks to our contributors – Have you sent in YOUR logs?  
Send to Gayle Van Horn, c/o Monitoring Times  
English broadcast unless otherwise noted.

## 'Tis the Season... of the Witch

**T**outed as broadcasting from Salem, Massachusetts, *Witch City Radio* was heard throughout the Eastern Seaboard, that fateful Halloween night in 1993. Scores of others have since joined Witch City, and you can bet that pirate radio operators are already planning their Halloween broadcasts. Especially with this year's holiday arriving on Saturday, the ghouls will be haunting the airwaves once again.

Unfortunately for fans, pirate stations do not adhere to a set broadcasting schedule. Almost all North American pirates are heard on 6925 (AM or USB), plus or minus 30 to 40 kHz. Broadcast hours can be at any time; however, the majority of North American pirates operate between 2000-0400 UTC. Pre-Halloween shows are popular, too, so begin checking the weekend of the 23-24, as well as Friday the 30<sup>th</sup> of October.

Various pirates scattered throughout Europe broadcast special Halloween programming, though not on the same scale as the US operators. European activity is best heard in North America from 2100-0200, so begin as early as Friday afternoon on the 30<sup>th</sup>. Most can be found on 3900-4025 and 5803-7490 upper or lower sideband. Check, too, on the weekends between 1300-1800 on 15055-15080 kHz. Operators present a variety of programming, usually with a mix of techno, pop, rap, rock or German schlager music.

### ❖ QSLing

Most pirates in the U.S. and Europe use mail drops to handle their mail. Letters to the drop are received by a "go-between," who forwards the letter to the station operator. This method eliminates any trace of where the station is located.

As postal rates increase, a growing number of stations are using email for electronic QSLing. Usually the station will include their email address or postal drop announcement during the broadcast. This month's *Email Contact List* comprises active stations using email correspondence.

Some stations prefer bulletin logs or internet web site reports. The *Free Radio Weekly* is devoted to the hobby of pirate listening. Newsletters focus on logs of the previous week, station news and, of course, QSLing.

To request a sample or contribute to the FRW, send your email to [freeradioweekly@gmail.com](mailto:freeradioweekly@gmail.com) For additional pirate news, programming, and the *Pirates Week Podcast* link, Radner Daneskjold runs the *Shortwave Pirate*

Info website at [www.piratesweek.info/](http://www.piratesweek.info/).

Some pirate operators also verify by regularly scanning the logs posted on the *Free Radio Network* website at [www.frn.net](http://www.frn.net) for potential QSLing, so be sure to include *please QSL* in your post.

Pirate operators may release special QSL cards for their Halloween broadcast. Former broadcaster *He-Man Radio*, broadcasting in upper sideband as "the manliest of modes," pictured He-Man lifting an oversized pumpkin on his shoulders. Tommy Pickles from Radio Halloween graced his veries with tombstones and bats, and a photo of a lighted jack-o-lantern.

Fans can only speculate on who will show up on the airwaves this year. Will *Voice of the Purple Pumpkin* or *Voice of Halloween* revive their shows? Maybe *Ann Hoffer Radio* will rebroadcast last year's *Werewolves of London* or the Door's *People are Strange* on 6925 AM around 2200 UTC.

*Tis the season ...of the Witch*

### EMAIL CONTACT LIST

#### USA

Balls to the Wall Radio [ballstothewall@gmail.com](mailto:ballstothewall@gmail.com)  
 Barnyard Radio [barnyardradio@gmail.com](mailto:barnyardradio@gmail.com)  
 Blind Faith Radio [blindfaithradio@yahoo.com](mailto:blindfaithradio@yahoo.com)  
 Blue Ridge Radio [blueridgeradio@gmail.com](mailto:blueridgeradio@gmail.com)  
 Calling Marco Radio [callingmarcoradio@gmail.com](mailto:callingmarcoradio@gmail.com)  
 Captain Morgan Shortwave [captainmorganshortwave@gmail.com](mailto:captainmorganshortwave@gmail.com)  
 Channel Z Radio [channelzradio@gmail.com](mailto:channelzradio@gmail.com)  
 Crystal Ship [tcshortwave@yahoo.com](mailto:tcshortwave@yahoo.com)  
 Dead Cat Radio [cattus.mortuus@gmail.com](mailto:cattus.mortuus@gmail.com)  
 Derby Radio [derbyradioshortwave@yahoo.com](mailto:derbyradioshortwave@yahoo.com)  
 Grasscutter Radio [grasscutterrado@yahoo.com](mailto:grasscutterrado@yahoo.com)  
 Grey Rhino Radio [greyrhinoradio@gmail.com](mailto:greyrhinoradio@gmail.com)  
 Gypsy Radio [piratepolka@gmail.com](mailto:piratepolka@gmail.com)  
 Ironman Radio [ironmanradio@hotmail.com](mailto:ironmanradio@hotmail.com)  
 KUSA [kusanorthamerica@gmail.com](mailto:kusanorthamerica@gmail.com)  
 Liquid Radio via Radio Jamba International [wrbfm@gmail.com](mailto:wrbfm@gmail.com)  
 MAC Shortwave [macshortwave@yahoo.com](mailto:macshortwave@yahoo.com)  
 Northwoods Radio [northwoodsradio@yahoo.com](mailto:northwoodsradio@yahoo.com)  
 Over the Horizon Radio [orthradio@gmail.com](mailto:orthradio@gmail.com)  
 Radio Casablanca [rcasablanca1@gmail.com](mailto:rcasablanca1@gmail.com)  
 Radio Cinco de Mayo [radiocinocodemayo@yahoo.com](mailto:radiocinocodemayo@yahoo.com)  
 Radio Dismuke [radio@dismuke.org](mailto:radio@dismuke.org)  
 Radio Free Euphoria [captainanja@pot.com](mailto:captainanja@pot.com)  
 Radio Ga Ga [rgaga@gmail.com](mailto:rgaga@gmail.com) [popeonthepoint@gmail.com](mailto:popeonthepoint@gmail.com)  
 Radio is My Friend [cherokeemental@yahoo.com](mailto:cherokeemental@yahoo.com)  
 Radio Josephine [radiojosephine@gmail.com](mailto:radiojosephine@gmail.com)  
 Radio Marlene [radiomarlene@gmail.com](mailto:radiomarlene@gmail.com)  
 Radio Mushroom [radiomushroom@gmail.com](mailto:radiomushroom@gmail.com)  
 Radio Pigmeat International [pigmeat\\_voab@yahoo.com](mailto:pigmeat_voab@yahoo.com)  
 Red Rhino Radio [redrhino@gmail.com](mailto:redrhino@gmail.com)  
 Roll Out the Barrel [piratepolka@gmail.com](mailto:piratepolka@gmail.com)  
 Somebody's Gotta Say It Radio [somebodyradio@gmail.com](mailto:somebodyradio@gmail.com)  
 Sunshine Radio [grasscutterrado@yahoo.com](mailto:grasscutterrado@yahoo.com)  
 Sycko Radio [syckoradio@yahoo.com](mailto:syckoradio@yahoo.com)

The Hole [kahn@whoever.com](mailto:kahn@whoever.com)  
 The Voice of the Purple Pumpkin [wvlsw@netscape.net](mailto:wvlsw@netscape.net)  
 Thinking Man Radio [thinkingmanradio@gmail.com](mailto:thinkingmanradio@gmail.com)  
 Undercover Radio [undercoverradio@gmail.com](mailto:undercoverradio@gmail.com)  
 Voice of Captain Ron [captainronswr@yahoo.com](mailto:captainronswr@yahoo.com)  
 Voice of KAOS [voiceofkaos@gmail.com](mailto:voiceofkaos@gmail.com)  
 Voice of the Beast [voiceofthebeast@gmail.com](mailto:voiceofthebeast@gmail.com)  
 Voice of Honor [voiceofhonor@gmail.com](mailto:voiceofhonor@gmail.com)  
 Voice of the New World Order [vonwoun@yahoo.com](mailto:vonwoun@yahoo.com)  
 Voice of the Robots [voiceoftherobots@gmail.com](mailto:voiceoftherobots@gmail.com)  
 WBM Black Mountain Radio [wbmrradio@hotmail.com](mailto:wbmrradio@hotmail.com)  
 WBNY Radio Bunny [wbnradiobunny@gmail.com](mailto:wbnradiobunny@gmail.com)  
 rodentrevolutionhq@yahoo.com  
 WEAK Radio [weakradio@gmail.com](mailto:weakradio@gmail.com)  
 WQAAZ [wqaz@gmail.com](mailto:wqaz@gmail.com)  
 YRTK Your Right to Know Radio [yrtkradio@gmail.com](mailto:yrtkradio@gmail.com)  
 Yellow Rhino Radio [yellowrhinoradio@gmail.com](mailto:yellowrhinoradio@gmail.com)

#### EUROPE

Though not a complete list of all European pirates, the following contacts represent a sampling of stations monitored recently.

Antonio Radio [antonioradio@hotmail.com](mailto:antonioradio@hotmail.com)  
 Bogus Radio [differentradio@yahoo.co.uk](mailto:differentradio@yahoo.co.uk)  
 Britain Radio International [britainradio@hotmail.com](mailto:britainradio@hotmail.com)  
 Cactus Jack Radio [cactusjackradio@hotmail.com](mailto:cactusjackradio@hotmail.com)  
 DRP Radio [drpradio@aol.com](mailto:drpradio@aol.com)  
 Electric Blues Radio [electricbluesradio@hotmail.com](mailto:electricbluesradio@hotmail.com)  
 Laser Hot Hits [hohits@radiolink.net](mailto:hohits@radiolink.net)  
 Misty Radio [misty.shortwave@gmail.com](mailto:misty.shortwave@gmail.com)  
 Mustang Radio [mustangradio@live.nl](mailto:mustangradio@live.nl)  
 Mystery Radio [radio6220@hotmail.com](mailto:radio6220@hotmail.com)  
 Playback International [playbackinternational@gmail.com](mailto:playbackinternational@gmail.com)  
 Radio Albatross [radioalbatross@hotmail.com](mailto:radioalbatross@hotmail.com)  
 Radio Alice [radioalice@hotmail.com](mailto:radioalice@hotmail.com)  
 Radio Borderhunter [borderhunterradio@hotmail.com](mailto:borderhunterradio@hotmail.com)  
 Radio Contact [radiocontact@gmail.com](mailto:radiocontact@gmail.com)  
 Radio Halloween [halloweenradio@gmx.net](mailto:halloweenradio@gmx.net)  
 Radio Mistletoe [radiomistletoe@live.com](mailto:radiomistletoe@live.com)  
 Radio Shadowman [radioshadowman@hotmail.com](mailto:radioshadowman@hotmail.com)  
 Shortwave Cowboy [webmaster@radiopcn.nl](mailto:webmaster@radiopcn.nl)  
 Spider Radio [spider.sw@hotmail.com](mailto:spider.sw@hotmail.com)  
 WNKR Western Kent Radio [wknrsw@gmail.com](mailto:wknrsw@gmail.com)

#### PIRATE MAIL DROPS

Basel Box 510 CH-4010 Basel Switzerland	Merlin Box 293 Merlin, Ontario NOP 1W0 Canada
Belfast P.O. Box 1 Belfast, NY 14711 USA	Neede P.O. Box 73 Netherlands
BRS/ Blue Ridge Summit P.O. Box 109 Blue Ridge Summit, PA 17214 USA	Santiago Casilla 159 Santiago 14 Chile
Eisenach SRS Deutschland (station name) Postfach 10 11 45 DE-99801 Eisenach Germany	Stoneham P.O. Box 146 Stoneham, MA 02180 USA
Herten P.O. Box 2702 6049ZG Herten Netherlands	Ytterby c/o SRS News Ostra Porten 29 S-442 54 Ytterby Sweden





## HOW TO USE THE SHORTWAVE GUIDE

0000-0100 twhfa USA, Voice of America 5995am 6130ca 7405am 9455af  
 ① ② ⑤ ③ ④ ⑥ ⑦

### Convert your time to UTC.

Broadcast time on ① and time off ② are expressed in Coordinated Universal Time (UTC) – the time at the 0 meridian near Greenwich, England. To translate your local time into UTC, first convert your local time to 24-hour format, then add (during Daylight Time) 4, 5, 6 or 7 hours for Eastern, Central, Mountain or Pacific Times, respectively. Eastern, Central, and Pacific Times are already converted to UTC for you at the top of each hour.

Note that all dates, as well as times, are in UTC; for example, a show which might air at 0030 UTC Sunday will be heard on Saturday evening in America (in other words, 8:30 pm Eastern, 7:30 pm Central, etc.).

### Find the station you want to hear.

Look at the page which corresponds to the time you will be listening. English broadcasts are listed by UTC time on ①, then alphabetically by country ③, followed by the station name ④. (If the station name is the same as the country, we don't repeat it, e.g., "Vanuatu, Radio" [Vanuatu].)

If a broadcast is not daily, the days of broadcast ⑤ will appear in the column following the time of broadcast, using the following codes:

<b>Codes</b>	
s/Sun	Sunday
m/Mon	Monday
t	Tuesday
w	Wednesday
h	Thursday
f	Friday
a/Sat	Saturday
occ:	occasional
DRM:	Digital Radio Mondiale
irreg	Irregular broadcasts
vl	Various languages
USB:	Upper Sideband

### Choose the most promising frequencies for the time, location and conditions.

The frequencies ⑥ follow to the right of the station listing; all frequencies are listed in kilohertz (kHz). Not all listed stations will be heard from your location and virtually none of them will be heard all the time on all frequencies.

Shortwave broadcast stations change some of their frequencies at least twice a year, in April and October, to adapt to seasonal conditions. But they can also change in response to short-term conditions, interference, equipment problems, etc. Our frequency manager coordinates published station schedules with confirmations and reports from her monitoring team and MT readers to make the Shortwave Guide up-to-date as of one week before

print deadline.

To help you find the most promising signal for your location, immediately following each frequency we've included information on the target area ⑦ of the broadcast. Signals beamed toward your area will generally be easier to hear than those beamed elsewhere, even though the latter will often still be audible.

#### Target Areas

- af: Africa
- al: alternate frequency (occasional use only)
- am: The Americas
- as: Asia
- ca: Central America
- do: domestic broadcast
- eu: Europe
- me: Middle East
- na: North America
- pa: Pacific
- sa: South America
- va: various

**Mode used by all stations in this guide is AM unless otherwise indicated.**

### Shortwave Broadcast Bands

kHz	Meters
2300-2495	120 meters (Note 1)
3200-3400	90 meters (Note 1)
3900-3950	75 meters (Regional band, used for broadcasting in Asia only)
3950-4000	75 meters (Regional band, used for broadcasting in Asia and Europe)
4750-4995	60 meters (Note 1)
5005-5060	60 meters (Note 1)
5730-5900	49 meter NIB (Note 2)
5900-5950	49 meter WARC-92 band (Note 3)
5950-6200	49 meters
6200-6295	49 meter NIB (Note 2)
6890-6990	41 meter NIB (Note 2)
7100-7300	41 meters (Regional band, not allocated for broadcasting in the western hemisphere) (Note 4)
7300-7350	41 meter WARC-92 band (Note 3)
7350-7600	41 meter NIB (Note 2)
9250-9400	31 meter NIB (Note 2)
9400-9500	31 meter WARC-92 band (Note 3)
9500-9900	31 meters
11500-11600	25 meter NIB (Note 2)
11600-11650	25 meter WARC-92 band (Note 3)
11650-12050	25 meters
12050-12100	25 meter WARC-92 band (Note 3)
12100-12600	25 meter NIB (Note 2)
13570-13600	22 meter WARC-92 band (Note 3)
13600-13800	22 meters
13800-13870	22 meter WARC-92 band (Note 3)
15030-15100	19 meter NIB (Note 2)
15100-15600	19 meters
15600-15800	19 meter WARC-92 band (Note 3)
17480-17550	17 meter WARC-92 band (Note 3)
17550-17900	17 meters
18900-19020	15 meter WARC-92 band (Note 3)
21450-21850	13 meters
25670-26100	11 meters

#### Notes

- Note 1 Tropical bands, 120/90/60 meters are for broadcast use only in designated tropical areas of the world.
- Note 2 Broadcasters can use this frequency range on a (NIB) non-interference basis only.
- Note 3 WARC-92 bands are allocated officially for use by HF broadcasting stations in 2007
- Note 4 WRC-03 update. After March 29, 2009, the spectrum from 7100-7200 kHz will no longer be available for broadcast purposes and will be turned over to amateur radio operations worldwide

#### MT MONITORING TEAM

Gayle Van Horn  
 Frequency Manager

[gaylevanhorn@monitoringtimes.com](mailto:gaylevanhorn@monitoringtimes.com)

Larry Van Horn, MT Asst. Editor

[larryvanhorn@monitoringtimes.com](mailto:larryvanhorn@monitoringtimes.com)

### Thank You ...

#### Additional Contributors to This Month's Shortwave Guide:

AOKI; *BCL News*; *Ardic DX Club*; *DX Asia*; *British DX Club*; *Cumbre DX*; EIBI; *HFCC*; *Hard-Core DX*; *Radio Bulgaria DX Mix News*; Media Broadcast, *Play DX 2003*; *WWDXC- BC DX*, *Top News*; *World DX Club/Contact.*, *World News*.

Alan Roe, UK; Alexey Zinevich, Russia; Alokesh Gupta, New Delhi, India; Daniel Sampson, Ernest Riley/PTSW; Dragan Lekic; Evelyn Marcy/WYFR; Ivo Ivanov; Bulgaria; Jaisakthivel, Chennai, India; José Miguel Romero, Spain; Mike Barracough, UK; Noel Green, UK; Rachel Baughn/MT; Rich D' Angelo/NASWA *Flash Sheet*, *NASWA Journal*; Tom Taylor, UK; Wolfgang Büschel, Germany,

**GLENN HAUSER'S  
 WORLD OF RADIO**  
<http://www.worldofradio.com>

For the latest DX and programming news, amateur nets, DX program schedules, audio archives and much more!

**0000 UTC - 8PM EDT / 7PM CDT / 5PM PDT**

0000	0000	UK, BBC World Service	5970as	6195as
		7395as	9410as	9740as
		13725as	15335as	15360as
0000	0005	Canada, Radio Canada International		6100am
0000	0005	Greece, Voice of Greece		9420va
0000	0020	Japan, NHK World/ Radio Japan		5960eu
		6145na	13650as	17810as
0000	0027	Czech Republic, Radio Prague		7345na
0000	0030	Egypt, Radio Cairo		1590na
0000	0030	Thailand, Radio Thailand World Svc		15275na
0000	0030	USA, Voice of America		7555va
0000	0045	India, All India Radio		9705as
		11620as	11645as	
0000	0045	USA, WYFR/Family Radio Worldwide		17805na
0000	0056	Romania, R Romania International		6135na
		7535na	9580na	
0000	0100	Anguilla, Worldwide Univ Network		6090am
0000	0100	Australia, ABC NT Alice Springs		4835do
0000	0100	Australia, ABC NT Katherine		5025do
0000	0100	Australia, ABC NT Tennant Creek		4910do
0000	0100	Australia, Radio Australia		9660as
		13690as	15240pa	17665as
		17750va	17775va	17795va
0000	0100	Bahrain, Radio Bahrain		6010me
0000	0100	Canada, CFVP Calgary AB		6030na
0000	0100	Canada, CKZN St John's NF		6160na
0000	0100	Canada, CKZU Vancouver BC		6160na
0000	0100	Canada, Radio Canada International		11700as
0000	0100	China, China Radio International		6020na
		6075as	6180as	7415as
		11790as	11885as	13750as
0000	0100	Germany, Deutsche Welle		9885as
		17525as		15595as
0000	0100	Guyana, Voice of Guyana		3291do
0000	0100	Malaysia, RTM/Traxx FM		7295do
0000	0100	DRM New Zealand, Radio NZ International		13730pa
0000	0100	DRM New Zealand, Radio NZ International		15720pa
0000	0100	Papua New Guinea, Wantok R. Light		7325do
0000	0100	Russia, Voice of Russia		9480sa
0000	0100	Spain, Radio Exterior de Espana		6055na
0000	0100	Ukraine, Radio Ukraine International		7440na
0000	0100	USA, American Forces Network		4319usb
		5446usb	5765usb	6350usb
		10320usb	12133usb	12759usb
0000	0100	USA, EWTN Vandiver AL		11520af
0000	0100	USA, WBCQ Monticello ME		5110am
0000	0100	USA, WBOH Newport NC		5920am
0000	0100	USA, WHRA Greenbush ME		7385eu
0000	0100	USA, WHRI Cypress Creek SC		5875na
0000	0100	USA, WINB Red Lion PA		9265am
0000	0100	USA, WRMI Miami FL		9955ca
0000	0100	USA, WTJC Newport NC		9370na
0000	0100	USA, WWCR Nashville TN		5070na
		7465na	9980na	
0000	0100	USA, WWRB Manchester TN		3185va
		5745va	6890va	5050va
0000	0100	USA, WYFR/Family Radio Worldwide		5950na
		6985na	7335as	9420as
		9835as	15440am	9505sa
0000	0100	Zambia CVC Intl/ The Voice Africa		4965af
0005	0100	Canada, Radio Canada International		6100am
0005	0100	Greece, Voice of Greece		7475va
0013	0017	twhfa Austria, Radio O1 International/ORF		9820am
0025	0100	Sri Lanka, SLBC		6005as
0030	0045	twhf as Albania, Radio Tirana		9345na
0030	0045	Sun Germany, Pan American BC		9640as
0030	0058	twhf as Serbia, International Radio of Serbia		9675na
0030	0100	Australia, Radio Australia		15415as
0030	0100	China, China Radio International		11730as
0030	0100	Thailand, Radio Thailand World Svc		15275na
0030	0100	fas UK, Bible Voice Broadcasting		9490as
0030	0100	USA, Voice of America/Special		7430as
		9780as	11725as	15205as
		17820as		15560as
0030	0100	Uzbekistan, CVC Intl-The Voice Asia		11800as
0043	0047	twhfa Austria, Radio O1 International/ORF		9820am

**0100 UTC - 9PM EDT / 8PM CDT / 6PM PDT**

0100	0105	Canada, Radio Canada International		6100am
0100	0105	m Greece, Voice of Greece		7475va
		15630va		9420va
0100	0127	Czech Republic, Radio Prague		6200na
0100	0127	Slovakia, R Slovakia International		5930am

0100	0128	9440am Serbia, International Radio of Serbia		9675na
0100	0130	Australia, Radio Australia		9660as
		13690as	15240pa	17665as
		17750va	17775va	17795va
0100	0130	Vietnam, Voice of Vietnam		6175na
0100	0157	North Korea, Voice of Korea		7140as
		9730as	11735sa	13760sa
0100	0200	Anguilla, Worldwide Univ Network		6090am
0100	0200	Australia, ABC NT Alice Springs		4835do
0100	0200	Australia, ABC NT Katherine		5025do
0100	0200	Australia, ABC NT Tennant Creek		4910do
0100	0200	Bahrain, Radio Bahrain		6010me
0100	0200	Canada, CFVP Calgary AB		6030na
0100	0200	Canada, CKZN St John's NF		6160na
0100	0200	Canada, CKZU Vancouver BC		6160na
0100	0200	Canada, Radio Canada International		9620as
0100	0200	China, China Radio International		6080na
		6175as	9410eu	9470eu
		9580na	9790na	11870as
		15785as		15125as
0100	0200	Cuba, Radio Havana Cuba		6000na
0100	0200	vi Guyana, Voice of Guyana		3291do
0100	0200	DRM Malaysia, RTM/Traxx FM		7295do
0100	0200	DRM New Zealand, Radio NZ International		13730pa
0100	0200	DRM New Zealand, Radio NZ International		15720pa
0100	0200	Palau, T8WH/World Harvest		15710as
0100	0200	Papua New Guinea, Wantok R. Light		7325do
0100	0200	Russia, Voice of Russia		9480sa
0100	0200	Sri Lanka, SLBC		6005as
0100	0200	Taiwan, R Taiwan International		9770as
0100	0200	UK, BBC World Service		7395as
		9740as	11750as	11955as
		15335as	15360as	17615as
0100	0200	USA, American Forces Network		4319usb
		5446usb	5765usb	6350usb
		10320usb	12133usb	12759usb
0100	0200	USA, EWTN Vandiver AL		11520af
0100	0200	USA, KJES Vado NM		7555na
0100	0200	USA, Voice of America		7430va
		11705va		9780va
0100	0200	twhfa USA, WBCQ Monticello ME		5110am
0100	0200	USA, WBOH Newport NC		5920am
0100	0200	USA, WHRA Greenbush ME		7385eu
0100	0200	USA, WHRI Cypress Creek SC		5875na
0100	0200	twhfa USA, WINB Red Lion PA		9265am
0100	0200	USA, WRMI Miami FL		9955ca
0100	0200	Sat/Sun USA, WTJC Newport NC		9370na
0100	0200	USA, WWRB Manchester TN		3185va
		5745va	6890va	5050va
0100	0200	USA, WYFR/Family Radio Worldwide		5950na
		6985na	7335sa	9420sa
		15440am		9505na
0100	0200	Uzbekistan, CVC Intl-The Voice Asia		11790as
		11880as		
0100	0200	Zambia CVC Intl/ The Voice Africa		4965af
0113	0117	twhfa Austria, Radio O1 International/ORF		9820am
0130	0200	Australia, Radio Australia		9660as
		13690as	15240pa	15415as
		17715va	17750va	17795va
0130	0200	Iran, Voice of Islamic Rep. of Iran		7235na
		9495na		
0130	0200	Sweden, Radio Sweden		6010na
0130	0200	twhfa USA, Voice of America/Special		6040ca
0140	0200	Vatican City, Vatican Radio		5915as
0145	0200	twhf as Albania, Radio Tirana		7425na

**0200 UTC - 10PM EDT / 9PM CDT / 7PM PDT**

0200	0227	Iran, Voice of Islamic Rep. of Iran		7235na
		9495na		
0200	0230	Thailand, Radio Thailand World Svc		15275na
0200	0230	USA, KJES Vado NM		7555na
0200	0257	North Korea, Voice of Korea		13650as
0200	0258	Sun Lithuania, Mighty KBC Radio		6110na
0200	0300	Anguilla, Worldwide Univ Network		6090am
0200	0300	Argentina, Radio Nacional RAE		11710am
0200	0300	Australia, ABC NT Alice Springs		4835do
0200	0300	Australia, ABC NT Katherine		5025do
0200	0300	Australia, ABC NT Tennant Creek		4910do
0200	0300	Australia, Radio Australia		9660as
		13690as	15240pa	15415as

		17750va	21725va		
0200	0300	Bahrain, Radio Bahrain	6010me	9745al	
0200	0300	DRM Bulgaria, Radio Bulgaria	9500na		
0200	0300	Bulgaria, Radio Bulgaria	9700na	11700na	
0200	0300	Canada, CFVP Calgary AB	6030na		
0200	0300	Canada, CKZN St John's NF	6160na		
0200	0300	Canada, CKZU Vancouver BC	6160na		
0200	0300	China, China Radio International	11770as		
		13640as			
0200	0300	Cuba, Radio Havana Cuba	6000na	6140na	
0200	0300	Egypt, Radio Cairo	7540na		
0200	0300	vi Guyana, Voice of Guyana	3291do		
0200	0300	Indonesia, Voice of Indonesia	9525va	11785al	
		15150al			
0200	0300	Malaysia, RTM/Traxx FM	7295do		
0200	0300	DRM New Zealand, Radio NZ International	13730pa		
0200	0300	New Zealand, Radio NZ International	15720pa		
0200	0300	Palau, T8WH/World Harvest	15710as		
0200	0300	Papua New Guinea, Wantok R. Light	7325do		
0200	0300	Philippines, Radyo Pilipinas	11880va	15285va	
		15510va			
0200	0300	Russia, Voice of Russia	9480sa	9665sa	
		15425na			
0200	0300	South Korea, KBS World Radio	9580sa		
0200	0300	Sri Lanka, SLBC	6005as	9770as	
0200	0300	Taiwan, R Taiwan International	9680na		
		9680na			
0200	0300	Uganda, UBC Radio	4976do		
0200	0300	UK, BBC World Service	6005af	6195me	
		9410eu	11955as	15310as	
0200	0300	USA, American Forces Network	4319usb		
		5446usb	5765usb	6350usb	7812usb
		10320usb	12133usb	12759usb	13362usb
0200	0300	USA, EWTN Vandiver AL	11520af		
0200	0300	mtwhfa USA, WBCQ Monticello ME	5110am	7415am	
0200	0300	USA, WBOH Newport NC	5920am		
0200	0300	USA, WHRA Greenbush ME	7385eu		
0200	0300	USA, WHRI Cypress Creek SC	5875na	7315va	
0200	0300	USA, WINB Red Lion PA	9265am		
0200	0300	smtwhfa USA, WRMI Miami FL	9955am		
0200	0300	USA, WRNO New Orleans LA	7505am		
0200	0300	USA, WTJC Newport NC	9370na		
0200	0300	USA, WWCR Nashville TN	3215na	5070na	
		5890na	5935na		
0200	0300	USA, WWRB Manchester TN	3185va	5050va	
		5745va	6890va		
0200	0300	USA, WYFR/Family Radio Worldwide	5985sa		
		6985na	7335sa	9420sa	9505na
		9680am	11855sa		
0200	0300	Uzbekistan, CVC Intl-The Voice Asia	11790as		
		11880as			
0200	0300	vi Vatican City, Vatican Radio	9310va	12070va	
0200	0300	Zambia CVC Intl/ The Voice Africa	4965af		
0215	0230	Nepal, Radio Nepal	5005as		
0230	0300	twhf Albania, Radio Tirana	7425na		
0230	0300	China, China Radio International	15435as		
0230	0300	Sweden, Radio Sweden	6010na	11550as	
0230	0300	Vietnam, Voice of Vietnam	6175na		
0245	0300	Australia, HCJB Global	15400as		
0245	0300	Zambia, Zambia Natl Broadcasting Corp	6165do		
0250	0300	Vatican City, Vatican Radio	6040na	7305na	

### 0300 UTC - 11PM EDT / 10PM CDT / 8PM PDT

0300	0320	Vatican City, Vatican Radio	6040am	7305na	
		9545as			
0300	0327	Czech Republic, Radio Prague	7345na	9870na	
0300	0330	Egypt, Radio Cairo	7540na		
0300	0330	Philippines, Radyo Pilipinas	11880va	15285va	
		15510va			
0300	0330	Uzbekistan, CVC Intl-The Voice Asia	11800as		
		11880as			
0300	0330	vi Vatican City, Vatican Radio	7360af	9310va	
		9660af	12070va		
0300	0355	Turkey, Voice of Turkey	5975va	6165me	
		7325na			
0300	0356	Romania, R Romania International	6150na		
		9645na	9735as	11895as	
0300	0357	North Korea, Voice of Korea	7140as	9345as	
		9730as			
0300	0400	Anguilla, Worldwide Univ Network	6090am		
0300	0400	Australia, ABC NT Alice Springs	4835do		
0300	0400	Australia, ABC NT Katherine	5025do		
0300	0400	Australia, ABC NT Tennant Creek	4910do		
0300	0400	Australia, Radio Australia	9660as	12080as	
		13690as	15240pa	15415as	15515as
		17750va	21725va		

0300	0400	Bahrain, Radio Bahrain	6010me	9745al	
0300	0400	twhf Canada, CBC NQ SW Service	9625na		
0300	0400	Canada, CFVP Calgary AB	6030na		
0300	0400	Canada, CKZN St John's NF	6160na		
0300	0400	Canada, CKZU Vancouver BC	6160na		
0300	0400	China, China Radio International	9690na		
		9790na	11770as	13750as	15110as
		15120as	15785as		
0300	0400	Cuba, Radio Havana Cuba	6000na	6140na	
0300	0400	Germany, Deutsche Welle	11975as	13770as	
		15595as			
0300	0400	vi Guyana, Voice of Guyana	3291do		
0300	0400	Malaysia, RTM/Traxx FM	7295do		
0300	0400	Malaysia, RTM/Voice of Malaysia	6175as		
		9750as	15295as		
0300	0400	DRM New Zealand, Radio NZ International	13730pa		
0300	0400	New Zealand, Radio NZ International	15720pa		
0300	0400	Oman, Radio Oman	15355af		
0300	0400	Palau, T8WH/World Harvest	15700as		
0300	0400	Papua New Guinea, Wantok R. Light	7325do		
0300	0400	DRM Russia, Voice of Russia	15735as		
0300	0400	Russia, Voice of Russia	9665sa	15425na	
		15585as	15755as		
0300	0400	South Africa, Channel Africa	3345af	6135af	
0300	0400	Sri Lanka, SLBC	6005as	9770as	
0300	0400	Sweden, Radio Sweden	6010na		
0300	0400	Taiwan, R Taiwan International	9680na	5950na	
		9680na			
0300	0400	Uganda, UBC Radio	4976do		
0300	0400	UK, BBC World Service	3255af	6005af	
		6145af	6190af	6195as	7255af
		9410eu	9750af	12035af	12095as
		15310as	17790as		
0300	0400	Ukraine, Radio Ukraine International	7440na		
0300	0400	USA, American Forces Network	4319usb		
		5446usb	5765usb	6350usb	7812usb
		10320usb	12133usb	12759usb	13362usb
0300	0400	USA, EWTN Vandiver AL	11520af		
0300	0400	USA, Voice of America	4930af	6080af	
		9885af	15580af		
0300	0400	twhf USA, WBCQ Monticello ME	7415am		
0300	0400	USA, WBOH Newport NC	5920am		
0300	0400	USA, WHRA Greenbush ME	7385eu		
0300	0400	USA, WHRI Cypress Creek SC	5875na	7315na	
0300	0400	USA, WRMI Miami FL	9955am		
0300	0400	USA, WRNO New Orleans LA	7505am		
0300	0400	USA, WTJC Newport NC	9370na		
0300	0400	USA, WWCR Nashville TN	3215na	5070na	
		5890na	5935na		
0300	0400	USA, WWRB Manchester TN	3185va	5050va	
		5745va	6890va		
0300	0400	USA, WYFR/Family Radio Worldwide	6915na		
		6985na	11740na	15255am	
0300	0400	Uzbekistan, CVC Intl-The Voice Asia	13680as		
0300	0400	Zambia CVC Intl/ The Voice Africa	4965af		
0300	0400	Zambia, Zambia Natl Broadcasting Corp	6165do		
0330	0357	Czech Republic, Radio Prague	9445na	11600na	
0330	0400	twhf Albania, Radio Tirana	7425na		
0330	0400	UK, BBC World Service	11945af		
0330	0400	Uzbekistan, CVC Intl-The Voice Asia	15555as		
0330	0400	Vietnam, Voice of Vietnam	6175na		
0345	0400	vi/Sat/Sun Uganda, UBC Radio	4976do		

### 0400 UTC - 12AM EDT / 11PM CDT / 9PM PDT

0400	0430	Australia, Radio Australia	9660as	12080as	
		13690as	15160as	15240pa	15515as
		17750va	21725va		
0400	0430	mtwhf France, France International	9805af		
		11995af			
0400	0445	USA, WYFR/Family Radio Worldwide	6985na		
		9505na			
0400	0458	DRM New Zealand, Radio NZ International	13730pa		
0400	0458	New Zealand, Radio NZ International	15720pa		
0400	0500	Anguilla, Worldwide Univ Network	6090am		
0400	0500	Australia, ABC NT Alice Springs	4835do		
0400	0500	Australia, ABC NT Katherine	5025do		
0400	0500	Australia, ABC NT Tennant Creek	4910do		
0400	0500	Bahrain, Radio Bahrain	6010me	9745al	
0400	0500	twhf Canada, CBC NQ SW Service	9625na		
0400	0500	Canada, CKZN St John's NF	6160na		
0400	0500	Canada, CKZU Vancouver BC	6160na		
0400	0500	China, China Radio International	6020na		
		6080na	6190na	13750as	15120as
		15785as	17730as	17855as	
0400	0500	Cuba, Radio Havana Cuba	6000na	6140na	
0400	0500	Germany, Deutsche Welle	6180af	7245af	

			12045af	15445af		
0400	0500	vl	Guyana, Voice of Guyana	3291do		
0400	0500		Malaysia, RTM/Traxx FM	7295do		
0400	0500		Malaysia, RTM/Voice of Malaysia	6175as		
			9750as	15295as		
0400	0500		Palau, T8WH/World Harvest	15700as		
0400	0500		Papua New Guinea, Wantok R. Light	7325do		
0400	0500	DRM	Russia, Voice of Russia	15735as		
0400	0500		Russia, Voice of Russia	13755na	15585as	
			15755as			
0400	0500		South Africa, Channel Africa	3345af		
0400	0500		Sri Lanka, SLBC	6005as	15745as	
0400	0500		Uganda, UBC Radio	4976do		
0400	0500	DRM	UK, BBC World Service	3995eu		
0400	0500		UK, BBC World Service	3255af	6005af	
			6190af	7255af	7310af	9410eu
			11945af	12035af	12095as	13675eu
			15310as	15360as	17790as	
0400	0500		USA, American Forces Network	4319usb		
			5446usb	5765usb	6350usb	7812usb
			10320usb	12133usb	12759usb	13362usb
0400	0500		USA, EWTN Vandiver AL	11520af		
0400	0500		USA, Voice of America	4930af	4960af	
			6080af	9885af	15580af	
0400	0500		USA, WBOH Newport NC	5920am		
0400	0500		USA, WHRA Greenbush ME	7385eu		
0400	0500		USA, WHRI Cypress Creek SC	5875na	7315va	
0400	0500	smtwhf	USA, WHRI Cypress Creek SC	5850na		
0400	0500	Sat	USA, WHRI Cypress Creek SC	9825na		
0400	0500		USA, WRMI Miami FL	9955am		
0400	0500		USA, WTJC Newport NC	9370na		
0400	0500		USA, WWCR Nashville TN	3215na	5070na	
			5890na	5935na		
0400	0500		USA, WWRB Manchester TN	3185va	5745va	
0400	0500		USA, WYFR/Family Radio Worldwide	5950na		
			6915na	9680na		
0400	0500		Uzbekistan, CVC Intl-The Voice Asia	13680as		
			15555as			
0400	0500		Zambia CVC Intl/ The Voice Africa	4965af		
			9430af			
0400	0500		Zambia, Zambia Natl Broadcasting Corp	6165do		
0430	0500		Australia, Radio Australia	9660as	12080as	
			13690as	15240pa	15415as	15515as
			17750va	21725va		
0430	0500	mtwh	Italy, IRRS-Shortwave	5990va		
0430	0500	vl	Nigeria, Radio Nigeria-Kaduna	4770do		
0430	0500	mtwhf	Swaziland, TWR Swaziland	3200af		
0459	0500	DRM	New Zealand, Radio NZ International	11675pa		
0459	0500		New Zealand, Radio NZ International	11725pa		

**0500 UTC - 1AM EDT / 12AM CDT / 10PM PDT**

0500	0507	twhf	Canada, CBC NQ SW Service	9625na		
0500	0530		Australia, Radio Australia	9660as	12080as	
			13690as	15160as	15240pa	15515as
			17750va			
0500	0530	mtwhf	France, Radio France International	11995af		
			13680af	15160as		
0500	0530		Germany, Deutsche Welle	6180af	7430af	
			9700af	9825af		
0500	0530	mtwh	Italy, IRRS-Shortwave	5990va		
0500	0530		Japan, NHK World/ Radio Japan	5975eu		
			6110na	11970af	15325as	17810as
0500	0530		Vatican City, Vatican Radio	4005eu	5965eu	
			7250eu	9660af	11625af	13765af
0500	0600		Anguilla, Worldwide Univ Network	6090am		
0500	0600		Australia, ABC NT Alice Springs	4835do		
0500	0600		Australia, ABC NT Katherine	5025do		
0500	0600		Australia, ABC NT Tennant Creek	4910do		
0500	0600		Bahrain, Radio Bahrain	6010me	9745al	
0500	0600		Bhutan, Bhutan Broadcasting Svc	6035as		
0500	0600		Canada, CKZN St John's NF	6160na		
0500	0600		Canada, CKZU Vancouver BC	6160na		
0500	0600		China, China Radio International	6020na		
			11710af	11880as	11895as	15350as
			15465as	17505va	17540as	17730as
			17855as			
0500	0600		Cuba, Radio Havana Cuba	6000na	6010na	
			6140na	11760na		
0500	0600	DRM	Germany, Deutsche Welle	17525as		
0500	0600	vl	Guyana, Voice of Guyana	3291do		
0500	0600		Kuwait, Radio Kuwait	15110as		
0500	0600		Malaysia, RTM/Traxx FM	7295do		
0500	0600		Malaysia, RTM/Voice of Malaysia	6175as		
			9750as	15295as		
0500	0600	DRM	New Zealand, Radio NZ International	11675pa		
0500	0600		New Zealand, Radio NZ International	11725pa		

0500	0600	vl	Nigeria, Radio Nigeria-Kaduna	4770do		
0500	0600		Nigeria, Voice of Nigeria/External Svc	15120af		
0500	0600		Palau, T8WH/World Harvest	15700as		
0500	0600		Papua New Guinea, Wantok R. Light	7325do		
0500	0600		Russia, Voice of Russia	13755na		
0500	0600		South Africa, Channel Africa	7230af		
0500	0600		Swaziland, TWR Swaziland	3200af		
0500	0600		Taiwan, R Taiwan International	5950na		
0500	0600		Uganda, UBC Radio	4976do		
0500	0600	DRM	UK, BBC World Service	3995af		
0500	0600		UK, BBC World Service	3255af	3995eu	
			6005af	6190af	7255af	7310af
			9410eu	11945af	12095as	15310as
			15360as	15420af	15565eu	17640af
			17790as			
0500	0600		Ukraine, Radio Ukraine International	7440na		
0500	0600		USA, American Forces Network	4319usb		
			5446usb	5765usb	6350usb	7812usb
			10320usb	12133usb	12759usb	13362usb
0500	0600		USA, EWTN Vandiver AL	11520af		
0500	0600		USA, Voice of America	4930af	6080af	
			12080af	15580af		
0500	0600		USA, WBOH Newport NC	5920am		
0500	0600		USA, WHRA Greenbush ME	7390af		
0500	0600		USA, WHRI Cypress Creek SC	5875na	11565na	
0500	0600	Sun	USA, WHRI Cypress Creek SC	7365na		
0500	0600		USA, WRMI Miami FL	9955am		
0500	0600		USA, WTJC Newport NC	9370na		
0500	0600		USA, WWCR Nashville TN	3215na	5070na	
			5890na	5935na		
0500	0600		USA, WWRB Manchester TN	3185va		
0500	0600		USA, WYFR/Family Radio Worldwide	5950na		
			6915na	9680na		
0500	0600		Uzbekistan, CVC Intl-The Voice Asia	13680as		
			15555as			
0500	0600		Zambia CVC Intl/ The Voice Africa	4965af		
			9430af			
0500	0600		Zambia, Zambia Natl Broadcasting Corp	6165do		
0515	0530		Rwanda, Radio Rwanda	6055do		
0530	0556		Romania, R Romania International	7305eu		
			9655eu	15345pa	17760pa	
0530	0600		Australia, Radio Australia	9660as	12080as	
			13690as	15160as	15240pa	15415as
			15515as	17750va		
0530	0600		China, Central People's BS/CNR	9530do		
			11685do	15570do		
0530	0600		Thailand, Radio Thailand World Svc	17655va		

**0600 UTC - 2AM EDT / 1AM CDT / 11PM PDT**

0600	0603		Croatia, Voice of Croatia	7355eu		
0600	0615	Sat/Sun	South Africa, Trans World Radio	11640af		
0600	0630	Sat/Sun	Australia, Radio Australia	15180as	15290as	
0600	0630		Australia, Radio Australia	9660as	11650as	
			12080as	13690as	15160as	15240pa
			15515as	17750va		
0600	0630	mtwhf	France, Radio France International	9765af		
			11610af	15160af	17800af	
0600	0630		Germany, Deutsche Welle	7310af	15275af	
0600	0630		Laos, Lao National Radio	7145as		
0600	0645	mtwhf	South Africa, Trans World Radio	11640af		
0600	0658	DRM	New Zealand, Radio NZ International	11675pa		
0600	0658		New Zealand, Radio NZ International	11725pa		
0600	0700		Anguilla, Worldwide Univ Network	6090am		
0600	0700		Australia, ABC NT Alice Springs	4835do		
0600	0700		Australia, ABC NT Katherine	5025do		
0600	0700		Australia, ABC NT Tennant Creek	4910do		
0600	0700		Bahrain, Radio Bahrain	6010me	9745al	
0600	0700		Canada, CFVP Calgary AB	6030na		
0600	0700		Canada, CKZN St John's NF	6160na		
0600	0700		Canada, CKZU Vancouver BC	6160na		
0600	0700		China, China Radio International	11710af		
			11870as	11880as	11895as	13660as
			15140as	15350as	15465as	17505va
			17540as	17710as		
0600	0700		Cuba, Radio Havana Cuba	6000na	6010na	
			6140na	11760na		
0600	0700	DRM	Germany, Deutsche Welle	3995eu	6130eu	
0600	0700		Greece, Voice of Greece	11645eu		
0600	0700	vl	Guyana, Voice of Guyana	3291do		
0600	0700		Kuwait, Radio Kuwait	15110as		
0600	0700		Malaysia, RTM/Traxx FM	7295do		
0600	0700		Malaysia, RTM/Voice of Malaysia	6175as		
			9750as	15295as		
0600	0700	vl	Nigeria, Radio Nigeria-Kaduna	4770do		
0600	0700		Nigeria, Voice of Nigeria/External Svc	15120af		
0600	0700		Palau, T8WH/World Harvest	15700as		

0600	0700		Papua New Guinea, Wantok R. Light	7325do	
0600	0700		Russia, Voice of Russia	17635pa	
0600	0700		South Africa, Channel Africa	7230af	15255af
0600	0700		UK, BBC World Service	3995eu	6005af
			6190af	9410af	9860af
			12015af	12095as	15310as
			17790as		
0600	0700	Sat/Sun	UK, BBC World Service	15420af	
0600	0700		USA, American Forces Network		4319usb
			5446usb	5765usb	6350usb
			10320usb	12133usb	12759usb
					13362usb
0600	0700		USA, EWTN Vandiver AL	11520af	
0600	0700		USA, Voice of America	6080af	12080af
			15580af		
0600	0700		USA, WBOH Newport NC	5920am	
0600	0700		USA, WHRA Greenbush ME	7390af	
0600	0700		USA, WHRI Cypress Creek SC	5875va	7365na
			11565na		
0600	0700		USA, WRMI Miami FL	9955am	
0600	0700		USA, WTJC Newport NC	9370na	
0600	0700		USA, WWCR Nashville TN	3215na	5070na
			5890na	5935na	
0600	0700		USA, WWRB Manchester TN	3185va	
0600	0700		USA, WYFR/Family Radio Worldwide		5850eu
			7520sa	9680na	11530va
					11580va
0600	0700		Uzbekistan, CVC Intl-The Voice Asia	15555as	
0600	0700		Zambia CVC Intl/ The Voice Africa	13590af	6065af
0600	0700		Zambia, Zambia Natl Broadcasting Corp		6165do
0609	0613	mtwhf	Austria, Radio O1 International/ORF		6155eu
			13730eu		
0630	0645		Vatican City, Vatican Radio	4005eu	5965eu
			7250eu	9645eu	11740eu
					15595me
0630	0700		Australia, Radio Australia	9660as	11650as
			12080as	13690as	15160as
			15415as	15515as	17750va
0630	0700		Bulgaria, Radio Bulgaria	9600eu	11600eu
0630	0700		Swaziland, TWR Swaziland	6120af	
0645	0700	Sun	Germany, TWR Europe	6105eu	9800eu
0645	0700	Sun	Monaco, TWR Europe	9800eu	
0659	0700	DRM	New Zealand, Radio NZ International		7285pa
0659	0700		New Zealand, Radio NZ International		6170pa

**0700 UTC - 3AM EDT / 2AM CDT / 12AM PDT**

0700	0727		Czech Republic, Radio Prague	9880eu	11600na
0700	0727		Slovakia, R Slovakia International		9440va
			11650va		
0700	0730		France, Radio France International		13675af
0700	0730	Sun	UK, Bible Voice Broadcasting	5945eu	
0700	0745		USA, WYFR/Family Radio Worldwide		7520eu
0700	0750	smtwhf	Germany, TWR Europe	6105eu	9800eu
0700	0750	smtwhf	Monaco, TWR Europe	9800eu	
0700	0800		Anguilla, Worldwide Univ Network		6090am
0700	0800		Australia, ABC NT Alice Springs		4835do
0700	0800		Australia, ABC NT Katherine	5025do	
0700	0800		Australia, ABC NT Tennant Creek		4910do
0700	0800		Australia, Radio Australia	9475as	9660as
			9710as	11650as	11945as
			13630pa	15160va	15240pa
					17750va
0700	0800		Bahrain, Radio Bahrain	6010me	9745al
0700	0800	DRM	Belgium, TDP Radio	17755as	
0700	0800		Bhutan, Bhutan Broadcasting Svc		6035as
0700	0800		Canada, CFVP Calgary AB	6030na	
0700	0800		Canada, CKZN St John's NF	6160na	
0700	0800		Canada, CKZU Vancouver BC	6160na	
0700	0800		China, China Radio International		11880as
			11895as	13660as	13710eu
			15350as	15465as	17490eu
			17710as		17540as
0700	0800	mtwhf	Equatorial Guinea, Radio Africa # 2		15190af
0700	0800	Sat/Sun	Equatorial Guinea, Radio East Africa		15190af
0700	0800	DRM	Germany, Deutsche Welle	5790eu	9545eu
0700	0800	vl	Guyana, Voice of Guyana	3291do	
0700	0800		Kuwait, Radio Kuwait	15110as	
0700	0800	Sat	Latvia, Radio SWH 9290eu		
0700	0800		Malaysia, RTM/Traxx FM	7295do	
0700	0800		Malaysia, RTM/Voice of Malaysia		6175as
			9750as	15295as	
0700	0800		Myanmar, Myanma Radio	9731do	
0700	0800	DRM	New Zealand, Radio NZ International		7285pa
0700	0800		New Zealand, Radio NZ International		6170pa
0700	0800	vl	Nigeria, Radio Nigeria-Kaduna		4770do
0700	0800		Palau, T8WH/World Harvest	9930as	15700as
0700	0800		Papua New Guinea, Wantok R. Light		7325do
0700	0800		Russia, Voice of Russia	17635as	21790as
0700	0800		South Africa, Channel Africa	7230af	

0700	0800		Swaziland, TWR Swaziland	6120af	
0700	0800	Sat/Sun	UK, BBC World Service	15420af	
0700	0800		UK, BBC World Service	5790eu	6190af
			9860af	11760me	11765af
			15310af	15400af	15575as
			17830af		17790as
0700	0800	Sat	UK, Bible Voice Broadcasting	5945eu	
0700	0800		USA, American Forces Network		4319usb
			5446usb	5765usb	6350usb
			10320usb	12133usb	12759usb
					13362usb
0700	0800		USA, EWTN Vandiver AL	11520af	
0700	0800		USA, WBOH Newport NC	5920am	
0700	0800		USA, WHRA Greenbush ME	11565pa	
0700	0800		USA, WHRI Cypress Creek SC	7385va	7390na
			11565na		
0700	0800		USA, WRMI Miami FL	9955am	
0700	0800		USA, WTJC Newport NC	9370na	
0700	0800		USA, WWCR Nashville TN	3215na	5070na
			5890na	5935na	
0700	0800		USA, WWRB Manchester TN	3185va	
0700	0800		USA, WYFR/Family Radio Worldwide		5950na
			5985na	6915na	9385am
					9505af
0700	0800		Uzbekistan, CVC Intl-The Voice Asia		15555as
0700	0800		Zambia CVC Intl/ The Voice Africa		6065af
			13590af		
0700	0800		Zambia, Zambia Natl Broadcasting Corp		6165do
0715	0750	Sat	Germany, TWR Europe	6105eu	9800eu
0715	0750	Sat	Monaco, TWR Europe	9800eu	
0730	0800		Australia, HCJB Global	11750pa	
0745	0800	f	UK, Bible Voice Broadcasting	5945eu	

**0800 UTC - 4AM EDT / 3AM CDT / 1AM PDT**

0800	0815	Sat	UK, Bible Voice Broadcasting	5945eu	
0800	0825		Malaysia, RTM/Voice of Malaysia		6175as
			9750as	15295as	
0800	0830		Australia, ABC NT Alice Springs		4835do
0800	0830		Australia, ABC NT Katherine	5025do	
0800	0830		Australia, ABC NT Tennant Creek		4910do
0800	0830		Myanmar, Myanma Radio	9731do	
0800	0845		USA, WYFR/Family Radio Worldwide		5950na
			9385af		
0800	0900		Anguilla, Worldwide Univ Network		6090am
0800	0900		Australia, HCJB Global	11750pa	
0800	0900		Australia, Radio Australia	5995as	9475as
			9580va	9590as	9710as
			12080as	13630pa	11945pa
0800	0900		Bahrain, Radio Bahrain	6010me	9745al
0800	0900	m/DRM	Belgium, TDP Radio	6015eu	
0800	0900		Bhutan, Bhutan Broadcasting Svc		6035as
0800	0900		Canada, CFVP Calgary AB	6030na	
0800	0900		Canada, CKZN St John's NF	6160na	
0800	0900		Canada, CKZU Vancouver BC	6160na	
0800	0900		China, China Radio International		11620as
			11880as	11895as	13710eu
			15350as	15465as	15625as
			17540as		17490eu
0800	0900	mtwhf	Equatorial Guinea, Radio Africa # 2		15190af
0800	0900	Sat/Sun	Equatorial Guinea, Radio East Africa		15190af
0800	0900	DRM	Germany, Deutsche Welle	9545eu	12095as
			13810eu		
0800	0900	vl	Guyana, Voice of Guyana	3291do	
0800	0900	Sat	Italy, IRRS-Shortwave	9510va	
0800	0900		Malaysia, RTM/Traxx FM	7295do	
0800	0900	DRM	New Zealand, Radio NZ International		7285pa
0800	0900		New Zealand, Radio NZ International		6170pa
0800	0900	vl	Nigeria, Radio Nigeria-Kaduna		4770do
0800	0900		Nigeria, Voice of Nigeria/External Svc		9690af
0800	0900		Palau, T8WH/World Harvest	9930as	15700as
0800	0900		Papua New Guinea, Wantok R. Light		7325do
0800	0900	DRM	Russia, Voice of Russia	12060eu	
0800	0900		Russia, Voice of Russia	17635as	21790as
0800	0900		South Africa, Channel Africa	9625af	
0800	0900	Sun	South Africa, SA Radio League	7205af	17570af
0800	0900		South Korea, KBS World Radio		9570as
0800	0900		Swaziland, TWR Swaziland	6120af	
0800	0900		UK, BBC World Service	6190af	9860af
			11760me	15310as	15400af
			17640af	17790as	17830af
0800	0900		USA, American Forces Network		4319usb
			5446usb	5765usb	6350usb
			10320usb	12133usb	12759usb
					13362usb
0800	0900		USA, EWTN Vandiver AL	11520af	
0800	0900		USA, KNLS Anchor Point AK	7355as	
0800	0900		USA, WBOH Newport NC	5920am	
0800	0900		USA, WHRA Greenbush ME	11565pa	
0800	0900		USA, WHRI Cypress Creek SC	7385va	

0800	0900	USA, WRMI Miami FL	9955am	
0800	0900	USA, WTJC Newport NC	9370na	
0800	0900	USA, WWCR Nashville TN	3215na	5070na
		5890na	5935na	
0800	0900	USA, WWRB Manchester TN	3185va	
0800	0900	USA, WYFR/Family Radio Worldwide		5985am
		6915na		
0800	0900	Uzbekistan, CVC Intl-The Voice Asia	15555as	
0800	0900	Zambia CVC Intl/ The Voice Africa	6065af	
		13590af		
0800	0900	Zambia, Zambia Natl Broadcasting Corp	6165do	
0805	0900	thf	Guam, KTWR/TWR	15190as
0820	0900	w	Guam, KTWR/TWR	15170as
0830	0900		Australia, ABC NT Alice Springs	2310do
0830	0900		Australia, ABC NT Katherine	2485do
0830	0900		Australia, ABC NT Tennant Creek	2325do
0830	0900		Australia, CVC International	15555as
0835	0900	m	Guam, KTWR/TWR	15170as
0855	0900	mtwhf	Guam, KTWR/TWR	11840pa

**0900 UTC - 5AM EDT / 4AM CDT / 2AM PDT**

0900	0927		Czech Republic, Radio Prague	9880am	9955na
			21745af		
0900	0930		Australia, HCJB Global	11750pa	
0900	0930	mtwhf	Guam, KTWR/TWR	11840pa	
0900	0930		Japan, NHK World/ Radio Japan		9625pa
			9825pa	11815as	15590as
0900	0930		Uzbekistan, CVC Intl-The Voice Asia		15555as
0900	1000		Anguilla, Worldwide Univ Network		6090am
0900	1000		Australia, ABC NT Alice Springs		2310do
0900	1000		Australia, ABC NT Katherine		2485do
0900	1000		Australia, ABC NT Tennant Creek		2325do
0900	1000		Australia, Radio Australia	9475va	9580va
			9590va	11945as	12080as
0900	1000		Bahrain, Radio Bahrain		9745al
0900	1000	t/DRM	Belgium, TDP Radio	6015eu	
0900	1000		Canada, CFVP Calgary AB	6030na	
0900	1000		Canada, CKZN St John's NF	6160na	
0900	1000		Canada, CKZU Vancouver BC	6160na	
0900	1000		China, China Radio International		11620as
			15210va	15270eu	15350as
			17490eu	17570eu	17690va
					17750as
0900	1000	mtwhf	Equatorial Guinea, Radio Africa # 2		15190af
0900	1000	Sat/Sun	Equatorial Guinea, Radio East Africa		15190af
0900	1000	2nd Sun	Germany, Blue Star Radio	6140eu	
0900	1000	DRM	Germany, Deutsche Welle	9545eu	13810eu
0900	1000		Germany, Deutsche Welle	15340as	17705as
0900	1000	3rd Sun	Germany, European Music Radio		6140eu
0900	1000	4th Sun	Germany, Radio Gloria International		6140eu
0900	1000	vl	Guyana, Voice of Guyana	3291do	
0900	1000		Malaysia, RTM/Traxx FM		7295do
0900	1000	DRM	New Zealand, Radio NZ International		7285pa
0900	1000		New Zealand, Radio NZ International		6170pa
0900	1000	vl	Nigeria, Radio Nigeria-Kaduna		4770do
0900	1000		Nigeria, Voice of Nigeria/External Svc		9690af
0900	1000		Palau, T8WH/World Harvest	9930as	15700as
0900	1000		Papua New Guinea, Wantok R. Light		7325do
0900	1000	DRM	Russia, Voice of Russia	12060eu	
0900	1000		Russia, Voice of Russia	15470as	15610as
			21790as		
0900	1000		South Africa, Channel Africa	9625af	
0900	1000		UK, BBC World Service	6190af	6195as
			9740as	9860af	11760me
			15400af	15575as	17640af
			17790as	17830af	21470af
					21660as
0900	1000		Ukraine, Radio Ukraine International	9950eu	
0900	1000		USA, American Forces Network		4319usb
			5446usb	5765usb	6350usb
			10320usb	12133usb	12759usb
					13362usb
0900	1000		USA, EWTN Vandiver AL	11640as	
0900	1000		USA, WBOH Newport NC	5920am	
0900	1000		USA, WHRA Greenbush ME	11565pa	
0900	1000		USA, WHRI Cypress Creek SC	7385va	
0900	1000	smtwhf	USA, WHRI Cypress Creek SC	9425na	
0900	1000	Sat	USA, WHRI Cypress Creek SC	7465na	
0900	1000		USA, WRMI Miami FL	9955am	
0900	1000		USA, WTJC Newport NC	9370na	
0900	1000		USA, WWCR Nashville TN	5070na	5890na
			5935na	9985na	
0900	1000		USA, WWRB Manchester TN	3185va	
0900	1000		USA, WYFR/Family Radio Worldwide		5950na
			6915na	9755as	
0900	1000		Zambia CVC Intl/ The Voice Africa		6065af
			13590af		
0900	1000		Zambia, Zambia Natl Broadcasting Corp	6165do	
0915	0930	Sat	Guam, KTWR/TWR	11840pa	

0930	1000		Australia, CVC International	15555as	
0930	1000	Sat/Sun	Italy, IRRS-Shortwave	9510va	

**1000 UTC - 6AM EDT / 5AM CDT / 3AM PDT**

1000	1004		Pakistan, Radio Pakistan	15100as	17835as
1000	1030		Vietnam, Voice of Vietnam	9840as	12020as
1000	1057		Netherlands, R Netherlands Worldwide		11895as
			12065as	15110as	
1000	1057		North Korea, Voice of Korea	11710sa	11735as
			13650as	15180sa	
1000	1058		New Zealand, Radio NZ International		6170pa
1000	1100		Anguilla, Worldwide Univ Network		11775am
1000	1100		Australia, ABC NT Alice Springs		2310do
1000	1100		Australia, ABC NT Katherine	2485do	
1000	1100		Australia, ABC NT Tennant Creek		2325do
1000	1100		Australia, CVC International	15555as	
1000	1100		Australia, Radio Australia	9475va	9580va
			9590va	11945as	12080as
1000	1100		Bahrain, Radio Bahrain	6010me	9745al
1000	1100	w/DRM	Belgium, TDP Radio	6015eu	
1000	1100		Canada, CFVP Calgary AB	6030na	
1000	1100		Canada, CKZN St John's NF	6160na	
1000	1100		Canada, CKZU Vancouver BC	6160na	
1000	1100		China, China Radio International		6040na
			6090as	11610as	11635as
			13590as	13620as	13720as
				15350as	17490eu
1000	1100	mtwhf	Equatorial Guinea, Radio Africa # 2		15190af
1000	1100	Sat/Sun	Equatorial Guinea, Radio East Africa		15190af
1000	1100	DRM	Germany, Deutsche Welle	9545eu	13810eu
1000	1100	vl	Guyana, Voice of Guyana	3291do	
1000	1100		India, All India Radio	7270as	13695va
			15070as	15260as	15410pa
			17800pa	17895pa	17510pa
1000	1100		Indonesia, Voice of Indonesia	9525va	11785al
1000	1100	Sat/Sun	Italy, IRRS-Shortwave	9510va	
1000	1100		Malaysia, RTM/Traxx FM	7295do	
1000	1100	DRM	New Zealand, Radio NZ International		7285pa
1000	1100	vl	Nigeria, Radio Nigeria-Kaduna		4770do
1000	1100		Nigeria, Voice of Nigeria/External Svc		9690af
1000	1100		Palau, T8WH/World Harvest	9930as	15700as
1000	1100		Papua New Guinea, Wantok R. Light		7325do
1000	1100		Russia, Voice of Russia	15470as	15610as
1000	1100		Saudi Arabia, BSKSA/External Svc.		15250af
1000	1100		South Africa, Channel Africa	9625af	
1000	1100	Sat/Sun	UK, BBC World Service	15400af	17830af
1000	1100		UK, BBC World Service	6190af	6195as
			9545eu	9740as	9860af
			15310af	15575as	17640af
			17790as	21470af	21660as
1000	1100		USA, American Forces Network		4319usb
			5446usb	5765usb	6350usb
			10320usb	12133usb	12759usb
					13362usb
1000	1100		USA, EWTN Vandiver AL	11640as	
1000	1100		USA, KNLS Anchor Point AK	6890as	
1000	1100		USA, WBOH Newport NC	5920am	
1000	1100		USA, WHRA Greenbush ME	11565pa	
1000	1100		USA, WHRI Cypress Creek SC	7385va	
1000	1100		USA, WINB Red Lion PA	9265am	
1000	1100		USA, WRMI Miami FL	9955am	
1000	1100		USA, WTJC Newport NC	9370na	
1000	1100		USA, WWCR Nashville TN	5070na	5890na
			5935na	9985na	
1000	1100		USA, WWRB Manchester TN	3185va	
1000	1100		USA, WYFR/Family Radio Worldwide		5950na
			6890na	9915na	9450sa
1000	1100		Zambia CVC Intl/ The Voice Africa		6065af
			13590af		
1000	1100		Zambia, Zambia Natl Broadcasting Corp	6165do	
1015	1045	Sun	UK, Bible Voice Broadcasting	5910as	
1030	1057		Czech Republic, Radio Prague	9880eu	11665eu
1030	1100		Iran, Voice of Islamic Rep. of Iran		15600as
			17660as		
1030	1100		Mongolia, Voice of Mongolia	12085as	
1059	1100		New Zealand, Radio NZ International		9655pa

**1100 UTC - 7AM EDT / 6AM CDT / 4AM PDT**

1100	1103	mtwhf	Croatia, Voice of Croatia	6165eu	
1100	1112		Venezuela, R Nacional de Venezuela		6060ca
1100	1127		Iran, Voice of Islamic Rep. of Iran		15600as
			17660as		
1100	1130		Australia, CVC International	15555as	
1100	1130		China, China Radio International		6060as
1100	1130	DRM	Japan, NHK World/ Radio Japan		9760eu

1100	1130		Vietnam, Voice of Vietnam	7285as	
1100	1145		USA, WYFR/Family Radio Worldwide	9550am	
			9755sa		
1100	1156		Romania, R Romania International	11775af	
			15210af	15430af	17730af
1100	1158	DRM	New Zealand, Radio NZ International	7285pa	
1100	1200		Anguilla, Worldwide Univ Network	11775am	
1100	1200		Australia, ABC NT Alice Springs	2310do	
1100	1200		Australia, ABC NT Katherine	2485do	
1100	1200		Australia, ABC NT Tennant Creek	2325do	
1100	1200	DRM	Australia, Radio Australia	5995pa	
1100	1200		Australia, Radio Australia	6020va	9475as
			9560as	9580va	9590va
					11945as
					9745al
1100	1200		Bahrain, Radio Bahrain	6010me	
1100	1200	h/DRM	Belgium, TDP Radio	6015eu	
1100	1200	Sat/Sun	Canada, CBC NQ SW Service	9625na	
1100	1200		Canada, CFVP Calgary AB	6030na	
1100	1200		Canada, CKZN St John's NF	6160na	
1100	1200		Canada, CKZU Vancouver BC	6160na	
1100	1200		China, China Radio International	5955as	
			6040na	11660as	11795as
				13645as	13650eu
					13790eu
					15190af
1100	1200	mtwhf	Equatorial Guinea, Radio Africa # 2	15190af	
1100	1200	Sat/Sun	Equatorial Guinea, Radio East Africa	15190af	
1100	1200	DRM	Germany, Deutsche Welle	9545eu	13810eu
1100	1200	Sat/Sun	Italy, IRRS-Shortwave	9510va	
1100	1200		Malaysia, RTM/Traxx FM	7295do	
1100	1200		New Zealand, Radio NZ International	9655pa	
1100	1200	vl	Nigeria, Radio Nigeria-Kaduna	4770do	
1100	1200		Nigeria, Voice of Nigeria/External Svc	9690af	
1100	1200		Palau, T8WH/World Harvest	9930as	15700as
1100	1200		Papua New Guinea, Wantok R. Light	7325do	
1100	1200		Russia, Voice of Russia	12065as	15470as
1100	1200		Saudi Arabia, BSKSA/External Svc.	15250af	
1100	1200		South Africa, Channel Africa	9625af	
1100	1200		Taiwan, R Taiwan International	7445as	
			11715as		
1100	1200		UK, BBC World Service	6190af	6195as
			9740as	9860af	9545eu
					11760me
				15310as	15340as
				15400af	15575as
				17640af	17760as
				17790as	17830af
				21470af	
1100	1200		Ukraine, Radio Ukraine International	9950eu	
1100	1200		USA, American Forces Network	4319usb	
			5446usb	5765usb	6350usb
				10320usb	12133usb
				12759usb	13362usb
1100	1200		USA, EWTV Vandiver AL	11640as	
1100	1200		USA, WBOH Newport NC	5920am	
1100	1200		USA, WHRI Cypress Creek SC	7315va	7385va
1100	1200		USA, WINB Red Lion PA	9265am	
1100	1200		USA, WRMI Miami FL	9955am	
1100	1200		USA, WTJC Newport NC	9370na	
1100	1200		USA, WWCR Nashville TN	5890na	5935na
			7490na	15830na	
1100	1200		USA, WWRB Manchester TN	3185va	
1100	1200		USA, WYFR/Family Radio Worldwide	5950af	
			5985na	7730sa	9550sa
					9625sa
1100	1200		Zambia CVC Intl/ The Voice Africa	6065af	
			13590af		
1100	1200		Zambia, Zambia Natl Broadcasting Corp	6165do	
1115	1130	mtwhfa	UK, Bible Voice Broadcasting	5945as	
1115	1145	Sun	UK, Bible Voice Broadcasting	5945as	
1130	1200		Australia, CVC International	13635as	
1130	1200		Bulgaria, Radio Bulgaria	11700eu	15700eu
1130	1200		Vatican City, Vatican Radio	15565me	17765me
1130	1200		Vietnam, Voice of Vietnam	9840as	12020as

**1200 UTC - 8AM EDT / 7AM CDT / 5AM PDT**

1200	1225		Saudi Arabia, BSKSA/External Svc.	15250af	
1200	1230		China, China Radio International	11780as	
1200	1230		France, Radio France International	13640af	
			17800af	21620af	
1200	1230		Japan, NHK World/ Radio Japan	6120na	
			9625pa	9695as	9790eu
1200	1245		Australia, HCJB Global	15400as	
1200	1245		USA, WYFR/Family Radio Worldwide	5950na	
			5985na		
1200	1258		New Zealand, Radio NZ International	9655pa	
1200	1300		Anguilla, Worldwide Univ Network	11775am	
1200	1300		Australia, ABC NT Alice Springs	2310do	
1200	1300		Australia, ABC NT Katherine	2485do	
1200	1300		Australia, ABC NT Tennant Creek	2325do	
1200	1300		Australia, CVC International	13635as	
1200	1300	DRM	Australia, Radio Australia	5995va	12080pa
1200	1300		Australia, Radio Australia	6020va	9475as
			9560pa	9580va	9590va
					11945as

1200	1300		Bahrain, Radio Bahrain	6010me	9745al
1200	1300	f/DRM	Belgium, TDP Radio	6015eu	
1200	1300	Sat/Sun	Canada, CBC NQ SW Service	9625na	
1200	1300		Canada, CFVP Calgary AB	6030na	
1200	1300		Canada, CKZN St John's NF	6160na	
1200	1300		Canada, CKZU Vancouver BC	6160na	
1200	1300		China, China Radio International	5955as	
			9460as	9600as	9645as
				9760va	11660as
				11760va	11980as
				13645as	13650eu
				17490eu	
1200	1300	Sat/Sun	Equatorial Guinea, Radio East Africa	15190af	
1200	1300	DRM	Germany, Deutsche Welle	9545eu	13810eu
1200	1300	Sun	Latvia, Radio SWH 9290eu		
1200	1300	vl	Libya, LJB/Voice of Africa	17725af	21695af
1200	1300		Malaysia, RTM/Traxx FM	7295do	
1200	1300	vl	Nigeria, Radio Nigeria-Kaduna	4770do	
1200	1300		Nigeria, Voice of Nigeria/External Svc	9690af	
1200	1300		Palau, T8WH/World Harvest	9930as	12130as
1200	1300		Papua New Guinea, Wantok R. Light	7325do	
1200	1300		Poland, Polish Radio	7330eu	9525eu
1200	1300		Russia, Voice of Russia	7330as	12065as
			15470as		
1200	1300		South Korea, KBS World Radio	9650na	
1200	1300	DRM	Taiwan, R Taiwan International	9850va	
1200	1300		UK, BBC World Service	5875as	6190af
			6195as	9545eu	9740as
				11750as	11760me
				17640af	17790as
				17830af	21470af
1200	1300		USA, American Forces Network	4319usb	
			5446usb	5765usb	6350usb
				10320usb	12133usb
				12759usb	13362usb
1200	1300		USA, EWTV Vandiver AL	11530as	
1200	1300		USA, KNLS Anchor Point AK	7355as	9780as
1200	1300		USA, Voice of America	6140va	7575va
			9510va	9760va	12075va
1200	1300		USA, WBOH Newport NC	5920am	
1200	1300		USA, WHRI Cypress Creek SC	7315va	7385va
1200	1300		USA, WINB Red Lion PA	9265am	
1200	1300		USA, WRMI Miami FL	9955am	
1200	1300		USA, WTJC Newport NC	9370na	
1200	1300		USA, WWCR Nashville TN	7490na	9980na
			13845na	15830na	
1200	1300		USA, WWRB Manchester TN	9385va	
1200	1300		USA, WYFR/Family Radio Worldwide	17555am	
			17795na		
1200	1300		Zambia CVC Intl/ The Voice Africa	6065af	
			13590af		
1200	1300		Zambia, Zambia Natl Broadcasting Corp	6165do	
1209	1213	mtwhf	Austria, Radio O1 International/ORF	17715va	
1230	1300		Bangladesh, Bangla Betar	7250as	
1230	1300	mtwhf	Ethiopia, Radio Ethiopia/National Svc	5990do	
			7110do	9704do	
1230	1300		Thailand, Radio Thailand World Svc	9890va	
1230	1300		Turkey, Voice of Turkey	15420eu	15520as
1230	1300		Vietnam, Voice of Vietnam	9840as	12020as
1245	1300	smtwhf	Australia, HCJB Global	15400as	

**1300 UTC - 9AM EDT / 8AM CDT / 6AM PDT**

1300	1325		Turkey, Voice of Turkey	15450eu	15520as
1300	1327		Czech Republic, Radio Prague	13580af	17540af
1300	1330		Egypt, Radio Cairo	17835as	
1300	1357		North Korea, Voice of Korea	9335na	11710na
			13760eu	15245eu	
1300	1400		Anguilla, Worldwide Univ Network	11775am	
1300	1400		Australia, ABC NT Alice Springs	2310do	
1300	1400		Australia, ABC NT Katherine	2485do	
1300	1400		Australia, CVC International	13635as	
1300	1400	DRM	Australia, Radio Australia	5995va	12080pa
1300	1400		Australia, Radio Australia	6020va	9560as
			9580va	9590va	
1300	1400		Bahrain, Radio Bahrain	6010me	9745al
1300	1400	a/DRM	Belgium, TDP Radio	6015eu	
1300	1400	Sat/Sun	Canada, CBC NQ SW Service	9625na	
1300	1400		Canada, CFVP Calgary AB	6030na	
1300	1400		Canada, CKZN St John's NF	6160na	
1300	1400		Canada, CKZU Vancouver BC	6160na	
1300	1400		China, China Radio International	5995as	
			9570na	9650na	9730as
				9870as	11660as
				11980as	13610eu
				13755as	13790eu
				15260na	
1300	1400	Sat/Sun	Equatorial Guinea, Radio East Africa	15190af	
1300	1400		Indonesia, Voice of Indonesia	9525va	11785al
1300	1400	vl	Libya, LJB/Voice of Africa	17725af	21695af
1300	1400		Malaysia, RTM/Traxx FM	7295do	
1300	1400		New Zealand, Radio NZ International	6170pa	

1300	1400	vi	Nigeria, Radio Nigeria-Kaduna	4770do	
1300	1400		Nigeria, Voice of Nigeria/External Svc	9690af	
1300	1400		Palau, T8WH/World Harvest	9930as	
1300	1400		Papua New Guinea, Wantok R. Light	7325do	
1300	1400		Russia, Voice of Russia	7330as	12065as
1300	1400		South Korea, KBS World Radio		9570na
			9770as		
1300	1400		Uganda, UBC Radio	4976do	
1300	1400	DRM	UK, BBC World Service	9545eu	13810eu
1300	1400		UK, BBC World Service	5875as	6190af
			6195as	9545eu	9740as
			9740as	9860af	
			11760me	15310as	15420af
			15420af	15575as	
			17640af	17790as	17830af
			17830af	21470af	
1300	1400		USA, American Forces Network		4319usb
			5446usb	5765usb	6350usb
			6350usb	7812usb	
			10320usb	12133usb	12759usb
			12759usb	13362usb	
1300	1400		USA, EWTV Vandiver AL	11530as	
1300	1400		USA, KJES Vado NM	11715na	
1300	1400		USA, Voice of America	7575va	9340va
			9510va	9760va	
1300	1400		USA, WBOH Newport NC	5920am	
1300	1400	Sat/Sun	USA, WHRA Greenbush ME	15195va	
1300	1400		USA, WHRI Cypress Creek SC	7315va	
1300	1400	Sat/Sun	USA, WHRI Cypress Creek SC	9840va	
1300	1400		USA, WINB Red Lion PA	9265am	
1300	1400		USA, WRMI Miami FL	9955am	
1300	1400		USA, WTJC Newport NC	9370na	
1300	1400		USA, WWCN Nashville TN	7490na	9980na
			13845na	15830na	
1300	1400		USA, WWRB Manchester TN	9385va	
1300	1400		USA, WYFR/Family Radio Worldwide		11830am
			11865na	11910na	13810as
			13810as	17795na	
1300	1400		Zambia CVC Intl/ The Voice Africa		6065af
			13590af		
1300	1400		Zambia, Zambia Natl Broadcasting Corp	6165do	
1305	1400	Sun	Greece, Voice of Greece	9420va	15630va
1310	1340		Japan, NHK World/ Radio Japan		11985as
1330	1357	fa/DRM	Czech Republic, Radio Prague	9850eu	
1330	1400	mtwhf	Guam, KSDA/ AWR	15275as	
1330	1400	ha	Guam, KSDA/ AWR	11880as	
1330	1400		India, All India Radio	9690as	11620as
			13710as		
1330	1400		Laos, Lao National Radio	7145as	
1330	1400		Sweden, Radio Sweden	15735va	
1330	1400		Vietnam, Voice of Vietnam	9840as	12020as

**1400 UTC - 10AM EDT / 9AM CDT / 7AM PDT**

1400	1427		Czech Republic, Radio Prague	9955na	
1400	1430		Australia, Radio Australia	5995va	6080va
			7240va	9590va	
1400	1430		China, China Radio International		7325as
1400	1430	Sun	Germany, Pan American BC	15205as	
1400	1430		Japan, NHK World/ Radio Japan		11705as
			11985as	13630eu	21560af
1400	1430		Thailand, Radio Thailand World Svc		9455va
1400	1430	Sun	United Arab Emirates, FEBA	12025as	
1400	1457		Netherlands, R Netherlands Worldwide		5825as
			7530as	9345as	11835as
			11835as	15815as	
1400	1500		Anguilla, Worldwide Univ Network		11775am
1400	1500		Australia, ABC NT Alice Springs		2310do
1400	1500		Australia, ABC NT Katherine	2485do	
1400	1500		Australia, ABC NT Tennant Creek		2325do
1400	1500		Australia, CVC International	13635as	
1400	1500		Australia, HCJB Global	15425as	
1400	1500		Bahrain, Radio Bahrain	6010me	9745al
1400	1500	s/DRM	Belgium, TDP Radio	6015eu	
1400	1500		Bhutan, Bhutan Broadcasting Svc		6035as
1400	1500	Sat/Sun	Canada, CBC NQ SW Service	9625na	
1400	1500		Canada, CFVP Calgary AB	6030na	
1400	1500		Canada, CKZN St John's NF	6160na	
1400	1500		Canada, CKZU Vancouver BC	6160na	
1400	1500		China, China Radio International		5955as
			9870as	11675as	11765as
			11765as	13740na	
			13710eu	13790eu	
1400	1500	Sat/Sun	Equatorial Guinea, Radio East Africa	15190af	
1400	1500		Germany, CVC Intl-Christian Vision		17770af
1400	1500	DRM	Germany, Deutsche Welle	english	5790eu
1400	1500		Germany, Overcomer Ministries		6110eu
			13810as		
1400	1500		India, All India Radio	9690as	11620as
			13710as		
1400	1500	vi	Libya, LJB/Voice of Africa	17725af	21695af
1400	1500		Malaysia, RTM/Traxx FM	7295do	
1400	1500		New Zealand, Radio NZ International		6170pa
1400	1500	vi	Nigeria, Radio Nigeria-Kaduna	4770do	
1400	1500		Nigeria, Voice of Nigeria/External Svc	9690af	

1400	1500		Oman, Radio Oman		15140va
1400	1500		Palau, T8WH/World Harvest	9930as	9965as
1400	1500		Papua New Guinea, Wantok R. Light		7325do
1400	1500	DRM	Russia, Voice of Russia	9445as	9750eu
1400	1500		Russia, Voice of Russia	6045as	7330as
			9850as	15605as	
1400	1500		South Africa, Channel Africa	9625af	
1400	1500		Uganda, UBC Radio	4976do	
1400	1500	DRM	UK, BBC World Service	9545eu	15780eu
1400	1500		UK, BBC World Service	5875as	6190af
			6195as	9545eu	9740as
			9740as	9860af	
			11920as	12095as	15310as
			12095as	15310as	17640af
			17830af	21470af	
1400	1500	Sat/Sun	UK, Bible Voice Broadcasting		17805as
1400	1500		USA, American Forces Network		4319usb
			5446usb	5765usb	6350usb
			6350usb	7812usb	
			10320usb	12133usb	12759usb
			12759usb	13362usb	
1400	1500		USA, EWTV Vandiver AL	11530as	
1400	1500		USA, KJES Vado NM	11715na	
1400	1500		USA, KNLS Anchor Point AK	7355as	
1400	1500		USA, Voice of America	4930af	6080af
			7575va	9760va	11715va
			11715va	13750af	
			15580af	17585af	
1400	1500		USA, WBOH Newport NC	5920am	
1400	1500	Sat/Sun	USA, WHRA Greenbush ME	15195va	
1400	1500	Sat/Sun	USA, WHRI Cypress Creek SC	9840va	
1400	1500		USA, WINB Red Lion PA	13570am	
1400	1500		USA, WRMI Miami FL	9955am	
1400	1500		USA, WTJC Newport NC	9370na	
1400	1500		USA, WWCN Nashville TN	7490na	9980na
			13845na	15830na	
1400	1500		USA, WWRB Manchester TN	9385va	
1400	1500		USA, WYFR/Family Radio Worldwide		9365as
			9615as	9865as	11725as
			11725as	13810as	
1400	1500		Zambia CVC Intl/ The Voice Africa		6065af
			13590af		
1400	1500		Zambia, Zambia Natl Broadcasting Corp	6165do	
1415	1430		Nepal, Radio Nepal	5005as	
1415	1439	mtwhfa	Germany, Pan American BC	15205as	
1415	1450		Guam, KTW/TWR	9975as	
1430	1445	Sun	Germany, Pan American BC	15205as	
1430	1500	mtwhfa	Albania, Radio Tirana	13625na	
1430	1500		Australia, Radio Australia	5995va	6080va
			7240va	9475as	9590va
			9590va	11660pa	
1430	1500		China, Central People's BS/CNR		6010do
			7350do	9480do	
1430	1500	DRM	South Korea, KBS World Radio		9660eu
1430	1500		Sweden, Radio Sweden		13820va

**1500 UTC - 11AM EDT / 10AM CDT / 8AM PDT**

1500	1510	mtwhfa	Turkmenistan, Turkmen Radio	5015eu	
1500	1515	Sun	UK, Bible Voice Broadcasting	15680as	
1500	1525	Sun	China, Voice of the Strait	9505as	
1500	1530		Australia, HCJB Global	15425as	
1500	1530		China, China Radio International		9600as
1500	1530		Guam, KSDA/ AWR	11720as	
1500	1530		UK, BBC World Service	7385af	11860af
			15420af		
1500	1530	Sat	UK, Bible Voice Broadcasting	15295as	
1500	1530		UK, Sudan Radio Service	17745af	
1500	1530		Vietnam, Voice of Vietnam	7285va	9840va
			12020va		
1500	1545		USA, WYFR/Family Radio Worldwide		15770sa
1500	1550		New Zealand, Radio NZ International		6170pa
1500	1557		North Korea, Voice of Korea	9335na	11710na
			13760eu	15245eu	
1500	1600		Anguilla, Worldwide Univ Network		11775am
1500	1600		Australia, ABC NT Alice Springs		2310do
1500	1600		Australia, ABC NT Katherine	2485do	
1500	1600		Australia, CVC International	11730as	
1500	1600		Australia, Radio Australia	5995va	6080va
			7240va	9475as	9590va
			9590va	11660pa	
1500	1600		Bahrain, Radio Bahrain	6010me	9745al
1500	1600	DRM	Belgium, TDP Radio	6015eu	
1500	1600	Sat/Sun	Canada, CBC NQ SW Service	9625na	
1500	1600		Canada, CFVP Calgary AB	6030na	
1500	1600		Canada, CKZN St John's NF	6160na	
1500	1600		Canada, CKZU Vancouver BC	6160na	
1500	1600	DRM	Canada, Radio Canada International		9800na
1500	1600		Canada, Radio Canada International		11675va
			17720va		
1500	1600		China, China Radio International		5955as
			6095as	7160as	7325as
			7325as	7405as	
			9720as	9800as	9870as
			9870as	11965eu	
			13640as	13740na	
1500	1600	Sat/Sun	Equatorial Guinea, Radio East Africa	15190af	



1500 1600		Germany, CVC Intl-Christian Vision	17770af	
1500 1600		Germany, Overcomer Ministries	6110eu	
		13810as	17485af	
1500 1600 vl		Libya, LJB/Voice of Africa	17725af	21695af
1500 1600		Malaysia, RTM/Traxx FM	7295do	
1500 1600		Myanmar, Myanma Radio	5985as	
1500 1600 vl		Nigeria, Radio Nigeria-Kaduna		4770do
1500 1600		Palau, T8WH/World Harvest	9965as	
1500 1600		Papua New Guinea, Wantok R. Light	7325do	
1500 1600		Russia, Voice of Russia	4975me	9625as
		9660as	9735me	9850as
		12040eu	15605as	
1500 1600		South Africa, Channel Africa	9625af	
1500 1600		Uganda, Dunamis Shortwave	4750af	
1500 1600		Uganda, UBC Radio	4976do	
1500 1600 DRM		UK, BBC World Service	5790eu	15780eu
1500 1600		UK, BBC World Service	5875as	5975as
		6190af	6195as	7230af
		9740as	11920as	12095eu
		15400af	17640af	17830af
1500 1600		USA, American Forces Network		4319usb
		5446usb	5765usb	6350usb
		10320usb	12133usb	12759usb
				13362usb
1500 1600		USA, EWTN Vandiver AL	15610eu	
1500 1600		USA, Voice of America	4930af	6080af
		7545va	7575va	9700va
		12150va	13750va	15530va
		17895af		17740va
		17895af		15580af
1500 1600		USA, Voice of America/Special	6160va	7520va
		9485va	9760va	15550va
1500 1600		USA, WBOH Newport NC	5920am	
1500 1600 Sat/Sun		USA, WHRA Greenbush ME	15195va	
1500 1600 Sat/Sun		USA, WHRI Cypress Creek SC	9840va	11785va
1500 1600		USA, WINB Red Lion PA	13570am	
1500 1600		USA, WRMI Miami FL	9955am	
1500 1600		USA, WTJC Newport NC	9370na	
1500 1600		USA, WWCR Nashville TN	7490na	9980na
		13845na	15830na	
1500 1600		USA, WWRB Manchester TN	9385va	
1500 1600		USA, WYFR/Family Radio Worldwide		11830am
		11910na	17795na	
1500 1600		Zambia CVC Intl/ The Voice Africa		6065af
		13590af		
1500 1600		Zambia, Zambia Natl Broadcasting Corp	6165do	
1505 1600		Canada, Radio Canada International	9515na	
1530 1545		India, All India Radio	7255as	9820as
		9910as		
1530 1550		Vatican City, Vatican Radio	13765as	15235as
1530 1600		Germany, AWR-Europe	15335as	
1530 1600		Iran, Voice of Islamic Rep. of Iran		7305as
		9600as	9635as	
1530 1600		Mongolia, Voice of Mongolia	9665as	
1530 1600		Sweden, Radio Sweden	13600va	
1530 1600 Sat		UK, BBC World Service	7385af	15420af
1530 1600 Sun		UK, Bible Voice Broadcasting	13590me	
1530 1600 ha		UK, Bible Voice Broadcasting	15680as	
1545 1600 mw		UK, Bible Voice Broadcasting	13590me	
1545 1600 thf		UK, Bible Voice Broadcasting	13590me	
1551 1600 DRM		New Zealand, Radio NZ International		6170pa
1551 1600		New Zealand, Radio NZ International		7285pa

**1600 UTC - 12PM EDT / 11AM CDT / 9AM PDT**

1600 1605 Sun		Croatia, Voice of Croatia	6165eu	
1600 1615 mtwhfa		Croatia, Voice of Croatia	6165eu	
1600 1615		Pakistan, Radio Pakistan	9385va	11565va
		15100as		
1600 1615		UK, Bible Voice Broadcasting	13590me	
1600 1627		Czech Republic, Radio Prague	5930eu	17845na
1600 1627		Iran, Voice of Islamic Rep. of Iran		7305as
		9600as		
1600 1630 Sun		Germany, Pan American BC	13830as	
1600 1630		Guam, KSDA/ AWR	11720as	11805as
1600 1630		Myanmar, Myanma Radio	9730do	
1600 1630		Vietnam, Voice of Vietnam	7220va	7280va
		9550va	9730va	
1600 1630		Yemen, Rep of Yemen R/Radio Sana'a		9780me
1600 1645 h		UK, Bible Voice Broadcasting	13590me	
1600 1645		USA, WYFR/Family Radio Worldwide		11830am
		11865na		
1600 1657		North Korea, Voice of Korea	9990va	11545va
1600 1700		Anguilla, Worldwide Univ Network		11775am
1600 1700		Australia, ABC NT Alice Springs		2310do
1600 1700		Australia, ABC NT Katherine	2485do	
1600 1700		Australia, CVC International	9680as	
1600 1700		Australia, Radio Australia	5995va	6080va

			7240as	9475va	9580va	9710as
			11660pa			
1600 1700		Bahrain, Radio Bahrain		6010me		9745al
1600 1700 Sat		Canada, CBC NQ SW Service		9625na		
1600 1700		Canada, CFVP Calgary AB		6030na		
1600 1700		Canada, CKZN St John's NF		6160na		
1600 1700		Canada, CKZU Vancouver BC		6160na		
1600 1700 DRM		Canada, Radio Canada International				9800am
1600 1700		Canada, Radio Canada International				9515na
1600 1700		China, China Radio International				6095af
		6180as	7235as	7420af		9570af
		9720af	9760as	11650eu		11900af
		11940eu	11965eu	13760eu		
1600 1700 Sat		Clandestine, Cheetah Radio		11730as		
1600 1700		Egypt, Radio Cairo		12170af		
1600 1700		Ethiopia, Radio Ethiopia/External Svc				7165af
		9560af				
1600 1700		France, Radio France International				15605af
		17605af				
1600 1700		Germany, CVC Intl-Christian Vision				17770af
1600 1700		Germany, Deutsche Welle	6170as			9485as
		9540as	15640as			
1600 1700		Malaysia, RTM/Traxx FM		7295do		
1600 1700 DRM		New Zealand, Radio NZ International				6170pa
1600 1700		New Zealand, Radio NZ International				7285pa
1600 1700 vl		Nigeria, Radio Nigeria-Kaduna				4770do
1600 1700		Palau, T8WH/World Harvest		9965as		
1600 1700		Papua New Guinea, Wantok R. Light				7325do
1600 1700		Russia, Voice of Russia		4975me		11985va
		12040af	13855af			
1600 1700		South Korea, KBS World Radio				9515eu
1600 1700		Taiwan, R Taiwan International				11550as
		13840as				
1600 1700		Uganda, Dunamis Shortwave		4750af		
1600 1700		Uganda, UBC Radio		4976do		
1600 1700 DRM		UK, BBC World Service		5790eu		11810eu
1600 1700		UK, BBC World Service		3255af		5790eu
		5975as	6190af	7385af		9625as
		11920as	12095eu	15400af		17640af
		17795af	17830af	21470af		
1600 1700 Sat		UK, BBC World Service		7385af		15420af
1600 1700 t		UK, Bible Voice Broadcasting		13590me		
1600 1700 Sun		UK, Bible Voice Broadcasting		13590me		
1600 1700		USA, American Forces Network				4319usb
		5446usb	5765usb	6350usb		7812usb
		10320usb	12133usb	12759usb		13362usb
1600 1700		USA, EWTN Vandiver AL		15610eu		
1600 1700		USA, Voice of America		4930af		6080af
		9885af	15580af	17715af		
1600 1700		USA, Voice of America/Special		12080va		13570va
		17895va				
1600 1700		USA, WBOH Newport NC		5920am		
1600 1700		USA, WHRA Greenbush ME		17520af		
1600 1700		USA, WHRI Cypress Creek SC		9840va		11785va
1600 1700		USA, WINB Red Lion PA		13570am		
1600 1700		USA, WRMI Miami FL		9955ca		
1600 1700		USA, WTJC Newport NC		9370na		
1600 1700		USA, WWCR Nashville TN		9980na		12160na
		13845na	15830na			
1600 1700		USA, WWRB Manchester TN		9385va		
1600 1700		USA, WYFR/Family Radio Worldwide				6085sa
		13695as	17795na	18980af		21455eu
		21525af				
1600 1700		Zambia CVC Intl/ The Voice Africa				6065af
		13590af				
1600 1700		Zambia, Zambia Natl Broadcasting Corp		6165do		
1615 1630		Vatican City, Vatican Radio	4005eu			5885eu
		7250eu	9645eu	15595me		
1615 1700 Sun		UK, BBC World Service		7385af		11860af
		15420af				
1630 1657		Slovakia, R Slovakia International				5920eu
		6055eu				
1630 1700		Guam, KSDA/ AWR		6190as		
1630 1700 mtwhf		UK, BBC World Service		15420af		
1630 1700 Sat		UK, BBC World Service		11860af		
1640 1650 mtwhfa		Turkmenistan, Turkmen Radio		4930eu		
1645 1700		Tajikistan, Tajik Radio		7245as		

**1700 UTC - 1PM EDT / 12PM CDT / 10AM PDT**

1700 1705 DRM		Canada, Radio Canada International		9800am		
1700 1727		Czech Republic, Radio Prague		5930eu		17485eu
1700 1730		Australia, CVC International		9680as		
1700 1730 DRM		Romania, R Romania International				7460eu
1700 1730		USA, Voice of America		6080af		9885af
		11835af	15580af			
1700 1730		Vietnam, Voice of Vietnam				9725pa

1700	1746		UK, BBC World Service	6005af	9410af
1700	1750	DRM	New Zealand, Radio NZ International		6170pa
1700	1750		New Zealand, Radio NZ International		7285pa
1700	1756		Romania, R Romania International		9535eu
			11735eu		
1700	1759	DRM	Poland, Polish Radio	7265eu	
1700	1759		Poland, Polish Radio	9790eu	
1700	1800		Anguilla, Worldwide Univ Network		11775am
1700	1800		Australia, ABC NT Alice Springs		2310do
1700	1800		Australia, ABC NT Katherine	2485do	
1700	1800		Australia, Radio Australia	5995va	6080va
			9475as	9580va	9710as
					11880as
					9745al
1700	1800		Bahrain, Radio Bahrain	6010me	
1700	1800	Sat	Canada, CBC NQ SW Service	9625na	
1700	1800		Canada, CFVP Calgary AB	6030na	
1700	1800		Canada, CKZN St John's NF	6160na	
1700	1800		Canada, CKZU Vancouver BC	6160na	
1700	1800		Canada, Radio Canada International		9515va
1700	1800	Sat/Sun	Canada, Radio Canada International		5850va
			China, China Radio International		6060as
			6090as	6140as	6145eu
			7235as	7265as	7315va
			7410as	7420as	9570af
			11900af	11940eu	13760eu
1700	1800		Egypt, Radio Cairo	12170af	
1700	1800		Equatorial Guinea, Radio Africa		7190af
			15190af		
1700	1800		Germany, CVC Intl-Christian Vision		17770af
1700	1800	DRM	Germany, Deutsche Welle	5790eu	9960eu
1700	1800		Malaysia, RTM/Traxx FM	7295do	
1700	1800	vl	Nigeria, Radio Nigeria-Kaduna		4770do
1700	1800		Nigeria, Voice of Nigeria/External Svc		15120af
1700	1800		Palau, T8WH/World Harvest	9965as	
1700	1800		Papua New Guinea, Wantok R. Light		7325do
1700	1800	DRM	Romania, R Romania International		9535eu
1700	1800		Russia, Voice of Russia	4975me	11610me
			11985af	12040af	12070af
					13855af
1700	1800		South Africa, Channel Africa	15235af	
1700	1800		Swaziland, TWR Swaziland	3200af	
1700	1800		Taiwan, R Taiwan International		15690af
1700	1800		Uganda, Dunamis Shortwave	4750af	
1700	1800		Uganda, UBC Radio	4976do	
1700	1800		UK, BBC World Service	3255af	5790eu
			5875eu	5975as	6190af
			7405af	9625as	9960eu
			13675eu	15400af	17795af
					17830af
1700	1800	smtwhf	UK, Bible Voice Broadcasting	13590me	
1700	1800	Sat	UK, Bible Voice Broadcasting	9430me	
1700	1800	Sun	UK, Bible Voice Broadcasting	13590me	
1700	1800		USA, American Forces Network		4319usb
			5446usb	5765usb	6350usb
			10320usb	12133usb	12759usb
					13362usb
1700	1800		USA, EWTN Vandiver AL	15610na	
1700	1800	Sat/Sun	USA, Voice of America	15675af	
1700	1800		USA, WBCQ Monticello ME	15420am	
1700	1800		USA, WBOH Newport NC	5920am	
1700	1800		USA, WHRA Greenbush ME	17520af	
1700	1800		USA, WHRI Cypress Creek SC	11785va	
1700	1800	smtwhf	USA, WHRI Cypress Creek SC	9840va	
1700	1800	Sat	USA, WHRI Cypress Creek SC	9495va	
1700	1800		USA, WINB Red Lion PA	13570am	
1700	1800		USA, WRMI Miami FL	9955ca	
1700	1800		USA, WTJC Newport NC	9370na	
1700	1800		USA, WWCR Nashville TN	9980na	12160na
			13845na	15830na	
1700	1800		USA, WWRB Manchester TN	9385va	
1700	1800		USA, WYFR/Family Radio Worldwide		13690na
			17795na	18980af	21455eu
1700	1800		Zambia CVC Intl/ The Voice Africa		4965af
			13590af		
1700	1800		Zambia, Zambia Natl Broadcasting Corp	6165do	
1720	1740	fas	USA, Voice of America	4930va	11605va
			15775va		
1730	1800	DRM	Bulgaria, Radio Bulgaria	9400eu	
1730	1800		Bulgaria, Radio Bulgaria	5900eu	7400eu
1730	1800	fa	UK, Bible Voice Broadcasting	13590me	
1730	1800	mtwhf	UK, Sudan Radio Service	9840af	
1730	1800		USA, Voice of America	6080af	9885af
			15580af	17895af	
1730	1800	mtwh	USA, Voice of America	4930va	11605va
			15775va		
1730	1800		Vatican City, Vatican Radio	11625af	13765af
			15570af		
1745	1800		Bangladesh, Bangla Betar	7250as	
1745	1800	DRM	India, All India Radio	9950eu	
1745	1800		India, All India Radio	7410eu	9445af
			11620eu	11935af	13605as
			17670af		15155af

1750	1800	DRM	New Zealand, Radio NZ International	7285pa
1750	1800		New Zealand, Radio NZ International	6170pa

**1800 UTC - 2PM EDT / 1PM CDT / 11AM PDT**

1800	1810	mtwfs	Zanzibar, Voice of Tanzania Zanzibar	11735do
1800	1815	Sun	UK, Bible Voice Broadcasting	13590me
1800	1830		China, China Radio International	6020eu
			7265eu	
1800	1830		South Africa, AWR Africa	3215af
			9610af	3345af
1800	1830		UK, BBC World Service	5975as
			9625as	6015as
1800	1830	Sat	UK, Bible Voice Broadcasting	13590as
1800	1830		USA, Voice of America	6080af
			15580af	9885af
1800	1830	Sat/Sun	USA, Voice of America	4930af
1800	1845	smtwhf	Swaziland, TWR Swaziland	9500af
1800	1845	Sat	UK, Bible Voice Broadcasting	6130eu
1800	1850	DRM	New Zealand, Radio NZ International	7285pa
1800	1850		New Zealand, Radio NZ International	6170pa
1800	1857		Netherlands, R Netherlands Worldwide	6020af
			15535af	
1800	1857		North Korea, Voice of Korea	13760eu
1800	1900		Anguilla, Worldwide Univ Network	11775am
1800	1900	mtwhf	Argentina, Radio Nacional RAE	9690eu
			15345eu	
1800	1900		Australia, ABC NT Alice Springs	2310do
1800	1900		Australia, ABC NT Katherine	2485do
1800	1900		Australia, Radio Australia	6080va
			9475va	9580as
				9710as
				11880as
				9745al
1800	1900		Bahrain, Radio Bahrain	6010me
1800	1900		Bangladesh, Bangla Betar	7250as
1800	1900		Canada, CFVP Calgary AB	6030na
1800	1900		Canada, CKZN St John's NF	6160na
1800	1900		Canada, CKZU Vancouver BC	6160na
1800	1900		Canada, Radio Canada International	9530af
			11765af	17735af
				17810af
1800	1900		China, China Radio International	6030eu
			9600eu	13760eu
1800	1900		Equatorial Guinea, Radio Africa	7190af
			15190af	
1800	1900		Germany, CVC Intl-Christian Vision	17770af
1800	1900	DRM	Germany, Deutsche Welle	5790eu
1800	1900	DRM	India, All India Radio	9950eu
1800	1900		India, All India Radio	7410eu
			11620eu	11935af
				13605as
				15155af
			17670af	
1800	1900	fas	Italy, IRRS-Shortwave	7290va
1800	1900		Kuwait, Radio Kuwait	11990va
1800	1900		Malaysia, RTM/Traxx FM	7295do
1800	1900	vl	Nigeria, Radio Nigeria-Kaduna	4770do
1800	1900		Nigeria, Voice of Nigeria/External Svc	15120af
1800	1900		Palau, T8WH/World Harvest	9965as
1800	1900		Papua New Guinea, Wantok R. Light	7325do
1800	1900		Russia, Voice of Russia	4975me
			12070af	12040af
1800	1900		South Korea, KBS World Radio	7275eu
1800	1900		Swaziland, TWR Swaziland	3200af
1800	1900	Sat	Swaziland, TWR Swaziland	9500af
1800	1900		Taiwan, R Taiwan International	6155eu
1800	1900		Uganda, Dunamis Shortwave	4750af
1800	1900		Uganda, UBC Radio	4976do
1800	1900		UK, BBC World Service	3255af
			5875eu	5995as
			9485as	9660eu
			13675eu	15400af
				17795af
1800	1900		USA, American Forces Network	4319usb
			5446usb	5765usb
			10320usb	12133usb
				12759usb
				13362usb
1800	1900		USA, EWTN Vandiver AL	15610na
1800	1900		USA, Voice of America	17895af
1800	1900		USA, WBCQ Monticello ME	15420am
1800	1900		USA, WBOH Newport NC	5920am
1800	1900		USA, WHRA Greenbush ME	17520af
1800	1900		USA, WHRI Cypress Creek SC	9840va
1800	1900		USA, WINB Red Lion PA	13570am
1800	1900		USA, WRMI Miami FL	9955ca
1800	1900		USA, WTJC Newport NC	9370na
1800	1900		USA, WWCR Nashville TN	9980na
			13845na	15830na
1800	1900		USA, WWRB Manchester TN	9385va
1800	1900		USA, WYFR/Family Radio Worldwide	5910eu
			6180af	7430eu
			9505af	9770af
				11875af
				13830af
				17795af
				17845af
				18930af
				18940af
1800	1900		Yemen, Rep of Yemen R/Radio Sana'a	9780me

1800	1900	Zambia CVC Intl/ The Voice Africa	4965af
		13590af	
1800	1900	Zambia, Zambia Natl Broadcasting Corp	6165do
1805	1810	Sat Croatia, Voice of Croatia	6165eu
1805	1815	mtwhf Croatia, Voice of Croatia	6165eu
1810	1820	f USA, Voice of America	4930va 11605va
		15775va	
1815	1845	Sun UK, Bible Voice Broadcasting	9430me
1830	1845	Rwanda, Radio Rwanda	6055do
1830	1857	Slovakia, R Slovakia International	5920eu
		6055eu	
1830	1858	Serbia, International Radio of Serbia	6100eu
1830	1900	Turkey, Voice of Turkey	9785eu
1830	1900	UK, BBC World Service	6005af 9410af
1830	1900	f UK, Bible Voice Broadcasting	9430me
1830	1900	USA, Voice of America	4930af 6080af
		9885af 15580af	17895af
1845	1900	mtwhfa Albania, Radio Tirana	7435eu 13640na
1845	1900	Sun UK, Bible Voice Broadcasting	11830af
1851	1900	DRM New Zealand, Radio NZ International	9890pa

### 1900 UTC - 3PM EDT / 2PM CDT / 12PM PDT

1900	1905	Canada, Radio Canada International	9515va
1900	1925	Turkey, Voice of Turkey	9785eu
1900	1930	Germany, Deutsche Welle	6150af 11795af
		13650af 17860af	
1900	1930	Vietnam, Voice of Vietnam	7280va 9730va
1900	1935	DRM New Zealand, Radio NZ International	9890pa
1900	1945	DRM India, All India Radio	9950eu
1900	1945	India, All India Radio	7410eu 9445af
		11620eu 11935af	13605as 15155af
		17670af	
1900	1945	USA, WYFR/Family Radio Worldwide	6085sa
1900	1950	New Zealand, Radio NZ International	9615pa
1900	1955	Netherlands, R Netherlands Worldwide	9480af
		11660af 15335af	
1900	1957	North Korea, Voice of Korea	7100af 9975va
		11910af 11535va	
1900	2000	Anguilla, Worldwide Univ Network	11775am
1900	2000	Australia, ABC NT Alice Springs	2310do
1900	2000	Australia, ABC NT Katherine	2485do
1900	2000	Australia, Radio Australia	6080va 7240as
		9500va 9580va	9710as 11880as
1900	2000	Bahrain, Radio Bahrain	6010me 9745al
1900	2000	Canada, CFVP Calgary AB	6030na
1900	2000	Canada, CKZN St John's NF	6160na
1900	2000	Canada, CKZU Vancouver BC	6160na
1900	2000	China, China Radio International	7285eu
		7295va 9435va	9440va
1900	2000	Egypt, Radio Cairo	11510af
1900	2000	Equatorial Guinea, Radio Africa	7190af
		15190af	
1900	2000	Germany, CVC Intl-Christian Vision	17770af
1900	2000	DRM Germany, Deutsche Welle	3995eu 5875eu
1900	2000	Germany, Overcomer Ministries	6175eu
1900	2000	fas Italy, IRRS-Shortwave	7290va
1900	2000	Kuwait, Radio Kuwait	11990va
1900	2000	Malaysia, RTM/Traxx FM	7295do
1900	2000	vi Nigeria, Radio Nigeria-Kaduna	4770do
1900	2000	Nigeria, Voice of Nigeria/External Svc	15120af
1900	2000	Palau, T8WH/World Harvest	9965as
1900	2000	Papua New Guinea, Wantok R. Light	7325do
1900	2000	Russia, Voice of Russia	12040af
1900	2000	mtwhf Spain, Radio Exterior de Espana	9665eu
		11620af	
1900	2000	Swaziland, TWR Swaziland	3200af
1900	2000	Thailand, Radio Thailand World Svc	7570eu
1900	2000	Uganda, UBC Radio	4976do
1900	2000	UK, BBC World Service	3255af 3995eu
		5875eu 5995as	6005af 6155as
		6190af 9410af	11810af 12095af
		15400af 17795af	
1900	2000	Sun UK, Bible Voice Broadcasting	11830af
1900	2000	Ukraine, Radio Ukraine International	7490eu
1900	2000	USA, American Forces Network	4319usb
		5446usb 5765usb	6350usb 7812usb
		10320usb 12133usb	12759usb 13362usb
1900	2000	USA, EWTN Vandiver AL	15610na
1900	2000	USA, Voice of America	4930af 4940af
		6120af 9885af	15580af 17895af
			9780va
1900	2000	USA, Voice of America/Special	7480va
1900	2000	smtwhf USA, WBCQ Monticello ME	7415am
1900	2000	USA, WBOH Newport NC	5920am
1900	2000	twhf USA, WHRA Greenbush ME	9840af
1900	2000	USA, WHRI Cypress Creek SC	11785va
1900	2000	USA, WINB Red Lion PA	13570am

1900	2000	USA, WRMI Miami FL	9955ca
1900	2000	USA, WTJC Newport NC	9370na
1900	2000	USA, WWCR Nashville TN	9980na 12160na
		13845na 15830na	
1900	2000	USA, WWRB Manchester TN	9385va
1900	2000	USA, WYFR/Family Radio Worldwide	3230af
		9610af 11855as	13615am 13690af
		17795na 17845af	18930eu 18980eu
1900	2000	Zambia CVC Intl/ The Voice Africa	4965af
		5940af	
1900	2000	Zambia, Zambia Natl Broadcasting Corp	6165do
1905	1920	Sat Mali, RDTV Du Mali	5995do
1905	2000	Mon South Africa, SA Radio League	3215af
1930	2000	Sat/Sun Germany, Pan American BC	9515af
1930	2000	Iran, Voice of Islamic Rep. of Iran	5940eu
		6205eu 7205eu	9800af 9925af
1930	2000	vi South Africa, RTE Radio Worldwide	6220af
1936	1950	DRM New Zealand, Radio NZ International	9890pa
1945	2000	mtwhf UK, Bible Voice Broadcasting	11830af
1945	2000	DRM Vatican City, Vatican Radio	9800na
1950	2000	New Zealand, Radio NZ International	11725pa
1951	2000	DRM New Zealand, Radio NZ International	9890pa

### 2000 UTC - 4PM EDT / 3PM CDT / 1PM PDT

2000	2005	Mon South Africa, SA Radio League	3215af
2000	2015	Sat/Sun Germany, Pan American BC	9515af
2000	2015	mtwhf UK, Bible Voice Broadcasting	11830af
2000	2027	Czech Republic, Radio Prague	5930eu
2000	2028	Iran, Voice of Islamic Rep. of Iran	5940eu
		6205eu 7205eu	9800af 9925af
2000	2030	mtwhfa Albania, Radio Tirana	7465eu 13640na
2000	2030	Egypt, Radio Cairo	11510af
2000	2030	Sat Germany, Pan American BC	9515af
2000	2030	vi South Africa, RTE Radio Worldwide	6220af
2000	2030	Swaziland, TWR Swaziland	3200af
2000	2030	USA, Voice of America	4930af 4940af
		6080af 9885af	15580af 17895af
2000	2030	DRM Vatican City, Vatican Radio	9800na
2000	2030	Vatican City, Vatican Radio	7365af 9755af
		11625af	
2000	2045	USA, WYFR/Family Radio Worldwide	17750sa
2000	2050	DRM New Zealand, Radio NZ International	9890pa
2000	2050	New Zealand, Radio NZ International	11725pa
2000	2057	Netherlands, R Netherlands Worldwide	5905af
		7425af 11610af	
2000	2100	Anguilla, Worldwide Univ Network	11775am
2000	2100	Australia, ABC NT Alice Springs	2310do
2000	2100	Australia, ABC NT Katherine	2485do
2000	2100	Australia, ABC NT Tennant Creek	2325do
2000	2100	Sat/Sun Australia, Radio Australia	6080va 7240va
		12080as	
2000	2100	Australia, Radio Australia	9500va 11650as
		11660pa 11880as	
2000	2100	Bahrain, Radio Bahrain	6010me 9745al
2000	2100	Belarus, Radio Belarus	7210eu 7255as
		7390eu	
2000	2100	Canada, CFVP Calgary AB	6030na
2000	2100	Canada, CKZN St John's NF	6160na
2000	2100	Canada, CKZU Vancouver BC	6160na
2000	2100	Canada, Radio Canada International	15235va
		17735va	
2000	2100	China, China Radio International	5960eu
		5985af 7275va	7285eu 7415eu
		9600eu 11640af	13630af
2000	2100	Equatorial Guinea, Radio Africa	7190af
		15190af	
2000	2100	Germany, CVC Intl-Christian Vision	17770af
2000	2100	Germany, Deutsche Welle	6150af 11795af
		11865af 13650af	
2000	2100	Indonesia, Voice of Indonesia	9525va 11785al
2000	2100	Kuwait, Radio Kuwait	11990va
2000	2100	Malaysia, RTM/Traxx FM	7295do
2000	2100	vi Nigeria, Radio Nigeria-Kaduna	4770do
2000	2100	Nigeria, Voice of Nigeria/External Svc	15120af
2000	2100	Palau, T8WH/World Harvest	9965as
2000	2100	Papua New Guinea, Wantok R. Light	7325do
2000	2100	Russia, Voice of Russia	12040af 12070af
2000	2100	Uganda, UBC Radio	4976do
2000	2100	DRM UK, BBC World Service	3995eu 5875eu
2000	2100	UK, BBC World Service	3255af 3995eu
		5875eu 6005af	6190af 9410af
		11810af 12095af	13820af 15400af
2000	2100	USA, American Forces Network	4319usb
		5446usb 5765usb	6350usb 7812usb
		10320usb 12133usb	12759usb 13362usb
2000	2100	USA, EWTN Vandiver AL	15610me

2000	2100	USA, WBCQ Monticello ME	7415am	
2000	2100	USA, WBOH Newport NC	5920am	
2000	2100	USA, WHRA Greenbush ME	15665af	
2000	2100	mtwhf	USA, WHRI Cypress Creek SC	7520va
	Sun	USA, WHRI Cypress Creek SC	9495va	
2000	2100	USA, WHRI Cypress Creek SC	11785va	15665na
2000	2100	USA, WINB Red Lion PA	13570am	
2000	2100	USA, WRMI Miami FL	9955ca	
2000	2100	USA, WTJC Newport NC	9370na	
2000	2100	USA, WWCN Nashville TN	9980na	12160na
			13845na	15830na
2000	2100	USA, WWRB Manchester TN	9385va	
2000	2100	USA, WYFR/Family Radio Worldwide	9610af	
			13615am	17725sa
			17795na	17845af
			18980eu	
2000	2100	Zambia CVC Intl/ The Voice Africa	4965af	
			5940af	
2000	2100	Zambia, Zambia Natl Broadcasting Corp	6165do	
2000	2105	Uganda, UBC Radio	4976do	
2030	2045	Thailand, Radio Thailand World Svc	9680eu	
2030	2056	Romania, R Romania International	9690na	
			9765eu	11810eu
			11940af	
2030	2100	Cuba, Radio Havana Cuba	11760va	17660va
2030	2100	Sweden, Radio Sweden	7395va	
2030	2100	Turkey, Voice of Turkey	7205va	
2030	2100	USA, Voice of America	4930af	6080af
			7555va	9885af
			15580af	17895af
2030	2100	Vietnam, Voice of Vietnam	7220va	7280va
			9550va	9730va
2045	2100	India, All India Radio	7410eu	9445eu
			9910pa	9950eu
			11620va	11715pa
2051	2100	New Zealand, Radio NZ International	13730pa	
2051	2200	DRM	New Zealand, Radio NZ International	15720pa

**2100 UTC - 5PM EDT / 4PM CDT / 2PM PDT**

2100	2125	Turkey, Voice of Turkey	7205va	
2100	2128	Serbia, International Radio of Serbia	6100eu	
2100	2130	Australia, ABC NT Alice Springs	2310do	
2100	2130	Australia, ABC NT Alice Springs	2310do	
2100	2130	Australia, ABC NT Katherine	2485do	
2100	2130	Australia, ABC NT Tennant Creek	2325do	
2100	2130	Sat	Canada, CBC NQ SW Service	9625na
2100	2130	China, China Radio International	6135eu	
			7225eu	7415eu
			9490eu	9600eu
			11640af	13630af
2100	2130	Cuba, Radio Havana Cuba	17600va	17660va
2100	2130	Germany, TWR Europe	11955af	
2100	2130	South Korea, KBS World Radio	3955eu	
2100	2145	USA, WYFR/Family Radio Worldwide	13615am	
			13690na	17795na
			18980af	
2100	2157	North Korea, Voice of Korea	13760eu	15245eu
2100	2200	Angola, Radio Nacional de Angola	7217do	
2100	2200	Anguilla, Worldwide Univ Network	11775am	
2100	2200	Australia, Radio Australia	9500as	9660as
			11650pa	11660pa
			11695as	12080as
			13630as	15515as
2100	2200	Bahrain, Radio Bahrain	6010me	9745al
2100	2200	Belarus, Radio Belarus	7210eu	7255as
			7390eu	
2100	2200	Bulgaria, Radio Bulgaria	5900eu	7400eu
2100	2200	Canada, CFVP Calgary AB	6030na	
2100	2200	Canada, CKZN St John's NF	6160na	
2100	2200	Canada, CKZU Vancouver BC	6160na	
2100	2200	DRM	Canada, Radio Canada International	9800na
2100	2200	China, China Radio International	5990eu	
			7205af	7285eu
			7325af	
2100	2200	Equatorial Guinea, Radio Africa	7190af	
			15190af	
2100	2200	Germany, Deutsche Welle	9735af	11865af
			15205af	
2100	2200	Germany, Overcomer Ministries	6175eu	
2100	2200	vi	Guyana, Voice of Guyana	3291do
2100	2200	India, All India Radio	7410eu	9445eu
			9910pa	9950eu
			11620va	11715pa
2100	2200	Malaysia, RTM/Traxx FM	7295do	
2100	2200	New Zealand, Radio NZ International	13730pa	
2100	2200	vi	Nigeria, Radio Nigeria-Kaduna	4770do
2100	2200	Palau, T8WH/World Harvest	9965as	
2100	2200	Papua New Guinea, Wantok R. Light	7325do	
2100	2200	Russia, Voice of Russia	12070af	
2100	2200	Sat/Sun	Spain, Radio Exterior de Espana	9650eu
2100	2200	Syria, Radio Damascus	9330eu	12085as
2100	2200	DRM	UK, BBC World Service	3995eu
2100	2200	UK, BBC World Service	3255af	3915as
			5790eu	5905as
			6190af	6195as
			12095af	7410af
			9915af	

2100	2200	Ukraine, Radio Ukraine International	5840eu	
2100	2200	USA, American Forces Network	4319usb	
			5446usb	5765usb
			6350usb	7812usb
			10320usb	12133usb
			12759usb	13362usb
2100	2200	USA, EWTN Vandiver AL	15610me	
2100	2200	USA, Voice of America	6080af	7555va
			15580af	
2100	2200	USA, WBCQ Monticello ME	7415am	
2100	2200	USA, WBOH Newport NC	5920am	
2100	2200	USA, WHRA Greenbush ME	15665af	
2100	2200	USA, WHRI Cypress Creek SC	11785va	11885na
2100	2200	mtwhfa	USA, WHRI Cypress Creek SC	9690na
	Sun	USA, WHRI Cypress Creek SC	9690na	
2100	2200	USA, WINB Red Lion PA	9265am	
2100	2200	USA, WRMI Miami FL	9955ca	
2100	2200	USA, WTJC Newport NC	9370na	
2100	2200	USA, WWCN Nashville TN	7465na	9980na
			12160na	15830na
2100	2200	USA, WWRB Manchester TN	9385va	
2100	2200	USA, WYFR/Family Radio Worldwide	7430eu	
			9610af	12055af
			17845na	
2100	2200	Zambia CVC Intl/ The Voice Africa	4965af	
			5940af	
2100	2200	Zambia, Zambia Natl Broadcasting Corp	6165do	
2115	2200	Egypt, Radio Cairo6255eu		
2130	2157	Czech Republic, Radio Prague	9410na	11600na
2130	2200	Australia, ABC NT Alice Springs	4835do	
2130	2200	Australia, ABC NT Katherine	5025do	
2130	2200	mtwhfa	Canada, CBC NQ SW Service	9625na
2130	2200	China, China Radio International	6135eu	
			7225eu	7325eu
			7365eu	7415eu
			9600eu	
2130	2200	Guam, KSDA/ AWR	11850as	
2130	2200	Sweden, Radio Sweden	7395va	
2130	2228	Lithuania, Mighty KBC Radio	6055eu	

**2200 UTC - 6PM EDT / 5PM CDT / 3PM PDT**

2200	2205	Zambia, Zambia Natl Broadcasting Corp	6165do	
2200	2220	Japan, NHK World/ Radio Japan	13640pa	
2200	2230	Australia, HCJB Global	15525as	
2200	2230	India, All India Radio	7410eu	9445eu
			9910pa	9950eu
			11620va	11715pa
2200	2235	DRM	New Zealand, Radio NZ International	15720pa
2200	2235	New Zealand, Radio NZ International	13730pa	
2200	2245	Egypt, Radio Cairo6255eu		
2200	2245	USA, WYFR/Family Radio Worldwide	15770af	
			17845va	
2200	2255	Turkey, Voice of Turkey	9830va	
2200	2256	Romania, R Romania International	7440eu	
			9675eu	9790af
			11940af	
2200	2300	Anguilla, Worldwide Univ Network	6090am	
2200	2300	Australia, ABC NT Alice Springs	4835do	
2200	2300	Australia, ABC NT Katherine	5025do	
2200	2300	Australia, Radio Australia	12010va	13630pa
			15230va	15240pa
			15515as	15560pa
			17795va	
2200	2300	Bahrain, Radio Bahrain	6010me	9745al
2200	2300	smtwhf	Canada, CBC NQ SW Service	9625na
2200	2300	Canada, CFVP Calgary AB	6030na	
2200	2300	Canada, CKZN St John's NF	6160na	
2200	2300	Canada, CKZU Vancouver BC	6160na	
2200	2300	China, China Radio International	7240as	
			7350eu	7360eu
			9590as	
2200	2300	Equatorial Guinea, Radio Africa	7190af	
			15190af	
2200	2300	vi	Guyana, Voice of Guyana	3291do
2200	2300	Malaysia, RTM/Traxx FM	7295do	
2200	2300	vi	Nigeria, Radio Nigeria-Kaduna	4770do
2200	2300	Palau, T8WH/World Harvest	9965as	
2200	2300	Papua New Guinea, Wantok R. Light	7325do	
2200	2300	Russia, Voice of Russia	9890na	12040af
			12070af	
2200	2300	UK, BBC World Service	3915as	5905as
			5965as	6005af
			6195as	9440as
			9740as	9915af
			12095af	
2200	2300	USA, American Forces Network	4319usb	
			5446usb	5765usb
			6350usb	7812usb
			10320usb	12133usb
			12759usb	13362usb
2200	2300	USA, EWTN Vandiver AL	15610me	
2200	2300	USA, Voice of America	5895va	5915va
			7480va	7555va
			9415va	11955va
2200	2300	USA, WBCQ Monticello ME	5110am	7415am
2200	2300	USA, WBOH Newport NC	5920am	
2200	2300	USA, WHRA Greenbush ME	11885af	
2200	2300	USA, WHRI Cypress Creek SC	11785va	11885na
2200	2300	USA, WINB Red Lion PA	9265am	

2200	2300	USA, WRMI Miami FL	9955ca	
2200	2300	USA, WTJC Newport NC	9370na	
2200	2300	USA, WWCR Nashville TN	7465na	9980na
		12160na	13845na	
2200	2300	USA, WWRB Manchester TN	5050va	6890va
		9385va		
2200	2300	USA, WYFR/Family Radio Worldwide	5950na	
		7360sa	9835sa	11740af
				15440na
2200	2300	Zambia CVC Intl/ The Voice Africa	4965af	
2215	2230	mtwhs	Moldova, Radio PMR	9665na
2230	2257	Czech Republic, Radio Prague	7345na	9415na
2230	2300	Guam, KSDA/ AWR	15320as	
2230	2300	USA, Voice of America/Special	9570va	11705va
		15145va		
2236	2300	DRM	New Zealand, Radio NZ International	13730pa
2245	2300	India, All India Radio	9705eu	9950as
		11620as	11645as	13605as

### 2300 UTC - 7PM EDT / 6PM CDT / 4PM PDT

2300	0000	Anguilla, Worldwide Univ Network	6090am	
2300	0000	Australia, ABC NT Alice Springs	4835do	
2300	0000	Australia, ABC NT Katherine	5025do	
2300	0000	Bahrain, Radio Bahrain	6010me	9745al
2300	0000	DRM	Belgium, TDP Radio	9790na
2300	0000	Bulgaria, Radio Bulgaria	9700na	11700na
2300	0000	smtwhf	Canada, CBC NQ SW Service	9625na
2300	0000	Canada, CFVP Calgary AB	6030na	
2300	0000	Canada, CKZN St John's NF	6160na	
2300	0000	Canada, CKZU Vancouver BC	6160na	
2300	0000	China, China Radio International	5915as	
		5990na	6145na	7410na
		11690as	11790as	11840na
2300	0000	Cuba, Radio Havana Cuba	13790sa	
2300	0000	vi	Egypt, Radio Cairo	11590na
2300	0000	Guyana, Voice of Guyana	3291do	
2300	0000	India, All India Radio	9705eu	9950as
		11620as	11645as	13605as
2300	0000	DRM	Malaysia, RTM/Traxx FM	7295do
2300	0000	New Zealand, Radio NZ International	13730pa	
2300	0000	New Zealand, Radio NZ International	15720pa	
2300	0000	Papua New Guinea, Wantok R. Light	7325do	
2300	0000	Russia, Voice of Russia	9665sa	9890na
2300	0000	UK, BBC World Service	3915as	5965as
		6195as	9580as	9740as
		11850as	12010as	
2300	0000	USA, American Forces Network	4319usb	
		5446va	5765va	6350va
		10320va	12133va	12759va
				13362va
2300	0000	USA, EWTN Vandiver AL	15610me	
2300	0000	USA, Voice of America	5895va	5915va
		7480va	9415va	11955va
2300	0000	USA, WBCQ Monticello ME	5110am	7415am
2300	0000	USA, WBOH Newport NC	5920am	
2300	0000	USA, WHRA Greenbush ME	9615eu	
2300	0000	USA, WHRI Cypress Creek SC	5875na	7315va
		11785va		
2300	0000	USA, WINB Red Lion PA	9265am	
2300	0000	USA, WRMI Miami FL	9955ca	
2300	0000	USA, WTJC Newport NC	9370na	
2300	0000	USA, WWCR Nashville TN	5070na	7465na
		9980na	13845na	
2300	0000	USA, WWRB Manchester TN	5050va	6890va
		9385va		
2300	0000	USA, WYFR/Family Radio Worldwide	5950na	
		9835sa	11580na	15255as
		17750eu		15400na
2300	0000	vi	Zambia CVC Intl/ The Voice Africa	4965af
2300	2305	Nigeria, Radio Nigeria-Kaduna	4770do	
2300	2330	Australia, Radio Australia	9660as	12010pa
		12080pa	13690pa	15230va
		15560va	17795va	15240pa
2300	2330	Palau, T8WH/World Harvest	15550as	
2300	2330	USA, Voice of America/Special	9570va	13755va
		15145va		
2300	2330	Venezuela, R Nacional de Venezuela	13680ca	
		15250ca		
2300	2345	USA, WYFR/Family Radio Worldwide	11740am	
2300	2345	DRM	Vatican City, Vatican Radio	9755na
2305	0000	mtwhf	Canada, Radio Canada International	6100am
2305	0000	Sat	Greece, Voice of Greece	7475va
			3985eu	7375sa
2315	2330	Croatia, Voice of Croatia	3985eu	
2330	0000	Australia, Radio Australia	9660as	12010as
		12080as	13690as	15230va
		15560va	17750va	15415as
2330	0000	USA, Voice of America/Special	9570va	13755va
		13755va	15145va	15340va
2330	2358	Vietnam, Voice of Vietnam	9840as	12020as

### MT EXPRESS SHORTWAVE STATION RESOURCE GUIDE

Albania, Radio Tirana.....	http://rtsh.sil.at/
Angola, Radio Nacional de Angola.....	www.rna.ao/
Anguilla, Worldwide Univ Network.....	www.worldwideuniversitynetwork.com/
Argentina, Radio Nacional RAE.....	www.radi nacional.com.ar/
Australia, ABC NT Alice Springs.....	www.abc.net.au/radio/
Australia, ABC NT Katherine.....	www.abc.net.au/radio/
Australia, ABC NT Tennant Creek.....	www.abc.net.au/radio/
Australia, CVC International.....	www.christianvision.com/
Australia, HCJB Global.....	www.hcjb.org/
Australia, Radio Australia.....	www.abc.net.au/ra/
Austria, Radio O1 International/ORF.....	http://oe1.orf.at/service/international
Bahrain, Radio Bahrain.....	www.radiobahrain.net
Bangladesh, Bangla Betar.....	www.betar.org.bd/
Belarus, Radio Belarus.....	www.radiobelarus.tv.by/eng/
Belgium, TDP Radio.....	www.airtime.be/schedule.html
Bhutan, Bhutan Broadcasting Service.....	www.bbs.com.bt/
Bulgaria, Radio Bulgaria.....	www.bnr.bg/
Canada, CBC NQ SW Service.....	www.cbc.ca/north/
Canada, Radio Canada International.....	www.rcinet.ca/
China, Central People's BS/CNR.....	www.rcinet.ca/
China, China Radio International.....	www.cri.cn/
China, Voice of the Strait.....	www.vos.com.cn
Croatia, Voice of Croatia.....	www.hrt.hr/
Cuba, Radio Havana Cuba.....	www.radiohc.cu/
Czech Republic, Radio Prague.....	www.radio.cz/
Egypt, Radio Cairo.....	www.sis.gov.eg/
Ethiopia, Radio Ethiopia/External Svc.....	www.angelfire.com/biz/radioethiopia/
France, Radio France International.....	http://rfienglish.com
Germany, AWR-Europe.....	www.awr2.org/
Germany, CVC Intl-Christian Vision.....	www.christianvision.com/
Germany, Deutsche Welle.....	www.dw-world.de/
Germany, European Music Radio.....	www.emr.org.uk/
Germany, Overcomer Ministries.....	www.overcomerministry.org/
Germany, Pan American BC.....	www.radiopanam.com/
Germany, TWR Europe.....	www.twr.org
Greece, Voice of Greece.....	www.voiceofgreece.gr/
Guam, KSDA/ AWR.....	www.awr2.org/
Guam, KTWR/TWR.....	www.twr.org/
Guyana, Voice of Guyana.....	http://voiceofguyana.com/
India, All India Radio.....	www.allindiaradio.org/
Indonesia, Voice of Indonesia.....	www.voi.co.id
Iran, Voice of Islamic Rep. of Iran.....	www.irib.ir/English/
Italy, IRRS-Shortwave.....	www.nexus.org
Japan, NHK World/ Radio Japan.....	www.nhk.or.jp/english/
Kuwait, Radio Kuwait.....	www.media.gov.kw/
Laos, Lao National Radio.....	www.lnr.org.la
Latvia, Radio SWH.....	www.radioswh.lv/index.php
Libya, LJB/Voice of Africa.....	www.voiceofafrica.com.ly
Lithuania, Mighty KBC Radio.....	www.kbradio.eu
Malaysia, RTM/Traxx FM.....	www.traxx.net/index.php
Malaysia, RTM/Voice of Malaysia.....	www.rtm.gov.my
Mali, RDTV Du Mali.....	www.rtm.ml
Monaco, TWR Europe.....	www.twr.org/
Nepal, Radio Nepal.....	www.radionepal.org/
Netherlands, R Netherlands Worldwide.....	www.radioneetherlands.nl/
New Zealand, Radio NZ International.....	www.rnz.com
Nigeria, Radio Nigeria-Kaduna.....	http://radionigeriaonline.com
Nigeria, Voice of Nigeria/External Svc.....	www.voiceofnigeria.org
Oman, Radio Oman.....	www.oman-tv.gov.om
Pakistan, Radio Pakistan.....	www.radio.gov.pk
Palau, T8WH/World Harvest.....	www.whr.org/
Poland, Polish Radio.....	www.polskieradio.pl
Romania, R Romania International.....	www.rrr.ro/
Russia, Voice of Russia.....	www.ruvr.ru/
Rwanda, Radio Rwanda.....	www.orinfor.gov.rw/
Saudi Arabia, BSKSA/External Svc.....	www.saudiaradio.net/
Slovakia, R Slovakia International.....	www.rsi.sk
South Africa, AWR Africa.....	www.awr2.org/
South Africa, Channel Africa.....	www.channelafrica.org
South Africa, SA Radio League.....	www.channelafrica.org
South Africa, Trans World Radio.....	www.twr.org/
South Korea, KBS World Radio.....	http://rki.kbs.co.kr/english/
Spain, Radio Exterior de Espana.....	www.ree.rne.es/
Sri Lanka, SLBC.....	www.slbc.lk
Swaziland, TWR Swaziland.....	www.twr.org.za
Sweden, Radio Sweden.....	www.sr.se/rs/english/
Syria, Radio Damascus.....	www.rtv.gov.sy/
Taiwan, R Taiwan International.....	http://english.rii.org.tw/
Thailand, Radio Thailand World Svc.....	www.hsk9.com/
Turkey, Voice of Turkey.....	www.tit.net.tr
Uganda, Dunamis Shortwave.....	www.biblevoice.org/stations/east-africa
UK, BBC World Service.....	www.bbc.co.uk/worldservice/
UK, Bible Voice Broadcasting.....	www.biblevoice.org/
UK, Sudan Radio Service.....	www.sudanradio.org/
Ukraine, Radio Ukraine International.....	www.nrcu.gov.ua/
United Arab Emirates, FEBA.....	www.febardio.info
USA, American Forces Network.....	http://myafn.dodmedia.osd.mil/
USA, EWTN Vandiver AL.....	www.ewtn.com
USA, KNLS Anchor Point AK.....	www.knls.org/
USA, Voice of America.....	www.voanews.com/
USA, Voice of America/Special English.....	www.voanews.com/
USA, WBCQ Monticello ME.....	www.wbcq.com/
USA, WBOH Newport NC.....	www.fbncradio.com/
USA, WHRA Greenbush ME.....	www.whr.org/
USA, WHRI Cypress Creek SC.....	www.whr.org/
USA, WINB Red Lion PA.....	www.winb.com/
USA, WRMI Miami FL.....	www.wrmi.net/
USA, WRNO New Orleans LA.....	www.wrnoworldwide.org/
USA, WTJC Newport NC.....	www.wtjcradio.com/
USA, WWCR Nashville TN.....	www.wwcr.com
USA, WWRB Manchester TN.....	www.wwr.org/
USA, WYFR/Family Radio Worldwide.....	www.worldwide.familyradio.org
Uzbekistan, CVC Intl-The Voice Asia.....	www.christianvision.com/
Vatican City, Vatican Radio.....	www.vaticanradio.org
Vietnam, Voice of Vietnam.....	www.vov.org.vn
Zambia CVC Intl/ The Voice Africa.....	www.christianvision.com/
Zambia, Zambia Natl Broadcasting Corp.....	www.znbc.co.zm

# European Military HF Communications

**N**ow that fall has arrived, we should see improved east/west propagation conditions in the HF spectrum. So this month I will feature some a few of the more interesting European military HF radio networks that you might be able to monitor here in the United States. Of course, our European readers should have no problem monitoring these networks.

## ❖ United Kingdom TASCOTT

It has been a little over three years since I first reported on my *Milcom* Internet blog (<http://mt-milcom.blogspot.com/>) about a new United Kingdom military HF radio network operated under contract by VT Communications. Operating under the Defense High Frequency Communications Service (DHFCS) umbrella, this new network, known as Terrestrial Air Sea Communications (TASCOTT), replaced the old UK STCICS "Architect" HF network.

Information about this network has been hard to uncover and compile. Recently I did find some interesting background information on the VTC's own website. This new information lifts a corner of the secrecy veil to give a small peek at this interesting radio system.

Here is the VTC press release regarding opening the primary network control station (NCS) at Forest Moor in North Yorkshire:

*"The refurbished Defence High Frequency Communications Service (DHFCS) Network Control Station (NCS) is at the centre of a multi-million pound investment by VT Communications as part of a 15-year PPP (Public Private Partnership) contract valued at £220 million (\$345 million-LVH). The DHFCS contract was awarded in 2003 to modernise the HF beyond line of sight communications capability for UK armed forces and other authorised users.*

*"The contract has enhanced the quality, availability and reliability of the worldwide network of HF communications assets used by all three UK armed forces, with a programme of improved operational arrangements and new technology introduced by VT. This includes new transmitters, receivers, antennas, and an integrated control system to provide new data services offering Automatic Link Establishment (ALE), Automatic Repeat Request (ARQ) and Automatic Link Management (ALM).*

*"Admiral Rees Ward, Chief Executive of the Defence Communication Services Agency (DCSA), commented: 'The opening of the Network Control Station marks another major step towards the delivery of the new DHFCS but more importantly demonstrates the strong partnership between the MoD and VT Communications. This successful relationship helps to promote the DCSA's Vision of Industry/MoD partnering to deliver assured, integrated information services to the UK's Armed Forces.'*

*"VT Communications Managing Director Doug Umbers added, 'DHFCS has produced considerable benefits for the users by streamlining and modernising the use of HF communications for ships and aircraft and other users. The programme is a great example of industry and Government working together. Our partnership with the Defence Communications Services Agency (DCSA) and, in particular, the Strategic Terrestrial Radio Systems (STRS) Integrated Project Team has delivered one of the most advanced HF communications systems used by any military in the world.'*

*"VT has achieved significant cost savings by utilising modern technology. This has led to the rationalisation of the number of UK sites delivering the service from 14 to six, allowing the return of surplus land. Overseas, four sites provide services to both air and surface platforms. In addition, the global rationalisation programme has led to the release of approximately 200 military personnel to other higher priority duties.*

*"Under DHFCS, Terrestrial Air Sea Communications (TASCOTT) is available for use by RN, RAF and the Army. TASCOTT is a ground-air-ground, ship-shore and ground-to-ground HF radio communications service designed for NATO and National use. Previously known as STCICS, TASCOTT has its control centre at the NCS at Forest Moor with an alternative network control centre (ANCS) located at RAF Kinloss. Both the NCS and ANCS will control, transmit and receive assets around the world to provide an efficient and responsive service to the users.*

*"Combined with the introduction of new RAF and RN platform HF communications equipment supplied under separate contracts, DHFCS will take full advantage of the modern high-speed waveforms to provide rapid data throughput, eventually including HF email. ALE, ARQ and ALM techniques both simplify and speed up the process of establishing HF communication channels."*

On a RAF Cadet page on the Internet, I learned that, during a recent summer camp, they were able to communicate with one of the control stations at "RAF High Wycombe" via the TASCOTT network.

Digging a bit deeper on the VTC website I uncovered this additional information about the system:

*"... Investment includes new transmitters, receivers, antennas, and an integrated control system to provide new data services which have created substantial business benefits. As principal subcontractor and system design authority, Rockwell Collins UK implemented the system enhancements. New services introduced are NATO Broadcast and Ship Shore (BRASS), Automatic Link Establishment (ALE) and Automatic Repeat Request (ARQ) Ship-Shore data services, and voice ALE and direct access voice services. The new ALE and ARQ techniques introduced as part of the programme allow automatic optimum frequency selection to be determined and error free communication channels to be operated. Under DHFCS, Terrestrial Air Sea Communications (TASCOTT) is also available for use by Royal Navy, Royal Air Force and the Army."*

Most HF utility monitors are familiar with ALE, but may not know about Automatic Repeat Request (ARQ). The ARQ protocol used on the TASCOTT HF network is detailed in NATO STANAG 5066 standard. STANAG 5066 is a NATO wide communications protocol that enables all NATO vessels to communicate efficiently and securely with each other over high frequency links. You can learn more about this protocol at [www.isode.com/whitepapers/stanag-5066.html](http://www.isode.com/whitepapers/stanag-5066.html)

US Military aircraft are authorized to use the TASCOTT Flight Watch network. Department of Defense (DoD) aircraft can use the network to pass command and control messages; distress/emergency calls; and request for or relay of weather information. Phone patches can be made on this network by DoD aircraft to DSN numbers only.

The official primary frequencies for the TASCOTT net are listed below:

### TASCOTT Flight Watch

Note: DHFCS Forest Moor and DHFCS Kinloss are manned 24 hours.

### United Kingdom (TASCOTT)

Voice call sign: Architect

Frequencies: 4742.0 5702.0 9031.0 (ALE noted this freq) 11247.0 13257.0 18018.0 kHz

### Ascension

Voice call sign: Haven

Frequencies: 4742.0 9031.0 (ALE noted this freq) 11247.0 kHz

### Cyprus

Voice call sign: Cyprus

Frequencies: 4742.0 <Ch. 1>\* 9031.0 <Ch. 2> (ALE noted this freq) 11247.0 <Ch. 3>

\* indicates H+15 weather broadcasts when active

### Mount Pleasant (MPA) Falkland Islands

Voice call sign: Viper

Frequencies: 4742.0\*\* 11247.0\*\* kHz

\*\* indicates H+35 weather broadcasts when active

The frequencies listed below are the latest that I have compiled on the TASCOTT ALE network (based on intercepts from 2008-2009), ALE/USB mode, frequencies in kHz.

2216.0 (replaced 2217.4) 2705.0 2784.0 2794.0 3226.0 (replaced 3227.4) 3236.5 3260.0 3503.5 4166.3 (replaced 4168.5) 4232.0 4239.5 (replaced 4226.5) 4258.5

4275.5 4372.0 4706.0 5268.5 5295.0 6233.0 6251.0 (replaced 6243.0) 6416.5  
 (replaced 6425.0) 6522.0 6691.0 6703.0 6706.0 6768.5 6771.5 6873.5 6898.0  
 7535.0 7641.5 8035.0 8107.0 (replaced 8108.5) 8125.0 8165.5 8167.0 8182.0  
 (replaced 8126.4) 8192.0 8321.0 8532.5 8932.5 8980.0 9019.0 9020.0 9022.0  
 9265.0 10344.5 (replaced 10360.0) 10351.0 10477.0 10575.0 10893.5 11208.0  
 11217.0 11292.0 11514.0 12230.0 (replaced 12333.0) 12376.5 12736.0 13242.0  
 14455.0 14485.5 14508.5 (replaced 14510.0) 14818.5 16132.0 16552.0 16606.0  
 (replaced by 16553.5) 18403.0 18403.5 19427.0

E-3A 4D03C9 LX-N90451  
 E-3A 4D03CA LX-N90452  
 E-3A 4D03CB LX-N90453  
 E-3A 4D03CC LX-N90454  
 E-3A 4D03CD LX-N90455  
 E-3A 4D03CE LX-N90456  
 E-3A 4D03CF LX-N90458

Other possible TASCOMM ALE frequencies to monitor include, ALE/  
 USB mode, frequencies in kHz:

2240.0 2431.0 2840.0 3161.0 4232.0 4732.0 5080.0 5265.5 5270.0 6225.0  
 6865.0 7635.0 8119.0 8408.5 8809.0 9286.0 10168.0 10225.0 10233.5  
 10420.0 10427.0 12663.0 13077.0 13092.0 13215.0 14665.0 14728.5 14855.0  
 14968.0 16350.0 16402.0 16411.0 16535.5 18403.4 18405.0 18509.0 18840.0  
 18846.5 19464.0 20168.5 20300.0 20328.5 20430.0 20965.0

The following ALE addresses have been monitored on the TASCOMM  
 network and have been confirmed.

#### C-17 aircraft below based at RAF Brize Norton, England

ALE Address	Type	Unit	Serial	Miscellaneous Notes
200201	C-17A	99 Squadron	ZZ171:	Selcal JK-ES
200202	C-17A	99 Squadron	ZZ172:	00-0202/N172UK
200203	C-17A	99 Squadron	ZZ173:	Selcal KP-DF
200204	C-17A	99 Squadron	ZZ174:	00-0204/N714UK

#### E-3D AWACS aircraft below based at RAF Waddington, UK

ALE Address	Type	Unit	Serial
UKE301	E-3D AWACS	RAF 8 Sqn/No. 23 Sqn	ZH101
UKE302	E-3D AWACS	RAF 8 Sqn/No. 23 Sqn	ZH102
UKE303	E-3D AWACS	RAF 8 Sqn/No. 23 Sqn	ZH103
UKE304	E-3D AWACS	RAF 8 Sqn/No. 23 Sqn	ZH104
UKE305	E-3D AWACS	RAF 8 Sqn/No. 23 Sqn	ZH105
UKE306	E-3D AWACS	RAF 8 Sqn/No. 23 Sqn	ZH106
UKE307	E-3D AWACS	RAF 8 Sqn/No. 23 Sqn	ZH107

#### Ground Station

XSS TASCOMM NCS RAF Forest Moor

The following ALE addresses have not been positively identified and  
 any help with a tie-up would be appreciated.

X951Q1 XAE XAP XAS XAX XBC XBE XBX XCA XCV XDA XDB XDD XDV XEJ  
 XFT XFW XFY XGF XGG XGJ XGK XGP XGV XGX XGZ XHJ XHK XHN XHR XHZ  
 XIM XJD XJF XJH XJJ XJK XJP XJT XJV XKA XKB XKD XKK XKP XKW XKY XLE  
 XLG XOP XPK XPU XPZ XSA XSB

This is one of the more interesting military HF nets to monitor and if  
 any of my readers have an update, please drop me an email at the address in  
 the masthead.

### ❖ NATO AWACS Net

Another interesting European HF military net to monitor is the NATO  
 AWACS air-to-ground network. The net control station on this net is DHN66  
 Geilenkirchen, Germany. The AWACS aircraft normally use their Magic ##  
 callsign. Modes that have been monitored include USB, RATT, Stanag 4285,  
 ALE and ANDVT.

#### NATO AWACS frequencies and channels

Freq (kHz)	Channel
3089.0	A01
3900.0	A02
6690.0	A03
8980.0	A04
10172.0	A05
10315.0	A06
10429.0	A07
11228.0	A08
15016.0	A09
15018.0	A10
18009.0	A11

#### Aircraft assigned to various NATO AWACS squadrons

Type	S-mode Hex	Aircraft Serial	Selcal
CT-49A	4D03D3	LX-N19997	EM-FK
CT-49A	4D03D1	LX-N20199	EM-FL
E-3A	4D03C0	LX-N90442	
E-3A	4D03C1	LX-N90443	
E-3A	4D03C2	LX-N90444	
E-3A	4D03C3	LX-N90445	
E-3A	4D03C4	LX-N90446	
E-3A	4D03C5	LX-N90447	
E-3A	4D03C6	LX-N90448	
E-3A	4D03C7	LX-N90449	
E-3A	4D03C8	LX-N90450	

### ❖ German Coast Guard HF Net

The German Coast Guard (Kuestenwache) is a combination of the  
 Federal Police for Sea (Bundespolizei See) under the Ministry of Interior;  
 the German Customs Service (Zoll) under the Ministry of Finance; and the  
 Water Protection Police (Wasserschutzpolizei) of the state of Lower Saxony  
 (Niedersachsen).

The operations headquarters is located at Cuxhaven where the river Elbe  
 goes into the North Sea, in Neustadt/Holstein at the Baltic Sea shoreline for  
 Bundespolizei, and in Oldenburg.

#### Active German CG frequencies (in kHz)

Mode ALE/USB:  
 2070.5 2074.0 2151.5 2503.5 2505.0 2559.0 3200.0 3206.0 3831.0 3845.0  
 3850.0 4357.5 4537.5 4553.5 4618.0 5022.0 5208.0 5258.0 5258.5 5803.0  
 6890.0 6905.0 7597.0 8038.0 8132.0

#### ALE Addresses:

##### German Customs Service (Zoll)

ZHAM Zollkreuzer Hamburg  
 ZHEL Zollkreuzer Helgoland  
 ZHID Zollkreuzer Hiddensee  
 ZHOH Zollkreuzer Hohwacht  
 ZKNI Zollkreuzer Kniepsand  
 ZLST Zollleitstelle Cuxhaven  
 ZPRI Zollkreuzer Priwall  
 ZRUE Zollkreuzer Ruegen

##### Federal Police Sea (Bundespolizei See)

BP05 Bundespolizeischiff Rettin  
 BP21 Bundespolizeischiff Bredstedt  
 BP22 Bundespolizeischiff Neustrelitz  
 BP23 Bundespolizeischiff Bad Dübren  
 BP24 Bundespolizeischiff Bad Bramstedt  
 BP25 Bundespolizeischiff Bayreuth  
 BP26 Bundespolizeischiff Eschwege  
 BP51 Bundespolizeischiff Vogtland  
 BP52 Bundespolizeischiff Rhön  
 BP53 Bundespolizeischiff Spreewald  
 BP61 Bundespolizeischiff Prignitz  
 BP62 Bundespolizeischiff Uckermark  
 BP63 Bundespolizeischiff Altmark  
 BP64 Bundespolizeischiff Börde  
 BP65 Bundespolizeischiff Rhön 2  
 BPLEZS Bundespolizei Cuxhaven former callsign was LEZSEE

##### Water Protection Police (Wasserschutzpolizei)

NDSWSPOL Wasserschutzpolizei probably at Cuxhaven (Police Lower Saxony)  
 W03 Patrolboat of the WSPAN  
 WSPAN Wasserschutzpolizeiamt Oldenburg (Police Lower Saxony)

Thanks to Michael, DH5FAU, and the UDXF group for some of the  
 information used in this HF profile.

### ❖ North American VHF/UHF military frequencies

Last but not least, I have some interesting frequencies being used on this  
 side of the big pond to pass along. I recently discovered an official document  
 on the Internet that had a couple of interesting low band VHF frequencies  
 being used by the US National Guard in Illinois.

For those of you who live near Ottawa, Illinois, just south of IH-80,  
 here are two frequencies used by the Marseilles Training Center  
 32.325 MHz (FM) MTC Range Control Secondary  
 41.925 MHz (FM) MTC Range Control Primary

A friend of mine also passed along this set of interesting frequencies for  
 the Canadian Forces Maritime Experimental and Test Ranges, the Nanoose  
 Range.

139.500 MHz (FM) Range control secondary  
 140.525 MHz (FM) Range control primary  
 309.800 MHz Aircraft primary (sub chasers)  
 320.300 MHz Aircraft secondary

And that will do it for this month. Until next time, 73 and good hunting.

## “Translating” AM and FM

In the late 1950s, the FCC created an “FM translator” service. The idea of the service was to bring the benefits of FM to places that weren’t big enough to economically support a full-power FM station. FM translators were allowed only to rebroadcast the signals of FM stations. Since it was felt the AM service didn’t need the help; translators could not relay AM stations.

Fast forward to 2009. The absolute dominance of AM is gone. A daytime-only AM station is no longer a license to print money. If anything, it’s now a license to throw your money in the trash!

Roughly two years ago, the FCC began granting Special Temporary Authority (STA) for FM translators to rebroadcast AM stations. After granting dozens of these STAs, the Commission has finally established regular rules for the service. There are a number of restrictions, some of them expected; some of them a surprise.

Not all FM translators will be allowed to be used to relay AM stations. Only existing translators – those holding either a construction permit or an operating license as of May 1<sup>st</sup> of this year – may be used to relay an AM station. The Commission feared allowing AM stations to pursue the numerous new-translator applications currently on file would risk squeezing out LPFM. They expect to hold another LPFM window late this year; after that is complete, the FCC may review this restriction.

A translator may not be used to *extend* an AM station’s (theoretical) daytime coverage beyond what is achieved with their AM transmitter. The “60dBu contour” of the translator’s signal may not extend beyond the “2mV/m daytime contour” of the AM station (or 25 miles, if the AM station’s contour extends beyond that).

For a typical maximum-power (250 watts) FM translator with an antenna 30 meters high, the “60dBu contour” extends 7km, about 4 miles. The “2mv/m contour” of an AM station varies dramatically with frequency. As a *very* rough estimate, “2mv/m” is the area in which the AM station provides a “clean” signal on a typical car radio.

Of course, most AM stations are required to reduce power, and/or switch to directional operation, or go off the air entirely at night. There is no technical need for an FM translator to do so; the interference potential of an FM signal doesn’t increase at night.

FM translators relaying AM stations will be allowed to operate 24/7. They will be allowed to operate at night without reducing power or going directional, even if that means the FM signal extends the AM station’s nighttime coverage.

Indeed, that is much of the purpose behind allowing FM relays: allowing people who lose the AM signal at sunset to continue to listen to the station. Those AMs which go off the air completely at sunset will be able to leave their translators operating.

I would expect most AM stations to be interested in obtaining an FM relay; however, many will not be able to find a suitable translator. As you may remember last time, WDKN-1260 in Dickson, Tennessee, went silent in part because of the lack of a nighttime signal. There is an unused translator permit in Dickson, but it’s in the non-commercial band (89.1 MHz) and cannot be used to relay a commercial station like WDKN.

However, it is possible to *move* a translator (within limits) from another city. It is also possible for AM stations to buy existing translators from other parties. A translator does exist in the commercial band (98.9) in Dickson, which WDKN could use if they were able to negotiate a deal with the Kentucky religious FM station that owns the translator.

By the way, the FCC prohibition on full-power AM/FM simulcasts in large markets has since been repealed. In a number of cases, the full-power simulcasts are back – trying to maintain the huge rural coverage of the big 50,000-watt AM signals, while also reaching office workers (with their AM-killing computers) by using an FM signal.

One example is San Francisco’s “KCBS All News 740 AM & FM 106.9.” Ironically, the call letters of the FM station are actually KFRC-FM; KCBS-FM is in Los Angeles...

### ❖ Analog TV: Dead

We know analog TV is gone, but for some viewers digital TV is dead, too. Regular full-power analog TV did end as scheduled on June 12<sup>th</sup>. Most markets had at least one station providing analog “nightlight” service for two to four additional weeks. The last nightlight service

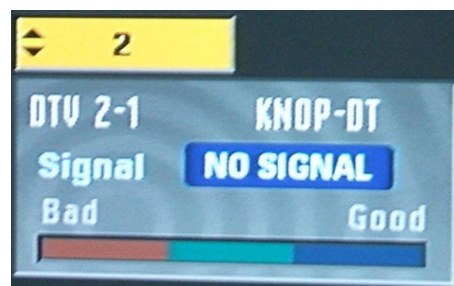

Digital TV does *not* mean the end of DX. KNOP-DT is 804 miles from the author’s setup near Nashville.

ended a few hours into July 13<sup>th</sup>.

Low-power and translator stations are allowed to continue to broadcast in analog, though a growing number of these stations are voluntarily switching to digital.

Some *very* interesting TV DX has been reported. Reports of digital TV via sporadic-E had been rare indeed. However, since mid-June, most active TV DXers have received at least one digital signal. (You can include me in that count: see the photo.) Reception of low-power analog stations via skip is even rarer, with none at all reported most years. This year, we have at least half a dozen such reports.

Local viewers, on the other hand, have not had quite as much luck with DTV. To nobody’s surprise, stations using low-band frequencies (channels 2-6) for digital operation have had serious coverage issues, especially in large cities.

Probably the best-known problems are those of WPVI channel 6 in Philadelphia. This station has obtained Special Temporary Authority to increase power to 30,200 watts – nearly four times the amount that would normally be permitted to a channel 6 digital station at that tower height in the Northeast. WRGB, on the same channel in Schenectady, New York, has requested an increase to the same power level. Due to a higher antenna, this constitutes *seven* times the power that would normally be allowed.

My local CBS affiliate WTVF channel 5 is pursuing a different route. They’ve applied for a relay station on UHF channel 50 – located on the same tower as the main channel 5 transmitter. Their goal is to use channel 5 to reach rural viewers (which seems to be working pretty well) and channel 50 to reach viewers in the city.

Many urban viewers are using indoor antennas that are subject to serious noise from various consumer-electronic devices. WTVF is also requesting a waiver of power limits: they want to operate the channel 50 transmitter at 100 kilowatts, six times the normal limit.

What has surprised many are problems with *high-band* VHF channels 7-13. Many stations flocked to this band, expecting an optimum combination of lower power requirements and low noise. Almost immediately after transition, WHDH channel 7 in Boston began receiving numerous complaints from viewers who lost their signal. They filed for Special Temporary Authority to reactivate their pre-transition digital facility on UHF channel 42. This seems to have solved their problem; WHDH has now filed to use channel 42 permanently.

Stations in New Orleans and Biloxi, Mississippi, have made similar moves, and a station in



Duluth, Minnesota, has filed for a UHF relay to operate from their channel 8 tower.

Unfortunately, this option – of returning to a pre-transition UHF digital channel – is not available to all stations. WTVF and WPVI couldn't do it, because their pre-transition UHF digital channels were "outside core" – above channel 51. Those channels simply are not TV channels anymore. Other stations never had a UHF pre-transition channel. Their original pre-transition high-VHF channel is the same one they're using post-transition.

Finally, in some cases, a station's pre-transition UHF channel is now in use by some other station. For example, Knoxville's WBIR moved from pre-transition channel 31 to post-transition channel 10; WDKY in Lexington, Kentucky promptly took over channel 31.

Reader Bob Fraser in Maine forwarded an item from the Bangor Daily News which concentrates on a different digital problem: lip sync errors. In analog TV, the picture and sound are transmitted simultaneously – so when you see a performer's lips move, you'll hear their voice at the same time. In digital, the sound and picture are transmitted alternately on the same frequency; your TV is responsible for reassembling them so you hear the voice at the same time the lips move. This doesn't always work. It's especially annoying when the sound arrives before the picture, as this condition doesn't happen in "real life."

## ❖ Canadian Notes

The CBC's CFWH-570 Whitehorse, Yukon, transmits from land leased from the territorial government. Citing the need to use the land for development, the government told the CBC the lease would not be renewed; CFWH would have to move to a new site.

Citing costs of \$700,000 to move the AM station to a new location, the CBC proposed instead to move to FM. They have an existing transmission site which hosts a Radio Two station on 104.5 and two TV transmitters; adding a second FM transmitter would be much less expensive than moving the AM.

However, listeners in outlying areas objected to the move. Their fear is that the new FM transmitter will not provide reliable service in areas covered by the AM rig.

In mid-July, the Yukon government changed their mind. They decided to offer the CBC a three-year extension to their lease. This would make the closure of the AM-570 transmitter unnecessary.

The CBC is not, however, convinced. Will the process be repeated in three years? There is a good chance the CBC will go ahead with the FM move in Whitehorse.

## ❖ Programming Weirdness

Brock Whaley wrote from Oahu with news of an interesting format change in Honolulu: KHCM-880 flipped from a country music simulcast with KHCM-FM to carrying programming from China Radio International. Most programming will be in Chinese, with occasional blocks from CRI's English service.

Ironically, KHCM is owned by Salem Media. Most of Salem's stations carry either Christian formats or stridently conservative talk. They're about

the last group one would expect to be carrying programming from a foreign country, especially an (ostensibly) Communist foreign country.

## ❖ 'Til Next Time

Are there any stations in your town broadcasting in languages besides English and Spanish? Write me at 7540 Highway 64 West, Brassstown NC 28902-0098, or by email to [dougsmith@monitoringtimes.com](mailto:dougsmith@monitoringtimes.com). Good DX!

## Antenna Designer

New Version 2.1 for Microsoft Windows 95 and 98

Computer program helps you design and build 17 different antennas from common materials. Based on Antenna Handbook by W. Clem Small.

**Only \$39.95**

\$5 S/H on all orders  
CA residents add 8.5%  
Shipped on CD ROM

Send check or money order to:

Small Planet Systems  
623 Mangels Avenue  
San Francisco, CA 94127

[www.smallplanetssystems.com](http://www.smallplanetssystems.com) 415-337-9394

## URLS IN THIS MONTH'S COLUMN

<http://americanbandscan.blogspot.com>

My DX blog.

[http://hraunfoss.fcc.gov/edocs\\_public/attachmatch/FCC-09-59A1.pdf](http://hraunfoss.fcc.gov/edocs_public/attachmatch/FCC-09-59A1.pdf)

FCC Report and Order on FM translators relaying AM stations

[www.cbc.ca/arts/story/2009/07/15/whse-cbc-tower.html](http://www.cbc.ca/arts/story/2009/07/15/whse-cbc-tower.html)

Two articles on CFWH-570 Yukon's proposed move to FM

[www.cbc.ca/arts/story/2009/07/14/abc-whse-am.html](http://www.cbc.ca/arts/story/2009/07/14/abc-whse-am.html)

<http://abclocal.go.com/wpvi/story?section=news/technology&id=6876502>

Notes from WPVI Philadelphia on problems with digital reception

## AM BANDSCAN STATION REPORT

### NEW

#### New station permits granted

Steamboat Springs, Colo.	1340	1,000/1,000 ND
Agana, Guam	1350	250/250 ND
Paradise, Nevada	1590	6,500/1,000 DA-N

(Paradise is adjacent to Las Vegas)

#### New station applications denied/dismitted

Star, Idaho	1590	
Toronto, Ontario	1480	(withdrawn)

#### Existing stations deleted:

Umatilla, Oregon	1090	KLWJ
------------------	------	------

### CHANGES:

#### Stations granted moves to new frequencies & locations

Goodlettsville, Tennessee	830	WQZQ	from 1550 in Clarksville
---------------------------	-----	------	--------------------------

(this is a Nashville suburb)

#### Callsign changes

Eagle River, Alaska	1020	KOAN	from KABA
Cortaro, Arizona	1030	KVOI	from KCEE
Tucson, Arizona	690	KCEE	from KVOI
Dover, Delaware	1600	WDPZ	from WXXY
Clayton, Georgia	1400	WGHC	from WNGA
Swainsboro, Georgia	1590	WXRS	from WRJS
Hilo, Hawaii	1060	KIPA	from KHBC
South Bend, Indiana	1490	WPNT	from WDND
South Bend, Indiana	1620	WDND	from WPNT
Garden City, Kansas	1340	KGGS	for new station
Florence, Kentucky	1160	WQRT	from WDJO
Brunswick, Maine	900	WCME	from WWBK
Newport, Maine	1230	WGUY	for new station
Richmond, Maine	1120	WZME	for new station
Silver Spring, Maryland	1050	WZAA	from WTOP
Whitehall, Michigan	1490	WKLQ	from WODJ
Sparks, Nevada	1060	KFOY	for new station
Asbury Park, New Jersey	1310	WADB	from WBUD
Albuquerque, N.M.	1550	KIVA	from KQNM
Milan, N.M.	1100	KQNM	from KIVA
Mount Holly, N. Carolina	870	WTCG	from WGHC
Cincinnati, Ohio	1480	WDJO	from WCIN
Lima, Ohio	940	WCIT	from WZOQ
Florence, Oregon	1250	KCFM	from KCST
Salem, Oregon	1390	KWOD	from KVXX
Tunkhannock, Penna.	1460	WGMF	from WEMR
Charleston, S. Carolina	1390	WSPO	from WXTC
Gaffney, S. Carolina	1500	WZZQ	from WEAC
Memphis, Tennessee	680	WMFS	from WSMB
Kilgore, Texas	1240	KDOK	from KBGE
Quanah, Texas	1150	KOLJ	from KREL

ND: non-directional

DA-N: directional at night only

DA-D: directional during daytime only

DA-2: directional all hours, two different patterns

DA-3: directional day, night and critical hours, three different patterns

## Marine VHF Winter Freeze-Up

**W**ith October approaching as you read this column, VHF radio traffic such as the one below will have significantly decreased. Pleasure craft will be lifted from the water as their season ends. Commercial traffic on the St. Lawrence Seaway has been down more than 30% this year, so there will be less radio traffic from there as well.

My scanner will be almost quiet, so you can bet that any traffic heard will be important. Even our local search and Rescue Cutter, *CCGC Cape Hearne*, will be heard less often as the traffic decreases, until they go off duty in December.

On the other hand, as the weather changes, we often get longer range VHF signals here because of atmospheric inversion. This ducting effect causes VHF signals to bend and go a long way. This summer I had one that allowed me to hear traffic from Lake Erie here in Kingston.

Again, the Environment Canada / NOAA weather frequencies are a great indicator of this phenomenon. If you are hearing weather stations other than the usual one you hear in your area, check the marine frequencies for longer range traffic. The Canadian marine weather is on channel 83B (161.775 MHz) here. If I hear the other Canadian weather channel, 21B (161.65 MHz), it is an indicator of inversion.

In October, I change my scanner settings and focus on the commercial channels. Channels such as channel 68, used for Canadian Marinas, go virtually silent. Commercial traffic control channels, which in this area are channels 11, 12, 13 and 14, often contain some interesting infor-

mation as the winter freeze-up approaches.

With one local exception for the Seaway, channel 13 is for bridge to bridge communication on commercial vessels only. Commercial ships use ship to ship channels that yachts are not allowed to use. Channels 8 and 10 are common ones here. However, channel 10 is sometimes used for traffic control as in Montreal Harbour.

I lock out the pleasure craft channels and sometime enter the commercial channels twice in the memory bank to get faster scanning. This is a good trick with older scanners, as it effectively increases the scan speed. If you are using a marine radio to scan, I delete the pleasure craft channels about mid-October.

*“Prescott Coast Guard Radio this is the Cape Hearne Zodiac. We have removed the sailing vessel Sea Biscuit from Snake Island Shoal and are escorting the vessel to Portsmouth Olympic Harbour.”*

Ships are often waiting for weather to be less severe. Channel 16 is always monitored, as any Mayday at this time of year will certainly be a major incident.

The Canadian Coastguard uses channels 82A and 65A for their internal communications with VBR Prescott Radio. The United States Coast Guard uses mainly channel 22A, but is heard on 21A, 23A, and 81A.

Channel 82A is also used by Search and Rescue aircraft when they leave CFB Trenton on missions. You can often get great range from the aircraft and it is interesting to know what missions are going on.

### ❖ VHF of Global Interest

I would remind the marine radio enthusiast and traveler that the VHF channels are used worldwide. Kriss Larson, KR6ISS, reported that on a vacation trip to Italy he heard the marine weather, on channel 68, when he was passing cities such as Rome, Palermo and Naples. He also stated that in Rome weather was also broadcast on channel 25B. Broadcasts alternated between Italian and English.

He was wondering if channel 68 was officially designated as a weather channel in Europe. I have not been able to find out, but I will keep looking. Any reader information would be greatly appreciated.

Kriss also said he had a similar experience of weather on a marine channel while touring France some years ago.

In Canada, the shore station frequency or B frequency of some duplex channels is being used for continuous broadcasts, particularly since ship to shore phone calls, via shore stations, are virtually a thing of the past. Channels 87B (161.975 MHz) and 88B (162.025 MHz) have been allocated to the AIS system as channels 1 and 2 respectively.

Even in the dead of winter here, when most navigation stops because of ice, I still leave channel 16 and some other marine channels in, as it is surprising what comes up. We have local ferries in operation and weather warnings are still broadcast.

I have seen several listings of VHF frequencies that the USCG uses that are not marine frequencies. I would appreciate knowing what our readers monitor. Frequencies mentioned range from the 139 to 171 MHz.

### ❖ Winter Monitoring

Since the weather in many areas will already be cold when you read this column, I hope everyone has done their antenna maintenance, feed line replacement, and radio repair. I know all amateurs say, with tongue in cheek, antennas work better when they are put up in January, but I, for one, do not believe it. I have had enough cold weather antenna repairs and freezing hands.

Of course, the shorter days and longer nights here affect the HF bands significantly. As we get back to Standard time and it gets dark earlier, the 2, 4 and 6 MHz bands come alive sooner and for longer. It is actually good to leave a receiver on 2182 kHz USB.

My Navtex monitoring on 518 kHz also improves in range and quantity of transmissions. I am still using a program called MultiPSK to decode Navtex etc. It is a free download and can be found by just inserting MultiPSK in Google or other search engine. The program has periodic upgrades as well.

Canadian arctic marine radio stations mentioned in previous columns will also be shutting down in October, so this will be the last chance to catch them for 6 months.



*Cape Vincent Ferry, William Darrell, with the MV Sabina in background*

## ❖ Severe Weather

This is, of course, hurricane season in the Atlantic and the Pacific. Marine weather forecasts can provide important weather information for coastal regions. The USCG broadcasts on VHF channel 22A and 2670 kHz USB. Canadian Marine stations use 2598 and 2747 kHz.

6501 kHz USB is a great weather monitoring channel for the computer voice USCG broadcasts. It is not uncommon for me to monitor as far away as Kodiak, Alaska, on 6501 kHz at night. Chesapeake, Virginia, Pt. Reyes, California, and Honolulu, Hawaii, have also been heard here.

Guam also transmits on this frequency at 0930 and 1530 UTC, but I have not heard them as yet. This is a good DX target! The complete USCG HF voice broadcast schedule can be found at [www.nws.noaa.gov/om/marine/hfvoice.htm](http://www.nws.noaa.gov/om/marine/hfvoice.htm)

The good old standby frequencies of 5696 and 8983 for the USCG and 5717 for the Canadian Military Search and Rescue Aircraft can also be very interesting.

As an amateur, there are two frequencies I always monitor. First is the Hurricane Watch Net on the 20 meter band, 14325 kHz USB. This net is activated whenever there is an active hurricane. They handle traffic and reports from the affected areas and give up-to-date reports on the storm's status, evacuation orders, storm landfalls, etc.

You can also monitor to see where health and welfare traffic is being handled and stand by in case you can handle some traffic for a person in need. Their web site of [www.hwn.org](http://www.hwn.org) has many useful maps, links, etc. for tracking hurricanes. You may even hear the Hurricane Center in Miami on this frequency.

Second is the Maritime Mobile Service Net and the Pacific Seafarers Net on 14,300 kHz USB. Weather is given every hour on the half hour by the net controller.

I can't stress enough to monitor the local amateur radio frequencies when there is severe weather in your area. Both VHF and HF area nets can be heard and are sources of up-to-date information.

## ❖ Marine Radio Historical Society

Richard Dillman, W6WAO, reports that the 25 wpm (words per minute) Morse code broadcasts from their stations are used by hobbysts for code practice. They wanted something to copy other than highly formatted weather



*Search and Rescue Cutter CCGS Cape Hearne returning to base in Kingston*

broadcasts. Thus, the KSM RTTY (radioteletype) broadcasts will be repeated on CW, giving an extended press and weather service. I am not that fast yet, but do try to copy as much as possible.

KSM is a commercial coast station but is operated entirely by volunteers. The station operates Saturdays from 1900 to 2130 UTC. KSM transmits CW on 426, 500, 4350.5, 6474, 8438.3, 12993.0, 16914 and 22445.8 kHz.

The press is transmitted at 2130 UTC. RTTY is transmitted in two modes, Baudot and FEC (forward error correction). The Baudot is at 170 cps and 45 baud, while the FEC is at 170 cps and 100 baud. Frequencies are 8433 and 12631 kHz.

This a good catch and you will find CW at about 18 wpm is used to make contact. I still feel like a dedicated shortwave listener, with my headphones on, when I try to copy KSM. You can send in QSL (verification) requests, and often K6KPH will be on the air from the Point Reyes site. You can get all their info from their website at [www.radiomarine.org](http://www.radiomarine.org) as well as in last month's feature article on KSM's "QSL Mistress," Denise Stoops.

## ❖ Lighthouses

You never know where amateur radio operators will turn up. I had the pleasure of doing some historical commentary on a charter cruise of this area with the Chesapeake Chapter of the U. S. Lighthouse Society. We visited the most notable of the local lighthouses. Since the following day was the start of amateur radio lighthouse week, I asked if there were any other amateurs aboard. KF5MU, Paul Masuy and his wife Michelle, KB3IDM introduced themselves and we had quite a chat over the course of the voyage.

One lighthouse we saw was the Main Duck Island lighthouse on eastern Lake Ontario. I found it sad to remember when this was a manned station and not a remotely controlled facility as it is now. During the manned era they could be heard on HF and VHF marine radio. They also had a 410/415 MHz UHF service with the local Coast Guard Radio Station.

The most interesting conversation I remember on this channel was the day when Queen Elizabeth II and Prince Phillip left the Royal yacht *Britannia* and had a picnic on the Main Duck Islands. The light keeper could not believe his surprise visitors and had a hard time convincing the radio operator of the visit.

As I passed I could almost hear the now silent sequenced radio beacon on 306 kHz that operated there during the navigation season and the 2 MHz AM marine radio they used to use to contact shore.

## ❖ Propagation

It has been great to see the HF propagation improve over the last few months. I have been



*MV Sabrina departing Iroquois lock of the Seaway*

hearing many more signals and stronger signals on all bands. Even 6 meters (50 MHz) has been open. I have worked Belgium on 6 meter CW. This is a sign that the DX may be good this winter and a few more marine stations may make it into my log book. I am still trying to log Australia on 8 MHz.

## ❖ Reminder!

The frequencies you listen to may have traffic on them that you cannot divulge to others without breaking the law. Of course, this does not pertain to distress calls.

Also, I have received a note, as a Marine Radio License Examiner, that the Canadian police agencies have been checking to ensure that pleasure craft operators have the proper radio license. Be sure you have the required license to operate the marine radio on your vessel.

Good DX to all the readers! The first tropical depression that could become a named storm is being tracked and I am about to monitor ZBR Bermuda on 2582 kHz.

### Marine Channels Frequency Key

Channel	Frequency (MHz)
8	156.400
10	156.500
11	156.550
12	156.600
13	156.650
16	156.800
21A	157.050
22A	157.100
23A	157.150
25B	161.850
65A	156.275
68	156.425
81A	157.075
82A	157.125

### USCG Non Marine frequencies

(partial list)  
139.975, 140.475, 140.725, 141.6125,  
150.725, 165.325

## Books by Ernest H. Robl:

*THE BASIC RAILFAN BOOK*

*UNDERSTANDING INTERMODAL*

*THE POWDER RIVER BASIN*

Detailed descriptions at

<http://www.robl.w1.com>

# Underground VLF and Uncovering Noise

**A**s I prepare this column, we are in the middle of August and conditions are not ideal for longwave work. Things are still happening on the band, however, and this month we share news from two of our readers, list sub-100 kHz loggings, and introduce a new book that should be of interest to many readers.

## ❖ 500 kHz Experimental License

First, from *The ARRL Letter*, Vol. 28, No 30, comes this exciting news on the status of the experimental work being done by the WD2XSH group near 500 kHz...

FCC Expands ARRL's 500 kHz Experimental License: On July 28, the FCC approved a modification that expands the ARRL's 500 kHz experimental license WD2XSH. According to Experiment Coordinator Fritz Raab, W1FR, the expansion allows for more frequencies, more stations and portable operations. "We can now operate between 495-510 kHz," Raab said. "We were previously limited to 505-510 kHz. We will not be using 500 kHz itself so as to ensure that there is no conflict with the heritage stations on that frequency. The expansion also gives us the opportunity to expand the number of participating stations. We can now have 42 stations, where before we were limited to 23."

Raab said that the expansion will now let participants operate within 50 km of their designated stations. This was not allowed under the previous terms of the experimental license. "Some stations have reduced operating bands to ensure that they do not interfere with nearby non-directional beacons (NDB)." The FCC's Office of Engineering and Technology granted the WD2XSH experimental license to the ARRL in September 2006 ([www.arrrl.org/news/stories/2006/09/15/104/](http://www.arrrl.org/news/stories/2006/09/15/104/)). Find out more information on the ARRL's 500 kHz Experiment in the July/August 2007 issue of QEX (<http://www.arrrl.org/qex>).

## ❖ Deep Down VLF

Kriss Larson, KR6ISS (CA) travels frequently to many parts of the world in search of natural attractions. More often than not he succeeds in finding something related to longwave radio during his travels, and we are fortunate to hear from him again this month, reporting on a destination a bit closer to home for him: New Mexico.

Kriss writes: "I went on a short trip to Carlsbad Caverns two weekends ago particularly to try cave photography in the wild caves they allow you into now, but by accident found out some interest-

ing facts about caves and low frequency radio. I talked with the Cave Resource Ranger, who said that the national park was mixed up in early Navy experiments with submarine radio in the 1950s. They set up a stretch of 4" wide copper wire strung from parachute cord in a backcountry cave called Chimney Cave, and were able to transmit directly to the White House from there on VLF to demonstrate to the President that these frequencies would penetrate ground and water. After the experiments were finished, the antenna was abandoned in the cave and the remains are still there!

"Independent of that, the Ranger also told me about the still ongoing experiments with longwave cave radio communications. Traditionally they use about 1 meter square loops you place horizontally on the ground of the cave, and use doctored SSB CB radios that transmit on around 185 kHz. You can usually penetrate about 200-300 feet of rock with such a setup."

"More recently, commercially made radios operating around 85 kHz that inject a signal with spaced electrodes have been able to go maybe 1,000 feet in rock. Supposedly at the Dayton Hamvention a section of cave radio guys have a meeting there. It would be interesting to read more about this in longwave publications.

"A British caving society has a whole section on cave radio – called Speleionics. If you go to [www.caves.org/section/commelect/spelonic.html](http://www.caves.org/section/commelect/spelonic.html), and then go to issues #19 and #20, there are explanations about doctoring CB radios to transmit around 185 kHz. A commercial cave radio maker has a web site at [www.barrabes.com/](http://www.barrabes.com/)." (*As of press time, it appears that this supplier no longer lists radio equipment, although there is a heading for "Lighting & Communication" gear. -K.C.*)

"I must say this whole underground radio thing was news to me – you never know when you will go someplace and stumble into a longwave radio activity!"

Kriss, thanks for this "spelunking" report from the field! Years ago, there was much discussion about cave radio in the LWCA's *Lowdown Journal*, but there hasn't been much written about it lately. It's good to hear that the technology is alive and well, and it shows just one more application where longwave outshines the other frequencies.

## ❖ Unplugging from the Grid

Perry Crabill, W3HQX (VA) wrote in response to our August column on Summer Survival on LW. He points out that merely turning off some devices may not be enough to eliminate interference. "For maximum interference reduction, devices such as stereos, VHS, and DVD players

with remote control features should be unplugged from 120-volt AC power outlets" Perry says. "These appliances have switching power supplies that generate harmonics especially rich in the LW band. This may also be true for certain UPS battery backup power supplies for computers."

Thanks, Perry, for this interesting information. Indeed, some modern devices are not truly "off" even when we think they are. Hunting interference can be a frustrating task, and this additional tip could help readers get to the bottom of a puzzling RFI issue.

## ❖ New Book

There are a few books out there dealing with how to identify and cure sources of Radio Frequency Interference (RFI), but little has been written about the nature of RFI, why it causes difficulty in reception, or its overall effects on radio communications. Donald J. Arndt's new book, *Demystifying Radio Frequency Interference*, is a new entry in the field, providing a historical context for RFI (both natural and man-made), and offering real-world techniques for locating RFI problems.

The book is 259 pages, softcover, and is available from Trafford Publishing for \$37.95 in the USA. For more information, including pricing in other countries, point your browser to: <http://books.trafford.com/09-0388>.

## ❖ Loggings

Our loggings this month are courtesy of Kriss Larson, KR6ISS, who, in addition to his widespread travels (see above) also enjoys tuning the band from his home area in California. On this occasion, he took his Icom IC-7000, a Palomar VLF converter, and a 50-foot random wire antenna to a local park to see what could be heard in daylight.

He notes that he hasn't heard Dixon, CA locally at 55 kHz for quite a while – years he believes, and that the station has probably left the air indefinitely.

See you next month!

**Table 1. Daytime VLF Loggings from CA**

FREQ	ID	ST/PR/ITU	CITY	Date/Time
19.8	NWC	Australia	Exmouth	7/9 2230
20.9	HPWU?	France	Le Blanc	7/9 2230
21.4	NPM	HI	Lualualei	7/9 2230
22.2	JJ12	Japan	Ebino	7/9 2230
24.0	NAA	ME	Cutler	7/9 2230
24.8	NLK	WA	Jim Creek	7/9 2230
25.2	NML	ND	La Moure	7/9 2230
40.7	NAU	PR	Aguada	7/9 2230
60.0	WWVB	CO	Ft. Collins	7/9 2230
100	-	Several	LORAN	7/9 2230

## Thirty-Four Venezuelan Radio Stations Pirates

In one of the most unusual developments in unlicensed broadcasting history, Venezuelan President Hugo Chavez has declared 34 radio stations to be pirates in Venezuela. Chavez ordered the stations to cease broadcasting by August 1, and they all complied. On July 31 these stations had been traditional licensed radio stations. But, the next day, having been declared to be pirates by Chavez, they all left the air.

Diosdado Cabello, Venezuelan Public Works Minister and also head of the Venezuelan telecommunications regulatory agency Conatel said that the reclassification of the 34 radio stations was part of an effort to "make Venezuelan media more democratic." He also said that a review of station licenses revealed that the stations did not renew their licenses in a timely fashion or that they illegally transferred the ownership of the station to different individuals without registering the ownership shift.

Both the BBC and Reuters reported that numerous radio station owners and Chavez political opponents denounced the move as an attempt to eliminate freedom of expression in Venezuela.

A complete list of the 34 stations that shut down following Chavez' order was not available at press time for *MT*. But, numerous press services reported that CNB Radio in Caracas and ten stations operated by President Nelson Belfort of the Venezuelan Broadcasting Chamber were among the stations that shut down. The Associated Press reported that Radio Barlovento on 1230 kHz in Maranda was among the newly eliminated "pirates," and that station owner Romulo Raymondi planned to appeal the closedown of the station that his father had started 45 years ago. Chavez indicated that an additional 120 stations remain under investigation for either failing to license themselves properly or for other regulatory flaws.

Numerous individuals and groups denounced the Chavez "busts" as transparent political censorship moves.

### ❖ Expanded Band

Chris Lobdell, who for many years edited the pirate column in *The Journal* of the North American Shortwave Association, reports that he heard numerous ethnic pirates in the expanded band during a recent DXpedition. He noted such programming on 1630, 1670, 1680, 1690, and 1710 kHz. Has anybody else been hearing these signals on the east coast?

### ❖ Address

You will note that as a result of technical difficulties, the e-mail address to reach *Outer*

*Limits* columnist George Zeller has changed at the top of this column. Your loggings, news, and other information about unlicensed broadcasting should now be sent to [georgez@nacs.net](mailto:georgez@nacs.net). *Monitoring Times* magazine appreciates your support.

### ❖ What We Are Hearing

*Monitoring Times* readers heard nearly three dozen different pirate radio stations this month. You can hear them, too, if you use some simple techniques. Pirate radio stations never use regularly announced schedules, but shortwave pirate broadcasting increases noticeably on weekends and major holidays. You sometimes have to tune your dial up and down through typically used pirate radio frequencies to find the stations, but more than 95% of all North American shortwave pirate broadcasts are heard on 6925 kHz, plus or minus 30 or 40 kHz.

**All Aboard-** This new one combines numbers station broadcasts with a train whistle. ([allboardradio@gmail.com](mailto:allboardradio@gmail.com))

**Barnyard Radio-** Chuck Manson adds plenty of animal noises to his rock music and political discussions. ([barnyardradio@gmail.com](mailto:barnyardradio@gmail.com))

**Brando Radio-** Little is known about this new pirate. They have featured pop music and a slogan of "The Wild One." (Unknown)

**Captain Morgan-** Audio from the old Twilight Zone TV show is inevitably mixed with their rock music productions. ([captainmorganshortwave@gmail.com](mailto:captainmorganshortwave@gmail.com))

**Cupid Radio-** This Netherlands-based Europirate has a video of their antenna, studio, and music at [www.youtube.com/watch?v=1kSXbck-Glc](http://www.youtube.com/watch?v=1kSXbck-Glc) on U-Tube. (Olddebok and [cupidradio@hotmail.com](mailto:cupidradio@hotmail.com))

**Dead Cat Radio-** Classic rock music is their normal fare, but a meowing cat and the Felix the Cat theme is part of their shows. ([cattus.mortuus@gmail.com](mailto:cattus.mortuus@gmail.com))

**KHAQQ-** This one advertised itself as a once a year annual pirate. Its purpose is a memorial to Amelia Earhart. (None known)

**KUSA-** Formerly reported mainly by west coast DXers, Less Whitehouse's rock music station is now more widely heard. Try their <http://kusaradio.com/Welcome.html> podcast. ([contact@kusaradio.com](mailto:contact@kusaradio.com))

**James Bond Radio-** They are still the only radio station in the world that exclusively programs music from the James Bond movies. (None known)

**Liquid Radio-** Techno rock dance music makes up their playlist. ([wvrbfm@gmail.com](mailto:wvrbfm@gmail.com))

**MAC Shortwave-** Paul Star and his young boy sidekick Ultra Man use the old Radio Prague interval signal as a lead-in to their rock and novelty music shows. ([macshortwave@yahoo.com](mailto:macshortwave@yahoo.com))

**Mystery Radio-** Among the best heard European pirate stations is this one on 6220 kHz. Look for it around your local sunset on weekends. ([radio6220@hotmail.com](mailto:radio6220@hotmail.com))

**Northwoods Radio-** Jack Pine Savage uses a loon call interval signal at the beginning of his rock music broadcasts "from the Great Lakes." ([northwoodsradio@yahoo.com](mailto:northwoodsradio@yahoo.com))

**Outhouse Radio-** Their rock and novelty music predates

indoor plumbing. (None, asks for reports to the FRN web site)

**Pirates Week Relay-** From time to time some pirate will relay on of Ragnar Daneskjold's excellent weekly podcast about pirate radio news. If you don't hear the relay, the podcast is still up at [www.piratesweek.info/](http://www.piratesweek.info/) on the internet. (None)

**Radio Appalachia-** Bluegrass and country music are often supplemented with the Beverly Hillbillies theme on this Moundsville, WV pirate. (None)

**Radio Casablanca-** Inspired by the movie "Casablanca," their format is 1940s big band music. ([radiocasablanca@gmail.com](mailto:radiocasablanca@gmail.com))

**Radio Free Euphoria-** Marijuana advocacy from Captain Ganja is a mix of rock music, and comedy. (Belfast)

**Radio Gaga-** Uncle Bob programs both rock music and SSTV digital pictures. ([popeonthepoint@gmail.com](mailto:popeonthepoint@gmail.com))

**Radio Marlene-** This month we see a photo of Marlene herself "from the Jersey Shore." ([radiomarlene@gmail.com](mailto:radiomarlene@gmail.com))



**Radio Mushroom-** Their classic rock format has now been broadcasting for two months. ([radiomushroom@gmail.com](mailto:radiomushroom@gmail.com))

**Radio Station XXP-** They normally play oldies rock music. ([radiostationxxp@gmail.com](mailto:radiostationxxp@gmail.com))

**Sycko Radio-** Sycko's rock music and pirate radio advocacy have been on the pirate bands for years. ([syckoradio@yahoo.com](mailto:syckoradio@yahoo.com))

**The Crystal Ship-** Rock music and leftist political commentary from The Poet normally uses odd frequencies such as 6876 kHz. He's been on the air for decades now. (Belfast)

**Thinking Man Radio-** This man normally thinks about rock music. ([Thinkingmanradio@gmail.com](mailto:Thinkingmanradio@gmail.com))

**Voice of Honor-** The rock music on this new pirate has a patriotic theme. (None known)

**Voice of KAOS-** This station laments the chaos that it sees, mainly through rock music. ([voiceofkaos@gmail.com](mailto:voiceofkaos@gmail.com))

**Voice of the Beast-** The ID sounds nasty, but they broadcast classic rock. ([voiceofthebeast@gmail.com](mailto:voiceofthebeast@gmail.com))

**Voice of the Robots-** The robots on this rock music station inform listeners that they are powerless to stop the robots as they plan their attack on Rhode Island. ([voiceoftherobots@gmail.com](mailto:voiceoftherobots@gmail.com))

**WBNY-** The Rodent Revolution is still headed by its charismatic leader Commander Bunny. (Belfast and uses [rodentrevolutionhq@yahoo.com](mailto:rodentrevolutionhq@yahoo.com))

Continued on page 61

## 10TH Month – 10 Meters

**10**Meters is a funny old band, to be sure. When it is open, you can work the world loading a wet piece of string. (Joking! But very near the truth.) When it isn't, you need to muster up all the skills of a master propagation wizard to get a signal across the street, much less around the world.

Yet, more than a few hams have made 10 Meters their band of choice and even their obsession. Even in these times of minimal sunspot activity, there are folks who ply 28,000 kHz through 29,700 kHz in search of the wonders this band has to offer.

### ❖ Something for Everyone

Maybe one of the best things about 10 Meters is that it is a place where everyone gets to play together. All hams of all classes are invited – to some portion of the spectrum, at least. Novice and Technician Plus folks have had access to some portion of the 10 Meter spectrum since 1987. However, with the dropping of the code requirement in 2007, Techs of all types have had access to 28,300 kHz through 28,500 kHz for CW, Phone and Image modes with up to 200 Watts PEP, in addition to the 28,000 kHz through 28,300 kHz swath granted under the old rules.

This makes 10 Meters a very popular spot for a new ham to get his or her feet wet in the HF spectrum. Many contests even set aside certain blocks of frequencies for Novice/Techs or award additional points or multipliers for Novice/Techs on 10 Meters.

And once you get your feet wet on 10 Meters, moving up the license structure gives you access to an additional 200 kHz or so of 10 Meter spectrum. Not too shabby!

### ❖ Propagation

Let's put on our propagation beanies for a few minutes and look at what this band has to offer.

Under *normal* circumstances (more on this in a moment) 10 Meters is a slave to the F2 layer of the Ionosphere. At times of maximum sunspots, the F2 layer is well poised to allow 10 Meters to bounce signals around the world at will. Sadly, we are some years away from those salad days. In these current times of low sunspots, the F2 layer does not want to come out and play with 10 Meters.

At the risk of raising the ghost of Billy Mays, dare I say, "But wait... There's more!" 10 Meters is a band that can come alive under conditions *other than normal*. Fun can be found by the tenacious amateur radio operator almost any time of the year, and yes, even at any time of the Solar Cycle.

The F2 layer can even do some heavy lifting during times of minimum solar activity. 10 Meters is a band that is known for transequatorial

openings. Look for this phenomenon during late afternoon and early evening.

Late spring and early summer can bring about Sporadic E propagation. Small areas of reflective ionized gas can form in the E layer of the Ionosphere. If you find one of these, you can usually bounce your signal distances well beyond what skywave conditions can offer. You never quite know when these things can pop up.

In addition to the seasonal periods mentioned above, late December and early January can be times of E Skip activity. In a word...Cool!

### ❖ Beacons

So how can you take advantage of the various openings that 10 Meters is prone to, even in these darks days of the bottom of the solar cycle? Quite easily, my friends: monitor the many 10 Meter beacons set up to help you track these wondrous phenomena. Bill Hays WJ50 keeps a great list of the dozens of beacons you can keep track of at: [www.qsl.net/wj50/bcn.htm](http://www.qsl.net/wj50/bcn.htm).

If you have a memory stack in your transmitter, or better yet, if you have a good portable HF receiver with scanning memory functions, you can set up a continuous monitoring of the 10 Meter band using Bill's list. When a call sign comes through, you know that things are likely to pick up in a particular region, at least for a short period of time. Crank up the transmitter and start calling CQ.

One of the great complaints about 10 meters is that it is often open, but nobody tosses their call out. As the Ole Perfessor used to say, "Ya gotta play to win!"

### ❖ CB Conversions

10 Meter aficionados hold the year 1977 in special esteem. That was the year that the FCC issued the current "40 channel" CB Band Plan. This put many older 23 channel CB rigs out to pasture (or better yet, on to flea market and swap meet tables).

Now any ham who knows which end of a soldering iron to hold could easily figure out that a couple of tweaked coils and maybe a substitute crystal or two would put these old CB rigs into the 10 Meter ham bands. Even today you will hear a lot of low power AM activity on 10 Meters.

This move to modify CB gear is not limited to old crystal-bound 23 channel CB sets. Folks like Steve "Melt Solder" Weber KD1JV have found ways to twiddle the chips in modern synthesized 40 channel CB rigs with great success.

A search of the internet will yield many plans



*The Maxon MCB-30 is just one of dozens of CB radios that have been modified to operate on 10 meters.*

to take CB rigs of all shapes and sizes into the 10 Meter band. You can't keep a ham down when it comes to modifying radios to suit his or her needs.

### ❖ Fun with Antennas

With a quarter wavelength of just 8 feet (give or take a few inches – do the math!), antennas dedicated to 10 Meters are small enough for just about any real estate you have to play with. Better yet, this short physical length allows you to try some more complex, multi-wire designs that can give you improved gain and directivity impossible with other HF bands.

A quick look through antenna design resources will show you many great ideas that scale down nicely to the 10 Meter band. For example, "curtain" antenna designs, popular with commercial shortwave broadcasters, require acres of land to do their work. But simple curtain designs adapt well to a modest back yard when cut for 10 Meters. And guess what: they get out just like the big boys do!

So pick up a spool or two of wire, along with a good antenna resource and have at it. There are lots of folks just waiting to hear you.

### ❖ Satellites

Amateur satellites have used 10 Meters for various functions since the earliest birds we put up for ourselves. 10 Meters is still common for various downlink functions on many satellites. PC-SAT2 (launched in 2005 and still semi-operational) has a 10 Meter digital uplink for PSK31 operation.

Again, 10 Meter antennas are relatively small and easy to build, even for satellite work. Even if you only put up a good 10 Meter dipole, you can at least monitor what is flying by in the sky.

## UNCLE SKIP'S CONTEST CALENDAR

### California QSO Party

Oct 3 1600 UTC - Oct 4 2200 UTC

### RSGB 21/28 MHz Contest

Oct 4 0700 - 1900 UTC

### 10-10 International Day Sprint

Oct 10 0100 - 2359 UTC

### FISTS Fall Sprint

Oct 10 1700 - 2100 UTC

### Pennsylvania QSO Party

Oct 10 1600 UTC - Oct 11 2200 UTC

### Illinois QSO Party

Oct 18 1700 UTC - Oct 19 0100 UTC

### CQ Worldwide DX Contest SSB

Oct 24 0000 UTC - Oct 25 2400 UTC

### 10-10 Int. Fall Contest CW and Digital

Oct 24 0001 UTC - Oct 25 2359 UTC

## ❖ FM and Repeaters

Interestingly enough, about the same time as the CB to 10 Meter conversion craze began (around 1977), commercial ham transceivers began to appear with an FM mode position for 10 meters. You have to remember that this was the high point of local 2 Meter FM repeater operation, and folks were looking for new places to play.

10 FM never took off with the fervor that 2 Meters did. I think this was due, in part, to the rapid development of the 70 Centimeter Repeaters and the advent of dual band handhelds. That said, 10 FM – both simplex operation and using repeaters – is alive and well in many parts of the country.

If your rig allows for this type of operation, tune around and see what you might find. It is an underutilized ham radio resource that could make for excellent local communications for emergency services operations.

## ❖ Contests

There are many 10 Meter specific contests out there for you to compete in and enjoy. You will find no less than three such events listed in this month's *Contest Corner*: the RSGB 21/28 MHz Contest, the 10-10 International Day Sprint, and the 10-10 Int. Fall Contest.

Also, many general HF contests offer single band competition for 10 Meters as well as the other HF bands. I have long been a big fan of the December ARRL 10 Meter Contest. I even managed to win my section in the QRP/SSB category in 2002.

Because of how propagation works on 10 Meters, it is also a very challenging band to earn single band WAS, WAC and DXCC endorsements. At the risk of repeating myself: the ease of building gain and directional antennas for this band make it easy to ramp up your station's capabilities against the "Big Guns."

## ❖ 10-10 International

So, if there is a specific area of interest in the amateur radio community, there has to be a club to support it, right? 10 Meters has a group of folks

that bring folks with a love of this band together for fun and fellowship. 10-10 International ([www.ten-ten.org/](http://www.ten-ten.org/)) is just such a group.

10 – 10 International grew out of a West Coast net to an identified membership of over 75 thousand. Joining 10-10 International gets you, among other things, a "10-10 Number" used in on the air exchanges. This number is used during various on air contests and for 10-10 International awards.

10 – 10 International runs on-the-air nets and has chapters organized around the country. You have to get a kick out of a club whose chapters have names such as "Crazy Eights," "Neanderthal Chapter," "Margarita and Martini," and "Possum Trot."

They also have their own QSL Bureau and hold a bi-annual national convention. A great bunch of folks keeping the flame alight for a great band.

## THE ARRL REPEATER DIRECTORY

38th Edition (2009-2010)

Edited by Steve Ford WB8IMY

ISBN10: 0-87259-128-x/  
ISBN13: 978-0-87259-128-8

Pocket Sized Edition \$10.95 ARRL

Order No. 1288

NOTE: Desktop Sized Edition

\$15.95 ARRL Order No. 1318

The American Radio Relay League

225 Main Street, Newington, CT

06111-1494

[www.arrl.org/shop](http://www.arrl.org/shop) 1-888-277-5289

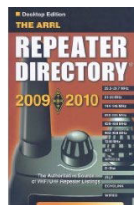

And speaking of 10 Meter FM repeaters: Accurately billed as "The Authoritative Source of VHF/UHF Repeater Listings," this kudo leaves out the fact that the ARRL's 757-page guide dips into the HF spectrum, covering 10 Meter activity

## Outer Limits continued from page 59

**WEAK Radio**- They broadcast the typical pirate format of rock music and comedy. ([weakradio@gmail.com](mailto:weakradio@gmail.com))

**WMDR**- This new "Monkey Domination Radio" pirate is an offshoot from monkey themes used at **WBNY**. (None known)

**WMPR**- Micro Power Radio is still the home of "dance party" techno rock music. (None; known to QSL occasionally only at the Kulpville Winter SWL Festival)

**YTRK**- The call letters on this new pirate stand for a slogan of "your right to know." ([ytrkradio@gmail.com](mailto:ytrkradio@gmail.com))

**Wolverine Radio**- Their rock music is often performed by relatively obscure artists. Some still report the diction of the announcer's voice as Long Range Radio. (None)

## ❖ QSLing Pirates

Reception reports to pirate stations require three first class stamps for USA maildrops or \$2 US to foreign locations. The cash defrays postage for mail forwarding and a souvenir QSL to your mailbox. Letters go to these addresses, identified above in parentheses:

PO Box 1, Belfast, NY 14711

PO Box 109, Blue Ridge Summit, PA 17214

PO Box 146, Stoneham, MA 02180

PO Box 293, Merlin, Ontario N0P 1W0.

PO Box 9, 8096 ZG, Oldebroek, Netherlands

Some pirates prefer e-mail, bulletin logs or internet web site reports instead of snail mail correspondence. The best bulletin for submitting pirate loggings is the e-mailed *Free Radio Weekly* newsletter, free to contributors via *fre-*

as mentioned in the above article. But we can overlook this minor peccadillo because of the quality and quantity of information in this book.

If you want to find your way around the repeaters in your area, or, more importantly, the repeaters when you travel outside of your area, this handy little volume fits in your glove box or arm rest compartment.

There have been many improvements to this book over the years; for example, the guide is now tabbed for easy searching by band. Also, the book now uses an icon based system to indicate "open" repeaters – very handy when entering an area where you are a stranger and sojourner.

In addition to traditional FM voice operation, the book addresses the newer digital modes, including lists of D-Star and APCO 25 systems. IRLP, WIRES-II, and Echolink nodes are listed as well.

The book now includes many helpful tables and hints, including a place to write in your transceiver memory log. (Very handy for those times when you buy a new radio or accidentally wipe the memory of your current rig.)

The League has answered the many requests of all of us hams who have entered the bifocal brigade by producing a larger type and format edition as well as the traditional pocket-sized version. You can put your magnifying glass to other uses.

Even with diligent searching of the Internet, you will be hard pressed to find this much useful information anywhere else. Well worth the cover price!

So give 10 Meters a try. I think you will be surprised, even under the current solar conditions. I'll be looking for you on the bottom end of Forty Meters (unless the 10 Meter beacons tell me to head up there for some fun!)

*eradioweekly@gmail.com*. A few pirates will sometimes QSL reports left on the outstanding Free Radio Network web site, at [www.frn.net](http://www.frn.net). *The ACE*, a formerly widely read print bulletin, now has a good loggings section and a valuable archive of *Free Radio Weekly* issues at [www.theaceonline.com/](http://www.theaceonline.com/)

## ❖ Thanks

Your loggings and news about unlicensed broadcasting stations are always welcome via 7540 Highway 64 W, Brasstown, NC 28902, or via the e-mail address atop the column. We thank this month's valuable contributors: Kirk Allen, Ponca City, OK; Skip Arey, Beverly, NJ; Dave Balint, Wooster, OH; Kirk Baxter, North Canton, OH; John T. Arthur, Belfast, NY; Jerry Berg, Lexington, MA; Artie Bingley, Columbus, OH; Wendel Craighead, Prairie View, KS; Rich D'Angelo, Wyomissing, PA; Ragnar Daneskjold, North America; Gerry Dexter, Lake Geneva, WI; Bill Finn, Philadelphia, PA; Harold Frodge, Midland, MI; Captain Ganja, Belfast, NY; William T. Hassig, Mt. Prospect, IL; Rick Helmke, Auburn, AL; Ed Kusalik, Camrose, Alberta; Chris Lobdell, Tewksbury, MA; Greg Majewski, Oakdale, CT; A. J. Michaels, Blue Ridge Summit, PA; John Poet, Belfast, NY; Mike Rhode, Columbus, OH; and Lee Silvi, Mentor, OH;

## A Noise that Improves Antenna Performance

Last month we discussed the negative effects of noise on reception and ways to lessen those effects. Electrical noise received via the antenna and internal noise generated within the receiver itself can both be detrimental to reception. Of course, when the noise level is sufficiently high, it can even totally prevent reception.

On the other hand, there is at least one piece of test gear that uses noise to help us improve antenna performance. Let's see how this seeming contradiction can actually be so.

### ❖ Noise Bridges

The piece of test gear that I refer to in the above paragraph is called a "noise bridge" (fig. 1A). By determining the reactance presented by a circuit, a noise bridge can tell us several things that are useful in antenna work. Use of a noise bridge requires a detector, which is usually the station receiver, to indicate when the bridge is balanced.

Typically, the bridge will provide a broad-spectrum noise that covers lower frequencies on through the HF band, and perhaps a bit into the VHF band. The noise bridge is connected to the antenna (or other circuit) to be tested, and to the receiver. By adjustment of the controls of the noise bridge, an antenna's reactance value, type of reactance (inductive or capacitive) and resistance can be determined at the frequency to which the receiver is tuned.

Determining an antenna's resonant frequency is a matter of finding the frequency at which the noise bridge indicates zero reactance.

Information gained with a noise bridge can be used in various ways. For instance, antennas can be adjusted to a desired resonant frequency by lengthening antennas that show resonance above the desired operating frequency, or shortening the antenna if it shows resonance below that frequency. And, if we know an antenna's reactance, we can add capacity or inductance to matching circuits to get a good match between antenna and feed line.

The traps of multi-band trap antennas can be tuned to their proper resonant frequency by using a noise bridge. Certain lengths of transmission line sections can be determined by using a noise bridge. These line sections are often used to provide a needed phase shift in signals routed to elements of certain kinds of antennas, or to correct a mismatch between two circuits such as a feed line and an antenna.

Some other functions of a noise bridge include measuring inductance and capacitance, measuring the input impedance and output impedance of an RF (radio frequency) amplifier, and setting your station's antenna tuner to match your feed line without need of putting a signal on the air. Although a noise bridge does not measure with precision, it is accurate enough for use by most amateurs, monitoring buffs, and radio experimenters.

### ❖ Noise Bridges versus Antenna Analyzers

The miniaturization of modern components has made it possible to economically manufacture small, sophisticated, hand-held

test instruments called "antenna analyzers." Noise bridges provide much of the kind of information that antenna analyzers provide. Nevertheless, there are significant differences between the two, so let's take a look at those differences.

Perhaps the most important difference between noise bridges and antenna analyzers is that antenna analyzers offer standing wave ratio (SWR) measurements. Some antenna analyzers also offer readout of various other measurements, such as return loss and reflection coefficient. On the other hand, the bridge identifies measured reactance as either capacitive or inductive: a feature some low-end

#### This Month's Interesting Antenna-Related Web sites:

Unfortunately it's tedious to copy long web addresses from the hard copy (paper copy) of *Monitoring Times*. However, if you subscribe to *Monitoring Times* as *MT Express* (both versions have the same content) it's delivered digitally via the internet, and you can click right on the link and go directly there without having to copy it at all. Plus, *MT Express* is delivered to you much earlier, costs much less than a paper subscription, and reduces our carbon footprint. It's a win, win, win, win way to go!

- Information on building your own noise bridge: <http://newenglandgrp.org/files/noise-bridge-instructions.pdf>
- MFJ has their noise bridge manual, and a copy of the bridge's schematic diagram at: [www.mfjenterprises.com/man/pdf/MFJ-202B.pdf](http://www.mfjenterprises.com/man/pdf/MFJ-202B.pdf)
- Comments on the pros and cons of noise bridges versus various antenna test gear: [http://lists.contesting.com/\\_top-band/2004-01/msg00124.html](http://lists.contesting.com/_top-band/2004-01/msg00124.html)
- Joe Carr discusses building and using a noise bridge for antenna measurement in his book *Secrets of RF Circuit Design* (start at page 319) see this on the web: [http://books.google.com/books?id=beg188-yUBwC&pg=PA321&pg=PA321&dq=%22noise+bridge%22+antenna&source=bl&ots=0\\_Oj25IBJr&sig=XRZ9vTCwuHEc\\_vpsHo8Vaw4q5VM&hl=en&ei=bDoLSoyCaDaswOS29H\\_Ag&sa=X&oi=book\\_result&ct=result&resnum=4#PPA321\\_M1](http://books.google.com/books?id=beg188-yUBwC&pg=PA321&pg=PA321&dq=%22noise+bridge%22+antenna&source=bl&ots=0_Oj25IBJr&sig=XRZ9vTCwuHEc_vpsHo8Vaw4q5VM&hl=en&ei=bDoLSoyCaDaswOS29H_Ag&sa=X&oi=book_result&ct=result&resnum=4#PPA321_M1)
- Info on using a noise bridge to tune your antenna tuner: <http://kv5r.com/articles/ham/noisebridge.asp>
- A sophisticated antenna-impedance meter: [http://w5big.com/QST\\_Article.pdf](http://w5big.com/QST_Article.pdf)
- Discussion of SWR meters: [http://en.wikipedia.org/wiki/SWR\\_meter](http://en.wikipedia.org/wiki/SWR_meter)

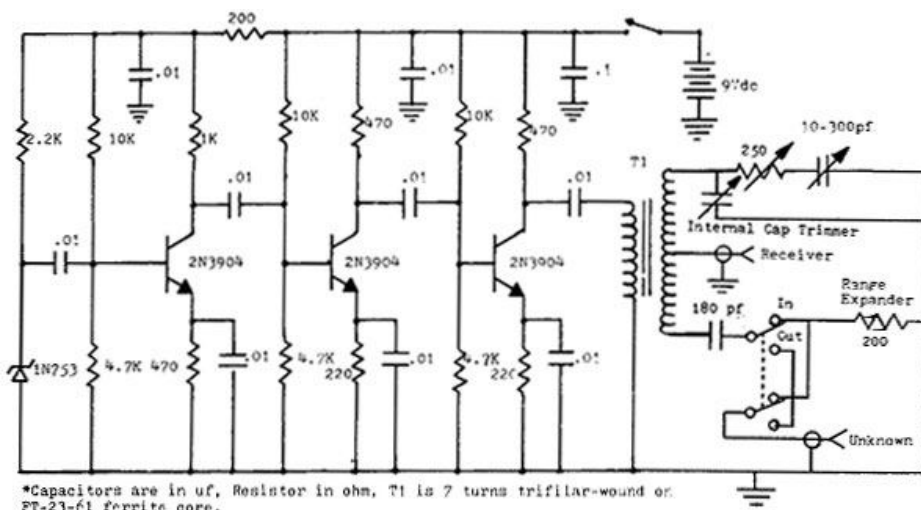

FIG. 1. THE CIRCUIT OF THE MFJ-202B NOISE BRIDGE (used with permission)



analyzers don't offer.

And, antenna analyzers don't require an external detector (a receiver) as does the noise bridge. The analyzers connect directly to the circuit (antenna, feed line, etc) with no other device required. Depending on the analyzer, antenna analyzers may measure velocity factor of coaxial cable, distance to a short or open connection in a cable, and a number of other resonance and impedance-matching parameters.

Noise bridge measurements are slow, taken after much knob turning. In contrast, antenna analyzers are much easier to adjust, and results come more quickly. Some antenna analyzers also allow direct connection to a computer for analysis and readout. Therefore, using an antenna analyzer is easier, quicker, and sometimes more informative than using a noise bridge.

Perhaps a noise bridge could be called "the poor man's antenna analyzer," because the price of a noise bridge is far less than the cost of an antenna analyzer, and yet much of the basic information available from an antenna analyzer is also available from using a noise bridge.

Another significant difference between noise bridges and antenna analyzers is that it's not too difficult to make your own noise bridge, whereas home-brewing an antenna analyzer would be a formidable task for most of us. I've seen build-it-yourself noise bridge plans in the 20<sup>th</sup> edition of the *ARRL Antenna Handbook*, and possibly other editions. Also check out the "Antenna-Related Web Sites" box in this

## RADIO RIDDLES

### Last Month:

I asked: "Although noise is generally something we want to avoid, there is at least one piece of antenna test gear that requires noise for its proper functioning. What is that piece of test gear called, and of what value is it to us in working with our antennas?"

As you can see, the answer is obvious

from the above discussion.

### This Month:

An antenna is sometimes said to "capture" the signals it receives from passing radio waves. After the waves are captured, can they ever escape back into space?

You'll find an answer to this month's riddle, another riddle, another antenna-related web site or so, and much more, in next month's issue of *Monitoring Times*. 'Til then Peace, DX, and 73.

column for more on building your own noise bridge.

### ❖ Another Useful Piece of Gear

The noise bridge gives some useful information about your antenna system, but it doesn't provide SWR measurements. Simple, basic SWR meters are relatively inexpensive to purchase, and are also easy to construct as a home brew project.

Measuring SWR at the antenna-feed line connection gives an indication of how well the feed line and antenna are impedance matched. SWR at the transmitter-feed line connection gives an indication of how well the transmitter output is matched to the whole antenna system.

Impedance matching is important if you are to have maximum transfer of RF energy between the transmitter and feed line, receiver and feed line, or feed line and antenna. However, as we've discussed on various occasions in this column, impedance matching impedances for receiver, antenna, and feed line is often neither necessary nor even desirable for high-frequency reception (see January 2009 for one such mention).

### ❖ Like to Roll Your Own?

Information on building and using various kinds of antenna test gear can be found in the "Interesting Antenna-Related Web Sites" box in this column, and in books such as the *ARRL Antenna Book* and Joe Carr's *Practical Antenna Handbook*.

# MFJ-269

## HF/VHF/UHF Antenna/SWR Analyzer

- Analyzer covers 1.8 to 170 MHz and 415 to 470 MHz
- Tunable oscillator can be used as a signal source for testing and alignment
- Function status and detailed analysis shown on LCD display and two panel meters
- Powered by 10 AA alkaline or NiCd/NiMH rechargeable batteries (not included); built-in recharger with battery save mode and low battery warning
- Built-in calculator shows coax line length in feet and electrical degrees for any frequency and velocity factor; useful for building matching sections and phasing lines
- 12-bit A/D converter provides superior accuracy and resolution over competitive 8-bit converters
- 1.8 to 170MHz range features
- Read antenna SWR and Complex Impedance (as series equivalent resistance and reactance ( $R_s + jX_s$ ) or as magnitude ( $Z$ ) and phase (degrees). Also read parallel equivalent resistance and reactance ( $R_p + jX_p$ ).
- Determine velocity factor, coax loss in dB, length of coax and distance to short or open in feet.
- Read SWR, return loss and reflection coefficient simultaneously on 10-600+ ohm transmission lines; also shows match efficiency.
- Measure inductance in uH and capacitance in pF at RF frequencies.



# GROVE

800-438-8155

828-837-9200 fax: 828-837-2216

WWW.GROVE-ENT.COM

order@grove-ent.com

7540 Highway 64 West  
Brasstown, NC 28902

\* plus \$13.95 UPS Ground shipping in the U.S.

Order  
Yours  
Today!

Order ACC69

\$349<sup>95\*</sup>

## The S20-R: It's a Wrap!

**R**eaders Reg Curtis, VE9RWC, sent a query regarding the installation of three-wire cords having a "ground pin" plug to replace deteriorating cords on equipment being restored. The wire from the ground pin, of course, would be connected to the chassis of the equipment.

I agree with Reg that 3-wire cords should never be installed in a.c.-d.c. radios, which generally have one side of the line connected to the chassis. Instead, use a two-wire cord with a polarized plug wired so that the wide, or ground, blade is the one connected to the chassis. (For additional concerns regarding the wiring of line cords for a.c.-d.c. receivers, see the August column.)

If a 3-wire cord with a ground lead is used, there is possibility for danger even if the 3-wire cord is polarized and connected with wide blade to the chassis. Why? Well the lead which goes from the "ground pin" on the plug to the chassis is (assuming proper installation of the outlet's electrical box) always grounded. The lead from the wide blade to the chassis is *probably* grounded, and if it is, the "third wire" from the pin is redundant and unnecessary. But if the outlet is wired incorrectly, then the lead from the wide blade could be "hot," causing an immediate short to the chassis and – at the very least – a blown fuse.

For transformer-powered equipment (in which the incoming a.c. line is completely isolated from the chassis), the use of a line cord with a ground wire can provide added safety – particularly in situations where developing leakage in transformer windings or a capacitor causes some line voltage to appear on the chassis.

But watch out when using test equipment having a 3-wire line plug with a.c.-d.c. radios! If the chassis of the a.c.-d.c. set should happen to be hot to ground, you would be in quite a dangerous situation as you try to attach the grounded test lead from the equipment to the chassis of the a.c.-d.c. set! And in any case, *never* work on a plugged-in a.c.-d.c. set unless it is connected to the line through an isolation transformer!

### ❖ The Restoration So Far

Since this month's work session will complete the restoration of the S20-R, let's take a moment and review the work that has been done so far. The restoration began in May, when we took a first look at the receiver and conducted some preliminary tests that included the tubes and power transformer.

In June, we dealt with the unexpectedly difficult job of merely removing the chassis from the cabinet. The problems included a frozen set screw on the bandswitch knob and some very recalcitrant decorative switch "ring nuts."

July saw the changing out of the paper capacitors and the disconnection of the speaker, which had been hanging loose since the removal of the cabinet. In August, the cabinet of the extra parts set was dismantled and cleaned for use on the set being restored. Other parts, such as the speaker and the bandswitch shaft were also salvaged for re-use.

Then, in September, the electrolytic capacitors were replaced and the wraparound front panel was installed, paving the way for initial testing.

When most elderly radios are powered up after restoration, no matter how careful the restoration may have been, they usually have to be coaxed back into life. Perhaps there's a dirty contact here or an accidentally miswired part there. In this case (once I remembered to put the send-receive switch in "receive" position), the start up was immediate – almost as if the radio were enthusiastically waiting for the chance to play again. It was exciting!

I was picking up stations all over the broadcast band in the basement and without an antenna connected. It looked like once the radio had been realigned, restoration would be complete.

### ❖ Realignment Instruments

To those who have never attempted it, realigning a multi-band short-wave radio might seem complicated and daunting. But actually it is a fairly non-technical operation, requiring only a good signal generator, a gain indicating

device, a cool head, and the ability to follow simple manufacturer's instructions. And it is extremely satisfying to see the set's sensitivity and calibration improve moment by moment as you work.

If you don't have a signal generator, you should be able to find one easily at a very reasonable price at almost any hamfest or antique radio meet. Look for one made for the radio service technician (such as a Triplett or Hickock model) rather than a hobbyist kit model as sold by Heathkit, Eico, etc. Also avoid the elaborate instruments intended for laboratory use.

If you get a service technician's model you won't have to worry about it having a range of stable frequencies covering most i.f.s and the standard shortwave bands. It will also have good output level controls and provision for generating an r.f. signal with or without audio modulation.

Depending on where you connect it in the circuit, your indicating device can be a simple VOM or it might have to be a more sensitive instrument. A VOM (set to indicate a.c.) can be hooked up directly across the voice coil of the loudspeaker or (through a .05 uf capacitor) between the B plus end of the output transformer and ground. The latter hookup will be more sensitive, not requiring the radio to be played as loudly to get good readings.

I prefer to connect between ground and the radio's AVC (automatic volume control) line. This gives a reading that is independent of the audio you hear at the speaker – so it saves your ears. The stronger the received signal, the greater will be the negative voltage on the AVC line.

Measuring at this location requires a very sensitive instrument such as a VTVM (or in my case a "FET VOM," which is equivalent to a VTVM but uses semiconductors instead of tubes) set for d.c.. To find the AVC line, look for a bus that interconnects the bottoms of the tuned circuits at the grids of the r.f. and i.f. amplifier tubes.

### ❖ I.F. Alignment

The alignment procedure usually begins with the i.f. channel. For the S20-R, Hallicrafters suggests inserting the i.f. test signal (455 kHz, modulated) into the grid cap of the 6K8 oscillator/mixer tube with the grid connection removed. Set the signal generator r.f. level for the minimum setting that will give you usable meter readings. Have the audio gain control at maximum if you are measuring at the voice coil or output transformer.

Now the trimmer capacitors at the primary

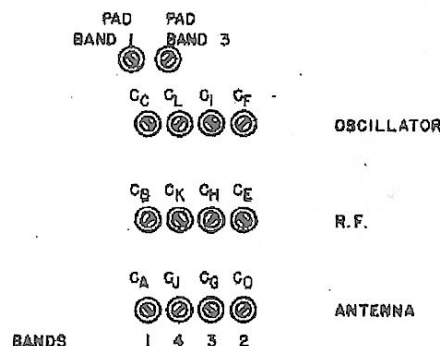

Illustration from Hallicrafters manual showing locations for all of the front-end trimmers and two of the three padders.



*The remains of a cable in the parts set after it was taken apart to trace the BFO B+ lead. I'm glad I didn't have to do this to the restored set!*

and secondary of each i.f. transformer are adjusted for maximum gain on your meter. On the S20-R the adjustment is done with simple slotted screws – both located at the top of the transformer.

But, it's wise to keep a set of i.f. adjustment tools on hand to be prepared for transformers that require a special hex driver. And some transformers may have one adjustment location on top and the other under the chassis.

Technically, one must use a non-metallic screwdriver or other tool to make i.f. adjustments. But I often find the blades on non-metallic screwdrivers are not up to the task of moving age-stiffened trimmers. So I resort to small metallic screwdrivers instead, finding that their presence does not compromise the adjustment being carried out.

The screws on the i.f. transformers are adjusted for maximum signal strength in the order given by the manufacturer (although the order is not really critical). When tweaking the i.f.s on these older radios, it's not unusual to see, as I did, great increases in gain – and very satisfying it is! As the gain increases, one should reduce the output level of the signal generator to maintain minimal usable signal strength.

### ❖ Front End Alignment

The final phase of alignment is done at the receiver's front end. For each band of a short-wave set (in this case four), there are trimmers for the antenna, r.f. amplifier, and oscillator circuits. To obtain a test signal for front-end alignment, Hallicrafters specifies that the output of the signal generator be connected to one of the radio's antenna terminals (the other being grounded) through a 400-ohm resistor. Of course, the connection to the grid cap of the 6K8 oscillator/mixer is now to be restored.

A test frequency near the high end of its range is specified for each band. In the case of the oscillator circuit, which controls the calibration of the receiver, additional adjustments called padders are provided for three of the four bands. Test frequencies near the low end of the bands are specified for these and their purpose is to improve the linearity of the dial calibration.

Just as with the i.f. transformer adjustments, the trimmers and padders are adjusted for maximum output at each test frequency. As I went through these adjustments, I found that I could improve the tuning in most cases – as you would expect in a radio that might be 70 years

old. But on one band, the settings were so far off that I had to approach the required test frequency slowly by readjusting the signal generator and maximizing the trimmers a little at a time.

In any case, once the adjustments were completed, reception on all but the top band (15.5 - 44 MHz) was quite lively – with many signals being received on a short basement antenna. There were signals on the top band also, but – as would be expected on lower-end receivers of this type – there was a noticeable difference in sensitivity.

### ❖ One Last Thing!

I was quite pleased with the results of my S20-R restoration, but there was one fly in the ointment. The BFO (beat frequency oscillator) didn't work, which meant it would be impossible



*With the restoration complete, I'm pleased with the appearance of my S20-R. Now here's a radio that looks like a radio!*

to receive code signals properly. It turned out that there was no plate voltage on the 6J5 BFO tube. Should be a simple fix, I thought.

Well, it might have been a simple fix conceptually, but most of the wiring in the S20-R is tightly cabled. The plate lead for the 6J5 dives into the cabling in the vicinity of that tube to emerge who knows where. The schematic showed where it was supposed to connect electrically but not physically.

I started to cut apart the cabling to see if I could trace the wire – but gave up when it was apparent that I would have to mess up a good part of the lead dress before I got the answer. Then I

### FROM THE READERS

Back in the August issue, I asked if there were readers who could share experience with screw extracting tools. Recently I received an e-mail from "Ted," who was kind enough to respond. First, says Ted, a regular bit is used to drill a hole down through the stripped head and into the screw. Then the appropriately sized extractor bit is tapped into the hole with a hammer so that it bites into the screw.

With the extractor in place, a wrench can be used on it to back the screw out. Failing that, one could chuck the head of the extractor in an electric drill set on reverse (use a SLOW speed). Thanks Ted!

thought of my parts set. The chassis was a rusted out junker – but it had the same cable. After pulling apart about a foot of it, I found the connection point.

Going to the same spot on the restored set, I found the broken-off lead – buried under the cable. Apparently it had been disturbed during the course of an obvious repair that had been carried out at that spot. Re-connecting the lead, I now had a BFO with a very robust signal.

Stay tuned for a new project next month!

### JOIN THE AWA

#### Antique Wireless Association

*The original and largest historical radio-collector group*

- Publishes *The AWA Journal*, Marc Ellis, Editor, with:
  - Battery and AC receiver restoration
  - Vacuum-tube history and collecting
  - Old-time amateur-radio contests
  - Communications receivers
  - Free want-sell-swap ads
  - Early television
  - Horn loudspeakers
  - News of U.S. and foreign clubs



- Produces the famous annual Rochester meet
  - Maintains unique radio-TV museum
- Membership is only \$20 per year in U.S.; \$25.00 elsewhere.

Mail check to:  
AWA Membership - P.O. Box 421, Dept. 2 Bloomfield, NY 14469-0421  
http://www.antiquewireless.org  
awamembership@rochester.rr.com (585) 392-3088

### Now Transmit & Receive in Ultrasound !!



Our Ultra-TR40 transceiver kit tunes an active part of the band, 35-45 kHz, with 10 kHz wide audio and transmits (CW) at 40 kHz. You can listen to bats, insects, beetles, rodents, earth sounds, and man-made sounds. Sound pressure levels (SPL) emitted by bats and insects range from 70 to 110 dB at one foot, sufficient to be heard from 25 to 100 feet with the TR40's receiver or with our Ultra-RX1 receiver. Input power on transmit is adjustable up to 2 mW, thus emitting a comparable SPL signal level.

This 2-hour kit includes TX & RX piezo transducers, PCB, case, parts, & 20+ page manual and sells for \$99.95 plus shipping. See our [ultrasonic web pages](#) for details or call 405-517-7347. Join the ultra-revolution now!

### Ultra-TR40

The Xtal Set Society, Inc

[www.midnightscience.com](http://www.midnightscience.com)

## “Sky-Wires & Inhalers” Part 1: Catching Photons

By Walter Lindenbach

“*Huh? Whazzat?*” This from Chuck as he walked in to Bill’s workshop.

“Whazz what?” Bill wanted to know.

“Well, look at the top of the page. ‘Sky-Wires and Inhalers’? Somehow, I thought we were going to talk about antennas and receivers.”

“It’s obvious, Chuck, that you aren’t a ham operator. That’s exactly what it means in ham-speak. Walt (y’know, the guy who writes this thing) is just being cute. He isn’t a ham operator either.”

“Yeah, well, if we’re done being cute, are you gonna tell me about antennas like you said?”

“Sure enough, and I’m going to start with a wee bit of history.”

Chuck was not thrilled.

“Look buddy, all I want is an antenna that will pull in the shortwave stations better than the thing I have now. What’s history got to do with that?”

“Lots!” replied Bill emphatically, “You ever heard: ‘Those who cannot remember the past are condemned to repeat it.’? It’s from George Santayana. The way to avoid making a lot of mistakes and wasting a pile of time is to see how this antenna business began, the mistakes others have made, and the things they have learned. No point in reinventing the wheel.

“First, we’d better be sure we know what we’re talking about. It’s generally called an ‘antenna’. Some people call it an ‘aerial’ – they mean the same thing.

“Now have a look at this.” Bill pulled out a book, and showed Chuck this:

“Do you think the Marconi antenna would do?” Bill grinned.

“Well – uh – hmmm – somehow I don’t think it will fit into my backyard!”

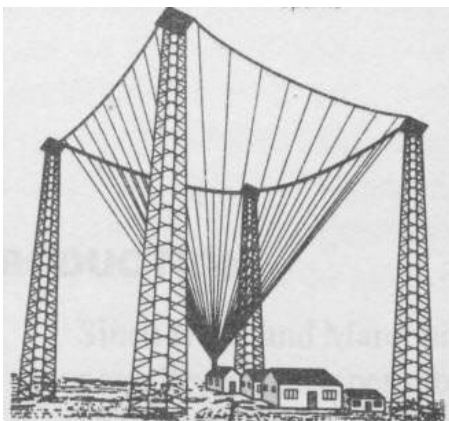

Figure 1: Marconi’s Antenna, 1905

“Good! That’s settled. Now, it would be useful to have a general definition:

*‘a radio antenna may be defined as the structure associated with the region of transition between a guided wave and a free-space wave or vice versa. Antennas convert electrons to photons, or vice versa.’*<sup>1</sup>

It’s the ‘vice versa’ case that you want, photons to electrons – at least for now. Who knows, maybe one day you’ll turn into a radio ham! Then you’ll want it to work both ways. And, the fact is, antennas *always* work both ways at the same time! An antenna, connected to a load equal to its own characteristic impedance *re-radiates* as much energy as it delivers to the load!”

“Okay, now hold on a sec. Did you say ‘photons’? What are we talking about now? Bill, all I want is an antenna to collect radio waves.”

“Believe it or not, that’s exactly what we’re talking about. Strange as it sounds, radio waves are photons. Now, if we go on like this, we could continue the old argument about waves versus particles. But I don’t think that will help us.”

### ❖ Characteristic Impedance

“Ah, that’s a relief! But what’s all this about ‘characteristic impedance’? I’ve heard cables – like RG58 – described as having a characteristic impedance of 50 ohms. So I took a piece of cable and connected an ohmmeter to it. I didn’t see 50 ohms – just an open circuit! And do antennas have characteristic impedance, too? What’s this ‘characteristic impedance’ stuff?”

“Good question. It’s a little off the subject, but we’ll have to talk about it, so it may as well be now.

“Now first, you don’t measure characteristic impedance with an ohmmeter, and the term applies mainly to high-frequency operation.

“Think of a cable that is infinitely long. If you connect a battery to one end, a voltage wave will start traveling down the cable at a rate that is some fraction of the speed of light. That speed is determined by the structure of the cable.

“While that voltage wave is traveling down the cable, a current is required from the battery. Now, all you have to do is divide the battery voltage by the current flowing into the cable, and you have the characteristic impedance.”

Chuck was not thrilled. “Oh, that’s fine! All we need now is an infinite piece of cable!”

“Now don’t get all het up, Chuck. I’m going to tell you how to *make* a cable look as if it

is infinitely long. You connect a resistor that is equal to the characteristic impedance to the far end of the cable – *whether it’s a foot long or a mile long!* Then, when you connect the battery to the near end, a current will flow such that, if you divide the battery voltage by the current, the result will be the characteristic impedance. So the cable looks just like our hypothetical infinitely long cable, no matter how long it is.

“Remember, the result with the short piece of cable is the same as with the infinitely long cable *only* if the resistor at the end of the short cable is equal to the characteristic impedance.”

“Well, that’s no good,” complained Chuck, “unless you scare up that infinite length of cable, it still isn’t possible to find the characteristic impedance.”

“True enough. Don’t go away – we’re not done.”

### ❖ Real Transmission Lines and Real Signals

“Now we’re going to talk about a practical application of a transmission line. Suppose we connect a 30 MHz signal generator to a piece of RG58 transmission line that is just one wavelength long. How long is that?”

“Well, the wavelength is the distance that the signal will travel in free space – that’s the speed of light, 300,000,000 meters per second or, more conveniently,  $3 \times 10^8$  meters per second – during the period of one cycle, which is  $1/30$  MHz or 33.33 ns (nanosecond:  $1 \times 10^{-9}$  second). So, the question is: how far will a wave go at the speed of light in 33.33 ns?”

“We multiply the time by the speed and get 10 meters. Isn’t that nice? That’s why we call the 28 to 29.7 MHz band the 10 meter ham band.

“These things can be expressed as an equation.

$$l = \frac{C}{f}$$
 where:  $l$  is the wavelength in meters,  $C$  is the speed of light,  $3 \times 10^8$  meters per second, and  $f$  is the frequency in hertz.

#### Radio Waves and the Speed of Light

“But the speed of a radio signal in an RG58 cable is only 66% of the speed of light. That’s called the velocity factor (VF). So the speed of our 30 MHz signal in the cable is  $3 \times 10^8$  meters per second times 66% or  $1.98 \times 10^8$  meters per second, and if we multiply that by 33.33 ns, we get 6.6 meters. So that’s the length of cable that

will accommodate just one wavelength of a 30 MHz signal.

“The equation looks like this.

$$l_c = \frac{(C)(PF)}{f}$$
 where:  $l_c$  is the wavelength in the cable, in meters,  $C$  is the speed of light,  $3 \times 10^8$  meters per second,  $PF$  is the propagation factor as a percentage of the velocity of light, and  $f$  is the frequency in hertz.

### Wavelength in a Cable.

“Now, let’s put the signal generator on one end and leave the other end open. This is where the fun begins. What do you think the generator ‘sees’ at the end of the cable where it is connected?”

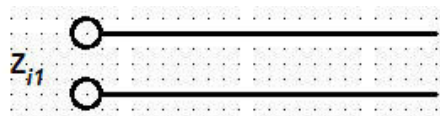

Figure 2: Transmission Line

“Well,” said Chuck doubtfully, “if it weren’t you asking, I’d say that the generator end of the cable is open. But you’re a cagey critter, and I just know you have a surprise waiting for me, so suppose you just tell me.”

“Chicken! But you’re right! The answer is that, when the transmission line is an even number of quarter-wavelengths long – like the one that we just calculated, which is one wavelength long or four quarter-wavelengths, an even number – the generator will ‘see’ an open circuit if the other end is open. Similarly, if the far end is shorted, the generator will ‘see’ a short.

“Now hang on! This is where things get more exciting. If the transmission line is an odd number of quarter-wavelengths long, the situation is exactly opposite. If the far end is open, the generator will ‘see’ a short! If the far end is shorted, the generator will ‘see’ an open circuit.”

“Oh, wonderful!” Chuck sang out. “Now tell me what happens if the transmission line is not exactly a quarter-wavelength or a multiple of a quarter-wavelength. And what happens if you connect resistors or maybe capacitors or inductors to the far end?”

“Sorry, ol’ Buddy, that’s a very long sub-

ject. But now we come to the whole point in this exercise: if the far end of the cable is terminated in the characteristic impedance of the cable in this case, 50 ohms, the generator will also ‘see’ 50 ohms! And this is the condition for maximum, most efficient power transfer.”

“Well, that’s nice. But Bill, why are we talking about power transfer and transmission lines? That sounds a lot more like stuff for a transmitter than for a receiving antenna and you know, that’s really what I’m after!”

“Good point. The reason we are talking about these things is because the same principles apply to a receiving antenna operating into a receiver as with a transmitter operating into a transmitting antenna. Both are problems in power transfer!

“In the transmitting case, we can consider the transmitter to be a generator with a characteristic impedance that has to be connected efficiently to the antenna which – ideally – looks like a resistor of a value equal to the characteristic impedance of the transmitter.

“In the receiving case, we can consider the antenna to be the generator, again with a characteristic impedance, that has to be connected efficiently to the receiver which – ideally – you guessed it – looks like a resistor of a value equal to the characteristic impedance of the antenna.

“Now here is a simplified view of characteristic impedance. Think of a generator that produces one volt of something – DC, low frequency AC, high frequency AC – doesn’t matter. Now, short it out and measure the current. Divide the open-circuit output voltage – one volt, in our example – by the short-circuit current, and that’s the characteristic impedance. Then, if you connect a resistor equal to the characteristic impedance to the generator, you will find the voltage across the resistor is just one half of the open-circuit voltage, or, in this case, 0.5 V.”

“So, you had a point in all this after all!” chortled Chuck. “Now let’s see how this would look with a receiving antenna. If we had an antenna with a characteristic impedance of 50 ohms, we should use a lead-in cable with 50-ohm characteristic impedance, and it should connect to a radio antenna input, also of 50 ohms impedance. How’s that?”

“Good stuff, man, you’ve got it,” Bill cheered, “That’s the first condition. Now all we have to do is get some signals into the antenna. And, we want an antenna that gets more signals and less noise. And for that, we need to know –”

## ❖ What are Radio Signals?

“Oh wow! I think that’s a very big question!”

“You can bet your boots it is,” replied Bill, “but we have to understand all we can about this stuff that we want to catch.

“The general definition from Dr. Kraus, that we gave at the start of all this, mentioned that an antenna is ‘the structure associated with the region of transition between a guided wave and a free-space wave or vice versa.’ The ‘vice versa’ case applies to a receiving antenna, but notice, he doesn’t say that the antenna converts

a free-space wave to a guided wave – that is, a radio signal to a current in a wire. No, he says the antenna is merely a structure associated with the region of transition! Isn’t that a deliciously mysterious statement? Do you get the feeling that he is being very careful not to say something that he does not know for sure? I do.

“Then he says ‘antennas convert electrons to photons, or vice versa.’ ‘Vice versa’ would be photons to electrons, or a radio signal to a current in a wire.

“First we have something he calls ‘a guided wave’. That, believe it or not, is another way to say ‘an alternating current in a wire’! Then he mentions ‘a free-space wave.’ That’s what we’d call a radio signal. But he talks about an antenna turning photons into electrons.”

“Whoosh! I’m getting a little dizzy, Bill!”

“You’re not alone: If I think about this stuff too long, I get a headache. Now which is it? Photons and electrons are particles, and waves are – well – waves – aren’t they?”

“You asking me?” Chuck moaned. “I thought we were going to talk about antennas!”

“You betcha’! Let’s stop worrying about these esoteric physics concepts. The fact is, we just don’t know all there is to know about how these things work, but we know quite a bit about how to use them, so we’ll stick to that!”

“I feel better already,” said Chuck, “What’s next?”

“Well, this may sound odd, but what makes an antenna work is something called ‘radiation resistance.’ Again, that term implies transmitting antennas but, since antennas work both ways, we can say that radiation resistance is the ‘stuff’ in an antenna that is associated with the ‘region of transition’ – turning radio waves into alternating electric currents.

“(Actually, ordinary resistors can do the same thing! The big difference is that ordinary resistors operate in the terahertz region, which means they radiate wavelengths of between 300 and 3 microns wavelength. That’s heat; so when they get hot, they actually radiate infrared light waves – photons!)”

“Yeah, but could we get back to shortwave antennas?”

“Have you noticed the time, ol’ Buddy?”

“Aiya! Judy will wonder what ever has happened to me!”

“Well, if she calls, I’ll tell her you’re toddling along home. Next time, I’ll tell you about how a transmission line turns into an antenna. And, we’ll start talking about an antenna that you can use without getting in trouble with your condo board. One kind is called a random-wire. Then there’s another kind which has a very special advantage. It’s called an untuned loop.”

“That’s good. Thanks, Bill. G’nite.”

“G’nite.”

## REFERENCES

- 1: “Antennas for All Applications”, John D. Kraus, Ronald J. Marhefka, page 12, Tata McGraw-Hill, Third Edition, 2003

Diagrams and graphs were prepared using National Instrument’s program “Multisim,” kindly provided by Analog Devices Inc. Walter Lindenbach can be reached at lindenbachw@shaw.ca

## VLF Detection of the Sun

**O**ur Sun is a variable star, G2 classification and close by (approximately, 92 million miles), which makes it a relatively easy study, in the radio and visual spectrum.

As we come into the next solar upswing, we will see more solar activity ranging from solar flares, sun spots, and possibly more beautiful displays of the Northern and Southern Lights, in those respective latitudes. For those who follow the Global Warming activity, this means more light and heat with the increased activity.

### SOLAR STATISTICS (NASA)

Solar radius = 695,990 km = 432,470 mi = 109 Earth radii  
 Solar mass = 1.989 1030 kg = 4.376 1030 lb = 333,000 Earth masses  
 Solar luminosity (energy output of the Sun) = 3.846 1033 erg/s  
 Surface temperature = 5770 °K = 10,400 °F  
 Surface density = 2.07 10<sup>-7</sup> g/cm<sup>3</sup> = 1.6 10<sup>-4</sup> Air density  
 Surface composition = 70% H, 28% He, 2% (C, N, O, ...) by mass  
 Central temperature = 15,600,000 °K = 28,000,000 °F  
 Central density = 150 g/cm<sup>3</sup> = 8 × Gold density  
 Central composition = 35% H, 63% He, 2% (C, N, O, ...) by mass

How do we study the Sun? Let's talk about the tools used in this area. We are all familiar with the optical telescope, which many of us have used. These, with solar filters, Hydrogen Alpha filters, etc. give us wonderful visual views of the Sun.

**WARNING:** NEVER VIEW THE SUN WITHOUT PROPER EYE PROTECTION OR FILTERS DESIGNED FOR SOLAR VIEWING. SERIOUS EYE DAMAGE OR BLINDNESS MAY OCCUR IF WARNING IS NOT OBSERVED.

The Sun is also studied in the radio spectrum, since it emits, as they say, "DC to Daylight." One part of the radio spectrum where observations are conducted is VLF (Very Low Frequency). Receivers normally used in this area are called SID or SED (Sudden Ionospheric/Enhancement of the D Layer).

A Sudden Ionospheric Disturbance (SID) is an abnormally high ionization/plasma density in the D region of the ionosphere caused by a solar flare.

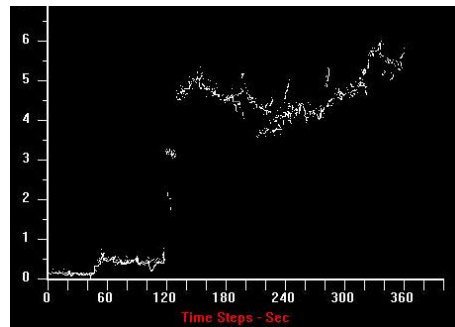

40 kHz VLF Receiver and Typical VLF (Sunrise) Courtesy of Radio Astronomy Supplies

(In physics and chemistry, plasma is a partially ionized gas, in which a certain proportion of electrons are free rather than being bound to an atom or molecule.)

The SID results in a sudden increase in radio-wave absorption that is most severe in the upper medium frequency (MF) and lower high frequency (HF) ranges<sup>1</sup> and, as a result, often interrupts or interferes with telecommunications systems.

When a solar flare occurs on the Sun, a blast of intense ultraviolet and x-ray radiation hits the dayside of the Earth after a propagation time of about 8 minutes. This high energy radiation is absorbed by atmospheric particles, raising them to excited states and knocking electrons free in the process of photoionization. The low altitude ionospheric layers (D region and E region) immediately increase in density over the entire dayside.

The ionospheric disturbance enhances VLF radio propagation. Scientists on the ground can use this enhancement to detect solar flares: By monitoring the signal strength of a distant VLF transmitter, sudden ionospheric disturbances (SIDs) are recorded and indicate when solar flares have taken place.

Shortwave radio waves (in the HF range) are absorbed by the increased particles in the low altitude ionosphere, causing a complete blackout of radio communications. This is called a shortwave fading. These fadeouts last for a few minutes to a few hours and are most severe in the equatorial regions where the Sun is most directly overhead. The ionospheric disturbance enhances long wave (VLF) radio propagation.

### ❖ What other frequencies can we use?

Many radio astronomers and amateur radio hobbyists use frequencies allocated for radio

astronomy "Receive Only." Some of those are in the HF – MHz. spectrum:

- 13.36 - 13.41 MHz
- 25.55 - 25.67 MHz
- 73.00 - 74.60 MHz
- 150.05 - 153.00 MHz
- 406.10 - 410.00 MHz
- 1400.0 - 1427.0 MHz

Further information may be found at:  
[www.ntia.doc.gov/osmhome/reports/pub9835/raspexec.htm](http://www.ntia.doc.gov/osmhome/reports/pub9835/raspexec.htm)  
[www.fcc.gov/oet/spectrum/table/fcctable.pdf](http://www.fcc.gov/oet/spectrum/table/fcctable.pdf)

### ❖ VLF Detection of GRB's (Gamma Ray Bursts) and UHF

Software Design Engineer, James Van Prooyen has been very successful in detecting these bursts.

Shown in the graphs below is what appears to be a GRB (Gamma Ray Burst) event observed first on VLF (40 kHz) when the gamma rays hit the Earth's ionosphere, creating a change in the F1 and F2 layers similar to sunrise. A very small amount of time later, the radio "after glow" of the GRB reaches the Earth. At 406 MHz this energy passes through the Earth ionosphere and reaches the radio telescope tuned to the above listed frequency.

Gamma-ray bursts are flashes of gamma rays associated with extremely energetic explosions in distant galaxies. They are the most luminous electromagnetic events occurring in the universe. Bursts can last from milliseconds to nearly an hour, although a typical burst lasts a few seconds. The initial burst is usually followed by a longer-lived "afterglow" emitting at longer wavelengths (X-ray, ultraviolet, optical, infrared, and radio).

Most observed GRBs are believed to be a narrow beam of intense radiation released during a supernova event, as a rapidly rotating, high-mass star collapses to form a black hole. A subclass of GRBs (the "short" bursts) appear to originate from a different process, possibly the merger of binary neutron stars.

The sources of most GRBs are billions of light years away from Earth, implying that the explosions are both extremely energetic (a typical burst releases as much energy in a few seconds as the Sun will in its entire 10 billion year lifetime) and extremely rare (a few per galaxy per million years).

All observed GRBs have originated from

outside the Milky Way galaxy, although a related class of phenomena, soft gamma repeater flares, are associated with magnetars within the Milky Way. It has been hypothesized that a gamma-ray burst in the Milky Way could cause a mass extinction on Earth.

GRBs were first detected in 1967 by the Vela satellites, a series of satellites designed to detect covert nuclear weapons tests. Hundreds of theoretical models were proposed to explain these bursts in the years following their discovery, such as collisions between comets and neutron stars. Little information was available to verify these models until the 1997 detection of the first X-ray and optical afterglows and direct measurement of their redshifts using optical spectroscopy.

These discoveries, and subsequent studies of the galaxies and supernovae associated with the bursts, clarified the distance and luminosity of GRBs, definitively placing them in distant galaxies and connecting long GRBs with the deaths of massive stars.

Further information may be found at:  
[http://en.wikipedia.org/wiki/Gamma-ray\\_burst](http://en.wikipedia.org/wiki/Gamma-ray_burst)  
[http://imagine.gsfc.nasa.gov/docs/science/known\\_l1/bursts.html](http://imagine.gsfc.nasa.gov/docs/science/known_l1/bursts.html)

Many of the radio astronomers who are looking at the data from the 406 MHz radio telescope may have seen this type of event before: We call them HEPs (High Energy Pulses). But there is one more bit of information on this GRB: the SWIFT spacecraft also reports a GRB at about the same time, giving the event its official name, GRB080919.

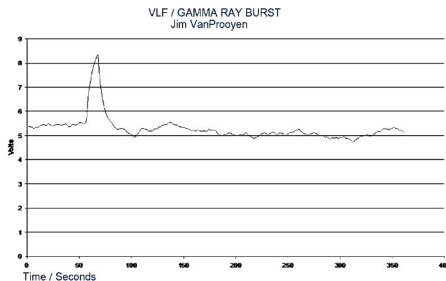

The event which provided the first direct link between HEPs and a GRB was observed on September 19, 2008, using the radio telescopes of GRRO (Grand Rapids Radio Observatory), located in Grand Rapids, Michigan. The 40 kHz radio telescope receiver was fed by a dipole of several hundred turns of wire, mounted on a 3 inch diameter, 10 foot long PVC pipe. In addition, a 406 MHz receiver was fed by a 3.1 meter dish antenna. Both receivers were built by Radio Astronomy Supplies.

#### Time Line VLF Event

- The plots both start at 19:48:31 Eastern Time or 23:48:31 UTC
- The VLF Event start is 23:49:28 UTC
- High point of the VLF Event is at 23:49:39 UTC
- End of the VLF Event is at 23:50:00 UTC

#### SWIFT Satellite Observations:

A search of GRB data bases found that gamma-ray burst 080919 was observed at about the same time by the SWIFT satellite. See the

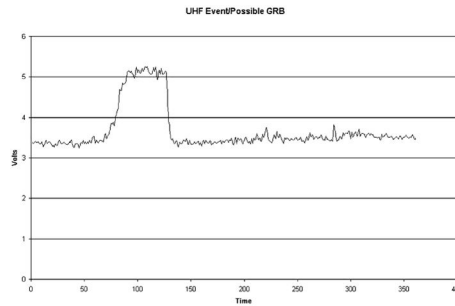

web page listed below for more information:  
[www.mpe.mpg.de/~jcg/grb080919.html](http://www.mpe.mpg.de/~jcg/grb080919.html)

Note there is a difference in the time that the Swift Satellite reported as the event and the observed time by the VLF and UHF radio telescopes. More analysis is needed in this area. The VLF and UHF radio telescopes are connected to different computers. Each of these computers has an internal clock set by the US Navy clock via the internet at the start of each day (~ local sun rise).

#### Time Line UHF Event:

- The plots both start at 19:48:31 Eastern Time or 23:48:31 UTC
- The UHF Event starts at 23:49:40

#### Summary:

Due to the fact that we have three sources of data – the VLF and UHF observations, along with data from the Swift satellite all in the same time line – and the fact that the UHF observation looks like HEP (High Energy Pulse), we may have found the source for some of the HEP events observed by the radio astronomy community.

### ❖ Closer to Home, Lightning Detection

A lightning detector, primarily at VLF, is a device that detects lightning produced by thunderstorms. There are three primary types of detectors:

- ground-based systems using multiple antennas
- mobile systems using a direction and a sense antenna in the same location (often aboard an aircraft)
- Space-based systems

Frequencies most used for detection are: 40 kHz, 60 kHz, and 200-400 kHz. Lightning detection may also be accomplished with a standard VLF receiver, most often used for solar flare research, as seen in the photo at the head of this article.

Ground-based lightning detector networks are used by meteorological services like the National Weather Service in United States and the Meteorological Service of Canada, and by other organizations such as electrical utilities and forest fire prevention services.

One type of lightning detector slowly increasing in popularity is the battery-operated personal lightning detector as shown above (Stormwise Inc.). Similar in size to a pager, personal lightning detectors are popular among golfers, campers, law enforcement, sports officials and other persons who work or recreate outdoors. Personal lightning detectors function by detecting the electromagnetic pulse emitted by a lightning strike. By measuring the strength



Photographer: C. Clark. Credit: NOAA Photo Library, NOAA Central Library; OAR/ERL/ National Severe Storms Laboratory (NSSL)

of the detected EMP (Electro Magnetic Pulse), the device can then estimate how far away the detected strike was. When exposed to multiple detected strikes, some personal lightning detectors can even calculate and extrapolate the direction of the storm's movement relative to its position (approaching, departing or stationary).

Although personal lightning detectors do function well in regards to their ability to detect nearby lightning, they are quite basic in functionality when compared to professional lightning detectors. For example, they cannot tell where a lightning strike was located or from which



direction the lightning is approaching, only that lightning is in the area.

Also, since a personal lightning detector is triggered by EMPs, interference from other EMP-emitting devices (such as electronic equipment, appliances, fluorescent lights and even car engines) can sometimes result in either false alarms or missed strikes. This interference often has the additional effect of preventing personal lightning detectors from functioning properly while indoors. Despite these limitations, personal lightning detectors continue to increase in popularity among individuals and professionals.

If this discussion has piqued your interest or curiosity, you may contact me for further information and with your questions to address in this column at the email in the masthead.

#### About the Writer

Jeffrey M. Lichtman is the Founder Emeritus of the Society of Amateur Radio Astronomers (SARA) and founder of Radio Astronomy Supplies. For more about Jeff, see this month's *Letters* column.

#### Footnotes and Acknowledgements

- 1 (Adapted from Federal Standard 1037C and from MIL-STD-188)  
<http://en.wikipedia.org/>  
[http://imagine.gsfc.nasa.gov/docs/science/known\\_l1/bursts.html](http://imagine.gsfc.nasa.gov/docs/science/known_l1/bursts.html)  
[http://www.lmsal.com/solarsoft/latest\\_events/](http://www.lmsal.com/solarsoft/latest_events/)  
[http://www.lmsal.com/solarsoft/latest\\_events/](http://www.lmsal.com/solarsoft/latest_events/www.lmsal.com/solarsoft/latest_events/)  
<http://photojournal.jpl.nasa.gov/target/Sun>  
<http://www.photolib.noaa.gov/htmls/nssl0010.htm>  
<http://stormwise.com>  
<http://RadioAstronomySupplies.com>  
<http://www.jpl.nasa.gov/>  
 James Van Prooyen

## The Degen DE1103/Kaito KA1103: A Second Look

By Eric Bryan

Since my review of the DE1103 in the March 2005 *MT*, and Ken Reitz's review of the KA1103 in April 2007, there have been several other articles in *Monitoring Times* with praise for this little portable world band radio. A few years ago, Grove Enterprises confirmed the positive reviews of this unit by adding it to their selection of shortwave radios.

Now that I've been using the radio daily for four years, I thought I would update readers on its performance and how well it's worn over that time.

### ❖ What I Was Looking For

I was originally looking for a replacement for my Sony ICF SW1, which, after 15 years of daily use (including travel), started to develop problems. That radio was a little gem, but for my next go-around, I wanted to make sure I got a portable radio with full coverage, from the bottom of longwave to the top of shortwave, tuned via a tuning dial in 1 kHz increments, dual-conversion for image-rejection, capable of decoding single-sideband signals, with direct-entry capability and a reasonable number of memories – 20-40 or so (the SW1's 10 memories were pretty restricting).

I noticed a flurry of new analog radios coming from the Tecsun factory in Hong Kong, some of which were rebadged as Grundigs and other brands. These looked fun; some were dual-conversion with impressive coverage, but most didn't have the SSB facility – plus, I would forego the memory function on an analog set.

The Grundig YB 400/400 PE, with its proven track record and solid reviews, almost fit the bill. But it didn't quite cover all of longwave, and it lacked a tuning knob.

### ❖ Enter the DE1103

Shortly thereafter, I came across the Degen DE1103 online and did a double-take at the faux analog dial. I was surprised, as I read up on it, to find it fulfilled all of my requirements.

But one thing concerned me: With that



big dial face, what about a keypad and direct-frequency entry? The specs claimed the DE1103 had direct keypad entry, but where was the keypad? Oh, there – underneath the dial face – tiny keys in a single row, numbered 1 to 0.

That would be hard to operate by feel in the darkness, I thought.

And where was longwave? The specs said it covered longwave, but that band didn't appear on the dial face.

I found the *Passport to Worldband Radio's* DE1103 review online, which praised the set except for the ergonomics of the multi-function tuning knob/decoder and the row of tiny buttons. I liked the dial face, but that little row of buttons was holding me up. What sealed my decision were the informal users' reviews I found online and at the KA1103 Yahoo group.

Hong Kong-based eBay sellers were offering the radio for about \$65 delivered. At that price, I took the plunge.

As the tuning knob/decoder developed problems, I had to return the first radio. The second radio had the same fault. I returned that one for a third, which is the unit I own today. About four years later, the tuning knob function is still normal. Since I had to pay for postage on all of this shipping back and forth, I ended up spending about \$110 dollars to get my DE1103 – about the same as if I'd bought the Kaito version, the KA1103, from a US or Canadian seller in the first place!

The specs of this radio can be hard to come by. They are in Table One, according to the Degen DE1103 user's manual, translated from the Chinese.

### TABLE ONE: SPECIFICATIONS

Derived from Degen DE1103 User's Manual

Frequency Range:  
 FM 76 - 108 MHz  
 LW 100 - 519 kHz  
 MW 520 - 1710 kHz  
 SW 1711 - 29999 kHz  
 Sensitivity:  
 FM - 10 mV  
 MW - 1mV/m  
 SW - 20 mV  
 SW Selectivity:

Wide band - 40dB  
 Narrow band - 50dB  
 AM 1st IF wide band: 55.845 MHz  
 AM 2nd IF narrow band: 450 kHz  
 Wide band < 6 kHz  
 Narrow band < 4 kHz  
 Power Supply:  
 Battery: 4 AA cells  
 External power: DC 8V 300mA  
 Recharging time: 1-23 hours  
 Speaker: D 77mm  
 Earphones: D 3.5mm

### ❖ Points of Confusion

There have been some inconsistencies in the ads for the Kaito KA1103, which, so far as I know, is still identical to the Degen DE1103 in all but name:

- SW coverage is indeed complete, starting from 1711 kHz, and not 3000 kHz, all the way to 29999 kHz.
- Though LW doesn't appear on the dial face, the 1103 covers LW from 100 to 519 kHz.
- There is no beeper alarm, only radio.
- The 1103 runs on four AA cells, not three.
- There are 268 memories, but some of these are used to remember your place on each of the bands shown on the dial.
- And, of course, though there is no keypad in the traditional layout, you can indeed direct-enter and tune through any frequency between 100 to 29999 kHz, and 76 to 108 MHz.

In order to listen to longwave, you must direct-enter a LW frequency, or have LW memories stored, in order to access that band. If you direct-enter a LW frequency, you can then tune up and down in that band via the tuning dial.

If, while tuning, you go past 519 kHz, you'll then be locked in MW, and will have to go through the procedure again to get to LW. If you tune below 100 kHz, you will land in the FM band, and ditto to get back to LW.

So, though shortwave coverage is complete from 1711 to 29999 kHz, if you are on a frequency within one of the bands on the dial face, you are locked into that band (needle wraps around to the other end of the band when you try to go past the top or bottom limit on that band).

You must direct-enter via the keypad a frequency or memory outside one of these bands in order to tune out-of-band. But, the memory function covers the full frequency spectrum, so you can have as many "out-of-band" memories as you like.

The actual coverage of the bands on the faux analog dial in kHz is:  
 3100 - 4100  
 4500 - 5500



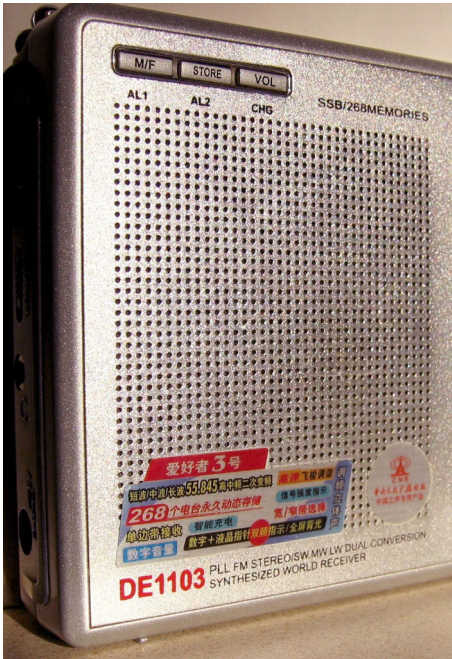

5500 - 6500  
6500 - 7500  
9000 - 10000  
11450 - 12450  
13450 - 14450  
14950 - 15950  
17050 - 18050  
20950 - 21950

Again, to tune outside of these frequency limits, direct-enter a frequency or go to a memory not covered on the dial face.

## ❖ Biggest Drawbacks

When this radio first came out, the major complaints were about the volume control – you must pres the VOL button, then adjust the volume with the jog dial, or you can direct-enter a volume level with the keypad. Having used the radio for several years, this is not a problem for me. I almost always use the jog dial method of volume control.

I've found the main bugaboos in operating the 1103 are:

- Not being able to tune continuously up the 41 meter band past 7500 kHz; you have to enter a frequency above 7500 kHz in order to tune that section of 41 meters. Usually, I enter 7600 kHz, and tune down.
- The calibration isn't perfect on my unit. The tuner likes to be set 1 kHz below the actual frequency, so WWV on 10000 kHz is always 9999 kHz. I'm used to this, but now all of these 1 kHz-off frequencies are ingrained in my mind, so when I think of Croatian Radio on 31 meters, it's 9924 kHz, etc. This is annoying when reporting a logging, and I accidentally write it as 1 kHz off, or read a frequency listing and forget to make the mental conversion.
- On the keypad, the buttons aren't perfect, and the "6" button sometimes doesn't take, causing another try or two to enter my frequency.
- Though I liked the dial face at first, I find I don't use it, always relying on the digital readout. The LCD needle/indicator jumps in 25 kHz increments on SW, so it can read up to 24 kHz off, making it of limited use.

For operating by feel at the bedside at night, or for blind users, the traditional telephone keypad layout would be easier. (Though now I'm so used to operating it at night in memory mode, tuning up and down with the jog dial through my selected memories, this isn't as

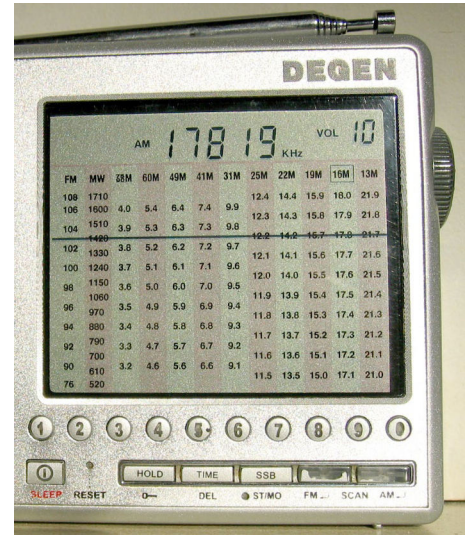

big an issue for me.)

- In the same vein, when operating by feel, it's hard to access a memory by direct-entry. You have to first enter the memory's number on the keypad, then find the M/F button in the upper left corner of the radio, and press that. With the linear keypad layout, it's an impractical exercise in the dark.
- Again, the way to access your memories in this situation is to enter memory mode, and cycle through your memories by the jog dial.
- The scan in 5 kHz increments on SW is so slow I never use it – it's faster to just use the tuning dial.

## ❖ Biggest Pluses

The first one is easy and it's a biggie, but I

# Kaito KA-1103

**NEW! Dual Conversion, Digital Entry, AM/FM-stereo/mono, Shortwave Radio with SSB**

Kaito's latest entry into the multiband portable market may look like an analog-dial radio, but it's actually a precision PLL circuit with 1 kHz steps and digital LCD readout! It tunes 76-108 MHz FM and also continuous 522-29900 kHz AM and shortwave—and it has infinite clarifying SSB as well!

This powerful, dual-conversion portable also has 190 memory channels (10 pages of 19 + 1 page for SSB) to store your favorite stations, and runs off 4 Ni-MH AA rechargeable batteries (included) and AC; an automatic charger/adaptor is provided.



### Just look at these additional specifications:

- 268 memory presets (Dynamic memory on 19 Pages) with autoscanner, radio and sleep clock/alarm
- Manual or direct-entry frequency tuning
- Electronic volume set
- Smart charger with count-down timer and battery power/charge indicator
- Meter band to frequency conversion
- 3 backlight modes
- LCD bar graph signal strength indicator
- External speaker, earphone, line output and antenna jacks
- Auto reset prevents deadlocking
- Extra-long telescoping antenna improves reception
- DX/LOCAL switch to prevent front-end overload
- FM mono/stereo selection
- Music/news (voice) tone control with "Super bass" selection
- Measures only 6.5"W x 4"H x 1"D

Order Now!

Order RCV55  
Only \$ **89<sup>95</sup>\***

800-438-8155  
828-837-9200 fax: 828-837-2216  
WWW.GROVE-ENT.COM  
order@grove-ent.com  
7540 Highway 64 West  
Brasstown, NC 28902

\* plus \$9.95 Priority Mail or UPS Ground shipping in the US



forgot to mention it in my initial review:

- The memory function remembers the mode – AM or SSB – of that memory/frequency. There is a ham channel I sometimes listen to at night, where they broadcast in SSB, and it has been a snap to go into memory mode and tune up and down with the jog dial through my entered memory frequencies from FM, into MW, and on into SW, without having to manually go in and out of SSB mode.

This is a gigantic advantage for bedside operating-by-feel listening. I can't imagine now having to punch in and out of SSB mode. Plus, the 1103's SSB is stable, so rarely do I have to fine tune that SSB signal that's in my memory (once it's been initially tuned in). I would find it hard to do without this function, now.

- The radio has fallen off the nightstand and landed hard several times with no serious permanent damage. Sometimes the fine tuning gets knocked askew, so I have to retune my stored SSB frequency, but that's all.
- Sensitivity and selectivity have been good across all the bands, with the narrow IF usually doing the trick when I need to separate closely-spaced SW signals.
- It's been freeing to get away from button-only tuning to the tuning/jog dial on the 1103. Using the tuning dial in memory mode is very handy and the way to go for regular bedside listening, unless you're exploring for new signals.
- The built-in battery charger has been great, eliminating the hassle of regularly removing and inserting batteries.

## ❖ Wear

Though it's survived the falls and knocks well, there are a few little signs of wear on the 1103 to note:

- Number one is the headphone jack has become a little temperamental – sometimes I have to rotate and fiddle with the mini-plug in order to get a full connection.
- The slider switches have become, at times, scratchy.
- The paint has worn off the oft-used BAND- and BAND+ buttons. The telescopic antenna suffered a little damage, but was my fault, being bent in a fall. Any other slight dings have also been from knocks and falls.

The only other wear notes to add are the demise of the Degen earphones, which had the best sound of any mini-phones I'd ever used; and the snarling and damage to the included wire antenna, which was prone to injury because it had no facility for winding or storage.

## ❖ Performance

I've never seen another shortwave radio where it performs almost equally well, whether with the extended whip or on an indoor wire. Just about everything that's audible with the wire is as good or almost as good with the whip.

One thing I learned when struggling with a shortwave signal that was being crushed by noise or interference of some kind, was that it pays to try all the power,



antenna, and sensitivity options and combinations possible. I was trying to listen to one of the Central or Eastern European stations which was being clobbered with noise, when I started to experiment with DC versus AC power, the wire antenna versus the whip extended to various lengths, and the settings of the LOCAL/DX switch.

Though there is a considerable drop in RF when switching to DC/battery power, I found that this lowering of sensitivity also decreased the noise or interference. Further, while running on DC, unhooking the wire and receiving over a partially extended whip, the European signal, though weaker, was now set in a background of quiet, and was just listenable. (The AC power supply does cause buzz on AM and 90 and 75 meters shortwave, but is not usually a problem in the higher shortwave spectrum.)

Other combinations – running on AC with the switch set to LOCAL, both with and without the wire antenna; running on DC with the switch set to DX, but with the wire, etc. – all produced varying effects, and usually an improvement over my standard mode of running via AC with the switch set to DX and using the wire antenna.

The general effect of all these methods was a lessening of sensitivity, but a more listenable, though sometimes weaker signal, with noise or interference decreased or eliminated.

Here in the Northwest, I believe I've caught all of the Central and Eastern European international shortwave stations with the 1103. When conditions are decent, Egypt and Argentina have been listenable. Greece on 9420 or 7475 kHz is pretty reliable. Gabon on 15475

and Jordan on 11690 are regular. Also Morocco and Tunisia are semi-regular.

Turkey (from Turkey, not relayed) and *Galei Zahal* in Israel are occasional catches. Good old Rai/Italy on 11800 used to be daily (a frustrating loss, there). I would sometimes get Libya, and once caught a clandestine in Moldova. The Voice of Nigeria and Channel Africa are pretty routine catches. All of this with a portable, randomly-strung indoor wire, or with the whip.

I'm sure, in a quiet area with less local noise and with an outdoor antenna, many more tropical and other more challenging stations could be had with the 1103. I regularly hear hams in SSB in Spanish, probably in Central or South America. I also hear hams in SSB speaking in Chinese or a related language, though whether they are transmitting from ships at sea, or the Far East, I can't say. Several Australian hams have come in over SSB, too.

## ❖ Should You or Shouldn't You?

For the price (about \$100 delivered from Grove), getting a dual-conversion, full-coverage LW/MW/SW/SSB radio (plus extended FM) that tunes in 1 kHz increments via a tuning knob, with excellent sensitivity and selectivity for any portable, despite some of the ergonomic challenges, is a good deal.

You can always pay less by ordering the radio from Hong Kong/China through eBay – but be forewarned by my experience of paying for shipping three times over in order to get a correctly working unit.

I've mostly overcome the ergonomic issues. When using the radio in the light, or during the daylight, there's no problem with direct-entering frequencies, etc. A blind radio enthusiast might want to think twice, since the dial face will be useless for them, combined with the lack of a traditional keypad layout. There is a slight ridge on the "5" button to help you get your bearings by touch, but the buttons are tiny and the ridge even tinier. Plus, once you've found it, you have to count your way out either side of the 5 button.

At least 1 and 0, at either end, are easy to find.

Despite being a portable, with a size of about 6.5 x 4 x 1 inches, you can truly DX with this radio. I think, being able to do that for around \$100 – possibly more or less – makes it a good deal. Other comparable units start at about \$150 – some with easier ergonomics, but some without the coveted tuning knob (which is a huge ergonomic plus!).

So, if the 1103's peculiarities don't bother you, it looks as though it's the best deal available right now in a dual-conversion portable world band radio.

I think, if it looks right for you, yes, you should.

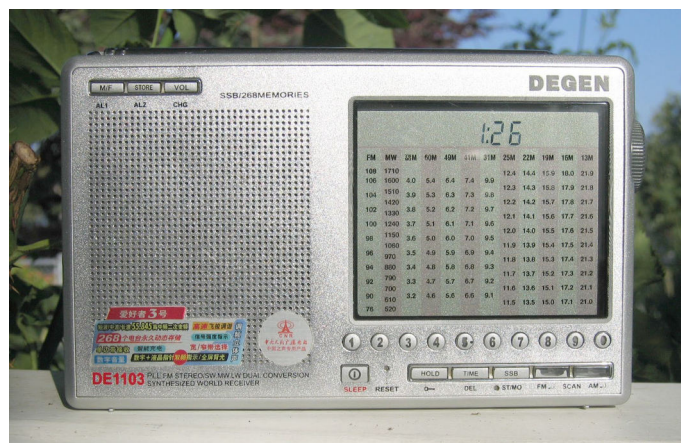

# MTX PRESS

**SPECIAL  
OFFER  
BELOW!**

## Going **Green** has never been more exciting!

Before the rising prices of gasoline, and before going “green” became a sales pitch, Monitoring Times created MT Express. The full version of the magazine you’ve come to depend on, in full electronic form. Now going into our 11th year of digital perfection, MT Express is better than ever. You get more with our digital magazine than you could ever have with print. The entire magazine is full color. All of the web links are clickable, so if you see a link to a website that you want to visit, just click on it! Want to email an author? Just click on their email address at the top of their column, and MT Express opens your email program, drops in their address, and is ready for your input! All of this, and it’s even CHEAPER than the regular print version! Plus, you’ll get it faster than you would your print copy, no matter where you are in the world. Now is the time to make the switch to digital. Sure, it’s saving a tree and saving some gas, but it’s also getting you what you need, when you want it. Make the switch today.

For a mere \$19.95 U.S., **MT EXPRESS** gives you *Monitoring Times* magazine

- in PDF format viewable with free software, delivered by FTP
- viewable in **brilliant color** (the **whole** magazine, not just what you see in the print version) on your computer screen
- easily navigated by clicking on the Table of Contents
- printable using your own computer printer
- searchable to find every mention of a topic or station schedule
- importable into your frequency databases
- compatible with software to convert text to audio for sight impaired listeners

**Now with**  
**MTXTRA**

Not only do you now have the complete *Monitoring Times* magazine, in full color, but for no extra cost, we are now adding **MTXTRA**, which will have a worldwide broadcast guide with **ALL** offered languages, not just English! So no matter where you are in the world, *Monitoring Times* has something just for you!

To find out if this new subscription is the delivery solution for you, you may download a sample issue for free! Just go to <http://www.grove-ent.com> to find out how.

**If you order NOW, you will get 14 ISSUES for the price of 12! That’s right, for only \$19.95 you’ll get an EXTRA 2 MONTHS AND MTXTRA! Just mention code MTOCT09 when you place your order!**

**GROVE**

800-438-8155

828-837-9200 fax: 828-837-2216

**WWW.GROVE-ENT.COM**



# What's NEW

Tell them you saw it in Monitoring Times

## The ARRL Ham Radio License Manual

The amateur radio service offers a unique mix of technology, public service, convenience and fun. Some hams enjoy communicating across the country and around the globe, making new friends over the airwaves. Others like to build and experiment with electronics, experiencing cutting edge technologies. Some use their radios and skills during emergencies or disasters when all else fails.

And, today's ham radio gear offers possibilities for getting started at any level. Your first radio station might be at home, in the car, or small enough to take with you on the go.

In order to get in on the fun, you have to first get your ham radio license. If you want to get that ham ticket, then you have to pass the written exam. And one of the best products to use to study for that first ham exam is the new *ARRL Ham Radio License Manual*.

Use this book, and you will find it easy to pass the 35-question Technician license test. The book presents study material in easy-to-understand "bite-sized" sections. Every page presents information you will need to pass the exam and become an effective operator. It includes the latest question pool with answer key, which became effective July 1, 2006. This new book is designed for self-study and for classroom use, and it is intended for all newcomers, instructors and schoolteachers.

The book covers the following topics:

- Welcome to Amateur Radio
- Radio and Electronics Fundamentals
- Operating Station Equipment
- Communicating with Other Hams
- Licensing Regulations
- Operating Regulations
- Radio Safety

At the end of the book, you'll find the entire Technician question pool so you can be sure you're ready at exam time.

The most common question asked by new radio amateurs is "Now that I have my license, what kind of radio should I get?" The ARRL, in an attempt to help newcomers to amateur radio answer that very question, has added a bonus supplement to the *ARRL Ham Radio License Manual*. "Choosing a Ham Radio: Your Guide to Selecting the Right Equipment" is aimed at the new Technician licensee ready to acquire a first radio, a licensee recently upgraded to General class and wanting to explore HF, or someone getting back into amateur radio after a period of inactivity.

The guide features two main sections – one

covering gear for the VHF and UHF bands, and one for HF band equipment, including a VHF/UHF and an HF glossary of terms you will encounter. The guide also urges you to discover just what you want to do with amateur radio and where you want to do it from. Do you want to be a "big gun" HF contester? Do you want to ragchew on your local repeater system? Maybe you want to join your local ARES® unit and help provide communications support in times of emergency. This guide will help you select the right rig for what you want to do.

"Choosing a Ham Radio: Your Guide to Selecting the Right Equipment" isn't a traditional "buyer's guide" with feature lists and prices for many radios. Manufacturer's websites and catalogs from radio stores have plenty of information on the latest models and features. As such, you won't find operating instructions or technical specifications here, but many manufacturers' websites will let you download brochures and manuals directly.

Second only to "What kind of radio should I get?" "What kind of antenna do I need?" is the next most common question asked by the new amateur. "Choosing a Ham Radio: Your Guide to Selecting the Right Equipment" talks about all kinds of antennas – from "rubber duckies" to verticals to dipoles to Yagis; it even explains rotators and antenna gain.

Power, filters, digital signal processing (DSP), as well as special features commonly found on VHF/UHF and HF radios are also included in the guide. ARRL members who are logged on the ARRL website can also view the guide online at the ARRL website.

All in all, this license manual is the most popular introduction to Amateur Radio. The *ARRL Ham Radio License Manual* is your ticket to joining the ranks of "ham" radio operators.

This first edition, fifth printing ARRL product 9639 costs \$24.95 plus shipping.

You can order all ARRL publications from the ARRL, 225 Main Street, Newington, CT 06111-1494. Order Hotline 1-888-277-5289 (toll-free US only), Monday through Friday, 8am to 8pm Eastern Time. You can also order online at [www.arrl.org](http://www.arrl.org).

## Yesterday and Today - A 20 Year Retrospective of SW Broadcasting

Many DXers have awaited the release of the *Yesterday and Today*, CD series 3, hosted by Ian McFarland, former Radio Canada International and Radio Japan broadcaster/producer. The two-CD package begins at the annual Kulpville radio convention in 2007, as respected DXers give their thoughts and opinions on "What's the lure of shortwave listening?" followed by their take on "Why do I need a shortwave radio to follow world events?"



Ian McFarland (courtesy [www.dxe.ca](http://www.dxe.ca))

You can follow Ian's expert panel, including Colin Newell, Jeff White of WRMI, Kim Elliot of Voice of America and others as they discuss the role of shortwave radio broadcasting, where it has been, and where it may be heading in the future.

This interesting CD series also takes a nostalgic look back to 1989 in Berlin at the joint Radio Canada International-Swiss Radio International broadcast conducted by Ian and Bob Zanotti of *Two Bob's* fame.

The two CD set is about 155 minutes, and the cost is \$15.00 in North America, or \$17.00 worldwide. It is available from Ian McFarland, #17-3025 Cowichan Lake Road, Duncan, BC Canada V9L 4B5. Checks, cash and charge cards (American Express, Discover, Master Charge, VISA) are accepted. You may also order directly from [www.dxe.ca](http://www.dxe.ca), where you can also read about or order the previous two sets of CDs. Colin Newell is the editor and founder/owner of this website.

*Yesterday and Today - A 20 Year Retrospective* delves into the past, present and the future of international broadcasting. You will find a variety of interesting opinions among the panel on this question and a few may surprise you. Where do you think shortwave will be in twenty years? Ian and his panel have some interesting insights on this very enjoyable CD series.

– Gayle Van Horn, W4GVH

Books and equipment for announcement or review should be sent to What's New, c/o Monitoring Times, 7540 Highway 64 West, Brasstown, NC 28902. Press releases may be faxed to 828-837-2216 or emailed to [larryvanhorn@monitoringtimes.com](mailto:larryvanhorn@monitoringtimes.com)

# SEE More and HEAR More!

## With the SR2000A and AR8200MkIII from AOR

### SR2000A Color Frequency Monitor

The SR2000A is an ultra-fast spectrum display monitor that lets you SEE received signals in FULL color.

Using the power of FFT (Fast Fourier Transform) algorithms with a sensitive receiver covering 25MHz ~ 3GHz\*, the SR2000A features a color monitor that displays up to 40MHz spectrum bandwidth\*\*, a switchable time-lapse "waterfall" display or live video in NTSC or PAL formats.

Ultra sensitive, incredibly fast, yet easy to use with a high quality internal speaker for crisp, clean audio signals. Scans 10MHz in as little as 0.2 seconds! Instantly detects, captures and displays transmitted signals. PC control through RS232C serial port or USB interface. With 12 VDC input, it's perfect for base, mobile or field use.



### AR8200MkIII Handheld Receiver

From inter-agency coordination to surveillance, you can't know too much. The world-class AR8200MkIII portable receiver features a TXCO that delivers solid frequency stability and performance not found in most desktop units. With 1,000 alphanumeric memory channels, it covers 500 KHz ~ 3GHz\*. Improved RF circuits combine greater sensitivity, resistance to intermod and enhanced Signal to Noise ratio. It offers increased audio frequency response and includes NiMH AA batteries that can be charged while the unit is in use.

Optional internal slot cards expand the AR8200MkIII's capabilities. Choose from Memory Expansion (up to 4,000 memories), CTCSS Squelch and Search, and Tone Eliminator.

The AR8200MkIII offers "all mode" reception that includes "super narrow" FM plus wide and narrow FM in addition to USB, LSB, CW and standard AM and FM modes. It also features true carrier reinsertion in USB and LSB modes and includes a 3KHz SSB filter. The data port can be used for computer control, memory configuration and transfer, cloning or tape recording output.

A special government version, AR8200MkIII IR features infra-red illumination (IR) of the display and operating keys. The IR illumination function is selectable, allowing operation by users wearing night vision apparatus without removing goggles and waiting for the eyes to re-adjust. Ideal for military, law enforcement and surveillance operators.



Authority on Radio  
Communications

AOR U.S.A., Inc.

20655 S. Western Ave., Suite 112, Torrance, CA 90501, USA  
Tel: 310-787-8615 Fax: 310-787-8619  
info@aorusa.com http://www.aorusa.com

\* Government version, cellular blocked for US consumer version.  
\*\*No audio is available when the frequency span is set to 20MHz or 40MHz.  
Specifications subject to change without notice or obligation.

SEE more and HEAR  
more with AOR, the  
serious choice in  
Advanced Technology  
Receivers™.

## INDEX OF ADVERTISERS

Antique Wireless.....	65
AOR.....	Cover 2, 75
Kevin Carey.....	7
C Crane.....	21
CIDX.....	76
Communications Electronics.....	19
Computer Aided Technology .....	25
Grove Enterprises ..	23, 25, 63, 71, CVR3
Hauser, Glenn.....	39
ICOM .....	Cover 4
MT Express.....	73
NASB .....	33
Popular Communications .....	5
Robl, Ernest.....	57
Small Planet Systems .....	55
Universal Radio.....	23, 76
WINRADiO.....	1
Xtal Society.....	65

## Stock Exchange

### LINE ADS

NON-COMMERCIAL SUBSCRIBER RATES: \$.25 per word. All merchandise must be personal and radio-related.  
COMMERCIAL, NON-SUBSCRIBER, AND MULTIPLE SALES RATES: \$1.00 per word. Commercial line ads printed in bold type.

Ads for Stock Exchange must be received 45 days prior to publication date. All ads must be paid in advance to Monitoring Times. Ad copy must be typed for legibility.

### 1-3/4" SQUARE DISPLAY AD:

\$50 per issue if camera-ready copy or, \$85 if copy to be typeset. Photo-reduction \$5 additional charge. For more information on commercial ads, contact Beth Leinbach, 828-389-4007.

## Subscribe to *MT* for as little as \$17.95 (U.S. Second Class Mail)

7540 Hwy. 64 W.; Brasstown, NC 28902  
1-800-438-8155 US and Can.; 828-837-9200; Fax 828- 837-2216  
e-mail [order@grove-ent.com](mailto:order@grove-ent.com)

	6 months	One Year	Two Years	Three Years
<b>Electronic Subscription</b>	<input type="checkbox"/> \$17.95	<input type="checkbox"/> \$19.95	<input type="checkbox"/> \$38.90	<input type="checkbox"/> \$57.85
US Second Class Mail	<input type="checkbox"/> \$32.95	<input type="checkbox"/> \$32.95	<input type="checkbox"/> \$59.95	<input type="checkbox"/> \$89.95
US 1st Class Mail	<input type="checkbox"/> \$32.95	<input type="checkbox"/> \$59.95	<input type="checkbox"/> \$119.00	<input type="checkbox"/> \$179.95
Canada Surface*	<input type="checkbox"/> \$22.95*	<input type="checkbox"/> \$42.95*	<input type="checkbox"/> \$79.95*	<input type="checkbox"/> \$119.95*
Canada Air*	<input type="checkbox"/> \$35.95*	<input type="checkbox"/> \$69.95*	<input type="checkbox"/> \$125.95*	<input type="checkbox"/> \$189.95*
Foreign International*	<input type="checkbox"/> \$30.95*	<input type="checkbox"/> \$58.95*	<input type="checkbox"/> \$119.95*	<input type="checkbox"/> \$179.95*
Foreign Air*	<input type="checkbox"/> \$62.95*	<input type="checkbox"/> \$119.95*	<input type="checkbox"/> \$229.95*	<input type="checkbox"/> \$349.95*

\* All payments must be in US funds drawn on a US bank.

MasterCard, Visa, and Discover Card accepted!



[www.SecondHandRadio.com](http://www.SecondHandRadio.com) **FREE** classified advertising with photos for used radios & electronics.

Log stations, manage QSLs with Reception Log: [www.dxtreme.com](http://www.dxtreme.com)

Got something you'd like to sell? Can't find something you've been searching for? *MT* is THE way to buy or sell all of your radio equipment! It's inexpensive and is seen by tens of thousands of fellow hobbyists! Call today to get your listing in the next issue!

## MT BLOGS

Blogs offer an opportunity for columnists to share information that does not make their columns. The news might be too timely for deadline, too short, confined to a small geographical area, too far away to be heard in North America, or even off the columnist's regular "beat." Bookmark these blogs for frequent visits!

MT: AMERICAN BANDSCAN  
<http://americanbandscan.blogspot.com/> - by Doug Smith

MT: FED FILES  
<http://mt-fedfiles.blogspot.com/> - by Chris Parris

MT: MILCOM  
<http://mt-milcom.blogspot.com/> - by Larry Van Horn

Larry's Monitoring Post  
<http://monitor-post.blogspot.com/> - by Larry Van Horn

MT: SHORTWAVE  
<http://mt-shortwave.blogspot.com/> - by Gayle Van Horn

MT: UTILITY WORLD  
<http://mt-utility.blogspot.com/> - by Hugh Stegman

## Looking for Writers

*MT* is soliciting feature articles, reviews, and how-to articles covering shortwave broadcasting, utilities, scanning, frequency profiles, construction projects or whatever excites you! Contact Feature Editor Ken Reitz at [kenreitz@monitoringtimes.com](mailto:kenreitz@monitoringtimes.com) or write c/o Monitoring Times, 7540 Hwy 64 West, Brasstown, NC 28902.

## Join the Club!

Open to hobbyists worldwide, the **CANADIAN INTERNATIONAL DX CLUB** is Canada's national, general coverage radio club serving members since 1962.

For a free sample of our monthly electronic newsletter, **Messenger**, please e-mail CIDX at:

[cidxclub@yahoo.com](mailto:cidxclub@yahoo.com)  
Web: [www.cidx.ca](http://www.cidx.ca)

## HUGE 100 PAGE CATALOG

- Shortwave & Ham Gear
- Scanners & RTTY/FAX
- Antennas & Accessories
- Radio Books & CDs.

Send \$1 to



**Universal Radio**  
6830 Americana Pkwy.  
Reynoldsburg, OH 43068  
Tel. 800 431-3939  
[www.universal-radio.com](http://www.universal-radio.com)

# GROVE

**Your Source for  
Radio Scanners,  
Receivers, Accessories,  
and Publications**

## AOR

AR-5000A Plus 3	RCV44P	\$2709.95
AR-8600II	RCV11	\$919.95
AOR SR2000A (B)	RCV36	\$2899.95

<b>KAITO</b>	KA1103	RCV55	\$89.95
	KA1121	RCV37	\$149.95

## SANGEAN

ATS-505P	RCV7	\$109.95
ATS-909	RCV8	\$239.95
WFR-20	RCV40	\$279.95
WFR-1	RCV56	\$349.95

<b>GRUNDIG</b>	S350 DELUXE	RCV4	\$99.95
	G3	RCV65	\$149.95
	G6	RCV59	\$99.95
	Satellit 750	RCV58	\$299.95
	E1XM	RCV34	\$499.95

## ICOM

R75	RCV32	\$619.95
PCR1500	RCV15	\$479.95
R1500	RCV25	\$599.95
R2500	RCV52	\$899.95

<b>PERSEUS</b>	RCV57	\$1199.00
----------------	-------	-----------

## WINRADIO

WR-G33EM	RCV16	\$849.95
WR-G33EM/GPS	RCV16/GPS	\$999.95
WR-G33WSM	RCV28	\$999.95
WR-3500 (External)	RCV49-E	\$1995.95
WR-3500 (Internal)	RCV49-I	\$2195.95
WR-3700 (External)	RCV50-E	\$2895.95
WR-G303e	RCV46E	\$549.95
WR-G303e w/pro demodulator	RCV46EP	\$699.95
WR-G303i	RCV46	\$449.95
WR-G303i w/ pro demodulator	RCV46-P	\$549.95
WR-G313 (Internal)	RCV31	\$949.95
WR-G313 (External)	RCV31-E	\$1149.95
WR-G305i	RCV53	\$519.95
WR-G305i w/pro demodulator	RCV53P	\$619.95
WR-G305e	RCV63	\$619.95
WR-G305e w/pro demodulator	RCV63P	\$719.95
WR-G315 (Internal)	RCV54	\$CALL
WR-G315 (External)	RCV64	\$CALL

**Grove means service. You won't find better customer service anywhere. BUY TODAY!**

Established in 1979 by well-known communications expert Bob Grove, Grove Enterprises has become a world leader in radio monitoring equipment, accessories, and publications.

If you decide you don't like a product, Grove Enterprises doesn't penalize you for it. There is NO restocking fee so long as you call our toll free number for a return authorization within fifteen days of shipment and the item is returned in new condition. Once the item is received we will give you credit toward another item or issue a full refund (less shipping charges). Software cannot be returned if opened.

That's it! No hassle! No negotiations! Just call 1-800-438-8155 and our friendly staff will assist you with a return authorization number.

## WINRADIO Accessories

WR-DNC-3500 Frequency downconverter	CVR02	\$189.95
APCO P25 Decoder, G305 Series	SFT42	\$89.95
AX-07B flexible VHF/UHF antenna	ANT47	\$24.95
AX-37A wide-band log-periodic antenna	ANT28	\$389.95
AX-71C discone antenna	ANT01	\$89.95
AX-81S active HF antenna	ANT51	\$189.95
WR-AX-31C	ANT58	\$139.95
AX-91M magnetic antenna base	ANT48	\$24.95
WR-LNA-3500 LOW NOISE AMPLIFIER	PRE03	\$199.95
Mounting Clamps for AX-71C	ACC71	\$14.95
USB Adaptor	ACC 2	\$49.95
Client Server Option-1000/1500 Series	ACC 14C	\$99.00
Client Server Option-3000 Series	ACC14B	\$399.00
Client Server Option-G313 Series	ACC14D	\$149.95
G303 Professional Demodulator	SFT20	\$179.95
G305 Professional Demodulator	SFT40	\$199.95
PCMCIA PC Card	ACC 28	\$89.95
FSK Decoder	DEC 1	\$349.95
WR-PPS portable power supply for external 1000/1500/3000 series receivers	PWR 5	\$189.95
Digital Suite	SFT 15	\$85.00
Advanced Digital Suite Upgrade	SFT 15U	\$85.00
Advanced Digital Suite	SFT 15A	\$179.95
World Radio Database Manager	SFT 16	\$85.00
Trunking Software	SFT 23	\$89.95
AX-37AM wide-band log-periodic antenna	ANT29	\$499.95
WR-G3E-WMB Wall-mount Bracket for G3	BRK02	\$19.95
WR-PPS-G3 portable power supply for G3	PWR09	\$189.95

## Shipping/ Handling Charges

Total Order	Shipping Charges
\$1-\$29.99	\$3.00
\$30-\$49.99	\$6.95
\$50-\$99.99	\$9.95
\$100-\$399.99	\$13.95
\$400-\$899.99	\$17.95
\$900-\$1499.99	\$20.95
\$1500-\$1999.99	\$24.95
\$2000-\$2499.99	\$28.95
\$2500+	\$32.95

**Make sure to visit us on the web to get the latest and greatest deals!**

# GROVE

## (800) 438-8155

**Grove Enterprises, Inc. - [www.grove-ent.com](http://www.grove-ent.com)**

(800) 438-8155; (828) 837-9200; fax: (828) 837-2216

7540 Hwy 64 W; Brasstown, NC 28902 - email: [order@grove-ent.com](mailto:order@grove-ent.com)

**Icom has the radio  
for the experts...**



**IC-R9500** ICOM'S ULTIMATE WIDE BAND RECEIVER

- 0.005 - 3335.000MHz\*
- USB, LSB, CW, FSK, FM, WFM, AM
- 1020 Alphanumeric Memory Channels
- P25 (Option UT-122)
- Five Roofing Filters and so much more!

**...or for those just  
getting started.**



**IC-R75** WIDE BAND RECEIVER

- 0.03 - 60.0 MHz\*
- Triple Conversion
- Twin Passband Tuning
- Digital Signal Processing (DSP)

**Now bundled with RadioCom 4.5**

Icom's black box radios now come bundled with Bonito's RadioCom 4.5 software.

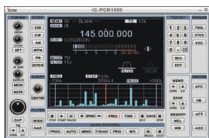

**PCR1500**

**THE "BLACK BOX"**

- 0.01 ~ 3299.99 MHz\*
- AM, FM, WFM, CW, SSB
- Record and Save Audio as .WAV File
- USB Cable Connection
- Optional DSP



**IC-R1500**

**MOBILE OR PC CONTROL**

- 0.01 - 3299.99 MHz\*
- AM, FM, WFM, USB, LSB, CW
- 1000 Memory Channels
- Fast Scan
- Optional DSP (UT-106)
- PCR Software Included
- Very Compact Design

**PCR2500**

**DUAL BAND "BLACK BOX"**

- 0.01 ~ 3299.99 MHz\* (Main)
- 50 to 1300 MHz\* (Sub)
- AM, FM, WFM, CW, SSB
- Opt. APCO 25 and D-STAR
- Dual Wideband Receivers
- Dual Watch PC Window
- Optional DSP



**IC-R2500**

**2 WIDE BAND RX IN 1**

- 0.01 - 3299.99 MHz\*
- AM, FM, WFM, SSB, CW (Main)
- AM, FM and WFM (Sub)
- 1000 Memory Channels
- Optional D-STAR (UT-118)
- Optional P25 (UT-122)
- Optional DSP

**NEW IC-RX7**

**STYLISH SCANNER WITH SMART INTERFACE**

- 0.150 - 1300.000MHz\*
- AM, FM, WFM
- 1650 Alphanumeric Memory Channels
- Digital Signal Processing (DSP)
- IPX4 Water Resistant Rating



**IC-R5 SPORT**

**COMPACT WIDE BAND**

- 0.5 - 1300.0 MHz\*
- AM, FM, WFM
- 1250 Memory Channels
- CTCSS/DTCS Decode
- Weather Alert



**IC-R20**

**ADVANCED WIDE BAND**

- 0.150 - 3304.0 MHz\*
- AM, FM, WFM, SSB, CW
- 1000 Memory Channels
- Dual Watch Receiver
- 4 Hour Digital Recorder



**Contact your favorite Authorized Icom Dealer today!**



\*Frequency coverage may vary. Refer to owner's manual for exact frequency specs.  
©2009 Icom America Inc. The Icom logo is a registered trademark of Icom Inc. All specifications are subject to change without notice or obligation. 30161